

# ETSI TS 124 008 V6.14.0 (2006-09)

---

*Technical Specification*

**Digital cellular telecommunications system (Phase 2+);  
Universal Mobile Telecommunications System (UMTS);  
Mobile radio interface Layer 3 specification;  
Core network protocols;  
Stage 3  
(3GPP TS 24.008 version 6.14.0 Release 6)**

---



---

Reference

RTS/TSGC-0124008v6e0

---

Keywords

GSM, UMTS

**ETSI**

650 Route des Lucioles  
F-06921 Sophia Antipolis Cedex - FRANCE

Tel.: +33 4 92 94 42 00 Fax: +33 4 93 65 47 16

Siret N° 348 623 562 00017 - NAF 742 C  
Association à but non lucratif enregistrée à la  
Sous-Préfecture de Grasse (06) N° 7803/88

---

**Important notice**

Individual copies of the present document can be downloaded from:

<http://www.etsi.org>

The present document may be made available in more than one electronic version or in print. In any case of existing or perceived difference in contents between such versions, the reference version is the Portable Document Format (PDF). In case of dispute, the reference shall be the printing on ETSI printers of the PDF version kept on a specific network drive within ETSI Secretariat.

Users of the present document should be aware that the document may be subject to revision or change of status. Information on the current status of this and other ETSI documents is available at

<http://portal.etsi.org/tb/status/status.asp>

If you find errors in the present document, please send your comment to one of the following services:

[http://portal.etsi.org/chaicor/ETSI\\_support.asp](http://portal.etsi.org/chaicor/ETSI_support.asp)

---

**Copyright Notification**

No part may be reproduced except as authorized by written permission.  
The copyright and the foregoing restriction extend to reproduction in all media.

© European Telecommunications Standards Institute 2006.  
All rights reserved.

**DECT**<sup>TM</sup>, **PLUGTESTS**<sup>TM</sup> and **UMTS**<sup>TM</sup> are Trade Marks of ETSI registered for the benefit of its Members.  
**TIPHON**<sup>TM</sup> and the **TIPHON logo** are Trade Marks currently being registered by ETSI for the benefit of its Members.  
**3GPP**<sup>TM</sup> is a Trade Mark of ETSI registered for the benefit of its Members and of the 3GPP Organizational Partners.

---

## Intellectual Property Rights

IPRs essential or potentially essential to the present document may have been declared to ETSI. The information pertaining to these essential IPRs, if any, is publicly available for **ETSI members and non-members**, and can be found in ETSI SR 000 314: *"Intellectual Property Rights (IPRs); Essential, or potentially Essential, IPRs notified to ETSI in respect of ETSI standards"*, which is available from the ETSI Secretariat. Latest updates are available on the ETSI Web server (<http://webapp.etsi.org/IPR/home.asp>).

Pursuant to the ETSI IPR Policy, no investigation, including IPR searches, has been carried out by ETSI. No guarantee can be given as to the existence of other IPRs not referenced in ETSI SR 000 314 (or the updates on the ETSI Web server) which are, or may be, or may become, essential to the present document.

---

## Foreword

This Technical Specification (TS) has been produced by ETSI 3rd Generation Partnership Project (3GPP).

The present document may refer to technical specifications or reports using their 3GPP identities, UMTS identities or GSM identities. These should be interpreted as being references to the corresponding ETSI deliverables.

The cross reference between GSM, UMTS, 3GPP and ETSI identities can be found under <http://webapp.etsi.org/key/queryform.asp>.

# Contents

Intellectual Property Rights .....	2
Foreword.....	2
Foreword.....	23
Introduction .....	23
1 Scope .....	24
1.1 Scope of the Technical Specification .....	24
1.2 Application to the interface structures.....	24
1.3 Structure of layer 3 procedures.....	24
1.4 Test procedures .....	24
1.5 Use of logical channels in A/Gb mode.....	25
1.6 Overview of control procedures .....	25
1.6.1 List of procedures .....	25
1.7 Applicability of implementations .....	27
1.7.1 Voice Group Call Service (VGCS) and Voice Broadcast Service (VBS).....	27
1.7.2 General Packet Radio Service (GPRS).....	27
1.7.2.1 Packet services in GSM (A/Gb mode only).....	27
1.7.2.2 Packet services in Iu mode (Iu mode only).....	28
2 References .....	28
2.1 Definitions and abbreviations.....	33
2.1.1 Random values.....	33
2.2.2 Vocabulary.....	33
3 Radio Resource management procedures.....	35
4 Elementary procedures for Mobility Management.....	35
4.1 General .....	35
4.1.1 MM and GMM procedures .....	36
4.1.1.1 Types of MM and GMM procedures .....	36
4.1.1.1.1 Integrity Checking of Signalling Messages in the Mobile Station (Iu mode only).....	37
4.1.1.1.1a Integrity protection for emergency call (Iu mode only).....	38
4.1.1.2 MM-GMM co-ordination for GPRS MS's .....	39
4.1.1.2.1 GPRS MS operating in mode A or B in a network that operates in mode I .....	39
4.1.1.2.2 GPRS MS operating in mode A or B in a network that operates in mode II or III.....	40
4.1.1.3 Core Network System Information for MM (Iu mode only).....	40
4.1.1.4 Core Network System Information for GMM (Iu mode only).....	40
4.1.2 MM sublayer states .....	40
4.1.2.1 MM sublayer states in the mobile station.....	41
4.1.2.1.1 Main states.....	41
4.1.2.1.2 Substates of the MM IDLE state .....	44
4.1.2.2 The update Status .....	45
4.1.2.3 MM sublayer states on the network side.....	46
4.1.3 GPRS mobility management (GMM) sublayer states.....	47
4.1.3.1 GMM states in the MS .....	47
4.1.3.1.1 Main states.....	48
4.1.3.1.2 Substates of state GMM-DEREGISTERED.....	48
4.1.3.1.3 Substates of state GMM-REGISTERED.....	49
4.1.3.2 GPRS update status .....	51
4.1.3.3 GMM mobility management states on the network side.....	51
4.1.3.3.1 Main States .....	51
4.1.3.3.2 Substates of state GMM-REGISTERED.....	52
4.2 Behaviour of the MS in MM Idle state, GMM-DEREGISTERED state and GMM-REGISTERED state .....	52
4.2.1 Primary Service State selection .....	53
4.2.1.1 Selection of the Service State after Power On.....	53
4.2.1.2 Other Cases .....	53
4.2.2 Detailed Description of the MS behaviour in MM IDLE State. ....	54

4.2.2.1	Service State, NORMAL SERVICE .....	54
4.2.2.2	Service State, ATTEMPTING TO UPDATE .....	54
4.2.2.3	Service State, LIMITED SERVICE .....	55
4.2.2.4	Service State, NO IMSI .....	55
4.2.2.5	Service State, SEARCH FOR PLMN, NORMAL SERVICE .....	56
4.2.2.6	Service State, SEARCH FOR PLMN .....	56
4.2.2.7	Service State, RECEIVING GROUP CALL (NORMAL SERVICE) .....	56
4.2.2.8	Service State, RECEIVING GROUP CALL (LIMITED SERVICE) .....	57
4.2.3	Service state when back to state MM IDLE from another state .....	57
4.2.4	Behaviour in state GMM-DEREGISTERED .....	58
4.2.4.1	Primary substate selection .....	58
4.2.4.1.1	Selection of the substate after power on or enabling the MS's GPRS capability .....	58
4.2.4.1.2	Other Cases .....	59
4.2.4.2	Detailed description of the MS behaviour in state GMM-DEREGISTERED .....	59
4.2.4.2.1	Substate, NORMAL-SERVICE .....	59
4.2.4.2.2	Substate, ATTEMPTING-TO-ATTACH .....	59
4.2.4.2.3	Substate, LIMITED-SERVICE .....	59
4.2.4.2.4	Substate, NO-IMSI .....	59
4.2.4.2.5	Substate, NO-CELL .....	60
4.2.4.2.6	Substate, PLMN-SEARCH .....	60
4.2.4.2.7	Substate, ATTACH-NEEDED .....	60
4.2.4.2.8	Substate, SUSPENDED (A/Gb mode only) .....	60
4.2.4.3	Substate when back to state GMM-DEREGISTERED from another GMM state .....	60
4.2.5	Behaviour in state GMM-REGISTERED .....	60
4.2.5.1	Detailed description of the MS behaviour in state GMM-REGISTERED .....	61
4.2.5.1.1	Substate, NORMAL-SERVICE .....	61
4.2.5.1.2	Substate, SUSPENDED (A/Gb mode only) .....	61
4.2.5.1.3	Substate, UPDATE-NEEDED .....	61
4.2.5.1.4	Substate, ATTEMPTING-TO-UPDATE .....	61
4.2.5.1.5	Substate, NO-CELL-AVAILABLE .....	62
4.2.5.1.6	Substate, LIMITED-SERVICE .....	62
4.2.5.1.7	Substate, ATTEMPTING-TO-UPDATE-MM .....	62
4.2.5.1.8	Substate, PLMN-SEARCH .....	62
4.3	MM common procedures .....	62
4.3.1	TMSI reallocation procedure .....	62
4.3.1.1	TMSI reallocation initiation by the network .....	63
4.3.1.2	TMSI reallocation completion by the mobile station .....	63
4.3.1.3	TMSI reallocation completion in the network .....	63
4.3.1.4	Abnormal cases .....	63
4.3.2	Authentication procedure .....	64
4.3.2a	Authentication procedure used for a UMTS authentication challenge .....	64
4.3.2b	Authentication Procedure used for a GSM authentication challenge .....	64
4.3.2.1	Authentication request by the network .....	65
4.3.2.2	Authentication response by the mobile station .....	65
4.3.2.3	Authentication processing in the network .....	66
4.3.2.4	Ciphering key sequence number .....	66
4.3.2.5	Authentication not accepted by the network .....	66
4.3.2.5.1	Authentication not accepted by the MS .....	67
4.3.2.6	Abnormal cases .....	67
4.3.2.6.1	MS behaviour towards a network that has failed the authentication procedure .....	70
4.3.2.7	Handling of keys at intersystem change from Iu mode to A/Gb mode .....	70
4.3.2.7a	Use of established security contexts .....	70
4.3.2.8	Handling of keys at intersystem change from A/Gb mode to Iu mode .....	71
4.3.2.9	Void .....	72
4.3.3	Identification procedure .....	72
4.3.3.1	Identity request by the network .....	72
4.3.3.2	Identification response by the mobile station .....	72
4.3.3.3	Abnormal cases .....	72
4.3.4	IMSI detach procedure .....	73
4.3.4.1	IMSI detach initiation by the mobile station .....	73
4.3.4.2	IMSI detach procedure in the network .....	73
4.3.4.3	IMSI detach completion by the mobile station .....	73

4.3.4.4	Abnormal cases .....	74
4.3.5	Abort procedure .....	74
4.3.5.1	Abort procedure initiation by the network .....	74
4.3.5.2	Abort procedure in the mobile station .....	74
4.3.6	MM information procedure.....	74
4.3.6.1	MM information procedure initiation by the network.....	74
4.3.6.2	MM information procedure in the mobile station .....	74
4.4	MM specific procedures .....	75
4.4.1	Location updating procedure .....	75
4.4.2	Periodic updating .....	76
4.4.3	IMSI attach procedure .....	77
4.4.4	Generic Location Updating procedure.....	77
4.4.4.1	Location updating initiation by the mobile station.....	77
4.4.4.1a	Network Request for Additional mobile station Capability Information .....	78
4.4.4.2	Identification request from the network .....	78
4.4.4.3	Authentication by the network .....	78
4.4.4.4	Security mode setting by the network .....	78
4.4.4.5	Attempt Counter.....	78
4.4.4.6	Location updating accepted by the network.....	78
4.4.4.7	Location updating not accepted by the network.....	80
4.4.4.8	Release of RR connection after location updating .....	80
4.4.4.9	Abnormal cases on the mobile station side .....	81
4.4.4.10	Abnormal cases on the network side.....	82
4.4.5	Void .....	83
4.4.6	Void .....	83
4.5	Connection management sublayer service provision .....	83
4.5.1	MM connection establishment.....	83
4.5.1.1	MM connection establishment initiated by the mobile station.....	83
4.5.1.2	Abnormal cases .....	86
4.5.1.3	MM connection establishment initiated by the network .....	87
4.5.1.3.1	Mobile Terminating CM Activity.....	87
4.5.1.3.2	Mobile Originating CM Activity \$(CCBS)\$ .....	87
4.5.1.3.3	Paging response in Iu mode (Iu mode only) .....	88
4.5.1.4	Abnormal cases .....	89
4.5.1.5	MM connection establishment for emergency calls.....	89
4.5.1.6	Call re-establishment.....	89
4.5.1.6.1	Call re-establishment, initiation by the mobile station .....	89
4.5.1.6.2	Abnormal cases .....	91
4.5.1.7	Forced release during MO MM connection establishment .....	92
4.5.2	MM connection information transfer phase.....	92
4.5.2.1	Sending CM messages .....	92
4.5.2.2	Receiving CM messages .....	92
4.5.2.3	Abnormal cases .....	92
4.5.3	MM connection release.....	93
4.5.3.1	Release of associated RR connection .....	93
4.5.3.2	Uplink release in a voice group call .....	93
4.6	Receiving a MM STATUS message by a MM entity.....	93
4.7	Elementary mobility management procedures for GPRS services .....	94
4.7.1	General.....	94
4.7.1.1	Lower layer failure.....	94
4.7.1.2	Ciphering of messages (A/Gb mode only) .....	94
4.7.1.3	P-TMSI signature.....	94
4.7.1.4	Radio resource sublayer address handling .....	94
4.7.1.4.1	Radio resource sublayer address handling (A/Gb mode only) .....	95
4.7.1.5	P-TMSI handling.....	95
4.7.1.5.1	P-TMSI handling in A/Gb mode .....	95
4.7.1.5.2	P-TMSI handling in Iu mode.....	96
4.7.1.6	Change of network mode of operation.....	96
4.7.1.6.1	Change of network mode of operation in A/Gb mode (A/Gb mode only) .....	96
4.7.1.6.2	Change of network mode of operation in Iu mode (Iu mode only) .....	97
4.7.1.6.3	Change of network mode of operation at Iu mode to A/Gb mode inter-system change.....	98
4.7.1.6.4	Change of network mode of operation at A/Gb mode to Iu mode inter-system change.....	99

4.7.1.7	Intersystem change between A/Gb mode and Iu mode .....	99
4.7.1.8	List of forbidden PLMNs for GPRS service .....	100
4.7.2	GPRS Mobility management timers and UMTS PS signalling connection control.....	101
4.7.2.1	READY timer behaviour.....	101
4.7.2.1.1	READY timer behaviour (A/Gb mode only).....	101
4.7.2.1.2	Handling of READY timer in Iu mode (Iu mode only).....	102
4.7.2.2	Periodic routing area updating .....	102
4.7.2.3	PMM-IDLE mode and PMM-CONNECTED mode (Iu mode only).....	103
4.7.2.4	Handling of <i>Force to standby</i> in Iu mode (Iu mode only).....	103
4.7.2.5	RA Update procedure for Signalling Connection Re-establishment (Iu mode only).....	104
4.7.2.6	Cell Update triggered by low layers.....	104
4.7.3	GPRS attach procedure .....	104
4.7.3.1	GPRS attach procedure for GPRS services.....	105
4.7.3.1.1	GPRS attach procedure initiation .....	105
4.7.3.1.2	GMM common procedure initiation.....	105
4.7.3.1.3	GPRS attach accepted by the network.....	105
4.7.3.1.4	GPRS attach not accepted by the network.....	107
4.7.3.1.5	Abnormal cases in the MS.....	109
4.7.3.1.6	Abnormal cases on the network side .....	110
4.7.3.2	Combined GPRS attach procedure for GPRS and non-GPRS services .....	112
4.7.3.2.1	Combined GPRS attach procedure initiation.....	112
4.7.3.2.2	GMM Common procedure initiation .....	112
4.7.3.2.3	Combined GPRS attach accepted by the network .....	113
4.7.3.2.4	Combined GPRS attach not accepted by the network .....	114
4.7.3.2.5	Abnormal cases in the MS.....	116
4.7.3.2.6	Abnormal cases on the network side .....	116
4.7.4	GPRS detach procedure .....	116
4.7.4.1	MS initiated GPRS detach procedure.....	117
4.7.4.1.1	MS initiated GPRS detach procedure initiation.....	117
4.7.4.1.2	MS initiated GPRS detach procedure completion for GPRS services only.....	117
4.7.4.1.3	MS initiated combined GPRS detach procedure completion.....	118
4.7.4.1.4	Abnormal cases in the MS.....	118
4.7.4.2	Network initiated GPRS detach procedure .....	119
4.7.4.2.1	Network initiated GPRS detach procedure initiation.....	119
4.7.4.2.2	Network initiated GPRS detach procedure completion by the MS.....	119
4.7.4.2.3	Network initiated GPRS detach procedure completion by the network .....	122
4.7.4.2.4	Abnormal cases on the network side .....	122
4.7.5	Routing area updating procedure .....	123
4.7.5.1	Normal and periodic routing area updating procedure.....	125
4.7.5.1.1	Normal and periodic routing area updating procedure initiation .....	125
4.7.5.1.2	GMM Common procedure initiation .....	125
4.7.5.1.3	Normal and periodic routing area updating procedure accepted by the network.....	125
4.7.5.1.4	Normal and periodic routing area updating procedure not accepted by the network.....	128
4.7.5.1.5	Abnormal cases in the MS.....	130
4.7.5.1.6	Abnormal cases on the network side .....	131
4.7.5.2	Combined routing area updating procedure .....	133
4.7.5.2.1	Combined routing area updating procedure initiation .....	133
4.7.5.2.2	GMM Common procedure initiation .....	134
4.7.5.2.3	Combined routing area updating procedure accepted by the network.....	134
4.7.5.2.4	Combined routing area updating not accepted by the network.....	136
4.7.5.2.5	Abnormal cases in the MS.....	138
4.7.5.2.6	Abnormal cases on the network side .....	138
4.7.6	P-TMSI reallocation procedure.....	138
4.7.6.1	P-TMSI reallocation initiation by the network.....	139
4.7.6.2	P-TMSI reallocation completion by the MS .....	139
4.7.6.3	P-TMSI reallocation completion by the network .....	139
4.7.6.4	Abnormal cases on the network side.....	139
4.7.7	Authentication and ciphering procedure .....	140
4.7.7a	Authentication and ciphering procedure used for UMTS authentication challenge.....	140
4.7.7b	Authentication and ciphering procedure used for GSM authentication challenge .....	141
4.7.7c	Change of the ciphering algorithm at PS Handover.....	141
4.7.7.1	Authentication and ciphering initiation by the network .....	142

4.7.7.2	Authentication and ciphering response by the MS.....	142
4.7.7.3	Authentication and ciphering completion by the network.....	143
4.7.7.4	GPRS ciphering key sequence number.....	144
4.7.7.5	Authentication not accepted by the network.....	145
4.7.7.5.1	Authentication not accepted by the MS.....	145
4.7.7.6	Abnormal cases.....	145
4.7.7.6.1	MS behaviour towards a network that has failed the authentication procedure.....	149
4.7.7.7	Use of established security contexts.....	149
4.7.7.8	Handling of keys at intersystem change from Iu mode to A/Gb mode.....	150
4.7.7.9	Handling of keys at intersystem change from A/Gb mode to Iu mode.....	150
4.7.8	Identification procedure.....	150
4.7.8.1	Identification initiation by the network.....	151
4.7.8.2	Identification response by the MS.....	151
4.7.8.3	Identification completion by the network.....	151
4.7.8.3a	Abnormal cases in the MS.....	151
4.7.8.4	Abnormal cases on the network side.....	151
4.7.9	Paging procedure.....	152
4.7.9.1	Paging for GPRS services.....	152
4.7.9.1.1	Paging for GPRS services using P-TMSI.....	152
4.7.9.1.2	Paging for GPRS services using IMSI.....	153
4.7.9.2	Paging for non-GPRS services.....	153
4.7.10	Receiving a GMM STATUS message by a GMM entity.....	153
4.7.11	Void.....	154
4.7.12	GMM Information procedure.....	154
4.7.12.1	GMM information procedure initiation by the network.....	154
4.7.12.2	GMM information procedure in the mobile station.....	154
4.7.13	Service Request procedure (Iu mode only).....	154
4.7.13.1	Service Request procedure initiation.....	156
4.7.13.2	GMM common procedure initiation.....	156
4.7.13.3	Service request procedure accepted by the network.....	156
4.7.13.4	Service request procedure not accepted by the network.....	156
4.7.13.5	Abnormal cases in the MS.....	158
4.7.13.6	Abnormal cases on the network side.....	159
4.7.14	Void.....	160
5	Elementary procedures for circuit-switched Call Control.....	160
5.1	Overview.....	160
5.1.1	General.....	160
5.1.2	Call Control States.....	165
5.1.2.1	Call states at the mobile station side of the interface.....	165
5.1.2.1.1	Null (State U0).....	165
5.1.2.1.2	MM Connection pending (U0.1).....	165
5.1.2.1.2a	CC prompt present (U0.2) \$(CCBS)\$.....	166
5.1.2.1.2b	Wait for network information (U0.3) \$(CCBS)\$.....	166
5.1.2.1.2c	CC-Establishment present (U0.4) \$(CCBS)\$.....	166
5.1.2.1.2d	CC-Establishment confirmed (U0.5) \$(CCBS)\$.....	166
5.1.2.1.2e	Recall present (U0.6) \$(CCBS)\$.....	166
5.1.2.1.3	Call initiated (U1).....	166
5.1.2.1.4	Mobile originating call proceeding (U3).....	166
5.1.2.1.5	Call delivered (U4).....	166
5.1.2.1.6	Call present (U6).....	166
5.1.2.1.7	Call received (U7).....	166
5.1.2.1.8	Connect Request (U8).....	166
5.1.2.1.9	Mobile terminating call confirmed (U9).....	167
5.1.2.1.10	Active (U10).....	167
5.1.2.1.11	Disconnect request (U11).....	167
5.1.2.1.12	Disconnect indication (U12).....	167
5.1.2.1.13	Release request (U19).....	167
5.1.2.1.14	Mobile originating modify (U26).....	167
5.1.2.1.15	Mobile terminating modify (U27).....	167
5.1.2.2	Network call states.....	167
5.1.2.2.1	Null (State N0).....	167



5.1.2.2.2	MM connection pending (N0.1) .....	167
5.1.2.2.2a	CC connection pending (N0.2) \$(CCBS)\$ .....	167
5.1.2.2.2b	Network answer pending (N0.3) \$(CCBS)\$ .....	167
5.1.2.2.2c	CC-Establishment present (N0.4) \$(CCBS)\$ .....	168
5.1.2.2.2d	CC-Establishment confirmed (N0.5) \$(CCBS)\$ .....	168
5.1.2.2.3	Call initiated (N1) .....	168
5.1.2.2.4	Mobile originating call proceeding (N3) .....	168
5.1.2.2.5	Call delivered (N4) .....	168
5.1.2.2.6	Call present (N6) .....	168
5.1.2.2.7	Call received (N7) .....	168
5.1.2.2.8	Connect request (N8) .....	168
5.1.2.2.9	Mobile terminating call confirmed (N9) .....	168
5.1.2.2.10	Active (N10) .....	168
5.1.2.2.11	Not used .....	168
5.1.2.2.12	Disconnect indication (N12) .....	168
5.1.2.2.13	Release request (N19) .....	169
5.1.2.2.14	Mobile originating modify (N26) .....	169
5.1.2.2.15	Mobile terminating modify (N27) .....	169
5.1.2.2.16	Connect Indication (N28) .....	169
5.2	Call establishment procedures .....	169
5.2.1	Mobile originating call establishment .....	169
5.2.1.1	Call initiation .....	170
5.2.1.2	Receipt of a setup message .....	171
5.2.1.3	Receipt of a CALL PROCEEDING message .....	172
5.2.1.4	Notification of progressing mobile originated call .....	173
5.2.1.4.1	Notification of interworking in connection with mobile originated call establishment .....	173
5.2.1.4.2	Call progress in the PLMN/ISDN environment .....	173
5.2.1.5	Alerting .....	173
5.2.1.6	Call connected .....	174
5.2.1.7	Call rejection .....	174
5.2.1.8	Transit network selection .....	175
5.2.1.9	Traffic channel assignment at mobile originating call establishment .....	175
5.2.1.10	Call queuing at mobile originating call establishment .....	175
5.2.1.11	Speech Codec Selection .....	175
5.2.1.12	Cellular Text telephone Modem (CTM) selection .....	176
5.2.2	Mobile terminating call establishment .....	176
5.2.2.1	Call indication .....	177
5.2.2.2	Compatibility checking .....	177
5.2.2.3	Call confirmation .....	177
5.2.2.3.1	Response to SETUP .....	177
5.2.2.3.2	Receipt of CALL CONFIRMED and ALERTING by the network .....	178
5.2.2.3.3	Call failure procedures .....	179
5.2.2.3.4	Called mobile station clearing during mobile terminating call establishment .....	179
5.2.2.4	Notification of interworking in connection with mobile terminating call establishment .....	179
5.2.2.5	Call accept .....	180
5.2.2.6	Active indication .....	180
5.2.2.7	Traffic channel assignment at mobile terminating call establishment .....	180
5.2.2.8	Call queuing at mobile terminating call establishment .....	181
5.2.2.9	User connection attachment during a mobile terminating call .....	181
5.2.2.10	Speech Codec Selection .....	181
5.2.2.11	Cellular Text telephone Modem (CTM) selection .....	181
5.2.3	Network initiated MO call \$(CCBS)\$ .....	181
5.2.3.1	Initiation .....	181
5.2.3.2	CC-Establishment present .....	182
5.2.3.2.1	Recall Alignment Procedure .....	183
5.2.3.3	CC-Establishment confirmation .....	184
5.2.3.4	Recall present .....	184
5.2.3.5	Traffic channel assignment during network initiated mobile originating call establishment .....	185
5.3	Signalling procedures during the "active" state .....	185
5.3.1	User notification procedure .....	185
5.3.2	Call rearrangements .....	185
5.3.3	Codec Change Procedure .....	185

5.3.4	Support of Dual Services .....	186
5.3.4.1	Service Description .....	186
5.3.4.2	Call establishment .....	186
5.3.4.2.1	Mobile Originating Establishment.....	186
5.3.4.2.2	Mobile Terminating Establishment .....	187
5.3.4.3	Changing the Call Mode .....	187
5.3.4.3.1	Initiation of in-call modification.....	187
5.3.4.3.2	Successful completion of in-call modification .....	188
5.3.4.3.3	Change of the channel configuration.....	189
5.3.4.3.4	Failure of in-call modification .....	189
5.3.4.4	Abnormal procedures .....	190
5.3.5	User initiated service level up- and downgrading (A/Gb mode and GERAN Iu mode only).....	190
5.3.5.1	Initiation of service level up- and downgrading.....	190
5.3.5.2	Successful completion of service level up- and downgrading .....	191
5.3.5.3	Rejection of service level up- and downgrading .....	191
5.3.5.4	Time-out recovery .....	191
5.3.6	Support of multimedia calls .....	191
5.3.6.1	Service description .....	191
5.3.6.2	Call establishment .....	191
5.3.6.2.1	Mobile originated multimedia call establishment.....	192
5.3.6.2.2	Mobile terminating multimedia call .....	193
5.3.6.2.2.1	Fallback to speech.....	193
5.3.6.3	In-call modification in the "active" state .....	193
5.3.6.3.1	Void.....	194
5.3.6.3.2	Void.....	194
5.3.6.3.3	Void.....	194
5.4	Call clearing .....	194
5.4.1	Terminology .....	194
5.4.2	Exception conditions.....	194
5.4.3	Clearing initiated by the mobile station .....	195
5.4.3.1	Initiation of call clearing .....	195
5.4.3.2	Receipt of a DISCONNECT message from the mobile station.....	195
5.4.3.3	Receipt of a RELEASE message from the network.....	195
5.4.3.4	Receipt of a RELEASE COMPLETE message from the mobile station .....	195
5.4.3.5	Abnormal cases .....	195
5.4.4	Clearing initiated by the network.....	196
5.4.4.1	Clearing initiated by the network: mobile does not support "Prolonged Clearing Procedure" .....	196
5.4.4.1.1	Clearing when tones/announcements provided.....	196
5.4.4.1.2	Clearing when tones/announcements not provided .....	196
5.4.4.1.3	Completion of clearing .....	197
5.4.4.2	Clearing initiated by the network: mobile supports "Prolonged Clearing Procedure" .....	197
5.4.4.2.1	Clearing when tones/announcements provided and the network does not indicate that "CCBS activation is possible" .....	197
5.4.4.2.2	Clearing when the network indicates that "CCBS activation is possible" .....	198
5.4.4.2.3	Clearing when tones/announcements are not provided and the network does not indicate that "CCBS activation is possible" .....	199
5.4.4.2.4	Receipt of a RELEASE message from the mobile station.....	200
5.4.4.2.5	Completion of clearing .....	200
5.5	Miscellaneous procedures .....	201
5.5.1	In-band tones and announcements .....	201
5.5.2	Call collisions .....	201
5.5.3	Status procedures .....	201
5.5.3.1	Status enquiry procedure.....	201
5.5.3.2	Reception of a STATUS message by a CC entity .....	202
5.5.3.2.1	STATUS message with incompatible state .....	202
5.5.3.2.2	STATUS message with compatible state .....	202
5.5.4	Call re-establishment, mobile station side .....	202
5.5.4.1	Indication from the mobility management sublayer.....	202
5.5.4.2	Reaction of call control .....	202
5.5.4.3	Completion of re-establishment .....	203
5.5.4.4	Unsuccessful outcome.....	203
5.5.5	Call re-establishment, network side.....	203

5.5.5.1	State alignment.....	203
5.5.6	Progress .....	203
5.5.7	DTMF protocol control procedure.....	203
5.5.7.1	Start DTMF request by the mobile station .....	204
5.5.7.2	Start DTMF response by the network .....	204
5.5.7.3	Stop DTMF request by the mobile station .....	204
5.5.7.4	Stop DTMF response by the network.....	204
5.5.7.5	Sequencing of subsequent start DTMF requests by the mobile station.....	204
6	Support for packet services .....	205
6.1	GPRS Session management .....	205
6.1.1	General.....	205
6.1.2	Session management states .....	206
6.1.2.1	Session management states in the MS.....	206
6.1.2.1.1	PDP-INACTIVE.....	206
6.1.2.1.2	PDP-ACTIVE-PENDING .....	206
6.1.2.1.3	PDP-INACTIVE-PENDING .....	206
6.1.2.1.4	PDP-ACTIVE.....	206
6.1.2.1.5	PDP-MODIFY_PENDING .....	206
6.1.2.1.6	MBMS-ACTIVE-PENDING .....	206
6.1.2.1.7	MBMS-ACTIVE .....	206
6.1.2.2	Session management states on the network side .....	208
6.1.2.2.1	PDP-INACTIVE.....	208
6.1.2.2.2	PDP-ACTIVE-PENDING .....	208
6.1.2.2.3	PDP-INACTIVE-PENDING .....	208
6.1.2.2.4	PDP-ACTIVE.....	208
6.1.2.2.5	PDP-MODIFY_PENDING .....	208
6.1.2.2.6	MBMS-ACTIVE-PENDING .....	209
6.1.2.2.7	MBMS-INACTIVE-PENDING .....	209
6.1.2.2.8	MBMS-ACTIVE .....	209
6.1.3	Session Management procedures .....	210
6.1.3.1	PDP context activation .....	210
6.1.3.1.1	Successful PDP context activation initiated by the mobile station.....	210
6.1.3.1.2	Successful PDP context activation requested by the network .....	211
6.1.3.1.3	Unsuccessful PDP context activation initiated by the MS.....	212
6.1.3.1.4	Unsuccessful PDP context activation requested by the network .....	212
6.1.3.1.5	Abnormal cases .....	212
6.1.3.2	Secondary PDP Context Activation Procedure .....	214
6.1.3.2.1	Successful Secondary PDP Context Activation Procedure Initiated by the MS.....	215
6.1.3.2.2	Unsuccessful Secondary PDP Context Activation Procedure initiated by the MS.....	216
6.1.3.2.3	Abnormal cases .....	216
6.1.3.3	PDP context modification procedure .....	217
6.1.3.3.1	Network initiated PDP Context Modification .....	218
6.1.3.3.2	MS initiated PDP Context Modification accepted by the network.....	218
6.1.3.3.3	MS initiated PDP Context Modification not accepted by the network.....	219
6.1.3.3.4	Abnormal cases .....	221
6.1.3.4	PDP context deactivation procedure .....	222
6.1.3.4.1	PDP context deactivation initiated by the MS .....	222
6.1.3.4.2	PDP context deactivation initiated by the network.....	222
6.1.3.4.3	Abnormal cases .....	223
6.1.3.4a	Void.....	224
6.1.3.5	Void.....	224
6.1.3.6	Receiving a SM STATUS message by a SM entity .....	224
6.1.3.7	Protocol configuration options .....	224
6.1.3.8	MBMS context activation .....	225
6.1.3.8.1	Successful MBMS context activation.....	225
6.1.3.8.2	Unsuccessful MBMS context activation requested by the MS.....	225
6.1.3.8.3	Unsuccessful MBMS context activation requested by the network.....	226
6.1.3.8.4	Abnormal cases .....	226
6.1.3.9	MBMS context deactivation.....	227
6.1.3.9.1	MBMS context deactivation initiated by the network .....	227
6.1.3.9.2	Abnormal cases .....	227

6.1.3.10	MBMS protocol configuration options .....	228
6.2	void.....	228
7	Examples of structured procedures .....	228
8	Handling of unknown, unforeseen, and erroneous protocol data.....	228
8.1	General .....	228
8.2	Message too short.....	229
8.3	Unknown or unforeseen transaction identifier .....	229
8.3.1	Call Control .....	229
8.3.2	Session Management .....	230
8.4	Unknown or unforeseen message type .....	231
8.5	Non-semantic mandatory information element errors .....	231
8.5.1	Radio resource management .....	232
8.5.2	Mobility management .....	232
8.5.3	Call control .....	232
8.5.4	GMM mobility management.....	232
8.5.5	Session management.....	232
8.6	Unknown and unforeseen IEs in the non-imperative message part.....	233
8.6.1	IEs unknown in the message .....	233
8.6.2	Out of sequence IEs .....	233
8.6.3	Repeated IEs .....	233
8.7	Non-imperative message part errors.....	233
8.7.1	Syntactically incorrect optional IEs .....	233
8.7.2	Conditional IE errors .....	233
8.8	Messages with semantically incorrect contents.....	234
9	Message functional definitions and contents.....	234
9.1	Messages for Radio Resources management.....	235
9.2	Messages for mobility management .....	235
9.2.1	Authentication reject.....	236
9.2.2	Authentication request .....	236
9.2.2.1	Authentication Parameter AUTN.....	236
9.2.3	Authentication response.....	237
9.2.3.1	Authentication Response Parameter.....	237
9.2.3.2	Authentication Response Parameter (extension).....	237
9.2.3a	Authentication Failure .....	237
9.2.3a.1	Authentication Failure parameter.....	238
9.2.4	CM Re-establishment request .....	238
9.2.4.1	Location area identification.....	238
9.2.4.2	Mobile Station Classmark .....	238
9.2.5	CM service accept.....	238
9.2.5a	CM service prompt \$(CCBS)\$.....	239
9.2.6	CM service reject.....	239
9.2.7	CM service abort.....	240
9.2.8	Abort.....	240
9.2.9	CM service request .....	241
9.2.9.1	Mobile Station Classmark .....	241
9.2.9.2	Priority .....	241
9.2.10	Identity request .....	241
9.2.11	Identity response.....	242
9.2.12	IMSI detach indication.....	242
9.2.12.1	Mobile Station Classmark .....	243
9.2.13	Location updating accept .....	243
9.2.13.1	Follow on proceed.....	243
9.2.13.2	CTS permission .....	244
9.2.13.3	Equivalent PLMNs.....	244
9.2.13.4	Emergency Number List .....	244
9.2.14	Location updating reject .....	244
9.2.15	Location updating request.....	244
9.2.15.1	Location area identification.....	245
9.2.15.2	Mobile Station Classmark .....	245
9.2.15.3	Mobile Station Classmark for Iu mode .....	245

9.2.15a	MM information .....	245
9.2.15a.1	Full name for network .....	246
9.2.15a.2	Short name for network .....	246
9.2.15a.3	Local time zone .....	246
9.2.15a.4	Universal time and local time zone .....	246
9.2.15a.5	LSA Identity .....	246
9.2.15a.6	Network Daylight Saving Time .....	247
9.2.16	MM Status .....	247
9.2.17	TMSI reallocation command .....	247
9.2.18	TMSI reallocation complete .....	248
9.2.19	MM Null .....	248
9.3	Messages for circuit-switched call control .....	249
9.3.1	Alerting .....	249
9.3.1.1	Alerting (network to mobile station direction) .....	249
9.3.1.1.1	Facility .....	250
9.3.1.1.2	Progress indicator .....	250
9.3.1.1.3	User-user .....	250
9.3.1.2	Alerting (mobile station to network direction) .....	250
9.3.1.2.1	Facility .....	251
9.3.1.2.2	User-user .....	251
9.3.1.2.3	SS version .....	251
9.3.2	Call confirmed .....	251
9.3.2.1	Repeat indicator .....	252
9.3.2.2	Bearer capability 1 and bearer capability 2 .....	252
9.3.2.3	Cause .....	253
9.3.2.4	CC Capabilities .....	253
9.3.2.5	Stream Identifier .....	253
9.3.2.6	Supported Codecs .....	253
9.3.3	Call proceeding .....	253
9.3.3.1	Repeat indicator .....	253
9.3.3.2	Bearer capability 1 and bearer capability 2 .....	254
9.3.3.3	Facility .....	254
9.3.3.4	Progress Indicator .....	254
9.3.3.5	Priority granted .....	254
9.3.3.6	Network Call Control Capabilities .....	254
9.3.4	Congestion control .....	254
9.3.4.1	Cause .....	255
9.3.5	Connect .....	255
9.3.5.1	Connect (network to mobile station direction) .....	255
9.3.5.1.1	Facility .....	255
9.3.5.1.2	Progress indicator .....	255
9.3.5.1.3	User-user .....	255
9.3.5.2	Connect (mobile station to network direction) .....	255
9.3.5.2.1	Facility .....	256
9.3.5.2.2	User-user .....	256
9.3.5.2.3	SS version .....	256
9.3.5.2.4	Stream Identifier .....	256
9.3.6	Connect acknowledge .....	256
9.3.7	Disconnect .....	257
9.3.7.1	Disconnect (network to mobile station direction) .....	257
9.3.7.1.1	Facility .....	257
9.3.7.1.2	Progress indicator .....	257
9.3.7.1.3	User-user .....	257
9.3.7.1.4	Allowed actions \$(CCBS)\$ .....	257
9.3.7.2	Disconnect (mobile station to network direction) .....	258
9.3.7.2.1	Facility .....	258
9.3.7.2.2	User-user .....	258
9.3.7.2.3	SS version .....	258
9.3.8	Emergency setup .....	258
9.3.8.1	Bearer capability .....	259
9.3.8.2	Stream Identifier .....	259
9.3.8.3	Supported Codecs .....	259

9.3.8.4	Service category .....	259
9.3.9	Facility .....	259
9.3.9.1	Facility (network to mobile station direction) .....	259
9.3.9.2	Facility (mobile station to network direction) .....	260
9.3.9.2.1	SS version .....	260
9.3.10	Hold .....	261
9.3.11	Hold Acknowledge .....	261
9.3.12	Hold Reject .....	261
9.3.13	Modify .....	262
9.3.13.1	Low layer compatibility .....	262
9.3.13.2	High layer compatibility .....	262
9.3.13.3	Reverse call setup direction .....	262
9.3.13.4	Void .....	263
9.3.13.5	Network-initiated Service Upgrade indicator .....	263
9.3.14	Modify complete .....	263
9.3.14.1	Low layer compatibility .....	263
9.3.14.2	High layer compatibility .....	263
9.3.14.3	Reverse call setup direction .....	263
9.3.15	Modify reject .....	263
9.3.15.1	Low layer compatibility .....	264
9.3.15.2	High layer compatibility .....	264
9.3.16	Notify .....	264
9.3.17	Progress .....	264
9.3.17.1	User-user .....	265
9.3.17a	CC-Establishment \$(CCBS)\$ .....	265
9.3.17a.1	Void .....	266
9.3.17a.2	Setup container .....	266
9.3.17b	CC-Establishment confirmed \$(CCBS)\$ .....	266
9.3.17b.1	Repeat indicator .....	266
9.3.17b.2	Bearer capability 1 and bearer capability 2 .....	266
9.3.17b.3	Cause .....	266
9.3.17b.4	Supported Codecs .....	266
9.3.18	Release .....	267
9.3.18.1	Release (network to mobile station direction) .....	267
9.3.18.1.1	Cause .....	267
9.3.18.1.2	Second cause .....	267
9.3.18.1.3	Facility .....	267
9.3.18.1.4	User-user .....	267
9.3.18.2	Release (mobile station to network direction) .....	267
9.3.18.2.1	Cause .....	268
9.3.18.2.2	Second cause .....	268
9.3.18.2.3	Facility .....	268
9.3.18.2.4	User-user .....	268
9.3.18.2.5	SS version .....	268
9.3.18a	Recall \$(CCBS)\$ .....	268
9.3.18a.1	Recall Type .....	269
9.3.18a.2	Facility .....	269
9.3.19	Release complete .....	269
9.3.19.1	Release complete (network to mobile station direction) .....	269
9.3.19.1.1	Cause .....	270
9.3.19.1.2	Facility .....	270
9.3.19.1.3	User-user .....	270
9.3.19.2	Release complete (mobile station to network direction) .....	270
9.3.19.2.1	Cause .....	271
9.3.19.2.2	Facility .....	271
9.3.19.2.3	User-user .....	271
9.3.19.2.4	SS version .....	271
9.3.20	Retrieve .....	271
9.3.21	Retrieve Acknowledge .....	272
9.3.22	Retrieve Reject .....	272
9.3.23	Setup .....	273
9.3.23.1	Setup (mobile terminated call establishment) .....	273

9.3.23.1.1	BC repeat indicator.....	274
9.3.23.1.2	Bearer capability 1 and bearer capability 2 .....	275
9.3.23.1.3	Facility.....	275
9.3.23.1.4	Progress indicator .....	275
9.3.23.1.4a	Called party BCD number .....	275
9.3.23.1.5	Called party subaddress.....	275
9.3.23.1.6	LLC repeat indicator.....	275
9.3.23.1.7	Low layer compatibility I.....	275
9.3.23.1.8	Low layer compatibility II.....	275
9.3.23.1.9	HLC repeat indicator .....	275
9.3.23.1.10	High layer compatibility i.....	275
9.3.23.1.11	High layer compatibility ii.....	276
9.3.23.1.12	User-user .....	276
9.3.23.1.13	Redirecting party BCD number .....	276
9.3.23.1.14	Redirecting party subaddress.....	276
9.3.23.1.15	Priority.....	276
9.3.23.1.16	Alert \$(Network Indication of Alerting in the MS)\$ .....	276
9.3.23.1.17	Network Call Control Capabilities .....	276
9.3.23.1.18	Cause of No CLI.....	276
9.3.23.1.19	Backup bearer capability .....	276
9.3.23.2	Setup (mobile originating call establishment).....	276
9.3.23.2.1	BC repeat indicator.....	277
9.3.23.2.2	Facility.....	278
9.3.23.2.3	LLC repeat indicator.....	278
9.3.23.2.4	Low layer compatibility I.....	278
9.3.23.2.5	Low layer compatibility II.....	278
9.3.23.2.6	HLC repeat indicator .....	278
9.3.23.2.7	High layer compatibility i.....	278
9.3.23.2.8	High layer compatibility ii.....	278
9.3.23.2.9	User-user .....	278
9.3.23.2.10	SS version.....	278
9.3.23.2.11	CLIR suppression.....	278
9.3.23.2.12	CLIR invocation .....	279
9.3.23.2.13	CC Capabilities.....	279
9.3.23.2.14	Stream Identifier.....	279
9.3.23.2.15	Bearer capability 1 and bearer capability 2 .....	279
9.3.23.2.16	Supported Codecs.....	279
9.3.23.2.17	Redial .....	279
9.3.23a	Start CC \$(CCBS)\$.....	279
9.3.23a.1	CC Capabilities .....	279
9.3.24	Start DTMF.....	280
9.3.25	Start DTMF Acknowledge.....	280
9.3.25.1	Keypad facility .....	280
9.3.26	Start DTMF reject.....	280
9.3.27	Status .....	281
9.3.27.1	Auxiliary states .....	281
9.3.28	Status enquiry .....	281
9.3.29	Stop DTMF.....	282
9.3.30	Stop DTMF acknowledge.....	282
9.3.31	User information.....	283
9.3.31.1	User-user .....	283
9.3.31.2	More data .....	283
9.4	GPRS Mobility Management Messages.....	283
9.4.1	Attach request .....	283
9.4.1.1	Old P-TMSI signature .....	284
9.4.1.2	Requested READY timer value .....	284
9.4.1.3	TMSI status .....	284
9.4.1.4	PS LCS Capability .....	284
9.4.2	Attach accept .....	284
9.4.2.1	P-TMSI signature.....	285
9.4.2.2	Negotiated READY timer .....	285
9.4.2.3	Allocated P-TMSI.....	285

9.4.2.4	MS identity.....	285
9.4.2.5	GMM cause.....	286
9.4.2.6	T3302 value.....	286
9.4.2.7	Cell Notification (A/Gb mode only) .....	286
9.4.2.8	Equivalent PLMNs.....	286
9.4.2.9	Network feature support.....	286
9.4.2.10	Emergency Number List .....	286
9.4.2.11	Requested MS Information .....	286
9.4.3	Attach complete .....	286
9.4.3.1	Inter RAT handover information.....	287
9.4.4	Attach reject.....	287
9.4.4.1	T3302 value.....	287
9.4.5	Detach request .....	287
9.4.5.1	Detach request (mobile terminated detach).....	287
9.4.5.1.1	GMM cause.....	288
9.4.5.2	Detach request (mobile originating detach) .....	288
9.4.5.2.1	P-TMSI.....	288
9.4.5.2.2	P-TMSI signature .....	288
9.4.6	Detach accept.....	289
9.4.6.1	Detach accept (mobile terminated detach) .....	289
9.4.6.2	Detach accept (mobile originating detach).....	289
9.4.7	P-TMSI reallocation command.....	289
9.4.7.1	P-TMSI signature .....	290
9.4.8	P-TMSI reallocation complete.....	290
9.4.9	Authentication and ciphering request .....	290
9.4.9.1	Authentication Parameter RAND.....	291
9.4.9.2	GPRS ciphering key sequence number .....	291
9.4.9.3	Authentication Parameter AUTN.....	291
9.4.10	Authentication and ciphering response .....	291
9.4.10.1	Authentication Response Parameter.....	292
9.4.10.2	IMEISV .....	292
9.4.10.3	Authentication Response Parameter (extension).....	292
9.4.10a	Authentication and Ciphering Failure .....	292
9.4.10a.1	Authentication Failure parameter.....	293
9.4.11	Authentication and ciphering reject.....	293
9.4.12	Identity request .....	293
9.4.13	Identity response.....	294
9.4.14	Routing area update request.....	294
9.4.14.1	Old P-TMSI signature.....	295
9.4.14.2	Requested READY timer value .....	295
9.4.14.3	DRX parameter .....	295
9.4.14.4	TMSI status .....	295
9.4.14.5	P-TMSI (UMTS only).....	295
9.4.14.6	MS network capability .....	295
9.4.14.7	PDP context status .....	296
9.4.14.8	PS LCS Capability .....	296
9.4.14.9	MBMS context status.....	296
9.4.15	Routing area update accept.....	296
9.4.15.1	P-TMSI signature.....	297
9.4.15.2	Allocated P-TMSI.....	297
9.4.15.3	MS identity.....	297
9.4.15.4	List of Receive N-PDU Numbers.....	297
9.4.15.5	Negotiated READY timer value .....	298
9.4.15.6	GMM cause.....	298
9.4.15.7	T3302 value.....	298
9.4.15.8	Cell Notification (A/Gb mode only) .....	298
9.4.15.9	Equivalent PLMNs.....	298
9.4.15.10	PDP context status .....	298
9.4.15.11	Network feature support.....	298
9.4.15.12	Emergency Number List .....	298
9.4.15.13	MBMS context status.....	298
9.4.15.14	Requested MS Information .....	298



9.4.16	Routing area update complete.....	298
9.4.16.1	List of Receive N-PDU Numbers.....	299
9.4.16.2	Inter RAT handover information.....	299
9.4.17	Routing area update reject .....	299
9.4.17.1	T3302 value.....	300
9.4.18	GMM Status.....	300
9.4.19	GMM Information .....	300
9.4.19.1	Full name for network.....	301
9.4.19.2	Short name for network.....	301
9.4.19.3	Local time zone .....	301
9.4.19.4	Universal time and local time zone .....	301
9.4.19.5	LSA Identity.....	301
9.4.19.6	Network Daylight Saving Time .....	301
9.4.20	Service Request (UMTS only).....	302
9.4.20.1	PDP context status .....	302
9.4.20.2	MBMS context status.....	302
9.4.21	Service Accept (UMTS only) .....	302
9.4.21.1	PDP context status .....	303
9.4.21.2	MBMS context status.....	303
9.4.22	Service Reject (UMTS only) .....	303
9.5	GPRS Session Management Messages.....	303
9.5.1	Activate PDP context request .....	303
9.5.1.1	Access point name.....	304
9.5.1.2	Protocol configuration options .....	304
9.5.2	Activate PDP context accept.....	304
9.5.2.1	PDP address .....	305
9.5.2.2	Protocol configuration options .....	305
9.5.2.3	Packet Flow Identifier .....	305
9.5.3	Activate PDP context reject.....	305
9.5.3.1	Protocol configuration options .....	306
9.5.4	Activate Secondary PDP Context Request .....	306
9.5.4.1	TFT .....	306
9.5.4.2	Protocol configuration options .....	306
9.5.5	Activate Secondary PDP Context Accept.....	307
9.5.5.1	Packet Flow Identifier .....	307
9.5.5.2	Protocol configuration options .....	307
9.5.6	Activate Secondary PDP Context Reject .....	307
9.5.6.1	Protocol configuration options .....	308
9.5.7	Request PDP context activation.....	308
9.5.7.1	Protocol configuration options .....	308
9.5.8	Request PDP context activation reject.....	308
9.5.8.1	Protocol configuration options .....	309
9.5.9	Modify PDP context request (Network to MS direction) .....	309
9.5.9.1	PDP address .....	309
9.5.9.2	Packet Flow Identifier .....	310
9.5.9.3	Protocol configuration options .....	310
9.5.10	Modify PDP context request (MS to network direction) .....	310
9.5.10.1	Requested LLC SAPI.....	310
9.5.10.2	Requested new QoS .....	310
9.5.10.3	New TFT.....	310
9.5.10.4	Protocol configuration options .....	310
9.5.11	Modify PDP context accept (MS to network direction).....	311
9.5.11.1	Protocol configuration options .....	311
9.5.12	Modify PDP context accept (Network to MS direction).....	311
9.5.12.1	Negotiated QoS .....	312
9.5.12.2	Negotiated LLC SAPI.....	312
9.5.12.3	New radio priority.....	312
9.5.12.4	Packet Flow Identifier .....	312
9.5.12.5	Protocol configuration options .....	312
9.5.13	Modify PDP Context Reject .....	312
9.5.13.1	Protocol configuration options .....	312
9.5.14	Deactivate PDP context request.....	313

9.5.14.1	Tear down indicator .....	313
9.5.14.2	Protocol configuration options .....	313
9.5.14.3	MBMS protocol configuration options .....	313
9.5.15	Deactivate PDP context accept .....	313
9.5.15.1	Protocol configuration options .....	314
9.5.15.2	MBMS protocol configuration options .....	314
9.5.16	Void .....	314
9.5.17	Void .....	314
9.5.18	Void .....	314
9.5.19	Void .....	314
9.5.20	Void .....	314
9.5.21	SM Status .....	314
9.5.22	Activate MBMS Context Request .....	315
9.5.22.1	MBMS protocol configuration options .....	315
9.5.23	Activate MBMS Context Accept .....	315
9.5.23.1	MBMS protocol configuration options .....	316
9.5.24	Activate MBMS Context Reject .....	316
9.5.24.1	MBMS protocol configuration options .....	316
9.5.25	Request MBMS Context Activation .....	316
9.5.25.1	Linked NSAPI .....	317
9.5.25.2	MBMS protocol configuration options .....	317
9.5.26	Request MBMS Context Activation Reject .....	317
9.5.26.1	MBMS protocol configuration options .....	317
10	General message format and information elements coding .....	318
10.1	Overview .....	318
10.2	Protocol Discriminator .....	318
10.3	Skip indicator and transaction identifier .....	318
10.3.1	Skip indicator .....	318
10.3.2	Transaction identifier .....	319
10.4	Message Type .....	319
10.5	Other information elements .....	322
10.5.1	Common information elements .....	323
10.5.1.1	Cell identity .....	323
10.5.1.2	Ciphering Key Sequence Number .....	324
10.5.1.3	Location Area Identification .....	324
10.5.1.4	Mobile Identity .....	326
10.5.1.5	Mobile Station Classmark 1 .....	330
10.5.1.6	Mobile Station Classmark 2 .....	332
10.5.1.7	Mobile Station Classmark 3 .....	335
10.5.1.8	Spare Half Octet .....	346
10.5.1.9	Descriptive group or broadcast call reference .....	346
10.5.1.10	Group Cipher Key Number .....	347
10.5.1.10a	PD and SAPI \$(CCBS)\$ .....	348
10.5.1.11	Priority Level .....	349
10.5.1.12	Core Network System Information (UMTS only) .....	349
10.5.1.12.1	CN Common GSM-MAP NAS system information .....	349
10.5.1.12.2	CS domain specific system information .....	350
10.5.1.12.3	PS domain specific system information .....	350
10.5.1.13	PLMN list .....	351
10.5.1.14	NAS container for PS HO .....	352
10.5.2	Radio Resource management information elements .....	353
10.5.3	Mobility management information elements .....	353
10.5.3.1	Authentication parameter RAND .....	353
10.5.3.1.1	Authentication Parameter AUTN (UMTS authentication challenge only) .....	353
10.5.3.2	Authentication Response parameter .....	354
10.5.3.2.1	Authentication Response Parameter (extension) (UMTS authentication challenge only) .....	355
10.5.3.2.2	Authentication Failure parameter (UMTS authentication challenge only) .....	355
10.5.3.3	CM service type .....	356
10.5.3.4	Identity type .....	356
10.5.3.5	Location updating type .....	357
10.5.3.5a	Network Name .....	357

10.5.3.6	Reject cause.....	358
10.5.3.7	Follow-on Proceed .....	359
10.5.3.8	Time Zone .....	360
10.5.3.9	Time Zone and Time .....	360
10.5.3.10	CTS permission.....	361
10.5.3.11	LSA Identifier .....	362
10.5.3.12	Daylight Saving Time .....	362
10.5.3.13	Emergency Number List .....	363
10.5.4	Call control information elements .....	364
10.5.4.1	Extensions of codesets .....	364
10.5.4.2	Locking shift procedure .....	364
10.5.4.3	Non-locking shift procedure.....	365
10.5.4.4	Auxiliary states .....	366
10.5.4.4a	Backup bearer capability.....	367
10.5.4.4a.1	Static conditions for the backup bearer capability IE contents .....	375
10.5.4.5	Bearer capability .....	375
10.5.4.5.1	Static conditions for the bearer capability IE contents .....	390
10.5.4.5a	Call Control Capabilities .....	390
10.5.4.6	Call state.....	391
10.5.4.7	Called party BCD number.....	392
10.5.4.8	Called party subaddress.....	394
10.5.4.9	Calling party BCD number .....	395
10.5.4.10	Calling party subaddress .....	396
10.5.4.11	Cause.....	397
10.5.4.11a	CLIR suppression.....	402
10.5.4.11b	CLIR invocation.....	403
10.5.4.12	Congestion level.....	403
10.5.4.13	Connected number .....	403
10.5.4.14	Connected subaddress .....	404
10.5.4.15	Facility .....	404
10.5.4.16	High layer compatibility .....	405
10.5.4.16.1	Static conditions for the high layer compatibility IE contents.....	406
10.5.4.17	Keypad facility .....	406
10.5.4.18	Low layer compatibility .....	406
10.5.4.19	More data .....	406
10.5.4.20	Notification indicator .....	407
10.5.4.21	Progress indicator.....	407
10.5.4.21a	Recall type \$(CCBS)\$ .....	408
10.5.4.21b	Redirecting party BCD number.....	409
10.5.4.21c	Redirecting party subaddress.....	409
10.5.4.22	Repeat indicator .....	410
10.5.4.22a	Reverse call setup direction.....	410
10.5.4.22b	SETUP Container \$(CCBS)\$ .....	411
10.5.4.23	Signal .....	411
10.5.4.24	SS Version Indicator .....	412
10.5.4.25	User-user .....	412
10.5.4.26	Alerting Pattern \$(NIA)\$ .....	413
10.5.4.27	Allowed actions \$(CCBS)\$ .....	414
10.5.4.28	Stream Identifier .....	415
10.5.4.29	Network Call Control Capabilities.....	415
10.5.4.30	Cause of No CLI .....	416
10.5.4.31	Void.....	416
10.5.4.32	Supported codec list .....	416
10.5.4.33	Service category .....	417
10.5.4.34	Redial .....	418
10.5.4.35	Network-initiated Service Upgrade indicator.....	418
10.5.5	GPRS mobility management information elements.....	419
10.5.5.1	Attach result .....	419
10.5.5.2	Attach type .....	419
10.5.5.3	Ciphering algorithm .....	420
10.5.5.4	TMSI status .....	420
10.5.5.5	Detach type .....	421

10.5.5.6	DRX parameter .....	422
10.5.5.7	Force to standby .....	424
10.5.5.8	P-TMSI signature .....	424
10.5.5.8a	P-TMSI signature 2 .....	425
10.5.5.9	Identity type 2 .....	425
10.5.5.10	IMEISV request .....	426
10.5.5.11	Receive N-PDU Numbers list .....	426
10.5.5.12	MS network capability .....	427
10.5.5.12a	MS Radio Access capability .....	429
10.5.5.13	Spare .....	439
10.5.5.14	GMM cause .....	439
10.5.5.15	Routing area identification .....	440
10.5.5.16	Spare .....	442
10.5.5.17	Update result .....	442
10.5.5.18	Update type .....	442
10.5.5.19	A&C reference number .....	443
10.5.5.20	Service type .....	443
10.5.5.21	Cell Notification .....	444
10.5.5.22	PS LCS Capability .....	444
10.5.5.23	Network feature support .....	445
10.5.5.24	Inter RAT information container .....	446
10.5.5.25	Requested MS information .....	447
10.5.6	Session management information elements .....	447
10.5.6.1	Access point name .....	447
10.5.6.2	Network service access point identifier .....	447
10.5.6.3	Protocol configuration options .....	448
10.5.6.4	Packet data protocol address .....	452
10.5.6.5	Quality of service .....	453
10.5.6.6	SM cause .....	461
10.5.6.7	Linked TI .....	463
10.5.6.8	Spare .....	463
10.5.6.9	LLC service access point identifier .....	463
10.5.6.10	Tear down indicator .....	464
10.5.6.11	Packet Flow Identifier .....	464
10.5.6.12	Traffic Flow Template .....	465
10.5.6.13	Temporary Mobile Group Identity (TMGI) .....	469
10.5.6.14	MBMS bearer capabilities .....	470
10.5.6.15	MBMS protocol configuration options .....	471
10.5.6.16	Enhanced network service access point identifier .....	471
10.5.7	GPRS Common information elements .....	472
10.5.7.1	PDP context status .....	472
10.5.7.2	Radio priority .....	473
10.5.7.3	GPRS Timer .....	473
10.5.7.4	GPRS Timer 2 .....	474
10.5.7.5	Radio priority 2 .....	474
10.5.7.6	MBMS context status .....	475
11	List of system parameters .....	476
11.1	Timers and counters for radio resource management .....	476
11.2	Timers of mobility management .....	476
11.2.1	Timer T3240 and Timer T3241 .....	477
11.2.2	Timers of GPRS mobility management .....	478
11.2.3	Timers of GPRS session management .....	481
11.3	Timers of circuit-switched call control .....	483
<b>Annex A (informative):</b>	<b>Example of subaddress information element coding .....</b>	<b>485</b>
<b>Annex B (normative):</b>	<b>Compatibility checking .....</b>	<b>486</b>
B.1	Introduction .....	486
B.2	Calling side compatibility checking .....	486
B.2.1	Compatibility checking of the CM SERVICE REQUEST message .....	486

B.2.2	Compatibility/Subscription checking of the SETUP message .....	486
B.3	Called side compatibility checking .....	486
B.3.1	Compatibility checking with addressing information.....	487
B.3.2	Network-to-MS compatibility checking.....	487
B.3.3	User-to-User compatibility checking.....	487
B.4	High layer compatibility checking .....	487
<b>Annex C (normative): Low layer information coding principles.....</b>		<b>488</b>
C.1	Purpose .....	488
C.2	Principles.....	488
C.2.1	Definition of types of information.....	488
C.2.2	Examination by network .....	488
C.2.3	Location of type I information .....	489
C.2.4	Location of types II and III information .....	489
C.2.5	Relationship between bearer capability and low layer compatibility information elements .....	489
<b>Annex D (informative): Examples of bearer capability information element coding .....</b>		<b>490</b>
D.1	Coding for speech for a full rate support only mobile station.....	490
D.1.1	Mobile station to network direction .....	490
D.1.2	Network to mobile station direction .....	490
D.2	An example of a coding for modem access with V22-bis, 2,4 kbit/s, 8 bit no parity.....	491
D.2.1	Mobile station to network direction, data compression allowed .....	491
D.2.2	Network to mobile station direction, data compression possible .....	492
D.3	An example of a coding for group 3 facsimile (9,6 kbit/s, transparent).....	493
D.3.1	Mobile station to network direction .....	493
D.3.2	Network to mobile station direction .....	494
<b>Annex E (informative): Comparison between call control procedures specified in 3GPP TS 24.008 and ITU-T Recommendation Q.931.....</b>		<b>495</b>
<b>Annex F (informative): A/Gb mode specific cause values for radio resource management .....</b>		<b>499</b>
<b>Annex G (informative): 3GPP specific cause values for mobility management.....</b>		<b>500</b>
G.1	Causes related to MS identification.....	500
G.2	Cause related to subscription options.....	500
G.3	Causes related to PLMN specific network failures and congestion/Authentication Failures.....	501
G.4	Causes related to nature of request.....	501
G.5	Causes related to invalid messages .....	501
G.6	Additional cause codes for GMM .....	502
<b>Annex H (informative): 3GPP specific cause values for call control.....</b>		<b>503</b>
H.1	Normal class.....	503
H.1.1	Cause No. 1 "unassigned (unallocated) number" .....	503
H.1.2	Cause No. 3 "no route to destination" .....	503
H.1.3	Cause No. 6 "channel unacceptable" .....	503
H.1.4	Cause No. 8 "operator determined barring" .....	503
H.1.5	Cause No.16 "normal call clearing" .....	503
H.1.6	Cause No.17 "user busy" .....	503
H.1.7	Cause No. 18 "no user responding" .....	503
H.1.8	Cause No. 19 "user alerting, no answer" .....	503
H.1.9	Cause No. 21 "call rejected" .....	504
H.1.10	Cause No. 22 "number changed".....	504
H.1.11	Cause No. 25 "pre-emption".....	504
H.1.12	Cause No. 26 "non-selected user clearing".....	504

H.1.13	Cause No. 27 "destination out of order" .....	504
H.1.14	Cause No. 28 "invalid number format (incomplete number)" .....	504
H.1.15	Cause No. 29 "facility rejected" .....	504
H.1.16	Cause No. 30 "response to STATUS ENQUIRY" .....	504
H.1.17	Cause No. 31 "normal, unspecified" .....	504
H.2	Resource unavailable class .....	504
H.2.1	Cause No. 34 "no circuit/channel available" .....	504
H.2.2	Cause No. 38 "network out of order" .....	505
H.2.3	Cause No. 41 "temporary failure" .....	505
H.2.4	Cause No. 42 "switching equipment congestion" .....	505
H.2.5	Cause No. 43 "access information discarded" .....	505
H.2.6	Cause No. 44 "requested circuit/channel not available" .....	505
H.2.7	Cause No. 47 "resource unavailable, unspecified" .....	505
H.3	Service or option not available class .....	505
H.3.1	Cause No. 49 "quality of service unavailable" .....	505
H.3.2	Cause No. 50 "Requested facility not subscribed" .....	505
H.3.3	Cause No. 55 "Incoming calls barred within the CUG" .....	505
H.3.4	Cause No. 57 "bearer capability not authorized" .....	506
H.3.5	Cause No. 58 "bearer capability not presently available" .....	506
H.3.6	Cause No. 63 "service or option not available, unspecified" .....	506
H.3.7	Cause No. 68 "ACM equal to or greater than ACMmax" .....	506
H.4	Service or option not implemented class .....	506
H.4.1	Cause No. 65 "bearer service not implemented" .....	506
H.4.2	Cause No. 69 "Requested facility not implemented" .....	506
H.4.3	Cause No. 70 "only restricted digital information bearer capability is available" .....	506
H.4.4	Cause No. 79 "service or option not implemented, unspecified" .....	506
H.5	Invalid message (e.g., parameter out of range) class .....	506
H.5.1	Cause No. 81 "invalid transaction identifier value" .....	506
H.5.2	Cause No. 87 "user not member of CUG" .....	507
H.5.3	Cause No. 88 "incompatible destination" .....	507
H.5.4	Cause No. 91 "invalid transit network selection" .....	507
H.5.5	Cause No. 95 "semantically incorrect message" .....	507
H.6	Protocol error (e.g., unknown message) class .....	507
H.6.1	Cause No. 96 "invalid mandatory information" .....	507
H.6.2	Cause No. 97 "message type non-existent or not implemented" .....	507
H.6.3	Cause No. 98 "message type not compatible with protocol state" .....	507
H.6.4	Cause No. 99 "information element non-existent or not implemented" .....	507
H.6.5	Cause No. 100 "conditional IE error" .....	507
H.6.6	Cause No. 101 "message not compatible with protocol state" .....	508
H.6.7	Cause No. 102 "recovery on timer expiry" .....	508
H.6.8	Cause No. 111 "protocol error, unspecified" .....	508
H.7	Interworking class .....	508
H.7.1	Cause No. 127 "interworking, unspecified" .....	508
<b>Annex I (informative): GPRS specific cause values for GPRS Session Management.....</b>		<b>509</b>
I.1	Causes related to nature of request .....	509
I.2	Causes related to invalid messages .....	511
<b>Annex J (informative): Algorithm to encode frequency list information elements .....</b>		<b>512</b>
<b>Annex K (informative): Default Codings of Information Elements .....</b>		<b>513</b>
K.1	Common information elements .....	513
K.2	Radio Resource management information elements .....	513
K.3	Mobility management information elements .....	513
K.4	Call control information elements .....	514

<b>Annex L (normative):</b>	<b>Establishment cause (Iu mode only).....</b>	<b>516</b>
L.1	Mapping of NAS procedure to RRC establishment cause(Iu mode only).....	516
<b>Annex M (normative):</b>	<b>Additional Requirements for backward compatibility with PCS 1900 for NA revision 0 ME.....</b>	<b>518</b>
<b>Annex N (normative):</b>	<b>Ranking of reject causes for Location Registration (MM and GMM) in a shared network .....</b>	<b>519</b>
<b>Annex O (informative):</b>	<b>Change Record.....</b>	<b>520</b>
History .....		527

---

## Foreword

This Technical Specification has been produced by the 3<sup>rd</sup> Generation Partnership Project (3GPP).

The contents of the present document are subject to continuing work within the TSG and may change following formal TSG approval. Should the TSG modify the contents of the present document, it will be re-released by the TSG with an identifying change of release date and an increase in version number as follows:

Version x.y.z

where:

- x the first digit:
  - 1 presented to TSG for information;
  - 2 presented to TSG for approval;
  - 3 or greater indicates TSG approved document under change control.
- y the second digit is incremented for all changes of substance, i.e. technical enhancements, corrections, updates, etc.
- z the third digit is incremented when editorial only changes have been incorporated in the document.

---

## Introduction

The present document includes references to features which are not part of the Phase 2+ Release 96 of the GSM Technical specifications. All subclauses which were changed as a result of these features contain a marker (see table below) relevant to the particular feature.

The following table lists all features that were introduced after GSM Release 96.

Feature	Designator
BA Range IE handling	\$(impr-BA-range-handling)\$
Advanced Speech Call Item	\$(ASCI)\$
Call Completion Busy Subscriber	\$(CCBS)\$
Mobile Assisted Frequency Allocation	\$(MAFA)\$
Network Indication of Alerting in MS	\$(NIA)\$



---

# 1 Scope

The present document specifies the procedures used at the radio interface core network protocols within the 3<sup>rd</sup> generation mobile telecommunications system and the digital cellular telecommunications system.

It specifies the procedures used at the radio interface (Reference Point Um or Uu, see 3GPP TS 24.002 or 3GPP TS 23.002) for Call Control (CC), Mobility Management (MM), and Session Management (SM).

When the notations for "further study" or "FS" or "FFS" are present in this TS they mean that the indicated text is not a normative portion of the present document.

These procedures are defined in terms of messages exchanged over the control channels of the radio interface. The control channels are described in 3GPP TS 44.003 and 3GPP TS 25.301.

The structured functions and procedures of this protocol and the relationship with other layers and entities are described in general terms in 3GPP TS 24.007.

## 1.1 Scope of the Technical Specification

The procedures currently described in this TS are for the call control of circuit-switched connections, session management for GPRS services, mobility management and radio resource management for circuit-switched and GPRS services.

3GPP TS 24.010 contains functional procedures for support of supplementary services.

3GPP TS 24.011 contains functional procedures for support of point-to-point short message services.

3GPP TS 24.012 contains functional description of short message - cell broadcast.

3GPP TS 44.060 [76] contains procedures for radio link control and medium access control (RLC/MAC) of packet data physical channels.

3GPP TS 44.071 [23a] contains functional descriptions and procedures for support of location services.

NOTE: "layer 3" includes the functions and protocols described in the present document. The terms "data link layer" and "layer 2" are used interchangeably to refer to the layer immediately below layer 3.

## 1.2 Application to the interface structures

The procedures defined in the present document apply to the interface structures defined in 3GPP TS 44.003 and 3GPP TS 25.301. They use the functions and services provided by lower layers defined in 3GPP TS 44.005 and 3GPP TS 44.006 or 3GPP TS 25.331 [23c], 3GPP TS 25.322 and 3GPP TS 25.321. 3GPP TS 24.007 [20] gives the general description of layer 3 (A/Gb mode) and Non Access Stratum (Iu mode) including procedures, messages format and error handling.

## 1.3 Structure of layer 3 procedures

A building block method is used to describe the layer 3 procedures.

The basic building blocks are "elementary procedures" provided by the protocol control entities of the three sublayers, i.e. radio resource management, mobility management and connection management sublayer.

Complete layer 3 transactions consist of specific sequences of elementary procedures. The term "structured procedure" is used for these sequences.

## 1.4 Test procedures

Test procedures of the GSM radio interface signalling are described in 3GPP TS 51.010 and 3GPP TS 51.02x series.

## 1.5 Use of logical channels in A/Gb mode

The logical control channels are defined in 3GPP TS 45.002 [32]. In the following those control channels are considered which carry signalling information or specific types of user packet information:

- i) Broadcast Control CHannel (BCCH): downlink only, used to broadcast Cell specific information;
- ii) Synchronization CHannel (SCH): downlink only, used to broadcast synchronization and BSS identification information;
- iii) Paging CHannel (PCH): downlink only, used to send page requests to Mobile Stations (MSs);
- iv) Random Access CHannel (RACH): uplink only, used to request a Dedicated Control CHannel;
- v) Access Grant CHannel (AGCH): downlink only, used to allocate a Dedicated Control CHannel;
- vi) Standalone Dedicated Control CHannel (SDCCH): bi-directional;
- vii) Fast Associated Control CHannel (FACCH): bi-directional, associated with a Traffic CHannel;
- viii) Slow Associated Control CHannel (SACCH): bi-directional, associated with a SDCCH or a Traffic CHannel;
- ix) Cell Broadcast CHannel (CBCH): downlink only used for general (not point to point) short message information;
- x) Notification CHannel (NCH): downlink only, used to notify mobile stations of VBS (Voice Broadcast Service) calls or VGCS (Voice Group Call Service) calls.

Two service access points are defined on signalling layer 2 which are discriminated by their Service Access Point Identifiers (SAPI) (see 3GPP TS 44.006):

- i) SAPI 0: supports the transfer of signalling information including user-user information;
- ii) SAPI 3: supports the transfer of user short messages.

Layer 3 selects the service access point, the logical control channel and the mode of operation of layer 2 (acknowledged, unacknowledged or random access, see 3GPP TS 44.005 and 3GPP TS 44.006) as required for each individual message.

## 1.6 Overview of control procedures

### 1.6.1 List of procedures

The following procedures are specified in the present document:

- a) Clause 4 specifies elementary procedures for Mobility Management:
  - mobility management common procedures (subclause 4.3):
    - TMSI reallocation procedure (subclause 4.3.1);
    - authentication procedure (subclause 4.3.2);
    - identification procedure (subclause 4.3.3);
    - IMSI detach procedure (subclause 4.3.4);
    - abort procedure (subclause 4.3.5);
    - MM information procedure (subclause 4.3.6).
  - mobility management specific procedures (subclause 4.4):
    - location updating procedure (subclause 4.4.1);
    - periodic updating (subclause 4.4.2);

- IMSI attach procedure (subclause 4.4.3);
  - generic location updating procedure (subclause 4.4).
  - connection management sublayer service provision:
    - mobility management connection establishment (subclause 4.5.1);
    - mobility management connection information transfer phase (subclause 4.5.2);
    - mobility management connection release (subclause 4.5.3).
  - GPRS specific mobility management procedures (subclause 4.7):
    - GPRS attach procedure (subclause 4.7.3);
    - GPRS detach procedure (subclause 4.7.4);
    - GPRS routing area updating procedure (subclause 4.7.5).
  - GPRS common mobility management procedures (subclause 4.7):
    - GPRS P-TMSI reallocation procedure (subclause 4.7.6);
    - GPRS authentication and ciphering procedure (subclause 4.7.7);
    - GPRS identification procedure (subclause 4.7.8);
    - GPRS information procedure (subclause 4.7.12).
- b) Clause 5 specifies elementary procedures for circuit switched Call Control comprising the following elementary procedures:
- mobile originating call establishment (subclause 5.2.1);
  - mobile terminating call establishment (subclause 5.2.2);
  - signalling procedures during the active state (subclause 5.3):
    - user notification procedure (subclause 5.3.1);
    - call rearrangements (subclause 5.3.2);
    - DTMF protocol control procedure (subclause 5.5.7);
    - in-call modification (subclause 5.3.4).
  - call clearing initiated by the mobile station (subclause 5.4.3);
  - call clearing initiated by the network (subclause 5.4.4);
  - miscellaneous procedures:
    - in-band tones and announcements (subclause 5.5.1);
    - status enquiry procedure (subclause 5.5.3);
    - call re-establishment procedure (subclause 5.5.4).
- d) Clause 6 specifies elementary procedures for session management:
- GPRS session management procedures (subclause 6.1):
    - PDP context activation (subclause 6.1.3.1 and 6.1.3.2);
    - PDP context modification (subclause 6.1.3.3);
    - PDP context deactivation (subclause 6.1.3.4).

- MBMS context activation (subclause 6.1.3.8);
- MBMS context deactivation (subclause 6.1.3.9).

The elementary procedures can be combined to form structured procedures. Examples of such structured procedures are given in clause 7. This part of the present document is only provided for guidance to assist implementations.

Clause 8 specifies actions to be taken on various error conditions and also provides rules to ensure compatibility with future enhancements of the protocol.

## 1.7 Applicability of implementations

The applicability of procedures of the present document for the mobile station is dependent on the services and functions which are to be supported by a mobile station.

### 1.7.1 Voice Group Call Service (VGCS) and Voice Broadcast Service (VBS)

Voice Group Call Service and Voice Broadcast Service are applicable in A/Gb mode only.

For mobile stations supporting the Voice Group Call Service or the Voice Broadcast Service, it is explicitly mentioned throughout the present document if a certain procedure is applicable only for such a service and, if necessary, how mobile stations not supporting such a service shall behave.

For VGCS and VBS, the following possible mobile station implementations exist:

- support of listening to voice broadcast calls (VBS listening);
- support of originating a voice broadcast call (VBS originating);
- support of listening to voice group calls (VGCS listening);
- support of talking in voice group calls (VGCS talking. This always includes the implementation for VGCS listening);
- support of originating a voice group call (VGCS originating. This always includes the implementation for VGCS talking).

Apart from the explicitly mentioned combinations, all possible combinations are optional and supported by the present document.

The related terms are used in the present document, if information on these implementation options is required.

### 1.7.2 General Packet Radio Service (GPRS)

#### 1.7.2.1 Packet services in GSM (A/Gb mode only)

For mobile stations supporting the General Packet Radio Service (GPRS), it is explicitly mentioned throughout the technical specification if a certain procedure is applicable only for such a service and, if necessary, how mobile stations not supporting such a service shall behave.

A GPRS MS may operate in one of the following MS operation modes, see 3GPP TS 23.060 [74]:

- MS operation mode A;
- MS operation mode B; or
- MS operation mode C.

The MS operation mode depends on the services that the MS is attached to, i.e., only GPRS or both GPRS and non-GPRS services, and upon the MS's capabilities to operate GPRS and other GSM services simultaneously. Mobile stations that are capable to operate GPRS services are referred to as GPRS MSs.

NOTE: Other GSM technical specifications may refer to the MS operation modes A, B, and C as GPRS class-A MS, GPRS class-B MS, and GPRS class-C MS.

It should be noted that it is possible that for a GPRS MS, the GMM procedures currently described in the ETS do not support combinations of VGCS, VBS and GPRS. The possible interactions are not studied yet.

### 1.7.2.2 Packet services in lu mode (lu mode only)

An MS attached to packet switched domain may operate in one of the following MS operation modes, see 23.060 [74]:

- PS/CS mode of operation; or
- PS mode of operation.

The terms 'PS/CS mode of operation' and 'PS mode of operation' are not used in the present document with some exceptions. Instead the terms 'MS operation mode A' and 'MS operation mode C' are used.

In network operation mode I and II (see 3GPP TS 23.060 [74]), an MS in PS/CS mode of operation shall use the same procedures as for a GPRS MS operating in MS operation mode A, unless it is explicitly stated for A/Gb mode only or Iu mode only.

In network operation mode I and II, an MS in PS mode of operation shall use the same procedures as for a GPRS MS operating in MS operation mode C, unless it is explicitly stated for A/Gb mode only or Iu mode only.

NOTE: Network operation mode III is not applicable for Iu mode, see 3GPP TS 23.060 [74].

---

## 2 References

The following documents contain provisions which, through reference in this text, constitute provisions of the present document.

- References are either specific (identified by date of publication, edition number, version number, etc.) or non-specific.
- For a specific reference, subsequent revisions do not apply.
- For a non-specific reference, the latest version applies. In the case of a reference to a 3GPP document (including a GSM document), a non-specific reference implicitly refers to the latest version of that document *in the same Release as the present document*.

- [1] Void.
- [2] Void.
- [2a] 3GPP TR 21.905 "Vocabulary for 3GPP Specifications"
- [3] 3GPP TS 22.002: "Circuit Bearer Services (BS) supported by a Public Land Mobile Network (PLMN)".
- [4] 3GPP TS 22.003: "Teleservices supported by a Public Land Mobile Network (PLMN)".
- [5] 3GPP TS 42.009: "Security aspects".
- [5a] 3GPP TS 33.102: "3G security; Security architecture".
- [6] 3GPP TS 22.011: "Service accessibility".
- [7] 3GPP TS 42.017: "Subscriber Identity Modules (SIM); Functional characteristics".
- [8] 3GPP TS 22.101: "Service aspects; Service principles".
- [8a] 3GPP TS 22.001: "Principles of circuit telecommunication services supported by a Public Land Mobile Network (PLMN)".

- [8b] 3GPP TS 23.038: "Alphabets and language-specific information".
- [9] 3GPP TS 23.101: "General UMTS Architecture".
- [9a] 3GPP TS 23.108: "Mobile radio interface layer 3 specification core network protocols; Stage 2 (structured procedures)".
- [10] 3GPP TS 23.003: "Numbering, addressing and identification".
- [11] 3GPP TS 43.013: "Discontinuous Reception (DRX) in the GSM system".
- [12] 3GPP TS 23.014: "Support of Dual Tone Multi-Frequency (DTMF) signalling".
- [12a] ETSI ES 201 235-2, v1.2.1: "Specification of Dual Tone Multi-Frequency (DTMF); Transmitters and Receivers; Part 2: Transmitters".
- [13] 3GPP TS 43.020: "Security-related network functions".
- [14] 3GPP TS 23.122: "Non-Access-Stratum functions related to Mobile Station (MS) in idle mode".
- [15] 3GPP TS 24.002: "GSM-UMTS Public Land Mobile Network (PLMN) access reference configuration".
- [16] 3GPP TS 44.003: "Mobile Station - Base Station System (MS - BSS) interface; Channel structures and access capabilities".
- [17] 3GPP TS 44.004: "Layer 1; General requirements".
- [18] 3GPP TS 44.005: "Data Link (DL) layer; General aspects".
- [19] 3GPP TS 44.006: "Mobile Station - Base Station System (MS - BSS) interface; Data Link (DL) layer specification".
- [19a] 3GPP TS 25.321: "Medium Access Control (MAC) protocol specification".
- [19b] 3GPP TS 25.322: "Radio Link Control (RLC) protocol specification".
- [19c] 3GPP TS 25.413: "UTRAN Iu interface RANAP signalling".
- [20] 3GPP TS 24.007: "Mobile radio interface signalling layer 3; General aspects".
- [21] 3GPP TS 24.010: "Mobile radio interface layer 3; Supplementary services specification; General aspects".
- [22] 3GPP TS 24.011: "Point-to-Point (PP) Short Message Service (SMS) support on mobile radio interface".
- [23] 3GPP TS 24.012: "Short Message Service Cell Broadcast (SMSCB) support on the mobile radio interface".
- [23a] 3GPP TS 44.071: "Location Services (LCS); Mobile radio interface layer 3 specification."
- [23b] 3GPP TS 44.031 "Location Services LCS); Mobile Station (MS) - Serving Mobile Location Centre (SMLC); Radio Resource LCS Protocol (RRLP)".
- [23c] 3GPP TS 25.331: "Radio Resource Control (RRC) protocol specification"
- [24] 3GPP TS 24.080: "Mobile radio Layer 3 supplementary service specification; Formats and coding".
- [25] 3GPP TS 24.081: "Line identification supplementary services; Stage 3".
- [26] 3GPP TS 24.082: "Call Forwarding (CF) supplementary services; Stage 3".
- [27] 3GPP TS 24.083: "Call Waiting (CW) and Call Hold (HOLD) supplementary services; Stage 3".
- [28] 3GPP TS 24.084: "MultiParty (MPTY) supplementary services; Stage 3".

- [29] 3GPP TS 24.085: "Closed User Group (CUG) supplementary services; Stage 3".
- [30] 3GPP TS 24.086: "Advice of Charge (AoC) supplementary services; Stage 3".
- [31] 3GPP TS 24.088: "Call Barring (CB) supplementary services; Stage 3".
- [32] 3GPP TS 45.002: "Multiplexing and multiple access on the radio path".
- [33] 3GPP TS 45.005: "Radio transmission and reception".
- [34] 3GPP TS 45.008: "Radio subsystem link control".
- [35] 3GPP TS 45.010: "Radio subsystem synchronization".
- [36] 3GPP TS 27.001: "General on Terminal Adaptation Functions (TAF) for Mobile Stations (MS)".
- [36a] 3GPP TS 27.060: "Mobile Station (MS) supporting Packet Switched Services".
- [37] 3GPP TS 29.002: "Mobile Application Part (MAP) specification".
- [38] 3GPP TS 29.007: "General requirements on interworking between the Public Land Mobile Network (PLMN) and the Integrated Services Digital Network (ISDN) or Public Switched Telephone Network (PSTN)".
- [39] 3GPP TS 51.010: "Mobile Station (MS) conformance specification".
- [40] 3GPP TS 51.021: "GSM radio aspects base station system equipment specification".
- [41] ISO/IEC 646 (1991): "Information technology - ISO 7-bit coded character set for information interchange".
- [42] ISO/IEC 6429: "Information technology - Control functions for coded character sets".
- [43] ISO 8348 (1987): "Information technology -- Open Systems Interconnection -- Network Service Definition".
- [44] ITU-T Recommendation E.163: "Numbering plan for the international telephone service".
- [45] ITU-T Recommendation E.164: "The international public telecommunication numbering plan".
- [46] ITU-T Recommendation E.212: "The international identification plan for mobile terminals and mobile users".
- [47] ITU-T Recommendation F.69 (1993): "The international telex service - Service and operational provisions of telex destination codes and telex network identification codes".
- [48] ITU-T Recommendation I.330: "ISDN numbering and addressing principles".
- [49] ITU-T Recommendation I.440 (1989): "ISDN user-network interface data link layer - General aspects".
- [50] ITU-T Recommendation I.450 (1989): "ISDN user-network interface layer 3 General aspects".
- [51] ITU-T Recommendation I.500 (1993): "General structure of the ISDN interworking recommendations".
- [52] ITU-T Recommendation T.50: "International Reference Alphabet (IRA) (Formerly International Alphabet No. 5 or IA5) - Information technology - 7-bit coded character set for information interchange".
- [53] ITU Recommendation Q.931: ISDN user-network interface layer 3 specification for basic control".
- [54] ITU-T Recommendation V.21: "300 bits per second duplex modem standardized for use in the general switched telephone network".
- [55] ITU-T Recommendation V.22: "1200 bits per second duplex modem standardized for use in the general switched telephone network and on point-to-point 2-wire leased telephone-type circuits".

- [56] ITU-T Recommendation V.22bis: "2400 bits per second duplex modem using the frequency division technique standardized for use on the general switched telephone network and on point-to-point 2-wire leased telephone-type circuits".
- [57] Void.
- [58] ITU-T Recommendation V.26ter: "2400 bits per second duplex modem using the echo cancellation technique standardized for use on the general switched telephone network and on point-to-point 2-wire leased telephone-type circuits".
- [59] ITU-T Recommendation V.32: "A family of 2-wire, duplex modems operating at data signalling rates of up to 9600 bit/s for use on the general switched telephone network and on leased telephone-type circuits".
- [60] ITU-T Recommendation V.110: "Support by an ISDN of data terminal equipments with V-Series type interfaces".
- [61] ITU-T Recommendation V.120: "Support by an ISDN of data terminal equipment with V-Series type interfaces with provision for statistical multiplexing".
- [62] ITU-T Recommendation X.21: "Interface between Data Terminal Equipment (DTE) and Data Circuit-terminating Equipment (DCE) for synchronous operation on public data networks".
- [63] Void.
- [64] Void.
- [65] ITU-T Recommendation X.30: "Support of X.21, X.21 bis and X.20 bis based Data Terminal Equipments (DTEs) by an Integrated Services Digital Network (ISDN)".
- [66] ITU-T Recommendation X.31: "Support of packet mode terminal equipment by an ISDN".
- [67] Void.
- [68] Void.
- [69] ITU-T Recommendation X.121: "International numbering plan for public data networks".
- [70] ETSI ETS 300 102-1: "Integrated Services Digital Network (ISDN); User-network interface layer 3; Specifications for basic call control".
- [71] ETSI ETS 300 102-2: "Integrated Services Digital Network (ISDN); User-network interface layer 3; Specifications for basic call control; Specification Description Language (SDL) diagrams".
- [72] ISO/IEC 10646: "Information technology -- Universal Multiple-Octet Coded Character Set (UCS)".
- [73] 3GPP TS 22.060: "General Packet Radio Service (GPRS); Service Description; Stage 1".
- [74] 3GPP TS 23.060: "General Packet Radio Service (GPRS); Service Description; Stage 2".
- [75] 3GPP TS 43.064: "General Packet Radio Service (GPRS); Overall description of the GPRS radio interface; Stage 2".
- [76] 3GPP TS 44.060: "General Packet Radio Service (GPRS); Mobile Station (MS) - Base Station System (BSS) interface; Radio Link Control/Medium Access Control (RLC/MAC) protocol".
- [77] IETF RFC 1034: "Domain names - concepts and facilities".
- [78] 3GPP TS 44.065: "Mobile Station (MS) - Serving GPRS Support Node (SGSN); Subnetwork Dependent Convergence Protocol (SNDCCP)".
- [78a] 3GPP TS 44.064: "Mobile Station - Serving GPRS Support Node (MS-SGSN) Logical Link Control (LLC) Layer Specification".
- [79] ITU Recommendation I.460: "Multiplexing, rate adaption and support of existing interfaces".



- [80] 3GPP TS 26.111: "Codec for Circuit Switched Multimedia Telephony Service; Modifications to H.324".
- [81] 3GPP TS 23.107: "Quality of Service (QoS) concept and architecture".
- [82] 3GPP TS 43.022: "Functions related to Mobile Station (MS) in idle mode and group receive mode".
- [83] 3GPP TS 26.103: "Speech Codec List for GSM and UMTS".
- [84] 3GPP TS 44.018: "Mobile radio interface layer 3 specification, Radio Resource Control Protocol".
- [85] 3GPP TS 48.008: "Mobile-services Switching Centre – Base Station System (MSC – BSS) interface; layer 3 specification".
- [86] 3GPP TS 48.018: "General Packet Radio Service (GPRS); Base Station System (BSS) - Serving GPRS Support Node (SGSN); BSS GPRS Protocol (BSSGP)".
- [87] 3GPP TS 43.055: "Dual Transfer Mode (DTM); Stage 2".
- [88] 3GPP TS 23.067: "enhanced Multi-Level Precedence and Pre-emption service (eMLPP); Stage 2".
- [88a] 3GPP TS 23.093: "Technical realization of Completion of Calls to Busy Subscriber (CCBS); Stage 2".
- [89] 3GPP TS 22.042: "Network Identity and Time Zone (NITZ), Stage 1".
- [90] 3GPP TS 23.040: "Technical realization of Short Message Service (SMS)".
- [91] 3GPP TS 44.056: "GSM Cordless Telephony System (CTS), (Phase 1) CTS Radio Interface Layer 3 Specification".
- [92] 3GPP TS 23.226: "Global Text Telephony; Stage 2 "
- [93] 3GPP TS 26.226: "Cellular Text Telephone Modem (CTM), General Description "
- [94] 3GPP TS 23.236: "Intra Domain Connection of RAN Nodes to Multiple CN Nodes"
- [95] 3GPP TS 24.229: "IP Multimedia Call Control Protocol based on SIP and SDP"
- [96] 3GPP TS 23.205: "Bearer-independent circuit-switched core network; Stage 2".
- [97] 3GPP TS 23.172: "UDI/RDI Fallback and Service Modification; Stage 2".
- [98] 3GPP TS 25.304: "UE Procedures in Idle Mode and Procedures for Cell Reselection in Connected Mode"
- [99] RFC 3513 (April 2003): "Internet Protocol Version 6 (IPv6) Addressing Architecture".
- [100] 3GPP TS 29.207: "Policy control over Gm interface".
- [101] 3GPP TS 21.111: "USIM and IC card requirements".
- [102] RFC 1661 (July 1994): "The Point-to-Point Protocol (PPP)".
- [103] RFC 3232 (January 2002): "Assigned Numbers: RFC 1700 is Replaced by an On-line Database".
- [104] 3GPP TS 23.034: "High Speed Circuit Switched Data (HSCSD) – Stage 2".
- [105] 3GPP TS 23.271: "Functional stage 2 description of LCS".
- [106] 3GPP TS 23.246: "Multimedia Broadcast/Multicast Service (MBMS); Architecture and Functional Description".
- [107] RFC 3376 (October 2002): "Internet Group Management Protocol, Version 3".
- [108] RFC 2710 (October 1999): "Multicast Listener Discovery (MLD) for IPv6".

- [109] 3GPP TS 23.251: "Network Sharing; Architecture and Functional Description".
- [110] 3GPP TS 25.346: 'Introduction of the Multimedia Broadcast Multicast Service (MBMS) in the Radio Access Network'
- [111] 3GPP TS 44.118: "Radio Resource Control (RRC) protocol; Iu mode".
- [112] 3GPP TS 31.102: "Characteristics of the USIM Application".
- [113] 3GPP TS 43.129: "Packet-switched handover for GERAN A/Gb mode; Stage 2".
- [114] 3GPP TS 23.009: "Handover procedures".
- [115] 3GPP TR 23.903: " Redial solution for voice-video switching".

## 2.1 Definitions and abbreviations

For the purposes of the present document, the abbreviations defined in 3GPP TR 21.905 [2a] and the followings apply:

TMGI                      Temporary Mobile Group Identity

### 2.1.1 Random values

In a number of places in the present document, it is mentioned that some value must take a "random" value, in a given range, or more generally with some statistical distribution. Such cases interest only the Mobile Station.

It is required that there is a low probability that two MSs in the same conditions (including the case of two MSs of the same type from the same manufacturer) will choose the same value. Moreover, it is required that, if it happens that two MSs in similar conditions choose the same value, the probability of their choices being identical at the next occasion is the same as if their first choices had been different.

The meaning of such a specification is that any statistical test for these values, done on a series of similar events, will obtain a result statistically compatible with the specified distribution. This shall hold even in the cases where the tests are conducted with a subset of possible events, with some common parameters. Moreover, basic tests of independence of the values within the series shall pass.

Data against which correlation with the values shall not be found are the protocol state, or the IMSI, or identities or other unrelated information broadcast by the network, or the current TDMA frame number.

### 2.2.2 Vocabulary

For the purposes of the present document, the following terms and definitions apply:

- A **GSM security context** is established and stored in the MS and the network as a result of a successful execution of a GSM authentication challenge. The GSM security context consists of the GSM ciphering key and the ciphering key sequence number.
- A **UMTS security context** is established and stored in the MS and the network as a result of a successful execution of a UMTS authentication challenge. The UMTS security context consists of the UMTS ciphering key, the UMTS integrity key, the GSM ciphering key and the cipher key sequence number.
- **idle mode:** In this mode, the mobile station is not allocated any dedicated channel; it listens to the CCCH and the BCCH;
- **group receive mode:** (only applicable for mobile stations supporting VGCS listening or VBS listening) In this mode, the mobile station is not allocated a dedicated channel with the network; it listens to the downlink of a voice broadcast channel or voice group call channel allocated to the cell. Occasionally, the mobile station has to listen to the BCCH of the serving cell as defined in 3GPP TS 43.022 [82] and 3GPP TS 45.008 [34];
- **dedicated mode:** In this mode, the mobile station is allocated at least two dedicated channels, only one of them being a SACCH;

- **group transmit mode:** (only applicable for mobile stations supporting VGCS talking) In this mode, one mobile station of a voice group call is allocated two dedicated channels, one of them being a SACCH. These channels can be allocated to one mobile station at a time but to different mobile stations during the voice group call;
- **packet idle mode:** (only applicable for mobile stations supporting GPRS) In this mode, mobile station is not allocated any radio resource on a packet data physical channel; it listens to the PBCCH and PCCCH or, if those are not provided by the network, to the BCCH and the CCCH, see 3GPP TS 44.060 [76].
- **packet transfer mode:** (only applicable for mobile stations supporting GPRS) In this mode, the mobile station is allocated radio resource on one or more packet data physical channels for the transfer of LLC PDUs.
- **main DCCH:** In Dedicated mode and group transmit mode, only two channels are used as DCCH, one being a SACCH, the other being a SDCCH or a FACCH; the SDCCH or FACCH is called here "the main DCCH";
- A channel is **activated** if it can be used for transmission, in particular for signalling, at least with UI frames. On the SACCH, whenever activated, it must be ensured that a contiguous stream of layer 2 frames is sent;
- A TCH is **connected** if circuit mode user data can be transferred. A TCH cannot be connected if it is not activated. A TCH which is activated but not connected is used only for signalling, i.e. as a DCCH;
- The data link of SAPI 0 on the main DCCH is called the **main signalling link**. Any message specified to be sent on the main signalling link is sent in acknowledged mode except when otherwise specified;
- The term "**to establish**" a link is a short form for "**to establish the multiframe mode**" on that data link. It is possible to send UI frames on a data link even if it is not established as soon as the corresponding channel is activated. Except when otherwise indicated, a data link layer establishment is done without an information field.
- "**channel set**" is used to identify TCHs that carry related user information flows, e.g., in a multislot configuration used to support circuit switched connection(s), which therefore need to be handled together.
- A **temporary block flow** (TBF) is a physical connection used by the two RR peer entities to support the uni-directional transfer of LLC PDUs on packet data physical channels, see 3GPP TS 44.060 [76].
- **RLC/MAC block:** A RLC/MAC block is the protocol data unit exchanged between RLC/MAC entities, see 3GPP TS 44.060 [76].
- A **GMM context** is established when a GPRS attach procedure is successfully completed.

#### - **Network operation mode**

The three different network operation modes I, II, and III are defined in 3GPP TS 23.060 [74].

The network operation mode shall be indicated as system information. For proper operation, the network operation mode should be the same in each cell of one routing area.

#### - **GPRS MS operation mode**

The three different GPRS MS operation modes A, B, and C are defined in 3GPP TS 23.060 [74].

- **RR connection:** A RR connection is a dedicated physical circuit switched domain connection used by the two RR or RRC peer entities to support the upper layers' exchange of information flows.
- **PS signalling connection** is a peer to peer Iu mode connection between MS and CN packet domain node.
- **Inter-System change** is a change of an MS from A/Gb mode to Iu mode of operation or vice versa.
- **GPRS:** Packet Services for systems which operate the Gb or Iu-PS interfaces.
- The label (**A/Gb mode only**) indicates this section or paragraph applies only to a system which operates in A/Gb mode, i.e. with a functional division that is in accordance with the use of an A or a Gb interface between the radio access network and the core network. For multi system case this is determined by the current serving radio access network.
- The label (**Iu mode only**) indicates this section or paragraph applies only to a system which operates in Iu mode. The Iu mode includes UTRAN and GERAN Iu modes, i.e. with a functional division that is in accordance

with the use of an Iu-CS or Iu-PS interface between the radio access network and the core network. For multi system case this is determined by the current serving radio access network.

- **In A/Gb mode,...** Indicates this paragraph applies only to a system which operates in A/Gb mode. For multi system case this is determined by the current serving radio access network.
- **In Iu mode,...** Indicates this paragraph applies only to a system which operates in Iu mode. The Iu mode includes both UTRAN Iu mode and GERAN Iu mode. For multi system case this is determined by the current serving radio access network.
- **In A/Gb mode and GERAN Iu mode,...** Indicates this paragraph applies only to a system which operates in A/Gb mode or GERAN Iu mode. For multi system case this is determined by the current serving radio access network.
- **In UTRAN Iu mode,...** Indicates this paragraph applies only to a system which operates in UTRAN Iu mode. For multi system case this is determined by the current serving radio access network.
- **In a shared network,...** Indicates this paragraph applies only to a shared network. For the definition of shared network see 3GPP TS 23.122 [14].
- **SIM**, Subscriber Identity Module (see 3GPP TS 42.017 [7]).
- **USIM**, Universal Subscriber Identity Module (see 3GPP TS 21.111 [101]).
- **MS**, Mobile Station. The present document makes no distinction between MS and UE.
- **Cell Notification** is an (optimised) variant of the Cell Update Procedure which uses the LLC NULL frame for cell change notification which does not trigger the restart of the READY timer
- **DTM**: dual transfer mode, see 3GPP TS 44.018 [84] and 3GPP TS 43.055 [87]

---

## 3 Radio Resource management procedures

See 3GPP TS 44.018 [84].

---

## 4 Elementary procedures for Mobility Management

### 4.1 General

This clause describes the procedures used for mobility management for non-GPRS services and for GPRS-services at the radio interface (Reference Point Um and Uu).

The main function of the Mobility Management sublayer is to support the mobility of user terminals, such as informing the network of its present location and providing user identity confidentiality.

A further function of the MM sublayer is to provide connection management services to the different entities of the upper Connection Management (CM) sublayer (see 3GPP TS 24.007).

There are two sets of procedures defined in this chapter:

- MM procedures for non-GPRS services (performed by the MM entity of the MM sublayer); and
- GMM procedures for GPRS services (performed by the GMM entity of the MM sublayer), see 3GPP TS 24.007 [20].

All the MM procedures described in this clause can only be performed if a RR connection has been established between the MS and the network. Else, the MM sublayer has to initiate the establishment of a RR connection (see 3GPP TS 44.018 [84] clause 3.3 and 3GPP TS 25.331 [23c]).

In A/Gb mode, the GMM procedures described in this clause, use services provided by the RR sublayer without prior RR connection establishment.

In Iu mode: all the GMM procedures described in this clause can only be performed if a PS signalling connection has been established between the MS and the network. Else, the GMM sublayer has to initiate the establishment of a PS signalling connection (see 3GPP TS 25.331 [23c]).

GMM procedures are mandatory and applicable only for GPRS MSs and networks supporting those MSs. For GPRS MSs which are IMSI attached for both GPRS and non-GPRS services, some MM procedures are replaced by GMM combined procedures provided that the network operates in network operation mode I, i.e. is supporting combined GMM procedures. GMM combined procedures are not applicable for the GPRS MS operation mode C but are mandatory for the GPRS MS operation modes A and B and networks supporting network operation mode I, see 3GPP TS 23.060 [74].

## 4.1.1 MM and GMM procedures

### 4.1.1.1 Types of MM and GMM procedures

Depending on how they can be initiated, three types of MM procedures can be distinguished:

#### 1) MM common procedures:

A MM common procedure can always be initiated whilst a RR connection exists. The procedures belonging to this type are:

Initiated by the network:

- TMSI reallocation procedure;
- authentication procedure;
- identification procedure;
- MM information procedure;
- abort procedure.

However, abort procedure is used only if an MM connection is being established or has already been established i.e. not during MM specific procedures or during IMSI detach procedure, see subclause 4.3.5.

Initiated by the mobile station:

- IMSI detach procedure (with the exceptions specified in subclause 4.3.4).

#### 2) MM specific procedures:

A MM specific procedure can only be initiated if no other MM specific procedure is running or no MM connection exists. The procedures belonging to this type are:

- normal location updating procedure;
- periodic updating procedure;
- IMSI attach procedure.

#### 3) MM connection management procedures:

These procedures are used to establish, maintain and release a MM connection between the mobile station and the network, over which an entity of the upper CM layer can exchange information with its peer. A MM connection establishment can only be performed if no MM specific procedure is running. More than one MM connection may be active at the same time.

Depending on how they can be initiated, three types of GMM procedures can be distinguished:

#### 1) GMM common procedures:

In Iu mode, a GMM common procedure can always be initiated whilst a PS signalling connection exists.

The procedures belonging to this type are:

Initiated by the network when a GMM context has been established:

- P-TMSI (re-) allocation;
- GPRS authentication and ciphering;
- GPRS identification;
- GPRS information.

2) GMM specific procedures:

Initiated by the network and used to detach the IMSI in the network for GPRS services and/or non-GPRS services and to release a GMM context:

- GPRS detach.

Initiated by the MS and used to attach or detach the IMSI in the network for GPRS services and/or non-GPRS services and to establish or release a GMM context:

- GPRS attach and combined GPRS attach;
- GPRS detach and combined GPRS detach.

Initiated by the MS when a GMM context has been established:

- normal routing area updating and combined routing area updating;
- periodic routing area updating.

3) GMM connection management procedures (Iu mode only):

Initiated by the MS and used to establish a secure connection to the network and/or to request the resource reservation for sending data:

Service Request.

The Service Request procedure can only be initiated if no MS initiated GMM specific procedure is ongoing.

#### 4.1.1.1.1 Integrity Checking of Signalling Messages in the Mobile Station (Iu mode only)

In Iu mode only, integrity protected signalling is mandatory with one exception regarding emergency calls (see subclause 4.1.1.1.1a). In Iu mode only, all layer 3 protocols shall use integrity protected signalling once the security mode procedure has been successfully activated in the network and the MS. Integrity protection of all layer 3 signalling messages is the responsibility of lower layers. It is the network which activates integrity protection. This is done using the security mode control procedure (3GPP TS 25.331 [23c] and 3GPP TS 44.118 [111]).

The supervision that integrity protection is activated shall be the responsibility of the MM and GMM layer in the MS (see 3GPP TS 33.102 [5a]). In order to do this, the lower layers shall provide the MM and GMM layer with an indication on when the integrity protection is activated in the MS (i.e. one indication to the MM layer when a security mode control procedure for the CS domain is processed successfully and one indication to the GMM layer when a security mode control procedure for the PS domain is processed successfully).

The CS and PS domains in the network and the MM and GMM layers in the MS, are not aware of whether integrity protection has been started in the lower layers by the other domain. It is mandatory for the network to initiate one security mode control procedure for the CS domain and one for the PS domain.

Except the messages listed below, no layer 3 signalling messages shall be processed by the receiving MM and GMM entities or forwarded to the CM entities, unless the security mode control procedure is activated for that domain.

- MM messages:
  - AUTHENTICATION REQUEST
  - AUTHENTICATION REJECT

- IDENTITY REQUEST
- LOCATION UPDATING ACCEPT (at periodic location update with no change of location area or temporary identity)
- LOCATION UPDATING REJECT
- CM SERVICE ACCEPT, if the following two conditions apply:
  - no other MM connection is established; and
  - the CM SERVICE ACCEPT is the response to a CM SERVICE REQUEST with CM SERVICE TYPE IE set to "emergency call establishment"
- CM SERVICE REJECT
- ABORT
- GMM messages:
  - AUTHENTICATION & CIPHERING REQUEST
  - AUTHENTICATION & CIPHERING REJECT
  - IDENTITY REQUEST
  - ATTACH REJECT
  - ROUTING AREA UPDATE ACCEPT (at periodic routing area update with no change of routing area or temporary identity)
  - ROUTING AREA UPDATE REJECT
  - SERVICE REJECT
  - DETACH ACCEPT (for non power-off)

CC messages:

- all CC messages, if the following two conditions apply:
  - no other MM connection is established; and
  - the MM entity in the MS has received a CM SERVICE ACCEPT message with no ciphering or integrity protection applied as response to a CM SERVICE REQUEST message, with CM SERVICE TYPE set to "Emergency call establishment" sent to the network.

The receiving layer 3 entity in the MS shall not process any other layer 3 signalling messages unless they have been successfully integrity checked by the lower layers once integrity protection is activated. If any signalling messages, having not successfully passed the integrity check, are received, then the lower layers in the MS shall discard that message (see 3GPP TS 25.331 [23c] and 3GPP TS 44.118 [111]). If any layer 3 signalling message is received, in either PS or CS domains, as not integrity protected even though the integrity protection has been activated in the MS by that domain in the network, then the lower layers shall discard this message (see 3GPP TS 25.331 [23c] and 3GPP TS 44.118 [111]).

Integrity checking on the network side is performed by the RNC and is described in 3GPP TS 25.331 [23c] and 3GPP TS 44.118 [111].

#### 4.1.1.1.1a Integrity protection for emergency call (lu mode only)

The network should initiate the security mode procedure for an emergency call, in the same way as it would for any other call except in the cases defined in sub-clause "Security Procedures Not Applied" in 3GPP TS 33.102 [5a].

For the establishment of a MM connection for an emergency call when no other MM connection is established (e.g. for an emergency call initiated without a SIM/USIM no other MM connections can exist) the decision on whether or not to

apply the security procedures shall be made by the network as defined in the sub-clause "Emergency Call Handling" in 3GPP TS 33.102 [5a].

#### 4.1.1.2 MM-GMM co-ordination for GPRS MS's

##### 4.1.1.2.1 GPRS MS operating in mode A or B in a network that operates in mode I

If the network operates in mode I, GPRS MSs that operate in mode A or B and wish to be or are simultaneously IMSI attached for GPRS and non-GPRS services, shall use the combined GPRS attach and the combined and periodic routing area updating procedures instead of the corresponding MM specific procedures IMSI attach and normal and periodic location area updating.

NOTE: A GPRS MS operating in mode A or B in a network that operates in mode I, shall perform the combined GPRS attach or routing area update procedure regardless the value of the ATT flag.

If a GPRS MS is operating in mode A or B in a network that operates in mode I the IMSI detach shall be performed by the GMM using the combined GPRS detach procedure.

NOTE: A GPRS MS operating in mode A or B in a network that operates in mode I, shall perform the combined GPRS detach procedure regardless the value of the ATT flag.

A GPRS MS operating in mode A or B in network that operates in mode I, shall use the combined GMM specific procedures in place of the MM specific procedures unless the re-activation of the MM specific procedures is explicitly described, so all conditions describing when to trigger a MM specific procedure listed in subclauses 4.3 and 4.4 shall not apply.

A GPRS MS operating in mode A or B in a network that operates in mode I should not use any MM timers relating to MM specific procedures, (e.g T3210, T3211, T3212, T3213) unless the re-activation of the MM specific procedures is explicitly described. If the MM timers are already running, the MS should not react on the expiration of the timers.

NOTE: Whenever GMM performs a combined GMM procedure, a GPRS MS enters the MM state MM LOCATION UPDATING PENDING in order to prevent the MM to perform a location update procedure.

If the authentication procedure is performed by MM and the authentication is rejected by the network (i.e upon receive of AUTHENTICATION REJECT), the MS shall in addition set the GPRS update status to GU3 ROAMING NOT ALLOWED and shall, if available, delete the P-TMSI, P-TMSI signature, RAI and GPRS ciphering key sequence number stored. The SIM/USIM shall be considered as invalid for GPRS and non-GPRS services until switching off or the SIM/USIM is removed. The MS shall abort any GMM procedure and shall enter state GMM-DEREGISTERED.

If the PS or CS domain is barred because of domain specific access control, a GPRS MS operating in mode A or B in a network that operates in mode I shall act as if in network operation mode II or III (depending on whether a PCCCH is present in Gb-mode) and access to the barred domain shall be stopped entirely. If the MS detects that a domain is barred, this shall not trigger any MM or GMM specific procedure.

A GPRS MS operating in mode A or B in a network that operates in mode I shall perform a normal location updating procedure (in order to remove the Gs association in the MSC/VLR) when the following conditions are fulfilled:

- the GPRS MS has camped on a cell where the PS domain is barred and the CS domain is unbarred; and
- T3312, T3311, T3302, or T3330 expires.

Additionally the MS shall treat the expiry of T3312 when the PS domain changes from barred to unbarred, analogous to the descriptions for the cases when the timer expires out of coverage or in a cell that does not support GPRS (see subclause 4.7.2.2).

If timer T3312 expires and both the PS and CS domain are barred, then a GPRS MS operating in mode A or B in a network that operates in mode I shall treat the expiry of T3312 when the GPRS MS detects that the PS or CS domain becomes unbarred, analogous to the descriptions for the cases when the timer expires out of coverage (see subclause 4.7.2.2).

If the PS domain is barred and timer T3312 expires during an ongoing CS connection, then a GPRS MS operating in mode A or B in a network that operates in mode I shall treat the expiry of T3312 when the MM state MM-IDLE is entered, analogous to the descriptions for the cases when the timer expires out of coverage or in a cell that does not support GPRS (see subclause 4.7.2.2), or in a cell where the PS domain is barred.



A GPRS MS operating in mode A or B in a network that operates in mode I shall perform a combined routing area update procedure indicating "combined RA/LA updating with IMSI attach" (in order to establish the Gs association in the MSC/VLR) when the following conditions are fulfilled:

- the GPRS MS detects that CS or PS domain or both change from barred to unbarred;
- as a result of the change of the domain specific barring status, both domains are unbarred; and
- for the last attempt to update the registration of the location area an MM specific procedure was performed (see subclause 4.7.5.2.1) or for the last attempt to update the registration of the routing area a normal routing area update was performed.

#### 4.1.1.2.2 GPRS MS operating in mode A or B in a network that operates in mode II or III

If the network operates in mode II or III, a GPRS MSs that operate in mode A or B and wish to be or are simultaneously IMSI attached for GPRS and non-GPRS services, shall use the MM specific procedures listed in subclauses 4.3 and 4.4 and the GMM specific procedures listed in subclauses 4.7.3, 4.7.4 and 4.7.5. The applicability of periodic location updating is further specified in subclause 4.4.2 and the periodic routing area updating is specified in subclause 4.7.2.2.

If the authentication procedure is performed by MM and the authentication is rejected by the network (i.e upon receive of AUTHENTICATION REJECT), the MS shall in addition set the GPRS update status to GU3 ROAMING NOT ALLOWED and shall, if available, delete the P-TMSI, P-TMSI signature, RAI and GPRS ciphering key sequence number stored. The SIM/USIM shall be considered as invalid for GPRS and non-GPRS services until switching off or the SIM/USIM is removed. The MS shall abort any GMM procedure and shall enter state GMM-DEREGISTERED.

If the PS or CS domain is barred because of domain specific access control, a GPRS MS operating in mode A or B in a network that operates in mode II or III shall use the MM specific procedures or GMM specific procedures, respectively, in the domain which is unbarred. If the MS detects that a domain changes from barred to unbarred, it shall behave as specified in subclauses 4.4.4.9, 4.5.1.2, 4.7.3.1.5, 4.7.5.1.5, and 4.7.13.5.

#### 4.1.1.3 Core Network System Information for MM (lu mode only)

In the network broadcast system information some of the system information is used by MM.

At reception of new system information, the RRC layer in the MS delivers the contents of the CN common system information and the CS domain specific system information to the MM layer in the MS.

The Core Network system information is included in specific information elements within some RRC messages sent to MS (see 3GPP TS 25.331 [23c] and 3GPP TS 44.118 [111]). In the Core Network system information the Common system information part and the CS domain specific system information part contains settings of parameters controlling MM functionality. No MM messages contain the Core Network System Information.

#### 4.1.1.4 Core Network System Information for GMM (lu mode only)

In the network broadcast system information some of the system information is used by GMM.

At reception of new system information, the RRC layer in the MS delivers the contents of the CN common system information and the PS domain specific system information to the GMM layer in the MS.

The Core Network system information is included in specific information elements within some RRC messages sent to MS (see 3GPP TS 25.331 [23c] and 3GPP TS 44.118 [111]). In the Core Network system information the Common system information part and the PS domain specific system information part contains settings of parameters controlling GMM functionality. No GMM messages contain the Core Network System Information.

### 4.1.2 MM sublayer states

The description of the states for the MM sublayer is organized as follows. The main states for the MS side, related to the procedures, are described in subclause 4.1.2.1.1. The MM IDLE state is subdivided in substates for the description

of the behaviour in idle mode (subclause 4.1.2.1.2). This behaviour depends on an update status, described in subclause 4.1.2.2. The states for the network side are described in subclause 4.1.2.3.

#### 4.1.2.1 MM sublayer states in the mobile station

In this subclause, the possible states for the MM sublayer in the mobile station is described. In figure 4.1 of the present document, an overview of the MM sublayer protocol is given.

##### 4.1.2.1.1 Main states

0 NULL

The mobile station is inactive (e.g. power down). Important parameters are stored. Only manual action by the user may transfer the MM sublayer to another state.

3 LOCATION UPDATING INITIATED

A location updating procedure has been started and the MM awaits a response from the network. The timer T3210 is running.

5 WAIT FOR OUTGOING MM CONNECTION

The MM connection establishment has been started, and the MM awaits a response from the network. The timer T3230 is running.

6 MM CONNECTION ACTIVE

The MM sublayer has a RR connection to its peer entity on the network side. One or more MM connections are active.

7 IMSI DETACH INITIATED

The IMSI detach procedure has been started. The timer T3220 is running.

8 PROCESS CM SERVICE PROMPT

The MM sublayer has a RR connection to its peer entity on the network side. The Mobile Station has received a CM SERVICE PROMPT message but has not yet responded \$(CCBS)\$.

9 WAIT FOR NETWORK COMMAND

The MM sublayer has a RR connection to its peer entity in the network, but no MM connection is established. The mobile station is passive, awaiting further commands from the network. The timer T3240 may be running.

10 LOCATION UPDATE REJECTED

A location updating procedure has been rejected and RR connection release is awaited. The timer T3240 is running.

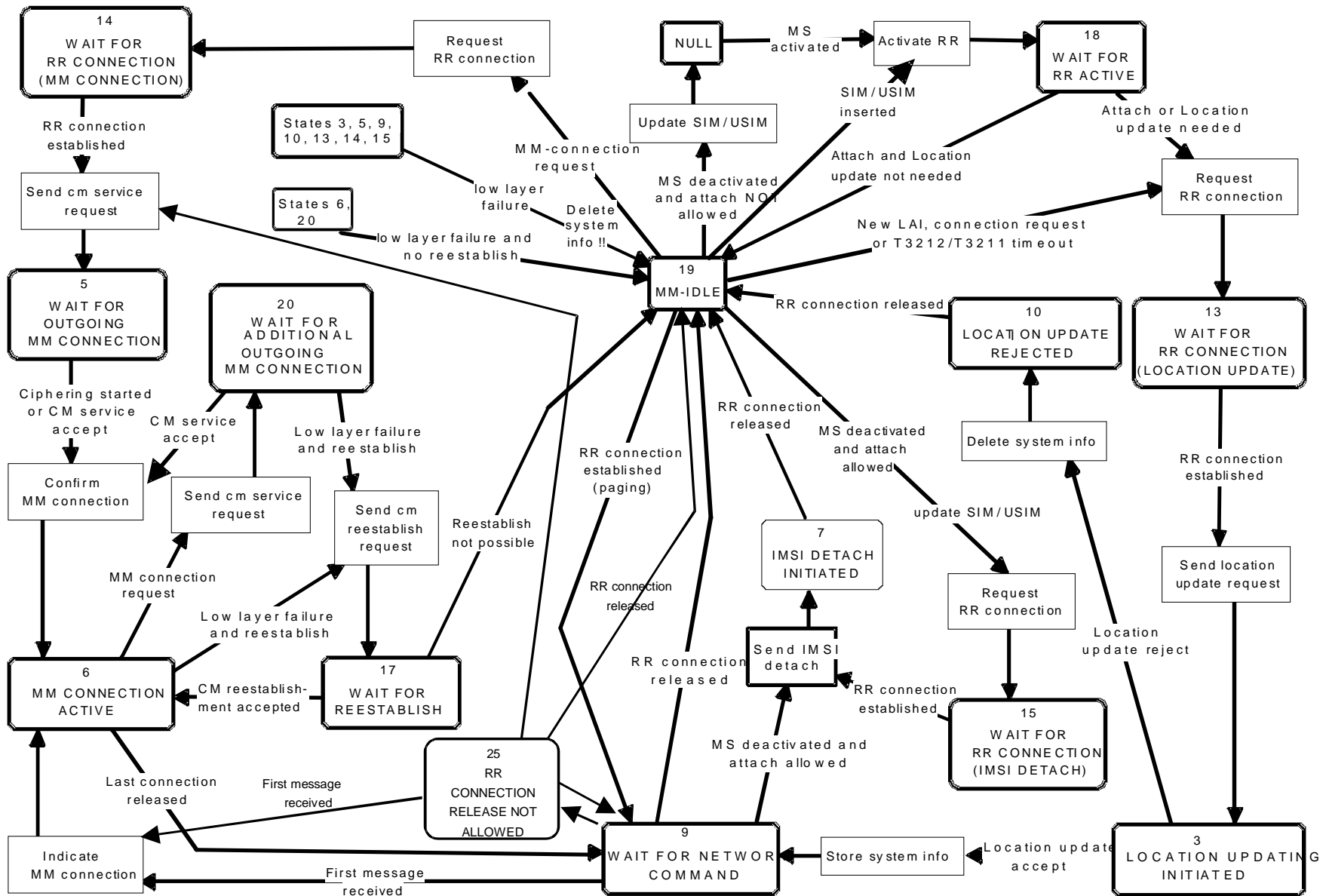
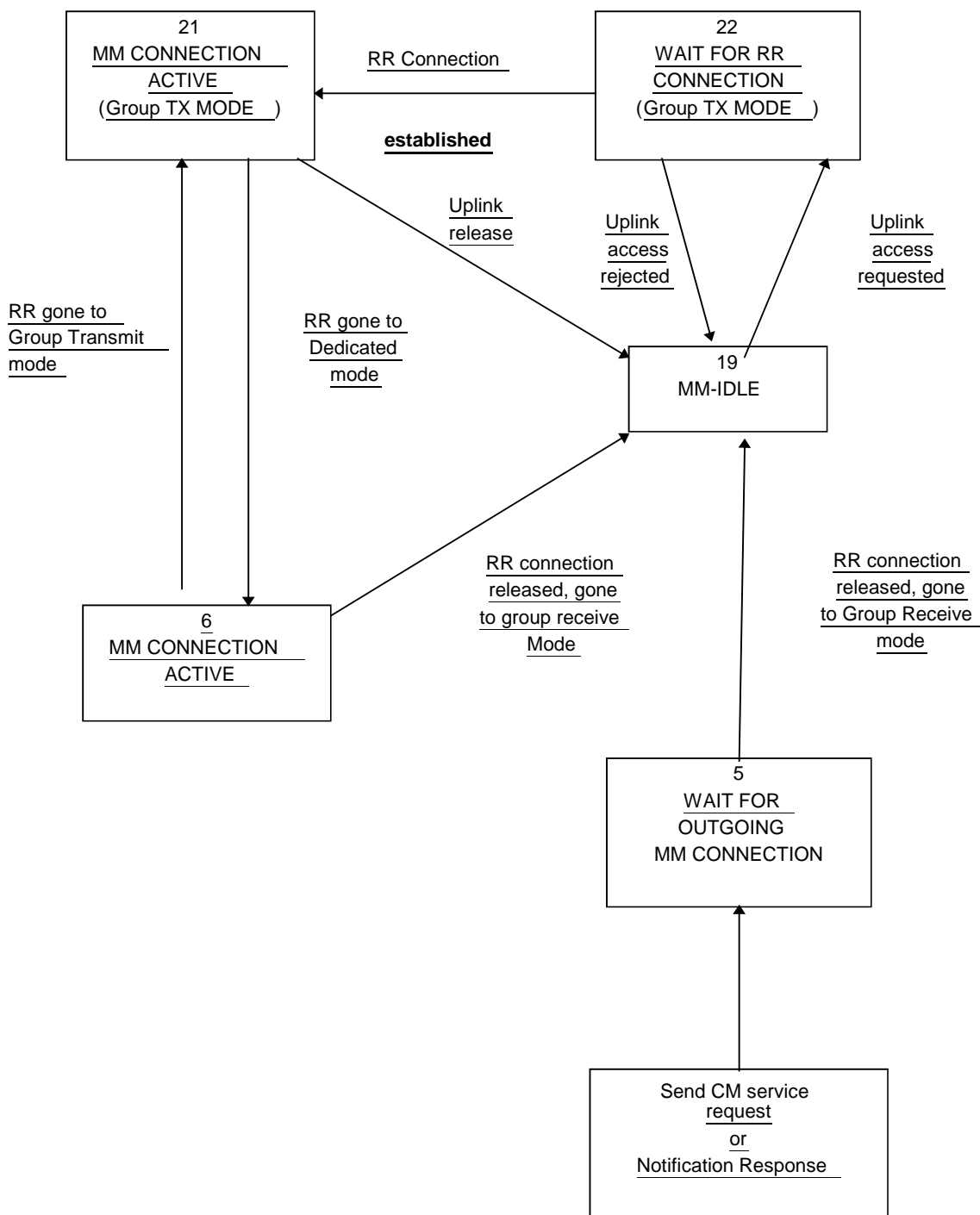

Figure 4.1a/3GPP TS 24.008: Overview mobility management protocol/MS Side



**Additions to Figure 4.1.a/3GPP TS 24.008**

13. WAIT FOR RR CONNECTION (LOCATION UPDATING)

The MM sublayer has requested RR connection establishment for starting the location updating procedure.

14. WAIT FOR RR CONNECTION (MM CONNECTION)

The MM sublayer has requested RR connection establishment for dedicated mode for starting the MM connection establishment.

15. WAIT FOR RR CONNECTION (IMSI DETACH)

The MM sublayer has requested RR connection establishment for starting the IMSI detach procedure.

#### 17. WAIT FOR REESTABLISH

A lower layer failure has occurred and re-establishment may be performed from the disturbed CM layer entities.

#### 18. WAIT FOR RR ACTIVE

The MM sublayer has requested activation of the RR sublayer.

#### 19. MM IDLE

There is no MM procedure running and no RR connection exists except that a local MM context may exist when the RR sublayer is in Group Receive mode. This is a compound state, and the actual behaviour of the mobile station to Connection Management requests is determined by the actual substate as described hereafter.

#### 20. WAIT FOR ADDITIONAL OUTGOING MM CONNECTION.

The MM connection establishment for an additional MM connection has been started, and the MM awaits response from the network.

#### 21. MM CONNECTION ACTIVE (GROUP TRANSMIT MODE)

(Only applicable for mobile stations supporting VGCS talking:;) The MM sublayer has a RR connection on the VGCS channel to its peer entity on the network side. Only one MM connection is active.

#### 22. WAIT FOR RR CONNECTION (GROUP TRANSMIT MODE)

(Only applicable for mobile stations supporting VGCS talking:;) The MM sublayer has requested to perform an uplink access on the VGCS channel.

#### 23. LOCATION UPDATING PENDING

(Only applicable for GPRS MS operation modes A and B; not shown in figure 4.1a) A location updating has been started using the combined GPRS routing area updating procedure.

#### 24. IMSI DETACH PENDING

(Only applicable for GPRS MS operation modes A and B; not shown in figure 4.1a) An IMSI detach for non-GPRS services has been started using the combined GPRS detach procedure at not switching off.

#### 25. RR CONNECTION RELEASE NOT ALLOWED

(Only applicable for mobile stations supporting RRLP procedures (see 3GPP TS 44.031 [23b]) or LCS procedures over RRC (see 3GPP TS 25.331 [23c])). All MM connections are released by their CM entities, but the RR connection is maintained by the network due to an ongoing RRLP procedure or LCS procedure over RRC.

### 4.1.2.1.2 Substates of the MM IDLE state

For the description of the behaviour of the MS the MM IDLE state is subdivided in several substates, also called the service states. The service state pertains to the whole MS (ME alone if no SIM/USIM is inserted, or ME plus SIM/USIM). The service state depends on the update status (see subclause 4.1.2.2) and on the selected cell.

#### 19.1 NORMAL SERVICE

Valid subscriber data are available, update status is U1, a cell is selected that belongs to the LA where the subscriber is registered.

In this state, all requests from the CM layers are treated normally.

#### 19.2 ATTEMPTING TO UPDATE

Valid subscriber data are available, update status is U2 and a cell is selected. Requests from upper layers are accepted. Emergency call requests are treated normally, otherwise the request triggers first a location

updating attempt in the selected cell, and then triggers the needed procedure only in case of successful location updating, otherwise the request is rejected.

#### 19.3 LIMITED SERVICE

Valid subscriber data are available, update status is U3, and a cell is selected, which is known not to be able to provide normal service. Only emergency services are offered.

#### 19.4 NO IMSI

No valid subscriber data (no SIM/USIM, or the SIM/USIM is not considered valid by the ME), and a cell is selected. Only emergency services are offered.

#### 19.5 NO CELL AVAILABLE

No cell can be selected. This state is entered after a first intensive search failed (state 19.7). Cells are searched at a low rhythm. No services are offered.

#### 19.6 LOCATION UPDATE NEEDED

Valid subscriber data are available, and for some reason a location updating must be done as soon as possible (for instance update status is U1 but the selected cell is not in the registered LA, or the timer has expired, ...). This state is usually of no duration, but can last, e.g., if the access class is blocked due to common access class control or CS domain specific access control (see subclause 4.1.1.2.1).

#### 19.7 PLMN SEARCH

The mobile station is searching for PLMNs, and the conditions for state 19.8 are not met. This state is ended when either a cell is selected (the new state is 19.1, 19.3 or 19.6), or when it is concluded that no cell is available for the moment (the new state is 19.5).

#### 19.8 PLMN SEARCH, NORMAL SERVICE

Valid subscriber data are available, update status is U1, a cell is selected which belongs to the LA where the subscriber is registered, and the mobile station is searching for PLMNs. This state is ended when either a cell is selected (the new state is 19.1, 19.3 or 19.6), or when it is concluded that no cell is available for the moment (the new state is 19.5).

#### 19.9 RECEIVING GROUP CALL (NORMAL SERVICE)

Only applicable for mobile stations supporting VGCS listening or VBS listening. Valid subscriber data are available, update status is U1, a VGCS channel or VBS channel is received in a cell that belongs to the LA where the subscriber is registered.

In this state, only requests from the GCC or BCC layers are treated.

#### 19.10 RECEIVING GROUP CALL (LIMITED SERVICE)

Only applicable for mobile stations supporting VGCS listening or VBS listening. Valid subscriber data are available, update status is U3, a VGCS channel or VBS channel is received in a cell which is known not to be able to provide normal service.

In this state, only requests from the GCC or BCC layers for the reception of VGCS or VBS calls are treated and group call emergency services are offered.

### 4.1.2.2 The update Status

In parallel with the sublayer states described in subclause 4.1.2.1 and which control the MM sublayer protocol, an update status exists.

The update status pertains to a specific subscriber embodied by a SIM/USIM. This status is defined even when the subscriber is not activated (SIM/USIM removed or connected to a switched-off ME). It is stored in a non volatile memory in the SIM/USIM. The update status is changed only as a result of a location updating procedure attempt (with the exception of an authentication failure and of some cases of CM service rejection). In some cases, the update status is changed as a result of a GPRS attach, GPRS routing area update, service request or network initiated GPRS detach procedure.

#### U1 UPDATED

The last location updating attempt was successful (correct procedure outcome, and the answer was acceptance from the network). With this status, the SIM/USIM contains also the LAI of the LA where the subscriber is registered, and possibly valid TMSI, GSM ciphering key, UMTS integrity key, UMTS ciphering key and ciphering key sequence number. The "Location update status" stored on the SIM/USIM shall be "updated".

#### U2 NOT UPDATED

The last location updating attempt made failed procedurally (no significant answer was received from the network, including the cases of failures or congestion inside the network).

For this status, the SIM/USIM does not contain any valid LAI, TMSI, GSM ciphering key, UMTS integrity key, UMTS ciphering key or ciphering key sequence number. For compatibility reasons, all these fields must be set to the "deleted" value at the moment the status is set to NOT UPDATED. However the presence of other values shall not be considered an error by the mobile station. The "Location update status" stored on the SIM/USIM shall be "not updated".

#### U3 ROAMING NOT ALLOWED

The last location updating attempt run correctly, but the answer from the network was negative (because of roaming or subscription restrictions).

For this status, the SIM/USIM may contain a valid LAI, TMSI, GSM ciphering key, UMTS integrity key, UMTS ciphering key or ciphering key sequence number. For compatibility reasons, all these fields must be set to the "deleted" value if the LAI is deleted. However the presence of other values shall not be considered an error by the mobile station. The "Location update status" stored on the SIM/USIM shall be "Location Area not allowed".

### 4.1.2.3 MM sublayer states on the network side

#### 1. IDLE

The MM sublayer is not active except possibly when the RR sublayer is in Group Receive mode.

#### 2. WAIT FOR RR CONNECTION

The MM sublayer has received a request for MM connection establishment from the CM layer. A RR connection to the mobile station is requested from the RR sublayer (i.e. paging is performed).

#### 3. MM CONNECTION ACTIVE

The MM sublayer has a RR connection to a mobile station. One or more MM connections are active, or no MM connection is active but an RRLP procedure or LCS procedure over RRC is ongoing.

#### 4. IDENTIFICATION INITIATED

The identification procedure has been started by the network. The timer T3270 is running.

#### 5. AUTHENTICATION INITIATED

The authentication procedure has been started by the network. The timer T3260 is running.

#### 6. TMSI REALLOCATION INITIATED

The TMSI reallocation procedure has been started by the network. The timer T3250 is running.

#### 7. SECURITY MODE INITIATED

In Iu mode, the security mode setting procedure has been requested to the RR sublayer. In A/Gb mode, the cipher mode setting procedure has been requested to the RR sublayer.

#### 8a. WAIT FOR MOBILE ORIGINATED MM CONNECTION

A CM SERVICE REQUEST message is received and processed, and the MM sublayer awaits the "opening message" of the MM connection.

#### 8b. WAIT FOR NETWORK ORIGINATED MM CONNECTION

A CM SERVICE PROMPT message has been sent by the network and the MM sublayer awaits the "opening message" of the MM connection \$(CCBS)\$.

#### 9. WAIT FOR REESTABLISHMENT

The RR connection to a mobile station with one or more active MM connection has been lost. The network awaits a possible re-establishment request from the mobile station.

#### 10. WAIT OF A GROUP CALL

Only applicable in case for mobile station supporting VGCS talking. The MM sublayer has received a request for establishing a VGCS from the GCC sublayer. The request for establishing a VGCS channels is given to the RR sublayer.

#### 11. GROUP CALL ACTIVE

Only applicable in case of mobile station supporting VGCS talking. A VGCS channel is established by the RR sublayer. An RR connection to the talking mobile station can be established by the RR sublayer on the VGCS channel. The MM sublayer is active but no sending of MM message between the network and the mobile station has occurred.

#### 12. MM CONNECTION ACTIVE (GROUP CALL)

Only applicable in case of mobile station supporting VGCS talking. The MM sublayer has a RR connection to the talking mobile station on the VGCS channel. Only one MM connection is active.

#### 13. WAIT FOR BROADCAST CALL

Only applicable in case of VBS. The MM sublayer has received a request for a VBS establishment from the BCC sublayer. The request for establishment of VBS channels is given to the RR sublayer.

#### 14. BROADCAST CALL ACTIVE

Only applicable in case of VBS. A VBS channel is established by the RR sublayer. The MM sublayer is active but no explicit MM establishment between the Network and the mobile station has occurred.

### 4.1.3 GPRS mobility management (GMM) sublayer states

In this subclause, the GMM protocol of the MS and the network are described by means of two different state machines. In subclause 4.1.3.1, the states of the GMM entity in the MS are introduced. The behaviour of the MS depends on a GPRS update status that is described in subclause 4.1.3.2. The states for the network side are described in subclause 4.1.3.3.

#### 4.1.3.1 GMM states in the MS

In this subclause, the possible GMM states are described of a GMM entity in the mobile station. subclause 4.1.3.1.1 summarises the main states of a GMM entity, see figure 4.1b of the present document. The substates that have been defined are described in subclause 4.1.3.1.2 and subclause 4.1.3.1.3.

However, it should be noted that this subclause does not include a description of the detailed behaviour of the MS in the single states and does not cover abnormal cases. Thus, figure 4.1b of the present document is rather intended to give an overview of the state transitions than to be a complete state transition diagram. A detailed description of the behaviour of the MS is given in subclause 4.2. Especially, with respect to the behaviour of the MS in abnormal cases it is referred to subclause 4.7.



#### 4.1.3.1.1 Main states

##### 4.1.3.1.1.1 GMM-NULL

The GPRS capability is disabled in the MS. No GPRS mobility management function shall be performed in this state.

##### 4.1.3.1.1.2 GMM-DEREGISTERED

The GPRS capability has been enabled in the MS, but no GMM context has been established. In this state, the MS may establish a GMM context by starting the GPRS attach or combined GPRS attach procedure.

##### 4.1.3.1.1.3 GMM-REGISTERED-INITIATED

A GPRS attach or combined GPRS attach procedure has been started and the MS is awaiting a response from the network.

##### 4.1.3.1.1.4 GMM-REGISTERED

A GMM context has been established, i.e. the GPRS attach or combined GPRS attach procedure has been successfully performed. In this state, the MS may activate PDP contexts, MBMS contexts, may send and receive user data and signalling information and may reply to a page request. Furthermore, cell and routing area updating are performed.

##### 4.1.3.1.1.5 GMM-DEREGISTERED-INITIATED

The MS has requested release of the GMM context by starting the GPRS detach or combined GPRS detach procedure. This state is only entered if the MS is not being switched off at detach request.

##### 4.1.3.1.1.6 GMM-ROUTING-AREA-UPDATING-INITIATED

A routing area updating procedure has been started and the MS is awaiting a response from the network.

##### 4.1.3.1.1.7 GMM-SERVICE-REQUEST-INITIATED (UMTS only)

A service request procedure has been started and the MS is awaiting a response from the network.

#### 4.1.3.1.2 Substates of state GMM-DEREGISTERED

The GMM-DEREGISTERED state is subdivided into several substates as explained below. The substates pertain to the whole MS (ME alone if no SIM/USIM is inserted, or ME plus SIM/USIM). The selection of the appropriate substate depends on the GPRS update status, see subclause 4.1.3.2, and on the selected cell.

##### 4.1.3.1.2.1 GMM-DEREGISTERED.NORMAL-SERVICE

Valid subscriber data is available, the GPRS update status is GU1 or GU2, a cell has been selected. In this state, a request for GPRS attach is performed using the stored temporary mobile subscriber identity for GPRS (P-TMSI), routing area identification (RAI) and GPRS ciphering key sequence number in case of GU1. If the GPRS update status is GU2, the IMSI shall be used to attach for GPRS services.

##### 4.1.3.1.2.2 GMM-DEREGISTERED.LIMITED-SERVICE

Valid subscriber data is available, GPRS update status is GU3, and a cell is selected, which is known not to be able to provide normal service.

##### 4.1.3.1.2.3 GMM-DEREGISTERED.ATTACH-NEEDED

Valid subscriber data is available and for some reason a GPRS attach must be performed as soon as possible. This state is usually of no duration, but can last, e.g. if the access class is blocked due to common access class control or PS domain specific access control (see subclause 4.1.1.2.1).

#### 4.1.3.1.2.4 GMM-DEREGISTERED.ATTEMPTING-TO-ATTACH

The GPRS update status is GU2, a cell is selected, a previous GPRS attach was rejected. The execution of further attach procedures depends on the GPRS attach attempt counter. No GMM procedure except GPRS attach shall be initiated by the MS in this substate.

#### 4.1.3.1.2.5 GMM-DEREGISTERED.NO-IMSI

No valid subscriber data is available (no SIM/USIM, or the SIM/USIM is not considered valid by the ME) and a cell has been selected.

#### 4.1.3.1.2.6 GMM-DEREGISTERED.NO-CELL-AVAILABLE

No cell can be selected. This substate is entered after a first intensive search failed (substate PLMN SEARCH). Cells are searched for at a low rhythm. No services are offered.

#### 4.1.3.1.2.7 GMM-DEREGISTERED.PLMN-SEARCH

The mobile station is searching for PLMNs. This substate is left either when a cell has been selected (the new substate is NORMAL-SERVICE or LIMITED-SERVICE) or when it has been concluded that no cell is available at the moment (the new substate is NO-CELL-AVAILABLE).

#### 4.1.3.1.2.8 GMM-DEREGISTERED.SUSPENDED (A/Gb mode only)

The MS shall enter this substate when entering dedicated mode and the MS limitations make it unable to communicate on GPRS channels. The MS shall leave this substate when leaving dedicated mode.

### 4.1.3.1.3 Substates of state GMM-REGISTERED

The state GMM-REGISTERED is subdivided into several substate as explained below. The substates pertain to the whole MS (ME alone if no SIM/USIM is inserted, or ME plus SIM/USIM).

#### 4.1.3.1.3.1 GMM-REGISTERED.NORMAL-SERVICE

User data and signalling information may be sent and received.

#### 4.1.3.1.3.2 GMM-REGISTERED.SUSPENDED (A/Gb mode only)

The MS shall enter this substate when entering dedicated mode and when the MS limitations makes it unable to communicate on GPRS channels. In this substate, no user data should be sent and no signalling information shall be sent. The MS shall leave this substate when leaving dedicated mode.

#### 4.1.3.1.3.3 GMM-REGISTERED.UPDATE-NEEDED

The MS has to perform a routing area updating procedure, but its access class is not allowed in the cell due to common access class control or PS domain specific access control (see subclause 4.1.1.2.1). The procedure will be initiated as soon as access is granted (this might be due to a cell-reselection or due to change of the access classes allowed in the current cell). No GMM procedure except routing area updating shall be initiated by the MS in this substate. In this substate, no user data and no signalling information shall be sent.

#### 4.1.3.1.3.4 GMM-REGISTERED.ATTEMPTING-TO-UPDATE

A routing area updating procedure failed due to a missing response from the network. The MS retries the procedure controlled by timers and a GPRS attempt counter. No GMM procedure except routing area updating shall be initiated by the MS in this substate. No data shall be sent or received.

#### 4.1.3.1.3.5 GMM-REGISTERED.NO-CELL-AVAILABLE

GPRS coverage has been lost. In this substate, the MS shall not initiate any GMM procedures except of cell (and PLMN) reselection.

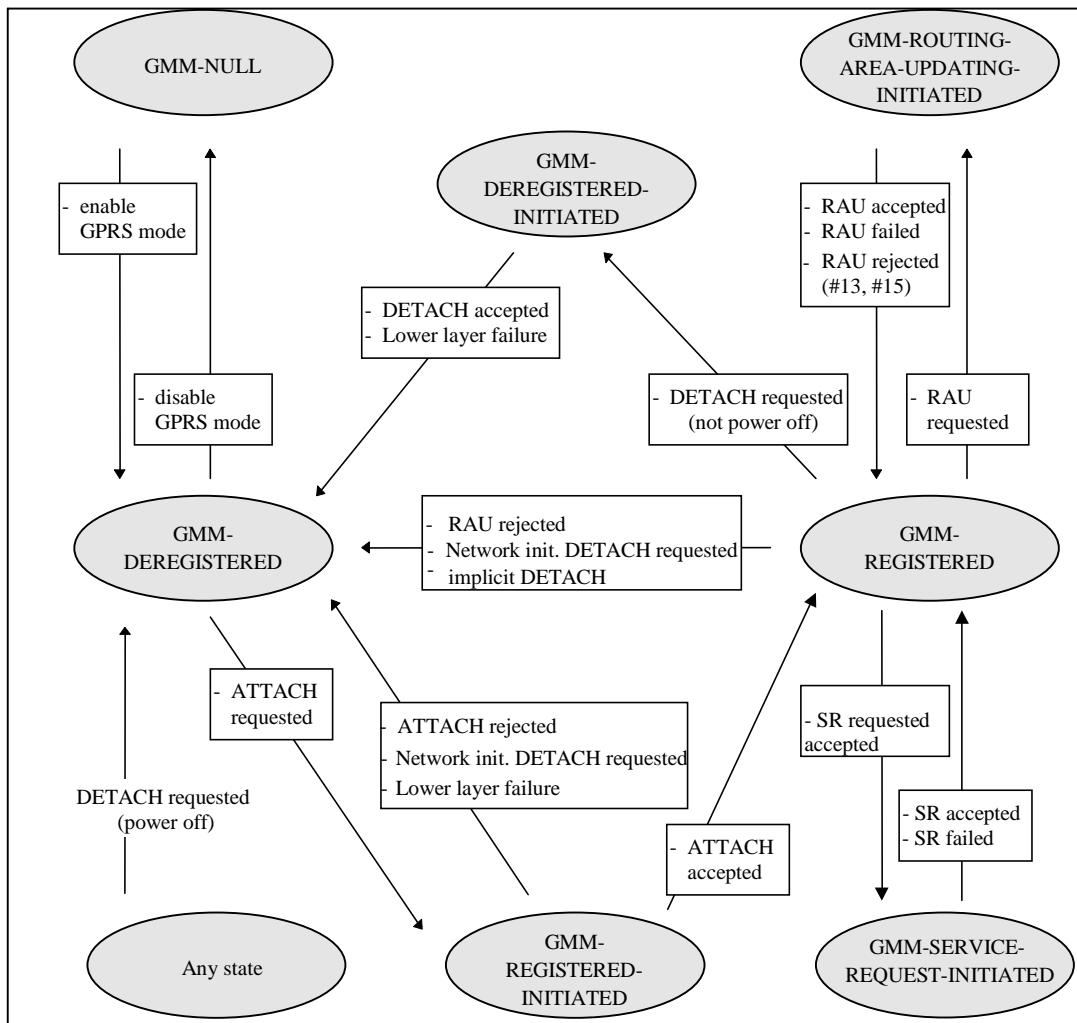

Figure 4.1b/3GPP TS 24.008:GMM main states in the MS

4.1.3.1.3.6 GMM-REGISTERED.LIMITED-SERVICE

A cell is selected, which is known not to be able to provide normal service. The MS will remain in this sub-state until a cell is selected which is able to provide normal service.

4.1.3.1.3.7 GMM-REGISTERED.ATTEMPTING-TO-UPDATE-MM

A combined routing area updating procedure or a combined GPRS attach procedure was successful for GPRS services only. The MS retries the procedure controlled by timers and a GPRS attempt counter. User data and signalling information may be sent and received.

4.1.3.1.3.8 GMM-REGISTERED.IMSI-DETACH-INITIATED

The MS performs a combined GPRS detach procedure for non-GPRS services only (detach type "IMSI Detach"). This state is entered if the MS is attached for GPRS and non-GPRS services in a network that operates in network mode I and wants to detach for non-GPRS services only. User data and signalling information may be sent and received.

4.1.3.1.3.9 GMM-REGISTERED.PLMN-SEARCH

The mobile station is searching for PLMNs. This substate is left either when a cell has been selected (the new substate is NORMAL-SERVICE or LIMITED-SERVICE) or when it has been concluded that no cell is available at the moment (the new substate is NO-CELL-AVAILABLE).

### 4.1.3.2 GPRS update status

In addition to the GMM sublayer states described so far, a GPRS update status exists.

The GPRS update status pertains to a specific subscriber embodied by a SIM/USIM. This status is defined even when the subscriber is not activated (SIM/USIM removed or connected to a switched off ME). It is stored in a non volatile memory in the SIM/USIM. The GPRS update status is changed only after execution of a GPRS attach, network initiated GPRS detach, authentication procedure, or routing area updating procedure.

#### GU1: UPDATED

The last GPRS attach or routing area updating attempt was successful (correct procedure outcome, and the answer was accepted by the network). The SIM/USIM contains the RAI of the routing area (RA) to which the subscriber was attached, and possibly a valid P-TMSI, GPRS GSM ciphering key, GPRS UMTS ciphering key, GPRS UMTS integrity key and GPRS ciphering key sequence number.

#### GU2: NOT UPDATED

The last GPRS attach or routing area updating attempt failed procedurally, i.e. no response was received from the network. This includes the cases of failures or congestion inside the network.

In this case, the SIM/USIM may contain the RAI of the routing area (RA) to which the subscriber was attached, and possibly also a valid P-TMSI, GPRS GSM ciphering key, GPRS UMTS ciphering key, GPRS UMTS integrity key and GPRS ciphering key sequence number. For compatibility reasons, all these fields shall be set to the "deleted" value if the RAI is deleted. However, the presence of other values shall not be considered an error by the MS.

#### GU3: ROAMING NOT ALLOWED

The last GPRS attach or routing area updating attempt was correctly performed, but the answer from the network was negative (because of roaming or subscription restrictions).

In this case, the SIM/USIM may contain the RAI of the routing area (RA) to which the subscriber was attached, and possibly also a valid P-TMSI, GPRS GSM ciphering key, GPRS UMTS ciphering key, GPRS UMTS integrity key or GPRS ciphering key sequence number. For compatibility reasons, all these fields shall be set to the value "deleted" if the RAI is deleted. However, the presence of other values shall not be considered an error by the MS.

### 4.1.3.3 GMM mobility management states on the network side

In this subsubclause, the possible states are described for the GMM on the network side. Subclause 4.1.3.3.1 summarises the main states. The corresponding substates are described in subclause 4.1.3.3.2.

However, it should be noted that this subclause does not include a description of the detailed behaviour of the network in the single states and does not cover abnormal cases. Thus, figure 4.1c/3GPP TS 24.008 is rather intended to give an overview of the state transitions than to be a complete state transition diagram. A detailed description of the behaviour of the MS is given in subclause 4.2. Especially, with respect to the behaviour of the MS in abnormal cases it is referred to subclause 4.7.

#### 4.1.3.3.1 Main States

##### 4.1.3.3.1.1 GMM-DEREGISTERED

The network has no GMM context or the GMM context is marked as detached, the MS is detached. In this state, the network may answer to a GPRS attach or combined GPRS attach procedure initiated by the MS.

##### 4.1.3.3.1.2 GMM-COMMON-PROCEDURE-INITIATED

A common GMM procedure, as defined in subclause 4.1.1, has been started. The network is awaiting the answer from the MS.

## 4.1.3.3.1.3 GMM-REGISTERED

The GMM context has been established and the GPRS attach procedure has been successfully performed.

## 4.1.3.3.1.4 GMM-DEREGISTERED-INITIATED

The network has started a GPRS detach procedure and is awaiting the answer from the MS.

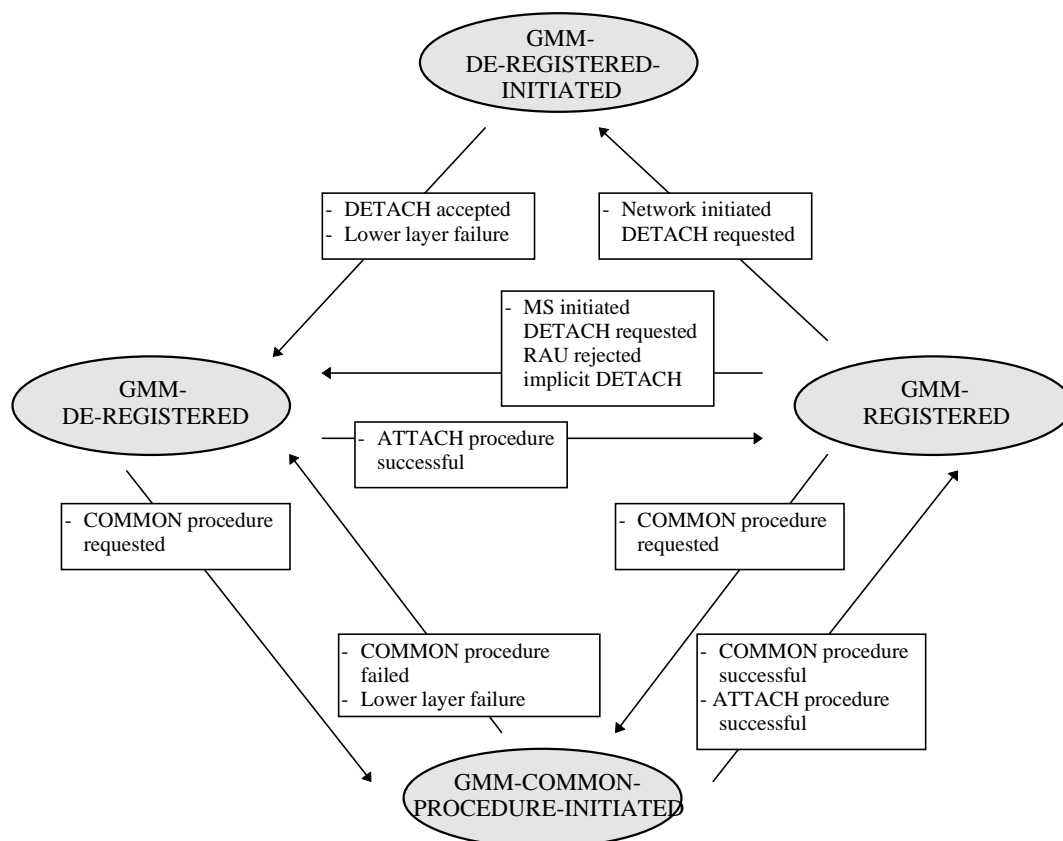

Figure 4.1c/3GPP TS 24.008: GMM main states on the network side

## 4.1.3.3.2 Substates of state GMM-REGISTERED

The state GMM-REGISTERED is subdivided into two substates as explained below.

## 4.1.3.3.2.1 GMM-REGISTERED.NORMAL-SERVICE

User data and signalling information may be sent and received.

## 4.1.3.3.2.2 GMM-REGISTERED.SUSPENDED (A/Gb mode only)

In this substate, the lower layers shall be prevented of sending user data or signalling information.

## 4.2 Behaviour of the MS in MM Idle state, GMM-DEREGISTERED state and GMM-REGISTERED state

In this subclause, the detailed behaviour of the MS in the main states MM IDLE, GMM-DEREGISTERED and GMM-REGISTERED is described. Subclauses 4.2.1 to 4.2.3 refer to the state MM IDLE, whereas subclauses 4.2.4 and 4.2.5 refer to the states GMM-DEREGISTERED and GMM-REGISTERED, respectively.

The MM IDLE state is entered when none of the MM procedures are running and no RR connection exists. It is left when one of the MM procedures are triggered or a RR connection is established.

The specific behaviour in the MM IDLE state depends on the service state of the mobile station as described in subclause 4.1.2.1.2. The service state depends in particular on the update status which is defined in subclause 4.1.2.2.

How an appropriate service state is chosen after power on is described in subclause 4.2.1, and the specific behaviour of the mobile station in MM IDLE state is described in subclause 4.2.2. The service state chosen when the MM IDLE state is returned to from any state except NULL state is described in 4.2.3.

It should be noted that transitions between the various MM idle states are caused by (e.g.):

- results of procedures on RR connected mode (see subclause 4.2.3);
- insertion or removal of the SIM/USIM;
- cell selection/reselection (see also 3GPP TS 43.022 [82] and 3GPP TS 25.304 [98]);
- PLMN search;
- loss of coverage.

How various MM procedures affects the service state and the update status is described in the detailed descriptions of the procedures in subclauses 4.3 to 4.5.

## 4.2.1 Primary Service State selection

### 4.2.1.1 Selection of the Service State after Power On.

When mobility management is activated after power-on, the service state is 19.7 PLMN SEARCH. The detailed processing in this state is described in detail in 3GPP TS 23.122 [14], 3GPP TS 43.022 [82], 3GPP TS 45.008 [34] and 3GPP TS 25.304 [98], where procedures for power on and selection of PLMN is described in detail. If the "Location update status" stored on the SIM/USIM is different from "updated", then the mobile shall act as if the "Location update status" stored on the SIM/USIM is "not updated".

The service state when the PLMN SEARCH state is left depends on the outcome of the search and on the presence of the SIM/USIM:

- if no cell has been found, the state is NO CELL AVAILABLE, until a cell is found;
- if no SIM/USIM is present the state is NO IMSI;
- if the mobile station has been continuously activated since losing coverage and then returns to coverage, and if the selected cell is in the location area where the mobile station is registered and the timer T3212 has not expired, then the state is NORMAL SERVICE;
- if the selected cell is in the location area where the mobile station is registered and IMSI ATTACH is not required and timer T3212 has not expired, then the state is NORMAL SERVICE;
- if the mobile station is in automatic network selection mode and the selected cell is in a forbidden PLMN or a forbidden LA, then the mobile station enters the LIMITED SERVICE state;
- if the mobile station is in manual network selection mode and no cell of the selected PLMN has been found, then the mobile station enters the LIMITED SERVICE state;
- otherwise, the mobile station enters the LOCATION UPDATE NEEDED state.

### 4.2.1.2 Other Cases

The state PLMN SEARCH is also entered in the following cases:

- in state NO IMSI, a SIM/USIM is inserted;
- in any state except NO IMSI, NO CELL AVAILABLE, NORMAL SERVICE and RECEIVING GROUP CALL (NORMAL SERVICE) after the user has asked for a PLMN selection;
- in any state except NO IMSI and NO CELL AVAILABLE, coverage is lost;

- roaming is denied;
- optionally, when the mobile station is in the ATTEMPTING TO UPDATE state and is in Automatic Network Selection mode and location update attempt counter is greater than or equal to 4.

The service state when the PLMN SEARCH is left depends on the outcome of the search and on the presence of the SIM/USIM as specified in subclause 4.2.1.1.

## 4.2.2 Detailed Description of the MS behaviour in MM IDLE State.

In the MM IDLE state the mobile station shall behave according to the service state. In the following subclauses the behaviour is described for the non transient service states. It should be noted that after procedures in RR connected mode, e.g. location updating procedures, subclause 4.2.3 applies which specifies the selection of the MM idle state. Furthermore when in sub-state NORMAL SERVICE, if a PLMN selection is requested, the MS enters sub-state SEARCH FOR PLMN, NORMAL SERVICE.

### 4.2.2.1 Service State, NORMAL SERVICE

When in state MM IDLE and service state NORMAL SERVICE, the mobile station shall:

- perform normal location updating when a new location area is entered;
- perform location updating procedure at expiry of timer T3211 or T3213;
- perform periodic updating at expiration of timer T3212;
- perform IMSI detach;
- support requests from the CM layer;
- respond to paging.

In addition, mobile stations supporting VGCS listening or VBS listening shall:

- indicate notifications to the GCC or BCC sublayer;
- respond to notification if the GCC or BCC sublayer requests the reception of a voice group or broadcast call for which no channel description has been received in the notification by the RR sublayer;
- request the RR sublayer to receive a voice group or broadcast call if the GCC or BCC sublayer requests the reception of a voice group or broadcast call for which a channel description has been received in the notification by the RR sublayer and then go to the service state RECEIVING GROUP CALL (NORMAL SERVICE).

### 4.2.2.2 Service State, ATTEMPTING TO UPDATE

When in state MM IDLE and service state ATTEMPTING TO UPDATE the mobile station shall:

- perform location updating procedure at expiry of timer T3211 or T3213;
- perform normal location updating when the location area identification of the serving cell changes;
- if entry into this state was caused by c) or d) or f) (with cause different from "abnormal release, unspecified") or g) (with cause "retry upon entry into a new cell") of subclause 4.4.4.9, then location updating shall be performed when a new cell is entered;
- if entry into this state was caused by e) or f) (with cause "abnormal release, unspecified") or g) (with cause different from "retry upon entry into a new cell") of subclause 4.4.4.9, then location updating shall not be performed because a new cell is entered;
- perform normal location updating at expiry of timer T3212;
- not perform IMSI detach;
- support request for emergency calls;

- use other request from CM layer as triggering of normal location updating procedure (if the location updating procedure is successful, then the request for MM connection is accepted, see subclause 4.5.1);
- respond to paging (with IMSI).

In addition, mobile stations supporting VGCS listening or VBS listening shall:

- indicate notifications to the GCC or BCC sublayer for which a channel description has been received in the notification by the RR sublayer;
- reject requests of the GCC or BCC sublayer to respond to notifications for which no channel description has been received in the notification by the RR sublayer;
- request the RR sublayer to receive a voice group or broadcast call if the GCC or BCC sublayer requests the reception of a voice group or broadcast call for which a channel description has been received in the notification by the RR sublayer and then go to the service state RECEIVING GROUP CALL (LIMITED SERVICE).

#### 4.2.2.3 Service State, LIMITED SERVICE

When in state MM IDLE and service state LIMITED SERVICE the mobile station shall:

- not perform periodic updating;
- not perform IMSI detach;
- reject any requests from CM entities for MM connections except for emergency calls;
- perform normal location updating when a cell is entered which may provide normal service (e.g. location area not in one of the forbidden LAI lists.);
- it may respond to paging (with IMSI).

In addition, mobile stations supporting VGCS listening or VBS listening shall:

- indicate notifications to the GCC or BCC sublayer for which a channel description has been received in the notification by the RR sublayer;
- reject requests of the GCC or BCC sublayer to respond to notifications for which no channel description has been received in the notification by the RR sublayer;
- request the RR sublayer to receive a voice group or broadcast call if the GCC or BCC sublayer requests the reception of a voice group or broadcast call for which a channel description has been received in the notification by the RR sublayer and then go to the service state RECEIVING GROUP CALL (LIMITED SERVICE).

#### 4.2.2.4 Service State, NO IMSI

When in state MM IDLE and service state NO IMSI the mobile station shall (see subclause 3.2, 3GPP TS 43.022 [82] and 3GPP TS 45.008 [34]):

- not start any normal location updating attempt;
- not perform periodic updating;
- not perform IMSI detach if powered down;
- reject any request from CM entities for MM connections except for emergency calls;
- not respond to paging;
- only perform default cell selection.

In addition, mobile stations supporting VGCS listening or VBS listening shall:

- not indicate notifications to the GCC or BCC layer.



#### 4.2.2.5 Service State, SEARCH FOR PLMN, NORMAL SERVICE

When in state MM IDLE and service state SEARCH FOR PLMN, NORMAL SERVICE the mobile station shall:

- if timer T3211 or T3213 expires in this state perform a location updating procedure at the latest if and when back to NORMAL SERVICE state and if the cell is not changed;
- if timer T3212 expires in this state perform a periodic location updating procedure at the latest if and when back to NORMAL SERVICE state;
- perform IMSI detach;
- support requests from the CM layer;
- listen as far as possible to paging, and respond.

In addition, mobile stations supporting VGCS listening or VBS listening shall:

- listen as far as possible to notifications and indicate notifications to the GCC or BCC layer;
- respond to notification if the GCC or BCC sublayer requests the reception of a voice group or broadcast call for which no channel description has been received in the notification by the RR sublayer;
- request the RR sublayer to receive a voice group or broadcast call if the GCC or BCC sublayer requests the reception of a voice group or broadcast call for which a channel description has been received in the notification by the RR sublayer.

#### 4.2.2.6 Service State, SEARCH FOR PLMN

When in state MM IDLE and service state SEARCH FOR PLMN the mobile station shall:

- not start any normal location updating attempt;
- not perform periodic updating;
- not perform IMSI detach if powered down;
- reject any request from CM entities for MM connections except emergency calls;
- not respond to paging.

#### 4.2.2.7 Service State, RECEIVING GROUP CALL (NORMAL SERVICE)

Only applicable for mobile stations supporting VGCS listening or VBS listening:

When in state MM IDLE and service state RECEIVING GROUP CALL (NORMAL SERVICE), the mobile station shall:

- perform normal location updating when a new location area is entered;
- perform location updating procedure at expiry of timer T3211 or T3213;
- perform periodic updating at expiration of timer T3212;
- perform IMSI detach;
- support requests from the GCC or BCC layers;
- indicate notifications or paging information to the GCC or BCC layer;
- respond to notification if the GCC or BCC sublayer requests the reception of a voice group or broadcast call for which no channel description has been received in the notification by the RR sublayer;
- request the RR sublayer to receive another voice group or broadcast call if the GCC or BCC sublayer requests the reception of a voice group or broadcast call for which a channel description has been received in the notification by the RR sublayer.

#### 4.2.2.8 Service State, RECEIVING GROUP CALL (LIMITED SERVICE)

Only applicable for mobile stations supporting VGCS listening or VBS listening:

When in state MM IDLE and service state RECEIVING GROUP CALL (LIMITED SERVICE), the mobile station shall:

- not perform periodic updating;
- not perform IMSI detach;
- reject any requests from CM entities for MM connections except for emergency calls;
- perform normal location updating when a cell is entered which may provide normal service (e.g. location area not in one of the forbidden LAI lists.);
- it may respond to paging (with IMSI);
- indicate notifications to the GCC or BCC sublayer for which a channel description has been received in the notification by the RR sublayer;
- reject requests of the GCC or BCC sublayer to respond to notifications for which no channel description has been received in the notification by the RR sublayer;
- request the RR sublayer to receive a voice group or broadcast call if the GCC or BCC sublayer requests the reception of a voice group or broadcast call for which a channel description has been received in the notification by the RR sublayer and then go to the service state RECEIVING GROUP CALL (LIMITED SERVICE).

#### 4.2.3 Service state when back to state MM IDLE from another state

When returning to MM IDLE, e.g., after a location updating procedure, the mobile station selects the cell as specified in 3GPP TS 43.022 [82] and 3GPP TS 25.304 [98]. With one exception, this is a normal cell selection.

If this return to idle state is not subsequent to a location updating procedure terminated with reception of cause "Roaming not allowed in this location area" the service state depends on the result of the cell selection procedure, on the update status of the mobile station, on the location data stored in the mobile station and on the presence of the SIM/USIM:

- if no cell has been found, the state is NO CELL AVAILABLE, until a cell is found;
- if no SIM/USIM is present, or if the inserted SIM/USIM is considered invalid by the MS, the state is NO IMSI;
- if the selected cell is in the location area where the MS is registered, then the state is NORMAL SERVICE; it shall be noted that this also includes an abnormal case described in subclause 4.4.4.9;
- (Only applicable for mobile stations supporting VGCS listening or VBS listening.) if the mobile stations was in the service state RECEIVING GROUP CALL (NORMAL SERVICE) or RECEIVING GROUP CALL (LIMITED SERVICE) before the location updating procedure and the selected cell is in the location area where the mobile station is registered, then the state is RECEIVING GROUP CALL (NORMAL SERVICE);
- if the selected cell is in a location area where the mobile station is not registered but in which the MS is allowed to attempt a location update, then the state is LOCATION UPDATE NEEDED;
- if the selected cell is in a location area where the mobile station is not allowed to attempt a location update, then the state is LIMITED SERVICE;
- (Only applicable for MSs supporting VGCS listening or VBS listening.) if the MSs was in the service state RECEIVING GROUP CALL (NORMAL SERVICE) or RECEIVING GROUP CALL (LIMITED SERVICE) before the location updating procedure and the selected cell is in the location area where the MS is not allowed to attempt a location update, then the state is RECEIVING GROUP CALL (LIMITED SERVICE);
- after some abnormal cases occurring during an unsuccessful location updating procedure, as described in subclause 4.4.4.9, the state is ATTEMPTING TO UPDATE.

In case of a return from a location updating procedure to which was answered "Roaming not allowed in this location area", the service state PLMN SEARCH is entered as specified in subclause 4.2.1.2.

## 4.2.4 Behaviour in state GMM-DEREGISTERED

The state GMM-DEREGISTERED is entered when:

- the MS is switched on;
- the GPRS capability has been enabled in the MS;
- a GPRS detach or combined GPRS detach procedure has been performed; or
- a GMM procedure has failed (except routing area updating, see subclause 4.7.5).

The selection of the appropriate substate of GMM-DEREGISTERED after switching on is described in subclause 4.2.4.1. The specific behaviour of the MS in state GMM-DEREGISTERED is described in subclause 4.2.4.2. The substate chosen when the GMM-DEREGISTERED state is returned to from another state except state GMM-NULL is described in subclause 4.2.4.3.

It should be noted that transitions between the various substates of GMM-DEREGISTERED are caused by (e.g.):

- insertion or removal of the SIM/USIM;
- cell selection/reselection (see also 3GPP TS 43.022 [82] and 3GPP TS 25.304 [98]);
- PLMN search;
- loss/regain of coverage; or
- change of RA.

How various GMM procedures affect the GMM-DEREGISTERED substates and the GPRS update status is described in the detailed description of the GMM procedures in subclause 4.7.

### 4.2.4.1 Primary substate selection

#### 4.2.4.1.1 Selection of the substate after power on or enabling the MS's GPRS capability

When the MS is switched on, the substate shall be PLMN-SEARCH in case the SIM/USIM is inserted and valid. See 3GPP TS 23.122 [14] and 3GPP TS 45.008 [34] for further details.

When the GPRS capability in an activated MS has been enabled, the selection of the GMM-DEREGISTERED substate depends on the MM state and the GPRS update status.

The substate chosen after PLMN-SEARCH, in case of power on or after enabling of the GPRS capability is:

- if the cell is not supporting GPRS, the substate shall be NO-CELL-AVAILABLE;
- if no SIM/USIM is present the substate shall be NO-IMSI;
- if a cell supporting GPRS has been found and the PLMN or LA is not in the forbidden list, then the substate shall be NORMAL-SERVICE;
- if the selected cell supporting GPRS is in a forbidden PLMN or a forbidden LA, then the MS shall enter the substate LIMITED-SERVICE;
- if the MS is in manual network selection mode and no cell supporting GPRS of the selected PLMN has been found, the MS shall enter the substate NO-CELL-AVAILABLE.

#### 4.2.4.1.2 Other Cases

When the MM state is IDLE, the GMM substate PLMN-SEARCH shall also be entered in the following cases:

- when a SIM/USIM is inserted in substate NO-IMSI;
- when the user has asked for a PLMN selection in any substate except NO IMSI and NO CELL AVAILABLE ;
- when coverage is lost in any substate except NO IMSI and NO CELL AVAILABLE ;
- Roaming is denied;
- optionally, when the MS is in automatic network selection mode and the maximum allowed number of subsequently unsuccessful attach attempts controlled by the GPRS attach attempt counter (subclause 4.7.3) have been performed.

#### 4.2.4.2 Detailed description of the MS behaviour in state GMM-DEREGISTERED

In state GMM-DEREGISTERED, the MS shall behave according to the substate. In the following subclauses, the behaviour is described for the non transient substates.

##### 4.2.4.2.1 Substate, NORMAL-SERVICE

The MS shall:

- perform GPRS attach.

##### 4.2.4.2.2 Substate, ATTEMPTING-TO-ATTACH

The MS shall:

- perform GPRS attach on the expiry of timers T3311 or T3302;
- perform GPRS attach when the routing area of the serving cell has changed and the location area this cell is belonging to is not in the list of forbidden LAs;
- if entry into this state was caused by b) or d) with cause "Retry upon entry into a new cell" of subclause 4.7.3.1.5, GPRS attach shall be performed when a new cell is entered;
- if entry into this state was caused by c) or d) with cause different from "Retry upon entry into a new cell" of subclause 4.7.3.1.5, GPRS attach shall not be performed when a new cell is entered; and
- use requests from CM layers to trigger the combined GPRS attach procedure, if the network operates in network operation mode I. Depending on which of the timers T3311 or T3302 is running the MS shall stop the relevant timer and act as if the stopped timer has expired.

##### 4.2.4.2.3 Substate, LIMITED-SERVICE

The MS shall:

- perform GPRS attach when a cell is entered which may provide normal service (e.g. location area is not in one of the forbidden lists).

##### 4.2.4.2.4 Substate, NO-IMSI

The MS shall:

- only perform default cell selection.

#### 4.2.4.2.5 Substate, NO-CELL

The MS shall:

- perform cell selection according to 3GPP TS 43.022 [82] and 3GPP TS 25.304 [98] and shall choose an appropriate substate.

#### 4.2.4.2.6 Substate, PLMN-SEARCH

No specific action is required in this substate.

#### 4.2.4.2.7 Substate, ATTACH-NEEDED

The MS shall start a GPRS attach procedure if still needed as soon as the access class allows network contact in the selected cell.

#### 4.2.4.2.8 Substate, SUSPENDED (A/Gb mode only)

The MS:

- shall not send any user data; and
- shall not send any signalling information.

#### 4.2.4.3 Substate when back to state GMM-DEREGISTERED from another GMM state

When returning to state GMM-DEREGISTERED, the MS shall select a cell as specified in 3GPP TS 43.022 [82] and 3GPP TS 25.304 [98].

The substate depends on the result of the cell selection procedure, the outcome of the previously performed GMM specific procedures, on the GPRS update status of the MS, on the location area data stored in the MS and on the presence of the SIM/USIM:

- if no cell has been found, the substate is NO-CELL-AVAILABLE, until a cell is found;
- if no SIM/USIM is present or if the inserted SIM/USIM is considered invalid by the MS, the substate shall be NO-IMSI;
- if the selected cell is in a location area where the MS is allowed to roam, the substate shall be NORMAL-SERVICE;
- if a GPRS attach shall be performed (e.g. network requested reattach), the substate shall be ATTEMPTING-TO-ATTACH
- if a PLMN reselection (according to 3GPP TS 23.122 [14]) is needed, the substate shall be PLMN SEARCH
- if the selected cell is in a location area where the MS is not allowed to roam, the state shall be LIMITED-SERVICE.

### 4.2.5 Behaviour in state GMM-REGISTERED

The state GMM-REGISTERED is entered when:

- a GMM context is established, i.e. the MS is IMSI attached for GPRS services only or for GPRS and non-GPRS services.

The specific behaviour of the MS in state GMM-REGISTERED is described in subclause 4.2.5.1. The primary substate when entering the state GMM-REGISTERED is always NORMAL-SERVICE.

It should be noted that transitions between the various substates of GMM-REGISTERED are caused by (e.g.):

- cell selection/reselection (see also 3GPP TS 43.022 [82] and 3GPP TS 25.304 [98]);

- change of RA;
- loss/regain of coverage.

How various GMM procedures affect the GMM-REGISTERED substates is described in the detailed description of the procedures in subclause 4.7.

#### 4.2.5.1 Detailed description of the MS behaviour in state GMM-REGISTERED

In state GMM-REGISTERED, the MS shall behave according to the substate as explained below.

##### 4.2.5.1.1 Substate, NORMAL-SERVICE

The MS shall:

- perform cell selection/reselection according to 3GPP TS 43.022 [82] and 3GPP TS 25.304 [98];
- perform normal and periodic routing area updating; and
- receive and transmit user data and signalling information.

GPRS MSs in operation modes C or A shall answer to paging requests.

GPRS MS in operation mode B may answer to paging requests.

##### 4.2.5.1.2 Substate, SUSPENDED (A/Gb mode only)

The MS:

- shall not send any user data;
- shall not send any signalling information; and
- shall not perform cell-updates.

##### 4.2.5.1.3 Substate, UPDATE-NEEDED

The MS shall:

- not send any user data;
- not send any signalling information;
- perform cell selection/reselection according to 3GPP TS 43.022 [82] and 3GPP TS 25.304 [98]; and
- chose the appropriate new substate depending on the GPRS update status as soon as the access class allows network contact in the selected cell.

##### 4.2.5.1.4 Substate, ATTEMPTING-TO-UPDATE

The MS:

- should not send any user data;
- shall perform routing area update on the expiry of timers T3311 or T3302;
- shall perform routing area update when the routing area of the serving cell has changed and the location area this cell is belonging to is not in the list of forbidden LAs;
- shall if entry into this state was caused by b) or d) with cause "Retry upon entry into a new cell", of subclause 4.7.5.1.5, perform routing area updating when a new cell is entered;
- shall if entry into this state was caused by c) or d) with cause different from "Retry upon entry into a new cell" of subclause 4.7.5.1.5, not perform routing area updating when a new cell is entered; and

- shall use request from CM layers to trigger the combined routing area update procedure, if the network operates in network operation mode I. Depending on which of the timers T3311 or T3302 is running the MS shall stop the relevant timer and act as if the stopped timer has expired.

#### 4.2.5.1.5 Substate, NO-CELL-AVAILABLE

The MS shall perform cell selection/reselection according to 3GPP TS 43.022 [82] and 3GPP TS 25.304 [98].

#### 4.2.5.1.6 Substate, LIMITED-SERVICE

The MS shall perform cell selection/reselection according to 3GPP TS 43.022 [82] and 3GPP TS 25.304 [98];

#### 4.2.5.1.7 Substate, ATTEMPTING-TO-UPDATE-MM

The MS shall:

- perform cell selection/reselection according to 3GPP TS 43.022 [82] and 3GPP TS 25.304 [98];
- receive and transmit user data and signalling information;
- perform routing area update indicating "combined RA/LA updating with IMSI attach" on the expiry of timers T3311 or T3302;
- perform routing area update indicating "combined RA/LA updating with IMSI attach" when the routing area of the serving cell has changed and the location area this cell is belonging to is not in the list of forbidden LAs.

GPRS MSs in operation modes C or A shall answer to paging requests.

GPRS MS in operation mode B may answer to paging requests.

#### 4.2.5.1.8 Substate, PLMN-SEARCH

When the MM state is IDLE, the GMM substate PLMN-SEARCH may be entered if the MS is in automatic network selection mode and the maximum allowed number of subsequently unsuccessful routing area update attempts controlled by the GPRS routing area update attempt counter (clause 4.7.5) have been performed. If a new PLMN is selected the MS shall perform the routing area updating procedure.

## 4.3 MM common procedures

As described in subclause 4.1.1, a MM common procedure can be initiated at any time whilst a RR connection exists between the network and the mobile station.

### 4.3.1 TMSI reallocation procedure

The purpose of the TMSI reallocation procedure is to provide identity confidentiality, i.e. to protect a user against being identified and located by an intruder (see 3GPP TS 42.009, 3GPP TS 43.020 [13] and 3GPP TS 33.102 [5a]).

If the identity confidentiality service is applied for an IMSI, a Temporary Mobile Subscriber Identity (TMSI) is used for identification within the radio interface signalling procedures.

In a network supporting the feature "Intra domain connection of RAN nodes to multiple CN nodes" a TMSI shall be allocated to each IMSI attached mobile station. See 3GPP TS 23.236 [94], chapter 4.3.

The structure of the TMSI is specified in 3GPP TS 23.003 [10]. The TMSI has significance only within a location area. Outside the location area it has to be combined with the Location Area Identifier (LAI) to provide for an unambiguous identity.

Usually the TMSI reallocation is performed at least at each change of a location area. (Such choices are left to the network operator).

The reallocation of a TMSI can be performed either by a unique procedure defined in this subclause or implicitly by a location updating procedure using the TMSI. The implicit reallocation of a TMSI is described together with that procedure.

If a TMSI provided by a mobile station is unknown in the network e.g. due to a data base failure, the network may require the mobile station to provide its International Mobile Subscriber Identity (IMSI). In this case the identification procedure (see subclause 4.3.3) should be used before the TMSI reallocation procedure may be initiated.

The TMSI reallocation can be initiated by the network at any time whilst a RR connection exists between the network and the mobile station.

NOTE 1: Usually the TMSI reallocation is performed in ciphered mode.

NOTE 2: Normally the TMSI reallocation will take place in conjunction with another procedure, e.g. at location updating or at call setup (see 3GPP TS 29.002 [37]).

#### 4.3.1.1 TMSI reallocation initiation by the network

The network initiates the TMSI reallocation procedure by sending a TMSI REALLOCATION COMMAND message to the mobile station and starts the timer T3250.

The TMSI REALLOCATION COMMAND message contains a new combination of TMSI and LAI allocated by the network or a LAI and the IMSI if the used TMSI shall be deleted. Usually the TMSI-REALLOCATION COMMAND message is sent to the mobile station using a RR connection in ciphered mode (see 3GPP TS 43.020 [13] and 3GPP TS 33.102 [5a]).

#### 4.3.1.2 TMSI reallocation completion by the mobile station

Upon receipt of the TMSI REALLOCATION COMMAND message the mobile station stores the Location Area Identifier (LAI) in the SIM/USIM. If the received identity is the IMSI of the relevant mobile station, the mobile station deletes any TMSI. If the received identity is a TMSI the mobile station stores the TMSI in the SIM/USIM. In both cases the mobile station sends a TMSI REALLOCATION COMPLETE message to the network.

#### 4.3.1.3 TMSI reallocation completion in the network.

Upon receipt of the TMSI REALLOCATION COMPLETE message, the network stops the timer T3250 and either considers the new TMSI as valid or, if an IMSI was sent to the mobile station, considers the old TMSI as deleted.

If the RR connection is no more needed, then the network will request the RR sublayer to release it (see 3GPP TS 44.018 [84] subclause 3.5 and 3GPP TS 25.331 [23c]).

#### 4.3.1.4 Abnormal cases

Mobile station side:

The mobile station shall consider the new TMSI and new LAI, if any, as valid and the old TMSI and old LAI as deleted as soon as a TMSI REALLOCATION COMMAND or another message containing a new TMSI (e.g. LOCATION UPDATING ACCEPT) is correctly received. Any RR connection failure at a later stage shall not have any impact on the TMSI and LAI storage.

Network side:

(a) RR connection failure:

If the RR connection is lost before the TMSI REALLOCATION COMPLETE message is received, all MM connections (if any) shall be released and both the old and the new TMSIs should be considered as occupied for a certain recovery time.

During this period the network may:

- use the IMSI for paging in the case of network originated transactions on the CM layer. Upon response from the mobile station the TMSI reallocation is restarted;



- consider the new TMSI as valid if it is used by the mobile station in mobile originated requests for RR connection;
- use the Identification procedure followed by a new TMSI reallocation if the mobile station uses the old TMSI.

Other implementations are possible.

(b) Expiry of timer T3250:

The TMSI reallocation is supervised by the timer T3250 in the network. At the first expiry of timer T3250 the network may release the RR connection. In this case, the network shall abort the reallocation procedure release all MM connections if any, and follow the rules described for RR connection failure above.

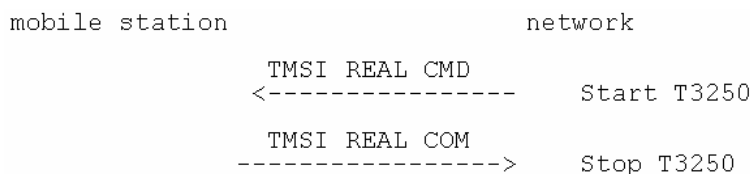

**Figure 4.1/3GPP TS 24.008: TMSI reallocation sequence**

## 4.3.2 Authentication procedure

### 4.3.2a Authentication procedure used for a UMTS authentication challenge

The purpose of the authentication procedure is fourfold (see 3GPP TS 33.102 [5a]):

- First to permit the network to check whether the identity provided by the mobile station is acceptable or not;
- Second to provide parameters enabling the mobile station to calculate a new UMTS ciphering key;
- Third to provide parameters enabling the mobile station to calculate a new UMTS integrity key;
- Fourth to permit the mobile station to authenticate the network.

The cases where the authentication procedure should be used are defined in 3GPP TS 33.102 [5a].

The UMTS authentication procedure is always initiated and controlled by the network. However, there is the possibility for the MS to reject the UMTS authentication challenge sent by the network.

The MS shall support the UMTS authentication challenge, if a USIM is inserted.

A UMTS security context is established in the MS and the network when a UMTS authentication challenge is performed in A/Gb mode or in Iu mode. After a successful UMTS authentication, the UMTS ciphering key, the UMTS integrity key, the GSM ciphering key and the ciphering key sequence number, are stored both in the network and the MS.

### 4.3.2b Authentication Procedure used for a GSM authentication challenge

The purpose of the authentication procedure is twofold (see 3GPP TS 43.020 [13]):

- First to permit the network to check whether the identity provided by the mobile station is acceptable or not;
- Second to provide parameters enabling the mobile station to calculate a new GSM ciphering key.

The cases where the authentication procedure should be used are defined in 3GPP TS 42.009 [5].

The authentication procedure is always initiated and controlled by the network. GSM authentication challenge shall be supported by a ME supporting GERAN or UTRAN.

A GSM security context is established in the MS and the network when a GSM authentication challenge is performed in A/Gb mode or in Iu mode. However, in Iu mode the MS shall not accept a GSM authentication challenge, if a USIM is

inserted. After a successful GSM authentication, the GSM ciphering key and the ciphering key sequence number, are stored both in the network and the MS.

#### 4.3.2.1 Authentication request by the network

The network initiates the authentication procedure by transferring an AUTHENTICATION REQUEST message across the radio interface and starts the timer T3260. The AUTHENTICATION REQUEST message contains the parameters necessary to calculate the response parameters (see 3GPP TS 43.020 [13] (in case of GSM authentication challenge) and 3GPP TS 33.102 [5a] (in case of an UMTS authentication challenge)). In a GSM authentication challenge, the AUTHENTICATION REQUEST message also contains the GSM ciphering key sequence number allocated to the key which may be computed from the given parameters. In a UMTS authentication challenge, the AUTHENTICATION REQUEST message also contains the ciphering key sequence number allocated to the key set of UMTS ciphering key, UMTS integrity key and GSM ciphering key which may be computed from the given parameters.

#### 4.3.2.2 Authentication response by the mobile station

The mobile station shall be ready to respond upon an AUTHENTICATION REQUEST message at any time whilst a RR connection exists. With exception of the cases described in subclause 4.3.2.5.1, it shall process the challenge information and send back an AUTHENTICATION RESPONSE message to the network.

If a SIM is inserted in the MS, the MS shall ignore the Authentication Parameter AUTN IE if included in the AUTHENTICATION REQUEST message and shall proceed as in case of a GSM authentication challenge. It shall not perform the authentication of the network described in subclause 4.3.2.5.1.

In a GSM authentication challenge, the new GSM ciphering key calculated from the challenge information shall overwrite the previous GSM ciphering key and any previously stored UMTS ciphering key and UMTS integrity key shall be deleted. The new GSM ciphering key shall be stored on the SIM/USIM together with the ciphering key sequence number.

In a UMTS authentication challenge, the new UMTS ciphering key, the new GSM ciphering key and the new UMTS integrity key calculated from the challenge information shall overwrite the previous UMTS ciphering key, GSM ciphering key and UMTS integrity key. The new UMTS ciphering key, GSM ciphering key and UMTS integrity key are stored on the USIM together with the ciphering key sequence number.

The SIM/USIM will provide the mobile station with the authentication response, based upon the authentication challenge given from the ME. A UMTS authentication challenge will result in the USIM passing a RES to the ME. A GSM authentication challenge will result in the SIM/USIM passing a SRES to the ME.

A ME supporting UMTS authentication challenge may support the following procedure:

In order to avoid a synchronisation failure, if the same RAND is received twice, the mobile station shall store the received RAND together with the RES returned from the USIM in the volatile memory and compare it with any subsequently received RAND values, until the RAND value stored in the mobile station is deleted. If the stored RAND value is equal to the new received value in the AUTHENTICATION REQUEST message, then the mobile station shall not pass the RAND to the USIM, but shall immediately send the AUTHENTICATION RESPONSE message with the stored RES. If there is no valid stored RAND in the mobile station or the stored RAND is different from the new received value in the AUTHENTICATION REQUEST message, the mobile station shall pass the RAND to the USIM, shall override any previously stored RAND and RES with the new ones and start, or reset and restart timer T3218.

The RAND and RES values stored in the mobile station shall be deleted and timer T3218, if running, shall be stopped:

- upon receipt of a SECURITY MODE COMMAND (Iu mode only),  
CIPHERING MODE COMMAND (A/Gb mode only),  
CM\_SERVICE\_ACCEPT,  
CM\_SERVICE\_REJECT,  
LOCATION\_UPDATING\_ACCEPT  
or AUTHENTICATION REJECT message;
- upon expiry of timer T3218; or
- if the mobile station enters the MM state MM IDLE or NULL.

### 4.3.2.3 Authentication processing in the network

Upon receipt of the AUTHENTICATION RESPONSE message, the network stops the timer T3260 and checks the validity of the response (see 3GPP TS 43.020 [13] in case of a GSM authentication challenge respective 3GPP TS 33.102 [5a] in case of an UMTS authentication challenge).

Upon receipt of the AUTHENTICATION FAILURE message, the network stops the timer T3260. In Synch failure case, the core network may renegotiate with the HLR/AuC and provide the MS with new authentication parameters.

### 4.3.2.4 Ciphering key sequence number

The security parameters for authentication and ciphering are tied together in sets. In a GSM authentication challenge, from a challenge parameter RAND both the authentication response parameter SRES and the GSM ciphering key can be computed given the secret key associated to the IMSI. In a UMTS authentication challenge, from a challenge parameter RAND, the authentication response parameter RES and the UMTS ciphering key and the UMTS integrity key can be computed given the secret key associated to the IMSI. In addition, a GSM ciphering key can be computed from the UMTS ciphering key and the UMTS integrity key by means of an unkeyed conversion function.

In order to allow start of ciphering on a RR connection without authentication, the ciphering key sequence numbers are introduced. The ciphering key sequence number is managed by the network in the way that the AUTHENTICATION REQUEST message contains the ciphering key sequence number allocated to the GSM ciphering key (in case of a GSM authentication challenge) or the UMTS ciphering key and the UMTS integrity key (in case of a UMTS authentication challenge) which may be computed from the RAND parameter carried in that message.

The mobile station stores the ciphering key sequence number with the GSM ciphering key (in case of a GSM authentication challenge) and the UMTS ciphering key and the UMTS integrity key (in case of a UMTS authentication challenge) and indicates to the network in the first message (LOCATION UPDATING REQUEST, CM SERVICE REQUEST, PAGING RESPONSE, CM RE-ESTABLISHMENT REQUEST) which ciphering key sequence number the stored GSM ciphering key (in case of a GSM authentication challenge) or set of UMTS ciphering, UMTS integrity and derived GSM ciphering keys (in case of a UMTS authentication challenge) has.

When the deletion of the ciphering key sequence number is described this also means that the associated GSM ciphering key, the UMTS ciphering key and the UMTS integrity key shall be considered as invalid (i.e. the established GSM security context or the UMTS security context is no longer valid).

In A/Gb mode, the network may choose to start ciphering with the stored GSM ciphering key (under the restrictions given in 3GPP TS 42.009 [5]) if the stored ciphering key sequence number and the one given from the mobile station are equal.

In Iu mode, the network may choose to start ciphering and integrity with the stored UMTS ciphering key and UMTS integrity key (under the restrictions given in 3GPP TS 42.009 [5] and 3GPP TS 33.102 [5a]) if the stored ciphering key sequence number and the one given from the mobile station are equal.

NOTE: In some specifications the term KSI (Key Set Identifier) might be used instead of the term ciphering key sequence number.

### 4.3.2.5 Authentication not accepted by the network

If authentication fails, i.e. if the response is not valid, the network may distinguish between the two different ways of identification used by the mobile station:

- the TMSI was used;
- the IMSI was used.

If the TMSI has been used, the network may decide to initiate the identification procedure. If the IMSI given by the mobile station then differs from the one the network had associated with the TMSI, the authentication should be restarted with the correct parameters. If the IMSI provided by the MS is the expected one (i.e. authentication has really failed), the network should proceed as described below.

If the IMSI has been used, or the network decides not to try the identification procedure, an AUTHENTICATION REJECT message should be transferred to the mobile station.

After having sent this message, all MM connections in progress (if any) are released and the network should initiate the RR connection release procedure described in subclause 3.5. of 3GPP TS 44.018 [84] (A/Gb mode only), 3GPP TS 25.331 [23c] (UTRAN Iu mode only), or in 3GPP TS 44.118 [110] (GERAN Iu mode only).

Upon receipt of an AUTHENTICATION REJECT message, the mobile station shall set the update status in the SIM/USIM to U3 ROAMING NOT ALLOWED, delete from the SIM/USIM the stored TMSI, LAI and ciphering key sequence number. The SIM/USIM shall be considered as invalid until switching off or the SIM/USIM is removed.

If the AUTHENTICATION REJECT message is received in the state IMSI DETACH INITIATED the mobile station shall follow subclause 4.3.4.3.

If the AUTHENTICATION REJECT message is received in any other state the mobile station shall abort any MM specific, MM connection establishment or call re-establishment procedure, stop any of the timers T3210 or T3230 (if running), release all MM connections (if any), start timer T3240 and enter the state WAIT FOR NETWORK COMMAND, expecting the release of the RR connection. If the RR connection is not released within a given time controlled by the timer T3240, the mobile station shall abort the RR connection. In both cases, either after a RR connection release triggered from the network side or after a RR connection abort requested by the MS-side, the MS enters state MM IDLE, substate NO IMSI.

#### 4.3.2.5.1 Authentication not accepted by the MS

In a UMTS authentication challenge, the authentication procedure is extended to allow the MS to check the authenticity of the core network. Thus allowing, for instance, detection of false base station.

Following a UMTS authentication challenge, the MS may reject the core network, on the grounds of an incorrect AUTN parameter (see 3GPP TS 33.102 [5a]). This parameter contains two possible causes for authentication failure:

a) MAC code failure:

If the MS considers the MAC code (supplied by the core network in the AUTN parameter) to be invalid, it shall send an AUTHENTICATION FAILURE message to the network, with the reject cause 'MAC failure'. The MS shall then follow the procedure described in subclause 4.3.2.6 (c).

b) SQN failure:

If the MS considers the SQN (supplied by the core network in the AUTN parameter) to be out of range, it shall send a AUTHENTICATION FAILURE message to the network, with the reject cause 'Synch failure' and a re-synchronization token AUTS provided by the USIM (see 3GPP TS 33.102 [5a]). The MS shall then follow the procedure described in subclause 4.3.2.6 (d).

In UMTS, an MS with a USIM inserted shall reject the authentication challenge if no Authentication Parameter AUTN IE was present in the AUTHENTICATION REQUEST message (i.e. a GSM authentication challenge has been received when the MS expects a UMTS authentication challenge). In such a case, the MS shall send the AUTHENTICATION FAILURE message to the network, with the reject cause "GSM authentication unacceptable". The MS shall then follow the procedure described in subclause 4.3.2.6 (c).

If the MS returns an AUTHENTICATION\_FAILURE message to the network, the MS shall delete any previously stored RAND and RES and shall stop timer T3218, if running.

#### 4.3.2.6 Abnormal cases

(a) RR connection failure:

Upon detection of a RR connection failure before the AUTHENTICATION RESPONSE is received, the network shall release all MM connections (if any) and abort any ongoing MM specific procedure.

(b) Expiry of timer T3260:

The authentication procedure is supervised on the network side by the timer T3260. At expiry of this timer the network may release the RR connection. In this case the network shall abort the authentication procedure and any ongoing MM specific procedure, release all MM connections if any, and initiate the RR connection release procedure described in subclause 3.5.

(c) Authentication failure (reject cause "MAC failure" or "GSM authentication unacceptable"):

The MS shall send an AUTHENTICATION FAILURE message, with reject cause "MAC failure" or "GSM authentication unacceptable" according to subclause 4.3.2.5.1, to the network and start timer T3214. Furthermore, the MS shall stop any of the retransmission timers that are running (e.g. T3210, T3220 or T3230). Upon the first receipt of an AUTHENTICATION FAILURE message from the MS with reject cause "MAC failure" or "GSM authentication unacceptable", the network may initiate the identification procedure described in subclause 4.3.3. This is to allow the network to obtain the IMSI from the MS. The network may then check that the TMSI originally used in the authentication challenge corresponded to the correct IMSI. Upon receipt of the IDENTITY REQUEST message from the network, the MS shall send the IDENTITY RESPONSE message.

NOTE: Upon receipt of an AUTHENTICATION FAILURE message from the MS with reject cause "MAC failure" or "GSM authentication unacceptable", the network may also terminate the authentication procedure (see subclause 4.3.2.5).

If the TMSI/IMSI mapping in the network was incorrect, the network should respond by sending a new AUTHENTICATION REQUEST message to the MS. Upon receiving the new AUTHENTICATION REQUEST message from the network, the MS shall stop the timer T3214, if running, and then process the challenge information as normal.

If the network is validated successfully (an AUTHENTICATION REQUEST that contains a valid SQN and MAC is received), the MS shall send the AUTHENTICATION RESPONSE message to the network and shall start any retransmission timers (e.g. T3210, T3220 or T3230), if they were running and stopped when the MS received the first failed AUTHENTICATION REQUEST message.

If the MS receives the second AUTHENTICATION REQUEST while T3214 is running, and the MAC value cannot be resolved or the message contains a GSM authentication challenge, the MS shall follow the procedure specified in this subclause (c), starting again from the beginning. If the SQN is invalid, the MS shall proceed as specified in (d).

It can be assumed that the source of the authentication challenge is not genuine (authentication not accepted by the MS) if any of the following occur:

- after sending the AUTHENTICATION FAILURE message with the reject cause "MAC failure" or "GSM authentication unacceptable" the timer T3214 expires;
- the MS detects any combination of the authentication failures: "MAC failure", "invalid SQN", and "GSM authentication unacceptable", during three consecutive authentication challenges. The authentication challenges shall be considered as consecutive only, if the authentication challenges causing the second and third authentication failure are received by the MS, while the timer T3214 or T3216 started after the previous authentication failure is running.

When it has been deemed by the MS that the source of the authentication challenge is not genuine (i.e. authentication not accepted by the MS), the MS shall behave as described in subclause 4.3.2.6.1.

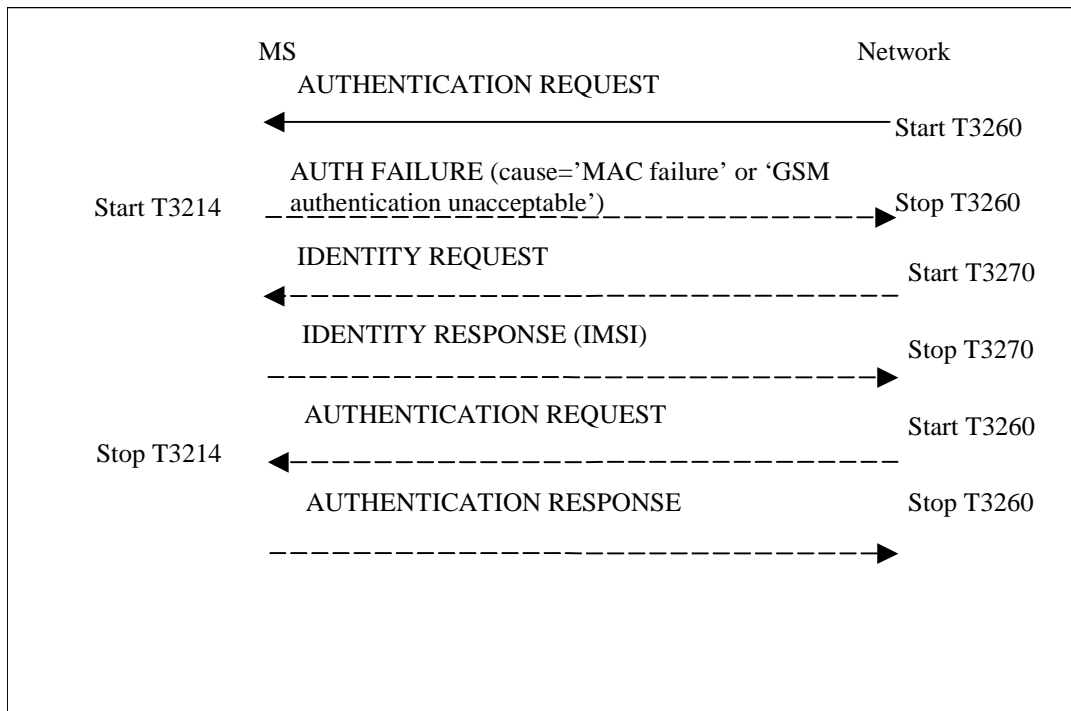

**Figure 4.2/3GPP TS 24.008: Authentication Failure Procedure (reject cause "MAC failure" or "GSM authentication unacceptable")**

(d) Authentication failure (reject cause "synch failure"):

The MS shall send an AUTHENTICATION FAILURE message, with reject cause "synch failure", to the network and start the timer T3216. Furthermore, the MS shall stop any of the retransmission timers that are running (e.g. T3210, T3220 or T3230). Upon the first receipt of an AUTHENTICATION FAILURE message from the MS with the reject cause "synch failure", the network shall use the returned AUTS parameter from the authentication failure parameter IE in the AUTHENTICATION FAILURE message, to re-synchronise. The re-synchronisation procedure requires the VLR/MSC to delete all unused authentication vectors for that IMSI and obtain new vectors from the HLR. When re-synchronisation is complete, the network shall initiate the authentication procedure. Upon receipt of the AUTHENTICATION REQUEST message, the MS shall stop the timer T3216, if running.

**NOTE:** Upon receipt of two consecutive AUTHENTICATION FAILURE messages from the MS with reject cause "synch failure", the network may terminate the authentication procedure by sending an AUTHENTICATION REJECT message.

If the network is validated successfully (a new AUTHENTICATION REQUEST is received which contains a valid SQN and MAC) while T3216 is running, the MS shall send the AUTHENTICATION RESPONSE message to the network and shall start any retransmission timers (e.g. T3210, T3220 or T3230), if they were running and stopped when the MS received the first failed AUTHENTICATION REQUEST message.

If the MS receives the second AUTHENTICATION REQUEST while T3216 is running, and the MAC value cannot be resolved or the message contains a GSM authentication challenge, the MS shall proceed as specified in (c); if the SQN is invalid, the MS shall follow the procedure specified in this subclause (d), starting again from the beginning.

The MS shall deem that the network has failed the authentication check and behave as described in subclause 4.3.2.6.1, if any of the following occurs:

- the timer T3216 expires;
- the MS detects any combination of the authentication failures: "MAC failure", "invalid SQN", and "GSM authentication unacceptable", during three consecutive authentication challenges. The authentication challenges shall be considered as consecutive only, if the authentication challenges causing the second and third authentication failure are received by the MS, while the timer T3214 or T3216 started after the previous authentication failure is running.

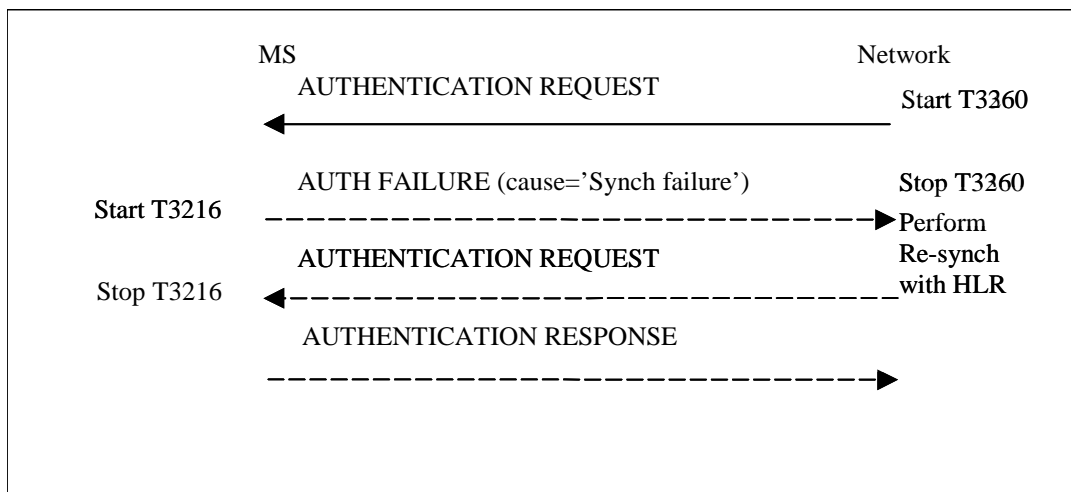

Figure 4.2a/3GPP TS 24.008: Authentication Failure Procedure (reject cause "Synch failure")

4.3.2.6.1 MS behaviour towards a network that has failed the authentication procedure

If the MS deems that the network has failed the authentication check, then it shall request RR or RRC to release the RR connection and the PS signalling connection, if any, and bar the active cell or cells (see 3GPP TS 25.331 and 3GPP TS 44.018). The MS shall start any retransmission timers (e.g. T3210, T3220 or T3230), if they were running and stopped when the MS received the first AUTHENTICATION REQUEST message containing an invalid MAC or invalid SQN, or no AUTN when a UMTS authentication challenge was expected.

4.3.2.7 Handling of keys at intersystem change from Iu mode to A/Gb mode

At inter-system change from Iu mode to A/Gb mode, ciphering may be started (see 3GPP TS 44.018 [86]) without any new authentication procedure. Deduction of the appropriate security key for ciphering in A/Gb mode, depends on the current GSM/UMTS security context stored in the MS and the network.

The ME shall handle the GSM ciphering key according to table 4.3.2.7.1.

Table 4.3.2.7.1/3GPP TS 24.008: Inter-system change from Iu mode to A/Gb mode

Security context established in MS and network in Iu mode	At inter-system change to A/Gb mode:
GSM security context	An ME shall apply the stored GSM cipher key that was received from the GSM security context residing in the SIM/USIM during the latest successful ciphering mode setting or security mode control procedure before the inter-system change.
UMTS security context	An ME shall apply the stored GSM cipher key that was derived by the USIM from the UMTS cipher key and the UMTS integrity key and provided by the USIM during the latest successful ciphering mode setting or security mode control procedure before the inter-system change.

NOTE: A USIM with UMTS security context, passes the UMTS cipher key, the UMTS integrity key and the derived GSM cipher key to the ME independent on the current radio access being UTRAN or GERAN.

4.3.2.7a Use of established security contexts

In A/Gb mode, in the case of an established GSM security context, the GSM ciphering key shall be loaded from the SIM/USIM and taken into use by the ME when any valid CIPHERING MODE COMMAND is received during an RR connection (the definition of a valid CIPHERING MODE COMMAND message is given in 3GPP TS 44.018 [84] subclause 3.4.7.2).

In A/Gb mode, in the case of an established UMTS security context, the GSM ciphering key shall be loaded from the USIM and taken into use by the MS when a valid CIPHERING MODE COMMAND is received during an RR connection (the definition of a valid CIPHERING MODE COMMAND message is given in 3GPP TS 44.018 [84] subclause 3.4.7.2). The network shall derive a GSM ciphering key from the UMTS ciphering key and the UMTS integrity key by using the conversion function named "c3" defined in 3GPP TS 33.102 [5a].

In Iu mode, in the case of an established GSM security context, the ME shall derive a UMTS ciphering key and a UMTS integrity key from the GSM ciphering key by using the conversion functions named "c4" and "c5" defined in 3GPP TS 33.102 [5a]. The GSM ciphering key shall be loaded from the SIM/USIM and the derived UMTS ciphering key and UMTS integrity key shall be taken into use by the MS when a valid SECURITY MODE COMMAND indicating CS domain is received during an RR connection (the definition of a valid SECURITY MODE COMMAND message is given in 3GPP TS 25.331 [23c] and 3GPP TS 44.118 [111]). The network shall derive a UMTS ciphering key and a UMTS integrity key from the GSM ciphering key by using the conversion functions named "c4" and "c5" defined in 3GPP TS 33.102 [5a].

In Iu mode, in the case of an established UMTS security context, the UMTS ciphering key and UMTS integrity key shall be loaded from the USIM and taken into use by the MS when a valid SECURITY MODE COMMAND indicating CS domain is received during a RR connection (the definition of a valid SECURITY MODE COMMAND message is given in 3GPP TS 25.331 [23c] and 3GPP TS 44.118 [111]).

In Iu mode and A/Gb mode, if the MS received a valid SECURITY MODE COMMAND indicating CS domain in Iu mode or a valid CIPHERING MODE COMMAND in A/Gb mode before the network initiates a new Authentication procedure and establishes a new GSM/UMTS security context, the new keys are taken into use in the MS when a new valid SECURITY MODE COMMAND indicating CS domain in Iu mode, or a new valid CIPHERING MODE COMMAND in A/Gb mode, is received during the RR connection. In case of Iu mode to Iu mode handover, A/Gb mode to A/Gb mode handover, or inter-system change to A/Gb mode, the MS and the network shall continue to use the key from the old key set until a new valid SECURITY MODE COMMAND indicating CS domain in Iu mode, or a new valid CIPHERING MODE COMMAND in A/Gb mode, is received during the RR connection. In case of inter-system change to Iu mode, the MS and the network shall continue to use the keys from the old key set until the second valid SECURITY MODE COMMAND indicating CS domain is received during the RR connection.

NOTE 1: If the MS received a valid SECURITY MODE COMMAND indicating CS domain in Iu mode or a valid CIPHERING MODE COMMAND in A/Gb mode before the inter-system change to Iu mode occurs, the first SECURITY MODE COMMAND message after the inter-system change, which indicates CS domain and includes only an Integrity protection mode IE, is initiated by the UTRAN without receipt of a corresponding RANAP security mode control procedure from the MSC/VLR. The only purpose of this SECURITY MODE COMMAND message is to activate the integrity protection, but not to load a new key set from the SIM/USIM (see 3GPP TS 25.331 [23c] and 3GPP TS 44.118 [111]).

NOTE 2: If the MS received a valid SECURITY MODE COMMAND indicating CS domain in Iu mode or a valid CIPHERING MODE COMMAND in A/Gb mode before the inter-system change to Iu mode occurs, the first SECURITY MODE COMMAND message after the inter-system change, which indicates CS domain, is initiated by the UTRAN on receipt of a RANAP security mode control procedure from the MSC/VLR. The purpose of this SECURITY MODE COMMAND message is to load a key set from the SIM/USIM and to activate either integrity protection or ciphering and integrity protection (see 3GPP TS 25.331 [23c] and 3GPP TS 44.118 [111]).

#### 4.3.2.8 Handling of keys at intersystem change from A/Gb mode to Iu mode

At inter-system change from A/Gb mode to Iu mode, ciphering and integrity may be started (see 3GPP TS 25.331 [23c]) without any new authentication procedure. Deduction of the appropriate security keys for ciphering and integrity check in Iu mode, depends on the current GSM/UMTS security context stored in the MS and the network.

The ME shall handle the UMTS cipher key and the UMTS integrity key according to table 4.3.2.8.1.



**Table 4.3.2.8.1/3GPP TS 24.008: Inter-system change from A/Gb mode to lu mode**

Security context established in MS and network in A/Gb mode	At inter-system change to lu mode:
GSM security context	An ME shall derive the UMTS cipher key and the UMTS integrity key from the stored GSM cipher key that was provided by the SIM/USIM during the latest successful ciphering mode setting or security mode control procedure before the inter-system change. The conversion functions named "c4" and "c5" in 3GPP TS 33.102 [5a] are used for this purpose.
UMTS security context	An ME shall apply the stored UMTS ciphering key and the stored UMTS integrity key that were received from the UMTS security context residing in the USIM during the latest successful ciphering mode setting or security mode control procedure before the inter-system change.

NOTE: A USIM with UMTS security context, passes the UMTS cipher key, the UMTS integrity key and the derived GSM cipher key to the ME independent on the current radio access being UTRAN or GERAN.

#### 4.3.2.9 Void

### 4.3.3 Identification procedure

The identification procedure is used by the network to request a mobile station to provide specific identification parameters to the network e.g. International Mobile Subscriber Identity, International Mobile Equipment Identity (see 3GPP TS 23.003 [10]). For the presentation of the IMEI, the requirements of 3GPP TS 42.009 [5] apply.

#### 4.3.3.1 Identity request by the network

The network initiates the identification procedure by transferring an IDENTITY REQUEST message to the mobile station and starts the timer T3270. The IDENTITY REQUEST message specifies the requested identification parameters in the identity type information element.

#### 4.3.3.2 Identification response by the mobile station

The mobile station shall be ready to respond to an IDENTITY REQUEST message at any time whilst a RR connection exists.

Upon receipt of the IDENTITY REQUEST message the mobile station sends back an IDENTITY RESPONSE message. The IDENTITY RESPONSE message contains the identification parameters as requested by the network.

Upon receipt of the IDENTITY RESPONSE the network shall stop timer T3270.

#### 4.3.3.3 Abnormal cases

##### (a) RR connection failure:

Upon detection of a RR connection failure before the IDENTITY RESPONSE is received, the network shall release all MM connections (if any) and abort any ongoing MM specific procedure.

##### (b) Expiry of timer T3270:

The identification procedure is supervised by the network by the timer T3270. At expiry of the timer T3270 the network may release the RR connection. In this case, the network shall abort the identification procedure and any ongoing MM specific procedure, release all MM connections if any, and initiate the RR connection release procedure as described in 3GPP TS 44.018 [84] subclause 3.5 and 3GPP TS 25.331 [23c].

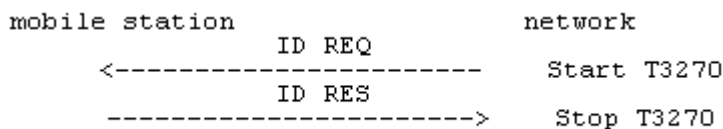

**Figure 4.3/3GPP TS 24.008: Identification sequence**

(c) Requested identity is not available:

If the MS cannot encode the requested identity in the IDENTITY RESPONSE message, e.g. because no valid SIM is available, then it shall encode the identity type as "No identity".

### 4.3.4 IMSI detach procedure

The IMSI detach procedure may be invoked by a mobile station if the mobile station is deactivated or if the Subscriber Identity Module (see 3GPP TS 42.017 [7] and 3GPP TS 31.102 [112]) is detached from the mobile station.

In A/Gb mode and GERAN Iu mode, a flag (ATT) broadcast in the L3-RR SYSTEM INFORMATION TYPE 3 message on the BCCH is used by the network to indicate whether the detach procedure is required. The value of the ATT flag to be taken into account shall be the one broadcast when the mobile station was in MM idle.

In UTRAN Iu mode, a flag (ATT) in the CS domain specific system information element is used by the network to indicate whether the detach procedure is required. The value of the ATT flag to be taken into account shall be the one received when the mobile station was in MM idle.

The procedure causes the mobile station to be indicated as inactive in the network.

#### 4.3.4.1 IMSI detach initiation by the mobile station

The IMSI detach procedure consists only of the IMSI DETACH INDICATION message sent from the mobile station to the network. The mobile station then starts timer T3220 and enters the MM sublayer state IMSI DETACH INITIATED.

If no RR connection exists, the MM sublayer within the mobile station will request the RR sublayer to establish a RR connection. If establishment of the RR connection is not possible because a suitable cell is not (or not yet) available then, the mobile station shall try for a period of at least 5 seconds and for not more than a period of 20 seconds to find a suitable cell. If a suitable cell is found during this time then, the mobile station shall request the RR sublayer to establish an RR connection, otherwise the IMSI detach is aborted.

If a RR connection exists, the MM sublayer will release locally any ongoing MM connections before the IMSI DETACH INDICATION message is sent.

The IMSI detach procedure may not be started if a MM specific procedure is active. If possible, the IMSI detach procedure is then delayed until the MM specific procedure is finished, else the IMSI detach is omitted.

#### 4.3.4.2 IMSI detach procedure in the network

When receiving an IMSI DETACH INDICATION message, the network may set an inactive indication for the IMSI. No response is returned to the mobile station. After reception of the IMSI DETACH INDICATION message the network shall release locally any ongoing MM connections, and start the normal RR connection release procedure (see 3GPP TS 44.018 [84] subclause 3.5 and 3GPP TS 25.331 [23c]).

Only applicable for a network supporting VGCS: If an IMSI DETACH INDICATION message is received from the talking mobile station in a group call while the network is in service state MM CONNECTION ACTIVE (GROUP TRANSMIT MODE), the network shall release locally the ongoing MM connection and then go to the service state GROUP CALL ACTIVE.

#### 4.3.4.3 IMSI detach completion by the mobile station

Timer T3220 is stopped when the RR connection is released. The mobile station should, if possible, delay the local release of the channel to allow a normal release from the network side until T3220 timeout. If this is not possible (e.g. detach at power down) the RR sublayer on the mobile station side should be aborted.

#### 4.3.4.4 Abnormal cases

If the establishment of an RR connection is unsuccessful, or the RR connection is lost, the IMSI detach is aborted by the mobile station.

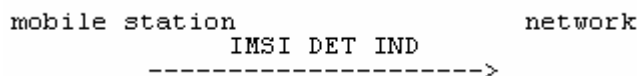

**Figure 4.4/3GPP TS 24.008: IMSI detach sequence**

### 4.3.5 Abort procedure

The abort procedure may be invoked by the network to abort any on-going MM connection establishment or already established MM connection. The mobile station shall treat ABORT message as compatible with current protocol state only if it is received when at least one MM connection exists or an MM connection is being established.

#### 4.3.5.1 Abort procedure initiation by the network

The abort procedure consists only of the ABORT message sent from the network to the mobile station. Before the sending of the ABORT message the network shall locally release any ongoing MM connection. After the sending the network may start the normal RR connection release procedure.

The Cause information element indicates the reason for the abortion. The following cause values may apply:

- # 6: Illegal ME
- #17: Network failure

#### 4.3.5.2 Abort procedure in the mobile station

At the receipt of the ABORT message the mobile station shall abort any MM connection establishment or call re-establishment procedure and release all MM connections (if any). If cause value #6 is received the mobile station shall delete any TMSI, LAI and ciphering key sequence number stored in the SIM/USIM, set the update status to ROAMING NOT ALLOWED (and store it in the SIM/USIM according to subclause 4.1.2.2) and consider the SIM/USIM invalid until switch off or the SIM/USIM is removed. As a consequence the mobile station enters state MM IDLE, substate NO IMSI after the release of the RR connection.

The mobile station shall then wait for the network to release the RR connection - see subclause 4.5.3.1.

### 4.3.6 MM information procedure

The MM information message support is optional in the network.

The MM information procedure may be invoked by the network at any time during an RR connection.

#### 4.3.6.1 MM information procedure initiation by the network

The MM information procedure consists only of the MM INFORMATION message sent from the network to the mobile station. During an RR connection, the network shall send none, one, or more MM INFORMATION messages to the mobile station. If more than one MM INFORMATION message is sent, the messages need not have the same content.

**NOTE:** The network may be able to select particular instants where it can send the MM INFORMATION message without adding delay to, or interrupting, any CM layer transaction, e.g. immediately after the AUTHENTICATION REQUEST message.

#### 4.3.6.2 MM information procedure in the mobile station

When the mobile station (supporting the MM information message) receives an MM INFORMATION message, it shall accept the message and optionally use the contents to update appropriate information stored within the mobile station.

If the mobile station does not support the MM information message the mobile station shall ignore the contents of the message and return an MM STATUS message with cause #97.

## 4.4 MM specific procedures

A MM specific procedure can only be started if no other MM specific procedure is running or no MM connection exists between the network and the mobile station. The end of the running MM specific procedure or the release of all MM connections have to be awaited before a new MM specific procedure can be started.

During the lifetime of a MM specific procedure, if a MM connection establishment is requested by a CM entity, this request will either be rejected or be delayed until the running MM specific procedure is terminated (this depends on the implementation).

Any MM common procedure (except IMSI detach) may be initiated during a MM specific procedure.

Unless it has specific permission from the network (follow-on proceed) the mobile station side should await the release of the RR connection used for a MM specific procedure before a new MM specific procedure or MM connection establishment is started.

NOTE: The network side may use the same RR connection for MM connection management.

### 4.4.1 Location updating procedure

The location updating procedure is a general procedure which is used for the following purposes:

- normal location updating (described in this subclause);
- periodic updating (see subclause 4.4.2);
- IMSI attach (see subclause 4.4.3).

The normal location updating procedure is used to update the registration of the actual Location Area of a mobile station in the network. The location updating type information element in the LOCATION UPDATING REQUEST message shall indicate normal location updating. The conditions under which the normal location updating procedure is used by a mobile station in the MM IDLE state are defined for each service state in subclause 4.2.2.

Only applicable for mobile stations supporting VGCS listening or VBS listening: A mobile station in RR group receive mode is in the MM IDLE state, substate RECEIVING GROUP CALL (NORMAL SERVICE) or RECEIVING GROUP CALL (LIMITED SERVICE). To perform a location updating, the MS in RR group receive mode shall leave the group receive mode, establish an independent dedicated RR connection to perform the location updating as described above and return to the RR group receive mode afterwards.

The normal location updating procedure shall also be started if the network indicates that the mobile station is unknown in the VLR as a response to MM connection establishment request.

To limit the number of location updating attempts made, where location updating is unsuccessful, an attempt counter is used. The attempt counter is reset when a mobile station is switched on or a SIM/USIM card is inserted.

Upon successful location updating the mobile station sets the update status to UPDATED in the SIM/USIM, and stores the Location Area Identification received in the LOCATION UPDATING ACCEPT message in the SIM/USIM. The attempt counter shall be reset.

The detailed handling of the attempt counter is described in subclauses 4.4.4.6 to 4.4.4.9.

The Mobile Equipment shall contain a list of "forbidden location areas for roaming", as well as a list of "forbidden location areas for regional provision of service". These lists shall be erased when the MS is switched off or when the SIM/USIM is removed, and periodically (with period in the range 12 to 24 hours). The location area identification received on the BCCH that triggered the location updating request shall be added to the suitable list whenever a location update reject message is received with the cause "Roaming not allowed in this location area" or with the cause "Location Area not allowed". The lists shall accommodate each 10 or more location area identifications. When the list is full and a new entry has to be inserted, the oldest entry shall be deleted.

In a shared network, the MS shall choose one of the PLMN identities as specified in 3GPP TS 23.122 [14]. The MS shall construct the Location Area Identification of the cell from this chosen PLMN identity and the LAC received on the BCCH. If the constructed LAI is different from the stored LAI, the MS shall initiate the location updating procedure. The chosen PLMN identity shall be indicated to the RAN in the RRC INITIAL DIRECT TRANSFER message (see 3GPP TS 25.331 [23c]). Whenever a LOCATION UPDATING REJECT message with the cause "PLMN not allowed" is received by the MS, the PLMN identity used to construct the LAI which triggered the location updating procedure shall be stored in the "forbidden PLMN list". Whenever a LOCATION UPDATING REJECT message is received by the MS with the cause "Roaming not allowed in this location area", "Location Area not allowed", or "No suitable cells in Location Area", the constructed LAI which triggered the location updating procedure shall be stored in the suitable list.

The Mobile Equipment shall store a list of "equivalent PLMNs". This list is replaced or deleted at the end of each location update procedure, routing area update procedure and GPRS attach procedure. The stored list consists of a list of equivalent PLMNs as downloaded by the network plus the PLMN code of the registered PLMN that downloaded the list. The stored list shall not be deleted when the MS is switched off. The stored list shall be deleted if the SIM/USIM is removed. The maximum number of possible entries in the stored list is 16.

The cell selection processes in the different states are described in 3GPP TS 43.022 [82] and 3GPP TS 45.008 [34].

The location updating procedure is always initiated by the mobile station.

In the case that the mobile station is initiating an emergency call but, due to cell re-selection or redirection by the network, it moves to a different LAI then the mobile station may delay the location updating procedure in the new LA until after the emergency call is completed.

## 4.4.2 Periodic updating

Periodic updating may be used to notify periodically the availability of the mobile station to the network. Periodic updating is performed by using the location updating procedure. The location updating type information element in the LOCATION UPDATING REQUEST message shall indicate periodic updating.

The procedure is controlled by the timer T3212 in the mobile station. If the timer is not already started, the timer is started each time the mobile station enters the MM IDLE substate NORMAL SERVICE or ATTEMPTING TO UPDATE. When the MS leaves the MM Idle State the timer T3212 shall continue running until explicitly stopped.

The timer is stopped (shall be set to its initial value for the next start) when:

- a LOCATION UPDATING ACCEPT or LOCATION UPDATING REJECT message is received;
- an AUTHENTICATION REJECT message is received;
- the first MM message is received, or security mode setting is completed in the case of MM connection establishment, except when the most recent service state is LIMITED SERVICE;
- the mobile station has responded to paging and thereafter has received the first correct layer 3 message except RR message;
- the mobile station is deactivated (i.e. equipment powered down or SIM/USIM removed).

When the timer T3212 expires, the location updating procedure is started and the timer shall be set to its initial value for the next start. If the mobile station is in other state than MM Idle when the timer expires the location updating procedure is delayed until the MM Idle State is entered.

The conditions under which the periodic location updating procedure is used by a mobile station in the MM IDLE state are defined for each service state in subclause 4.2.2.

If the mobile station is in service state NO CELL AVAILABLE, LIMITED SERVICE, PLMN SEARCH or PLMN SEARCH-NORMAL SERVICE when the timer expires the location updating procedure is delayed until this service state is left.

In A/Gb mode and GERAN Iu mode, the (periodic) location updating procedure is not started if the BCCH information at the time the procedure is triggered indicates that periodic location shall not be used. The timeout value is broadcasted

in the L3-RR SYSTEM INFORMATION TYPE 3 message on the BCCH, in the Control channel description IE, see 3GPP TS 44.018 [84] subclause 10.5.2.11.

In UTRAN Iu mode, the (periodic) location updating procedure is not started if the information on BCCH or in the last received dedicated system information at the time the procedure is triggered indicates that periodic location shall not be used. The timeout value is included in the CS domain specific system information element.

The T3212 timeout value shall not be changed in the NO CELL AVAILABLE, LIMITED SERVICE, PLMN SEARCH and PLMN SEARCH-NORMAL SERVICE states.

When a change of the T3212 timeout value has to be taken into account and the timer is running (at change of the serving cell or, change of the broadcast value of T3212), the MS shall behave as follows:

Let  $t1$  be the new T3212 timeout value and let  $t$  be the current timer value at the moment of the change to the new T3212 timeout value; then the timer shall be restarted with the value  $t$  modulo  $t1$ .

When the mobile station is activated, or when a change of the T3212 timeout value has to be taken into account and the timer is not running, the mobile station shall behave as follows:

Let  $t1$  be the new T3212 timeout value, the new timer shall be started at a value randomly, uniformly drawn between 0 and  $t1$ .

### 4.4.3 IMSI attach procedure

The IMSI attach procedure is the complement of the IMSI detach procedure (see subclause 4.3.4). It is used to indicate the IMSI as active in the network.

In A/Gb mode and GERAN Iu mode, a flag (ATT) is broadcast in the L3-RR SYSTEM INFORMATION TYPE 3 message. It indicates whether the attach and detach procedures are required to be used or not.

In UTRAN mode, a flag (ATT) is included in the CS domain specific system information element. It indicates whether the attach and detach procedures are required to be used or not.

The IMSI attach procedure is invoked if the detach/attach procedures are required by the network and an IMSI is activated in a mobile station (i.e. activation of a mobile station with plug-in SIM/USIM, insertion of a card in a card-operated mobile station etc.) within coverage area from the network or a mobile station with an IMSI activated outside the coverage area enters the coverage area. The IMSI attach procedure is used only if the update status is UPDATED and if the stored Location Area Identification is the same as the one which is actually broadcasted on the BCCH of the current serving cell. In a shared network, the MS shall choose one of the PLMN identities as specified in 3GPP TS 23.122 [14]. The MS shall use the IMSI attach procedure only if the update status is UPDATED and the stored Location Area Identification is equal to the combination of the chosen PLMN identity and the LAC received on the BCCH. Otherwise a normal location updating procedure (see subclause 4.4.1) is invoked independently of the ATT flag indication.

IMSI attach is performed by using the location updating procedure. The location updating type information element in the LOCATION UPDATING REQUEST message shall in this case indicate IMSI attach.

### 4.4.4 Generic Location Updating procedure

#### 4.4.4.1 Location updating initiation by the mobile station

Any timer used for triggering the location updating procedure (e.g. T3211, T3212) is stopped if running.

As no RR connection exists at the time when the location updating procedure has to be started, the MM sublayer within the mobile station will request the RR sublayer to establish a RR connection and enter state WAIT FOR RR CONNECTION (LOCATION UPDATE). The procedure for establishing an RR connection is described in 3GPP TS 44.018 [84] subclause 3.3 and 3GPP TS 25.331 [23c].

The mobile station initiates the location updating procedure by sending a LOCATION UPDATING REQUEST message to the network, starts the timer T3210 and enters state LOCATION UPDATING INITIATED. The location updating type information element shall indicate what kind of updating is requested.

#### 4.4.4.1a Network Request for Additional mobile station Capability Information

In A/Gb mode, the network may initiate the classmark interrogation procedure, for example, to obtain further information on the mobile station's encryption capabilities.

#### 4.4.4.2 Identification request from the network

The network may initiate the identification procedure, e.g. if the network is unable to get the IMSI based on the TMSI and LAI used as identification by the mobile station (see subclause 4.3.3).

#### 4.4.4.3 Authentication by the network

The authentication procedure (see subclause 4.3.2) may be initiated by the network upon receipt of the LOCATION UPDATING REQUEST message from the mobile station. (See the cases defined in 3GPP TS 42.009 [5]).

#### 4.4.4.4 Security mode setting by the network

In A/Gb mode, the security mode setting procedure (see 3GPP TS 44.018 [84] subclause 3.4.7) may be initiated by the network, e.g., if a new TMSI has to be allocated.

In Iu mode, the security mode control procedure (see 3GPP TS 25.331 [23c] and 3GPP TS 44.118 [111]) may be initiated by the network, e.g., if a new TMSI has to be allocated.

#### 4.4.4.5 Attempt Counter

To limit the number of location updating attempts made, where location updating is unsuccessful, an attempt counter is used. It counts the number of consecutive unsuccessful location update attempts.

The attempt counter is incremented when a location update procedure fails. The specific situations are specified in subclause 4.4.4.9.

The attempt counter is reset when:

- the mobile station is powered on;
- a SIM/USIM is inserted;
- location update is successfully completed;
- location update completed with cause #11, #12, #13 or #15 (see subclause 4.4.4.7).

and in case of service state ATTEMPTING to UPDATE:

- a MS detects that a new location area is entered;
- expiry of timer T3212;
- location update is triggered by CM sublayer requests.

The attempt counter is used when deciding whether to re-attempt a location update after timeout of timer T3211.

#### 4.4.4.6 Location updating accepted by the network

If the location updating is accepted by the network a LOCATION UPDATING ACCEPT message is transferred to the mobile station.

In case the identity confidentiality service is active (see subclauses 4.3.1 and 4.4.4.4), the TMSI reallocation may be part of the location updating procedure. The TMSI allocated is then contained in the LOCATION UPDATING ACCEPT message together with the location area identifier LAI. The network shall in this case start the supervision timer T3250 as described in subclause 4.3.1.

In a shared network, the network shall indicate in the LAI the PLMN identity of the CN operator that has accepted the location updating (see 3GPP TS 23.251 [109]).

If the network wishes to prolong the RR connection to allow the mobile station to initiate MM connection establishment (for example if the mobile station has indicated in the LOCATION UPDATING REQUEST that it has a follow-on request pending) the network shall send "follow on proceed" in the LOCATION UPDATING ACCEPT and start timer T3255.

The mobile station receiving a LOCATION UPDATING ACCEPT message shall store the received location area identification LAI, stop timer T3210, reset the attempt counter and set the update status in the SIM/USIM to UPDATED. If the message contains an IMSI, the mobile station is not allocated any TMSI, and shall delete any TMSI in the SIM/USIM accordingly. If the message contains a TMSI, the mobile station is allocated this TMSI, and shall store this TMSI in the SIM/USIM and a TMSI REALLOCATION COMPLETE shall be returned to the network. If neither IMSI nor TMSI is received in the LOCATION UPDATING ACCEPT message, the old TMSI if any available shall be kept.

If the LAI or PLMN identity contained in the LOCATION UPDATING ACCEPT message is a member of any of the "forbidden lists" then any such entries shall be deleted.

The network may also send a list of "equivalent PLMNs" in the LOCATION UPDATING ACCEPT message. Each entry of the list contains a PLMN code (MCC+MNC). The mobile station shall store the list, as provided by the network, except that any PLMN code that is already in the "forbidden PLMN list" shall be removed from the "equivalent PLMNs" list before it is stored by the mobile station. In addition the mobile station shall add to the stored list the PLMN code of the registered PLMN that sent the list. All PLMNs in the stored list shall be regarded as equivalent to each other for PLMN selection, cell selection/re-selection and handover. The stored list in the mobile station shall be replaced on each occurrence of the LOCATION UPDATING ACCEPT message. If no list is contained in the message, then the stored list in the mobile station shall be deleted. The list shall be stored in the mobile station while switched off so that it can be used for PLMN selection after switch on.

After that, the mobile station shall act according to the presence of the "Follow-on proceed" information element in the LOCATION UPDATING ACCEPT; if this element is present and the mobile station has a CM application request pending, it shall send a CM SERVICE REQUEST to the network and proceed as in subclause 4.5.1.1. Otherwise, it shall start timer T3240 and enter state WAIT FOR NETWORK COMMAND.

Furthermore, the network may grant authorisation for the mobile station to use GSM-Cordless Telephony System (CTS) in the Location Area and its immediate neighbourhood. The mobile should memorise this permission in non-volatile memory. If the "CTS permission" IE is not present in the message, the mobile is not authorised to use GSM-CTS, and shall accordingly delete any memorised permission.

NOTE 1: the interaction between CTS and GPRS procedures are not yet defined.

The network may also send a list of local emergency numbers in the LOCATION UPDATING ACCEPT, by including the Emergency Number List IE. The mobile equipment shall store the list, as provided by the network, except that any emergency number that is already stored in the SIM/USIM shall be removed from the list before it is stored by the mobile equipment. If there are no emergency numbers stored on the SIM/USIM, then before storing the received list the mobile equipment shall remove from it any emergency number stored permanently in the ME for use in this case (see 3GPP TS 22.101 [8]). The list stored in the mobile equipment shall be replaced on each receipt of a new Emergency Number List IE.

The emergency number(s) received in the Emergency Number List IE are valid only in networks with the same MCC as in the cell on which this IE is received. If no list is contained in the LOCATION UPDATING ACCEPT message, then the stored list in the mobile equipment shall be kept, except if the mobile equipment has successfully registered to a PLMN with an MCC different from that of the last registered PLMN.

The mobile equipment shall use the stored list of emergency numbers received from the network in addition to the emergency numbers stored on the SIM/USIM or ME to detect that the number dialled is an emergency number.

NOTE 2: The mobile equipment may use the emergency numbers list to assist the end user in determining whether the dialled number is intended for an emergency service or for another destination, e.g. a local directory service. The possible interactions with the end user are implementation specific.

The list of emergency numbers shall be deleted at switch off and removal of the SIM/USIM. The mobile equipment shall be able to store up to ten local emergency numbers received from the network.



#### 4.4.4.7 Location updating not accepted by the network

If the location updating cannot be accepted the network sends a LOCATION UPDATING REJECT message to the mobile station. The mobile station receiving a LOCATION UPDATING REJECT message shall stop the timer T3210, store the reject cause, start T3240, enter state LOCATION UPDATING REJECTED await the release of the RR connection triggered by the network, and for all causes except #12, #14 and #15 deletes the list of "equivalent PLMNs".

Upon the release of the RR connection the mobile station shall take the following actions depending on the stored reject cause:

# 2: (IMSI unknown in HLR);

# 3: (Illegal MS); or

# 6: (Illegal ME).

The mobile station shall set the update status to ROAMING NOT ALLOWED (and store it in the SIM/USIM according to subclause 4.1.2.2), and delete any TMSI, stored LAI and ciphering key sequence number and shall consider the SIM/USIM as invalid for non-GPRS services until switch-off or the SIM/USIM is removed.

# 11: (PLMN not allowed);

The mobile station shall delete any LAI, TMSI and ciphering key sequence number stored in the SIM/USIM, reset the attempt counter, set the update status to ROAMING NOT ALLOWED (and store it in the SIM/USIM according to subclause 4.1.2.2). The mobile station shall store the PLMN identity in the "forbidden PLMN list".

The MS shall perform a PLMN selection when back to the MM IDLE state according to 3GPP TS 23.122 [14].

# 12: (Location Area not allowed);

The mobile station shall delete any LAI, TMSI and ciphering key sequence number stored in the SIM/USIM, reset the attempt counter, set the update status to ROAMING NOT ALLOWED (and store it in the SIM/USIM according to subclause 4.1.2.2).

The mobile station shall store the LAI in the list of "forbidden location areas for regional provision of service".

The MS shall perform a cell selection when back to the MM IDLE state according to 3GPP TS 43.022 [82] and 3GPP TS 25.304.

# 13: (Roaming not allowed in this location area).

The mobile station shall reset the attempt counter, set the update status to ROAMING NOT ALLOWED (and store it in the SIM/USIM according to clause 4.1.2.2).

The mobile station shall store the LAI in the list of "forbidden location areas for roaming".

The mobile station shall perform a PLMN selection instead of a cell selection when back to the MM IDLE state according to 3GPP TS 23.122 [14].

# 15: (No Suitable Cells In Location Area).

The mobile station shall reset the attempt counter, set the update status to ROAMING NOT ALLOWED (and store it in the SIM/USIM according to clause 4.1.2.2).

The mobile station shall store the LAI in the list of "forbidden location areas for roaming".

The mobile station shall search for a suitable cell in another location area in the same PLMN according to 3GPP TS 43.022 [82] and 3GPP TS 25.304.

Other values are considered as abnormal cases and the specification of the mobile station behaviour in those cases is given in subclause 4.4.4.9.

#### 4.4.4.8 Release of RR connection after location updating

When the Location updating procedure is finished (see subclause s 4.4.4.6 and 4.4.4.7) the mobile station shall (except in the case where the mobile has a follow-on CM application request pending and has received the follow-on proceed

indication, see subclause 4.4.4.6) set timer T3240 and enter the state WAIT FOR NETWORK COMMAND, expecting the release of the RR connection. The network may decide to keep the RR connection for network initiated establishment of a MM connection, or to allow for mobile initiated MM connection establishment.

Any release of the RR connection shall be initiated by the network according to subclause 3.5 in 3GPP TS 44.018 [84], and 3GPP TS 25.331 [23c]. If the RR connection is not released within a given time controlled by the timer T3240, the mobile station shall abort the RR connection. In both cases, either after a RR connection release triggered from the network side or after a RR connection abort requested by the MS-side, the MS shall return to state MM IDLE.

At transition to state MM IDLE, substates NORMAL SERVICE or RECEIVING GROUP CALL (NORMAL SERVICE) or ATTEMPTING TO UPDATE either timer T3212 or timer T3211 is started as described in subclause 4.4.4.9.

#### 4.4.4.9 Abnormal cases on the mobile station side

The different abnormal cases that can be identified are the following:

- a) Access barred because of common access class control or CS domain specific access control

The location updating procedure is not started. The mobile station stays in the current serving cell and applies normal cell reselection process. The procedure is started as soon as possible and if still necessary (when the barred state is ended or because of a cell change).

- b) The answer to random access is an IMMEDIATE ASSIGNMENT REJECT message (A/Gb mode only)

The location updating is not started. The mobile station stays in the chosen cell and applies normal cell selection process. The waiting timer T3122 is reset when a cell change occurs. The procedure is started as soon as possible after T3122 timeout if still necessary.

- c) Random access failure (A/Gb mode only)

Timer T3213 is started. When it expires the procedure is attempted again if still necessary.

NOTE: As specified in 3GPP TS 45.008 [34], a cell reselection then takes place, with return to the cell inhibited for 5 seconds if there is at least one other suitable cell. Typically the selection process will take the mobile station back to the cell where the random access failed after 5 seconds.

If at the expiry of timer T3213 a new cell has not been selected due to the lack of valid information (see 3GPP TS 45.008 [34]), the mobile station may as an option delay the repeated attempt for up to 8 seconds to allow cell re-selection to take place. In this case the procedure is attempted as soon as a new cell has been selected or the mobile station has concluded that no other cell can be selected.

If random access failure occurs for two successive random access attempts for location updating the mobile station proceeds as specified below.

- d) RR connection failure

The procedure is aborted and the mobile station proceeds as specified below.

- e) T3210 timeout

The procedure is aborted, the RR connection is aborted and the MS proceeds as specified below.

- f) RR release before the normal end of procedure

The procedure is aborted and the mobile station proceeds as specified below.

- g) Location updating reject, other causes than those treated in subclause 4.4.4.7

Upon reception of the cause codes # 95, # 96, # 97, # 99 and # 111 the MS should set the attempt counter to 4. The MS waits for release of the RR connection as specified in subclause 4.4.4.8, and then proceeds as specified below.

- h) RR connection establishment failure (Iu mode only)

The procedure is aborted and the mobile station proceeds as specified below.

NOTE: Case h) covers all cases when the signalling connection cannot be established, including random access failure and access reject. As the RRC protocol has error specific retransmission mechanisms (see 3GPP TS 25.331 [23c]), there is no need to distinguish between the different error cases within MM.

In cases d) to h) above and for repeated failures as defined in c) above the mobile station proceeds as follows. Timer T3210 is stopped if still running. The RR Connection is aborted in case of timer T3210 timeout. The attempt counter is incremented. The next actions depend on the Location Area Identities (stored and received from the BCCH of the current serving cell) and the value of the attempt counter.

- the update status is UPDATED, and the stored LAI is equal to the one received on the BCCH from the current serving cell and the attempt counter is smaller than 4:

The mobile station shall keep the update status to UPDATED, the MM IDLE sub-state after the RR connection release is NORMAL SERVICE. The mobile station shall memorize the location updating type used in the location updating procedure. It shall start timer T3211 when the RR connection is released. When timer T3211 expires the location updating procedure is triggered again with the memorized location updating type;

- either the update status is different from UPDATED, or the stored LAI is different from the one received on the BCCH from the current serving cell, or the attempt counter is greater or equal to 4:

When the RR connection is released the mobile station shall delete any LAI, TMSI, ciphering key sequence stored in the SIM/USIM, and list of equivalent PLMNs, set the update status to NOT UPDATED and enter the MM IDLE sub-state ATTEMPTING TO UPDATE (see subclause 4.2.2.2 for the subsequent actions) or optionally the MM IDLE sub-state PLMN SEARCH (see subclause 4.2.1.2) in order to perform a PLMN selection according to 3GPP TS 23.122 [14]. If the attempt counter is smaller than 4, the mobile station shall memorize that timer T3211 is to be started when the RR connection is released, otherwise it shall memorize that timer T3212 is to be started when the RR connection is released.

#### 4.4.4.10 Abnormal cases on the network side

##### a) RR connection failure

If a RR connection failure occurs during a common procedure integrated with the location updating procedure, the behaviour of the network should be according to the description of that common procedure.

If a RR connection failure occurs when a common procedure does not exist, the location updating procedure towards the mobile station should be aborted.

##### b) protocol error

If the LOCATION UPDATING REQUEST message is received with a protocol error, the network should, if possible, return a LOCATION UPDATING REJECT message with one of the following Reject causes:

- #96: Mandatory information element error
- #99: Information element non-existent or not implemented
- #100: Conditional IE error
- #111: Protocol error, unspecified

Having sent the response, the network should start the channel release procedure (see subclause 3.5).

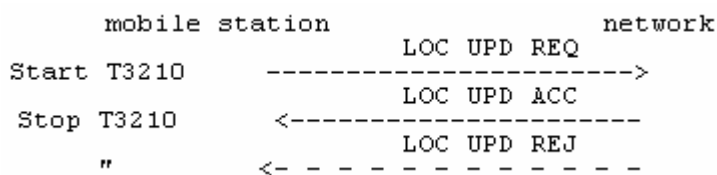

Figure 4.5/3GPP TS 24.008: Location updating sequence

#### 4.4.5 Void

#### 4.4.6 Void

### 4.5 Connection management sublayer service provision

The concept of MM connection is introduced in this subclause. This concept is mainly a descriptive tool: The establishment of an MM connection by the network can be local (i.e. it is achieved by the transmission of the first CM layer message and without the transmission of any MM layer messages) or can be achieved by the transmission of a CM SERVICE PROMPT message (eg. in the case of certain ring back services). The release of an MM connection by the network or by the mobile station is always local, i.e. these purposes can be achieved without sending any MM messages over the radio interface. (On the contrary, establishment of an MM connection by the mobile station requires the sending of MM messages over the radio interface. An exception is VGCS, where an MM connection will be established as result of an uplink access procedure (see subclause 3.7.2.1.1 in 3GPP TS 44.018 [84]).)

The Mobility Management (MM) sublayer is providing connection management services to the different entities of the upper Connection management (CM) sublayer (see 3GPP TS 24.007 [20]). It offers to a CM entity the possibility to use an MM connection for the exchange of information with its peer entity. An MM connection is established and released on request from a CM entity. Different CM entities communicate with their peer entity using different MM connections. Several MM connections may be active at the same time.

An MM connection requires an RR connection. All simultaneous MM connections for a given mobile station use the same RR connection.

In the following subclause s, the procedures for establishing, re-establishing, maintaining, and releasing an MM connection are described, usually separately for the mobile station and the network side.

#### 4.5.1 MM connection establishment

##### 4.5.1.1 MM connection establishment initiated by the mobile station

Upon request of a CM entity to establish an MM connection the MM sublayer first decides whether to accept, delay, or reject this request:

- An MM connection establishment may only be initiated by the mobile station when the following conditions are fulfilled:
  - Its update status is UPDATED.
  - The MM sublayer is in one of the states MM IDLE, RR CONNECTION RELEASE NOT ALLOWED or MM connection active but not in MM connection active (Group call).

An exception from this general rule exists for emergency calls (see subclause 4.5.1.5). A further exception is defined in the following clause.

- If an MM specific procedure is running at the time the request from the CM sublayer is received, and the LOCATION UPDATING REQUEST message has been sent, the request will either be rejected or delayed, depending on implementation, until the MM specific procedure is finished and, provided that the network has not sent a "follow-on proceed" indication, the RR connection is released. If the LOCATION UPDATING REQUEST message has not been sent, the mobile station may include a "follow-on request" indicator in the message. The mobile station shall then delay the request until the MM specific procedure is completed, when it may be given the opportunity by the network to use the RR connection: see subclause 4.4.4.6.

In order to establish an MM connection, the mobile station proceeds as follows:

- a) If no RR connection exists, the MM sublayer requests the RR sublayer to establish an RR connection and enters MM sublayer state WAIT FOR RR CONNECTION (MM CONNECTION). This request contains an establishment cause and a CM SERVICE REQUEST message. When the establishment of an RR connection is indicated by the RR sublayer, the MM sublayer of the mobile station starts timer T3230, gives an indication to the CM entity that requested the MM connection establishment, and enters MM sublayer state WAIT FOR OUTGOING MM CONNECTION.

- b) If an RR connection is available, the MM sublayer of the mobile station sends a CM SERVICE REQUEST message to the network, starts timer T3230, stops and resets timer T3241, gives an indication to the CM entity that requested the MM connection establishment, and enters:
- MM sublayer state WAIT FOR OUTGOING MM CONNECTION, if no MM connection is active;
  - MM sublayer state WAIT FOR ADDITIONAL OUTGOING MM CONNECTION, if at least one MM connection is active;
  - If an RR connection exists but the mobile station is in the state WAIT FOR NETWORK COMMAND then any requests from the CM layer that are received will either be rejected or delayed until this state is left.

c) Only applicable for mobile stations supporting VGCS talking:

If a mobile station which is in the MM sublayer state MM IDLE, service state RECEIVING GROUP CALL (NORMAL SERVICE), receives a request from the GCC sublayer to perform an uplink access, the MM sublayer requests the RR sublayer to perform an uplink access procedure and enters MM sublayer state WAIT FOR RR CONNECTION (GROUP TRANSMIT MODE).

When a successful uplink access is indicated by the RR sublayer, the MM sublayer of the mobile station gives an indication to the GCC sublayer and enters MM sublayer state MM CONNECTION ACTIVE (GROUP TRANSMIT MODE).

When an uplink access reject is indicated by the RR sublayer, the MM sublayer of the mobile station gives an indication to the GCC sublayer and enters the MM sublayer state MM IDLE, service state RECEIVING GROUP CALL (NORMAL SERVICE).

In the network, if an uplink access procedure is performed, the RR sublayer in the network provides an indication to the MM sublayer together with the mobile subscriber identity received in the TALKER INDICATION message. The network shall then enter the MM sublayer state MM CONNECTION ACTIVE (GROUP TRANSMIT MODE).

The CM SERVICE REQUEST message contains the:

- mobile identity according to subclause 10.5.1.4;
- mobile station classmark 2;
- ciphering key sequence number; and
- CM service type identifying the requested type of transaction (e.g. mobile originating call establishment, emergency call establishment, short message service, supplementary service activation, location services).

A MS supporting eMLPP may optionally include a priority level in the CM SERVICE REQUEST message.

A collision may occur when a CM layer message is received by the mobile station in MM sublayer state WAIT FOR OUTGOING MM CONNECTION or in WAIT FOR ADDITIONAL OUTGOING MM CONNECTION. In this case the MM sublayer in the MS shall establish a new MM connection for the incoming CM message as specified in subclause 4.5.1.3.

Upon receiving a CM SERVICE REQUEST message, the network shall analyse its content. The type of semantic analysis may depend on other on going MM connection(s). Depending on the type of request and the current status of the RR connection, the network may start any of the MM common procedures and RR procedures.

In A/Gb mode, the network may initiate the classmark interrogation procedure, for example, to obtain further information on the mobile station's encryption capabilities.

The identification procedure (see subclause 4.3.3) may be invoked for instance if a TMSI provided by the mobile station is not recognized.

The network may invoke the authentication procedure (see subclause 4.3.2) depending on the CM service type.

In A/Gb mode, the network decides also if the ciphering mode setting procedure shall be invoked (see subclause 3.4.7 in 3GPP TS 44.018 [84]).

In Iu mode, the network decides also if the security mode control procedure shall be invoked (see 3GPP TS 25.331 [23c] and 3GPP TS 44.118 [111]).

NOTE: If the CM\_SERVICE\_REQUEST message contains a priority level the network may use this to perform queuing and pre-emption as defined in 3GPP TS 23.067 [88].

In A/Gb mode, an indication from the RR sublayer that the ciphering mode setting procedure is completed, or reception of a CM SERVICE ACCEPT message, shall be treated as a service acceptance indication by the mobile station.

In Iu mode, an indication from the RR sublayer that the security mode control procedure is completed, or reception of a CM SERVICE ACCEPT message, shall be treated as a service acceptance indication by the mobile station. The procedures in subclause 4.1.1.1.1 shall always have precedence over this subclause.

In Iu mode, during a MM connection establishment for all services, except for emergency call (see subclause 4.1.1.1.1), the security mode control procedure with activation of integrity protection shall be invoked by the network unless integrity protection is already started (see subclause 4.1.1.1.1).

The MM connection establishment is completed, timer T3230 shall be stopped, the CM entity that requested the MM connection shall be informed, and MM sublayer state MM CONNECTION ACTIVE is entered. The MM connection is considered to be active.

If the service request cannot be accepted, the network returns a CM SERVICE REJECT message to the mobile station.

The reject cause information element (see subclause 10.5.3.6 and annex G) indicates the reason for rejection. The following cause values may apply:

- #4: IMSI unknown in VLR
- #6: Illegal ME
- #17: Network failure
- #22: Congestion
- #32: Service option not supported
- #33: Requested service option not subscribed
- #34: Service option temporarily out of order

If no other MM connection is active, the network may start the RR connection release (see subclause 3.5) when the CM SERVICE REJECT message is sent.

If a CM SERVICE REJECT message is received by the mobile station, timer T3230 shall be stopped, the requesting CM sublayer entity informed. Then the mobile station shall proceed as follows:

- If the cause value is not #4 or #6 the MM sublayer returns to the previous state (the state where the request was received). Other MM connections shall not be affected by the CM SERVICE REJECT message.
- If cause value #4 is received, the mobile station aborts any MM connection, deletes any TMSI, LAI and ciphering key sequence number in the SIM/USIM, changes the update status to NOT UPDATED (and stores it in the SIM/USIM according to subclause 4.1.2.2), and enters the MM sublayer state WAIT FOR NETWORK COMMAND. If subsequently the RR connection is released or aborted, this will force the mobile station to initiate a normal location updating). Whether the CM request shall be memorized during the location updating procedure, is a choice of implementation.
- If cause value #6 is received, the mobile station aborts any MM connection, deletes any TMSI, LAI and ciphering key sequence number in the SIM/USIM, changes the update status to ROAMING NOT ALLOWED (and stores it in the SIM/USIM according to subclause 4.1.2.2), and enters the MM sublayer state WAIT FOR NETWORK COMMAND. The mobile station shall consider the SIM/USIM as invalid for non-GPRS services until switch-off or the SIM/USIM is removed.

### 4.5.1.2 Abnormal cases

Mobile station side:

- a) RR connection failure or IMSI deactivation

If an RR connection failure occurs or the IMSI is deactivated during the establishment of an MM connection, the MM connection establishment is aborted, timers T3230 is stopped, and an indication is given to the CM entity that requested the MM connection establishment. This shall be treated as a rejection for establishment of the new MM connection, and the MM sublayer shall release all active MM connections.

- b) T3230 expiry

If T3230 expires (i.e. no response is given but a RR connection is available) the MM connection establishment is aborted and the requesting CM sublayer is informed. If no other MM connection exists then the mobile station shall proceed as described in subclause 4.5.3.1 for release of the RR connection. Otherwise the mobile station shall return to the MM sublayer state where the request of an MM connection was received, i.e. to MM sublayer state MM connection active. Other ongoing MM connections (if any) shall not be affected.

- c) Reject cause values #95, #96, #97, #99, #100, #111 received

The same actions as on timer expiry shall be taken by the mobile station.

- d) Random access failure or RR connection establishment failure

If the mobile station detects a random access failure or RR connection establishment failure during the establishment of an MM connection, it aborts the MM connection establishment and gives an indication to the CM entity that requested the MM connection establishment.

NOTE: Further actions of the mobile station depend on the RR procedures and MM specific procedures during which the abnormal situation has occurred and are described together with those procedures.

- e) Access barred because of CS domain specific access control

The MM connection establishment shall not be initiated. The MS stays in the current serving cell and applies normal cell reselection process. The MM connection establishment may be initiated by CM layer if it is still necessary, i.e. when access is granted or because of a cell change.

Network side:

- a) RR connection failure

The actions to be taken upon RR connection failure within a MM common procedure are described together with that procedure. A RR connection failure occurring outside such MM common procedures, shall trigger the release of all active MM connections if any.

- b) Invalid message or message content

Upon reception of an invalid initial message or a CM SERVICE REQUEST message with invalid content, a CM SERVICE REJECT message shall be returned with one of the following appropriate Reject cause indications:

- # 95: Semantically incorrect message
- # 96: Mandatory information element error
- # 97: Message type non-existent or not implemented
- # 99: Information element non-existent or not implemented
- # 100: Conditional IE error
- # 111: Protocol error, unspecified

When the CM SERVICE REJECT message has been sent, the network may start RR connection release if no other MM connections exist or if the abnormal condition also has influence on the other MM connections.

### 4.5.1.3 MM connection establishment initiated by the network

#### 4.5.1.3.1 Mobile Terminating CM Activity

When a CM sublayer entity in the network requests the MM sublayer to establish a MM connection, the MM sublayer will request the establishment of an RR connection to the RR sublayer if no RR connection to the desired mobile station exists. The MM sublayer is informed when the paging procedure is finished (see 3GPP TS 44.018 [84] subclause 3.3.2 and 3GPP TS 25.331 [23c]) and the mobile station shall enter the MM state WAIT FOR NETWORK COMMAND.

In A/Gb mode, when an RR connection is established (or if it already exists at the time the request is received), the MM sublayer may initiate any of the MM common procedures (except IMSI detach); it may request the RR sublayer to perform the RR classmark interrogation procedure, and/or the security mode setting procedure.

In Iu mode, when an RR connection is established (or if it already exists at the time the request is received), the MM sublayer may initiate any of the MM common procedures (except IMSI detach); it may request the RR sublayer to perform the security mode control procedure.

When all MM and RR procedures are successfully completed which the network considers necessary, the MM sublayer will inform the requesting mobile terminating CM sublayer entity on the success of the MM connection establishment.

If an RR connection already exists and no MM specific procedure is running, the network may also establish a new mobile terminating MM connection by sending a CM message with a new PD/TI combination.

If the MS receives the first CM message in the MM states WAIT FOR NETWORK COMMAND or RR CONNECTION RELEASE NOT ALLOWED, the MS shall stop and reset the timers T3240 and T3241 and shall enter the MM state MM CONNECTION ACTIVE.

In A/Gb mode, if the establishment of an RR connection is unsuccessful, or if any of the MM common procedures or the security mode setting fail, this is indicated to the CM layer with an appropriate error cause.

In Iu mode, if the establishment of an RR connection is unsuccessful, or if any of the MM common procedures or the security mode control fail, this is indicated to the CM layer with an appropriate error cause.

If an RR connection used for a MM specific procedure exists to the mobile station, the CM request may be rejected or delayed depending on implementation. When the MM specific procedure has been completed, the network may use the same RR connection for the delayed CM request.

Only applicable in case of VGCS talking:

In the MM CONNECTION ACTIVE (GROUP TRANSMIT MODE) the mobile station is in RR Group transmit mode. There shall be only one MM connection active.

When in MM CONNECTION ACTIVE (GROUP TRANSMIT MODE) state, the MM sublayer in the network shall reject the request for the establishment of another MM connection by any CM layer.

If the RR sublayer in the network indicates a request to perform a transfer of the mobile station from RR connected mode to RR Group transmit mode which will result in a transition from MM CONNECTION ACTIVE state to MM CONNECTION ACTIVE (GROUP TRANSMIT MODE) state in the MM sublayer, the MM sublayer shall not allow the transition if more than one MM connection is active with the mobile station.

#### 4.5.1.3.2 Mobile Originating CM Activity \$(CCBS)\$

When a CM sublayer entity in the network requests the MM sublayer to establish a MM connection, the MM sublayer will request the establishment of an RR connection to the RR sublayer if no RR connection to the desired mobile station exists. The MM sublayer is informed when the paging procedure is finished (see 3GPP TS 44.018 [84] subclause 3.3.2 and 3GPP TS 25.331 [23c]) and the mobile station shall enter the MM state WAIT FOR NETWORK COMMAND.

In A/Gb mode, when an RR connection is established (or if it already exists at the time the request is received), the MM sublayer may initiate any of the MM common procedures (except IMSI detach), it may request the RR sublayer to perform the RR classmark interrogation procedure and/or the security mode setting procedure.

In Iu mode, when an RR connection is established (or if it already exists at the time the request is received), the MM sublayer may initiate any of the MM common procedures (except IMSI detach), it may request the RR sublayer to perform the security mode control procedure.



The network should use the information contained in *the Mobile Station Classmark Type 2 IE* on the mobile station's support for "Network Initiated MO CM Connection Request" to determine whether to:

- not start this procedure (eg if an RR connection already exists), or,
- to continue this procedure, or,
- to release the newly established RR connection.

In the case of a "Network Initiated MO CM Connection Request" the network shall use the established RR connection to send a CM SERVICE PROMPT message to the mobile station.

If the mobile station supports "Network Initiated MO CM Connection Request", the MM sublayer of the MS gives an indication to the CM entity identified by the CM SERVICE PROMPT message and enters the MM sublayer state PROCESS CM SERVICE PROMPT. In the state PROCESS CM SERVICE PROMPT the MM sublayer waits for either the rejection or confirmation of the recall by the identified CM entity. Any other requests from the CM entities shall either be rejected or delayed until this state is left.

When the identified CM entity informs the MM sublayer, that it has send the first CM message in order to start the CM recall procedure the MM sublayer enters the state MM CONNECTION ACTIVE.

If the identified CM entity indicates that it will not perform the CM recall procedure and all MM connections are released by their CM entities the MS shall proceed according to subclause 4.5.3.1.

If the CM SERVICE PROMPT message is received by the MS in MM sublayer states WAIT FOR OUTGOING MM CONNECTION or in WAIT FOR ADDITIONAL OUTGOING MM CONNECTION then the mobile station shall send an MM STATUS message with cause " Message not compatible with protocol state".

A mobile that does not support "Network Initiated MO CM Connection Request" shall return an MM STATUS message with cause #97 "message type non-existent or not implemented" to the network.

If the mobile station supports "Network Initiated MO CM Connection Request" but the identified CM entity in the mobile station does not provide the associated support, then the mobile station shall send an MM STATUS message with cause "Service option not supported". In the case of a temporary CM problem (eg lack of transaction identifiers) then the mobile station shall send an MM STATUS message with cause "Service option temporarily out of order".

If an RR connection already exists and no MM specific procedure is running, the network may use it to send the CM SERVICE PROMPT message.

In A/Gb mode, if the establishment of an RR connection is unsuccessful, or if any of the MM common procedures or the security mode setting fail, this is indicated to the CM layer in the network with an appropriate error cause.

In Iu mode, if the establishment of an RR connection is unsuccessful, or if any of the MM common procedures or the security mode control fail, this is indicated to the CM layer in the network with an appropriate error cause.

If an RR connection used for a MM specific procedure exists to the mobile station, the "Network Initiated MO CM Connection Request" may be rejected or delayed depending on implementation. When the MM specific procedure has been completed, the network may use the same RR connection for the delayed "Network Initiated MO CM Connection Request".

#### 4.5.1.3.3 Paging response in Iu mode (Iu mode only)

The network may initiate the paging procedure for CS services when the MS is IMSI attached for CS services. To initiate the procedure, the MM entity requests the RR sublayer to initiate paging (see 3GPP TS 25.331 [23c], 3GPP TS 25.413 and 3GPP TS 44.118 [111]) for CS services.

At reception of a paging message, the RR sublayer in the MS shall deliver a paging indication to the MM sublayer if the paging was initiated by the MM entity in the network (see 3GPP TS 25.331 [23c] and 3GPP TS 44.118 [111]). The MS shall respond with the PAGING RESPONSE message defined in 3GPP TS 44.018 [84], subclause 9.1.25. For reasons of backward compatibility the paging response shall use the RR protocol discriminator.

If the MS receives a paging request for CS services during an ongoing MM procedure, and the MS has already requested the establishment of a radio connection, the MS shall ignore the paging request and the MS and the network shall continue the MM procedure.

#### 4.5.1.4 Abnormal cases

The behaviour upon abnormal events is described together with the relevant RR procedure or MM common procedure.

#### 4.5.1.5 MM connection establishment for emergency calls

A MM connection for an emergency call may be established in all states of the mobility management sublayer which allow MM connection establishment for a normal originating call. In addition, establishment may be attempted in all service states where a cell is selected (see subclause 4.2.2) but not in the MM CONNECTION ACTIVE state (GROUP TRANSMIT MODE) state. However, as a network dependent option, a MM connection establishment for emergency call may be rejected in some of the states.

When a user requests an emergency call establishment the mobile station will send a CM SERVICE REQUEST message to the network with a CM service type information element indicating emergency call establishment. If the network does not accept the emergency call request, e.g., because IMEI was used as identification and this capability is not supported by the network, the network will reject the request by returning a CM SERVICE REJECT message to the mobile station.

The reject cause information element indicates the reason for rejection. The following cause values may apply:

- #3 "Illegal MS"
- #4 "IMSI unknown in VLR"
- #5 "IMEI not accepted"
- #6 "Illegal ME"
- #17 "Network failure"
- #22 "Congestion"
- #32 "Service option not supported"
- #34 "Service option temporarily out of order"

With the above defined exceptions, the procedures described for MM connection establishment in subclauses 4.5.1.1 and 4.5.1.2 shall be followed.

NOTE: Normally, the mobile station will be identified by an IMSI or a TMSI. However, if none of these identifiers is available in the mobile station, then the mobile station shall use the IMEI for identification purposes. The network may in that case reject the request by returning a CM SERVICE REJECT message with reject cause: #5 "IMEI not accepted".

#### 4.5.1.6 Call re-establishment

The re-establishment procedure allows a MS to resume a connection in progress after a radio link failure, possibly in a new cell and possibly in a new location area. The conditions in which to attempt call re-establishment or not depend on the call control state, see subclause 5.5.4 and, whether or not a cell allowing call re-establishment has been found (as described in 3GPP TS 45.008 [34]). MM connections are identified by their protocol discriminators and transaction identifiers: these shall not be changed during call re-establishment.

The re-establishment takes place when a lower layer failure occurs and at least one MM connection is active (i.e.. the mobile station's MM sublayer is either in state 6 "MM CONNECTION ACTIVE" or state 20 "WAIT FOR ADDITIONAL OUTGOING MM CONNECTION").

NOTE: During a re-establishment attempt the mobile station does not return to the MM IDLE state; thus no location updating is performed even if the mobile is not updated in the location area of the selected cell.

No call re-establishment shall be performed for voice group and broadcast calls.

##### 4.5.1.6.1 Call re-establishment, initiation by the mobile station

NOTE: The network is unable to initiate call re-establishment.

If at least one request to re-establish an MM connection is received from a CM entity as a response to the indication that the MM connection is interrupted (see subclause 4.5.2.3.) the mobile station initiates the call re-establishment procedure. If several CM entities request re-establishment only one re-establishment procedure is initiated. If any CM entity requests re-establishment, then re-establishment of all transactions belonging to all Protocol Discriminators that permit Call Re-establishment shall be attempted.

Upon request of a CM entity to re-establish an MM connection the MM sublayer requests the RR sublayer to establish an RR connection and enters MM sublayer state WAIT FOR REESTABLISH. This request contains an establishment cause and a CM RE-ESTABLISHMENT REQUEST message. When the establishment of an RR connection is indicated by the RR sublayer, the MM sublayer of the mobile station starts timer T3230, gives an indication to all CM entities that are being re-established, and remains in the MM sublayer state WAIT FOR REESTABLISH.

The CM RE-ESTABLISHMENT REQUEST message contains the

- mobile identity according to subclause 10.5.1.4;
- mobile station classmark 2;
- ciphering key sequence number.

NOTE: Whether or not a CM entity can request re-establishment depends upon the Protocol Discriminator. The specifications for Short Message Service (3GPP TS 24.011), Call Independent Supplementary Services (3GPP TS 24.010 [21]) and Location Services (3GPP TS 44.071 [23a]) do not currently specify any re-establishment procedures.

Upon receiving a CM RE-ESTABLISHMENT REQUEST message, the network shall analyse its content. Depending on the type of request, the network may start any of the MM common procedures and RR procedures.

The network may initiate the classmark interrogation procedure, for example, to obtain further information on the mobile station's encryption capabilities.

The identification procedure (see subclause 4.3.3) may be invoked.

The network may invoke the authentication procedure (see subclause 4.3.2).

In A/Gb mode, the network decides if the security mode setting procedure shall be invoked (see 3GPP TS 44.018 [84] subclause 3.4.7).

An indication from the RR sublayer that the security mode setting procedure is completed, or reception of a CM SERVICE ACCEPT message, shall be treated as a service acceptance indication by the mobile station.

In Iu mode, the network decides if the security mode control procedure shall be invoked (see 3GPP TS 25.331 [23c] and 3GPP TS 44.118 [111]). An indication from the RR sublayer that the security mode control procedure is completed, or reception of a CM SERVICE ACCEPT message, shall be treated as a service acceptance indication by the mobile station.

The MM connection re-establishment is completed, timer T3230 shall be stopped, all CM entities associated with the re-establishment shall be informed, and MM sublayer state MM CONNECTION ACTIVE is re-entered. All the MM connections are considered to be active.

If the network cannot associate the re-establishment request with any existing call for that mobile station, a CM SERVICE REJECT message is returned with the reject cause:

#38 "call cannot be identified"

If call re-establishment cannot be performed for other reasons, a CM SERVICE REJECT is returned, the appropriate reject cause may be any of the following (see annex G):

- # 4 "IMSI unknown in VLR";
- # 6 "illegal ME";
- #17 "network failure";
- #22 "congestion";

- #32 "service option not supported";
- #34 "service option temporarily out of order".

Whatever the reject cause a mobile station receiving a CM SERVICE REJECT as a response to the CM RE-ESTABLISHMENT REQUEST shall stop T3230, release all MM connections and proceed as described in subclause 4.5.3.1. In addition:

- if cause value #4 is received, the mobile station deletes any TMSI, LAI and ciphering key sequence number in the SIM/USIM, changes the update status to NOT UPDATED (and stores it in the SIM/USIM according to subclause 4.1.2.2), and enters the MM sublayer state WAIT FOR NETWORK COMMAND. If subsequently the RR connection is released or aborted, this will force the mobile station to initiate a normal location updating). The CM re-establishment request shall not be memorized during the location updating procedure.
- if cause value #6 is received, the mobile station deletes any TMSI, LAI and ciphering key sequence number in the SIM/USIM, changes the update status to ROAMING NOT ALLOWED (and stores it in the SIM/USIM according to subclause 4.1.2.2), and enters the MM sublayer state WAIT FOR NETWORK COMMAND. The MS shall consider the SIM/USIM as invalid for non-GPRS services until switch-off or the SIM/USIM is removed.

#### 4.5.1.6.2 Abnormal cases

Mobile station side:

- a) Random access failure or RR connection establishment failure

If the mobile station detects a random access failure or RR connection establishment failure during the re-establishment of an MM connection, the re-establishment is aborted and all MM connections are released.

- b) RR connection failure

If a RR connection failure occurs, timer T3230 is stopped, the re-establishment is aborted and all active MM connections are released.

- c) IMSI deactivation

If the IMSI deactivated during the re-establishment attempt then timer T3230 is stopped, the re-establishment is aborted and all MM connections are released.

- d) T3230 expires

If T3230 expires (i.e. no response is given but a RR connection is available) the re-establishment is aborted, all active MM connections are released and the mobile station proceeds as described in subclause 4.5.3.1.

- e) Reject causes #96, #97, #99, #100, #111 received

The mobile station shall perform the same actions as if timer T3230 had expired.

Network side:

- a) RR connection failure

If a RR connection failure occurs after receipt of the CM RE-ESTABLISHMENT REQUEST the network shall release all MM connections.

- b) Invalid message content

Upon reception an invalid initial of message or a CM RE-ESTABLISHMENT REQUEST message with invalid content, a CM SERVICE REJECT message shall be returned with one of the following appropriate Reject cause indications:

- #96: Mandatory information element error
- #99: Information element non-existent or not implemented
- #100: Conditional IE error

#111: Protocol error, unspecified

When the CM SERVICE REJECT message has been sent, the network shall release the RR connection.

#### 4.5.1.7 Forced release during MO MM connection establishment

If the mobile station's CM layer initiated the MM connection establishment but the CM layer wishes to abort the establishment prior to the completion of the establishment phase, the mobile station shall send a CM SERVICE ABORT message any time after the completion of the RR connection and not after the first CM message (e.g. SETUP) is sent.

If the first CM message has already been sent, the normal release procedure defined by the appropriate CM protocol applies and the CM SERVICE ABORT shall not be sent.

Sending of the CM SERVICE ABORT message is only allowed during the establishment of the first MM connection, where no other MM connection exists in parallel. If parallel MM connections exist already, a new connection establishment cannot be aborted and normal MM connection release according to subclause 4.5.3 applies after MM connection establishment.

Upon transmission of the CM SERVICE ABORT message the mobile station shall set timer T3240 and enter the state WAIT FOR NETWORK COMMAND, expecting the release of the RR connection.

Upon receipt of the CM SERVICE ABORT message the network shall abort ongoing processes, release the appropriate resources, and unless another MM connection establishment is pending, initiate a normal release of the RR connection.

If the RR connection is not released within a given time controlled by timer T3240, the mobile station shall abort the RR connection. In both cases, either after a RR connection release triggered from the network side or after a RR connection abort requested by the mobile station side the mobile station shall return to state MM IDLE; the service state depending upon the current update status as specified in subclause 4.2.3.

### 4.5.2 MM connection information transfer phase

After the MM connection has been established, it can be used by the CM sublayer entity for information transfer. According to the protocol architecture described in 3GPP TS 24.007 [20], each CM entity will have its own MM connection. These different MM connections are identified by the protocol discriminator PD and, additionally, by the transaction identifier TI.

All MM common procedures may be initiated at any time while MM connections are active. Except for Short Message Control which uses a separate layer 2 low priority data link, no priority mechanism is defined between the CM, MM and RR sublayer messages.

#### 4.5.2.1 Sending CM messages

A CM sublayer entity, after having been advised that a MM connection has been established, can request the transfer of CM messages. The CM messages passed to the MM sublayer are then sent to the other side of the interface with the PD and TI set according to the source entity.

#### 4.5.2.2 Receiving CM messages

Upon receiving a CM message, the MM sublayer will distribute it to the relevant CM entity according to the PD value and TI value. However, if the received CM message is the first for the MM connection (identified by PD and TI), the MM sublayer will in addition indicate to the CM entity that a new MM connection has been established.

#### 4.5.2.3 Abnormal cases

RR connection failure:

If the RR connection failure occurs during a RR or MM common procedure, the consequent actions are described together with that procedure.

In other cases, the following applies:

- Mobile station:

The MM sublayer shall indicate to all CM entities associated with active MM connections that the MM connection is interrupted, the subsequent action of the MM sublayer (call re-establishment, see 4.5.1.6, or local release) will then depend on the decisions by the CM entities.

- Network:

The MM sublayer shall locally release all active MM connections. As an option the network may delay the release of all or some of the MM connections to allow the mobile station to initiate call re-establishment.

### 4.5.3 MM connection release

An established MM connection can be released by the local CM entity. The release of the CM connection will then be done locally in the MM sublayer, i.e. no MM message are sent over the radio interface for this purpose.

#### 4.5.3.1 Release of associated RR connection

If all MM connections are released by their CM entities, and no RRLP procedure (see 3GPP TS 44.031 [23b]) and no LCS procedure over RRC (see 3GPP TS 25.331 [23c]) is ongoing, the mobile station shall set timer T3240 and enter the state WAIT FOR NETWORK COMMAND, expecting the release of the RR connection.

If all MM connections are released by their CM entities and an RRLP procedure or LCS procedure over RRC is ongoing, the MS shall start the timer T3241 and enter the state RR CONNECTION RELEASE NOT ALLOWED.

If the MS is expecting the release of the RR connection in MM state WAIT FOR NETWORK COMMAND and an RRLP procedure or LCS procedure over RRC is started, the MS shall stop the timer T3240, start the timer T3241 and enter the state RR CONNECTION RELEASE NOT ALLOWED.

If the MS is in MM state RR CONNECTION RELEASE NOT ALLOWED and the ongoing RRLP procedure or LCS procedure over RRC is finished, the MS shall stop the timer T3241, reset and start the timer T3240 and shall enter the state WAIT FOR NETWORK COMMAND.

In the network, if the last MM connection is released by its user, the MM sublayer may decide to release the RR connection. The RR connection may be maintained by the network, e.g. in order to establish another MM connection.

If the RR connection is not released within a given time controlled by the timer T3240 or T3241, the mobile station shall abort the RR connection. In both cases, either after a RR connection release triggered from the network side or after a RR connection abort requested by the MS-side, the MS shall return to MM IDLE state; the service state depending upon the current update status as specified in subclause 4.2.3.

#### 4.5.3.2 Uplink release in a voice group call

(Only applicable for mobile stations supporting VGCS talking:)

If a mobile station which is in the MM sublayer state MM CONNECTION ACTIVE (GROUP TRANSMIT MODE) receives a request from the GCC sublayer to perform an uplink release, the MM sublayer requests the RR sublayer to perform an uplink release procedure and enters the MM sublayer state RECEIVING GROUP CALL (NORMAL SERVICE).

## 4.6 Receiving a MM STATUS message by a MM entity.

If the MM entity of the mobile station receives a MM STATUS message no state transition and no specific action shall be taken as seen from the radio interface, i.e. local actions are possible.

With the exceptions described for the responses to the CM SERVICE PROMPT message, the actions to be taken on receiving a MM STATUS message in the network are an implementation dependent option.

## 4.7 Elementary mobility management procedures for GPRS services

### 4.7.1 General

This subclause describes the basic functions offered by the mobility management (GMM) sublayer at the radio interface (reference point  $U_m/U_{ij}$ ). The functionality is described in terms of timers and procedures. During GMM procedures, procedures of CM layer services via the PS domain, e.g. SM, SMS, and SS, are suspended.

#### 4.7.1.1 Lower layer failure

The lower layers shall indicate a logical link failure or an RR sublayer failure or an RRC sublayer failure to the GMM sublayer. The failure indicates an error that cannot be corrected by the lower layers.

#### 4.7.1.2 Ciphering of messages (A/Gb mode only)

If ciphering is to be applied on a GMM context, all GMM messages shall be ciphered except the following messages:

- ATTACH REQUEST;
- ATTACH REJECT;
- AUTHENTICATION AND CIPHERING REQUEST;
- AUTHENTICATION AND CIPHERING RESPONSE;
- AUTHENTICATION AND CIPHERING FAILURE;
- AUTHENTICATION AND CIPHERING REJECT;
- IDENTITY REQUEST;
- IDENTITY RESPONSE;
- ROUTING AREA UPDATE REQUEST; and
- ROUTING AREA UPDATE REJECT.

#### 4.7.1.3 P-TMSI signature

The network may assign a P-TMSI signature to an MS in an attach, routing area update, or P-TMSI reallocation procedure. Only in combination with a valid P-TMSI, this P-TMSI signature is used by the MS for authentication and identification purposes in the subsequent attach, routing area update or detach procedure. If the MS has no valid P-TMSI it shall not use the P-TMSI signature in the subsequent attach, routing area update or detach procedure. Upon successful completion of the subsequent attach or routing area update procedure, the used P-TMSI signature shall be deleted. Upon completion of an MS initiated detach procedure, the used P-TMSI signature shall be deleted. Upon completion of a network initiated detach procedure the P-TMSI signature shall be kept, unless explicitly specified otherwise in subclause 4.7.4.2.2.

#### 4.7.1.4 Radio resource sublayer address handling

In A/Gb mode, while a packet TMSI (P-TMSI) is used in the GMM sublayer for identification of an MS, a temporary logical link identity (TLLI) is used for addressing purposes at the RR sublayer.

In Iu mode a Radio Network Temporary Identity (RNTI) identifies a user between the MS and the UTRAN or GERAN. The relationship between RNTI and IMSI is known only in the MS and in the UTRAN, see 3GPP TS 25.301[10].

#### 4.7.1.4.1 Radio resource sublayer address handling (A/Gb mode only)

This subclause describes how the RR addressing is managed by GMM. For the detailed coding of the different TLLI types and how a TLLI can be derived from a P-TMSI, see 3GPP TS 23.003 [10].

Two cases can be distinguished:

- a valid P-TMSI is available in the MS; or
  - no valid P-TMSI is available in the MS.
- i) valid P-TMSI available

If the MS has stored a valid P-TMSI, the MS shall derive a foreign TLLI from that P-TMSI and shall use it for transmission of the:

- ATTACH REQUEST message of any GPRS combined/non-combined attach procedure; other GMM messages sent during this procedure shall be transmitted using the same foreign TLLI until the ATTACH ACCEPT message or the ATTACH REJECT message is received; and
- ROUTING AREA UPDATE REQUEST message of a combined/non-combined RAU procedure if the MS has entered a new routing area, or if the GPRS update status is not equal to GU1 UPDATED. Other GMM messages sent during this procedure shall be transmitted using the same foreign TLLI, until the ROUTING AREA UPDATE ACCEPT message or the ROUTING AREA UPDATE REJECT message is received.

After a successful GPRS attach or routing area update procedure, independent whether a new P-TMSI is assigned, if the MS has stored a valid P-TMSI then the MS shall derive a local TLLI from the stored P-TMSI and shall use it for addressing at lower layers.

NOTE: Although the MS derives a local TLLI for addressing at lower layers, the network should not assume that it will receive only LLC frames using a local TLLI. Immediately after the successful GPRS attach or routing area update procedure, the network must be prepared to continue accepting LLC frames from the MS still using the foreign TLLI.

ii) no valid P-TMSI available

When the MS has not stored a valid P-TMSI, i.e. the MS is not attached to GPRS, the MS shall use a randomly selected random TLLI for transmission of the:

- ATTACH REQUEST message of any combined/non-combined GPRS attach procedure.

The same randomly selected random TLLI value shall be used for all message retransmission attempts and for the cell updates within one attach attempt.

Upon receipt of an ATTACH REQUEST message, the network shall assign a P-TMSI to the MS. The network derives a local TLLI from the assigned P-TMSI, and transmits the assigned P-TMSI to the MS.

Upon receipt of the assigned P-TMSI, the MS shall derive the local TLLI from this P-TMSI and shall use it for addressing at lower layers.

NOTE: Although the MS derives a local TLLI for addressing at lower layers, the network should not assume that it will receive only LLC frames using a local TLLI. Immediately after the successful GPRS attach, the network must be prepared to continue accepting LLC frames from the MS still using the random TLLI.

In both cases, the MS shall acknowledge the reception of the assigned P-TMSI to the network. After receipt of the acknowledgement, the network shall use the local TLLI for addressing at lower layers.

#### 4.7.1.5 P-TMSI handling

##### 4.7.1.5.1 P-TMSI handling in A/Gb mode

If a new P-TMSI is assigned by the network the MS and the network shall handle the old and the new P-TMSI as follows:



Upon receipt of a GMM message containing a new P-TMSI the MS shall consider the new P-TMSI and new RAI and also the old P-TMSI and old RAI as valid in order to react to paging requests and downlink transmission of LLC frames. For uplink transmission of LLC frames the new P-TMSI shall be used.

The MS shall consider the old P-TMSI and old RAI as invalid as soon as an LLC frame is received with the local TLLI derived from the new P-TMSI.

Upon the transmission of a GMM message containing a new P-TMSI the network shall consider the new P-TMSI and new RAI and also the old P-TMSI and old RAI as valid in order to be able to receive LLC frames from the MS.

The network shall consider the old P-TMSI and old RAI as invalid as soon as an LLC frame is received with the local TLLI derived from the new P-TMSI.

#### 4.7.1.5.2 P-TMSI handling in lu mode

If a new P-TMSI is assigned by the network the MS and the network shall handle the old and the new P-TMSI as follows:

Upon receipt of a GMM message containing a new P-TMSI the MS shall consider the new P-TMSI and new RAI as valid. Old P-TMSI and old RAI are regarded as invalid.

The network shall consider the old P-TMSI and old RAI as invalid as soon as an acknowledge message (e.g. ATTACH COMPLETE, ROUTING AREA UPDATE COMPLETE and P-TMSI REALLOCATION COMPLETE) is received.

#### 4.7.1.6 Change of network mode of operation

In the following tables below the abbreviations 'A/Gb mode I', 'A/Gb mode II' and 'A/Gb mode III' are used for network operation mode I, II and III in A/Gb mode.

In the following tables below the abbreviations 'lu mode I' and 'lu mode II' are used for network operation modes I and II in lu mode.

##### 4.7.1.6.1 Change of network mode of operation in A/Gb mode (A/Gb mode only)

Whenever an MS moves to a new RA, the procedures executed by the MS depend on the network mode of operation in the old and new routing area.

In case the MS is in state GMM-REGISTERED or GMM-ROUTING-AREA-UPDATING-INITIATED and is in operation mode:

- a) A or B (with the exceptions in b and c below), the MS shall execute:

**Table 4.7.1.6.1/3GPP TS 24.008: Mode A or B**

Network operation mode change	Procedure to execute
I → II or I → III	Normal Location Update(*), followed by a Normal Routing Area Update
II → III or III → II	Normal Location Update (see subclause 4.2.2) if a new LA is entered, followed by a Normal Routing Area Update
II → I or III → I	Combined Routing Area Update with IMSI attach(**)

b) B which reverts to operation mode C in network operation mode III, the MS shall execute:

**Table 4.7.1.6.2/3GPP TS 24.008: Mode B which reverts into mode C in network operation mode III**

Network operation mode change	Procedure to execute
I → II	Normal Location Update(*), followed by a Normal Routing Area Update
I → III or II → III	IMSI Detach (see subclause 4.3.4), followed by a Normal Routing Area Update
II → I or III → I	Combined Routing Area Update with IMSI attach(**)
III → II	IMSI attach (see subclause 4.4.3), followed by a Normal Routing Area Update

c) B which reverts to IMSI attached for CS services only in network operation mode III, the MS shall execute:

**Table 4.7.1.6.3/3GPP TS 24.008: Mode B which reverts into IMSI attached for CS services only in network operation mode III**

Network operation mode change	Procedure to execute
I → II	Normal Location Update(*), followed by a Normal Routing Area Update
I → III	Normal Location Update(*), followed by a GPRS Detach with type indicating "GPRS Detach"
II → III	Normal Location Update (see subclause 4.2.2) if a new LA is entered, followed by a GPRS Detach with detach type indicating "GPRS Detach"
II → I	Combined Routing Area Update with IMSI attach(**)
III → I	Combined GPRS Attach(**)
III → II	Normal Location Update (see subclause 4.2.2) if a new LA is entered, followed by a Normal GPRS Attach

(\*) Intended to remove the Gs association in the MSC/VLR.

(\*\*) Intended to establish the Gs association in the MSC/VLR.

Further details are implementation issues.

#### 4.7.1.6.2 Change of network mode of operation in Iu mode (Iu mode only)

Whenever an MS moves to a new RA, the procedures executed by the MS depend on the network mode of operation in the old and new routing area.

In case the MS is in state GMM-REGISTERED or GMM-ROUTING-AREA-UPDATING-INITIATED and is in operation mode A, the MS shall execute:

**Table 4.7.1.6.4/3GPP TS 24.008: Mode A**

Network operation mode change	Procedure to execute
I → II	Normal Location Update(*), followed by a Normal Routing Area Update
II → I	Combined Routing Area Update with IMSI attach(**)

(\*) Intended to remove the Gs association in the MSC/VLR.

(\*\*) Intended to establish the Gs association in the MSC/VLR.

Further details are implementation issues.

#### 4.7.1.6.3 Change of network mode of operation at Iu mode to A/Gb mode inter-system change

Whenever an MS moves to a new RA supporting the A/Gb mode radio interface, the procedures executed by the MS depend on the network mode of operation in the old and new routing area.

In case the MS is in state GMM-REGISTERED or GMM-ROUTING-AREA-UPDATING-INITIATED and is in operation mode:

- a) A in Iu mode, an MS that changes to GPRS operation mode A or B in A/Gb mode shall execute:

**Table 4.7.1.6.5/3GPP TS 24.008: Mode A in Iu mode changing to GPRS mode A or B in A/Gb mode**

Network operation mode change	Procedure to execute
Iu mode I → A/Gb mode I	Combined Routing Area Update
Iu mode II → A/Gb mode I	Combined Routing Area Update with IMSI attach(**)
Iu mode I → A/Gb mode II or Iu mode I → A/Gb mode III	Normal Location Update(*), followed by a Normal Routing Area Update

- b) A in Iu mode, an MS that changes due to MS specific characteristics to GPRS operation mode C in network operation mode III in A/Gb mode shall execute:

**Table 4.7.1.6.6/3GPP TS 24.008: Mode A in Iu mode changing to GPRS mode C in A/Gb mode**

Network operation mode change	Procedure to execute
Iu mode I → A/Gb mode III or Iu mode II → A/Gb mode III	IMSI detach (see subclause 4.3.4), followed by a Normal Routing Area Update

- c) A in Iu mode, an MS that changes due to MS specific characteristics to IMSI attached for CS services only in network operation mode III in A/Gb mode shall execute:

**Table 4.7.1.6.7/3GPP TS 24.008: Mode A in Iu mode changing to IMSI attached for CS services only in A/Gb mode**

Network operation mode change	Procedure to execute
Iu mode I → A/Gb mode III	Normal Location Update (see subclause 4.4.1)(*), followed by a GPRS Detach with detach type indicating "GPRS Detach"
Iu mode II → A/Gb mode III	Normal Location Update (see subclause 4.4.1) if a new LA is entered, followed by a GPRS Detach with detach type indicating "GPRS Detach"

- d) C in Iu mode, the MS shall change to GPRS operation mode C in A/Gb mode and shall execute the normal Routing Area Update procedure.
- e) CS in Iu mode, the MS shall execute the normal Location Update procedure.

(\*) Intended to remove the Gs association in the MSC/VLR.

(\*\*) Intended to establish the Gs association in the MSC/VLR.

Further details are implementation issues.

#### 4.7.1.6.4 Change of network mode of operation at A/Gb mode to Iu mode inter-system change

Whenever an MS moves to a new RA supporting the Iu mode radio interface, the procedures executed by the MS depend on the network mode of operation in the old and new routing area.

In case the MS is in state GMM-REGISTERED or GMM-ROUTING-AREA-UPDATING-INITIATED and is in operation mode:

- a) A or B in A/Gb mode, the MS shall change to operation mode A in Iu mode and shall execute:

**Table 4.7.1.6.8/3GPP TS 24.008: Mode A or B in A/Gb mode changing to mode A in Iu mode**

Network operation mode change	Procedure to execute
A/Gb mode I → Iu mode I	Combined Routing Area Update
A/Gb mode II → Iu mode I	Combined Routing Area Update with IMSI attach(**)
A/Gb mode I → Iu mode II	Normal Location Update(*), followed by a Normal Routing Area Update
A/Gb mode II → Iu mode II or A/Gb mode III → Iu mode II	Normal Location Update if a new LA is entered, followed by a Normal Routing Area Update

- b) C in A/Gb mode, an MS that changes to operation mode C in Iu mode shall execute a Normal Routing Area Update.
- c) C in A/Gb mode, an MS that, due to MS specific characteristics operated in GPRS operation mode C in network operation mode III in A/Gb mode changes to operation mode A in Iu mode shall execute:

**Table 4.7.1.6.9/3GPP TS 24.008: Mode C changing to mode A in Iu mode**

Network operation mode change	Procedure to execute
A/Gb mode III → Iu mode I	Combined Routing Area Update with IMSI attach(**)
A/Gb mode III → Iu mode II	IMSI attach (see subclause 4.4.3), followed by a Normal Routing Area Update

- d) IMSI attached for non-GPRS services only, an MS that, due to MS specific characteristics, operated in network operation mode III in A/Gb mode and changes to operation mode A in Iu mode shall execute:

**Table 4.7.1.6.10/3GPP TS 24.008: IMSI attached for non-GPRS services only changing to mode A in Iu mode**

Network operation mode change	Procedure to execute
A/Gb mode III → Iu mode I	Combined GPRS Attach for GPRS and non-GPRS services(**)
A/Gb mode III → Iu mode II	GPRS Attach

(\*) Intended to remove the Gs association in the MSC/VLR.

(\*\*) Intended to establish the Gs association in the MSC/VLR.

Further details are implementation issues.

#### 4.7.1.7 Intersystem change between A/Gb mode and Iu mode

For the Iu mode to A/Gb mode and A/Gb mode to Iu mode intersystem change the following cases can be distinguished:

a) Intersystem change between cells belonging to different RA's:

The procedures executed by the MS depends on the network mode of operation in the old and new RA. If a change of the network operation mode has occurred in the new RA, then the MS shall behave as specified in subclause 4.7.1.6. If no change of the network operation mode has occurred in the new RA, then the MS shall initiate the normal or combined RA update procedure depending on the network operation mode in the current RA.

b) Intersystem change between cells belonging to the same RA:

If the READY timer is running in the MS in A/Gb mode or the MS is in PMM-CONNECTED mode in Iu mode, then the MS shall perform a normal or combined RA update procedure depending on the network mode of operation in the current RA.

If the READY timer is not running in the MS in A/Gb mode or the MS is in PMM-IDLE mode in Iu mode, then the MS shall not perform a RA update procedure (as long as the MS stays within the same RA) until up-link user data or signalling information needs to be sent from the MS to the network, except case c) is applicable.

- If the MS is in the same access network, A/Gb mode or Iu mode, as when it last sent user data or signalling messages, the procedures defined for that access system shall be followed. This shall be sending of an LLC PDU in a A/Gb mode cell or initiating the SERVICE REQUEST procedure in an Iu mode cell.
- If the MS is in a different access network, A/Gb mode or Iu mode, as when it last sent user data or signalling messages, the normal or combined RA update procedure shall be performed depending on the network operation mode in the current RA, before the sending of user data or signalling messages. If the signalling message is a DETACH REQUEST containing cause "power off", the RA update procedure need not to be performed.
- If the periodic routing area update timer expires the MS shall initiate the periodic RA update procedure.

If the READY timer is not running in the network in A/Gb mode or the network is in PMM-IDLE mode in Iu mode, then the network shall page the MS if down-link user data or signalling information needs to be sent from the network to the MS. This shall include both A/Gb mode and Iu mode cells.

- If the MS receives the paging indication in the same access network, A/Gb mode or Iu mode, as when it last sent user data or signalling information, the MS shall send any LLC PDU in a A/Gb mode cell or shall initiate the SERVICE REQUEST procedure indicating service type "paging response" in an Iu mode cell.
- If the MS receives the paging indication in a different access network, A/Gb mode or Iu mode, as when it last sent user data or signalling information, the normal or combined RA update procedure shall be performed depending on the network operation mode in the current RA.

c) Intersystem handover from A/Gb mode to Iu mode during a CS connection:

After the successful completion of the handover from an A/Gb mode cell to an Iu mode cell, an MS which has performed the GPRS suspension procedure in Gb mode (see 3GPP TS 44.018 [84]) (i.e. an MS in MS operation mode B or an DTM MS in a A/Gb mode cell that does not support DTM) shall perform a normal RA update procedure in the Iu mode cell in order to resume the GPRS services in the network, before sending any other signalling messages or user data.

#### 4.7.1.8 List of forbidden PLMNs for GPRS service

The Mobile Equipment shall contain a list of "forbidden PLMNs for GPRS service". This lists shall be erased when the MS is switched off or when the SIM/USIM is removed. The PLMN identification received on the BCCH shall be added to the list whenever a GPRS attach or routing area update is rejected by the network with the cause "GPRS services not allowed in this PLMN" or whenever a GPRS detach is initiated by the network with the cause "GPRS services not allowed in this PLMN".

In a shared network, the MS shall choose one of the PLMN identities as specified in 3GPP TS 23.122 [14]. The PLMN identity chosen for a GPRS attach procedure, or the PLMN identity used to construct the RAI that triggered the routing area updating procedure shall be added to the list of "forbidden PLMNs for GPRS service" whenever such a procedure is rejected by the network with the cause "GPRS services not allowed in this PLMN". Whenever a GPRS detach is initiated by the network with the cause "GPRS services not allowed in this PLMN", the chosen PLMN identity shall be added to the list of "forbidden PLMNs for GPRS service".

The maximum number of possible entries in this list is implementation dependent, but must be at least one entry. When the list is full and a new entry has to be inserted, the oldest entry shall be deleted.

## 4.7.2 GPRS Mobility management timers and UMTS PS signalling connection control

### 4.7.2.1 READY timer behaviour

#### 4.7.2.1.1 READY timer behaviour (A/Gb mode only)

The READY timer, T3314 is used in the MS and in the network per each assigned P-TMSI to control the cell updating procedure.

When the READY timer is running or has been deactivated the MS shall perform cell update each time a new cell is selected (see 3GPP TS 43.022 [82]). If a routing area border is crossed, a routing area updating procedure shall be performed instead of a cell update.

When the READY timer has expired the MS shall:

- perform the routing area updating procedure when a routing area border is crossed;
- not perform a cell update when a new cell is selected.

All other GMM procedures are not affected by the READY timer.

The READY timer is started:

- in the MS when the GMM entity receives an indication from lower layers that an LLC frame other than LLC NULL frame has been transmitted on the radio interface; and
- in the network when the GMM entity receives an indication from lower layers that an LLC frame other than LLC NULL frame has been successfully received by the network.

Within GMM signalling procedures the network includes a "force to standby" information element, in order to indicate whether or not the READY timer shall be stopped when returning to the GMM-REGISTERED state. If the "force to standby" information element is received within more than one message during a ongoing GMM specific procedure, the last one received shall apply. If the READY timer is deactivated and the network indicates "force to standby" with the "force to standby" information element, this shall not cause a modification of the READY timer.

The READY timer is not affected by state transitions to and from the GMM-REGISTERED.SUSPENDED sub-state.

The value of the READY timer may be negotiated between the MS and the network using the GPRS attach or GPRS routing area updating procedure.

- If the MS wishes to indicate its preference for a READY timer value it shall include the preferred values into the ATTACH REQUEST and/or ROUTING AREA UPDATE REQUEST messages. The preferred values may be smaller, equal to or greater than the default values or may be equal to the value requesting the READY Timer function to be deactivated.
- Regardless of whether or not a timer value has been received by the network in the ATTACH REQUEST or ROUTING AREA UPDATE REQUEST messages, the network may include a timer value for the READY timer (different or not from the default value) into the ATTACH ACCEPT or ROUTING AREA UPDATE ACCEPT messages, respectively. If the READY Timer value was included, it shall be applied for the GMM context by the network and by the MS.
- When the MS proposes a READY Timer value and the Network does not include any READY Timer Value in its answer, then the value proposed by the MS shall be applied for the GMM context by the Network and by the MS.
- When neither the MS nor the Network proposes a READY Timer value into the ATTACH ACCEPT or ROUTING AREA UPDATE ACCEPT message, then the default value shall be used.

If the negotiated READY timer value indicates that the ready timer function is deactivated, the READY timer shall always run without expiry. If the negotiated READY timer value indicates that the ready timer function is deactivated, and within the same procedure the network indicates "force to standby" with the "force to standby" information element, the READY timer shall always run without expiry. If the negotiated READY timer value is set to zero, READY timer shall be stopped immediately.

To account for the LLC frame uplink transmission delay, the READY timer value should be slightly shorter in the network than in the MS. This is a network implementation issue.

If a new READY timer value is negotiated, the MS shall upon the reception of the ATTACH ACCEPT or ROUTING AREA UPDATE ACCEPT message perform a initial cell update (either by transmitting a LLC frame or, if required, a ATTACH COMPLETE or ROUTING AREA UPDATE COMPLETE message), in order to apply the new READY timer value immediately. If both the network and the MS supports the Cell Notification, the initial cell update shall use any LLC frame except the LLC NULL frame. If the new READY timer value is set to zero or if the network indicates "force to standby" with the "force to standby" IE, the initial cell update should not be done.

#### 4.7.2.1.2 Handling of READY timer in Iu mode (Iu mode only)

The READY timer is not applicable for Iu mode.

An MS may indicate a READY timer value to the network in the ATTACH REQUEST and the ROUTING AREA UPDATE REQUEST messages.

If a READY timer value is received by an MS capable of both Iu mode and A/Gb mode in the ATTACH ACCEPT or the ROUTING AREA UPDATE ACCEPT messages, then the received value shall be stored by the MS in order to be used at an intersystem change from Iu mode to A/Gb mode.

#### 4.7.2.2 Periodic routing area updating

Periodic routing area updating is used to periodically notify the availability of the MS to the network. The procedure is controlled in the MS by the periodic RA update timer, T3312. The value of timer T3312 is sent by the network to the MS in the messages ATTACH ACCEPT and ROUTING AREA UPDATE ACCEPT. The value of the timer T3312 shall be unique within a RA.

If the T3312 received by the MS in A/Gb mode or received in Iu mode in a message with integrity protection contains an indication that the timer is deactivated or the timer value is zero, then the periodic routing area update timer is deactivated and the MS shall not perform periodic routing area updating.

In Iu mode, if the value of timer T3312 is received in a message without integrity protection and the indicated value is larger than the last received value, or the indicated value is "deactivated" or zero, the MS shall use the last received value.

In A/Gb mode, the timer T3312 is reset and started with its initial value, when the READY timer is stopped or expires. The timer T3312 is stopped and shall be set to its initial value for the next start when the READY timer is started. If after a READY timer negotiation the READY timer value is set to zero, timer T3312 is reset and started with its initial value. If the initial READY timer value is zero, the timer T3312 is reset and started with its initial value, when the ROUTING AREA UPDATE REQUEST message is transmitted.

In Iu mode, the timer T3312 is reset and started with its initial value, when the MS goes from PMM-CONNECTED to PMM-IDLE mode. The timer T3312 is stopped when the MS enters PMM-CONNECTED mode.

When timer T3312 expires, the periodic routing area updating procedure shall be started and the timer shall be set to its initial value for the next start.

If the MS is in other state than GMM-REGISTERED.NORMAL-SERVICE when the timer expires the periodic routing area updating procedure is delayed until the MS returns to GMM-REGISTERED.NORMAL-SERVICE.

In A/Gb mode, if the MS in MS operation mode B is in the state GMM-REGISTERED.SUSPENDED when the timer expires the periodic routing area updating procedure is delayed until the state is left.

The network supervises the periodic routing area updating procedure by means of the Mobile Reachable timer. The Mobile Reachable timer shall be longer than the periodic RA update timer. When the Mobile Reachable timer expires, typically the network stops sending paging messages to the mobile and may take other appropriate actions.

In A/Gb mode, the Mobile Reachable timer is reset and started with its initial value, when the READY timer is stopped or expires. The Mobile Reachable timer is stopped and shall be set to its initial value for the next start when the READY timer is started.

In A/Gb mode, if after a READY timer negotiation the READY timer value is set to zero the Mobile Reachable timer is reset and started with its initial value. If the initial READY timer value is zero, the Mobile Reachable is reset and started with its initial value, when the ROUTING AREA UPDATE REQUEST message is received.

In Iu mode, the Mobile Reachable timer is reset and started with its initial value, when the MS goes from PMM-CONNECTED to PMM-IDLE mode. The Mobile Reachable timer is stopped when the MS enters PMM-CONNECTED mode.

If the MS is both IMSI attached for GPRS and non-GPRS services, and if the MS lost coverage of the registered PLMN and timer T3312 expires, then:

- a) if the MS returns to coverage in a cell that supports GPRS and that indicates that the network is in network operation mode I, then the MS shall either perform the combined routing area update procedure indicating "combined RA/LA updating with IMSI attach"; or
- b) if the MS returns to coverage in a cell in the same RA that supports GPRS and that indicates that the network is in network operation mode II or III, then the MS shall perform the periodic routing area updating procedure indicating "Periodic updating"; or
- c) if the MS was both IMSI attached for GPRS and non-GPRS services in network operation mode I and the MS returns to coverage in a cell in the same LA that does not support GPRS, then the MS shall perform the periodic location updating procedure. In addition, the MS shall perform a combined routing area update procedure indicating "combined RA/LA updating with IMSI attach" when the MS enters a cell that supports GPRS and that indicates that the network is in network operation mode I; or
- d) if the MS returns to coverage in a new RA the description given in subclause 4.7.5 applies.

If the MS is both IMSI attached for GPRS and non-GPRS services in a network that operates in network operation mode I, and if the MS has camped on a cell that does not support GPRS, and timer T3312 expires, then the MS shall start an MM location updating procedure. In addition, the MS shall perform a combined routing area update procedure indicating "combined RA/LA updating with IMSI attach" when the MS enters a cell that supports GPRS and indicates that the network is in operation mode I.

If timer T3312 expires during an ongoing CS connection, then a MS operating in MS operation mode B shall treat the expiry of T3312 when the MM state MM-IDLE is entered, analogous to the descriptions for the cases when the timer expires out of coverage or in a cell that does not support GPRS.

In A/Gb mode, timer T3312 shall not be stopped when a GPRS MS enters state GMM-REGISTERED.SUSPENDED.

#### 4.7.2.3 PMM-IDLE mode and PMM-CONNECTED mode (Iu mode only)

An MS shall enter PMM-CONNECTED mode when a PS signalling connection for packet switched domain is established between the MS and the network. The MS shall not perform periodic routing area update in PMM-CONNECTED mode.

An MS shall enter PMM-IDLE mode when the PS signalling connection for packet switched domain between the MS and the network has been released. The MS shall perform periodic routing area update in PMM-IDLE mode.

#### 4.7.2.4 Handling of *Force to standby* in Iu mode (Iu mode only)

Force to standby is not applicable for Iu mode.

The network shall always indicate *Force to standby not indicated* in the *Force to standby* information element.

The *Force to standby* information element shall be ignored by the MS.



#### 4.7.2.5 RA Update procedure for Signalling Connection Re-establishment (lu mode only)

When the MS receives an indication from the lower layers that the RRC connection has been released with cause "Directed signalling connection re-establishment", see 3GPP TS 25.331 [23c] and 3GPP TS 44.118 [111], then the MS shall enter PMM-IDLE mode and initiate immediately a normal routing area update procedure (the use of normal or combined procedure depends on the network operation mode in the current serving cell) regardless whether the routing area has been changed since the last update or not. This routing area update procedure shall also be performed or continued if the MS has performed an inter-system change towards GSM, irrespective whether the READY timer is running or the MS is in PMM-IDLE or PMM-CONNECTED mode.

#### 4.7.2.6 Cell Update triggered by low layers

A Cell Update may be requested by the low layers, see 3GPP TS 44.060. In this case the Cell Update shall be performed even if the READY timer is not running. If both the network and the MS support the Cell Notification, then the MS shall use the LLC NULL frame to perform the Cell Update.

### 4.7.3 GPRS attach procedure

The GPRS attach procedure is used for two purposes:

- normal GPRS attach, performed by the MS to IMSI attach for GPRS services only. The normal GPRS attach procedure shall be used:
  - by GPRS MSs in MS operation mode C, independent of the network operation mode;
  - by GPRS MSs in MS operation modes A or B if the network operates in network operation mode II or III; and
  - by GPRS MSs in MS operation mode A, independent of the network operation mode, if a circuit-switched transaction is ongoing;
- combined GPRS attach procedure, used by GPRS MSs in MS operation modes A or B to attach the IMSI for GPRS and non-GPRS services provided that the network operates in network operation mode I.

With a successful GPRS attach procedure a GMM context is established.

Subclause 4.7.3.1 describes the GPRS attach procedure to attach the IMSI only for GPRS services. The combined GPRS attach procedure used to attach the IMSI for both GPRS and non-GPRS services is described in subclause 4.7.3.2.

If an IMSI attach for non-GPRS services is requested and a GMM context exists, the routing area updating procedure shall be used as described in subclause 4.7.5.2.

To limit the number of subsequently rejected attach attempts, a GPRS attach attempt counter is introduced. The GPRS attach attempt counter shall be incremented as specified in subclause 4.7.3.1.5. Depending on the value of the GPRS attach attempt counter, specific actions shall be performed. The GPRS attach attempt counter shall be reset when:

- the MS is powered on;
- a SIM/USIM is inserted;
- a GPRS attach procedure is successfully completed;
- a combined GPRS attach procedure is completed for GPRS services only with cause #2, #16, #17 or #22; or
- a GPRS attach procedure is completed with cause #11, #12, #13 or #15,

and additionally when the MS is in substate ATTEMPTING-TO-ATTACH:

- expiry of timer T3302;
- a new routing area is entered; or

- an attach is triggered by CM sublayer requests.

The mobile equipment shall contain a list of "forbidden location areas for roaming", as well as a list of "forbidden location areas for regional provision of service". The handling of these lists is described in subclause 4.4.1; the same lists are used by GMM and MM procedures.

The Mobile Equipment shall contain a list of "equivalent PLMNs". The handling of this list is described in subclause 4.4.1, the same list is used by GMM and MM procedures.

In a shared network, the MS shall choose one of the PLMN identities as specified in 3GPP TS 23.122 [14]. The MS shall construct the Routing Area Identification of the cell from this chosen PLMN identity, and the LAC and the RAC received on the BCCH. The chosen PLMN identity shall be indicated to the RAN in the RRC INITIAL DIRECT TRANSFER message (see 3GPP TS 25.331 [23c]). Whenever an ATTACH REJECT message with the cause "PLMN not allowed" is received by the MS, the chosen PLMN identity shall be stored in the "forbidden PLMN list". Whenever an ATTACH REJECT message is received by the MS with the cause "Roaming not allowed in this location area", "Location Area not allowed", or "No suitable cells in Location Area", the LAI that is part of the constructed RAI shall be stored in the suitable list.

The network informs the MS about the support of specific features, such as LCS-MOLR or MBMS, in the "Network feature support" Information Element. The information is either explicitly given by sending the "Network feature support" IE or implicitly by not sending it. The handling in the network is described in subclause 9.4.2.9. The MS may use the indication to inform the user about the availability of the appropriate services and it shall not request services that have not been indicated as available. The indication for MBMS is defined in subclause "MBMS feature support indication" in 3GPP TS 23.246 [106].

#### 4.7.3.1 GPRS attach procedure for GPRS services

The GPRS attach procedure is a GMM procedure used by GPRS MSs to IMSI attach for GPRS services.

The attach type information element shall indicate "GPRS attach".

##### 4.7.3.1.1 GPRS attach procedure initiation

In state GMM-DEREGISTERED, the MS initiates the GPRS attach procedure by sending an ATTACH REQUEST message to the network, starts timer T3310 and enters state GMM-REGISTERED-INITIATED.

The MS capable of both Iu mode and A/Gb mode or only of A/Gb mode shall include a valid P-TMSI, if any is available, the P-TMSI signature associated with the P-TMSI and the routing area identity associated with the P-TMSI in the ATTACH REQUEST message. If there is no valid P-TMSI available, the IMSI shall be included instead of the P-TMSI and P-TMSI signature.

The MS shall also indicate within the DRX parameters whether it supports the split pg cycle option on CCCH. The optional support of the split pg cycle on CCCH by the network is indicated in S113 or PSI1. Split pg cycle on CCCH is applied by both the network and the MS when the split pg cycle option is supported by both (see 3GPP TS 45.002 [32]).

In Iu mode, if the MS wishes to prolong the established PS signalling connection after the GPRS attach procedure (for example, the MS has any CM application request pending), it may set a follow-on request pending indicator on (see subclause 4.7.13).

##### 4.7.3.1.2 GMM common procedure initiation

The network may initiate GMM common procedures, e.g. the GMM identification and GMM authentication and ciphering procedure, depending on the received information such as IMSI, CKSN, old RAI, P-TMSI and P-TMSI signature.

##### 4.7.3.1.3 GPRS attach accepted by the network

If the GPRS attach request is accepted by the network, an ATTACH ACCEPT message is sent to the MS.

The P-TMSI reallocation may be part of the GPRS attach procedure. When the ATTACH REQUEST includes the IMSI, the SGSN shall allocate the P-TMSI. The P-TMSI that shall be allocated is then included in the ATTACH ACCEPT message together with the routing area identifier. The network shall, in this case, change to state GMM-COMMON-PROCEDURE-INITIATED and shall start timer T3350 as described in subclause 4.7.6. Furthermore, the

network may assign a P-TMSI signature for the GMM context which is then also included in the ATTACH ACCEPT message. If the LAI or PLMN identity that has been transmitted in the ATTACH ACCEPT message is a member of any of the "forbidden" lists, any such entry shall be deleted. Additionally, the network shall include the radio priority level to be used by the MS for mobile originated SMS transfer in the ATTACH ACCEPT message. In a shared network, the network shall indicate the PLMN identity of the CN operator that has accepted the GPRS attach request in the RAI contained in the ATTACH ACCEPT message (see 3GPP TS 23.251 [109]).

If the MS has indicated in the ATTACH REQUEST message that it supports PS inter-RAT handover to UTRAN Iu mode, the network may include in the ATTACH ACCEPT message a request to provide the Inter RAT information container.

In A/Gb mode, the Cell Notification information element shall be included in the ATTACH ACCEPT message by the network which indicates that the Cell Notification is supported by the network.

In Iu mode, the network should prolong the PS signalling connection if the mobile station has indicated a follow-on request pending in ATTACH REQUEST. The network may also prolong the PS signalling connection without any indication from the mobile terminal.

The MS, receiving an ATTACH ACCEPT message, stores the received routing area identification, stops timer T3310, reset the GPRS attach attempt counter, reset the routing area updating attempt counter, enters state GMM-REGISTERED and sets the GPRS update status to GU1 UPDATED.

If the message contains a P-TMSI, the MS shall use this P-TMSI as the new temporary identity for GPRS services. In this case, an ATTACH COMPLETE message is returned to the network. The MS shall delete its old P-TMSI and shall store the new one. If no P-TMSI has been included by the network in the ATTACH ACCEPT message, the old P-TMSI, if any available, shall be kept.

If the message contains a P-TMSI signature, the MS shall use this P-TMSI signature as the new temporary signature for the GMM context. The MS shall delete its old P-TMSI signature, if any is available, and shall store the new one. If the message contains no P-TMSI signature, the old P-TMSI signature, if available, shall be deleted.

If the network has requested the provision of the Inter RAT information container the MS shall return an ATTACH COMPLETE message including the Inter RAT information container IE to the network.

The network may also send a list of "equivalent PLMNs" in the ATTACH ACCEPT message. Each entry of the list contains a PLMN code (MCC+MNC). The mobile station shall store the list, as provided by the network, except that any PLMN code that is already in the "forbidden PLMN" list shall be removed from the "equivalent PLMNs" list before it is stored by the mobile station. In addition the mobile station shall add to the stored list the PLMN code of the registered PLMN that sent the list. All PLMNs in the stored list shall be regarded as equivalent to each other for PLMN selection, cell selection/re-selection and handover. The stored list in the mobile station shall be replaced on each occurrence of the ATTACH ACCEPT message. If no list is contained in the message, then the stored list in the mobile station shall be deleted. The list shall be stored in the mobile station while switched off so that it can be used for PLMN selection after switch on.

In Iu mode, if the network wishes to prolong the PS signalling connection (for example, if the mobile station has indicated "follow-on request pending" in ATTACH REQUEST message) the network shall indicate the "follow-on proceed" in the ATTACH ACCEPT message. If the network wishes to release the PS signalling connection, the network shall indicate "no follow-on proceed" in the ATTACH ACCEPT message.

After that in Iu mode, the mobile station shall act according to the follow-on proceed flag included in the Attach result information element in the ATTACH ACCEPT message (see subclause 4.7.13).

In A/Gb mode, if the ATTACH ACCEPT message contains the Cell Notification information element, then the MS shall start to use the LLC NULL frame to perform cell updates. The network receiving an ATTACH COMPLETE message stops timer T3350, changes to GMM-REGISTERED state and considers the P-TMSI sent in the ATTACH ACCEPT message as valid.

The network may also send a list of local emergency numbers in the ATTACH ACCEPT, by including the Emergency Number List IE. The mobile equipment shall store the list, as provided by the network, except that any emergency number that is already stored in the SIM/USIM shall be removed from the list before it is stored by the mobile equipment. If there are no emergency numbers stored on the SIM/USIM, then before storing the received list the mobile equipment shall remove from it any emergency number stored permanently in the ME for use in this case (see 3GPP TS 22.101 [8]). The list stored in the mobile equipment shall be replaced on each receipt of a new Emergency Number List IE.

The emergency number(s) received in the Emergency Number List IE are valid only in networks with the same MCC as in the cell on which this IE is received. If no list is contained in the ATTACH ACCEPT message, then the stored list in the mobile equipment shall be kept, except if the mobile equipment has successfully registered to a PLMN with an MCC different from that of the last registered PLMN.

The mobile equipment shall use the stored list of emergency numbers received from the network in addition to the emergency numbers stored on the SIM/USIM or ME to detect that the number dialled is an emergency number.

NOTE: The mobile equipment may use the emergency numbers list to assist the end user in determining whether the dialled number is intended for an emergency service or for another destination, e.g. a local directory service. The possible interactions with the end user are implementation specific.

The list of emergency numbers shall be deleted at switch off and removal of the SIM/USIM. The mobile equipment shall be able to store up to ten local emergency numbers received from the network.

#### 4.7.3.1.4 GPRS attach not accepted by the network

If the attach request cannot be accepted by the network, an ATTACH REJECT message is transferred to the MS. The MS receiving the ATTACH REJECT message, stops timer T3310 and for all causes except #12, #14 and #15 deletes the list of "equivalent PLMNs".

The MS shall then take one of the following actions depending upon the reject cause:

# 3 (Illegal MS);

# 6 (Illegal ME);

The MS shall set the GPRS update status to GU3 ROAMING NOT ALLOWED (and shall store it according to subclause 4.1.3.2) and shall delete any P-TMSI, P-TMSI signature, RAI and GPRS ciphering key sequence number. The new GMM state is GMM-DEREGISTERED. The SIM/USIM shall be considered as invalid for GPRS services until switching off or the SIM/USIM is removed.

If the MS is IMSI attached, the MS shall in addition set the update status to U3 ROAMING NOT ALLOWED, shall delete any TMSI, LAI and ciphering key sequence number. If the MS is operating in MS operation mode A and an RR connection exists, the MS shall abort the RR connection, unless an emergency call is ongoing. The SIM/USIM shall be considered as invalid also for non-GPRS services until switching off or the SIM/USIM is removed.

# 7 (GPRS services not allowed);

The MS shall set the GPRS update status to GU3 ROAMING NOT ALLOWED (and shall store it according to subclause 4.1.3.2) and shall delete any P-TMSI, P-TMSI signature, RAI and GPRS ciphering key sequence number. The SIM/USIM shall be considered as invalid for GPRS services until switching off or the SIM/USIM is removed. The new state is GMM-DEREGISTERED.

# 8 (GPRS services and non-GPRS services not allowed);

The MS shall set the GPRS update status to GU3 ROAMING NOT ALLOWED (and shall store it according to subclause 4.1.3.2) and shall delete any P-TMSI, P-TMSI signature, RAI and GPRS ciphering key sequence number. The new GMM state is GMM-DEREGISTERED.

The MS shall set the update status to U3 ROAMING NOT ALLOWED, shall delete any TMSI, LAI and ciphering key sequence number. If the MS is operating in MS operation mode A and an RR connection exists, the MS shall abort the RR connection, unless an emergency call is ongoing. The SIM/USIM shall be considered as invalid for GPRS and non-GPRS services until switching off or the SIM/USIM is removed.

# 11 (PLMN not allowed);

The MS shall delete any RAI, P-TMSI, P-TMSI signature, and GPRS ciphering key sequence number stored, shall set the GPRS update status to GU3 ROAMING NOT ALLOWED (and shall store it according to subclause 4.1.3.2), shall reset the GPRS attach attempt counter and shall change to state GMM-DEREGISTERED.

The MS shall store the PLMN identity in the "forbidden PLMN list".

If no RR connection exists, the MS shall perform the following additional actions immediately. If the MS is operating in MS operation mode A and an RR connection exists, the MS shall perform these actions when the RR connection is subsequently released:

- If the MS is IMSI attached, the MS shall set the update status to U3 ROAMING NOT ALLOWED, shall delete any TMSI, LAI and ciphering key sequence number and shall reset the location update attempt counter. The new MM state is MM IDLE.
- The MS shall perform a PLMN selection according to 3GPP TS 23.122 [14].

# 12 (Location area not allowed);

The MS shall delete any RAI, P-TMSI, P-TMSI signature and GPRS ciphering key sequence number, shall set the GPRS update status to GU3 ROAMING NOT ALLOWED (and shall store it according to clause 4.1.3.2) and shall reset the attach attempt counter. The state is changed to GMM-DEREGISTERED.LIMITED-SERVICE.

The mobile station shall store the LAI in the list of "forbidden location areas for regional provision of service".

If no RR connection exists, the MS shall perform the following additional actions immediately. If the MS is operating in MS operation mode A and an RR connection exists, the MS shall perform these actions when the RR connection is subsequently released:

- If the MS is IMSI attached, the MS shall set the update status to U3 ROAMING NOT ALLOWED, shall delete any TMSI, LAI and ciphering key sequence number and shall reset the location update attempt counter. The new MM state is MM IDLE.
- The MS shall perform a cell selection according to 3GPP TS 43.022 [82] and 3GPP TS 25.304.

# 13 (Roaming not allowed in this location area);

The MS shall delete any RAI, P-TMSI, P-TMSI signature and GPRS ciphering key sequence number, shall set the GPRS update status to GU3 ROAMING NOT ALLOWED (and shall store it according to clause 4.1.3.2) and shall reset the attach attempt counter. The state is changed to GMM-DEREGISTERED.LIMITED-SERVICE or optionally to GMM-DEREGISTERED.PLMN-SEARCH.

The MS shall store the LAI in the list of "forbidden location areas for roaming".

If no RR connection exists, the MS shall perform the following additional actions immediately. If the MS is operating in MS operation mode A and an RR connection exists, the MS shall perform these actions when the RR connection is subsequently released:

- If the MS is IMSI attached, the MS shall set the update status to U3 ROAMING NOT ALLOWED, shall delete any TMSI, LAI and ciphering key sequence number and shall reset the location update attempt counter. The new MM state is MM IDLE.
- The MS shall perform a PLMN selection according to 3GPP TS 23.122 [14].

# 14 (GPRS services not allowed in this PLMN);

The MS shall delete any RAI, P-TMSI, P-TMSI signature, and GPRS ciphering key sequence number stored, shall set the GPRS update status to GU3 ROAMING NOT ALLOWED (and shall store it according to subclause 4.1.3.2) and shall change to state GMM-DEREGISTERED.

The MS shall store the PLMN identity in the "forbidden PLMNs for GPRS service" list. A GPRS MS operating in MS operation mode C shall perform a PLMN selection instead of a cell selection.

A GPRS MS operating in MS operation mode A or B in network operation mode II or III, is still IMSI attached for CS services in the network.

As an implementation option, a GPRS MS operating in operation mode A or B may perform the following additional action. If no RR connection exists the MS may perform the action immediately. If the MS is operating in MS operation mode A and an RR connection exists, the MS may only perform the action when the RR connection is subsequently released:

- The MS may perform a PLMN selection according to 3GPP TS 23.122 [14].

The MS shall not perform the optional PLMN selection in the case where the PLMN providing this reject cause is:

- On the "User Controlled PLMN Selector with Access Technology " list or,
- On the "Operator Controlled PLMN Selector with Access Technology " list or,
- A PLMN identified as equivalent to any PLMN, with the same MCC, contained in the lists above.

# 15 (No Suitable Cells In Location Area);

The MS shall delete any RAI, P-TMSI, P-TMSI signature and GPRS ciphering key sequence number, shall set the GPRS update status to GU3 ROAMING NOT ALLOWED (and shall store it according to clause 4.1.3.2) and shall reset the attach attempt counter. The state is changed to GMM-DEREGISTERED.LIMITED-SERVICE.

The MS shall store the LAI in the list of "forbidden location areas for roaming".

If no RR connection exists, the MS shall perform the following additional actions immediately. If the MS is operating in MS operation mode A and an RR connection exists, the MS shall perform these actions when the RR connection is subsequently released:

- If the MS is IMSI attached, the MS shall set the update status to U3 ROAMING NOT ALLOWED, shall delete any TMSI, LAI and ciphering key sequence number and shall reset the location update attempt counter. The new MM state is MM IDLE.
- The MS shall search for a suitable cell in another location area in the same PLMN according to 3GPP TS 43.022 [82] and 3GPP TS 25.304.

Other values are considered as abnormal cases. The specification of the MS behaviour in those cases is specified in subclause 4.7.3.1.5.

#### 4.7.3.1.5 Abnormal cases in the MS

The following abnormal cases can be identified:

- a) Access barred because of common access class control or PS domain specific access control

The GPRS attach procedure shall not be started. The MS stays in the current serving cell and applies normal cell reselection process. The GPRS attach procedure is started as soon as possible, i.e. when access is granted or because of a cell change.

- b) Lower layer failure before the ATTACH ACCEPT or ATTACH REJECT message is received

The procedure shall be aborted. The MS shall proceed as described below.

- c) T3310 time-out

On the first expiry of the timer, the MS shall reset and restart timer T3310 and shall retransmit the ATTACH REQUEST message. This retransmission is repeated four times, i.e. on the fifth expiry of timer T3310, the MS shall abort the GPRS attach procedure and, in Iu mode, release the PS signalling connection (see 3GPP TS 25.331 [23c]). The MS shall proceed as described below.

- d) ATTACH REJECT, other causes than those treated in subclause 4.7.3.1.4

Upon reception of the cause codes # 95, # 96, # 97, # 99 and # 111 the MS should set the GPRS attach attempt counter to 5. The MS shall proceed as described below.

- e) Change of cell within the same RA (A/Gb mode only)

If a cell change occurs within the same RA when the MS is in state GMM-REGISTERED-INITIATED, then the cell update procedure shall be performed before completion of the attach procedure.

## f) Change of cell into a new routing area

If a cell change into a new routing area occurs before an ATTACH ACCEPT or ATTACH REJECT message has been received, the GPRS attach procedure shall be aborted and re-initiated immediately. If a routing area border is crossed when the ATTACH ACCEPT message is received but before an ATTACH COMPLETE message is sent, the GPRS attach procedure shall be aborted and the routing area updating procedure shall be initiated. If a P-TMSI was allocated during the GPRS attach procedure, this P-TMSI shall be used in the routing area updating procedure. If a P-TMSI signature was allocated together with the P-TMSI during the GPRS attach procedure, this P-TMSI signature shall be used in the routing area updating procedure.

## g) Mobile originated detach required

If the MS is in state GMM-REGISTERED-INITIATED, the GPRS attach procedure shall be aborted and the GPRS detach procedure shall be performed (see subclause 4.7.4.1).

## h) Procedure collision

If the MS receives a DETACH REQUEST message from the network in state GMM-REGISTERED-INITIATED with type of detach 're-attach not required', the GPRS detach procedure shall be progressed and the GPRS attach procedure shall be aborted. Otherwise the GPRS attach procedure shall be progressed and the DETACH REQUEST message shall be ignored.

In cases b, c and d the MS shall proceed as follows. Timer T3310 shall be stopped if still running. The GPRS attach attempt counter shall be incremented.

If the GPRS attach attempt counter is less than 5:

- timer T3311 is started and the state is changed to GMM-DEREGISTERED.ATTEMPTING-TO-ATTACH.

If the GPRS attach attempt counter is greater than or equal to 5:

- the MS shall delete any RAI, P-TMSI, P-TMSI signature, list of equivalent PLMNs, and GPRS ciphering key sequence number, shall set the GPRS update status to GU2 NOT UPDATED, shall start timer T3302. The state is changed to GMM-DEREGISTERED. ATTEMPTING-TO-ATTACH or optionally to GMM-DEREGISTERED.PLMN-SEARCH (see subclause 4.2.4.1.2) in order to perform a PLMN selection according to 3GPP TS 23.122 [14].

#### 4.7.3.1.6 Abnormal cases on the network side

The following abnormal cases can be identified:

## a) Lower layer failure

If a low layer failure occurs before the message ATTACH COMPLETE has been received from the MS and a new P-TMSI (or a new P-TMSI and a new P-TMSI signature) has been assigned, the network shall consider both the old and new P-TMSI each with its corresponding P-TMSI-signature as valid until the old P-TMSI can be considered as invalid by the network (see subclause 4.7.1.5) and shall not resent the message ATTACH ACCEPT. During this period the network may:

- use the identification procedure followed by a P-TMSI reallocation procedure if the old P-TMSI is used by the MS in a subsequent message.

## b) Protocol error

If the ATTACH REQUEST message is received with a protocol error, the network shall return an ATTACH REJECT message with one of the following reject causes:

- #96: Mandatory information element error;
- #99: Information element non-existent or not implemented;
- #100: Conditional IE error;
- #111: Protocol error, unspecified.

## c) T3350 time-out

On the first expiry of the timer, the network shall retransmit the ATTACH ACCEPT message and shall reset and restart timer T3350.

This retransmission is repeated four times, i.e. on the fifth expiry of timer T3350, the GPRS attach procedure shall be aborted. If a new P-TMSI or a new P-TMSI together with a new P-TMSI signature were allocated in the ATTACH ACCEPT message, the network shall consider both the old and new P-TMSI each together with the corresponding P-TMSI signatures as valid until the old P-TMSI can be considered as invalid by the network (see subclause 4.7.1.5). During this period the network acts as specified for case a.

d.1) ATTACH REQUEST received after the ATTACH ACCEPT message has been sent and before the ATTACH COMPLETE message is received

- If one or more of the information elements in the ATTACH REQUEST message differ from the ones received within the previous ATTACH REQUEST message, the previously initiated GPRS attach procedure shall be aborted if the ATTACH COMPLETE message has not been received and the new GPRS attach procedure shall be progressed, or
- If the information elements do not differ, then the ATTACH ACCEPT message shall be resent and the timer T3350 shall be restarted if an ATTACH COMPLETE message is expected. In that case, the retransmission counter related to T3350 is not incremented.

d.2) More than one ATTACH REQUEST received and no ATTACH ACCEPT or ATTACH REJECT message has been sent

- If one or more of the information elements in the ATTACH REQUEST message differs from the ones received within the previous ATTACH REQUEST message, the previously initiated GPRS attach procedure shall be aborted and the new GPRS attach procedure shall be progressed;
- If the information elements do not differ, then the network shall continue with the previous attach procedure and shall not treat any further this ATTACH REQUEST message.

e) ATTACH REQUEST received in state GMM-REGISTERED

If an ATTACH REQUEST message is received in state GMM-REGISTERED the network may initiate the GMM common procedures; if it turned out that the ATTACH REQUEST message was sent by an MS that has already been attached, the GMM context, PDP contexts and MBMS contexts, if any, are deleted and the new ATTACH REQUEST is progressed.

f) ROUTING AREA UPDATE REQUEST message received before ATTACH COMPLETE message.

Timer T3350 shall be stopped. The allocated P-TMSI shall be considered as valid and the routing area updating procedure shall be progressed as described in subclause 4.7.5.



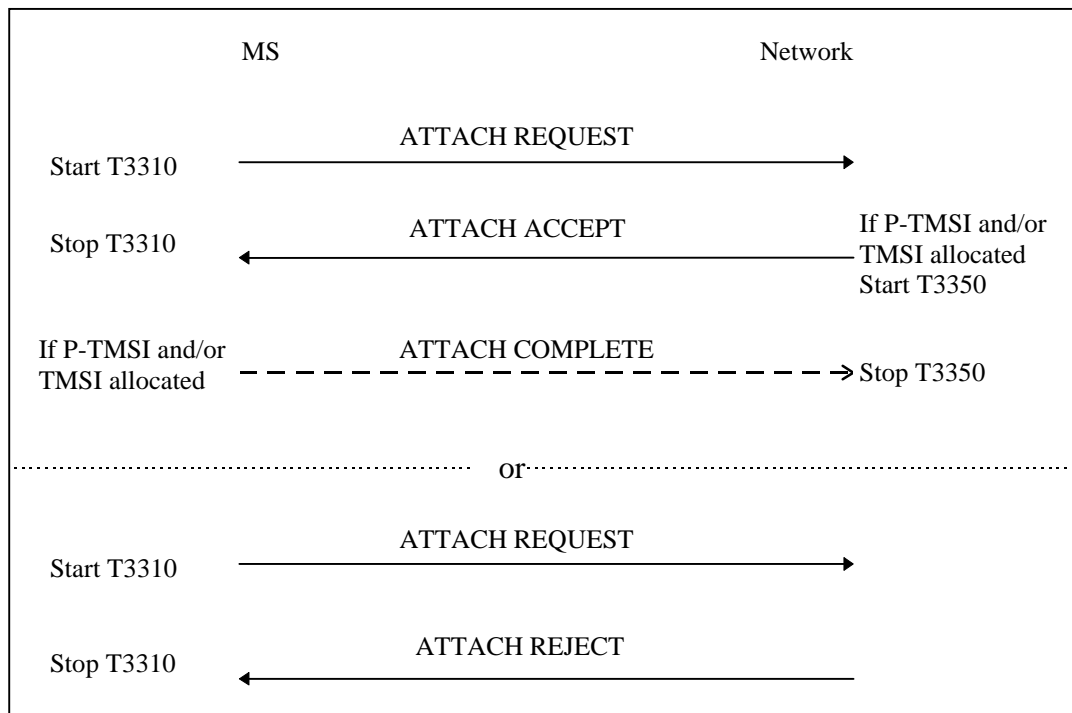

**Figure 4.7.3/1 3GPP TS 24.008: GPRS attach procedure and combined GPRS attach procedure**

#### 4.7.3.2 Combined GPRS attach procedure for GPRS and non-GPRS services

The combined GPRS attach procedure is a GMM procedure used by a GPRS MS operating in MS operation modes A or B for IMSI attach for GPRS and non-GPRS services if the network operates in network operation mode I.

If a GPRS MS operating in MS operation modes A or B is already attached for non-GPRS services by use of the MM specific IMSI attach procedure, but additionally wishes to perform an IMSI attach for GPRS services, the combined GPRS attach procedure shall also be used.

The attach type information element shall indicate "combined GPRS/IMSI attach". In this case, the messages ATTACH ACCEPT, ATTACH COMPLETE, and ATTACH REJECT used by the combined GPRS attach procedure carry information for both the GPRS and the non-GPRS services.

A GPRS MS in MS operation mode A shall perform the normal GPRS/IMSI attach procedure during an ongoing circuit-switched transaction.

##### 4.7.3.2.1 Combined GPRS attach procedure initiation

If the MS is in GMM state GMM-DEREGISTERED and in MM state MM IDLE, the MS initiates the combined GPRS attach procedure by sending an ATTACH REQUEST message to the network, starts timer T3310 and enters state GMM-REGISTERED-INITIATED and MM LOCATION UPDATING PENDING.

The MS shall include a valid P-TMSI, if available, the P-TMSI signature associated with the P-TMSI and the routing area identity associated with the P-TMSI in the ATTACH REQUEST message. If there is no valid P-TMSI available, the IMSI shall be included instead of the P-TMSI and P-TMSI signature. Furthermore the MS shall include the TMSI status IE if no valid TMSI is available.

In Iu mode, if the MS wishes to prolong the established PS signalling connection after the GPRS attach (for example, the MS has any CM application request pending), it may set a follow-on request pending indicator on (see subclause 4.7.13).

##### 4.7.3.2.2 GMM Common procedure initiation

The network may initiate GMM common procedures, e.g. the GMM identification and GMM authentication and ciphering procedure, depending on the received information such as IMSI, CKSN, old RAI, P-TMSI and P-TMSI signature.

#### 4.7.3.2.3 Combined GPRS attach accepted by the network

Depending on the value of the attach result IE received in the ATTACH ACCEPT message, two different cases can be distinguished:

- Case 1) The attach result IE value indicates "combined GPRS attach": IMSI attach for GPRS and non-GPRS services have been successful.
- Case 2) The attach result IE value indicates "GPRS only": IMSI attach for GPRS services has been successful but IMSI attach for non-GPRS services has not been successful.

In Iu mode, if the network wishes to prolong the PS signalling connection (for example, if the mobile station has indicated "follow-on request pending" in ATTACH REQUEST message) the network shall indicate the "follow-on proceed" in the ATTACH ACCEPT message. If the network wishes to release the PS signalling connection, the network shall indicate "no follow-on proceed" in the ATTACH ACCEPT message.

After that in Iu mode, the mobile station shall act according to the follow-on proceed flag included in the Attach result information element in the ATTACH ACCEPT message (see subclause 4.7.13).

##### 4.7.3.2.3.1 Combined attach successful for GPRS and non-GPRS services

The description for IMSI attach for GPRS services as specified in subclause 4.7.3.1.3 shall be followed. In addition, the following description for IMSI attach for non-GPRS services applies.

The TMSI reallocation may be part of the combined GPRS attach procedure. The TMSI allocated is then included in the ATTACH ACCEPT message together with the location area identification (LAI). The network shall, in this case, change to state GMM-COMMON-PROCEDURE-INITIATED and shall start timer T3350 as described in subclause 4.7.6.

The MS, receiving an ATTACH ACCEPT message, stores the received location area identification, stops timer T3310, reset the location update attempt counter and sets the update status to U1 UPDATED. If the message contains an IMSI, the mobile station is not allocated any TMSI, and shall delete any TMSI accordingly. If the message contains a TMSI, the MS shall use this TMSI as the new temporary identity. The MS shall delete its old TMSI and shall store the new TMSI. In this case, an ATTACH COMPLETE message is returned to the network. If neither a TMSI nor an IMSI has been included by the network in the ATTACH ACCEPT message, the old TMSI, if any available, shall be kept. The new MM state is MM IDLE, the new GMM state is GMM-REGISTERED.

If the network has requested the provision of the Inter RAT information container the MS shall return an ATTACH COMPLETE message including the Inter RAT information container IE to the network.

Any timer used for triggering the location update procedure (e.g T3211, T3212) shall be stopped if running.

The network receiving an ATTACH COMPLETE message stops timer T3350, changes to state GMM-REGISTERED and considers the new TMSI as valid.

##### 4.7.3.2.3.2 Combined attach successful for GPRS services only

The description for IMSI attach for GPRS services as specified in subclause 4.7.3.1.3 shall be followed. In addition, the following description for IMSI attach for non-GPRS services applies.

The MS receiving the ATTACH ACCEPT message takes one of the following actions depending on the reject cause:

###### # 2 (IMSI unknown in HLR)

The MS shall set the update status to U3 ROAMING NOT ALLOWED and shall delete any TMSI, LAI and ciphering key sequence number. The new MM state is MM IDLE. The SIM/USIM shall be considered as invalid for non-GPRS services until switching off or the SIM/USIM is removed.

###### # 16 (MSC temporarily not reachable)

###### # 17 (Network failure); or

###### # 22 (Congestion)

The MS shall change to state GMM-REGISTERED.ATTEMPTING-TO-UPDATE-MM. Timer T3310 shall be stopped if still running. The routing area updating attempt counter shall be incremented.

If the routing area updating attempt counter is less than 5, and the stored RAI is equal to the RAI of the current serving cell and the GMM update status is equal to GU1 UPDATED:

- the MS shall keep the GMM update status GU1 UPDATED and changes state to GMM-REGISTERED.ATTEMPTING-TO-UPDATE-MM. The MS shall start timer T3311. When timer T3311 expires the combined routing area update procedure indicating "combined RA/LA updating with IMSI attach" is triggered again.

If the routing area updating attempt counter is greater than or equal to 5:

- the MS shall start timer T3302 and shall change to state GMM-REGISTERED.ATTEMPTING-TO-UPDATE-MM;
- a GPRS MS operating in MS operation mode A shall then proceed with appropriate MM specific procedure; a GPRS MS operating in MS operation mode B may then proceed with appropriate MM specific procedures. The MM sublayer shall act as in network operation mode II or III (depending whether a PCCCH is present) as long as the combined GMM procedures are not successful and no new RA is entered. The new MM state is MM IDLE.

Other reject cause values and the case that no GMM cause IE was received are considered as abnormal cases. The combined attach procedure shall be considered as failed for GPRS and non-GPRS services. The behaviour of the MS in those cases is specified in subclause 4.7.3.2.5.

#### 4.7.3.2.4 Combined GPRS attach not accepted by the network

If the attach request can neither be accepted by the network for GPRS nor for non-GPRS services, an ATTACH REJECT message is transferred to the MS. The MS receiving the ATTACH REJECT message stops timer T3310, and for all causes except #12, #14 and #15 deletes the list of "equivalent PLMNs".

The MS shall then take one of the following actions depending upon the reject cause:

- # 3 (Illegal MS);
- # 6 (Illegal ME), or
- # 8 (GPRS services and non-GPRS services not allowed);

The MS shall set the GPRS update status to GU3 ROAMING NOT ALLOWED (shall store it according to subclause 4.1.3.2) and shall delete any P-TMSI, P-TMSI signature, RAI and GPRS ciphering key sequence number. The new GMM state is GMM-DEREGISTERED. The new MM state is MM IDLE.

The MS shall set the update status to U3 ROAMING NOT ALLOWED, shall delete any TMSI, LAI and ciphering key sequence number. The SIM/USIM shall be considered as invalid for GPRS and non-GPRS services until switching off or the SIM/USIM is removed.

- # 7 (GPRS services not allowed);

The MS shall set the GPRS update status to GU3 ROAMING NOT ALLOWED (and shall store it according to subclause 4.1.3.2) and shall delete any P-TMSI, P-TMSI signature, RAI and GPRS ciphering key sequence number. The SIM/USIM shall be considered as invalid for GPRS services until switching off or the SIM/USIM is removed. The new GMM state is GMM-DEREGISTERED; the MM state is MM IDLE.

A GPRS MS operating in MS operation mode A or B which is not yet IMSI attached for CS services in the network shall then perform an IMSI attach for non-GPRS services according to the conditions for the MM IMSI attach procedure (see 4.4.3).

A GPRS MS operating in MS operation mode A or B which is already IMSI attached for CS services in the network is still IMSI attached for CS services in the network and shall then proceed with the appropriate MM specific procedure according to the MM service state.

- # 11 (PLMN not allowed);

The MS shall delete any RAI, P-TMSI, P-TMSI signature and GPRS ciphering key sequence number stored, shall set the GPRS update status to GU3 ROAMING NOT ALLOWED (and shall store it according to subclause 4.1.3.2), shall reset the routing area updating attempt counter and reset the GPRS attach attempt counter and changes to state GMM-DEREGISTERED.

The MS shall set the update status to U3 ROAMING NOT ALLOWED, reset the location update attempt counter and shall delete any TMSI, LAI and ciphering key sequence number. The new MM state is MM IDLE.

The MS shall store the PLMN identity in the "forbidden PLMN list".

The MS shall perform a PLMN selection according to 3GPP TS 23.122 [14].

# 12 (Location area not allowed);

The MS shall delete any RAI, P-TMSI, P-TMSI signature GPRS ciphering key sequence number, shall set the GPRS update status to GU3 ROAMING NOT ALLOWED (and shall store it according to clause 4.1.3.2) and shall reset the attach attempt counter. The state is changed to GMM-DEREGISTERED.LIMITED-SERVICE.

The MS shall set the update status to U3 ROAMING NOT ALLOWED, reset the location update attempt counter and shall delete any TMSI, LAI and ciphering key sequence number. The new MM state is MM IDLE.

The MS shall store the LAI in the list of "forbidden location areas for regional provision of service".

The MS shall perform a cell selection according to 3GPP TS 43.022 [82] and 3GPP TS 25.304.

# 13 (Roaming not allowed in this location area);

The MS shall delete any RAI, P-TMSI, P-TMSI signature and GPRS ciphering key sequence number, shall set the GPRS update status to GU3 ROAMING NOT ALLOWED (and shall store it according to clause 4.1.3.2) and shall reset the attach attempt counter. The state is changed to GMM-DEREGISTERED.LIMITED-SERVICE or optionally to GMM-DEREGISTERED.PLMN-SEARCH.

The MS shall set the update status to U3 ROAMING NOT ALLOWED, reset the location update attempt counter and shall delete any TMSI, LAI and ciphering key sequence number. The new MM state is MM IDLE.

The mobile station shall store the LAI in the list of "forbidden location areas for roaming".

The MS shall perform a PLMN selection according to 3GPP TS 23.122 [14].

# 14 (GPRS services not allowed in this PLMN);

The MS shall delete any RAI, P-TMSI, P-TMSI signature, and GPRS ciphering key sequence number stored, shall set the GPRS update status to GU3 ROAMING NOT ALLOWED (and shall store it according to subclause 4.1.3.2) and shall change to state GMM-DEREGISTERED.

The MS shall store the PLMN identity in the "forbidden PLMNs for GPRS service" list.

As an implementation option, a GPRS MS operating in operation mode A or B may perform a PLMN selection according to 3GPP TS 23.122 [14].

The MS shall not perform the optional PLMN selection in the case where the PLMN providing this reject cause is:

- On the "User Controlled PLMN Selector with Access Technology " or,
- On the "Operator Controlled PLMN Selector with Access Technology " list or,
- A PLMN identified as equivalent to any PLMN, with the same MCC, contained in the lists above.

If the MS does not perform a PLMN selection then a GPRS MS operating in MS operation mode A or B which is not yet IMSI attached for CS services in the network shall then perform an IMSI attach for non-GPRS services according to the conditions for the MM IMSI attach procedure (see 4.4.3).

A GPRS MS operating in MS operation mode A or B which is already IMSI attached for CS services in the network is still IMSI attached for CS services in the network and shall then proceed with the appropriate MM specific procedure according to the MM service state.

# 15 (No Suitable Cells In Location Area);

The MS shall delete any RAI, P-TMSI, P-TMSI signature and GPRS ciphering key sequence number, shall set the GPRS update status to GU3 ROAMING NOT ALLOWED (and shall store it according to clause 4.1.3.2) and shall reset the attach attempt counter. The state is changed to GMM-DEREGISTERED.LIMITED-SERVICE.

The MS shall set the update status to U3 ROAMING NOT ALLOWED, reset the location update attempt counter and shall delete any TMSI, LAI and ciphering key sequence number. The new MM state is MM IDLE.

The MS shall store the LAI in the list of "forbidden location areas for roaming".

The MS shall search for a suitable cell in another location area in the same PLMN according to 3GPP TS 43.022 [82] and 3GPP TS 25.304.

Other values are considered as abnormal cases. The specification of the MS behaviour in those cases is specified in subclause 4.7.3.2.5.

#### 4.7.3.2.5 Abnormal cases in the MS

The abnormal cases specified in subclause 4.7.3.1.5 apply with the following modification:

If the GPRS attach attempt counter is incremented according to subclause 4.7.3.1.5 the next actions depend on the Location Area Identities (stored on SIM/USIM and the one of the current serving cell) and the value of the attach attempt counter:

- if the update status is U1 UPDATED, and the stored LAI is equal to the one of the current serving cell and the attach attempt counter is smaller than 5, then the mobile station shall keep the update status to U1 UPDATED, the new MM state is MM IDLE substate NORMAL SERVICE;
- if the attach attempt counter is smaller than 5 and, additionally, the update status is different from U1 UPDATED or the stored LAI is different from the one of the current serving cell, then the mobile station shall delete any LAI, TMSI, ciphering key sequence number stored in the SIM/USIM and list of equivalent PLMNs and set the update status to U2 NOT UPDATED. The MM state remains MM LOCATION UPDATING PENDING; or
- if the attach attempt counter is greater or equal to 5, then the mobile station shall delete any LAI, TMSI, ciphering key sequence number stored in the SIM/USIM and list of equivalent PLMNs and set the update status to U2 NOT UPDATED.  
A GPRS MS operating in MS operation mode A shall then proceed with appropriate MM specific procedure; a GPRS MS operating in MS operation mode B may then proceed with appropriate MM specific procedures. The MM sublayer shall act as in network operation mode II or III (depending whether a PCCCH is present) as long as the combined GMM procedures are not successful and no new RA is entered. The new MM state is MM IDLE substate ATTEMPTING TO UPDATE or optionally MM IDLE substate PLMN SEARCH in order to perform a PLMN selection according to 3GPP TS 23.122 [14].

#### 4.7.3.2.6 Abnormal cases on the network side

The abnormal cases specified in subclause 4.7.3.1.6 apply with the exceptions for cases a and c in which in addition to the P-TMSI and P-TMSI signature the old TMSI shall be considered occupied until the new TMSI is used by the MS in a subsequent message.

### 4.7.4 GPRS detach procedure

The GPRS detach procedure is used:

- to detach the IMSI for GPRS services only. Independent of the network operation mode, this procedure is used by all kind of GPRS MSs;
- as a combined GPRS detach procedure used by GPRS MSs operating in MS operation mode A or B to detach the IMSI for GPRS and non-GPRS services or for non-GPRS services only, if the network operates in network operation mode I and no circuit-switched transaction is ongoing; or

- in the case of a network failure condition to indicate to the MS that a re-attach with successive activation of previously active PDP contexts shall be performed. In this case, the MS may also perform the procedures needed in order to activate any previously active multicast service(s).

After completion of a GPRS detach procedure or combined GPRS detach procedure for GPRS and non-GPRS services the GMM context is released.

The GPRS detach procedure shall be invoked by the MS if the MS is switched off, the SIM/USIM card is removed from the MS or if the GPRS or non-GPRS capability of the MS is disabled. The procedure may be invoked by the network to detach the IMSI for GPRS services. The GPRS detach procedure causes the MS to be marked as inactive in the network for GPRS services, non-GPRS services or both services.

In A/Gb mode, if the GPRS detach procedure is performed, the PDP contexts and the MBMS contexts, if any, are deactivated locally without peer to peer signalling between the SM and LLC entities in the MS and the network.

In Iu mode, if the GPRS detach procedure is performed, the PDP contexts and the MBMS contexts, if any, are deactivated locally without peer to peer signalling between the SM entities in the MS and the network.

#### 4.7.4.1 MS initiated GPRS detach procedure

##### 4.7.4.1.1 MS initiated GPRS detach procedure initiation

The GPRS detach procedure is initiated by the MS by sending a DETACH REQUEST message. The detach type information element may indicate "GPRS detach with switching off", "GPRS detach without switching off", "IMSI detach", "GPRS/IMSI detach with switching off" or "GPRS/IMSI detach without switching off".

The MS shall include the P-TMSI in the DETACH REQUEST message. The MS shall also include a valid P-TMSI signature, if available.

If the MS is not switched off and the MS is in the state GMM\_REGISTERED, timer T3321 shall be started after the DETACH REQUEST message has been sent. If the detach type information element value indicates "IMSI Detach" the MS shall enter GMM-REGISTERED.IMSI-DETACH\_INITIATED, otherwise the MS shall enter the state GMM-DEREGISTERED-INITIATED. If the detach type information element value indicates "IMSI Detach" or "GPRS/IMSI Detach", state MM IMSI DETACH PENDING is entered. If the MS is to be switched off, the MS shall try for a period of 5 seconds to send the DETACH REQUEST message. If the MS is able to send the DETACH REQUEST message during this time the MS may be switched off.

If the detach type information element value indicates "GPRS detach without switching off" and the MS is attached for GPRS and non-GPRS services and the network operates in network operation mode I, then if in the MS the timer T3212 is not already running, the timer T3212 shall be set to its initial value and restarted after the DETACH REQUEST message has been sent.

##### 4.7.4.1.2 MS initiated GPRS detach procedure completion for GPRS services only

When the DETACH REQUEST message is received by the network, the network shall send a DETACH ACCEPT message to the MS, if the detach type IE value indicates that the detach request has not been sent due to switching off. If switching off was indicated, the procedure is completed when the network receives the DETACH REQUEST message. The network and the MS shall deactivate the PDP contexts, the MBMS contexts and deactivate the logical link(s), if any.

The MS is marked as inactive in the network for GPRS services; state GMM-DEREGISTERED is entered in the MS and the network.

In Iu mode, if the detach has been sent due to switching off, then the network shall release the resources in the lower layers for this MS (see 3GPP TS 25.331 [23c]).

- NOTE: When the DETACH REQUEST message is received by the network, and if the detach type IE value indicates that the detach is not due to power off, the authentication and ciphering procedure as well as the identification procedure may be performed.

#### 4.7.4.1.3 MS initiated combined GPRS detach procedure completion

When the DETACH REQUEST message is received by the network, a DETACH ACCEPT message shall be sent to the MS, if the detach type IE value indicates that the detach request has not been sent due to switching off. Depending on the value of the detach type IE the following applies:

GPRS/IMSI detach:

The MS is marked as inactive in the network for GPRS and for non-GPRS services. The network and the MS shall deactivate the PDP contexts, the MBMS contexts and deactivate the logical link(s), if any. The States GMM-DEREGISTERED and MM NULL are entered in both the MS and the network.

In Iu mode, if the detach has been sent due to switching off, then the network shall release the resources in the lower layers for this MS (see 3GPP TS 25.331 [23c]).

IMSI detach:

The MS is marked as inactive in the network for non-GPRS services. State MM NULL is entered in the MS and the network.

#### 4.7.4.1.4 Abnormal cases in the MS

The following abnormal cases can be identified:

a) T3321 time-out

On the first expiry of the timer, the MS shall retransmit the DETACH REQUEST message and shall reset and restart timer T3321. This retransmission is repeated four times, i.e. on the fifth expiry of timer T3321, the GPRS detach procedure shall be aborted, the MS shall change to state:

- MM-NULL if "IMSI detach" was requested;
- GMM-REGISTERED.NORMAL-SERVICE if "IMSI Detach" was requested;
- GMM-DEREGISTERED if "GPRS detach" was requested;
- GMM-DEREGISTERED and MM-NULL if "GPRS/IMSI" detach was requested.

b) Lower layer failure before reception of DETACH ACCEPT message

The detach procedure is aborted and the MS shall change to state:

- MM-NULL if "IMSI detach" was requested;
- GMM-REGISTERED.NORMAL-SERVICE if "IMSI Detach" was requested;
- GMM-DEREGISTERED if "GPRS detach" was requested;
- GMM-DEREGISTERED and MM-NULL if "IMSI/GPRS" detach was requested.

c) Detach procedure collision

If the MS receives a DETACH REQUEST message before the MS initiated GPRS detach procedure has been completed, a DETACH ACCEPT message shall be sent to the network.

d) Detach and GMM common procedure collision

GPRS detach containing cause "power off":

- If the MS receives a message used in a GMM common procedure before the GPRS detach procedure has been completed, this message shall be ignored and the GPRS detach procedure shall continue.

GPRS detach containing other causes than "power off":

- If the MS receives a P-TMSI REALLOCATION COMMAND, a GMM STATUS, or a GMM INFORMATION message before the GPRS detach procedure has been completed, this message shall be ignored and the GPRS detach procedure shall continue.

- If the MS receives an AUTHENTICATION AND CIPHERING REQUEST or IDENTITY REQUEST message, before the GPRS detach procedure has been completed, the MS shall respond to it as described in subclause 4.7.7 and 4.7.8 respectively.

e) Change of cell within the same RA (A/Gb mode only)

If a cell change occurs within the same RA before a DETACH ACCEPT message has been received, then the cell update procedure shall be performed before completion of the detach procedure.

f) Change of cell into a new routing area

If a cell change into a new routing area occurs before a DETACH ACCEPT message has been received, the GPRS detach procedure shall be aborted and re-initiated after successfully performing a routing area updating procedure. If the detach procedure is performed due to the removal of the SIM/USIM the MS shall abort the detach procedure and enter the state GMM-DEREGISTERED.

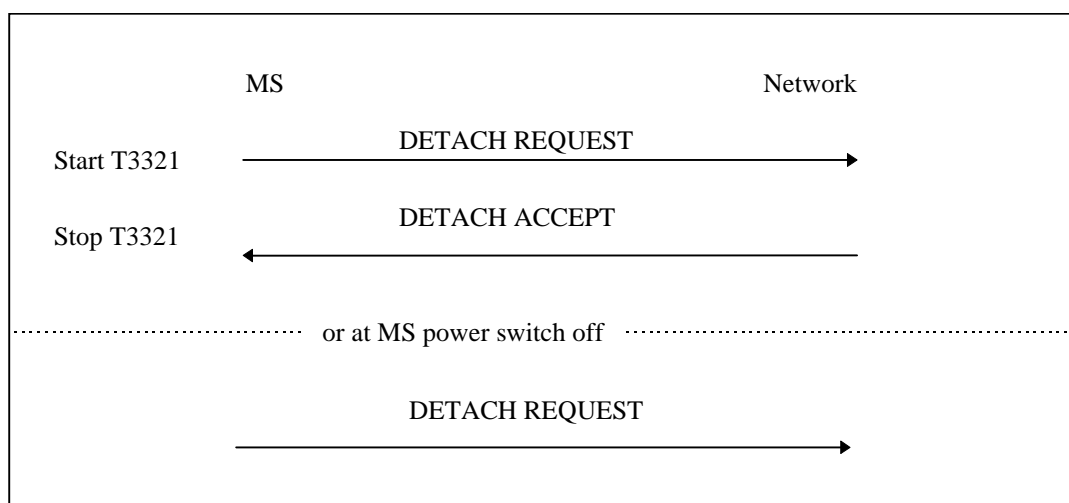

**Figure 4.7.4/1 3GPP TS 24.008: MS initiated GPRS detach procedure**

#### 4.7.4.2 Network initiated GPRS detach procedure

##### 4.7.4.2.1 Network initiated GPRS detach procedure initiation

The network initiates the GPRS detach procedure by sending a DETACH REQUEST message to the MS. The DETACH REQUEST message shall include a detach type IE. In addition, the network may include a cause IE to specify the reason for the detach request. The network shall start timer T3322. If the detach type IE indicates "re-attach not required" or "re-attach required", the network shall deactivate the PDP contexts, the MBMS contexts and deactivate the logical link(s), if any, and shall change to state GMM-DEREGISTERED-INITIATED.

##### 4.7.4.2.2 Network initiated GPRS detach procedure completion by the MS

When receiving the DETACH REQUEST message and the detach type IE indicates "re-attach required", the MS shall deactivate the PDP contexts, the MBMS contexts and deactivate the logical link(s), if any. The MS shall then send a DETACH ACCEPT message to the network and shall change state to GMM-DEREGISTERED. The MS shall, after the completion of the GPRS detach procedure, initiate a GPRS attach procedure. The MS should also activate PDP context(s) to replace any previously active PDP context(s). The MS should also perform the procedures needed in order to activate any previously active multicast service(s).

**NOTE:** In some cases, user interaction may be required and then the MS cannot activate the PDP/MBMS context(s) automatically.

A GPRS MS operating in MS operation mode A or B in network operation mode I, which receives an DETACH REQUEST message with detach type indicating "re-attach required" or "re-attach not required" and no cause code, is only detached for GPRS services in the network.



When receiving the DETACH REQUEST message and the detach type IE indicates "IMSI detach", the MS shall not deactivate the PDP/MBMS contexts. The MS shall set the MM update status to U2 NOT UPDATED. A MS in operation mode A or B in network operation mode I may send a DETACH ACCEPT message to the network, and shall re-attach to non-GPRS service by performing the combined routing area updating procedure according to subclause 4.7.5.2, sending a ROUTING AREA UPDATE REQUEST message with Update type IE indicating "combined RA/LA updating with IMSI attach". A MS in operation mode A that is in an ongoing circuit-switched transaction shall initiate the combined routing area updating after the circuit-switched transaction has been released. A MS in operation mode C, or in MS operation mode A or B in network operation mode II or III, shall send a DETACH ACCEPT message to the network.

If the detach type IE indicates "IMSI detach", or "re-attach required" then the MS shall ignore the cause code if received.

If the detach type information element value indicates "re-attach required" or "re-attach not required" and the MS is attached for GPRS and non-GPRS services and the network operates in network operation mode I, then if in the MS the timer T3212 is not already running, the timer T3212 shall be set to its initial value and restarted.

When receiving the DETACH REQUEST message and the detach type IE indicates "re-attach not required" and the cause code is not "#2 (IMSI unknown in HLR)", the MS shall deactivate the PDP contexts, the MBMS contexts and deactivate the logical link(s), if any. The MS shall then send a DETACH ACCEPT message to the network and shall change state to GMM-DEREGISTERED.

If the detach type IE indicates "re-attach not required", then, depending on the received cause code, the MS shall act as follows:

# 2 (IMSI unknown in HLR);

The MS shall set the update status to U3 ROAMING NOT ALLOWED and shall delete any TMSI, LAI and ciphering key sequence number. The new MM state is MM IDLE. The SIM/USIM shall be considered as invalid for non-GPRS services until switching off or the SIM/USIM is removed.

A GPRS MS operating in MS operation mode A or B in network operation mode I, is still IMSI attached for GPRS services in the network.

# 3 (Illegal MS);

# 6 (Illegal ME);

The MS shall set the GPRS update status to GU3 ROAMING NOT ALLOWED (and shall store it according to subclause 4.1.3.2) and shall delete any P-TMSI, P-TMSI signature, RAI and GPRS ciphering key sequence number. The new GMM state is GMM-DEREGISTERED. The SIM/USIM shall be considered as invalid for GPRS services until switching off or the SIM/USIM is removed.

A GPRS MS operating in MS operation mode A or B shall in addition set the update status to U3 ROAMING NOT ALLOWED, shall delete any TMSI, LAI and ciphering key sequence number. If the MS is operating in MS operation mode A and an RR connection exists, the MS shall abort the RR connection, unless an emergency call is ongoing. The SIM/USIM shall be considered as invalid also for non-GPRS services until switching off or the SIM/USIM is removed.

# 7 (GPRS services not allowed);

The MS shall set the GPRS update status to GU3 ROAMING NOT ALLOWED (and shall store it according to subclause 4.1.3.2) and shall delete any P-TMSI, P-TMSI signature, RAI and GPRS ciphering key sequence number. The SIM/USIM shall be considered as invalid for GPRS services until switching off or the SIM/USIM is removed. The new state is GMM-DEREGISTERED.

A GPRS MS operating in MS operation mode A or B in network operation mode I shall set the timer T3212 to its initial value and restart it, if it is not already running.

A GPRS MS operating in MS operation mode A or B in network operation mode I, is still IMSI attached for CS services in the network.

# 8 (GPRS services and non-GPRS services not allowed);

The MS shall set the GPRS update status to GU3 ROAMING NOT ALLOWED (and shall store it according to subclause 4.1.3.2) and shall delete any P-TMSI, P-TMSI signature, RAI and GPRS ciphering key sequence number. The new GMM state is GMM-DEREGISTERED.

The MS shall set the update status to U3 ROAMING NOT ALLOWED, shall delete any TMSI, LAI and ciphering key sequence number. If the MS is operating in MS operation mode A and an RR connection exists, the MS shall abort the RR connection, unless an emergency call is ongoing. The SIM/USIM shall be considered as invalid for GPRS and non-GPRS services until switching off or the SIM/USIM is removed.

# 11 (PLMN not allowed);

The MS shall delete any RAI or LAI, P-TMSI, P-TMSI signature and GPRS ciphering key sequence number, shall set the GPRS update status to GU3 ROAMING NOT ALLOWED (and shall store it according to subclause 4.1.3.2). The new GMM state is GMM-DEREGISTERED.

The MS shall store the PLMN identity in the "forbidden PLMN list".

If no RR connection exists, the MS shall perform the following additional actions immediately. If the MS is operating in MS operation mode A and an RR connection exists, the MS shall perform these actions when the RR connection is subsequently released:

- A GPRS MS operating in MS operation mode A or B shall set the update status to U3 ROAMING NOT ALLOWED and shall delete any TMSI, LAI and ciphering key sequence number. The new MM state is MM IDLE.
- The MS shall perform a PLMN selection according to 3GPP TS 23.122 [14].

# 12 (Location area not allowed);

The MS shall delete any RAI, P-TMSI, P-TMSI signature GPRS ciphering key sequence number, shall set the GPRS update status to GU3 ROAMING NOT ALLOWED (and shall store it according to clause 4.1.3.2) and shall reset the attach attempt counter. The state is changed to GMM-DEREGISTERED.LIMITED-SERVICE.

The MS shall store the LAI in the list of "forbidden location areas for regional provision of service".

If no RR connection exists, the MS shall perform the following additional actions immediately. If the MS is operating in MS operation mode A and an RR connection exists, the MS shall perform these actions when the RR connection is subsequently released:

- If the MS is IMSI attached, the MS shall set the update status to U3 ROAMING NOT ALLOWED, shall delete any TMSI, LAI and ciphering key sequence number and shall reset the location update attempt counter. The new MM state is MM IDLE.
- The MS shall perform a cell selection according to 3GPP TS 43.022 [82] and 3GPP TS 25.304.

# 13 (Roaming not allowed in this location area);

The MS shall delete any RAI, P-TMSI, P-TMSI signature and GPRS ciphering key sequence number, shall set the GPRS update status to GU3 ROAMING NOT ALLOWED (and shall store it according to clause 4.1.3.2) and shall reset the attach attempt counter. The state is changed to GMM-DEREGISTERED.LIMITED-SERVICE or optionally to GMM-DEREGISTERED.PLMN-SEARCH.

The MS shall store the LAI in the list of "forbidden location areas for roaming".

If no RR connection exists, the MS shall perform the following additional actions immediately. If the MS is operating in MS operation mode A and an RR connection exists, the MS shall perform these actions when the RR connection is subsequently released:

- If the MS is IMSI attached, the MS shall set the update status to U3 ROAMING NOT ALLOWED, shall delete any TMSI, LAI and ciphering key sequence number and shall reset the location update attempt counter. The new MM state is MM IDLE.
- The MS shall perform a PLMN selection according to 3GPP TS 23.122 [14].

## # 14 (GPRS services not allowed in this PLMN);

The MS shall delete any RAI, P-TMSI, P-TMSI signature, and GPRS ciphering key sequence number stored, shall set the GPRS update status to GU3 ROAMING NOT ALLOWED (and shall store it according to subclause 4.1.3.2) and shall change to state GMM-DEREGISTERED.

The MS shall store the PLMN identity in the "forbidden PLMNs for GPRS service" list.

A GPRS MS operating in MS operation mode A or B in network operation mode I shall set the timer T3212 to its initial value and restart it, if it is not already running.

A GPRS MS operating in MS operation mode A or B, is still IMSI attached for CS services in the network.

## # 15 (No Suitable Cells In Location Area);

The MS shall delete any RAI, P-TMSI, P-TMSI signature and GPRS ciphering key sequence number, shall set the GPRS update status to GU3 ROAMING NOT ALLOWED (and shall store it according to clause 4.1.3.2) and shall reset the attach attempt counter. The state is changed to GMM-DEREGISTERED.LIMITED-SERVICE.

The MS shall store the LAI in the list of "forbidden location areas for roaming".

If no RR connection exists, the MS shall perform the following additional actions immediately. If the MS is operating in MS operation mode A and an RR connection exists, the MS shall perform these actions when the RR connection is subsequently released:

- If the MS is IMSI attached, the MS shall set the update status to U3 ROAMING NOT ALLOWED, shall delete any TMSI, LAI and ciphering key sequence number and shall reset the location update attempt counter. The new MM state is MM IDLE.
- The MS shall search for a suitable cell in another location area in the same PLMN according to 3GPP TS 43.022 [82] and 3GPP TS 25.304.

Other cause values shall not impact the update status. Further actions of the MS are implementation dependent.

#### 4.7.4.2.3 Network initiated GPRS detach procedure completion by the network

The network shall, upon receipt of the DETACH ACCEPT message, stop timer T3322 and shall change state to GMM-DEREGISTERED.

#### 4.7.4.2.4 Abnormal cases on the network side

The following abnormal cases can be identified:

a) T3322 time-out

On the first expiry of the timer, the network shall retransmit the DETACH REQUEST message and shall start timer T3322. This retransmission is repeated four times, i.e. on the fifth expiry of timer T3322, the GPRS detach procedure shall be aborted and the network changes to state GMM-DEREGISTERED.

b) Low layer failure

The GPRS detach procedure is aborted and the network changes to state GMM-DEREGISTERED.

c) GPRS detach procedure collision

If the network receives a DETACH REQUEST message with "switching off" indicated, before the network initiated GPRS detach procedure has been completed, both procedures shall be considered completed.

If the network receives a DETACH REQUEST message without "switching off" indicated, before the network initiated GPRS detach procedure has been completed, the network shall send a DETACH ACCEPT message to the MS.

## d) GPRS detach and GPRS attach procedure collision

If the network receives an ATTACH REQUEST message before the network initiated GPRS detach procedure with type of detach 're-attach not required' has been completed, the network shall ignore the ATTACH REQUEST message. If the detach type IE value, sent in the DETACH REQUEST message, indicates "re-attach required" the detach procedure is aborted and the GPRS attach procedure shall be progressed after the PDP contexts and MBMS contexts, if any, have been deleted. If the detach type IE value, sent in the DETACH REQUEST message, indicates "IMSI detach" the detach procedure is aborted and the GPRS attach procedure shall be progressed.

## e) GPRS detach and routing area updating procedure collision

GPRS detach containing detach type "re-attach required" or "re-attach not required":

If the network receives a ROUTING AREA UPDATE REQUEST message before the network initiated GPRS detach procedure has been completed, the detach procedure shall be progressed, i.e. the ROUTING AREA UPDATE REQUEST message shall be ignored.

GPRS detach containing detach type "IMSI detach":

If the network receives a ROUTING AREA UPDATE REQUEST message before the network initiated GPRS detach procedure has been completed, the network shall abort the detach procedure, shall stop T3322 and shall progress the routing area update procedure.

## f) GPRS detach and service request procedure collision

If the network receives a SERVICE REQUEST message before the network initiated GPRS detach procedure has been completed, the network shall ignore the SERVICE REQUEST message.

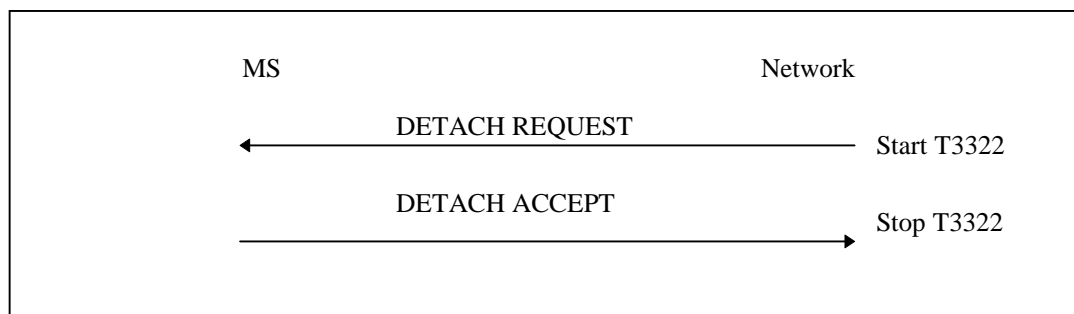

Figure 4.7.4/2 3GPP TS 24.008: Network initiated GPRS detach procedure

## 4.7.5 Routing area updating procedure

This procedure is used for:

- normal routing area updating to update the registration of the actual routing area of an MS in the network. This procedure is used by GPRS MSs in MS operation mode C and by GPRS MSs in MS operation modes A or B that are IMSI attached for GPRS and non-GPRS services if the network operates in network operation mode II or III;
- combined routing area updating to update the registration of the actual routing and location area of an MS in the network. This procedure is used by GPRS MSs in MS operation modes A or B that are IMSI attached for GPRS and non-GPRS services provided that the network operates in network operation mode I;
- periodic routing area updating. This procedure is used by GPRS MSs in MS operation mode C and by GPRS MSs in MS operation modes A or B that are IMSI attached for GPRS or for GPRS and non-GPRS services independent of the network operation mode;
- IMSI attach for non-GPRS services when the MS is IMSI attached for GPRS services. This procedure is used by GPRS MSs in MS operation modes A or B, if the network operates in network operation mode I;
- in A/Gb mode, resuming GPRS services when the RR sublayer indicated a resumption failure after dedicated mode was left, see 3GPP TS 44.018 [84];

- in A/Gb mode, updating the network with the new MS Radio Access Capability IE when the content of the IE has changed;
- updating the network with the new DRX parameter IE when the content of the IE has changed;

NOTE 1: Such changes can be used e.g. when the MS activates a PDP context with service requirements that cannot be met with the current DRX parameter. As PDP context(s) are activated and deactivated, the GMM context will be updated with an appropriate DRX parameter;

- re-negotiation of the READY timer value;
- Iu mode to A/Gb mode and for A/Gb mode to Iu mode intersystem change, see subclause 4.7.1.7; or
- in Iu mode, to re-synchronize the PMM mode of MS and network after RRC connection release with cause "Directed signalling connection re-establishment", see subclause 4.7.2.5.

The routing area updating procedure shall also be used by a MS which is attached for GPRS services if a new PLMN is entered (see 3GPP TS 23.122 [14]).

Subclause 4.7.5.1 describes the routing area updating procedures for updating the routing area only. The combined routing area updating procedure used to update both the routing and location area is described in subclause 4.7.5.2.

The routing area updating procedure is always initiated by the MS. It is only invoked in state GMM-REGISTERED.

To limit the number of subsequently rejected routing area update attempts, a routing area updating attempt counter is introduced. The routing area updating attempt counter shall be incremented as specified in subclause 4.7.5.1.5.

Depending on the value of the routing area updating attempt counter, specific actions shall be performed. The routing area updating attempt counter shall be reset when:

- a GPRS attach procedure is successfully completed; or
- a routing area updating procedure is successfully completed;

and additionally when the MS is in substate ATTEMPTING-TO-UPDATE:

- a new routing area is entered;
- expiry of timer T3302; or
- at request from registration function.

The mobile equipment shall contain a list of "forbidden location areas for roaming", as well as a list of "forbidden location areas for regional provision of service". The handling of these lists is described in subclause 4.4.1.

The Mobile Equipment shall contain a list of "equivalent PLMNs". The handling of this list is described in subclause 4.4.1.

In a shared network, the MS shall choose one of the PLMN identities as specified in 3GPP TS 23.122 [14]. The MS shall construct the Routing Area Identification of the cell from this chosen PLMN identity, and the LAC and the RAC received on the BCCH. If the constructed RAI is different from the stored RAI, the MS shall initiate the routing area updating procedure. The chosen PLMN identity shall be indicated to the RAN in the RRC INITIAL DIRECT TRANSFER message (see 3GPP TS 25.331 [23c]). Whenever a ROUTING AREA UPDATING REJECT message with the cause "PLMN not allowed" is received by the MS, the chosen PLMN identity shall be stored in the "forbidden PLMN list". Whenever a ROUTING AREA UPDATING REJECT message is received by the MS with the cause "Roaming not allowed in this location area", "Location Area not allowed", or "No suitable cells in Location Area", the LAI that is part of the constructed RAI which triggered the routing area updating procedure shall be stored in the suitable list.

In A/Gb mode, user data transmission in the MS shall be suspended during the routing area updating procedure, except if the routing area updating procedure is triggered by a PS handover procedure as described in 3GPP TS 43.129 [113]; user data reception shall be possible. User data transmission in the network may be suspended during the routing area updating procedure.

In Iu mode, user data transmission and reception in the MS shall not be suspended during the routing area updating procedure. User data transmission in the network shall not be suspended during the routing area updating procedure.

In Iu mode, when a ROUTING AREA UPDATE REQUEST is received by the SGSN over a new PS signalling connection while there is an ongoing PS signalling connection (network is already in mode PMM-CONNECTED) for this UE, the network shall progress the routing area update procedure as normal and release the previous PS signalling connection when the routing area update procedure has been accepted by the network.

NOTE 2: The re-establishment of the radio bearers of active PDP contexts is done as described in subclause "Service Request procedure".

The network informs the MS about the support of specific features, such as LCS-MOLR or MBMS, in the "Network feature support" Information Element. The information is either explicitly given by sending the "Network feature support" IE or implicitly by not sending it. The handling in the network is described in subclause 9.4.15.11. The MS may use the indication to inform the user about the availability of the appropriate services and it shall not request services that have not been indicated as available. The indication for MBMS is defined in subclause "MBMS feature support indication" in 3GPP TS 23.246 [106].

#### 4.7.5.1 Normal and periodic routing area updating procedure

Periodic routing area updating is used to periodically notify the availability of the MS to the network. The value of the update type IE in the ROUTING AREA UPDATE REQUEST message shall indicate "periodic updating". The procedure is controlled in the MS by timer T3312. When timer T3312 expires, the periodic routing area updating procedure is started. Start and reset of timer T3312 is described in subclause 4.7.2.2.

In A/Gb mode, the normal routing area updating procedure is initiated:

- when the MS detects a change of the routing area in state GMM-REGISTERED;
- when the MS determines that GPRS resumption shall be performed;
- when the MS needs to update the network with the new MS Radio Access Capability IE; or
- when the MS needs to update the network with the new DRX parameter IE.

The ROUTING AREA UPDATE REQUEST message shall always be the first data sent by the MS when a routing area border is crossed. The routing area identification is broadcast on the broadcast channel(s).

In Iu mode, the normal routing area updating procedure is initiated when the MS detects a change of the routing area in state GMM-REGISTERED. The ROUTING AREA UPDATE REQUEST message shall always be the first GMM message sent by the MS when a routing area border is crossed.

A normal routing area updating shall abort any ongoing GMM procedure. Aborted GMM procedures may be repeated after the normal routing area updating procedure has been successfully performed. The value of the update type IE included in the message shall indicate "RA updating".

##### 4.7.5.1.1 Normal and periodic routing area updating procedure initiation

To initiate the normal routing area updating procedure, the MS sends the message ROUTING AREA UPDATE REQUEST to the network, starts timer T3330 and changes to state GMM-ROUTING-AREA-UPDATING-INITIATED. The message ROUTING AREA UPDATE REQUEST shall contain the P-TMSI signature when received within a previous ATTACH ACCEPT or ROUTING AREA UPDATE ACCEPT message.

In Iu mode, if the MS wishes to prolong the established PS signalling connection after the normal routing area updating procedure (for example, the MS has any CM application request pending), it may set a follow-on request pending indicator on (see subclause 4.7.13).

##### 4.7.5.1.2 GMM Common procedure initiation

The network may initiate GMM common procedures, e.g. the GMM authentication and ciphering procedure.

##### 4.7.5.1.3 Normal and periodic routing area updating procedure accepted by the network

If the routing area updating request has been accepted by the network, a ROUTING AREA UPDATE ACCEPT message shall be sent to the MS. The network may assign a new P-TMSI and/or a new P-TMSI signature for the MS. If a new P-TMSI and/or P-TMSI signature have been assigned to the MS, it/they shall be included in the ROUTING

AREA UPDATE ACCEPT message together with the routing area identification. In a shared network the network shall indicate the PLMN identity of the CN operator that has accepted the routing area updating request in the RAI contained in the ROUTING AREA UPDATE ACCEPT message (see 3GPP TS 23.251 [109]).

If a new DRX parameter was included in the ROUTING AREA UPDATE REQUEST message, the network shall store the new DRX parameter and use it for the downlink transfer of signalling and user data.

If the MS has indicated in the ROUTING AREA UPDATE REQUEST message that it supports PS inter-RAT handover to UTRAN Iu mode, the network may include in the ROUTING AREA UPDATE ACCEPT message a request to provide the Inter RAT information container.

In A/Gb mode the Cell Notification information element shall be included in the ROUTING AREA UPDATE ACCEPT message in order to indicate the ability of the network to support the Cell Notification.

The network shall change to state GMM-COMMON-PROCEDURE-INITIATED and shall start the supervision timer T3350 as described in subclause 4.7.6.

If the LAI or PLMN identity contained in the ROUTING AREA UPDATE ACCEPT message is a member of any of the "forbidden" lists then any such entry shall be deleted.

In Iu mode, the network should prolong the PS signalling connection if the mobile station has indicated a follow-on request pending in ROUTING AREA UPDATE REQUEST. The network may also prolong the PS signalling connection without any indication from the mobile terminal.

If the PDP context status information element is included in ROUTING AREA UPDATE REQUEST message, then the network shall deactivate all those PDP contexts locally (without peer to peer signalling between the MS and the network), which are not in SM state PDP-INACTIVE on network side but are indicated by the MS as being in state PDP-INACTIVE.

If the MBMS context status information element is included in the ROUTING AREA UPDATE REQUEST message, then the network shall deactivate all those MBMS contexts locally (without peer to peer signalling between the MS and network) which are not in SM state PDP-INACTIVE on the network side, but are indicated by the MS as being in state PDP-INACTIVE. If no MBMS context status information element is included, then the network shall deactivate all MBMS contexts locally which are not in SM state PDP-INACTIVE on the network side.

Upon receipt of a ROUTING AREA UPDATE ACCEPT message, the MS stores the received routing area identification, stops timer T3330, shall reset the routing area updating attempt counter and sets the GPRS update status to GU1 UPDATED. If the message contains a P-TMSI, the MS shall use this P-TMSI as new temporary identity for GPRS services and shall store the new P-TMSI. If no P-TMSI was included by the network in the ROUTING AREA UPDATING ACCEPT message, the old P-TMSI shall be kept. Furthermore, the MS shall store the P-TMSI signature if received in the ROUTING AREA UPDATING ACCEPT message. If no P-TMSI signature was included in the message, the old P-TMSI signature, if available, shall be deleted.

If the ROUTING AREA UPDATE REQUEST message was used to update the network with a new DRX parameter IE, the MS shall start using the new DRX parameter upon receipt of the ROUTING AREA UPDATE ACCEPT message.

If the PDP context status information element is included in ROUTING AREA UPDATE ACCEPT message, then the MS shall deactivate all those PDP contexts locally (without peer to peer signalling between the MS and network), which are not in SM state PDP-INACTIVE in the MS but are indicated by the network as being in state PDP-INACTIVE.

If the MBMS context status information element is included in the ROUTING AREA UPDATE ACCEPT message, then the MS shall deactivate all those MBMS contexts locally (without peer to peer signalling between the MS and network) which are not in SM state PDP-INACTIVE in the MS, but are indicated by the network as being in state PDP-INACTIVE. If no MBMS context status information element is included, then the MS shall deactivate all those MBMS contexts locally which are not in SM state PDP-INACTIVE in the MS.

In A/Gb mode, if the ROUTING AREA UPDATE ACCEPT message contains the Cell Notification information element, then the MS shall start to use the LLC NULL frame to perform cell updates.

The network may also send a list of "equivalent PLMNs" in the ROUTING AREA UPDATE ACCEPT message. Each entry of the list contains a PLMN code (MCC+MNC). The mobile station shall store the list, as provided by the network, except that any PLMN code that is already in the "forbidden PLMN" list shall be removed from the "equivalent PLMNs" list before it is stored by the mobile station. In addition the mobile station shall add to the stored list the PLMN code of the registered PLMN that sent the list. All PLMNs in the stored list shall be regarded as equivalent to each other for PLMN selection, cell selection/re-selection and handover. The stored list in the mobile

station shall be replaced on each occurrence of the ROUTING AREA UPDATE ACCEPT message. If no list is contained in the message, then the stored list in the mobile station shall be deleted. The list shall be stored in the mobile station while switched off so that it can be used for PLMN selection after switch on.

A ROUTING AREA UPDATE COMPLETE message shall be returned to the network if the ROUTING AREA UPDATE ACCEPT message contained any of:

- a P-TMSI;
- Receive N-PDU Numbers (see 3GPP TS 44.065 [78] and 3GPP TS 25.322); or
- a request for the provision of the Inter RAT information container.

If Receive N-PDU Numbers were included, the Receive N-PDU Numbers values valid in the MS, shall be included in the ROUTING AREA UPDATE COMPLETE message.

If the network has requested the provision of the Inter RAT information container the MS shall return a ROUTING AREA UPDATE COMPLETE message including the Inter RAT information container IE to the network.

NOTE 1: In Iu mode, after a routing area updating procedure, the mobile station can initiate Service Request procedure to request the resource reservation for the active PDP contexts if the resources have been released by the network or send upper layer message (e.g. ACTIVATE PDP CONTEXT REQUEST) to the network via the existing PS signaling connection.

In Iu mode, if the network wishes to prolong the PS signalling connection (for example, if the mobile station has indicated "follow-on request pending" in ROUTING AREA UPDATE REQUEST message) the network shall indicate the "follow-on proceed" in the ROUTING AREA UPDATE ACCEPT message. If the network wishes to release the PS signalling connection, the network shall indicate "no follow-on proceed" in the ROUTING AREA UPDATE ACCEPT message.

After that in Iu mode, the mobile station shall act according to the follow-on proceed flag included in the Update result information element in the ROUTING AREA UPDATE ACCEPT message (see subclause 4.7.13).

The network may also send a list of local emergency numbers in the ROUTING AREA UPDATE ACCEPT, by including the Emergency Number List IE. The mobile equipment shall store the list, as provided by the network, except that any emergency number that is already stored in the SIM/USIM shall be removed from the list before it is stored by the mobile equipment. If there are no emergency numbers stored on the SIM/USIM, then before storing the received list the mobile equipment shall remove from it any emergency number stored permanently in the ME for use in this case (see 3GPP TS 22.101 [8]). The list stored in the mobile equipment shall be replaced on each receipt of a new Emergency Number List IE.

The emergency number(s) received in the Emergency Number List IE are valid only in networks with the same MCC as in the cell on which this IE is received. If no list is contained in the ROUTING AREA UPDATE ACCEPT message, then the stored list in the mobile equipment shall be kept, except if the mobile equipment has successfully registered to a PLMN with an MCC different from that of the last registered PLMN.

The mobile equipment shall use the stored list of emergency numbers received from the network in addition to the emergency numbers stored on the SIM/USIM or ME to detect that the number dialled is an emergency number.

NOTE 2: The mobile equipment may use the emergency numbers list to assist the end user in determining whether the dialled number is intended for an emergency service or for another destination, e.g. a local directory service. The possible interactions with the end user are implementation specific.

The list of emergency numbers shall be deleted at switch off and removal of the SIM/USIM. The mobile equipment shall be able to store up to ten local emergency numbers received from the network.



#### 4.7.5.1.4 Normal and periodic routing area updating procedure not accepted by the network

If the routing area updating cannot be accepted, the network sends a ROUTING AREA UPDATE REJECT message to the MS. An MS that receives a ROUTING AREA UPDATE REJECT message, stops timer T3330, and for all causes except #12, #14 and #15 deletes the list of "equivalent PLMNs". If a ROUTING AREA UPDATE REJECT message is received, the MS shall stop any ongoing transmission of user data.

The MS shall then take different actions depending on the received reject cause value:

# 3 (Illegal MS);

# 6 (Illegal ME);

The MS shall set the GPRS update status to GU3 ROAMING NOT ALLOWED (and shall store it according to subclause 4.1.3.2) and enter the state GMM-DEREGISTERED. Furthermore, it shall delete any P-TMSI, P-TMSI signature, RAI and GPRS ciphering key sequence number and shall consider the SIM/USIM as invalid for GPRS services until switching off or the SIM/USIM is removed.

If the MS is IMSI attached, the MS shall in addition set the update status to U3 ROAMING NOT ALLOWED, shall delete any TMSI, LAI and ciphering key sequence number. If the MS is operating in MS operation mode A and an RR connection exists, the MS shall abort the RR connection, unless an emergency call is ongoing. The SIM/USIM shall be considered as invalid also for non-GPRS services until switching off or the SIM/USIM is removed.

# 7 (GPRS services not allowed);

The MS shall set the GPRS update status to GU3 ROAMING NOT ALLOWED (and shall store it according to subclause 4.1.3.2.9) and shall delete any P-TMSI, P-TMSI signature, RAI and GPRS ciphering key sequence number. The SIM/USIM shall be considered as invalid for GPRS services until switching off or the SIM/USIM is removed. The new state is GMM-DEREGISTERED.

If the update type is "periodic updating" a GPRS MS operating in MS operation mode A or B in networkoperation mode I shall set the timer T3212 to its initial value and restart it, if it is not already running.

# 9 (MS identity cannot be derived by the network);

The MS shall set the GPRS update status to GU2 NOT UPDATED (and shall store it according to subclause 4.1.3.2), enter the state GMM-DEREGISTERED, and shall delete any P-TMSI, P-TMSI signature, RAI and GPRS ciphering key sequence number. Subsequently, the MS may automatically initiate the GPRS attach procedure.

# 10 (Implicitly detached);

The MS shall change to state GMM-DEREGISTERED.NORMAL-SERVICE. The MS shall then perform a new attach procedure. The MS should also activate PDP context(s) to replace any previously active PDP contexts. The MS should also perform the procedures needed in order to activate any previously active multicast service(s).

NOTE: In some cases, user interaction may be required and then the MS cannot activate the PDP and MBMS context(s) automatically.

# 11 (PLMN not allowed);

The MS shall delete any RAI, P-TMSI, P-TMSI signature and GPRS ciphering key sequence number, shall set the GPRS update status to GU3 ROAMING NOT ALLOWED (and shall store it according to subclause 4.1.3.2) and enter the state GMM-DEREGISTERED.

The MS shall store the PLMN identity in the "forbidden PLMN list".

If no RR connection exists, the MS shall perform the following additional actions immediately. If the MS is operating in MS operation mode A and an RR connection exists, the MS shall perform these actions when the RR connection is subsequently released:

- If the MS is IMSI attached, the MS shall set the update status to U3 ROAMING NOT ALLOWED and shall delete any TMSI, LAI and ciphering key sequence number and shall reset the location update attempt counter. The new MM state is MM IDLE.
- The MS shall perform a PLMN selection according to 3GPP TS 23.122 [14].

# 12 (Location area not allowed);

The MS shall delete any RAI, P-TMSI, P-TMSI signature and GPRS ciphering key sequence number, shall set the GPRS update status to GU3 ROAMING NOT ALLOWED (and shall store it according to clause 4.1.3.2), shall reset the routing area updating attempt counter and shall change to state GMM-DEREGISTERED.LIMITED-SERVICE.

The mobile station shall store the LAI in the list of "forbidden location areas for regional provision of service".

If no RR connection exists, the MS shall perform the following additional actions immediately. If the MS is operating in MS operation mode A and an RR connection exists, the MS shall perform these actions when the RR connection is subsequently released:

- If the MS is IMSI attached, the MS shall set the update status to U3 ROAMING NOT ALLOWED, shall delete any TMSI, LAI and ciphering key sequence number and shall reset the location update attempt counter. The new MM state is MM IDLE.
- The MS shall perform a cell selection according to 3GPP TS 43.022 [82] and 3GPP TS 25.304.

# 13 (Roaming not allowed in this location area);

The MS shall set the GPRS update status to GU3 ROAMING NOT ALLOWED (and shall store it according to clause 4.1.3.2) shall reset the routing area updating attempt counter and shall change to state GMM-REGISTERED.LIMITED-SERVICE.

The MS shall store the LAI in the list of "forbidden location areas for roaming".

If no RR connection exists, the MS shall perform the following additional actions immediately. If the MS is operating in MS operation mode A and an RR connection exists, the MS shall perform these actions when the RR connection is subsequently released:

- If the MS is IMSI attached, the MS shall set the update status to U3 ROAMING NOT ALLOWED and shall reset the location update attempt counter. The new MM state is MM IDLE.
- The MS shall perform a PLMN selection according to 3GPP TS 23.122 [14].

# 14 (GPRS services not allowed in this PLMN);

The MS shall delete any RAI, P-TMSI, P-TMSI signature, and GPRS ciphering key sequence number stored, shall set the GPRS update status to GU3 ROAMING NOT ALLOWED (and shall store it according to subclause 4.1.3.2) and shall change to state GMM-DEREGISTERED.

The MS shall store the PLMN identity in the "forbidden PLMNs for GPRS service" list. A GPRS MS operating in MS operation mode C shall perform a PLMN selection instead of a cell selection.

If the update type is "periodic updating" a GPRS MS operating in MS operation mode A or B in network operation mode I shall set the timer T3212 to its initial value and restart it, if it is not already running.

A GPRS MS operating in MS operation mode A or B in network operation mode II or III, is still IMSI attached for CS services in the network.

As an implementation option, a GPRS MS operating in operation mode A or B may perform the following additional action. If no RR connection exists the MS may perform the action immediately. If the MS is operating in MS operation mode A and an RR connection exists, the MS may only perform the action when the RR connection is subsequently released:

- The MS may perform a PLMN selection according to 3GPP TS 23.122 [14].

The MS shall not perform the optional PLMN selection in the case where the PLMN providing this reject cause is:

- On the "User Controlled PLMN Selector with Access Technology " or,
- On the "Operator Controlled PLMN Selector with Access Technology " list or,
- A PLMN identified as equivalent to any PLMN, with the same MCC, contained in the lists above.

#### # 15 (No Suitable Cells In Location Area);

The MS shall set the GPRS update status to GU3 ROAMING NOT ALLOWED (and shall store it according to clause 4.1.3.2) shall reset the routing area updating attempt counter and shall change to state GMM-REGISTERED.LIMITED-SERVICE.

The MS shall store the LAI in the list of "forbidden location areas for roaming".

If no RR connection exists, the MS shall perform the following additional actions immediately. If the MS is operating in MS operation mode A and an RR connection exists, the MS shall perform these actions when the RR connection is subsequently released:

- If the MS is IMSI attached, the MS shall set the update status to U3 ROAMING NOT ALLOWED and shall reset the location update attempt counter. The new MM state is MM IDLE.
- The MS shall search for a suitable cell in another location area in the same PLMN according to 3GPP TS 43.022 [82] and 3GPP TS 25.304.

Other values are considered as abnormal cases. The specification of the MS behaviour in those cases is described in subclause 4.7.5.1.5.

#### 4.7.5.1.5 Abnormal cases in the MS

The following abnormal cases can be identified:

- a) Access barred because of common access class control or PS domain specific access control

The routing area updating procedure shall not be started. The MS stays in the current serving cell and applies the normal cell reselection process. The procedure is started as soon as possible and if still necessary, i.e. when the barred state is removed or because of a cell change.

- b) Lower layer failure before the ROUTING AREA UPDATE ACCEPT or ROUTING AREA UPDATE REJECT message is received

The procedure shall be aborted. The MS shall proceed as described below.

- c) T3330 time-out

The procedure is restarted four times, i.e. on the fifth expiry of timer T3330, the MS shall abort the procedure and, in Iu mode, release the PS signalling connection (see 3GPP TS 25.331 [23c]). The MS shall proceed as described below.

- d) ROUTING AREA UPDATE REJECT, other causes than those treated in subclause 4.7.5.1.4

Upon reception of the cause codes # 95, # 96, # 97, # 99 and # 111 the MS should set the routing area updating attempt counter to 5. The MS shall proceed as described below.

- e) If a routing area border is crossed, when the MS is in state GMM-ROUTING-AREA-UPDATE-INITIATED, the routing area updating procedure shall be aborted and re-initiated immediately. The MS shall set the GPRS update status to GU2 NOT UPDATED.

- f) In A/Gb mode, if a cell change occurs within the same RA, when the MS is in state GMM-ROUTING-AREA-UPDATE-INITIATED, the cell update procedure is performed, before completion of the routing area updating procedure.

- g) Routing area updating and detach procedure collision

GPRS detach containing detach type "re-attach required" or "re-attach not required":

If the MS receives a DETACH REQUEST message before the routing area updating procedure has been completed, the routing area updating procedure shall be aborted and the GPRS detach procedure shall be progressed.

GPRS detach containing detach type "IMSI detach":

If the MS receives a DETACH REQUEST message before the routing area updating procedure has been completed, the routing area updating procedure shall be progressed, i.e. the DETACH REQUEST message shall be ignored.

#### h) Routing area updating and P-TMSI reallocation procedure collision

If the MS receives a P-TMSI REALLOCATION REQUEST message before the routing area updating procedure has been completed, the P-TMSI reallocation procedure shall be aborted and the routing area updating procedure shall be progressed.

In cases b, c, d, e, and g with detach type "re-attach required" or "re-attach not required", the MS shall stop any ongoing transmission of user data.

In cases b, c and d the MS shall proceed as follows:

Timer T3330 shall be stopped if still running. The routing area updating attempt counter shall be incremented.

If the routing area updating attempt counter is less than 5, and the stored RAI is equal to the RAI of the current serving cell and the GMM update status is equal to GU1 UPDATED:

- the MS shall keep the GMM update status to GU1 UPDATED and changes state to GMM-REGISTERED.NORMAL-SERVICE. The MS shall start timer T3311. When timer T3311 expires the routing area updating procedure is triggered again.

If the routing area updating attempt counter is less than 5, and the stored RAI is different to the RAI of the current serving cell or the GMM update status is different to GU1 UPDATED:

- the MS shall start timer T3311, shall set the GPRS update status to GU2 NOT UPDATED and changes state to GMM-REGISTERED.ATTEMPTING-TO-UPDATE.

If the routing area updating attempt counter is greater than or equal to 5:

- the MS shall start timer T3302, shall delete the list of equivalent PLMNs, shall set the GPRS update status to GU2 NOT UPDATED and shall change to state GMM-REGISTERED.ATTEMPTING-TO-UPDATE or optionally to GMM-REGISTERED.PLMN-SEARCH(see subclause 4.2.5.1.8) in order to perform a PLMN selection according to 3GPP TS 23.122 [14].

### 4.7.5.1.6 Abnormal cases on the network side

The following abnormal cases can be identified:

- a) If a lower layer failure occurs before the message ROUTING AREA UPDATE COMPLETE has been received from the MS and a P-TMSI and/or PTMSI signature has been assigned, the network shall abort the procedure and shall consider both, the old and new P-TMSI and the corresponding P-TMSI signatures as valid until the old P-TMSI can be considered as invalid by the network (see subclause 4.7.1.5). During this period the network may use the identification procedure followed by a P-TMSI reallocation procedure if the old P-TMSI is used by the MS in a subsequent message.

NOTE: Optionally, paging with IMSI may be used if paging with old and new P-TMSI fails. Paging with IMSI causes the MS to re-attach as described in subclause 4.7.9.1.

#### b) Protocol error

If the ROUTING AREA UPDATE REQUEST message has been received with a protocol error, the network shall return a ROUTING AREA UPDATE REJECT message with one of the following reject causes:

- #96: Mandatory information element error;
- #99: Information element non-existent or not implemented;

#100: Conditional IE error;

#111: Protocol error, unspecified.

c) T3350 time-out

On the first expiry of the timer, the network shall retransmit the ROUTING AREA UPDATE ACCEPT message and shall reset and restart timer T3350. The retransmission is performed four times, i.e. on the fifth expiry of timer T3350, the routing area updating procedure is aborted. Both, the old and the new P-TMSI and the corresponding P-TMSI signatures shall be considered as valid until the old P-TMSI can be considered as invalid by the network(see subclause 4.7.1.5). During this period the network acts as described for case a above.

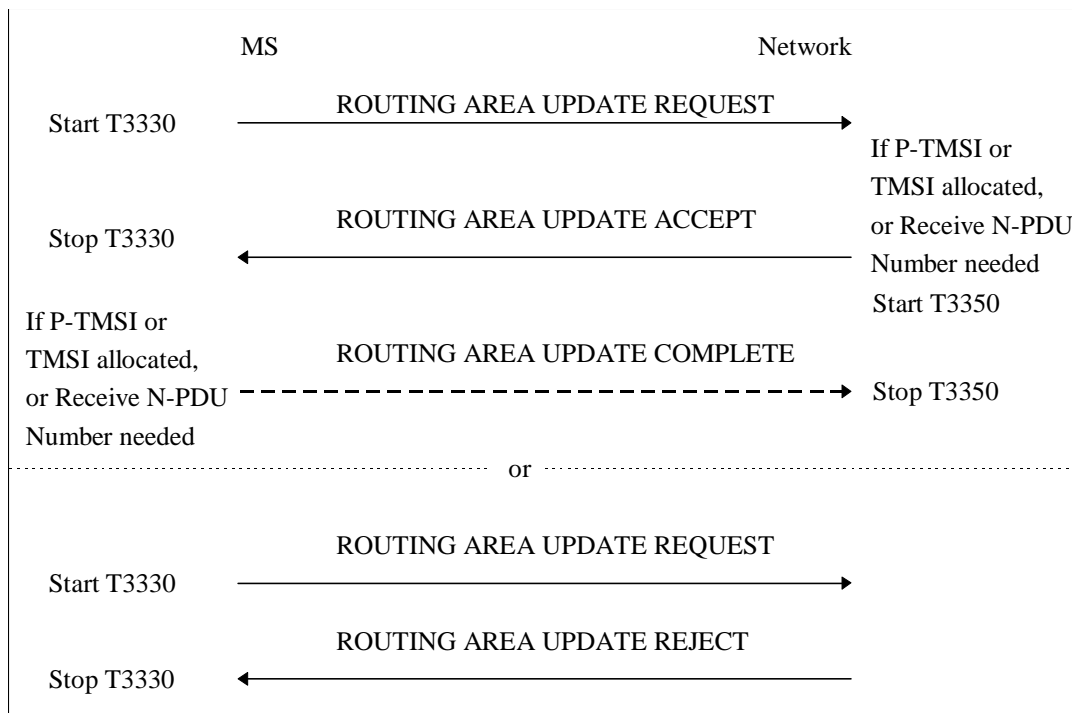

**Figure 4.7.5/1 3GPP TS 24.008: Routing and combined routing area updating procedure**

- d.1) ROUTING AREA UPDATE REQUEST received after the ROUTING AREA UPDATE ACCEPT message has been sent and before the ROUTING AREA UPDATE COMPLETE message is received
- If one or more of the information elements in the ROUTING AREA UPDATE REQUEST message differ from the ones received within the previous ROUTING AREA UPDATE REQUEST message, the previously initiated routing area updating procedure shall be aborted if the ROUTING AREA UPDATE COMPLETE message has not been received and the new routing area updating procedure shall be progressed, or
  - If the information elements do not differ, then the ROUTING AREA UPDATE ACCEPT message shall be resent and the timer T3350 shall be restarted if an ROUTING AREA UPDATE COMPLETE message is expected. In that case, the retransmission counter related to T3350 is not incremented.
- d.2) More than one ROUTING AREA UPDATE REQUEST received and no ROUTING AREA UPDATE ACCEPT or ROUTING AREA UPDATE REJECT message has been sent
- If one or more of the information elements in the ROUTING AREA UPDATE REQUEST message differs from the ones received within the previous ROUTING AREA UPDATE REQUEST message, the previously initiated routing area updating procedure shall be aborted and the new routing area updating procedure shall be progressed;
  - If the information elements do not differ, then the network shall continue with the previous routing area updating procedure and shall not treat any further this ROUTING AREA UPDATE REQUEST message.

### 4.7.5.2 Combined routing area updating procedure

Within a combined routing area updating procedure the messages ROUTING AREA UPDATE ACCEPT and ROUTING AREA UPDATE COMPLETE carry information for the routing area updating and the location area updating.

#### 4.7.5.2.1 Combined routing area updating procedure initiation

The combined routing area updating procedure is initiated only by a GPRS MS operating in MS operation modes A or B, if the MS is in state GMM-REGISTERED and MM-IDLE, and if the network operates in network operation mode I:

- when a GPRS MS that is IMSI attached for GPRS and non-GPRS services detects a change of the routing area in state GMM-REGISTERED and MM-IDLE;
- when a GPRS MS that is IMSI attached for GPRS services wants to perform an IMSI attach for non-GPRS services;
- after termination of a non-GPRS service via non-GPRS channels to update the association if the MS has changed the RA during that non-GPRS service transaction;
- after termination of a non-GPRS service via non-GPRS channels to update the association if GPRS services were suspended during the non-GPRS service but no resume is received. See 3GPP TS 23.060 subclause 16.2.1;
- after termination of a non-GPRS service via non-GPRS channels to update the association, if the GPRS MS in MS operation mode A performed a normal GPRS attach or a normal routing area updating procedure during the circuit-switched transaction;
- after a CM SERVICE REJECT message with cause value #4 is received by the mobile station (see subclause 4.5.1.1); in this case the update type IE shall be set to "Combined RA/LA updating with IMSI attach";
- when a GPRS MS needs to update the network with the new MS Radio Access Capability IE;
- when a GPRS MS needs to update the network with a new DRX parameter IE; or
- in Iu mode, to re-synchronize the PMM mode of MS and network after RRC connection release with cause "Directed signalling connection re-establishment", see subclause 4.7.2.5.

In A/Gb mode, the routing and location area identification are broadcast on the broadcast channel(s). A combined routing area updating procedure shall abort any ongoing GMM procedure. Aborted GMM procedures shall be repeated after the combined routing area updating procedure has been successfully performed. The ROUTING AREA UPDATE REQUEST message shall always be the first message sent from the MS in the new routing area after routing area change.

In Iu mode, the routing and location area identification are broadcast on the broadcast channel(s) or sent to the MS via the PS signalling connection. A combined routing area updating procedure shall abort any ongoing GMM procedure. Aborted GMM procedures may be repeated after the combined routing area updating procedure has been successfully performed. The ROUTING AREA UPDATE REQUEST message shall always be the first GMM message sent from the MS in the new routing area after routing area change.

To initiate a combined routing area updating procedure the MS sends the message ROUTING AREA UPDATE REQUEST to the network, starts timer T3330 and changes to state GMM-ROUTING-UPDATING-INITIATED and MM LOCATION UPDATING PENDING. The value of the Update type IE in the message shall indicate "combined RA/LA updating" unless explicitly specified otherwise. If for the last attempt to update the registration of the location area a MM specific procedure was performed, the value of the Update type IE in the ROUTING AREA UPDATE REQUEST message shall indicate "combined RA/LA updating with IMSI attach". Furthermore the MS shall include the TMSI status IE if no valid TMSI is available.

A GPRS MS in MS operation modes B that is in an ongoing circuit-switched transaction, shall initiate the combined routing area updating procedure after the circuit-switched transaction has been released, if the MS has changed the RA during the circuit-switched transaction and if the network operates in network operation mode I.

A GPRS MS in MS operation mode A shall initiate the combined routing area updating procedure with IMSI attach after the circuit-switched transaction has been released, if a normal GPRS attach or a normal routing area updating procedure was performed during the circuit-switched transaction and provided that the network operates in network operation mode I.

A GPRS MS in MS operation mode A shall perform the normal routing area update procedure during an ongoing circuit-switched transaction.

In Iu mode, if the MS wishes to prolong the established PS signalling connection after the normal routing area updating procedure (for example, the MS has any CM application request pending), it may set a follow-on request pending indicator on (see subclause 4.7.13).

In Iu mode, when a ROUTING AREA UPDATE REQUEST is received by the SGSN over a new PS signalling connection while there is an ongoing PS signalling connection (network is already in mode PMM-CONNECTED) for this UE, the network shall progress the routing area update procedure as normal and release the previous PS signalling connection when the routing area update procedure has been accepted by the network.

NOTE: The re-establishment of the radio bearers of active PDP contexts is done as described in subclause "Service Request procedure".

#### 4.7.5.2.2 GMM Common procedure initiation

The network may initiate GMM common procedures, e.g. the GMM authentication and ciphering procedure.

#### 4.7.5.2.3 Combined routing area updating procedure accepted by the network

Depending on the value of the update result IE received in the ROUTING AREA UPDATE ACCEPT message, two different cases can be distinguished:

- Case 1) The update result IE value indicates "combined RA/LA": Routing and location area updating is successful;
- Case 2) The update result IE value indicates "RA only": Routing area updating is successful, but location area updating is not successful.

A ROUTING AREA UPDATE COMPLETE message shall be returned to the network if the ROUTING AREA UPDATE ACCEPT message contains any of:

- a P-TMSI and/or a TMSI;
- Receive N-PDU Numbers (see 3GPP TS 44.065 [78] and 3GPP TS 25.322); or
- a request for the provision of the Inter RAT information container.

If Receive N-PDU Numbers were included, the Receive N-PDU Numbers that are valid in the MS shall be included in the ROUTING AREA UPDATE COMPLETE message.

If the network has requested the provision of the Inter RAT information container the MS shall return a ROUTING AREA UPDATE COMPLETE message including the Inter RAT information container IE to the network.

In Iu mode, if the network wishes to prolong the PS signalling connection (for example, if the mobile station has indicated "follow-on request pending" in ROUTING AREA UPDATE REQUEST message) the network shall indicate the "follow-on proceed" in the ROUTING AREA UPDATE ACCEPT message. If the network wishes to release the PS signalling connection, the network shall indicate "no follow-on proceed" in the ROUTING AREA UPDATE ACCEPT message.

After that in Iu mode, the mobile station shall act according to the follow-on proceed flag included in the Update result information element in the ROUTING AREA UPDATE ACCEPT message (see subclause 4.7.13).

#### 4.7.5.2.3.1 Combined routing area updating successful

The description for normal routing area update as specified in subclause 4.7.5.1.3 shall be followed. In addition, the following description for location area updating applies.

The handling at the receipt of the ROUTING AREA UPDATE ACCEPT depends on the value received in the update result IE as specified below.

The TMSI reallocation may be part of the combined routing area updating procedure. The TMSI allocated is then included in the ROUTING AREA UPDATE ACCEPT message together with the location area identification (LAI). The network shall, in this case, change to state GMM-COMMON-PROCEDURE-INITIATED and shall start the timer T3350 as described in subclause 4.7.6.

The MS, receiving a ROUTING AREA UPDATE ACCEPT message, stores the received location area identification, stops timer T3330, enters state MM IDLE, reset the location update attempt counter and sets the update status to U1 UPDATED. If the ROUTING AREA UPDATE ACCEPT message contains an IMSI, the mobile station is not allocated any TMSI, and shall delete any TMSI accordingly. If the ROUTING AREA UPDATE ACCEPT message contains a TMSI, the MS shall use this TMSI as new temporary identity. The MS shall delete its old TMSI and shall store the new TMSI. In this case, a ROUTING AREA UPDATE COMPLETE message is returned to the network. If neither a TMSI nor an IMSI has been included by the network in the ROUTING AREA UPDATE ACCEPT message, the old TMSI, if any is available, shall be kept.

Any timer used for triggering the location updating procedure (e.g. T3211, T3212) shall be stopped if running.

The network receiving a ROUTING AREA UPDATE COMPLETE message stops timer T3350, changes to GMM-REGISTERED state and considers the new TMSI as valid.

#### 4.7.5.2.3.2 Combined routing area updating successful for GPRS services only

The description for normal routing area update as specified in subclause 4.7.5.1.3 shall be followed. In addition, the following description for location area updating applies.

The MS receiving the ROUTING AREA UPDATE ACCEPT message takes one of the following actions depending on the reject cause:

#2 (IMSI unknown in HLR);

The MS shall set the update status to U3 ROAMING NOT ALLOWED and shall delete any TMSI, LAI and ciphering key sequence number. The new MM state is MM IDLE. The SIM/USIM shall be considered as invalid for non-GPRS services until switching off or the SIM/USIM is removed.

#16 (MSC temporarily not reachable);

#17 (Network failure); or

#22 (Congestion).

The MS shall change to state GMM-REGISTERED.ATTEMPTING-TO-UPDATE-MM. Timer T3330 shall be stopped if still running. The routing area updating attempt counter shall be incremented. If the routing area updating attempt counter is less than 5, and the stored RAI is equal to the RAI of the current serving cell and the GMM update status is equal to GU1 UPDATED:

- the MS shall keep the GMM update status GU1 UPDATED and changes state to GMM-REGISTERED.ATTEMPTING-TO-UPDATE-MM. The MS shall start timer T3311. When timer T3311 expires the combined routing area update procedure indicating "combined RA/LA updating with IMSI attach" is triggered again.

If the routing area updating attempt counter is greater than or equal to 5:

- the MS shall start timer T3302 and shall change to state GMM-REGISTERED.ATTEMPTING-TO-UPDATE-MM;
- a GPRS MS operating in MS operation mode A shall then proceed with appropriate MM specific procedure; a GPRS MS operating in MS operation mode B may then proceed with appropriate MM specific procedures. The MM sublayer shall act as in network operation mode II or III (depending whether a PCCCH is present) as long as the combined GMM procedures are not successful and no new RA is entered. The new MM state is MM IDLE.

Other reject cause values and the case that no GMM cause IE was received are considered as abnormal cases. The combined routing area updating shall be considered as failed for GPRS and non-GPRS services. The specification of the MS behaviour in those cases is specified in subclause 4.7.5.2.5.



#### 4.7.5.2.4 Combined routing area updating not accepted by the network

If the combined routing area updating cannot be accepted, the network sends a ROUTING AREA UPDATE REJECT message to the MS. An MS that receives a ROUTING AREA UPDATE REJECT message stops timer T3330, enters state MM IDLE, and for all causes except #12, #14 and #15 deletes the list of "equivalent PLMNs". If a ROUTING AREA UPDATE REJECT message is received, the MS shall stop any ongoing transmission of user data.

The MS shall then take different actions depending on the received reject cause:

- # 3 (Illegal MS);
- # 6 (Illegal ME), or
- # 8 (GPRS services and non GPRS services not allowed);

The MS shall set the GPRS update status to GU3 ROAMING NOT ALLOWED and the update status to U3 ROAMING NOT ALLOWED (and shall store it according to subclause 4.1.3.2) and enter the state GMM-DEREGISTERED. Furthermore, it shall delete any P-TMSI, P-TMSI signature, TMSI, RAI, LAI, ciphering key sequence number and GPRS ciphering key sequence number and shall consider the SIM/USIM as invalid for GPRS and non GPRS services until switching off or the SIM/USIM is removed.

- # 7 (GPRS services not allowed);

The MS shall set the GPRS update status to GU3 ROAMING NOT ALLOWED (and shall store it according to subclause 4.1.3.2) and shall delete any P-TMSI, P-TMSI signature, RAI and GPRS ciphering key sequence number. The SIM/USIM shall be considered as invalid for GPRS services until switching off or the SIM/USIM is removed. The new state is GMM-DEREGISTERED. If in the MS the timer T3212 is not already running, the timer shall be set to its initial value and restarted.

A GPRS MS operating in MS operation mode A or B in network operation mode I, is still IMSI attached for CS services in the network. and shall then proceed with the appropriate MM specific procedure according to the MM service state.

- # 9 (MS identity cannot be derived by the network);

The MS shall set the GPRS update status to GU2 NOT UPDATED (and shall store it according to subclause 4.1.3.2), enter the state GMM-DEREGISTERED, and shall delete any P-TMSI, P-TMSI signature, RAI and GPRS ciphering key sequence number. Subsequently, the MS may automatically initiate the GPRS attach procedure.

A GPRS MS operating in MS operation mode A or B in network operation mode I, is still IMSI attached for CS services in the network.

- # 10 (Implicitly detached);

A GPRS MS operating in MS operation mode A or B in network operation mode I, is IMSI detached for both GPRS and CS services in the network.

The MS shall change to state GMM-DEREGISTERED.NORMAL-SERVICE. The MS shall then perform a new attach procedure. The MS should also activate PDP context(s) to replace any previously active PDP context(s). The MS should also perform the procedures needed in order to activate any previously active multicast service(s).

NOTE: In some cases, user interaction may be required and then the MS cannot activate the PDP/MBMS context(s) automatically.

- # 11 (PLMN not allowed);

The MS shall set the GPRS update status to GU3 ROAMING NOT ALLOWED and the update status to U3 ROAMING NOT ALLOWED (and shall store it according to subclause 4.1.3.2) and enter the state GMM-DEREGISTERED. Furthermore, it shall delete any P-TMSI, P-TMSI signature, TMSI, RAI, LAI, ciphering key sequence number GPRS ciphering key sequence number, and reset the location update attempt counter.

The MS shall store the PLMN identity in the "forbidden PLMN list".

The MS shall then perform a PLMN selection according to 3GPP TS 23.122 [14].

# 12 (Location area not allowed);

The MS shall delete any RAI, P-TMSI, P-TMSI signature and GPRS ciphering key sequence number, shall set the GPRS update status to GU3 ROAMING NOT ALLOWED (and shall store it according to clause 4.1.3.2), shall reset the routing area updating attempt counter and shall change to state GMM-DEREGISTERED.LIMITED-SERVICE.

The MS shall in addition set the update status to U3 ROAMING NOT ALLOWED, shall delete any TMSI, LAI and ciphering key sequence number and shall reset the location update attempt counter. The new MM state is MM IDLE.

The mobile station shall store the LAI in the list of "forbidden location areas for regional provision of service".

The MS shall perform a cell selection according to 3GPP TS 43.022 [82] and 3GPP TS 25.304.

# 13 (Roaming not allowed in this location area);

The MS shall set the GPRS update status to GU3 ROAMING NOT ALLOWED (and shall store it according to clause 4.1.3.2), shall reset the routing area updating attempt counter and shall change to state GMM-REGISTERED.LIMITED-SERVICE.

The MS shall in addition set the update status to U3 ROAMING NOT ALLOWED and shall reset the location update attempt counter. The new MM state is MM IDLE.

The MS shall store the LAI in the list of "forbidden location areas for roaming".

The MS shall perform a PLMN selection according to 3GPP TS 23.122 [14].

The MS shall indicate the Update type IE "combined RA/LA updating with IMSI attach" when performing the routing area updating procedure following the PLMN selection.

# 14 (GPRS services not allowed in this PLMN);

The MS shall delete any RAI, P-TMSI, P-TMSI signature, and GPRS ciphering key sequence number stored, shall set the GPRS update status to GU3 ROAMING NOT ALLOWED (and shall store it according to subclause 4.1.3.2) and shall change to state GMM-DEREGISTERED. If in the MS the timer T3212 is not already running, the timer shall be set to its initial value and restarted.

The MS shall store the PLMN identity in the "forbidden PLMNs for GPRS service" list.

A GPRS MS operating in MS operation mode A or B in network operation mode I, is still IMSI attached for CS services in the network and shall then proceed with the appropriate MM specific procedure according to the MM service state.

As an implementation option, a GPRS MS operating in operation mode A or B may perform a PLMN selection according to 3GPP TS 23.122 [14].

The MS shall not perform the optional PLMN selection in the case where the PLMN providing this reject cause is:

- On the "User Controlled PLMN Selector with Access Technology " or,
- On the "Operator Controlled PLMN Selector with Access Technology " list or,
- A PLMN identified as equivalent to any PLMN, with the same MCC, contained in the lists above.

# 15 (No Suitable Cells In Location Area);

The MS shall set the GPRS update status to GU3 ROAMING NOT ALLOWED (and shall store it according to clause 4.1.3.2), shall reset the routing area updating attempt counter and shall change to state GMM-REGISTERED.LIMITED-SERVICE.

The MS shall in addition set the update status to U3 ROAMING NOT ALLOWED and shall reset the location update attempt counter. The new MM state is MM IDLE.

The MS shall store the LAI in the list of "forbidden location areas for roaming".

The MS shall search for a suitable cell in another location area in the same PLMN according to 3GPP TS 43.022 [82] and 3GPP TS 25.304.

The MS shall indicate the Update type IE "combined RA/LA updating with IMSI attach" when performing the routing area updating procedure.

Other values are considered as abnormal cases. The specification of the MS behaviour in those cases is described in subclause 4.7.5.2.5.

#### 4.7.5.2.5 Abnormal cases in the MS

The abnormal cases specified in subclause 4.7.5.1.5 apply with the following modification:

If the GPRS routing area updating attempt counter is incremented according to subclause 4.7.5.1.5 the next actions depend on the Location Area Identities (stored on SIM/USIM and the one of the current serving cell) and the value of the routing area updating attempt counter.

- if the update status is U1 UPDATED, and the stored LAI is equal to the one of the current serving cell and the routing area updating attempt counter is smaller than 5, then the mobile station shall keep the update status to U1 UPDATED, the new MM state is MM IDLE substate NORMAL SERVICE;
- if the routing area updating attempt counter is smaller than 5 and, additionally, the update status is different from U1 UPDATED or the stored LAI is different from the one of the current serving cell, the mobile station shall delete any LAI, TMSI, ciphering key sequence number stored in the SIM/USIM and list of equivalent PLMNs and set the update status to U2 NOT UPDATED. The MM state remains MM LOCATION UPDATING PENDING; or
- if the routing area updating attempt counter is greater or equal to 5, the mobile station shall delete any LAI, TMSI, ciphering key sequence number stored in the SIM/USIM and list of equivalent PLMNs and set the update status to U2 NOT UPDATED.

A GPRS MS operating in MS operation mode A shall then proceed with appropriate MM specific procedure; a GPRS MS operating in MS operation mode B may then proceed with appropriate MM specific procedures. The MM sublayer shall act as in network operation mode II or III (depending whether a PCCCH is present) as long as the combined GMM procedures are not successful and no new RA is entered. The new MM state is MM IDLE substate ATTEMPTING TO UPDATE or optionally MM IDLE substate PLMN SEARCH in order to perform a PLMN selection according to 3GPP TS 23.122 [14].

#### 4.7.5.2.6 Abnormal cases on the network side

The abnormal cases specified in subclause 4.7.5.1.6 apply with the exceptions for cases a and c in which in addition to the P-TMSI and P-TMSI signature the old TMSI shall be considered occupied until the new TMSI is used by the MS in a subsequent message.

### 4.7.6 P-TMSI reallocation procedure

A temporary mobile station identity for GPRS services, the Packet-TMSI (P-TMSI), is used for identification within the radio interface signalling procedures. The structure of the P-TMSI is specified in 3GPP TS 23.003 [10]. The P-TMSI has significance only within a routing area. Outside the routing area it has to be combined with the routing area identification (RAI) to provide for an unambiguous identity.

The purpose of the P-TMSI reallocation procedure is to provide identity confidentiality, i.e. to protect a user against being identified and located by an intruder (see 3GPP TS 42.009 [5] and 43.020 [13]).

Usually, P-TMSI reallocation is performed at least at each change of a routing area. (Such choices are left to the network operator).

The reallocation of a P-TMSI is performed by the unique procedure defined in this subclause. This procedure can only be initiated by the network in state GMM-REGISTERED.

P-TMSI can also be implicitly reallocated in the attach or routing area updating procedures. The implicit reallocation of a P-TMSI is described in the corresponding subclause s.

NOTE: Normally, the P-TMSI reallocation will take place in conjunction with another GMM procedure, e.g. at routing area updating (see 3GPP TS 29.002 [37]).

#### 4.7.6.1 P-TMSI reallocation initiation by the network

The network initiates the P-TMSI reallocation procedure by sending a P-TMSI REALLOCATION COMMAND message to the MS and starts the timer T3350.

The P-TMSI REALLOCATION COMMAND message contains a new combination of P-TMSI, RAI and optionally a P-TMSI signature allocated by the network.

The network may suspend the transmission of user data during the P-TMSI reallocation procedure.

#### 4.7.6.2 P-TMSI reallocation completion by the MS

Upon receipt of the P-TMSI REALLOCATION COMMAND message, the MS stores the Routing Area Identifier (RAI) and the P-TMSI and sends a P-TMSI REALLOCATION COMPLETE message to the network.

If a P-TMSI signature is present in the P-TMSI REALLOCATION COMMAND message, the MS shall store the new P-TMSI signature and shall if available delete the old P-TMSI signature. If no P-TMSI signature is present in the P-TMSI REALLOCATION COMMAND message, the old P-TMSI signature, if available, shall be kept.

#### 4.7.6.3 P-TMSI reallocation completion by the network

Upon receipt of the P-TMSI REALLOCATION COMPLETE message, the network stops the timer T3350 and considers both the old and the new P-TMSI and the corresponding P-TMSI signatures as valid until the old P-TMSI can be considered as invalid by the network (see subclause 4.7.1.5).

In A/Gb mode, the GMM layer shall notify the LLC layer that the P-TMSI has been changed (see 3GPP TS 44.064 [78a]).

#### 4.7.6.4 Abnormal cases on the network side

The following abnormal cases can be identified:

##### a) Lower layer failure

If a lower layer failure is detected before the P-TMSI REALLOCATION COMPLETE message is received, the old and the new P-TMSI shall be considered as occupied until the old P-TMSI can be considered as invalid by the network (see subclause 4.7.1.5).

During this period the network:

may first use the old P-TMSI for paging for an implementation dependent number of paging attempts in the case of network originated transactions. Upon response from the MS, the network may re-initiate the P-TMSI reallocation. If no response is received to the paging attempts, the network may use the new P-TMSI for paging for an implementation dependent number of paging attempts. Upon response from the MS the network shall consider the new P-TMSI as valid and the old P-TMSI as invalid. If no response is received to the paging attempts, the network may use the IMSI for paging. for an implementation dependent number of paging attempts;

NOTE: Paging with IMSI causes the MS to re-attach as described in subclause 4.7.9.1.

- shall consider the new P-TMSI as valid if it is used by the MS (see subclause 4.7.1.5); or
- may use the identification procedure followed by a new P-TMSI reallocation if the MS uses the old P-TMSI.

##### b) Expiry of timer T3350

The P-TMSI reallocation procedure is supervised by the timer T3350. The network shall, on the first expiry of timer T3350, reset and restart timer T3350 and shall retransmit the P-TMSI REALLOCATION COMMAND.

This retransmission is repeated four times, i.e. on the fifth expiry of timer T3350, the network shall abort the reallocation procedure and shall follow the rules for case a as described above.

c) P-TMSI reallocation and GPRS attach procedure collision

If the network receives an ATTACH REQUEST message before the ongoing P-TMSI reallocation procedure has been completed the network shall proceed with the GPRS attach procedure after deletion of the GMM context.

d) P-TMSI reallocation and an MS initiated GPRS detach procedure collision

If the network receives a DETACH REQUEST message before the ongoing P-TMSI reallocation procedure has been completed, the network shall abort the P-TMSI reallocation procedure and shall progress the GPRS detach procedure.

e) P-TMSI reallocation and a routing area updating procedure collision

If the network receives a ROUTING AREA UPDATE REQUEST message before the ongoing P-TMSI reallocation procedure has been completed, the network shall abort the P-TMSI reallocation procedure and shall progress the routing area updating procedure. The network may then perform a new P-TMSI reallocation.

f) P-TMSI reallocation and a service request procedure collision

If the network receives a SERVICE REQUEST message before the ongoing P-TMSI reallocation procedure has been completed, the network shall progress both procedures.

If there are different new P-TMSI included in subsequent P-TMSI REALLOCATION COMMAND messages, due to an aborted or repeated P-TMSI reallocation procedure, the MS always regards the newest and its existing P-TMSI as valid for the recovery time.

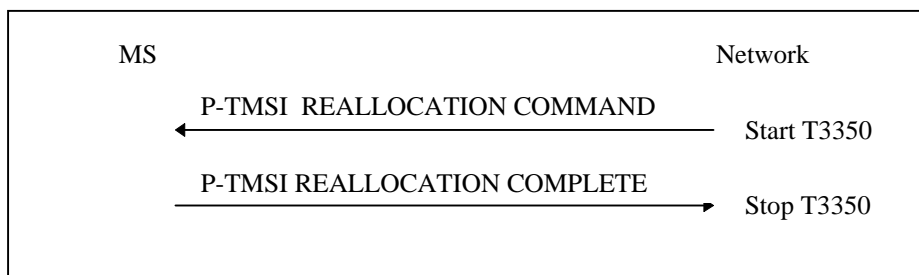

Figure 4.7.6/1 3GPP TS 24.008: P-TMSI reallocation procedure

## 4.7.7 Authentication and ciphering procedure

### 4.7.7a Authentication and ciphering procedure used for UMTS authentication challenge.

The purpose of the authentication and ciphering procedure is fourfold (see 3GPP TS 33.102 [5a]):

- to permit the network to check whether the identity provided by the MS is acceptable or not;
- to provide parameters enabling the MS to calculate a new GPRS UMTS ciphering key and a new GPRS UMTS integrity key;
- to let the network set the GSM ciphering mode (ciphering /no ciphering) and GSM ciphering algorithm; and
- to permit the mobile station to authenticate the network.

In Iu mode, and in the case of a UMTS authentication challenge, the authentication and ciphering procedure can be used for authentication only.

The cases in which the authentication and ciphering procedure shall be used are defined in 3GPP TS 33.102 [5a] and 3GPP TS 42.009 [5].

The authentication and ciphering procedure is always initiated and controlled by the network. However, in the case of a UMTS authentication challenge, there is the possibility for the MS to reject the network.

The MS shall support the UMTS authentication challenge, if a USIM is inserted.

The authentication and ciphering procedure can be used for either:

- authentication only;
- setting of the GSM ciphering mode and the GSM ciphering algorithm only; or
- authentication and the setting of the GSM ciphering mode and the GSM ciphering algorithm.

In A/Gb mode, the network should not send any user data during the authentication and ciphering procedure.

A UMTS security context is established in the MS and the network when a UMTS authentication challenge is performed in A/Gb mode or in Iu mode. After a successful UMTS authentication, the GPRS UMTS ciphering key, the GPRS UMTS integrity key, the GPRS GSM ciphering key and the GPRS ciphering key sequence number, are stored both in the network and the MS.

#### 4.7.7b Authentication and ciphering procedure used for GSM authentication challenge

The purpose of the authentication and ciphering procedure is threefold (see 3GPP TS 43.020 [13]):

- to permit the network to check whether the identity provided by the MS is acceptable or not;
- to provide parameters enabling the MS to calculate a new GPRS GSM ciphering key; and
- to let the network set the GSM ciphering mode (ciphering/no ciphering) and GSM ciphering algorithm.

The authentication and ciphering procedure can be used for either:

- authentication only;
- setting of the GSM ciphering mode and the GSM ciphering algorithm only; or
- authentication and the setting of the GSM ciphering mode and the GSM ciphering algorithm.

The cases in which the authentication and ciphering procedure shall be used are defined in 3GPP TS 42.009 [5].

In A/Gb mode, the authentication and ciphering procedure is always initiated and controlled by the network. It shall be performed in a non ciphered mode because of the following reasons:

- the network cannot decipher a ciphered AUTHENTICATION\_AND\_CIPHERING RESPONSE from an unauthorised MS and put it on the black list; and
- to be able to define a specific point in time from which on a new GPRS GSM ciphering key should be used instead of the old one.

GSM authentication challenge shall be supported by a ME supporting GERAN or UTRAN.

In A/Gb mode, the network should not send any user data during the authentication and ciphering procedure.

A GSM security context is established in the MS and the network when a GSM authentication challenge is performed in A/Gb mode or in Iu mode. However, in Iu mode the MS shall not accept a GSM authentication challenge, if a USIM is inserted. After a successful GSM authentication challenge, the GPRS GSM ciphering key and the GPRS ciphering key sequence number, are stored both in the network and the MS.

#### 4.7.7c Change of the ciphering algorithm at PS Handover

For PS handover to A/Gb mode (see subclause 10.5.1.14 and 3GPP TS 44.060 [76]) the network shall either assign a GSM ciphering algorithm to be used in the target cell or deactivate ciphering in the target cell. The MS shall start to use the new GSM ciphering algorithm or deactivate ciphering upon an indication from the lower layers that the PS handover procedure has been successfully completed (see 3GPP TS 44.060 [76])

After PS handover to Iu mode (see 3GPP TS 25.331 [23c] and 3GPP TS 44.118 [111]) the network shall activate integrity protection and shall either assign a ciphering algorithm to be used in the target cell or deactivate ciphering in the target cell, using the security mode control procedure (3GPP TS 25.331 [23c] and 3GPP TS 44.118 [111]).

If the GSM ciphering algorithm is changed at PS handover and the routing area updating procedure triggered by the PS handover procedure is not accepted by the network, the MS shall delete any GPRS ciphering key sequence number and proceed as specified in subclauses 4.7.5.1.4 and 4.7.5.2.4. If the routing area updating procedure fails, because the radio resources assigned in the new cell are released before the MS receives a ROUTING AREA UPDATE ACCEPT message, the MS shall delete any GPRS ciphering key sequence number and proceed as specified in subclauses 4.7.5.1.5 item b and 4.7.5.2.5, respectively.

#### 4.7.7.1 Authentication and ciphering initiation by the network

The network initiates the authentication and ciphering procedure by transferring an AUTHENTICATION\_AND\_CIPHERING REQUEST message across the radio interface and starts timer T3360. The AUTHENTICATION\_AND\_CIPHERING REQUEST message shall contain all parameters necessary to calculate the response parameters when authentication is performed (see 3GPP TS 43.020 [13] and 3GPP TS 33.102 [5a]).

If authentication is requested, then the AUTHENTICATION\_AND\_CIPHERING REQUEST message shall contain either:

- In a GSM authentication challenge, the GPRS ciphering key sequence number, allocated to the GPRS GSM ciphering key and the RAND, or
- In a UMTS authentication challenge, the GPRS ciphering key sequence number, allocated to the GPRS UMTS ciphering and GPRS UMTS integrity keys, the RAND and the AUTN.

In A/Gb mode, if authentication is not requested, then the AUTHENTICATION\_AND\_CIPHERING REQUEST message shall not contain neither the GPRS ciphering key sequence number, the RAND nor the AUTN.

In A/Gb mode, if ciphering is requested, in a GSM authentication challenge or in a UMTS authentication challenge, then the AUTHENTICATION\_AND\_CIPHERING REQUEST message shall indicate the GPRS GSM ciphering algorithm.

The network includes the A&C reference number information element in the AUTHENTICATION\_AND\_CIPHERING REQUEST message. Its value is chosen in order to link an AUTHENTICATION\_AND\_CIPHERING REQUEST in a RA with its RESPONSE. The A&C reference number value might be based on the RA Colour Code value.

Additionally, the network may request the MS to include its IMEISV in the AUTHENTICATION\_AND\_CIPHERING RESPONSE message.

#### 4.7.7.2 Authentication and ciphering response by the MS

In A/Gb mode, a MS that is attached to GPRS shall be ready to respond upon an AUTHENTICATION\_AND\_CIPHERING REQUEST message at any time.

In UMTS, an MS that is attached to GPRS shall be ready to respond upon an AUTHENTICATION\_AND\_CIPHERING REQUEST message at any time whilst a PS signalling connection exists.

If a SIM is inserted in the MS, the MS shall ignore the Authentication Parameter AUTN IE if included in the AUTHENTICATION\_AND\_CIPHERING REQUEST message and perform the GSM authentication challenge. It shall not perform the authentication of the network described in 4.7.7.5.1.

In a GSM authentication challenge, if the AUTHENTICATION\_AND\_CIPHERING REQUEST message includes the authentication parameters RAND and GPRS CKSN, then upon receipt of the message, the MS processes the challenge information and sends an AUTHENTICATION\_AND\_CIPHERING RESPONSE message to the network. The value of the received A&C reference number information element shall be copied into the A&C reference number information element in the AUTHENTICATION\_AND\_CIPHERING RESPONSE message. A GSM authentication challenge will result in the SIM/USIM passing a SRES and a GPRS GSM ciphering key to the ME. The new GPRS GSM ciphering key calculated from the challenge information shall overwrite the previous one and any previously stored GPRS UMTS ciphering and GPRS UMTS integrity keys shall be deleted. The calculated GSM ciphering key shall be stored on the

SIM/USIM together with the GPRS ciphering key sequence number before the AUTHENTICATION\_AND\_CIPHERING RESPONSE message is transmitted.

In a UMTS authentication challenge, if the AUTHENTICATION\_AND\_CIPHERING REQUEST message includes the UMTS authentication parameters GPRS CKSN, RAND and AUTN, then upon receipt of the message, the MS verifies the AUTN parameter and if this is accepted, the MS processes the challenge information and sends an AUTHENTICATION\_AND\_CIPHERING RESPONSE message to the network. The value of the received A&C reference number information element shall be copied into the A&C reference number information element in the AUTHENTICATION\_AND\_CIPHERING RESPONSE message. A UMTS authentication challenge will result in the USIM passing a RES, a GPRS UMTS ciphering key, a GPRS UMTS integrity key and a GPRS GSM ciphering key to the ME. The new GPRS UMTS ciphering key, GPRS UMTS integrity key and GPRS GSM ciphering key calculated from the challenge information shall overwrite the previous ones. The new GPRS UMTS ciphering key, GPRS UMTS integrity key and GPRS GSM ciphering key shall be stored on the USIM together with the GPRS ciphering key sequence number before the AUTHENTICATION\_AND\_CIPHERING RESPONSE message is transmitted.

In Iu mode, an MS capable of UMTS only shall ignore the Ciphering Algorithm IE in the AUTHENTICATION\_AND\_CIPHERING REQUEST message. An MS capable of both Iu mode and A/Gb mode shall store the received value in the Ciphering Algorithm IE in the AUTHENTICATION\_AND\_CIPHERING REQUEST message in order to use it at an inter system change from Iu mode to A/Gb mode.

If the AUTHENTICATION\_AND\_CIPHERING REQUEST message does not include neither the GSM authentication parameters (RAND and GPRS CKSN) nor the UMTS authentication parameters (RAND, AUTN and GPRS CKSN), then upon receipt of the message, the MS replies by sending an AUTHENTICATION\_AND\_CIPHERING RESPONSE message to the network.

In A/Gb mode, the GMM layer shall notify the LLC layer if ciphering shall be used or not and if yes which GSM ciphering algorithm and GPRS GSM ciphering key that shall be used (see 3GPP TS 44.064 [78a]).

A ME supporting UMTS authentication challenge shall support the following procedure:

In order to avoid a synchronisation failure, if the same RAND is received twice, the mobile station shall store the received RAND together with the RES returned from the USIM in the volatile memory and compare it with any subsequently received RAND values, until the RAND value stored in the mobile station is deleted. If the stored RAND value is equal to the new received value in the AUTHENTICATION\_AND\_CIPHERING REQUEST message, then the mobile station shall not pass the RAND to the USIM, but shall immediately send the AUTHENTICATION\_AND\_CIPHERING RESPONSE message with the stored RES. If there is no valid stored RAND in the mobile station or the stored RAND is different from the new received value in the AUTHENTICATION\_AND\_CIPHERING REQUEST message, the mobile station shall pass the RAND to the USIM, shall override any previously stored RAND and RES with the new ones and start, or reset and restart timer T3316.

The RAND and RES values stored in the mobile station shall be deleted and timer T3316, if running, shall be stopped:

- upon receipt of a SECURITY MODE COMMAND (Iu mode only), SERVICE\_ACCEPT (Iu mode only), SERVICE\_REJECT (Iu mode only), ROUTING\_AREA\_UPDATE\_ACCEPT or AUTHENTICATION\_AND\_CIPHERING REJECT message;
- upon expiry of timer T3316; or
- if the mobile station enters the GMM states GMM-DEREGISTERED or GMM-NULL.

#### 4.7.7.3 Authentication and ciphering completion by the network

Upon receipt of the AUTHENTICATION AND CIPHERING RESPONSE message, the network stops the timer T3360 and checks the validity of the response (see 3GPP TS 43.020 [13] and 3GPP TS 33.102 [5a]). For this, it may use the A&C reference number information element within the AUTHENTICATION AND CIPHERING RESPONSE message to determine whether the response is correlating to the last request that was sent.

In A/Gb mode, the GMM layer shall notify the LLC sublayer if ciphering shall be used or not and if yes which algorithm and GPRS GSM ciphering key that shall be used (see 3GPP TS 44.064 [78a]).



Upon receipt of the AUTHENTICATION AND CIPHERING FAILURE message, the network stops the timer T3360. In Synch failure case, the core network may renegotiate with the HLR/AuC and provide the MS with new authentication parameters.

#### 4.7.7.4 GPRS ciphering key sequence number

The security parameters for authentication and ciphering are tied together in sets. In a GSM authentication challenge, from a challenge parameter RAND both the authentication response parameter SRES and the GPRS GSM ciphering key can be computed given the secret key associated to the IMSI. In a UMTS authentication challenge, from a challenge parameter RAND, the authentication response parameter RES and the GPRS UMTS ciphering key and the GPRS UMTS integrity key can be computed given the secret key associated to the IMSI.

In order to allow start of ciphering on a logical link without authentication, GPRS ciphering key sequence numbers are introduced.

The GPRS ciphering key sequence number is managed by the network such that the AUTHENTICATION AND CIPHERING REQUEST message contains the GPRS ciphering key sequence number allocated to the GPRS GSM ciphering key (in case of a GSM authentication challenge) or the GPRS UMTS ciphering key and the GPRS UMTS integrity key (in case of a UMTS authentication challenge) which may be computed from the RAND parameter carried in that message.

The MS stores the GPRS ciphering key sequence number with the GPRS GSM ciphering key (in case of a GSM authentication challenge) and the GPRS UMTS ciphering key and the GPRS UMTS integrity key (in case of a UMTS authentication challenge), and includes the corresponding GPRS ciphering key sequence number in the ROUTING AREA UPDATE REQUEST, SERVICE REQUEST and ATTACH REQUEST messages.

If the GPRS ciphering key sequence number is deleted, the associated GPRS GSM ciphering key, GPRS UMTS ciphering key and GPRS UMTS integrity key shall be deleted (i.e. the established GSM security context or the UMTS security context is no longer valid).

In Iu mode, the network may choose to start ciphering and integrity checking with the stored GPRS UMTS ciphering key and the stored GPRS UMTS integrity key (under the restrictions given in 3GPP TS 42.009 [5] and 3GPP TS 33.102 [5a]) if the stored GPRS ciphering key sequence number and the one given from the MS are equal.

In A/Gb mode, the network may choose to start ciphering with the stored GPRS GSM ciphering key (under the restrictions given in 3GPP TS 42.009 [5]) if the stored GPRS ciphering key sequence number and the one given from the MS are equal and the previously negotiated ciphering algorithm is known and supported in the network. When ciphering is requested at GPRS attach, the authentication and ciphering procedure shall be performed since the MS does not store the ciphering algorithm at detach.

Upon GPRS attach, if ciphering is to be used, an AUTHENTICATION AND CIPHERING REQUEST message shall be sent to the MS to start ciphering.

If the GPRS ciphering key sequence number stored in the network does not match the GPRS ciphering key sequence number received from the MS in the ATTACH REQUEST message, then the network should authenticate the MS.

In A/Gb mode, the MS starts ciphering after sending the AUTHENTICATION AND CIPHERING RESPONSE message. The network starts ciphering when a valid AUTHENTICATION AND CIPHERING RESPONSE is received from the MS.

In Iu mode, the MS starts ciphering and integrity checking according to the conditions specified in specification 3GPP TS 25.331 [23c].

In A/Gb mode, as an option, the network may decide to continue ciphering without sending an AUTHENTICATION AND CIPHERING REQUEST message after receiving a ROUTING AREA UPDATE REQUEST message with a valid GPRS ciphering key sequence number. Both the MS and the network shall use the latest ciphering parameters. The network starts ciphering when sending the ciphered ROUTING AREA UPDATE ACCEPT message to the MS. The MS starts ciphering after receiving a valid ciphered ROUTING AREA UPDATE ACCEPT message from the network.

NOTE: In some specifications the term KSI (Key Set Identifier) is used instead of the term GPRS ciphering key sequence number.

#### 4.7.7.5 Authentication not accepted by the network

If authentication and ciphering fails, i.e. if the response is not valid, the network considers whether the MS has used the P-TMSI or the IMSI for identification.

- If the P-TMSI has been used, the network may decide to initiate the identification procedure. If the IMSI given by the MS differs from the one the network had associated with the P-TMSI, the authentication should be restarted with the correct parameters. If the IMSI provided by the MS is the expected one (i.e. authentication has really failed), the network should proceed as described below.
- If the IMSI has been used, or the network decides not to try the identification procedure, an AUTHENTICATION AND CIPHERING REJECT message should be transferred to the MS.

Upon receipt of an AUTHENTICATION AND CIPHERING REJECT message, the MS shall set the GPRS update status to GU3 ROAMING NOT ALLOWED and shall delete the P-TMSI, P-TMSI signature, RAI and GPRS ciphering key sequence number stored. If available, also the TMSI, LAI and ciphering key sequence number shall be deleted and the update status shall be set to U3 ROAMING NOT ALLOWED. The SIM/USIM shall be considered as invalid until switching off or the SIM/USIM is removed.

If the AUTHENTICATION AND CIPHERING REJECT message is received, the MS shall abort any GMM procedure, shall stop the timers T3310, T3317 and T3330 (if running) and shall enter state GMM-DEREGISTERED.

##### 4.7.7.5.1 Authentication not accepted by the MS

In a UMTS authentication challenge, the authentication procedure is extended to allow the MS to check the authenticity of the core network. Thus allowing, for instance, detection of false base station.

Following a UMTS authentication challenge, the MS may reject the core network, on the grounds of an incorrect AUTN parameter (see 3GPP TS 33.102 [5a]). This parameter contains two possible causes for authentication failure:

###### a) MAC code failure

If the MS considers the MAC code (supplied by the core network in the AUTN parameter) to be invalid, it shall send a AUTHENTICATION AND CIPHERING FAILURE message to the network, with the GMM cause 'MAC failure'. The MS shall then follow the procedure described in subclause 4.7.7.6 (f).

###### b) SQN failure

If the MS considers the SQN (supplied by the core network in the AUTN parameter) to be out of range, it shall send a AUTHENTICATION AND CIPHERING FAILURE message to the network, with the GMM cause 'Synch failure' and the re-synchronization token AUTS provided by the USIM (see 3GPP TS 33.102 [5a]). The MS shall then follow the procedure described in subclause 4.7.7.6 (g).

In Iu mode, an MS with a USIM inserted shall reject the authentication challenge if no Authentication Parameter AUTN IE was present in the AUTHENTICATION REQUEST message (i.e. a GSM authentication challenge has been received when the MS expects a UMTS authentication challenge). In such a case, the MS shall send the AUTHENTICATION AND CIPHERING FAILURE message to the network, with the GMM cause "GSM authentication unacceptable". The MS shall then follow the procedure described in subclause 4.7.7.6 (f).

If the MS returns an AUTHENTICATION\_AND\_CIPHERING\_FAILURE message to the network, the MS shall delete any previously stored RAND and RES and shall stop timer T3316, if running.

#### 4.7.7.6 Abnormal cases

The following abnormal cases can be identified:

##### a) Lower layer failure

Upon detection of a lower layer failure before the AUTHENTICATION AND CIPHERING RESPONSE is received, the network shall abort the procedure.

##### b) Expiry of timer T3360

The network shall, on the first expiry of the timer T3360, retransmit the AUTHENTICATION AND CIPHERING REQUEST and shall reset and start timer T3360. This retransmission is repeated four times, i.e. on the fifth expiry of timer T3360, the procedure shall be aborted.

c) Collision of an authentication and ciphering procedure with a GPRS attach procedure

If the network receives an ATTACH REQUEST message before the ongoing authentication procedure has been completed and no GPRS attach procedure is pending on the network (i.e. no ATTACH ACCEPT/REJECT message has to be sent as an answer to an ATTACH REQUEST message), the network shall abort the authentication and ciphering procedure and proceed with the new GPRS attach procedure.

d) Collision of an authentication and ciphering procedure with a GPRS attach procedure when the authentication and ciphering procedure has been caused by a previous GPRS attach procedure

If the network receives an ATTACH REQUEST message before the ongoing authentication procedure has been completed and a GPRS attach procedure is pending (i.e. an ATTACH ACCEPT/REJECT message has still to be sent as an answer to an earlier ATTACH REQUEST message), then:

- If one or more of the information elements in the ATTACH REQUEST message differs from the ones received within the previous ATTACH REQUEST message, the network shall not treat the authentication any further and proceed with the GPRS attach procedure; or
- If the information elements do not differ, then the network shall not treat any further this new ATTACH REQUEST.

Collision of an authentication and ciphering procedure with a GPRS detach procedure

GPRS detach containing cause "power off":

If the network receives a DETACH REQUEST message before the ongoing authentication and ciphering procedure has been completed, the network shall abort the authentication and ciphering procedure and shall progress the GPRS detach procedure.

GPRS detach containing other causes than "power off":

If the network receives a DETACH REQUEST message before the ongoing authentication and ciphering procedure has been completed, the network shall complete the authentication and ciphering procedure and shall respond to the GPRS detach procedure as described in subclause 4.7.4.

e) Collision of an authentication and ciphering procedure with a routing area updating procedure

If the network receives a ROUTING AREA UPDATE REQUEST message before the ongoing authentication procedure has been completed, the network shall progress both procedures.

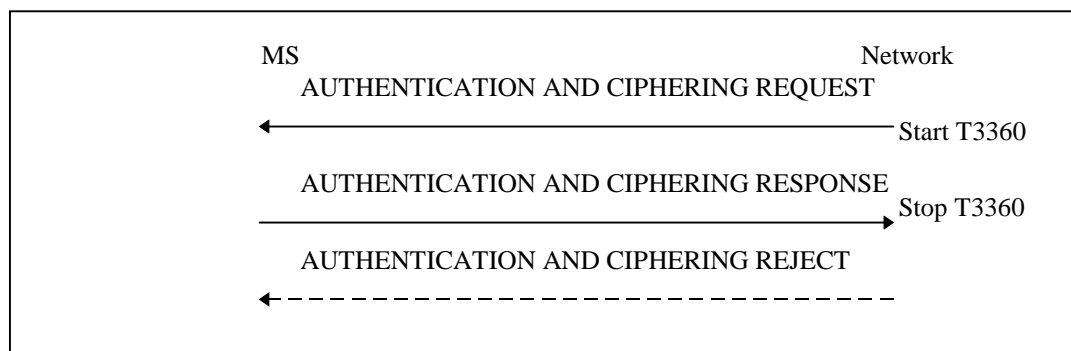

**Figure 4.7.7/1 3GPP TS 24.008: Authentication and ciphering procedure**

(f) Authentication failure (GMM cause "MAC failure" or "GSM authentication unacceptable")

The MS shall send an AUTHENTICATION & CIPHERING FAILURE message, with GMM cause "MAC failure" or "GSM authentication unacceptable" according to subclause 4.7.7.5.1, to the network and start timer T3318. Furthermore, the MS shall stop any of the retransmission timers that are running (e.g. T3310, T3321, T3330 or T3317). Upon the first receipt of an AUTHENTICATION & CIPHERING FAILURE message from

the MS with GMM cause "MAC failure" or "GSM authentication unacceptable" the network may initiate the identification procedure described in subclause 4.7.8. This is to allow the network to obtain the IMSI from the MS. The network may then check that the P-TMSI originally used in the authentication challenge corresponded to the correct IMSI. Upon receipt of the IDENTITY REQUEST message from the network, the MS shall send the IDENTITY RESPONSE message.

NOTE: Upon receipt of an AUTHENTICATION & CIPHERING FAILURE message from the MS with reject cause "MAC failure" or "GSM authentication unacceptable", the network may also terminate the authentication procedure (see subclause 4.7.7.5).

If the P-TMSI/IMSI mapping in the network was incorrect, the network should respond by sending a new AUTHENTICATION & CIPHERING REQUEST message to the MS. Upon receiving the new AUTHENTICATION & CIPHERING REQUEST message from the network, the MS shall stop timer T3318, if running, and then process the challenge information as normal.

If the network is validated successfully (an AUTHENTICATION & CIPHERING REQUEST message that contains a valid SQN and MAC is received), the MS shall send the AUTHENTICATION & CIPHERING RESPONSE message to the network and shall start any retransmission timers (e.g. T3310, T3321, T3330 or T3317), if they were running and stopped when the MS received the first failed AUTHENTICATION AND CIPHERING REQUEST message.

If the MS receives the second AUTHENTICATION AND CIPHERING REQUEST while T3318 is running and

- the MAC value cannot be resolved; or
- the message was received in UMTS and contains a GSM authentication challenge,

the MS shall follow the procedure specified in this subclause (f), starting again from the beginning. If the SQN is invalid, the MS shall proceed as specified in (g).

It can be assumed that the source of the authentication challenge is not genuine (authentication not accepted by the MS) if any of the following occurs:

- after sending the AUTHENTICATION & CIPHERING FAILURE message with GMM cause "MAC failure" or "GSM authentication unacceptable" the timer T3318 expires;
- the MS detects any combination of the authentication failures: "MAC failure", "invalid SQN", and "GSM authentication unacceptable", during three consecutive authentication challenges. The authentication challenges shall be considered as consecutive only, if the authentication challenges causing the second and third authentication failure are received by the MS, while the timer T3318 or T3320 started after the previous authentication failure is running.

When it has been deemed by the MS that the source of the authentication challenge is not genuine (authentication not accepted by the MS), the MS shall behave as described in subclause 4.7.7.6.1.

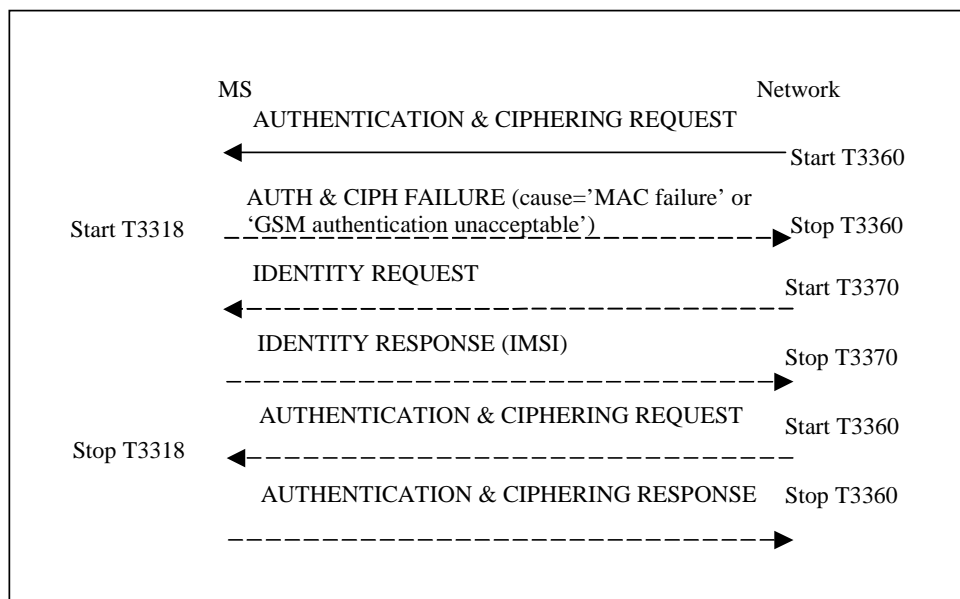

**Figure 4.7.7a/1 3GPP TS 24.008: Authentication failure cause "MAC failure" or "GSM authentication unacceptable"**

(g) Authentication failure (GMM cause "Synch failure"):

The MS shall send an AUTHENTICATION & CIPHERING FAILURE message, with the GMM cause "Synch failure", to the network and start the timer T3320. Furthermore, the MS shall stop any of the retransmission timers that are running (e.g. T3310, T3321, T3330 or T3317). Upon the first receipt of an AUTHENTICATION & CIPHERING message from the MS with the GMM cause "synch failure", the network shall use the returned AUTS parameter from the authentication & ciphering failure parameter IE in the AUTHENTICATION & CIPHERING FAILURE message, to re-synchronise. The re-synchronisation procedure requires the SGSN to delete all unused authentication vectors for that IMSI and obtain new vectors from the HLR. When re-synchronisation is complete, the network shall initiate the authentication & ciphering procedure. Upon receipt of the AUTHENTICATION & CIPHERING REQUEST message, the MS shall stop timer T3320, if running.

**NOTE:** Upon receipt of two consecutive AUTHENTICATION & CIPHERING FAILURE messages from the MS with reject cause "synch failure", the network may terminate the authentication procedure by sending an AUTHENTICATION & CIPHERING REJECT message.

If the network is validated successfully (a new AUTHENTICATION & CIPHERING REQUEST message is received which contains a valid SQN and MAC) while T3320 is running, the MS shall send the AUTHENTICATION & CIPHERING RESPONSE message to the network and shall start any retransmission timers (i.e. T3310, T3321, T3330 or T3317), if they were running and stopped when the MS received the first failed AUTHENTICATION AND CIPHERING REQUEST message.

If the MS receives the second AUTHENTICATION & CIPHERING REQUEST while T3320 is running and

- the MAC value cannot be resolved; or
- the message was received in Iu mode and contains a GSM authentication challenge,

the MS shall proceed as specified in (f). If the SQN is invalid, the MS shall follow the procedure specified in this subclause (g), starting again from the beginning.

The MS shall deem that the network has failed the authentication check and behave as described in subclause 4.7.7.6.1, if any of the following occurs:

- the timer T3320 expires;
- the MS detects any combination of the authentication failures: "MAC failure", "invalid SQN", and "GSM authentication unacceptable", during three consecutive authentication challenges. The authentication challenges shall be considered as consecutive only, if the authentication challenges causing the second and third authentication failure are received by the MS, while the timer T3318 or T3320 started after the previous authentication failure is running.

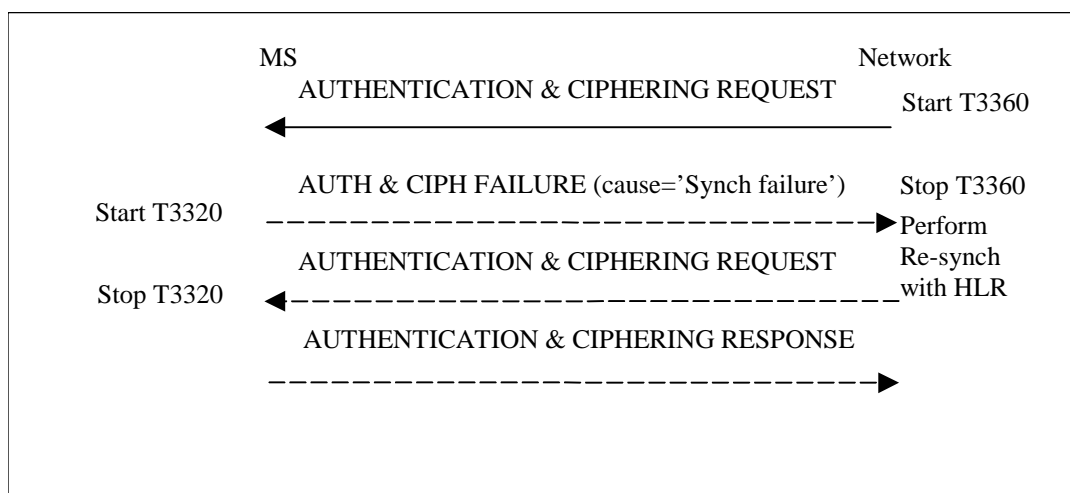

**Figure 4.7.7b/1 3GPP TS 24.008: Authentication failure cause "Synch failure"**

#### 4.7.7.6.1 MS behaviour towards a network that has failed the authentication procedure

If the MS deems that the network has failed the authentication check, then it shall request RR or RRC to release the RR connection and the PS signalling connection, if any, and bar the active cell or cells (see 3GPP TS 25.331 and 3GPP TS 44.018). The MS shall start any retransmission timers (i.e. T3310, T3321, T3330 or T3317), if they were running and stopped when the MS received the first AUTHENTICATION AND CIPHERING REQUEST message containing an invalid MAC or invalid SQN, or no AUTN when a UMTS authentication challenge was expected.

#### 4.7.7.7 Use of established security contexts

In A/Gb mode, in the case of an established GSM security context, the GPRS GSM ciphering key shall be taken into use by the MS before the AUTHENTICATION AND CIPHERING RESPONSE message is transmitted.

In A/Gb mode, in the case of an established UMTS security context, the GPRS GSM ciphering key shall be taken into use by the MS before the AUTHENTICATION AND CIPHERING RESPONSE message is transmitted. The network shall derive a GPRS GSM ciphering key from the GPRS UMTS ciphering key and the GPRS UMTS integrity key, by using the conversion function named "c3" defined in 3GPP TS 33.102 [5a].

In A/Gb mode, if during an ongoing, already ciphering protected RR connection, the network initiates a new Authentication and ciphering procedure, the new GPRS GSM ciphering key shall be taken into use by the MS before the AUTHENTICATION AND CIPHERING RESPONSE message is transmitted. In case of inter-system change to Iu mode after receipt of the AUTHENTICATION AND CIPHERING REQUEST message, the MS and the network shall take the new keys into use immediately after the inter-system change.

In Iu mode, in the case of an established GSM security context, the ME shall derive a GPRS UMTS ciphering key and a GPRS UMTS integrity key from the GPRS GSM ciphering key by using the conversion functions named "c4" and "c5" defined in 3GPP TS 33.102 [5a]. The derived GPRS UMTS ciphering key and GPRS UMTS integrity key shall be taken into use by the MS when a valid SECURITY MODE COMMAND indicating PS domain is received during an RR connection (the definition of a valid SECURITY MODE COMMAND message is given in 3GPP TS 25.331 [23c]). The network shall derive a GPRS UMTS ciphering key and a GPRS UMTS integrity key from the GPRS GSM ciphering key by using the conversion functions named "c4" and "c5" defined in 3GPP TS 33.102 [5a].

In Iu mode, in the case of an established UMTS security context, the GPRS UMTS ciphering key and the GPRS UMTS integrity key shall be taken into use by the MS when a valid SECURITY MODE COMMAND indicating PS domain is received during an PS signalling connection (the definition of a valid SECURITY MODE COMMAND message is given in 3GPP TS 25.331[23c]).

In Iu mode, if the MS received a valid SECURITY MODE COMMAND indicating PS domain in Iu mode or a valid AUTHENTICATION AND CIPHERING REQUEST in A/Gb mode before the network initiates a new Authentication and ciphering procedure and establishes a new GSM/UMTS security context, the new GPRS UMTS ciphering key and GPRS UMTS integrity key are taken into use by the MS, when a new valid SECURITY MODE COMMAND indicating PS domain is received during the PS signalling connection. In case of inter-system change to A/Gb mode, the MS and the network shall take the new keys into use immediately after the inter-system change.

#### 4.7.7.8 Handling of keys at intersystem change from Iu mode to A/Gb mode

At an inter-system change from Iu mode to A/Gb mode, ciphering may be started (see 3GPP TS 44.064 [78a]) without any new authentication and ciphering procedure. Deduction of the appropriate security key for ciphering in A/Gb mode, depends on the current GSM/UMTS security context stored in the MS and the network.

The ME shall handle the GPRS GSM ciphering key according to table 4.7.7.8.1.

Before any initial GMM message is sent in the new cell in A/Gb mode, the GMM layer in the MS shall notify the LLC layer if ciphering shall be used or not. If yes, the GPRS GSM ciphering key and the applicable ciphering algorithm according to the stored *Ciphering Algorithm IE* in the MS shall also be indicated to the LLC layer (see 3GPP TS 44.064 [78a]).

**Table 4.7.7.8.1/3GPP TS 24.008: Inter-system change from Iu mode to A/Gb mode**

Security context established in MS and network in Iu mode	At inter-system change to A/Gb mode:
GSM security context	An ME shall apply the GPRS GSM cipher key that was received from the GSM security context created in the SIM/USIM during the latest successful authentication procedure.
UMTS security context	An ME shall apply the GPRS GSM cipher key that was derived by the USIM from the GPRS UMTS cipher key and the GPRS UMTS integrity key during the latest successful authentication procedure.

NOTE: A USIM with UMTS security context, passes the GPRS UMTS ciphering key, the GPRS UMTS integrity key and the derived GPRS GSM ciphering key to the ME independent on the current radio access being UTRAN or GERAN.

#### 4.7.7.9 Handling of keys at intersystem change from A/Gb mode to Iu mode

At an inter-system change from A/Gb mode to Iu mode, ciphering and integrity may be started (see 3GPP TS 25.331) without any new authentication and ciphering procedure. Deduction of the appropriate security keys for ciphering and integrity check in Iu mode, depend on the current GSM/UMTS security context stored in the MS and the network.

The ME shall handle the GPRS UMTS cipher key and the GPRS UMTS integrity key according to table 4.7.7.9.1.

**Table 4.7.7.9.1/3GPP TS 24.008: Inter-system change from A/Gb mode to Iu mode**

Security context established in MS and network in A/Gb mode	At inter-system change to Iu mode:
GSM security context	An ME shall derive the GPRS UMTS cipher key and the GPRS UMTS integrity key from the GPRS GSM cipher key that was provided by the SIM/USIM during the latest successful authentication procedure. The conversion functions named "c4" and "c5" in 3GPP TS 33.102 [5a] are used for this purpose.
UMTS security context	An ME shall apply the GPRS UMTS ciphering key and the GPRS UMTS integrity key that were received from the UMTS security context created in the USIM during the latest successful authentication procedure.

NOTE: A USIM with UMTS security context, passes the GPRS UMTS ciphering key, the GPRS UMTS integrity key and the derived GPRS GSM ciphering key to the ME independent on the current radio access being UTRAN or GERAN.

### 4.7.8 Identification procedure

The identification procedure is used by the network to request an MS to provide specific identification parameters to the network e.g. International Mobile Subscriber Identity, International Mobile Equipment Identity (see 3GPP TS 23.003 [10]). For the presentation of the IMEI, the requirements of 3GPP TS 42.009 [5] apply.

#### 4.7.8.1 Identification initiation by the network

The network initiates the identification procedure by transferring an IDENTITY REQUEST message to the MS and starts the timer T3370. The IDENTITY REQUEST message specifies the requested identification parameters in the identity type information element.

#### 4.7.8.2 Identification response by the MS

An MS that has been attached to GPRS shall be ready to respond to an IDENTITY REQUEST message at any time.

Upon receipt of the IDENTITY REQUEST message the MS sends back an IDENTITY RESPONSE message. The IDENTITY RESPONSE message shall contain the identification parameters as requested by the network.

#### 4.7.8.3 Identification completion by the network

Upon receipt of the IDENTITY RESPONSE the network shall stop timer T3370.

#### 4.7.8.3a Abnormal cases in the MS

- (a) Requested identity is not available:

If the MS cannot encode the requested identity in the IDENTITY RESPONSE message, e.g. because no valid SIM is available, then it shall encode the identity type as "No identity".

#### 4.7.8.4 Abnormal cases on the network side

The following abnormal cases can be identified:

- a) Lower layer failure

Upon detection of a lower layer failure before the IDENTITY RESPONSE is received, the network shall abort any ongoing GMM procedure.

- b) Expiry of timer T3370

The identification procedure is supervised by the network by the timer T3370. The network shall, on the first expiry of the timer T3370, retransmit the IDENTITY REQUEST message and reset and restart the timer T3370. This retransmission is repeated four times, i.e. on the fifth expiry of timer T3370, the network shall abort the identification procedure and any ongoing GMM procedure.

- c) Collision of an identification procedure with a GPRS attach procedure

If the network receives an ATTACH REQUEST message before the ongoing identification procedure has been completed and no GPRS attach procedure is pending on the network (i.e. no ATTACH ACCEPT/REJECT message has still to be sent as an answer to an ATTACH REQUEST message), the network shall proceed with the GPRS attach procedure.

- d) Collision of an identification procedure with a GPRS attach procedure when the identification procedure has been caused by a GPRS attach procedure

If the network receives an ATTACH REQUEST message before the ongoing identification procedure has been completed and a GPRS attach procedure is pending (i.e. an ATTACH ACCEPT/REJECT message has to be sent as an answer to an earlier ATTACH REQUEST message), then:

- If one or more of the information elements in the ATTACH REQUEST message differs from the ones received within the previous ATTACH REQUEST message, the network shall proceed with the GPRS attach procedure; or
- If the information elements do not differ, then the network shall not treat any further this new ATTACH REQUEST.

Collision of an identification procedure with an MS initiated GPRS detach procedure

GPRS detach containing cause "power off":



If the network receives a DETACH REQUEST message before the ongoing identification procedure has been completed, the network shall abort the identification procedure and shall progress the GPRS detach procedure.

GPRS detach containing other causes than "power off":

If the network receives a DETACH REQUEST message before the ongoing identification procedure has been completed, the network shall complete the identification procedure and shall respond to the GPRS detach procedure as described in subclause 4.7.4.

- e) Collision of an identification procedure with a routing area updating procedure

If the network receives a ROUTING AREA UPDATE REQUEST message before the ongoing identification procedure has been completed, the network shall progress both procedures.

- f) Collision of an identification procedure with a service request procedure

If the network receives a SERVICE REQUEST message before the ongoing identification procedure has been completed, the network shall progress both procedures.

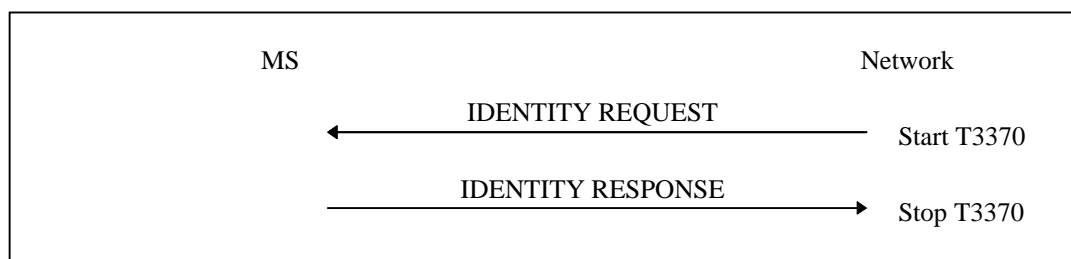

Figure 4.7.8/1 3GPP TS 24.008: Identification procedure

## 4.7.9 Paging procedure

### 4.7.9.1 Paging for GPRS services

In A/Gb mode, paging is used by the network to identify the cell the MS has currently selected, or to prompt the mobile to re-attach if necessary as a result of network failure. If the MS is not GPRS attached when it receives a paging for GPRS services, the MS shall ignore the paging.

In Iu mode, paging is used by the network to request the establishment of PS signalling connection or to prompt the mobile to re-attach if necessary as a result of network failure. If the MS is not GPRS attached when it receives a paging for GPRS services, the MS shall ignore the paging.

#### 4.7.9.1.1 Paging for GPRS services using P-TMSI

The network shall initiate the paging procedure for GPRS services using P-TMSI when GMM signalling messages or user data is pending to be sent to the MS while the Mobile Reachable timer is running. The network may page only GPRS MSs which are GMM-REGISTERED and identified by a local P-TMSI.

In Iu mode, to initiate the procedure the GMM entity in the network requests the lower layer to start paging (see 3GPP TS 25.331 [23c] and 3GPP TS 25.413) and starts timer T3313. Upon reception of a paging indication, the MS shall respond to the paging with a SERVICE REQUEST message with service type "paging response" (see 3GPP TS 24.007 [20], 3GPP TS 23.060 [74], 3GPP TS 25.331 [23c] and 3GPP TS 25.413). If the paging request for GPRS services was received during an ongoing MS initiated GMM specific procedure, then the MS shall progress the GMM specific procedure, and the network shall proceed with the GMM specific procedure.

In A/Gb mode, to initiate the procedure the GMM entity requests the RR sublayer to start paging (see 3GPP TS 44.018 [84], 3GPP TS 44.060 [76], and starts timer T3313). Upon reception of a paging indication, the MS shall respond to the paging with any LLC frame (see 3GPP TS 44.064 [78a], TS 24.007 [20], 3GPP TS 23.060 [74]).

At intersystem change, an MS not having the READY timer running in A/Gb mode or an MS in PMM-IDLE mode in Iu mode, being paged in a different access network as when it last sent user data or signalling message, uses ROUTING

AREA UPDATE REQUEST message as paging response, i.e. the RA update procedure shall be performed instead according to the selective routing area update procedure.

The network shall stop timer T3313 when a response is received from the MS. When the timer T3313 expires the network may reinitiate paging.

In Iu mode, when a response is received from the MS, the network shall change from PMM-IDLE mode to PMM-CONNECTED mode.

In A/Gb mode, when a response different from an LLC NULL frame is received from the MS, the network shall start the READY timer.

#### 4.7.9.1.2 Paging for GPRS services using IMSI

Paging for GPRS services using IMSI is an abnormal procedure used for error recovery in the network.

The network may initiate paging using IMSI if the P-TMSI is not available due to a network failure.

In Iu mode, to initiate the procedure the GMM entity in the network requests the lower layer to start paging (see 3GPP TS 25.331 [23c] and 3GPP TS 25.413).

In A/Gb mode, to initiate the procedure the GMM entity in the network requests the RR sublayer to start paging (see 3GPP TS 44.018 [84], 3GPP TS 44.060 [76]).

Upon reception of a paging indication for GPRS services using IMSI, the MS shall locally deactivate any active PDP context(s), MBMS context(s) and locally detach from GPRS. The local detach includes deleting any RAI, P-TMSI, P-TMSI signature and GPRS ciphering key sequence number stored, setting the GPRS update status to GU2 NOT UPDATED and changing state to GMM-DEREGISTERED.

In Iu mode, when an MS receives a paging request for GPRS services using the IMSI from the network before an MS initiated GMM specific procedure has been completed, then the MS shall abort the GMM specific procedure, and the MS shall proceed according to the description in this clause.

After performing the local detach, the MS shall then perform a GPRS attach or combined GPRS attach procedure.

After performing the attach, the MS should activate PDP context(s) to replace any previously active PDP context(s). The MS should also perform the procedures needed in order to activate any previously active multicast service(s).

NOTE 1: In some cases, user interaction may be required and then the MS cannot activate the PDP and MBMS context(s) automatically.

NOTE 2: The MS does not respond to the paging except with the Attach Request. Hence timer T3313 in the network is not used when paging with IMSI.

NOTE 3: Paging without DRX parameters may require a considerable extension of the paging duration.

#### 4.7.9.2 Paging for non-GPRS services

The network may initiate the paging procedure for non-GPRS services when the MS is IMSI attached for non-GPRS services.

In Iu mode, to initiate the procedure the GMM entity requests the lower layer to start paging (see 3GPP TS 25.331 [23c] and 3GPP TS 25.413) for non-GPRS services.

In A/Gb mode, to initiate the procedure the GMM entity requests the RR sublayer to start paging (see 3GPP TS 44.018 [84] and 3GPP TS 44.060 [76] for non-GPRS services).

The MS identity used for paging shall be the allocated TMSI if acknowledged by the MS, otherwise the IMSI.

#### 4.7.10 Receiving a GMM STATUS message by a GMM entity

If the MS receives a GMM STATUS message no state transition and no specific action shall be taken as seen from the radio interface, i.e. local actions are possible. The actions to be taken on receiving a GMM STATUS message in the network are an implementation dependent option.

## 4.7.11 Void

## 4.7.12 GMM Information procedure

The GMM information message support is optional in the network. The MM information procedure may be invoked by the network at any time during an established GMM context.

### 4.7.12.1 GMM information procedure initiation by the network

The GMM information procedure consists only of the GMM INFORMATION message sent from the network to the mobile station. During an established GMM context, the network may send none, one, or more GMM INFORMATION messages to the mobile station. If more than one GMM INFORMATION message is sent, the messages need not have the same content.

### 4.7.12.2 GMM information procedure in the mobile station

When the mobile station (supporting the GMM information message) receives an GMM INFORMATION message, it shall accept the message and optionally use the contents to update appropriate information stored within the mobile station.

If the mobile station does not support the GMM information message the mobile station shall ignore the contents of the message and return an GMM STATUS message with cause #97.

## 4.7.13 Service Request procedure (lu mode only)

The purpose of this procedure is to transfer the PMM mode from PMM-IDLE to PMM-CONNECTED mode, and/or to assign radio access bearer in case of PDP contexts are activated without radio access bearer assigned. In latter case, the PMM mode may be PMM-IDLE mode or may alternatively be the PMM-CONNECTED mode if the MS requires radio access bearer re-establishment. This procedure is used for;

- the initiation of CM layer service (e.g. SM or SMS) procedure from the MS in PMM-IDLE mode,
- the network to transfer down link signalling,
- uplink (in PMM-IDLE or PMM CONNECTED) and downlink (only in PMM-IDLE) user data,
- counting the number of mobile stations in a cell which are interested in a specific MBMS multicast service.
- requesting the establishment of a point-to-point Radio Bearer for receiving a MBMS service.

For downlink transfer of signalling or user data in PMM-IDLE mode, the trigger is given from the network by the paging request procedure, which is out of scope of the present document.

For pending downlink user data in PMM-CONNECTED mode, the re-establishment of radio access bearers for all active PDP contexts is done without paging.

For counting the number of mobile stations in PMM-IDLE mode interested in a specific MBMS service, the trigger is given from the network by the MBMS notification procedure (see 3GPP TS 25.331 [23c]).

For establishing a point-to-point radio bearer to allow MBMS service, the trigger is given from the RRC determining this need from the MBMS control parameters broadcasted by the network (see 3GPP TS 25.331 [23c]).

Service type can take either of the following values; "signalling", "data", "paging response" or "MBMS service reception". Each of the values shall be selected according to the criteria to initiate the Service request procedure.

The criteria to invoke the Service request procedure are when;

- a) the MS has any signalling messages except GMM messages (e.g. for SM or SMS) to be sent to the network in PMM-IDLE mode (i.e., no secure PS signalling connection has been established). In this case, the service type shall be set to "signalling".
- b) the MS, either in PMM-IDLE or PMM-CONNECTED mode, has pending user data to be sent, no radio access bearer is established for the corresponding PDP context, and timer T3319 (see subclause 4.7.13.3) is not running.

The procedure is initiated by an indication from the lower layers (see 3GPP TS 24.007 [20]). In this case, the service type shall be set to "data".

- c) the MS receives a paging request for PS domain from the network in PMM-IDLE mode. In this case, the service type shall be set to "paging response".
- d) the MS is in PMM-IDLE mode, receives an MBMS notification for an MBMS multicast service for which the MS has activated an MBMS context, and is prompted by the contents of the notification to establish a PS signalling connection (see 3GPP TS 25.346 [110]). In this case, the service type shall be set to "MBMS service reception".
- e) the MS in PMM-IDLE mode, determines from the broadcast MBMS control parameters that there is a need to establish a point-to-point Radio Bearer to enable MBMS reception (see 3GPP TS 25.346 [110]). In this case, the service type shall be set to "MBMS service reception".

If one of the above criteria to invoke the Service request procedure is fulfilled, then the Service request procedure may only be initiated by the MS when the following conditions are fulfilled:

- its GPRS update status is GU1 UPDATED; and
- no GMM specific procedure is ongoing (see subclause 4.1.1.1).

If a GMM specific procedure is ongoing at the time a request from CM sublayer, the RRC or the RABM (see 3GPP TS 24.007 [20]) is received and the ATTACH REQUEST or ROUTING AREA UPDATE REQUEST message has been sent, then, depending on implementation, the MS shall abort the received request or delay it until the GMM specific procedure is completed. If the ATTACH REQUEST or ROUTING AREA UPDATE REQUEST message has not been sent, the MS may indicate "follow-on request pending" in the message (i.e. the MS wishes to prolong the established PS signalling connection after the GMM specific procedure). Then, the MS shall delay the Service request procedure until the GMM specific procedure is completed.

If the network indicates "follow-on proceed" in the ATTACH ACCEPT or ROUTING AREA UPDATE ACCEPT message and the MS has a service request pending, the MS shall react depending on the service type. If the service type is:

- "signalling": the MS shall abort the Service request procedure and send the pending signalling messages immediately;
- "data": the MS shall immediately perform the pending Service request procedure using the current PS signalling connection;
- "paging response": the MS shall abort the Service request procedure. No further specific action is required from the MS.

If the network indicates "follow-on proceed" and the MS has no service request pending, then no specific action is required from the MS.

If the network indicates "no follow-on proceed" in the ATTACH ACCEPT or ROUTING AREA UPDATE ACCEPT message, the MS shall not initiate the pending Service request procedure until the current PS signalling connection is released.

**NOTE:** The "follow-on proceed" indication was not defined in earlier versions of the protocol. A network that is compliant with the earlier versions of the protocol will always encode the respective bit as zero, i.e. as "follow-on proceed", even if it does not prolong the PS signalling connection.

After completion of a Service request procedure but before re-establishment of radio access bearer, if the PDP and MBMS context status information elements are included, then the network shall deactivate all those PDP and MBMS contexts locally (without peer to peer signalling between the MS and the network), which are not in SM state PDP-INACTIVE on network side but are indicated by the MS as being in state PDP-INACTIVE.

After completion of a Service request procedure, the pending service is resumed and uses then the connection established by the procedure. If the service type is indicating "data", then the radio access bearers for all activated PDP contexts are re-established by the network, except for those activated PDP contexts having maximum bit rate value set to 0 kbit/s for both uplink and downlink. The re-establishment of radio access bearers for those PDP contexts is specified in subclause 6.1.3.3.

The selective re-assignment capability is not supported for the simplicity of the function.

#### 4.7.13.1 Service Request procedure initiation

The MS initiates the Service request procedure by sending a SERVICE REQUEST message. The timer T3317 shall be started after the SERVICE REQUEST message has been sent and state GMM-SERVICE-REQUEST-INITIATED is entered. The message SERVICE REQUEST shall contain the P-TMSI and the Service type shall indicate either "data", "signalling", "paging response" or "MBMS notification response".

If the PDP context status information element is included in the SERVICE REQUEST message, then the network shall deactivate all those PDP contexts locally (without peer to peer signalling between the MS and the network) which are not in SM state PDP-INACTIVE on the network side, but are indicated by the MS as being in state PDP-INACTIVE.

If the MBMS context status information element is included in the SERVICE REQUEST message, then the network shall deactivate all those MBMS contexts locally (without peer to peer signalling between the MS and network) which are not in SM state PDP-INACTIVE on the network side, but are indicated by the MS as being in state PDP-INACTIVE. If no MBMS context status information element is included, then the network shall deactivate all MBMS contexts locally which are not in SM state PDP-INACTIVE on the network side.

#### 4.7.13.2 GMM common procedure initiation

The network may initiate GMM common procedures, e.g. the GMM identification or the GMM authentication and ciphering procedure, depending on the received information such as GPRS ciphering key sequence number and P-TMSI.

#### 4.7.13.3 Service request procedure accepted by the network

If the SERVICE REQUEST message was sent in PMM-IDLE mode, the indication from the lower layers that the security mode control procedure is completed shall be treated as a successful completion of the procedure. The timer T3317 shall be stopped, and the MS enters GMM-REGISTERED state and PMM-CONNECTED mode.

If the SERVICE REQUEST message was sent in PMM-CONNECTED mode, then the reception of the SERVICE ACCEPT message shall be treated as a successful completion of the procedure. The timer T3317 shall be stopped and the MS remains in PMM-CONNECTED mode.

At successful completion of a service request procedure with Service type "data", the MS shall start timer T 3319. The timer T 3319 shall be stopped when the MS returns to PMM-IDLE mode or when the network releases the radio access bearer of any active PDP context. The MS shall not issue another Service Request with service type "data" while timer T 3319 is running.

If the PDP context status information element is included in the Service Accept, then the MS shall deactivate locally (without peer to peer signalling between the MS and the network) all that PDP contexts which are not in SM state PDP-INACTIVE on MS side but are indicated by the Network as being in state PDP-INACTIVE.

If the MBMS context status information element is included in the SERVICE ACCEPT message, then the MS shall deactivate all those MBMS contexts locally (without peer to peer signalling between the MS and network) which are not in SM state PDP-INACTIVE in the MS, but are indicated by the network as being in state PDP-INACTIVE. If no MBMS context status information element is included, then the MS shall deactivate all those MBMS contexts locally which are not in SM state PDP-INACTIVE in the MS.

#### 4.7.13.4 Service request procedure not accepted by the network

If the Service request cannot be accepted, the network returns a SERVICE REJECT message to the mobile station. An MS that receives a SERVICE REJECT message stops timer T3317. The MS shall then take different actions depending on the received reject cause value:

# 3 (Illegal MS); or

# 6 (Illegal ME);

- The MS shall set the GPRS update status to GU3 ROAMING NOT ALLOWED (and shall store it according to subclause 4.1.3.2) and enter the state GMM-DEREGISTERED. Furthermore, it shall delete any P-TMSI, P-

TMSI signature, RAI and GPRS ciphering key sequence number and shall consider the SIM/USIM as invalid for GPRS services until switching off or the SIM/USIM is removed.

- A GPRS MS operating in MS operation mode A shall in addition set the update status to U3 ROAMING NOT ALLOWED, shall delete any TMSI, LAI and ciphering key sequence number. If the MS is operating in MS operation mode A and an RR connection exists, the MS shall abort the RR connection, unless an emergency call is ongoing. The SIM/USIM shall be considered as invalid also for non-GPRS services until switching off or the SIM/USIM is removed.

# 7 (GPRS services not allowed);

- The MS shall set the GPRS update status to GU3 ROAMING NOT ALLOWED (and shall store it according to subclause 4.1.3.2.9) and shall delete any P-TMSI, P-TMSI signature, RAI and GPRS ciphering key sequence number. The SIM/USIM shall be considered as invalid for GPRS services until switching off or the SIM/USIM is removed. The new state is GMM-DEREGISTERED.

# 9 (MS identity cannot be derived by the network);

- The MS shall set the GPRS update status to GU2 NOT UPDATED (and shall store it according to subclause 4.1.3.2), enter the state GMM-DEREGISTERED, and shall delete any P-TMSI, P-TMSI signature, RAI and GPRS ciphering key sequence number. Subsequently, the MS may automatically initiate the GPRS attach procedure.

# 10 (Implicitly detached);

- The MS shall change to state GMM-DEREGISTERED.NORMAL-SERVICE. The MS shall then perform a new attach procedure. The MS should also activate PDP context(s) to replace any previously active PDP contexts. The MS should also perform the procedures needed in order to activate any previously active multicast service(s).

NOTE: In some cases, user interaction may be required and then the MS cannot activate the PDP and MBMS context(s) automatically.

# 11 (PLMN not allowed);

- The MS shall delete any RAI, P-TMSI, P-TMSI signature and GPRS ciphering key sequence number, shall set the GPRS update status to GU3 ROAMING NOT ALLOWED (and shall store it according to subclause 4.1.3.2) and enter the state GMM-DEREGISTERED.
- The MS shall store the PLMN identity in the "forbidden PLMN list".
- If no RR connection exists, the MS shall perform the following additional actions immediately. If the MS is operating in MS operation mode A and an RR connection exists, the MS shall perform these actions when the RR connection is subsequently released:
  - A GPRS MS operating in MS operation mode A shall set the update status to U3 ROAMING NOT ALLOWED and shall delete any TMSI, LAI and ciphering key sequence number. The new MM state is MM IDLE.
  - The MS shall perform a PLMN selection according to 3GPP TS 23.122 [14].

# 12 (Location area not allowed);

- The MS shall delete any RAI, P-TMSI, P-TMSI signature and GPRS ciphering key sequence number, shall set the GPRS update status to GU3 ROAMING NOT ALLOWED (and shall store it according to subclause 4.1.3.2) and shall change to state GMM-DEREGISTERED.LIMITED-SERVICE.
- The mobile station shall store the LAI in the list of "forbidden location areas for regional provision of service".
- If no RR connection exists, the MS shall perform the following additional actions immediately. If the MS is operating in MS operation mode A and an RR connection exists, the MS shall perform these actions when the RR connection is subsequently released:
  - If the MS is IMSI attached, the MS shall set the update status to U3 ROAMING NOT ALLOWED, shall delete any TMSI, LAI and ciphering key sequence number and shall reset the location update attempt counter. The new MM state is MM IDLE.

- The MS shall perform a cell selection according to 3GPP TS 43.022 [82] and 3GPP TS 25.304.

# 13 (Roaming not allowed in this location area);

- The MS shall set the GPRS update status to GU3 ROAMING NOT ALLOWED (and shall store it according to subclause 4.1.3.2) and shall change to state GMM-REGISTERED.LIMITED-SERVICE.
- The MS shall store the LAI in the list of "forbidden location areas for roaming".
- If no RR connection exists, the MS shall perform the following additional actions immediately. If the MS is operating in MS operation mode A and an RR connection exists, the MS shall perform these actions when the RR connection is subsequently released:
  - If the MS is IMSI attached, the MS shall set the update status to U3 ROAMING NOT ALLOWED and shall reset the location update attempt counter. The new MM state is MM IDLE.
  - The MS shall perform a PLMN selection according to 3GPP TS 23.122 [14].

# 15 (No Suitable Cells In Location Area);

- The MS shall set the GPRS update status to GU3 ROAMING NOT ALLOWED (and shall store it according to subclause 4.1.3.2) and shall change to state GMM-REGISTERED.LIMITED-SERVICE.
- The MS shall store the LAI in the list of "forbidden location areas for roaming".
- If no RR connection exists, the MS shall perform the following additional actions immediately. If the MS is operating in MS operation mode A and an RR connection exists, the MS shall perform these actions when the RR connection is subsequently released:
  - If the MS is IMSI attached, the MS shall set the update status to U3 ROAMING NOT ALLOWED and shall reset the location update attempt counter. The new MM state is MM IDLE.
  - The MS shall search for a suitable cell in another location area in the same PLMN according to 3GPP TS 43.022 [82] and 3GPP TS 25.304.

# 40 (No PDP context activated)

- The MS shall deactivate locally all active PDP and MBMS contexts and the MS shall enter the state GMM-REGISTERED.NORMAL-SERVICE. The MS may also activate PDP context(s) to replace any previously active PDP contexts. The MS may also perform the procedures needed in order to activate any previously active multicast service(s).

NOTE: In some cases, user interaction may be required and then the MS cannot activate the PDP and MBMS context(s) automatically.

Other values are considered as abnormal cases. The specification of the MS behaviour in those cases is described in subclause 4.7.13.5.

#### 4.7.13.5 Abnormal cases in the MS

The following abnormal cases can be identified:

- a) Access barred because of common access class control or PS domain specific access control

The Service request procedure shall not be started. The MS stays in the current serving cell and applies normal cell reselection process. The Service request procedure may be started by CM layer if it is still necessary, i.e. when access is granted or because of a cell change.

- b) Lower layer failure before the security mode control procedure is completed, SERVICE ACCEPT or SERVICE REJECT message is received

The procedure shall be aborted.

- c) T3317 expired

The MS shall enter GMM-REGISTERED state.

If the MS is in PMM-IDLE mode then the procedure shall be aborted and the MS shall release locally any resources allocated for the service request procedure.

If the MS is in PMM-CONNECTED mode, then the procedure shall be aborted.

- d) SERVICE REJECT received, other causes than those treated in subclause 4.7.13.4

The procedure shall be aborted.

- e) Routing area update procedure is triggered

If a cell change into a new routing area occurs and the necessity of routing area update procedure is determined before the security mode control procedure is completed, a SERVICE ACCEPT or SERVICE REJECT message has been received, the Service request procedure shall be aborted and the routing area updating procedure is started immediately. Follow-on request pending may be indicated in the ROUTING AREA UPDATE REQUEST for the service, which was the trigger of the aborted Service request procedure, to restart the pending service itself or the Service request procedure after the completion of the routing area updating procedure. If the Service type of the aborted SERVICE REQUEST was indicating "data", then the routing area update procedure may be followed by a re-initiated Service request procedure indicating "data", if it is still necessary. If the Service type was indicating "MBMS notification response", the Service request procedure shall be aborted.

- f) Power off

If the MS is in state GMM-SERVICE-REQUEST-INITIATED at power off, the GPRS detach procedure shall be performed.

- g) Procedure collision

If the MS receives a DETACH REQUEST message from the network in state GMM-SERVICE-REQUEST-INITIATED, the GPRS detach procedure shall be progressed and the Service request procedure shall be aborted. If the cause IE, in the DETACH REQUEST message, indicated a "reattach request", the GPRS attach procedure shall be performed.

#### 4.7.13.6 Abnormal cases on the network side

The following abnormal cases can be identified:

- a) Lower layer failure

If a low layer failure occurs before the security mode control procedure is completed, a SERVICE ACCEPT or SERVICE REJECT message has been sent to the MS, the network enters/stays in PMM-IDLE.

- b) Protocol error

If the SERVICE REQUEST message is received with a protocol error, the network shall return a SERVICE REJECT message with one of the following reject causes:

#96: Mandatory information element error;

#99: Information element non-existent or not implemented;

#100: Conditional IE error;

#111: Protocol error, unspecified.

The network stays in PMM-IDLE mode.

- c) More than one SERVICE REQUEST received and the procedure has not been completed (i.e., the security mode control procedure has not been completed or SERVICE ACCEPT, SERVICE REJECT message has not been sent)

- If one or more of the information elements in the SERVICE REQUEST message differs from the ones received within the previous SERVICE REQUEST message, the previously initiated Service request procedure shall be aborted and the new Service request procedure shall be progressed;



- If the information elements do not differ, then the network shall continue with the previous Service request procedure and shall not treat any further this SERVICE REQUEST message.

- d) ATTACH REQUEST received before the security mode control procedure has been completed or an SERVICE ACCEPT or an SERVICE REJECT message has been sent

If an ATTACH REQUEST message is received and the security mode control procedure has not been completed or an SERVICE ACCEPT or an SERVICE REJECT message has not been sent, the network may initiate the GMM common procedures, e.g. the GMM authentication and ciphering procedure. The network may e.g. after a successful GMM authentication and ciphering procedure execution, abort the Service request procedure, the GMM context, PDP contexts and MBMS contexts, if any, are deleted and the new ATTACH REQUEST is progressed.

- e) ROUTING AREA UPDATE REQUEST message received before the security mode control procedure has been completed or an SERVICE ACCEPT or an SERVICE REJECT message has been sent

If an ROUTING AREA UPDATE REQUEST message is received and the security mode control procedure has not been completed or an SERVICE ACCEPT or an SERVICE REJECT message has not been sent, the network may initiate the GMM common procedures, e.g. the GMM authentication and ciphering procedure. The network may e.g. after a successful GMM authentication and ciphering procedure execution, abort the Service request procedure and progress the routing area update procedure.

- f) If the Service Type indicates "data" and the network fails to re-establish some or all RAB(s) then the SGSN may determine if PDP Context Modification or PDP Context Deactivation should be initiated. The appropriate action depends on the QoS profile of the PDP Context and is an operator choice.

#### 4.7.14 Void

---

## 5 Elementary procedures for circuit-switched Call Control

### 5.1 Overview

#### 5.1.1 General

This subclause describes the call control (CC) protocol, which is one of the protocols of the Connection Management (CM) sublayer (see 3GPP TS 24.007 [20]).

Every mobile station must support the call control protocol. If a mobile station does not support any bearer capability at all then it shall respond to a SETUP message with a RELEASE COMPLETE message as specified in subclause 5.2.2.2.

In Iu mode only, integrity protected signalling (see subclause 4.1.1.1.1 of the present document and in general, see 3GPP TS 33.102 [5a]) is mandatory. In Iu mode only, all protocols shall use integrity protected signalling. Integrity protection of all CC signalling messages is the responsibility of lower layers. It is the network which activates integrity protection. This is done using the security mode control procedure (3GPP TS 25.331 [23c] and 3GPP TS 44.118 [111]).

In the call control protocol, more than one CC entity are defined. Each CC entity is independent from each other and shall communicate with the correspondent peer entity using its own MM connection. Different CC entities use different transaction identifiers.

With a few exceptions the present document describes the call control protocol only with regard to two peer entities. The call control entities are described as communicating finite state machines which exchange messages across the radio interface and communicate internally with other protocol (sub)layers. This description is only normative as far as the consequential externally observable behaviour is concerned.

Certain sequences of actions of the two peer entities compose "elementary procedures" which are used as a basis for the description in this subclause. These elementary procedures may be grouped into the following classes:

- call establishment procedures;

- call clearing procedures;
- call information phase procedures;
- miscellaneous procedures.

The terms "mobile originating" or "mobile originated" (MO) are used to describe a call initiated by the mobile station. The terms "mobile terminating" or "mobile terminated" (MT) are used to describe a call initiated by the network.

Figure 5.1a/3GPP TS 24.008 gives an overview of the main states and transitions on the mobile station side.

The MS side extension figure 5.1a.1/3GPP TS 24.008 shows how for the Network Initiated MO call the MS reaches state U1.0 from state U0 (CCBS).

Figure 5.1b/3GPP TS 24.008 gives an overview of the main states and transitions on the network side.

The Network side extension figure 5.1b.1/3GPP TS 24.008 shows for Network Initiated MO Calls the Network reaches state N1.0 from state N0 (CCBS).



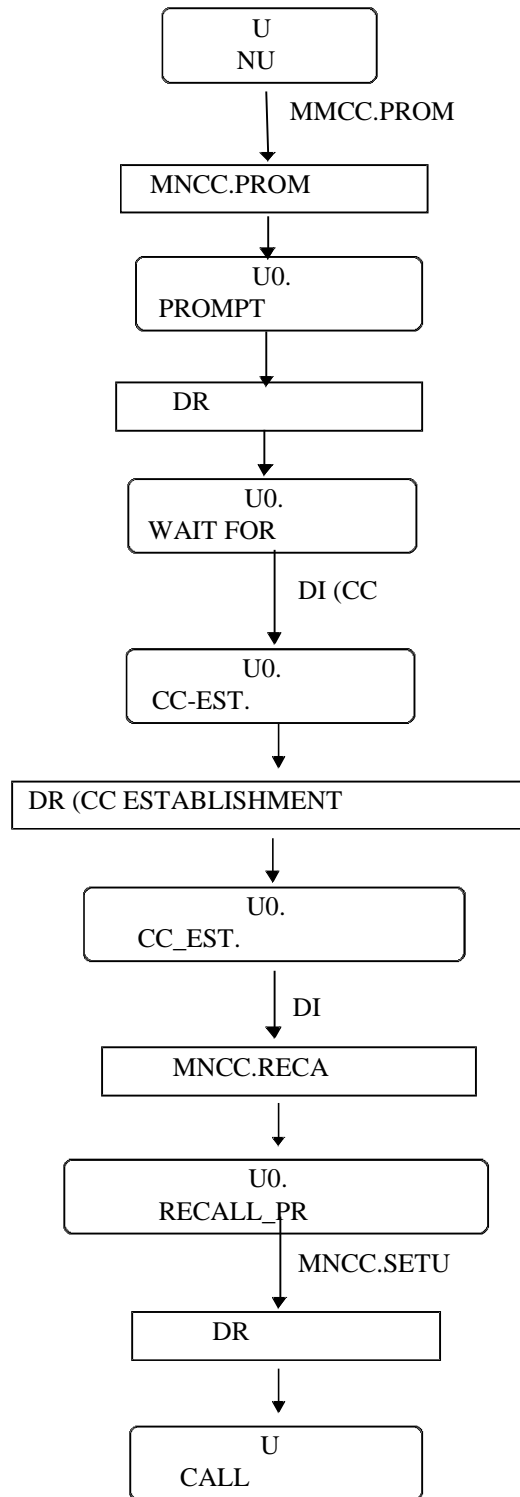

Figure5.1a.1/3GPP TS 24.008: Overview call control protocol/MS side, extension:

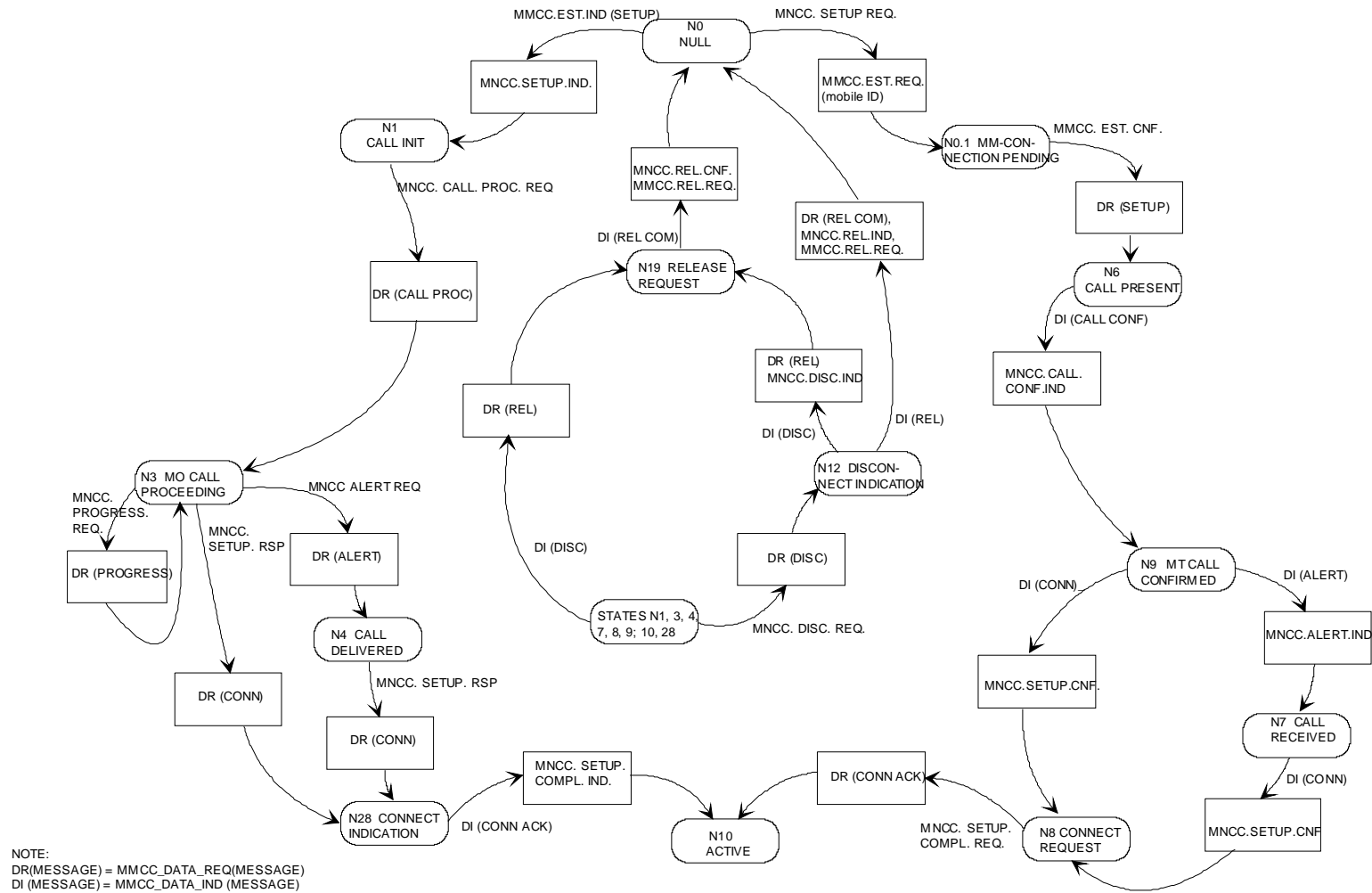

Figure 5.1b/3GPP TS 24.008 Overview call control protocol/Network side

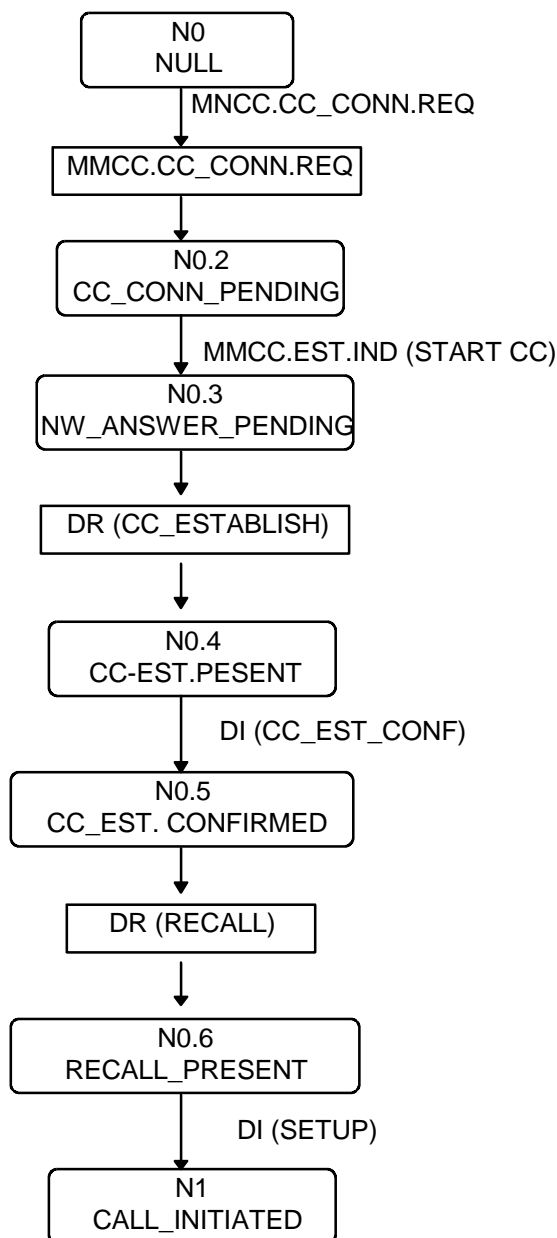

Figure 5.1b.1/3GPP TS 24.008 Overview call control protocol/Network side, extension

## 5.1.2 Call Control States

### 5.1.2.1 Call states at the mobile station side of the interface

The states which may exist on the mobile station side of the radio interface are defined in this subclause.

NOTE: States U0.1, U0.2, U0.3, U0.4, U0.5, U0.6, U26, and U27 are 3GPP specific. All other states are ITU-T defined.

#### 5.1.2.1.1 Null (State U0)

No call exists.

#### 5.1.2.1.2 MM Connection pending (U0.1)

This state exists for a mobile originating call, when the mobile station requests the establishment of a MM connection.

**5.1.2.1.2a CC prompt present (U0.2) \$(CCBS)\$**

This state exists for a mobile originating call when the network has prompted the mobile station to establish a CC connection but the mobile station has not yet responded.

NOTE: This state is transient.

**5.1.2.1.2b Wait for network information (U0.3) \$(CCBS)\$**

This state exists for a mobile originating call when the mobile station has responded to the prompt from the network to establish a CC connection and the mobile station is waiting for further information from the network.

**5.1.2.1.2c CC-Establishment present (U0.4) \$(CCBS)\$**

This state exists for a mobile originating call when the mobile station has received a CC-establishment request but has not yet responded.

NOTE: This state is transient.

**5.1.2.1.2d CC-Establishment confirmed (U0.5) \$(CCBS)\$**

This state exists for a mobile originating call when the mobile station has sent the acknowledgement that the mobile station has received all the CC information that is needed.

**5.1.2.1.2e Recall present (U0.6) \$(CCBS)\$**

This state exists for a mobile originating call when the mobile station has received a recall request but has not yet responded.

NOTE: This state is transient.

**5.1.2.1.3 Call initiated (U1)**

This state exists for a mobile originating call, when the MS requests call establishment from the network.

**5.1.2.1.4 Mobile originating call proceeding (U3)**

This state exists for a mobile originating call when the mobile station has received acknowledgement that the network has received all call information necessary to effect call establishment.

**5.1.2.1.5 Call delivered (U4)**

This state exists for a mobile originating call, when the calling mobile station has received an indication that remote user alerting has been initiated.

**5.1.2.1.6 Call present (U6)**

This state exists for a mobile terminating call when the mobile station has received a call establishment request but has not yet responded.

**5.1.2.1.7 Call received (U7)**

This state exists for a mobile terminating call when the mobile station has indicated alerting but has not yet answered.

**5.1.2.1.8 Connect Request (U8)**

This state exists for a mobile terminating call, when the mobile station has answered the call and is waiting to be awarded the call.

#### 5.1.2.1.9 Mobile terminating call confirmed (U9)

This state exists for a mobile terminating call when the mobile station has sent acknowledgement that the mobile station has received all call information necessary to effect call establishment.

#### 5.1.2.1.10 Active (U10)

This state exists for a mobile terminating call when the MS has answered the call. This state exists for a mobile originating call when the MS has received an indication that the remote user has answered the call.

#### 5.1.2.1.11 Disconnect request (U11)

This state exists when the mobile station has requested the network to clear the end-to-end connection (if any) and is waiting for a response.

#### 5.1.2.1.12 Disconnect indication (U12)

This state exists when the mobile station has received an invitation to disconnect because the network has disconnected the end-to-end connection (if any).

#### 5.1.2.1.13 Release request (U19)

This state exists when the MS has requested the network to release and is waiting for a response.

#### 5.1.2.1.14 Mobile originating modify (U26)

This state exists when the mobile station has sent a request to the network for a new mode but has not yet received an answer.

#### 5.1.2.1.15 Mobile terminating modify (U27)

This state exists when the mobile station has received a request from the network for a new mode and has not yet sent a response to this request.

### 5.1.2.2 Network call states

NOTE: States N0.1, N0.2, N0.3, N0.4, N0.5, N0.6, N26, N27, N28, N3a, N4,a, N7a, and N9a are 3GPP specific. All other states are ITU-T defined.

The call states that may exist on the network side of the radio interface are defined in this subclause.

#### 5.1.2.2.1 Null (State N0)

No call exists.

#### 5.1.2.2.2 MM connection pending (N0.1)

This state exists for a mobile terminating call, when the network requests the establishment of a MM connection.

#### 5.1.2.2.2a CC connection pending (N0.2) \$(CCBS)\$

This state exists for a mobile originating call when the network has requested the mobile station to establish a CC connection.

#### 5.1.2.2.2b Network answer pending (N0.3) \$(CCBS)\$

This state exists for a mobile originating call when the mobile station has established a CC connection upon the request of the network, but the network has not yet informed the mobile station of the reason for the network's action.



**5.1.2.2.2c CC-Establishment present (N0.4) \$(CCBS)\$**

This state exists for a mobile originating call when the network has sent a CC establishment request but has not yet received a satisfactory response.

**5.1.2.2.2d CC-Establishment confirmed (N0.5) \$(CCBS)\$**

This state exists for a mobile originating call when the network has received acknowledgement that the mobile station has received all call information necessary to effect call establishment.

**5.1.2.2.2e Recall present (N0.6) \$(CCBS)\$**  
This state exists for a mobile originating call when the network has sent a recall request but has not yet received a satisfactory response.

**5.1.2.2.3 Call initiated (N1)**

This state exists for a mobile originating call when the network has received a call establishment request but has not yet responded.

**5.1.2.2.4 Mobile originating call proceeding (N3)**

This state exists for a mobile originating call when the network has sent acknowledgement that the network has received all call information necessary to effect call establishment.

**5.1.2.2.5 Call delivered (N4)**

This state exists for a mobile originating call when the network has indicated that remote user alerting has been initiated.

**5.1.2.2.6 Call present (N6)**

This state exists for a mobile terminating call when the network has sent a call establishment request but has not yet received a satisfactory response.

**5.1.2.2.7 Call received (N7)**

This state exists for a mobile terminating call when the network has received an indication that the mobile station is alerting but has not yet received an answer.

**5.1.2.2.8 Connect request (N8)**

This state exists for a mobile terminating call when the network has received an answer but the network has not yet awarded the call.

**5.1.2.2.9 Mobile terminating call confirmed (N9)**

This state exists for a mobile terminating call when the network has received acknowledgement that the mobile station has received all call information necessary to effect call establishment.

**5.1.2.2.10 Active (N10)**

This state exists for a mobile terminating call when the network has awarded the call to the called mobile station. This state exists for a mobile originating call when the network has indicated that the remote user has answered the call.

**5.1.2.2.11 Not used****5.1.2.2.12 Disconnect indication (N12)**

This state exists when the network has disconnected the end- to-end connection (if any) and has sent an invitation to disconnect the mobile station to network connection.

#### 5.1.2.2.13 Release request (N19)

This state exists when the network has requested the MS to release and is waiting for a response.

#### 5.1.2.2.14 Mobile originating modify (N26)

This state exists when the network has received a request from the mobile station for a new mode but has not yet sent a response.

#### 5.1.2.2.15 Mobile terminating modify (N27)

This state exists when the network has sent a request to the mobile station for a new mode but has not yet received an answer.

#### 5.1.2.2.16 Connect Indication (N28)

This state exists for a mobile originating call when the network has indicated that the remote user has answered the call and the network is waiting for acknowledgement by the mobile station.

## 5.2 Call establishment procedures

Establishment of a call is initiated by request of upper layer in either the mobile station or the network; it consists of:

- the establishment of a CC connection between the mobile station and the network;
- the activation of the codec or interworking function.

Whenever it is specified in the present document clause 5 that the mobile station shall attach the user connection, this means that the mobile station shall activate the codec or interworking function as soon as an appropriate channel is available. The mobile station shall de-activate the codec or interworking function whenever an appropriate channel is no longer available. As soon as an appropriate channel is (again) available, the codec or interworking function shall be re-activated. If a new order to attach the user connection is received, the new order shall supersede the previous one.

A channel shall be considered as appropriate if it is consistent with the possibly negotiated bearer capability applicable for the actual phase of the call. The mobile station shall not consider a channel as not appropriate because the type of the channel (full rate/half rate) is not the preferred one. If:

- the user connection has to be attached but no appropriate channel is available for a contiguous time of 30 seconds; or if
- the codec or interworking function is de-activated for a contiguous time of 30 seconds;

then the mobile station may initiate call clearing.

Upon request of upper layers to establish a call, restricting conditions for the establishment of the call are examined. These restricting conditions concern the states of parallel CC entities and are defined elsewhere. If these restricting conditions are fulfilled, the call establishment is rejected. Otherwise a CC entity in state U0, "null", is selected to establish the call. It initiates the establishment by requesting the MM sublayer to establish an MM connection.

In Iu mode, if the lower layers indicate the release of a radio access bearer, whereas the corresponding call is still active, the MS shall not automatically initiate the release of that call.

### 5.2.1 Mobile originating call establishment

The call control entity of the mobile station initiates establishment of a CC connection by requesting the MM sublayer to establish a mobile originating MM connection and entering the "MM connection pending" state. There are two kinds of a mobile originating call: basic call and emergency call. The request to establish an MM connection shall contain a parameter to specify whether the call is a basic or an emergency call. This information may lead to specific qualities of services to be provided by the MM sublayers. Timer T303 is started when the CM SERVICE REQUEST message is sent.

For mobile stations supporting eMLPP basic calls may optionally have an associated priority level as defined in 3GPP TS 23.067 [88]. This information may also lead to specified qualities of service to be provided by the MM sublayers.

While being in the "MM connection pending" state, the call entity of the mobile station may cancel the call prior to sending the first call control message according to the rules given in subclause 4.5.1.7.

The mobile station supporting multicall that is initiating an emergency call shall release one or more existing call to ensure the emergency call can be established if the multicall supported information stored in the mobile station described in subclauses 5.2.1.2 and 5.2.2.1 indicates the network does not support multicall and some ongoing calls exists.

Having entered the "MM connection pending" state, upon MM connection establishment, the call control entity of the mobile station sends a setup message to its peer entity. This setup message is

- a SETUP message, if the call to be established is a basic call, and
- an EMERGENCY SETUP message, if the call to be established is an emergency call.

The mobile station then enters the "call initiated" state. Timer T303 is not stopped.

The setup message shall contain all the information required by the network to process the call. In particular, the SETUP message shall contain the called party address information.

If the mobile station supports multicall, it shall include the Stream Identifier (SI) information element. For the first call i.e. when there are no other ongoing calls the SI value shall be 1.

For speech calls the mobile station shall indicate all codecs that it supports for UTRAN in the *Supported Codec List* information element. Codecs for GERAN shall be indicated in the *Bearer Capability* information element, if this information element is included. Additionally, if the mobile station supports codecs for GERAN and UTRAN, it shall indicate the codecs for GERAN also in the *Supported Codec List* information element.

If the call is a redial attempt to switch from speech to multimedia or vice-versa, the SETUP message shall include the Redial information element.

NOTE: Redial attempt is defined in 3GPP TR 23.903: "Redial solution for voice-video switching"[115].

If the MS supports the enhanced network-initiated in-call modification procedure as specified in subclause 5.3.4.3, the MS shall indicate this in the *Call Control Capabilities* IE in the SETUP message.

If timer T303 elapses in the "MM connection pending" state, the MM connection in progress shall be aborted and the user shall be informed about the rejection of the call.

### 5.2.1.1 Call initiation

The "call initiated" state is supervised by timer T303. For normal MO calls, this timer will have already been started after entering the "MM connection pending" state. For network-initiated MO calls this timer will be started in the recall present state as defined in subclause 5.2.3.4

When the call control entity of the mobile station is in the "call initiated" state and if it receives:

- i) a CALL PROCEEDING message, it shall proceed as described in subclause 5.2.1.3;
- ii) an ALERTING message, it shall proceed as described in subclause 5.2.1.5;
- iii) a CONNECT message, it shall proceed as described in subclause 5.2.1.6;
- iv) a RELEASE COMPLETE message it shall proceed as described in subclause 5.2.1.2.

Abnormal case:

- If timer T303 elapses in the "call initiated" state before any of the CALL PROCEEDING, ALERTING, CONNECT or RELEASE COMPLETE messages has been received, the clearing procedure described in subclause 5.4 is performed.

### 5.2.1.2 Receipt of a setup message

In the "null" or "recall present" states, upon receipt of a setup message (a SETUP message or an EMERGENCY SETUP message, see subclause 5.2.1.1), the call control entity of the network enters the "call initiated" state. It shall then analyse the call information contained in the setup message.

In lu mode, network shall include the SI received in the SETUP message into the RABid and send it back to the mobile station. For RABid see 3GPP TS 25.413 and 3GPP TS 44.118 [111]. If the network receives the SETUP message with no SI, the network shall set the SI value to 1.

- i) If, following the receipt of the setup message, the call control entity of the network determines that the call information received from the mobile station is invalid (e.g. invalid number), then the network shall initiate call clearing as defined in subclause 5.4 with one of the following cause values:
  - # 1 "unassigned (unallocated) number",
  - # 3 "no route to destination",
  - # 22 "number changed",
  - # 28 "invalid number format (incomplete number)".
- ii) If, following the receipt of the setup message, the call control entity of the network determines that a requested service is not authorized or is not available, it shall initiate call clearing in accordance with subclause 5.4.2 with one of the following cause values:
  - # 8 "operator determined barring",
  - # 57 "bearer capability not authorized",
  - # 58 "bearer capability not presently available",
  - # 63 "service or option not available, unspecified", or
  - # 65 "bearer service not implemented".
- iii) Otherwise, the call control entity of the network shall either:
  - send a CALL PROCEEDING message to its peer entity to indicate that the call is being processed; and enter the "mobile originating call proceeding" state;
  - or: send an ALERTING message to its peer entity to indicate that alerting has been started at the called user side; and enter the "call received" state;
  - or: send a CONNECT message to its peer entity to indicate that the call has been accepted at the called user side; and enter the "connect request" state.

The call control entity of the network may insert bearer capability information element(s) in the CALL PROCEEDING message to select options presented by the mobile station in the Bearer Capability information element(s) of the SETUP message. The bearer capability information element(s) shall contain the same parameters as received in the SETUP except those presenting a choice. Where choices were offered, appropriate parameters indicating the results of those choices shall be included.

The CALL\_PROCEEDING message shall also contain the priority of the call in the case where the network supports eMLPP. Mobile stations supporting eMLPP shall indicate this priority level to higher sublayers and store this information for the duration of the call for further action. Mobile stations not supporting eMLPP shall ignore this information element if provided in a CALL\_PROCEEDING message.

NOTE: If the network supports only R98 or older versions of this protocol and the priority is not included in the CALL\_PROCEEDING message, this does not imply that the network does not support eMLPP.

- The CALL\_PROCEEDING message shall contain the multicall supported information in the network call control capabilities in the case where the network supports multicall and there are no other ongoing calls to the MS. Mobile stations supporting multicall shall store this information until the call control state for all calls returns to null. Mobile stations not supporting multicall shall ignore this information if provided in a CALL

PROCEEDING message. If the multicall supported information is not sent in the CALL\_PROCEEDING message, the mobile station supporting multicall shall regard that the network doesn't support multicall.

The call control entity of the network having entered the "mobile originating call proceeding" state, the network may initiate the assignment of a traffic channel according to subclause 5.2.1.9 (early assignment).

For speech calls, if the SETUP message or EMERGENCY SETUP message contains a *Supported Codec List* information element, the network shall use this list to select the codec for UTRAN. If no *Supported Codec List* information element is received, then for UTRAN the network shall select the default UMTS speech codec according to subclause 5.2.1.11.

Codecs for GERAN shall be selected from the codecs indicated in the *Supported Codec List* information element or in the *Bearer Capability* information element. If neither a *Supported Codec List* information element nor a *Bearer Capability* information element is received, then for GERAN the network shall select GSM full rate speech version 1.

Codec information that does not apply to the currently serving radio access shall be used by the network if an inter-system change occurs.

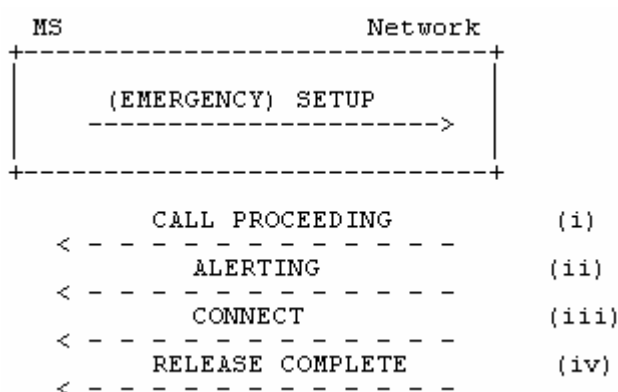

Figure 5.2/3GPP TS 24.008 Mobile originated call initiation and possible subsequent responses.

### 5.2.1.3 Receipt of a CALL PROCEEDING message

Having entered the "call initiated" state, when the call control entity of the mobile station receives a CALL PROCEEDING message, it shall stop timer T303; start timer T310 unless

- the CALL PROCEEDING message contains a *progress indicator* IE specifying progress description #1, #2, or #64; or
- it has received a PROGRESS message containing a *progress indicator* IE specifying progress description #1, #2, or #64 prior to the CALL PROCEEDING message

and enter the "mobile originating call proceeding" state.

Abnormal case:

If timer T310 elapses before any of the ALERTING, CONNECT or DISCONNECT messages has been received, the mobile station shall perform the clearing procedure described in subclause 5.4.

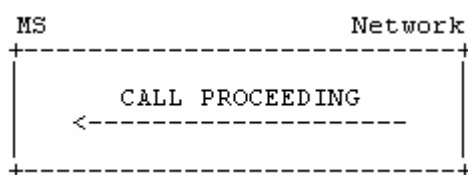

Figure 5.3/3GPP TS 24.008 Call proceeding sequence at mobile originating call establishment

#### 5.2.1.4 Notification of progressing mobile originated call

In this subclause, the term "interworking" is used only in the meaning of interworking with a network other than PLMN or ISDN, not as interworking between PLMN and ISDN since this is the normal case. In this sense, PLMN and ISDN are seen within the same environment, called the PLMN/ISDN environment.

##### 5.2.1.4.1 Notification of interworking in connection with mobile originated call establishment

During call establishment, the call may leave a PLMN/ISDN environment; e.g., because of interworking with another network, with a non-PLMN/ISDN user, or with non-PLMN/ISDN equipment within the called user's premises; the call may also return to a PLMN/ISDN environment. When such situations occur, the network may send a *progress indicator* information element to the calling mobile station either:

- a) in an appropriate call control message, if a state change is required (e.g. ALERTING or CONNECT); or,
- b) in the PROGRESS message, if no state change is appropriate.

This *progress indicator* information element shall contain one of the following progress description values:

- a) #1 "call is not end-to-end PLMN/ISDN; further call progress information may be available in-band".
- b) #2 "destination address is non-PLMN/ISDN".
- c) #4 "call has returned to PLMN/ISDN".

See also subclauses 5.5.1 and 5.5.6 for further reactions of the mobile station.

##### 5.2.1.4.2 Call progress in the PLMN/ISDN environment

In order to inform the mobile station that the call is progressing in the PLMN/ISDN environment the network may send a *progress indicator* information element to the calling mobile station either:

- a) in an appropriate call control message, if a state change is required (e.g., ALERTING or CONNECT); or
- b) in the PROGRESS message, if no state change is appropriate.

This *progress indicator* information element shall contain progress description value #32 "Call is end-to-end ISDN/PLMN". See also subclause 5.5.6 for further reactions of the mobile station.

#### 5.2.1.5 Alerting

Having entered the "mobile originating call proceeding" state, upon receiving an indication that user alerting has been initiated at the called address, the call control entity of the network shall: send an ALERTING message to its peer entity at the calling mobile station and enter the "call delivered" state.

When the call control entity of the mobile station in the "call initiated" state or "mobile originating call proceeding" state receives an ALERTING message then, the call control entity of the mobile station shall stop timer T303 and T310 (if running) and shall enter the "call delivered" state. In this state, for speech calls:

- an alerting indication should be given to the user. If the mobile station has not attached the user connection then the mobile station shall internally generate an alerting indication. If the mobile station has attached the user connection then the network is responsible for generating the alerting indication and the mobile station need not generate one.

Abnormal cases:

On the mobile station side, if timer T310 expires, the call control entity of the mobile station shall initiate call clearing as described in subclause 5.4.

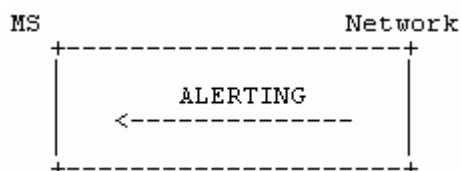

**Figure 5.4/3GPP TS 24.008 Call confirmation at mobile originating call establishment**

### 5.2.1.6 Call connected

Upon receiving an indication that the call has been accepted, the call control entity of the network shall: through connect the traffic channel (including the connection of an interworking function, if required) and send a CONNECT message to its peer entity at the calling mobile station; start timer T313 and enter the "connect indication" state.

This message indicates to the call control entity of the calling mobile station that a connection has been established through the network.

The call control entity of the mobile station in the "call initiated" state, in the "mobile originating call proceeding" state or in the "call delivered" state, shall, upon receipt of a CONNECT message:

- attach the user connection;
- return a CONNECT ACKNOWLEDGE message;
- stop any locally generated alerting indication (if applied);
- stop timer T303 and T310 (if running);
- enter the "active" state.

Abnormal cases:

On the mobile station side, if timer T303 or T310 expires, the call control entity of the mobile station shall initiate call clearing as described in subclause 5.4.

NOTE: The mobile station may have applied an additional internal alerting supervision which causes initiation of call clearing prior to the expiry of T303 or T310.

The call control of the network in the "connect indication" state, shall, upon receipt of a CONNECT ACKNOWLEDGE message:

- stop timer T313 and enter the "active" state.

Abnormal cases:

On the network side, if timer T313 elapses before a CONNECT ACKNOWLEDGE message has been received, the network shall perform the clearing procedure as described in subclause 5.4.

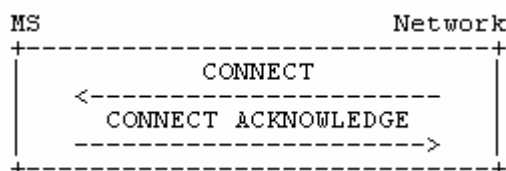

**Figure 5.5/3GPP TS 24.008 Call acceptance sequence at mobile originating call establishment**

### 5.2.1.7 Call rejection

Upon receiving an indication that the network or the called user is unable to accept the call, the network shall initiate call clearing at the radio interface to the mobile which originated the call, as described in subclause 5.4 using the cause provided by the terminating network or the called user.

### 5.2.1.8 Transit network selection

NOTE: For further study.

### 5.2.1.9 Traffic channel assignment at mobile originating call establishment

The mobile station supporting multicall includes the Stream Identifier (SI) in the SETUP message. The multicall supporting network shall interpret the SI value as follows:

- a) Mobile station generates a new SI value at the initiation of an originating call, then a new traffic channel shall be assigned to the mobile originating call.
- b) Mobile station indicates an existing SI value, then the indicated traffic channel shall be used for the mobile originating call.

Mobile station supporting multicall shall never send an additional SETUP with indication that a new traffic channel is requested to a network that does not support multicall.

It is a network dependent decision when to initiate the assignment of an appropriate traffic channel during the mobile originating call establishment phase. Initiation of a suitable RR procedure to assign an appropriate traffic channel does neither change the state of a call control entity nor affect any call control timer.

NOTE: During certain phases of such an RR procedure, transmission of CC and MM messages may be suspended, see 3GPP TS 44.018 [84], clause 3 and 3GPP TS 48.008 [85].

The assignment procedure does not affect any call control timer.

### 5.2.1.10 Call queuing at mobile originating call establishment

If an idle traffic channel is not available at the assignment instant, the network may place the traffic channel request in a queue. Calls arriving when all positions in the queue are occupied shall be cleared by the network using the cause #34 "no circuit/channel available".

The maximum queuing interval is supervised by the network. The limit is a network dependent choice. In case the network is not able to allocate a traffic channel within the queuing limit, the network will release the call using cause #34 "no circuit/channel available".

Optionally, e.g. if eMLPP is used, the network may decide to pre-empt existing calls or to place the traffic channel request at some preferential position within the queue.

Specific indications provided in the network to the remote user are a network dependent choice.

### 5.2.1.11 Speech Codec Selection

For speech calls, a mobile station implementing this version of the protocol shall indicate all codecs that it supports for UTRAN in the *Supported Codec List* information element. Codecs for GERAN shall be indicated in the *Bearer Capability* information element, if this information element is included. Additionally, if the mobile station supports codecs for GERAN and UTRAN, it shall indicate the codecs for GERAN also in the *Supported Codec List* information element.

If the network does not receive a *Supported Codec List* information element then for speech calls in UTRAN it shall select the default UMTS speech codec.

For speech calls in GERAN, if the network does not receive a *Supported Codec List* information element nor a *Bearer Capability* information element, the network shall select GSM full rate speech version 1.

The network shall determine the default UMTS speech codec by the following:

- i) If no GSM Speech Version codepoints are received in the *Supported Codec List* IE or in octet 3a etc. of the *Bearer Capabilities* IE then a "UMTS only" terminal is assumed and the default UMTS speech codec shall be UMTS\_AMR.



- ii) If at least one GSM Speech Version codepoint is received in the *Supported Codec List* IE or in octet 3a etc. of the *Bearer Capabilities* IE then the ME supports GSM and UMTS and the default UMTS speech codec shall be UMTS\_AMR\_2.

NOTE 1: In case (ii), if the call is set up in A/Gb or GERAN Iu mode by a R99 ME, call control in the core network may treat the ME as a "GSM only" ME. The default UMTS speech codec will only become relevant when an intersystem handover to UTRAN Iu mode is initiated by the radio access network, and can be determined when this procedure is started.

If the *Supported Codec List* IE is received, then the network shall use this list to select the codec for Iu mode and indicate the selected codec to the ME via RANAP and RRC protocol in the NAS Synchronisation Indicator IE. See 3GPP TS 25.413, 3GPP TS 25.331 [32c] and 3GPP TS 44.118 [111].

The NAS Synchronisation Indicator IE shall be coded as the 4 least significant bits of the selected codec type (CoID) defined in 3GPP TS 26.103 [83], subclause 6.3.

The network shall determine the preference for the selected codec type; codec type prioritisation is not provided by the ME.

The ME shall activate the codec type received in the NAS Synchronisation Indicator IE.

If the mobile station does not receive the NAS Synchronisation Indicator IE (RRC protocol)

- during setup of a speech call;
- during inter-system handover of a speech call from A/Gb or GERAN Iu mode to UTRAN Iu mode; or
- during an in-call modification from data to speech,

then it shall select the UMTS\_AMR\_2 speech codec.

NOTE 2: If the network does not support UMTS\_AMR\_2, it may activate the UMTS\_AMR codec and indicate to the mobile station that it shall select UMTS\_AMR\_2. According to 3GPP TS 26.103 [83], subclause 5.4, no interworking problem will occur in this case.

If the mobile station has selected a speech codec for UTRAN Iu mode, it shall keep this codec until

- a new codec is requested by the network by sending a NAS Synchronisation Indicator IE (RRC protocol);
- a new codec is requested by the network during inter-system handover from UTRAN Iu mode to A/Gb or GERAN Iu mode; or
- an in-call modification from speech to data is performed.

For adaptive multirate codec types no indication of subsets of modes is supported in this protocol, from the mobile station or to the mobile station. It is a pre-condition that the support of such codec types by the mobile station implicitly includes all modes defined for that codec type.

### 5.2.1.12 Cellular Text telephone Modem (CTM) selection

The mobile station can send a CTM support indication in the *Bearer Capability* IE in call establishment messages to inform the network of the use of CTM text in the call.

When the mobile station indicates speech and support of CTM text telephony, the network shall select a speech codec and additionally CTM text telephony detection/conversion functions as specified in 3GPP TS 23.226 [92] and 3GPP TS 26.226 [93], if such functions are available.

NOTE: If CTM support is indicated by the mobile station, then it supports CTM text telephony together with any supported speech codec and for any supported radio access.

## 5.2.2 Mobile terminating call establishment

Before call establishment can be initiated in the mobile station, the MM connection must be established by the network.

### 5.2.2.1 Call indication

After the arrival of a call from a remote user, the corresponding call control entity in the network shall: initiate the MM connection establishment according to clause 4 and enter the "MM connection pending" state. The request to establish the MM connection is passed from the CM sublayer to the MM sublayer. It contains the necessary routing information derived from the SETUP message.

Upon completion of the MM connection, the call control entity of the network shall: send the SETUP message to its peer entity at the mobile station, start timer T303 and enter the "call present" state.

The SETUP message shall contain the multicall supported information in the network call control capabilities in the case where the network supports multicall and there are no other ongoing calls to the MS. Mobile stations supporting multicall shall store this information until the call control state for all calls returns to null. Mobile stations not supporting multicall shall ignore this information if provided in a SETUP message. If the multicall supported information is not sent in the SETUP message, the mobile station supporting multicall shall regard that the network does not support multicall.

Upon receipt of a SETUP message, the mobile station shall perform compatibility checking as described in subclause 5.2.2.2. If the result of the compatibility checking was compatibility, the call control entity of the mobile station shall enter the "call present" state. An incompatible mobile station shall respond with a RELEASE COMPLETE message in accordance with subclause 5.2.2.3.4.

If there are no *bearer capability* IEs in the SETUP message, the network may provide information about the requested service in the *backup bearer capability* IE.

If no response to the SETUP message is received by the call control entity of the network before the expiry of timer T303, the procedures described in subclause 5.2.2.3.3 shall apply.

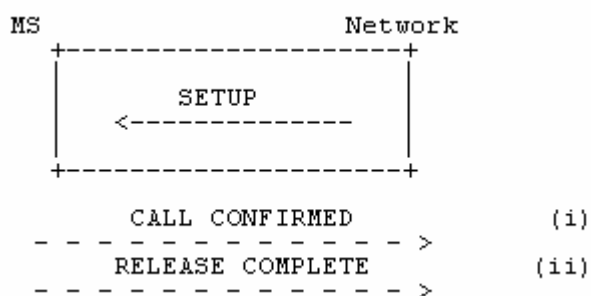

**Figure 5.6/3GPP TS 24.008 Mobile terminating call initiation and possible subsequent responses.**

### 5.2.2.2 Compatibility checking

The mobile station receiving a SETUP message shall perform compatibility checking before responding to that SETUP message. Annex B defines compatibility checking to be performed by the mobile station upon receiving a SETUP message. For a *backup bearer capability* IE received with a SETUP message the mobile station shall not perform compatibility checking as described in annex B.

### 5.2.2.3 Call confirmation

#### 5.2.2.3.1 Response to SETUP

Having entered the "call present state" the call control entity of the mobile station shall - with the exception of the cases described below - acknowledge the SETUP message by a CALL CONFIRMED message, and enter the "mobile terminating call confirmed" state.

If the mobile station supports multicall, it shall include the Stream Identifier (SI) information element in the CALL CONFIRMED message.

If the mobile station is located in the network supporting multicall, it shall never include the SI that is in use and shall include with either of the following two values:

- SI="no bearer";
- SI=new value (not used by any of the existing bearers).

If the mobile station supporting multicall is located in the network not supporting multicall, it shall include the SI with value 1.

The call control entity of the mobile station may include in the CALL CONFIRMED message to the network one or two bearer capability information elements to the network, either preselected in the mobile station or corresponding to a service dependent directory number (see 3GPP TS 29.007 [38]). The mobile station may also use the *backup bearer capability* IE, if provided by the network, to deduce the requested service (see 3GPP TS 27.001, subclause 8.3.3.1). The mobile station may also include one or two bearer capabilities in the CALL CONFIRMED message to define the radio channel requirements. In any case the rules specified in subclause 9.3.2.2 shall be followed.

NOTE: The possibility of alternative responses (e.g., in connection with supplementary services) is for further study.

For speech calls the mobile station shall indicate all codecs that it supports for UTRAN in the *Supported Codec List* information element. Codecs for GERAN shall be indicated in the *Bearer Capability* information element, if this information element is included. Additionally, if the mobile station supports codecs for GERAN and UTRAN, it shall indicate the codecs for GERAN also in the *Supported Codec List* information element.

If the MS supports the enhanced network-initiated in-call modification procedure as specified in subclause 5.3.4.3, the MS shall indicate this in the *Call Control Capabilities* IE in the CALL CONFIRMED message.

A busy MS which satisfies the compatibility requirements indicated in the SETUP message shall respond either with a CALL CONFIRMED message if the call setup is allowed to continue or a RELEASE COMPLETE message if the call setup is not allowed to continue, both with cause #17 "user busy".

If the mobile user wishes to refuse the call, a RELEASE COMPLETE message shall be sent with the cause #21 "call rejected".

In the cases where the mobile station responds to a SETUP message with RELEASE COMPLETE message the mobile station shall release the MM connection and enter the "null" state after sending the RELEASE COMPLETE message.

The network shall process the RELEASE COMPLETE message in accordance with subclause 5.4.

#### 5.2.2.3.2 Receipt of CALL CONFIRMED and ALERTING by the network

The call control entity of the network in the "call present" state, shall, upon receipt of a CALL CONFIRMED message: stop timer T303, start timer T310 and enter the "mobile terminating call confirmed" state.

In Iu mode, network shall include the SI received in the CALL CONFIRMED message into the RABid and send it back to the mobile station. For RABid see 3GPP TS 25.413 and 3GPP TS 44.118 [111]. If the network receives the CALL CONFIRMED message with no SI, the network shall set the SI value to 1.

For speech calls, if the CALL CONFIRMED message contains a *Supported Codec List* information element, the network shall use this list to select the codec for UTRAN. If no *Supported Codec List* information element is received, then for UTRAN the network shall select the default UMTS speech codec according to subclause 5.2.1.11.

Codecs for GERAN shall be selected from the codecs indicated in the *Supported Codec List* information element or in the *Bearer Capability* information element. If neither a *Supported Codec List* information element nor a *Bearer Capability* information element is received, then for GERAN the network shall select GSM full rate speech version 1.

Codec information that does not apply to the currently serving radio access shall be used by the network if an inter-system change occurs.

The call control entity of the mobile station having entered the "mobile terminating call confirmed" state, if the call is accepted at the called user side, the mobile station proceeds as described in subclause 5.2.2.5. Otherwise, if the signal information element was present in the SETUP message user alerting is initiated at the mobile station side; if the signal information element was not present in the SETUP message, user alerting is initiated when an appropriate channel is available.

Here, initiation of user alerting means:

- the generation of an appropriate tone or indication at the mobile station; and
- sending of an ALERTING message by the call control entity of the MS to its peer entity in the network and entering the "call received" state.

The call control entity of the network in the "mobile terminated call confirmed" state shall, upon receipt of an ALERTING message: send a corresponding ALERTING indication to the calling user; stop timer T310; start timer T301, and enter the "call received" state.

In the "mobile terminating call confirmed" state or the "call received" state, if the user of a mobile station is User Determined User Busy then a DISCONNECT message shall be sent with cause #17 "user busy". In the "mobile terminating call confirmed" state, if the user of a mobile station wishes to reject the call then a DISCONNECT message shall be sent with cause #21 "call rejected".

#### 5.2.2.3.3 Call failure procedures

In case of abnormal behaviour the following call failure procedures apply:

- i. If the network does not receive any response to the SETUP message prior to the expiration of timer T303, then the network shall: initiate clearing procedures towards the calling user with cause #18 "no user responding"; and initiate clearing procedures towards the called mobile station in accordance with subclause 5.4.4 using cause #102 "recovery on timer expiry".
- ii. If the network has received a CALL CONFIRMED message, but does not receive an ALERTING, CONNECT or DISCONNECT message prior to the expiration of timer T310, then the network shall:
  - initiate clearing procedures towards the calling user with cause #18 "no user responding"; and
  - initiate clearing procedures towards the called MS in accordance with subclause 5.4.4 using cause #102 "recovery on timer expiry".
- iii. If the network has received an ALERTING message, but does not receive a CONNECT or DISCONNECT message prior to the expiry of timer T301 (or a corresponding internal alerting supervision timing function), then the network shall: initiate clearing procedures towards the calling user with cause #19 "user alerting, no answer"; and initiate clearing procedures towards the called mobile station in accordance with subclause 5.4.4, using cause #102 "recovery on timer expiry" or using cause #31 "normal, unspecified".

NOTE: The choice between cause #31 and cause #102 may have consequences on indications generated by the mobile station, see 3GPP TS 22.001 [8a].

#### 5.2.2.3.4 Called mobile station clearing during mobile terminating call establishment

See subclause 5.4.2.

#### 5.2.2.4 Notification of interworking in connection with mobile terminating call establishment

In this subclause, the term "interworking" is used only in the meaning of interworking with a network other than PLMN or ISDN, not as interworking between PLMN and ISDN since this is the normal case. In this sense, PLMN and ISDN are seen within the same environment, called the PLMN/ISDN environment.

During call establishment the call may enter an PLMN/ISDN environment, e.g., because of interworking with another network, with a non-PLMN/ISDN user, or with non-PLMN/ISDN equipment within the calling or called user's premises. When this occurs, the network may include a *progress indicator* information element to be included in the SETUP message to be sent to the called mobile station specifying progress description value:

- a) #1 "call is not end-to-end PLMN/ISDN; further call progress information may be available in-band" or
- b) #3 "origination address is non-PLMN/ISDN".

See also subclause 5.5.1 for further reactions of the mobile station.

### 5.2.2.5 Call accept

In the "mobile terminating call confirmed" state or the "call received" state, the call control entity in the mobile station indicates acceptance of a mobile terminating call by:

- sending a CONNECT message to its peer entity in the network;
- starting Timer T313; and
- entering the "connect request" state.

If the call control entity of the mobile station has indicated "No Bearer" as the SI value in the CALL CONFIRMED message, it shall assign the SI value and include the SI information element in the CONNECT message. Otherwise the SI information element shall not be included in the CONNECT message.

### 5.2.2.6 Active indication

In the "mobile terminated call confirmed" state or in the "call received" state, the call control entity of the network shall, upon receipt of a CONNECT message: through connect the traffic channel (including the connection of an interworking function, if required), stop timers T310, T303 or T301 (if running); send a CONNECT ACKNOWLEDGE message to its peer entity at the mobile station of the called user; initiate procedures to send a CONNECT message towards the calling user and enter the "active" state.

In the "connect request" state, the call control entity of the mobile station shall, upon receipt of a CONNECT ACKNOWLEDGE message: stop timer T313 and enter the "active" state.

When timer T313 expires prior to the receipt of a CONNECT ACKNOWLEDGE message, the mobile station shall initiate clearing in accordance with subclause 5.4.3.

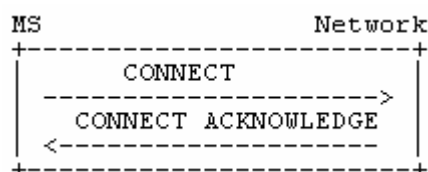

**Figure 5.7/3GPP TS 24.008 Call acceptance and active indication at mobile terminating call establishment**

### 5.2.2.7 Traffic channel assignment at mobile terminating call establishment

After receiving the SETUP message, the mobile station supporting multicall may either require a new traffic channel or reuse an existing traffic channel.

If a mobile station in the network supporting multicall requires a new traffic channel, it shall:

- send a CALL CONFIRMED message including the SI indicating a new value, not used by any of the existing traffic channels.

If a mobile station in the network supporting multicall does not require a new traffic channel, it shall:

- send a CALL CONFIRMED message including the SI equal to "no bearer".

After the mobile station has send the CALL CONFIRMED with SI="no bearer", the SI value in the CONNECT message will tell to the network if a user requests a new traffic channel or one of the existing ones will be re-used.

If a new traffic channel is requested by the user, the mobile station in the network supporting multicall shall:

- send a CONNECT message containing the SI with a new value, not used by any existing traffic channel.

If the user decides that an existing traffic channel will be reused, the mobile station in the network supporting multicall shall:

- send a CONNECT message with an SI indicating an existing value used by an existing traffic channel.

It is a network dependent decision when to initiate the assignment of a traffic channel during the mobile terminating call establishment phase.

Initiation of the assignment phase does not directly change the state of a CC entity nor affect any call control timer, but may have some secondary effects (see e.g. clause 5.2.2.3.2).

#### 5.2.2.8 Call queuing at mobile terminating call establishment

The principles described in subclause 5.2.1.10 apply accordingly.

NOTE: The interworking to the fixed network has to fulfil the network specific requirements.

#### 5.2.2.9 User connection attachment during a mobile terminating call

For speech calls:

The mobile station shall attach the user connection at latest when sending the connect message.

For data calls:

The mobile station shall attach the user connection when receiving the CONNECT ACKNOWLEDGE message from the network.

#### 5.2.2.10 Speech Codec Selection

The principles described in section 5.2.1.11 apply accordingly.

#### 5.2.2.11 Cellular Text telephone Modem (CTM) selection

The principles described in subclause 5.2.1.12 apply accordingly.

### 5.2.3 Network initiated MO call \$(CCBS)\$

The procedures of subclause 5.2.3 are mandatory for mobile stations supporting "Network initiated MO call".

NOTE: The behaviour of a mobile station that does not support "Network initiated MO call" is described in clause 4.

#### 5.2.3.1 Initiation

Before call establishment can be initiated in the mobile station, the MM connection shall be established by the network.

After the arrival of an appropriate stimulus (for example a Remote User Free Indication), the corresponding call control entity in the network shall initiate the MM connection establishment according to clause 4, enter the "CC connection pending" state and start timer T331. The request to establish the MM connection is passed from the CM sublayer to the MM sublayer. It contains the necessary routing information derived from the received stimulus.

Upon completion of the MM connection, the call control entity of the mobile station shall send a START CC message to its peer entity in the network. The mobile station shall then enter the "Wait for network information" state and start timer T332.

If the network receives a START CC message while in the "CC connection pending" state, the network stops T331, sends the CC-ESTABLISHMENT message, starts timer T333 and enters the "CC-establishment present" state.

The MM connection establishment may be unsuccessful for a variety of reasons, in which case the MM sublayer in the network will inform the CC entity in the network with an indication of the reason for the failure. The CC entity shall then stop all running timers, enter the "Null" state and inform all appropriate entities within the network.

If timer T331 expires, the network shall abort the MM connection establishment attempt, stop all running CC timers, enter the "Null" state and inform all appropriate entities within the network.

### 5.2.3.2 CC-Establishment present

In the "CC establishment present" state, the mobile station, upon receipt of the CC-ESTABLISHMENT message, shall stop timer T332.

The CC-ESTABLISHMENT message contains information which the mobile station shall use for the subsequent SETUP message (if any) related to this CC-ESTABLISHMENT.

The CC-ESTABLISHMENT message shall contain the *Setup Container IE*.

If no CC-ESTABLISHMENT message is received by the call control entity of the mobile station before the expiry of timer T332, then the mobile station shall initiate clearing procedures towards the network using a RELEASE COMPLETE message with cause #102 "recovery on timer expiry" and proceed in accordance with subclause 5.4.2.

Upon receipt of a CC-ESTABLISHMENT message the mobile station shall perform checks on the Setup Container IE in order to align the contained information with the mobile's present capabilities and configuration. The "recall alignment procedure" is defined later on in this subclause.

If the recall alignment procedure has succeeded, the call control entity of the Mobile Station shall:

- form and store the SETUP message for sending later in the "Recall present" state,
- acknowledge the CC-ESTABLISHMENT message with a CC-ESTABLISHMENT CONFIRMED message,
- start timer T335, and
- enter the "CC-establishment confirmed" state.

Exception:

A busy mobile station which has successfully performed the recall alignment procedure shall respond with a CC-ESTABLISHMENT CONFIRMED message with cause #17 "user busy", and proceed as stated above.

For speech calls the mobile station shall indicate all codecs that it supports for UTRAN in the *Supported Codec List* information element of the CC-ESTABLISHMENT CONFIRMED message. Codecs for GERAN shall be indicated in the *Bearer Capability* information element. Additionally, if the mobile station supports codecs for GERAN and UTRAN, it shall indicate the codecs for GERAN also in the *Supported Codec List* information element.

A mobile station, for which the recall alignment procedure failed, shall respond with a RELEASE COMPLETE message in accordance with subclause 5.4.2 with the appropriate cause code as indicated in the description of the recall alignment procedure.

The SETUP message is constructed from the *Setup Container IE* received in the CC ESTABLISHMENT MESSAGE. The mobile station shall assume that the *Setup Container IE* contains an entire SETUP message with the exception of the Protocol Discriminator, Transaction ID and Message Type elements. The mobile station may assume that the contents of the *Setup Container IE* are the same as were sent from the subscriber in a previous SETUP message of the mobile originating call establishment attempt. The mobile station shall copy the *Setup Container* to the SETUP message and not modify the contents except as defined in the recall alignment procedure and as defined in *exceptions* below. The mobile station shall not add other Information Elements to the end of the SETUP message.

Exceptions:

*Bearer Capability IE(s)*, *HLC IE(s)* and *LLC IE(s)* (including *Repeat Indicator(s)*, if there are 2 bearer capabilities), and the *Supported Codec List IE* require handling as described in the recall alignment procedure below.

If the *CC Capabilities* in the *Setup Container IE* is different to that supported by the mobile station, the mobile station shall modify the *CC Capabilities* in the SETUP message to indicate the true capabilities of the mobile station.

*Facility IE(s)* and *SS Version IE(s)* require handling as described in the recall alignment procedure.

*Stream Identifier IE* requires handling as described in the recall alignment procedure.

If no response to the CC-ESTABLISHMENT message is received by the call control entity of the network before the expiry of timer T333, then the network shall initiate clearing procedures towards the called mobile station using a

RELEASE COMPLETE message with cause #102 "recovery on timer expiry" and inform all appropriate entities within the network, proceeding in accordance with subclause 5.4.2.

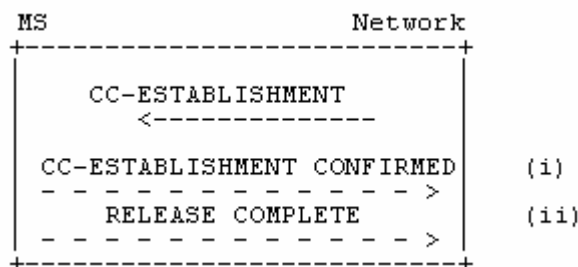

**Figure 5.7a/3GPP TS 24.008 Call initiation and possible subsequent responses.**

### 5.2.3.2.1 Recall Alignment Procedure

The recall alignment procedure consists of three parts:

- basic service group alignment,
- facility alignment, and
- stream identifier alignment.

Basic service group alignment:

The mobile station shall check that the *Bearer Capability*, *HLC* and *LLC* and *Repeat Indicator* fields, which are embedded in the *Setup Container IE*, match a basic service group supported by the mobile station.

If this check fails, then the recall alignment procedure has failed. The mobile station shall use the cause #88 "incompatible destination" afterwards.

Otherwise, the mobile station is allowed to alter the content within the *Bearer Capability*, *HLC* and *LLC* Information Elements (e.g. the speech codec version(s), the data rate, the radio channel requirement) provided that the basic service group is not changed. Furthermore, for speech calls the mobile station is allowed to add or remove the *Supported Codec List* Information Element, or to alter the contents of this information element dependent on the codecs supported by the mobile station. The result shall be that the mobile station has derived *Bearer Capability*, *HLC*, *LLC*, and *Supported Codec List* Information Elements, which it can use for a later call setup according to its configuration and capabilities.

Facility alignment:

This only applies if the *Setup Container* contains 1 or more *Facility IEs*. Each *Facility IE* within the *Setup Container* will be associated with the common *SS Version IE*, if present. The handling for each *Facility IE* is defined below. The mobile station shall align each facility IE contained in the *Setup Container*. The rules defined in 3GPP TS 24.010 also apply.

The *Facility IE* is encoded as 'simple recall alignment', 'advanced recall alignment' or 'recall alignment not essential' (see 3GPP TS 24.010). If the encoding indicates, that

- a simple recall alignment is required, the mobile station shall copy the Facility IE and the common SS version IE from the *Setup Container* to the SETUP message without modifying the content.
- an advanced recall alignment is required, the mobile station must recognise and support the operation defined in the facility. If the mobile station does not recognise or support the operation, then the recall alignment procedure has failed and the mobile station shall use the cause #29 "facility rejected" in the subsequent rejection of the CC establishment request.
- the recall alignment is not essential, then the facility operation is not an essential part of the SETUP. If the MS does not recognise the operation then the SS Version IE and Facility IE are discarded, and NOT copied into the SETUP message.

NOTE: A mobile station may include a *Facility IE* without an associated *SS Version IE*. This would indicate that the SS operation is encoded using Phase 1 protocols.



Further details on Facility handling are given in 3GPP TS 24.010.

Stream identifier alignment:

The mobile station shall check whether the *Stream Identifier* field is contained in the *Setup Container* or not.

If the *Stream Identifier* is contained in the *Setup Container*, the mobile station shall behave as one of the following.

- the mobile station re-assign the *Stream Identifier* value, and modify the *Stream Identifier* field.
- the mobile station remove the *Stream Identifier* field.

If the *Stream Identifier* is not contained in the *Setup Container*, the mobile station may behave as follows.

- the mobile station assign the *Stream Identifier* value, and add the *Stream Identifier IE* to the end of the SETUP message.

### 5.2.3.3 CC-Establishment confirmation

The call control entity of the network in the "CC-establishment present" state, shall, upon receipt of a CC-ESTABLISHMENT CONFIRMED message, stop timer T333 and enter the "CC-establishment confirmed" state.

For speech calls, if the ESTABLISHMENT CONFIRMED message contains a *Supported Codec List* information element, the network shall use this list to select the codec for UMTS. If no *Supported Codec List* information element is received, then for UMTS the network shall select the default UMTS speech codec according to subclause 5.2.1.11.

Codecs for GERAN shall be selected from the codecs indicated in the *Supported Codec List* information element or in the *Bearer Capability* information element. If neither a *Supported Codec List* information element nor a *Bearer Capability* information element is received, then for GERAN the network shall select GSM full rate speech version 1.

Codec information that does not apply to the currently serving radio access shall be used by the network if an inter-system change occurs.

In the "CC-establishment confirmed" state, the network sends a RECALL message. This message initiates user alerting and also shall include the Facility IE (providing additional information to be presented to the user for notification). The network starts timer T334 and enters the 'recall present' state.

Upon reception of the RECALL message the Mobile station stops T335 and enters the "recall present" state.

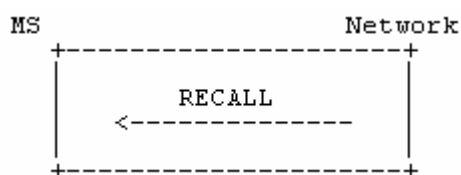

Figure 5.7b/3GPP TS 24.008 Recall

### 5.2.3.4 Recall present

In the "recall present" state, the call control entity in the mobile station waits for acceptance of the Recall by the user. Once confirmation is received, the mobile station indicates acceptance of a recall by

- sending a SETUP message to its peer entity in the network;
- starting Timer T303; and
- entering the "call initiated" state and proceeding as described in subclause 5.2.1.1.

The MS shall ensure that the contents of the *Bearer Capability IE(s)* and *Supported Codec List IE* sent in the SETUP message are the same as the *Bearer Capability IE(s)* and *Supported Codec List IE* in the previous CC-ESTABLISHMENT CONFIRMED message related to this Network Initiated MO Call.

In the "recall-present" state, if the user of a mobile station is User Determined User Busy then a RELEASE COMPLETE message shall be sent with cause #17 "user busy" In the "recall-present" state. If the user of a mobile station wishes to reject the recall then a RELEASE COMPLETE message shall be sent with cause #21 "call rejected".

In either case, the mobile shall release the connection in accordance with subclause 5.4.2

On receipt of the SETUP message in the "recall present" state, the network shall stop timer T334 and proceed as specified in subclause 5.2.1.2.

If the call control entity of the network does not receive a SETUP message before the expiry of timer T334, then the network shall send a RELEASE COMPLETE message to the mobile using cause #102 "recovery on timer expiry", release the MM connection, enter the "null" state and shall inform all appropriate entities within the network.

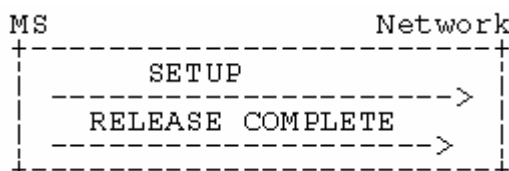

Figure 5.7b/3GPP TS 24.008 Recall acceptance or rejection by user

### 5.2.3.5 Traffic channel assignment during network initiated mobile originating call establishment

It is a network dependent decision whether or not to initiate the assignment of a traffic channel during the "CC-establishment confirmed" state.

## 5.3 Signalling procedures during the "active" state

### 5.3.1 User notification procedure

The mobile terminating user notification procedure allows the network to notify a mobile station of any appropriate call-related event during the "active" state of a call. The procedure consists in the network sending a NOTIFY message to the mobile station. No state change occurs at any of the interface sides following the sending or the receipt of this message (but an appropriate indication may optionally be generated in the mobile station).

The mobile originating notification procedure allows the mobile station to notify the remote user of any appropriate call-related event during the "active" state of a call by sending a NOTIFY message containing a notification indicator to the network; upon receipt of this message, the network sends a NOTIFY message containing the same notify indicator to the other user involved in the call. No state change occurs at any of the interface sides following the sending or the receipt of this message.

### 5.3.2 Call rearrangements

Call rearrangements on the radio interface are not supported by explicit messages (e.g. SUSPEND and RESUME messages as defined in ETS 300 102-1 [70]). However if a remote non-PLMN user initiates call rearrangements, the network shall inform the mobile station by means of a NOTIFY message. In a similar way the mobile station can inform the network about rearrangements by sending a NOTIFY message (e.g. change of user equipment connected to the mobile station).

### 5.3.3 Codec Change Procedure

During a speech call in UMTS, if a mobile station supports more than one UMTS codec, the network can change the UMTS codec via RRC procedures. In order to request the mobile station to change the codec, the network shall send the new selected codec type in the NAS Synchronisation Indicator IE (RRC protocol), see subclause 5.2.1.11.

## 5.3.4 Support of Dual Services

The behaviour described in this subclause is used to realize the following required services throughout subclause 5.3.4. The mobile station is not obliged to support the network originated in-call modification procedure. In that case, the mobile station shall, when receiving a MODIFY message, treat the message as unknown and react as described in subclause 8.4. If the mobile station is already prepared to support the procedure in both directions, it shall act as described in this subclause.

Alternate Speech/Group 3 fax (Teleservice 61 according to 3GPP TS 22.003 [4]).

### 5.3.4.1 Service Description

This circuit switched service allows the two users on a point-to-point connection to use the connection between them for different information transfer during the same call, but not at the same time.

If the negotiation during call establishment leads to the recognition of the above mentioned services, the in-call modification procedure is allowed to be executed within the current call by changing from one call mode to the other.

In some cases the in-call modification procedure makes it necessary to change the channel configuration by allocating a new channel and in other cases to change channel configuration parameters while keeping the previously allocated channel. This change is determined by the network, which initiates either the channel assignment procedure, handover procedure or channel mode modify procedure (see clause 3).

The capability and the initial mode desired must be identified by the mobile station by identifying each mode of operation with a separate information element during call establishment. Further the type of change between the modes must be identified by means of the repeat indicator:

mode 1 "alternate" mode 2.

### 5.3.4.2 Call establishment

For both mobile originating and mobile terminating calls, the normal call establishment procedures apply.

#### 5.3.4.2.1 Mobile Originating Establishment

The service is requested by the originating mobile station by transferring a SETUP message to the network containing the *BC repeat indicator* IE, the *bearer capability 1* information element, and the *bearer capability 2* information element. The first mode of operation ("call mode") shall be indicated by the *bearer capability 1* information element and the second call mode by the *bearer capability 2* information element.

A low layer compatibility may optionally be specified for each call mode in a *low layer compatibility I* and *low layer compatibility II* information element. In that case:

- the SETUP message shall contain the *LLC repeat indicator* IE and both *low layer compatibility I* and *low layer compatibility II* information elements. The *low layer compatibility I* information element then corresponds to the *bearer capability 1* information element and the *low layer compatibility II* information element to the *bearer capability 2* information element;
- if no low layer compatibility specification applies for one of the two call modes, the corresponding low layer compatibility IE (*low layer compatibility I* or *low layer compatibility II*) shall indicate "not applicable";
- the *LLC repeat indicator* shall specify the same repeat indication as the *BC repeat indicator* IE.

Similarly, a high layer compatibility may optionally be specified for each call mode in a *high layer compatibility i* and *high layer compatibility ii* information element. In that case:

- the SETUP message shall contain the *HLC repeat indicator* IE and both *high layer compatibility i* and *high layer compatibility ii* information elements. The *high layer compatibility i* information element then corresponds to the *bearer capability 1* information element and the *high layer compatibility ii* information element to the *bearer capability 2* information element;
- if no high layer compatibility specification applies for one of the two call modes, the corresponding high layer compatibility IE (*high layer compatibility i* or *high layer compatibility ii*) shall indicate "not applicable";

- the *HLC repeat indicator* shall specify the same repeat indication as the *BC repeat indicator IE*.

The receiving entity shall ignore whether the *LLC repeat indicator IE* or *HLC repeat indicator* are contained in the message or not; it shall also ignore the repeat indication of an *LLC repeat indicator IE* or *HLC repeat indicator IE*. If the *low layer compatibility II IE* is not contained in the message and the *low layer compatibility I IE* is contained in the message, the receiving entity shall relate it to a call mode indicated in the message that does not specify speech (if any). If the *high layer compatibility ii IE* is not contained in the message and the *high layer compatibility i IE* is contained in the message, the receiving entity shall relate it to a call mode indicated in the message that does not specify speech (if any).

The specific part of the network which is sensitive to the call mode shall examine each mode described in the bearer capabilities included in the SETUP message by performing compatibility checking as defined in Annex B. If as a result of this compatibility checking the network decides to reject the call, then the network shall initiate call clearing as specified in subclause 5.4 with the following causes:

- a) #57 "bearer capability not authorized";
- b) #58 "bearer capability not presently available";
- c) #65 "bearer service not implemented";
- d) #70 "only restricted digital information bearer capability is available".

#### 5.3.4.2.2 Mobile Terminating Establishment

The service is indicated to the called mobile station by a SETUP message coded in the same manner as in the mobile originating call establishment. As specified for normal terminating call establishment, the service may be indicated by the called mobile station in the CALL CONFIRMED message.

The destination mobile station shall perform the compatibility checking as defined in Annex B for both required modes if indicated in the SETUP message. If as a result of compatibility checking the mobile station decides to reject the call, the mobile station shall initiate call clearing according to the procedures of subclause 5.4 with one of the following causes:

- a) #57 "bearer capability not authorized";
- b) #58 "bearer capability not presently available";
- c) #65 "bearer service not implemented";
- d) #88 "incompatible destination".

The mobile station may accept the call if the first mode indicated is free irrespective of whether the other mode is free or busy.

#### 5.3.4.3 Changing the Call Mode

In order to change the call mode, the following in-call modification procedures shall be used.

Either side of the radio interface may act as the requesting user to invoke the in-call modification.

Upon each successful completion of the in-call modification procedure, the call changes to the next mode negotiated and agreed during the establishment phase of the call.

The in-call modification procedures are completely symmetrical at the radio interface.

##### 5.3.4.3.1 Initiation of in-call modification

The procedure is initiated by the requesting originating side in the "active" state of the call. It shall send a MODIFY message including the new mode to be changed to. The requesting originating side shall also start timer T323 and enter the "mobile originating modify" state (mobile station side) or the "mobile terminating modify" state (network side). The new mode given in the MODIFY message shall be one of those already negotiated and agreed during the establishment phase of the call. If the data call direction is different from the direction of the call setup a reverse call setup direction IE shall be included in the MODIFY message; otherwise this IE shall not be included.

If the in-call modification is originated by the mobile station, the mobile station shall reserve any internal resources necessary to support the next call mode, stop sending Bm-channel information; and stop interpreting received Bm-channel information according to the old call mode.

If the in-call modification is originated by the network, the network may reserve any internal resources necessary to support the next call mode. The network shall stop sending Bm-channel information and stop interpreting received Bm-channel information according to the old call mode at the latest when it changes the channel configuration.

Upon receipt of the MODIFY message, the destination side shall check to ensure that the requested call mode can still be supported and if so, it shall initiate the reservation of any resources necessary to support the next call mode; start T324 (mobile station side only) if the in-call modification procedure is triggered as a result of a service change from speech to UDI/RDI multimedia modes; and enter the "mobile originating modify" (network side) or "mobile terminating modify" state (mobile station side).

#### 5.3.4.3.2 Successful completion of in-call modification

If the destination network/mobile station receives a MODIFY message with a new mode which is already the actual one of the call the network/mobile station shall remain in the "active" state; send a MODIFY COMPLETE message with the actual mode; and shall not initiate anything else.

If the requested mode is speech and if during call establishment the network received a *Supported Codec List* IE, the network shall use this list to select the codec for UTRAN. If no *Supported Codec List* information element is received, then for UTRAN the network shall select the default UMTS speech codec according to subclause 5.2.1.11.

Codecs for GERAN shall be selected from the codecs indicated in the *Supported Codec List* information element or in the *Bearer Capability* information element. If neither a *Supported Codec List* information element nor a *Bearer Capability* information element is received, then for GERAN the network shall select GSM full rate speech version 1.

If the *Supported Codec List* IE is received, then the network shall indicate the codec selected for Iu mode to the mobile station via RANAP and RRC protocol in the NAS Synchronisation Indicator IE (see subclause 5.2.1.11).

If the in-call modification was originated by the mobile station, the mobile station and the network shall proceed as follows:

If the requested mode is not the actual one and can be supported by the network it shall change the channel configuration, if required, and step on to any internal resources necessary to support the next call mode. If the requested mode is a data or facsimile mode, it shall also perform the appropriate means to take the direction of the data call into account. After successful change of the channel configuration it shall start sending user information according to the next call mode and start interpreting received user channel information according to the next call mode; send a MODIFY COMPLETE message with the new call mode included and enter the "active" state (network side). If the MODIFY message had contained a *reverse call setup direction* IE, the same IE shall be included in the MODIFY COMPLETE message.

Upon receipt of the MODIFY COMPLETE message the mobile station shall: initiate the alternation to those resources necessary to support the next call mode; stop timer T323; and enter the "active" state (mobile station side).

If the in-call modification was originated by the network, the mobile station and the network shall proceed as follows:

If the requested mode is not the actual one and can be supported by the mobile station it shall reserve any internal resources necessary to support the next call mode.

NOTE: For a change from speech to a different call mode, user interaction may be required, before the mobile decides that the requested mode can be supported.

If the requested mode is a data or facsimile mode, it shall also perform the appropriate means to take the direction of the data call into account. The mobile station shall send a MODIFY COMPLETE message with the new call mode included, stop timer T324 and enter the "active" state (mobile station side). If the MODIFY message had contained a *reverse call setup direction* IE, the same IE shall be included in the MODIFY COMPLETE message. If the old call mode is speech, the mobile station shall continue sending Bm-channel information and interpreting received Bm-channel information for speech until the network modifies its channel configuration.

After receipt of the MODIFY COMPLETE message the network shall: reserve any internal resources necessary to support the next call mode, stop sending Bm-channel information, and stop interpreting received Bm-channel information according to the old call mode, unless these actions were already performed earlier. Furthermore, the network shall change the channel configuration, if required; after successful change of the channel configuration initiate the alternation to those resources necessary to support the next call mode; stop timer T323; and enter the "active" state (network side).

The mobile station shall start sending user information according to the next call mode and start interpreting received user channel information according to the next call mode as soon as a suitable channel for the new mode is available.

In both cases:

For an alternate speech/facsimile group 3 service (refer to subclause 5.3.4) the old resources may still be kept reserved.

The reaction of the originating side if it had included a reverse call setup direction IE in the MODIFY message, but the destination side did not include the IE in the MODIFY COMPLETE message is implementation dependent.

#### 5.3.4.3.3 Change of the channel configuration

In case the requested bearer capability cannot be supported by the current channel configuration the network shall initiate the assignment procedure and change the channel configuration accordingly.

#### 5.3.4.3.4 Failure of in-call modification

##### 5.3.4.3.4.1 Network rejection of in-call modification

If the network cannot support the change to the requested call mode or if the change of the channel configuration fails the network shall: release the resources which had been reserved for the alternation: send a MODIFY REJECT message with the old bearer capability and with cause # 58 "bearer capability not presently available" to the initiating mobile station; and enter the "active" state. If the change of the channel configuration fails, the network shall return to the internal resources required for the old call mode.

Upon receipt of the MODIFY REJECT message with the old bearer capability the initiating mobile station shall: stop timer T323; release any resources which had been reserved for the alternation; resume sending user channel information according to the present call mode; resume interpreting received user channel information according to the present call mode; and enter the "active" state.

##### 5.3.4.3.4.2 Mobile station rejection of in-call modification

If the mobile station cannot support the change to the requested call mode, the mobile station shall: stop timer T324; release any resources which had been reserved for the alternation; send a MODIFY REJECT message with the old bearer capability and cause # 58 "bearer capability not presently available", and enter the "active" state.

Upon receipt of the MODIFY REJECT message the network shall: stop timer T323, release any resources which had been reserved for the alternation.

##### 5.3.4.3.4.3 Time-out recovery

Upon expiration of T323 in either the mobile station or the network the procedures for call clearing shall be initiated (see subclause 5.4) with cause # 102 "recovery on timer expiry".

Upon expiration of T324 the mobile station shall: release any resources which had been reserved for the alternation; send a MODIFY REJECT message with the old bearer capability and cause #58 "bearer capability not presently available"; and enter the "active" state.

### 5.3.4.4 Abnormal procedures

If a MODIFY, MODIFY COMPLETE or MODIFY REJECT message is received in the "disconnect indication", "disconnect request" (mobile station side only) or "release request" state then the received message shall be discarded and no action shall be taken.

If a MODIFY COMPLETE message indicating a call mode which does not correspond to the requested one is received or if a MODIFY REJECT message indicating a call mode which does not correspond to the actual one is received then the received message shall be discarded and no action shall be taken.

If a MODIFY message indicating a call mode which does not belong to those negotiated and agreed during the establishment phase of the call, is received, then a MODIFY REJECT message with the actual call mode and with cause # 57 "bearer capability not authorized" shall be sent back.

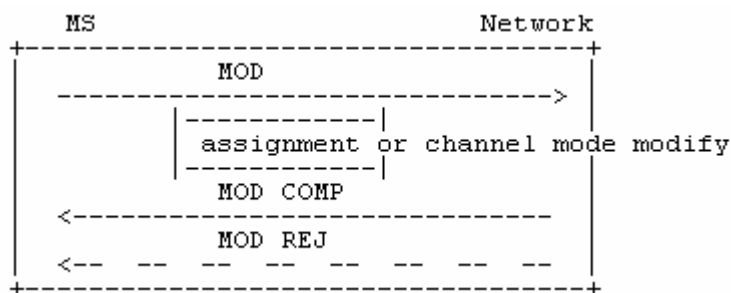

Figure 5.10a/3GPP TS 24.008 In-call modification sequence initiated by MS

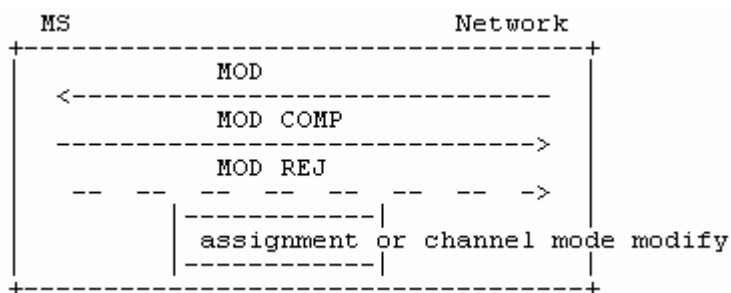

Figure 5.10b/3GPP TS 24.008 In-call modification sequence initiated by network

### 5.3.5 User initiated service level up- and downgrading (A/Gb mode and GERAN lu mode only)

The user initiated service level up- and downgrading is applicable for non-transparent multislot data services, only. By means of this procedure the user can request a change of the "maximum number of traffic channels" and/or "wanted air interface user rate" parameters, to be assigned by the network.

#### 5.3.5.1 Initiation of service level up- and downgrading

The procedure is initiated by the mobile station in the "active" state of the call. It shall:

- send a MODIFY message including the wanted value of the "maximum number of traffic channels" and/or the "wanted air interface user rate" parameters;
- not change any of the other, possibly negotiated, parameters of the bearer capability information element;
- start timer T323; and
- enter the "mobile originating modify" state.

Any internal resources necessary to support the next service parameters shall be reserved. If a dual service was negotiated at call setup, the mobile station shall initiate the service level up- or down-grading only during the data phase of the dual service.

Upon receipt of the MODIFY message, the network shall check if the indicated maximum number of traffic channels can be supported and enter the "mobile originating modify" state.

### 5.3.5.2 Successful completion of service level up- and downgrading

The network may upon reception of the MODIFY message initiate a change of the channel configuration assigned to the mobile station.

As a response to the MODIFY message the network sends a MODIFY COMPLETE message including the bearer capability negotiated at call setup and enters the "active" state.

Upon receipt of the MODIFY COMPLETE message the mobile station shall stop timer T323 and enter the "active" state.

### 5.3.5.3 Rejection of service level up- and downgrading

If a change of bearer service is requested together with a change of the "maximum number of traffic channels" and/or the "wanted air interface user rate", or if the current used service is not a data service where up- and downgrading is applicable, or if the receiver chooses not to grant the request, the network shall:

- send a MODIFY REJECT message with bearer capability negotiated at call setup and with cause #58 "bearer capability not presently available";
- enter the "active" state.

Upon receipt of the MODIFY REJECT message with the bearer capability negotiated at call setup, the mobile station shall: stop timer T323 and enter the "active" state.

### 5.3.5.4 Time-out recovery

Upon expiration of T323 in the mobile station the procedures for call clearing shall be initiated with cause #102 "recovery on timer expiry".

## 5.3.6 Support of multimedia calls

### 5.3.6.1 Service description

The 3GPP circuit-switched multimedia call is based on the 3G-324M [26.111], which is a 3GPP-variant of the ITU-T H.324 recommendation. CS Multimedia telephony is a Bearer Service, which utilizes the Synchronous Transparent Data service (BS30) [3].

At the multimedia call setup the required call type, 3G-324M, is indicated, for the network to be able to invoke appropriate interworking functionality. In the peer end the H.324 information is used to invoke the terminal application. In addition to H.324 indication the terminal must select Information Transfer Capability (ITC) for the multimedia call. The 'correct' ITC depends on the peer end and the transporting networks; an all-ISDN call is a UDI/RDI call, and a call, which involves PSTN, is an analog "3.1 kHz audio" call.

For the case when the setup of a multimedia call is not successful, fallback to speech is specified.

Users may also request a service change between UDI/RDI multimedia and speech modes during a call (see 3GPP TS 23.172 [97]).

### 5.3.6.2 Call establishment

For both mobile originating and mobile terminating calls, the normal call establishment procedures apply, with the exceptions specified in the following subclauses.

For further description of the function of MSC/IWF in the following clauses, see 3GPP TS 29.007 [38].



### 5.3.6.2.1 Mobile originated multimedia call establishment

At call setup the required call type, 3G-324M, is indicated by the originating MS in the SETUP message, with the *bearer capability IE* parameter Other Rate Adaptation set to "H.223 and H.245".

For analogue multimedia, the support of a fallback to speech is requested by including two *bearer capability IEs*, multimedia first and speech as the second BC in the SETUP message. The MS shall indicate fallback to speech by these two BC IEs and the associated Repeat Indicator set to "support of fallback".

For UDI/RDI multimedia, the support of a fallback and service change is requested by including two *bearer capability IEs*, with the first BC as the preferred service in the SETUP message. The MS shall indicate service change and fallback by these two BC IEs and the associated Repeat Indicator set to "support of service change and fallback".

If the *bearer capability IE* is received from the MS either in A/Gb or GERAN Iu mode and indicates no A/Gb mode support for the requested bearer service, the network shall consider it as a request to perform an inter-system handover to UTRAN Iu mode, as described in TS 23.009 [114] subclause 14.2.

The bearer compatibility checking in the network is according to 5.3.4.2.1.

If the MS requested for an analogue multimedia call with fallback to speech, or for a UDI/RDI multimedia call with fallback and service change, and the network accepts the call, the network has the following options for the inclusion of *bearer capability IEs* in the CALL PROCEEDING message:

- if the network accepts the requested analogue multimedia call and supports fallback to speech, both multimedia and speech *bearer capability IEs* shall be included;
- if the network accepts the requested UDI/RDI multimedia call and supports fallback and service change, both multimedia and speech *bearer capability IEs* shall be included. The order of the *bearer capability IEs* determines the preferred service, and the network may reverse the order of these IEs (see 3GPP TS 23.172 [97], subclause 4.2.1);
- if the network accepts a multimedia (only) call, a multimedia *bearer capability IE* shall be included;
- if the network accepts a speech (only) call, a speech *bearer capability IE* shall be included;
- for a UDI/RDI multimedia call, if the network accepts the requested speech call and supports service change, both multimedia and speech *bearer capability IEs* shall be included. The order of the *bearer capability IEs* determines the preferred service, and the network may reverse the order of these IEs (see 3GPP TS 23.172 [97], subclause 4.2.1);
- if the network received a UDI/RDI multimedia *bearer capability IE* with FNUR equal to 32kbit/s and a speech *bearer capability IE* in the SETUP message, the network shall not release the call, but shall reply with one *bearer capability IE* only, as specified in 3GPP TS 23.172 [97].

NOTE: Service change and fallback for UDI/RDI multimedia calls is not supported with Fixed Network User Rate set to 32 kbit/s (see 3GPP TS 23.172 [97]).

If the MS requested for a multimedia call only, and the network accepts the call, the network shall always include a single multimedia *bearer capability IE* in the CALL PROCEEDING message.

The originating user shall determine (possibly by pre-configuration of the terminal) whether a digital connection is required or if the call will be an analog modem call. If the call is expected to be digital the multimedia *bearer capability IE* parameter ITC is set to UDI/RDI. In an analog call the multimedia *bearer capability IE* parameter ITC is set to "3,1 kHz audio ex PLMN". Additionally required modem type is indicated (Other Modem Type = V.34).

#### 5.3.6.2.1.1 Fallback

If the network, during the setup of an H.324-call, detects that the transit network or the called end does not support an H.324 call (e.g. because of a failure in the modem handshaking in case of an analogue multimedia call), then the network initiates the in-call modification procedure (see subclause 5.3.4.3) towards the MS to modify the call mode to speech, if the MS had included a speech *bearer capability IE* in the SETUP message.

In case of a UDI/RDI multimedia call with service change and fallback, if the network detects that the called end does not support speech, then it initiates an in-call modification procedure towards the MS to modify the call mode to multimedia, if the first *bearer capability IE* was for a speech call.

### 5.3.6.2.2 Mobile terminating multimedia call

At call setup the required call type, 3G-324M, is indicated by the network in the SETUP message, with the *bearer capability IE* parameter. Other Rate Adaptation set to 'H.223 and H.245'. ITC is either '3,1 kHz audio ex PLMN' or 'UDI/RDI'.

For analogue multimedia, if the network supports fallback to speech and the subscriber has subscription to speech, two *bearer capability IEs*, multimedia first and speech as the second BC are included in the SETUP message. The network shall indicate fallback to speech by these two BC IEs and the associated Repeat Indicator set to "support of fallback".

For UDI/RDI multimedia, if the network supports fallback and service change, and the subscriber has subscription to speech, two *bearer capability IEs*, with the first BC as the preferred service are included in the SETUP message. The network shall indicate service change and fallback by these two BC IEs and the associated Repeat Indicator set to "service change and fallback".

If the *bearer capability IE* is received from the MS either in A/Gb or GERAN Iu mode and indicates no A/Gb mode support for the requested bearer service, the network shall consider it as a request to perform an inter-system handover to UTRAN Iu mode, as described in TS 23.009 [114] subclause 14.2.

The *bearer capability IE(s)* may (in the case of the single numbering scheme) be missing from the SETUP message.

The bearer compatibility checking in the MS is according to 5.3.4.2.2.

The MS shall indicate the supported call type(s) in the CALL CONFIRMED message, which is the acknowledgement to SETUP. If the network offered an analogue multimedia call with fallback to speech, or a UDI/RDI multimedia call with fallback and service change, the MS has the following options for the inclusion of *bearer capability IEs* in the CALL CONFIRMED message:

- if the MS/user accepts the offered analogue multimedia call and supports fallback to speech, both multimedia and speech *bearer capability IEs* shall be included;
- if the MS/user accepts the offered UDI/RDI multimedia call, and supports fallback and service change, both multimedia and speech *bearer capability IEs* shall be included. The order of the BC IEs determines the preferred service, and the MS/user may reverse the order of these IEs;
- if the MS/user accepts the offered multimedia call, but does not support fallback or service change, only a multimedia *bearer capability IE* shall be included;
- if the MS/user wishes a speech (only) call a speech *bearer capability IE* is included;
- for a UDI/RDI multimedia call, if the MS/user accepts the offered speech call and supports service change, both speech and multimedia *bearer capability IEs* shall be included. The order of the BC IEs determines the preferred service, and the MS/user may reverse the order of these IEs.

If the network offered a multimedia call only, and the MS/user accepts the call, the MS shall always include a single multimedia *bearer capability IE* in the CALL CONFIRMED message.

If the SETUP contained no *bearer capability IE* the network shall perform compatibility checking of the CALL CONFIRMED message in the same way as the compatibility checking of the SETUP message in the mobile originating call case, described in subclause 5.3.6.2.1.

#### 5.3.6.2.2.1 Fallback to speech

If modem handshaking fails (in a modem call), the call mode will be modified to speech if a speech *bearer capability IE* was included. The modem signalling is inband, so the call must have reached the active state, when these conclusions about the presence of modems can be done. The call modifications are realized through the in-call modification procedure, by which the network requests the MS to modify the call mode (see subclause 5.3.4.3).

NOTE: Fallback from digital (UDI) H.324-call to speech after call setup is not a valid case at the terminating side.

### 5.3.6.3 In-call modification in the "active" state

The in-call modification procedure as described in chapter 5.3.4.3 shall be used to:

- trigger a service change between speech and UDI/RDI multimedia modes, when service change has been agreed at call setup;
- trigger a network-initiated service upgrade from speech to UDI/RDI multimedia modes (see 3GPP TS 23.172 [97]). The network shall initiate this procedure only if the mobile station indicated support of the enhanced network-initiated in-call modification procedure in the Call Control Capabilities IE at call establishment. In this case, the MODIFY message shall include the *Network-initiated Service Upgrade indicator IE*; or
- modify the multimedia bearer capability for an analogue multimedia call (restricted to the network initiated in-call modification only). In this case, the network shall send a MODIFY message including the new Bearer Capability to be changed to. The following bearer capability parameters can be modified with the procedure (see 3GPP TS 29.007 [38]):
  - Fixed Network User Rate (analogue multimedia calls only).

5.3.6.3.1        Void

5.3.6.3.2        Void

5.3.6.3.3        Void

5.3.6.3.3.1        Void

5.3.6.3.3.2        Void

## 5.4        Call clearing

### 5.4.1      Terminology

The following terms are used in the present document in the description of clearing procedures:

- A traffic channel (see 3GPP TS 44.003 [16]) is "connected" when the channel is part of a circuit-switched connection established according to the present document.
- A traffic channel is "disconnected" when the channel is no longer part of a circuit-switched connection, but is not yet available for use in a new connection.

### 5.4.2      Exception conditions

Under normal conditions, the call control entity of the mobile station or of the network initiates call clearing by sending a DISCONNECT message to its peer entity; then both entities follow the procedures defined in subclauses 5.4.3 and 5.4.4 respectively.

As an exception to the above rule, the call control entity of the mobile station or of the network, in response to a SETUP or START CC or CC-ESTABLISHMENT CC-ESTABLISHMENT CONFIRMED or RECALL message, can reject a call by stopping all running call control timers, responding with a RELEASE COMPLETE message, releasing the MM connection, and returning to the "null" state, provided no other response has previously been sent.

As a further exception, the call control entity of the network may initiate call clearing by stopping all running call control timers, sending a RELEASE message, starting timer T308, and entering the "release request" state.

NOTE: This way to initiate call clearing by sending a RELEASE message should not be used by the network:

- if in-band tones/announcements are provided and the network decides to use the procedure described in subclause 5.4.4.1.1.1 or 5.4.4.2.1;
- if the network wants to have the opportunity to respond to information sent by the mobile station during call clearing, e.g. when the network indicates that "CCBS activation is possible".

A call control entity shall accept an incoming RELEASE COMPLETE message used to initiate the call clearing even though the cause information element is not included.

A control entity shall accept an incoming RELEASE message used to initiate the call clearing even though the cause information element is not included.

Furthermore, a call control entity shall regard an incoming RELEASE COMPLETE message as consistent with any of its states; a call control entity shall regard an incoming RELEASE message as consistent with any of its states except the null state: a call control entity of the mobile station shall regard an incoming DISCONNECT message as consistent with any of its call control states except the "null" state, the "release request" state, and the "disconnect indication" state; a call control entity of the network shall regard an incoming DISCONNECT message as consistent with any of its call control states except the "null" state and the "release request" state.

NOTE: This allows the introduction of shorter call clearing procedures in the future.

### 5.4.3 Clearing initiated by the mobile station

#### 5.4.3.1 Initiation of call clearing

Apart from the exceptions identified in subclause 5.4.2, the call control entity of the mobile station shall initiate clearing by: stopping all running call control timers, sending a DISCONNECT message; starting timer T305; and entering the "disconnect request" state.

#### 5.4.3.2 Receipt of a DISCONNECT message from the mobile station.

The call control entity in the network in any state except the "null" state and the "release request" state shall, upon receipt of a DISCONNECT message:

- Stop all running call control timers;
- initiate procedures to clear the network connection and the call to the remote user;
- send a RELEASE message to its peer entity;
- start timer T308; and
- enter the "release request" state.

NOTE: The RELEASE message has only local significance and does not imply an acknowledgement of clearing from the remote user.

#### 5.4.3.3 Receipt of a RELEASE message from the network

The call control entity of the mobile station in any state except the "null" state and the "release request" state, shall, upon receipt of a RELEASE message: stop all running call control timers; send a RELEASE COMPLETE message; release the MM connection; and return to the "null" state.

#### 5.4.3.4 Receipt of a RELEASE COMPLETE message from the mobile station

A call control entity of the network in any call control state shall, upon receipt of a RELEASE COMPLETE message from its peer entity in the mobile station: stop all running call control timers; release the MM connection; and return to the "null" state.

#### 5.4.3.5 Abnormal cases

The call control entity of the mobile station in the "disconnect request" state, shall upon expiry of timer T305: send a RELEASE message to the network with the cause number originally contained in the DISCONNECT message and optionally, a second cause information element with cause #102 "recovery on timer expiry", start timer T308, and enter the "release request" state.

The call control entity of the network in the "release request" state, shall, at first expiry of timer T308, retransmit the RELEASE message, start timer T308, and stay in the "release request" state. At second expiry of timer T308, the call control entity of the network shall: release the MM connection; and return to the "null" state.

#### 5.4.4 Clearing initiated by the network

Apart from the exception conditions identified in subclause 5.4.2, the call control entity of the network shall initiate clearing by: sending a DISCONNECT message; and entering the "disconnect indication" state. The DISCONNECT message is a local invitation to clear the call.

**NOTE:** When the network initiates clearing by sending a RELEASE message, the procedures described in subclauses 5.4.3., 5.4.3.4 and 5.4.3.5 are followed.

A mobile station that does not support the "Prolonged Clearing Procedure" shall comply with the requirements of subclause 5.4.4.1 and shall ignore subclause 5.4.4.2. A mobile station that supports the "Prolonged Clearing Procedure" shall comply with the requirements of subclauses 5.4.4.2 and shall ignore subclause 5.4.4.1.

##### 5.4.4.1 Clearing initiated by the network: mobile does not support "Prolonged Clearing Procedure"

Subclause 5.4.4.1 only applies to mobile stations that do not support the "Prolonged Clearing Procedure" option.

###### 5.4.4.1.1 Clearing when tones/announcements provided

When in-band tones/announcements are provided (see subclause 5.5.1), the call control entity of the network may initiate clearing by sending a DISCONNECT message containing progress indicator #8 "in-band information or appropriate pattern now available", starting timer T306, and entering the "disconnect indication" state.

###### 5.4.4.1.1.1 Receipt of a DISCONNECT message with progress indicator #8 from the network

The call control entity of the MS in any state except the "null" state, the "disconnect indication" state, and the "release request" state, shall, upon receipt of a DISCONNECT message with progress indicator #8:

- i) if an appropriate speech traffic channel is not connected, continue clearing as defined in subclause 5.4.4.1.2.1 without connecting to the in-band tone/announcement;
- ii) if an appropriate speech traffic channel is connected, attach the user connection for speech if it is not yet attached and enter the "disconnect indication" state. In that state, if upper layers request the clearing of the call, the call control entity of the MS shall proceed as defined in subclause 5.4.4.1.2.1.

###### 5.4.4.1.1.2 Expiry of timer T306

The call control entity of the network, having entered the "disconnect indication" state after sending a disconnect message with the progress indicator #8, shall, upon expiry of timer T306, continue clearing by sending a RELEASE message with the cause number originally contained in the DISCONNECT message; starting timer T308; and entering the "release request" state.

###### 5.4.4.1.2 Clearing when tones/announcements not provided

When in-band tones and announcements are not provided, the call control entity of the network shall initiate call clearing by stopping all running call control timers, sending a DISCONNECT message without progress indicator, starting timer T305 and entering the "disconnect indication" state.

#### 5.4.4.1.2.1 Receipt of a DISCONNECT message without progress indicator or with progress indicator different from #8 from the network

The call control entity of the mobile station in any state except the "null" state, the "disconnect indication" state, and the "release request" state, shall, upon the receipt of a DISCONNECT message without progress indicator information element or with progress indicator different from #8:

- stop all running call control timers;
- send a RELEASE message;
- start timer T308; and
- enter the "release request" state.

#### 5.4.4.1.2.2 Receipt of a RELEASE message from the mobile station

The call control entity of the network in any state except the "null" state and the "release request" state, shall, upon receipt of a RELEASE message: stop all running call control timers; send a RELEASE COMPLETE message; release the MM connection; and return to the "null" state.

#### 5.4.4.1.2.3 Abnormal cases

The call control entity of the network, having entered the "disconnect indication" state after sending a DISCONNECT message without progress indicator or with progress indicator different from #8, shall upon expiry of timer T305: send a RELEASE message to the mobile station with the cause number originally contained in the DISCONNECT message; start timer T308; and enter the "release request" state. In addition to the original clearing cause, the RELEASE message may contain a second cause information element with cause #102 "recovery on timer expiry".

#### 5.4.4.1.3 Completion of clearing

A call control entity of the mobile station in any call control state shall, upon receipt of a RELEASE COMPLETE message from its peer entity in the network: stop all running call control timers; release the MM connection; and return to the "null" state.

#### 5.4.4.1.3.1 Abnormal cases

The call control entity of the mobile station in the "release request" state shall at first expiry of timer T308 retransmit the RELEASE message and restart timer T308. At second expiry of timer T308, the call control entity of the mobile station shall: release the MM connection; and return to the "null" state.

#### 5.4.4.2 Clearing initiated by the network: mobile supports "Prolonged Clearing Procedure"

Subclause 5.4.4.2 only applies to mobile stations that support the "Prolonged Clearing Procedure" option.

#### 5.4.4.2.1 Clearing when tones/announcements provided and the network does not indicate that "CCBS activation is possible"

When in-band tones/announcements are provided (see subclause 5.5.1) and CCBS is not applicable, the call control entity of the network may initiate clearing by sending a DISCONNECT message containing progress indicator #8 "in-band information or appropriate pattern now available", either not containing an *Allowed Actions* IE or containing an *Allowed Actions* IE indicating "CCBS activation is not possible", starting timer T306, and entering the "disconnect indication" state.

#### 5.4.4.2.1.1 Receipt of a DISCONNECT message

The call control entity of the MS in any state except the "null" state, the "disconnect indication" state, and the "release request" state, shall, upon receipt of a DISCONNECT message with progress indicator #8 and, either not containing an *Allowed Actions* IE or containing an *Allowed Actions* IE indicating "CCBS activation is not possible":

- i) if an appropriate speech traffic channel is not connected,
  - stop all running call control timers;
  - send a RELEASE message;
  - start timer T308;
  - enter the "release request" state; and
  - not connect to the in-band tone/announcement.
- ii) if an appropriate speech traffic channel is connected, attach the user connection for speech if it is not yet attached and enter the "disconnect indication" state. In that state, if upper layers request the clearing of the call, the call control entity of the MS shall:
  - stop all running call control timers;
  - send a RELEASE message;
  - start timer T308; and
  - enter the "release request" state.

#### 5.4.4.2.1.2 Expiry of timer T306

The call control entity of the network, having entered the "disconnect indication, shall, upon expiry of timer T306, continue clearing by sending a RELEASE message with the cause number originally contained in the DISCONNECT message; starting timer T308; and entering the "release request" state.

#### 5.4.4.2.2 Clearing when the network indicates that "CCBS activation is possible"

When Activation of CCBS is possible, the call control entity of the network may initiate clearing by sending a DISCONNECT message containing the *Allowed Actions* IE with an indication that "Activation of CCBS is possible" and starting T338. Optionally, progress indicator #8 "in-band information or appropriate pattern now available" may also be contained in the DISCONNECT message (in which case, T338 shall not be greater than T306).

##### 5.4.4.2.2.1 Receipt of a DISCONNECT

Relative to the current state the following procedures apply:

- The call control entity of the MS in the "null" state, the "disconnect indication" state and the "release request" state, shall, upon receipt of a DISCONNECT message react as described in clause 8.
- The call control entity of the MS in the "disconnect request" state, shall, upon receipt of a DISCONNECT message:
  - stop all running call control timers;
  - send a RELEASE message;
  - start timer T308; and
  - enter the "release request" state.
- The call control entity of the MS in any other states, shall, upon receipt of a DISCONNECT message with an *Allowed Actions* IE indicating "Activation of CCBS is possible" pass the "Activation of CCBS is possible" indication to the upper layer, enter the "disconnect indication" state, stop all running call control timers and await a response from the upper layers.

If the DISCONNECT message contained the progress indicator #8 "in-band information or appropriate pattern now available" and an appropriate speech traffic channel is connected, then the MS shall attach the user connection for speech if it is not yet attached. If the DISCONNECT message did not contain the progress indicator #8 "in-band information or appropriate pattern now available" any connected speech traffic channel shall be disconnected.

Response from the upper layers:

- i) If the upper layers request the clearing of the call, the call control entity of the MS shall:
  - stop all running call control timers;
  - send a RELEASE message;
  - start timer T308; and
  - enter the "release request" state.
- ii) If the upper layers request that the "CCBS activation is to be attempted" then the MS shall
  - send a RELEASE message containing a *Facility* IE including an
  - Invoke=CCBSRequest to the network;
  - stop all running call control timers;
  - start timer T308; and
  - enter the "release request" state.

If an appropriate speech traffic channel is connected, transmission of this RELEASE message shall not cause it to be disconnected.

#### 5.4.4.2.2.2 Expiry of timer T338

The call control entity of the network, having entered the "disconnect indication" state after sending a DISCONNECT message with an *Allowed Actions* IE indicating "Activation of CCBS is possible" shall, upon expiry of timer T338, continue clearing by sending a RELEASE message with the cause number originally contained in the DISCONNECT message; starting timer T308; and entering the "release request" state.

#### 5.4.4.2.3 Clearing when tones/announcements are not provided and the network does not indicate that "CCBS activation is possible"

When in-band tones and announcements are not provided, and, the network does not wish to indicate in the *Allowed Actions* IE that "CCBS is possible", the call control entity of the network shall initiate call clearing by stopping all running call control timers, sending a DISCONNECT message without progress indicator, either without the *Allowed Actions* IE or with the *Allowed Actions* IE indicating that "CCBS is not possible", starting timer T305 and entering the "disconnect indication" state.

#### 5.4.4.2.3.1 Receipt of a DISCONNECT message

The call control entity of the mobile station in any state except the "null" state, the "disconnect indication" state, and the "release request" state, shall, upon the receipt of a DISCONNECT message either without progress indicator information element or with progress indicator different from #8, and, either without the *Allowed Actions* IE or with the *Allowed Actions* IE indicating that "CCBS is not possible":

- stop all running call control timers;
- send a RELEASE message;
- start timer T308; and
- enter the "release request" state.



#### 5.4.4.2.3.2 Abnormal cases

The call control entity of the network, having entered the "disconnect indication", shall upon expiry of timer T305: send a RELEASE message to the mobile station with the cause number originally contained in the DISCONNECT message; start timer T308; and enter the "release request" state.

#### 5.4.4.2.4 Receipt of a RELEASE message from the mobile station

##### 5.4.4.2.4.1 Release, CCBS not requested

For a network that does not support the "CCBS activation" option:

The call control entity of the network in any state except the "null" state and the "release request" state, shall, upon receipt of a RELEASE message: stop all running call control timers; send a RELEASE COMPLETE message; release the MM connection; and return to the "null" state.

For a network that does support the "CCBS activation" option:

The call control entity of the network in any state except the "null" state and the "release request" state, shall, upon receipt of a RELEASE message without a *Facility* IE including an Invoke=CCBSRequest: stop all running call control timers; send a RELEASE COMPLETE message; release the MM connection; and return to the "null" state.

##### 5.4.4.2.4.2 Release, CCBS Requested

For a network that does not support the "CCBS activation" option:

The call control entity of the network in any state except the "null" state and the "release request" state, shall, upon receipt of a RELEASE message: stop all running call control timers; send a RELEASE COMPLETE message; release the MM connection; and return to the "null" state.

For a network that does support the "CCBS activation" option:

The call control entity of the network in any state except the "null" state and the "release request" state, shall, upon receipt of a RELEASE message containing a *Facility* IE including an Invoke=CCBSRequest: stop all running call control timers; then attempt to activate the recall; then send a RELEASE COMPLETE message indicating the success or failure of the recall activation attempt; release the MM connection; and return to the "null" state.

#### 5.4.4.2.5 Completion of clearing

A call control entity of the mobile station in any call control state shall, upon receipt of a RELEASE COMPLETE message from its peer entity in the network: stop all running call control timers; release the MM connection; and return to the "null" state.

##### 5.4.4.2.5.1 Abnormal cases

The call control entity of the mobile station in the "release request" state shall at first expiry of timer T308 retransmit the RELEASE message and restart timer T308. At second expiry of timer T308, the call control entity of the mobile station shall: release the MM connection; and return to the "null" state.

The retransmitted RELEASE message need not contain the *Facility* IE including an Invoke=CCBSRequest, even if the original RELEASE message did contain this IE.5.4.5Clear collision

Clear collision occurs when both the mobile station and the network simultaneously transfer DISCONNECT messages specifying the same call.

The behaviour of the network call control entity receiving a DISCONNECT message whilst in the "disconnect indication" state is specified in subclause 5.4.3. The behaviour of the MS call control entity receiving a DISCONNECT message whilst in the "disconnect request" state is defined in subclause 5.4.4.

Clear collision can also occur when both sides simultaneously transfer RELEASE messages related to the same call. The entity receiving such a RELEASE message whilst within the "release request" state shall: stop timer T308; release the MME connection; and enter the "null" state (without sending a RELEASE COMPLETE message).

## 5.5 Miscellaneous procedures

### 5.5.1 In-band tones and announcements

When the network wants to make the mobile station attach the user connection (e.g. in order to provide in-band tones/announcement) before the mobile station has reached the "active" state of a call, the network may include a *progress indicator* IE indicating user attachment in a suitable CC message:

- Either it includes the IE in a SETUP, CALL PROCEEDING, ALERTING, or CONNECT message that is sent during call establishment
- it sends a PROGRESS message containing the IE.

A *progress indicator* IE indicates user attachment if it specifies a progress description in the set {1, 2, 3} or in the set {6, 7, 8, ..., 20}.

On reception of a SETUP, CALL PROCEEDING, ALERTING, CONNECT, or PROGRESS message the mobile station shall proceed as specified elsewhere in clause 5; if the *progress indicator* IE indicated user attachment and a speech mode traffic channel is appropriate for the call the mobile station shall in addition: attach the user connection for speech as soon as an appropriate channel in speech mode is available. (If a new order to attach the user connection is received before the attachment has been performed, the new order shall supersede the previous one.)

Under certain conditions the MS will have to attach the user connection before the CONNECT message. It is up to the network to ensure that no undesired end-to-end through connection takes place during the establishment of a MT call.

NOTE: This allows the use of *progress indicator* IEs independently from the channel modes appropriate for the call.

### 5.5.2 Call collisions

Call collisions as such cannot occur at the network. Any simultaneous mobile originating or mobile terminating calls are dealt with separately assigned and different transaction identifiers.

### 5.5.3 Status procedures

#### 5.5.3.1 Status enquiry procedure

Whenever a call control entity wishes to check the call state of its peer entity, it may initiate the status enquiry procedure.

NOTE: This may, in particular, apply to procedural error conditions described in clause 8.

A call control entity initiates the status enquiry procedure by sending the STATUS ENQUIRY message and starting timer T322. While timer T322 is running, the call control entity shall not send further STATUS ENQUIRY messages.

Upon receipt of a STATUS ENQUIRY message, the receiver shall respond with a STATUS message, reporting the current call state and cause value #30 "response to STATUS ENQUIRY". Receipt of the STATUS ENQUIRY shall not result in a state change relating to any protocol and connection of the receiver.

If a STATUS message is received that contains cause value #30 "response to status enquiry", timer T322 shall be stopped and further appropriate actions taken, based on the information in that STATUS message, relative to the current state of the receiver of the STATUS message. These further "appropriate actions" are implementation dependent. However, the actions prescribed in subclause 5.5.3.2 shall apply.

If a clearing message is received while timer T322 is running, timer T322 shall be stopped, and call clearing shall continue.

If timer T322 expires, the STATUS ENQUIRY message may be retransmitted maximally once. If T322 expires after the STATUS ENQUIRY has been transmitted the maximum number of times, clearing of the call shall be initiated with cause value #41, "temporary failure", in the first call clearing message.

### 5.5.3.2 Reception of a STATUS message by a CC entity

#### 5.5.3.2.1 STATUS message with incompatible state

On receipt of a STATUS message reporting an incompatible call control state, the receiving entity shall clear the call by sending a RELEASE COMPLETE message with cause # 101 "message not compatible with protocol state". The reported call control state is incompatible if the combination of call control states at the sender and receiver side cannot occur, do not match or cannot be aligned by actions of the receiver; the exact definition is implementation dependent.

#### 5.5.3.2.2 STATUS message with compatible state

A STATUS message may be received indicating a compatible call state but containing one of the following causes:

- # 95 "semantically incorrect message"; or
- # 96 "invalid mandatory information"; or
- # 97 "message type non-existent or not implemented"; or
- # 98 "message type not compatible with protocol state"; or
- # 99 "information element non-existent or not implemented"; or
- # 100 "conditional IE error".

This indicates that the transmitter of the STATUS message was unable to accept some information sent by the recipient of the STATUS message. This allow the recipient to retransmit some or all of the information. Other actions are possible and are implementation dependent; they may include releasing the call.

In the case the MS receives a STATUS message with the cause #100 due to the presence of a Repeat Indicator with the value 'service change and fallback' in a SETUP message, it may then resend a new SETUP message with a single BC-IE (no Repeat Indicator is included). The actual behaviour is dependent on the implementation.

In the case the network receives a STATUS message with the cause #100 due to the presence of a Repeat Indicator with the value 'service change and fallback' in a SETUP message, it shall then resend a new SETUP message, with either the BC-IE of the preferred service or the speech BC-IE (fallback to speech) as the only BC (no Repeat Indicator is included). The preferred behaviour is decided by configuration.

### 5.5.4 Call re-establishment, mobile station side

This subclause describes the internal handling in the mobile station as far as call control is concerned.

#### 5.5.4.1 Indication from the mobility management sublayer

When a MM connection is active, an indication may be given by the MM sublayer to the call control entity to announce that the current MM connection has been interrupted but might be re-established on request of call control.

#### 5.5.4.2 Reaction of call control

Depending whether call re-establishment is allowed or not and on its actual state, call control shall decide to either request re-establishment or to release the MM connection.

a) Re-establishment not required

If the call is in the call establishment or call clearing phase, i.e. any state other than the "active" state or the "mobile originating modify" state, call control shall release the MM connection

b) Re-establishment required

If the call is in the "active" state or "mobile originating modify" state, the indication from MM that re-establishment is possible shall cause call control to request re-establishment from the MM connection, suspend any further message to be sent and await the completion of the re-establishment procedure.

#### 5.5.4.3 Completion of re-establishment

Call Control is notified when the MM connection is re-established and shall then resume the transmission of possibly suspended messages and resume user data exchange when an appropriate channel is available.

#### 5.5.4.4 Unsuccessful outcome

If the attempt to re-establish the connection was unsuccessful, the MM connection will be released and a release indication will be given to call control, see subclause 4.5.1.6.

### 5.5.5 Call re-establishment, network side

This subclause describes the handling in the network as far as call control is concerned.

#### 5.5.5.1 State alignment

After a successful call re-establishment it is a network responsibility to identify (e.g. by using the status enquiry procedure, if needed, and resolve, if possible, any call state or auxiliary state mismatch between the network and the mobile station.

### 5.5.6 Progress

At any time during the establishment or release of a call and during an active call the network may send a PROGRESS message to the mobile station.

On receipt of a PROGRESS message during the establishment or release of a call the mobile station shall stop all call control timers related to that call.

NOTE: If the PROGRESS has been received before the receipt of a CALL PROCEEDING message, the mobile station will not start timer T310 on receipt of a CALL PROCEEDING message, see subclause 5.2.1.1.3.

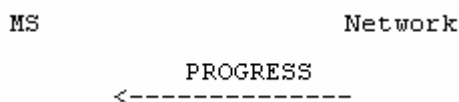

Figure 5.11/3GPP TS 24.008 Progress

### 5.5.7 DTMF protocol control procedure

Dual Tone Multi Frequency (DTMF) is an inband one out of four plus one out of four signalling system primarily used from terminal instruments in telecommunication networks. The support of DTMF in the network is described in 3GPP TS 23.014 [12].

The mobile station shall be capable of transmitting DTMF messages if and only if the mobile station has the user connection for speech attached and an appropriate channel is available.

The transaction identifier used by the DTMF messages shall be that of the attached speech call.

NOTE 1: The present document means that DTMF messages can generally be sent in the active state of a call in speech transmission mode or when a traffic channel is available during setup or release and the *progress indicator* IE has been received.

NOTE 2: Since the DTMF protocol messages are sent in a store and forward mode on the signalling channels the control of the device at the far end may be delayed dependent on the load or quality of the channels.

NOTE 3: The procedures described in this paragraph support DTMF only in the direction mobile station to network.

#### 5.5.7.1 Start DTMF request by the mobile station

A user may cause a DTMF tone to be generated e.g. by depression of a key in the mobile station. The relevant action is interpreted by the mobile station as a requirement for a DTMF digit to be sent in a START DTMF message on an established FACCH. This message contains the value of the digit to be transmitted (0, 1, ..., 9, A, B, C, D, \*, #).

Only a single digit will be transferred in each START DTMF message.

On sending a START DTMF message the MS shall start timer T336.

Where a previous START DTMF message has been sent, another START DTMF message shall only be sent by the MS following receipt of its STOP DTMF ACKNOWLEDGE message (see subclause 5.5.7.4) or a START DTMF REJECT message from the network (see subclause 5.5.7.2) or following the expiry of timers T336 and T337.

If timer T336 expires, the MS shall terminate the ongoing DTMF procedure without any retransmissions, and is free to begin another DTMF procedure (e.g. another START DTMF message).

#### 5.5.7.2 Start DTMF response by the network

Upon receiving the START DTMF message the network shall either:

- convert the received digit into a DTMF tone which is applied toward the remote user, or
- send the DTMF digit as an out-of-band message (see 3GPP TS 23.205 [96])

and return a START DTMF ACKNOWLEDGE message to the mobile station. This acknowledgement may be used in the mobile station to generate an indication as a feedback for a successful transmission.

If the network cannot accept the START DTMF message a START DTMF REJECT message will be sent to the mobile station. Upon receipt of a START DTMF ACK message or a START DTMF REJECT message, the MS shall stop timer T336.

#### 5.5.7.3 Stop DTMF request by the mobile station

When the user indicates that the DTMF sending should cease e.g. by releasing the key the mobile station will send a STOP DTMF message to the network.

On sending a STOP DTMF message the MS shall start timer T337.

The MS shall only send a STOP DTMF message if a START DTMF ACKNOWLEDGE message has been received from the network (see subclause 5.5.7.2).

If timer T337 expires, the MS shall terminate the ongoing DTMF procedure without any retransmissions, and is free to begin another DTMF procedure. (e.g. another START DTMF message).

#### 5.5.7.4 Stop DTMF response by the network

Upon receiving the STOP DTMF message the network shall either:

- stop sending the DTMF tone if applied by the network, or
- initiate a suitable out-of-band message (see 3GPP TS 23.205 [96])

and return a STOP DTMF ACKNOWLEDGE message to the mobile station. Upon receipt of a STOP DTMF ACKNOWLEDGE message, the MS shall stop timer T337.

#### 5.5.7.5 Sequencing of subsequent start DTMF requests by the mobile station

If the network is generating DTMF tones it shall ensure that the minimum length of tone and the minimum gap between two subsequent tones (according to ETSI ES 201 235-2 [12a]) is achieved.

NOTE 1: In ETSI ES 201 235-2 [12a] the minimum duration of a DTMF tone is 65ms.

NOTE 2: In ETSI ES 201 235-2 [12a] the minimum gap between DTMF tones is 65ms.

There is no defined maximum length to the tone, which will normally cease when a STOP DTMF message is received from the MS. However, the operator may choose to put a pre-defined time limit on the duration of tones sent.

The appropriate sequencing of DTMF control messages is shown in figures 5.8 and 5.9.

NOTE 3: The network may implement the time limit option where the DTMF tone duration is controlled by the network irrespective of the receipt of a STOP DTMF message from the mobile station.

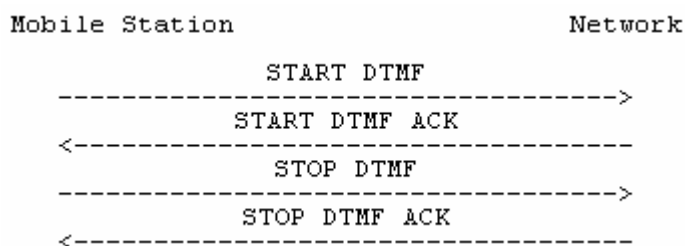

Figure 5.8/3GPP TS 24.008 Single DTMF transmission

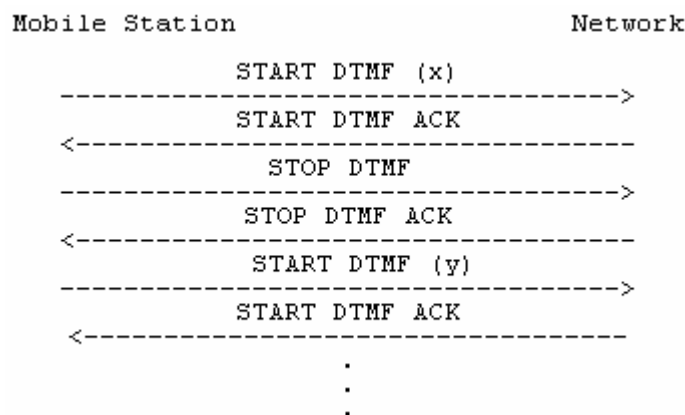

Figure 5.9/3GPP TS 24.008 Multiple DTMF transmission

## 6 Support for packet services

This chapter contains the description of the procedures for the session management of GPRS point-to-point data services and MBMS point-to-point and point-to-multipoint data services at the radio interface (Reference point U<sub>u</sub> and U<sub>m</sub>).

### 6.1 GPRS Session management

#### 6.1.1 General

The main function of the session management (SM) is to support PDP context handling of the user terminal. Furthermore, the SM supports the MBMS context handling within the MS and the network, which allows the MS to receive data from a specific MBMS source.

The SM comprises procedures for

- identified PDP context activation, deactivation and modification; and
- identified MBMS context activation and deactivation.

SM procedures for identified access can only be performed if a GMM context has been established between the MS and the network. If no GMM context has been established, the MM sublayer has to initiate the establishment of a GMM context by use of the GMM procedures as described in chapter 4. After GMM context establishment, SM uses services offered by GMM (see 3GPP TS 24.007 [20]). Ongoing SM procedures are suspended during GMM procedure execution.

The SM procedures for identified MBMS context activation and deactivation can only be performed, if in addition to the GMM context the MS has a PDP context activated.

In Iu mode only, integrity protected signalling (see subclause 4.1.1.1.1 of the present document and in general, see 3GPP TS 33.102 [5a]) is mandatory. In Iu mode only, all protocols shall use integrity protected signalling. Integrity protection of all SM signalling messages is the responsibility of lower layers. It is the network which activates integrity protection. This is done using the security mode control procedure (3GPP TS 25.331 [23c] and 3GPP TS 44.118 [111]).

For the session management protocol, the extended TI mechanism may be used (see 3GPP TS 24.007 [20]).

## 6.1.2 Session management states

In this subclause, the SM states are described for one SM entity (see 3GPP TS 24.007 [20]). Each SM entity is associated with one PDP context or MBMS context. Subclause 6.1.2.1 describes the SM states in the MS and subclause 6.1.2.2 describes the SM states on the network side.

### 6.1.2.1 Session management states in the MS

In this subclause, the possible states of an SM entity in the mobile station are described. As illustrated in figure 6.1/3GPP TS 24.008 and 6.1a/3GPP TS 24.008 there are seven SM states in the MS.

#### 6.1.2.1.1 PDP-INACTIVE

This state indicates that neither PDP context nor MBMS context exist.

#### 6.1.2.1.2 PDP-ACTIVE-PENDING

This state exists when PDP context activation was requested by the MS.

#### 6.1.2.1.3 PDP-INACTIVE-PENDING

This state exists when deactivation of the PDP contexts was requested by the MS.

#### 6.1.2.1.4 PDP-ACTIVE

This state indicates that the PDP context is active.

#### 6.1.2.1.5 PDP-MODIFY\_PENDING

This state exists when modification of the PDP context was requested by the MS.

#### 6.1.2.1.6 MBMS-ACTIVE-PENDING

This state exists when the MS has requested the network to activate an MBMS context.

#### 6.1.2.1.7 MBMS-ACTIVE

This state indicates that the MBMS context is active.

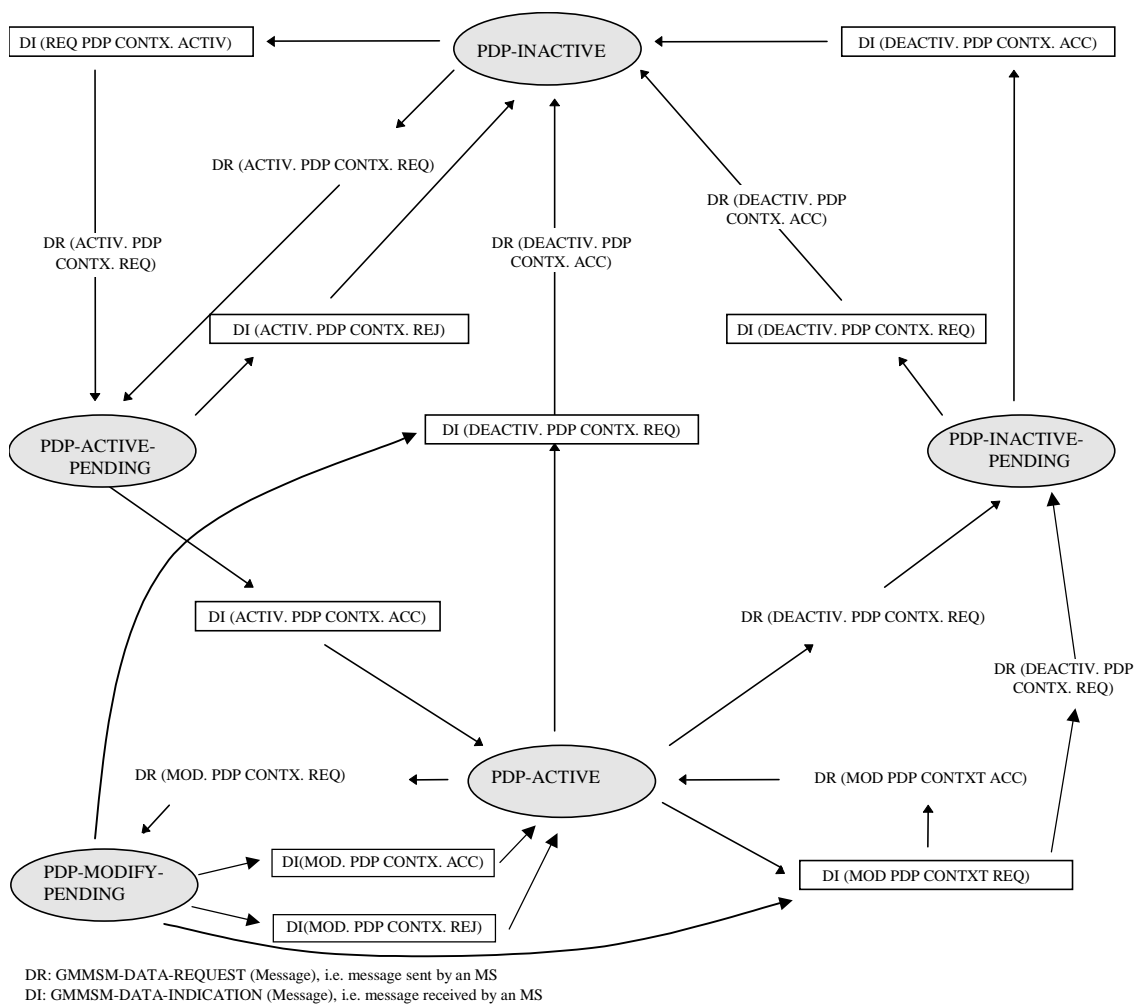

**Figure 6.1/3GPP TS 24.008: Session management states for PDP context handling in the MS (overview)**

It shall be noted, that Figure 6.1/3GPP TS 24.008 applies to both the PDP context activation procedure and the secondary PDP context activation procedure, though the distinction in messages regarding the activation of PDP contexts is not shown here for simplicity.



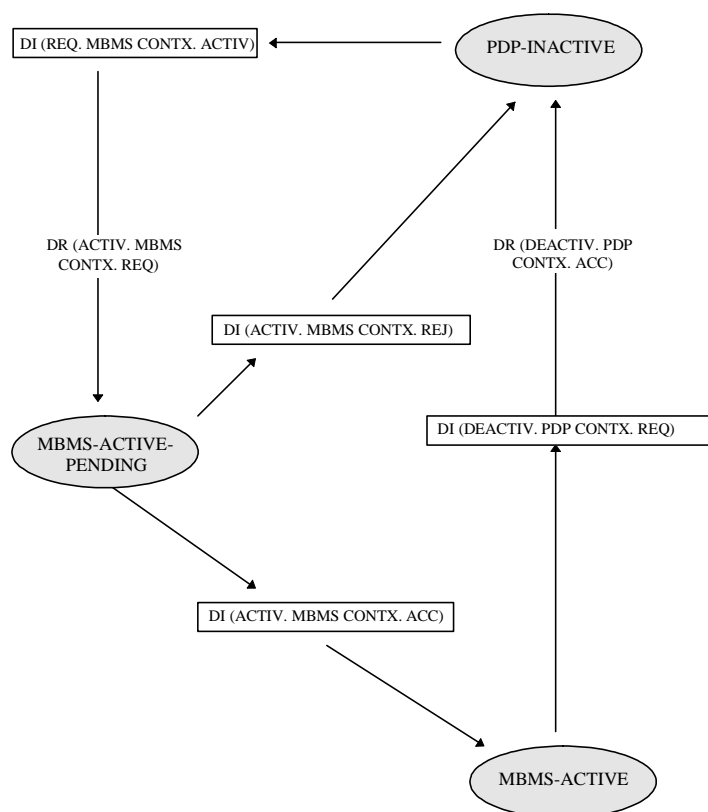

DR: GMM-SM-DATA-REQUEST (Message), i.e. message sent by an MS  
 DI: GMM-SM-DATA-INDICATION (Message), i.e. message received by an MS

**Figure 6.1a/3GPP TS 24.008: Session management states for MBMS context handling in the MS (overview)**

### 6.1.2.2 Session management states on the network side

In this subclause, the possible states of an SM entity on the network side are described. As illustrated in figures 6.2/3GPP TS 24.008 and 6.2a/3GPP TS 24.008 there are eight SM states on the network side.

#### 6.1.2.2.1 PDP-INACTIVE

This state indicates that the PDP context or MBMS context is not active.

#### 6.1.2.2.2 PDP-ACTIVE-PENDING

This state exists when the PDP context activation was initiated by the network.

#### 6.1.2.2.3 PDP-INACTIVE-PENDING

This state exists when deactivation of the PDP context was requested by the network.

#### 6.1.2.2.4 PDP-ACTIVE

This state indicates that the PDP context is active.

#### 6.1.2.2.5 PDP-MODIFY-PENDING

This state exists when modification of the PDP context was requested by the network.

6.1.2.2.6 MBMS-ACTIVE-PENDING

This state exists when the network has initiated MBMS context activation.

6.1.2.2.7 MBMS-INACTIVE-PENDING

This state exists when the network has requested the MS to deactivate an MBMS context.

6.1.2.2.8 MBMS-ACTIVE

This state indicates that the MBMS context is active.

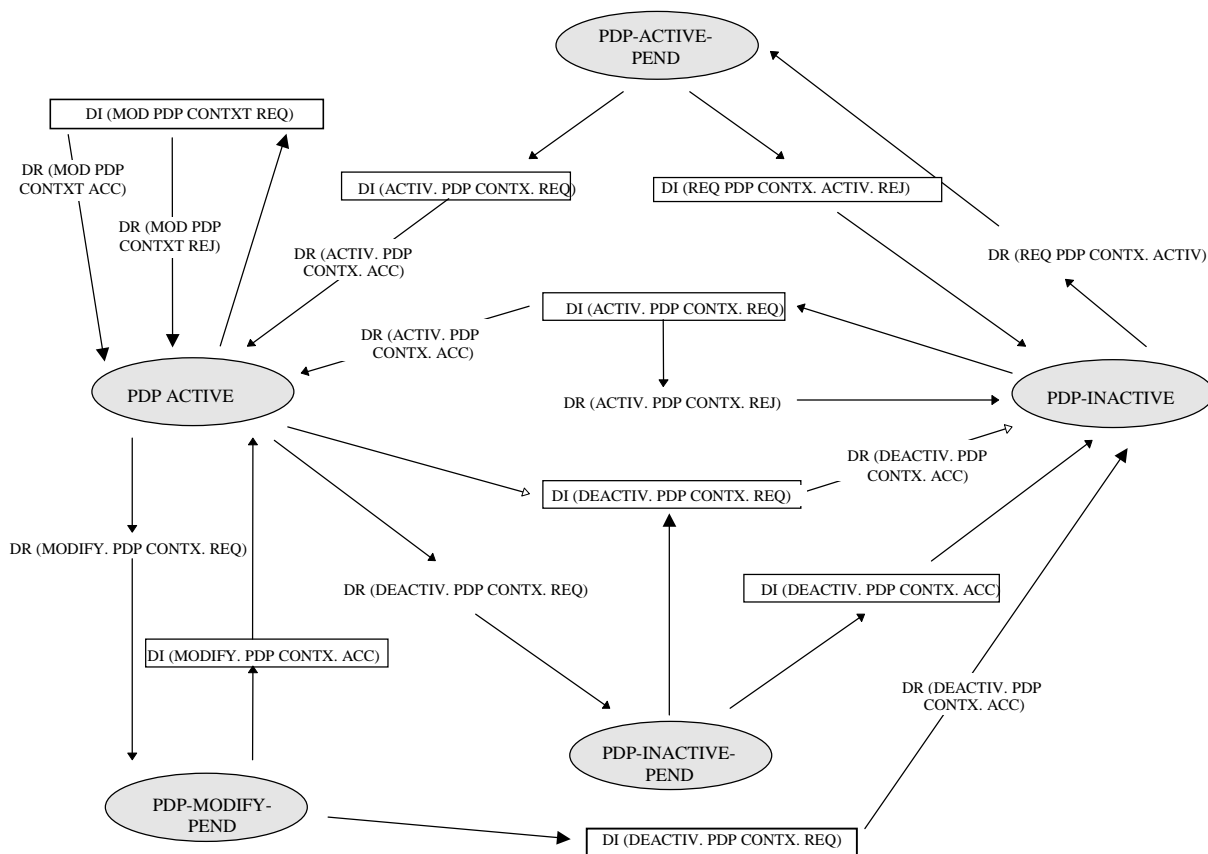

DR: GMM-SM-DATA-REQUEST (Message), i.e. message sent by network  
 DI: GMM-SM-DATA-INDICATION (Message), i.e. message received by the network

Figure 6.2/3GPP TS 24.008: Session management states for PDP context handling on the network side (overview)

It shall be noted, that figure 6.2/3GPP TS 24.008 applies to both the PDP context activation procedure and the secondary PDP context activation procedure, though the distinction in messages regarding the activation of PDP contexts is not shown here for simplicity.

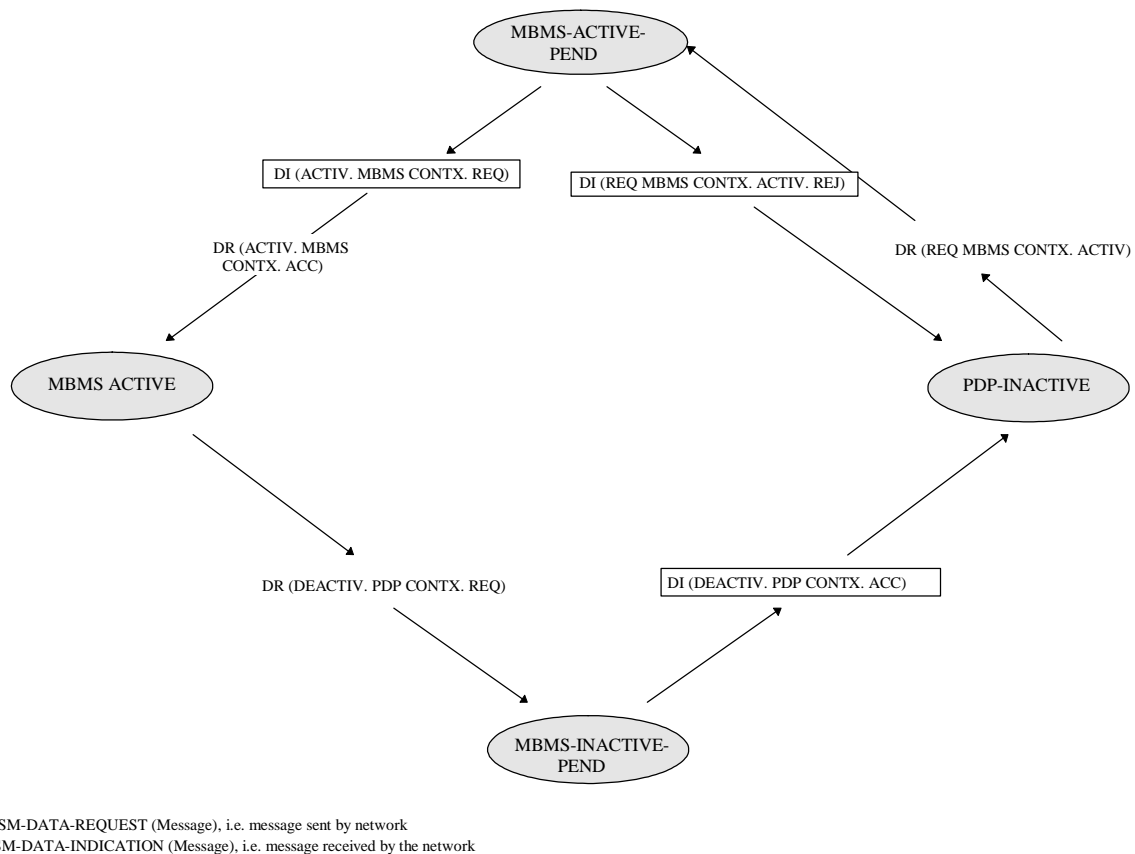

**Figure 6.2a/3GPP TS 24.008: Session management states for MBMS context handling on the network side (overview)**

## 6.1.3 Session Management procedures

### 6.1.3.1 PDP context activation

The purpose of this procedure is to establish a PDP context between the MS and the network for a specific QoS on a specific NSAPI. The PDP context activation may be initiated by the MS or the initiation may be requested by the network.

Each PDP address may be described by one or more PDP contexts in the MS or the network. The PDP Context Activation procedure is used to activate the first PDP context for a given PDP address and APN, whereas all additional contexts associated to the same PDP address and APN are activated with the secondary PDP context activation procedure. When more than one PDP contexts are associated to a PDP address, there shall be a Traffic Flow Template (TFT) for each or all but one context. If present, the TFT shall be sent transparently via the SGSN to the GGSN to enable packet classification and policing for downlink data transfer (see 3GPP TS 23.060 [74]).

#### 6.1.3.1.1 Successful PDP context activation initiated by the mobile station

In order to request a PDP context activation, the MS sends an ACTIVATE PDP CONTEXT REQUEST message to the network, enters the state PDP-ACTIVE-PENDING and starts timer T3380. The message contains the selected NSAPI, PDP type, requested QoS and, if the MS requests a static address, the PDP address. The MS shall ensure that the selected NSAPI is not currently being used by another Session Management entity in the MS.

Upon receipt of an ACTIVATE PDP CONTEXT REQUEST message, the network selects a radio priority level based on the QoS negotiated and may reply with an ACTIVATE PDP CONTEXT ACCEPT message. Upon receipt of the message ACTIVATE PDP CONTEXT ACCEPT the MS shall stop timer T3380, shall enter the state PDP-ACTIVE. If the offered QoS parameters received from the network differ from the QoS requested by the MS, the MS shall either accept the negotiated QoS or initiate the PDP context deactivation procedure.

NOTE 1: If the MS requested a value for a QoS parameter that is not within the range specified by 3GPP TS 23.107, the network should negotiate the parameter to a value that lies within the specified range.

In A/Gb mode, the MS shall initiate establishment of the logical link for the LLC SAPI indicated by the network with the offered QoS and selected radio priority level if no logical link has been already established for that SAPI. If the offered QoS parameters received from the network differ from the QoS requested by the MS, the MS shall either accept the negotiated QoS or initiate the PDP context deactivation procedure. If the LLC SAPI indicated by the network can not be supported by the MS, the MS shall initiate the PDP context deactivation procedure.

In Iu mode, both the network and the MS shall store the LLC SAPI and the radio priority in the PDP context. If a Iu mode to A/Gb mode system change is performed, the new SGSN shall initiate establishment of the logical link using the negotiated QoS profile, the negotiated LLC SAPI, and selected radio priority level stored in the PDP context as in a A/Gb mode to A/Gb mode Routing Area Update.

An MS, which is capable of operating in both A/Gb mode and Iu mode, shall use a valid LLC SAPI, while an MS which is capable of operating only in Iu mode shall indicate the LLC SAPI value as "LLC SAPI not assigned" in order to avoid unnecessary value range checking and any other possible confusion in the network. When the MS uses a valid LLC SAPI, the network shall return a valid LLC SAPI. The network shall return the 'LLC SAPI not assigned' value only when the MS uses the 'LLC SAPI not assigned' value.

NOTE 2: The radio priority level and the LLC SAPI parameters, though not used in Iu mode, shall be included in the messages, in order to support handover between Iu mode and A/Gb mode networks.

#### 6.1.3.1.2 Successful PDP context activation requested by the network

In order to request a PDP context activation, the network sends a REQUEST PDP CONTEXT ACTIVATION message to the MS and starts timer T3385. The message contains an offered PDP address. If available, the APN shall be included in the REQUEST PDP CONTEXT ACTIVATION message.

Upon receipt of a REQUEST PDP CONTEXT ACTIVATION message, the MS shall then either initiate the PDP context activation procedure as described in the previous subclause or shall reject the activation request by sending a REQUEST PDP CONTEXT ACTIVATION REJECT message as described in subclause 6.1.3.1.4. The value of the reject cause IE of the REQUEST PDP CONTEXT ACTIVATION REJECT message shall indicate the reason for rejection, e.g. "insufficient resources to activate another context".

The ACTIVATE PDP CONTEXT REQUEST message sent by the MS in order to initiate the PDP context activation procedure shall contain the PDP address, PDP Type and APN requested by the network in the REQUEST PDP CONTEXT ACTIVATION message.

Upon receipt of the ACTIVATE PDP CONTEXT REQUEST message, the network shall stop timer T3385.

The same procedures then apply as described for MS initiated PDP context activation.

#### 6.1.3.1.3 Unsuccessful PDP context activation initiated by the MS

Upon receipt of an ACTIVATE PDP CONTEXT REQUEST message the network may reject the MS initiated PDP context activation by sending an ACTIVATE PDP CONTEXT REJECT message to the MS. The message shall contain a cause code that typically indicates one of the following causes:

- # 8: Operator Determined Barring;
- # 26: insufficient resources;
- # 27: missing or unknown APN;
- # 28: unknown PDP address or PDP type;
- # 29: user authentication failed;
- # 30: activation rejected by GGSN;
- # 31: activation rejected, unspecified;
- # 32: service option not supported;
- # 33: requested service option not subscribed;
- # 34: service option temporarily out of order;
- # 35: NSAPI already used. The network shall not send this cause code (see note 1); or
- # 95 - 111: protocol errors.
- #112: APN restriction value incompatible with active PDP context.

NOTE 1: Pre-R99 network may send this cause code.

Upon receipt of an ACTIVATE PDP CONTEXT REJECT message, the MS shall stop timer T3380 and enter/remain in state PDP-INACTIVE.

#### 6.1.3.1.4 Unsuccessful PDP context activation requested by the network

Upon receipt of the REQUEST PDP CONTEXT ACTIVATION message, the MS may reject the network requested PDP context activation by sending the REQUEST PDP CONTEXT ACTIVATION REJECT message to the network. The message contains the same TI as included in the REQUEST PDP CONTEXT ACTIVATION and an additional cause code that typically indicates one of the following causes:

- # 26: insufficient resources;
- # 31: activation rejected, unspecified;
- # 40: feature not supported; or
- # 95 - 111: protocol errors.

The network shall stop timer T3385 and enter state PDP-INACTIVE.

#### 6.1.3.1.5 Abnormal cases

The following abnormal cases can be identified:

- a) Expiry of timers

In the mobile station:

On the first expiry of the timer T3380, the MS shall resend the ACTIVATE PDP CONTEXT REQUEST and shall reset and restart timer T3380. This retransmission is repeated four times, i.e. on the fifth expiry of timer T3380, the MS shall release all resources possibly allocated for this invocation and shall abort the procedure; no automatic PDP context activation re-attempt shall be performed.

On the network side:

On the first expiry of the timer T3385, the network shall resend the message REQUEST PDP CONTEXT ACTIVATION and shall reset and restart timer T3385. This retransmission is repeated four times, i.e. on the fifth expiry of timer T3385, the network shall release possibly allocated resources for this activation and shall abort the procedure.

b) Collision of MS initiated and network requested PDP context activation

Dynamic PDP address collision case:

If the MS uses dynamic PDP addressing that turns out to collide with the network requested PDP address, then there is no detection of collision specified but left for network implementation.

Static PDP address collision detected within the mobile station:

A collision of an MS initiated and a network requested PDP context activation procedure is identified by the MS if a REQUEST PDP CONTEXT ACTIVATION message is received from the network after the MS has sent an ACTIVATE PDP CONTEXT REQUEST message, and the MS has not yet received an ACTIVATE PDP CONTEXT ACCEPT or ACTIVATE PDP CONTEXT REJECT message.

NOTE: In general, the MS is unable to test if the PDP type, PDP address and APN in the REQUEST PDP CONTEXT ACTIVATION message are the same as those for the PDN to which it is attempting to activate a context. This is because the MS may have omitted one or more of the parameters in the ACTIVATE PDP CONTEXT REQUEST message, since it is relying on default values to be provided by the network.

- In the case of such a collision, the MS initiated PDP context activation shall take precedence over the network requested PDP context activation. If the MS is able to compare the PDP type, PDP address and APN requested in the ACTIVATE PDP CONTEXT REQUEST message with those requested in the REQUEST PDP CONTEXT ACTIVATION message and these parameters are equal, then the MS shall discard the REQUEST PDP CONTEXT ACTIVATION message and shall wait for the network response to its ACTIVATE PDP CONTEXT REQUEST message. If the MS is not able to compare the PDP type, PDP address, and APN requested in the ACTIVATE PDP CONTEXT REQUEST message with those requested in the REQUEST PDP CONTEXT ACTIVATION message, then the MS shall send a REQUEST PDP CONTEXT ACTIVATION REJECT message with the cause 'insufficient resources' to the network, and wait for an ACTIVATE PDP CONTEXT ACCEPT message.

Static PDP address collision detected on the network side:

A collision is detected by the network in the case where the PDP address, PDP type and APN derived (according to 23.060 annex A) from the ACTIVATE PDP CONTEXT REQUEST message received from the MS match those in the REQUEST PDP CONTEXT ACTIVATION message sent to the MS.

- In the case of such a collision, the MS initiated PDP context activation shall take precedence over the network requested PDP context activation. The network shall terminate the network requested PDP context activation procedure, and proceed with the MS initiated PDP context activation procedure.

c) MS initiated PDP context activation request for an already activated PDP context (on the network side)

- i) If the network receives a ACTIVATE PDP CONTEXT REQUEST message with the same combination of APN, PDP type and PDP address as an already activated PDP context, the network shall deactivate the existing PDP context and, if any, all the linked PDP contexts (matching the combination of APN, PDP type and PDP address), locally without notification to the MS and proceed with the requested PDP context activation.
- ii) Alternatively (different combination of APN, PDP type and PDP address), if the NSAPI matches that of an already activated PDP context, then the network shall deactivate only the existing PDP context locally without notification to the MS and proceed with the requested PDP context activation.

It is an implementation option if the parameters used for comparison described in clause i) and ii) are the parameters provided in the (current and previous) ACTIVATE PDP CONTEXT REQUESTs or the parameters which are the result of the application of the selection rules defined in TS23.060 Annex A.2.

The parameter provided in the current ACTIVATE PDP CONTEXT REQUEST can not be compared to the actually used parameters (result of application of selection rules defined in TS23.060 Annex A.2) of the previously activated PDP contexts.

- d) Network initiated PDP context activation request for an already activated PDP context (on the mobile station side)

If the MS receives a REQUEST PDP CONTEXT ACTIVATION message with the same combination of APN, PDP type and PDP address as an already activated PDP context, the MS shall deactivate the existing PDP context and, if any, all the linked PDP contexts (matching the combination of APN, PDP type and PDP address) locally without notification to the network and proceed with the requested PDP context activation.

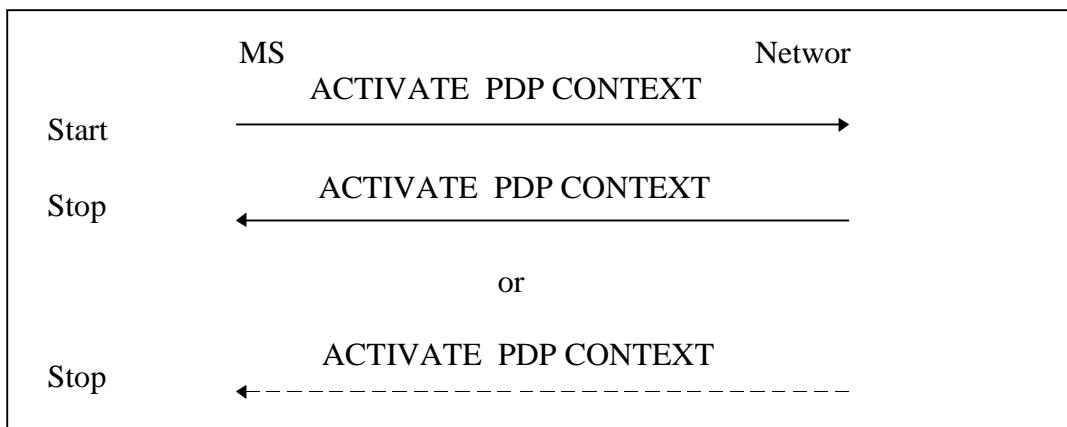

Figure 6.3/3GPP TS 24.008: MS initiated PDP context activation procedure

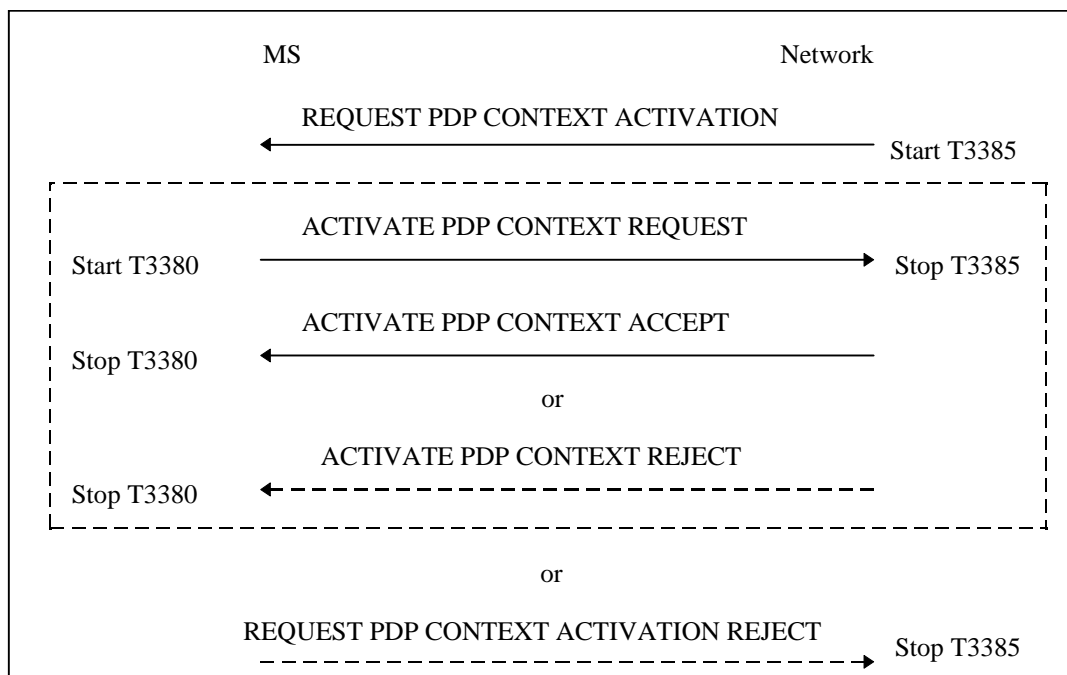

Figure 6.4/3GPP TS 24.008: Network initiated PDP context activation procedure

### 6.1.3.2 Secondary PDP Context Activation Procedure

The purpose of this procedure is to establish an additional PDP context between the MS and the network for a specific Traffic Flow Template (TFT) and QoS profile on a specific NSAPI, when one or more PDP contexts has/have already been established for the particular PDP address. The MS shall include a request for a TFT if a PDP context without a TFT is presently active, for the particular PDP address.

### 6.1.3.2.1 Successful Secondary PDP Context Activation Procedure Initiated by the MS

In order to request a PDP context activation with the same PDP address and APN as an already active PDP context, the MS shall send an **ACTIVATE SECONDARY PDP CONTEXT REQUEST** message to the network, enter the state **PDP-ACTIVE-PENDING** and start timer T3380. The message shall contain the selected NSAPI. The MS shall ensure that the selected NSAPI is not currently being used by another Session Management entity in the MS. The message shall also include a QoS profile, a requested LLC SAPI and the Linked TI. The QoS profile is the requested QoS. If present, the TFT shall be sent transparently through the SGSN to the GGSN to enable packet classification and policing for downlink data transfer.

Upon receipt of an **ACTIVATE SECONDARY PDP CONTEXT REQUEST**, the network shall validate the message by verifying the TI given in the Linked TI IE to be any of the active PDP context(s). The same GGSN address shall be used by the SGSN as for the already established PDP context(s) for that PDP address. The network shall select a radio priority level based on the QoS negotiated and shall reply with an **ACTIVATE SECONDARY PDP CONTEXT ACCEPT** message, if the request can be accepted.

NOTE 1: If the MS requested a value for a QoS parameter that is not within the range specified by 3GPP TS 23.107, the network should negotiate the parameter to a value that lies within the specified range.

Upon receipt of the message **ACTIVATE SECONDARY PDP CONTEXT ACCEPT**, the MS shall stop timer T3380 and enter the state **PDP-ACTIVE**. If the offered QoS parameters received from the network differ from the QoS requested by the MS, the MS shall either accept the negotiated QoS or initiate the PDP context deactivation procedure.

In A/Gb mode the MS shall initiate establishment of the logical link for the LLC SAPI indicated by the network with the offered QoS and selected radio priority level if no logical link has been already established for that SAPI. If the LLC SAPI indicated by the network can not be supported by the MS, the MS shall initiate the PDP context deactivation procedure.

In Iu mode, both SGSN and MS shall store the LLC SAPI and the radio priority in the PDP context. If an Iu mode to A/Gb mode Routing Area Update is performed, the new SGSN shall initiate establishment of the logical link using the negotiated LLC SAPI, the negotiated QoS profile and selected radio priority level stored in the PDP context as in an A/Gb mode to A/Gb mode Routing Area Update.

An MS, which is capable of operating in both A/Gb mode and Iu mode, shall use a valid LLC SAPI, while an MS which is capable of operating only in Iu mode shall indicate the LLC SAPI value as "LLC SAPI not assigned" in order to avoid unnecessary value range checking and any other possible confusion in the network. When the MS uses a valid LLC SAPI, the network shall return a valid LLC SAPI. The network shall return the 'LLC SAPI not assigned' value only when the MS uses the 'LLC SAPI not assigned' value.

NOTE 2: The radio priority level and the LLC SAPI parameters, though not used in Iu mode, shall be included in the messages, in order to support handover between Iu mode and A/Gb mode networks.



### 6.1.3.2.2 Unsuccessful Secondary PDP Context Activation Procedure initiated by the MS

Upon receipt of an ACTIVATE SECONDARY PDP CONTEXT REQUEST message, the network may reject the MS initiated PDP context activation by sending an ACTIVATE SECONDARY PDP CONTEXT REJECT message to the MS. The message shall contain a cause code that typically indicates one of the following:

- # 26: insufficient resources;
- # 30: activation rejected by GGSN;
- # 31: activation rejected, unspecified;
- # 32: service option not supported;
- # 33: requested service option not subscribed;
- # 34: service option temporarily out of order;
- # 41: semantic error in the TFT operation;
- # 42: syntactical error in the TFT operation;
- # 43: unknown PDP context;
- # 44: semantic errors in packet filter(s);
- # 45: syntactical errors in packet filter(s);
- # 46: PDP context without TFT already activated;
- # 95: 111: protocol errors.

Upon receipt of an ACTIVATE SECONDARY PDP CONTEXT REJECT message, the MS shall stop timer T3380 and enter the state PDP-INACTIVE.

### 6.1.3.2.3 Abnormal cases

The following abnormal cases can be identified:

a) Expiry of timers

On the first expiry of the timer T3380, the MS shall resent the ACTIVATE SECONDARY PDP CONTEXT REQUEST and shall reset and restart timer T3380. This retransmission is repeated four times, i.e. on the fifth expiry of timer T3380, the MS shall release all resources possibly allocated for this invocation and shall abort the procedure; no automatic PDP context activation re-attempt shall be performed.

b) MS initiated secondary PDP context activation procedure for an already activated PDP context (On the network side)

If the NSAPI matches that of an already activated PDP context, the network shall deactivate the existing PDP context locally without notification to the MS and proceed with the requested PDP context activation. The case of a TI match is described in subclause 8.3.2.

c) no PDP context with linked TI activated

The network shall then check whether there is an activated PDP context for the TI given in the Linked TI IE in the ACTIVATE SECONDARY PDP CONTEXT REQUEST message. If there is no active PDP context for the specified TI, the network shall reply with an ACTIVATE SECONDARY PDP CONTEXT REJECT message, cause code indicating "unknown PDP context".

If there exists a PDP context for the TI given in the Linked TI IE, then the TFT in the request message is checked for different types of TFT IE errors as follows:

a) Semantic errors in TFT operations:

- 1) When the *TFT operation* is an operation other than "Create a new TFT" or "No TFT operation".

The network shall reject the activation request with cause "semantic error in the TFT operation".

b) Syntactical errors in TFT operations:

- 1) When the *TFT operation* = "Create a new TFT" and the packet filter list in the TFT IE is empty.
- 2) When the *TFT operation* = "No TFT operation" with a non-empty packet filter list in the TFT IE
- 3) When there are other types of syntactical errors in the coding of the TFT IE, such as a mismatch between the number of packet filters subfield, and the number of packet filters in the packet filter list.

The network shall reject the activation request with cause "syntactical error in the TFT operation".

c) Semantic errors in packet filters:

- 1) When a packet filter consists of conflicting packet filter components which would render the packet filter ineffective, i.e. no IP packet will ever fit this packet filter. How the network determines a semantic error in a packet filter is outside the scope of the present document.

The network shall reject the activation request with cause "semantic errors in packet filter(s)".

d) Syntactical errors in packet filters:

- 1) When the *TFT operation* = "Create a new TFT" and two or more packet filters in the resultant TFT would have identical packet filter identifiers.
- 2) When the *TFT operation* = "Create a new TFT" and two or more packet filters in all TFTs associated with this PDP address and APN would have identical packet filter precedence values.
- 3) When there are other types of syntactical errors in the coding of packet filters, such as the use of a reserved value for a packet filter component identifier.

In case 2) the network shall not diagnose an error, further process the new activation request and, if it was processed successfully, delete the old packet filters which have identical filter precedence values. Furthermore, by means of explicit peer-to-peer signalling between the MS and the network, the network shall deactivate the PDP context(s) for which it has deleted the packet filters.

Otherwise the network shall reject the activation request with cause "syntactical errors in packet filter(s)".

Otherwise, the network shall accept the activation request by replying to the MS with an ACTIVATE SECONDARY PDP CONTEXT ACCEPT message.

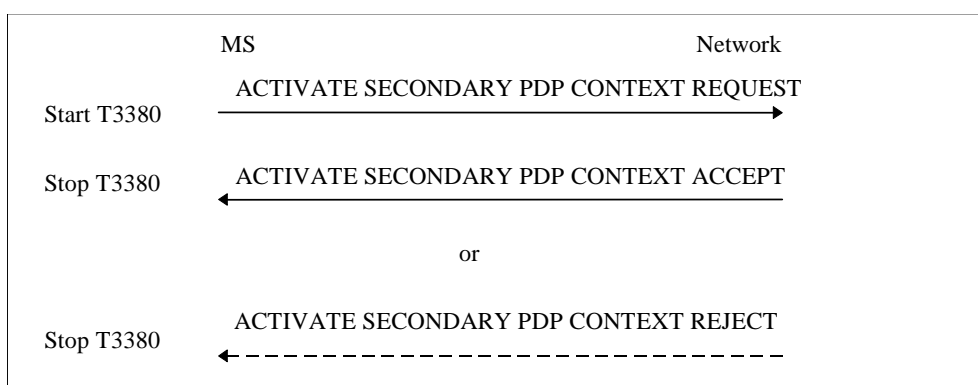

Figure 6.5/3GPP TS 24.008: MS initiated secondary PDP context activation procedure

### 6.1.3.3 PDP context modification procedure

The PDP context modification procedure is invoked by the network or by the MS, in order to change the QoS negotiated, the Radio priority level, or the TFT, negotiated during the PDP context activation procedure, the secondary PDP context activation procedure or at previously performed PDP context modification procedures. The MS may also create and delete a TFT in an active PDP context. The procedure can be initiated by the network or the MS at any time when a PDP context is active.

The PDP context modification procedure may also be invoked by the MS, in order to upgrade the maximum bit rate and to trigger the re-establishment of the radio access bearer for an activated PDP context which is preserved in the MS with maximum bit rate values of 0kbit/s for both uplink and downlink (see 3GPP TS 23.060 [74]). If

- the PDP Context Modification request is accepted by the network but the radio access bearer is not established;  
or
- the PDP Context Modification request is rejected with cause "insufficient resources" (see subclause 6.1.3.3.3),

then the MS is not required to start a new PDP Context Modification procedure or to start a Service Request procedure in order to trigger the re-establishment of the radio access bearer.

The network requested PDP context modification procedure may also be used to update the PDP address when external PDN address allocation is performed, in which case the MS receives the PDP address in the MODIFY PDP CONTEXT REQUEST (Network to MS direction) message.

NOTE: The procedure may be initiated by the network due to an inter-SGSN Routing Area Updating when a PDP context is active.

#### 6.1.3.3.1 Network initiated PDP Context Modification

In order to initiate the procedure, the network sends the MODIFY PDP CONTEXT REQUEST message to the MS and starts timer T3386. The message shall contain the new QoS and the radio priority level and LLC SAPI that shall be used by the MS in A/Gb mode at the lower layers for the transmission of data related to the PDP context.

Upon receipt of this message the MS shall reply with the MODIFY PDP CONTEXT ACCEPT message, if the MS accepts the new QoS and the indicated LLC SAPI.

If the MS does not accept the new QoS or the indicated LLC SAPI, the MS shall initiate the PDP context deactivation procedure for the PDP context - the reject cause IE value of the DEACTIVATE PDP CONTEXT REQUEST message shall indicate "QoS not accepted".

The network shall upon receipt of the MODIFY PDP CONTEXT ACCEPT message stop timer T3386.

In A/Gb mode, the network shall establish, reconfigure or continue using the logical link with the new QoS for the LLC SAPI indicated in the MODIFY PDP CONTEXT REQUEST message.

In Iu mode, the network shall establish, reconfigure or continue using the Radio Access Bearer with the new QoS indicated in the MODIFY PDP CONTEXT REQUEST message.

#### 6.1.3.3.2 MS initiated PDP Context Modification accepted by the network

In order to initiate the procedure, the MS sends the MODIFY PDP CONTEXT REQUEST message to the network, enters the state PDP-MODIFY-PENDING and starts timer T3381. The message may contain the requested new QoS and/or the TFT and the requested LLC SAPI (used in A/Gb mode).

Upon receipt of the MODIFY PDP CONTEXT REQUEST message, the network may reply with the MODIFY PDP CONTEXT ACCEPT message in order to accept the context modification. The reply message may contain the negotiated QoS and the radio priority level based on the new QoS profile and the negotiated LLC SAPI, that shall be used in A/Gb mode by the logical link.

Upon receipt of the MODIFY PDP CONTEXT ACCEPT message, the MS shall stop the timer T3381. If the offered QoS parameters received from the network differs from the QoS requested by the MS, the MS shall either accept the negotiated QoS or initiate the PDP context deactivation procedure.

NOTE: When modification of QoS was requested by the MS, if the network does not accept the MS request, being unable to provide the requested QoS, it should maintain the QoS negotiated as previously negotiated or propose a new QoS. Therefore, the network would not reject the MS initiated PDP context modification request due to the unavailability of the required QoS. If the MS requested a value for a QoS parameter that is not within the range specified by 3GPP TS 23.107, the network should negotiate the parameter to a value that lies within the specified range.

### 6.1.3.3.3 MS initiated PDP Context Modification not accepted by the network

Upon receipt of a MODIFY PDP CONTEXT REQUEST message, the network may reject the MS initiated PDP context modification request by sending a MODIFY PDP CONTEXT REJECT message to the MS. The message shall contain a cause code that typically indicates one of the following:

- # 26: insufficient resources;
- # 32: Service option not supported;
- # 41: semantic error in the TFT operation;
- # 42: syntactical error in the TFT operation;
- # 44: semantic errors in packet filter(s);
- # 45: syntactical errors in packet filter(s);
- # 95 - 111: protocol errors.

If upon the reception of a MODIFY PDP CONTEXT REQUEST message the network fails to re-establish the radio access bearer for a PDP context whose maximum bit rate in uplink and downlink is set to 0kbit/s, the network shall reply with MODIFY PDP CONTEXT REJECT with cause "insufficient resources".

The TFT in the request message is checked for different types of TFT IE errors as follows:

a) Semantic errors in TFT operations:

- 1) *TFT operation* = "Create a new TFT" when there is already an existing TFT for the PDP context.
- 2) When the *TFT operation* is an operation other than "Create a new TFT" and there is no TFT for the PDP context.
- 3) *TFT operation* = "Delete existing TFT" when there is already another PDP context with the same PDP address and APN without a TFT.
- 4) *TFT operation* = "Delete packet filters from existing TFT" when it would render the TFT empty.

In these cases the network shall not diagnose an error and perform the following actions to resolve the inconsistency:

In case 1) the network shall further process the new activation request and, if it was processed successfully, delete the old TFT.

In case 2) the network shall:

- further process the new request and, if no error according to list items b), c), and d) was detected, consider the TFT as successfully deleted, if the TFT operation is "Delete existing TFT" or "Delete packet filters from existing TFT";
- process the new request as an activation request, if the TFT operation is "Add packet filters in existing TFT" or "Replace packet filters in existing TFT".

In case 3) the network shall process the new deletion request and, after successful deletion of the TFT, deactivate the old PDP context with the same PDP address and APN without a TFT by explicit peer-to-peer signalling between the MS and the network.

In case 4) the network shall further process the new request and, if no error according to list items b), c), and d) was detected, delete the existing TFT. After successful deletion of the TFT, if there was already another PDP context with the same PDP address and APN without a TFT, the network shall deactivate this old PDP context without a TFT by explicit peer-to-peer signalling between the MS and the network.

b) Syntactical errors in TFT operations:

- 1) When the *TFT operation* is an operation other than "Delete existing TFT" or "No TFT operation" and the packet filter list in the TFT IE is empty.

- 2) *TFT operation* = "Delete existing TFT" or "No TFT operation" with a non-empty packet filter list in the TFT IE.
- 3) *TFT operation* = "Replace packet filters in existing TFT" when a to be replaced packet filter does not exist in the original TFT.
- 4) *TFT operation* = "Delete packet filters from existing TFT" when a to be deleted packet filter does not exist in the original TFT.
- 5) *TFT operation* = "Delete packet filters from existing TFT" with a packet filter list also including packet filters in addition to the packet filter identifiers.
- 6) When there are other types of syntactical errors in the coding of the TFT IE, such as a mismatch between the number of packet filters subfield, and the number of packet filters in the packet filter list.

In case 3) the network shall not diagnose an error, further process the replace request and, if no error according to list items c) and d) was detected, include the packet filters received to the existing TFT.

In case 4) the network shall not diagnose an error, further process the deletion request and, if no error according to list items c) and d) was detected, consider the respective packet filter as successfully deleted.

Otherwise the network shall reject the modification request with cause "syntactical error in the TFT operation".

c) Semantic errors in packet filters:

When a packet filter consists of conflicting packet filter components which would render the packet filter ineffective, i.e. no IP packet will ever fit this packet filter. How the network determines a semantic error in a packet filter is outside the scope of the present document.

The network shall reject the modification request with cause "semantic errors in packet filter(s)".

d) Syntactical errors in packet filters:

- 1) When the *TFT operation* = "Create a new TFT" or "Add packet filters to existing TFT" and two or more packet filters in the resultant TFT would have identical packet filter identifiers.
- 2) When the *TFT operation* = "Create a new TFT" or "Add packet filters to existing TFT" or "Replace packet filters in existing TFT" and two or more packet filters in all TFTs associated with this PDP address and APN would have identical packet filter precedence values.
- 3) When there are other types of syntactical errors in the coding of packet filters, such as the use of a reserved value for a packet filter component identifier.

In case 1), if two or more packet filters with identical packet filter identifiers are contained in the new request, the network shall reject the modification request with cause "syntactical errors in packet filter(s)". Otherwise, the network shall not diagnose an error, further process the new request and, if it was processed successfully, delete the old packet filters which have the identical packet filter identifiers.

In case 2) the network shall not diagnose an error, further process the new request and, if it was processed successfully, delete the old packet filters which have identical filter precedence values. Furthermore, by means of explicit peer-to-peer signalling between the MS and the network, the network shall deactivate the PDP context(s) for which it has deleted the packet filters.

Otherwise the network shall reject the modification request with cause "syntactical errors in packet filter(s)".

Upon receipt of a MODIFY PDP CONTEXT REJECT message, the MS shall stop timer T3381 and enter the state PDP-ACTIVE.

## 6.1.3.3.4 Abnormal cases

## a) Expiry of timers

On the network side:

On the first expiry of timer T3386, the network shall resend the MODIFY PDP CONTEXT REQUEST message reset and restart timer T3386. This retransmission is repeated four times, i.e. on the fifth expiry of timer T3386, the network may continue to use the previously negotiated QoS or it may initiate the PDP context deactivation procedure.

In the MS:

On the first expiry of timer T3381, the MS shall resend the MODIFY PDP CONTEXT REQUEST message reset and restart timer T3381. This retransmission is repeated four times, i.e. on the fifth expiry of timer T3381, the MS may continue to use the previously negotiated QoS or it may initiate the PDP context deactivation procedure.

## b) Collision of MS and Network initiated PDP Context Modification Procedures

A collision of a MS and network initiated PDP context modification procedures is identified by the MS if a MODIFY PDP CONTEXT REQUEST message is received from the network after the MS has sent a MODIFY PDP CONTEXT REQUEST message itself, and both messages contain the same TI and the MS has not yet received a MODIFY PDP CONTEXT ACCEPT message from the network.

A collision is detected by the network in case a MODIFY PDP CONTEXT REQUEST message is received from the MS with the same TI as the MODIFY PDP CONTEXT REQUEST message sent to the MS.

In the case of such a collision, the network initiated PDP context modification shall take precedence over the MS initiated PDP context modification. The MS shall terminate internally the MS initiated PDP context modification procedure, enter the state PDP-Active and proceed with the network initiated PDP context modification procedure by sending a MODIFY PDP CONTEXT ACCEPT message. The network shall ignore the MODIFY PDP CONTEXT REQUEST message received in the state PDP-MODIFY-PENDING. The network shall proceed with the network initiated PDP context modification procedure as if no MODIFY PDP CONTEXT REQUEST message was received from the MS.

## c) Collision of MS initiated PDP Context Modification Procedures and Network initiated Deactivate PDP Context Request Procedures

A collision of a MS initiated PDP context modification procedures and a network initiated PDP context deactivation procedures is identified by the MS if a DEACTIVATE PDP CONTEXT REQUEST message is received from the network after the MS has sent a MODIFY PDP CONTEXT REQUEST message, and the MS has not yet received a MODIFY PDP CONTEXT ACCEPT message from the network.

In the case of such a collision, the network initiated PDP context deactivation shall take precedence over the MS initiated PDP context modification. The MS shall terminate internally the MS initiated PDP context modification procedure, and proceed with the network initiated PDP context deactivation procedure by sending a DEACTIVATE PDP CONTEXT ACCEPT, enter the state PDP-INACTIVE. The network shall ignore the MODIFY PDP CONTEXT REQUEST message received in the state PDP-INACTIVE-PENDING. The network shall proceed with the network initiated PDP context deactivation procedure as if no MODIFY PDP CONTEXT REQUEST message was received from the MS.

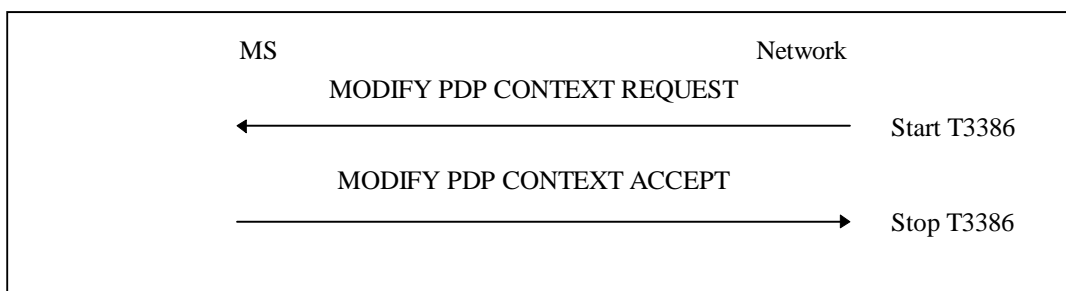
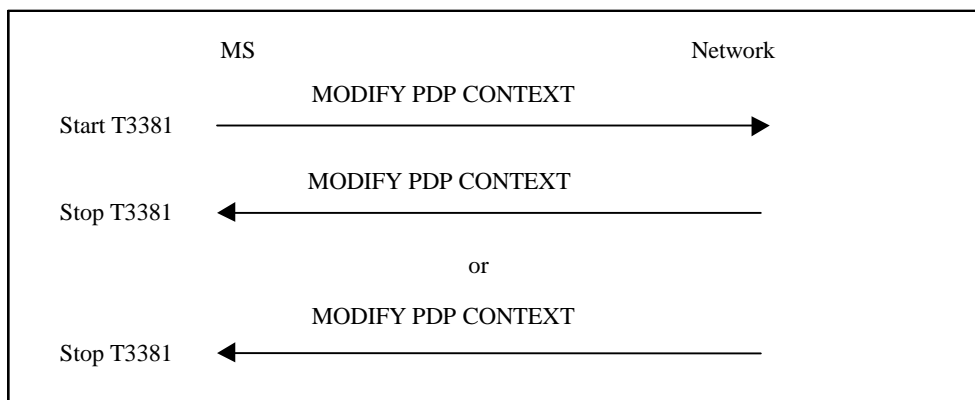

Figure 6.6/3GPP TS 24.008: Network initiated PDP context modification procedure



**Figure 6.7/3GPP TS 24.008: MS initiated PDP context modification procedure**

#### 6.1.3.4 PDP context deactivation procedure

The purpose of this procedure is to deactivate an existing PDP context between the MS and the network. The PDP context deactivation may be initiated by the MS or by the network. The *tear down indicator* information element may be included in the DEACTIVATE PDP CONTEXT REQUEST message in order to indicate whether only the PDP context associated with this specific TI or all active PDP contexts sharing the same PDP address and APN as the PDP context associated with this specific TI shall be deactivated. If the tear down is requested, all other active PDP contexts sharing the same PDP address and APN as the PDP context associated with this specific TI shall be deactivated locally without peer-to-peer signalling. If the *tear down indicator* information element is not included in the DEACTIVATE PDP CONTEXT REQUEST message, only the PDP context associated with this specific TI shall be deactivated.

After successful PDP context deactivation, the associated NSAPI and TI values are released and can be reassigned to another PDP context.

If one or more MBMS contexts are linked to a PDP context that has been deactivated, the MS shall deactivate all those MBMS contexts locally (without peer to peer signalling between the MS and the network).

##### 6.1.3.4.1 PDP context deactivation initiated by the MS

In order to deactivate a PDP context, the MS sends a DEACTIVATE PDP CONTEXT REQUEST message to the network, enters the state PDP-INACTIVE-PENDING and starts timer T3390. The message contains the transaction identifier (TI) in use for the PDP context to be deactivated and a cause code that typically indicates one of the following causes:

- # 25: LLC or SMD failure (A/Gb mode only);
- # 26: insufficient resources;
- # 36: regular deactivation; or
- # 37: QoS not accepted.

The network shall reply with the DEACTIVATE PDP CONTEXT ACCEPT message. Upon receipt of the DEACTIVATE PDP CONTEXT ACCEPT message, the MS shall stop timer T3390.

In A/Gb mode, both the MS and the network shall initiate local release of the logical link if it is not used by another PDP context.

In Iu mode, the network shall initiate the release of Radio Access Bearer associated with this PDP context.

##### 6.1.3.4.2 PDP context deactivation initiated by the network

In order to deactivate a PDP context, the network sends a DEACTIVATE PDP CONTEXT REQUEST message to the MS and starts timer T3395. The message contains the transaction identifier in use for the PDP context to be deactivated and a cause code that typically indicates one of the following causes:

- # 8: Operator Determined Barring;

- # 25: LLC or SNDCP failure (A/Gb mode only);
- # 36: regular deactivation;
- # 38: network failure; or
- # 39: reactivation requested.

The MS shall, upon receipt of this message, reply with a DEACTIVATE PDP CONTEXT ACCEPT message. Upon receipt of the DEACTIVATE PDP CONTEXT ACCEPT message, the network shall stop the timer T3395.

In A/Gb mode, both the MS and the network shall initiate local release of the logical link if it is not used by another PDP context.

In Iu mode, the network shall initiate the release of Radio Access Bearer associated with this PDP context.

#### 6.1.3.4.3 Abnormal cases

The following abnormal cases can be identified:

##### a) Expiry of timers

In the mobile station:

On the first expiry of timer T3390, the MS shall resent the message DEACTIVATE PDP CONTEXT REQUEST and shall reset and restart the timer T3390. This retransmission is repeated four times, i.e. on the fifth expiry of timer T3390, the MS shall release all resources allocated and shall erase the PDP context related data.

On the network side:

On the first expiry of timer T3395, the network shall resent the message DEACTIVATE PDP CONTEXT REQUEST and shall reset and restart timer T3395. This retransmission is repeated four times, i.e. on the fifth expiry of timer T3395, the network shall erase the PDP context related data for that MS.

##### b) Collision of MS and network initiated PDP context deactivation requests

If the MS and the network initiated PDP context deactivation requests collide, the MS and the network shall each reply with the messages DEACTIVATE PDP CONTEXT ACCEPT and shall stop timer T3390 and T3395, respectively.

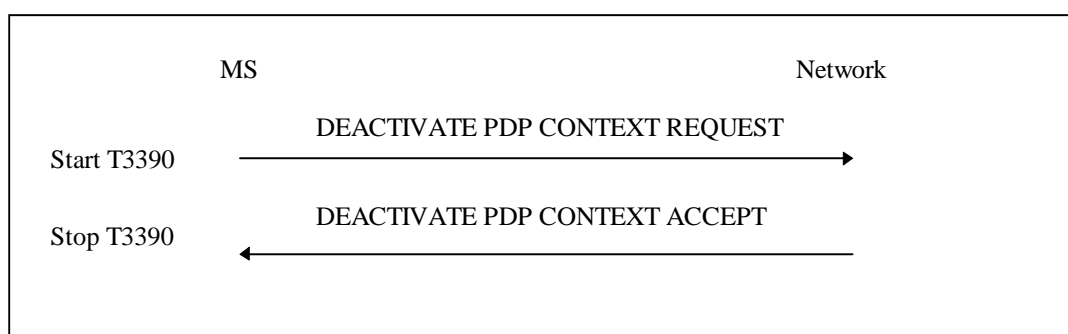

**Figure 6.8/3GPP TS 24.008: MS initiated PDP context deactivation procedure**



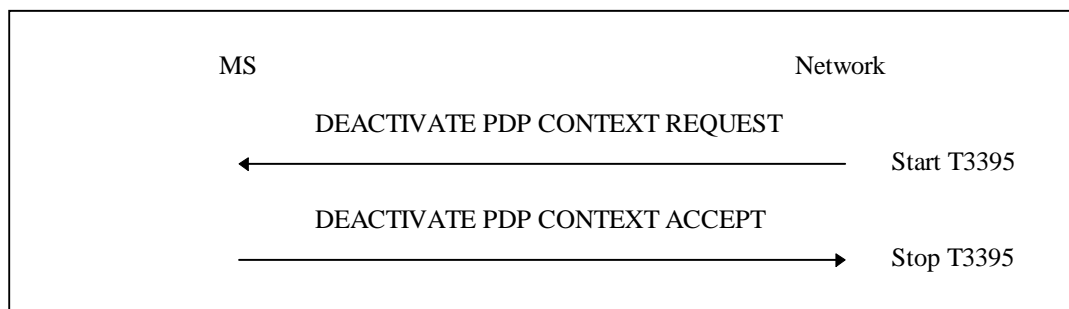

**Figure 6.9/3GPP TS 24.008: Network initiated PDP context deactivation procedure**

6.1.3.4a Void

6.1.3.5 Void

### 6.1.3.6 Receiving a SM STATUS message by a SM entity

If the SM entity of the MS receives an SM STATUS message the MS shall take different actions depending on the received SM cause value:

#### #81 Invalid transaction identifier value

The MS shall abort any ongoing SM procedure related to the received transaction identifier value, stop any related timer, and deactivate the corresponding PDP or MBMS context locally (without peer to peer signalling between the MS and the network).

If one or more MBMS contexts are linked to a PDP context that has been deactivated, the MS shall deactivate all those MBMS Contexts locally (without peer to peer signalling between the MS and the network).

#### #97 Message type non-existent or not implemented

The MS shall abort any ongoing SM procedure related to the received transaction identifier value and stop any related timer.

If the SM entity of the MS receives a SM STATUS message with any other SM cause value no state transition and no specific action shall be taken as seen from the radio interface, i.e. local actions are possible.

If the SM entity of the network receives an SM STATUS message the network shall take different actions depending on the received SM cause value:

#### #81 Invalid transaction identifier value

The network shall abort any ongoing SM procedure related to the received transaction identifier value, stop any related timer, and deactivate the corresponding PDP or MBMS context locally (without peer to peer signalling between the MS and the network).

If one or more MBMS contexts are linked to a PDP context that has been deactivated, the MS shall deactivate all those MBMS Contexts locally (without peer to peer signalling between the MS and the network).

#### #97 Message type non-existent or not implemented

The network shall abort any ongoing SM procedure related to the received transaction identifier value and stop any related timer.

The actions to be taken in the network on receiving a SM STATUS message with any other SM cause value are an implementation dependent option.

### 6.1.3.7 Protocol configuration options

The MS and the GGSN may communicate parameters by means of the protocol configuration options information element when activating, modifying or deactivating a PDP context. Such parameters can e.g. be used to convey

information from external protocols between the MS and the GGSN. An overview of how the protocol configuration options information element is used is specified in 3GPP TS 27.060 [36a].

The protocol configuration options information element is transparent to the SGSN.

### 6.1.3.8 MBMS context activation

The purpose of this procedure is to establish an MBMS context in the MS and in the network for a specific IP Multicast Address using a specific NSAPI for MBMS user plane transmission. The MS shall only initiate the MBMS context activation when requested by the network. However, the trigger for the activation request by the network is initiated by the MS at the application layer (see 3GPP TS 23.246 [106]).

#### 6.1.3.8.1 Successful MBMS context activation

In order to request an MBMS context activation, the network sends a REQUEST MBMS CONTEXT ACTIVATION message to the MS, enters the state MBMS-ACTIVE-PENDING and starts timer T3385. The message shall contain the IP multicast address, the APN and the Linked NSAPI.

Upon receipt of a REQUEST MBMS CONTEXT ACTIVATION message, the MS shall validate the message by verifying the NSAPI given in the Linked NSAPI IE to be one of the active PDP context(s), and send an ACTIVATE MBMS CONTEXT REQUEST, enter state MBMS-ACTIVE-PENDING and start timer T3380. The message shall contain an IP multicast address and an APN, which shall be the same as the IP multicast address and the APN requested by the network in the REQUEST MBMS CONTEXT ACTIVATION message. Furthermore, the MS shall include the Supported MBMS bearer capabilities, i.e. the maximum downlink bit rate the MS can handle.

Upon receipt of the ACTIVATE MBMS CONTEXT REQUEST message, the network shall stop timer T3385. If the network accepts the request, it shall reply with an ACTIVATE MBMS CONTEXT ACCEPT message.

Upon receipt of the message ACTIVATE MBMS CONTEXT ACCEPT the MS shall stop timer T3380 and shall enter the state MBMS-ACTIVE.

#### 6.1.3.8.2 Unsuccessful MBMS context activation requested by the MS

Upon receipt of an ACTIVATE MBMS CONTEXT REQUEST message the network may reject the MS initiated MBMS context activation by sending an ACTIVATE MBMS CONTEXT REJECT message to the MS. The sender of the message shall include the same TI as included in the ACTIVATE MBMS CONTEXT REQUEST and an additional cause code that typically indicates one of the following causes:

- # 8: Operator Determined Barring;
- # 24: MBMS bearer capabilities insufficient for the service;
- # 26: insufficient resources;
- # 27: missing or unknown APN;
- # 29: user authentication failed;
- # 30: activation rejected by GGSN;
- # 31: activation rejected, unspecified;
- # 32: service option not supported;
- # 33: requested service option not subscribed;
- # 34: service option temporarily out of order; or
- # 95 - # 111: protocol errors.

Upon receipt of an ACTIVATE MBMS CONTEXT REJECT message, the MS shall stop timer T3380 and enter/remain in state PDP-INACTIVE.

#### 6.1.3.8.3 Unsuccessful MBMS context activation requested by the network

Upon receipt of the REQUEST MBMS CONTEXT ACTIVATION message, the MS may reject the network requested MBMS context activation by sending the REQUEST MBMS CONTEXT ACTIVATION REJECT message to the network. The sender of the message shall include the same TI as included in the REQUEST MBMS CONTEXT ACTIVATION and an additional cause code that typically indicates one of the following causes:

- # 26: insufficient resources;
- # 31: activation rejected, unspecified;
- # 40: feature not supported; or
- # 95 - # 111: protocol errors.

The network shall stop timer T3385 and enter in state PDP-INACTIVE.

#### 6.1.3.8.4 Abnormal cases

The following abnormal cases can be identified:

- a) Expiry of timers in the mobile station: On the first expiry of the timer T3380, the MS shall resend the ACTIVATE MBMS CONTEXT REQUEST and shall reset and restart timer T3380. This retransmission is repeated four times, i.e. on the fifth expiry of timer T3380, the MS shall release all resources possibly allocated for this invocation and shall abort the procedure; no automatic MBMS context activation re-attempt shall be performed.
- b) Expiry of timers on the network side: On the first expiry of the timer T3385, the network shall resend the message REQUEST MBMS CONTEXT ACTIVATION and shall reset and restart timer T3385. This retransmission is repeated four times, i.e. on the fifth expiry of timer T3385, the network shall release possibly allocated resources for this activation and shall abort the procedure.
- c) MBMS context activation request for an already activated MBMS context (on the mobile station side): If the MS receives a REQUEST MBMS CONTEXT ACTIVATION message with the same combination of APN and IP multicast address (i.e. PDP type and PDP address) as an already activated MBMS context, the MS shall deactivate the existing MBMS context locally without notification to the network and proceed with the requested MBMS context activation.
- d) MBMS context activation request for an already activated MBMS context (on the network side): If the network receives an ACTIVATE MBMS CONTEXT REQUEST message with the same combination of APN and IP multicast address (i.e. PDP type and PDP address) as an already activated MBMS context, the network shall deactivate the existing MBMS context locally without notification to the MS and proceed with the requested MBMS context activation.

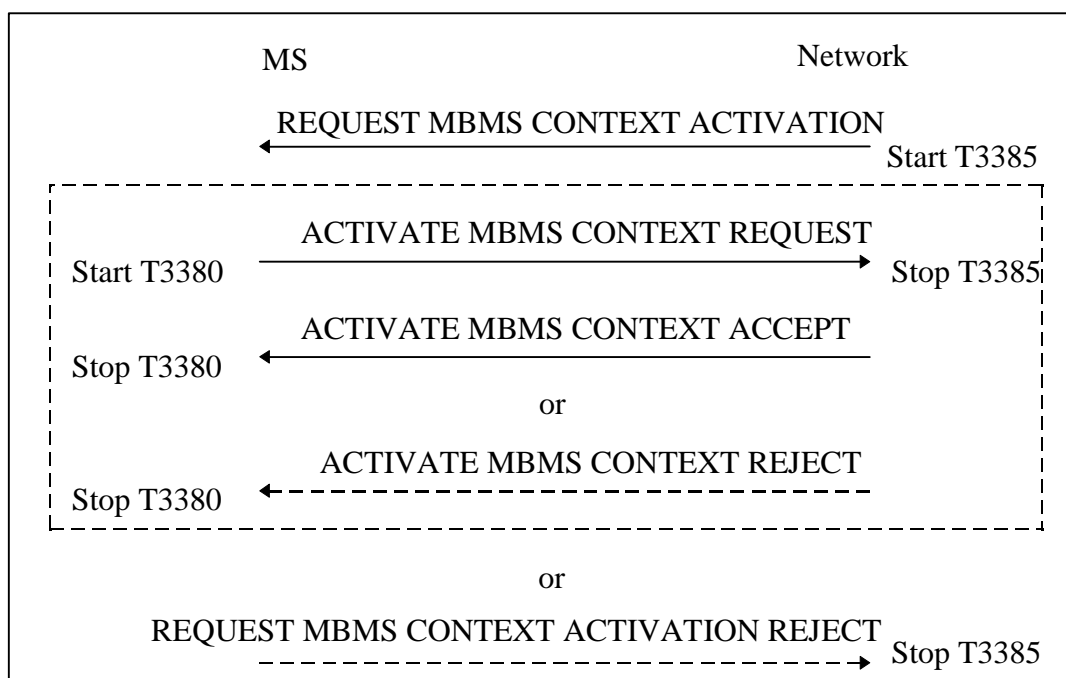

**Figure 6.10/3GPP TS 24.008: MBMS context activation procedure**

### 6.1.3.9 MBMS context deactivation

The purpose of this procedure is to deactivate an existing MBMS context in the MS and the network. The MS shall only initiate the MBMS context deactivation when requested by the network, however the trigger for the deactivation request by the network may be initiated by the MS at application layer or by the network, see 3GPP TS 23.246 [106].

After a successful MBMS context deactivation, the associated MBMS NSAPI and TI values shall be released in both the MS and the network and can be reassigned to another MBMS context.

The MBMS context deactivation procedure makes use of the messaging and signalling of the PDP context deactivation procedure as described in the subclause 6.2.3.2.1.

#### 6.1.3.9.1 MBMS context deactivation initiated by the network

In order to request an MBMS context deactivation, the network sends a **DEACTIVATE PDP CONTEXT REQUEST** message to the MS, enters the state **MBMS-INACTIVE-PENDING** and starts timer **T3395**. The message contains the transaction identifier (TI) in use for the MBMS context to be deactivated and a cause code that typically indicates one of the following causes:

- # 36: regular deactivation;
- # 38: network failure;
- # 47: multicast group membership time-out.

The MS shall reply with a **DEACTIVATE PDP CONTEXT ACCEPT** message and enter the state **PDP-INACTIVE**. Upon receipt of the **DEACTIVATE PDP CONTEXT ACCEPT** message, the network shall stop the timer **T3395** and enter the state **PDP-INACTIVE**.

#### 6.1.3.9.2 Abnormal cases

The following abnormal cases can be identified:

- a) Expiry of timers:

On the first expiry of the timer T3395, the network shall resend the message DEACTIVATE PDP CONTEXT REQUEST and shall reset and restart the timer T3395. This retransmission is repeated, i.e. on the fifth expiry of the timer T3395, the network shall erase the MBMS context related data for that MS.

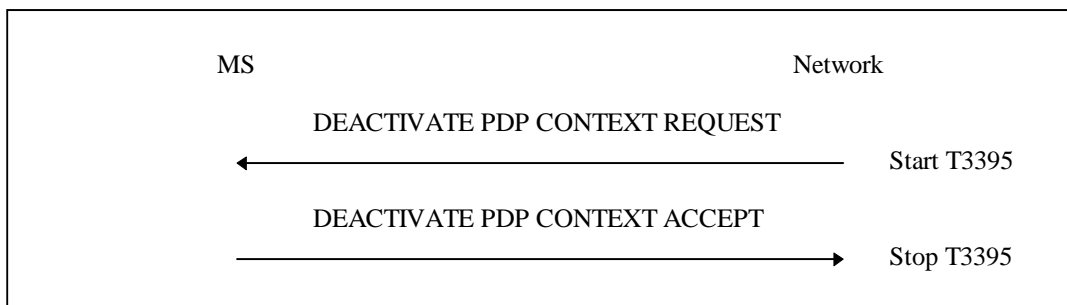

Figure 6.11/3GPP TS 24.008: MBMS context deactivation procedure

### 6.1.3.10 MBMS protocol configuration options

The MS and the GGSN may communicate parameters related to the MBMS bearer by means of the MBMS protocol configuration options information element when activating or deactivating an MBMS context. For example, such parameters can be used to convey information between the MS and the GGSN.

The MBMS protocol configuration options information element is transparent to the SGSN.

## 6.2 void

---

# 7 Examples of structured procedures

See 3GPP TS 23.108 [9a].

---

# 8 Handling of unknown, unforeseen, and erroneous protocol data

## 8.1 General

The procedures specified in 3GPP TS 24.008 and call-related supplementary service handling in 3GPP TS 24.010 [21] apply to those messages which pass the checks described in this subclause.

This subclause also specifies procedures for the handling of unknown, unforeseen, and erroneous protocol data by the receiving entity. These procedures are called "error handling procedures", but in addition to providing recovery mechanisms for error situations they define a compatibility mechanism for future extensions of the protocols.

Error handling concerning the value part of the Facility IE and of the SS Version Indicator IE are not in the scope of the present document. It is defined in 3GPP TS 24.010 [21] and the 3GPP TS 24.08x series.

Sub subclauses 8.1 to 8.8 shall be applied in order of precedence.

Most error handling procedures are mandatory for the mobile station.

Detailed error handling procedures in the network are implementation dependent and may vary from PLMN to PLMN. However, when extensions of this protocol are developed, networks will be assumed to have the error handling that is

indicated in this subclause as mandatory ("shall") and that is indicated as strongly recommended ("should"). Subclauses 8.2, 8.3, 8.4, 8.5 and 8.7.2 do not apply to the error handling in the network applied to the receipt of initial layer 3 message: If the network diagnoses an error described in one of these subclauses in the initial layer 3 message received from the mobile station, it shall either:

- try to recognize the classmark and then take further implementation dependent actions; or
- release the RR-connection.

Also, the error handling of the network is only considered as mandatory or strongly recommended when certain thresholds for errors are not reached during a dedicated connection.

For definition of semantical and syntactical errors see 3GPP TS 24.007 [20], subclause 11.4.2.

## 8.2 Message too short

When a message is received that is too short to contain a complete message type information element, that message shall be ignored, cf. 3GPP TS 24.007 [20].

## 8.3 Unknown or unforeseen transaction identifier

### 8.3.1 Call Control

The mobile station and the network shall ignore a Call Control message received with TI EXT bit = 0. Otherwise, if the TI EXT bit = 1 or no extension is used, the behaviour described below shall be followed.

The mobile station and network shall reject a SETUP, EMERGENCY SETUP or START CC message received with octet 1 part of the TI value coded as "111" by sending RELEASE COMPLETE with cause #81 "Invalid transaction identifier value" The TI value in RELEASE COMPLETE shall be the complete TI value including the extension octet from the message that caused the rejection.

Any message other than SETUP, EMERGENCY SETUP or START CC received with octet 1 part of the TI value coded as "111" shall be ignored.

For a call control message received with octet 1 part of the TI value not coded as "111", the following procedures shall apply:

- a) For a network that does not support the "Network initiated MO call" option and for all mobile stations:

Whenever any call control message except EMERGENCY SETUP, SETUP or RELEASE COMPLETE is received specifying a transaction identifier which is not recognized as relating to an active call or to a call in progress, the receiving entity shall send a RELEASE COMPLETE message with cause #81 "invalid transaction identifier value" using the received transaction identifier value and remain in the Null state.

For a network that does support the "Network initiated MO call" option \$(CCBS)\$:

Whenever any call control message except EMERGENCY SETUP, SETUP, START CC or RELEASE COMPLETE is received specifying a transaction identifier which is not recognized as relating to an active call or to a call in progress, the receiving entity shall send a RELEASE COMPLETE message with cause #81 "invalid transaction identifier value" using the received transaction identifier value and remain in the Null state.

- b) When a RELEASE COMPLETE message is received specifying a transaction identifier which is not recognized as relating to an active call or to a call in progress, the MM connection associated with that transaction identifier shall be released.
- c) For a network that does not support the "Network initiated MO call" option and for all mobile stations:

When an EMERGENCY SETUP or, a SETUP message is received specifying a transaction identifier which is not recognized as relating to an active call or to a call in progress, and with a transaction identifier flag incorrectly set to "1", this message shall be ignored.

For a network that does support the "Network initiated MO call" option \$(CCBS)\$:

When an EMERGENCY SETUP, a START CC or, a SETUP message is received specifying a transaction identifier which is not recognised as relating to an active call or to a call in progress, and with a transaction identifier flag incorrectly set to "1", this message shall be ignored.

- d) When a SETUP message is received by the mobile station specifying a transaction identifier which is recognized as relating to an active call or to a call in progress, this SETUP message shall be ignored.
- e) For a network that does not support the "Network initiated MO call" option:

When an EMERGENCY SETUP message or a SETUP message is received by the network specifying a transaction identifier which is recognized as relating to an active call or to a call in progress, this message need not be treated and the network may perform other actions.

For a network that does support the "Network initiated MO call" option \$(CCBS)\$:

When an EMERGENCY SETUP message or a START CC message is received by the network specifying a transaction identifier which is recognised as relating to an active call or to a call in progress, this message need not be treated and the network may perform other actions.

The same applies to a SETUP message unless the transaction has been established by a START\_CC message and the network is in the "recall present" state (N0.6).

### 8.3.2 Session Management

The mobile station and network shall ignore a session management message with TI EXT bit = 0. Otherwise, the following procedures shall apply:

- a) Whenever any session management message except ACTIVATE PDP CONTEXT REQUEST, ACTIVATE SECONDARY PDP CONTEXT REQUEST, or SM-STATUS is received by the network specifying a transaction identifier which is not recognized as relating to an active PDP context or MBMS context, or to a PDP context or MBMS context that is in the process of activation or deactivation, the network shall send a SM-STATUS message with cause #81 "invalid transaction identifier value" using the received transaction identifier value including the extension octet and remain in the PDP-INACTIVE state.
- b) Whenever any session management message except REQUEST PDP CONTEXT ACTIVATION, REQUEST MBMS CONTEXT ACTIVATION, or SM-STATUS is received by the MS specifying a transaction identifier which is not recognized as relating to an active context or to a context that is in the process of activation or deactivation, the MS shall send a SM-STATUS message with cause #81 "invalid transaction identifier value" using the received transaction identifier value including the extension octet and remain in the PDP-INACTIVE state.
- c) When a REQUEST PDP CONTEXT ACTIVATION message or REQUEST MBMS CONTEXT ACTIVATION message is received by the MS with a transaction identifier flag set to "1", this message shall be ignored.
- d) When an ACTIVATE PDP CONTEXT REQUEST message is received by the network specifying a transaction identifier which is not recognized as relating to a PDP context that is in the process of activation, and with a transaction identifier flag set to "1", this message shall be ignored.
- e) Whenever an ACTIVATE PDP CONTEXT REQUEST or ACTIVATE SECONDARY PDP CONTEXT REQUEST message is received by the network specifying a transaction identifier relating to a PDP context or MBMS context not in state PDP-INACTIVE, the network shall deactivate the old PDP context or MBMS context relating to the received transaction identifier without notifying the MS. Furthermore, the network shall continue with the activation procedure of a new PDP context as indicated in the received message. Whenever an ACTIVATE MBMS CONTEXT REQUEST message is received by the network specifying a transaction identifier relating to an MBMS context not in state PDP-INACTIVE, the network shall deactivate the old MBMS context relating to the received transaction identifier without notifying the MS. Furthermore, the network shall continue with the activation procedure of a new MBMS context as indicated in the received message.
- f) Whenever a REQUEST PDP CONTEXT ACTIVATION message is received by the MS specifying a transaction identifier relating to a PDP context or MBMS context not in state PDP-INACTIVE, the MS shall locally deactivate the old PDP context or MBMS context relating to the received transaction identifier. Furthermore, the MS shall continue with the activation procedure of a new PDP context as indicated in the received message.  
Whenever a REQUEST MBMS CONTEXT ACTIVATION message is received by the MS specifying a transaction identifier relating to a PDP context or MBMS context not in state PDP-INACTIVE, the MS shall

locally deactivate the old PDP context or MBMS context relating to the received transaction identifier. Furthermore, the MS shall continue with the activation procedure of a new MBMS context as indicated in the received message.

- g) When an ACTIVATE SECONDARY PDP CONTEXT REQUEST message is received by the network with a transaction identifier flag set to "1", this message shall be ignored.

## 8.4 Unknown or unforeseen message type

If a mobile station receives an RR, MM or CC message with message type not defined for the PD or not implemented by the receiver in unacknowledged mode, it shall ignore the message.

If a mobile station receives an RR, MM or CC message with message type not defined for the PD or not implemented by the receiver in acknowledged mode, it shall return a status message (STATUS, MM STATUS depending on the protocol discriminator) with cause # 97 "message type non-existent or not implemented".

If a mobile station receives a GMM message or SM message with message type not defined for the PD or not implemented by the receiver, it shall return a status message (GMM STATUS or SM STATUS depending on the protocol discriminator) with cause # 97 "message type non-existent or not implemented".

If the network receives an MM message with message type not defined for the PD or not implemented by the receiver in a protocol state where reception of an unsolicited message with the given PD from the mobile station is not foreseen in the protocol, the network actions are implementation dependent. Otherwise, if the network receives a message with message type not defined for the PD or not implemented by the receiver, it shall ignore the message except that it should return a status message (STATUS, MM STATUS, GMM STATUS or SM STATUS depending on the protocol discriminator) with cause #97 "message type non-existent or not implemented".

NOTE: A message type not defined for the PD in the given direction is regarded by the receiver as a message type not defined for the PD, see 3GPP TS 24.007 [20].

If the mobile station receives a message not compatible with the protocol state, the mobile station shall ignore the message except for the fact that, if an RR connection exists, it returns a status message (STATUS, MM STATUS depending on the protocol discriminator) with cause #98 "Message type not compatible with protocol state". When the message was a GMM message the GMM-STATUS message with cause #98 "Message type not compatible with protocol state" shall be returned. When the message was a SM message the SM-STATUS message with cause #98 "Message type not compatible with protocol state" shall be returned.

If the network receives a message not compatible with the protocol state, the network actions are implementation dependent.

NOTE: The use by GMM and SM of unacknowledged LLC may lead to messages "not compatible with the protocol state".

## 8.5 Non-semantical mandatory information element errors

When on receipt of a message,

- an "imperative message part" error; or
- a "missing mandatory IE" error;

is diagnosed or when a message containing:

- a syntactically incorrect mandatory IE; or
- an IE unknown in the message, but encoded as "comprehension required" (see 3GPP TS 24.007); or
- an out of sequence IE encoded as "comprehension required" (see 3GPP TS 24.007) is received,

the mobile station shall proceed as follows:

If the message is not one of the messages listed in subclauses 8.5.1, 8.5.2, 8.5.3, 8.5.4 and 8.5.5 a), b) or f), the mobile station shall ignore the message except for the fact that, if an RR connection exists, it shall return a status



message (STATUS, MM STATUS depending on the protocol discriminator) with cause # 96 "Invalid mandatory information". If the message was a GMM message the GMM-STATUS message with cause #96 "Invalid mandatory information" shall be returned. If the message was an SM message the SM-STATUS message with cause # 96 "invalid mandatory information" shall be returned.

- the network shall proceed as follows:

When the message is not one of the messages listed in subclause 8.5.3 b), c), d) or e) and 8.5.5 a), c), d), e) or g), the network shall either:

- try to treat the message (the exact further actions are implementation dependent), or
- ignore the message except that it should return a status message (STATUS, or MM STATUS (depending on the protocol discriminator), GMM STATUS, or SM STATUS) with cause # 96 "Invalid mandatory information".

## 8.5.1 Radio resource management

See 3GPP TS 44.018 [84].

## 8.5.2 Mobility management

No exceptional cases are described for mobility management messages.

## 8.5.3 Call control

- a) If the message is a SETUP message, a RELEASE COMPLETE message with cause # 96 "invalid mandatory information" shall be returned.
- b) If the message is a DISCONNECT message, a RELEASE message shall be returned with cause value # 96 "invalid mandatory information" and subclause 5.4. "call clearing" applies as normal.
- c) If the message is a RELEASE message, a RELEASE COMPLETE message shall be returned with cause value # 96 "invalid mandatory information".
- d) If the message is a RELEASE COMPLETE message, it shall be treated as a normal RELEASE COMPLETE message.
- e) If the message is a HOLD REJECT or RETRIEVE REJECT message, it shall be treated as a normal HOLD REJECT or RETRIEVE REJECT message.
- f) If the message is a STATUS message and received by the network, a RELEASE COMPLETE message may be returned with cause value # 96 "invalid mandatory information".

## 8.5.4 GMM mobility management

No exceptional cases are described for mobility management messages.

## 8.5.5 Session management

- a) If the message is a DEACTIVATE PDP CONTEXT REQUEST, a DEACTIVATE PDP CONTEXT ACCEPT message shall be returned. All resources allocated for that context shall be released.
- b) If the message is a REQUEST PDP CONTEXT ACTIVATION, a REQUEST PDP CONTEXT ACTIVATION REJECT message with cause # 96 "Invalid mandatory information" shall be returned.
- c) If the message is an ACTIVATE PDP CONTEXT REQUEST, an ACTIVATE PDP CONTEXT REJECT message with cause # 96 "Invalid mandatory information" shall be returned.
- d) If the message is an ACTIVATE SECONDARY PDP CONTEXT REQUEST, an ACTIVATE SECONDARY PDP CONTEXT REJECT message with cause # 96 "Invalid mandatory information" shall be returned.
- e) If the message is a MODIFY PDP CONTEXT REQUEST, a MODIFY PDP CONTEXT REJECT message with cause # 96 "Invalid mandatory information" shall be returned.

- f) If the message is a REQUEST MBMS CONTEXT ACTIVATION, a REQUEST MBMS CONTEXT ACTIVATION REJECT message with cause # 96 "Invalid mandatory information" shall be returned.
- g) If the message is an ACTIVATE MBMS CONTEXT REQUEST, an ACTIVATE MBMS CONTEXT REJECT message with cause # 96 "Invalid mandatory information" shall be returned.

## 8.6 Unknown and unforeseen IEs in the non-imperative message part

### 8.6.1 IEs unknown in the message

The MS shall ignore all IEs unknown in a message which are not encoded as "comprehension required" (see 3GPP TS 24.007).

The network shall take the same approach.

### 8.6.2 Out of sequence IEs

The MS shall ignore all out of sequence IEs in a message which are not encoded as "comprehension required" (see 3GPP TS 24.007).

The network should take the same approach.

### 8.6.3 Repeated IEs

If an information element with format T, TV, or TLV is repeated in a message in which repetition of the information element is not specified in clause 9 of the present document, only the contents of the information element appearing first shall be handled and all subsequent repetitions of the information element shall be ignored. When repetition of information elements is specified, only the contents of specified repeated information elements shall be handled. If the limit on repetition of information elements is exceeded, the contents of information elements appearing first up to the limit of repetitions shall be handled and all subsequent repetitions of the information element shall be ignored.

The network should follow the same procedures.

## 8.7 Non-imperative message part errors

This category includes:

- syntactically incorrect optional IEs;
- conditional IE errors.

### 8.7.1 Syntactically incorrect optional IEs

The MS shall treat all optional IEs that are syntactically incorrect in a message as not present in the message.

The network shall take the same approach.

### 8.7.2 Conditional IE errors

When the MS upon receipt of an RR, MM or CC message diagnoses a "missing conditional IE" error or an "unexpected conditional IE" error or when it receives an RR, MM or CC message containing at least one syntactically incorrect conditional IE, it shall ignore the message except for the fact that, if an RR connection exists, it shall return a status message (STATUS, or MM STATUS depending on the PD) with cause value # 100 "conditional IE error".

When the MS upon receipt of a GMM or SM message diagnoses a "missing conditional IE" error or an "unexpected conditional IE" error or when it receives a GMM or SM message containing at least one syntactically incorrect

conditional IE, it shall ignore the message and it shall return a status message (GMM STATUS or SM STATUS depending on the PD) with cause value # 100 "conditional IE error".

When the network receives a message and diagnose a "missing conditional IE" error or an "unexpected conditional IE" error or when it receives a message containing at least one syntactically incorrect conditional IE, the network shall either

- try to treat the message (the exact further actions are implementation dependent), or
- ignore the message except that it should return a status message (STATUS, MM STATUS, GMM STATUS or SM STATUS depending on the protocol discriminator) with cause # 100 "conditional IE error".

## 8.8 Messages with semantically incorrect contents

When a message with semantically incorrect contents is received, the foreseen reactions of the procedural part of 3GPP TS 24.008 (i.e. of clauses 3, 4, 5, 6) are performed. If however no such reactions are specified, the MS shall ignore the message except for the fact that, if an RR connection exists, it returns a status message (STATUS, or MM STATUS depending on the PD) with cause value # 95 "semantically incorrect message". If the message was a GMM message the GMM-STATUS message with cause #95 "semantically incorrect message" shall be returned. If the message was an SM message the SM-STATUS message with cause # 95 "semantically incorrect message" shall be returned.

The network should follow the same procedure except that a status message is not normally transmitted.

Semantic checking of the Facility information element value part (defined in 3GPP TS 24.080 [24]) is the subject of the technical specifications 3GPP TS 24.010 [21] and the 3GPP TS 24.08x series.

---

# 9 Message functional definitions and contents

This clause defines the structure of the messages of those layer 3 protocols defined in 3GPP TS 24.008. These are standard L3 messages as defined in 3GPP TS 24.007 [20].

Each definition given in the present clause includes:

- a) a brief description of the message direction and use, including whether the message has:
  1. Local significance, i.e. relevant only on the originating or terminating access;
  2. Access significance, i.e. relevant in the originating and terminating access, but not in the network;
  3. Dual significance, i.e. relevant in either the originating or terminating access and in the network; or
  4. Global significance, i.e. relevant in the originating and terminating access and in the network.
- b) a table listing the information elements known in the message and their order of their appearance in the message. In messages for circuit-switched call control also a *shift* information element shall be considered as known even if not included in the table. All information elements that may be repeated are explicitly indicated. (V and LV formatted IEs, which compose the imperative part of the message, occur before T, TV, and TLV formatted IEs which compose the non-imperative part of the message, cf. 3GPP TS 24.007.) In a (maximal) sequence of consecutive information elements with half octet length, the first information element with half octet length occupies bits 1 to 4 of octet N, the second bits 5 to 8 of octet N, the third bits 1 to 4 of octet N+1 etc. Such a sequence always has an even number of elements.

For each information element the table indicates:

1. the information element identifier, in hexadecimal notation, if the IE has format T, TV, or TLV. Usually, there is a default IEI for an information element type; default IEIs of different IE types of the same protocol are different. If the IEI has half octet length, it is specified by a notation representing the IEI as a hexadecimal digit followed by a "-" (example: B-).

NOTE 1: The same IEI may be used for different information element types in different messages of the same protocol..

NOTE 2: In the CC protocol the IEI of the locking shift and non-locking shift information elements is the same in all messages and is not used for any other information elements.

2. the name of the information element (which may give an idea of the semantics of the element). The name of the information element (usually written in italics) followed by "IE" or "information element" is used in 3GPP TS 24.008 as reference to the information element within a message.
  3. the name of the type of the information element (which indicates the coding of the value part of the IE), and generally, the referenced subclause of clause 10 of 3GPP TS 24.008 describing the value part of the information element.
  4. the presence requirement indication (M, C, or O) for the IE as defined in 3GPP TS 24.007 [20].
  5. The format of the information element (T, V, TV, LV, TLV) as defined in 3GPP TS 24.007 [20].
  6. The length of the information element (or permissible range of lengths), in octets, in the message, where "?" means that the maximum length of the IE is only constrained by link layer protocol, and in the case of the Facility IE by possible further conditions specified in 3GPP TS 24.010 [21]. This indication is non-normative.
- c.) subclauses specifying, where appropriate, conditions for IEs with presence requirement C or O in the relevant message which together with other conditions specified in 3GPP TS 24.008 define when the information elements shall be included or not, what non-presence of such IEs means, and - for IEs with presence requirement C - the static conditions for presence and/or non-presence of the IEs (see 3GPP TS 24.007 [20]).

## 9.1 Messages for Radio Resources management

See 3GPP TS 44.018 [84].

## 9.2 Messages for mobility management

Table 9.2.1/3GPP TS 24.008 summarizes the messages for mobility management.

**Table 9.2.1/3GPP TS 24.008: Messages for mobility management**

<b>Registration messages:</b>	<b>Reference</b>
IMSI DETACH INDICATION	9.2.12
LOCATION UPDATING ACCEPT	9.2.13
LOCATION UPDATING REJECT	9.2.14
LOCATION UPDATING REQUEST	9.2.15
<b>Security messages:</b>	<b>Reference</b>
AUTHENTICATION REJECT	9.2.1
AUTHENTICATION REQUEST	9.2.2
AUTHENTICATION RESPONSE	9.2.3
AUTHENTICATION FAILURE	9.2.3a
IDENTITY REQUEST	9.2.10
IDENTITY RESPONSE	9.2.11
TMSI REALLOCATION COMMAND	9.2.17
TMSI REALLOCATION COMPLETE	9.2.18
<b>Connection management messages:</b>	<b>Reference</b>
CM SERVICE ACCEPT	9.2.5
CM SERVICE PROMPT	9.2.5a
CM SERVICE REJECT	9.2.6
CM SERVICE ABORT	9.2.7
CM SERVICE REQUEST	9.2.9
CM RE-ESTABLISHMENT REQUEST	9.2.4
ABORT	9.2.8
<b>Miscellaneous message:</b>	<b>Reference</b>
MM INFORMATION	9.2.15a
MM STATUS	9.2.16
MM NULL	9.2.19

## 9.2.1 Authentication reject

This message is sent by the network to the mobile station to indicate that authentication has failed (and that the receiving mobile station shall abort all activities). See table 9.2.2/3GPP TS 24.008.

Message type: AUTHENTICATION REJECT

Significance: dual

Direction: network to mobile station

**Table 9.2.2/3GPP TS 24.008: AUTHENTICATION REJECT message content**

IEI	Information element	Type/Reference	Presence	Format	Length
	Mobility management protocol discriminator	Protocol discriminator 10.2	M	V	1/2
	Skip Indicator	Skip Indicator 10.3.1	M	V	1/2
	Authentication Reject message type	Message type 10.4	M	V	1

## 9.2.2 Authentication request

This message is sent by the network to the mobile station to initiate authentication of the mobile station identity. See table 9.2.3/3GPP TS 24.008.

Message type: AUTHENTICATION REQUEST

Significance: dual

Direction: network to mobile station

**Table 9.2.3/3GPP TS 24.008: AUTHENTICATION REQUEST message content**

IEI	Information element	Type/Reference	Presence	Format	Length
	Mobility management protocol discriminator	Protocol discriminator 10.2	M	V	1/2
	Skip Indicator	Skip Indicator 10.3.1	M	V	1/2
	Authentication Request message type	Message type 10.4	M	V	1
	Ciphering key sequence number	Ciphering key sequence number 10.5.1.2	M	V	1/2
	Spare half octet	Spare half octet 10.5.1.8	M	V	1/2
	Authentication parameter RAND (UMTS challenge or GSM challenge)	Auth. parameter RAND 10.5.3.1	M	V	16
20	Authentication Parameter AUTN	Auth. parameter AUTN 10.5.3.1.1	O	TLV	18

### 9.2.2.1 Authentication Parameter AUTN

This IE shall be present if and only if the authentication challenge is a UMTS authentication challenge. The presence or absence of this IE defines- in the case of its absence- a GSM authentication challenge or- in the case of its presence- a UMTS authentication challenge.

The MS shall ignore the IE if a SIM is inserted in the MS.

In UMTS, the MS shall reject the AUTHENTICATION REQUEST message as specified in subclause 4.3.2.5.1 if this IE is not present and a USIM is inserted in the MS.

### 9.2.3 Authentication response

This message is sent by the mobile station to the network to deliver a calculated response to the network. See table 9.2.4/3GPP TS 24.008.

Message type: AUTHENTICATION RESPONSE

Significance: dual

Direction: mobile station to network

**Table 9.2.4/3GPP TS 24.008: AUTHENTICATION RESPONSE message content**

IEI	Information element	Type/Reference	Presence	Format	Length
	Mobility management protocol discriminator	Protocol discriminator 10.2	M	V	1/2
	Skip Indicator	Skip Indicator 10.3.1	M	V	1/2
	Authentication Response message type	Message type 10.4	M	V	1
	Authentication Response parameter	Auth. Response parameter 10.5.3.2	M	V	4
21	Authentication Response Parameter (extension)	Auth. Response parameter 10.5.3.2.1	O	TLV	3-14

#### 9.2.3.1 Authentication Response Parameter

This IE contains the SRES, if it was a GSM authentication challenge, or the RES (all or just the 4 most significant octets of) if it was a UMTS authentication challenge (see also subclause 9.2.3.2).

#### 9.2.3.2 Authentication Response Parameter (extension)

This IE shall be included if and only if the authentication challenge was a UMTS authentication challenge and the RES parameter is greater than 4 octets in length. It shall contain the least significant remaining bits of the RES (the four most significant octets shall be sent in the Authentication Response Parameter IE (see subclause 9.2.3.1))

This IE shall not be included if a SIM is inserted in the MS.

### 9.2.3a Authentication Failure

This message is sent by the mobile station to the network to indicate that authentication of the network has failed. See table 9.2.4a/3GPP TS 24.008.

Message type: AUTHENTICATION FAILURE

Significance: dual

Direction: mobile station to network

**Table 9.2.4a/3GPP TS 24.008: AUTHENTICATION FAILURE message content**

IEI	Information element	Type/Reference	Presence	Format	Length
	Mobility management Protocol discriminator	Protocol discriminator 10.2	M	V	1/2
	Skip Indicator	Skip Indicator 10.3.1	M	V	1/2
	Authentication Failure Message type	Message type 10.4	M	V	1
	Reject Cause	Reject Cause 10.5.3.6	M	V	1
22	Authentication Failure parameter	Authentication Failure parameter 10.5.3.2.2	O	TLV	16

### 9.2.3a.1 Authentication Failure parameter

This IE shall be sent if and only if the reject cause was "Synch failure". It shall include the response to the authentication challenge from the USIM, which is made up of the AUTS parameter (see 3GPP TS 33.102 [5a]).

## 9.2.4 CM Re-establishment request

This message is sent by the mobile station to the network to request re-establishment of a connection if the previous one has failed. See table 9.2.5/3GPP TS 24.008.

Message type: CM RE-ESTABLISHMENT REQUEST

Significance: dual

Direction: mobile station to network

**Table 9.2.5/3GPP TS 24.008: CM RE-ESTABLISHMENT REQUEST message content**

IEI	Information element	Type/Reference	Presence	Format	Length
	Mobility management protocol discriminator	Protocol discriminator 10.2	M	V	½
	Skip Indicator	Skip Indicator 10.3.1	M	V	½
	CM Re-Establishment Request message type	Message type 10.4	M	V	1
	Ciphering key sequence number	Ciphering key sequence number 10.5.1.2	M	V	½
	Spare half octet	Spare half octet 10.5.1.8	M	V	½
	Mobile station classmark	Mobile station classmark 2 10.5.1.6	M	LV	4
	Mobile identity	Mobile identity 10.5.1.4	M	LV	2-9
13	Location area identification	Location area identification 10.5.1.3	C	TV	6

### 9.2.4.1 Location area identification

The *location area identification* information element shall appear when a TMSI is used as mobile identity, to render that mobile identity non-ambiguous. This is the LAI stored in the SIM/USIM.

### 9.2.4.2 Mobile Station Classmark

This IE shall include for multiband mobile station the Classmark 2 corresponding to the frequency band in use.

## 9.2.5 CM service accept

This message is sent by the network to the mobile station to indicate that the requested service has been accepted. See table 9.2.6/3GPP TS 24.008.

Message type: CM SERVICE ACCEPT

Significance: dual

Direction: network to mobile station

**Table 9.2.6/3GPP TS 24.008: CM SERVICE ACCEPT message content**

IEI	Information element	Type/Reference	Presence	Format	Length
	Mobility management protocol discriminator	Protocol discriminator 10.2	M	V	1/2
	Skip Indicator	Skip Indicator 10.3.1	M	V	1/2
	CM Service Accept message type	Message type 10.4	M	V	1

### 9.2.5a CM service prompt \$(CCBS)\$

A mobile station that does not support the "Network initiated MO call" option shall treat this message as a message with message type not defined for the PD.

This message is sent by the network to the mobile station to request the mobile to establish a service for the specified CM protocol using the specified SAPI, e.g. circuit switched connection establishment on SAPI 0, supplementary services activation on SAPI 0, or short message transfer on SAPI 3. See Table 9.2.7/3GPP TS 24.008.

Message type: CM SERVICE PROMPT

Significance: dual

Direction: network to mobile station

**Table 9.2.7/3GPP TS 24.008: CM SERVICE PROMPT message content**

IEI	Information element	Type/Reference	Presence	Format	Length
	Mobility management protocol discriminator	Protocol discriminator 10.2	M	V	1/2
	Skip Indicator	Skip Indicator 10.3.1	M	V	1/2
	CM Service Prompt message type	Message type 10.4	M	V	1
	PD and SAPI of CM	PD and SAPI 10.5.1.10a	M	V	1

### 9.2.6 CM service reject

This message is sent by the network to the mobile station to indicate that the requested service cannot be provided. See table 9.2.8/3GPP TS 24.008.

Message type: CM SERVICE REJECT

Significance: dual

Direction: network to mobile station



**Table 9.2.8/3GPP TS 24.008: CM SERVICE REJECT message content**

IEI	Information element	Type/Reference	Presence	Format	Length
	Mobility management protocol discriminator	Protocol discriminator 10.2	M	V	1/2
	Skip Indicator	Skip Indicator 10.3.1	M	V	1/2
	CM Service Reject message type	Message type 10.4	M	V	1
	Reject cause	Reject cause 10.5.3.6	M	V	1

## 9.2.7 CM service abort

This message is sent by the mobile station to the network to request the abortion of the first MM connection establishment in progress and the release of the RR connection. See table 9.2.9/3GPP TS 24.008.

Message type: CM SERVICE ABORT

Significance: dual

Direction: mobile station to network

**Table 9.2.9/3GPP TS 24.008: CM SERVICE ABORT message content**

IEI	Information element	Type/Reference	Presence	Format	Length
	Mobility management protocol discriminator	Protocol discriminator 10.2	M	V	1/2
	Skip Indicator	Skip Indicator 10.3.1	M	V	1/2
	CM Service Abort message type	Message type 10.4	M	V	1

## 9.2.8 Abort

This message is sent by the network to the mobile station to initiate the abortion of all MM connections and to indicate the reason for the abortion. See table 9.2.10/3GPP TS 24.008.

Message type: ABORT

Significance: dual

Direction: network to mobile station

**Table 9.2.10/3GPP TS 24.008: ABORT message content**

IEI	Information element	Type/Reference	Presence	Format	Length
	Mobility management protocol discriminator	Protocol discriminator 10.2	M	V	1/2
	Skip Indicator	Skip Indicator 10.3.1	M	V	1/2
	Abort message type	Message type 10.4	M	V	1
	Reject cause	Reject cause 10.5.3.6	M	V	1

## 9.2.9 CM service request

This message is sent by the mobile station to the network to request a service for the connection management sublayer entities, e.g. circuit switched connection establishment, supplementary services activation, short message transfer, location services. See table 9.2.11/3GPP TS 24.008.

Message type: CM SERVICE REQUEST

Significance: dual

Direction: mobile station to network

**Table 9.2.11/3GPP TS 24.008: CM SERVICE REQUEST message content**

IEI	Information element	Type/Reference	Presence	Format	Length
	Mobility management protocol discriminator	Protocol discriminator 10.2	M	V	½
	Skip Indicator	Skip Indicator 10.3.1	M	V	½
	CM Service Request message type	Message type 10.4	M	V	1
	CM service type	CM service type 10.5.3.3	M	V	½
	Ciphering key sequence number	Ciphering key sequence number 10.5.1.2	M	V	½
	Mobile station classmark	Mobile station classmark 2 10.5.1.6	M	LV	4
	Mobile identity	Mobile identity 10.5.1.4	M	LV	2-9
8-	Priority	Priority Level 10.5.1.11	O	TV	1

### 9.2.9.1 Mobile Station Classmark

This IE shall include for multiband mobile station the Classmark 2 corresponding to the frequency band in use.

### 9.2.9.2 Priority

May be included by mobile station supporting eMLPP to indicate the priority requested.

This information element is only meaningful when the CM service type is:

Mobile originating call establishment;

Emergency call establishment;

Voice group call establishment;

Voice broadcast call establishment.

## 9.2.10 Identity request

This message is sent by the network to the mobile station to request a mobile station to submit the specified identity to the network. See table 9.2.12/3GPP TS 24.008.

Message type: IDENTITY REQUEST

Significance: dual

Direction: network to mobile station

**Table 9.2.12/3GPP TS 24.008: IDENTITY REQUEST message content**

IEI	Information element	Type/Reference	Presence	Format	Length
	Mobility management protocol discriminator	Protocol discriminator 10.2	M	V	1/2
	Skip Indicator	Skip Indicator 10.3.1	M	V	1/2
	Identity Request message type	Message type 10.4	M	V	1
	Identity type	Identity type 10.5.3.4	M	V	1/2
	Spare half octet	Spare half octet 10.5.1.8	M	V	1/2

## 9.2.11 Identity response

This message is sent by the mobile station to the network in response to an IDENTITY REQUEST message providing the requested identity. See table 9.2.13/3GPP TS 24.008.

Message type: IDENTITY RESPONSE

Significance: dual

Direction: mobile station to network

**Table 9.2.13/3GPP TS 24.008: IDENTITY RESPONSE message content**

IEI	Information element	Type/Reference	Presence	Format	Length
	Mobility management protocol discriminator	Protocol discriminator 10.2	M	V	1/2
	Skip Indicator	Skip Indicator 10.3.1	M	V	1/2
	Identity Response message type	Message type 10.4	M	V	1
	Mobile identity	Mobile identity 10.5.1.4	M	LV	2-10

## 9.2.12 IMSI detach indication

This message is sent by the mobile station to the network to set a deactivation indication in the network. See table 9.2.14/3GPP TS 24.008.

Message type: IMSI DETACH INDICATION

Significance: dual

Direction: mobile station to network

**Table 9.2.14/3GPP TS 24.008: IMSI DETACH INDICATION message content**

IEI	Information element	Type/Reference	Presence	Format	Length
	Mobility management protocol discriminator	Protocol discriminator 10.2	M	V	1/2
	Skip Indicator	Skip Indicator 10.3.1	M	V	1/2
	IMSI Detach Indication message type	Message type 10.4	M	V	1
	Mobile station classmark	Mobile station classmark 1 10.5.1.5	M	V	1
	Mobile identity	Mobile identity 10.5.1.4	M	LV	2-9

### 9.2.12.1 Mobile Station Classmark

This IE shall include for multiband mobile station the Classmark 1 corresponding to the frequency band in use.

### 9.2.13 Location updating accept

This message is sent by the network to the mobile station to indicate that updating or IMSI attach in the network has been completed. See table 9.2.15/3GPP TS 24.008.

Message type: LOCATION UPDATING ACCEPT

Significance: dual

Direction: network to mobile station

**Table 9.2.15/3GPP TS 24.008: LOCATION UPDATING ACCEPT message content**

IEI	Information element	Type/Reference	Presence	Format	Length
	Mobility management protocol discriminator	Protocol discriminator 10.2	M	V	1/2
	Skip Indicator	Skip Indicator 10.3.1	M	V	1/2
	Location Updating Accept message type	Message type 10.4	M	V	1
	Location area identification	Location area identification 10.5.1.3	M	V	5
17	Mobile identity	Mobile identity 10.5.1.4	O	TLV	3-10
A1	Follow on proceed	Follow on proceed 10.5.3.7	O	T	1
A2	CTS permission	CTS permission 10.5.3.10	O	T	1
4A	Equivalent PLMNs	PLMN list 10.5.1.13	O	TLV	5-47
34	Emergency Number List	Emergency Number List 10.5.3.13	O	TLV	5-50

### 9.2.13.1 Follow on proceed

The *follow on proceed* information element appears if the network wishes to indicate that the mobile station may attempt an MM connection establishment using the same RR connection.

### 9.2.13.2 CTS permission

The *CTS permission* information element appears if the network wishes to allow the mobile station to use GSM-Cordless Telephony System in the Location Area.

### 9.2.13.3 Equivalent PLMNs

The *Equivalent PLMNs* information element is included if the network wants to inform the mobile station of equivalent PLMNs.

### 9.2.13.4 Emergency Number List

This IE may be sent by the network. If this IE is sent, the contents of this IE indicates a list of emergency numbers valid within the same MCC as in the cell on which this IE is received.

## 9.2.14 Location updating reject

This message is sent by the network to the mobile station to indicate that updating or IMSI attach has failed. See table 9.2.16/3GPP TS 24.008.

Message type: LOCATION UPDATING REJECT

Significance: dual

Direction: network to mobile station

**Table 9.2.16/3GPP TS 24.008: LOCATION UPDATING REJECT message content**

IEI	Information element	Type/Reference	Presence	Format	Length
	Mobility management protocol discriminator	Protocol discriminator 10.2	M	V	1/2
	Skip Indicator	Skip Indicator 10.3.1	M	V	1/2
	Location Updating Reject message type	Message type 10.4	M	V	1
	Reject cause	Reject cause 10.5.3.6	M	V	1

## 9.2.15 Location updating request

This message is sent by the mobile station to the network either to request update of its location file (normal updating or periodic updating) or to request IMSI attach. See table 9.2.17/3GPP TS 24.008.

Message type: LOCATION UPDATING REQUEST

Significance: dual

Direction: mobile station to network

**Table 9.2.17/3GPP TS 24.008: LOCATION UPDATING REQUEST message content**

IEI	Information element	Type/Reference	Presence	Format	Length
	Mobility management protocol discriminator	Protocol discriminator 10.2	M	V	1/2
	Skip Indicator	Skip Indicator 10.3.1	M	V	1/2
	Location Updating Request message type	Message type 10.4	M	V	1
	Location updating type	Location updating type 10.5.3.5	M	V	1/2
	Ciphering key sequence number	Ciphering key sequence number 10.5.1.2	M	V	1/2
	Location area identification	Location area identification 10.5.1.3	M	V	5
	Mobile station classmark	Mobile station classmark 1 10.5.1.5	M	V	1
	Mobile identity	Mobile identity 10.5.1.4	M	LV	2-9
33	Mobile station classmark for UMTS	Mobile station classmark 2 10.5.1.6	O	TLV	5

### 9.2.15.1 Location area identification

The location area identification stored in the SIM/USIM is used.

### 9.2.15.2 Mobile Station Classmark

This IE shall include for multiband MS the Classmark 1 corresponding to the frequency band in use.

### 9.2.15.3 Mobile Station Classmark for Iu mode

This IE shall be included when the mobile station is in Iu mode network. The IE shall not be included when the mobile station is in A/Gb mode network.

### 9.2.15a MM information

This message is sent by the network to the mobile station to provide the mobile station with subscriber specific information. See table 9.2.18/3GPP TS 24.008.

Message type: MM INFORMATION

Significance: dual

Direction: network to mobile station

**Table 9.2.18/3GPP TS 24.008 MM INFORMATION message content**

IEI	Information element	Type/Reference	Presence	Format	Length
	Mobility management protocol discriminator	Protocol discriminator 10.2	M	V	1/2
	Skip Indicator	Skip Indicator 10.3.1	M	V	1/2
	MM Information message type	Message type 10.4	M	V	1
43	Full name for network	Network Name 10.5.3.5a	O	TLV	3-?
45	Short name for network	Network Name 10.5.3.5a	O	TLV	3-?
46	Local time zone	Time Zone 10.5.3.8	O	TV	2
47	Universal time and local time zone	Time Zone and Time  10.5.3.9	O	TV	8
48	LSA Identity	LSA Identifier 10.5.3.11	O	TLV	2-5
49	Network Daylight Saving Time	Daylight Saving Time 10.5.3.12	O	TLV	3

#### 9.2.15a.1 Full name for network

This IE may be sent by the network. If this IE is sent, the contents of this IE indicate the "full length name of the network" that the network wishes the mobile station to associate with the MCC and MNC contained in the Location Area Identification of the cell to which the mobile station sent its Channel Request message.

#### 9.2.15a.2 Short name for network

This IE may be sent by the network. If this IE is sent, the contents of this IE indicate the "abbreviated name of the network" that the network wishes the mobile station to associate with the MCC and MNC contained in the Location Area Identification of the cell to which the mobile station sent its Channel Request message.

#### 9.2.15a.3 Local time zone

This IE may be sent by the network. The mobile station should assume that this time zone applies to the Location Area of the cell to which the Channel Request message was sent.

If the local time zone has been adjusted for Daylight Saving Time, the network shall indicate this by including the IE Network Daylight Saving Time.

#### 9.2.15a.4 Universal time and local time zone

This IE may be sent by the network. The mobile station should assume that this time zone applies to the Location Area of the cell to which the Channel Request message was sent. The mobile station shall not assume that the time information is accurate.

If the local time zone has been adjusted for Daylight Saving Time, the network shall indicate this by including the IE Network Daylight Saving Time.

#### 9.2.15a.5 LSA Identity

This IE may be sent by the network. The contents of this IE indicate the LSA identity of the serving cell.

### 9.2.15a.6 Network Daylight Saving Time

This IE may be sent by the network. If this IE is sent, the contents of this IE indicates the value that has been used to adjust the local time zone.

### 9.2.16 MM Status

This message is sent by the mobile station or the network at any time to report certain error conditions listed in clause 8. See table 9.2.19/3GPP TS 24.008.

Message type: MM STATUS

Significance: local

Direction: both

**Table 9.2.19/3GPP TS 24.008: MM STATUS message content**

IEI	Information element	Type/Reference	Presence	Format	Length
	Mobility management protocol discriminator	Protocol discriminator 10.2	M	V	1/2
	Skip Indicator	Skip Indicator 10.3.1	M	V	1/2
	MM Status message type	Message type 10.4	M	V	1
	Reject cause	Reject cause 10.5.3.6	M	V	1

### 9.2.17 TMSI reallocation command

This message is sent by the network to the mobile station to reallocate or delete a TMSI. See table 9.2.20/3GPP TS 24.008.

Message type: TMSI REALLOCATION COMMAND

Significance: dual

Direction: network to mobile station

**Table 9.2.20/3GPP TS 24.008: TMSI REALLOCATION COMMAND message content**

IEI	Information element	Type/Reference	Presence	Format	Length
	Mobility management protocol discriminator	Protocol discriminator 10.2	M	V	1/2
	Skip Indicator	Skip Indicator 10.3.1	M	V	1/2
	TMSI Reallocation Command message type	Message type 10.4	M	V	1
	Location area identification	Location area identification 10.5.1.3	M	V	5
	Mobile identity	Mobile identity 10.5.1.4	M	LV	2-9



## 9.2.18 TMSI reallocation complete

This message is sent by the mobile station to the network to indicate that reallocation or deletion of a TMSI has taken place. See table 9.2.21/3GPP TS 24.008.

Message type: TMSI REALLOCATION COMPLETE

Significance: dual

Direction: mobile station to network

**Table 9.2.21/3GPP TS 24.008: TMSI REALLOCATION COMPLETE message content**

IEI	Information element	Type/Reference	Presence	Format	Length
	Mobility management protocol discriminator	Protocol discriminator 10.2	M	V	1/2
	Skip Indicator	Skip Indicator 10.3.1	M	V	1/2
	TMSI Reallocation Complete message type	Message type 10.4	M	V	1

## 9.2.19 MM Null

This message is sent in mobile to network direction.

This message is not used on the radio interface. When received by the network it shall be ignored.

The introduction of this message solves interworking issues.

Message type: MM NULL

**Table 9.2.22/3GPP TS 24.008 MM NULL message content**

IEI	Information element	Type/Reference	Presence	Format	Length
	Mobility management protocol discriminator	Protocol discriminator 10.2	M	V	1/2
	Skip Indicator	Skip Indicator 10.3.1	M	V	1/2
	MM Null message type	Message type 10.4	M	V	1

## 9.3 Messages for circuit-switched call control

Table 9.54/3GPP TS 24.008 summarizes the messages for circuit-switched call control.

**Table 9.54/3GPP TS 24.008: Messages for circuit-mode connections call control.**

<b>Call establishment messages:</b>	<b>Reference</b>
ALERTING	9.3.1
CALL CONFIRMED 1)	9.3.2
CALL PROCEEDING	9.3.3
CONNECT	9.3.5
CONNECT ACKNOWLEDGE	9.3.6
EMERGENCY SETUP 1)	9.3.8
PROGRESS	9.3.17
CC-ESTABLISHMENT	9.3.17a
CC-ESTABLISHMENT CONFIRMED	9.3.17b
START CC	9.3.23a
SETUP	9.3.23
<b>Call information phase messages:</b>	<b>Reference</b>
MODIFY 1)	9.3.13
MODIFY COMPLETE 1)	9.3.14
MODIFY REJECT 1)	9.3.15
USER INFORMATION	9.3.31
<b>Call clearing messages:</b>	<b>Reference</b>
DISCONNECT	9.3.7
RELEASE	9.3.18
RECALL	9.3.18a
RELEASE COMPLETE	9.3.19
<b>Messages for supplementary service control</b>	<b>Reference</b>
FACILITY	9.3.9
HOLD 1)	9.3.10
HOLD ACKNOWLEDGE 1)	9.3.11
HOLD REJECT 1)	9.3.12
RETRIEVE 1)	9.3.20
RETRIEVE ACKNOWLEDGE 1)	9.3.21
RETRIEVE REJECT 1)	9.3.22
<b>Miscellaneous messages</b>	<b>Reference</b>
CONGESTION CONTROL	9.3.4
NOTIFY	9.3.16
START DTMF 1)	9.3.24
START DTMF ACKNOWLEDGE 1)	9.3.25
START DTMF REJECT 1)	9.3.26
STATUS	9.3.27
STATUS ENQUIRY	9.3.28
STOP DTMF 1)	9.3.29
STOP DTMF ACKNOWLEDGE 1)	9.3.30

NOTE: Not supported by Blue Book ITU-T Rec. Q.931.

### 9.3.1 Alerting

#### 9.3.1.1 Alerting (network to mobile station direction)

This message is sent by the network to the calling mobile station to indicate that the called user alerting has been initiated.

See table 9.55/3GPP TS 24.008.

Message type: ALERTING

Significance: global

Direction: network to mobile station

**Table 9.55/3GPP TS 24.008: ALERTING message content (network to mobile station direction)**

IEI	Information element	Type/Reference	Presence	Format	Length
	Call control protocol discriminator	Protocol discriminator 10.2	M	V	1/2
	Transaction identifier	Transaction identifier 10.3.2	M	V	1/2
	Alerting message type	Message type 10.4	M	V	1
1C	Facility	Facility 10.5.4.15	O	TLV	2-?
1E	Progress indicator	Progress indicator 10.5.4.21	O	TLV	4
7E	User-user	User-user 10.5.4.25	O	TLV	3-131

#### 9.3.1.1.1 Facility

This information element may be used for functional operation of supplementary services.

#### 9.3.1.1.2 Progress indicator

This information element may be included by the network:

- in order to pass information about the call in progress, e.g., in the event of interworking; and/or
- to make the mobile station attach the user connection for speech.

#### 9.3.1.1.3 User-user

This information element may be included by the network if the called remote user included a *user-user* information element in the ALERTING message.

### 9.3.1.2 Alerting (mobile station to network direction)

This message is sent by the called mobile station to the network, to indicate that the called user alerting has been initiated.

See table 9.55a/3GPP TS 24.008.

Message type: ALERTING

Significance: global

Direction: mobile station to network

**Table 9.55a/3GPP TS 24.008: ALERTING message content (mobile station to network direction)**

IEI	Information element	Type/Reference	Presence	Format	Length
	Call control protocol discriminator	Protocol discriminator 10.2	M	V	1/2
	Transaction identifier	Transaction identifier 10.3.2	M	V	1/2
	Alerting message type	Message type 10.4	M	V	1
1C	Facility	Facility 10.5.4.15	O	TLV	2-?
7E	User-user	User-user 10.5.4.25	O	TLV	3-131
7F	SS version	SS version indicator 10.5.4.24	O	TLV	2-3

#### 9.3.1.2.1 Facility

This information element may be used for functional operation of supplementary services.

#### 9.3.1.2.2 User-user

This information element may be included when the called mobile station wants to return information to the calling remote user.

#### 9.3.1.2.3 SS version

This information element shall not be included if the *facility* information element is not present in this message.

This information element shall be included or excluded as defined in 3GPP TS 24.010. This information element should not be transmitted unless explicitly required by 3GPP TS 24.010.

### 9.3.2 Call confirmed

This message is sent by the called mobile station to confirm an incoming call request.

See table 9.56/3GPP TS 24.008.

Message type: CALL CONFIRMED

Significance: local

Direction: mobile station to network

Table 9.56/3GPP TS 24.008: CALL CONFIRMED message content

IEI	Information element	Type/Reference	Presence	Format	Length
	Call control protocol discriminator	Protocol discriminator 10.2	M	V	1/2
	Transaction identifier	Transaction identifier 10.3.2	M	V	1/2
	Call confirmed message type	Message type 10.4	M	V	1
D-	Repeat Indicator	Repeat Indicator 10.5.4.22	C	TV	1
04	Bearer capability 1	Bearer capability 10.5.4.5	O	TLV	3-16
04	Bearer capability 2	Bearer capability 10.5.4.5	O	TLV	3-16
08	Cause	Cause 10.5.4.11	O	TLV	4-32
15	CC Capabilities	Call Control Capabilities 10.5.4.5a	O	TLV	4
2D	Stream Identifier	Stream Identifier 10.5.4.28	O	TLV	3
40	Supported Codecs	Supported Codec List 10.5.4.32	O	TLV	5-n

### 9.3.2.1 Repeat indicator

The *repeat indicator* information element shall be included if *bearer capability 1* information element and *bearer capability 2* IE are both included in the message.

### 9.3.2.2 Bearer capability 1 and bearer capability 2

The *bearer capability 1* information element shall be included if and only if at least one of the following six cases holds:

- the mobile station wishes another bearer capability than that given by the *bearer capability 1* information element of the incoming SETUP message;
- the *bearer capability 1* information element is missing or not fully specified in the SETUP message;
- the *bearer capability 1* information element received in the SETUP message is accepted and the "radio channel requirement" of the mobile station is other than "full rate support only mobile station";
- the *bearer capability 1* information element received in the SETUP message indicates speech and is accepted and the mobile station supports CTM text telephony;
- the *bearer capability 1* information element received in the SETUP message indicates speech and is accepted and the mobile station supports other codecs for GERAN than GSM speech version 1;
- the *bearer capability 1* information element received in the SETUP message included the "fixed network user rate" parameter.

When the *bearer capability 1* information element is followed by the *bearer capability 2* IE in the SETUP, the above rules apply to both *bearer capability 1* IE and *bearer capability 2* IE. Except those cases identified in 3GPP TS 27.001, if either *bearer capability* needs to be included, both shall be included.

Furthermore, both *bearer capability* information elements may be present if the mobile station wishes to reverse the order of occurrence of the *bearer capability* information elements (which is referred to in the *repeat indicator* information element, see subclause 10.5.4.22) in cases identified in 3GPP TS 27.001 [36].

If the mobile station wishes to indicate capability for an alternative call mode, which can be entered during the call through in-call modification, this is indicated by adding a *bearer capability information element* (*bearer capability 2* information element, see subclause 5.3.6).

### 9.3.2.3 Cause

This information element is included if the mobile station is compatible but the user is busy.

### 9.3.2.4 CC Capabilities

This information element may be included by the mobile station to indicate its call control capabilities.

### 9.3.2.5 Stream Identifier

This information element shall be included by the mobile station supporting multicall.

### 9.3.2.6 Supported Codecs

This information element shall be included for speech calls, if the mobile station supports UMTS radio access.

## 9.3.3 Call proceeding

This message is sent by the network to the calling mobile station to indicate that the requested call establishment information has been received, and no more call establishment information will be accepted.

See table 9.57/3GPP TS 24.008.

Message type: CALL PROCEEDING

Significance: local

Direction: network to mobile station

**Table 9.57/3GPP TS 24.008: CALL PROCEEDING message content**

IEI	Information element	Type/Reference	Presence	Format	Length
	Call control protocol discriminator	Protocol discriminator 10.2	M	V	1/2
	Transaction identifier	Transaction identifier 10.3.2	M	V	1/2
	Call proceeding message type	Message type 10.4	M	V	1
D-	Repeat Indicator	Repeat Indicator 10.5.4.22	C	TV	1
04	Bearer capability 1	Bearer capability 10.5.4.5	O	TLV	3-16
04	Bearer capability 2	Bearer capability 10.5.4.5	O	TLV	3-16
1C	Facility	Facility 10.5.4.15	O	TLV	2-?
1E	Progress indicator	Progress indicator 10.5.4.21	O	TLV	4
8-	Priority granted	Priority Level 10.5.1.11	O	TV	1
2F	Network Call Control Capabilities	Network Call Control cap. 10.5.4.29	O	TLV	3

### 9.3.3.1 Repeat indicator

This information element is included if and only if *bearer capability 1 IE* and *bearer capability 2 IE* are both contained in the message.

### 9.3.3.2 Bearer capability 1 and bearer capability 2

The *bearer capability 1* information element shall be included if the network has to specify at least one of the negotiable parameters described in 3GPP TS 27.001, or if the *bearer capability 1* information element received in the SETUP message included the "fixed network user rate" parameter.

When the *bearer capability 1* information element is followed by the *bearer capability 2* IE in the SETUP, the above rule applies to both *bearer capability 1* IE and *bearer capability 2* IE. Except those cases identified in 3GPP TS 27.001 [36], if either *bearer capability* needs to be included, both shall be included.

### 9.3.3.3 Facility

This information element may be used for functional operation of supplementary services.

### 9.3.3.4 Progress Indicator

This information element may be included:

- in order to pass information about the call in progress e.g. in the event of interworking; and/or
- to make the MS attach the user connection for speech.

### 9.3.3.5 Priority granted

The priority field is provided by the network in the case that eMLPP is supported.

### 9.3.3.6 Network Call Control Capabilities

This information shall be included by the network to indicate its call control capabilities if the network supports multicall and there are no other ongoing calls to the MS.

## 9.3.4 Congestion control

This message is sent by the network to indicate the establishment or termination of flow control on the transmission of USER INFORMATION messages.

See table 9.58/3GPP TS 24.008.

Message type: CONGESTION CONTROL

Significance: local (note)

Direction: network to mobile station

**Table 9.58/3GPP TS 24.008: CONGESTION CONTROL message content**

IEI	Information element	Type/Reference	Presence	Format	Length
	Call control protocol discriminator	Protocol discriminator 10.2	M	V	1/2
	Transaction identifier	Transaction identifier 10.3.2	M	V	1/2
	Congestion control message type	Message type 10.4	M	V	1
	Congestion level	Congestion level 10.5.4.12	M	V	1/2
	Spare half octet	Spare half octet 10.5.1.8	M	V	1/2
08	Cause	Cause 10.5.4.11	O	TLV	4-32

NOTE: This message has local significance, but may carry information of global significance.

### 9.3.4.1 Cause

This information element is included if the user to user information has been discarded as a result of the congestion situation.

## 9.3.5 Connect

### 9.3.5.1 Connect (network to mobile station direction)

This message is sent by the network to the calling mobile station to indicate call acceptance by the called user.

See table 9.59/3GPP TS 24.008.

Message type: CONNECT

Significance: global

Direction: network to mobile station

**Table 9.59/3GPP TS 24.008: CONNECT message content(network to mobile station direction)**

IEI	Information element	Type/Reference	Presence	Format	Length
	Call control protocol discriminator	Protocol discriminator 10.2	M	V	1/2
	Transaction identifier	Transaction identifier 10.3.2	M	V	1/2
	Connect message type	Message type 10.4	M	V	1
1C	Facility	Facility 10.5.4.15	O	TLV	2-?
1E	Progress indicator	Progress indicator 10.5.4.21	O	TLV	4
4C	Connected number	Connected number 10.5.4.13	O	TLV	3-14
4D	Connected subaddress	Connected subaddress 10.5.4.14	O	TLV	2-23
7E	User-user	User-user 10.5.4.25	O	TLV	3-131

#### 9.3.5.1.1 Facility

This information element may be used for functional operation of supplementary services.

#### 9.3.5.1.2 Progress indicator

This information element may be included by the network:

- in order to pass information about the call in progress e.g. in the event of interworking; and/or
- to make the MS attach the user connection for speech.

#### 9.3.5.1.3 User-user

This information element may be included by the network if the remote user awarded the call included a user- user information element in the CONNECT message.

### 9.3.5.2 Connect (mobile station to network direction)

This message is sent by the called mobile station to the network to indicate call acceptance by the called user.

See table 9.59a/3GPP TS 24.008.



Message type: CONNECT

Significance: global

Direction: mobile station to network

**Table 9.59a/3GPP TS 24.008: CONNECT message content (mobile station to network direction)**

IEI	Information element	Type/Reference	Presence	Format	Length
	Call control protocol discriminator	Protocol discriminator 10.2	M	V	1/2
	Transaction identifier	Transaction identifier 10.3.2	M	V	1/2
	Connect message type	Message type 10.4	M	V	1
1C	Facility	Facility 10.5.4.15	O	TLV	2-?
4D	Connected subaddress	Connected subaddress 10.5.4.14	O	TLV	2-23
7E	User-user	User-user 10.5.4.25	O	TLV	3-131
7F	SS version	SS version indicator 10.5.4.24	O	TLV	2-3
2D	Stream Identifier	Stream Identifier 10.5.4.28	O	TLV	3

#### 9.3.5.2.1 Facility

This information element may be used for functional operation of supplementary services.

#### 9.3.5.2.2 User-user

This information element is included when the answering mobile station wants to return user information to the calling remote user.

#### 9.3.5.2.3 SS version

This information element shall not be included if the *facility* information element is not present in this message.

This information element shall be included or excluded as defined in 3GPP TS 24.010. This information element should not be transmitted unless explicitly required by 3GPP TS 24.010.

#### 9.3.5.2.4 Stream Identifier

This information element shall be included by a mobile station that supports multicall when a mobile station has indicated "No Bearer" as the SI value in the CALL CONFIRMED message.

### 9.3.6 Connect acknowledge

This message is sent by the network to the called mobile station to indicate that the mobile station has been awarded the call. It shall also be sent by the calling mobile station to the network to acknowledge the offered connection.

See table 9.60/3GPP TS 24.008.

Message type: CONNECT ACKNOWLEDGE

Significance: local

Direction: both

**Table 9.60/3GPP TS 24.008: CONNECT ACKNOWLEDGE message content**

IEI	Information element	Type/Reference	Presence	Format	Length
	Call control protocol discriminator	Protocol discriminator 10.2	M	V	1/2
	Transaction identifier	Transaction identifier 10.3.2	M	V	1/2
	Connect acknowledge message type	Message type 10.4	M	V	1

## 9.3.7 Disconnect

### 9.3.7.1 Disconnect (network to mobile station direction)

This message is sent by the network to indicate that the end-to-end connection is cleared.

See table 9.61/3GPP TS 24.008.

Message type: DISCONNECT

Significance: global

Direction: network to mobile station

**Table 9.61/3GPP TS 24.008: DISCONNECT message content (network to mobile station direction)**

IEI	Information element	Type/Reference	Presence	Format	Length
	Call control protocol discriminator	Protocol discriminator 10.2	M	V	1/2
	Transaction identifier	Transaction identifier 10.3.2	M	V	1/2
	Disconnect message type	Message type 10.4	M	V	1
	Cause	Cause 10.5.4.11	M	LV	3-31
1C	Facility	Facility 10.5.4.15	O	TLV	2-?
1E	Progress indicator	Progress indicator 10.5.4.21	O	TLV	4
7E	User-user	User-user 10.5.4.25	O	TLV	3-131
7B	Allowed actions \$(CCBS)\$	Allowed actions 10.5.4.27	O	TLV	3

#### 9.3.7.1.1 Facility

This information element may be used for functional operation of supplementary services, such as the user-user service.

#### 9.3.7.1.2 Progress indicator

This information element is included by the network to make the MS attach the user connection for speech and react in a specific way during call clearing (see subclause 5.4.4).

#### 9.3.7.1.3 User-user

This information element may be included by the network when the remote user initiates call clearing and included a user-user information element in the DISCONNECT message.

#### 9.3.7.1.4 Allowed actions \$(CCBS)\$

This information element may be included by the network to inform the MS about further possible reactions.

### 9.3.7.2 Disconnect (mobile station to network direction)

This message is sent by the mobile station to request the network to clear an end-to-end connection.

See table 9.61a/3GPP TS 24.008.

Message type: DISCONNECT

Significance: global

Direction: mobile station to network

**Table 9.61a/3GPP TS 24.008: DISCONNECT message content (mobile station to network direction)**

IEI	Information element	Type/Reference	Presence	Format	Length
	Call control protocol discriminator	Protocol discriminator 10.2	M	V	1/2
	Transaction identifier	Transaction identifier 10.3.2	M	V	1/2
	Disconnect message type	Message type 10.4	M	V	1
	Cause	Cause 10.5.4.11	M	LV	3-31
1C	Facility	Facility 10.5.4.15	O	TLV	2-?
7E	User-user	User-user 10.5.4.25	O	TLV	3-131
7F	SS version	SS version indicator 10.5.4.24	O	TLV	2-3

#### 9.3.7.2.1 Facility

This information element may be used for functional operation of supplementary services, such as the user-user service.

#### 9.3.7.2.2 User-user

This information element is included when the mobile station initiates call clearing and wants to pass user information to the remote user at call clearing time.

#### 9.3.7.2.3 SS version

This information element shall not be included if the *facility* information element is not present in this message.

This information element shall be included or excluded as defined in 3GPP TS 24.010 [21]. This information element should not be transmitted unless explicitly required by 3GPP TS 24.010 [21].

## 9.3.8 Emergency setup

This message is sent from the mobile station to initiate emergency call establishment.

See table 9.62/3GPP TS 24.008.

Message type: EMERGENCY SETUP

Significance: global

Direction: mobile station to network

Table 9.62/3GPP TS 24.008: EMERGENCY SETUP message content

IEI	Information element	Type/Reference	Presence	Format	Length
	Call control protocol discriminator	Protocol discriminator 10.2	M	V	1/2
	Transaction identifier	Transaction identifier 10.3.2	M	V	1/2
	Emergency setup message type	Message type 10.4	M	V	1
04	Bearer capability	Bearer capability 10.5.4.5	O	TLV	3-11
2D	Stream Identifier	Stream Identifier 10.5.4.28	O	TLV	3
40	Supported Codecs	Supported Codec List 10.5.4.32	O	TLV	5-n
2E	Emergency category	Service category  10.5.4.33	O	TLV	3

### 9.3.8.1 Bearer capability

If the element is not included, the network shall by default assume speech and select the speech codec according to subclauses 5.2.1.2 and 5.2.1.11. If this information element is included, it shall indicate speech, the appropriate speech version(s) and have the appropriate value of radio channel requirement field.

This information element shall be included by an ME supporting CTM text telephony.

### 9.3.8.2 Stream Identifier

This information element shall be included by the mobile station supporting multicall.

### 9.3.8.3 Supported Codecs

This information element shall be included if the mobile station supports UMTS radio access.

### 9.3.8.4 Service category

If this information element is included, it shall indicate the selected emergency call category.

If the element is not included, the network shall by default assume a non-specific emergency call.

## 9.3.9 Facility

### 9.3.9.1 Facility (network to mobile station direction)

This message is sent by the network to the mobile station to request or acknowledge a supplementary service. The supplementary service to be invoked and its associated parameters are specified in the facility information element.

See table 9.62a/3GPP TS 24.008.

Message type: FACILITY

Significance: local (NOTE 1)

Direction: network to mobile station

**Table 9.62a/3GPP TS 24.008: FACILITY message content (network to mobile station direction)**

IEI	Information element	Type/Reference	Presence	Format	Length
	Call control protocol discriminator	Protocol discriminator 10.2	M	V	1/2
	Transaction identifier	Transaction identifier 10.3.2	M	V	1/2
	Facility message type	Message type 10.4	M	V	1
	Facility (note 2)	Facility 10.5.4.15	M	LV	1-?

NOTE 1: This message has local significance; however, it may carry information of global significance.

NOTE 2: The *facility* information element has no upper length limit except that given by the maximum number of octets in a L3 message, see 3GPP TS 44.006 [19].

### 9.3.9.2 Facility (mobile station to network direction)

This message is sent by the mobile station to the network to request or acknowledge a supplementary service. The supplementary service to be invoked and its associated parameters are specified in the facility information element.

See table 9.62b/3GPP TS 24.008.

Message type: FACILITY

Significance: local (note 1)

Direction: mobile station to network

**Table 9.62b/3GPP TS 24.008: FACILITY message content (mobile station to network direction)**

IEI	Information element	Type/Reference	Presence	Format	Length
	Call control protocol discriminator	Protocol discriminator 10.2	M	V	1/2
	Transaction identifier	Transaction identifier 10.3.2	M	V	1/2
	Facility message type	Message type 10.4	M	V	1
	Facility (note 2)	Facility 10.5.4.15	M	LV	1-?
7F	SS version	SS version indicator 10.5.4.24	O	TLV	2-3

NOTE 1: This message has local significance; however, it may carry information of global significance.

NOTE 2: The *facility* information element has no upper length limit except that given by the maximum number of octets in a L3 message, see 3GPP TS 44.006.

#### 9.3.9.2.1 SS version

This information element shall be included or excluded as defined in 3GPP TS 24.010 [21]. This information element should not be transmitted unless explicitly required by 3GPP TS 24.010 [21].

### 9.3.10 Hold

This message is sent by the mobile user to request the hold function for an existing call.

See table 9.62c/3GPP TS 24.008 for the content of the HOLD message.

For the use of this message, see 3GPP TS 24.010.

Message type: HOLD

Significance: local

Direction: mobile station to network

**Table 9.62c/3GPP TS 24.008: HOLD message content**

IEI	Information element	Type/Reference	Presence	Format	Length
	Call control protocol discriminator	Protocol discriminator 10.2	M	V	1/2
	Transaction identifier	Transaction identifier 10.3.2	M	V	1/2
	Hold message type	Message type 10.4	M	V	1

### 9.3.11 Hold Acknowledge

This message is sent by the network to indicate that the hold function has been successfully performed.

See table 9.62d/3GPP TS 24.008 for the content of the HOLD ACKNOWLEDGE message.

For the use of this message, see 3GPP TS 24.010.

Message type: HOLD ACKNOWLEDGE

Significance: local

Direction: network to mobile station

**Table 9.62d/3GPP TS 24.008: HOLD ACKNOWLEDGE message content**

IEI	Information element	Type/Reference	Presence	Format	Length
	Call control protocol discriminator	Protocol discriminator 10.2	M	V	1/2
	Transaction identifier	Transaction identifier 10.3.2	M	V	1/2
	Hold Acknowledge message type	Message type 10.4	M	V	1

### 9.3.12 Hold Reject

This message is sent by the network to indicate the denial of a request to hold a call.

See table 9.62e/3GPP TS 24.008 for the content of the HOLD REJECT message.

For the use of this message, see 3GPP TS 24.010.

Message type: HOLD REJECT

Significance: local

Direction: network to mobile station

**Table 9.62e/3GPP TS 24.008: HOLD REJECT message content**

IEI	Information element	Type/Reference	Presence	Format	Length
	Call control protocol discriminator	Protocol discriminator 10.2	M	V	1/2
	Transaction identifier	Transaction identifier 10.3.2	M	V	1/2
	Hold Reject message type	Message type 10.4	M	V	1
	Cause	10.5.4.11	M	LV	3-31

### 9.3.13 Modify

This message is sent by the mobile station to the network or by the network to the mobile station to request a change in bearer capability for a call.

See table 9.63/3GPP TS 24.008.

Message type: MODIFY

Significance: global

Direction: both

**Table 9.63/3GPP TS 24.008: MODIFY message content**

IEI	Information element	Type/Reference	Presence	Format	Length
	Call control protocol discriminator	Protocol discriminator 10.2	M	V	1/2
	Transaction identifier	Transaction identifier 10.3.2	M	V	1/2
	Modify message type	Message type 10.4	M	V	1
	Bearer capability	Bearer capability 10.5.4.5	M	LV	2-15
7C	Low layer comp.	Low layer comp. 10.5.4.18	O	TLV	2-18
7D	High layer comp.	High layer comp. 10.5.4.16	O	TLV	2-5
A3	Reverse call setup direction	Reverse call setup direction 10.5.4.22a	O	T	1
A4	Network-initiated Service Upgrade indicator	Network-initiated Service Upgrade indicator 10.5.4.3x	O	T	1

#### 9.3.13.1 Low layer compatibility

This information element shall be included if it was included in the initial SETUP message.

#### 9.3.13.2 High layer compatibility

This information element shall be included if it was included in the initial SETUP message.

#### 9.3.13.3 Reverse call setup direction

This information element is included or omitted in the mobile to network direction according to the rules defined in subclause 5.3.4.3.1.

### 9.3.13.4 Void

### 9.3.13.5 Network-initiated Service Upgrade indicator

This information element shall be included only if the MODIFY message was sent by the network to switch from speech to UDI/RDI multimedia due to a network-initiated service upgrade.

## 9.3.14 Modify complete

This message is sent by the mobile station to the network or by the network to the mobile station to indicate completion of a request to change bearer capability for a call.

See table 9.64/3GPP TS 24.008.

Message type: MODIFY COMPLETE

Significance: global

Direction: both

**Table 9.64/3GPP TS 24.008: MODIFY COMPLETE message content**

IEI	Information element	Type/Reference	Presence	Format	Length
	Call control protocol discriminator	Protocol discriminator 10.2	M	V	1/2
	Transaction identifier	Transaction identifier 10.3.2	M	V	1/2
	Modify complete message type	Message type 10.4	M	V	1
	Bearer capability	Bearer capability 10.5.4.5	M	LV	2-15
7C	Low layer comp.	Low layer comp. 10.5.4.18	O	TLV	2-18
7D	High layer comp.	High layer comp. 10.5.4.16	O	TLV	2-5
A3	Reverse call setup direction	Reverse call setup direction 10.5.4.22a	O	T	1

### 9.3.14.1 Low layer compatibility

This information element shall be included if it was included in the initial SETUP message.

### 9.3.14.2 High layer compatibility

This information element shall be included if it was included in the initial SETUP message.

### 9.3.14.3 Reverse call setup direction

This information element is included or omitted according to the rules defined in subclause 5.3.4.3.2.

## 9.3.15 Modify reject

This message is sent by the mobile station to the network or by the network to the mobile station to indicate failure of a request to change the bearer capability for a call.

See table 9.65/3GPP TS 24.008.

Message type: MODIFY REJECT

Significance: global



Direction: both

**Table 9.65/3GPP TS 24.008: MODIFY REJECT message content**

IEI	Information element	Type/Reference	Presence	Format	Length
	Call control protocol discriminator	Protocol discriminator 10.2	M	V	1/2
	Transaction identifier	Transaction identifier 10.3.2	M	V	1/2
	Modify reject message type	Message type 10.4	M	V	1
	Bearer capability	Bearer capability 10.5.4.5	M	LV	2-15
	Cause	Cause 10.5.4.11	M	LV	3-31
7C	Low layer comp.	Low layer comp. 10.5.4.18	O	TLV	2-18
7D	High layer comp.	High layer comp. 10.5.4.16	O	TLV	2-5

### 9.3.15.1 Low layer compatibility

This information element shall be included if it was included in the initial SETUP message.

### 9.3.15.2 High layer compatibility

This information element shall be included if it was included in the initial SETUP message.

## 9.3.16 Notify

This message is sent either from the mobile station or from the network to indicate information pertaining to a call, such as user suspended.

See table 9.66/3GPP TS 24.008.

Message type: NOTIFY

Significance: access

Direction: both

**Table 9.66/3GPP TS 24.008: NOTIFY message content**

IEI	Information element	Type/Reference	Presence	Format	Length
	Call control protocol discriminator	Protocol discriminator 10.2	M	V	1/2
	Transaction identifier	Transaction identifier 10.3.2	M	V	1/2
	Notify message type	Message type 10.4	M	V	1
	Notification indicator	Notification indicator 10.5.4.20	M	V	1

### 9.3.17 Progress

This message is sent from the network to the mobile station to indicate the progress of a call in the event of interworking or in connection with the provision of in-band information/patterns.

See table 9.67/3GPP TS 24.008.

Message type: PROGRESS

Significance: global

Direction: network to mobile station

**Table 9.67/3GPP TS 24.008: PROGRESS message content**

IEI	Information element	Type/Reference	Presence	Format	Length
	Call control protocol discriminator	Protocol discriminator 10.2	M	V	1/2
	Transaction identifier	Transaction identifier 10.3.2	M	V	1/2
	Progress message type	Message type 10.4	M	V	1
	Progress indicator	Progress indicator 10.5.4.21	M	LV	3
7E	User-user	User-user 10.5.4.25	O	TLV	3-131

### 9.3.17.1 User-user

This information element is included when the PROGRESS message is sent by the network when the call has been cleared by the remote user before it reached the active state to indicate that the remote user wants to pass user information at call clearing time.

### 9.3.17a CC-Establishment \$(CCBS)\$

A mobile station that does not support the "Network initiated MO call" option shall treat this message as a message with message type not defined for the PD.

This message is sent from the network to the mobile station to provide information on the call that the mobile station should attempt to establish.

See Table 9.67a/3GPP TS 24.008.

Message type: CC-ESTABLISHMENT

Significance: local

Direction: network to mobile station

**Table 9.67a/3GPP TS 24.008: CC-Establishment message content**

IEI	Information element	Type/Reference	Presence	Format	Length
	Call control protocol discriminator	Protocol discriminator 10.2	M	V	1/2
	Transaction identifier	Transaction identifier 10.3.2	M	V	1/2
	CC-Establishment message type	Message type 10.4	M	V	1
	Setup container	Container 10.5.4.22a	M	LV	3-n

\* From the 4th IE onwards the message is coded in the same way as the SETUP message in MS to network direction from the 4th IE onwards.

### 9.3.17a.1 Void

### 9.3.17a.2 Setup container

This information element contains the contents of a SETUP message (Mobile Station to Network).

## 9.3.17b CC-Establishment confirmed \$(CCBS)\$

A Network that does not support the "Network initiated MO call" option shall treat this message as a message with message type not defined for the PD.

This message is sent by the mobile station to the network to indicate the requested channel characteristics for the call which may be initiated by the mobile station.

See Table 9.67b/3GPP TS 24.008.

Message type: CC-ESTABLISHMENT CONFIRMED

Significance: local

Direction: mobile station to network

**Table 9.67b/3GPP TS 24.008: CC-ESTABLISHMENT CONFIRMED message content**

IEI	Information element	Type/Reference	Presence	Format	Length
	Call control protocol discriminator	Protocol discriminator 10.2	M	V	1/2
	Transaction identifier	Transaction identifier 10.3.2	M	V	1/2
	CC-Establishment confirmed message type	Message type 10.4	M	V	1
D-	Repeat Indicator	Repeat Indicator 10.5.4.22	C	TV	1
04	Bearer capability 1	Bearer capability 10.5.4.5	M	TLV	3-10
04	Bearer capability 2	Bearer capability 10.5.4.5	O	TLV	3-10
08	Cause	Cause 10.5.4.11	O	TLV	4-32
40	Supported Codecs	Supported Codec List 10.5.4.32	O	TLV	5-n

### 9.3.17b.1 Repeat indicator

The *repeat indicator* information element shall be included if *bearer capability 1* information element and *bearer capability 2* IE are both included in the message.

### 9.3.17b.2 Bearer capability 1 and bearer capability 2

If, in any subsequent SETUP message to be sent on this transaction the *bearer capability 1* information element is to be followed by the *bearer capability 2* IE, then the *bearer capability 2* IE shall be included in this message.

### 9.3.17b.3 Cause

This information element is included if the mobile station is compatible but the user is busy.

### 9.3.17b.4 Supported Codecs

This information element shall be included for speech calls, if the mobile station supports UMTS radio access.

## 9.3.18 Release

### 9.3.18.1 Release (network to mobile station direction)

This message is sent, from the network to the mobile station to indicate that the network intends to release the transaction identifier, and that the receiving equipment shall release the transaction identifier after sending RELEASE COMPLETE.

See table 9.68/3GPP TS 24.008.

Message type: RELEASE

Significance: local (note)

Direction: network to mobile station

**Table 9.68/3GPP TS 24.008: RELEASE message content (network to mobile station direction)**

IEI	Information element	Type/Reference	Presence	Format	Length
	Call control protocol discriminator	Protocol discriminator 10.2	M	V	1/2
	Transaction identifier	Transaction identifier 10.3.2	M	V	1/2
	Release message type	Message type 10.4	M	V	1
08	Cause	Cause 10.5.4.11	O	TLV	4-32
08	Second cause	Cause 10.5.4.11	O	TLV	4-32
1C	Facility	Facility 10.5.4.15	O	TLV	2-?
7E	User-user	User-user 10.5.4.25	O	TLV	3-131

NOTE: This message has local significance; however, it may carry information of global significance when used as the first call clearing message.

#### 9.3.18.1.1 Cause

This information element shall be included if this message is used to initiate call clearing.

#### 9.3.18.1.2 Second cause

This information element may be included under the conditions described in subclause 5.4.4.1.2.3 "Abnormal cases" (Clearing initiated by the network).

#### 9.3.18.1.3 Facility

This information element may be included for functional operation of supplementary services.

#### 9.3.18.1.4 User-user

This information element may be included in the network to mobile station direction, when the RELEASE message is used to initiate call clearing, in order to transport user-user information from the remote user.

### 9.3.18.2 Release (mobile station to network direction)

This message is sent from the mobile station to the network to indicate that the mobile station intends to release the transaction identifier, and that the receiving equipment shall release the transaction identifier after sending RELEASE COMPLETE.

See table 9.68a/3GPP TS 24.008.

Message type: RELEASE

Significance: local (note)

Direction: mobile station to network direction

**Table 9.68a/3GPP TS 24.008: RELEASE message content (mobile station to network direction)**

IEI	Information element	Type/Reference	Presence	Format	Length
	Call control protocol discriminator	Protocol discriminator 10.2	M	V	1/2
	Transaction identifier	Transaction identifier 10.3.2	M	V	1/2
	Release message type	Message type 10.4	M	V	1
08	Cause	Cause 10.5.4.11	O	TLV	4-32
08	Second cause	Cause 10.5.4.11	O	TLV	4-32
1C	Facility	Facility 10.5.4.15	O	TLV	2-?
7E	User-user	User-user 10.5.4.25	O	TLV	3-131
7F	SS version	SS version indicator 10.5.4.24	O	TLV	2-3

NOTE: This message has local significance; however, it may carry information of global significance when used as the first call clearing message.

#### 9.3.18.2.1 Cause

This information element shall be included if this message is used to initiate call clearing.

#### 9.3.18.2.2 Second cause

This information element may be included under the conditions described in subclause 5.4.3.5 "Abnormal cases" (Clearing initiated by the mobile station).

#### 9.3.18.2.3 Facility

This information element may be included for functional operation of supplementary services.

#### 9.3.18.2.4 User-user

This information element is included when the RELEASE message is used to initiate call clearing and the mobile station wants to pass user information to the remote user at call clearing time.

#### 9.3.18.2.5 SS version

This information element shall not be included if the *facility* information element is not present in this message.

This information element shall be included or excluded as defined in 3GPP TS 24.010 [21]. This information element should not be transmitted unless explicitly required by 3GPP TS 24.010.

### 9.3.18a Recall \$(CCBS)\$

A mobile station that does not support the "Network initiated MO call" option shall treat this message as a message with message type not defined for the PD.

This message is sent from the network to the mobile station to initiate the sending of the SETUP message. In addition it provides information for user notification.

See Table 9.68b/3GPP TS 24.008.

Message type: RECALL  
 Significance: local  
 Direction: network to mobile station

**Table 9.68b/3GPP TS 24.008: Recall message content**

IEI	Information element	Type/Reference	Presence	Format	Length
	Call control protocol discriminator	Protocol discriminator 10.2	M	V	1/2
	Transaction identifier	Transaction identifier 10.3.2	M	V	1/2
	Recall message type	Message type 10.4	M	V	1
	Recall Type	Recall Type 10.5.4.21a	M	V	1
	Facility	Facility 10.5.4.15	M	LV	2-n

### 9.3.18a.1 Recall Type

The purpose of the recall type information element is to describe the reason for the recall.

### 9.3.18a.2 Facility

The information element shall be included for functional operation of supplementary services.

## 9.3.19 Release complete

### 9.3.19.1 Release complete (network to mobile station direction)

This message is sent from the network to the mobile station to indicate that the network has released the transaction identifier and that the mobile station shall release the transaction identifier.

See table 9.69/3GPP TS 24.008.

Message type: RELEASE COMPLETE  
 Significance: local (note)  
 Direction: network to mobile station direction

**Table 9.69/3GPP TS 24.008: RELEASE COMPLETE message content (network to mobile station direction)**

IEI	Information element	Type/Reference	Presence	Format	Length
	Call control protocol discriminator	Protocol discriminator 10.2	M	V	1/2
	Transaction identifier	Transaction identifier 10.3.2	M	V	1/2
	Release complete message type	Message type 10.4	M	V	1
08	Cause	Cause 10.5.4.11	O	TLV	4-32
1C	Facility	Facility 10.5.4.15	O	TLV	2-?
7E	User-user	User-user 10.5.4.25	O	TLV	3-131

NOTE: This message has local significance; however, it may carry information of global significance when used as the first call clearing message.

#### 9.3.19.1.1 Cause

This information element shall be included if the message is used to initiate call clearing.

#### 9.3.19.1.2 Facility

This information element may be included for functional operation of supplementary services.

#### 9.3.19.1.3 User-user

This information element is included in the network to mobile station direction, when the RELEASE COMPLETE message is used to initiate call clearing, in order to transport user-user information from the remote user.

### 9.3.19.2 Release complete (mobile station to network direction)

This message is sent from the mobile station to the network to indicate that the mobile station has released the transaction identifier and that the network shall release the transaction identifier.

See table 9.69a/3GPP TS 24.008.

Message type: RELEASE COMPLETE

Significance: local (note)

Direction: mobile station to network direction

**Table 9.69a/3GPP TS 24.008: RELEASE COMPLETE message content (mobile station to network direction)**

IEI	Information element	Type/Reference	Presence	Format	Length
	Call control protocol discriminator	Protocol discriminator 10.2	M	V	1/2
	Transaction identifier	Transaction identifier 10.3.2	M	V	1/2
	Release complete message type	Message type 10.4	M	V	1
08	Cause	Cause 10.5.4.11	O	TLV	4-32
1C	Facility	Facility 10.5.4.15	O	TLV	2-?
7E	User-user	User-user 10.5.4.25	O	TLV	3-131
7F	SS version	SS version indicator 10.5.4.24	O	TLV	2-3

NOTE: This message has local significance; however, it may carry information of global significance when used as the first call clearing message.

#### 9.3.19.2.1 Cause

This information element shall be included if the message is used to initiate call clearing.

#### 9.3.19.2.2 Facility

This information element may be included for functional operation of supplementary services.

#### 9.3.19.2.3 User-user

This information element is included in the mobile station to network direction when the RELEASE COMPLETE message is used to initiate call clearing and the mobile station wants to pass user information to the remote user at call clearing time.

#### 9.3.19.2.4 SS version.

This information element shall not be included if the *facility* information element is not present in this message.

This information element shall be included or excluded as defined in 3GPP TS 24.010 [21]. This information element should not be transmitted unless explicitly required by 3GPP TS 24.010.

### 9.3.20 Retrieve

This message is sent by the mobile user to request the retrieval of a held call.

See table 9.69b/3GPP TS 24.008 for the content of the RETRIEVE message.

For the use of this message, see 3GPP TS 24.010 [21].



Message type: RETRIEVE

Significance: local

Direction: mobile station to network

**Table 9.69b/3GPP TS 24.008: RETRIEVE message content**

IEI	Information element	Type/Reference	Presence	Format	Length
	Call control protocol discriminator	Protocol discriminator 10.2	M	V	1/2
	Transaction identifier	Transaction identifier 10.3.2	M	V	1/2
	Retrieve message type	Message type 10.4	M	V	1

### 9.3.21 Retrieve Acknowledge

This message is sent by the network to indicate that the retrieve function has been successfully performed.

See table 9.69c/3GPP TS 24.008 for the content of the RETRIEVE ACKNOWLEDGE message.

For the use of this message, see 3GPP TS 24.010.

Message type: RETRIEVE ACKNOWLEDGE

Significance: local

Direction: network to mobile station

**Table 9.69c/3GPP TS 24.008: RETRIEVE ACKNOWLEDGE message content**

IEI	Information element	Type/Reference	Presence	Format	Length
	Call control protocol discriminator	Protocol discriminator 10.2	M	V	1/2
	Transaction identifier	Transaction identifier 10.3.2	M	V	1/2
	Retrieve Acknowledge message type	Message type 10.4	M	V	1

### 9.3.22 Retrieve Reject

This message is sent by the network to indicate the inability to perform the requested retrieve function.

See table 9.69d/3GPP TS 24.008 for the content of the RETRIEVE REJECT message.

For the use of this message, see 3GPP TS 24.010.

Message type: RETRIEVE REJECT

Significance: local

Direction: network to mobile station

**Table 9.69d/3GPP TS 24.008: RETRIEVE REJECT message content**

<b>IEI</b>	<b>Information element</b>	<b>Type/Reference</b>	<b>Presence</b>	<b>Format</b>	<b>Length</b>
	Call control Protocol discriminator	Protocol discriminator 10.2	M	V	1/2
	Transaction identifier	Transaction identifier 10.3.2	M	V	1/2
	Retrieve Reject Message type	Message type 10.4	M	V	1
	Cause	10.5.4.11	M	LV	3-31

## 9.3.23 Setup

### 9.3.23.1 Setup (mobile terminated call establishment)

This message is sent by the network to the mobile station to initiate a mobile terminated call establishment.

See table 9.70/3GPP TS 24.008.

Message type: SETUP

Significance: global

Direction: network to mobile station

Table 9.70/3GPP TS 24.008: SETUP message content (network to mobile station direction)

IEI	Information element	Type/Reference	Presence	Format	Length
	Call control Protocol discriminator	Protocol discriminator 10.2	M	V	1/2
	Transaction identifier	Transaction identifier 10.3.2	M	V	1/2
	Setup Message type	Message type 10.4	M	V	1
D-	BC repeat indicator	Repeat indicator 10.5.4.22	C	TV	1
04	Bearer capability 1	Bearer capability 10.5.4.5	O	TLV	3-16
04	Bearer capability 2	Bearer capability 10.5.4.5	O	TLV	3-16
1C	Facility	Facility 10.5.4.15	O	TLV	2-?
1E	Progress indicator	Progress indicator 10.5.4.21	O	TLV	4
34	Signal	Signal 10.5.4.23	O	TV	2
5C	Calling party BCD Number	Calling party BCD num. 10.5.4.9	O	TLV	3-14
5D	Calling party sub-Address	Calling party subaddr. 10.5.4.10	O	TLV	2-23
5E	Called party BCD Number	Called party BCD num. 10.5.4.7	O	TLV	3-19
6D	Called party sub-Address	Called party subaddr. 10.5.4.8	O	TLV	2-23
74	Redirecting party BCD number	Redirecting party BCD num. 10.5.4.21b	O	TLV	3-19
75	Redirecting party sub-address	Redirecting party subaddress. 10.5.4.21c	O	TLV	2-23
D-	LLC repeat indicator	Repeat indicator 10.5.4.22	O	TV	1
7C	Low layer Compatibility I	Low layer comp. 10.5.4.18	O	TLV	2-18
7C	Low layer Compatibility II	Low layer comp. 10.5.4.18	C	TLV	2-18
D-	HLC repeat indicator	Repeat indicator 10.5.4.22	O	TV	1
7D	High layer Compatibility i	High layer comp. 10.5.4.16	O	TLV	2-5
7D	High layer Compatibility ii	High layer comp. 10.5.4.16	C	TLV	2-5
7E	User-user	User-user 10.5.4.25	O	TLV	3-35
8-	Priority	Priority Level 10.5.1.11	O	TV	1
19	Alert	Alerting Pattern 10.5.4.26	O	TLV	3
2F	Network Call Control Capabilities	Network Call Control cap. 10.5.4.29	O	TLV	3
3A	Cause of No CLI	Cause of No CLI 10.5.4.30	O	TLV	3
41	Backup bearer capability	Backup bearer capability 10.5.4.4a	O	TLV	3-15

### 9.3.23.1.1 BC repeat indicator

The *BC repeat indicator* information element is included if and only if *bearer capability 1* information element and *bearer capability 2* IE are both present in the message.

### 9.3.23.1.2 Bearer capability 1 and bearer capability 2

The *bearer capability 1* information element may be omitted in the case where the mobile subscriber is allocated only one directory number for all services (ref.: 3GPP TS 29.007 [38]). The *bearer capability 2* IE is missing at least if the *bearer capability 1* IE is missing.

If the MSC wishes to indicate capability for an alternative call mode, which can be entered through fallback, this is indicated by adding a *bearer capability information element (bearer capability) 2* element (see subclause 5.3.6).

### 9.3.23.1.3 Facility

This information element may be included for functional operation of supplementary services.

### 9.3.23.1.4 Progress indicator

This information element is included by the network

- in order to pass information about the call in progress e.g. in the event of interworking and/or
- to make the MS attach the user connection for speech.

### 9.3.23.1.4a Called party BCD number

For all bands except for PCS1900, the maximum length of this IE sent by the network shall be 13 octets

### 9.3.23.1.5 Called party subaddress

Included in the Network-to-mobile station direction if the calling user includes a *called party subaddress* information element in the SETUP message.

### 9.3.23.1.6 LLC repeat indicator

The *LLC repeat indicator* information element is included if and only if both following conditions hold:

- The *BC repeat indicator* IE is contained in the message.
- The *low layer compatibility I* IE is contained in the message.

If included, the *LLC repeat indicator* shall specify the same repeat indication as the *BC repeat indicator* IE.

### 9.3.23.1.7 Low layer compatibility I

Included in the network-to-mobile station direction if the calling user specified a low layer compatibility.

### 9.3.23.1.8 Low layer compatibility II

Included if and only if the *LLC repeat indicator* information element is contained in the message.

### 9.3.23.1.9 HLC repeat indicator

The *HLC repeat indicator* information element is included if and only both following conditions hold:

- The *BC repeat indicator* IE is contained in the message.
- The *high layer compatibility i* IE is contained in the message.

If included, the *HLC repeat indicator* shall specify the same repeat indication as the *BC repeat indicator* IE.

### 9.3.23.1.10 High layer compatibility i

Included in the network-to-mobile station direction if the calling user specified a high layer compatibility.

#### 9.3.23.1.11 High layer compatibility ii

Included if and only if the *HLC repeat indicator* information element is contained in the message.

#### 9.3.23.1.12 User-user

May be included in the network to called mobile station direction when the calling remote user included a user-user information element in the SETUP message.

#### 9.3.23.1.13 Redirecting party BCD number

May be included in the network to called mobile station direction when the call has been redirected.

#### 9.3.23.1.14 Redirecting party subaddress

May be included in the network to called mobile station direction when the calling remote user included a called party subaddress in the SETUP message and the call has been redirected

#### 9.3.23.1.15 Priority

May be included by the network to indicate the priority of the incoming call if eMLPP is used.

#### 9.3.23.1.16 Alert \$(Network Indication of Alerting in the MS)\$

May be included by the network to give some indication about alerting (category or level). If supported in the MS, this optional indication is to be used by the MS as specified in 3GPP TS 22.101 [8].

#### 9.3.23.1.17 Network Call Control Capabilities

This information shall be included by the network to indicate its call control capabilities if the network supports multicall.and there are no other ongoing calls to the MS.

#### 9.3.23.1.18 Cause of No CLI

This IE may be included by the network as defined by 3GPP TS 24.081 [25].

When both Calling Party BCD number IE and Cause of No CLI IE are included in SETUP message then the Cause of No CLI IE provides additional information on why the number digits are not present.

#### 9.3.23.1.19 Backup bearer capability

The *backup bearer capability* IE may be included by the network only if there are no *bearer capability* IEs contained in the message.

NOTE: The MSC may use the *backup bearer capability* IE if it is not able to provide a complete *bearer capability* IE.

### 9.3.23.2 Setup (mobile originating call establishment)

This message is sent from the mobile station to the network to initiate a mobile originating call establishment.

See table 9.70a/3GPP TS 24.008.

Message type: SETUP

Significance: global

Direction: mobile station to network

Table 9.70a/3GPP TS 24.008: SETUP message content (mobile station to network direction)

IEI	Information element	Type/Reference	Presence	Format	Length
	Call control protocol discriminator	Protocol discriminator 10.2	M	V	1/2
	Transaction identifier	Transaction identifier 10.3.2	M	V	1/2
	Setup message type	Message type 10.4	M	V	1
D-	BC repeat indicator	Repeat indicator 10.5.4.22	C	TV	1
04	Bearer capability 1	Bearer capability 10.5.4.5	M	TLV	3-16
04	Bearer capability 2	Bearer capability 10.5.4.5	O	TLV	3-16
1C	Facility(simple recall alignment)	Facility 10.5.4.15	O	TLV	2-
5D	Calling party sub-address	Calling party subaddr. 10.5.4.10	O	TLV	2-23
5E	Called party BCD number	Called party BCD num. 10.5.4.7	M	TLV	3-43
6D	Called party sub-address	Called party subaddr. 10.5.4.8	O	TLV	2-23
D-	LLC repeat indicator	Repeat indicator 10.5.4.22	O	TV	1
7C	Low layer compatibility I	Low layer comp. 10.5.4.18	O	TLV	2-18
7C	Low layer compatibility II	Low layer comp. 10.5.4.18	O	TLV	2-18
D-	HLC repeat indicator	Repeat indicator 10.5.4.22	O	TV	1
7D	High layer compatibility i	High layer comp. 10.5.4.16	O	TLV	2-5
7D	High layer compatibility ii	High layer comp. 10.5.4.16	O	TLV	2-5
7E	User-user	User-user 10.5.4.25	O	TLV	3-35
7F	SS version	SS version indicator 10.5.4.24	O	TLV	2-3
A1	CLIR suppression	CLIR suppression 10.5.4.11a	C	T	1
A2	CLIR invocation	CLIR invocation 10.5.4.11b	C	T	1
15	CC capabilities	Call Control Capabilities 10.5.4.5a	O	TLV	4
1D	Facility \$(CCBS)\$ (advanced recall alignment)	Facility 10.5.4.15	O	TLV	2-?
1B	Facility (recall alignment Not essential) \$(CCBS)\$	Facility 10.5.4.15	O	TLV	2-?
2D	Stream Identifier	Stream Identifier 10.5.4.28	O	TLV	3
40	Supported Codecs	Supported Codec List 10.5.4.32	O	TLV	5-n
A3	Redial	Redial 10.5.4.34	O	T	1

### 9.3.23.2.1 BC repeat indicator

The *BC repeat indicator* information element is included if and only if *bearer capability 1* IE and *bearer capability 2* IE are both present in the message.

#### 9.3.23.2.2 Facility

The information element may be included for functional operation of supplementary services.

Three different codings of this IE exist, for further details see 3GPP TS 24.010.

#### 9.3.23.2.3 LLC repeat indicator

The *LLC repeat indicator* information element is included if and only if both following conditions hold:

- The *BC repeat indicator* IE is contained in the message.
- The *low layer compatibility I* IE is contained in the message.

If included, the *LLC repeat indicator* shall specify the same repeat indication as the *BC repeat indicator* IE.

#### 9.3.23.2.4 Low layer compatibility I

The information element is included in the MS-to-network direction when the calling MS wants to pass low layer compatibility information to the called user.

#### 9.3.23.2.5 Low layer compatibility II

Included if and only if the *LLC repeat indicator* information element is contained in the message.

#### 9.3.23.2.6 HLC repeat indicator

The *HLC repeat indicator* information element is included if and only if both following conditions hold:

- The *BC repeat indicator* IE is contained in the message.
- The *high layer compatibility i* IE is contained in the message.

If included, the *HLC repeat indicator* shall specify the same repeat indication as the *BC repeat indicator* IE.

#### 9.3.23.2.7 High layer compatibility i

The information element is included when the calling MS wants to pass high layer compatibility information to the called user.

#### 9.3.23.2.8 High layer compatibility ii

Included if and only if the *HLC repeat indicator* information element is contained in the message.

#### 9.3.23.2.9 User-user

The information element is included in the calling mobile station to network direction when the calling mobile station wants to pass user information to the called remote user.

#### 9.3.23.2.10 SS version

This information element shall not be included if the *facility* information element is not present in this message.

This information element shall be included or excluded as defined in 3GPP TS 24.010 [21]. This information element should not be transmitted unless explicitly required by 3GPP TS 24.010.

#### 9.3.23.2.11 CLIR suppression

The information element may be included by the MS (see 3GPP TS 24.081 [25]). If this information element is included the *CLIR invocation* IE shall not be included.

### 9.3.23.2.12 CLIR invocation

The information element may be included by the MS (see 3GPP TS 24.081). If this information element is included the *CLIR suppression* IE shall not be included.

### 9.3.23.2.13 CC Capabilities

This information element may be included by the mobile station to indicate its call control capabilities.

### 9.3.23.2.14 Stream Identifier

This information element shall be included by the mobile station supporting multicall.

### 9.3.23.2.15 Bearer capability 1 and bearer capability 2

If the mobile station wishes to indicate capability for an alternative call mode, which can be entered through fallback, this is indicated by adding a *bearer capability information element* (bearer capability) 2 element (see subclause 5.3.6).

### 9.3.23.2.16 Supported Codecs

This information element shall be included for speech calls, if the mobile station supports UMTS radio access.

### 9.3.23.2.17 Redial

This information element shall be included if the mobile station is attempting to set up a call to switch from speech to multimedia or vice-versa.

## 9.3.23a Start CC \$(CCBS)\$

A Network that does not support the "Network initiated MO call" option shall treat this message as a message with message type not defined for the PD.

This message is sent by the mobile station to the network to open a Call Control transaction which the network has requested the mobile station to open.

See Table 9.70b/3GPP TS 24.008.

Message type: START CC  
Significance: local  
Direction: mobile station to network

**Table 9.70b/3GPP TS 24.008: START CC message content**

IEI	Information element	Type/Reference	Presence	Format	Length
	Call control Protocol discriminator	Protocol discriminator 10.2	M	V	1/2
	Transaction identifier	Transaction identifier 10.3.2	M	V	1/2
	Start CC message type	Message type 10.4	M	V	1
15	CC Capabilities	Call Control Capabilities 10.5.4.5a	O	TLV	4

### 9.3.23a.1 CC Capabilities

This information element may be included by the mobile station to indicate its call control capabilities



### 9.3.24 Start DTMF

This message is sent by the mobile station to the network and contains the digit the network should reconvert back into a DTMF tone which is then applied towards the remote user.

See table 9.71/3GPP TS 24.008.

Message type: START DTMF

Significance: local

Direction: mobile station to network

**Table 9.71/3GPP TS 24.008: START DTMF message content**

IEI	Information element	Type/Reference	Presence	Format	Length
	Call control protocol discriminator	Protocol discriminator 10.2	M	V	1/2
	Transaction identifier	Transaction identifier 10.3.2	M	V	1/2
	Start DTMF message type	Message type 10.4	M	V	1
2C	Keypad facility	Keypad facility 10.5.4.17	M	TV	2

### 9.3.25 Start DTMF Acknowledge

This message is sent by the network to the mobile station to indicate the successful initiation of the action requested by the START DTMF message (conversion of the digit contained in this message into a DTMF tone).

See table 9.72/3GPP TS 24.008.

Message type: START DTMF ACKNOWLEDGE

Significance: local

Direction: network to mobile station

**Table 9.72/3GPP TS 24.008: START DTMF ACKNOWLEDGE message content**

IEI	Information element	Type/Reference	Presence	Format	Length
	Call control protocol discriminator	Protocol discriminator 10.2	M	V	1/2
	Transaction identifier	Transaction identifier 10.3.2	M	V	1/2
	Start DTMF acknowledge message type	Message type 10.4	M	V	1
2C	Keypad facility	Keypad facility 10.5.4.17	M	TV	2

#### 9.3.25.1 Keypad facility

This information element contains the digit corresponding to the DTMF tone that the network applies towards the remote user.

### 9.3.26 Start DTMF reject

This message is sent by the network to the mobile station, if the network can not accept the START DTMF message.

See table 9.73/3GPP TS 24.008.

Message type: START DTMF REJECT

Significance: local

Direction: network to mobile station

**Table 9.73/3GPP TS 24.008: START DTMF REJECT message content**

IEI	Information element	Type/Reference	Presence	Format	Length
	Call control protocol discriminator	Protocol discriminator 10.2	M	V	1/2
	Transaction identifier	Transaction identifier 10.3.2	M	V	1/2
	Start DTMF reject message type	Message type 10.4	M	V	1
	Cause	Cause 10.5.4.11	M	LV	3-31

### 9.3.27 Status

This message is sent by the mobile station or the network at any time during a call to report certain error conditions listed in clause 8. It shall also be sent in response to a STATUS ENQUIRY message.

See table 9.74/3GPP TS 24.008.

Message type: STATUS

Significance: local

Direction: both

**Table 9.74/3GPP TS 24.008: STATUS message content**

IEI	Information element	Type/Reference	Presence	Format	Length
	Call control protocol discriminator	Protocol discriminator 10.2	M	V	1/2
	Transaction identifier	Transaction identifier 10.3.2	M	V	1/2
	Status message type	Message type 10.4	M	V	1
	Cause	Cause 10.5.4.11	M	LV	3-31
	Call state	Call state 10.5.4.6	M	V	1
24	Auxiliary states	Auxiliary states 10.5.4.4	O	TLV	3

#### 9.3.27.1 Auxiliary states

The information element is included if and only if the call state is "active" or "mobile originating modify" and any auxiliary state is different from "idle". For the definition of the auxiliary states see 3GPP TS 24.083 and 3GPP TS 24.084

### 9.3.28 Status enquiry

This message is sent by the mobile station or the network at any time to solicit a STATUS message from the peer layer 3 entity. Sending of STATUS message in response to a STATUS ENQUIRY message is mandatory.

See table 9.75/3GPP TS 24.008.

Message type: STATUS ENQUIRY

Significance: local

Direction: both

**Table 9.75/3GPP TS 24.008: STATUS ENQUIRY message content**

IEI	Information element	Type/Reference	Presence	Format	Length
	Call control protocol discriminator	Protocol discriminator 10.2	M	V	1/2
	Transaction identifier	Transaction identifier 10.3.2	M	V	1/2
	Status enquiry message type	Message type 10.4	M	V	1

### 9.3.29 Stop DTMF

This message is sent by a mobile station to the network and is used to stop the DTMF tone sent towards the remote user.

See table 9.76/3GPP TS 24.008.

Message type: STOP DTMF

Significance: local

Direction: mobile station to network

**Table 9.76/3GPP TS 24.008: STOP DTMF message content**

IEI	Information element	Type/Reference	Presence	Format	Length
	Call control protocol discriminator	Protocol discriminator 10.2	M	V	1/2
	Transaction identifier	Transaction identifier 10.3.2	M	V	1/2
	Stop DTMF message type	Message type 10.4	M	V	1

### 9.3.30 Stop DTMF acknowledge

This message is sent by the network to the mobile station to indicate that the sending of the DTMF tone has been stopped.

See table 9.77/3GPP TS 24.008.

Message type: STOP DTMF ACKNOWLEDGE

Significance: local

Direction: network to mobile station

**Table 9.77/3GPP TS 24.008: STOP DTMF ACKNOWLEDGE message content**

IEI	Information element	Type/Reference	Presence	Format	Length
	Call control protocol discriminator	Protocol discriminator 10.2	M	V	1/2
	Transaction identifier	Transaction identifier 10.3.2	M	V	1/2
	Stop DTMF acknowledge message type	Message type 10.4	M	V	1

### 9.3.31 User information

This message is sent by the mobile station to the network to transfer information to the remote user. This message is also sent by the network to the mobile station to deliver information transferred from the remote user. This message is used if the user-to-user transfer is part of an allowed information transfer as defined in 3GPP TS 24.010.

See table 9.78/3GPP TS 24.008.

Message type: USER INFORMATION

Significance: access

Direction: both

**Table 9.78/3GPP TS 24.008: USER INFORMATION message content**

IEI	Information element	Type/Reference	Presence	Format	Length
	Call control protocol discriminator	Protocol discriminator 10.2	M	V	1/2
	Transaction identifier	Transaction identifier 10.3.2	M	V	1/2
	User Information message type	Message type 10.4	M	V	1
	User-user	User-user 10.5.4.25	M	LV	2-130
A0	More data	More data 10.5.4.19	O	T	1

#### 9.3.31.1 User-user

Some networks may only support a maximum length of 35 octets. Procedures for interworking are not currently defined and are for further study.

R98 and earlier versions of this protocol specified a minimum length of 3 octets for this information element (not counting the IEI). To avoid interworking problems with mobile stations supporting only R98 or earlier versions of the protocol, the network shall deliver the User information message to these mobile stations only if the length of the User-user IE is greater or equal to 3 octets (not counting the IEI).

#### 9.3.31.2 More data

The information element is included by the sending user to indicate that another USER INFORMATION message pertaining to the same message block will follow.

## 9.4 GPRS Mobility Management Messages

### 9.4.1 Attach request

This message is sent by the MS to the network in order to perform a GPRS or combined GPRS attach. See table 9.4.1/3GPP TS 24.008.

Message type: ATTACH REQUEST

Significance: dual

Direction: MS to network

**Table 9.4.1/3GPP TS 24.008: ATTACH REQUEST message content**

IEI	Information Element	Type/Reference	Presence	Format	Length
	Protocol discriminator	Protocol discriminator 10.2	M	V	1/2
	Skip indicator	Skip indicator 10.3.1	M	V	½
	Attach request message identity	Message type 10.4	M	V	1
	MS network capability	MS network capability 10.5.5.12	M	LV	3-9
	Attach type	Attach type 10.5.5.2	M	V	½
	GPRS ciphering key sequence number	Ciphering key sequence number 10.5.1.2	M	V	½
	DRX parameter	DRX parameter 10.5.5.6	M	V	2
	P-TMSI or IMSI	Mobile identity 10.5.1.4	M	LV	6 - 9
	Old routing area identification	Routing area identification 10.5.5.15	M	V	6
	MS Radio Access capability	MS Radio Access capability 10.5.5.12a	M	LV	6 - 52
19	Old P-TMSI signature	P-TMSI signature 10.5.5.8	O	TV	4
17	Requested READY timer value	GPRS Timer 10.5.7.3	O	TV	2
9-	TMSI status	TMSI status 10.5.5.4	O	TV	1
33	PS LCS Capability	PS LCS Capability 10.5.5.22	O	TLV	3

#### 9.4.1.1 Old P-TMSI signature

This IE is included if a valid P-TMSI and P-TMSI signature are stored in the MS.

#### 9.4.1.2 Requested READY timer value

This IE may be included if the MS wants to indicate a preferred value for the READY timer.

#### 9.4.1.3 TMSI status

This IE shall be included if the MS performs a combined GPRS attach and no valid TMSI is available.

#### 9.4.1.4 PS LCS Capability

This IE shall be included if the MS supports at least one positioning method for the provision of location services (LCS) via the PS domain in Gb-mode.

### 9.4.2 Attach accept

This message is sent by the network to the MS to indicate that the corresponding attach request has been accepted. See table 9.4.2/3GPP TS 24.008.

Message type: ATTACH ACCEPT

Significance: dual

Direction: network to MS

Table 9.4.2/3GPP TS 24.008: ATTACH ACCEPT message content

IEI	Information Element	Type/Reference	Presence	Format	Length
	Protocol discriminator	Protocol discriminator 10.2	M	V	1/2
	Skip indicator	Skip indicator 10.3.1	M	V	1/2
	Attach accept message identity	Message type 10.4	M	V	1
	Attach result	Attach result 10.5.5.1	M	V	1/2
	Force to standby	Force to standby 10.5.5.7	M	V	1/2
	Periodic RA update timer	GPRS Timer 10.5.7.3	M	V	1
	Radio priority for SMS	Radio priority 10.5.7.2	M	V	1/2
	Radio priority for TOM8	Radio priority 2 10.5.7.5	M	V	1/2
	Routing area identification	Routing area identification 10.5.5.15	M	V	6
19	P-TMSI signature	P-TMSI signature 10.5.5.8	O	TV	4
17	Negotiated READY timer value	GPRS Timer 10.5.7.3	O	TV	2
18	Allocated P-TMSI	Mobile identity 10.5.1.4	O	TLV	7
23	MS identity	Mobile identity 10.5.1.4	O	TLV	7-10
25	GMM cause	GMM cause 10.5.5.14	O	TV	2
2A	T3302 value	GPRS Timer 2 10.5.7.4	O	TLV	3
8C	Cell Notification	Cell Notification 10.5.5.21	O	T	1
4A	Equivalent PLMNs	PLMN List 10.5.1.13	O	TLV	5-47
B-	Network feature support	Network feature support 10.5.5.23	O	TV	1
34	Emergency Number List	Emergency Number List 10.5.3.13	O	TLV	5-50
A-	Requested MS Information	Requested MS Information 10.5.5.25	O	TV	1

#### 9.4.2.1 P-TMSI signature

This IE may be included to assign an identity to the MS's GMM context.

#### 9.4.2.2 Negotiated READY timer

This IE may be included to indicate a value for the READY timer.

#### 9.4.2.3 Allocated P-TMSI

This IE may be included to assign a P-TMSI to an MS in case of a GPRS or combined GPRS attach.

#### 9.4.2.4 MS identity

This IE may be included to assign or unassign a TMSI to an MS in case of a combined GPRS attach.

#### 9.4.2.5 GMM cause

This IE shall be included when IMSI attach for non-GPRS services was not successful during a combined GPRS attach procedure.

#### 9.4.2.6 T3302 value

This IE may be included to indicate a value for the T3302 timer.

#### 9.4.2.7 Cell Notification (A/Gb mode only)

In A/Gb mode, this IE shall be included by the SGSN in order to indicate the ability to support the Cell Notification.

#### 9.4.2.8 Equivalent PLMNs

The *Equivalent PLMNs* information element is included if the network wants to inform the mobile station of equivalent PLMNs.

#### 9.4.2.9 Network feature support

This IE may be included to inform the MS of the support of certain features. If this IE is not included then the respective features are not supported.

#### 9.4.2.10 Emergency Number List

This IE may be sent by the network. If this IE is sent, the contents of this IE indicates a list of emergency numbers valid within the same MCC as in the cell on which this IE is received.

#### 9.4.2.11 Requested MS Information

This IE may be sent by the network to request the MS to provide feature-related information.

### 9.4.3 Attach complete

This message is sent by the MS to the network if at least one of the following conditions is fulfilled:

- a P-TMSI and/or a TMSI was included within the *attach accept* message; or
- the network has requested the MS to provide feature-related information.

See table 9.4.3/3GPP TS 24.008.

Message type: ATTACH COMPLETE

Significance: dual

Direction: MS to network

**Table 9.4.3/3GPP TS 24.008: ATTACH COMPLETE message content**

IEI	Information Element	Type/Reference	Presence	Format	Length
	Protocol discriminator	Protocol discriminator 10.2	M	V	1/2
	Skip indicator	Skip indicator 10.3.1	M	V	1/2
	Attach complete message identity	Message type 10.4	M	V	1
27	Inter RAT handover information	Inter RAT information container 10.5.5.24	O	TLV	3-40

### 9.4.3.1 Inter RAT handover information

This IE shall be included if the network has requested this information in the *routing area update accept* message.

### 9.4.4 Attach reject

This message is sent by the network to the MS to indicate that the corresponding attach request has been rejected. See table 9.4.4/3GPP TS 24.008.

Message type: ATTACH REJECT

Significance: dual

Direction: network to MS

**Table 9.4.4/3GPP TS 24.008: ATTACH REJECT message content**

IEI	Information Element	Type/Reference	Presence	Format	Length
	Protocol discriminator	Protocol discriminator 10.2	M	V	1/2
	Skip indicator	Skip indicator 10.3.1	M	V	1/2
	Attach reject message identity	Message type 10.4	M	V	1
	GMM cause	GMM cause 10.5.5.14	M	V	1
2A	T3302 value	GPRS Timer 2 10.5.7.4	O	TLV	3

#### 9.4.4.1 T3302 value

This IE may be included to indicate a value for the T3302 timer.

In Iu mode, the network shall not include this IE if this message is to be sent non-integrity protected.

In Iu mode, the MS shall ignore the contents of this IE if this message is received without integrity protection.

If this IE is not included or if in Iu mode the message is not integrity protected, the MS shall use the default value.

### 9.4.5 Detach request

#### 9.4.5.1 Detach request (mobile terminated detach)

This message is sent by the network to request the release of a GMM context. See table 9.4.5.1/3GPP TS 24.008.

Message type: DETACH REQUEST

Significance: dual

Direction: network to MS



**Table 9.4.5.1/3GPP TS 24.008:DETACH REQUEST message content**

IEI	Information Element	Type/Reference	Presence	Format	Length
	Protocol discriminator	Protocol discriminator 10.2	M	V	1/2
	Skip indicator	Skip indicator 10.3.1	M	V	1/2
	Detach request message identity	Message type 10.4	M	V	1
	Detach type	Detach type 10.5.5.5	M	V	1/2
	Force to standby	Force to standby 10.5.5.7	M	V	1/2
25	GMM cause	GMM cause 10.5.5.14	O	TV	2

#### 9.4.5.1.1 GMM cause

This IE shall be included in case the detach reason has to be indicated to the MS, e.g. due to a failed IMEI check.

#### 9.4.5.2 Detach request (mobile originating detach)

This message is sent by the MS to request the release of a GMM context. See table 9.4.5.2/3GPP TS 24.008.

Message type: DETACH REQUEST

Significance: dual

Direction: MS to network

**Table 9.4.5.2/3GPP TS 24.008:DETACH REQUEST message content**

IEI	Information Element	Type/Reference	Presence	Format	Length
	Protocol discriminator	Protocol discriminator 10.2	M	V	1/2
	Skip indicator	Skip indicator 10.3.1	M	V	1/2
	Detach request message identity	Message type 10.4	M	V	1
	Detach type	Detach type 10.5.5.5	M	V	1/2
	Spare half octet	Spare half octet 10.5.1.8	M	V	1/2
18	P-TMSI	Mobile identity 10.5.1.4	O	TLV	7
19	P-TMSI signature	P-TMSI signature 2 10.5.5.8a	O	TLV	5

#### 9.4.5.2.1 P-TMSI

This IE shall be included by the MS.

#### 9.4.5.2.2 P-TMSI signature

This IE shall be included if the MS has a valid P-TMSI signature.

## 9.4.6 Detach accept

### 9.4.6.1 Detach accept (mobile terminated detach)

This message is sent by the MS to indicate that the detach procedure has been completed. See table 9.4.6.1/3GPP TS 24.008.

Message type: DETACH ACCEPT

Significance: dual

Direction: MS to network

**Table 9.4.6.1/3GPP TS 24.008:DETACH ACCEPT message content**

IEI	Information Element	Type/Reference	Presence	Format	Length
	Protocol discriminator	Protocol discriminator 10.2	M	V	1/2
	Skip indicator	Skip indicator 10.3.1	M	V	1/2
	Detach accept message identity	Message type 10.4	M	V	1

### 9.4.6.2 Detach accept (mobile originating detach)

This message is sent by the network to indicate that the detach procedure has been completed. See table 9.4.6.2/3GPP TS 24.008.

Message type: DETACH ACCEPT

Significance: dual

Direction: network to MS

**Table 9.4.6.2/3GPP TS 24.008:DETACH ACCEPT message content**

IEI	Information Element	Type/Reference	Presence	Format	Length
	Protocol discriminator	Protocol discriminator 10.2	M	V	1/2
	Skip indicator	Skip indicator 10.3.1	M	V	1/2
	Detach accept message identity	Message type 10.4	M	V	1
	Force to standby	Force to standby 10.5.5.7	M	V	1/2
	Spare half octet	Spare half octet 10.5.1.8	M	V	1/2

## 9.4.7 P-TMSI reallocation command

This message is sent by the network to the MS to reallocate a P-TMSI. See table 9.4.7/3GPP TS 24.008.

Message type: P-TMSI REALLOCATION COMMAND

Significance: dual

Direction: network to MS

**Table 9.4.7/3GPP TS 24.008: P-TMSI REALLOCATION COMMAND message content**

IEI	Information Element	Type/Reference	Presence	Format	Length
	Protocol discriminator	Protocol discriminator 10.2	M	V	1/2
	Skip indicator	Skip indicator 10.3.1	M	V	1/2
	P-TMSI reallocation command message identity	Message type 10.4	M	V	1
	Allocated P-TMSI	Mobile identity 10.5.1.4	M	LV	6
	Routing area identification	Routing area identification 10.5.5.15	M	V	6
	Force to standby	Force to standby 10.5.5.7	M	V	1/2
	Spare half octet	Spare half octet 10.5.1.8	M	V	1/2
19	P-TMSI signature	P-TMSI signature 10.5.5.8	O	TV	4

#### 9.4.7.1 P-TMSI signature

This IE may be included to assign an identity to the MS's GMM context.

#### 9.4.8 P-TMSI reallocation complete

This message is sent by the MS to the network to indicate that reallocation of a P-TMSI has taken place. See table 9.4.8/3GPP TS 24.008.

Message type: P-TMSI REALLOCATION COMPLETE

Significance: dual

Direction: MS to network

**Table 9.4.8/3GPP TS 24.008: P-TMSI REALLOCATION COMPLETE message content**

IEI	Information Element	Type/Reference	Presence	Format	Length
	Protocol discriminator	Protocol discriminator 10.2	M	V	1/2
	Skip indicator	Skip indicator 10.3.1	M	V	1/2
	P-TMSI reallocation complete message identity	Message type 10.4	M	V	1

#### 9.4.9 Authentication and ciphering request

This message is sent by the network to the MS to initiate authentication of the MS identity. Additionally, the ciphering mode is set, indicating whether ciphering will be performed or not. See table 9.4.9/3GPP TS 24.008.

Message type: AUTHENTICATION AND CIPHERING REQUEST

Significance: dual

Direction: network to MS

**Table 9.4.9/TS 24.008: AUTHENTICATION AND CIPHERING REQUEST message content**

IEI	Information Element	Type/Reference	Presence	Format	Length
	Protocol discriminator	Protocol discriminator 10.2	M	V	1/2
	Skip indicator	Skip indicator 10.3.1	M	V	1/2
	Authentication and ciphering request message identity	Message type 10.4	M	V	1
	Ciphering algorithm	Ciphering algorithm 10.5.5.3	M	V	1/2
	IMEISV request	IMEISV request 10.5.5.10	M	V	1/2
	Force to standby	Force to standby 10.5.5.7	M	V	1/2
	A&C reference number	A&C reference number 10.5.5.19	M	V	1/2
21	Authentication parameter RAND	Authentication parameter RAND 10.5.3.1	O	TV	17
8-	GPRS ciphering key sequence number	Ciphering key sequence number 10.5.1.2	C	TV	1
28	Authentication parameter AUTN	Authentication parameter AUTN 10.5.3.1.1	O	TLV	18

#### 9.4.9.1 Authentication Parameter RAND

This IE shall only be included if authentication shall be performed.

#### 9.4.9.2 GPRS ciphering key sequence number

This IE is included if and only if the *Authentication parameter RAND* is contained in the message.

#### 9.4.9.3 Authentication Parameter AUTN

This IE shall be present if and only if the authentication challenge is a UMTS authentication challenge. The presence or absence of this IE defines- in the case of its absence- a GSM authentication challenge or- in the case of its presence- a UMTS authentication challenge.

The MS shall ignore the IE if a SIM is inserted in the MS.

In UMTS, the MS shall reject the AUTHENTICATION & CIPHERING REQUEST message as specified in subclause 4.7.7.5.1 if this IE is not present and a USIM is inserted in the MS.

### 9.4.10 Authentication and ciphering response

This message is sent by the MS to the network in response to an *Authentication and ciphering request* message. See table 9.4.10/3GPP TS 24.008.

Message type: AUTHENTICATION AND CIPHERING RESPONSE

Significance: dual

Direction: MS to network

**Table 9.4.10/3GPP TS 24.008: AUTHENTICATION AND CIPHERING RESPONSE message content**

IEI	Information Element	Type/Reference	Presence	Format	Length
	Protocol discriminator	Protocol discriminator 10.2	M	V	1/2
	Skip indicator	Skip indicator 10.3.1	M	V	1/2
	Authentication and ciphering response message identity	GPRS message type 10.4	M	V	1
	A&C reference number	A&C reference number 10.5.5.19	M	V	1/2
	Spare half octet	Spare half octet 10.5.1.8	M	V	1/2
22	Authentication parameter Response	Authentication Response parameter 10.5.3.2	O	TV	5
23	IMEISV	Mobile identity 10.5.1.4	O	TLV	11
29	Authentication Response parameter (extension)	Authentication Response parameter 10.5.3.2.1	O	TLV	3-14

### 9.4.10.1 Authentication Response Parameter

This IE is included if authentication was requested within the corresponding *authentication and ciphering request* message. This IE contains the SRES, if the authentication challenge was for GSM or the RES (all or just the 4 most significant octets of) if it is a UMTS authentication challenge (see also subclause 9.4.10.2)

### 9.4.10.2 IMEISV

This IE is included if requested within the corresponding *authentication and ciphering request* message.

### 9.4.10.3 Authentication Response Parameter (extension)

This IE shall be included if and only if the authentication challenge was a UMTS authentication challenge and the RES parameter is greater than 4 octets in length. It shall contain the least significant remaining bits of the RES (the four most significant octets shall be sent in the Authentication Response Parameter IE (see subclause 9.2.3.1))

This IE shall not be included if a SIM is inserted in the MS.

## 9.4.10a Authentication and Ciphering Failure

This message is sent by the mobile station to the network to indicate that authentication of the network has failed. See table 9.4.10a/3GPP TS 24.008.

Message type: AUTHENTICATION AND CIPHERING FAILURE

Significance: dual

Direction: mobile station to network

**Table 9.4.10a/3GPP TS 24.008: AUTHENTICATION AND CIPHERING FAILURE message content**

IEI	Information element	Type/Reference	Presence	Format	Length
	Mobility management Protocol discriminator	Protocol discriminator 10.2	M	V	1/2
	Skip Indicator	Skip Indicator 10.3.1	M	V	1/2
	Authentication and Ciphering Failure Message type	Message type 10.4	M	V	1
	GMM Cause	GMM Cause 10.5.5.14	M	V	1
30	Authentication Failure parameter	Authentication Failure parameter 10.5.3.2.2	O	TLV	16

### 9.4.10a.1 Authentication Failure parameter

This IE shall be sent if and only if the GMM cause was "Synch failure". It shall include the response to the authentication challenge from the USIM, which is made up of the AUTS parameter (see 3GPP TS 33.102 [5a]).

### 9.4.11 Authentication and ciphering reject

This message is sent by the network to the MS to indicate that authentication has failed (and that the receiving MS shall abort all activities). See table 9.4.11/3GPP TS 24.008.

Message type: AUTHENTICATION AND CIPHERING REJECT

Significance: dual

Direction: network to MS

**Table 9.4.11/3GPP TS 24.008: AUTHENTICATION AND CIPHERING REJECT message content**

IEI	Information Element	Type/Reference	Presence	Format	Length
	Protocol discriminator	Protocol discriminator 10.2	M	V	1/2
	Skip indicator	Skip indicator 10.3.1	M	V	1/2
	Authentication and ciphering reject message identity	Message type 10.4	M	V	1

### 9.4.12 Identity request

This message is sent by the network to the MS to request submission of the MS identity according to the specified identity type. See table 9.4.12/3GPP TS 24.008.

Message type: IDENTITY REQUEST

Significance: dual

Direction: network to MS

**Table 9.4.12/3GPP TS 24.008: IDENTITY REQUEST message content**

IEI	Information Element	Type/Reference	Presence	Format	Length
	Protocol discriminator	Protocol discriminator 10.2	M	V	1/2
	Skip indicator	Skip indicator 10.3.1	M	V	1/2
	Identity request message identity	Message type 10.4	M	V	1
	Identity type	Identity type 2 10.5.5.9	M	V	1/2
	Force to standby	Force to standby 10.5.5.7	M	V	1/2

### 9.4.13 Identity response

This message is sent by the MS to the network in response to an *identity request* message providing the requested identity. See table 9.4.13/3GPP TS 24.008.

Message type: IDENTITY RESPONSE

Significance: dual

Direction: MS to network

**Table 9.4.13/3GPP TS 24.008: IDENTITY RESPONSE message content**

IEI	Information Element	Type/Reference	Presence	Format	Length
	Protocol discriminator	Protocol discriminator 10.2	M	V	1/2
	Skip indicator	Skip indicator 10.3.1	M	V	1/2
	Identity response message identity	Message type 10.4	M	V	1
	Mobile identity	Mobile identity 10.5.1.4	M	LV	4 - 10

### 9.4.14 Routing area update request

This message is sent by the MS to the network either to request an update of its location file or to request an IMSI attach for non-GPRS services. See table 9.4.14/3GPP TS 24.008.

Message type: ROUTING AREA UPDATE REQUEST

Significance: dual

Direction: MS to network

**Table 9.4.14/3GPP TS 24.008: ROUTING AREA UPDATE REQUEST message content**

IEI	Information Element	Type/Reference	Presence	Format	Length
	Protocol discriminator	Protocol discriminator 10.2	M	V	1/2
	Skip indicator	Skip indicator 10.3.1	M	V	1/2
	Routing area update request message identity	Message type 10.4	M	V	1
	Update type	Update type 10.5.5.18	M	V	1/2
	GPRS ciphering key sequence number	Ciphering key sequence number 10.5.1.2	M	V	1/2
	Old routing area identification	Routing area identification 10.5.5.15	M	V	6
	MS Radio Access capability	MS Radio Access capability 10.5.5.12a	M	LV	6 - 52
19	Old P-TMSI signature	P-TMSI signature 10.5.5.8	O	TV	4
17	Requested READY timer value	GPRS Timer 10.5.7.3	O	TV	2
27	DRX parameter	DRX parameter 10.5.5.6	O	TV	3
9-	TMSI status	TMSI status 10.5.5.4	O	TV	1
18	P-TMSI	Mobile identity 10.5.1.4	O	TLV	7
31	MS network capability	MS network capability 10.5.5.12	O	TLV	4-10
32	PDP context status	PDP context status 10.5.7.1	O	TLV	4
33	PS LCS Capability	PS LCS Capability 10.5.5.22	O	TLV	3
35	MBMS context status	MBMS context status 10.5.7.6	O	TLV	2 - 18

#### 9.4.14.1 Old P-TMSI signature

This IE is included by the MS if it was received from the network in an ATTACH ACCEPT or ROUTING AREA UPDATE ACCEPT message.

#### 9.4.14.2 Requested READY timer value

This IE may be included if the MS wants to indicate a preferred value for the READY timer.

#### 9.4.14.3 DRX parameter

This IE shall be included if the MS changes the access network from GSM to UMTS, or the MS wants to indicate new DRX parameters to the network.

#### 9.4.14.4 TMSI status

This IE shall be included if the MS performs a combined routing area update and no valid TMSI is available.

#### 9.4.14.5 P-TMSI (UMTS only)

This IE shall be included by the MS.

#### 9.4.14.6 MS network capability

This IE shall be included by the MS to indicate it's capabilities to the network.



#### 9.4.14.7 PDP context status

This IE shall be included by the MS.

#### 9.4.14.8 PS LCS Capability

This IE shall be included if the MS supports at least one positioning method for the provision of location services (LCS) via the PS domain in Gb-mode.

#### 9.4.14.9 MBMS context status

This IE shall be included by the MS, if it has MBMS contexts with an SM state different from PDP-INACTIVE.

### 9.4.15 Routing area update accept

This message is sent by the network to the MS to provide the MS with GPRS mobility management related data in response to a *routing area update request* message. See table 9.4.15/3GPP TS 24.008.

Message type: ROUTING AREA UPDATE ACCEPT

Significance: dual

Direction: network to MS

**Table 9.4.15/3GPP TS 24.008: ROUTING AREA UPDATE ACCEPT message content**

IEI	Information Element	Type/Reference	Presence	Format	Length
	Protocol discriminator	Protocol discriminator 10.2	M	V	1/2
	Skip indicator	Skip indicator 10.3.1	M	V	1/2
	Routing area update accept message identity	Message type 10.4	M	V	1
	Force to standby	Force to standby 10.5.5.7	M	V	1/2
	Update result	Update result 10.5.5.17	M	V	1/2
	Periodic RA update timer	GPRS Timer 10.5.7.3	M	V	1
	Routing area identification	Routing area identification 10.5.5.15	M	V	6
19	P-TMSI signature	P-TMSI signature 10.5.5.8	O	TV	4
18	Allocated P-TMSI	Mobile identity 10.5.1.4	O	TLV	7
23	MS identity	Mobile identity 10.5.1.4	O	TLV	7-10
26	List of Receive N-PDU Numbers	Receive N-PDU Number list 10.5.5.11	O	TLV	4 - 19
17	Negotiated READY timer value	GPRS Timer 10.5.7.3	O	TV	2
25	GMM cause	GMM cause 10.5.5.14	O	TV	2
2A	T3302 value	GPRS Timer 2 10.5.7.4	O	TLV	3
8C	Cell Notification	Cell Notification 10.5.5.21	O	T	1
4A	Equivalent PLMNs	PLMN List 10.5.1.13	O	TLV	5-47
32	PDP context status	PDP context status 10.5.7.1	O	TLV	4
B-	Network feature support	Network feature support 10.5.5.23	O	TV	1
34	Emergency Number List	Emergency Number List 10.5.3.13	O	TLV	5-50
35	MBMS context status	MBMS context status 10.5.7.6	O	TLV	2 - 18
A-	Requested MS Information	Requested MS Information 10.5.5.25	O	TV	1

#### 9.4.15.1 P-TMSI signature

This IE may be included to assign an identity to the MS's GMM context.

#### 9.4.15.2 Allocated P-TMSI

This IE may be included to assign a P-TMSI to an MS in case of a GPRS or combined routing area updating procedure.

#### 9.4.15.3 MS identity

This IE may be included to assign or unassign a TMSI to a MS in case of a combined routing area updating procedure.

#### 9.4.15.4 List of Receive N-PDU Numbers

This IE shall be included in case of an inter SGSN routing area updating from A/Gb mode to A/Gb mode, or inter SGSN routing area updating from Iu mode to A/Gb mode, or intra SGSN routing area updating from Iu mode to A/Gb mode, if there are PDP contexts that have been activated in LLC acknowledged transfer mode.

#### 9.4.15.5 Negotiated READY timer value

This IE may be included to indicate a value for the READY timer.

#### 9.4.15.6 GMM cause

This IE shall be included if the combined GPRS routing area updating procedure was successful for GPRS services only.

#### 9.4.15.7 T3302 value

This IE may be included to indicate a value for the T3302 timer.

In Iu mode, the network shall not include this IE if this message is to be sent non-integrity protected.

In Iu mode, if this message is received without integrity protection the MS shall ignore the contents of this IE and use the last received value if available. If there is no last received value, the MS shall use the default value.

If this IE is not included in the message in A/Gb mode or if in Iu mode this IE is not included in an integrity protected message, the MS shall use the default value.

#### 9.4.15.8 Cell Notification (A/Gb mode only)

In A/Gb mode, this IE shall be included if by the SGSN in order to indicate the ability to support the Cell Notification.

#### 9.4.15.9 Equivalent PLMNs

The *Equivalent PLMNs* information element is included if the network wants to inform the mobile station of equivalent PLMNs.

#### 9.4.15.10 PDP context status

This IE shall be included by the NW.

#### 9.4.15.11 Network feature support

This IE may be included to inform the MS of the support of certain features. If this IE is not included then the respective features are not supported.

#### 9.4.15.12 Emergency Number List

This IE may be sent by the network. If this IE is sent, the contents of this IE indicates a list of emergency numbers valid within the same MCC as in the cell on which this IE is received.

#### 9.4.15.13 MBMS context status

This IE shall be included by the network, if it has MBMS contexts for the MS with an SM state different from PDP-INACTIVE.

#### 9.4.15.14 Requested MS Information

This IE may be sent by the network to request the MS to provide feature-related information.

### 9.4.16 Routing area update complete

This message shall be sent by the MS to the network in response to a *routing area update accept message* if at least one of the following conditions is fulfilled:

- a P-TMSI and/or a TMSI has been assigned;

- there are established LLC connections; or
- the network has requested the MS to provide feature-related information.

See table 9.4.16/3GPP TS 24.008.

Message type: ROUTING AREA UPDATE COMPLETE

Significance: dual

Direction: MS to network

**Table 9.4.16/3GPP TS 24.008: ROUTING AREA UPDATE COMPLETE message content**

IEI	Information Element	Type/Reference	Presence	Format	Length
	Protocol discriminator	Protocol discriminator 10.2	M	V	1/2
	Skip indicator	Skip indicator 10.3.1	M	V	1/2
	Routing area update complete message identity	Message type 10.4	M	V	1
26	List of Receive N-PDU Numbers	Receive N-PDU Number list 10.5.5.11	O	TLV	4 – 19
27	Inter RAT handover information	Inter RAT information container 10.5.5.24	O	TLV	3-40

#### 9.4.16.1 List of Receive N-PDU Numbers

This IE shall be included if the *routing area update accept message* contained this IE.

#### 9.4.16.2 Inter RAT handover information

This IE shall be included if the network has requested this information in the *routing area update accept message*.

### 9.4.17 Routing area update reject

This message is sent by the network to the MS in order to reject the routing area update procedure. See table 9.4.17/3GPP TS 24.008.

Message type: ROUTING AREA UPDATE REJECT

Significance: dual

Direction: network to MS

**Table 9.4.17/3GPP TS 24.008: ROUTING AREA UPDATE REJECT message content**

IEI	Information Element	Type/Reference	Presence	Format	Length
	Protocol discriminator	Protocol discriminator 10.2	M	V	1/2
	Skip indicator	Skip indicator 10.3.1	M	V	1/2
	Routing area update reject message identity	Message type 10.4	M	V	1
	GMM cause	GMM cause 10.5.5.14	M	V	1
	Force to standby	Force to standby 10.5.5.7	M	V	1/2
	Spare half octet	Spare half octet 10.5.1.8	M	V	1/2
2A	T3302 value	GPRS Timer 2 10.5.7.4	O	TLV	3

### 9.4.17.1 T3302 value

This IE may be included to indicate a value for the T3302 timer.

In Iu mode, the network shall not include this IE if this message is to be sent non-integrity protected.

In Iu mode, the MS shall ignore the contents of this IE if this message is received without integrity protection.

If this IE is not included or if in Iu mode the message is not integrity protected, the MS shall use the default value.

## 9.4.18 GMM Status

This message is sent by the MS or by the network at any time to report certain error conditions listed in clause 8. See table 9.4.18/3GPP TS 24.008.

Message type: GMM STATUS

Significance: local

Direction: both

**Table 9.4.18/3GPP TS 24.008: GMM STATUS message content**

IEI	Information Element	Type/Reference	Presence	Format	Length
	Protocol discriminator	Protocol discriminator 10.2	M	V	1/2
	Skip indicator	Skip indicator 10.3.1	M	V	1/2
	GMM Status message identity	Message type 10.4	M	V	1
	GMM cause	GMM cause 10.5.5.14	M	V	1

## 9.4.19 GMM Information

This message is sent by the network at any time to sent certain information to the MS.  
See table 9.4.19/3GPP TS 24.008.

Message type: GMM INFORMATION

Significance: local

Direction: network to MS

**Table 9.4.19/3GPP TS 24.008: GMM INFORMATION message content**

IEI	Information Element	Type/Reference	Presence	Format	Length
	Protocol discriminator	Protocol discriminator 10.2	M	V	1/2
	Skip indicator	Skip indicator 10.3.1	M	V	1/2
	GMM Information message identity	Message type 10.4	M	V	1
43	Full name for network	Network name 10.5.3.5a	O	TLV	3 - ?
45	Short name for network	Network name 10.5.3.5a	O	TLV	3 - ?
46	Local time zone	Time zone 10.5.3.8	O	TV	2
47	Universal time and local time zone	Time zone and time 10.5.3.9	O	TV	8
48	LSA Identity	LSA Identifier 10.5.3.11	O	TLV	2-5
49	Network Daylight Saving Time	Daylight Saving Time 10.5.3.12	O	TLV	3

#### 9.4.19.1 Full name for network

This IE may be sent by the network. If this IE is sent, the contents of this IE indicate the "full length name of the network" that the network wishes the mobile station to associate with the MCC and MNC contained in the routing area identification of the current cell.

#### 9.4.19.2 Short name for network

This IE may be sent by the network. If this IE is sent, the contents of this IE indicate the "abbreviated name of the network" that the network wishes the mobile station to associate with the MCC and MNC contained in the routing area identification of the cell the MS is currently in.

#### 9.4.19.3 Local time zone

This IE may be sent by the network. The mobile station should assume that this time zone applies to the routing area of the cell the MS is currently in.

If the local time zone has been adjusted for Daylight Saving Time, the network shall indicate this by including the IE Network Daylight Saving Time.

#### 9.4.19.4 Universal time and local time zone

This IE may be sent by the network. The mobile station should assume that this time zone applies to the routing area the MS is currently in. The mobile station shall not assume that the time information is accurate.

If the local time zone has been adjusted for Daylight Saving Time, the network shall indicate this by including the IE Network Daylight Saving Time.

#### 9.4.19.5 LSA Identity

This IE may be sent by the network. The contents of this IE indicate the LSA identity of the serving cell.

#### 9.4.19.6 Network Daylight Saving Time

This IE may be sent by the network. If this IE is sent, the contents of this IE indicates the value that has been used to adjust the local time zone.

## 9.4.20 Service Request (UMTS only)

This message is sent by the MS to transfer to establish logical association between the MS and the network. See table 9.4.20/3GPP TS 24.008.

Message type: Service Request

Significance: dual

Direction: MS to network

**Table 9.4.20/3GPP TS 24.008: Contents of Service Request message content**

IEI	Information Element	Type/Reference	Presence	Format	Length
	Protocol discriminator	Protocol discriminator 10.2	M	V	1/2
	Skip indicator	Skip indicator 10.3.1	M	V	1/2
	Service Request	Message type 10.4	M	V	1
	Ciphering key sequence number	Ciphering key sequence number 10.5.1.2	M	V	1/2
	Service type	Service type 10.5.5.20	M	V	1/2
	P-TMSI	Mobile station identity 10.5.1.4	M	LV	6
32	PDP context status	PDP context status 10.5.7.1	O	TLV	4
35	MBMS context status	MBMS context status 10.5.7.6	O	TLV	2 - 18

### 9.4.20.1 PDP context status

This IE shall be included by the MS.

### 9.4.20.2 MBMS context status

This IE shall be included by the MS, if it has MBMS contexts with an SM state different from PDP-INACTIVE.

## 9.4.21 Service Accept (UMTS only)

This message is sent by the network in response to a *Service Request* message. See table 9.4.21/3GPP TS 24.008.

Message type: Service Accept

Significance: dual

Direction: network to MS

**Table 9.4.21/3GPP TS 24.008: Contents of Service Accept message content**

IEI	Information Element	Type/Reference	Presence	Format	Length
	Protocol discriminator	Protocol discriminator 10.2	M	V	1/2
	Skip indicator	Skip indicator 10.3.1	M	V	1/2
	Service Accept	Message type 10.4	M	V	1
32	PDP context status	PDP context status 10.5.7.1	O	TLV	4
35	MBMS context status	MBMS context status 10.5.7.6	O	TLV	2 - 18

### 9.4.21.1 PDP context status

This IE shall be included by the NW.

### 9.4.21.2 MBMS context status

This IE shall be included by the network, if it has MBMS contexts for the MS with an SM state different from PDP-INACTIVE.

## 9.4.22 Service Reject (UMTS only)

This message is sent by the network to the UE in order to reject the Service request procedure. See table 9.4.22/3GPP TS 24.008.

Message type: Service Reject

Significance: dual

Direction: network to MS

**Table 9.4.22/3GPP TS 24.008: Contents of Service Reject message content**

IEI	Information Element	Type/Reference	Presence	Format	Length
	Protocol discriminator	Protocol discriminator 10.2	M	V	1/2
	Skip indicator	Skip indicator 10.3.1	M	V	1/2
	Service Reject	Message type 10.4	M	V	1
	GMM cause	GMM cause 10.5.5.14	M	V	1

## 9.5 GPRS Session Management Messages

### 9.5.1 Activate PDP context request

This message is sent by the MS to the network to request activation of a PDP context. See table 9.5.1/3GPP TS 24.008.

Message type: ACTIVATE PDP CONTEXT REQUEST

Significance: global

Direction: MS to network



**Table 9.5.1/3GPP TS 24.008: ACTIVATE PDP CONTEXT REQUEST message content**

IEI	Information Element	Type/Reference	Presence	Format	Length
	Protocol discriminator	Protocol discriminator 10.2	M	V	1/2
	Transaction identifier	Transaction identifier 10.3.2	M	V	1/2– 3/2
	Activate PDP context request message identity	Message type 10.4	M	V	1
	Requested NSAPI	Network service access point identifier 10.5.6.2	M	V	1
	Requested LLC SAPI	LLC service access point identifier 10.5.6.9	M	V	1
	Requested QoS	Quality of service 10.5.6.5	M	LV	13-15
	Requested PDP address	Packet data protocol address 10.5.6.4	M	LV	3 - 19
28	Access point name	Access point name 10.5.6.1	O	TLV	3 - 102
27	Protocol configuration options	Protocol configuration options 10.5.6.3	O	TLV	3 - 253

### 9.5.1.1 Access point name

This IE is included in the message when the MS selects a specific external network to be connected to.

### 9.5.1.2 Protocol configuration options

This IE is included in the message when the MS wishes to transmit (protocol) data (e.g. configuration parameters, error codes or messages/events) to the network.

## 9.5.2 Activate PDP context accept

This message is sent by the network to the MS to acknowledge activation of a PDP context.  
See table 9.5.2/3GPP TS 24.008.

Message type: ACTIVATE PDP CONTEXT ACCEPT

Significance: global

Direction: network to MS

**Table 9.5.2/3GPP TS 24.008: ACTIVATE PDP CONTEXT ACCEPT message content**

IEI	Information Element	Type/Reference	Presence	Format	Length
	Protocol discriminator	Protocol discriminator 10.2	M	V	1/2
	Transaction identifier	Transaction identifier 10.3.2	M	V	1/2– 3/2
	Activate PDP context accept message identity	Message type 10.4	M	V	1
	Negotiated LLC SAPI	LLC service access point identifier 10.5.6.9	M	V	1
	Negotiated QoS	Quality of service 10.5.6.5	M	LV	13-15
	Radio priority	Radio priority 10.5.7.2	M	V	1/2
	Spare half octet	Spare half octet 10.5.1.8	M	V	1/2
2B	PDP address	Packet data protocol address 10.5.6.4	O	TLV	4-20
27	Protocol configuration options	Protocol configuration options 10.5.6.3	O	TLV	3-253
34	Packet Flow Identifier	Packet Flow Identifier 10.5.6.11	O	TLV	3

### 9.5.2.1 PDP address

This IE shall be included by the network if the MS has requested the activation of a PDP context with the PDP type IPv4 or IPv6 and dynamic addressing.

### 9.5.2.2 Protocol configuration options

This IE is included in the message when the network wishes to transmit (protocol) data (e.g. configuration parameters, error codes or messages/events) to the MS.

### 9.5.2.3 Packet Flow Identifier

This IE may be included if the network wants to indicate the Packet Flow Identifier associated to the PDP context. The network shall not include this IE if the MS has not indicated PFC procedure support in PFC feature mode field of MS Network Capability IE.

If the MS has not indicated PFC procedure support, then it shall ignore this IE, if received.

## 9.5.3 Activate PDP context reject

This message is sent by the network to the MS to reject activation of a PDP context.  
See table 9.5.3/3GPP TS 24.008.

Message type: ACTIVATE PDP CONTEXT REJECT

Significance: global

Direction: network to MS

**Table 9.5.3/3GPP TS 24.008: ACTIVATE PDP CONTEXT REJECT message content**

IEI	Information Element	Type/Reference	Presence	Format	Length
	Protocol discriminator	Protocol discriminator 10.2	M	V	1/2
	Transaction identifier	Transaction identifier 10.3.2	M	V	1/2– 3/2
	Activate PDP context reject message identity	Message type 10.4	M	V	1
	SM cause	SM Cause 10.5.6.6	M	V	1
27	Protocol configuration options	Protocol configuration options 10.5.6.3	O	TLV	3 - 253

### 9.5.3.1 Protocol configuration options

This IE is included in the message when the network wishes to transmit (protocol) data (e.g. configuration parameters, error codes or messages/events) to the MS.

## 9.5.4 Activate Secondary PDP Context Request

This message is sent by the MS to the network to request activation of an additional PDP context associated with the same PDP address and APN as an already active PDP context. See Table 9.5.4/3GPP TS 24.008.

Message type:       ACTIVATE SECONDARY PDP CONTEXT REQUEST

Significance:       global

Direction:         MS to network

**Table 9.5.4/3GPP TS 24.008: ACTIVATE SECONDARY PDP CONTEXT REQUEST message content**

IEI	Information Element	Type/Reference	Presence	Format	Length
	Protocol discriminator	Protocol discriminator 10.2	M	V	½
	Transaction identifier	Transaction identifier 10.3.2	M	V	½– 3/2
	Activate secondary PDP context request message identity	Message type 10.4	M	V	1
	Requested NSAPI	Network service access point identifier 10.5.6.2	M	V	1
	Requested LLC SAPI	LLC service access point identifier 10.5.6.9	M	V	1
	Requested QoS	Quality of service 10.5.6.5	M	LV	13-15
	Linked TI	Linked TI 10.5.6.7	M	LV	2-3
36	TFT	Traffic Flow Template 10.5.6.12	O	TLV	3-257
27	Protocol configuration options	Protocol configuration options 10.5.6.3	O	TLV	3-253

### 9.5.4.1 TFT

This IE shall be included if a linked PDP context without TFT has already been activated.

### 9.5.4.2 Protocol configuration options

This IE is included in the message when the MS wishes to transmit (protocol) data (e.g. configuration parameters, error codes or messages/events) to the network.

## 9.5.5 Activate Secondary PDP Context Accept

This message is sent by the network to the MS to acknowledge activation of an additional PDP context associated with the same PDP address and APN as an already active PDP context. See Table 9.5.5/3GPP TS 24.008.

Message type:       ACTIVATE SECONDARY PDP CONTEXT ACCEPT

Significance:       global

Direction:         network to MS

**Table 9.5.5/3GPP TS 24.008: ACTIVATE SECONDARY PDP CONTEXT ACCEPT message content**

IEI	Information Element	Type/Reference	Presence	Format	Length
	Protocol discriminator	Protocol discriminator 10.2	M	V	1/2
	Transaction identifier	Transaction identifier 10.3.2	M	V	1/2– 3/2
	Activate secondary PDP context accept message identity	Message type 10.4	M	V	1
	Negotiated LLC SAPI	LLC service access point identifier 10.5.6.9	M	V	1
	Negotiated QoS	Quality of service 10.5.6.5	M	LV	13-15
	Radio priority	Radio priority 10.5.7.2	M	V	1/2
	Spare half octet	Spare half octet 10.5.1.8	M	V	1/2
34	Packet Flow Identifier	Packet Flow Identifier 10.5.6.11	O	TLV	3
27	Protocol configuration options	Protocol configuration options 10.5.6.3	O	TLV	3-253

### 9.5.5.1 Packet Flow Identifier

This IE may be included if the network wants to indicate the Packet Flow Identifier associated to the PDP context. The network shall not include this IE if the MS has not indicated PFC procedure support in PFC feature mode field of MS Network Capability IE.

If the MS has not indicated PFC procedure support, then it shall ignore this IE, if received.

### 9.5.5.2 Protocol configuration options

This IE is included in the message when the network wishes to transmit (protocol) data (e.g. configuration parameters, error codes or messages/events) to the MS.

## 9.5.6 Activate Secondary PDP Context Reject

This message is sent by the network to the UE to reject activation of an additional PDP context associated with the same PDP address and APN as an already active PDP context. See Table 9.5.6/3GPP TS 24.008.

Message type:       ACTIVATE SECONDARY PDP CONTEXT REJECT

Significance:       global

Direction:         network to MS

**Table 9.5.6/3GPP TS 24.008: ACTIVATE SECONDARY PDP CONTEXT REJECT message content**

IEI	Information Element	Type/Reference	Presence	Format	Length
	Protocol discriminator	Protocol discriminator 10.2	M	V	1/2
	Transaction identifier	Transaction identifier 10.3.2	M	V	1/2– 3/2
	Activate secondary PDP context reject message identity	Message type 10.4	M	V	1
	SM cause	SM Cause 10.5.6.6	M	V	1
27	Protocol configuration options	Protocol configuration options 10.5.6.3	O	TLV	3 – 253

### 9.5.6.1 Protocol configuration options

This IE is included in the message when the network wishes to transmit (protocol) data (e.g. configuration parameters, error codes or messages/events) to the MS.

### 9.5.7 Request PDP context activation

This message is sent by the network to the MS to initiate activation of a PDP context.  
See table 9.5.7/3GPP TS 24.008.

Message type: REQUEST PDP CONTEXT ACTIVATION

Significance: global

Direction: network to MS

**Table 9.5.7/3GPP TS 24.008: REQUEST PDP CONTEXT ACTIVATION message content**

IEI	Information Element	Type/Reference	Presence	Format	Length
	Protocol discriminator	Protocol discriminator 10.2	M	V	1/2
	Transaction identifier	Transaction identifier 10.3.2	M	V	1/2– 3/2
	Request PDP context activation message identity	Message type 10.4	M	V	1
	Offered PDP address	Packet data protocol address 10.5.6.4	M	LV	3 - 19
28	Access point name	Access point name 10.5.6.1	O	TLV	3 – 102
27	Protocol configuration options	Protocol configuration options 10.5.6.3	O	TLV	3 – 253

### 9.5.7.1 Protocol configuration options

This IE is included in the message when the network wishes to transmit (protocol) data (e.g. configuration parameters, error codes or messages/events) to the MS.

### 9.5.8 Request PDP context activation reject

This message is sent by the MS to the network to reject initiation of a PDP context activation.  
See table 9.5.8/3GPP TS 24.008.

Message type: REQUEST PDP CONTEXT ACTIVATION REJECT

Significance: global

Direction: MS to network

**Table 9.5.8/3GPP TS 24.008: REQUEST PDP CONTEXT ACTIVATION REJECT message content**

IEI	Information Element	Type/Reference	Presence	Format	Length
	Protocol discriminator	Protocol discriminator 10.2	M	V	1/2
	Transaction identifier	Transaction identifier 10.3.2	M	V	1/2– 3/2
	Request PDP context act. reject message identity	Message type 10.4	M	V	1
	SM cause	SM cause 10.5.6.6	M	V	1
27	Protocol configuration options	Protocol configuration options 10.5.6.3	O	TLV	3 – 253

### 9.5.8.1 Protocol configuration options

This IE is included in the message when the MS wishes to transmit (protocol) data (e.g. configuration parameters, error codes or messages/events) to the network.

### 9.5.9 Modify PDP context request (Network to MS direction)

This message is sent by the network to the MS to request modification of an active PDP context. See table 9.5.9/3GPP TS 24.008.

Message type: MODIFY PDP CONTEXT REQUEST (NETWORK TO MS DIRECTION)

Significance: global

Direction: network to MS

**Table 9.5.9/3GPP TS 24.008: MODIFY PDP CONTEXT REQUEST (NETWORK TO MS DIRECTION) message content**

IEI	Information Element	Type/Reference	Presence	Format	Length
	Protocol discriminator	Protocol discriminator 10.2	M	V	1/2
	Transaction identifier	Transaction identifier 10.3.2	M	V	1/2– 3/2
	Modify PDP context request message identity	Message type 10.4	M	V	1
	Radio priority	Radio priority 10.5.7.2	M	V	1/2
	Spare half octet	Spare half octet 10.5.1.8	M	V	1/2
	Requested LLC SAPI	LLC service access point identifier 10.5.6.9	M	V	1
	New QoS	Quality of service 10.5.6.5	M	LV	13-15
2B	PDP address	Packet data protocol address 10.5.6.4	O	TLV	4-20
34	Packet Flow Identifier	Packet Flow Identifier 10.5.6.11	O	TLV	3
27	Protocol configuration options	Protocol configuration options 10.5.6.3	O	TLV	3 – 253

### 9.5.9.1 PDP address

If the MS requested external PDN address allocation at PDP context activation via an APN and this was confirmed by the network in the ACTIVATE PDP CONTEXT ACCEPT message, then the network shall include the PDP address IE in the MODIFY PDP CONTEXT REQUEST message once the address has been actually allocated, in order to update the PDP context in the MS.

### 9.5.9.2 Packet Flow Identifier

This IE may be included if the network wants to indicate the Packet Flow Identifier associated to the PDP context. The network shall not include this IE if the MS has not indicated PFC procedure support in PFC feature mode field of MS Network Capability IE.

If this IE is not included, the MS shall keep the old Packet Flow Identifier value. If the MS has not indicated PFC procedure support, then it shall ignore this IE, if received.

### 9.5.9.3 Protocol configuration options

This IE is included in the message when the network wishes to transmit (protocol) data (e.g. configuration parameters, error codes or messages/events) to the MS.

## 9.5.10 Modify PDP context request (MS to network direction)

This message is sent by the MS to the network to request modification of an active PDP context. See table 9.5.10/3GPP TS 24.008.

Message type: MODIFY PDP CONTEXT REQUEST (MS TO NETWORK DIRECTION)

Significance: global

Direction: MS to network

**Table 9.5.10/3GPP TS 24.008: MODIFY PDP CONTEXT REQUEST (MS to network direction) message content**

IEI	Information Element	Type/Reference	Presence	Format	Length
	Protocol discriminator	Protocol discriminator 10.2	M	V	1/2
	Transaction identifier	Transaction identifier 10.3.2	M	V	1/2– 3/2
	Modify PDP context request message identity	Message type 10.4	M	V	1
32	Requested LLC SAPI	LLC service access point identifier 10.5.6.9	O	TV	2
30	Requested new QoS	Quality of service 10.5.6.5	O	TLV	14-16
31	New TFT	Traffic Flow Template 10.5.6.12	O	TLV	3-257
27	Protocol configuration options	Protocol configuration options 10.5.6.3	O	TLV	3-253

### 9.5.10.1 Requested LLC SAPI

This IE may be included in the message to request a new LLC SAPI if a new QoS is requested.

### 9.5.10.2 Requested new QoS

This IE may be included in the message to request a modification of the QoS.

### 9.5.10.3 New TFT

This IE may be included in the message to request a new TFT or modification of an existing TFT or transfer extra parameters to the network (e.g. the Authorization Token; see 3GPP TS 24.229).

### 9.5.10.4 Protocol configuration options

This IE is included in the message when the MS wishes to transmit (protocol) data (e.g. configuration parameters, error codes or messages/events) to the network.

## 9.5.11 Modify PDP context accept (MS to network direction)

This message is sent by the MS to the network to acknowledge the modification of an active PDP context. See table 9.5.11/3GPP TS 24.008.

Message type: MODIFY PDP CONTEXT ACCEPT (MS TO NETWORK DIRECTION)

Significance: global

Direction: MS to network

**Table 9.5.11/3GPP TS 24.008: MODIFY PDP CONTEXT ACCEPT (MS TO NETWORK DIRECTION) message content**

IEI	Information Element	Type/Reference	Presence	Format	Length
	Protocol discriminator	Protocol discriminator 10.2	M	V	1/2
	Transaction identifier	Transaction identifier 10.3.2	M	V	1/2– 3/2
	Modify PDP context accept message identity	Message type 10.4	M	V	1
27	Protocol configuration options	Protocol configuration options 10.5.6.3	O	TLV	3 – 253

### 9.5.11.1 Protocol configuration options

This IE is included in the message when the MS wishes to transmit (protocol) data (e.g. configuration parameters, error codes or messages/events) to the network.

## 9.5.12 Modify PDP context accept (Network to MS direction)

This message is sent by the network to the MS to acknowledge the modification of an active PDP context. See table 9.5.12/3GPP TS 24.008.

Message type: MODIFY PDP CONTEXT ACCEPT (NETWORK TO MS DIRECTION)

Significance: global

Direction: Network to MS

**Table 9.5.12/3GPP TS 24.008: MODIFY PDP CONTEXT ACCEPT (NETWORK to MS direction) message content**

IEI	Information Element	Type/Reference	Presence	Format	Length
	Protocol discriminator	Protocol discriminator 10.2	M	V	½
	Transaction identifier	Transaction identifier 10.3.2	M	V	½– 3/2
	Modify PDP context accept message identity	Message type 10.4	M	V	1
30	Negotiated QoS	Quality of service 10.5.6.5	O	TLV	14-16
32	Negotiated LLC SAPI	LLC service access point identifier 10.5.6.9	O	TV	2
8	New radio priority	Radio priority 10.5.7.2	O	TV	1
34	Packet Flow Identifier	Packet Flow Identifier 10.5.6.11	O	TLV	3
27	Protocol configuration options	Protocol configuration options 10.5.6.3	O	TLV	3 – 253



### 9.5.12.1 Negotiated QoS

This IE is included in the message if the network assigns a new QoS.

### 9.5.12.2 Negotiated LLC SAPI

This IE is included in the message if the network assigns a new LLC SAPI.

### 9.5.12.3 New radio priority

This IE is included in the message only if the network modifies the radio priority.

### 9.5.12.4 Packet Flow Identifier

This IE may be included if the network wants to indicate the Packet Flow Identifier associated to the PDP context. The network shall not include this IE if the MS has not indicated PFC procedure support in PFC feature mode field of MS Network Capability IE.

If this IE is not included, the MS shall keep the old Packet Flow Identifier value. If the MS has not indicated PFC procedure support, then it shall ignore this IE, if received.

### 9.5.12.5 Protocol configuration options

This IE is included in the message when the network wishes to transmit (protocol) data (e.g. configuration parameters, error codes or messages/events) to the MS.

## 9.5.13 Modify PDP Context Reject

This message is sent by the network to the UE to reject the requested modification of the TFT. The network should not send a MODIFY PDP CONTEXT REJECT message only if the requested QoS is not available. If a TFT modification was requested and the requested new TFT is not available then MODIFY PDP CONTEXT REJECT shall be sent. See Table 9.5.13/3GPP TS 24.008.

Message type: MODIFY PDP CONTEXT REJECT

Significance: global

Direction: network to MS

**Table 9.5.13/3GPP TS 24.008: MODIFY PDP CONTEXT REJECT message content**

IEI	Information Element	Type/Reference	Presence	Format	Length
	Protocol discriminator	Protocol discriminator 10.2	M	V	1/2
	Transaction identifier	Transaction identifier 10.3.2	M	V	1/2– 3/2
	Modify PDP Context Reject	Message type 10.4	M	V	1
	SM cause	SM Cause 10.5.6.6	M	V	1
27	Protocol configuration options	Protocol configuration options 10.5.6.3	O	TLV	3 – 253

### 9.5.13.1 Protocol configuration options

This IE is included in the message when the network wishes to transmit (protocol) data (e.g. configuration parameters, error codes or messages/events) to the MS.

## 9.5.14 Deactivate PDP context request

This message is sent to request deactivation of an active PDP context or an active MBMS context. See table 9.5.14/3GPP TS 24.008.

Message type: DEACTIVATE PDP CONTEXT REQUEST

Significance: global

Direction: both

**Table 9.5.14/3GPP TS 24.008: DEACTIVATE PDP CONTEXT REQUEST message content**

IEI	Information Element	Type/Reference	Presence	Format	Length
	Protocol discriminator	Protocol discriminator 10.2	M	V	1/2
	Transaction identifier	Transaction identifier 10.3.2	M	V	1/2– 3/2
	Deactivate PDP context request message identity	Message type 10.4	M	V	1
	SM cause	SM cause 10.5.6.6	M	V	1
9-	Tear down indicator	Tear down indicator 10.5.6.10	O	TV	1
27	Protocol configuration options	Protocol configuration options 10.5.6.3	O	TLV	3 – 253
35	MBMS protocol configuration options	MBMS protocol configuration options 10.5.6.15	O	TLV	3 - 253

### 9.5.14.1 Tear down indicator

This IE is included in the message in order to indicate whether only the PDP context associated with this specific TI or all active PDP contexts sharing the same PDP address and APN as the PDP context associated with this specific TI shall be deactivated.

If this IE is received for an MBMS context, it shall be ignored by the receiver.

### 9.5.14.2 Protocol configuration options

This IE is included in the message when the MS or the network wishes to transmit (protocol) data (e.g. configuration parameters, error codes or messages/events) to the peer entity.

If this IE is received for an MBMS context, it shall be ignored by the receiver.

### 9.5.14.3 MBMS protocol configuration options

This IE is included in the message when the MS or the network wishes to transmit MBMS bearer related (protocol) data (e.g. configuration parameters, error codes or messages/events) to the peer entity for an MBMS context.

If the IE is received for a PDP context, it shall be ignored by the receiver.

## 9.5.15 Deactivate PDP context accept

This message is sent to acknowledge deactivation of the PDP context requested in the corresponding *Deactivate PDP context request* message. See table 9.5.15/3GPP TS 24.008.

Message type: DEACTIVATE PDP CONTEXT ACCEPT

Significance: global

Direction: both

**Table 9.5.15/3GPP TS 24.008: DEACTIVATE PDP CONTEXT ACCEPT message content**

IEI	Information Element	Type/Reference	Presence	Format	Length
	Protocol discriminator	Protocol discriminator 10.2	M	V	1/2
	Transaction identifier	Transaction identifier 10.3.2	M	V	1/2– 3/2
	Deactivate PDP context accept message identity	Message type 10.4	M	V	1
27	Protocol configuration options	Protocol configuration options 10.5.6.3	O	TLV	3 – 253
35	MBMS protocol configuration options	MBMS protocol configuration options 10.5.6.15	O	TLV	3 - 253

### 9.5.15.1 Protocol configuration options

This IE is included in the message when the MS or the network wishes to transmit (protocol) data (e.g. configuration parameters, error codes or messages/events) to the peer entity.

If this IE is received for an MBMS context, it shall be ignored by the receiver.

### 9.5.15.2 MBMS protocol configuration options

This IE is included in the message when the MS or the network wishes to transmit MBMS bearer related (protocol) data (e.g. configuration parameters, error codes or messages/events) to the peer entity for an MBMS context.

If the IE is received for a PDP context, it shall be ignored by the receiver.

9.5.16 Void

9.5.17 Void

9.5.18 Void

9.5.19 Void

9.5.20 Void

### 9.5.21 SM Status

This message is sent by the network or the MS to pass information on the status of the indicated context and report certain error conditions (eg. as listed in clause 8). See table 9.5.21/3GPP TS 24.008.

Message type: SM Status

Significance: local

Direction: both

**Table 9.5.21/3GPP TS 24.008: SM STATUS message content**

IEI	Information Element	Type/Reference	Presence	Format	Length
	Protocol discriminator	Protocol discriminator 10.2	M	V	1/2
	Transaction identifier	Transaction identifier 10.3.2	M	V	1/2– 3/2
	SM Status message identity	Message type 10.4	M	V	1
	SM Cause	SM Cause 10.5.6.6	M	V	1

## 9.5.22 Activate MBMS Context Request

This message is sent by the MS to the network as an explicit response to a *Request MBMS Context Activation* message  
See table 9.5.22/3GPP TS 24.008.

Message type: ACTIVATE MBMS CONTEXT REQUEST

Significance: global

Direction: MS to network

**TABLE 9.5.22 : ACTIVATE MBMS CONTEXT REQUEST message content**

IEI	Information Element	Type/	Presence	Format	Length
	Protocol discriminator	Protocol discriminator 10.2	M	V	1/2
	Transaction identifier	Transaction identifier 10.3.2	M	V	1/2– 3/2
	Activate MBMS context request message identity	Message type 10.4	M	V	1
	Requested MBMS NSAPI	Enhanced Network service access point identifier 10.5.6.16	M	V	1
	Requested LLC SAPI	LLC service access point identifier 10.5.6.9	M	V	1
	Supported MBMS bearer capabilities	MBMS bearer capabilities 10.5.6.14	M	LV	2 – 3
	Requested multicast address	Packet data protocol address 10.5.6.4	M	LV	3 - 19
	Access point name	Access point name 10.5.6.1	M	LV	2 – 101
35	MBMS protocol configuration options	MBMS protocol configuration options 10.5.6.15	O	TLV	3 - 253

NOTE: The MBMS NSAPI will be used in Iu mode when the network chooses a point-to-point MBMS bearer for the transfer of MBMS data in the user plane.

### 9.5.22.1 MBMS protocol configuration options

This IE is included in the message when the MS wishes to transmit MBMS bearer related (protocol) data (e.g. configuration parameters, error codes or messages/events) to the peer entity for an MBMS context.

## 9.5.23 Activate MBMS Context Accept

This message is sent by the network to the MS to acknowledge activation of an MBMS context.  
See table 9.5.23/3GPP TS 24.008.

Message type: ACTIVATE MBMS CONTEXT ACCEPT

Significance: global

Direction: network to MS

**TABLE 9.5.23 : ACTIVATE MBMS CONTEXT ACCEPT message content**

IEI	Information Element	Type/Reference	Presence	Format	Length
	Protocol discriminator	Protocol discriminator 10.2	M	V	1/2
	Transaction identifier	Transaction identifier 10.3.2	M	V	1/2– 3/2
	Activate MBMS context accept message identity	Message type 10.4	M	V	1
	Temporary Mobile Group Identity	Temporary Mobile Group Identity 10.5.6.13	M	LV	4-7
	Negotiated LLC SAPI	LLC service access point identifier 10.5.6.9	M	V	1
35	MBMS protocol configuration options	MBMS protocol configuration options 10.5.6.15	O	TLV	3 - 253

### 9.5.23.1 MBMS protocol configuration options

This IE is included in the message when the network wishes to transmit MBMS bearer related (protocol) data (e.g. configuration parameters, error codes or messages/events) to the peer entity for an MBMS context.

## 9.5.24 Activate MBMS Context Reject

This message is sent by the network to the MS to reject activation of a MBMS context.  
See table 9.5.24/3GPP TS 24.008.

Message type: ACTIVATE MBMS CONTEXT REJECT

Significance: global

Direction: network to MS

**TABLE 9.5.24 : ACTIVATE MBMS CONTEXT REJECT message content**

IEI	Information Element	Type/Reference	Presence	Format	Length
	Protocol discriminator	Protocol discriminator 10.2	M	V	1/2
	Transaction identifier	Transaction identifier 10.3.2	M	V	1/2– 3/2
	Activate MBMS context reject message identity	Message type 10.4	M	V	1
	SM cause	SM Cause 10.5.6.6	M	V	1
35	MBMS protocol configuration options	MBMS protocol configuration options 10.5.6.15	O	TLV	3 - 253

### 9.5.24.1 MBMS protocol configuration options

This IE is included in the message when the network wishes to transmit MBMS bearer related (protocol) data (e.g. configuration parameters, error codes or messages/events) to the peer entity for an MBMS context.

## 9.5.25 Request MBMS Context Activation

This message is sent by the network to the MS to initiate activation of an MBMS context.  
See table 9.5.25/3GPP TS 24.008.

Message type: REQUEST MBMS CONTEXT ACTIVATION

Significance: global

Direction: network to MS

**TABLE 9.5.25 : REQUEST MBMS CONTEXT ACTIVATION message content**

IEI	Information Element	Type/Reference	Presence	Format	Length
	Protocol discriminator	Protocol discriminator 10.2	M	V	1/2
	Transaction identifier	Transaction identifier 10.3.2	M	V	1/2– 3/2
	Request MBMS context activation message identity	Message type 10.4	M	V	1
	Linked NSAPI	Network service access point identifier 10.5.6.2	M	V	1
	Offered Multicast address	Packet data protocol address 10.5.6.4	M	LV	3 - 19
	Access point name	Access point name 10.5.6.1	M	LV	2 – 101
35	MBMS protocol configuration options	MBMS protocol configuration options 10.5.6.15	O	TLV	3 - 253

### 9.5.25.1 Linked NSAPI

This IE is included in the message to allow the UE to associate the MBMS context with the PDP context over which the IGMP/MLD join message was sent.

### 9.5.25.2 MBMS protocol configuration options

This IE is included in the message when the network wishes to transmit MBMS bearer related (protocol) data (e.g. configuration parameters, error codes or messages/events) to the peer entity for an MBMS context.

## 9.5.26 Request MBMS Context Activation Reject

This message is sent by the MS to the network to reject initiation of an MBMS context activation.  
See table 9.5.26/3GPP TS 24.008.

Message type: REQUEST MBMS CONTEXT ACTIVATION REJECT

Significance: global

Direction: MS to network

**TABLE 9.5.26 : REQUEST MBMS CONTEXT ACTIVATION REJECT message content**

IEI	Information Element	Type/Reference	Presence	Format	Length
	Protocol discriminator	Protocol discriminator 10.2	M	V	1/2
	Transaction identifier	Transaction identifier 10.3.2	M	V	1/2– 3/2
	Request MBMS context act. reject message identity	Message type 10.4	M	V	1
	SM cause	SM Cause 10.5.6.6	M	V	1
35	MBMS protocol configuration options	MBMS protocol configuration options 10.5.6.15	O	TLV	3 – 253

### 9.5.26.1 MBMS protocol configuration options

This IE is included in the message when the MS wishes to transmit MBMS bearer related (protocol) data (e.g. configuration parameters, error codes or messages/events) to the peer entity for an MBMS context.

## 10 General message format and information elements coding

The figures and text in this clause describe the Information Elements contents.

### 10.1 Overview

Within the Layer 3 protocols defined in 3GPP TS 24.008, every message is a standard L3 message as defined in 3GPP TS 24.007 [20]. This means that the message consists of the following parts:

- a) protocol discriminator;
- b) transaction identifier;
- c) message type;
- d) other information elements, as required.

This organization is illustrated in the example shown in figure 10.1/3GPP TS 24.008.

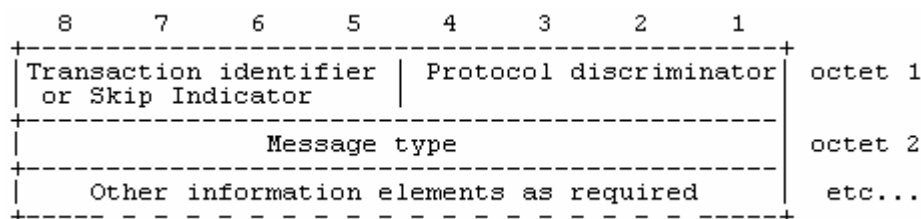

**Figure 10.1/3GPP TS 24.008 General message organization example**

Unless specified otherwise in the message descriptions of clause 9, a particular information element shall not be present more than once in a given message.

The term "default" implies that the value defined shall be used in the absence of any assignment, or that this value allows negotiation of alternative values in between the two peer entities.

When a field extends over more than one octet, the order of bit values progressively decreases as the octet number increases. The least significant bit of the field is represented by the lowest numbered bit of the highest numbered octet of the field.

### 10.2 Protocol Discriminator

The Protocol Discriminator (PD) and its use are defined in 3GPP TS 24.007 [20].

### 10.3 Skip indicator and transaction identifier

#### 10.3.1 Skip indicator

Bits 5 to 8 of the first octet of every Mobility Management message and GPRS Mobility Management message contains the skip indicator. A message received with skip indicator different from 0000 shall be ignored. A message received with skip indicator encoded as 0000 shall not be ignored (unless it is ignored for other reasons). A protocol entity sending a Mobility Management message or a GPRS Mobility Management message shall encode the skip indicator as 0000.

### 10.3.2 Transaction identifier

Bits 5 to 8 of the first octet of every message belonging to the protocols "Call Control; call related SS messages" and "Session Management" contain the transaction identifier (TI). The transaction identifier and its use are defined in 3GPP TS 24.007 [20].

For the session management protocol, the extended TI mechanism may be used (see 3GPP TS 24.007 [20]).

For the call control protocol, the extended TI mechanism shall be supported for the purpose of protocol error handling as specified in subclause 8.3.1

## 10.4 Message Type

The message type IE and its use are defined in 3GPP TS 24.007 [20]. Tables 10.3/3GPP TS 24.008, 10.4/3GPP TS 24.008, and 10.4a/3GPP TS 24.008 define the value part of the message type IE used in the Mobility Management protocol, the Call Control protocol, and Session management protocol.

**Table 10.2/3GPP TS 24.008: Message types for Mobility Management**

8	7	6	5	4	3	2	1	
x	x	0	0	-	-	-	-	Registration messages:
				0	0	0	1	- IMSI DETACH INDICATION
				0	0	1	0	- LOCATION UPDATING ACCEPT
				0	1	0	0	- LOCATION UPDATING REJECT
				1	0	0	0	- LOCATION UPDATING REQUEST
x	x	0	1	-	-	-	-	Security messages:
				0	0	0	1	- AUTHENTICATION REJECT
				0	0	1	0	- AUTHENTICATION REQUEST
				0	1	0	0	- AUTHENTICATION RESPONSE
				1	1	0	0	- AUTHENTICATION FAILURE.....
				1	0	0	0	- IDENTITY REQUEST
				1	0	0	1	- IDENTITY RESPONSE
				1	0	1	0	- TMSI REALLOCATION COMMAND
				1	0	1	1	- TMSI REALLOCATION COMPLETE
x	x	1	0	-	-	-	-	Connection management messages:
				0	0	0	1	- CM SERVICE ACCEPT
				0	0	1	0	- CM SERVICE REJECT
				0	0	1	1	- CM SERVICE ABORT
				0	1	0	0	- CM SERVICE REQUEST
				0	1	0	1	- CM SERVICE PROMPT
				0	1	1	0	- Reserved (see NOTE)
				1	0	0	0	- CM RE-ESTABLISHMENT REQUEST
				1	0	0	1	- ABORT
x	x	1	1	-	-	-	-	Miscellaneous messages:
				0	0	0	0	- MM NULL
				0	0	0	1	- MM STATUS
				0	0	1	0	- MM INFORMATION

NOTE: This value was allocated but never used in earlier phases of the protocol.

When the radio connection started with a core network node of earlier than R99, bit 8 shall be set to 0 and bit 7 is reserved for the send sequence number in messages sent from the mobile station. In messages sent from the network, bits 7 and 8 are coded with a "0". See 3GPP TS 24.007 [20].

When the radio connection started with a core network node of R'99 or later, bits 7 and 8 are reserved for the send sequence number in messages sent from the mobile station. In messages sent from the network, bits 7 and 8 are coded with a "0". See 3GPP TS 24.007 [20].



**Table 10.3/3GPP TS 24.008: Message types for Call Control and call related SS messages**

8	7	6	5	4	3	2	1	
x	x	0	0	0	0	0	0	escape to nationally specific message types; see 1) below
x	x	0	0	-	-	-	-	Call establishment messages:
				0	0	0	1	- ALERTING
				1	0	0	0	- CALL CONFIRMED
				0	0	1	0	- CALL PROCEEDING
				0	1	1	1	- CONNECT
				1	1	1	1	- CONNECT ACKNOWLEDGE
				1	1	1	0	- EMERGENCY SETUP
				0	0	1	1	- PROGRESS
				0	1	0	0	- CC-ESTABLISHMENT
				0	1	1	0	- CC-ESTABLISHMENT CONFIRMED
				1	0	1	1	- RECALL
				1	0	0	1	- START CC
				0	1	0	1	- SETUP
x	x	0	1	-	-	-	-	Call information phase messages:
				0	1	1	1	- MODIFY
				1	1	1	1	- MODIFY COMPLETE
				0	0	1	1	- MODIFY REJECT
				0	0	0	0	- USER INFORMATION
				1	0	0	0	- HOLD
				1	0	0	1	- HOLD ACKNOWLEDGE
				1	0	1	0	- HOLD REJECT
				1	1	0	0	- RETRIEVE
				1	1	0	1	- RETRIEVE ACKNOWLEDGE
				1	1	1	0	- RETRIEVE REJECT
x	x	1	0	-	-	-	-	Call clearing messages:
				0	1	0	1	- DISCONNECT
				1	1	0	1	- RELEASE
				1	0	1	0	- RELEASE COMPLETE
x	x	1	1	-	-	-	-	Miscellaneous messages:
				1	0	0	1	- CONGESTION CONTROL
				1	1	1	0	- NOTIFY
				1	1	0	1	- STATUS
				0	1	0	0	- STATUS ENQUIRY
				0	1	0	1	- START DTMF
				0	0	0	1	- STOP DTMF
				0	0	1	0	- STOP DTMF ACKNOWLEDGE
				0	1	1	0	- START DTMF ACKNOWLEDGE
				0	1	1	1	- START DTMF REJECT
				1	0	1	0	- FACILITY

1): When used, the message type is defined in the following octet(s), according to the national specification.

When the radio connection started with a core network node of earlier than R99, bit 8 shall be set to 0 and bit 7 is reserved for the send sequence number in messages sent from the mobile station. In messages sent from the network, bits 7 and 8 are coded with a "0". See 3GPP TS 24.007 [20].

When the radio connection started with a core network node of R'99 or later, bits 7 and 8 are reserved for the send sequence number in messages sent from the mobile station. In messages sent from the network, bits 7 and 8 are coded with a "0". See 3GPP TS 24.007 [20].

Table 10.4/3GPP TS 24.008: Message types for GPRS mobility management

Bits								
8	7	6	5	4	3	2	1	
0	0	-	-	-	-	-	-	Mobility management messages
0	0	0	0	0	0	0	1	Attach request
0	0	0	0	0	0	1	0	Attach accept
0	0	0	0	0	0	1	1	Attach complete
0	0	0	0	0	1	0	0	Attach reject
0	0	0	0	0	1	0	1	Detach request
0	0	0	0	0	1	1	0	Detach accept
0	0	0	0	1	0	0	0	Routing area update request
0	0	0	0	1	0	0	1	Routing area update accept
0	0	0	0	1	0	1	0	Routing area update complete
0	0	0	0	1	0	1	1	Routing area update reject
0	0	0	0	1	1	0	0	Service Request
0	0	0	0	1	1	0	1	Service Accept
0	0	0	0	1	1	1	0	Service Reject
0	0	0	1	0	0	0	0	P-TMSI reallocation command
0	0	0	1	0	0	0	1	P-TMSI reallocation complete
0	0	0	1	0	0	1	0	Authentication and ciphering req
0	0	0	1	0	0	1	1	Authentication and ciphering resp
0	0	0	1	0	1	0	0	Authentication and ciphering rej
0	0	0	1	1	1	0	0	Authentication and ciphering failure
0	0	0	1	0	1	0	1	Identity request
0	0	0	1	0	1	1	0	Identity response
0	0	1	0	0	0	0	0	GMM status
0	0	1	0	0	0	0	1	GMM information

**Table 10.4a/3GPP TS 24.008: Message types for GPRS session management**

Bits								
8	7	6	5	4	3	2	1	
0	1	-	-	-	-	-	-	Session management messages
0	1	0	0	0	0	0	1	Activate PDP context request
0	1	0	0	0	0	1	0	Activate PDP context accept
0	1	0	0	0	0	1	1	Activate PDP context reject
0	1	0	0	0	1	0	0	Request PDP context activation
0	1	0	0	0	1	0	1	Request PDP context activation rej.
0	1	0	0	0	1	1	0	Deactivate PDP context request
0	1	0	0	0	1	1	1	Deactivate PDP context accept
0	1	0	0	1	0	0	0	Modify PDP context request(Network to MS direction)
0	1	0	0	1	0	0	1	Modify PDP context accept (MS to network direction)
0	1	0	0	1	0	1	0	Modify PDP context request(MS to network direction)
0	1	0	0	1	0	1	1	Modify PDP context accept (Network to MS direction)
0	1	0	0	1	1	0	0	Modify PDP context reject
0	1	0	0	1	1	0	1	Activate secondary PDP context request
0	1	0	0	1	1	1	0	Activate secondary PDP context accept
0	1	0	0	1	1	1	1	Activate secondary PDP context reject
0	1	0	1	0	0	0	0	Reserved: was allocated in earlier phases of the protocol
0	1	0	1	0	0	0	1	Reserved: was allocated in earlier phases of the protocol
0	1	0	1	0	0	1	0	Reserved: was allocated in earlier phases of the protocol
0	1	0	1	0	0	1	1	Reserved: was allocated in earlier phases of the protocol
0	1	0	1	0	1	0	0	Reserved: was allocated in earlier phases of the protocol
0	1	0	1	0	1	0	1	SM Status
0	1	0	1	0	1	1	0	Activate MBMS Context Request
0	1	0	1	0	1	1	1	Activate MBMS Context Accept
0	1	0	1	1	0	0	0	Activate MBMS Context Reject
0	1	0	1	1	0	0	1	Request MBMS Context Activation
0	1	0	1	1	0	1	0	Request MBMS Context Activation Reject

## 10.5 Other information elements

The different formats (V, LV, T, TV, TLV) and the four categories of information elements (type 1, 2, 3, and 4) are defined in 3GPP TS 24.007 [20].

The first octet of an information element in the non-imperative part contains the IEI of the information element. If this octet does not correspond to an IEI known in the message, the receiver shall determine whether this IE is of type 1 or 2 (i.e. it is an information element of one octet length) or an IE of type 4 (i.e. that the next octet is the length indicator indicating the length of the remaining of the information element) (see 3GPP TS 24.007 [20]).

This allows the receiver to jump over unknown information elements and to analyse any following information elements.

The information elements which are common for at least two of the three protocols Radio Resources management, Mobility Management and Call Control, are listed in subclause 10.5.1.

The information elements for the protocols Mobility Management and Call Control are listed in subclauses 10.5.3 and 10.5.4 respectively. Default information element identifiers are listed in annex K.

**NOTE:** Different information elements may have the same default information element identifier if they belong to different protocols.

The descriptions of the information element types in subclauses 10.5.1, 10.5.3, and 10.5.4 are organized in alphabetical order of the IE types. Each IE type is described in one subclause.

The subclause may have an introduction:

- possibly explaining the purpose of the IE;
- possibly describing whether the IE belongs to type 1, 2, 3, 4 or 5;
- possibly indicating the length that the information element has if it is either type 5 or if it is used in format TV (type 1 and 3) or TLV (type 4).

A figure of the subclause defines the structure of the IE indicating:

- possibly the position and length of the IEI. (However it depends on the message in which the IE occurs whether the IE contains an IEI.);
- the fields the IE value part is composed of;
- possibly the position and length of the length indicator. (However it depends on the IE type whether the IE contains a length indicator or not.);
- possibly octet numbers of the octets that compose the IE (see clause a) below).

Finally, the subclause contains tables defining the structure and value range of the fields that compose the IE value part. The order of appearance for information elements in a message is defined in clause 9.

The order of the information elements within the imperative part of messages has been chosen so that information elements with 1/2 octet of content (type 1) go together in succession. The first type 1 information element occupies bits 1 to 4 of octet N, the second bits 5 to 8 of octet N, the third bits 1 to 4 of octet N + 1 etc. If the number of type 1 information elements is odd then bits 5 to 8 of the last octet occupied by these information elements contains a spare half octet IE in format V.

Where the description of information elements in the present document contains bits defined to be "spare bits", these bits shall set to the indicated value (0 or 1) by the sending side, and their value shall be ignored by the receiving side. With few exceptions, spare bits are indicated as being set to "0" in 3GPP TS 24.008.

## 10.5.1 Common information elements.

### 10.5.1.1 Cell identity

The purpose of the *Cell Identity* information element is to identify a cell within a location area.

The *Cell Identity* information element is coded as shown in figure 10.5.1/3GPP TS 24.008 and table 10.5.1/3GPP TS 24.008.

The *Cell Identity* is a type 3 information element with 3 octets length.

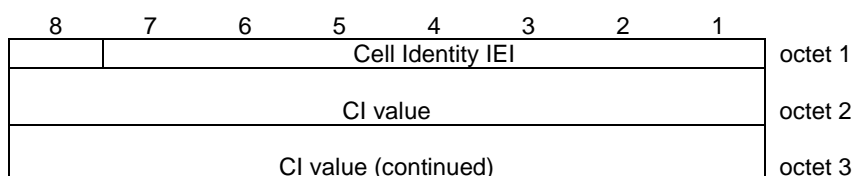

**Figure 10.5.1/3GPP TS 24.008 *Cell Identity* information element**

**Table 10.5.1/3GPP TS 24.008: Cell Identity information element**

<p>CI value, Cell identity value (octet 2 and 3)</p> <p>In the CI value field bit 8 of octet 2 is the most significant bit and bit 1 of octet 3 the least significant bit.</p> <p>The coding of the cell identity is the responsibility of each administration. Coding using full hexadecimal representation may be used.</p> <p>The cell identity consists of 2 octets.</p>
--

### 10.5.1.2 Cipherng Key Sequence Number

In a GSM authentication challenge, the purpose of the *Cipherng Key Sequence Number* information element is to make it possible for the network to identify the cipherng key Kc which is stored in the mobile station without invoking the authentication procedure.

The cipherng key sequence number is allocated by the network and sent with the AUTHENTICATION REQUEST message to the mobile station where it is stored together with the calculated cipherng key Kc.

The *Cipherng Key Sequence Number* information element is coded as shown in figure 10.5.2/3GPP TS 24.008 and table 10.5.2/3GPP TS 24.008.

In a UMTS authentication challenge, the purpose of the *Cipherng Key Sequence Number* information element is to make it possible for the network to identify the cipherng key CK and integrity key IK which are stored in the MS without invoking the authentication procedure. CK and IK form a Key Set Identifier (KSI) (see 3GPP TS 33.102 [5a]) which is encoded the same as the CKSN and is therefore included in the CKSN field.

The cipherng key sequence number is a type 1 information element.

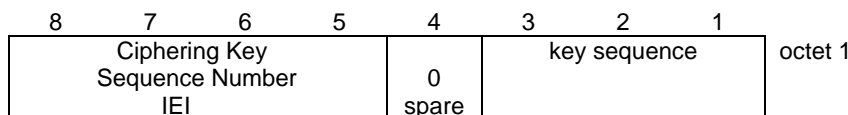

**Figure 10.5.2/3GPP TS 24.008 Cipherng Key Sequence Number information element**

**Table 10.5.2/3GPP TS 24.008: Cipherng Key Sequence Number information element**

Key sequence (octet 1)		
Bits		
3	2	1
0	0	0
through Possible values for the cipherng key		
1	1	0
sequence number		
1	1	1
No key is available (MS to network); Reserved (network to MS)		

### 10.5.1.3 Location Area Identification

The purpose of the *Location Area Identification* information element is to provide an unambiguous identification of location areas within the area covered by the 3GPP system.

The *Location Area Identification* information element is coded as shown in figure 10.5.3/3GPP TS 24.008 and table 10.5.3/3GPP TS 24.008.

The *Location Area Identification* is a type 3 information element with 6 octets length.

8	7	6	5	4	3	2	1	
Location Area Identification IEI								octet 1
MCC digit 2				MCC digit 1				octet 2
MNC digit 3				MCC digit 3				octet 3
MNC digit 2				MNC digit 1				octet 4
LAC								octet 5
LAC (continued)								octet 6

**Figure 10.5.3/3GPP TS 24.008 *Location Area Identification* information element**

**Table 10.5.3/3GPP TS 24.008: Location Area Identification information element**

<p>MCC, Mobile country code (octet 2 and 3) The MCC field is coded as in ITU-T Rec. E212, Annex A.</p> <p>If the LAI is deleted the MCC and MNC shall take the value from the deleted LAI.</p> <p>In abnormal cases, the MCC stored in the mobile station can contain elements not in the set {0, 1 ... 9}. In such cases the mobile station should transmit the stored values using full hexadecimal encoding. When receiving such an MCC, the network shall treat the LAI as deleted.</p> <p>MNC, Mobile network code (octet 3 bits 5 to 8, octet 4) The coding of this field is the responsibility of each administration but BCD coding shall be used. The MNC shall consist of 2 or 3 digits. For PCS 1900 for NA, Federal regulation mandates that a 3-digit MNC shall be used. However a network operator may decide to use only two digits in the MNC in the LAI over the radio interface. In this case, bits 5 to 8 of octet 3 shall be coded as "1111". Mobile equipment shall accept LAI coded in such a way.</p> <p>NOTE 1: In earlier versions of this protocol, the possibility to use a one digit MNC in LAI was provided on the radio interface. However as this was not used this possibility has been deleted.</p> <p>NOTE 2: In earlier versions of this protocol, bits 5 to 8 of octet 3 were coded as "1111". Mobile equipment compliant with these earlier versions of the protocol may be unable to understand the 3-digit MNC format of the LAI, and therefore unable to register on a network broadcasting the LAI in this format.</p> <p>In abnormal cases, the MNC stored in the mobile station can have:</p> <ul style="list-style-type: none"> <li>- digit 1 or 2 not in the set {0, 1 ... 9}, or</li> <li>- digit 3 not in the set {0, 1 ...9, F} hex.</li> </ul> <p>In such cases the mobile station shall transmit the stored values using full hexadecimal encoding. When receiving such an MNC, the network shall treat the LAI as deleted.</p> <p>The same handling shall apply for the network, if a 3-digit MNC is sent by the mobile station to a network using only a 2-digit MNC.</p> <p>LAC, Location area code (octet 5 and 6) In the LAC field bit 8 of octet 5 is the most significant bit and bit 1 of octet 6 the least significant bit. The coding of the location area code is the responsibility of each administration except that two values are used to mark the LAC, and hence the LAI, as deleted. Coding using full hexadecimal representation may be used. The location area code consists of 2 octets. If a LAI has to be deleted then all bits of the location area code shall be set to one with the exception of the least significant bit which shall be set to zero. If a SIM/USIM is inserted in a Mobile Equipment with the location area code containing all zeros, then the Mobile Equipment shall recognise this LAC as part of a deleted LAI</p>
--

#### 10.5.1.4 Mobile Identity

The purpose of the *Mobile Identity* information element is to provide either the international mobile subscriber identity, IMSI, the temporary mobile subscriber identity, TMSI/P-TMSI, the international mobile equipment identity, IMEI, the international mobile equipment identity together with the software version number, IMEISV, or the temporary mobile group identity (TMGI), associated with the optional MBMS Session Identity.

The IMSI shall not exceed 15 digits, the TMSI/P-TMSI is 4 octets long, and the IMEI is composed of 15 digits, the IMEISV is 16 digits (see 3GPP TS 23.003 [10]). The TMGI is at maximum 6 octets long and is defined in subclause 10.5.6.13. The MBMS Session Identity, if included, is 1 octet long (see 3GPP TS 48.018 [86]).

For packet paging the network shall select the mobile identity type with the following priority:

- 1- P-TMSI: The P-TMSI shall be used if it is available.
- 2- IMSI: The IMSI shall be used in cases where no P-TMSI is available.

For MBMS (pre-)notification (see 3GPP TS 44.018 [84] and 3GPP TS 44.060 [76]) the network shall select the mobile identity type "TMGI and optional MBMS Session Identity".

NOTE 1: The type of identity "TMGI and optional MBMS Session Identity" is only used by the MBMS (pre-)notification procedure in of A/Gb mode.

For all other transactions except emergency call establishment, emergency call re-establishment, mobile terminated call establishment, the identification procedure, the GMM identification procedure, the GMM authentication and ciphering procedure and the ciphering mode setting procedure, the mobile station and the network shall select the mobile identity type with the following priority:

- 1- TMSI: The TMSI shall be used if it is available.
- 2- IMSI: The IMSI shall be used in cases where no TMSI is available.

For mobile terminated call establishment the mobile station shall select the same mobile identity type as received from the network in the PAGING REQUEST message. In case of enhanced DTM CS establishment (see 3GPP TS 44.018 [84]) the mobile station shall select the mobile identity type with the following priority in the PAGING RESPONSE message:

- 1- TMSI: The TMSI shall be used if it is available.
- 2- IMSI: The IMSI shall be used in cases where no TMSI is available.

For emergency call establishment and re-establishment the mobile station shall select the mobile identity type with the following priority:

- 1- TMSI: The TMSI shall be used if it is available and if the location update status is UPDATED, and the stored LAI is equal to the one received on the BCCH from the current serving cell.
- 2- IMSI: The IMSI shall be used in cases where no TMSI is available or TMSI is available but either the update status is different from UPDATED, or the stored LAI is different from the one received on the BCCH from the current serving cell.
- 3- IMEI: The IMEI shall be used in cases where no SIM/USIM is available or the SIM/USIM is considered as not valid by the mobile station or no IMSI or TMSI is available.

In the identification procedure and in the GMM identification procedure the mobile station shall select the mobile identity type which was requested by the network, if available. If the requested identity is not available, then the mobile station shall indicate the identity type "No Identity".

In the ciphering mode setting procedure and in the GMM authentication and ciphering procedure the mobile shall select the IMEISV.

The *Mobile Identity* information element is coded as shown in figure 10.5.4/3GPP TS 24.008 and table 10.5.4/3GPP TS 24.008.

The *Mobile Identity* is a type 4 information element with a minimum length of 3 octet and 11 octets length maximal. Further restriction on the length may be applied, e.g. number plans.



8	7	6	5	4	3	2	1	
Mobile Identity IEI								octet 1
Length of mobile identity contents								octet 2
Identity digit 1				odd/ even indic	Type of identity			octet 3
Identity digit p+1				Identity digit p				octet 4*

Figure 10.5.4/3GPP TS 24.008 *Mobile Identity* information element

8	7	6	5	4	3	2	1	
Mobile Identity IEI								octet 1
Length of Mobile Identity contents								octet 2
0	0	MBMS Sess Id indic	MCC/ MNC indic	odd/ even indic	Type of identity			octet 3
MBMS Service ID								octet 4 octet 5 octet 6
MCC digit 2				MCC digit 1				octet 6a*
MNC digit 3				MCC digit 3				octet 6b*
MNC digit 2				MNC digit 1				octet 6c*
MBMS Session Identity								octet 7*

Figure 10.5.4a/3GPP TS 24.008: *Mobile Identity* information element for type of identity "TMGI and optional MBMS Session Identity"

**Table 10.5.4/3GPP TS 24.008: Mobile Identity information element**

Type of identity (octet 3)	
Bits	
<b>3</b>	<b>2 1</b>
0	0 1 IMSI
0	1 0 IMEI
0	1 1 IMEISV
1	0 0 TMSI/P-TMSI
1	0 1 TMGI and optional MBMS Session Identity
0	0 0 No Identity (note 1)
All other values are reserved.	
Odd/even indication (octet 3)	
Bit	
<b>4</b>	
0	even number of identity digits and also when the TMSI/P-TMSI or TMGI and optional MBMS Session Identity is used
1	odd number of identity digits
Identity digits (octet 3 etc)	
For the IMSI, IMEI and IMEISV this field is coded using BCD coding. If the number of identity digits is even then bits 5 to 8 of the last octet shall be filled with an end mark coded as "1111".	
For Type of identity "No Identity", the Identity digit bits shall be encoded with all 0s and the Length of mobile identity contents parameter shall be set to one of the following values:	
- '1' if the identification procedure is used (see subclause 9.2.11);	
- '3' if the GMM identification procedure is used (see subclause 9.4.13)	
If the mobile identity is the TMSI/P-TMSI then bits 5 to 8 of octet 3 are coded as "1111" and bit 8 of octet4 is the most significant bit and bit 1 of the last octet the least significant bit. The coding of the TMSI/P-TMSI is left open for each administration.	
For type of identity "TMGI and optional MBMS Session Identity" the coding of octet 3 etc is as follows:	
MCC/MNC indication (octet 3)	
Bit	
<b>5</b>	
0	MCC/MNC is not present
1	MCC/MNC is present
<b>MBMS Session Identity indication</b> (octet 3)	
Bit	
<b>6</b>	
0	MBMS Session Identity is not present
1	MBMS Session Identity is present
<b>MBMS Service ID</b> (octet 4, 5 and 6)	
The contents of the MBMS Service ID field are coded as octets 3 to 5 of the <i>Temporary Mobile Group Identity</i> IE. Bit 8 of octet 3 is the most significant bit and bit 1 of octet 5 the least significant bit. The coding of the MBMS Service ID is the responsibility of each administration. Coding using full hexadecimal representation may be used. The MBMS Service ID consists of 3 octets.	
<b>MCC, Mobile country code</b> (octet 6a, octet 6b bits 1 to 4)	
The MCC field is coded as in ITU-T Rec. E.212, Annex A.	

<p><b>MNC, Mobile network code</b> (octet 6b bits 5 to 8, octet 6c)</p> <p>The coding of this field is the responsibility of each administration but BCD coding shall be used. The MNC shall consist of 2 or 3 digits. If a network operator decides to use only two digits in the MNC, bits 5 to 8 of octet 7 shall be coded as "1111".</p> <p>The contents of the MCC and MNC digits are coded as octets 6 to 8 of the <i>Temporary Mobile Group Identity</i> IE in Figure 10.5.154/3GPP TS 24.008.</p> <p><b>MBMS Session Identity</b> (octet 7)</p> <p>The MBMS Session Identity field is encoded as the value part of the MBMS Session Identity IE as specified in 3GPP TS 48.018 [86].</p> <p>NOTE 1: This can be used in the case when a fill paging message without any valid identity has to be sent on the paging subchannel and when the requested identity is not available at the mobile station during the identity request procedure.</p>
--

### 10.5.1.5 Mobile Station Classmark 1

The purpose of the *Mobile Station Classmark 1* information element is to provide the network with information concerning aspects of high priority of the mobile station equipment. This affects the manner in which the network handles the operation of the mobile station. The Mobile Station Classmark information indicates general mobile station characteristics and it shall therefore, except for fields explicitly indicated, be independent of the frequency band of the channel it is sent on.

The *Mobile Station Classmark 1* information element is coded as shown in figure 10.5.5/3GPP TS 24.008 and table 10.5.5/3GPP TS 24.008.

The *Mobile Station Classmark 1* is a type 3 information element with 2 octets length.

8	7	6	5	4	3	2	1	
Mobile Station Classmark 1 IEI								octet 1
0 spare	Revision level	ES IND	A5/1	RF power capability				octet 2

**Figure 10.5.5/3GPP TS 24.008 *Mobile Station Classmark 1* information element**

**Table 10.5.5/3GPP TS 24.008: Mobile Station Classmark 1 information element**

Revision level (octet 2)			
Bits			
<b>7</b>	<b>6</b>		
0	0	Reserved for GSM phase 1	
0	1	Used by GSM phase 2 mobile stations	
1	0	Used by mobile stations supporting R99 or later versions of the protocol	
1	1	Reserved for future use. If the network receives a revision level specified as 'reserved for future use', then it shall use the highest revision level supported by the network.	
ES IND (octet 2, bit 5) "Controlled Early Classmark Sending" option implementation			
An MS not supporting A/Gb mode shall set this bit to "0".			
An MS supporting A/Gb mode shall indicate the associated capability (see table):			
0	"Controlled Early Classmark Sending" option is not implemented in the MS		
1	"Controlled Early Classmark Sending" option is implemented in the MS		
NOTE1: The value of the ES IND gives the implementation in the MS. It's value is <b>not</b> dependent on the broadcast SI 3 Rest Octet <Early Classmark Sending Control> value.			
A5/1 algorithm supported (octet 2, bit4) (Note 2)			
An MS not supporting A/Gb mode shall set this bit to "1".			
An MS supporting A/Gb mode shall indicate the associated capability (see table):			
0	encryption algorithm A5/1 available		
1	encryption algorithm A5/1 not available		
RF power capability (octet 2)			
When GSM 450, GSM 480, GSM 750, GSM 850, GSM 900 P, E [or R] band is used (for exceptions see 3GPP TS 44.018), the MS shall indicate the RF power capability of the band used (see table):			
When UMTS is used, a single band GSM 450, GSM 480, GSM 750, GSM 850, GSM 900 P, E [or R] MS shall indicate the RF power capability corresponding to the (GSM) band it supports (see table). In this case information on which single band is supported is found in classmark 3.			
Bits			
<b>3</b>	<b>2</b>	<b>1</b>	
0	0	0	class 1
0	0	1	class 2
0	1	0	class 3
0	1	1	class 4
1	0	0	class 5
All other values are reserved.			
When the GSM 1800 or GSM 1900 band is used (for exceptions see 3GPP TS 44.018, sub-clause 3.4.18), the MS shall indicate the RF power capability of the band used (see table):			
When UMTS is used, a single band GSM 1800 or GSM 1900 MS shall indicate the RF power capability corresponding to the (GSM) band it supports (see table). In this case, information on which single band is supported is found in classmark 3.			
Bits			
<b>3</b>	<b>2</b>	<b>1</b>	
0	0	0	class 1
0	0	1	class 2
0	1	0	class 3
All other values are reserved.			
When UMTS is used, an MS not supporting any GSM band or a multiband GSM MS shall code this field as follows (see table):			
Bits			
<b>3</b>	<b>2</b>	<b>1</b>	
1	1	1	RF power capability is irrelevant in this information element.
All other values are reserved.			

NOTE 2: The requirements for the support of the A5 algorithms in the MS are specified in 3GPP TS 43.020 [13].

### 10.5.1.6 Mobile Station Classmark 2

The purpose of the *Mobile Station Classmark 2* information element is to provide the network with information concerning aspects of both high and low priority of the mobile station equipment. This affects the manner in which the network handles the operation of the mobile station. The Mobile Station Classmark information indicates general mobile station characteristics and it shall therefore, except for fields explicitly indicated, be independent of the frequency band of the channel it is sent on.

The *Mobile Station Classmark 2* information element is coded as shown in figure 10.5.6/3GPP TS 24.008, table 10.5.6a/3GPP TS 24.008 and table 10.5.6b/3GPP TS 24.008.

The *Mobile Station Classmark 2* is a type 4 information element with 5 octets length.

	8	7	6	5	4	3	2	1	
	Mobile station classmark 2 IEI								octet 1
	Length of mobile station classmark 2 contents								octet 2
	0 spare	Revision level		ES IND	A5/1	RF power capability			octet 3
	0 spare	PS capa.	SS Screen. Indicator		SM ca pabi.	VBS	VGCS	FC	octet 4
	CM3	0 spare	LCSVA CAP	UCS2	SoLSA	CMSP	A5/3	A5/2	octet 5

NOTE1: Owing to backward compatibility problems, bit 8 of octet 4 should not be used unless it is also checked that the bits 8, 7 and 6 of octet 3 are not "0 0 0".

**Figure 10.5.6/3GPP TS 24.008 Mobile Station Classmark 2 information element**

**Table 10.5.6a/3GPP TS 24.008: Mobile Station Classmark 2 information element**

Revision level (octet 3)	
Bits	
<b>7</b>	<b>6</b>
0 0	Reserved for GSM phase 1
0 1	Used by GSM phase 2 mobile stations
1 0	Used by mobile stations supporting R99 or later versions of the protocol
1 1	Reserved for future use. If the network receives a revision level specified as 'reserved for future use', then it shall use the highest revision level supported by the network.
ES IND (octet 3, bit 5) "Controlled Early Classmark Sending" option implementation	
AN MS not supporting A/Gb mode shall set this bit to "0".	
An MS supporting A/Gb mode shall indicate the associated capability (see table):	
0	"Controlled Early Classmark Sending" option is not implemented in the MS
1	"Controlled Early Classmark Sending" option is implemented in the MS
NOTE1: The value of the ES IND gives the implementation in the MS. It's value is <b>not</b> dependent on the broadcast SI 3 Rest Octet <Early Classmark Sending Control> value	

**Table 10.5.6a/3GPP TS 24.008: Mobile Station Classmark 2 information element**

A5/1 algorithm supported (octet 3, bit 4) (Note 4)	
An MS not supporting A/Gb mode shall set this bit to "1".	
An MS supporting A/Gb mode shall indicate the associated capability (see table)	
0	encryption algorithm A5/1 available
1	encryption algorithm A5/1 not available
RF Power Capability (Octet 3)	
When T-GSM 380, T-GSM 410, GSM 450, GSM 480, GSM 750, GSM 850, GSM 900 P, E T [or R] band is used (for exceptions see 3GPP TS 44.018), the MS shall indicate the RF power capability of the band used (see table).	
When UMTS is used, a single band T-GSM 380, T-GSM 410, GSM 450, GSM 480, GSM 750, GSM 850, GSM 900 P, E T [or R] MS shall indicate the RF power capability corresponding to the (GSM) band it supports (see table). In this case, information on which single band is supported is found in classmark 3.	
Bits	
<b>3 2 1</b>	
0 0 0	class 1
0 0 1	class 2
0 1 0	class 3
0 1 1	class 4
1 0 0	class 5
All other values are reserved.	
When the GSM 1800 or GSM 1900 band is used (for exceptions see 3GPP TS 44.018) The MS shall indicate the RF power capability of the band used (see table).	
When UMTS is used, a single band GSM 1800 or GSM 1900 MS shall indicate the RF power capability corresponding to the (GSM) band it supports (see table). In this case, information on which single band is supported is found in classmark 3	
Bits	
<b>3 2 1</b>	
0 0 0	class 1
0 0 1	class 2
0 1 0	class 3
All other values are reserved.	
When UMTS is used, an MS not supporting any GSM band or a multiband GSM MS shall code this field as follows (see table):	
Bits	
<b>3 2 1</b>	
1 1 1	RF Power capability is irrelevant in this information element
All other values are reserved.	
PS capability (pseudo-synchronization capability) (octet 4)	
An MS not supporting A/Gb mode shall set this bit to "0".	
An MS supporting A/Gb mode shall indicate the associated capability (see table):	
Bit 7	
0	PS capability not present
1	PS capability present
SS Screening Indicator (octet 4)	
Bits	
<b>6 5</b>	
0 0	defined in 3GPP TS 24.080
0 1	defined in 3GPP TS 24.080
1 0	defined in 3GPP TS 24.080
1 1	defined in 3GPP TS 24.080
SM capability (MT SMS pt to pt capability) (octet 4)	
Bit 4	
0	Mobile station does not support mobile terminated point to point SMS
1	Mobile station supports mobile terminated point to point SMS

**Table 10.5.6a/3GPP TS 24.008: Mobile Station Classmark 2 information element**

VBS notification reception (octet 4)	
An MS not supporting A/Gb mode shall set this bit to "0".	
An MS supporting A/Gb mode shall indicate the associated GSM capability (see table):	
<b>Bit 3</b>	
0	no VBS capability or no notifications wanted
1	VBS capability and notifications wanted
VGCS notification reception (octet 4)	
An MS not supporting A/Gb mode shall set this bit to "0".	
An MS supporting A/Gb mode shall indicate the associated GSM capability (see table):	
<b>Bit 2</b>	
0	no VGCS capability or no notifications wanted
1	VGCS capability and notifications wanted
FC Frequency Capability (octet 4)	
When the T-GSM 400, GSM 400, or GSM 700, or GSM 850, or GSM 1800, T-GSM 900, or GSM 1900 band or UMTS is used (for exceptions see 3GPP TS 44.018), for definitions of frequency band see 3GPP TS 45.005, this bit shall be sent with the value "0".	
NOTE 2: This bit conveys no information about support or non support of the E-GSM or R-GSM bands when T-GSM 400, GSM 400, GSM 700, GSM 850, T-GSM 900, GSM 1800, GSM 1900 band or UMTS is used.	
When a GSM 900 band is used (for exceptions see 3GPP TS 44.018):	
<b>Bit 1</b>	
0	The MS does not support the E-GSM or R-GSM band (For definition of frequency bands see 3GPP TS 45.005 [33])
1	The MS does support the E-GSM or R-GSM (For definition of frequency bands see 3GPP TS 45.005 [33])
NOTE 3: For mobile station supporting the R-GSM band further information can be found in MS Classmark 3.	
CM3 (octet 5, bit 8)	
0	The MS does not support any options that are indicated in CM3
1	The MS supports options that are indicated in classmark 3 IE
LCS VA capability (LCS value added location request notification capability) (octet 5, bit 6)	
This information field indicates the support of the LCS value added location request notification via CS domain as defined in 3GPP TS 23.271 [105].	
0	location request notification via CS domain not supported
1	location request notification via CS domain supported
UCS2 treatment (octet 5, bit 5)	
This information field indicates the likely treatment by the mobile station of UCS2 encoded character strings. For backward compatibility reasons, if this field is not included, the value 0 shall be assumed by the receiver.	
0	the ME has a preference for the default alphabet (defined in 3GPP TS 23.038 [8b]) over UCS2.
1	the ME has no preference between the use of the default alphabet and the use of UCS2.

**Table 10.5.6a/3GPP TS 24.008: Mobile Station Classmark 2 information element**

SoLSA (octet 5, bit 4)	
An MS not supporting A/Gb mode shall set this bit to "0".	
An MS supporting A/Gb mode shall indicate the associated capability (see table):	
0	The ME does not support SoLSA.
1	The ME supports SoLSA.
CMSP: CM Service Prompt (octet 5, bit 3) \$(CCBS)\$	
0	"Network initiated MO CM connection request" not supported.
1	"Network initiated MO CM connection request" supported for at least one CM protocol.
A5/3 algorithm supported (octet 5, bit 2) (Note 4)	
An MS not supporting A/Gb mode shall set this bit to "0".	
An MS supporting A/Gb mode shall indicate the associated capability (see table):	
0	encryption algorithm A5/3 not available
1	encryption algorithm A5/3 available
A5/2 algorithm supported (octet 5, bit 1) (Note 4)	
An MS not supporting A/Gb mode shall set this bit to "0".	
An MS supporting A/Gb mode shall indicate the associated capability (see table):	
0	encryption algorithm A5/2 not available
1	encryption algorithm A5/2 available
NOTE 4: The requirements for the support of the A5 algorithms in the MS are specified in 3GPP TS 43.020 [13].	

NOTE 2: Additional mobile station capability information might be obtained by invoking the classmark interrogation procedure when GSM is used.

### 10.5.1.7 Mobile Station Classmark 3

The purpose of the *Mobile Station Classmark 3* information element is to provide the network with information concerning aspects of the mobile station. The contents might affect the manner in which the network handles the operation of the mobile station. The Mobile Station Classmark information indicates general mobile station characteristics and it shall therefore, except for fields explicitly indicated, be independent of the frequency band of the channel it is sent on.

The *MS Classmark 3* is a type 4 information element with a maximum of 14 octets length.

The value part of a *MS Classmark 3* information element is coded as shown in figure 10.5.7/3GPP TS 24.008 and table 10.5.7/3GPP TS 24.008.

NOTE: The 14 octet limit is so that the CLASSMARK CHANGE message will fit in one layer 2 frame.

SEMANTIC RULE: a multiband mobile station shall provide information about all frequency bands it can support. A single band mobile station shall not indicate the band it supports in the *Multiband Supported*, *GSM 400 Bands Supported*, *GSM 750 Associated Radio Capability*, *GSM 850 Associated Radio Capability* or *GSM 1900 Associated Radio Capability* fields in the MS Classmark 3. Due to shared radio frequency channel numbers between GSM 1800 and GSM 1900, the mobile should indicate support for either GSM 1800 band OR GSM 1900 band.

SEMANTIC RULE: a mobile station shall include the MS Measurement Capability field if the *Multi Slot Class* field contains a value of 19 or greater (see 3GPP TS 45.002 [32]).

Typically, the number of spare bits at the end is the minimum to reach an octet boundary. The receiver may add any number of bits set to "0" at the end of the received string if needed for correct decoding.



```

<Classmark 3 Value part> ::=
  < spare bit >
  { < Multiband supported : { 000 } >
    < A5 bits >
  | < Multiband supported : { 101 | 110 } >
    < A5 bits >
    < Associated Radio Capability 2 : bit(4) >
    < Associated Radio Capability 1 : bit(4) >
  | < Multiband supported : { 001 | 010 | 100 } >
    < A5 bits >
    < spare bit >(4)
    < Associated Radio Capability 1 : bit(4) > }
  { 0 | 1 < R Support > }
  { 0 | 1 < HSCSD Multi Slot Capability > }
  < UCS2 treatment: bit >
  < Extended Measurement Capability : bit >
  { 0 | 1 < MS measurement capability > }
  { 0 | 1 < MS Positioning Method Capability > }
  { 0 | 1 < ECSD Multi Slot Capability > }
  { 0 | 1 < 8-PSK Struct > }
  { 0 | 1 < GSM 400 Bands Supported : { 01 | 10 | 11 } >
    < GSM 400 Associated Radio Capability: bit(4) > }

  { 0 | 1 <GSM 850 Associated Radio Capability : bit(4) > }
  { 0 | 1 <GSM 1900 Associated Radio Capability : bit(4) > }
  < UMTS FDD Radio Access Technology Capability : bit >
  < UMTS 3.84 Mcps TDD Radio Access Technology Capability : bit >
  < CDMA 2000 Radio Access Technology Capability : bit >

  { 0 | 1 < DTM GPRS Multi Slot Class : bit(2) >
    < Single Slot DTM : bit >
    { 0 | 1 < DTM EGPRS Multi Slot Class : bit(2) > } }
  { 0 | 1 < Single Band Support > } -- Release 4 starts here:
  { 0 | 1 <GSM 750 Associated Radio Capability : bit(4)>}

  < UMTS 1.28 Mcps TDD Radio Access Technology Capability : bit >
  < GERAN Feature Package 1 : bit >

  { 0 | 1 < Extended DTM GPRS Multi Slot Class : bit(2) >
    < Extended DTM EGPRS Multi Slot Class : bit(2) > }

  { 0 | 1 < High Multislot Capability : bit(2) > } ---Release 5 starts here.

  { 0 | 1 < GERAN Iu Mode Capabilities > } -- "I" also means support of GERAN Iu mode
  < GERAN Feature Package 2 : bit >

  < GMSK Multislot Power Profile : bit (2) >
  < 8-PSK Multislot Power Profile : bit (2) >

  { 0 | 1 < T-GSM 400 Bands Supported : { 01 | 10 | 11 } > -- Release 6 starts here.
    < T-GSM 400 Associated Radio Capability: bit(4) > }

  { 0 | 1 < T-GSM 900 Associated Radio Capability: bit(4) > }
  < Downlink Advanced Receiver Performance : bit (2)>

  < DTM Enhancements Capability : bit >

  { 0 | 1 < DTM GPRS High Multi Slot Class : bit(3) >
    < Offset required : bit>
    { 0 | 1 < DTM EGPRS High Multi Slot Class : bit(3) > } }

  < Repeated ACCH Capability: bit >

  < spare bit > ;

< A5 bits > ::=

```

```

    < A5/7 : bit > < A5/6 : bit > < A5/5 : bit > < A5/4 : bit > ;

<R Support> ::=
    < R-GSM band Associated Radio Capability : bit(3) > ;

< HSCSD Multi Slot Capability > ::=
    < HSCSD Multi Slot Class : bit(5) > ;

< MS Measurement capability > ::=
    < SMS_VALUE : bit (4) >
    < SM_VALUE : bit (4) > ;

< MS Positioning Method Capability > ::=
    < MS Positioning Method : bit(5) > ;

< ECSD Multi Slot Capability > ::=
    < ECSD Multi Slot Class : bit(5) > ;

< 8-PSK Struct > ::=
    < Modulation Capability : bit >
    { 0 | 1 < 8-PSK RF Power Capability 1: bit(2) > }
    { 0 | 1 < 8-PSK RF Power Capability 2: bit(2) > }

< Single Band Support > ::=
    < GSM Band : bit (4) > ;

< GERAN lu Mode Capabilities > ::=
    < Length : bit (4) >      -- length in bits of lu mode only capabilities and spare bits
-- Additions in release 6
    < FLO lu Capability : bit >
    < spare bits > ** ;      -- expands to the indicated length
                           -- may be used for future enhancements

```

Figure 10.5.7/3GPP TS 24.008 *Mobile Station Classmark 3* information element

**Table 10.5.7/3GPP TS 24.008: Mobile Station Classmark 3 information element**

<p>Multiband Supported (3 bit field)</p> <p>Band 1 supported Bit 1 0 P-GSM not supported 1 P-GSM supported</p> <p>Band 2 supported Bit 2 0 E-GSM or R-GSM not supported 1 E-GSM or R-GSM supported</p> <p>Band 3 supported Bit 3 0 GSM 1800 not supported 1 GSM 1800 supported</p> <p>The indication of support of P-GSM band or E-GSM or R-GSM band is mutually exclusive.</p> <p>When the 'Band 2 supported' bit indicates support of E-GSM or R-GSM, the presence of the &lt;R Support&gt; field, see below, indicates if the E-GSM or R-GSM band is supported.</p> <p>In this version of the protocol, the sender indicates in this field either none, one or two of these 3 bands supported.</p> <p>For single band mobile station or a mobile station supporting none of the GSM 900 bands(P-GSM, E-GSM and R-GSM) and GSM 1800 bands, all bits are set to 0.</p> <p>A5/4 0 Encryption algorithm A5/4 not available 1 Encryption algorithm A5/4 available</p> <p>A5/5 0 Encryption algorithm A5/5 not available 1 Encryption algorithm A5/5 available</p> <p>A5/6 0 Encryption algorithm A5/6 not available 1 Encryption algorithm A5/6 available</p> <p>A5/7 0 Encryption algorithm A5/7 not available 1 Encryption algorithm A5/7 available</p> <p>Associated Radio capability 1 and 2 (4 bit fields)</p> <p>If either of P-GSM or E-GSM or R-GSM is supported, the radio capability 1 field indicates the radio capability for P-GSM, E-GSM or R-GSM, and the radio capability 2 field indicates the radio capability for GSM 1800 if supported, and is spare otherwise.</p> <p>If none of P-GSM or E-GSM or R-GSM are supported, the radio capability 1 field indicates the radio capability for GSM 1800, and the radio capability 2 field is spare.</p> <p>The radio capability contains the binary coding of the power class associated with the band indicated in multiband support bits (see 3GPP TS 45.005 [33]).</p>
---

*(continued...)*

**Table 10.5.1.7/3GPP TS 24.008 (continued): MS Classmark 3 information element**

<p><b>R-GSM band Associated Radio Capability</b> (3 bit field)</p> <p>In case where the R-GSM band is supported the R-GSM band associated radio capability field contains the binary coding of the power class associated (see 3GPP TS 45.005) (regardless of the number of GSM bands supported). A mobile station supporting the R-GSM band shall also when appropriate, (see 10.5.1.6) indicate its support in the 'FC' bit in the Mobile Station Classmark 2 information element.</p> <p>NOTE: The coding of the power class for P-GSM, E-GSM, R-GSM and GSM 1800 in radio capability 1 and/or 2 is different to that used in the Mobile Station Classmark 1 and Mobile Station Classmark 2 information elements.</p> <p><b>HSCSD Multi Slot Class</b> (5 bit field)</p> <p>In case the MS supports the use of multiple timeslots for HSCSD then the HSCSD Multi Slot Class field is coded as the binary representation of the multislot class defined in 3GPP TS 45.002 [32].</p> <p><b>UCS2 treatment</b> (1 bit field)</p> <p>This information field indicates the likely treatment by the mobile station of UCS2 encoded character strings. If not included, the value 0 shall be assumed by the receiver.</p> <ul style="list-style-type: none"> <li>0 the ME has a preference for the default alphabet (defined in 3GPP TS 23.038 [8b]) over UCS2.</li> <li>1 the ME has no preference between the use of the default alphabet and the use of UCS2.</li> </ul> <p><b>Extended Measurement Capability</b> (1 bit field)</p> <p>This bit indicates whether the mobile station supports 'Extended Measurements' or not</p> <ul style="list-style-type: none"> <li>0 the MS does not support Extended Measurements</li> <li>1 the MS supports Extended Measurements</li> </ul> <p><b>SMS_VALUE (Switch-Measure-Switch)</b> (4 bit field)</p> <p>The SMS field indicates the time needed for the mobile station to switch from one radio channel to another, perform a neighbour cell power measurement, and the switch from that radio channel to another radio channel.</p> <p>Bits</p> <table style="border: none;"> <tr><td>4</td><td>3</td><td>2</td><td>1</td><td></td></tr> <tr><td>0</td><td>0</td><td>0</td><td>0</td><td>1/4 timeslot (~144 microseconds)</td></tr> <tr><td>0</td><td>0</td><td>0</td><td>1</td><td>2/4 timeslot (~288 microseconds)</td></tr> <tr><td>0</td><td>0</td><td>1</td><td>0</td><td>3/4 timeslot (~433 microseconds)</td></tr> <tr><td>...</td><td></td><td></td><td></td><td></td></tr> <tr><td>1</td><td>1</td><td>1</td><td>1</td><td>16/4 timeslot (~2307 microseconds)</td></tr> </table> <p><b>SM_VALUE (Switch-Measure)</b> (4 bit field)</p> <p>The SM field indicates the time needed for the mobile station to switch from one radio channel to another and perform a neighbour cell power measurement.</p> <p>Bits</p> <table style="border: none;"> <tr><td>4</td><td>3</td><td>2</td><td>1</td><td></td></tr> <tr><td>0</td><td>0</td><td>0</td><td>0</td><td>1/4 timeslot (~144 microseconds)</td></tr> <tr><td>0</td><td>0</td><td>0</td><td>1</td><td>2/4 timeslot (~288 microseconds)</td></tr> <tr><td>0</td><td>0</td><td>1</td><td>0</td><td>3/4 timeslot (~433 microseconds)</td></tr> <tr><td>...</td><td></td><td></td><td></td><td></td></tr> <tr><td>1</td><td>1</td><td>1</td><td>1</td><td>16/4 timeslot (~2307 microseconds)</td></tr> </table> <p><b>MS Positioning Method</b> (5 bit field)</p> <p>This field indicates the Positioning Method(s) supported by the mobile station for the provision of location services (LCS) via the CS domain in A-mode.</p> <p><u>MS assisted E-OTD</u></p> <p>Bit 5</p> <ul style="list-style-type: none"> <li>0 MS assisted E-OTD not supported</li> <li>1 MS assisted E-OTD supported</li> </ul>	4	3	2	1		0	0	0	0	1/4 timeslot (~144 microseconds)	0	0	0	1	2/4 timeslot (~288 microseconds)	0	0	1	0	3/4 timeslot (~433 microseconds)	...					1	1	1	1	16/4 timeslot (~2307 microseconds)	4	3	2	1		0	0	0	0	1/4 timeslot (~144 microseconds)	0	0	0	1	2/4 timeslot (~288 microseconds)	0	0	1	0	3/4 timeslot (~433 microseconds)	...					1	1	1	1	16/4 timeslot (~2307 microseconds)
4	3	2	1																																																									
0	0	0	0	1/4 timeslot (~144 microseconds)																																																								
0	0	0	1	2/4 timeslot (~288 microseconds)																																																								
0	0	1	0	3/4 timeslot (~433 microseconds)																																																								
...																																																												
1	1	1	1	16/4 timeslot (~2307 microseconds)																																																								
4	3	2	1																																																									
0	0	0	0	1/4 timeslot (~144 microseconds)																																																								
0	0	0	1	2/4 timeslot (~288 microseconds)																																																								
0	0	1	0	3/4 timeslot (~433 microseconds)																																																								
...																																																												
1	1	1	1	16/4 timeslot (~2307 microseconds)																																																								

**Table 10.5.1.7/3GPP TS 24.008 (continued): MS Classmark 3 information element**

<u>MS based E-OTD</u>	
<u>Bit 4</u>	
0	MS based E-OTD not supported
1	MS based E-OTD supported
<u>MS assisted GPS</u>	
<u>Bit 3</u>	
0	MS assisted GPS not supported
1	MS assisted GPS supported
<u>MS based GPS</u>	
<u>Bit 2</u>	
0	MS based GPS not supported
1	MS based GPS supported
<u>MS Conventional GPS</u>	
<u>Bit 1</u>	
0	conventional GPS not supported
1	conventional GPS supported
<b>ECSD Multi Slot class (5 bit field)</b>	
An MS that supports ECSD shall include this field to indicate its ECSD capability. Whether the MS is capable of 8-PSK modulation in uplink is indicated by the value of the Modulation Capability field in the 8-PSK struct. The ECSD Multi Slot Class field is coded as the binary representation of the multislot class defined in 3GPP TS 45.002 [32].	
<b>8-PSK struct</b>	
The MS shall include the 8-PSK struct if it supports ECSD or DTM EGPRS or both.	
<b>Modulation Capability</b>	
The Modulation Capability field indicates the modulation scheme the MS supports in addition to GMSK.	
0	8-PSK supported for downlink reception only
1	8-PSK supported for uplink transmission and downlink reception
<b>8-PSK RF Power Capability 1 (2 bit field)</b>	
If 8-PSK modulation is supported for both uplink and downlink, the <b>8-PSK RF Power Capability 1</b> field indicates the radio capability for 8-PSK modulation in GSM 400, GSM 700, GSM 850 or GSM 900.	
<b>8-PSK RF Power Capability 2 (2 bit field)</b>	
If 8-PSK modulation is supported for both uplink and downlink, the <b>8-PSK RF Power Capability 2</b> field indicates the radio capability for 8-PSK modulation in GSM 1800 or GSM 1900 if supported, and is not included otherwise.	
The respective <b>8-PSK RF Power Capability 1</b> and <b>8-PSK RF Power Capability 2</b> fields contain the following coding of the 8-PSK modulation power class (see 3GPP TS 45.005 [33]):	
Bits	2 1
	0 0 Reserved
	0 1 Power class E1
	1 0 Power class E2
	1 1 Power class E3

**Table 10.5.1.7/3GPP TS 24.008 (continued): MS Classmark 3 information element****GSM 400 Bands Supported (2 bit field)**

See the semantic rule for the sending of this field.

Bits

2 1	
0 1	GSM 480 supported, GSM 450 not supported
1 0	GSM 450 supported, GSM 480 not supported
1 1	GSM 450 supported, GSM 480 supported

**GSM 400 Associated Radio Capability (4 bit field)**

If either GSM 450 or GSM 480 or both is supported, the GSM 400 Associated Radio Capability field indicates the radio capability for GSM 450 and/or GSM 480.

The radio capability contains the binary coding of the power class associated with the band indicated in GSM 400 Bands Supported bits (see 3GPP TS 45.005 [33]).

NOTE: The coding of the power class for GSM 450 and GSM 480 in GSM 400 Associated Radio Capability is different to that used in the Mobile Station Classmark 1 and Mobile Station Classmark 2 information elements.

**GSM 850 Associated Radio Capability (4 bit field)**

See the semantic rule for the sending of this field.

This field indicates whether GSM 850 band is supported and its associated radio capability.

The radio capability contains the binary coding of the power class associated with the GSM 850 band (see 3GPP TS 45.005 [33]).

Note: the coding of the power class for GSM 850 in GSM 850 Associated Radio Capability is different to that used in the Mobile Station Classmark 1 and Mobile Station Classmark 2 information elements.

**GSM 1900 Associated Radio Capability (4 bit field)**

See the semantic rule for the sending of this field.

This field indicates whether GSM 1900 band is supported and its associated radio capability.

The radio capability contains the binary coding of the power class associated with the GSM 1900 band (see 3GPP TS 45.005 [33]).

Note: the coding of the power class for GSM 1900 in GSM 1900 Associated Radio Capability is different to that used in the Mobile Station Classmark 1 and Mobile Station Classmark 2 information elements.

Table 10.5.1.7/3GPP TS 24.008 (continued): *MS Classmark 3* information element

<p><b>UMTS FDD Radio Access Technology Capability (1 bit field)</b></p> <p>0 UMTS FDD not supported 1 UMTS FDD supported</p> <p><b>UMTS 3.84 Mcps TDD Radio Access Technology Capability (1 bit field)</b></p> <p>0 UMTS 3.84 Mcps TDD not supported 1 UMTS 3.84 Mcps TDD supported</p> <p><b>CDMA 2000 Radio Access Technology Capability (1 bit field)</b></p> <p>0 CDMA2000 not supported 1 CDMA2000 supported</p> <p><b>DTM GPRS Multi Slot Class (2 bit field)</b> This field indicates the DTM GPRS multislot capabilities of the MS. It is coded as follows:</p> <p>Bit</p> <p>2 1</p> <p>0 0 Unused. If received, the network shall interpret this as "01" 0 1 Multislot class 5 supported 1 0 Multislot class 9 supported 1 1 Multislot class 11 supported</p> <p>If a multislot class type 1 MS indicates the support of a DTM GPRS multislot class for which three uplink timeslots can be assigned, the mobile station shall support Extended Dynamic Allocation.</p> <p>This field shall contain one of the following values if the <i>DTM GPRS High Multi Slot Class</i> field is present:</p> <ul style="list-style-type: none"> <li>- Multislot class 9 if DTM GPRS High Multi Slot Class is set to indicate Class 31/36 or Class 41;</li> <li>- Multislot class 11 if DTM GPRS High Multi Slot Class is set to indicate Classes 32/37, 33/38 or Classes 42, 43, 44.</li> </ul> <p><b>Single Slot DTM (1 bit field)</b> This field indicates whether the MS supports single slot DTM operation (see 3GPP TS 43.055 [87]). It is coded as follows:</p> <p>0 Single Slot DTM not supported 1 Single Slot DTM supported</p> <p>An MS indicating support for Extended DTM GPRS multislot class or Extended DTM EGPRS multislot class shall set this bit to "1". The network may ignore the bit in this case.</p> <p><b>DTM EGPRS Multi Slot Class (2 bit field)</b> This field indicates the DTM EGPRS multislot capabilities of the MS. Whether the MS is capable of 8-PSK modulation in uplink is indicated by the value of the Modulation Capability field in the 8-PSK struct. This field shall be included only if the mobile station supports EGPRS DTM. This field is coded as the DTM GPRS Multi Slot Class field.</p> <p>If a multislot class type 1 MS indicates the support of a DTM EGPRS multislot class for which three uplink timeslots can be assigned, the mobile station shall support Extended Dynamic Allocation.</p> <p>This field shall contain one of the following values if the <i>DTM EGPRS High Multi Slot Class</i> field is present:</p> <ul style="list-style-type: none"> <li>- Multislot class 9 if DTM EGPRS High Multi Slot Class is set to indicate Class 31/36 or Class 41;</li> <li>- Multislot class 11 if DTM EGPRS High Multi Slot Class is set to indicate Classes 32/37, 33/38 or Classes 42, 43, 44.</li> </ul> <p><b>Single Band Support</b> This field shall be sent if the mobile station supports UMTS and one and only one GSM band with the exception of R-GSM; this field shall not be sent otherwise</p> <p><b>GSM Band (4 bit field)</b></p> <p>Bits</p> <p>4 3 2 1</p> <p>0 0 0 0 E-GSM is supported 0 0 0 1 P-GSM is supported 0 0 1 0 GSM 1800 is supported 0 0 1 1 GSM 450 is supported</p>
---

0 1 0 0 GSM 480 is supported  
 0 1 0 1 GSM 850 is supported  
 0 1 1 0 GSM 1900 is supported  
 0 1 1 1 GSM 750 is supported

All other values are reserved for future use.

NOTE: When this field is received, the associated RF power capability is found in Classmark 1 or 2.

#### **GSM 750 Associated Radio Capability (4 bit field)**

See the semantic rule for the sending of this field.

This field indicates whether GSM 750 band is supported and its associated radio capability.

The radio capability contains the binary coding of the power class associated with the GSM 750 band (see 3GPP TS 45.005 [33]).

NOTE: The coding of the power class for GSM 750 in GSM 750 Associated Radio Capability is different to that used in the Mobile Station Classmark 1 and Mobile Station Classmark 2 information elements.

#### **UMTS 1.28 Mcps TDD Radio Access Technology Capability (1 bit field)**

0 UMTS 1.28 Mcps TDD not supported  
 1 UMTS 1.28 Mcps TDD supported

#### **GERAN Feature Package 1 (1 bit field)**

This field indicates whether the MS supports the GERAN Feature Package 1 (see 3GPP TS 44.060). It is coded as follows:

0 GERAN feature package 1 not supported.  
 1 GERAN feature package 1 supported.

#### **Extended DTM GPRS Multi Slot Class (2 bit field)**

This field indicates the extended DTM GPRS multislot capabilities of the MS and shall be interpreted in conjunction with the DTM GPRS Multi Slot Class field. It is coded as follows, where "DGMSC" denotes the DTM GPRS Multi Slot Class field:

DGMSC Bit	2	1	Bit	2	1	
	0	0		0	0	Unused. If received, it shall be interpreted as "01 00"
	0	0		0	1	Unused. If received, it shall be interpreted as "01 00"
	0	0		1	0	Unused. If received, it shall be interpreted as "01 00"
	0	0		1	1	Unused. If received, it shall be interpreted as "01 00"
	0	1		0	0	Multislot class 5 supported
	0	1		0	1	Multislot class 6 supported
	0	1		1	0	Unused. If received, it shall be interpreted as "01 00"
	0	1		1	1	Unused. If received, it shall be interpreted as "01 00"
	1	0		0	0	Multislot class 9 supported
	1	0		0	1	Multislot class 10 supported
	1	0		1	0	Unused. If received, it shall be interpreted as "10 00"
	1	0		1	1	Unused. If received, it shall be interpreted as "10 00"
	1	1		0	0	Multislot class 11 supported
	1	1		0	1	Unused. If received, it shall be interpreted as "11 00"
	1	1		1	0	Unused. If received, it shall be interpreted as "11 00"
	1	1		1	1	Unused. If received, it shall be interpreted as "11 00"

The presence of this field indicates that the MS supports combined fullrate and halfrate GPRS channels in the downlink. When this field is not present, the MS supports the multislot class indicated by the *DTM GPRS Multi Slot Class field*.

If this field is included, it shall contain one of the following values if the *DTM GPRS High Multi Slot Class* field is present:

- Multislot class 10 if DTM GPRS High Multi Slot Class is set to indicate Class 31/36 or Class 41;
- Multislot class 11 if DTM GPRS High Multi Slot Class is set to indicate Classes 32/37, 33/38 or Classes 42, 43, 44.

#### **Extended DTM EGPRS Multi Slot Class (2 bit field)**

This field is not considered when the DTM EGPRS Multi Slot Class field is not included. This field indicates the extended DTM EGPRS multislot capabilities of the MS and shall be interpreted in conjunction with the DTM EGPRS Multi Slot Class field. This field is coded as the Extended DTM GPRS Multi Slot Class field. The presence of this field indicates that the MS supports combined fullrate and halfrate GPRS channels in the



downlink. When this field is not present, the MS supports the multislot class indicated by the *DTM EGPRS Multi Slot Class* field.

If this field is included, it shall contain one of the following values if the *DTM EGPRS High Multi Slot Class* field is present:

- Multislot class 10 if DTM EGPRS High Multi Slot Class is set to indicate Class 31/36 or Class 41;
- Multislot class 11 if DTM EGPRS High Multi Slot Class is set to indicate Classes 32/37, 33/38 or Classes 42, 43, 44.

#### High Multislot Capability (2 bit field)

This field indicates the support of multislot classes 30 to 45, see 3GPP TS 45.002.

The High Multislot Capability is individually combined with each multislot class field sent by the MS (the possible multislot class fields are: GPRS multislot class, EGPRS multislot class) to extend the related multislot class with the rule described in the MS Radio Access Capability IE.

#### GERAN Iu Mode Capabilities

This field indicates if the mobile station supports GERAN Iu mode. Furthermore, it indicates the GERAN Iu mode capabilities of the mobile station. The field shall be included if the mobile station supports GERAN Iu mode. If the field is not present, the mobile station does not support GERAN Iu mode.

#### FLO Iu Capability (1 bit field)

If this parameter is not present, the value '0' shall be assumed by the receiver.

- 0 FLO in GERAN Iu mode not supported
- 1 FLO in GERAN Iu mode supported

#### GERAN Feature Package 2 (1 bit field)

This field indicates the MS support of the GERAN Feature Package 2. The GERAN Feature Package 2 includes **Enhanced Power Control (EPC)** (see 3GPP TS 45.008).

- 0 GERAN feature package 2 not supported.
- 1 GERAN feature package 2 supported.

#### GMSK Multislot Power Profile (2 bit field)

This field indicates the GMSK multislot power capability parameter GMSK\_MULTISLOT\_POWER\_PROFILE as described in 3GPP TS 45.005.

Bits

- 2 1
- 0 0 GMSK\_MULTISLOT\_POWER\_PROFILE 0
- 0 1 GMSK\_MULTISLOT\_POWER\_PROFILE 1
- 1 0 GMSK\_MULTISLOT\_POWER\_PROFILE 2
- 1 1 GMSK\_MULTISLOT\_POWER\_PROFILE 3

#### 8-PSK Multislot Power Profile (2 bit field)

This field indicates the 8-PSK multislot power capability parameter 8-PSK\_MULTISLOT\_POWER\_PROFILE as described in 3GPP TS 45.005. If the MS does not support 8-PSK in the uplink, then it shall set this field to "0 0".

Bits

- 2 1
- 0 0 8-PSK\_MULTISLOT\_POWER\_PROFILE 0
- 0 1 8-PSK\_MULTISLOT\_POWER\_PROFILE 1
- 1 0 8-PSK\_MULTISLOT\_POWER\_PROFILE 2
- 1 1 8-PSK\_MULTISLOT\_POWER\_PROFILE 3

#### T-GSM 400 Bands Supported (2 bit field)

See the semantic rule for the sending of this field.

Bits

- 2 1
- 0 1 T-GSM 380 supported, T-GSM 410 not supported
- 1 0 T-GSM 410 supported, T-GSM 380 not supported
- 1 1 T-GSM 410 supported, T-GSM 380 supported

#### T-GSM 400 Associated Radio Capability (4 bit field)

If either T-GSM 410 or T-GSM 380 or both is supported, the T-GSM 400 Associated Radio Capability field indicates the radio capability for T-GSM 410 and/or T-GSM 380.

The radio capability contains the binary coding of the power class associated with the band indicated in T-GSM

400 Bands Supported bits (see 3GPP TS 45.005 [33]).

NOTE: The coding of the power class for T-GSM 410 and T-GSM 380 in T-GSM 400 Associated Radio Capability is different to that used in the Mobile Station Classmark 1 and Mobile Station Classmark 2 information elements.

#### **T-GSM 900 Associated Radio Capability (4 bit field)**

See the semantic rule for the sending of this field.

This field indicates whether T-GSM 900 band is supported and its associated radio capability.

The radio capability contains the binary coding of the power class associated with the T-GSM 900 band (see 3GPP TS 45.005 [33]).

Note: the coding of the power class for T-GSM 900 in T-GSM 900 Associated Radio Capability is different to that used in the Mobile Station Classmark 1 and Mobile Station Classmark 2 information elements.

#### **Downlink Advanced Receiver Performance (2 bit field)**

This field indicates Downlink Advanced Receiver Performance capabilities of the MS (see 3GPP TS 45.005 [33]).

Bits

2 1

0 0 Downlink Advanced Receiver Performance not supported

0 1 Downlink Advanced Receiver Performance – phase I supported

Other values shall not be used by the MS.

If other values are received by the network, they shall be interpreted as "01".

#### **DTM Enhancements Capability (1 bit field)**

This field indicates whether the mobile station supports enhanced DTM CS establishment and enhanced DTM CS release or not. It is coded as follows:

0 The mobile station does not support enhanced DTM CS establishment and enhanced DTM CS release procedures.

1 The mobile station supports enhanced DTM CS establishment and enhanced DTM CS release procedures.

#### **DTM GPRS High Multi Slot Class (3 bit field)**

This field indicates the DTM GPRS multislot capabilities of the MS. It is coded as follows:

Bit

3 2 1

0 0 0 Unused. If received, the network shall interpret this as "0 0 1"

0 0 1 Multislot class 31 or 36 supported

0 1 0 Multislot class 32 or 37 supported

0 1 1 Multislot class 33 or 38 supported

1 0 0 Multislot class 41 supported

1 0 1 Multislot class 42 supported

1 1 0 Multislot class 43 supported

1 1 1 Multislot class 44 supported

The presence of this field indicates that the MS supports the DTM extension to high multislot classes. When this field is not present, the MS supports the DTM multislot class indicated by the *DTM GPRS Multi Slot Class field*.

The values '0 0 1', '0 1 0' and '0 1 1' shall be interpreted as indicating DTM GPRS multislot class 36, 37 or 38 respectively if the *Offset required* field indicates that the offset  $t_0$  is required; in all other cases those codepoints shall be interpreted as indicating DTM GPRS multislot class 31, 32 or 33 respectively.

#### **Offset required (1 bit field)**

This field indicates whether the GPRS multislot class of the mobile station is such that the Timing Advance offset  $t_0$  is required (see 3GPP TS 45.002). It is coded as follows:

0 The mobile station does not require the offset

1 The mobile station requires the offset

#### **DTM EGPRS High Multi Slot Class (3 bit field)**

This field indicates the DTM EGPRS multislot capabilities of the MS. This field may be included only if the mobile station supports EGPRS DTM. This field is coded as the DTM GPRS High Multi Slot Class field. When this field is not present, the MS supports the DTM multislot class indicated by the *DTM EGPRS Multi Slot Class field*.

The values '0 0 1', '0 1 0' and '0 1 1' shall be interpreted as indicating DTM EGPRS multislot class 36, 37 or 38 respectively if the *Offset required* field indicates that the Timing Advance offset  $t_0$  is required; in all other cases those codepoints shall be interpreted as indicating DTM EGPRS multislot class 31, 32 or 33 respectively.

**Repeated ACCH Capability** (1 bit field)

This field indicates whether the MS supports Repeated SACCH and Repeated Downlink FACCH (see 3GPP TS 44.006 [76]). It is coded as follows:

- 0 The mobile station does not support Repeated SACCH
- 1 The mobile station supports Repeated SACCH and Repeated Downlink FACCH

An MS that only supports Repeated Downlink FACCH shall set this bit field to "0".

### 10.5.1.8 Spare Half Octet

This element is used in the description of messages in clause 9 when an odd number of half octet type 1 information elements are used. This element is filled with spare bits set to zero and is placed in bits 5 to 8 of the octet unless otherwise specified.

### 10.5.1.9 Descriptive group or broadcast call reference

The purpose of the *Descriptive Group or Broadcast Call Reference* is to provide information describing a voice group or broadcast call. The IE of the *Descriptive Group or Broadcast Call Reference* is composed of the group or broadcast call reference together with a service flag, an acknowledgement flag, the call priority and the group cipher key number.

The *Descriptive Group or Broadcast Call Reference* information element is coded as shown in figure 10.5.8/3GPP TS 24.008 and Table 10.5.8/3GPP TS 24.008

The *Descriptive Group or Broadcast Call Reference* is a type 3 information element with 6 octets length.

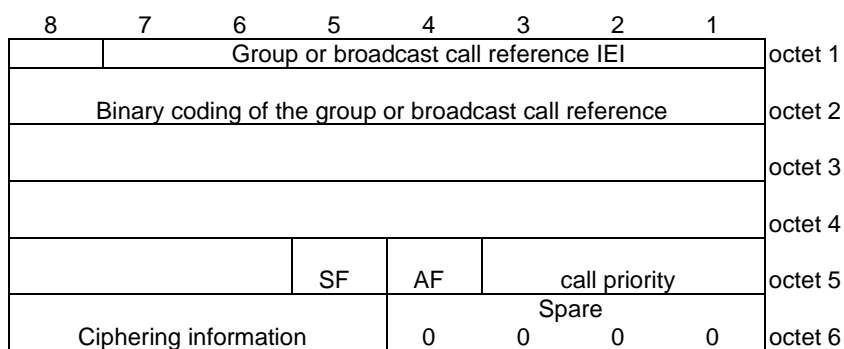

**Figure 10.5.8/3GPP TS 24.008 Descriptive Group or Broadcast Call Reference**

**Table 10.5.8/3GPP TS 24.008 Descriptive Group or Broadcast Call Reference**

Binary code of the group or broadcast call reference				
The length of the binary code has 27 bits which is encoded in the octet 2, 3, 4 and Bits 8,7,6 (octet 5).				
The highest bit of the BC is the bit 8 in the octet 2 and the lowest bit is allocated in the bit 6 in the octet 5. (see also 3GPP TS 23.003 [10])				
SF Service flag (octet 5)				
Bit				
<b>5</b>				
0	VBS (broadcast call reference)			
1	VGCS (group call reference)			
AF Acknowledgement flag (octet 5), network to MS direction:				
Bit				
<b>4</b>				
0	acknowledgement is not required			
1	acknowledgement is required			
Call priority (octet 5)				
Bit				
<b>3</b>	<b>2</b>	<b>1</b>		
0	0	0	no priority applied	
0	0	1	call priority level 4	
0	1	0	call priority level 3	
0	1	1	call priority level 2	
1	0	0	call priority level 1	
1	0	1	call priority level 0	
1	1	0	call priority level B	
1	1	1	call priority level A	
Cipherng information (octet 6)				
Bit				
<b>8</b>	<b>7</b>	<b>6</b>	<b>5</b>	
0	0	0	0	no cipherng
0	0	0	1	cipherng with cipher key number 1
0	0	1	0	cipherng with cipher key number 2
0	0	1	1	cipherng with cipher key number 3
0	1	0	0	cipherng with cipher key number 4
0	1	0	1	cipherng with cipher key number 5
0	1	1	0	cipherng with cipher key number 6
0	1	1	1	cipherng with cipher key number 7
1	0	0	0	cipherng with cipher key number 8
1	0	0	1	cipherng with cipher key number 9
1	0	1	0	cipherng with cipher key number A
1	0	1	1	cipherng with cipher key number B
1	1	0	0	cipherng with cipher key number C
1	1	0	1	cipherng with cipher key number D
1	1	1	0	cipherng with cipher key number E
1	1	1	1	cipherng with cipher key number F
AF Acknowledgement flag (octet 5), MS to network direction:				
Bit 4 is spare and shall be set to "0".				
Call priority (octet 5)				
Bits 1 to 3 are spare and shall be set to "0".				
Cipherng information (octet 6)				
Bits 5 to 8 are spare and shall be set to "0".				

### 10.5.1.10 Group Cipher Key Number

The purpose of the *Group Cipher Key Number* is to provide information on the group cipher key to be used for cipherng and decipherng by the mobile station.

The *Group Cipher Key Number* information element is coded as shown in figure 10.5.9/3GPP TS 24.008 and Table 10.5.9/3GPP TS 24.008

The *Group Cipher Key Number* is a type 1 information element with 1 octet length.

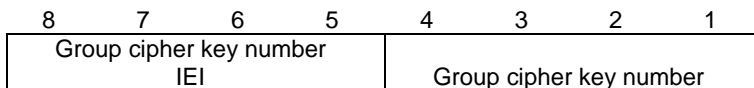

**Figure 10.5.9/3GPP TS 24.008 Group Cipher Key Number**

**Table 10.5.9/3GPP TS 24.008 Group Cipher Key Number**

Group cipher key number				
Bit				
<b>4</b>	<b>3</b>	<b>2</b>	<b>1</b>	
0	0	0	0	spare
0	0	0	1	cipher key number 1
0	0	1	0	cipher key number 2
0	0	1	1	cipher key number 3
0	1	0	0	cipher key number 4
0	1	0	1	cipher key number 5
0	1	1	0	cipher key number 6
0	1	1	1	cipher key number 7
1	0	0	0	cipher key number 8
1	0	0	1	cipher key number 9
1	0	1	0	cipher key number A
1	0	1	1	cipher key number B
1	1	0	0	cipher key number C
1	1	0	1	cipher key number D
1	1	1	0	cipher key number E
1	1	1	1	cipher key number F

**10.5.1.10a PD and SAPI \$(CCBS)\$**

The purpose of the *PD and SAPI* information element is to provide information concerning Protocol Discriminators and Service Access Point Identifiers.

The *PD and SAPI* information element is coded as shown in figure 10.5.10/3GPP TS 24.008 and table 10.5.10/3GPP TS 24.008.

The *PD and SAPI* is a type 3 information element with 2 octets length.

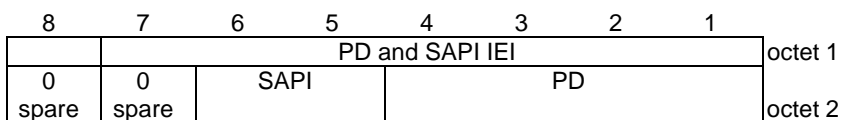

**Figure 10.5.10/3GPP TS 24.008 PD and SAPI information element**

**Table 10.5.1.10/3GPP TS 24.008: PD and SAPI information element**

SAPI: Service Access Point Identifier (octet 2)		
Bits		
<b>6</b>	<b>5</b>	
0	0	SAPI 0
0	1	reserved
1	0	reserved
1	1	SAPI 3
PD: Protocol Discriminator (octet 2)		
bits 4-1		
Encoded as specified in subclause 11.2.1 of 3GPP TS 24.007.		

### 10.5.1.11 Priority Level

The purpose of the *Priority Level* is to provide information defining the priority level requested or applied. The *Priority Level IE* may be included in CM\_SERVICE\_REQUEST, CALL\_PROCEEDING and SETUP messages.

The *Priority Level* information element is coded as shown in figure 10.5.11/3GPP TS 24.008 and table 10.5.11/3GPP TS 24.008.

The *Priority Level* is a type 1 information element with 1 octet length.

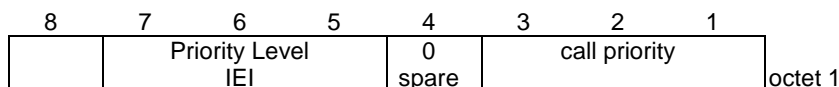
**Figure 10.5.11/3GPP TS 24.008 Priority Level****Table 10.5.11/3GPP TS 24.008 Priority Level**

Call priority (octet 1)			
Bit			
<b>3</b>	<b>2</b>	<b>1</b>	
0	0	0	no priority applied
0	0	1	call priority level 4
0	1	0	call priority level 3
0	1	1	call priority level 2
1	0	0	call priority level 1
1	0	1	call priority level 0
1	1	0	call priority level B
1	1	1	call priority level A

### 10.5.1.12 Core Network System Information (UMTS only)

The purpose of the *Core Network System Information* is to provide the MS with actual parameter settings of system information parameters controlling MM and GMM functionality. The Core Network system information is included in specific information elements within some RRC messages sent to MS, see 3GPP TS 25.331 [23c].

NOTE: These IEs do not have an IEI or a length indicator, because these IEs are never present in any layer 3 messages, Hence these IEs do not conform to the general IE rules defined in 24.007 [20].

#### 10.5.1.12.1 CN Common GSM-MAP NAS system information

The purpose of the *CN Common GSM-MAP NAS system information* element is to provide the MS with actual parameter settings of parameters relevant for both MM and GMM functionality. The coding of the information element

identifier and length information is defined in the 3GPP TS 25.331 [23c]. Only the coding of the content is in the scope of the present document.

The content of the *CN common GSM-MAP NAS system information* element is coded as shown in figure 10.5.1.12.1/3GPP TS 24.008 and table 10.5.1.12.1/3GPP TS 24.008.

The length of this element content is two octets. The MS shall ignore any additional octets received.

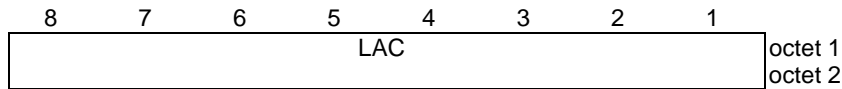

**Figure 10.5.1.12.1/3GPP TS 24.008 Common system information element**

**Table 10.5.1.12.1/3GPP TS 24.008: Common system information element**

<b>LAC, Location Area Code</b> (2 octet field) This field is the binary representation of the Location Area Code, see 3GPP TS 23.003. The LAC field consists of 16 bits. Bit 8 in octet 1 is the most significant bit and bit 1 in octet 2 is the least significant bit.
---

#### 10.5.1.12.2 CS domain specific system information

The purpose of the *CN domain specific GSM-MAP NAS system information* element, when used for the CS domain, is to provide the MS with actual parameter settings of parameters relevant only for MM functionality. The coding of the information element identifier and length information is defined in the 3GPP TS 25.331 [23c]. Only the coding of the content is in the scope of the present document.

For CS domain, the content of the *CN domain specific GSM-MAP NAS system information* element is coded as shown in figure 10.5.1.12.2/3GPP TS 24.008 and table 10.5.1.12.2/3GPP TS 24.008. The length of this element content is two octets. The MS shall ignore any additional octets received.

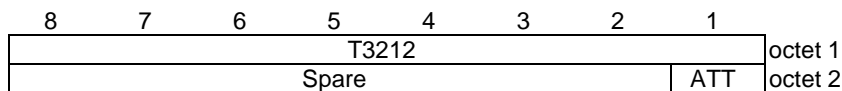

**Figure 10.5.1.12.2/3GPP TS 24.008 CS domain specific system information element**

**Table 10.5.1.12.2/3GPP TS 24.008: CS domain specific system information element**

<b>T3212 timeout value</b> (1 octet field) The T3212 timeout field is coded as the binary representation of the timeout value for periodic updating in dechours. Bit 8 in octet 1 is the most significant bit and bit 1 in octet 1 is the least significant bit. Range: 1 to 255 The value 0 is used for infinite timeout value i.e. periodic updating shall not be used
<b>ATT, Attach-detach allowed</b> (1 bit field): Bit 1 0 MSs shall not apply IMSI attach and detach procedure. 1 MSs shall apply IMSI attach and detach procedure
The bits 2 – 8 of octet 2 are spare and shall be coded all zeros.

#### 10.5.1.12.3 PS domain specific system information

The purpose of the *CN domain specific GSM-MAP NAS system information* element, when used for the PS domain, is to provide the MS with actual parameter settings of parameters relevant only for GMM functionality. The coding of the information element identifier and length information is defined in the 3GPP TS 25.331. Only the coding of the content is in the scope of the present document.

For PS domain, the content of the *CN domain specific GSM-MAP NAS system information* element is coded as shown in figure 10.5.1.12.3/3GPP TS 24.008 and table 10.5.1.12.3/3GPP TS 24.008. The length of this element content is two octets. The MS shall ignore any additional octets received.

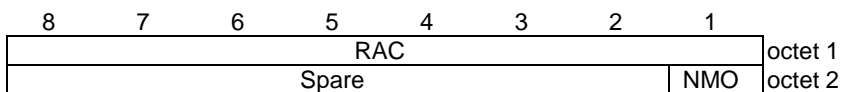

**Figure 10.5.1.12.3/3GPP TS 24.008 PS domain specific system information element**

**Table 10.5.1.12.3/3GPP TS 24.008: PS domain specific system information element**

<p><b>RAC, Routing Area Code</b> (8 bit field)                  This field is the binary representation of the Routing Area Code, see 3GPP TS 23.003. Bit 8 in octet 1 is the most significant bit and bit 1 in octet 1 is the least significant bit.</p> <p><b>NMO, Network Mode of Operation</b> (1 bit field)                  This field is the binary representation of the Network Mode of Operation, see 3GPP TS 23.060</p> <p>Bit 1                  0 Network Mode of Operation I                  1 Network Mode of Operation II</p> <p>The bits 2 – 8 of octet 2 are spare and shall be coded all zeros.</p>
---

### 10.5.1.13 PLMN list

The purpose of the *PLMN List* information element is to provide a list of PLMN codes to the mobile station.

The *PLMN List* information element is coded as shown in figure 10.5.13/3GPP TS 24.008 and table 10.5.13/3GPP TS 24.008.

The *PLMN List* is a type 4 information element with a minimum length of 5 octets and a maximum length of 47 octets.

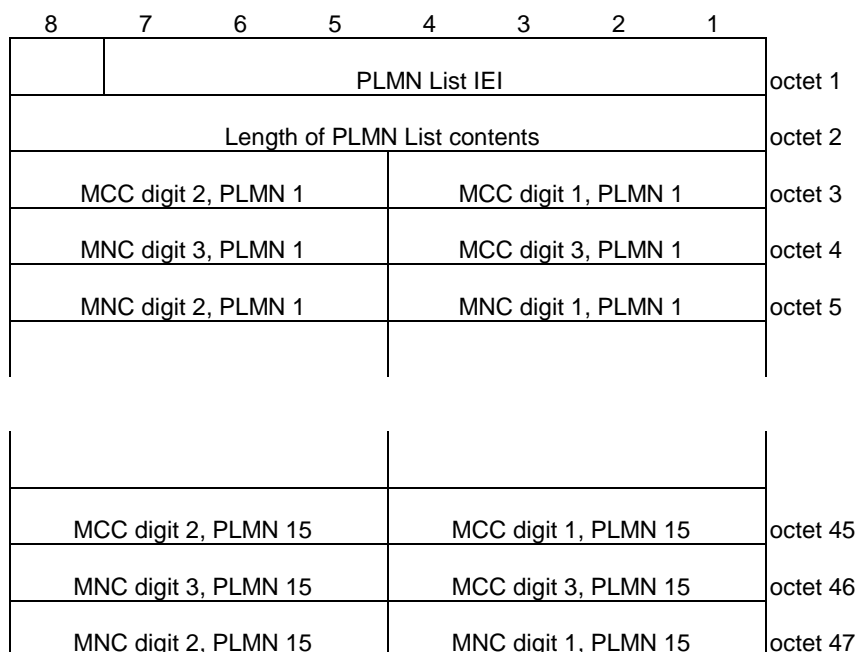

**Figure 10.5.13/3GPP TS 24.008 PLMN List information element**



**Table 10.5.13/3GPP TS 24.008: *PLMN List* information element**

<p>MCC, Mobile country code (octet 3, octet 4 bits 1 to 4) The MCC field is coded as in ITU-T Rec. E212, Annex A.</p> <p>MNC, Mobile network code (octet 5, octet 4 bits 5 to 8). The coding of this field is the responsibility of each administration but BCD coding shall be used. The MNC shall consist of 2 or 3 digits. For PCS 1900 for NA, Federal regulation mandates that a 3-digit MNC shall be used. However a network operator may decide to use only two digits in the MNC over the radio interface. In this case, bits 5 to 8 of octet 4 shall be coded as "1111". Mobile equipment shall accept MNC coded in such a way.</p>
--

10.5.1.14 NAS container for PS HO

The purpose of the *NAS container for PS HO* information element is to indicate the NAS specific information for the PS handover to A/Gb mode. The *NAS container for PS HO* information element is included in the PS HO command message, see 3GPP TS 44.060 [76]. The coding of the information element identifier and length information is defined in 3GPP TS 44.060 [76].

The content of the *NAS container for PS HO* information element is coded as shown in figure 10.5.1.14/3GPP TS 24.008 and table 10.5.1.14/3GPP TS 24.008. The length of this information element is 5 octets. The MS shall ignore any additional octets received.

8	7	6	5	4	3	2	1	
0	0	0	old	0	Type of ciphering			octet 1
spare	spare	spare	XID	spare	algorithm			
IOV-UI value (High-order octet)								octet 2
IOV-UI value (continued)								octet 3
IOV-UI value (continued)								octet 4
IOV-UI value (Low-order octet)								octet 5

**Figure 10.5.1.14/3GPP TS 24.008 *NAS container for PS HO* information element**

**Table 10.5.1.14/3GPP TS 24.008: *NAS container for PS HO* information element**

<b>Type of ciphering algorithm</b> (octet 1, bits 1 to 3)			
Bits			
<b>3</b>	<b>2</b>	<b>1</b>	
0	0	0	ciphering not used
0	0	1	GPRS Encryption Algorithm GEA/1
0	1	0	GPRS Encryption Algorithm GEA/2
0	1	1	GPRS Encryption Algorithm GEA/3
1	0	0	GPRS Encryption Algorithm GEA/4
1	0	1	GPRS Encryption Algorithm GEA/5
1	1	0	GPRS Encryption Algorithm GEA/6
1	1	1	GPRS Encryption Algorithm GEA/7
Bit 4 of octet 1 is spare and shall be coded as zero.			
<b>old XID</b> (octet 1, bit 5):			
With this bit the network indicates, which LLC layer parameters and layer-3 parameters the MS shall use in the target cell after it has performed the Reset of LLC and SNDCP.			
Bit 5			
0	The MS shall perform a Reset of LLC and SNDCP without old XID indicator as specified in 3GPP TS 44.064 [78a] and 3GPP TS 44.065 [78].		
1	The MS shall perform a Reset of LLC and SNDCP with old XID indicator as specified in 3GPP TS 44.064 [78a] and 3GPP TS 44.065 [78].		

The bits 6 – 8 of octet 1 are spare and shall be coded all zeroes.

**IOV-UI value** (octet 2 to 5)

The IOV-UI value consists of 32 bits, the format is defined in 3GPP TS 44.064 [78a].

## 10.5.2 Radio Resource management information elements.

See 3GPP TS 44.018 [84].

## 10.5.3 Mobility management information elements.

### 10.5.3.1 Authentication parameter RAND

The purpose of the *Authentication Parameter RAND* information element is to provide the mobile station with a non-predictable number to be used to calculate the authentication response signature SRES and the ciphering key Kc (for a GSM authentication challenge), or the response RES and both the ciphering key CK and integrity key IK (for a UMTS authentication challenge).

The *Authentication Parameter RAND* information element is coded as shown in figure 10.5.75/3GPP TS 24.008 and table 10.5.89/3GPP TS 24.008.

The *Authentication Parameter RAND* is a type 3 information element with 17 octets length.

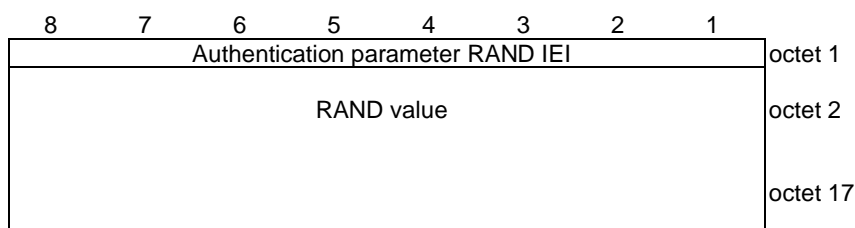

**Figure 10.5.75/3GPP TS 24.008 Authentication Parameter RAND information element**

**Table 10.5.89/3GPP TS 24.008: Authentication Parameter RAND information element**

**RAND value** (octet 2, 3,... and 17)

The RAND value consists of 128 bits. Bit 8 of octet 2 is the most significant bit while bit 1 of octet 17 is the least significant bit.

#### 10.5.3.1.1 Authentication Parameter AUTN (UMTS authentication challenge only)

The purpose of the *Authentication Parameter AUTN* information element is to provide the MS with a means of authenticating the network.

The *Authentication Parameter AUTN* information element is coded as shown in figure 10.5.75.1/3GPP TS 24.008 and table 10.5.89.1/3GPP TS 24.008.

The *Authentication Parameter AUTN* is a type 4 information element with a length of 18 octets.

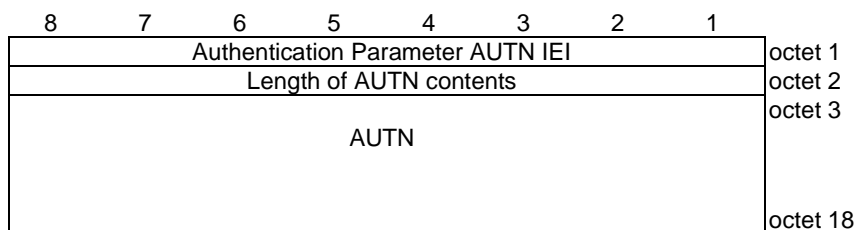

**Figure 10.5.75.1/3GPP TS 24.008 Authentication Parameter AUTN information element (UMTS authentication challenge only)**

**Table 10.5.89.1/3GPP TS 24.008 Authentication Parameter AUTN information element (UMTS authentication challenge only)**

AUTN value (octets 3 to 18) The AUTN consists of (SQN xor AK)  AMF  MAC =48+16+64 bits (see 3GPP TS 33.102 [5a])
---

### 10.5.3.2 Authentication Response parameter

The purpose of the *authentication response parameter* information element is to provide the network with the authentication response calculated in the SIM/USIM.

The *Authentication Parameter SRES* information element is coded as shown in figure 10.5.76/3GPP TS 24.008 and tables 10.5.90 a & b /3GPP TS 24.008.

The *Authentication Response Parameter* is a type 3 information element with 5 octets length. In a GSM authentication challenge, the response calculated in the SIM/USIM (SRES) is 4 bytes in length, and is placed in the *Authentication Response Parameter* information element.

In a UMTS authentication challenge, the response calculated in the USIM (RES) may be up to 16 octets in length. The 4 most significant octets shall be included in the *Authentication Response Parameter* information element. The remaining part of the RES shall be included in the Authentication Response Parameter (extension) IE (see subclause 10.5.3.2.1)

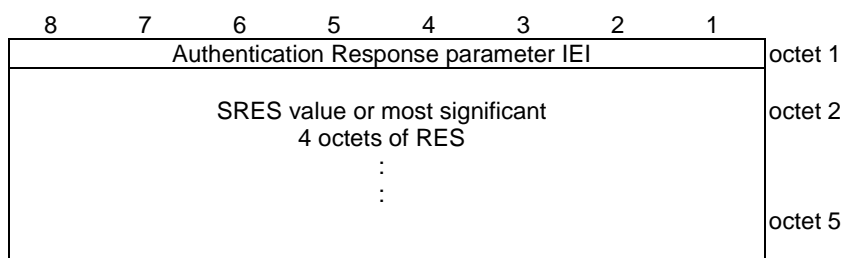

**Figure 10.5.76/3GPP TS 24.008 Authentication Response Parameter information element**

**Table 10.5.90a/3GPP TS 24.008: Authentication Response Parameter information element (SRES) (GSM authentication challenge only)**

SRES value (octet 2, 3, 4 and 5) The SRES value consists of 32 bits. Bit 8 of octet 2 is the most significant bit while bit 1 of octet 5 is the least significant bit.
---

**Table 10.5.90b/3GPP TS 24.008: Authentication Response Parameter information element (RES) (UMTS authentication challenge only)**

RES value (octet 2, 3, 4 and 5) This contains the most significant 4 octets of RES If RES>4 octets, the remaining octets of RES shall appear in the Authentication Response Parameter (extension) IE (see subclause 10.5.3.2.1)
---

**10.5.3.2.1 Authentication Response Parameter (extension) (UMTS authentication challenge only)**

This IE is included if the authentication response parameter RES is longer than 4 octets (UMTS only) and therefore does not fit in the Authentication Response Parameter field (see 10.5.3.2).

The Authentication Response parameter (extension) IE is coded as shown in figure 10.5.76.1/3GPP TS 24.008 and table 10.5.90.1/3GPP TS 24.008.

The Authentication Response parameter (extension) IE is a type 4 information element with a minimum length of 3 octets and a maximum length of 14 octets.

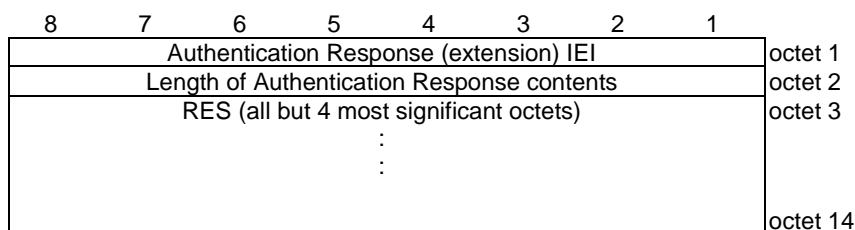

**Figure 10.5.76.1/3GPP TS 24.008 Authentication Response Parameter (extension) information element (UMTS authentication challenge only)**

**Table 10.5.90.1/3GPP TS 24.008: Authentication Response Parameter (extension) information element (RES)**

RES (extension) value (octet 3 to 14)  This contains all but the 4 most significant octets of RES
---

**10.5.3.2.2 Authentication Failure parameter (UMTS authentication challenge only)**

The purpose of the *Authentication Failure parameter* information element is to provide the network with the necessary information to begin a re-authentication procedure (see 3GPP TS 33.102 [5a]) in the case of a 'Synch failure', following a UMTS authentication challenge.

The Authentication Failure parameter IE is coded as shown in figure 10.5.76.2/3GPP TS 24.008 and table 10.5.90.2/3GPP TS 24.008.

The Authentication Failure parameter IE is a type 4 information element with a length of 16 octets.

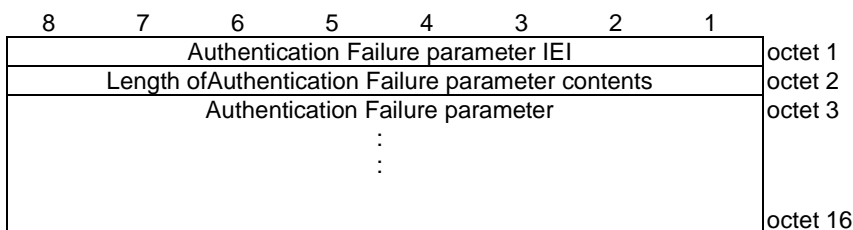

**Figure 10.5.76.2/3GPP TS 24.008 Authentication Failure parameter information element (UMTS authentication challenge only)**

**Table 10.5.90.2/3GPP TS 24.008: Authentication Failure parameter information element**

Authentication Failure parameter value (octet 3 to 16)
This contains AUTS (see 3GPP TS 33.102 [5a])

### 10.5.3.3 CM service type

The purpose of the *CM Service Type* information element is to specify which service is requested from the network.

The *CM Service Type* information element is coded as shown in figure 10.5.77/3GPP TS 24.008 and table 10.5.91/3GPP TS 24.008.

The *CM Service Type* is a type 1 information element.

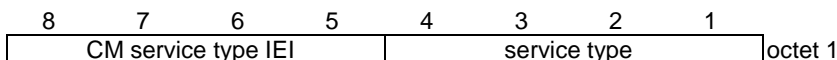

**Figure 10.5.77/3GPP TS 24.008 CM Service Type information element**

**Table 10.5.91/3GPP TS 24.008: CM Service Type information element**

Service type (octet 1)	
Bits	
4 3 2 1	
0 0 0 1	Mobile originating call establishment or packet mode connection establishment
0 0 1 0	Emergency call establishment
0 1 0 0	Short message service
1 0 0 0	Supplementary service activation
1 0 0 1	Voice group call establishment
1 0 1 0	Voice broadcast call establishment
1 0 1 1	Location Services (NOTE)
All other values are reserved.	
NOTE: this service type shall only be used by a type A LMU if the MM connection was requested for the transmission of LCS signalling messages specified in 3GPP TS 44.071 [23a].	

### 10.5.3.4 Identity type

The purpose of the *Identity Type* information element is to specify which identity is requested.

The *Identity Type* information element is coded as shown in figure 10.5.78/3GPP TS 24.008 and table 10.5.92/3GPP TS 24.008.

The *Identity Type* is a type 1 information element.

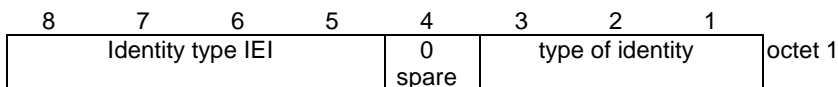

**Figure 10.5.78/3GPP TS 24.008 *Identity Type* information element**

**Table 10.5.92/3GPP TS 24.008: *Identity Type* information element**

Type of identity (octet 1)	
Bits	
<b>3</b>	<b>2 1</b>
0 0 1	IMSI
0 1 0	IMEI
0 1 1	IMEISV
1 0 0	TMSI
All other values are reserved.	

### 10.5.3.5 Location updating type

The purpose of the *Location Updating Type* information element is to indicate whether a normal updating, a periodic updating or an IMSI attach is wanted. It may also indicate that a follow-on request has been received from the mobile station CM layer.

The *Location Updating Type* information element is coded as shown in figure 10.5.79/3GPP TS 24.008 and table 10.5.93/3GPP TS 24.008.

The *Location Updating Type* is a type 1 information element.

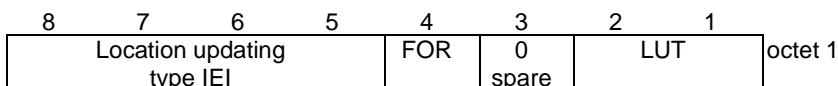

**Figure 10.5.79/3GPP TS 24.008 *Location Updating Type* information element**

**Table 10.5.93/3GPP TS 24.008: *Location Updating Type* information element**

LUT (octet 1)	
Bits	
<b>2</b>	<b>1</b>
0 0	Normal location updating
0 1	Periodic updating
1 0	IMSI attach
1 1	Reserved
FOR (octet 1)	
The Follow-On Request bit (FOR) is coded as follows:	
Bits	
<b>4</b>	
0	No follow-on request pending
1	Follow-on request pending

### 10.5.3.5a Network Name

The purpose of this information element is to pass a text string to the mobile station.

The *Network Name* information element is coded as shown in figure 10.5.80/3GPP TS 24.008 and table 10.5.94/3GPP TS 24.008.

The *Network Name* is a type 4 information element with a minimum length of 3 octets. No upper length limit is specified except for that given by the maximum number of octets in a L3 message (see 3GPP TS 44.006 [19]).

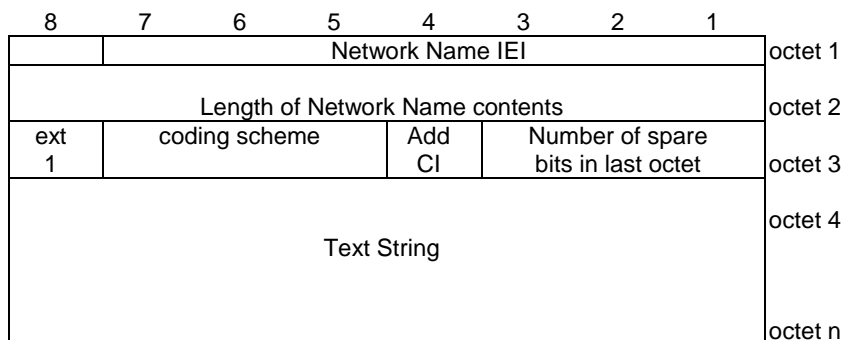

**Figure 10.5.80/3GPP TS 24.008 *Network Name* information element**

**Table 10.5.94/3GPP TS 24.008 *Network Name* information element**

Number of spare bits in last octet (octet 3, bits 1 to 3)	
<b>2 1</b>	
0 0 1	bit 8 is spare and set to "0" in octet n
0 1 0	bits 7 and 8 are spare and set to "0" in octet n
0 1 1	bits 6 to 8(inclusive) are spare and set to "0" in octet n
1 0 0	bits 5 to 8(inclusive) are spare and set to "0" in octet n
1 0 1	bits 4 to 8(inclusive) are spare and set to "0" in octet n
1 1 0	bits 3 to 8(inclusive) are spare and set to "0" in octet n
1 1 1	bits 2 to 8(inclusive) are spare and set to "0" in octet n
0 0 0	this field carries no information about the number of spare bits in octet n
Add CI (octet 3, bit 4)	
0	The MS should not add the letters for the Country's Initials to the text string
1	The MS should add the letters for the Country's Initials and a separator (e.g. a space) to the text string
Coding Scheme (octet 3, bits 5-7)	
0 0 0	Cell Broadcast data coding scheme, GSM default alphabet, language unspecified, defined in 3GPP TS 23.038 [8b]
0 0 1	UCS2 (16 bit) [72]
0 1 0	
to	reserved
1 1 1	
Text String (octet 4 to octet n, inclusive)	
Encoded according to the Coding Scheme defined by octet 3, bits 5-7	

### 10.5.3.6 Reject cause

The purpose of the *Reject Cause* information element is to indicate the reason why a request from the mobile station is rejected by the network.

The *Reject Cause* information element is coded as shown in figure 10.5.81/3GPP TS 24.008 and table 10.5.95/3GPP TS 24.008.

The *Reject Cause* is a type 3 information element with 2 octets length.

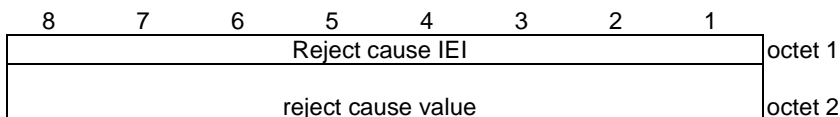

Figure 10.5.81/3GPP TS 24.008 *Reject Cause* information element

Table 10.5.95/3GPP TS 24.008: *Reject Cause* information element

Reject cause value (octet 2)								
Bits								
8	7	6	5	4	3	2	1	
0	0	0	0	0	0	1	0	IMSI unknown in HLR
0	0	0	0	0	0	1	1	Illegal MS
0	0	0	0	0	1	0	0	IMSI unknown in VLR
0	0	0	0	0	1	0	1	IMEI not accepted
0	0	0	0	0	1	1	0	Illegal ME
0	0	0	0	1	0	1	1	PLMN not allowed
0	0	0	0	1	1	0	0	Location Area not allowed
0	0	0	0	1	1	0	1	Roaming not allowed in this location area
0	0	0	0	1	1	1	1	No Suitable Cells In Location Area
0	0	0	1	0	0	0	1	Network failure
0	0	0	1	0	1	0	0	MAC failure
0	0	0	1	0	1	0	1	Synch failure
0	0	0	1	0	1	1	0	Congestion
0	0	0	1	0	1	1	1	GSM authentication unacceptable
0	0	1	0	0	0	0	0	Service option not supported
0	0	1	0	0	0	0	1	Requested service option not subscribed
0	0	1	0	0	0	1	0	Service option temporarily out of order
0	0	1	0	0	1	1	0	Call cannot be identified
0	0	1	1	0	0	0	0	}
to								} retry upon entry into a new cell
0	0	1	1	1	1	1	1	}
0	1	0	1	1	1	1	1	Semantically incorrect message
0	1	1	0	0	0	0	0	Invalid mandatory information
0	1	1	0	0	0	0	1	Message type non-existent or not implemented
0	1	1	0	0	0	1	0	Message type not compatible with the protocol state
0	1	1	0	0	0	1	1	Information element non-existent or not implemented
0	1	1	0	0	1	0	0	Conditional IE error
0	1	1	0	0	1	0	1	Message not compatible with the protocol state
0	1	1	0	1	1	1	1	Protocol error, unspecified

Any other value received by the mobile station shall be treated as 0010 0010, 'Service option temporarily out of order'. Any other value received by the network shall be treated as 0110 1111, 'Protocol error, unspecified'.

NOTE: The listed reject cause values are defined in Annex G.

### 10.5.3.7 Follow-on Proceed

The purpose of the *Follow-on Proceed* information element is to indicate that an MM connection may be established on an existing RR connection.

The *Follow-on Proceed* information element is coded as shown in figure 10.5.82/3GPP TS 24.008.

The *Follow-on Proceed* is a type 2 information element.



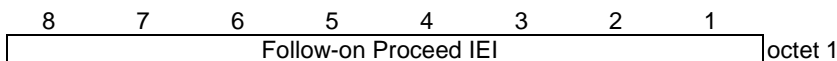

**Figure 10.5.82/3GPP TS 24.008 Follow-on Proceed information element**

### 10.5.3.8 Time Zone

The purpose of this information element is to encode the offset between universal time and local time in steps of 15 minutes.

The *Time Zone* information element is coded as shown in figure 10.5.83/3GPP TS 24.008 and table 10.5.96/3GPP TS 24.008.

The *Time Zone* is a type 3 information element with a length of 2 octets.

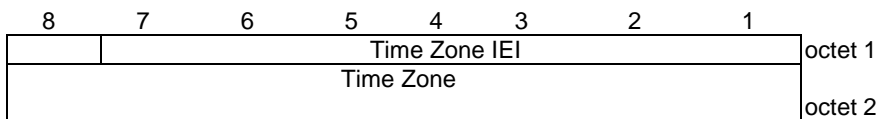

**Figure 10.5.83/3GPP TS 24.008 Time Zone information element**

**Table 10.5.96/3GPP TS 24.008 Time Zone information element**

<p>Time Zone (octet 2, bits 1-8)                  This field uses the same format as the Timezone field used in the TP-Service-Centre-Time-Stamp, which is defined in 3GPP TS 23.040 [90], and its value shall be set as defined in 3GPP TS 22.042 [89]</p>
---

### 10.5.3.9 Time Zone and Time

The purpose of the timezone part of this information element is to encode the offset between universal time and local time in steps of 15 minutes.

The purpose of the time part of this information element is to encode the universal time at which this information element may have been sent by the network.

The *Time Zone and Time* information element is coded as shown in figure 10.5.84/3GPP TS 24.008 and table 10.5.97/3GPP TS 24.008.

The *Time Zone and Time* is a type 3 information element with a length of 8 octets.

8	7	6	5	4	3	2	1	
Time Zone and Time IEI								octet 1
Year								octet 2
Month								octet 3
Day								octet 4
Hour								octet 5
Minute								octet 6
Second								octet 7
Time zone								octet 8

**Figure 10.5.84/3GPP TS 24.008 Time Zone and Time information element**

**Table 10.5.97/3GPP TS 24.008 Timezone and Time information element**

<p>Year (octet 2, bits 1-8)</p> <p>This field uses the same format as the Year field used in the TP-Service-Centre-Time-Stamp, which is defined in 3GPP TS 23.040 [90], and its value shall be set as defined in 3GPP TS 22.042 [89].</p> <p>Month (octet 3, bits 1-8)</p> <p>This field uses the same format as the Month field used in the TP-Service-Centre-Time-Stamp, which is defined in 3GPP TS 23.040 [90], and its value shall be set as defined in 3GPP TS 22.042 [89].</p> <p>Day (octet 4, bits 1-8)</p> <p>This field uses the same format as the Day field used in the TP-Service-Centre-Time-Stamp, which is defined in 3GPP TS 23.040 [90], and its value shall be set as defined in 3GPP TS 22.042 [89].</p> <p>Hour (octet 5, bits 1-8)</p> <p>This field uses the same format as the Hour field used in the TP-Service-Centre-Time-Stamp, which is defined in 3GPP TS 23.040 [90], and its value shall be set as defined in 3GPP TS 22.042 [89].</p> <p>Minute (octet 6, bits 1-8)</p> <p>This field uses the same format as the Minute field used in the TP-Service-Centre-Time-Stamp, which is defined in 3GPP TS 23.040 [90], and its value shall be set as defined in 3GPP TS 22.042 [89].</p> <p>Second (octet 7, bits 1-8)</p> <p>This field uses the same format as the Second field used in the TP-Service-Centre-Time-Stamp, which is defined in 3GPP TS 23.040 [90], and its value shall be set as defined in 3GPP TS 22.042 [89].</p> <p>Time Zone (octet 8, bits 1-8)</p> <p>This field uses the same format as the Time Zone field used in the TP-Service-Centre-Time-Stamp, which is defined in 3GPP TS 23.040 [90], and its value shall be set as defined in 3GPP TS 22.042 [89].</p>
---

**NOTE:** Due to ambiguities in earlier versions of the protocol specifications, some mobile stations may interpret the received NITZ time as local time. This may result in incorrect time settings in the mobile.

### 10.5.3.10 CTS permission

The purpose of the *CTS permission* information element is to indicate that the mobile station is allowed to use GSM-Cordless Telephony System in the Location Area. The *CTS permission* information element is coded as shown in figure 10.5.84a/3GPP TS 24.008.

The *CTS permission* is a type 2 information element.

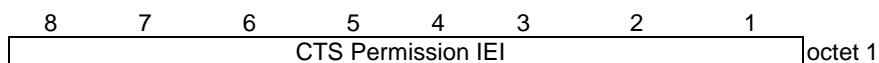

**Figure 10.5.84a/3GPP TS 24.008 CTS permission information element**

### 10.5.3.11 LSA Identifier

This element uniquely identifies a LSA.

The *LSA Identifier* information element is coded as shown in figure 10.68c/3GPP TS 24.008.

The *LSA Identifier* is a type 4 information element with a length of 2 or 5 octets.

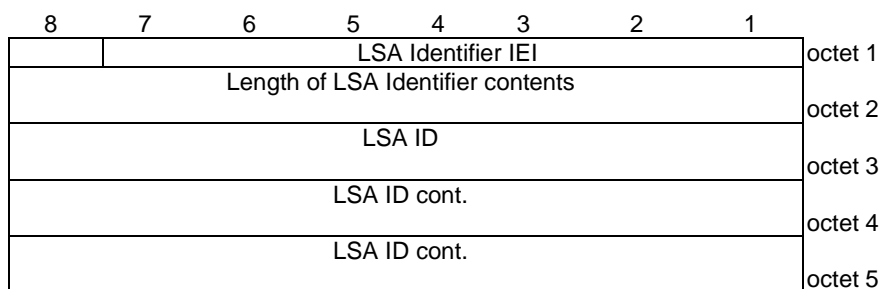

**Figure 10.68c/3GPP TS 24.008 LSA Identifier information element**

If the Length = 0, then no LSA ID is included. This is used to indicate that the MS has moved to an area where there is no LSA available for that MS.

Octets 3-5 are coded as specified in 3GPP TS 23.003 [10], 'Identification of Localised Service Area'. Bit 8 of octet 3 is the most significant bit.

### 10.5.3.12 Daylight Saving Time

The purpose of this information element is to encode the Daylight Saving Time in steps of 1 hour.

The *Daylight Saving Time* information element is coded as shown in figure 10.5.84b/3GPP TS 24.008 and table 10.5.97a/3GPP TS 24.008.

The *Daylight Saving Time* is a type 4 information element with a length of 3 octets.

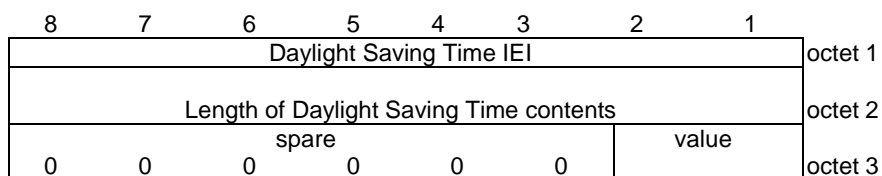

**Figure 10.5.84b/3GPP TS 24.008 Daylight Saving Time information element**

**Table 10.5.97a/3GPP TS 24.008: Daylight Saving Time information element**

Daylight Saving Time value (octet 3)		
Bits		
<b>2</b>	<b>1</b>	
0	0	No adjustment for Daylight Saving Time
0	1	+1 hour adjustment for Daylight Saving Time
1	0	+2 hours adjustment for Daylight Saving Time
1	1	Reserved

### 10.5.3.13 Emergency Number List

The purpose of this information element is to encode emergency number(s) for use within the country (as indicated by MCC) where the IE is received.

The *Emergency Number List* information element is coded as shown in figure 10.5.97b/3GPP TS 24.008.

The *Emergency Number List IE* is a type 4 information element with a minimum length of 5 octets and a maximum length of 50 octets.

8	7	6	5	4	3	2	1	
Emergency Number List IEI								octet 1
Length of Emergency Number List IE contents								octet 2
Length of 1 <sup>st</sup> Emergency Number information note 1)								octet 3
spare		Emergency Service Category Value (see Table 10.5.135d/3GPP TS 24.008)						octet 4
0	0	0						
Number digit 2				Number digit 1				octet 5 note 2)
Number digit 4				Number digit 3				octet 6*
:				:				:
note 3)								octet j-1*
Length of 2 <sup>nd</sup> Emergency Number information note 1)								octet j*
spare		Emergency Service Category Value (see Table 10.5.135d/3GPP TS 24.008)						Octet j+1*
0	0	0						
Number digit 2				Number digit 1				octet j+2* note 2)
Number digit 4				Number digit 3				octet j+3*
:				:				:
note 3)								octet n*

NOTE 1: The length contains the number of octets used to encode the Emergency Service Category Value and the Number digits.

NOTE 2: The number digit(s) in octet 5 precedes the digit(s) in octet 6 etc. The number digit, which would be entered first, is located in octet 5, bits 1 to 4. The contents of the number digits are coded as shown in table 10.5.118/3GPP TS 24.008.

NOTE 3: If the emergency number contains an odd number of digits, bits 5 to 8 of the last octet of the respective emergency number shall be filled with an end mark coded as "1111".

**Figure 10.5.97b/3GPP TS 24.008 Emergency Number List information element**

## 10.5.4 Call control information elements

### 10.5.4.1 Extensions of codesets

There is a certain number of possible information element identifier values using the formatting rules described in subclause 10.5: 128 from the type 3 & 4 information element format and at least 8 from the type 1 & 2 information element format.

One value in the type 1 format is specified for shift operations described below. One other value in both the type 3 & 4 and type 1 format is reserved. This leaves 133 information element identifier values available for assignment.

It is possible to expand this structure to eight codesets of 133 information element identifier values each. One common value in the type 1 format is employed in each codeset to facilitate shifting from one codeset to another. The contents of this shift information element identifies the codeset to be used for the next information element or elements. The codeset in use at any given time is referred to as the "active codeset". By convention, codeset 0 is the initially active codeset.

Two codeset shifting procedures are supported: locking shift and non-locking shift.

Codeset 5 is reserved for information elements reserved for national use.

Codeset 6 is reserved for information elements specific to the local network (either public or private).

Codeset 7 is reserved for user-specific information elements.

The coding rules specified in subclause 10.5 shall apply for information elements belonging to any active codeset.

The mobile station and the network shall not apply the "comprehension required" scheme (see 3GPP TS 24.007 [20]) to information elements belonging to codesets different from codeset 0.

IEIs with bits 5, 6, 7 and 8 all set to zero should not be allocated for new optional information elements in codesets different from codeset 0, because there are legacy mobile stations that apply the "comprehension required" scheme also to these information elements, e.g. if such a mobile station receives a SETUP message containing an unknown information element from codeset 5 with an IEI with bits 5, 6, 7 and 8 all set to zero, then the mobile station will release the call.

Transitions from one active codeset to another (i.e. by means of the locking shift procedure) may only be made to a codeset with a higher numerical value than the codeset being left.

An information element belonging to codeset 5, 6 or 7 may appear together with information elements belonging to codeset 0, by using the non-locking shift procedure (see subclause 10.5.4.3).

A user or network equipment shall have the capability to recognize a shift information element and to determine the length of the following information element, although the equipment need not be able to interpret and act on the content of the information element. This enables the equipment to determine the start of the subsequent information element.

### 10.5.4.2 Locking shift procedure

The locking shift procedure employs an information element to indicate the new active codeset. The specified codeset remains active until another locking shift information element is encountered which specifies the use of another codeset. For example, codeset 0 is active at the start of message content analysis. If a locking shift to codeset 5 is encountered, the next information elements will be interpreted according to the information element identifiers assigned in codeset 5, until another shift information element is encountered. This procedure is used only to shift to a higher order codeset than the one being left.

The locking shift is valid only within that message which contains the locking shift information element. At the start of every message content analysis, the active codeset is codeset 0.

The locking shift information element uses the type 1 information element format and coding shown in figure 10.5.85/3GPP TS 24.008 and table 10.5.98/3GPP TS 24.008.

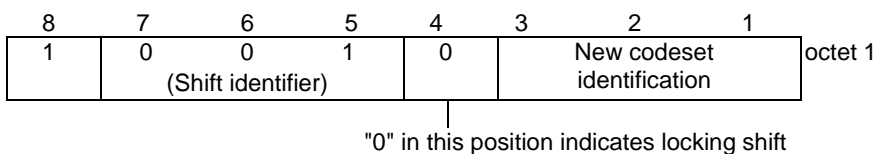

**Figure 10.5.85/3GPP TS 24.008 Locking shift element**

**Table 10.5.98/3GPP TS 24.008: Locking shift element**

Codeset identification (octet 1):			
Bits			
<b>3</b>	<b>2</b>	<b>1</b>	
0	0	0	not applicable
0	0	1	}
to		}	reserved
1	0	0	}
1	0	1	codeset 5: information elements for national use
1	1	0	codeset 6: information elements specific to the local network (either public or private)
1	1	1	codeset 7: user-specific information elements

### 10.5.4.3 Non-locking shift procedure

The non-locking shift procedure provides a temporary shift to the specified lower or higher codeset. The non-locking shift procedure uses a type 1 information element to indicate the codeset to be used to interpret the next information element. After the interpretation of the next information element, the active codeset is again used for interpreting any following information elements. For example, codeset 0 is active at the beginning of message content analysis. If a non-locking shift to codeset 6 is encountered, only the next information element is interpreted according to the information element identifiers assigned in codeset 6. After this information element is interpreted, codeset 0 will again be used to interpret the following information elements. A non-locking shift information element indicating the current codeset shall not be regarded as an error.

A locking shift information element shall not follow directly a non-locking shift information element. If this combination is received, it shall be interpreted as though a locking shift information element had been received.

The non-locking shift information element uses the type 1 information format and coding shown in figure 10.5.86/3GPP TS 24.008 and table 10.5.99/3GPP TS 24.008.

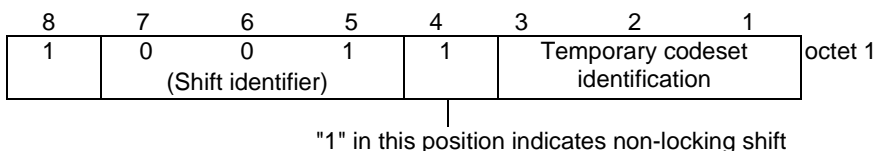

**Figure 10.5.86/3GPP TS 24.008 Non-locking shift element**

**Table 10.5.99/3GPP TS 24.008: Non-locking shift element**

Codeset identification (octet 1):			
Bits			
<b>3</b>	<b>2</b>	<b>1</b>	
0	0	0	codeset 0 (initially active): 3GPP TS 24.008 information elements
0	0	1	}
to			} reserved
1	0	0	}
1	0	1	codeset 5: information elements for national use
1	1	0	codeset 6: information elements specific to the local network (either public or private)
1	1	1	codeset 7: user-specific information elements

#### 10.5.4.4 Auxiliary states

The purpose of the auxiliary states information element is to describe the current status of the auxiliary states of a call in the call control states "active" and "mobile originating modify". (See TSs 3GPP TS 24.083 and 24.084 [28])

The auxiliary states information element is coded as shown in figure 10.5.87/3GPP TS 24.008, table 10.5.100/3GPP TS 24.008 and table 10.5.101/3GPP TS 24.008.

The auxiliary states is a type 4 information element with 3 octets length.

8	7	6	5	4	3	2	1	
Auxiliary states IEI								octet 1
Length of auxiliary states contents								octet 2
1	0	0	0	hold aux. state	MPTY aux. state			octet 3
ext	spare							

**Figure 10.5.87/3GPP TS 24.008 Auxiliary states information element****Table 10.5.100/3GPP TS 24.008: Auxiliary states information element**

Hold auxiliary state (octet 3)			
Bits			
<b>4</b>	<b>3</b>		
0	0	idle	Note 1
0	1	hold request	Note 1
1	0	call held	Note 1
1	1	retrieve request	Note 1
Note 1: These states are defined in Rec 3GPP TS 24.083 [27].			

**Table 10.5.101/3GPP TS 24.008: Auxiliary states information element**

Multi party auxiliary state (octet 3)			
Bits			
<b>2</b>	<b>1</b>		
0	0	idle	Note 2
0	1	MPTY request	Note 2
1	0	call in MPTY	Note 2
1	1	split request	Note 2
Note 2: These states are defined in Rec 3GPP TS 24.084 [28].			

### 10.5.4.4a Backup bearer capability

The purpose of the *backup bearer capability* IE is to indicate a requested service to a MS in case a complete description of the bearer service by a *bearer capability* IE is not available. The *backup bearer capability* information element is not subject to compatibility checking as described in annex B.

The *backup bearer capability* IE is coded as shown in figure 10.5.87a/3GPP TS 24.008 and tables 10.5.101a/3GPP TS 24.008 to 10.5.101m/3GPP TS 24.008.

The *backup bearer capability* is a type 4 information element with a minimum length of 3 octets and a maximum length of 15 octets.

	8	7	6	5	4	3	2	1	
	Backup bearer capability IEI								octet 1
	Length of the backup bearer capability contents								octet 2
1 ext	radio channel requirement		co-coding std	transfer mode	information transfer capability				octet 3
1 ext	comp-ress.	Structure		dupl. mode	confi gur.	NIRR	establi.		octet 4*
0/1 ext	0	0	rate adaption		signalling access protocol				octet 5*
1 ext	Other IT C		Other rate adaption		0	0	0 Spare		octet 5a*
0/1 ext	0	1	User information layer 1 protocol				sync/async		octet 6*
0/1 ext	numb. stop bits	negotiation	numb. data bits	user rate					octet 6a*
0/1 ext	intermed. rate		NIC on TX	NIC on RX	Parity				octet 6b*
0/1 ext	connection element		modem type					octet 6c*	
0/1 ext	Other modem type		Fixed network user rate					octet 6d*	
0/1 ext	Acceptable channel codings				Maximum number of traffic channels				octet 6e*
0/1 ext	UIMI			Wanted air interface user rate					octet 6f*
1 ext	Acceptable channel codings Extended			Asymmetry Indication		0	0 Spare		octet 6g*
1 ext	1	0	User information layer 2 protocol					octet 7*	

Figure 10.5.87a/3GPP TS 24.008 Backup bearer capability information element



NOTE: The coding of the octets of the *backup bearer capability* IE is not conforming to the coding of the *bearer capability* IE in ITU Q.931.

**Table 10.5.101a/3GPP TS 24.008: Backup bearer capability information element**

Radio channel requirement (octet 3)
In A/Gb mode and GERAN lu mode, i.e. not applicable for UTRAN lu mode data services.
Bits 6 and 7 are spare bits. The sending side (i.e. the network) shall set bit 7 to value 0 and bit 6 to value 1.
Coding standard (octet 3)
Bit
<b>5</b>
0 GSM standardized coding as described below
1 reserved
Transfer mode (octet 3)
Bit
<b>4</b>
0 circuit mode
1 packet mode
Information transfer capability (octet 3)
Bits
<b>3 2 1</b>
0 0 0 speech
0 0 1 unrestricted digital information
0 1 0 3.1 kHz audio, ex PLMN
0 1 1 facsimile group 3
1 0 1 Other ITC (See Octet 5a)
1 1 1 reserved, to be used in the network.
The meaning is: alternate speech/facsimile group 3 - starting with speech.
All other values are reserved

**Table 10.5.101b/3GPP TS 24.008: Backup bearer capability information element**

<p>Compression (octet 4) Bit 7 is spare and shall be set to '0'.</p> <p>Structure (octet 4)</p> <p>Bits <b>6 5</b> 0 0 service data unit integrity 1 1 unstructured</p> <p>All other values are reserved.</p> <p>Duplex mode (octet 4) Bit <b>4</b> 0 half duplex 1 full duplex</p> <p>Configuration (octet 4) Bit <b>3</b> 0 point-to-point</p> <p>All other values are reserved.</p> <p>NIRR (octet 4) (Negotiation of Intermediate Rate Requested) In A/Gb mode and GERAN lu mode, i.e. not applicable for UTRAN lu modedata services. Bit 2 is spare and shall be set to '0'.</p> <p>Establishment (octet 4) Bit <b>1</b> 0 demand</p> <p>All other values are reserved</p>
---

**Table 10.5.101c/3GPP TS 24.008: Backup bearer capability information element**

<p>Access identity (octet 5) Bits <b>7 6</b> 0 0 octet identifier</p> <p>All other values are reserved</p> <p>Rate adaption (octet 5) Bits <b>5 4</b> 0 0 no rate adaption 0 1 V.110, I.460/X.30 rate adaptation 1 0 ITU-T X.31 flag stuffing 1 1 Other rate adaption (see octet 5a)</p> <p>Signalling access protocol (octet 5) Bits <b>3 2 1</b> 0 0 1 I.440/450</p> <p>All other values are reserved.</p>
--

**Table 10.5.101d/3GPP TS 24.008: Backup bearer capability information element**

<p>Other ITC (octet 5a) If the value "Other ITC" is not signalled in the field "ITC" then the contents of this field shall be ignored.</p> <p>Bit <b>7 6</b> 0 0    restricted digital information</p> <p>All other values are reserved</p> <p>Other rate adaption (octet 5a) If the value " Other rate adaption" is not signalled in the field "Rate adaption" then the contents of this field shall be ignored. In UTRAN Iu mode, PIAFS shall be considered. In A/Gb mode and GERAN Iu mode, call shall be rejected if PIAFS requested.</p> <p>Bit <b>5 4</b> 0 0    V.120 0 1    H.223 &amp; H.245 1 0    PIAFS</p> <p>All other values are reserved.</p>
--

**Table 10.5.101e/3GPP TS 24.008: Backup bearer capability information element**

<p>Layer 1 identity (octet 6) Bits <b>7 6</b> 0 1    octet identifier</p> <p>All other values are reserved</p> <p>User information layer 1 protocol (octet 6) Bits <b>5 4 3 2</b> 0 0 0 0    default layer 1 protocol</p> <p>All other values reserved.</p> <p>Synchronous/asynchronous (octet 6) Bit <b>1</b> 0    synchronous 1    asynchronous</p>
---

**Table 10.5.101f/3GPP TS 24.008: Backup bearer capability information element**

Number of Stop Bits (octet 6a)	
Bit	
<b>7</b>	
0	1 bit (This value is also used in the case of synchronous mode)
1	2 bits
Negotiation (octet 6a)	
Bit	
<b>6</b>	
0	in-band negotiation not possible
NOTE: See Rec. V.110 and X.30	
All other values are reserved	
Number of data bits excluding parity bit if present (octet 6a)	
Bit	
<b>5</b>	
0	7 bits
1	8 bits (this value is also used in the case of bit oriented protocols)
User rate (octet 6a)	
In A/Gb mode and GERAN lu mode only.	
Bits	
<b>4 3 2 1</b>	
0 0 0 0	User rate unknown
0 0 0 1	0.3 kbit/s Recommendation X.1 and V.110
0 0 1 0	1.2 kbit/s Recommendation X.1 and V.110
0 0 1 1	2.4 kbit/s Recommendation X.1 and V.110
0 1 0 0	4.8 kbit/s Recommendation X.1 and V.110
0 1 0 1	9.6 kbit/s Recommendation X.1 and V.110
0 1 1 0	12.0 kbit/s transparent (non compliance with X.1 and V.110)
0 1 1 1	reserved: was allocated in earlier phases of the protocol.
All other values are reserved.	
For facsimile group 3 calls the user rate indicates the first and maximum speed the mobile station is using.	

**Table 10.5.101g/3GPP TS 24.008: Backup bearer capability information element**

Octet 6b for V.110/X.30 rate adaptation Intermediate rate (octet 6b)  
 In A/Gb mode and GERAN lu mode only.  
 If the value "User rate unknown" is signalled in the field "User rate" then the contents of this field shall be ignored.

Bits

**7 6**

0 0 reserved  
 0 1 reserved  
 1 0 8 kbit/s  
 1 1 16 kbit/s

Network independent clock (NIC) on transmission (Tx) (octet 6b) (See Rec. V.110 and X.30).  
 In A/Gb mode and GERAN lu mode only.

Bit

**5**

0 does not require to send data with network independent clock  
 1 requires to send data with network independent clock

Network independent clock (NIC) on reception (Rx) (octet 6b) (See Rec. V.110 and X.30)  
 In A/Gb mode and GERAN lu mode only.

Bit

**4**

0 cannot accept data with network independent clock (i.e. sender does not support this optional procedure)  
 1 can accept data with network independent clock (i.e. sender does support this optional procedure)

Parity information (octet 6b)

Bits

**3 2 1**

0 0 0 odd  
 0 1 0 even  
 0 1 1 none  
 1 0 0 forced to 0  
 1 0 1 forced to 1

All other values are reserved.

**Table 10.5.101h/3GPP TS 24.008: Backup bearer capability information element**

Connection element (octet 6c)	
Bit	
<b>7 6</b>	
0 0	transparent
0 1	non transparent (RLP)
1 0	both, transparent preferred
1 1	both, non transparent preferred
The network should use the 4 values depending on its capabilities to support the different modes.	
Modem type (octet 6c)	
Bits	
<b>5 4 3 2 1</b>	
0 0 0 0 0	none
0 0 0 0 1	V.21 (note 1)
0 0 0 1 0	V.22 (note 1)
0 0 0 1 1	V.22 bis (note 1)
0 0 1 0 0	reserved: was allocated in earlier phases of the protocol
0 0 1 0 1	V.26 ter (note 1)
0 0 1 1 0	V.32
0 0 1 1 1	modem for undefined interface
0 1 0 0 0	autobauding type 1
All other values are reserved.	
Note 1: In A/Gb mode and GERAN lu mode only.	

**Table 10.5.101i/3GPP TS 24.008: Backup bearer capability information element**

Other modem type (octet 6d)	
Bits	
<b>7 6</b>	
0 0	no other modem type specified in this field
1 0	V.34
All other values are reserved.	
Fixed network user rate (octet 6d)	
Bit	
<b>5 4 3 2 1</b>	
0 0 0 0 0	Fixed network user rate not applicable/No meaning is associated with this value.
0 0 0 0 1	9.6 kbit/s Recommendation X.1 and V.110
0 0 0 1 0	14.4 kbit/s Recommendation X.1 and V.110
0 0 0 1 1	19.2 kbit/s Recommendation X.1 and V.110
0 0 1 0 0	28.8 kbit/s Recommendation X.1 and V.110
0 0 1 0 1	38.4 kbit/s Recommendation X.1 and V.110
0 0 1 1 0	48.0 kbit/s Recommendation X.1 and V.110(synch) (note 1)
0 0 1 1 1	56.0 kbit/s Recommendation X.1 and V.110(synch) /bit transparent
0 1 0 0 0	64.0 kbit/s bit transparent
0 1 0 0 1	33.6 kbit/s bit transparent (note 2)
0 1 0 1 0	32.0 kbit/s Recommendation I.460
0 1 0 1 1	31.2 kbit/s Recommendation V.34 (note 2)
The value 31.2 kbit/s Recommendation V.34 shall be used only by the network to inform the MS about FNUR modification due to negotiation between the modems in a 3.1 kHz multimedia call.	
All other values are reserved.	
Note 1: In A/Gb mode and GERAN lu mode only.	
Note 2: In UTRAN lu mode only	

**Table 10.5.101j/3GPP TS 24.008: Backup bearer capability information element**

Acceptable channel codings (octet 6e):  
Bits 4 to 7 are spare and shall be set to "0".

Maximum number of traffic channels (octet 6e):  
Bits 1 to 3 are spare and shall be set to "0".

**Table 10.5.101k/3GPP TS 24.008: Backup bearer capability information element**

UIMI, User initiated modification indication (octet 6f),

**7 6 5**

0 0 0 User initiated modification not allowed/applicable  
0 0 1 User initiated modification up to 1 TCH/F allowed/may be requested  
0 1 0 User initiated modification up to 2 TCH/F allowed/may be requested  
0 1 1 User initiated modification up to 3 TCH/F allowed/may be requested  
1 0 0 User initiated modification up to 4 TCH/F allowed/may be requested

All other values shall be interpreted as "User initiated modification up to 4 TCH/F may be requested".

User initiated modification indication is not applicable for transparent connection.

Wanted air interface user rate (octet 6f):  
Bits 1 to 4 are spare and shall be set to "0".

**Table 10.5.101l/3GPP TS 24.008: Backup bearer capability information element**

Layer 2 identity (octet 7)

Bits

**7 6**

1 0 octet identifier

All other values are reserved

User information layer 2 protocol (octet 7)

Bits

**5 4 3 2 1**

0 0 1 1 0 reserved: was allocated in earlier phases of the protocol  
0 1 0 0 0 ISO 6429, codeset 0 (DC1/DC3)  
0 1 0 0 1 reserved: was allocated but never used in earlier phases of the protocol  
0 1 0 1 0 videotex profile 1  
0 1 1 0 0 COPnoFICt (Character oriented Protocol with no Flow Control mechanism)  
0 1 1 0 1 reserved: was allocated in earlier phases of the protocol

All other values are reserved.

**Table 10.5.101m/3GPP TS 24.008: Backup bearer capability information element**

Acceptable Channel Codings extended (octet 6g):

Bits 3 to 7 are spare and shall be set to "0".

Bits 2 and 1 are spare.

#### 10.5.4.4a.1 Static conditions for the backup bearer capability IE contents

If the information transfer capability field (octet 3) indicates "speech", octets 4, 5, 5a, 5b, 6, 6a, 6b, 6c, 6d, 6e, 6f, 6g and 7 shall not be included.

If the information transfer capability field (octet 3) indicates a value different from "speech", octets 4 and 5 shall be included, octets 6, 6a, 6b, 6c, 6d, 6e, 6f and 6g are optional. In case octet 6 is included, octets 6a, 6b, and 6c shall also be included. In case octet 6d is included, octets 6e, 6f and 6g may be included. If the information transfer capability field (octet 3) indicates "facsimile group 3" and octet 6c is included, the modem type field (octet 6c) shall indicate "none".

If the information transfer capability field (octet 3) indicates "other ITC" or the rate adaption field (octet 5) indicates "other rate adaption", octet 5a shall be included.

The modem type field (octet 6c) shall not indicate "autobauding type 1" unless the connection element field (octet 6c) indicates "non transparent".

#### 10.5.4.5 Bearer capability

The purpose of the bearer capability information element is to describe a bearer service. The use of the bearer capability information element in relation to compatibility checking is described in annex B.

The bearer capability information element is coded as shown in figure 10.5.88/3GPP TS 24.008 and tables 10.5.102/3GPP TS 24.008 to 10.5.115/3GPP TS 24.008.

The bearer capability is a type 4 information element with a minimum length of 3 octets and a maximum length of 16 octets.



	8	7	6	5	4	3	2	1	
	Bearer capability IEI								octet 1
	Length of the bearer capability contents								octet 2
0/1 ext	radio channel requirement		co-ding std	trans fer mode	information transfer capability				octet 3
0/1 ext	0 co-ding	CTM spare		speech version indication				octet 3a *	
0/1 ext	0 co-ding	0 spare	0 spare	Speech version Indication				octet 3b etc*	
1 ext	comp-ress.	structure		dupl. mode	confi gur.	NIRR	esta-bli.	octet 4*	
0/1 ext	0	0	rate adaption		signalling access protocol			octet 5*	
0/1 ext	Other ITC		Other rate adaption		0	0	0	octet 5a*	
1 ext	Hdr/noHdr	Multi frame	Mode	LLI	Assig nor/e	Inb. neg	0 Spare	octet 5b*	
0/1 ext	0	1	User information layer 1 protocol				sync/ async	octet 6*	
0/1 ext	numb. stop bits	nego-tia-tion	numb. data bits	user rate				octet 6a*	
0/1 ext	intermed. rate		NIC on TX	NIC on RX	Parity			octet 6b*	
0/1 ext	connection element		modem type					octet 6c*	
0/1 ext	Other modem type		Fixed network user rate					octet 6d*	
0/1 ext	Acceptable channel codings				Maximum number of traffic channels				octet 6e*
0/1 ext	UIMI			Wanted air interface user rate					octet 6f*
1 ext	Acceptable channel codings extended			Asymmetry Indication		0	0	octet 6g*	
1 ext	1	0	User information layer 2 protocol					octet 7*	

**Figure 10.5.88/3GPP TS 24.008 Bearer capability information element**

NOTE 1: The coding of the octets of the bearer capability information element is not conforming to ITU Q.931.

An MS shall encode the Bearer Capability information element according to A/Gb mode call control requirements also if it is requesting for a service in Iu mode, with the following exceptions:

1. A mobile station not supporting A/Gb mode and GERAN Iu mode for the requested bearer service shall set the following parameters to the value "0":
  - Maximum number of traffic channels (octet 6e, bits 1-3)
  - Acceptable Channel coding(s) (octet 6e, bits 4, 5 and 7)
2. Furthermore, a mobile station not supporting A/Gb mode and GERAN Iu mode for the requested bearer service shall also set the following parameters to the value "0", if the respective octets have to be included in the bearer capability information element according to subclause 10.5.4.5.1 and 3GPP TS 27.001 [36]:
  - UIMI, User initiated modification indication (octet 6f, bits 5-7)
  - Acceptable Channel Codings extended (octet 6g, bits 5-7)

For UTRAN Iu mode the following parameters are irrelevant for specifying the radio access bearer, because multiple traffic channels (multislot) are not deployed, see 3GPP TS 23.034 [104]. However, the parameters if received, shall be

stored in the MSC, and used for handover to A/Gb or GERAN Iu mode:

- Maximum number of traffic channels (octet 6e, bits 1-3)
- Acceptable Channel coding(s) (octet 6e, bits 4, 5 and 7)
- UIMI, User initiated modification indication (octet 6f, bits 5-7)
- Acceptable Channel Codings extended (octet 6g, bits 5-7)

NOTE 2: The following parameters are relevant in UTRAN Iu mode for non transparent data calls for deciding which RLP version to negotiate in order to avoid renegotiation of RLP version in case of inter-system handover from UTRAN Iu mode to A/Gb or GERAN Iu mode, see 3GPP TS 24.022 [9]:

- Maximum number of traffic channels (octet 6e, bits 1-3)
- Wanted air interface user rate (octet 6f, bits 1- 4)
- UIMI, User initiated modification indication (octet 6f, bits 5-7).

**Table 10.5.102/3GPP TS 24.008: Bearer capability information element**

Radio channel requirement (octet 3), network to MS direction In A/Gb mode and GERAN Iu mode, i.e. not applicable for UTRAN Iu mode data services.	
Bits 6 and 7 are spare bits. The sending side (i.e. the network) shall set bit 7 to value 0 and bit 6 to value 1.	
Radio channel requirement (octet 3) MS to network direction	
When information transfer capability (octet 3) indicates other values than speech:	
Bits	
<b>7 6</b>	
0 0	reserved
0 1	full rate support only MS
1 0	dual rate support MS/half rate preferred
1 1	dual rate support MS/full rate preferred
When information transfer capability (octet 3) indicates the value speech and no speech version indication is present in octet 3a etc.:	
Bits	
<b>7 6</b>	
0 0	reserved
0 1	full rate support only MS/fullrate speech version 1 supported
1 0	dual rate support MS/half rate speech version 1 preferred, full rate speech version 1 also supported
1 1	dual rate support MS/full rate speech version 1 preferred, half rate speech version 1 also supported
When information transfer capability (octet 3) indicates the value speech and speech version indication(s) is(are) present in octet 3a etc.:	
Bits	
<b>7 6</b>	
0 0	reserved
0 1	the mobile station supports at least full rate speech version 1 but does not support half rate speech version 1. The complete voice codec preference is specified in octet(s) 3a etc.
1 0	The mobile station supports at least full rate speech version 1 and half rate speech version 1. The mobile station has a greater preference for half rate speech version 1 than for full rate speech version 1. The complete voice codec preference is specified in octet(s) 3a etc.
1 1	The mobile station supports at least full rate speech version 1 and half rate speech version 1. The mobile station has a greater preference for full rate speech version 1 than for half rate speech version 1. The complete voice codec preference is specified in octet(s) 3a etc.

(continued...)

**Table 10.5.102/3GPP TS 24.008: Bearer capability information element (continued)**

Coding standard (octet 3)
Bit
<b>5</b>
0 GSM standardized coding as described below
1 reserved
Transfer mode (octet 3)
Bit
<b>4</b>
0 circuit mode
1 packet mode
Information transfer capability (octet 3)
Bits
<b>3 2 1</b>
0 0 0 speech
0 0 1 unrestricted digital information
0 1 0 3.1 kHz audio, ex PLMN
0 1 1 facsimile group 3
1 0 1 Other ITC (See Octet 5a)
1 1 1 reserved, to be used in the network.
The meaning is: alternate speech/facsimile group 3 - starting with speech.
All other values are reserved

**Table 10.5.103/3GPP TS 24.008 Bearer capability information element**

<p>Octet(s) 3a etc. MS to network direction</p> <p>Octet(s) 3a etc., bits 1 to 4 shall only be used to convey speech coding information belonging to a A/Gb mode or GERAN lu mode. When included for a UTRAN lu mode call establishment they shall be used for handover to A/Gb mode or GERAN lu mode.</p> <p>A mobile station supporting CTM text telephony, but not supporting A/Gb mode or GERAN lu mode shall encode octet 3a, bits 1 to 4 as 'no speech version supported for GERAN'.</p> <p>Coding</p> <p>Bit</p> <p><b>7</b></p> <p>0 octet used for extension of information transfer capability</p> <p>1 octet used for other extension of octet 3</p> <p>When information transfer capability (octet 3) indicates speech and coding (bit 7 in octet 3a etc.) is coded as 0, bits 1 through 6 are coded:</p> <p>CTM text telephony indication (octet 3a)</p> <p>Bit</p> <p><b>6</b></p> <p>0 CTM text telephony is not supported</p> <p>1 CTM text telephony is supported</p> <p>Bit 6 in octet(s) 3b etc. is spare.</p> <p>Bit 5 in octet(s) 3a etc. is spare.</p> <p>Speech version indication (octet(s) 3a etc.)</p> <p>Bits</p> <p><b>4 3 2 1</b></p> <p>0 0 0 0 GSM full rate speech version 1 (note 2)</p> <p>0 0 1 0 GSM full rate speech version 2 (note 2)</p> <p>0 1 0 0 GSM full rate speech version 3 (note 2)</p> <p>0 1 1 0 GSM full rate speech version 4 (note 2)</p> <p>1 0 0 0 GSM full rate speech version 5 (note 2)</p> <p>0 0 0 1 GSM half rate speech version 1 (note 2)</p> <p>0 1 0 1 GSM half rate speech version 3 (note 2)</p> <p>0 1 1 1 GSM half rate speech version 4 (note 2)</p> <p>1 0 1 1 GSM half rate speech version 6 (note 2)</p> <p>1 1 1 1 no speech version supported for GERAN (note 1)</p> <p>All other values have the meaning "speech version tbd" and shall be ignored when received.</p> <p>NOTE 1: This value shall only be used by an MS supporting CTM text telephony, but not supporting A/Gb or GERAN lu mode.</p> <p>NOTE 2: As defined in 3GPP TS 26.103 [83] and 3GPP TS 48.008 [85].</p> <p>If octet 3 is extended with speech version indication(s) (octets 3a etc.), all speech versions supported shall be indicated and be included in order of preference (the first octet (3a) has the highest preference and so on).</p> <p>If information transfer capability (octet 3) indicates speech and coding (bit 7 in octet 3a etc.) is coded as 1, or the information transfer capability does not indicate speech, then the extension octet shall be ignored.</p> <p>Octet(s) 3a etc. network to MS direction</p> <p>The octet(s) 3a etc. shall be ignored by the MS.</p>
---

**Table 10.5.104/3GPP TS 24.008: Bearer capability information element**

Compression (octet 4), network to MS direction:	
Bit	
<b>7</b>	
0	data compression not possible
1	data compression possible
Compression (octet 4), MS to network direction:	
Bit	
<b>7</b>	
0	data compression not allowed
1	data compression allowed
Structure (octet 4)	
Bits	
<b>6 5</b>	
0 0	service data unit integrity
1 1	unstructured
All other values are reserved.	
Duplex mode (octet 4)	
Bit	
<b>4</b>	
0	half duplex
1	full duplex
Configuration (octet 4)	
Bit	
<b>3</b>	
0	point-to-point
All other values are reserved.	
NIRR (octet 4)	
(Negotiation of Intermediate Rate Requested)	
In A/Gb mode and GERAN lu mode, i.e. not applicable for UTRAN lu mode data services.	
Bit	
<b>2</b>	
0	No meaning is associated with this value.
1	Data up to and including 4.8 kb/s, full rate, non-transparent, 6 kb/s radio interface rate is requested.
Establishment (octet 4)	
Bit	
<b>1</b>	
0	demand
All other values are reserved	

**Table 10.5.105/3GPP TS 24.008: Bearer capability information element**

<p>Access identity (octet 5)</p> <p>Bits</p> <p><b>7 6</b></p> <p>0 0 octet identifier</p> <p>All other values are reserved</p> <p>Rate adaption (octet 5)</p> <p>Bits</p> <p><b>5 4</b></p> <p>0 0 no rate adaption</p> <p>0 1 V.110, I.460/X.30 rate adaptation</p> <p>1 0 ITU-T X.31 flag stuffing</p> <p>1 1 Other rate adaption (see octet 5a)</p> <p>Signalling access protocol (octet 5)</p> <p>Bits</p> <p><b>3 2 1</b></p> <p>0 0 1 I.440/450</p> <p>0 1 0 reserved: was allocated in earlier phases of the protocol</p> <p>0 1 1 reserved: was allocated in earlier phases of the protocol</p> <p>1 0 0 reserved: was allocated in earlier phases of the protocol.</p> <p>1 0 1 reserved: was allocated in earlier phases of the protocol</p> <p>1 1 0 reserved: was allocated in earlier phases of the protocol</p> <p>All other values are reserved.</p>
--

**Table 10.5.106/3GPP TS 24.008: Bearer capability information element**

<p>Other ITC (octet 5a)</p> <p>If the value "Other ITC" is not signalled in the field "ITC" then the contents of this field shall be ignored.</p> <p>Bit</p> <p><b>7 6</b></p> <p>0 0 restricted digital information</p> <p>All other values are reserved</p> <p>Other rate adaption (octet 5a)</p> <p>If the value " Other rate adaption" is not signalled in the field "Rate adaption" then the contents of this field shall be ignored.</p> <p>In UTRAN Iu mode, PIAFS shall be considered. In A/Gb mode and GERAN Iu mode, call shall be rejected if PIAFS requested.</p> <p>Bit</p> <p><b>5 4</b></p> <p>0 0 V.120</p> <p>0 1 H.223 &amp; H.245</p> <p>1 0 PIAFS</p> <p>All other values are reserved.</p>
---

**Table 10.5.107/3GPP TS 24.008: Bearer capability information element**

Rate adaption header/no header (octet 5b)
Bit
<b>7</b>
0 Rate adaption header not included
1 Rate adaption header included
Multiple frame establishment support in data link (octet 5b)
Bit
<b>6</b>
0 Multiple frame establishment not supported, only UI frames allowed
1 Multiple frame establishment supported
Mode of operation (octet 5b)
Bit
<b>5</b>
0 Bit transparent mode of operation
1 Protocol sensitive mode of operation
Logical link identifier negotiation (octet 5b)
Bit
<b>4</b>
0 Default, LLI=256 only
1 Full protocol negotiation, (note: A connection over which protocol negotiation will be executed is indicated in bit 2 of octet 5b)
Assignor/Assignee (octet 5b)
Bit
<b>3</b>
0 Message originator is "default assignee"
1 Message originator is "assignor only"
In band/Out of band negotiation (octet 5b)
Bit
<b>2</b>
0 Negotiation is done in-band using logical link zero
1 Negotiation is done with USER INFORMATION messages on a temporary signalling connection
Bit 1 is spare and set to the value "0"

**Table 10.5.108/3GPP TS 24.008: Bearer capability information element**

Layer 1 identity (octet 6)
Bits
<b>7 6</b>
0 1 octet identifier
All other values are reserved
User information layer 1 protocol (octet 6)
Bits
<b>5 4 3 2</b>
0 0 0 0 default layer 1 protocol
All other values reserved.
Synchronous/asynchronous (octet 6)
Bit
<b>1</b>
0 synchronous
1 asynchronous

**Table 10.5.109/3GPP TS 24.008: Bearer capability information element**

Number of Stop Bits (octet 6a)
Bit
<b>7</b>
0 1 bit (This value is also used in the case of synchronous mode)
1 2 bits
Negotiation (octet 6a)
Bit
<b>6</b>
0 in-band negotiation not possible
NOTE: See Rec. V.110 and X.30
All other values are reserved
Number of data bits excluding parity bit if present (octet 6a)
Bit
<b>5</b>
0 7 bits
1 8 bits (this value is also used in the case of bit oriented protocols)
User rate (octet 6a)
In A/Gb mode and GERAN lu mode only.
Bits
<b>4 3 2 1</b>
0 0 0 1 0.3 kbit/s Recommendation X.1 and V.110
0 0 1 0 1.2 kbit/s Recommendation X.1 and V.110
0 0 1 1 2.4 kbit/s Recommendation X.1 and V.110
0 1 0 0 4.8 kbit/s Recommendation X.1 and V.110
0 1 0 1 9.6 kbit/s Recommendation X.1 and V.110
0 1 1 0 12.0 kbit/s transparent (non compliance with X.1 and V.110)
0 1 1 1 reserved: was allocated in earlier phases of the protocol.
All other values are reserved.
For facsimile group 3 calls the user rate indicates the first and maximum speed the mobile station is using.



**Table 10.5.110/3GPP TS 24.008: Bearer capability information element**

<p>Octet 6b for V.110/X.30 rate adaptation Intermediate rate (octet 6b) In A/Gb mode and GERAN lu mode only.</p> <p>Bits <b>7 6</b> 0 0 reserved 0 1 reserved 1 0 8 kbit/s 1 1 16 kbit/s</p> <p>Network independent clock (NIC) on transmission (Tx) (octet 6b) (See Rec. V.110 and X.30). In A/Gb mode and GERAN lu mode only.</p> <p>Bit <b>5</b> 0 does not require to send data with network independent clock 1 requires to send data with network independent clock</p> <p>Network independent clock (NIC) on reception (Rx) (octet 6b) (See Rec. V.110 and X.30) In A/Gb mode and GERAN lu mode only.</p> <p>Bit <b>4</b> 0 cannot accept data with network independent clock (i.e. sender does not support this optional procedure) 1 can accept data with network independent clock (i.e. sender does support this optional procedure)</p> <p>Parity information (octet 6b) Bits <b>3 2 1</b> 0 0 0 odd 0 1 0 even 0 1 1 none 1 0 0 forced to 0 1 0 1 forced to 1</p> <p>All other values are reserved.</p>
--

**Table 10.5.111/3GPP TS 24.008: Bearer capability information element**

<p>Connection element (octet 6c)</p> <p>Bit</p> <p><b>7 6</b></p> <p>0 0 transparent</p> <p>0 1 non transparent (RLP)</p> <p>1 0 both, transparent preferred</p> <p>1 1 both, non transparent preferred</p> <p>The requesting end (e.g. the one sending the SETUP message) should use the 4 values depending on its capabilities to support the different modes. The answering party shall only use the codings 00 or 01, based on its own capabilities and the proposed choice if any. If both MS and network support both transparent and non transparent, priority should be given to the MS preference.</p> <p>Modem type (octet 6c)</p> <p>Bits</p> <p><b>5 4 3 2 1</b></p> <p>0 0 0 0 none</p> <p>0 0 0 1 V.21 (note 1)</p> <p>0 0 1 0 V.22 (note 1)</p> <p>0 0 1 1 V.22 bis (note 1)</p> <p>0 0 1 0 0 reserved: was allocated in earlier phases of the protocol</p> <p>0 0 1 0 1 V.26 ter (note 1)</p> <p>0 0 1 1 0 V.32</p> <p>0 0 1 1 1 modem for undefined interface</p> <p>0 1 0 0 0 autobauding type 1</p> <p>All other values are reserved.</p> <p>Note 1: In A/Gb mode and GERAN Iu mode only.</p>
--

**Table 10.5.112/3GPP TS 24.008: Bearer capability information element**

Other modem type (octet 6d)	
Bits	
<b>7 6</b>	
0 0	no other modem type specified in this field
1 0	V.34
All other values are reserved.	
Fixed network user rate (octet 6d)	
Bit	
<b>5 4 3 2 1</b>	
0 0 0 0 0	Fixed network user rate not applicable/No meaning is associated with this value.
0 0 0 0 1	9.6 kbit/s Recommendation X.1 and V.110
0 0 0 1 0	14.4 kbit/s Recommendation X.1 and V.110
0 0 0 1 1	19.2 kbit/s Recommendation X.1 and V.110
0 0 1 0 0	28.8 kbit/s Recommendation X.1 and V.110
0 0 1 0 1	38.4 kbit/s Recommendation X.1 and V.110
0 0 1 1 0	48.0 kbit/s Recommendation X.1 and V.110(synch) (note 1)
0 0 1 1 1	56.0 kbit/s Recommendation X.1 and V.110(synch) /bit transparent
0 1 0 0 0	64.0 kbit/s bit transparent
0 1 0 0 1	33.6 kbit/s bit transparent (note 2)
0 1 0 1 0	32.0 kbit/s Recommendation I.460
0 1 0 1 1	31.2 kbit/s Recommendation V.34 (note 2)
The value 31.2 kbit/s Recommendation V.34 shall be used only by the network to inform the MS about FNUR modification due to negotiation between the modems in a 3.1 kHz multimedia call.	
All other values are reserved.	
Note 1: In A/Gb mode and GERAN Iu mode only.	
Note 2: In UTRAN Iu mode only	

**Table 10.5.113/3GPP TS 24.008: Bearer capability information element**

Acceptable channel codings (octet 6e), mobile station to network direction:	
Bit	
<b>7</b>	
0	TCH/F14.4 not acceptable
1	TCH/F14.4 acceptable
Bit	
<b>6</b>	
0	Spare
Bit	
<b>5</b>	
0	TCH/F9.6 not acceptable
1	TCH/F9.6 acceptable
Bit	
<b>4</b>	
0	TCH/F4.8 not acceptable
1	TCH/F4.8 acceptable
Acceptable channel codings (octet 6e), network to MS direction: Bits 4 to 7 are spare and shall be set to "0".	
Maximum number of traffic channels (octet 6e), MS to network direction:	
Bits	
<b>3 2 1</b>	
0 0 0	1 TCH
0 0 1	2 TCH
0 1 0	3 TCH
0 1 1	4 TCH
1 0 0	5 TCH
1 0 1	6 TCH
1 1 0	7 TCH
1 1 1	8 TCH
Maximum number of traffic channels (octet 6e), network to MS direction: Bits 1 to 3 are spare and shall be set to "0".	

**Table 10.5.114/3GPP TS 24.008: Bearer capability information element**

UIMI, User initiated modification indication (octet 6f),	
<b>7 6 5</b>	
0 0 0	User initiated modification not allowed/required/applicable
0 0 1	User initiated modification up to 1 TCH/F allowed/may be requested
0 1 0	User initiated modification up to 2 TCH/F allowed/may be requested
0 1 1	User initiated modification up to 3 TCH/F allowed/may be requested
1 0 0	User initiated modification up to 4 TCH/F allowed/may be requested
All other values shall be interpreted as "User initiated modification up to 4 TCH/F may be requested".	
User initiated modification indication is not applicable for transparent connection.	
Wanted air interface user rate (octet 6f), MS to network direction:	
Bits	
<b>4 3 2 1</b>	
0 0 0 0	Air interface user rate not applicable/No meaning associated with this value
0 0 0 1	9.6 kbit/s
0 0 1 0	14.4 kbit/s
0 0 1 1	19.2 kbit/s
0 1 0 1	28.8 kbit/s
0 1 1 0	38.4 kbit/s
0 1 1 1	43.2 kbit/s
1 0 0 0	57.6 kbit/s
1 0 0 1	interpreted by the network as 38.4 kbit/s in this version of the protocol
1 0 1 0	interpreted by the network as 38.4 kbit/s in this version of the protocol
1 0 1 1	interpreted by the network as 38.4 kbit/s in this version of the protocol
1 1 0 0	interpreted by the network as 38.4 kbit/s in this version of the protocol
All other values are reserved.	
Wanted air interface user rate (octet 6f), network to MS direction:	
Bits 1 to 4 are spare and shall be set to "0".	

**Table 10.5.115/3GPP TS 24.008: Bearer capability information element**

<p>Layer 2 identity (octet 7)</p> <p>Bits</p> <p><b>7 6</b></p> <p>1 0 octet identifier</p> <p>All other values are reserved</p> <p>User information layer 2 protocol (octet 7)</p> <p>Bits</p> <p><b>5 4 3 2 1</b></p> <p>0 0 1 1 0 reserved: was allocated in earlier phases of the protocol</p> <p>0 1 0 0 0 ISO 6429, codeset 0 (DC1/DC3)</p> <p>0 1 0 0 1 reserved: was allocated but never used in earlier phases of the protocol</p> <p>0 1 0 1 0 videotex profile 1</p> <p>0 1 1 0 0 COPnoFICt (Character oriented Protocol with no Flow Control mechanism)</p> <p>0 1 1 0 1 reserved: was allocated in earlier phases of the protocol</p> <p>All other values are reserved.</p>
--

**Table 10.5.115a/3GPP TS 24.008: Bearer capability information element**

<p>Acceptable Channel Codings extended (octet 6g) mobile station to network direction:</p> <p>Bit</p> <p>7</p> <p>0 TCH/F28.8 not acceptable</p> <p>1 TCH/F28.8 acceptable</p> <p>Bit</p> <p>6</p> <p>0 TCH/F32.0 not acceptable</p> <p>1 TCH/F32.0 acceptable</p> <p>Bit</p> <p>5</p> <p>0 TCH/F43.2 not acceptable</p> <p>1 TCH/F43.2 acceptable</p> <p>Channel Coding Asymmetry Indication</p> <p>Bits</p> <p>4 3</p> <p>0 0 Channel coding symmetry preferred</p> <p>1 0 Downlink biased channel coding asymmetry is preferred</p> <p>0 1 Uplink biased channel coding asymmetry is preferred</p> <p>1 1 Unused, if received it shall be interpreted as "Channel coding symmetry preferred"</p> <p>EDGE Channel Codings (octet 6g), network to MS direction:</p> <p>Bits 3 to 7 are spare and shall be set to "0".</p> <p>Bits 2 and 1 are spare.</p>
---

### 10.5.4.5.1 Static conditions for the bearer capability IE contents

If the information transfer capability field (octet 3) indicates "speech", octets 4, 5, 5a, 5b, 6, 6a, 6b, 6c, 6d, 6e, 6f, 6g and 7 shall not be included.

If the information transfer capability field (octet 3) indicates "speech", octet 3a etc. shall be included only if the mobile station supports CTM text telephony or if it supports at least one speech version for GERAN other than:

- GSM full rate speech version 1; or
- GSM half rate speech version 1.

If the information transfer capability field (octet 3) indicates a value different from "speech", octets 4, 5, 6, 6a, 6b, and 6c shall be included, octets 6d, 6e, 6f and 6g are optional. In the network to MS direction in case octet 6d is included, octets 6e, 6f and 6g may be included. In the MS to network direction in case octet 6d is included octet 6e shall also be included and 6f and 6g may be included.

If the information transfer capability field (octet 3) indicates "facsimile group 3", the modem type field (octet 6c) shall indicate "none".

If the information transfer capability field (octet 3) indicates "other ITC" or the rate adaption field (octet 5) indicates "other rate adaption", octet 5a shall be included.

If the rate adaption field (octet 5) indicates "other rate adaption" and the other rate adaption field (octet 5a) indicates "V.120", octet 5b shall be included.

The modem type field (octet 6c) shall not indicate "autobauding type 1" unless the connection element field (octet 6c) indicates "non transparent".

### 10.5.4.5a Call Control Capabilities

The purpose of the Call Control Capabilities information element is to identify the call control capabilities of the mobile station.

The Call Control Capabilities information element is coded as shown in figure 10.5.89/3GPP TS 24.008 and table 10.5.116/3GPP TS 24.008.

The Call Control Capabilities is a type 4 information element with a length of 4 octets.

8	7	6	5	4	3	2	1	
Call Control Capabilities IEI								octet 1
Length of Call Control Capabilities contents								octet 2
Maximum number of supported bearers				0 spare	ENICM	PCP	DTMF	octet3
0	0	0	0	Maximum number of speech bearers				octet 4

**Figure 10.5.89/3GPP TS 24.008 Call Control Capabilities information element**

**Table 10.5.116/3GPP TS 24.008: Call Control Capabilities**

DTMF (octet 3, bit 1)	
0	This value is reserved for earlier versions of the protocol.
1	This value indicates that the mobile station supports DTMF as specified in subclause 5.5.7 of the present document.
PCP (octet 3, bit 2)	
0	This value indicates that the mobile station does not support the Prolonged Clearing Procedure
1	This value indicates that the mobile station supports the Prolonged Clearing Procedure.
ENICM (octet 3, bit 3)	
0	This value indicates that the mobile station does not support the Enhanced Network-initiated In-Call Modification procedure.
1	This value indicates that the mobile station supports the Enhanced Network-initiated In-Call Modification procedure as specified in subclause 5.3.4.3 of the present document.
Maximum number of supported bearers (octet 3, bit 5 to bit 8)	
0 0 0 0 1 bearer supported	
All values are interpreted as the binary representation of the number of bearers supported.	
Bit 5 of octet 3 is the least significant bit and bit 8 of octet 3 is the most significant bit.	
Maximum number of speech bearers (octet 4, bit 1 to bit 4)	
All values are interpreted as the binary representation of the number of bearers supported.	
Bit 1 of octet 4 is the least significant bit and bit 4 of octet 4 is the most significant bit.	
Note:	In this version of the protocol, the MS should not indicate more than one speech bearer.

**10.5.4.6 Call state**

The purpose of the call state information element is to describe the current status of a call, (see subclause 5.1).

The call state information element is coded as shown in figure 10.5.90/3GPP TS 24.008 and table 10.5.117/3GPP TS 24.008.

The call state is a type 3 information element with 2 octets length.

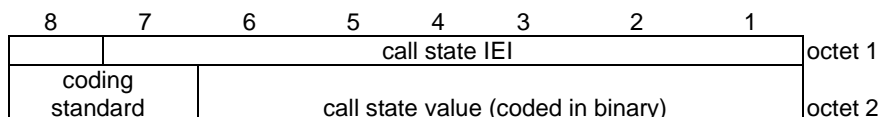

**Figure 10.5.90/3GPP TS 24.008 Call state information element**



Table 10.5.117/3GPP TS 24.008: Call state information element

Coding standard (octet 2)							
Bits							
<b>8</b>	<b>7</b>						
0 0	standardized coding as described in ITU-T Rec. Q.931						
0 1	reserved for other international standards						
1 0	national standard						
1 1	standard defined for the GSM PLMNS as described below						
Coding standards other than "1 1 - Standard defined for the GSM PLMNS" shall not be used if the call state can be represented with the GSM standardized coding.							
The mobile station or network need not support any other coding standard than "1 1 - Standard defined for the GSM PLMNS".							
If a call state IE indicating a coding standard not supported by the receiver is received, call state "active" shall be assumed.							
Call state value (octet 2)							
Bits							
<b>6</b>	<b>5</b>	<b>4</b>	<b>3</b>	<b>2</b>	<b>1</b>		
0	0	0	0	0	0	U0 - null	NO - null
0	0	0	0	1	0	U0.1- MM connection pending	N0.1- MM connection pending
1	0	0	0	1	0	U0.2- CC prompt present	N0.2- CC connection pending
1	0	0	0	1	1	U0.3- Wait for network information	N0.3- Network answer pending
1	0	0	1	0	0	U0.4- CC-Establishment present	N0.4- CC-Establishment present
1	0	0	1	0	1	U0.5- CC-Establishment confirmed	N0.5- CC-Establishment confirmed
1	0	0	1	1	0	U0.6- Recall present	N0.6- Recall present
0	0	0	0	0	1	U1 - call initiated	N1 - call initiated
0	0	0	0	1	1	U3 - mobile originating call proceeding	N3 - mobile originating call proceeding
0	0	0	1	0	0	U4 - call delivered	N4 - call delivered
0	0	0	1	1	0	U6 - call present	N6 - call present
0	0	0	1	1	1	U7 - call received	N7 - call received
0	0	1	0	0	0	U8 - connect request	N8 - connect request
0	0	1	0	0	1	U9 - mobile terminating call confirmed	N9 - mobile terminating call confirmed
0	0	1	0	1	0	U10- active	N10- active
0	0	1	0	1	1	U11- disconnect request	
0	0	1	1	0	0	U12- disconnect indication	N12-disconnect indication
0	1	0	0	1	1	U19- release request	N19- release request
0	1	1	0	1	0	U26- mobile originating modify	N26- mobile originating modify
0	1	1	0	1	1	U27- mobile terminating modify	N27- mobile terminating modify
0	1	1	1	0	0		N28- connect indication

#### 10.5.4.7 Called party BCD number

The purpose of the called party BCD number information element is to identify the called party.

The called party BCD number information element is coded as shown in figure 10.5.91/3GPP TS 24.008 and table 10.5.118/3GPP TS 24.008.

The called party BCD number is a type 4 information element with a minimum length of 3 octets and a maximum length of 43 octets. For PCS 1900 the maximum length is 19 octets.

8	7	6	5	4	3	2	1	
Called party BCD number IEI								octet 1
Length of called party BCD number contents								octet 2
1	type of number			Numbering plan identification				octet 3
ext								
Number digit 2				Number digit 1				octet 4*
Number digit 4				Number digit 3				octet 5*
2)								:
								:

**Figure 10.5.91/3GPP TS 24.008 Called party BCD number information element**

NOTE 1: The number digit(s) in octet 4 precedes the digit(s) in octet 5 etc. The number digit which would be entered first is located in octet 4, bits 1 to 4.

NOTE 2: If the called party BCD number contains an odd number of digits, bits 5 to 8 of the last octet shall be filled with an end mark coded as "1111".

Since the information element must contain the complete called party BCD number there is no need for an additional complete indication.

**Table 10.5.118/3GPP TS 24.008: Called party BCD number**

Type of number (octet 3) (Note 1)			
Bits			
<b>7</b>	<b>6</b>	<b>5</b>	
0	0	0	unknown (Note 2)
0	0	1	international number (Note 3, Note 5)
0	1	0	national number (Note 3)
0	1	1	network specific number (Note 4)
1	0	0	dedicated access, short code
1	0	1	reserved
1	1	0	reserved
1	1	1	reserved for extension

NOTE 1: For the definition of "number" see ITU-T Recommendation I.330 and 3GPP TS 23.003 [10].

NOTE 2: The type of number "unknown" is used when the user or the network has no knowledge of the type of number, e.g. international number, national number, etc. In this case the number digits field is organized according to the network dialling plan, e.g. prefix or escape digits might be present.

NOTE 3: Prefix or escape digits shall not be included.

NOTE 4: The type of number "network specific number" is used to indicate administration/service number specific to the serving network, e.g. used to access an operator.

NOTE 5: The international format shall be accepted by the MSC when the call is destined to a destination in the same country as the MSC.

**Table 10.5.118/3GPP TS 24.008: Called party BCD number (continued)**

Numbering plan identification (octet 3)				
Number plan (applies for type of number = 000, 001, 010 and 100)				
Bits				
4	3	2	1	
0	0	0	0	unknown
0	0	0	1	ISDN/telephony numbering plan (Rec. E.164/E.163)
0	0	1	1	data numbering plan (Recommendation X.121)
0	1	0	0	telex numbering plan (Recommendation F.69)
1	0	0	0	national numbering plan
1	0	0	1	private numbering plan
1	0	1	1	reserved for CTS (see 3GPP TS 44.056 [91])
1	1	1	1	reserved for extension

All other values are reserved.

- When an MS is the recipient of number information from the network, any incompatibility between the number digits and the number plan identification shall be ignored and a STATUS message shall not be sent to the network.
- In the case of numbering plan "unknown", the number digits field is organized according to the network dialling plan; e.g. prefix or escape digits might be present.

**Table 10.5.118/3GPP TS 24.008: Called party BCD number (continued)**

Number digits (octets 4, etc.)				Number digit value
Bits				
4	3	2	1	or
8	7	6	5	
0	0	0	0	0
0	0	0	1	1
0	0	1	0	2
0	0	1	1	3
0	1	0	0	4
0	1	0	1	5
0	1	1	0	6
0	1	1	1	7
1	0	0	0	8
1	0	0	1	9
1	0	1	0	*
1	0	1	1	#
1	1	0	0	a
1	1	0	1	b
1	1	1	0	c
1	1	1	1	used as an endmark in the case of an odd number of number digits

#### 10.5.4.8 Called party subaddress

The purpose of the Called party subaddress is to identify the subaddress of the called party of a call. For the definition of a subaddress see Rec. ITU-T I.330.

The Called party subaddress information element is coded as shown in figure 10.5.92/3GPP TS 24.008 and Table 10.5.119/3GPP TS 24.008.

The called party subaddress is a type 4 information element with a minimum length of 2 octets and a maximum length of 23 octets.

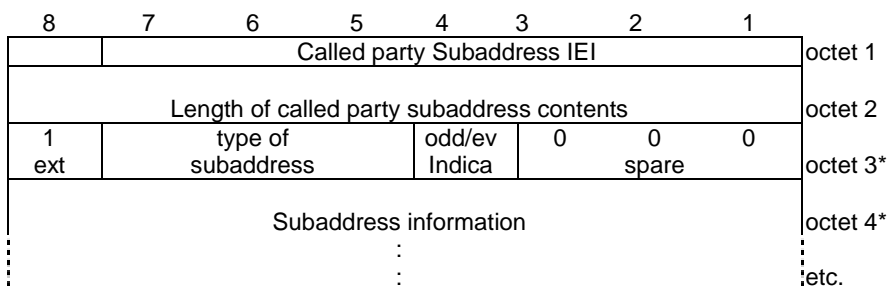

**Figure 10.5.92/3GPP TS 24.008 Called party subaddress**

**Table 10.5.119/3GPP TS 24.008: Called party subaddress**

Type of subaddress (octet 3)	
Bits	
<b>7 6 5</b>	
0 0 0	NSAP (X.213/ISO 8348 AD2)
0 1 0	User specified
All other values are reserved	
Odd/even indicator (octet 3)	
Bit	
<b>4</b>	
0	even number of address signals
1	odd number of address signals
NOTE 1: The odd/even indicator is used when the type of subaddress is "user specified" and the coding is BCD.	
Subaddress information (octet 4, etc...)	
The NSAP X.213/ISO8348AD2 address shall be formatted as specified by octet 4 which contains the Authority and Format Identifier (AFI). The encoding is made according to the "preferred binary encoding" as defined in X.213/ISO8348AD2. For the definition of this type of subaddress, see Rec. ITU-T I.334.	
A coding example is given in ANNEX A.	
For User-specific subaddress, this field is encoded according to the user specification, subject to a maximum length of 20 octets.	
NOTE 2: It is recommended that users apply NSAP subaddress type since this subaddress type allows the use of decimal, binary and IA5 characters in a standardised manner.	

### 10.5.4.9 Calling party BCD number

The purpose of the calling party BCD number information element is to identify the origin of a call.

The calling party BCD number information element is coded as shown in figure 10.5.93/3GPP TS 24.008 and table 10.5.120/3GPP TS 24.008.

The calling party BCD number is a type 4 information element. In the network to mobile station direction it has a minimum length of 3 octets and a maximum length of 14 octets. (This information element is not used in the mobile station to network direction.).

8	7	6	5	4	3	2	1		
Calling party BCD number IEI								octet 1	
Length of calling party BCD number contents								octet 2	
0/1 ext	type of number			Numbering plan identification				octet 3	
1 ext	presentat. indicator	0	0	0	spare			screening indicator	octet 3a*
Number digit 2				Number digit 1				octet 4*	
Number digit 4				Number digit 3				octet 5*	
								:	
								:	

**Figure 10.5.93/3GPP TS 24.008 Calling party BCD number information element**

The contents of octets 3, 4, etc. are coded as shown in table 10.5.118. The coding of octet 3a is defined in table 10.5.120 below.

If the calling party BCD number contains an odd number of digits, bits 5 to 8 of the last octet shall be filled with an end mark coded as "1111".

**Table 10.5.120/3GPP TS 24.008: Calling party BCD number**

Presentation indicator (octet 3a)		
Bits		
<b>7</b>	<b>6</b>	
0	0	Presentation allowed
0	1	Presentation restricted
1	0	Number not available due to interworking
1	1	Reserved
If octet 3a is omitted the value "00 - Presentation allowed" is assumed.		
Screening indicator (octet 3a)		
Bits		
<b>2</b>	<b>1</b>	
0	0	User-provided, not screened
0	1	User-provided, verified and passed
1	0	User-provided, verified and failed
1	1	Network provided
If octet 3a is omitted the value "0 0 - User provided, not screened" is assumed.		

### 10.5.4.10 Calling party subaddress

The purpose of the Calling party subaddress is to identify a subaddress associated with the origin of a call. For the definition of a subaddress see Rec. ITU-T I.330.

The Calling party subaddress information element is coded as shown in figure 10.5.94/3GPP TS 24.008 and table 10.5.121/3GPP TS 24.008.

The calling party subaddress is a type 4 information element with a minimum length of 2 octets and a maximum length of 23 octets.

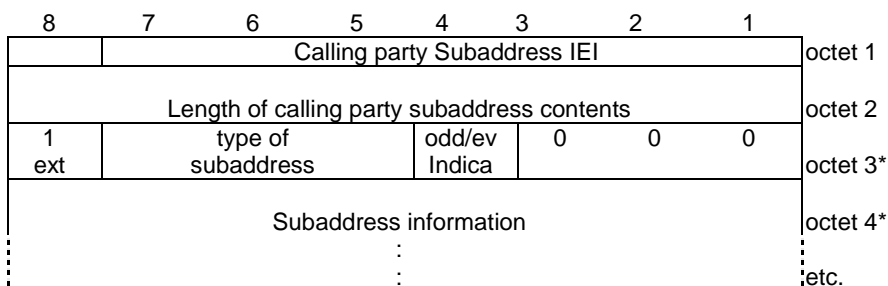

**Figure 10.5.94/3GPP TS 24.008 Calling party subaddress**

**Table 10.5.121/3GPP TS 24.008: Calling party subaddress**

Type of subaddress (octet 3)	
Bits	
<b>7 6 5</b>	
0 0 0	NSAP (X.213/ISO 8348 AD2)
0 1 0	User specified
All other values are reserved	
Odd/even indicator (octet 3)	
Bit	
<b>4</b>	
0	even number of address signals
1	odd number of address signals
The odd/even indicator is used when the type of subaddress is "user specified" and the coding is BCD	
Subaddress information (octet 4, etc...)	
The NSAP X.213/ISO8348AD2 address shall be formatted as specified by octet 4 which contains the Authority and Format Identifier (AFI). The encoding is made according to the "preferred binary encoding" as defined in X.213/ISO8348AD2. For the definition of this type of this type of subaddress, see Rec. ITU-T I.332.	
A coding example is given in annex A.	
For User-specific subaddress, this field is encoded according to the user specification, subject to a maximum length of 20 octets.	
NOTE:	It is recommended that users apply NSAP subaddress type since this subaddress type allows the use of decimal, binary and IA5 characters in a standardised manner.

**10.5.4.11 Cause**

The purpose of the cause information element is to describe the reason for generating certain messages, to provide diagnostic information in the event of procedural errors and to indicate the location of the cause originator.

The cause information element is coded as shown in figure 10.5.95/3GPP TS 24.008 and tables 10.5.122 and 10.5.123/3GPP TS 24.008.

The cause is a type 4 information element with a minimum length of 4 octets and a maximum length of 32 octets.

The cause information element may be repeated in a message.

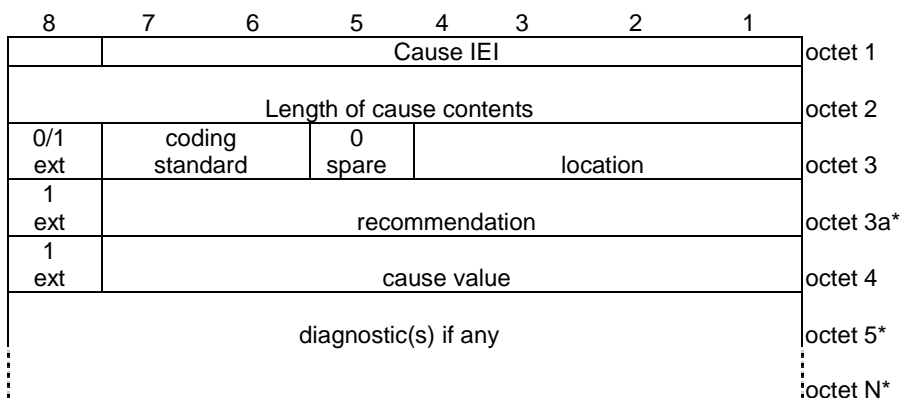

**Figure 10.5.95/3GPP TS 24.008 Cause information element**

If the default value applies for the recommendation field, octet 3a shall be omitted.

**Table 10.5.122/3GPP TS 24.008: Cause information element**

Coding standard (octet 3)	
Bits	
<b>7 6</b>	
0 0	Coding as specified in ITU-T Rec. Q.931
0 1	Reserved for other international standards
1 0	National standard
1 1	Standard defined for the GSM PLMNs as described below and in table 10.5.123/3GPP TS 24.008
Coding standards other than "1 1 - Standard defined for the GSM PLMNS" shall not be used if the cause can be represented with the GSM standardized coding.	
The mobile station or network need not support any other coding standard than "1 1 - Standard defined for the GSM PLMNS".	
If a cause IE indicating a coding standard not supported by the receiver is received, cause "interworking, unspecified" shall be assumed.	
Location (octet 3)	
Bits	
<b>4 3 2 1</b>	
0 0 0 0	user
0 0 0 1	private network serving the local user
0 0 1 0	public network serving the local user
0 0 1 1	transit network
0 1 0 0	public network serving the remote user
0 1 0 1	private network serving the remote user
0 1 1 1	international network
1 0 1 0	network beyond interworking point
All other values are reserved.	
Recommendation (octet 3a)	
Octet 3a shall not be included if the coding standard is coded as "1 1 - Standard defined for GSM PLMNS".	
If the coding standard is different from "1 1 - Standard defined for GSM PLMNS", the coding of octet 3a, if included, and octets 4 to N is according to that coding standard.	

**Table 10.5.122/3GPP TS 24.008: Cause information element (continued)**

Cause value (octet 4)	
The cause value is divided in two fields: a class (bits 5 through 7) and a value within the class (bits 1 through 4).	
The class indicates the general nature of the event.	
Class (000):	normal event
Class (001):	normal event
Class (010):	resource unavailable
Class (011):	service or option not available
Class (100):	service or option not implemented
Class (101):	invalid message (e.g. parameter out of range)
Class (110):	protocol error (e.g. unknown message)
Class (111):	interworking
The cause values are listed in Table 10.5.123/3GPP TS 24.008 below and defined in Annex H.	
Diagnostic(s) (octet 5)	
Diagnostic information is not available for every cause, see Table 10.5.123/3GPP TS 24.008 below.	
When available, the diagnostic(s) is coded in the same way as the corresponding information element in clause 10.	
The inclusion of diagnostic(s) is optional.	



Table 10.5.123/3GPP TS 24.008: Cause information element values

Cause value							Cause num.	Cause	Diag- nostic	Remarks
Class			Value							
7	6	5	4	3	2	1				
0	0	0	0	0	0	1	1.	Unassigned (unallocated) number	Note 9	
0	0	0	0	0	1	1	3.	No route to destination	Note 9	
0	0	0	0	1	1	0	6.	Channel unacceptable	-	
0	0	0	1	0	0	0	8.	Operator determined barring	-	
0	0	1	0	0	0	0	16.	Normal call clearing	Note 9	
0	0	1	0	0	0	1	17.	User busy	Note 1	
0	0	1	0	0	1	0	18.	No user responding	-	
0	0	1	0	0	1	1	19.	User alerting, no answer	-	
0	0	1	0	1	0	1	21.	Call rejected	Note 9 - user supplied diagnostic (note 4)	
0	0	1	0	1	1	0	22.	Number changed	New destination(note 5)	
0	0	1	1	0	0	1	25.	Pre-emption		
0	0	1	1	0	1	0	26.	Non selected user clearing	-	
0	0	1	1	0	1	1	27.	Destination out of order	-	
0	0	1	1	1	0	0	28.	Invalid number format (incomplete number)	-	
0	0	1	1	1	0	1	29.	Facility rejected	Note 1	
0	0	1	1	1	1	0	30.	Response to STATUS ENQUIRY	-	
0	0	1	1	1	1	1	31.	Normal, unspecified	-	
0	1	0	0	0	1	0	34.	No circuit/channel available	Note 1	
0	1	0	0	1	1	0	38.	Network out of order	-	
0	1	0	1	0	0	1	41.	Temporary failure	-	
0	1	0	1	0	1	0	42.	Switching equipment congestion	-	
0	1	0	1	0	1	1	43.	Access information discarded	Discarded information element identifiers (note 6)	
0	1	0	1	1	0	0	44.	requested circuit/channel not available	-	
0	1	0	1	1	1	1	47.	Resources unavailable, unspecified	-	
0	1	1	0	0	0	1	49.	Quality of service unavailable	Note 9	
0	1	1	0	0	1	0	50.	Requested facility not subscribed	Note 1	
0	1	1	0	1	1	1	55.	Incoming calls barred within the CUG	Note 1	
0	1	1	1	0	0	1	57.	Bearer capability not authorized	Note 3	
0	1	1	1	0	1	0	58.	Bearer capability not presently available	Note 3	
0	1	1	1	1	1	1	63.	Service or option not available, unspecified	-	
1	0	0	0	0	0	1	65.	Bearer service not implemented	Note 3	

(continued)

Table 10.5.123/3GPP TS 24.008 (concluded): Cause information element values

Cause value							Cause num.	Cause	Diagnostic	Remarks
Class			Value							
7	6	5	4	3	2	1				
1	0	0	0	1	0	0	68.	ACM equal to or greater than ACMmax		
1	0	0	0	1	0	1	69.	Requested facility not implemented	Note 1	
1	0	0	0	1	1	0	70.	Only restricted digital information bearer capability is available		
1	0	0	1	1	1	1	79.	Service or option not implemented, unspecified	-	
1	0	1	0	0	0	1	81.	Invalid transaction identifier value	-	
1	0	1	0	1	1	1	87.	User not member of CUG	Note 1	
1	0	1	1	0	0	0	88.	Incompatible destination	Incompatible parameter (Note 2)	
1	0	1	1	0	1	1	91.	Invalid transit network selection	-	
1	0	1	1	1	1	1	95.	Semantically incorrect message	-	
1	1	0	0	0	0	0	96.	Invalid mandatory information	Information element identifier(s)	
1	1	0	0	0	0	1	97.	Message type non-existent or not implemented	Message type	
1	1	0	0	0	1	0	98.	Message type not compatible with protocol state	Message type	
1	1	0	0	0	1	1	99.	Information element non-existent or not implemented	Information element identifier(s) (notes 6,7)	
1	1	0	0	1	0	0	100.	Conditional IE error	Information element identifier(s) (note 6)	
1	1	0	0	1	0	1	101.	Message not compatible with protocol state	Message type	
1	1	0	0	1	1	0	102.	Recovery on timer expiry	Timer number (note 8)	
1	1	0	1	1	1	1	111.	Protocol error, unspecified	-	
1	1	1	1	1	1	1	127.	Interworking, unspecified	-	

All other values in the range 0 to 31 shall be treated as cause 31.

All other values in the range 32 to 47 shall be treated as cause 47.

All other values in the range 48 to 63 shall be treated as cause 63.

All other values in the range 64 to 79 shall be treated as cause 79.

All other values in the range 80 to 95 shall be treated as cause 95.

All other values in the range 96 to 111 shall be treated as cause 111.

All other values in the range 112 to 127 shall be treated as cause 127.

NOTE 1: Diagnostics for supplementary services are handled as follows:

octet 5, bit 8:

This is an extension bit as defined in the preliminary part of subclause 10.5. In this version of this protocol, this bit shall be set to 1. If it is set to zero, the contents of the following octets shall be ignored.

octet 5, bit 7-1:

0000001 - Outgoing calls barred within CUG

0000010 - No CUG selected

0000011 - Unknown CUG index

0000100 - CUG index incompatible with requested basic service

0000101 - CUG call failure, unspecified

0000110 - CLIR not subscribed

0000111 - CCBS possible

0001000 - CCBS not possible

All other values shall be ignored.

NOTE 2: The incompatible parameter is composed of the incompatible information element identifier.

NOTE 3: The format of the diagnostic field for cause numbers 57, 58 and 65 is as shown in figure 10.5.88/3GPP TS 24.008 and tables 10.5.102/3GPP TS 24.008 to 10.5.115/3GPP TS 24.008.

NOTE 4: The user supplied diagnostics field is encoded according to the user specification, subject to the maximum length of the cause information element. The coding of user supplied diagnostics should be made in such a way that it does not conflict with the coding described in note 9 below.

NOTE 5: The new destination is formatted as the called party BCD number information element, including information element identifier.

NOTE 6: Locking and non-locking shift procedures described in subclause 10.5.4.2 and clause 3 are applied. In principle, information element identifiers are ordered in the same order as the information elements in the received message.

NOTE 7: When only the locking shift information element is included and no information element identifier follows, it means that the codeset in the locking shift itself is not implemented.

NOTE 8: The timer number is coded in IA5 characters, e.g., T308 is coded as "3" "0" "8". The following coding is used in each octet:

bit 8: spare "0"

bits 7-1: IA5 character

Octet 5 carries "3", octet 5a carries "0", etc.

NOTE 9: The following coding is used for octet 5:

bit 8 : 1

bits 7-3: 00000

bits 2-1: condition as follows:

00 - unknown

01 - permanent

10 - transient

### 10.5.4.11a CLIR suppression

The CLIR suppression information element may be sent by the mobile station to the network in the SETUP message. The use is defined in 3GPP TS 24.081 [25].

The CLIR suppression information element is coded as shown in figure 10.5.96/3GPP TS 24.008.

The CLIR suppression is a type 2 information element.

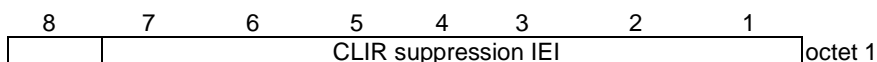

**Figure 10.5.96/3GPP TS 24.008 CLIR suppression information element**

### 10.5.4.11b CLIR invocation

The CLIR invocation information element may be sent by the mobile station to the network in the SETUP message. The use is defined in 3GPP TS 24.081 [25].

The CLIR invocation information element is coded as shown in figure 10.5.97/3GPP TS 24.008.

The CLIR invocation is a type 2 information element.

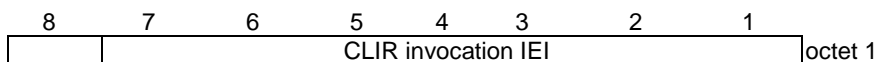

**Figure 10.5.97/3GPP TS 24.008 CLIR invocation information element**

### 10.5.4.12 Congestion level

The purpose of the congestion level information element is to describe the congestion status of the call.

The congestion level information element is coded as shown in figure 10.5.98/3GPP TS 24.008 and table 10.5.124/3GPP TS 24.008.

The congestion level is a type 1 information element.

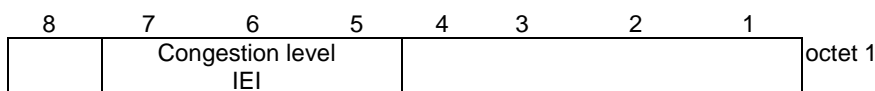

**Figure 10.5.98/3GPP TS 24.008 Congestion level information element**

**Table 10.5.124/3GPP TS 24.008: Congestion level information element**

Congestion level (octet 1)			
Bits			
<b>4</b>	<b>3</b>	<b>2</b>	<b>1</b>
0	0	0	0
1	1	1	1
receiver ready			
receiver not ready			
All other values are reserved.			

### 10.5.4.13 Connected number

The purpose of the connected number information element is to identify the connected party of a call.

The connected number information element is coded as shown in figure 10.5.99/3GPP TS 24.008.

The connected number is a type 4 information element with a minimum length of 3 octets and a maximum length of 14 octets.

8	7	6	5	4	3	2	1	
Connected number IEI								octet 1
Length of connected number contents								octet 2
0/1 ext	Type of number			Number plan identification				octet 3 note 1)
1 ext	Presentation indicator	0	0	0	Spare			octet 3a* note 1)
Number digit 2				Number digit 1				octet 4* note 1)
Number digit 4				Number digit 3				octet 5* note 1)
note 2)								:
								:

**Figure 10.5.99/3GPP TS 24.008**

NOTE 1: The contents of octets 3,4,5, etc. ... are coded as shown in table 10.5.118/3GPP TS 24.008. The coding of octet 3a is defined in table 10.5.120/3GPP TS 24.008.

NOTE 2: If the connected number contains an odd number of digits, bits 5 to 8 of the last octet shall be filled with the end mark coded as "1111".

### 10.5.4.14 Connected subaddress

The purpose of the connected subaddress information element is to identify a subaddress associated with the connected party of a call.

The connected subaddress information element is coded as shown in figure 10.5.100/3GPP TS 24.008.

The connected subaddress is a type 4 information element with a minimum length of 2 octets and a maximum length of 23 octets.

8	7	6	5	4	3	2	1	
Connected subaddress IEI								octet 1
Length of connected subaddress contents								octet 2
	Type of subaddress	odd/even indicator	0	0	0	Spare		octet 3*
Subaddress information								octet 4*
:								:
:								:
:								etc.

**Figure 10.5.100/3GPP TS 24.008**

The coding for Type of subaddress, odd/even indicator, and subaddress information is in table 10.5.119/3GPP TS 24.008.

### 10.5.4.15 Facility

The purpose of the facility information element is to transport supplementary service related information. Within the scope of 3GPP TS 24.008 the content of the Facility information field is an array of octets. The usage of this transportation mechanism is defined in 3GPP TS 24.080 [24].

The facility information element is coded as shown in figure 10.5.101/3GPP TS 24.008.

The facility is a type 4 information element with a minimum length of 2 octets. No upper length limit is specified except for that given by the maximum number of octets in a L3 message (see 3GPP TS 44.006 [19]).

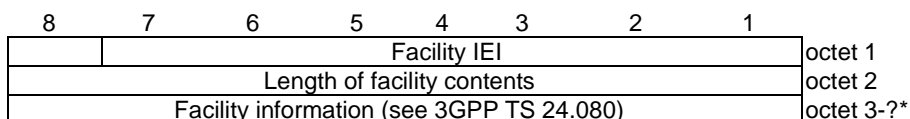

**Figure 10.5.101/3GPP TS 24.008**

### 10.5.4.16 High layer compatibility

The purpose of the high layer compatibility information element is to provide a means which should be used by the remote user for compatibility checking. See annex B.

The high layer compatibility information element is coded as shown in figure 10.5.102/3GPP TS 24.008 and table 10.5.125/3GPP TS 24.008.

The high layer compatibility is a type 4 information element with a minimum length of 2 octets and a maximum length of 5 octets.

**NOTE:** The high layer compatibility information element is transported transparently by a PLMN between a call originating entity (e.g. a calling user) and the addressed entity (e.g. a remote user or a high layer function network node addressed by the call originating entity). However, if explicitly requested by the user (at subscription time), a network which provides some capabilities to realize teleservices may interpret this information to provide a particular service.

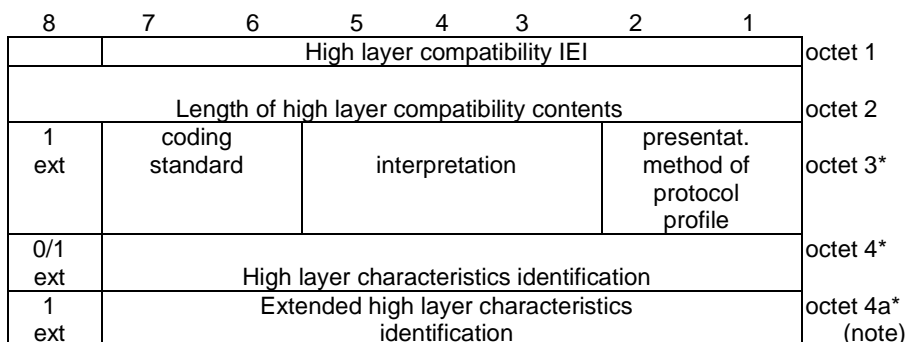

**Figure 10.5.102/3GPP TS 24.008 High layer compatibility information element**

If the value part of the IE is empty, the IE indicates "not applicable".

**NOTE:** Octet 4a may be present e.g. when octet 4 indicates Maintenance or Management, or audio visual.

**Table 10.5.125/3GPP TS 24.008: High layer compatibility information element**

Coding standard (octet 3) see ITU Recommendation Q.931.
Interpretation (octet 3) see ITU Recommendation Q.931.
Presentation method of protocol profile (octet 3) see ITU Recommendation Q.931.
High layer characteristics identification (octet 4) see ITU Recommendation Q.931.
Extended high layer characteristics identification (octet 4a) see ITU Recommendation Q.931.

### 10.5.4.16.1 Static conditions for the high layer compatibility IE contents

Either the value part of the IE is empty, or it contains at least octet 3 and 4.

### 10.5.4.17 Keypad facility

The purpose of the keypad facility information element is to convey IA5 characters, e.g. entered by means of a terminal keypad (see note).

The keypad facility information element is coded as shown in figure 10.5.103/3GPP TS 24.008.

The keypad facility is a type 3 information element with 2 octets length.

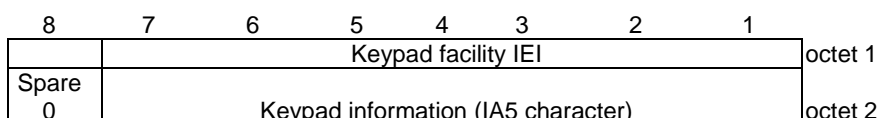

**Figure 10.5.103/3GPP TS 24.008 Keypad facility information element**

NOTE: In the 3GPP system this information element is only used to transfer one DTMF digit (0, 1, ... , 9, A, B, C, D, \*, #) as one IA5 character.

### 10.5.4.18 Low layer compatibility

The purpose of the low layer compatibility information element is to provide a means which should be used for compatibility checking by an addressed entity (e.g., a remote user or an interworking unit or a high layer function network node addressed by the calling user). The low layer compatibility information element is transferred transparently by a PLMN between the call originating entity (e.g. the calling user) and the addressed entity.

Except for the information element identifier, the low layer compatibility information element is coded as in ITU recommendation Q.931.

For backward compatibility reasons coding of the modem type field according to ETS 300 102-1 (12-90) shall also be supported.

The low layer compatibility is a type 4 information element with a minimum length of 2 octets and a maximum length of 18 octets.

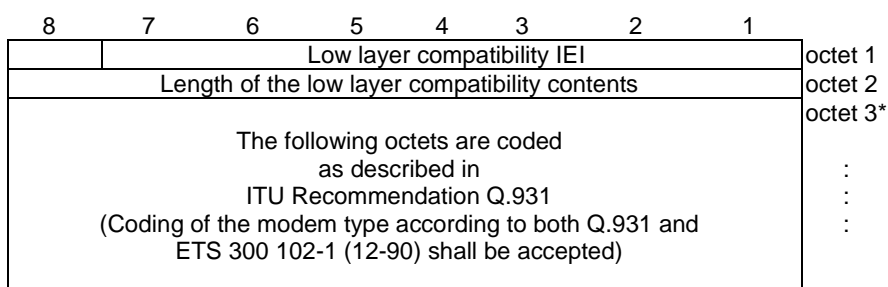

**Figure 10.5.104/3GPP TS 24.008 Low layer compatibility information element**

If the value part of the IE is empty, the IE indicates "not applicable".

### 10.5.4.19 More data

The more data information element is sent by the mobile station to the network or to the network to the mobile station in a USER INFORMATION message. The presence of the more data information element indicates to the destination remote user/mobile station that another USER INFORMATION message will follow containing information belonging to the same block.

The use of the more data information element is not supervised by the network.

The more data information element is coded as shown in figure 10.5.105/3GPP TS 24.008.

The more data is a type 2 information element.

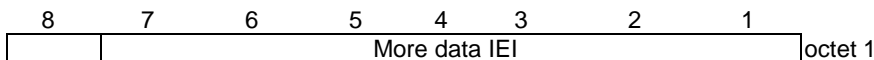

**Figure 10.5.105/3GPP TS 24.008 More data information element**

### 10.5.4.20 Notification indicator

The purpose of the notification indicator information element is to indicate information pertaining to a call.

The notification indicator element is coded as shown in figure 10.5.106/3GPP TS 24.008 and table 10.5.126/ 3GPP TS 24.008.

The notification indicator is a type 3 information element with 2 octets length.

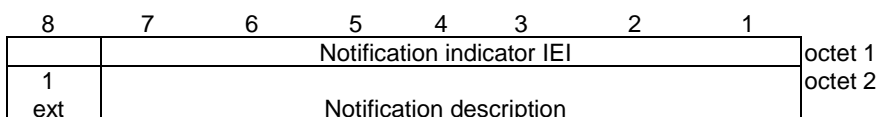

**Figure 10.5.106/3GPP TS 24.008 Notification indicator information element**

**Table 10.5.126/3GPP TS 24.008: Notification indicator information element**

Notification description (octet 2)								
Bits								
	7	6	5	4	3	2	1	
	0	0	0	0	0	0	0	User suspended
	0	0	0	0	0	0	1	User resumed
	0	0	0	0	0	1	0	Bearer change
All other values are reserved.								

### 10.5.4.21 Progress indicator

The purpose of the progress indicator information element is to describe an event which has occurred during the life of a call.

The progress indicator information element is coded as shown in figure 10.5.107/3GPP TS 24.008 and table 10.5.127/3GPP TS 24.008.

The progress indicator is a type 4 information element with a length of 4 octets.

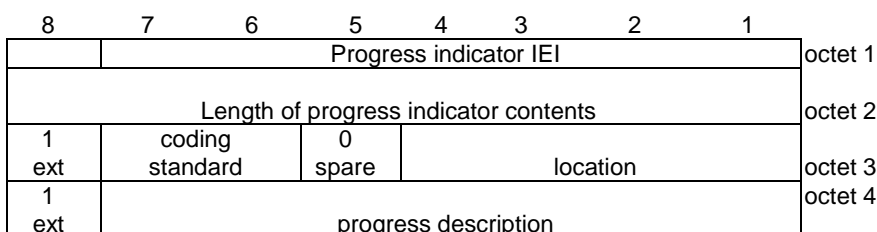

**Figure 10.5.107/3GPP TS 24.008 Progress indicator information element**



**Table 10.5.127/3GPP TS 24.008: Progress indicator information element**

Coding standard (octet 3)								
Bits								
<b>7</b>	<b>6</b>							
0 0	Standardized coding, as described in ITU-T Rec. Q.931							
0 1	Reserved for other international standards							
1 0	National standard							
1 1	Standard defined for the GSM PLMNS as described below							
Coding standards other than "1 1 - Standard defined for the GSM PLMNS" shall not be used if the progress description can be represented with the GSM standardized coding.								
The mobile station or network need not support any other coding standard than "1 1 - Standard defined for the GSM PLMNS".								
If a progress indicator IE indicating a coding standard not supported by the receiver is received, progress description "Unspecific" shall be assumed.								
Location (octet 3)								
Bits								
<b>4</b>	<b>3</b>	<b>2</b>	<b>1</b>					
0 0 0 0	User							
0 0 0 1	Private network serving the local user							
0 0 1 0	Public network serving the local user							
0 1 0 0	Public network serving the remote user							
0 1 0 1	Private network serving the remote user							
1 0 1 0	Network beyond interworking point							
All other values are reserved.								
Note: Depending on the location of the users, the local public network and remote public network may be the same network.								
Progress description (octet 4)								
Bits								
<b>7</b>	<b>6</b>	<b>5</b>	<b>4</b>	<b>3</b>	<b>2</b>	<b>1</b>	No.	
0	0	0	0	0	0	1	1.	Call is not end-to-end PLMN/ISDN, further call progress information may be available in-band
0	0	0	0	0	1	0	2.	Destination address in non-PLMN/ISDN
0	0	0	0	0	1	1	3.	Origination address in non-PLMN/ISDN
0	0	0	0	1	0	0	4.	Call has returned to the PLMN/ISDN
0	0	0	1	0	0	0	8.	In-band information or appropriate pattern now available
0	1	0	0	0	0	0	32.	Call is end-to-end PLMN/ISDN
1	0	0	0	0	0	0	64.	Queueing
All other values								Unspecific

**10.5.4.21a Recall type \$(CCBS)\$**

The purpose of the recall type information element is to describe the reason for the recall.

The recall type information element is coded as shown in Figure 10.5.108/3GPP TS 24.008 and Table 10.5.128/3GPP TS 24.008.

The recall type is a type 3 information element with 2 octets length.

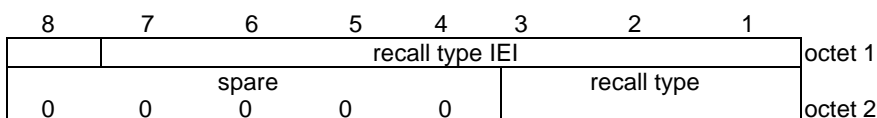

**Figure 10.5.108/3GPP TS 24.008 Recall type information element**

**Table 10.5.128/3GPP TS 24.008: Recall type information element**

recall type (octet 2, bits 1 to 4)			
Bits			
<b>3</b>	<b>2</b>	<b>1</b>	
0	0	0	- CCBS
0	0	1	}
		to	}- shall be treated as CCBS (intended for other similar types of Recall)
1	1	0	}
1	1	1	- reserved

### 10.5.4.21b Redirecting party BCD number

The purpose of the redirecting party BCD number information element is to identify the redirecting party.

The redirecting party BCD number information element is coded as shown in figure 10.5.108a/3GPP TS 24.008.

The redirecting party BCD number is a type 4 information element. In the network to mobile station direction it has a minimum length of 3 octets and a maximum length of 19 octets.

8	7	6	5	4	3	2	1	
Redirecting party BCD number IEI								octet 1
Length of redirecting party BCD number contents								octet 2
0/1 ext	type of number			Numbering plan identification				octet 3 (note 1)
1 ext	presentat. indicator	0	0	0	0	Screening indicator		octet 3a* (note 1)
Number digit 2				Number digit 1				octet 4* (note 1)
Number digit 4				Number digit 3				octet 5* (note 1)
								:
								:
Note 2)								:

**Figure 10.5.108a/3GPP TS 24.008**  
**Redirecting party BCD number information element**

NOTE 1: The contents of octets 3, 4, etc. are coded as shown in table 10.5.118/3GPP TS 24.008. The coding of octet 3a is defined in table 10.5.120/3GPP TS 24.008.

NOTE 2: If the redirecting party BCD number contains an odd number of digits, bits 5 to 8 of the last octet shall be filled with an end mark coded as "1111".

### 10.5.4.21c Redirecting party subaddress

The purpose of the Redirecting party subaddress is to identify a subaddress associated with the redirecting party. For the definition of a subaddress see Rec. ITU-T I.330.

The Redirecting party subaddress information element is coded as shown in figure 10.5.108b/3GPP TS 24.008 and table 10.5.121/3GPP TS 24.008.

The Redirecting party subaddress is a type 4 information element with a minimum length of 2 octets and a maximum length of 23 octets.

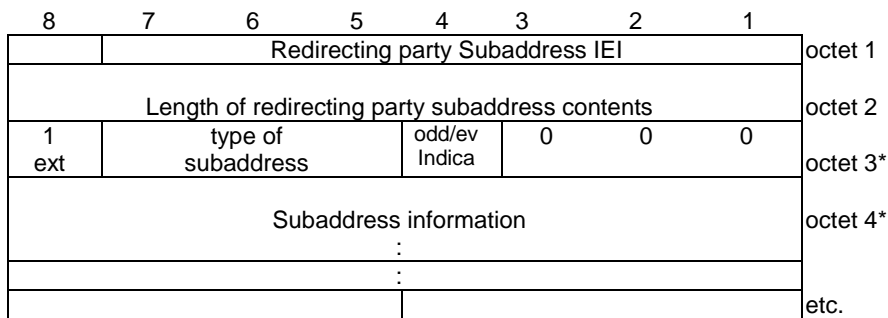

**Figure 10.5.108b/3GPP TS 24.008**  
**Redirecting party subaddress information element**

### 10.5.4.22 Repeat indicator

The purpose of the repeat indicator information element is to indicate how the associated repeated information elements shall be interpreted, when included in a message. The repeat indicator information element is included immediately before the first occurrence of the associated information element which will be repeated in a message. "Mode 1" refers to the first occurrence of that information element, "mode 2" refers to the second occurrence of that information element in the same message.

The repeat indicator information element is coded as shown in figure 10.5.109/3GPP TS 24.008 and table 10.5.129/3GPP TS 24.008.

The repeat indicator is a type 1 information element.

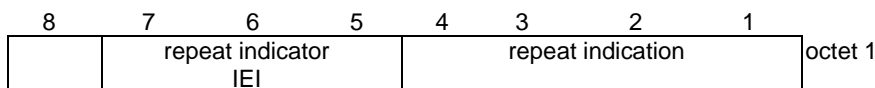

**Figure 10.5.109/3GPP TS 24.008 Repeat indicator information element**

**Table 10.5.129/3GPP TS 24.008: Repeat indicator information element**

Repeat indication (octet 1)			
Bits			
<b>4</b>	<b>3</b>	<b>2</b>	<b>1</b>
0	0	0	1
Circular for successive selection "mode 1 alternate mode 2"			
0	0	1	0
Support of fallback – mode 1 preferred, mode 2 selected if setup of mode 1 fails			
0	0	1	1
reserved: was allocated in earlier phases of the protocol			
0	1	0	0
Service change and fallback – mode 1 alternate mode 2, mode 1 preferred			
All other values are reserved.			

### 10.5.4.22a Reverse call setup direction

This information element may be included in a MODIFY and MODIFY COMPLETE message to indicate that the direction of the data call to which the MODIFY message relates is opposite to the call setup direction.

The *reverse call setup direction* information element is coded as shown in figure 10.5.110/3GPP TS 24.008.

The *reverse call setup direction* is a type 2 information element

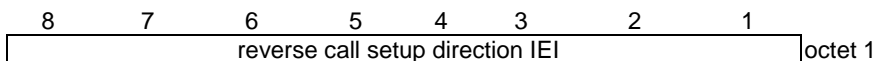

Figure 10.5.110/3GPP TS 24.008 Reverse call setup direction information element

10.5.4.22b SETUP Container \$(CCBS)\$

This information element contains the contents of a SETUP message (Mobile Station to Network). This means that the Call Control protocol discriminator IE, the Transaction Identifier IE and the Setup message type IE are not included.

The SETUP Container information element is coded as shown in figure 10.5.111/3GPP TS 24.008.

The SETUP Container is a type 4 information. No upper length limit is specified except for that given by the maximum number of octets in a L3 message (see 3GPP TS 44.006 [19]).

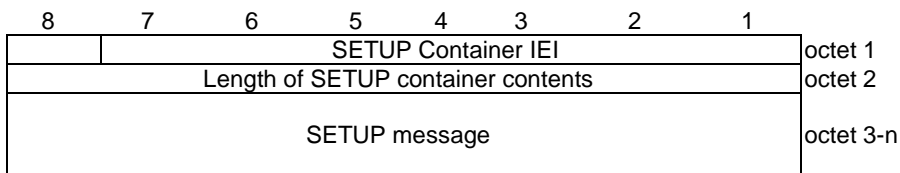

Figure 10.5.111/3GPP TS 24.008 Octet j (j = 3, 4 ... n) is the unchanged octet j of the SETUP message.

10.5.4.23 Signal

The purpose of the signal information element is to allow the network to convey information to a user regarding tones and alerting signals (see subclauses 5.2.2.3.2 and 7.3.3.).

The signal information element is coded as shown in figure 10.5.112/3GPP TS 24.008 and table 10.5.130/3GPP TS 24.008.

The signal is a type 3 information element with 2 octets length.

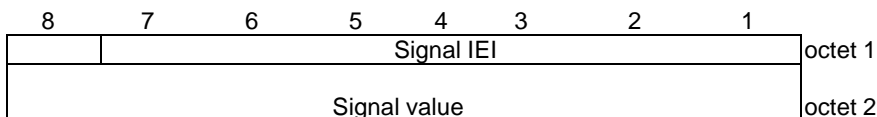

Figure 10.5.112/3GPP TS 24.008 Signal information element

**Table 10.5.130/3GPP TS 24.008: Signal information element**

Signal value (octet 2)								
Bits								
8	7	6	5	4	3	2	1	
0	0	0	0	0	0	0	0	dial tone on
0	0	0	0	0	0	0	1	ring back tone on
0	0	0	0	0	0	0	1	intercept tone on
0	0	0	0	0	0	0	1	network congestion tone on
0	0	0	0	0	0	1	0	busy tone on
0	0	0	0	0	0	1	0	confirm tone on
0	0	0	0	0	1	1	0	answer tone on
0	0	0	0	0	1	1	1	call waiting tone on
0	0	0	0	1	0	0	0	off-hook warning tone on
0	0	1	1	1	1	1	1	tones off
0	1	0	0	1	1	1	1	alerting off

All other values are reserved.

**10.5.4.24 SS Version Indicator**

The purpose of the SS version indicator information element is to aid the decoding of the Facility information element as described in 3GPP TS 24.010. Within the scope of 3GPP TS 24.008 the contents of the SS Version information field is an array of one or more octets. The usage of the SS version information field is defined in 3GPP TS 24.080.

The SS version indicator information element is coded as shown in figure 10.5.113/3GPP TS 24.008.

The SS version indicator is a type 4 information element with a minimum length of 2 octets. No upper length limit is specified except for that given by the maximum number of octets in a L3 message (see 3GPP TS 44.006 [19]).

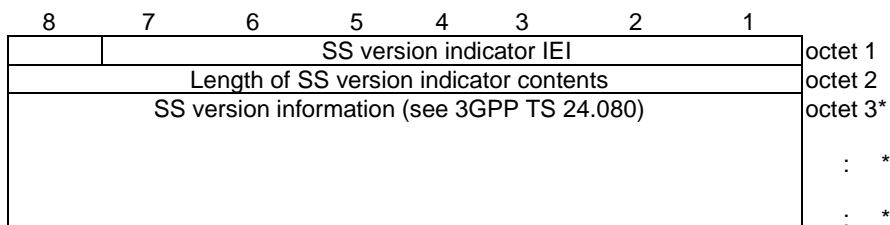

**Figure 10.5.113/3GPP TS 24.008**

NOTE: Usually, this information element has only one octet of content.

**10.5.4.25 User-user**

The purpose of the user-user information element is to convey information between the mobile station and the remote ISDN user.

The user-user information element is coded as shown in figure 10.5.114/3GPP TS 24.008 and table 10.5.131/3GPP TS 24.008. There are no restrictions on the content of the user-user information field.

The user-user is a type 4 information element with a minimum length of 3 octets and a maximum length of either 35 or 131 octets. In the SETUP message the user-user information element has a maximum size of 35 octets in a GSM PLMN. In the USER INFORMATION, ALERTING, CONNECT, DISCONNECT, PROGRESS, RELEASE and RELEASE COMPLETE messages the user-user information element has a maximum size of 131 octets in a GSM PLMN.

In other networks than GSM PLMNs the maximum size of the user-user information element is 35 or 131 octets in the messages mentioned above. The evolution to a single maximum value is the long term objective; the exact maximum value is the subject of further study.

NOTE: The user-user information element is transported transparently through a GSM PLMN.

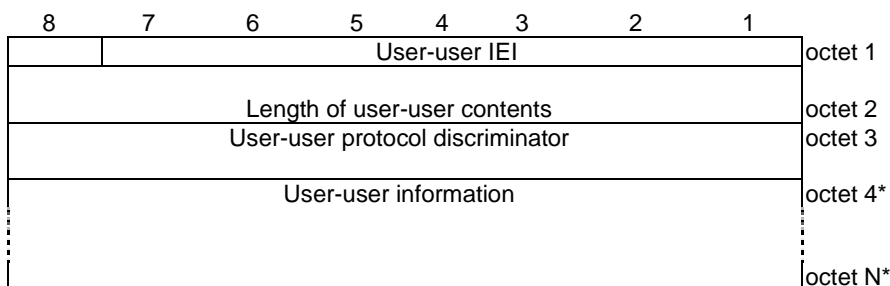

Figure 10.5.114/3GPP TS 24.008 User-user information element

Table 10.5.131/3GPP TS 24.008: User-user information element

User-user protocol discriminator (octet 3)								
Bits								
<b>8</b>	<b>7</b>	<b>6</b>	<b>5</b>	<b>4</b>	<b>3</b>	<b>2</b>	<b>1</b>	
0	0	0	0	0	0	0	0	User specific protocol (Note 1)
0	0	0	0	0	0	0	1	OSI high layer protocols
0	0	0	0	0	0	1	0	X.244 (Note 2)
0	0	0	0	0	0	1	1	Reserved for system management convergence function
0	0	0	0	0	1	0	0	IA5 characters (Note 3)
0	0	0	0	0	1	1	1	Rec.V.120 rate adaption
0	0	0	0	1	0	0	0	Q.931 (I.451) user-network call control messages
0	0	0	1	0	0	0	0	Reserved for other network layer or layer 3 protocols
through	0	0	1	1	1	1	1	
0	1	0	0	0	0	0	0	National use
through	0	1	0	0	1	1	1	
0	1	0	1	0	0	0	0	Reserved for other network layer or layer 3 protocols
through	1	1	1	1	1	1	0	
All other values are reserved.								
NOTE 1: The user information is structured according to user needs.								
NOTE 2: The user information is structured according to Rec.X.244 which specifies the structure of X.25 call user data.								
NOTE 3: The user information consists of IA5 characters.								

### 10.5.4.26 Alerting Pattern \$(NIA)\$

The purpose of the Alerting Pattern information element is to allow the network to convey information related to the alert to be used by the MS (see 3GPP TS 22.101 [8]).

The Alerting Pattern information element is coded as shown in figure 10.5.115/3GPP TS 24.008 and table 10.5.132/3GPP TS 24.008.

The Alerting Pattern IE is a type 4 information element with 3 octet length.

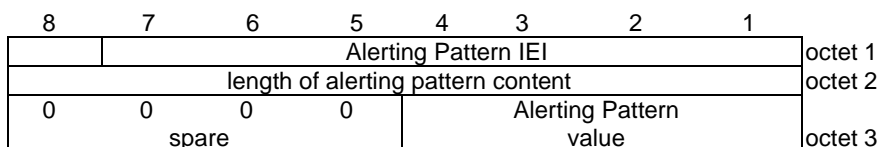

**Figure 10.5.115/3GPP TS 24.008 Alerting Pattern information element**

**Table 10.5.132/3GPP TS 24.008: Alerting Pattern information element**

Alerting Pattern value (octet 3)				
Bits				
<b>4</b>	<b>3</b>	<b>2</b>	<b>1</b>	
0	0	0	0	alerting pattern 1
0	0	0	1	alerting pattern 2
0	0	1	0	alerting pattern 3
0	1	0	0	alerting pattern 5
0	1	0	1	alerting pattern 6
0	1	1	0	alerting pattern 7
0	1	1	1	alerting pattern 8
1	0	0	0	alerting pattern 9
all other values are reserved				

Alerting pattern 1, 2 and 3 indicate alerting levels 0, 1 and 2.

Alerting pattern 5 to 9 indicate alerting categories 1 to 5

### 10.5.4.27 Allowed actions \$(CCBS)\$

The purpose of the *Allowed actions* information element is to provide the mobile station with information about further allowed procedures.

The *Allowed actions* information element is coded as shown in figure 10.5.116/3GPP TS 24.008 and table 10.5.133/3GPP TS 24.008.

The *Allowed actions* is a type 4 information element with 3 octets length.

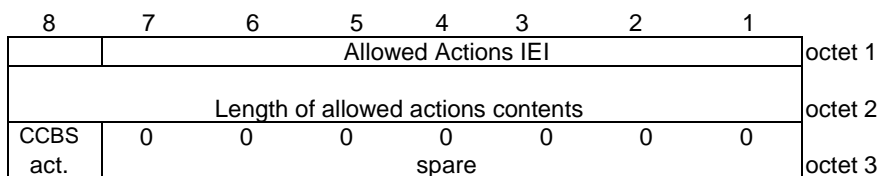

**Figure 10.5.116/3GPP TS 24.008 Allowed actions information element**

**Table 10.5.133/3GPP TS 24.008: Allowed actions information element**

CCBS activation (octet 3)	
Bits	
<b>8</b>	
0	Activation of CCBS not possible
1	Activation of CCBS possible

### 10.5.4.28 Stream Identifier

The purpose of the stream identifier (SI) information element is to associate a particular call with a Radio Access Bearer (RAB), and to identify whether a new traffic channel shall be assigned within the interface controlled by these signalling procedures. The SI value indicated in the CC protocol shall be sent in the RAB setup message. And mobile station is informed the relationship between the call and the RAB.

The Stream identifier information element is coded as shown in figure 10.5.117/3GPP TS 24.008 and table 10.5.134/3GPP TS 24.008.

The Stream Identifier is a type 4 information element with 3 octets length.

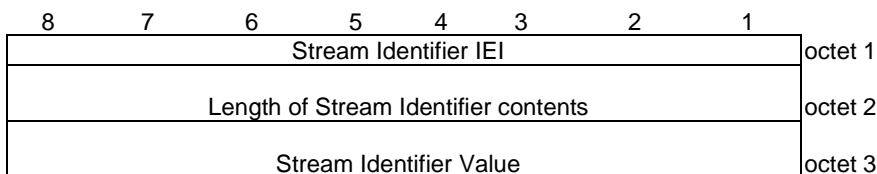

**Figure 10.5.117/3GPP TS 24.008: Stream Identifier information element**

**Table 10.5.134/3GPP TS 24.008: Stream Identifier information element**

Stream Identifier value(octet 3)								
Bit								
8	7	6	5	4	3	2	1	
0	0	0	0	0	0	0	0	No bearer
0	0	0	0	0	0	0	1	1
			⋮					
1	1	1	1	1	1	1	1	255

### 10.5.4.29 Network Call Control Capabilities

The purpose of the *Network Call Control Capabilities* information element is to identify the call control capabilities of the network. The contents might affect the manner in which the mobile station handles the call.

The Network Call Control Capabilities information element is coded as shown in figure 10.5.118/3GPP TS 24.008 and table 10.5.135/3GPP TS 24.008.

The Network Call Control Capabilities is a type 4 information element with a length of 3 octets.

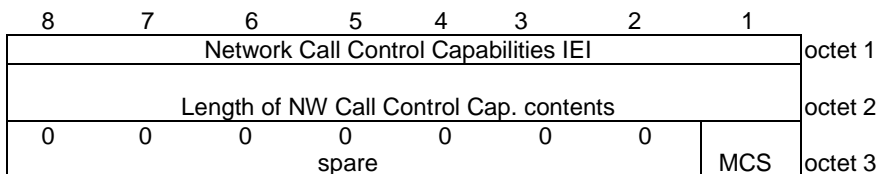

**Figure 10.5.118/3GPP TS 24.008 Network Call Control Capabilities information element**

**Table 10.5.135/3GPP TS 24.008: Network Call Control Capabilities**

MCS (octet 3, bit 1)	
0	This value indicates that the network does not support the multicall.
1	This value indicates that the network supports the multicall.



### 10.5.4.30 Cause of No CLI

*Cause of No CLI* information element provides the mobile station the detailed reason why Calling party BCD number is not notified (see 3GPP TS 24.081 [25]).

The *Cause of No CLI* information element is coded as shown in figure 10.5.118a/3GPP TS 24.008 and table 10.5.135a/3GPP TS 24.008.

The *Cause of No CLI* is a type 4 information element with the length of 3 octets.

8	7	6	5	4	3	2	1	
Cause of No CLI IEI								octet 1
Length of Cause of No CLI contents								octet 2
Cause of No CLI								octet 3

**Figure 10.5.118a/3GPP TS 24.008 Cause of No CLI information element**

**Table 10.5.135a/3GPP TS 24.008: Cause of No CLI information element**

Cause of No CLI (octet 3)								
Bits								
8	7	6	5	4	3	2	1	
0	0	0	0	0	0	0	0	Unavailable
0	0	0	0	0	0	0	1	Reject by user
0	0	0	0	0	0	1	0	Interaction with other service
0	0	0	0	0	0	1	1	Coin line/payphone
Other values shall be interpreted as "Unavailable".								

### 10.5.4.31 Void

### 10.5.4.32 Supported codec list

The purpose of the *Supported Codec List* information element is to provide the network with information about the speech codecs supported by the mobile.

The *Supported Codec List* information element is coded as shown in figure 10.5.118c/3GPP TS 24.008.

The *Supported Codec List* information element is a type 4 information element with a minimum length of 5 octets and a maximum length of m+3 octets.

Speech codec information belonging to GERAN and UTRAN shall be conveyed by this information element.

8	7	6	5	4	3	2	1	
Supported Codec List IEI								octet 1
Length Of Supported Codec list								octet 2
System Identification 1 (SysID 1)								octet 3
Length Of Bitmap for SysID 1								octet 4
Codec Bitmap for SysID 1, bits 1 to 8								octet 5
Codec Bitmap for SysID 1, bits 9 to 16								octet 6
System Identification 2 (SysID 2)								octet j
Length Of Bitmap for (SysID 2)								octet j+1
Codec Bitmap for (SysID 2), bits 1 to 8								octet j+2
Codec Bitmap for (SysID 2), bits 9 to 16								octet j+3
System Identification x (SysID x)								octet m
Length Of Bitmap for (SysID x)								octet m+1
Codec Bitmap for (SysID x), bits 1 to 8								octet m+2
Codec Bitmap for (SysID x), bits 9 to 16								octet m+3

Figure 10.5.118c/3GPP TS 24.008 Supported codec list information element

Table 10.5.4.135c/3GPP TS 24.008: Supported Codec List information element

<p>Octet 3, (j+1), m etc                  SysID indicates the radio access technology for which the proceeding codec types may be used.                  Coding of this Octet is defined in 3GPP TS 26.103.</p> <p>Octet 4, (j+2), m+1 etc                  Length Of Codec Bitmap for SysID indicates the number of octets included in the list for the given SysID.</p> <p>Octets (5 &amp; 6), (J+2 &amp; j+3), (m+2 &amp; m+3) etc                  The coding of the Codec Bitmap is defined in 3GPP TS 26.103.</p>
---

### 10.5.4.33 Service category

The purpose of the *Service category* information element is to provide the network with information about services invoked by the user equipment.

The *Service category* information element is coded as shown in figure 10.5.118d/3GPP TS 24.008 and table 10.5.135d/3GPP TS 24.008

The *Service category* is a type 4 information element with a minimum length of 3 octets.

8	7	6	5	4	3	2	1	
Service Category IEI								Octet 1
Length of Service Category								Octet 2
Emergency Service Category Value								octet 3
0	0	0						

Figure 10.5.118d/3GPP TS 24.008 Service Category information element

**Table 10.5.135d/3GPP TS 24.008: Service Category information element**

<p>Emergency Service Category Value (octet 3)  The meaning of the Emergency Category Value is derived from the following settings (Please see 3GPP TS 22.101 clause 8):</p> <ul style="list-style-type: none"> <li>Bit 1 Police</li> <li>Bit 2 Ambulance</li> <li>Bit 3 Fire Brigade</li> <li>Bit 4 Marine Guard</li> <li>Bit 5 Mountain Rescue</li> <li>Bits 6,7,8 are spare and set to "0"</li> </ul> <p>Mobile station may set one or more bits to "1"  If more than one bit is set to "1", routing to a combined Emergency centre (e.g. ambulance and fire brigade in Japan) is required. If the MSC can not match the received service category to any of the emergency centres, it shall route the call to an operator defined default emergency centre.</p> <p>If no bit is set to "1", the MSC shall route the Emergency call to an operator defined default emergency centre</p>
---

#### 10.5.4.34 Redial

The purpose of the *Redial* information element is to indicate to the network that a call is the result of a redial attempt to switch from speech to multimedia or vice-versa.

The *Redial* information element is coded as shown in figure 10.5.118e/3GPP TS 24.008

The *Redial* is a type 2 information element with a length of 1 octet.

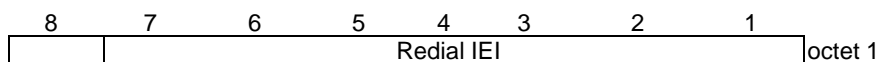
**Figure 10.5.118e/3GPP TS 24.008 Redial information element**

#### 10.5.4.35 Network-initiated Service Upgrade indicator

The purpose of the *Network-initiated Service Upgrade indicator* information element is to indicate to the mobile station that the in-call modification procedure is due to a network-initiated upgrade from speech to UDI/RDI multimedia (see 3GPP TS 23.172 [97]).

The *Network-initiated Service Upgrade indicator* information element is coded as shown in figure 10.5.118f/3GPP TS 24.008.

The *Network-initiated Service Upgrade indicator* is a type 2 information element with a length of 1 octet.

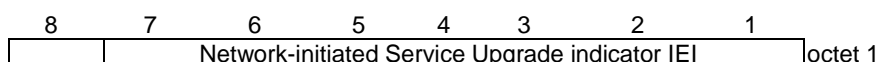
**Figure 10.5.118f/3GPP TS 24.008 Network-initiated Service Upgrade indicator information element**

## 10.5.5 GPRS mobility management information elements

### 10.5.5.1 Attach result

The purpose of the *attach result* information element is to specify the result of a GPRS attach procedure.

The *attach result* is a type 1 information element.

The *attach result* information element is coded as shown in figure 10.5.117a/3GPP TS 24.008 and table 10.5.134a/3GPP TS 24.008.

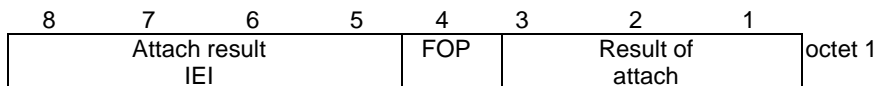

**Figure 10.5.117a/3GPP TS 24.008: *Attach result* information element**

**Table 10.5.134a/3GPP TS 24.008: *Attach result* information element**

Result of attach (octet 1)		
Bits		
<b>3</b>	<b>2</b>	<b>1</b>
0	0	1
GPRS only attached		
0	1	1
Combined GPRS/IMSI attached		
All other values are reserved.		
Follow-on proceed (octet 1)		
Bit		
<b>4</b>		
0	Follow-on proceed	
1	No follow-on proceed	
Follow-on proceed is applicable only in lu mode. This indication shall be ignored if received in A/Gb mode.		

### 10.5.5.2 Attach type

The purpose of the *attach type* information element is to indicate the type of the requested attach, i.e. whether the MS wants to perform a GPRS or combined GPRS attach.

The *attach type* is a type 1 information element.

The *attach type* information element is coded as shown in figure 10.5.117b/3GPP TS 24.008 and table 10.5.135b/3GPP TS 24.008.

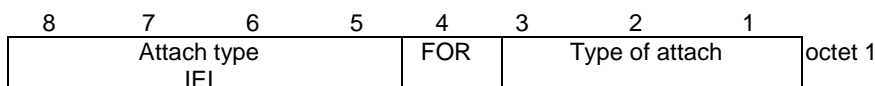

**Figure 10.5.117b/3GPP TS 24.008: *Attach type* information element**

**Table 10.5.135b/3GPP TS 24.008: Attach type information element**

Type of attach (octet 1, bit 1 to 3)		
Bits		
<b>3</b>	<b>2</b>	<b>1</b>
0	0	1
GPRS attach		
0	1	0
Not used. This value was allocated in earlier versions of the protocol (Note1)		
0	1	1
Combined GPRS/IMSI attach		
All other values are interpreted as <i>GPRS attach</i> in this version of the protocol.		
Follow-on request (octet 1, bit 4)		
Bits		
<b>4</b>		
0	No follow-on request pending	
1	Follow-on request pending	
Follow-on request pending is applicable only in Lu mode.		
NOTE 1: The code point '010' if received by the network, it shall be interpreted as "Combined GPRS/IMSI attach".		

### 10.5.5.3 Ciphering algorithm

The purpose of the *ciphering algorithm* information element is to specify which ciphering algorithm shall be used.

The *ciphering algorithm* is a type 1 information element.

The *ciphering algorithm* information element is coded as shown in figure 10.5.119/3GPP TS 24.008 and table 10.5.136/3GPP TS 24.008.

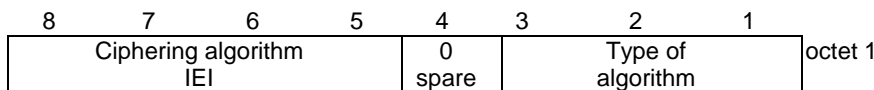

**Figure 10.5.119/3GPP TS 24.008: Ciphering algorithm information element**

**Table 10.5.136/3GPP TS 24.008: Ciphering algorithm information element**

Type of ciphering algorithm (octet 1)		
Bits		
<b>3</b>	<b>2</b>	<b>1</b>
0	0	0
ciphering not used		
0	0	1
GPRS Encryption Algorithm GEA/1		
0	1	0
GPRS Encryption Algorithm GEA/2		
0	1	1
GPRS Encryption Algorithm GEA/3		
1	0	0
GPRS Encryption Algorithm GEA/4		
1	0	1
GPRS Encryption Algorithm GEA/5		
1	1	0
GPRS Encryption Algorithm GEA/6		
1	1	1
GPRS Encryption Algorithm GEA/7		

### 10.5.5.4 TMSI status

The purpose of the *TMSI status* information element is to indicate whether a valid TMSI is available in the MS or not.

The *TMSI status* is a type 1 information element.

The *TMSI status* information element is coded as shown in figure 10.5.120/3GPP TS 24.008 and table 10.5.137/3GPP TS 24.008.

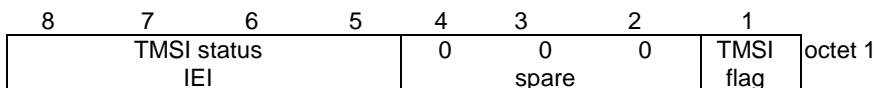

**Figure 10.5.120/3GPP TS 24.008: TMSI status information element**

**Table 10.5.137/3GPP TS 24.008: TMSI status information element**

TMSI flag (octet 1)	
Bit	
1	
0	no valid TMSI available
1	valid TMSI available

### 10.5.5.5 Detach type

The purpose of the *detach type* information element is to indicate which type of detach is requested by the MS. In the network to MS direction the *detach type* information element is used to indicate the reason why a detach request is sent.

The *detach type* is a type 1 information element.

The *detach type* information element is coded as shown in figure 10.5.121/3GPP TS 24.008 and table 10.5.138/3GPP TS 24.008.

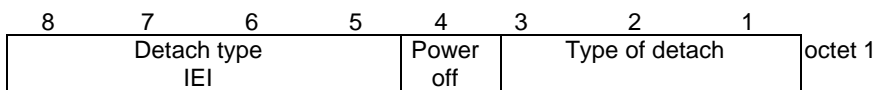

**Figure 10.5.121/3GPP TS 24.008: Detach type information element**

**Table 10.5.138/3GPP TS 24.008: *Detach type* information element**

Type of detach (octet 1)		
In the MS to network direction:		
Bits		
<b>3</b>	<b>2</b>	<b>1</b>
0 0 1		GPRS detach
0 1 0		IMSI detach
0 1 1		Combined GPRS/IMSI detach
All other values are interpreted as <i>Combined GPRS/IMSI detach</i> by this version of the protocol.		
In the network to MS direction:		
Bits		
<b>3</b>	<b>2</b>	<b>1</b>
0 0 1		re-attach required
0 1 0		re-attach not required
0 1 1		IMSI detach (after VLR failure)
All other values are interpreted as <i>re-attach not required</i> by this version of the protocol.		
Power off (octet 1)		
In the MS to network direction:		
Bit		
<b>4</b>		
0		normal detach
1		power switched off
In the network to MS direction the <i>Power off</i> bit shall be spare and set to zero.		

### 10.5.5.6 DRX parameter

The purpose of the *DRX parameter* information element is to indicate whether the MS uses DRX mode or not.

The *DRX parameter* is a type 3 information element with a length of 3 octets.

The value part of a *DRX parameter* information element is coded as shown in table 10.5.139/3GPP TS 24.008.

8	7	6	5	4	3	2	1	
DRX parameter IEI								octet 1
SPLIT PG CYCLE CODE								octet 2
CN Specific DRX cycle length coefficient				SPLIT on CCCH	non-DRX timer			octet 3

**Figure 10.5.122/3GPP TS 24.008: DRX parameter information element**

**Table 10.5.139/3GPP TS 24.008: DRX parameter information element**

SPLIT PG CYCLE CODE, octet 2	
The octet contains the binary coded value of the SPLIT PG CYCLE CODE. The SPLIT PG CYCLE value is derived from the SPLIT PG CYCLE CODE as follows:	
0	704 (equivalent to no DRX)
1 to 64	1 to 64, respectively
65	71
66	72
67	74
68	75
69	77
70	79
71	80
72	83
73	86
74	88
75	90
76	92
77	96
78	101
79	103
80	107
81	112
82	116
83	118
84	128
85	141
86	144
87	150
88	160
89	171
90	176
91	192
92	214
93	224
94	235
95	256
96	288
97	320
98	352
All other values are reserved and shall be interpreted as 1 by this version of the protocol.	
SPLIT on CCCH, octet 3 (bit 4)	
0	Split pg cycle on CCCH is not supported by the mobile station
1	Split pg cycle on CCCH is supported by the mobile station
non-DRX timer, octet 3	
bit	
<b>3</b>	<b>2</b>
<b>1</b>	
0 0 0	no non-DRX mode after transfer state
0 0 1	max. 1 sec non-DRX mode after transfer state
0 1 0	max. 2 sec non-DRX mode after transfer state
0 1 1	max. 4 sec non-DRX mode after transfer state
1 0 0	max. 8 sec non-DRX mode after transfer state
1 0 1	max. 16 sec non-DRX mode after transfer state
1 1 0	max. 32 sec non-DRX mode after transfer state
1 1 1	max. 64 sec non-DRX mode after transfer state



CN Specific DRX cycle length coefficient, octet 3				
bit				
<b>8</b>	<b>7</b>	<b>6</b>	<b>5</b>	lu mode specific
0	0	0	0	CN Specific DRX cycle length coefficient not specified by the MS, ie. the system information value 'CN domain specific DRX cycle length' is used. (Ref 3GPP TS 25.331)
0	1	1	0	CN Specific DRX cycle length coefficient 6
0	1	1	1	CN Specific DRX cycle length coefficient 7
1	0	0	0	CN Specific DRX cycle length coefficient 8
1	0	0	1	CN Specific DRX cycle length coefficient 9
All other values shall be interpreted as "CN Specific DRX cycle length coefficient not specified by the MS " by this version of the protocol.				
NOTE: In lu mode this field (octet 3 bits 8 to 5) is used, but was spare in earlier versions of this protocol.				

### 10.5.5.7 Force to standby

The purpose of the *force to standby* information element is to force the MS to stop the READY timer in order to prevent the MS to perform cell updates.

In lu mode, the network shall always indicate *force to standby not indicated* in the *force to standby* information element.

The *force to standby* is a type 1 information element.

The *force to standby* information element is coded as shown in figure 10.5.123/3GPP TS 24.008 and table 10.5.140/3GPP TS 24.008.

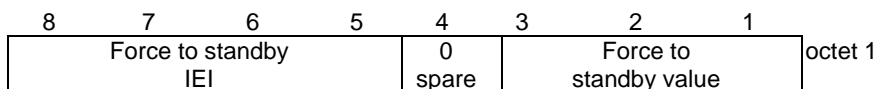

**Figure 10.5.123/3GPP TS 24.008: Force to standby information element**

**Table 10.5.140/3GPP TS 24.008: Force to standby information element**

Force to standby value (octet 1)			
Bits			
<b>3</b>	<b>2</b>	<b>1</b>	
0	0	0	Force to standby not indicated
0	0	1	Force to standby indicated
All other values are interpreted as <i>force to standby not indicated</i> by this version of the protocol.			

### 10.5.5.8 P-TMSI signature

The purpose of the *P-TMSI signature* information element is to identify a GMM context of an MS.

The *P-TMSI signature* is a type 3 information element with 4 octets length.

The *P-TMSI signature* information element is coded as shown in figure 10.5.124/3GPP TS 24.008 and table 10.5.141/3GPP TS 24.008.

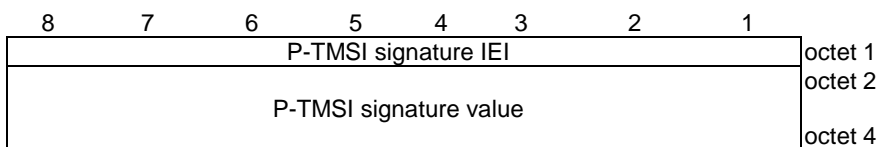

**Figure 10.5.124/3GPP TS 24.008: P-TMSI signature information element**

**Table 10.5.141/3GPP TS 24.008: P-TMSI signature information element**

P-TMSI signature value Octets 2, 3 and 4 contain the binary representation of the P-TMSI signature.  Bit 1 of octet 4 is the least significant bit and bit 8 of octet 2 is the most significant bit.
---

### 10.5.5.8a P-TMSI signature 2

The purpose of the *P-TMSI signature 2* information element is to identify a GMM context of an MS.

The *P-TMSI signature 2* is a type 4 information element with 5 octets length.

The *P-TMSI signature 2* information element is coded as shown in figure 10.5.124a/3GPP TS 24.008 and table 10.5.141a/3GPP TS 24.008.

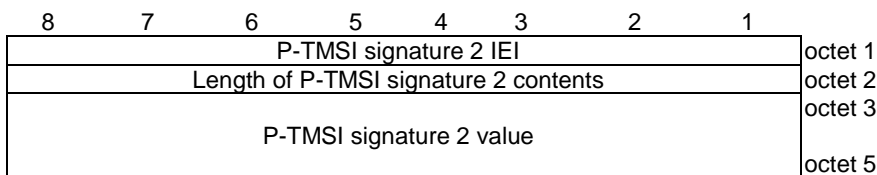

**Figure 10.5.124a/3GPP TS 24.008: P-TMSI signature 2 information element**

**Table 10.5.141a/3GPP TS 24.008: P-TMSI signature 2 information element**

P-TMSI signature 2 value is coded as octets 2 to 4 of the <i>P-TMSI signature</i> IE.
---

### 10.5.5.9 Identity type 2

The purpose of the *identity type 2* information element is to specify which identity is requested.

The *identity type 2* is a type 1 information element.

The *identity type 2* information element is coded as shown in figure 10.5.125/3GPP TS 24.008 and table 10.5.142/3GPP TS 24.008.

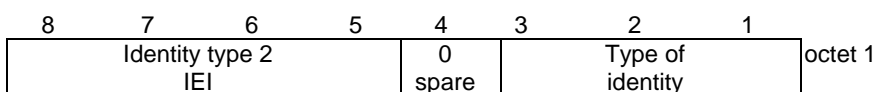

**Figure 10.5.125/3GPP TS 24.008: Identity type 2 information element**

**Table 10.5.142/3GPP TS 24.008: Identity type 2 information element**

Type of identity (octet 1)			
Bits			
<b>3</b>	<b>2</b>	<b>1</b>	
0	0	1	IMSI
0	1	0	IMEI
0	1	1	IMEISV
1	0	0	TMSI
All other values are interpreted as <i>IMSI</i> by this version of the protocol.			

**10.5.5.10 IMEISV request**

The purpose of the *IMEISV request* information element is to indicate that the IMEISV shall be included by the MS in the authentication and ciphering response message.

The *IMEISV request* is a type 1 information element.

The *IMEISV request* information element is coded as shown in figure 10.5.126/3GPP TS 24.008 and table 10.5.143/3GPP TS 24.008.

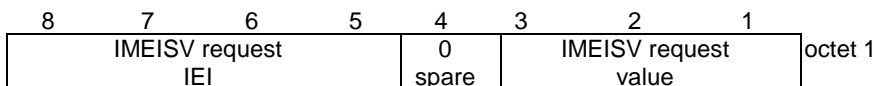

**Figure 10.5.126/3GPP TS 24.008: IMEISV request information element**

**Table 10.5.143/3GPP TS 24.008: IMEISV request information element**

IMEISV request value (octet 1)			
Bits			
<b>3</b>	<b>2</b>	<b>1</b>	
0	0	0	IMEISV not requested
0	0	1	IMEISV requested
All other values are interpreted as <i>IMEISV not requested</i> by this version of the protocol.			

**10.5.5.11 Receive N-PDU Numbers list**

The purpose of the *Receive N-PDU Numbers list* information element is to specify the current SNDCP Receive N-PDU Number values.

The *Receive N-PDU Number list* is a type 4 information element with a length of 4 to 19 octets.

The value part of a *Receive N-PDU Number list* information element is coded as shown in figure 10.5.127/3GPP TS 24.008 and table 10.5.144/3GPP TS 24.008.

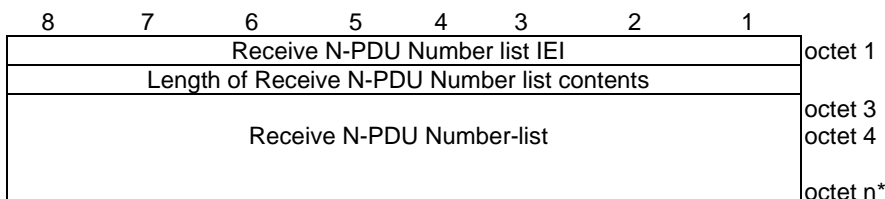

**Figure 10.5.127/3GPP TS 24.008: Receive N-PDU Number list information element**

Table 10.5.144/3GPP TS 24.008: *Receive N-PDU Number list* information element

<pre> Receive N-PDU Number -list value ::= {   &lt; Receive N-PDU Number -list &gt;   &lt; Padding bits&gt; };  &lt; Receive N-PDU Number-list &gt; ::= &lt; sapi : bit-string(4) &gt; &lt; Receive N-PDU Number-value : bit-string(8) &gt; { &lt; Receive N-PDU Number-list&gt;   &lt; null &gt; };  &lt; nsapi &gt; ::= { 0101 }; -- NSAPI 5 { 0110 }; -- NSAPI 6 { 0111 }; -- NSAPI 7 { 1000 }; -- NSAPI 8 { 1001 }; -- NSAPI 9 { 1010 }; -- NSAPI 10 { 1011 }; -- NSAPI 11 { 1100 }; -- NSAPI 12 { 1101 }; -- NSAPI 13 { 1110 }; -- NSAPI 14 { 1111 }; -- NSAPI 15  &lt; Receive N-PDU Number-value &gt; ::= { 0   1 } (8); -- Contains the binary coded representation of the receive N-PDU Number value. -- The first bit in transmission order is the most significant bit.  &lt;Padding bits&gt; ::= null   0000; </pre>
--

### 10.5.5.12 MS network capability

The purpose of the *MS network capability* information element is to provide the network with information concerning aspects of the mobile station related to GPRS. The contents might affect the manner in which the network handles the operation of the mobile station. The *MS network capability* information indicates general mobile station characteristics and it shall therefore, except for fields explicitly indicated, be independent of the frequency band of the channel it is sent on.

The *MS network capability* is a type 4 information element with a maximum of 10 octets length.

The value part of a *MS network capability* information element is coded as shown in figure 10.5.128/3GPP TS 24.008 and table 10.5.145/3GPP TS 24.008.

NOTE: The requirements for the support of the GEA algorithms in the MS are specified in 3GPP TS 43.020 [13].

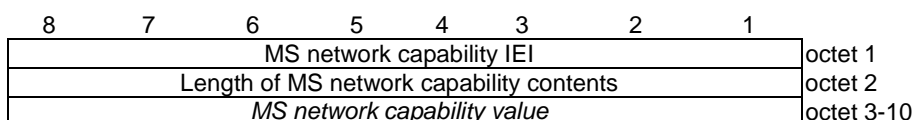

Figure 10.5.128/3GPP TS 24.008 MS network capability information element

Table 10.5.145/3GPP TS 24.008 *MS network capability* information element

<MS network capability value part> ::=

<GEA1 bits>  
 <SM capabilities via dedicated channels: bit>  
 <SM capabilities via GPRS channels: bit>  
 <UCS2 support: bit>  
 <SS Screening Indicator: bit string(2)>  
 <SoLSA Capability : bit>  
 <Revision level indicator: bit>  
 <PFC feature mode: bit>  
 <Extended GEA bits>  
 < LCS VA capability: bit >  
 < PS inter-RAT HO to UTRAN Iu mode capability: bit >  
 <Spare bits>;

<GEA1 bits> ::= < GEA/1 :bit>;

<Extended GEA bits> ::= <GEA/2:bit><GEA/3:bit>< GEA/4:bit >< GEA/5:bit >< GEA/6:bit ><GEA/7:bit>;

<Spare bits> ::= null | {<spare bit> < Spare bits >};

#### SS Screening Indicator

- 0 0 defined in 3GPP TS 24.080
- 0 1 defined in 3GPP TS 24.080
- 1 0 defined in 3GPP TS 24.080
- 1 1 defined in 3GPP TS 24.080

#### SM capabilities via dedicated channels

- 0 Mobile station does not support mobile terminated point to point SMS via CS domain
- 1 Mobile station supports mobile terminated point to point SMS via CS domain

#### SM capabilities via GPRS channels

- 0 Mobile station does not support mobile terminated point to point SMS via PS domain
- 1 Mobile station supports mobile terminated point to point SMS via PS domain

#### UCS2 support

This information field indicates the likely treatment by the mobile station of UCS2 encoded character strings.

- 0 the ME has a preference for the default alphabet (defined in 3GPP TS 23.038 [8b]) over UCS2.
- 1 the ME has no preference between the use of the default alphabet and the use of UCS2.

#### GPRS Encryption Algorithm GEA/1

- 0 encryption algorithm GEA/1 not available
- 1 encryption algorithm GEA/1 available

#### SoLSA Capability

- 0 The ME does not support SoLSA.
- 1 The ME supports SoLSA.

#### Revision level indicator

- 0 used by a mobile station not supporting R99 or later versions of the protocol
- 1 used by a mobile station supporting R99 or later versions of the protocol

#### PFC feature mode

- 0 Mobile station does not support BSS packet flow procedures
- 1 Mobile station does support BSS packet flow procedures

#### GEA/2

- 0 encryption algorithm GEA/2 not available

1 encryption algorithm GEA/2 available

**GEA/3**

0 encryption algorithm GEA/3 not available

1 encryption algorithm GEA/3 available

**GEA/4**

0 encryption algorithm GEA/4 not available

1 encryption algorithm GEA/4 available

**GEA/5**

0 encryption algorithm GEA/5 not available

1 encryption algorithm GEA/5 available

**GEA/6**

0 encryption algorithm GEA/6 not available

1 encryption algorithm GEA/6 available

**GEA/7**

0 encryption algorithm GEA/7 not available

1 encryption algorithm GEA/7 available

**LCS VA capability (LCS value added location request notification capability)**

This information field indicates the support of the LCS value added location request notification via PS domain as defined in 3GPP TS 23.271 [105].

0 location request notification via PS domain not supported

1 location request notification via PS domain supported

**PS inter-RAT HO to UTRAN Iu mode capability**

This information field indicates the support of the PS inter-RAT HO to UTRAN Iu mode.

0 PS inter-RAT HO to UTRAN Iu mode not supported

1 PS inter-RAT HO to UTRAN Iu mode supported

### 10.5.5.12a MS Radio Access capability

The purpose of the *MS RA capability* information element is to provide the radio part of the network with information concerning radio aspects of the mobile station. The contents might affect the manner in which the network handles the operation of the mobile station.

The *MS RA capability* is a type 4 information element, with a maximum length of 52 octets.

The value part of a *MS RA capability* information element is coded as shown in table 10.5.146/3GPP TS 24.008.

For the indication of the radio access capabilities the following conditions shall apply:

- Among the three Access Type Technologies GSM 900-P, GSM 900-E and GSM 900-R only one shall be present.
- Due to shared radio frequency channel numbers between GSM 1800 and GSM 1900, the mobile station should provide the relevant radio access capability for either GSM 1800 band OR GSM 1900 band, not both.
- The MS shall indicate its supported Access Technology Types during a single MM procedure.
- If the alternative coding by using the Additional access technologies struct is chosen by the mobile station, the mobile station shall indicate its radio access capability for the serving BCCH frequency band in the first included Access capabilities struct, if this information element is not sent in response to an Access Technologies Request from the network or if none of the requested Access Technology Types is supported by the MS. Otherwise, the mobile station shall include the radio access capabilities for the frequency bands it supports in the order of priority requested by the network (see 3GPP TS 44.060).
- The first Access Technology Type shall not be set to "1111".

For error handling the following shall apply:

- If a received Access Technology Type is unknown to the receiver, it shall ignore all the corresponding fields.
- If within a known Access Technology Type a receiver recognizes an unknown field it shall ignore it.
- For more details about error handling of MS radio access capability see 3GPP TS 48.018 [86].

NOTE: The requirements for the support of the A5 algorithms in the MS are specified in 3GPP TS 43.020 [13].

Table 10.5.146/3GPP TS 24.008: *Mobile Station Radio Access Capability* Information Element

```

<MS RA capability value part : < MS RA capability value part struct >>
<spare bits>**; -- may be used for future enhancements

<MS RA capability value part struct >::= --recursive structure allows any number of Access technologies
{ { < Access Technology Type: bit (4) > exclude 1111
  < Access capabilities : <Access capabilities struct> > }

  | { < Access Technology Type: bit (4) == 1111 > -- structure adding Access technologies with same
capabilities
  < Length : bit (7) > -- length in bits of list of Additional access technologies and spare bits
  { 1 < Additional access technologies: < Additional access technologies struct > > } ** 0
  <spare bits>** } }

{ 0 | 1 <MS RA capability value part struct> } ;

< Additional access technologies struct > ::=
  < Access Technology Type : bit (4) >
  < GMSK Power Class : bit (3) >
  < 8PSK Power Class : bit (2) > ;

< Access capabilities struct > ::=
  < Length : bit (7) > -- length in bits of Content and spare bits
  <Access capabilities : <Content>>
  <spare bits>** ; -- expands to the indicated length
  -- may be used for future enhancements

< Content > ::=
  < RF Power Capability : bit (3) >
  { 0 | 1 <A5 bits : <A5 bits>> } -- zero means that the same values apply for parameters as in the immediately
preceding Access capabilities field within this IE
  < ES IND : bit >
  < PS : bit >
  < VGCS : bit >
  < VBS : bit >
  { 0 | 1 < Multislot capability : Multislot capability struct > } -- zero means that the same values for multislot
parameters as given in an earlier Access capabilities field within this IE apply also here
-- Additions in release 99
  { 0 | 1 < 8PSK Power Capability : bit(2)> } -- '1' also means 8PSK modulation capability in uplink.
  < COMPACT Interference Measurement Capability : bit >
  < Revision Level Indicator : bit >
  < UMTS FDD Radio Access Technology Capability : bit > -- 3G RAT
  < UMTS 3.84 Mcps TDD Radio Access Technology Capability : bit > -- 3G RAT
  < CDMA 2000 Radio Access Technology Capability : bit > -- 3G RAT
-- Additions in release 4
  < UMTS 1.28 Mcps TDD Radio Access Technology Capability: bit > -- 3G RAT
  < GERAN Feature Package 1 : bit >
  { 0 | 1 < Extended DTM GPRS Multi Slot Class : bit(2) >
    < Extended DTM EGPRS Multi Slot Class : bit(2) > }
  < Modulation based multislot class support : bit >
-- Additions in release 5
  { 0 | 1 < High Multislot Capability : bit(2) > }
  { 0 | 1 < GERAN Iu Mode Capabilities > } -- '1' also means support of GERAN Iu mode
  < GMSK Multislot Power Profile : bit (2) >
  < 8-PSK Multislot Power Profile : bit (2) >
-- Additions in release 6
  < Multiple TBF Capability : bit >
  < Downlink Advanced Receiver Performance : bit(2) >
  < Extended RLC/MAC Control Message Segmentation Capability : bit >
  < DTM Enhancements Capability : bit >
  { 0 | 1 < DTM GPRS High Multi Slot Class : bit(3) >

```



```
{ 0 | 1 < DTM EGPRS High Multi Slot Class : bit(3) > } }  
< PS Handover Capability : bit >;  
-- error: struct too short, assume features do not exist  
-- error: struct too long, ignore data and jump to next Access technology
```

Table 10.5.146/3GPP TS 24.008 (continued): *Mobile Station Radio Access Capability IE*

```

< Multislot capability struct > ::=
  { 0 | 1 < HSCSD multislot class : bit (5) > }
  { 0 | 1 < GPRS multislot class : bit (5) > < GPRS Extended Dynamic Allocation Capability : bit > }
  { 0 | 1 < SMS_VALUE : bit (4) > < SM_VALUE : bit (4) > }
-- Additions in release 99
  { 0 | 1 < ECSD multislot class : bit (5) > }
  { 0 | 1 < EGPRS multislot class : bit (5) > < EGPRS Extended Dynamic Allocation Capability : bit > }
  { 0 | 1 < DTM GPRS Multi Slot Class: bit(2)>
    <Single Slot DTM : bit>
    { 0 | 1 <DTM EGPRS Multi Slot Class : bit(2)> } } ;
-- error: struct too short, assume features do not exist

< GERAN Iu Mode Capabilities > ::=
  < Length : bit (4) > -- length in bits of Iu mode-only capabilities and spare bits
-- Additions in release 6
  < FLO Iu Capability : bit >
  < spare bits > ** ; -- expands to the indicated length
                    -- may be used for future enhancements

< A5 bits > ::= < A5/1 : bit > < A5/2 : bit > < A5/3 : bit > < A5/4 : bit > < A5/5 : bit > < A5/6 : bit > < A5/7 : bit >; -- bits for circuit
mode ciphering algorithms. These fields are not used by the network and may be excluded by the MS.

Access Technology Type
This field indicates the access technology type to be associated with the following access capabilities.

Bits
4 3 2 1
0 0 0 0 GSM P
0 0 0 1 GSM E --note that GSM E covers GSM P
0 0 1 0 GSM R --note that GSM R covers GSM E and GSM P
0 0 1 1 GSM 1800
0 1 0 0 GSM 1900
0 1 0 1 GSM 450
0 1 1 0 GSM 480
0 1 1 1 GSM 850
1 0 0 0 GSM 750
1 0 0 1 GSM T 380
1 0 1 0 GSM T 410
1 0 1 1 GSM T 900
1 1 1 1 Indicates the presence of a list of Additional access technologies
All other values are treated as unknown by the receiver.

A MS which does not support any GSM access technology type shall set this field to '0000'.

RF Power Capability, GMSK Power Class (3 bit field)
This field contains the binary coding of the power class used for GMSK associated with the indicated Access
Technology Type (see 3GPP TS 45.005).

A MS which does not support any GSM access technology type shall set this field to '000'.

8PSK Power Capability (2 bit field)
If 8-PSK modulation is supported for uplink, this field indicates the radio capability for 8-PSK modulation. The
following coding is used (see 3GPP TS 45.005 [33]):
Bits 2 1
0 0 Reserved
0 1 Power class E1
1 0 Power class E2
1 1 Power class E3

8PSK Power Class (2 bit field)
This field indicates the radio capability for 8-PSK modulation. The following coding is used (see 3GPP TS 45.005):
Bits 2 1
0 0 8PSK modulation not supported for uplink
0 1 Power class E1
1 0 Power class E2

```

1 1 Power class E3

**Additional access technologies struct**

This structure contains the GMSK Power Class and 8PSK Power Class for an additional Access Technology. All other capabilities for this indicated Access Technology are the same as the capabilities indicated by the preceding Access capabilities struct.

**A5/1**

0 encryption algorithm A5/1 not available

1 encryption algorithm A5/1 available

**A5/2**

0 encryption algorithm A5/2 not available

1 encryption algorithm A5/2 available

**A5/3**

0 encryption algorithm A5/3 not available

1 encryption algorithm A5/3 available

**A5/4**

0 encryption algorithm A5/4 not available

1 encryption algorithm A5/4 available

**A5/5**

0 encryption algorithm A5/5 not available

1 encryption algorithm A5/5 available

**A5/6**

0 encryption algorithm A5/6 not available

1 encryption algorithm A5/6 available

**A5/7**

0 encryption algorithm A5/7 not available

1 encryption algorithm A5/7 available

**ES IND** – (Controlled early Classmark Sending)

0 "controlled early Classmark Sending" option is not implemented

1 "controlled early Classmark Sending" option is implemented

**Table 10.5.146/3GPP TS 24.008 (concluded): Mobile Station Radio Access Capability IE**

<p><b>PS</b> – (Pseudo Synchronisation)</p> <p>0 PS capability not present  1 PS capability present</p> <p><b>VGCS</b> – (Voice Group Call Service)</p> <p>0 no VGCS capability or no notifications wanted  1 VGCS capability and notifications wanted.</p> <p><b>VBS</b> – (Voice Broadcast Service)</p> <p>0 no VBS capability or no notifications wanted  1 VBS capability and notifications wanted</p> <p><b>HSCSD Multi Slot Class</b></p> <p>The Multi Slot Class field is coded as the binary representation of the multislot class defined in 3GPP TS 45.002 [32]. This field is not used by the network and may be excluded by the MS.  Range 1 to 18, all other values are reserved.</p> <p><b>GPRS Multi Slot Class</b></p> <p>The GPRS Multi Slot Class field is coded as the binary representation of the multislot class defined in 3GPP TS 45.002 [32].</p> <p><b>ECSD Multi Slot Class</b></p> <p>The presence of this field indicates ECSD capability. Whether the MS is capable of 8-PSK modulation in uplink is indicated by the presence of 8-PSK Power Capability field. The Multi Slot Class field is coded as the binary representation of the multislot class defined in 3GPP TS 45.002 [32]. This field is not used by the network and may be excluded by the MS.  Range 1 to 18, all other values are reserved.</p> <p><b>EGPRS Multi Slot Class</b></p> <p>The presence of this field indicates EGPRS capability. Whether the MS is capable of 8-PSK modulation in uplink is indicated by the presence of 8-PSK Power Capability field. The EGPRS Multi Slot Class field is coded as the binary representation of the multislot class defined in 3GPP TS 45.002 [32].</p> <p><b>GPRS Extended Dynamic Allocation Capability</b></p> <p>0 Extended Dynamic Allocation Capability for GPRS is not implemented  1 Extended Dynamic Allocation Capability for GPRS is implemented</p> <p>If a multislot class type 1 MS indicates in the GPRS Multi Slot Class field the support of a multislot class for which three or more uplink timeslots can be assigned, Extended Dynamic Allocation for GPRS shall be implemented in the mobile station.</p> <p><b>EGPRS Extended Dynamic Allocation Capability</b></p> <p>0 Extended Dynamic Allocation Capability for EGPRS is not implemented  1 Extended Dynamic Allocation Capability for EGPRS is implemented</p> <p>If a multislot class type 1 MS indicates in the EGPRS Multi Slot Class field the support of a multislot class for which three or more uplink timeslots can be assigned, Extended Dynamic Allocation for EGPRS shall be implemented in the mobile station.</p> <p><b>SMS_VALUE (Switch-Measure-Switch) (4 bit field)</b></p> <p>The SMS field indicates the time needed for the mobile station to switch from one radio channel to another, perform a neighbor cell power measurement, and the switch from that radio channel to another radio channel. This field is not used by the network and may be excluded by the MS.</p> <p>Bits  4 3 2 1  0 0 0 0 1/4 timeslot (~144 microseconds)  0 0 0 1 2/4 timeslot (~288 microseconds)  0 0 1 0 3/4 timeslot (~433 microseconds)  ...  1 1 1 1 16/4 timeslot (~2307 microseconds)</p> <p><b>(SM_VALUE) Switch-Measure (4 bit field)</b></p> <p>The SM field indicates the time needed for the mobile station to switch from one radio channel to another and perform a neighbour cell power measurement. This field is not used by the network and may be excluded by the MS.</p> <p>Bits  4 3 2 1</p>
--

0 0 0 0	1/4 timeslot (~144 microseconds)
0 0 0 1	2/4 timeslot (~288 microseconds)
0 0 1 0	3/4 timeslot (~433 microseconds)
...	
1 1 1 1	16/4 timeslot (~2307 microseconds)

**DTM GPRS Multi Slot Class** (2 bit field)

This field indicates the DTM GPRS multislot capabilities of the MS. It is coded as follows:

Bits

2 1

0 0	Unused. If received, the network shall interpret this as "01"
0 1	Multislot class 5 supported
1 0	Multislot class 9 supported
1 1	Multislot class 11 supported

This field shall contain one of the following values if the *DTM GPRS High Multi Slot Class* field is present:

- Multislot class 9 if DTM GPRS High Multi Slot Class is set to indicate Class 31/36 or Class 41;
- Multislot class 11 if DTM GPRS High Multi Slot Class is set to indicate Classes 32/37, 33/38 or Classes 42, 43, 44.

**Single Slot DTM** (1 bit field)

This field indicates whether the MS supports single slot DTM operation (see 3GPP TS 43.055 [87]).

Bit

0	Single Slot DTM not supported
1	Single Slot DTM supported

An MS indicating support for Extended DTM GPRS multislot class or Extended DTM EGPRS multislot class shall set this bit to "1". The network may ignore the bit in this case.

**DTM EGPRS Multi Slot Class** (2 bit field)

This field indicates the DTM EGPRS multislot capabilities of the MS. This field shall be included only if the mobile station supports EGPRS DTM. This field is coded as the DTM GPRS multislot Class field.

This field shall contain one of the following values if the *DTM EGPRS High Multi Slot Class* field is present:

- Multislot class 9 if DTM EGPRS High Multi Slot Class is set to indicate Class 31/36 or Class 41;
- Multislot class 11 if DTM EGPRS High Multi Slot Class is set to indicate Classes 32/37, 33/38 or Classes 42, 43, 44.

**COMPACT Interference Measurement Capability** (1 bit field)

0	COMPACT Interference Measurement Capability is not implemented
1	COMPACT Interference Measurement Capability is implemented

**Revision Level Indicator** (1 bit field)

Bit

0	The ME is Release "98 or older
1	The ME is Release "99 onwards

**UMTS FDD Radio Access Technology Capability** (1 bit field)

Bit

0	UMTS FDD not supported
1	UMTS FDD supported

**UMTS 3.84 Mcps TDD Radio Access Technology Capability** (1 bit field)

Bit

0	UMTS 3.84 Mcps TDD not supported
1	UMTS 3.84 Mcps TDD supported

**CDMA 2000 Radio Access Technology Capability** (1 bit field)

Bit

0	CDMA 2000 not supported
1	CDMA 2000 supported

**UMTS 1.28 Mcps TDD Radio Access Technology Capability** (1 bit field)

Bit

0 UMTS 1.28 Mcps TDD not supported  
1 UMTS 1.28 Mcps TDD supported

**GERAN Feature Package 1** (1 bit field)

This field indicates whether the MS supports the GERAN Feature Package 1 (see 3GPP TS 44.060). It is coded as follows:

0 GERAN feature package 1 not supported.  
1 GERAN feature package 1 supported.

**Extended DTM GPRS Multi Slot Class** (2 bit field)

This field indicates the extended DTM GPRS capabilities of the MS and shall be interpreted in conjunction with the DTM GPRS Multi Slot Class field. It is coded as follows, where "DGMSC" denotes the DTM GPRS multislot class field:

DGMSC Bit	2 1	Bit 2 1	
	0 0	0 0	Unused. If received, it shall be interpreted as "01 00"
	0 0	0 1	Unused. If received, it shall be interpreted as "01 00"
	0 0	1 0	Unused. If received, it shall be interpreted as "01 00"
	0 0	1 1	Unused. If received, it shall be interpreted as "01 00"
	0 1	0 0	Multislot class 5 supported
	0 1	0 1	Multislot class 6 supported
	0 1	1 0	Unused. If received, it shall be interpreted as "01 00"
	0 1	1 1	Unused. If received, it shall be interpreted as "01 00"
	1 0	0 0	Multislot class 9 supported
	1 0	0 1	Multislot class 10 supported
	1 0	1 0	Unused. If received, it shall be interpreted as "10 00"
	1 0	1 1	Unused. If received, it shall be interpreted as "10 00"
	1 1	0 0	Multislot class 11 supported
	1 1	0 1	Unused. If received, it shall be interpreted as "11 00"
	1 1	1 0	Unused. If received, it shall be interpreted as "11 00"
	1 1	1 1	Unused. If received, it shall be interpreted as "11 00"

The presence of this field indicates that the MS supports combined fullrate and halfrate GPRS channels in the downlink. When this field is not present, the MS supports the multislot class indicated by the *DTM GPRS Multi Slot Class* field.

If this field is included, it shall contain one of the following values if the *DTM GPRS High Multi Slot Class* field is present:

- Multislot class 10 if DTM GPRS High Multi Slot Class is set to indicate Class 31/36 or Class 41;
- Multislot class 11 if DTM GPRS High Multi Slot Class is set to indicate Classes 32/37, 33/38 or Classes 42, 43, 44.

**Extended DTM EGPRS Multislot Class** (2 bit field)

This field is not considered when the DTM EGPRS Multislot Class field is not included. This field indicates the extended DTM EGPRS multislot capabilities of the MS and shall be interpreted in conjunction with the DTM EGPRS Multislot Class field. This field is coded as the Extended DTM GPRS Multislot Class field. The presence of this field indicates that the MS supports combined fullrate and halfrate GPRS channels in the downlink. When this field is not present, the MS supports the multislot class indicated by the DTM EGPRS Multi Slot Class field.

If this field is included, it shall contain one of the following values if the *DTM EGPRS High Multi Slot Class* field is present:

- Multislot class 10 if DTM EGPRS High Multi Slot Class is set to indicate Class 31/36 or Class 41;
- Multislot class 11 if DTM EGPRS High Multi Slot Class is set to indicate Classes 32/37, 33/38 or Classes 42, 43, 44.

**Modulation based multislot class support** (1 bit field)

Bit  
0 "Modulation based multislot class" not supported  
1 "Modulation based multislot class" supported

**High Multislot Capability** (2 bit field)

The High Multislot Capability is individually combined with each multislot class field sent by the MS (the possible multislot class fields are: GPRS multislot class, EGPRS multislot class) to extend the related multislot class to multislot classes 30 to 45, see 3GPP TS 45.002.

For each multislot class, the following mapping is done:

Bits

2 1	coded multislot class field	actual multislot class
0 0	8	30
0 0	10, 23, 28, 29	39
0 0	11, 20, 25	32
0 0	12, 21, 22, 26, 27	33
0 0	Any other	Multislot Class field value
0 1	8	35
0 1	10, 19, 24	36
0 1	11, 23, 28, 29	45
0 1	12, 21, 22, 26, 27	38
0 1	Any other	Multislot Class field value
1 0	8	40
1 0	10, 19, 24	41
1 0	11, 20, 25	42
1 0	12, 23, 28, 29	44
1 0	Any other	Multislot Class field value
1 1	12, 21, 22, 26, 27	43
1 1	11, 20, 25	37
1 1	10, 19, 24	31
1 1	9, 23, 28, 29	34
1 1	Any other	Multislot Class field value

#### GERAN lu Mode Capabilities

This field indicates if the mobile station supports GERAN lu mode. Furthermore, it indicates the GERAN lu mode capabilities of the mobile station. The field shall be included if the mobile station supports GERAN lu mode. If the field is not present, the mobile station does not support GERAN lu mode.

#### FLO lu Capability (1 bit field)

If this parameter is not present, the value '0' shall be assumed by the receiver.

0	FLO in GERAN lu mode not supported
1	FLO in GERAN lu mode supported

#### GMSK Multislot Power Profile (2 bit field)

For detailed definitions, see the Mobile Station Classmark 3 information element.

#### 8-PSK Multislot Power Profile (2 bit field)

For detailed definitions, see the Mobile Station Classmark 3 information element.

#### Multiple TBF Capability (1 bit field)

Bit

0	Multiple TBF procedures in A/Gb mode not supported
1	Multiple TBF procedures in A/Gb mode supported

#### Downlink Advanced Receiver Performance (2 bit field)

This field indicates Downlink Advanced Receiver Performance capabilities of the MS (see 3GPP TS 45.005).

Bits

2 1	
0 0	Downlink Advanced Receiver Performance not supported
0 1	Downlink Advanced Receiver Performance – phase I supported

Other values shall not be used by the MS.

If other values are received by the network, they shall be interpreted as "01".

#### Extended RLC/MAC Control Message Segmentation capability (1 bit field)

Bit

0	Extended RLC/MAC control message segmentation not supported
1	Extended RLC/MAC control message segmentation supported

#### DTM Enhancements Capability (1 bit field)

This field indicates whether the mobile station supports enhanced DTM CS establishment and enhanced DTM CS release or not. It is coded as follows:

Bit

0	The mobile station does not support enhanced DTM CS establishment and enhanced DTM CS release procedures.
1	The mobile station supports enhanced DTM CS establishment and enhanced DTM CS release procedures.

#### DTM GPRS High Multi Slot Class (3 bit field)

This field indicates the DTM GPRS multislot capabilities of the MS. It is coded as follows:

Bit	
3 2 1	
0 0 0	Unused. If received, the network shall interpret this as "0 0 1"
0 0 1	Multislot class 31 or 36 supported
0 1 0	Multislot class 32 or 37 supported
0 1 1	Multislot class 33 or 38 supported
1 0 0	Multislot class 41 supported
1 0 1	Multislot class 42 supported
1 1 0	Multislot class 43 supported
1 1 1	Multislot class 44 supported

The presence of this field indicates that the MS supports the DTM extension to high multislot classes. When this field is not present, the MS supports the DTM multislot class indicated by the *DTM GPRS Multi Slot Class field*.

The values '0 0 1', '0 1 0' and '0 1 1' shall be interpreted as indicating DTM GPRS multislot class 36, 37 or 38 respectively in case the MS indicates support for one of the GPRS multislot classes 35 to 39; in all other cases those codepoints shall be interpreted as indicating DTM GPRS multislot class 31, 32 or 33 respectively.

This field shall be ignored if the High Multislot Capability field is not present.

#### **DTM EGPRS High Multi Slot Class (3 bit field)**

This field indicates the DTM EGPRS multislot capabilities of the MS. This field may be included only if the mobile station supports EGPRS DTM. This field is coded as the DTM GPRS High Multi Slot Class field. When this field is not present, the MS supports the DTM multislot class indicated by the *DTM EGPRS Multi Slot Class field*.

The values '0 0 1', '0 1 0' and '0 1 1' shall be interpreted as indicating DTM EGPRS multislot class 36, 37 or 38 respectively in case the MS indicates support for one of the EGPRS multislot classes 35 to 39; in all other cases those codepoints shall be interpreted as indicating DTM EGPRS multislot class 31, 32 or 33 respectively.

This field shall be ignored if the High Multislot Capability field is not present.

#### **PS Handover Capability (1 bit field)**

This field indicates whether the mobile station supports the PS Handover. The PS Handover Capability applies to all RATs and modes indicated as supported in this information element.

Bit	
0	The mobile station does not support the PS Handover.
1	The mobile station supports the PS Handover

### 10.5.5.13 Spare

This is intentionally left spare.

### 10.5.5.14 GMM cause

The purpose of the GMM cause information element is to indicate the reason why a GMM request from the mobile station is rejected by the network.

The GMM cause information element is coded as shown in figure 10.5.129/3GPP TS 24.008 and table 10.5.147/3GPP TS 24.008.

The GMM cause is a type 3 information element with 2 octets length.

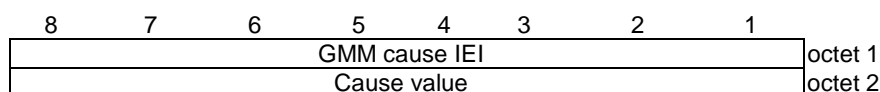

**Figure 10.5.129/3GPP TS 24.008: GMM cause information element**



Table 10.5.147/3GPP TS 24.008: GMM cause information element

Cause value (octet 2)								
Bits								
8	7	6	5	4	3	2	1	
0	0	0	0	0	0	1	0	IMSI unknown in HLR
0	0	0	0	0	0	1	1	Illegal MS
0	0	0	0	0	1	1	0	Illegal ME
0	0	0	0	0	1	1	1	GPRS services not allowed
0	0	0	0	1	0	0	0	GPRS services and non-GPRS services not allowed
0	0	0	0	1	0	0	1	MS identity cannot be derived by the network
0	0	0	0	1	0	1	0	Implicitly detached
0	0	0	0	1	0	1	1	PLMN not allowed
0	0	0	0	1	1	0	0	Location Area not allowed
0	0	0	0	1	1	0	1	Roaming not allowed in this location area
0	0	0	0	1	1	1	0	GPRS services not allowed in this PLMN
0	0	0	0	1	1	1	1	No Suitable Cells In Location Area
0	0	0	1	0	0	0	0	MSC temporarily not reachable
0	0	0	1	0	0	0	1	Network failure
0	0	0	1	0	1	0	0	MAC failure
0	0	0	1	0	1	0	1	Synch failure
0	0	0	1	0	1	1	0	Congestion
0	0	0	1	0	1	1	1	GSM authentication unacceptable
0	0	1	0	1	0	0	0	No PDP context activated
0	0	1	1	0	0	0	0	}
			to					}
0	0	1	1	1	1	1	1	}
0	1	0	1	1	1	1	1	Semantically incorrect message
0	1	1	0	0	0	0	0	Invalid mandatory information
0	1	1	0	0	0	0	1	Message type non-existent or not implemented
0	1	1	0	0	0	1	0	Message type not compatible with the protocol state
0	1	1	0	0	0	1	1	Information element non-existent or not implemented
0	1	1	0	0	1	0	0	Conditional IE error
0	1	1	0	0	1	0	1	Message not compatible with the protocol state
0	1	1	0	1	1	1	1	Protocol error, unspecified

Any other value received by the mobile station shall be treated as 0110 1111, "Protocol error, unspecified". Any other value received by the network shall be treated as 0110 1111, "Protocol error, unspecified".

NOTE: The listed reject cause values are defined in annex G.

### 10.5.5.15 Routing area identification

The purpose of the *routing area identification* information element is to provide an unambiguous identification of routing areas within the GPRS coverage area.

The *routing area identification* is a type 3 information element with 7 octets length.

The *routing area identification* information element is coded as shown in figure 10.5.130/3GPP TS 24.008 and table 10.5.148/3GPP TS 24.008.

8	7	6	5	4	3	2	1	
Routing Area Identification IEI								octet 1
MCC digit 2				MCC digit 1				octet 2
MNC digit 3				MCC digit 3				octet 3
MNC digit 2				MNC digit 1				octet 4
LAC								octet 5
LAC cont'd								octet 6
RAC								octet 7

**Figure 10.5.130/3GPP TS 24.008: Routing area identification information element**

**Table 10.5.148/3GPP TS 24.008: Routing area identification information element**

<p>MCC, Mobile country code (octet 2 and 3)</p> <p>The MCC field is coded as in ITU-T Rec. E212, Annex A. If the RAI is deleted, the MCC and MNC shall take the value from the deleted RAI.</p> <p>In abnormal cases, the MCC stored in the mobile station can contain elements not in the set {0, 1 ... 9}. In such cases the mobile station should transmit the stored values using full hexadecimal encoding. When receiving such an MCC, the network shall treat the RAI as deleted.</p> <p>MNC, Mobile network code (octet 3 bits 5 to 8, octet 4)</p> <p>The coding of this field is the responsibility of each administration but BCD coding shall be used. The MNC shall consist of 2 or 3 digits. For PCS 1900 for NA, Federal regulation mandates that a 3-digit MNC shall be used. However a network operator may decide to use only two digits in the MNC in the RAI over the radio interface. In this case, bits 5 to 8 of octet 3 shall be coded as "1111". Mobile equipment shall accept RAI coded in such a way.</p> <p>NOTE 1: In earlier versions of this protocol, the possibility to use a one digit MNC in RAI was provided on the radio interface. However as this was not used this possibility has been deleted.</p> <p>NOTE 2: In earlier versions of this protocol, bits 5 to 8 of octet 3 were coded as "1111". Mobile equipment compliant with these earlier versions of the protocol may be unable to understand the 3-digit MNC format of the RAI, and therefore unable to register on a network broadcasting the RAI in this format.</p> <p>In abnormal cases, the MNC stored in the mobile station can have:</p> <ul style="list-style-type: none"> <li>- digit 1 or 2 not in the set {0, 1 ... 9}, or</li> <li>- digit 3 not in the set {0, 1 ...9, F} hex.</li> </ul> <p>In such cases the mobile station shall transmit the stored values using full hexadecimal encoding. When receiving such an MNC, the network shall treat the RAI as deleted.</p> <p>The same handling shall apply for the network, if a 3-digit MNC is sent by the mobile station to a network using only a 2-digit MNC.</p> <p>LAC, Location area code (octet 5 and 6)</p> <p>In the LAC field bit 8 of octet 5 is the most significant bit and bit 1 of octet 6 the least significant bit. The coding of the location area code is the responsibility of each administration except that two values are used to mark the LAC, and hence the RAI, as deleted. Coding using full hexadecimal representation may be used. The location area code consists of 2 octets.</p> <p>If a RAI has to be deleted then all bits of the location area code shall be set to one with the exception of the least significant bit which shall be set to zero. If a SIM/USIM is inserted in a Mobile Equipment with the location area code containing all zeros, then the Mobile Equipment shall recognise this LAC as part of a deleted RAI.</p> <p>RAC, Routing area code (octet 7)</p> <p>In the RAC field bit 8 of octet 7 is the most significant. The coding of the routing area code is the responsibility of each administration. Coding using full hexadecimal representation may be used. The routing area code consists of 1 octet.</p>
--

### 10.5.5.16 Spare

This is intentionally left spare.

### 10.5.5.17 Update result

The purpose of the *update result* information element is to specify the result of the associated updating procedure.

The *update result* is a type 1 information element.

The *update result* information element is coded as shown in figure 10.5.131/3GPP TS 24.008 and table 10.5.149/3GPP TS 24.008.

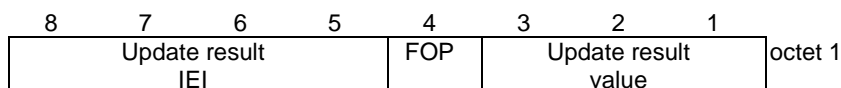

**Figure 10.5.131/3GPP TS 24.008: Update result information element**

**Table 10.5.149/3GPP TS 24.008: Update result information element**

Update result value (octet 1)	
Bits	
<b>3 2 1</b>	
0 0 0	RA updated
0 0 1	combined RA/LA updated
All other values are reserved.	
Follow-on proceed (octet 1, bit 4)	
Bit	
<b>4</b>	
0	Follow-on proceed
1	No follow-on proceed
Follow-on proceed is applicable only in lu mode. This indication shall be ignored if received in A/Gb mode.	

### 10.5.5.18 Update type

The purpose of the *update type* information element is to specify the area the updating procedure is associated with.

The *update type* is a type 1 information element.

The *update type* information element is coded as shown in figure 10.5.132/3GPP TS 24.008 and table 10.5.150/3GPP TS 24.008.

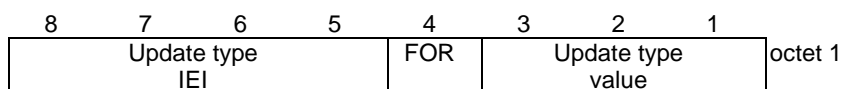

**Figure 10.5.132/3GPP TS 24.008: Update type information element**

**Table 10.5.150/3GPP TS 24.008: Update type information element**

Update type value (octet 1, bit 1 to 3)			
Bits			
<b>3</b>	<b>2</b>	<b>1</b>	
0	0	0	RA updating
0	0	1	combined RA/LA updating
0	1	0	combined RA/LA updating with IMSI attach
0	1	1	Periodic updating
All other values are reserved.			
Follow-on request (octet 1, bit 4)			
Bit			
<b>4</b>			
0	No follow-on request pending		
1	Follow-on request pending		
Follow-on request pending is applicable only in lu mode.			

### 10.5.5.19 A&C reference number

The purpose of the *A&C reference* number information element is to indicate to the network in the AUTHENTICATION AND CIPHERING RESPONSE message which AUTHENTICATION AND CIPHERING REQUEST message the MS is replying to.

The A&C reference number is a type 1 information element.

The A&C reference number information element is coded as shown in figure 10.5.134/3GPP TS 24.008 and table 10.5.152/3GPP TS 24.008.

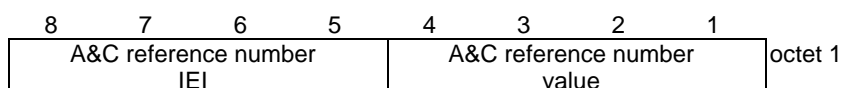
**Figure 10.5.134/3GPP TS 24.008: A&C reference number information element****Table 10.5.152/3GPP TS 24.008: A&C reference number information element**

A&C reference number value (octet 1)
Unformatted 4 bit field

### 10.5.5.20 Service type

The purpose of the *service type* information element is to specify the purpose of the Service request procedure.

The *service type* is a type 1 information element.

The *service type* information element is coded as shown in figure 10.5.135/3GPP TS 24.008 and table 10.5.153a/3GPP TS 24.008.

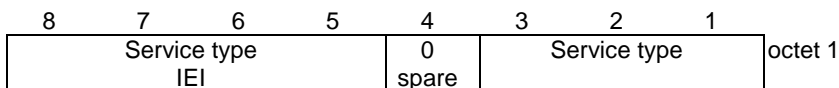

**Figure 10.5.135/3GPP TS 24.008: Service type information element**

**Table 10.5.153a/3GPP TS 24.008: Service type information element**

Service type value (octet 1)			
Bits			
<b>3</b>	<b>2</b>	<b>1</b>	
0	0	0	Signalling
0	0	1	Data
0	1	0	Paging Response
0	1	1	MBMS Service Reception
All other values are reserved.			

### 10.5.5.21 Cell Notification

The purpose of the Cell Notification information element is to indicate that the Cell Notification is supported by the network and shall be then used by MS.

The Cell Notification information element is coded as shown in figure 10.5.135a/3GPP TS 24.008.

The Cell Notification is a type 2 information element.

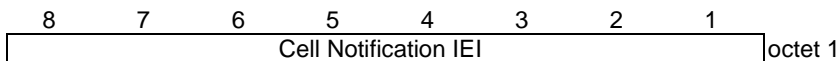

**Figure 10.5.135a/3GPP TS 24.008: Cell Notification information element**

### 10.5.5.22 PS LCS Capability

The purpose of the *PS LCS Capability* element is to indicate the positioning methods supported by the MS for the provision of location services (LCS) via the PS domain in Gb-mode.

The *PS LCS Capability* is a type 4 information element with a length of 3 octets.

The *PS LCS Capability* element is coded as shown in figure 10.5.135b/3GPP TS 24.008 and table 10.5.153b/3GPP TS 24.008.

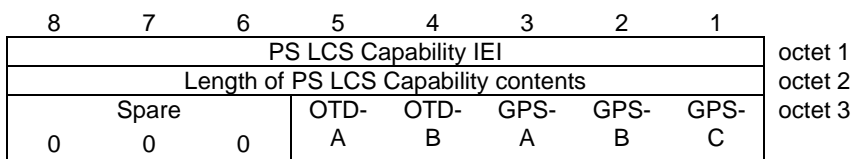

**Figure 10.5.135b/3GPP TS 24.008: PS LCS Capability information element**

**Table 10.5.153b/3GPP TS 24.008 PS LCS Capability information element**

<i>PS LCS Capability</i> value (octet 3, bit 1 to 5)	
<b>OTD-A</b> (MS assisted E-OTD)	
Bit 5	
0	MS assisted E-OTD not supported
1	MS assisted E-OTD supported
<b>OTD-B</b> (MS based E-OTD)	
Bit 4	
0	MS based E-OTD not supported
1	MS based E-OTD supported
<b>GPS-A</b> (MS assisted GPS)	
Bit 3	
0	MS assisted GPS not supported
1	MS assisted GPS supported
<b>GPS-B</b> (MS based GPS)	
Bit 2	
0	MS based GPS not supported
1	MS based GPS supported
<b>GPS-C</b> (Conventional GPS)	
Bit 1	
0	Conventional GPS not supported
1	Conventional GPS supported
Octet 3, bits 8, 7, 6 are spare and shall be coded all 0.	

### 10.5.5.23 Network feature support

The purpose of the *network feature support* information element is to indicate whether certain features are supported by the network. If this IE is not included then the respective features are not supported.

The *network feature support* is a type 1 information element.

The *network feature support* information element is coded as shown in figure 10.5.135c/3GPP TS 24.008 and table 10.5.153c/3GPP TS 24.008.

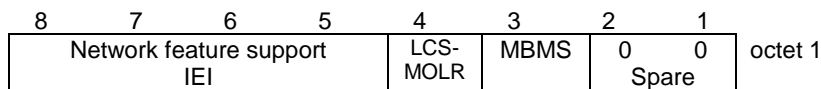

**Figure 10.5.135c/3GPP TS 24.008: Network feature support information element**

**Table 10.5.153c/3GPP TS 24.008: Network feature support information element**

Network feature support value (octet 1, bit 1 to 4)	
LCS-MOLR (1 bit field)	
Bit	
<b>4</b>	
0	LCS-MOLR via PS domain not supported
1	LCS-MOLR via PS domain supported
MBMS (1 bit field)	
Bit	
<b>3</b>	
0	MBMS not supported
1	MBMS supported
Bits 2 to 1 of octet 1 are spare and shall be coded all 0.	

### 10.5.5.24 Inter RAT information container

The purpose of the *Inter RAT information container* information element is to supply the network with Iu mode related information that needs to be transferred at PS inter-system handover to Iu mode (see 3GPP TS 43.129 [113]).

The *Inter RAT information container* information element is coded as shown in figure 10.5.150/3GPP TS 24.008.

The *Inter RAT information container* information element is a type 4 information element with a minimum length of 3 octets and a maximum length of 40 octets.

The Inter RAT information container contains:

- predefined configuration status information;
- mobile station security information to be used after handover to Iu mode, which includes the START-PS value that is stored by the MS at handover from Iu mode to A/Gb mode (see 3GPP TS 31.102 [5a]); and/or
- the specific Iu mode radio capabilities of the mobile station, i.e. UE RAC (see 3GPP TS 25.331 [23c]).

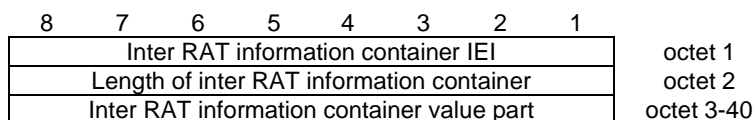
**Figure 10.5.150/3GPP TS 24.008: Inter RAT information container information element**

The value part of the *Inter RAT information container* information element is the INTER RAT HANDOVER INFO as defined in 3GPP TS 25.331 [23c]. If this field includes padding bits, they are defined in 3GPP TS 25.331 [23c].

### 10.5.5.25 Requested MS information

The purpose of the *Requested MS information* information element is to indicate whether certain feature-related information is requested from the MS by the network. If this IE is not included then no information is requested.

The *Requested MS information* information element is coded as shown in figure 10.5.151/3GPP TS 24.008 and table 10.5.166/3GPP TS 24.008.

The *Requested MS information* is a type 1 information element.

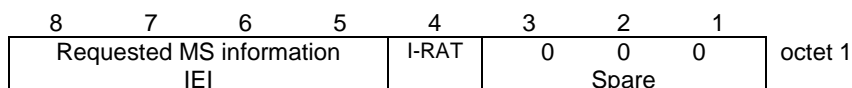

**Figure 10.5.151/3GPP TS 24.008: Requested MS information information element**

**Table 10.5.166/3GPP TS 24.008: Requested MS information information element**

Requested MS information value (octet 1, bit 1 to 4)	
I-RAT (1 bit field)	
Bit	
<b>4</b>	
0	Inter RAT information container IE not requested
1	Inter RAT information container IE requested

## 10.5.6 Session management information elements

### 10.5.6.1 Access point name

The purpose of the *Access point name* information element is to identify the packet data network to which the GPRS user wishes to connect and to notify the access point of the packet data network that wishes to connect to the MS.

The *Access point name* is a label or a fully qualified domain name according to DNS naming conventions (see 3GPP TS 23.003 [10]).

The *Access point name* is a type 4 information element with a minimum length of 3 octets and a maximum length of 102 octets.

The *Access point name* information element is coded as shown in figure 10.5.152/3GPP TS 24.008.

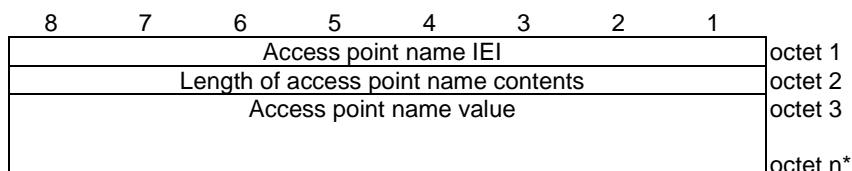

**Figure 10.5.152/3GPP TS 24.008: Access point name information element**

The value part is defined in 3GPP TS 23.003 [10].

### 10.5.6.2 Network service access point identifier

The purpose of the *Network service access point identifier* information element is to identify the service access point that is used for the GPRS data transfer at layer 3.



The *Network service access point identifier* is a type 3 information element with a length of 2 octets.

The value part of a *Network service access point identifier* information element is coded as shown in figure 10.5.153/3GPP TS 24.008 and table 10.5.167/3GPP TS 24.008.

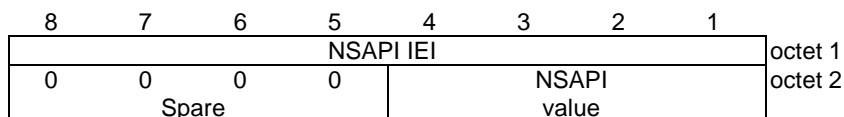

**Figure 10.5.153/3GPP TS 24.008: *Network service access point identifier* information element**

**Table 10.5.167/3GPP TS 24.008: *Network service access point identifier* information element**

NSAPI value (octet 2)				
Bits				
4	3	2	1	
0	0	0	0	reserved
0	0	0	1	reserved
0	0	1	0	reserved
0	0	1	1	reserved
0	1	0	0	reserved
0	1	0	1	NSAPI 5
0	1	1	0	NSAPI 6
0	1	1	1	NSAPI 7
1	0	0	0	NSAPI 8
1	0	0	1	NSAPI 9
1	0	1	0	NSAPI 10
1	0	1	1	NSAPI 11
1	1	0	0	NSAPI 12
1	1	0	1	NSAPI 13
1	1	1	0	NSAPI 14
1	1	1	1	NSAPI 15

### 10.5.6.3 Protocol configuration options

The purpose of the *protocol configuration options* information element is to:

- transfer external network protocol options associated with a PDP context activation, and
- transfer additional (protocol) data (e.g. configuration parameters, error codes or messages/events) associated with an external protocol or an application.

The *protocol configuration options* is a type 4 information element with a minimum length of 3 octets and a maximum length of 253 octets.

The *protocol configuration options* information element is coded as shown in figure 10.5.136/3GPP TS 24.008 and table 10.5.154/3GPP TS 24.008.

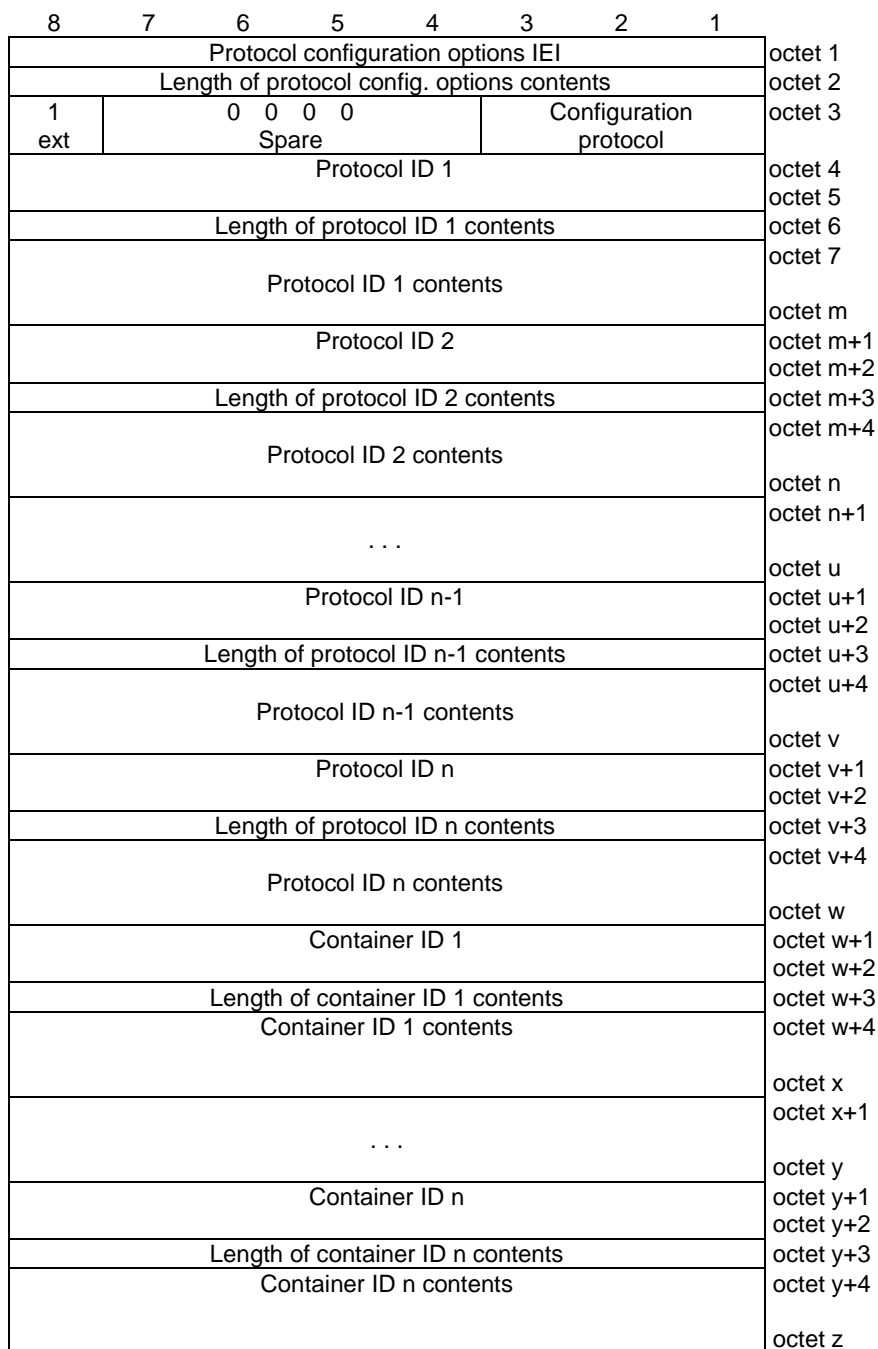

Figure 10.5.136/3GPP TS 24.008: Protocol configuration options information element

Table 10.5.154/3GPP TS 24.008: *Protocol configuration options* information element

<p><b>Configuration protocol</b> (octet 3)</p> <p>Bits 3 2 1 0 0 0 PPP for use with IP PDP type</p> <p>All other values are interpreted as PPP in this version of the protocol.</p> <p>After octet 3, i.e. from octet 4 to octet z, two logical lists are defined:</p> <ul style="list-style-type: none"> <li>- the Configuration protocol options list (octets 4 to w), and</li> <li>- the Additional parameters list (octets w+1 to z).</li> </ul> <p><b>Configuration protocol options list</b> (octets 4 to w)</p> <p>The <i>configuration protocol options list</i> contains a variable number of logical units, they may occur in an arbitrary order within the <i>configuration protocol options list</i>.</p> <p>Each unit is of variable length and consists of a:</p> <ul style="list-style-type: none"> <li>- protocol identifier (2 octets);</li> <li>- the length of the protocol identifier contents of the unit (1 octet); and</li> <li>- the protocol identifier contents itself (n octets).</li> </ul> <p>The <i>protocol identifier</i> field contains the hexadecimal coding of the configuration protocol identifier. Bit 8 of the first octet of the <i>protocol identifier</i> field contains the most significant bit and bit 1 of the second octet of the <i>protocol identifier</i> field contains the least significant bit.</p> <p>If the <i>configuration protocol options list</i> contains a protocol identifier that is not supported by the receiving entity the corresponding unit shall be discarded.</p> <p>The <i>length of the protocol identifier contents</i> field contains the binary coded representation of the length of the <i>protocol identifier contents</i> field of a unit. The first bit in transmission order is the most significant bit.</p> <p>The <i>protocol identifier contents</i> field of each unit contains information specific to the configuration protocol specified by the <i>protocol identifier</i>.</p> <p><b>PPP</b></p> <p>At least the following protocol identifiers (as defined in RFC 3232 [103]) shall be supported in this version of the protocol:</p> <ul style="list-style-type: none"> <li>- C021H (LCP);</li> <li>- C023H (PAP);</li> <li>- C223H (CHAP); and</li> <li>- 8021H (IPCP).</li> </ul> <p>The support of other protocol identifiers is implementation dependent and outside the scope of the present document.</p> <p>The <i>protocol identifier contents</i> field of each unit corresponds to a 'Packet' as defined in RFC 1661 [102] that is stripped off the 'Protocol' and the 'Padding' octets.</p> <p>The detailed coding of the <i>protocol identifier contents</i> field is specified in the RFC that is associated with the protocol identifier of that unit.</p> <p><b>Additional parameters list</b> (octets w+1 to z)</p> <p>The <i>additional parameters list</i> is included when special parameters and/or requests (associated with a PDP context) need to be transferred between the MS and the network. These parameters and/or requests are not related to a specific configuration protocol (e.g. PPP), and therefore are not encoded as the "Packets" contained in the <i>configuration protocol options list</i>.</p> <p>The <i>additional parameters list</i> contains a list of special parameters, each one in a separate container. The type of the parameter carried in a container is identified by</p>
--

a specific *container identifier*. In this version of the protocol, the following container identifiers are specified:

MS to network direction:

- 0001H (P-CSCF Address Request);
- 0002H (IM CN Subsystem Signaling Flag);
- 0003H (DNS Server Address Request); and
- 0004H (Not Supported).

Network to MS direction:

- 0001H (P-CSCF Address);
- 0002H (IM CN Subsystem Signaling Flag);
- 0003H (DNS Server Address); and
- 0004H (Policy Control rejection code).

If the *additional parameters list* contains a container identifier that is not supported by the receiving entity the corresponding unit shall be discarded.

The *container identifier* field is encoded as the *protocol identifier* field and the *length of container identifier contents* field is encoded as the *length of the protocol identifier contents* field.

When the *container identifier* indicates P-CSCF Address Request or DNS Server Address Request, the *container identifier contents* field is empty and the *length of container identifier contents* indicates a length equal to zero. If the *container identifier contents* field is not empty, it shall be ignored.

When the *container identifier* indicates IM CN Subsystem Signaling Flag (see 3GPP TS 24.229 [95]), the *container identifier contents* field is empty and the *length of container identifier contents* indicates a length equal to zero. If the *container identifier contents* field is not empty, it shall be ignored. In Network to MS direction this information may be used by the MS to indicate to the user whether the requested dedicated signalling PDP context was successfully established.

When the *container identifier* indicates P-CSCF Address, the *container identifier contents* field contains one IPv6 address corresponding to a P-CSCF address (see 3GPP TS 24.229 [95]). This IPv6 address is encoded as an 128-bit address according to RFC 3513 [99]. When there is need to include more than one P-CSCF address, then more logical units with *container identifier* indicating P-CSCF Address are used.

When the *container identifier* indicates DNS Server Address, the *container identifier contents* field contains one IPv6 DNS server address (see 3GPP TS 27.060 [36a]). This IPv6 address is encoded as an 128-bit address according to RFC 3513 [99]. When there is need to include more than one DNS server address, then more logical units with *container identifier* indicating DNS Server Address are used.

When the *container identifier* indicates Policy Control rejection code, the *container identifier contents* field contains a Go interface related cause code from the GGSN to the UE (see 3GPP TS 29.207 [100]). The *length of container identifier contents* indicates a length equal to one. If the *container identifier contents* field is empty or its actual length is greater than one octet, then it shall be ignored by the receiver.

NOTE 1: The *additional parameters list* and the *configuration protocol options list* are logically separated since they carry different type of information. The beginning of the *additional parameters list* is marked by a logical unit, which has an identifier (i.e. the first two octets) equal to a *container identifier* (i.e. it is not a *protocol identifier*).

### 10.5.6.4 Packet data protocol address

The purpose of the *packet data protocol address* information element is to identify an address associated with a PDP.

The *packet data protocol address* is a type 4 information element with minimum length of 4 octets and a maximum length of 20 octets.

The *packet data protocol address* information element is coded as shown in figure 10.5.137/3GPP TS 24.008 and table 10.5.155/3GPP TS 24.008.

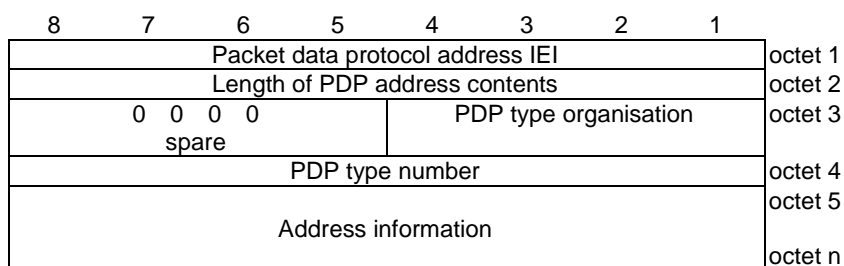

**Figure 10.5.137/3GPP TS 24.008: Packet data protocol address information element**

**Table 10.5.155/3GPP TS 24.008: Packet data protocol address information element**

<p>Length of PDP address contents (octet 2)</p> <p>If the value of octet 2 equals 0000 0010, then:</p> <ul style="list-style-type: none"> <li>- No PDP address is included in this information element; and</li> <li>- If the PDP type is IP, dynamic addressing is applicable.</li> </ul> <p>NOTE: For PPP no address is required in this information element.</p> <p>PDP type organisation (octet 3)</p> <p>Bits</p> <p style="margin-left: 20px;">4 3 2 1</p> <p>In MS to network direction :</p> <p style="margin-left: 20px;">0 0 0 0 ETSI allocated address</p> <p style="margin-left: 20px;">0 0 0 1 IETF allocated address</p> <p style="margin-left: 20px;">1 1 1 1 Empty PDP type</p> <p>All other values are reserved.</p> <p>In network to MS direction :</p> <p style="margin-left: 20px;">0 0 0 0 ETSI allocated address</p> <p style="margin-left: 20px;">0 0 0 1 IETF allocated address</p> <p>All other values are reserved.</p> <p>If bits 4,3,2,1 of octet 3 are coded 0 0 0 0</p> <p>PDP type number value (octet 4)</p> <p>Bits</p> <p style="margin-left: 20px;">8 7 6 5 4 3 2 1</p> <p style="margin-left: 20px;">0 0 0 0 0 0 0 0 Reserved, used in earlier version of this protocol</p> <p style="margin-left: 20px;">0 0 0 0 0 0 0 1 PDP-type PPP</p> <p>All other values are reserved in this version of the protocol.</p> <p>If bits 4,3,2,1 of octet 3 are coded 0 0 0 1</p> <p>PDP type number value (octet 4)</p> <p>Bits</p> <p style="margin-left: 20px;">8 7 6 5 4 3 2 1</p> <p style="margin-left: 20px;">0 0 1 0 0 0 0 1 IPv4 address</p>
--

0 1 0 1 0 1 1 1 IPv6 address

All other values shall be interpreted as IPv4 address in this version of the protocol.

In MS to network direction:

If bits 4,3,2,1 of octet 3 are coded 1 1 1 1

PDP type number value (octet 4)

bits 8 to 1 are spare and shall be coded all 0.

Octet 3, bits 8, 7, 6, and 5 are spare and shall be coded all 0.

If PDP type number indicates IPv4, the Address information in octet 5 to octet 8 contains the IPv4 address. Bit 8 of octet 5 represents the most significant bit of the IP address and bit 1 of octet 8 the least significant bit.

If PDP type number indicates IPv6, the Address information in octet 5 to octet 20 contains the IPv6 address. Bit 8 of octet 5 represents the most significant bit of the IP address and bit 1 of octet 20 the least significant bit.

### 10.5.6.5 Quality of service

The purpose of the *quality of service* information element is to specify the QoS parameters for a PDP context.

The QoS IE is defined to allow backward compatibility to earlier version of Session Management Protocol.

The *quality of service* is a type 4 information element with a minimum length of 14 octets and a maximum length of 16 octets. The QoS requested by the MS shall be encoded both in the QoS attributes specified in octets 3-5 and in the QoS attributes specified in octets 6-14.

In the MS to network direction and in the network to MS direction the following applies:

- Octets 15 and 16 are optional. If octet 15 is included, then octet 16 shall also be included.

A QoS IE received without octets 6-16, without octets 14-16, or without octets 15-16 shall be accepted by the receiving entity.

NOTE: This behavior is required for interworking with entities supporting an earlier version of the protocol, or when the Maximum bit rate for downlink is negotiated to a value lower than 8700 kbps.

The *quality of service* information element is coded as shown in figure 10.5.138/3GPP TS 24.008 and table 10.5.156/3GPP TS 24.008.

8	7	6	5	4	3	2	1	
Quality of service IEI								octet 1
Length of quality of service IE								Octet 2
0 0 spare		Delay class			Reliability class			octet 3
Peak throughput				0 spare	Precedence class			octet 4
0 0 0 spare			Mean throughput					octet 5
Traffic Class			Delivery order		Delivery of erroneous SDU			Octet 6
Maximum SDU size								Octet 7
Maximum bit rate for uplink								Octet 8
Maximum bit rate for downlink								Octet 9
Residual BER				SDU error ratio				Octet 10
Transfer delay						Traffic Handling priority		Octet 11
Guaranteed bit rate for uplink								Octet 12
Guaranteed bit rate for downlink								Octet 13
0 0 0 spare			Signal- ling Indicat- ion	Source Statistics Descriptor				Octet 14
Maximum bit rate for downlink (extended)								Octet 15
Guaranteed bit rate for downlink (extended)								Octet 16

Figure 10.5.138/3GPP TS 24.008: *Quality of service* information element

**Table 10.5.156/3GPP TS 24.008: Quality of service information element**

Reliability class, octet 3 (see 3GPP TS 23.107)
Bits
3 2 1
In MS to network direction:
0 0 0 Subscribed reliability class
In network to MS direction:
0 0 0 Reserved
In MS to network direction and in network to MS direction:
0 0 1 Unused. If received, it shall be interpreted as '010' (Note)
0 1 0 Unacknowledged GTP; Acknowledged LLC and RLC, Protected data
0 1 1 Unacknowledged GTP and LLC; Acknowledged RLC, Protected data
1 0 0 Unacknowledged GTP, LLC, and RLC, Protected data
1 0 1 Unacknowledged GTP, LLC, and RLC, Unprotected data
1 1 1 Reserved
All other values are interpreted as <i>Unacknowledged GTP and LLC; Acknowledged RLC, Protected data</i> in this version of the protocol.
NOTE: this value was allocated in earlier versions of the protocol.
Delay class, octet 3 (see 3GPP TS 22.060 and 3GPP TS 23.107)
Bits
6 5 4
In MS to network direction:
0 0 0 Subscribed delay class
In network to MS direction:
0 0 0 Reserved
In MS to network direction and in network to MS direction:
0 0 1 Delay class 1
0 1 0 Delay class 2
0 1 1 Delay class 3
1 0 0 Delay class 4 (best effort)
1 1 1 Reserved



All other values are interpreted as *Delay class 4 (best effort)* in this version of the protocol.

Bit 7 and 8 of octet 3 are spare and shall be coded all 0.

Precedence class, octet 4 (see 3GPP TS 23.107)

Bits

3 2 1

In MS to network direction:

0 0 0 Subscribed precedence

In network to MS direction:

0 0 0 Reserved

In MS to network direction and in network to MS direction:

0 0 1 High priority

0 1 0 Normal priority

0 1 1 Low priority

1 1 1 Reserved

All other values are interpreted as *Normal priority* in this version of the protocol.

Bit 4 of octet 4 is spare and shall be coded as 0.

Peak throughput, octet 4 (see 3GPP TS 23.107)

Bits

8 7 6 5

In MS to network direction:

0 0 0 0 Subscribed peak throughput

In network to MS direction:

0 0 0 0 Reserved

In MS to network direction and in network to MS direction:

0 0 0 1 Up to 1 000 octet/s

0 0 1 0 Up to 2 000 octet/s

0 0 1 1 Up to 4 000 octet/s

0 1 0 0 Up to 8 000 octet/s

0 1 0 1 Up to 16 000 octet/s

0 1 1 0 Up to 32 000 octet/s

0 1 1 1 Up to 64 000 octet/s

1 0 0 0 Up to 128 000 octet/s

1 0 0 1 Up to 256 000 octet/s

1 1 1 1 Reserved

All other values are interpreted as *Up to 1 000 octet/s* in this version of the protocol.

Mean throughput, octet 5 (see 3GPP TS 23.107)

Bits

5 4 3 2 1

In MS to network direction:  
0 0 0 0 Subscribed mean throughput  
In network to MS direction:  
0 0 0 0 Reserved  
In MS to network direction and in network to MS direction:  
0 0 0 1 100 octet/h  
0 0 0 1 0 200 octet/h  
0 0 0 1 1 500 octet/h  
0 0 1 0 0 1 000 octet/h  
0 0 1 0 1 2 000 octet/h  
0 0 1 1 0 5 000 octet/h  
0 0 1 1 1 10 000 octet/h  
0 1 0 0 0 20 000 octet/h  
0 1 0 0 1 50 000 octet/h  
0 1 0 1 0 100 000 octet/h  
0 1 0 1 1 200 000 octet/h  
0 1 1 0 0 500 000 octet/h  
0 1 1 0 1 1 000 000 octet/h  
0 1 1 1 0 2 000 000 octet/h  
0 1 1 1 1 5 000 000 octet/h  
1 0 0 0 0 10 000 000 octet/h  
1 0 0 0 1 20 000 000 octet/h  
1 0 0 1 0 50 000 000 octet/h  
1 1 1 1 0 Reserved  
1 1 1 1 1 Best effort

The value Best effort indicates that throughput shall be made available to the MS on a per need and availability basis. All other values are interpreted as *Best effort* in this version of the protocol.

Bits 8 to 6 of octet 5 are spare and shall be coded all 0.

Delivery of erroneous SDUs, octet 6 (see 3GPP TS 23.107)

Bits  
3 2 1  
In MS to network direction:  
0 0 0 Subscribed delivery of erroneous SDUs  
In network to MS direction:  
0 0 0 Reserved  
In MS to network direction and in network to MS direction:  
0 0 1 No detect ('-')  
0 1 0 Erroneous SDUs are delivered ('yes')  
0 1 1 Erroneous SDUs are not delivered ('no')  
1 1 1 Reserved

The network shall map all other values not explicitly defined onto one of the values defined in this version of the protocol. The network shall return a negotiated value which is explicitly defined in this version of this protocol.

The MS shall consider all other values as reserved.

Delivery order, octet 6 (see 3GPP TS 23.107)

Bits  
5 4 3  
In MS to network direction:  
0 0 Subscribed delivery order  
In network to MS direction:  
0 0 Reserved  
In MS to network direction and in network to MS direction:  
0 1 With delivery order ('yes')  
1 0 Without delivery order ('no')  
1 1 Reserved

Traffic class, octet 6 (see 3GPP TS 23.107)

Bits

8 7 6

In MS to network direction:

0 0 0 Subscribed traffic class

In network to MS direction:

0 0 0 Reserved

In MS to network direction and in network to MS direction:

0 0 1 Conversational class

0 1 0 Streaming class

0 1 1 Interactive class

1 0 0 Background class

1 1 1 Reserved

The network shall map all other values not explicitly defined onto one of the values defined in this version of the protocol. The network shall return a negotiated value which is explicitly defined in this version of this protocol.

The MS shall consider all other values as reserved.

Maximum SDU size, octet 7 (see 3GPP TS 23.107)

In MS to network direction:

0 0 0 0 0 0 0 0 Subscribed maximum SDU size

1 1 1 1 1 1 1 1 Reserved

In network to MS direction:

0 0 0 0 0 0 0 0 Reserved

1 1 1 1 1 1 1 1 Reserved

In MS to network direction and in network to MS direction:

For values in the range 00000001 to 10010110 the Maximum SDU size value is binary coded in 8 bits, using a granularity of 10 octets, giving a range of values from 10 octets to 1500 octets.

Values above 10010110 are as below:

1 0 0 1 0 1 1 1 1502 octets

1 0 0 1 1 0 0 0 1510 octets

1 0 0 1 1 0 0 1 1520 octets

The network shall map all other values not explicitly defined onto one of the values defined in this version of the protocol. The network shall return a negotiated value which is explicitly defined in this version of this protocol.

The MS shall consider all other values as reserved.

Maximum bit rate for uplink, octet 8

Bits

8 7 6 5 4 3 2 1

In MS to network direction:

0 0 0 0 0 0 0 0 Subscribed maximum bit rate for uplink

In network to MS direction:

0 0 0 0 0 0 0 0 Reserved

In MS to network direction and in network to MS direction:

0 0 0 0 0 0 0 1 The maximum bit rate is binary coded in 8 bits, using a granularity of 1 kbps

0 0 1 1 1 1 1 1 giving a range of values from 1 kbps to 63 kbps in 1 kbps increments.

0 1 0 0 0 0 0 0 The maximum bit rate is 64 kbps + ((the binary coded value in 8 bits – 01000000) \* 8 kbps)

0 1 1 1 1 1 1 1 giving a range of values from 64 kbps to 568 kbps in 8 kbps increments.

1 0 0 0 0 0 0 0 The maximum bit rate is 576 kbps + ((the binary coded value in 8 bits – 10000000) \* 64 kbps)

1 1 1 1 1 1 1 0 giving a range of values from 576 kbps to 8640 kbps in 64 kbps increments.

1 1 1 1 1 1 1 1 0kbps

Maximum bit rate for downlink, octet 9 (see 3GPP TS 23.107)

Coding is identical to that of Maximum bit rate for uplink.

If the sending entity wants to indicate a Maximum bit rate for downlink higher than 8640 kbps, it shall set octet 9 to '11111110', i.e. 8640 kbps, and shall encode the value for the Maximum bit rate in octet 15.

In this version of the protocol, for messages specified in the present document, the sending entity shall not request 0 kbps for both the Maximum bitrate for downlink and the Maximum bitrate for uplink at the same time. Any entity receiving a request for 0 kbps in both the Maximum bitrate for downlink and the Maximum bitrate for uplink shall consider that as a syntactical error (see clause 8).

Residual Bit Error Rate (BER), octet 10 (see 3GPP TS 23.107)

Bits

8 7 6 5

In MS to network direction:

0 0 0 0 Subscribed residual BER

In network to MS direction:

0 0 0 0 Reserved

In MS to network direction and in network to MS direction:

The Residual BER value consists of 4 bits. The range is from  $5 \cdot 10^{-2}$  to  $6 \cdot 10^{-8}$ .

0 0 0 1  $5 \cdot 10^{-2}$

0 0 1 0  $1 \cdot 10^{-2}$

0 0 1 1  $5 \cdot 10^{-3}$

0 1 0 0  $4 \cdot 10^{-3}$

0 1 0 1  $1 \cdot 10^{-3}$

0 1 1 0  $1 \cdot 10^{-4}$

0 1 1 1  $1 \cdot 10^{-5}$

1 0 0 0  $1 \cdot 10^{-6}$

1 0 0 1  $6 \cdot 10^{-8}$

1 1 1 1 Reserved

The network shall map all other values not explicitly defined onto one of the values defined in this version of the protocol. The network shall return a negotiated value which is explicitly defined in this version of the protocol.

The MS shall consider all other values as reserved.

SDU error ratio, octet 10 (see 3GPP TS 23.107)

Bits

4 3 2 1

In MS to network direction:

0 0 0 0 Subscribed SDU error ratio

In network to MS direction:

0 0 0 0 Reserved

In MS to network direction and in network to MS direction:

The SDU error ratio value consists of 4 bits. The range is from  $1 \cdot 10^{-1}$  to  $1 \cdot 10^{-6}$ .

0 0 0 1  $1 \cdot 10^{-2}$

0 0 1 0  $7 \cdot 10^{-3}$

0 0 1 1  $1 \cdot 10^{-3}$

0 1 0 0  $1 \cdot 10^{-4}$

0 1 0 1  $1 \cdot 10^{-5}$

0 1 1 0  $1 \cdot 10^{-6}$

0 1 1 1  $1 \cdot 10^{-1}$

1 1 1 1 Reserved

The network shall map all other values not explicitly defined onto one of the values defined in this version of the protocol. The network shall return a negotiated value which is explicitly defined in this version of the protocol.

The MS shall consider all other values as reserved.

Traffic handling priority, octet 11 (see 3GPP TS 23.107)

Bits

2 1

In MS to network direction:

0 0 Subscribed traffic handling priority

In network to MS direction:

0 0 Reserved

In MS to network direction and in network to MS direction:

0 1 Priority level 1  
 1 0 Priority level 2  
 1 1 Priority level 3

The Traffic handling priority value is ignored if the Traffic Class is Conversational class, Streaming class or Background class.

Transfer delay, octet 11 (See 3GPP TS 23.107)

Bits  
 8 7 6 5 4 3

In MS to network direction:

0 0 0 0 0 0 Subscribed transfer delay

In network to MS direction:

0 0 0 0 0 0 Reserved

In MS to network direction and in network to MS direction:

0 0 0 0 0 1 The Transfer delay is binary coded in 6 bits, using a granularity of 10 ms  
 0 0 1 1 1 1 giving a range of values from 10 ms to 150 ms in 10 ms increments

0 1 0 0 0 0 The transfer delay is 200 ms + ((the binary coded value in 6 bits – 010000) \* 50 ms)  
 0 1 1 1 1 1 giving a range of values from 200 ms to 950 ms in 50ms increments

1 0 0 0 0 0 The transfer delay is 1000 ms + ((the binary coded value in 6 bits – 100000) \* 100 ms)  
 1 1 1 1 1 0 giving a range of values from 1000 ms to 4000 ms in 100ms increments

1 1 1 1 1 1 Reserved

The Transfer delay value is ignored if the Traffic Class is Interactive class or Background class.

Guaranteed bit rate for uplink, octet 12 (See 3GPP TS 23.107)

Coding is identical to that of Maximum bit rate for uplink.

The Guaranteed bit rate for uplink value is ignored if the Traffic Class is Interactive class or Background class, or Maximum bit rate for uplink is set to 0 kbps.

Guaranteed bit rate for downlink, octet 13(See 3GPP TS 23.107)

Coding is identical to that of Maximum bit rate for uplink.

If the sending entity wants to indicate a Guaranteed bit rate for downlink higher than 8640 kbps, it shall set octet 13 to '11111110', i.e. 8640 kbps, and shall encode the value for the Guaranteed bit rate in octet 16.

The Guaranteed bit rate for downlink value is ignored if the Traffic Class is Interactive class or Background class, or Maximum bit rate for downlink is set to 0 kbps.

Source Statistics Descriptor, octet 14 (see 3GPP TS 23.107)

Bits  
 4 3 2 1  
 In MS to network direction  
 0 0 0 0 unknown  
 0 0 0 1 speech

The network shall consider all other values as unknown.

In network to MS direction

Bits 4 to 1 of octet 14 are spare and shall be coded all 0.

The Source Statistics Descriptor value is ignored if the Traffic Class is Interactive class or Background class.

Signalling Indication, octet 14 (see 3GPP TS 23.107)

Bit  
 5

In MS to network direction and in network to MS direction:  
 0 Not optimised for signalling traffic  
 1 Optimised for signalling traffic

If set to '1' the QoS of the PDP context is optimised for signalling

The Signalling Indication value is ignored if the Traffic Class is Conversational class, Streaming class or Background class.

Bits 8 to 6 of octet 14 are spare and shall be coded all 0.

Maximum bit rate for downlink (extended), octet 15  
 Bits  
 8 7 6 5 4 3 2 1  
 In MS to network direction and in network to MS direction:  
 0 0 0 0 0 0 0 0 Use the value indicated by the Maximum bit rate for downlink in octet 9.

0 0 0 0 0 0 0 1 Ignore the value indicated by the Maximum bit rate for downlink in octet 9. The maximum bit rate is  
 0 1 0 0 1 0 1 0 8600 kbps + ((the binary coded value in 8 bits) \* 100 kbps), giving a range of values from 8700 kbps to 16000 kbps in 100 kbps increments.

The network shall map all other values not explicitly defined onto one of the values defined in this version of the protocol. The network shall return a negotiated value which is explicitly defined in this version of the protocol.

Guaranteed bit rate for downlink (extended), octet 16  
 Bits  
 8 7 6 5 4 3 2 1  
 In MS to network direction and in network to MS direction:  
 0 0 0 0 0 0 0 0 Use the value indicated by the Guaranteed bit rate for downlink in octet 13.

0 0 0 0 0 0 0 1 Ignore the value indicated by the Guaranteed bit rate for downlink in octet 13. The maximum bit rate is  
 0 1 0 0 1 0 1 0 8600 kbps + ((the binary coded value in 8 bits) \* 100 kbps), giving a range of values from 8700 kbps to 16000 kbps in 100 kbps increments.

The network shall map all other values not explicitly defined onto one of the values defined in this version of the protocol. The network shall return a negotiated value which is explicitly defined in this version of the protocol.

### 10.5.6.6 SM cause

The purpose of the *SM cause* information element is to indicate the reason why a session management request is rejected.

The *SM cause* is a type 3 information element with 2 octets length.

The *SM cause* information element is coded as shown in figure 10.5.139/3GPP TS 24.008 and table 10.5.157/3GPP TS 24.008.

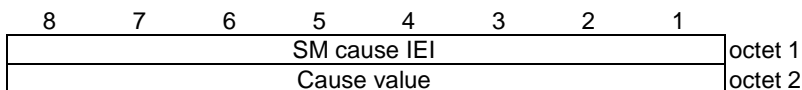

Figure 10.5.139/3GPP TS 24.008: *SM cause* information element

Table 10.5.157/3GPP TS 24.008: *SM cause* information element

Cause value (octet 2)	
Bits	
<b>8 7 6 5 4 3 2 1</b>	
0 0 0 0 1 0 0 0	Operator Determined Barring
0 0 0 1 1 0 0 0	MBMS bearer capabilities insufficient for the service
0 0 0 1 1 0 0 1	LLC or SNDCP failure(A/Gb mode only)
0 0 0 1 1 0 1 0	Insufficient resources
0 0 0 1 1 0 1 1	Missing or unknown APN
0 0 0 1 1 1 0 0	Unknown PDP address or PDP type
0 0 0 1 1 1 0 1	User authentication failed
0 0 0 1 1 1 1 0	Activation rejected by GGSN
0 0 0 1 1 1 1 1	Activation rejected, unspecified
0 0 1 0 0 0 0 0	Service option not supported
0 0 1 0 0 0 0 1	Requested service option not subscribed
0 0 1 0 0 0 1 0	Service option temporarily out of order
0 0 1 0 0 0 1 1	NSAPI already used (not sent)
0 0 1 0 0 1 0 0	Regular deactivation
0 0 1 0 0 1 0 1	QoS not accepted
0 0 1 0 0 1 1 0	Network failure
0 0 1 0 0 1 1 1	Reactivation required
0 0 1 0 1 0 0 0	Feature not supported
0 0 1 0 1 0 0 1	Semantic error in the TFT operation
0 0 1 0 1 0 1 0	Syntactical error in the TFT operation
0 0 1 0 1 0 1 1	Unknown PDP context
0 0 1 0 1 1 1 0	PDP context without TFT already activated
0 0 1 0 1 1 1 1	Multicast group membership time-out
0 0 1 0 1 1 0 0	Semantic errors in packet filter(s)
0 0 1 0 1 1 0 1	Syntactical errors in packet filter(s)
0 1 0 1 0 0 0 1	Invalid transaction identifier value
0 1 0 1 1 1 1 1	Semantically incorrect message
0 1 1 0 0 0 0 0	Invalid mandatory information
0 1 1 0 0 0 0 1	Message type non-existent or not implemented
0 1 1 0 0 0 1 0	Message type not compatible with the protocol state
0 1 1 0 0 0 1 1	Information element non-existent or not implemented
0 1 1 0 0 1 0 0	Conditional IE error
0 1 1 0 0 1 0 1	Message not compatible with the protocol state
0 1 1 0 1 1 1 1	Protocol error, unspecified
0 1 1 1 0 0 0 0	APN restriction value incompatible with active PDP context
Any other value received by the mobile station shall be treated as 0010 0010, "Service option temporarily out of order". Any other value received by the network shall be treated as 0110 1111, "Protocol error, unspecified".	
NOTE: The listed cause values are defined in Annex I	

### 10.5.6.7 Linked TI

The purpose of the *Linked TI* information element is to specify the active PDP context from which the PDP address for the new PDP context could be derived by the network.

The *Linked TI* is a type 4 information element with a minimum length of 3 octets and a maximum length of 4 octets.

The *Linked TI* information element is coded as shown in figure 10.5.140/3GPP TS 24.008.

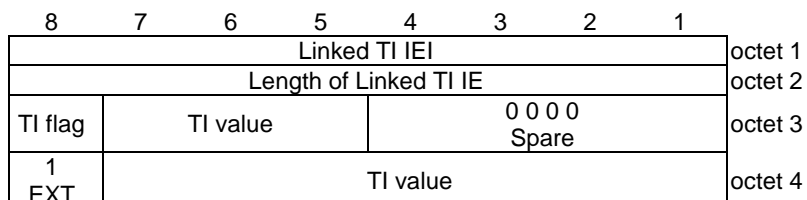

**Figure 10.5.140/3GPP TS 24.008: *Linked TI* information element**

The coding of the TI flag, the TI value and the EXT bit is defined in 3GPP TS 24.007[20].

### 10.5.6.8 Spare

### 10.5.6.9 LLC service access point identifier

The purpose of the *LLC service access point identifier* information element is to identify the service access point that is used for the GPRS data transfer at LLC layer.

The *LLC service access point identifier* is a type 3 information element with a length of 2 octets.

The value part of a *LLC service access point identifier* information element is coded as shown in figure 10.5.141/3GPP TS 24.008 and table 10.5.159/3GPP TS 24.008.

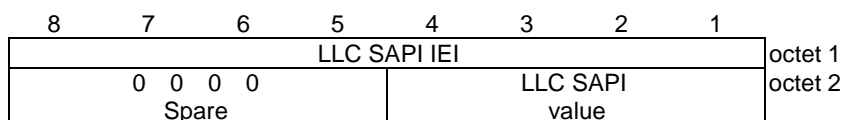

**Figure 10.5.141/3GPP TS 24.008: *LLC service access point identifier* information element**

**Table 10.5.159/3GPP TS 24.008: *LLC service access point identifier* information element**

LLC SAPI value (octet 2)	
Bit	
<b>4 3 2 1</b>	
0 0 0 0	LLC SAPI not assigned
0 0 1 1	SAPI 3
0 1 0 1	SAPI 5
1 0 0 1	SAPI 9
1 0 1 1	SAPI 11
All other values are reserved.	



### 10.5.6.10 Tear down indicator

The purpose of the *tear down indicator* information element is to indicate whether only the PDP context associated with this specific TI or all active PDP contexts sharing the same PDP address and APN as the PDP context associated with this specific TI shall be deactivated.

The *tear down indicator* is a type 1 information element.

The *tear down indicator* information element is coded as shown in figure 10.5.142/3GPP TS 24.008 and table 10.5.160/3GPP TS 24.008.

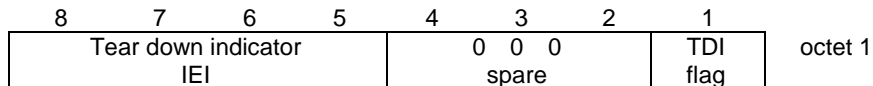

**Figure 10.5.142/3GPP TS 24.008: *Tear down indicator* information element**

**Table 10.5.160/3GPP TS 24.008: *Tear down indicator* information element**

Tear down indicator(TDI) flag (octet 1)	
Bit	
1	
0	tear down not requested
1	tear down requested

### 10.5.6.11 Packet Flow Identifier

The *Packet Flow Identifier (PFI)* information element indicates the Packet Flow Identifier for a Packet Flow Context.

The *Packet Flow Identifier* is a type 4 information element with 3 octets length.

The *Packet Flow Identifier* information element is coded as shown in figure 10.5.143/3GPP TS 24.008 and table 10.5.161/3GPP TS 24.008.

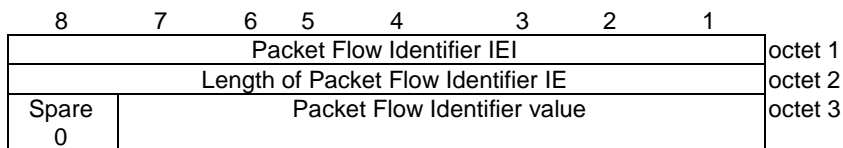

**Figure 10.5.143/3GPP TS 24.008: *Packet Flow Identifier* information element**

**Table 10.5.161/3GPP TS 24.008: Packet Flow Identifier information element**

Packet Flow Identifier value (octet 3)	
Bits	
<b>7 6 5 4 3 2 1</b>	
0 0 0 0 0 0	Best Effort
0 0 0 0 0 1	Signaling
0 0 0 0 1 0	SMS
0 0 0 0 1 1	TOM8
0 0 0 0 1 0 0 }	
to	} reserved
0 0 0 0 1 1 1 }	
0 0 0 1 0 0 0 }	
to	} dynamically assigned
1 1 1 1 1 1 1 }	

### 10.5.6.12 Traffic Flow Template

The purpose of the *traffic flow template* information element is to specify the TFT parameters and operations for a PDP context. In addition, this information element may be used to transfer extra parameters to the network (e.g. the Authorization Token; see 3GPP TS 24.229).

The *traffic flow template* is a type 4 information element with a minimum length of 3 octets. The maximum length for the IE is 257 octets.

NOTE 1: The IE length restriction is due to the maximum length that can be encoded in a single length octet.

NOTE 2: A maximum size IPv4 packet filter can be 32 bytes. Therefore, 7 maximum size IPv4 type packet filters, plus the last packet filter which can contain max 30 octets can fit into one TFT, i.e. if needed not all packet filter components can be defined into one message. A maximum size Ipv6 packet filter can be 60 bytes. Therefore, only 4 maximum size IPv6 packet filters can fit into one TFT. However, using "Add packet filters to existing TFT", it's possible to create a TFT including 8 maximum size Ipv4 or IPv6 filters.

The *traffic flow template* information element is coded as shown in figure 10.5.144/3GPP TS 24.008 and table 10.5.162/3GPP TS 24.008.

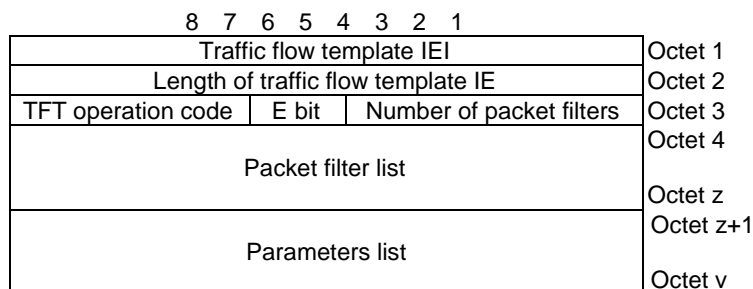

**Figure 10.5.144/3GPP TS 24.008: Traffic flow template information element**

8 7 6 5 4 3 2 1	Packet filter identifier 1	Octet 4
	Packet filter identifier 2	Octet 5
	...	
	Packet filter identifier N	Octet N+3

Figure 10.5.144a/3GPP TS 24.008: *Packet filter list* when the TFT operation is "delete packet filters from existing TFT" (z=N+3)

8 7 6 5 4 3 2 1	Packet filter identifier 1	Octet 4
	Packet filter evaluation precedence 1	Octet 5
	Length of Packet filter contents 1	Octet 6
	Packet filter contents 1	Octet 7
		Octet m
	Packet filter identifier 2	Octet m+1
	Packet filter evaluation precedence 2	Octet m+2
	Length of Packet filter contents 2	Octet m+3
	Packet filter contents 2	Octet m+4
		Octet n
	...	Octet n+1
		Octet y
	Packet filter identifier N	Octet y+1
	Packet filter evaluation precedence N	Octet y+2
	Length of Packet filter contents N	Octet y+3
	Packet filter contents N	Octet y+4
		Octet z

Figure 10.5.144b/3GPP TS 24.008: *Packet filter list* when the TFT operation is "create new TFT", or "add packet filters to existing TFT" or "replace packet filters in existing TFT"

8 7 6 5 4 3 2 1	Parameter identifier 1	Octet z+1
	Length of Parameter contents 1	Octet z+2
	Parameter contents 1	Octet z+3
		Octet k
	Parameter identifier 2	Octet k+1
	Length of Parameter contents 2	Octet k+2
	Parameter contents 2	Octet k+3
		Octet p
	...	Octet p+1
		Octet q
	Parameter identifier N	Octet q+1
	Length of Parameter contents N	Octet q+2
	Parameter contents N	Octet q+3
		Octet v

Figure 10.5.144c/3GPP TS 24.008: *Parameters list*

Table 10.5.162/3GPP TS 24.008: *Traffic flow template* information element

<p>TFT operation code (octet 3)</p> <p>Bits</p> <p>8 7 6</p> <p>0 0 0 Spare</p> <p>0 0 1 Create new TFT</p> <p>0 1 0 Delete existing TFT</p> <p>0 1 1 Add packet filters to existing TFT</p> <p>1 0 0 Replace packet filters in existing TFT</p> <p>1 0 1 Delete packet filters from existing TFT</p> <p>1 1 0 No TFT operation</p> <p>1 1 1 Reserved</p> <p>The TFT operation code "No TFT operation" shall be used if a <i>parameters list</i> is included but no <i>packet filter list</i> is included in the <i>traffic flow template</i> information element.</p> <p>E bit (bit 5 of octet 3)</p> <p>The <i>E bit</i> indicates if a <i>parameters list</i> is included in the TFT IE and it is encoded as follows:</p> <p>0 <i>parameters list</i> is not included</p> <p>1 <i>parameters list</i> is included</p> <p>Number of packet filters (octet 3)</p> <p>The <i>number of packet filters</i> contains the binary coding for the number of packet filters in the <i>packet filter list</i>. The <i>number of packet filters</i> field is encoded in bits 4 through 1 of octet 3 where bit 4 is the most significant and bit 1 is the least significant bit. For the "delete existing TFT" operation and for the "no TFT operation", the <i>number of packet filters</i> shall be coded as 0. For all other operations, the number of packet filters shall be greater than 0 and less than or equal to 8.</p> <p>Packet filter list (octets 4 to z)</p> <p>The <i>packet filter list</i> contains a variable number of packet filters. For the "delete existing TFT" operation and the "no TFT operation", the <i>packet filter list</i> shall be empty.</p> <p>For the "delete packet filters from existing TFT" operation, the <i>packet filter list</i> shall contain a variable number of packet filter identifiers. This number shall be derived from the coding of the <i>number of packet filters</i> field in octet 3.</p> <p>For the "create new TFT", "add packet filters to existing TFT" and "replace packet filters in existing TFT" operations, the <i>packet filter list</i> shall contain a variable number of packet filters. This number shall be derived from the coding of the <i>number of packet filters</i> field in octet 3.</p> <p>Each packet filter is of variable length and consists of</p> <ul style="list-style-type: none"> <li>- a packet filter identifier (1 octet);</li> <li>- a packet filter evaluation precedence (1 octet);</li> <li>- the length of the packet filter contents (1 octet); and</li> <li>- the packet filter contents itself (v octets).</li> </ul> <p>The <i>packet filter identifier</i> field is used to identify each packet filter in a TFT. Since the maximum number of packet filters in a TFT is 8, only the least significant 3 bits are used. Bits 8 through 4 are spare bits.</p> <p>The <i>packet filter evaluation precedence</i> field is used to specify the precedence for the packet filter among all packet filters in all TFTs associated with this PDP address. Higher the value of the <i>packet filter evaluation precedence</i> field, lower the</p>
---

precedence of that packet filter is. The first bit in transmission order is the most significant bit.

The *length of the packet filter contents* field contains the binary coded representation of the length of the *packet filter contents* field of a packet filter. The first bit in transmission order is the most significant bit.

The *packet filter contents* field is of variable size and contains a variable number (at least one) of *packet filter components*. Each *packet filter component* shall be encoded as a sequence of a one octet *packet filter component type identifier* and a fixed length *packet filter component value* field. The *packet filter component type identifier* shall be transmitted first.

In each packet filter, there shall not be more than one occurrence of each packet filter component type. Among the "IPv4 source address type" and "IPv6 source address type" packet filter components, only one shall be present in one packet filter. Among the "single destination port type" and "destination port range type" packet filter components, only one shall be present in one packet filter. Among the "single source port type" and "source port range type" packet filter components, only one shall be present in one packet filter.

Packet filter component type identifier

Bits

8 7 6 5 4 3 2 1

0 0 0 1 0 0 0 0	IPv4 source address type
0 0 1 0 0 0 0 0	IPv6 source address type
0 0 1 1 0 0 0 0	Protocol identifier/Next header type
0 1 0 0 0 0 0 0	Single destination port type
0 1 0 0 0 0 0 1	Destination port range type
0 1 0 1 0 0 0 0	Single source port type
0 1 0 1 0 0 0 1	Source port range type
0 1 1 0 0 0 0 0	Security parameter index type
0 1 1 1 0 0 0 0	Type of service/Traffic class type
1 0 0 0 0 0 0 0	Flow label type

All other values are reserved.

For "IPv4 source address type", the *packet filter component value* field shall be encoded as a sequence of a four octet *IPv4 address* field and a four octet *IPv4 address mask* field. The *IPv4 address* field shall be transmitted first.

For "IPv6 source address type", the *packet filter component value* field shall be encoded as a sequence of a sixteen octet *IPv6 address* field and a sixteen octet *IPv6 address mask* field. The *IPv6 address* field shall be transmitted first.

For "Protocol identifier/Next header type", the *packet filter component value* field shall be encoded as one octet which specifies the IPv4 protocol identifier or IPv6 next header.

For "Single destination port type" and "Single source port type", the *packet filter component value* field shall be encoded as two octet which specifies a port number.

For "Destination port range type" and "Source port range type", the *packet filter component value* field shall be encoded as a sequence of a two octet *port range low limit* field and a two octet *port range high limit* field. The *port range low limit* field shall be transmitted first.

For "Security parameter index", the *packet filter component value* field shall be encoded as four octet which specifies the IPsec security parameter index.

For "Type of service/Traffic class type", the *packet filter component value* field shall be encoded as a sequence of a one octet *Type-of-Service/Traffic Class* field and a one octet *Type-of-Service/Traffic Class mask* field. The *Type-of-Service/Traffic Class* field shall be transmitted first.

For "Flow label type", the *packet filter component value* field shall be encoded as three octet which specifies the IPv6 flow label. The bits 8 through 5 of the first octet shall be spare whereas the remaining 20 bits shall contain the IPv6 flow label.

Parameters list (octets z+1 to v)

The *parameters list* contains a variable number of parameters that may be transferred. If the *parameters list* is included, the *E bit* is set to 1; otherwise, the *E bit* is set to 0.

Each parameter included in the *parameters list* is of variable length and consists of:

- a parameter identifier (1 octet);
- the length of the parameter contents (1 octet); and
- the parameter contents itself (v octets).

The *parameter identifier* field is used to identify each parameter included in the *parameters list* and it contains the hexadecimal coding of the parameter identifier. Bit 8 of the *parameter identifier* field contains the most significant bit and bit 1 contains the least significant bit. In this version of the protocol, the following parameter identifiers are specified:

- 01H (Authorization Token);
- 02H (Flow Identifier).

If the *parameters list* contains a parameter identifier that is not supported by the receiving entity the corresponding parameter shall be discarded.

The *length of parameter contents* field contains the binary coded representation of the length of the *parameter contents* field. The first bit in transmission order is the most significant bit.

When the *parameter identifier* indicates Authorization Token, the *parameter contents* field contains an authorization token, as specified in 3GPP TS 29.207. The first octet is the most significant octet of the authorization token and the last octet is the least significant octet of the authorization token.

The *parameters list* shall be coded in a way that an Authorization Token (i.e. a parameter with identifier 01H) is always followed by one or more Flow Identifiers (i.e. one or more parameters with identifier 02H).

If the *parameters list* contains two or more consecutive Authorization Tokens without any Flow Identifiers in between, the receiver shall treat this as a semantical TFT error.

When the *parameter identifier* indicates Flow Identifier, the *parameter contents* field contains the binary representation of a flow identifier. The Flow Identifier consists of four octets. Octets 1 and 2 contains the Media Component number as specified in 3GPP TS 29.207 [100]. Bit 1 of octet 2 is the least significant bit, and bit 8 of octet 1 is the most significant bit. Octets 3 and 4 contains the IP flow number as specified in 3GPP TS 29.207 [100]. Bit 1 of octet 4 is the least significant bit, and bit 8 of octet 3 is the most significant bit.

### 10.5.6.13 Temporary Mobile Group Identity (TMGI)

The purpose of the TMGI element is for group paging in MBMS.

The TMGI information element is a type 4 information element with a minimum length of 5 octets and a maximum length of 8 octets. If octet 6 is included, then octets 7 and 8 shall also be included.

The content of the TMGI element is shown in Figure 10.5.154/3GPP TS 24.008 and table 10.5.168/3GPP TS 24.008.

8	7	6	5	4	3	2	1	
Temporary Mobile Group Identity IEI								Octet 1
Length of Temporary Mobile Group Identity contents								Octet 2
MBMS Service ID								Octet 3
MBMS Service ID								Octet 4
MBMS Service ID								Octet 5
MCC digit 2				MCC digit 1				Octet 6
MNC digit 3				MCC digit 3				Octet 7
MNC digit 2				MNC digit 1				Octet 8

**Figure 10.5.154/3GPP TS 24.008: TMGI information element**

**Table 10.5.168/3GPP TS 24.008: TMGI information element**

<p>MBMS Service ID (octet 3, 4 and 5)</p> <p>In the MBMS Service ID field bit 8 of octet 3 is the most significant bit and bit 1 of octet 5 the least significant bit. The coding of the MBMS Service ID is the responsibility of each administration. Coding using full hexadecimal representation may be used. The MBMS Service ID consists of 3 octets.</p> <p>MCC, Mobile country code (octet 6, octet 7 bits 1 to 4)</p> <p>The MCC field is coded as in ITU-T Rec. E.212, Annex A.</p> <p>MNC, Mobile network code (octet 7 bits 5 to 8, octet 8)</p> <p>The coding of this field is the responsibility of each administration but BCD coding shall be used. The MNC shall consist of 2 or 3 digits. If a network operator decides to use only two digits in the MNC, bits 5 to 8 of octet 7 shall be coded as "1111".</p>
--

#### 10.5.6.14 MBMS bearer capabilities

The purpose of the *MBMS bearer capabilities* information element is to indicate the maximum bit rate for downlink supported by the MS for an MBMS context.

**NOTE:** The information element indicates the static physical capabilities of the MS, independent of the radio access (UTRAN or GERAN), the radio conditions, or other CS or PS services possibly activated by the MS.

The *MBMS bearer capabilities* is a type 4 information element with a maximum length of 4 octets.

The *MBMS bearer capabilities* information element is coded as shown in figure 10.5.155/3GPP TS 24.008 and table 10.5.169/3GPP TS 24.008.

8	7	6	5	4	3	2	1	
MBMS bearer capabilities IEI								Octet 1
Length of MBMS bearer capabilities IE								Octet 2
Maximum bit rate for downlink								Octet 3
Maximum bit rate for downlink (extended)								Octet 4

**Figure 10.5.155/3GPP TS 24.008: MBMS bearer capabilities information element**

**Table 10.5.169/3GPP TR 24.008: MBMS bearer capabilities information element**

--

Maximum bit rate for downlink, octet 3 (see 3GPP TS 23.107 [81])

The coding is identical to that of the maximum bit rate for downlink, octet 9, in the *Quality of service* information element (see subclause 10.5.6.5).

If the sending entity wants to indicate a maximum bit rate for downlink higher than 8640 kbps, it shall set octet 3 to '11111110', i.e. 8640 kbps, and shall encode the value for the maximum bit rate in octet 4.

Maximum bit rate for downlink (extended), octet 4

The coding is identical to that of the maximum bit rate for downlink (extended), octet 15, in the *Quality of service* information element (see subclause 10.5.6.5).

### 10.5.6.15 MBMS protocol configuration options

The purpose of the *MBMS protocol configuration options* information element is to:

- transfer protocol options associated with the bearer level of an MBMS context activation, and
- transfer additional MBMS bearer related (protocol) data (e.g. configuration parameters, error codes or messages/events).

The *MBMS protocol configuration options* is a type 4 information element with a minimum length of 3 octets and a maximum length of 253 octets.

The *MBMS protocol configuration options* information element is coded as shown in figure 10.5.156/3GPP TS 24.008 and table 10.5.170/3GPP TS 24.008.

8	7	6	5	4	3	2	1	
MBMS protocol configuration options IEI								octet 1
Length of MBMS protocol configuration options contents								octet 2
0	0	0	0	0	0	0	0	octet 3
Spare								

**Figure 10.5.156/3GPP TS 24.008: *MBMS protocol configuration options* information element**

**Table 10.5.170/3GPP TR 24.008: *MBMS protocol configuration options* information element**

Bits 1 to 8 of octet 3 are spare and shall be coded as "0".
NOTE: The reason for defining the information element is to have a transparent mechanism in the SGSN available from the introduction of MBMS. This will ensure that MS – GGSN communication is possible if new MBMS bearer service related parameters are defined.

### 10.5.6.16 Enhanced network service access point identifier

The purpose of the *Enhanced network service access point identifier* information element is to identify the service access point that is used at layer 3.

The *Enhanced network service access point identifier* is a type 3 information element with a length of 2 octets.

The value part of an *Enhanced network service access point identifier* information element is coded as shown in figure 10.5.157/3GPP TS 24.008 and table 10.5.171/3GPP TS 24.008.



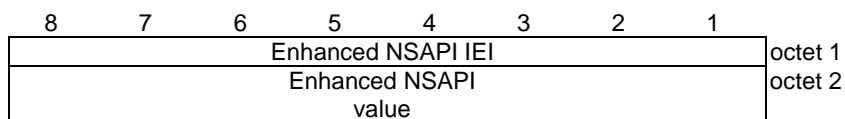

**Figure 10.5.157/3GPP TS 24.008: Enhanced network service access point identifier information element**

**Table 10.5.171/3GPP TS 24.008: Enhanced network service access point identifier information element**

Enhanced NSAPI value (octet 2, bits 1 to 7)								
Bits								
<b>8</b>	<b>7</b>	<b>6</b>	<b>5</b>	<b>4</b>	<b>3</b>	<b>2</b>	<b>1</b>	
0	0	0	0	0	0	0	0	Reserved
through								
0	1	1	1	1	1	1	1	Reserved
1	0	0	0	0	0	0	0	NSAPI 128 for Multimedia Broadcast/Multicast Service (MBMS) Multicast mode
through								
1	1	1	1	1	1	1	0	NSAPI 254 for Multimedia Broadcast/Multicast Service (MBMS) Multicast mode
1	1	1	1	1	1	1	1	Reserved (NOTE)
NOTE: NSAPI 255 is reserved for use by lower layers in the point-to-point radio bearer allocation message for Multimedia Broadcast/Multicast Service (MBMS) Broadcast mode (see 3GPP TS 25.331 [23c]).								

## 10.5.7 GPRS Common information elements

### 10.5.7.1 PDP context status

The purpose of the *PDP context status* information element is to indicate the state of each PDP context which can be identified by NSAPI.

The *PDP context status* information element is a type 4 information element with 4 octets length.

The *PDP context status* information element is coded as shown in figure 10.5.148/3GPP TS 24.008 and table 10.5.164/3GPP TS 24.008.

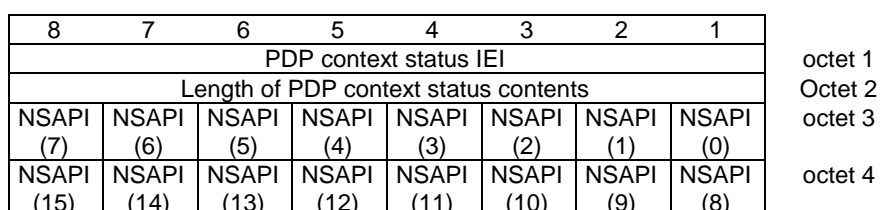

**Figure 10.5.148/3GPP TS 24.008 PDP context status information element**

**Table 10.5.164/3GPP TS 24.008: PDP context status information element**

<p>NSAPI(x) shall be coded as follows:</p> <p>NSAPI(0) - NSAPI(4): are coded as '0' and shall be treated as spare in this version of the protocol.</p> <p>NSAPI(5) – NSAPI(15): 0 indicates that the SM state of the corresponding PDP context is PDP-INACTIVE. 1 indicates that the SM state of the corresponding PDP context is not PDP-INACTIVE.</p>
---

### 10.5.7.2 Radio priority

The purpose of the *radio priority* information element is to specify the priority level that the MS shall use at the lower layers for transmission of data related to a PDP context or for mobile originated SMS transmission.

The *radio priority* information element is coded as shown in figure 10.5.145/3GPP TS 24.008 and table 10.5.161/3GPP TS 24.008.

The *radio priority* is a type 1 information element.

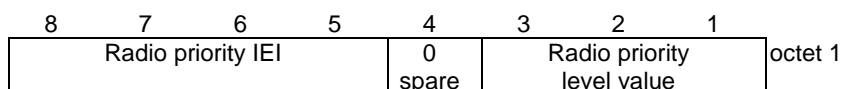

**Figure 10.5.145/3GPP TS 24.008: Radio priority information element**

**Table 10.5.161/3GPP TS 24.008: Radio priority information element**

<p>Radio priority level value (octet 1)</p> <p>Bits <b>3 2 1</b></p> <p>0 0 1 priority level 1 (highest) 0 1 0 priority level 2 0 1 1 priority level 3 1 0 0 priority level 4 (lowest)</p> <p>All other values are interpreted as priority level 4 by this version of the protocol.</p>
---

### 10.5.7.3 GPRS Timer

The purpose of the *GPRS timer* information element is to specify GPRS specific timer values, e.g. for the READY timer.

The *GPRS timer* is a type 3 information element with 2 octets length.

The *GPRS timer* information element is coded as shown in figure 10.5.146/3GPP TS 24.008 and table 10.5.172/3GPP TS 24.008.

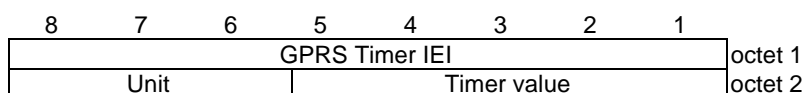

**Figure 10.5.146/3GPP TS 24.008: GPRS Timer information element**

**Table 10.5.172/3GPP TS 24.008: GPRS *Timer* information element**

<p>Timer value (octet 2)</p> <p>Bits 5 to 1 represent the binary coded timer value.</p> <p>Bits 6 to 8 defines the timer value unit for the GPRS timer as follows:</p> <p>Bits</p> <p><b>8 7 6</b></p> <p>0 0 0 value is incremented in multiples of 2 seconds</p> <p>0 0 1 value is incremented in multiples of 1 minute</p> <p>0 1 0 value is incremented in multiples of decihours</p> <p>1 1 1 value indicates that the timer is deactivated.</p> <p>Other values shall be interpreted as multiples of 1 minute in this version of the protocol.</p>
--

**10.5.7.4 GPRS Timer 2**

The purpose of the *GPRS timer 2* information element is to specify GPRS specific timer values, e.g. for the timer T3302.

The *GPRS timer 2* is a type 4 information element with 3 octets length.

The *GPRS timer 2* information element is coded as shown in figure 10.5.147/3GPP TS 24.008 and table 10.5.163/3GPP TS 24.008.

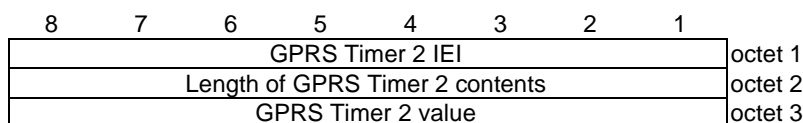

**Figure 10.5.147/3GPP TS 24.008: GPRS *Timer 2* information element**

**Table 10.5.163/3GPP TS 24.008: GPRS *Timer 2* information element**

GPRS Timer 2 value is coded as octet 2 of the <i>GPRS timer</i> information element.
--

**10.5.7.5 Radio priority 2**

The purpose of the *radio priority 2* information element is to specify the priority level that the MS shall use at the lower layers for transmission of mobile originated TOM8 transmission.

The *radio priority 2* information element is coded as shown in figure 10.5.148/3GPP TS 24.008 and table 10.5.164/3GPP TS 24.008.

The *radio priority* is a type 1 information element.

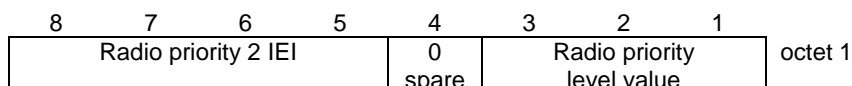

**Figure 10.5.148/3GPP TS 24.008: *Radio priority 2* information element**

**Table 10.5.164/3GPP TS 24.008: Radio priority 2 information element**

Radio priority level value (octet 1, bits 1-3)			
Bits			
<b>3</b>	<b>2</b>	<b>1</b>	
0	0	1	priority level 1 (highest)
0	1	0	priority level 2
0	1	1	priority level 3
1	0	0	priority level 4 (lowest)
All other values are interpreted as priority level 4 by this version of the protocol.			

**10.5.7.6 MBMS context status**

The purpose of the *MBMS context status* information element is to indicate the state of each MBMS context which can be identified by an NSAPI.

The *MBMS context status* information element is a type 4 information element with a minimum length of 2 octets and a maximum length of 18 octets.

The *MBMS context status* information element is coded as shown in figure 10.5.149/3GPP TS 24.008 and table 10.5.165/3GPP TS 24.008.

8	7	6	5	4	3	2	1	
MBMS context status IEI								octet 1
Length of MBMS context status contents								octet 2
NSAPI (135)	NSAPI (134)	NSAPI (133)	NSAPI (132)	NSAPI (131)	NSAPI (130)	NSAPI (129)	NSAPI (128)	octet 3
NSAPI (143)	NSAPI (142)	NSAPI (141)	NSAPI (140)	NSAPI (139)	NSAPI (138)	NSAPI (137)	NSAPI (136)	octet 4
⋮								
NSAPI (255)	NSAPI (254)	NSAPI (253)	NSAPI (252)	NSAPI (251)	NSAPI (250)	NSAPI (249)	NSAPI (248)	octet 18

**Figure 10.5.149/3GPP TS 24.008 MBMS context status information element**

**Table 10.5.165/3GPP TS 24.008: MBMS context status information element**

For x = 128 to 255, NSAPI(x) shall be coded as follows:	
0	indicates that the SM state of the corresponding MBMS context is PDP-INACTIVE.
1	indicates that the SM state of the corresponding MBMS context is not PDP-INACTIVE.
If octets are not included in the information element, the receiver shall interpret the NSAPI(x) values of these octets as set to 0.	

# 11 List of system parameters

The description of timers in the following table should be considered a brief summary. The precise details are found in clauses 3 to 6, which should be considered the definitive descriptions.

## 11.1 Timers and counters for radio resource management

See 3GPP TS 44.018 [84].

## 11.2 Timers of mobility management

**Table 11.1/3GPP TS 24.008: Mobility management timers - MS-side**

TIMER NUM.	MM ST AT	TIME OUT VAL.	CAUSE FOR START	NORMAL STOP	AT THE EXPIRY
T3210	3	20s	- LOC_UPD_REQ sent	- LOC_UPD_ACC - LOC_UPD_REJ - AUTH_REJ - Lower layer failure	Start T3211
T3211	1 2	15s	- LOC_UPD_REJ with cause#17 netw. failure - lower layer failure or RR conn. released after RR conn. abort during loc. updating	- Time out - cell change - request for MM connection establishment - change of LA	Restart the Location update proc.
T3212	1, 2	Note 1	- termination of MM service or MM signalling	- initiation of MM service or MM signalling	initiate periodic updating
T3213	1 2 11	4s	- location updating failure	- expiry - change of BCCH parameter	new random attempt
T3214	3 5 7	20s	AUTHENT FAILURE Cause = "MAC failure" or "GSM authentication unacceptable" sent	AUTHENT REQ received	Consider the network as "false" (see 4.3.2.6.1)
T3216	3 5 7	15s	AUTHENT FAILURE Cause = Synch failure sent	AUTHENT REQ received	Consider the network as "false" (see 4.3.2.6.1)
T3218	3 5 7	20s	RAND and RES stored as a result of of a UMTS authentication challenge	- Cipher mode setting (A/Gb mode only) - Security mode setting (lu mode only) - CM_SERV_ACCEPT received - CM SERVICE REJECT received - LOCATION UPDATING ACCEPT received - AUTHENT REJ received - AUTHENT FAIL sent - enter MM IDLE or NULL	Delete the stored RAND and RES
T3220	7	5s	- IMSI DETACH	- release from RM-sublayer	enter Null or Idle, ATTEMPTING TO UPDATE
T3230	5	15s	- CM SERV REQ CM REEST REQ	- Cipher mode setting - CM SERV REJ - CM SERV ACC	provide release ind.

T3240	9 10	10s	see subclause 11.2.1	see subclause 11.2.1	abort the RR connection
T3241	25	300s	see subclause 11.2.1	see subclause 11.2.1	abort the RR connection

NOTE 1: The timeout value is broadcasted in a SYSTEM INFORMATION message

**Table 11.2/3GPP TS 24.008: Mobility management timers - network-side**

TIMER NUM.	MM ST AT	TIME OUT VAL.	CAUSE FOR START	NORMAL STOP	AT THE EXPIRY	AT THE SECOND EXPIRY
T3250	6	12s	TMSI-REAL-CMD or LOC UPD ACC with new TMSI sent	TMSI-REALL-COM received	Optionally Release RR connection	
T3255		Note	LOC UPD ACC sent with "Follow on Proceed"	CM SERVICE REQUEST	Release RR Connection or use for mobile station terminating call	
T3260	5	12s	AUTHENT-REQUEST sent	AUTHENT-RESPONSE received  AUTHENT-FAILURE received	Optionally Release RR connection	
T3270	4	12s	IDENTITY REQUEST sent	IDENTITY RESPONSE received	Optionally Release RR connection	

NOTE 2: The value of this timer is not specified by this recommendation.

## 11.2.1 Timer T3240 and Timer T3241

Timer T3240 is started in the mobile station when:

- the mobile station receives a LOCATION UPDATING ACCEPT message completing a location updating procedure in the cases specified in subclauses 4.4.4.6 and 4.4.4.8;
- the mobile station receives a LOCATION UPDATING REJECT message in the cases specified in subclause 4.4.4.7;
- the mobile station has sent a CM SERVICE ABORT message as specified in subclause 4.5.1.7;
- the mobile station has released or aborted all MM connections in the cases specified in 4.3.2.5, 4.3.5.2, 4.5.1.1, and 4.5.3.1.

Timer T3240 is stopped, reset, and started again at receipt of an MM message.

Timer T3240 is stopped and reset (but not started) at receipt of a CM message that initiates establishment of an CM connection (an appropriate SETUP, REGISTER, or CP-DATA message as defined in 3GPP TS 24.008, 3GPP TS 24.010 or 3GPP TS 24.011).

Timer T3241 is started in the mobile station when entering MM state RR CONNECTION RELEASE NOT ALLOWED.

Timer T3241 is stopped and reset (but not started) when the MM state RR CONNECTION RELEASE NOT ALLOWED is left.

If timer T3241 expires, the MS shall abort the RR connection and enter the MM state MM IDLE.

## 11.2.2 Timers of GPRS mobility management

Table 11.3/3GPP TS 24.008: GPRS Mobility management timers - MS side

TIMER NUM.	TIMER VALUE	STATE	CAUSE OF START	NORMAL STOP	ON THE 1 <sup>st</sup> , 2 <sup>nd</sup> , 3 <sup>rd</sup> , 4 <sup>th</sup> EXPIRY Note 3
T3310	15s	GMM-REG-INIT	ATTACH REQ sent	ATTACH ACCEPT received ATTACH REJECT received	Retransmission of ATTACH REQ
T3311	15s	GMM-DEREG ATTEMPTING TO ATTACH or GMM-REG ATTEMPTING TO UPDATE	ATTACH REJ with other cause values as described in chapter 'GPRS Attach' ROUTING AREA UPDATE REJ with other cause values as described in chapter 'Routing Area Update' Low layer failure	Change of the routing area	Restart of the Attach or the RAU procedure with updating of the relevant attempt counter
T3316	30s	GMM-REG-INIT GMM-REG GMM-DEREG-INIT GMM-RA-UPDATING-INT GMM-SERV-REQ-INIT (lu mode only)	RAND and RES stored as a result of a UMTS authentication challenge	Security mode setting (lu mode only) SERVICE ACCEPT received. (lu mode only) SERVICE REJECT received (lu mode only) ROUTING AREA UPDATE ACCEPT received AUTHENTICATION AND CIPHERING REJECT received AUTHENTICATION_AND_CIPHERING_FAILURE sent  Enter GMM-DEREG or GMM-NULL	Delete the stored RAND and RES
T3318	20s	GMM-REG-INIT GMM-REG GMM-DEREG-INIT GMM-RA-UPDATING-INT GMM-SERV-REQ-INIT (lu mode only)	AUTHENTICATION & CIPHERING FAILURE (cause="MAC failure" or "GSM authentication unacceptable") sent	AUTHENTICATION & CIPHERING REQUEST received	On first expiry, the MS should consider the network as false (see 4.7.7.6.1)

T3320	15s	GMM-REG-INIT GMM-REG GMM-DEREG-INIT GMM-RA-UPDATING-INT GMM-SERV-REQ-INIT (lu mode only)	AUTHENTICATION & CIPHERING FAILURE (cause=synch failure) sent	AUTHENTICATION & CIPHERING REQUEST received	On first expiry, the MS should consider the network as false (see 4.7.7.6.1)
T3321	15s	GMM-DEREG-INIT	DETACH REQ sent	DETACH ACCEPT received	Retransmission of the DETACH REQ
T3330	15s	GMM-ROUTING-UPDATING-INITIATED	ROUTING AREA UPDATE REQUEST sent	ROUTING AREA UPDATE ACC received  ROUTING AREA UPDATE REJ received	Retransmission of the ROUTING AREA UPDATE REQUEST message

Table 11.3a/3GPP TS 24.008: GPRS Mobility management timers – MS side

TIMER NUM.	TIMER VALUE	STATE	CAUSE OF START	NORMAL STOP	ON EXPIRY
T3302	Default 12 min Note 1 Note 5	GMM-DEREG or GMM-REG	At attach failure and the attempt counter is greater than or equal to 5.  At routing area updating failure and the attempt counter is greater than or equal to 5.	At successful attach  At successful routing area updating	On every expiry, initiation of the GPRS attach procedure or RAU procedure
T3312	Default 54 min Note1	GMM-REG	In A/Gb mode, when READY state is left.  In lu mode, when PMM-CONNECTED mode is left.	When entering state GMM-DEREG	Initiation of the Periodic RAU procedure
T3314 READY (A/Gb mode only)	Default 44 sec Note 2	All except GMM-DEREG	Transmission of a PTP PDU	Forced to Standby	No cell-updates are performed
T3317 (lu mode only)	10s	GMM-SERVICE-REQUEST-INITIATED	SERVICE REQ sent	Security mode control procedure is completed, SERVICE ACCEPT received, or SERVICE REJECT received	Abort the procedure
T3319 (lu mode only)	30s Note 4	GMM-REG	Completion of the Security Mode Control procedure after the sending a SERVICE REQUEST with service type "data".  Reception of a SERVICE ACCEPT message.	When entering PMM-IDLE mode.  When the radio access bearer is released for any active PDP context.  When entering state GMM-DEREG.	SERVICE REQ with service type "data" may be invoked again, if required.

NOTE 1: The value of this timer is used if the network does not indicate another value in a GMM signalling procedure.



NOTE 2: The default value of this timer is used if neither the MS nor the Network send another value, or if the Network sends this value, in a signalling procedure.

NOTE 3: Typically, the procedures are aborted on the fifth expiry of the relevant timer. Exceptions are described in the corresponding procedure description.

NOTE 4: The purpose of this timer is to prevent the MS from repeating the SERVICE REQUEST message with service type "data" too early in case the request to setup the radio access bearer is queued by the radio access network.

NOTE 5: In Iu mode, the default value of this timer is used if the network provides a value for this timer in a non-integrity protected Iu mode GMM message.

**Table 11.4/3GPP TS 24.008: GPRS Mobility management timers - network side**

TIMER NUM.	TIMER VALUE	STATE	CAUSE OF START	NORMAL STOP	ON THE 1 <sup>st</sup> , 2 <sup>nd</sup> , 3 <sup>rd</sup> , 4 <sup>th</sup> EXPIRY Note 3
T3322	6s	GMM-DEREG-INIT	DETACH REQ sent	DETACH ACCEPT received	Retransmission of DETACH REQUEST
T3350	6s	GMM-COMMON-PROC-INIT	ATTACH ACCEPT sent with P-TMSI and/or TMSI RAU ACCEPT sent with P-TMSI and/or TMSI P-TMSI REALLOC COMMAND sent	ATTACH COMPLETE received RAU COMPLETE received P-TMSI REALLOC COMPLETE received	Retransmission of the same message type, i.e. ATTACH ACCEPT, RAU ACCEPT or REALLOC COMMAND
T3360	6s	GMM-COMMON-PROC-INIT	AUTH AND CIPH REQUEST sent	AUTH AND CIPH RESPONSE received AUTHENT-AND CIPHER-FAILURE received	Retransmission of AUTH AND CIPH REQUEST
T3370	6s	GMM-COMMON-PROC-INIT	IDENTITY REQUEST sent	IDENTITY RESPONSE received	Retransmission of IDENTITY REQUEST

**Table 11.4a/3GPP TS 24.008: GPRS Mobility management timers - network side**

TIMER NUM.	TIMER VALUE	STATE	CAUSE OF START	NORMAL STOP	ON EXPIRY
T3313	Note1	GMM_REG	Paging procedure initiated	Paging procedure completed	Network dependent
T3314 READY (A/Gb mode only)	Default 44 sec Note 2	All except GMM-DEREG	Receipt of a PTP PDU	Forced to Standby	The network shall page the MS if a PTP PDU has to be sent to the MS
Mobile Reachable	Default 4 min greater than T3312	All except GMM-DEREG	In A/Gb mode, change from READY to STANDBY state In Iu mode, change from PMM-CONNECTED mode to PMM-IDLE mode.	PTP PDU received	Network dependent but typically paging is halted on 1st expiry

NOTE 1: The value of this timer is network dependent.

NOTE 2: The default value of this timer is used if neither the MS nor the Network send another value, or if the Network sends this value, in a signalling procedure. The value of this timer should be slightly shorter in the network than in the MS, this is a network implementation issue.

NOTE 3: Typically, the procedures are aborted on the fifth expiry of the relevant timer. Exceptions are described in the corresponding procedure description.

### 11.2.3 Timers of GPRS session management

Table 11.2c/3GPP TS 24.008: GPRS session management timers - MS side

TIMER NUM.	TIMER VALUE	STATE	CAUSE OF START	NORMAL STOP	ON THE 1 <sup>st</sup> , 2 <sup>nd</sup> , 3 <sup>rd</sup> , 4 <sup>th</sup> EXPIRY
T3380	30s	PDP-ACTIVE-PEND or MBMS ACTIVE-PENDING	ACTIVATE PDP CONTEXT REQUEST, ACTIVATE SECONDARY PDP CONTEXT REQUEST or ACTIVATE MBMS CONTEXT REQUEST sent	ACTIVATE PDP CONTEXT ACCEPT, ACTIVATE SECONDARY PDP CONTEXT ACCEPT or ACTIVATE MBMS CONTEXT ACCEPT received  ACTIVATE PDP CONTEXT REJECT, ACTIVATE SECONDARY PDP CONTEXT REJECT or ACTIVATE MBMS CONTEXT REJECT received	Retransmission of ACTIVATE PDP CONTEXT REQ, ACTIVATE SECONDARY PDP CONTEXT REQUEST or ACTIVATE MBMS CONTEXT REQUEST
T3381	8s	PDP-MODIFY-PENDING	MODIFY PDP CONTEXT REQUEST sent	MODIFY PDP CONTEXT ACCEPT received	Retransmission of MODIFY PDP CONTEXT REQUEST
T3390	8s	PDP-INACT-PEND	DEACTIVATE PDP CONTEXT REQUEST sent	DEACTIVATE PDP CONTEXT ACC received	Retransmission of DEACTIVATE PDP CONTEXT REQUEST

NOTE: Typically, the procedures are aborted on the fifth expiry of the relevant timer. Exceptions are described in the corresponding procedure description.

Table 11.2d/3GPP TS 24.008: GPRS session management timers - network side

TIMER NUM.	TIMER VALUE	STATE	CAUSE OF START	NORMAL STOP	ON THE 1 <sup>st</sup> , 2 <sup>nd</sup> , 3 <sup>rd</sup> , 4 <sup>th</sup> EXPIRY
T3385	8s	PDP-ACT-PEND or MBMS ACTIVE-PENDING	REQUEST PDP CONTEXT ACTIVATION or REQUEST MBMS CONTEXT ACTIVATION sent	ACTIVATE PDP CONTEXT REQ or ACTIVATE MBMS CONTEXT REQUEST received	Retransmission of REQUEST PDP CONTEXT ACTIVATION or REQUEST MBMS CONTEXT ACTIVATION
T3386	8s	PDP-MOD-PEND	MODIFY PDP CONTEXT REQUEST sent	MODIFY PDP CONTEXT ACC received	Retransmission of MODIFY PDP CONTEXT REQ
T3395	8s	PDP-INACT-PEND or MBMS INACTIVE-PENDING	DEACTIVATE PDP CONTEXT REQUEST sent	DEACTIVATE PDP CONTEXT ACC received	Retransmission of DEACTIVATE PDP CONTEXT REQ

NOTE: Typically, the procedures are aborted on the fifth expiry of the relevant timer. Exceptions are described in the corresponding procedure description.

## 11.3 Timers of circuit-switched call control

Table 11.3/3GPP TS 24.008: Call control timers - MS side

TIM NUM.	TIM VAL	STATE OF CALL	CAUSE OF START	NORMAL STOP	AT FIRST EXPIRY	AT SECOND EXPIRY
T303	30s	Call initiated	CM SER RQ sent	CALL PROC, or REL COMP received	Clear the call	Timer is not restarted
T305	30s	Disconnect Request	DISC sent	REL or DISC received	REL sent.	Timer is not restarted
T308	30s	Release request	REL sent	REL COMP or REL received	Retrans. RELEASE restart T308	Call ref. release
T310 Note 1	30s	Outgoing call Proceeding	CALL PROC received	ALERT,CONN, DISC or PROG rec.	Send DISC	Timer is not restarted
T313	30s	Connect Request	CONN sent	CONNect ACKnowledge received	Send DISC	Timer is not restarted
T323	30s	Modify Request	MOD sent	MOD COMP or MOD REJ received	Clear the call	Timer is not restarted
T324	15s	Modify request	MOD received	MOD COMP or MOD REJ sent	MOD REJ with old bearer capability	Timer is not restarted
T332	30s	Wait for network info	START_CC sent	CC-EST. received	Clear the call	Timer is not restarted
T335	30s	CC-Est. Confirmed	CC-EST CONF.sent	RECALL received	Clear the call	Timer is not restarted
T336	10s		START DTMF sent	START DTMF ACK or START DTMF REJECT received		Timer is not restarted
					The MS considers the DTMF Procedure (for the digit) to be terminated	
T337	10s		STOP DTMF sent	STOP DTMF ACK received	The MS considers the DTMF procedure (for the current digit) to be terminated	Timer is not restarted

NOTE 1: T310 is not started if progress indicator #1, #2, or #64 has been delivered in the CALL PROCEEDING message or in a previous PROGRESS message.

Table 11.4/3GPP TS 24.008: Call control timers - network side

TIM NUM.	DFT TIM VAL	STATE OF CALL	CAUSE FOR START	NORMAL STOP	AT FIRST EXPIRY	AT SECOND EXPIRY
T301 Note 1	Min18 0s	Call received	ALERT received	CONN received	Clear the call	Timer is not restarted
T303	Note 2	Call present	SETUP sent	CALL CONF or REL COMP received	Clear the call	Timer is not restarted
T305	30s	Disconnect Indication	DISC without progress indic. #8 sent or CCBS Possible	REL or DISC received	Network sends RELEASE	Timer is not restarted
T306	30s	Disconnect Indication	DISC with progress indic. #8 sent but no CCBS possible	REL or DISC received	Stop the tone/ announc. Send REL	Timer is not restarted
T308	Note 2	Release request	REL sent	REL COMP or REL received	Retrans. RELEASE restart T308	Release call reference
T310	Note 2	Incoming call proceeding	CALL CONF received	ALERT, CONN or DISC received	Clear the call	Timer is not restarted
T313	Note 2	Connect Indication	CON sent	CON ACK received	Clear the call	Timer is not restarted
T323	30s	Modify request	MOD sent	MOD COMP or MOD REJ received	Clear the call	Timer is not restarted
T331	Note 2	CC Connec. Pending	CM-SERV PROMPT sent	START CC received	Clear the call	Timer is not restarted
T333	Note 2	CC-Est. Present	START CC received	CC-EST.CONF or REL COMP received	Clear the call	Timer is not restarted
T334 Note 3	Min 15s	CC-Est. Confirmed	RECALL sent	SETUP received	Clear the call	Timer is not restarted
T338	Note 2	Disconnect indication	DISC with CCBS possible	REL or DISC received	stop any tone/ announc. Send REL	Timer is not restarted

NOTE 1: The network may already have applied an internal alerting supervision function; e.g. incorporated within call control. If such a function is known to be operating on the call, then timer T301 is not used.

NOTE 2: These time values are set by the network operator.

NOTE 3: When applied to the supplementary service CCBS, the timer T334 can either represent the recall timer T4 or the notification timer T10 (see 3GPP TS 23.093). Thus the timer T334 can take two different values. 3GPP TS 23.093 defines the range of these values.

## Annex A (informative): Example of subaddress information element coding

This annex gives an example of how the Called Party Subaddress IE is encoded to carry subaddress digits that use IA5 characters. This example is also applicable to the Calling Party Subaddress IE.

8	7	6	5	4	3	2	1	octet
0	1	1	0	1	1	0	1	1
called party subaddress IEI								
0	0	0	0	0	1	1	1	2
Length								
1	0	0	0	X	0	0	0	3
not ext	NSAP (X.213/ISO 8348 AD2)			odd/ev note 1	note 2			
0	1	0	1	0	0	0	0	4
AFI (note 3)								
IA5 Character (note 4)								5
IA5 Character (note 4)								6
IA5 Character (note 4)								9

NOTE 1: The value of this bit has no significance when the type of subaddress is "NSAP".

NOTE 2: These bits are spare.

NOTE 3: The Authority and Format Identifier code 50 (in BCD) indicates that the subaddress consists of IA5 characters (see ISO standard 8348 AD2).

NOTE 4: IA5 character as defined in ITU-T Recommendation T.50/ISO 646 and then encoded into two semi-octets according to the "preferred binary encoding" defined in X.213/ISO 8348 AD2. (Each character is converted into a number in the range 32 to 127 using the ISO 646 encoding with zero parity and the parity bit in the most significant position. This number is then reduced by 32 to give a new number in the range 0 to 95. The new number is then treated as a pair of decimal digits with the value of each digit being encoded in a semi-octet.)

NOTE 5: the number of IA5 characters in the subaddress may vary, subject to an upper limit of 19 IA5 characters.

---

# Annex B (normative): Compatibility checking

## B.1 Introduction

This annex describes the various compatibility checks which shall be carried out to ensure that the best matched MS and network capabilities are achieved on a call between a PLMN and the ISDN.

Three different processes of compatibility checking shall be performed:

- i) at the user-to-network interface on the calling side (see B.2);
- ii) at the network-user interface on the called side (see B.3.2);
- iii) user-to-user (see B.3.3).

NOTE: In this context and throughout this annex the term "called user" is the end point entity which is explicitly addressed.

For details on the coding of the information required for compatibility checking, see annex C.

---

## B.2 Calling side compatibility checking

### B.2.1 Compatibility checking of the CM SERVICE REQUEST message

The network shall check if the service requested in the CM SERVICE REQUEST message is permitted for that subscriber.

### B.2.2 Compatibility/Subscription checking of the SETUP message

At the calling side the network shall check that the basic service(s) requested by the calling MS in the Bearer Capability information element(s) match(es) with the basic services provided to that subscriber by the PLMN. If for at least one bearer capability information element contained in the SETUP message a mismatch is detected, then the network shall proceed as follows:

- if the SETUP message contained two bearer capability information elements for only one of which a mismatch is detected, the network shall either:
  - under the conditions specified in 3GPP TS 27.001 (e.g. TS 61 and TS 62), accept the SETUP message with a CALL PROCEEDING message containing the, possibly negotiated, bearer capability information element for which no mismatch is detected, or
  - reject the call using one of the causes listed in annex H.
- otherwise the network shall reject the call using one of the causes listed in annex H.

Network services are described in 3GPP TS 22.002 and 3GPP TS 22.003 [4] as bearer services and teleservices, respectively.

---

## B.3 Called side compatibility checking

In this clause, the word "check" means that the MS examines the contents of the specified information element.

### B.3.1 Compatibility checking with addressing information

If an incoming SETUP message is offered to the MS with addressing information (i.e. sub-address or called party number) the following shall occur:

- a) if the MS has a DDI number or a sub-address, then the information in any Called Party BCD Number or any Called Party subaddress information elements of the incoming SETUP message shall be checked by the MS against the corresponding part of the number assigned to the user (e.g. for DDI) or the user's own sub-address.

In the cases of a mismatch, the MS shall release the call. In the case of a match, the compatibility checking described in B.3.2 and B.3.3 shall be performed.

- b) if the MS has no DDI number and no sub-address, then the Called Party BCD Number and Called Party Sub-address information element shall be ignored for the purposes of compatibility checking. The compatibility checking described in B.3.2 and B.3.3 shall be performed.

NOTE: According to the user's requirements, compatibility checking can be performed in various ways from the viewpoint of execution order and information to be checked, e.g. first DDI number/sub-address and then bearer capability or vice versa.

### B.3.2 Network-to-MS compatibility checking

When the network is providing a basic service at the called side, the MS shall check that the basic service(s) offered by the network in the Bearer Capability information element(s) match(es) the basic services that the MS is able to support. If a mismatch is detected, then the MS shall proceed as follows:

- if the SETUP message contained two bearer capability information elements for only one of which a mismatch is detected, the MS shall either:
  - under the conditions specified in 3GPP TS 27.001 [36] (e.g. TS 61 and TS 62), accept the SETUP message with a CALL CONFIRMED message containing the, possibly negotiated, bearer capability information element for which no mismatch is detected, or
  - reject the call using cause No. 88 "incompatible destination".
- otherwise the MS shall reject the offered call using a RELEASE COMPLETE message with cause No. 88 "incompatible destination".

NOTE: The *backup bearer capability* IE is not subject to compatibility checking.

When interworking with existing networks, limitations in network or distant user signalling (e.g. in the case of an incoming call from a PSTN or a call from an analogue terminal) may restrict the information available to the called MS in the incoming SETUP message (e.g. missing Bearer Capability Information Element or missing High Layer Compatibility Information Element). For compatibility checking, and handling of such calls see 3GPP TS 27.001 [36].

### B.3.3 User-to-User compatibility checking

See 3GPP TS 27.001 [36].

---

## B.4 High layer compatibility checking

See 3GPP TS 27.001 [36].



---

## Annex C (normative): Low layer information coding principles

### C.1 Purpose

This annex describes principles that shall be used when the calling MS specifies information during call setup regarding low layer capabilities required in the network and by the destination terminal. Refer also to 3GPP TS 27.001 [36].

NOTE: In this context and throughout this annex the term "called user" is the end point entity which is explicitly addressed. This may also be an explicitly addressed interworking unit (IWU) (see ITU-T I.500-Series Recommendations and ITU-T Recommendation X.31 case a).

---

### C.2 Principles

#### C.2.1 Definition of types of information

There are three different types of information that the calling PLMN user may specify during call setup to identify low layer capabilities needed in the network and in the destination terminal:

- a) type I information is information about the calling terminal which is only used at the destination end to allow a decision regarding terminal compatibility. An example would be the user information layer 3 protocol. Type I information is encoded in octets 5 to 7 of the low layer compatibility information element;
- b) type II information is only used by the network (PLMN) to which the calling user is connected for selection of PLMN specific network resources, e.g. channel type or specific functionality within the interworking function (IWF, see 3GPP TS 23.093). This type of information is always present. An example is the connection element. Type II information is coded in:
  - i) octet 3 of the bearer capability information element when the information transfer capability required by the calling user is speech ;
  - ii) octets 3, 4, 5, and optionally octet 7 of the bearer capability information element when the information transfer capability required by the calling user is not speech;
- c) type III information is required for selection of a basic service from the choice of basic services offered by the network and together with type II information for selection of an appropriate interworking function (IWF, see 3GPP TS 29.007 [38]), as well as for terminal compatibility checking at the destination terminal. An example is the information transfer capability. Type III information is always present and is encoded in:
  - i) octet 3 of the bearer capability information element when the information transfer capability required by the calling user is speech ;
  - ii) octets 3, 5, 6, 6a, 6b and 6c of the bearer capability information element when the information transfer capability required by the calling user is not speech;

#### C.2.2 Examination by network

Type I information is user-to-user (i.e. at the calling side not examined by network) while type II and III information should be available for examination by the destination user and the network.

NOTE: In the case of a mobile terminated call, if the type II and type III information is not sufficient for the selection of an appropriate interworking function, the type I information will also be examined by the network.

### C.2.3 Location of type I information

Type I information (i.e. terminal information only significant to the called user) shall, when used, be included in the low layer compatibility information element.

### C.2.4 Location of types II and III information

Type II information is included in the bearer capability information element. Type III information is also included in the bearer capability information element. The network may use and modify type III information (e.g. to provide interworking).

In any case a modification of the bearer capability information element has to be performed when interworking to the fixed network (e.g. ISDN) is required, where the signalling of the radio interface has to be mapped to fixed network signalling (e.g. mapping of GSM BCIE to ISDN BCIE, see 3GPP TS 29.007 [38]).

### C.2.5 Relationship between bearer capability and low layer compatibility information elements

There shall be no contradiction of information between the low layer compatibility and the bearer capability at the originating side. However, as some bearer capability code points may be modified during the transport of the call (e.g. by the interworking function), this principle implies that there should be minimal duplication of information between the bearer capability information element and the low layer compatibility information element.

**NOTE:** If as a result of duplication, a contradiction occurs at the terminating side between the bearer capability information element and the low layer compatibility information element at the terminating side, the receiving entity shall ignore the conflicting information in the low layer compatibility information element.

## Annex D (informative): Examples of bearer capability information element coding

This annex gives examples of the coding of bearer capability information elements for various telecommunication services. This annex is included for information purposes only. In the case of any inconsistency between this annex and 3GPP TS 27.001 [36], then 3GPP TS 27.001 shall take precedence over this annex.

### D.1 Coding for speech for a full rate support only mobile station

#### D.1.1 Mobile station to network direction

8	7	6	5	4	3	2	1	
0	0	0	0	0	1	0	0	octet 1
Bearer capability IEI								
0	0	0	0	0	0	0	1	octet 2
Length of the bearer capability contents								
1 not ext	0 full rate only	1 GSM	0 circ. mode	0 speech	0	0	0	octet 3

#### D.1.2 Network to mobile station direction

8	7	6	5	4	3	2	1	
0	0	0	0	0	1	0	0	octet 1
Bearer capability IEI								
0	0	0	0	0	0	0	1	octet 2
Length of the bearer capability contents								
1 not ext	0 spare	1 spare	0 GSM	0 circ. mode	0 speech	0	0	octet 3

## D.2 An example of a coding for modem access with V22-bis, 2,4 kbit/s, 8 bit no parity

### D.2.1 Mobile station to network direction, data compression allowed

8	7	6	5	4	3	2	1	
0	0	0	0	0	1	0	0	octet 1
Bearer capability IEI								
0	0	0	0	0	1	1	1	octet 2
Length of the bearer capability contents								
1 not ext	1	0	0	0	0	1	0	octet 3
	dual, half preferred	GSM	circ. mode	3.1 kHz audio ex PLMN				
1 not ext	1	0	0	1	0	0	0	octet 4
	comp- ress.	SDU integrity		full dupl.	pt to pt	no NIRR	de- mand	
1 not ext	0	0	0	0	0	0	1	octet 5
	access id.		no rate adaption		1.440/450			
0 ext	0	1	0	0	0	0	1	octet 6
	layer 1		default layer 1				async	
0 ext	0	0	1	0	0	1	1	octet 6a
	1 bit	no neg	8 bits	2.4 kbit/s				
0 ext	1	1	0	0	0	1	1	octet 6b
	16 kbit/s inter. rate		no NICtx	no NICrx	(parity) none			
1 not ext	0	1	0	0	0	1	1	octet 6c
	non trans RLP)		V.22 bis					

## D.2.2 Network to mobile station direction, data compression possible

8	7	6	5	4	3	2	1	
0	0	0	0	0	1	0	0	octet 1
Bearer capability IEI								
0	0	0	0	0	1	1	1	octet 2
Length of the bearer capability contents								
1 not ext	0 spare	1 spare	0 GSM	0 circ. mode	3.1 kHz audio ex PLMN			octet 3
1 not ext	1 comp- ress.	0 SDU integrity		1 full dupl.	0 pt to pt	0 no NIRR	0 de- mand	octet 4
1 not ext	0 access id.		0 no rate adaption		0 1.440/450			octet 5
0 ext	0 1 layer 1		0 0 0 0 default layer 1				1 async	octet 6
0 ext	0 1 bit	0 no neg	1 8 bits	0 0 1 1 2.4 kbit/s				octet 6a
0 ext	1 1 16 kbit/s inter. rate		0 no NICtx	0 no NICrx	0 1 1 (parity) none			octet 6b
1 not ext	0 1 non trans (RLP)		0 0 0 1 1 V.22 bis					octet 6c

## D.3 An example of a coding for group 3 facsimile (9,6 kbit/s, transparent)

### D.3.1 Mobile station to network direction

8	7	6	5	4	3	2	1		
0	0	0	0	0	1	0	0	octet 1	
Bearer capability IEI									
0	0	0	0	0	1	1	1	octet 2	
Length of the bearer capability contents									
1 not ext	0	1	0	0	0	1	1	octet 3	
full rate only MS		GSM		circ. mode		facsimile group 3			
1 not ext	0	1	1	1	0	0	0	octet 4	
comp- ress.		unstructured		full dupl.		pt to pt		no NIRR	
1 not ext	0	0	0	0	0	0	1	octet 5	
access id.		no rate adaption		I.440/450					
0 ext	0	1	0	0	0	0	0	octet 6	
layer 1		default layer 1					sync		
0 ext	0	0	1	0	1	0	1	octet 6a	
(syn)		no neg		(syn)		9.6 kbit/s			
0 ext	1	1	0	0	0	1	1	octet 6b	
16 kbit/s inter. rate		no NICtx		no NICrx		(parity) none			
1 not ext	0	0	0	0	0	1	1	octet 6c	
transparent		none (modem type)							

## D.3.2 Network to mobile station direction

8	7	6	5	4	3	2	1	
0	0	0	0	0	1	0	0	octet 1
Bearer capability IEI								
0	0	0	0	0	1	1	1	octet 2
Length of the bearer capability contents								
1 not ext	0 spare	1 spare	0 GSM	0 circ. mode	0	1	1	octet 3
facsimile group 3								
1 not ext	0 comp- ress.	1 unstructured	1	1 full dupl.	0 pt to pt	0 no NIRR	0 de- mand	octet 4
1 not ext	0	0	0	0	0	0	1	octet 5
access id. no rate adaption I.440/450								
0 ext	0	1	0	0	0	0	0	octet 6
layer 1 default layer 1 sync								
0 ext	0 (syn)	0 no neg	1 (syn)	0	1	0	1	octet 6a
9.6 kbit/s								
0 ext	1	1	0	0	0	1	1	octet 6b
16 kbit/s inter. rate NICtx NICrx (parity) none								
1 not ext	0	0	0	0	0	0	0	octet 6c
transparent none (modem type)								

## Annex E (informative): Comparison between call control procedures specified in 3GPP TS 24.008 and ITU-T Recommendation Q.931

This annex summarizes a comparison of the procedures for call control as specified in ITU-T Recommendation Q.931 (blue book) and 3GPP TS 24.008.

If no comment is given, it means that the procedures specified in ITU-T Recommendation Q.931 and 3GPP TS 24.008 are similar. However, it should be noted that even in such cases the procedures may be described in slightly different ways in the two documents.

**Table E.1/3GPP TS 24.008: Circuit-switched call control procedures**

Procedure	Q.931	3GPP TS 24.008
Call establishment at the originating interface	5.1	5.2.1
- call request	5.1.1	5.2.1.1.1 en-bloc sending only
- B-channel selection originating	5.1.2	not applicable
- overlap sending	5.1.3	not supported
- invalid call information	5.1.4	5.2.1.1.2
- call proceeding, en-bloc sending	5.1.5.1	5.2.1.1.3
- call proceeding, overlap sending	5.1.5.2	not supported
- notification of interworking at the originating interf.	5.1.6	5.2.1.1.4
- call confirmation indication	5.1.7	5.2.1.1.5
- call connected	5.1.8	5.2.1.1.6
- call rejection	5.1.9	5.2.1.1.7
- transit network selection	5.1.10	5.2.1.1.8



**Table E.1/3GPP TS 24.008: Circuit-switched call control procedures (continued)**

Procedure	Q.931	3GPP TS 24.008
Call establishment at the destination interface	5.2	5.2.2
- call indication	5.2.1	5.2.2.1 procedure for multiple terminal configuration not required, i.e. delivery of SETUP messages on broadcast data links is not supported
- compatibility checking	5.2.2	5.2.2.2 equivalent, except that delivery of SETUP messages on broadcast data links is not supported
- B-channel selection destination	5.2.3	not applicable
- overlap receiving	5.2.4	not supported
- call confirmation information	5.2.5	5.2.2.3 equivalent, except that delivery of SETUP messages on broadcast data links is not supported
- notification of interworking at the terminating interf.	5.2.6	5.2.2.4
- call accept indication	5.2.7	5.2.2.5
- active indication	5.2.8	5.2.2.6 equivalent, except that SETUP messages are not sent on broadcast data links
- non-selected user clearing	5.2.9	not applicable

**Table E.1/3GPP TS 24.008: Circuit-switched call control procedures (continued)**

Procedure	Q.931	3GPP TS 24.008
Call clearing	5.3	5.4
- terminology	5.3.1	5.4.1 terminology adapted to A/Gb mode and GERAN lu mode applications
- exception conditions	5.3.2	5.4.2 only case a) of clause 5.3.2 of Rec. Q.931 applies. All other exceptions apply to functions which are not relevant to A/Gb mode and GERAN lu mode
- clearing initiated by the user/MS	5.3.3	5.4.3
- clearing initiated by the network	5.3.4	5.4.4
- clearing when tones/announcements are provided	5.3.4.1	5.4.4.1.1 and 5.4.4.2.1 exception: if not already connected, the traffic channel is connected in order to provide the tone/announcement
- clearing when tones/announcements are not provided	5.3.4.2	5.4.4.1.2 and 5.4.4.2.3
- completion of clearing	5.3.4.3	5.4.4.1.3 and 5.4.4.2.5
Clear collision	5.3.5	5.4.5

**Table E.1/3GPP TS 24.008: Circuit-switched call control procedures (continued)**

Procedure	Q.931	3GPP TS 24.008
In-band tones and announcements	5.4	5.5.1
Restart procedure	5.5	not supported
Call rearrangements	5.6	5.3.4 call suspension/call re-establishment not supported on the radio path. The functions, if required, are to be supported locally in the MS. On the radio interface, the notification procedure of Rec. Q.931 (clause 5.6.7) applies
Call collisions	5.7	5.5.2 call collisions cannot occur
Emergency call establishment at the originating interface	not specified not supported	5.2.1.2
In-call modification	Annex O Rec. Q.931 is incomplete with regard to in-call modification procedures	5.3.4
DTMF protocol control procedures	not specified not supported	5.3.3
Call re-establishment	not specified not supported	5.5.4
Status enquiry procedure	5.8.10, 5.8.11	5.5.3
User-to-user signalling	7	3GPP TS 24.010
User notification procedure	5.9	5.3.1

---

## Annex F (informative): A/Gb mode specific cause values for radio resource management

See 3GPP TS 44.018 [84].

---

## Annex G (informative): 3GPP specific cause values for mobility management

This annex describes the cause values for the mobility management procedures for non-GPRS services (MM) and GPRS services (GMM). Clauses G1 to G5 are valid for both MM and GMM. However, the following codes are applicable for non-GPRS services only:

#38 Call cannot be identified

Clause G.6 applies only for GMM procedures.

---

### G.1 Causes related to MS identification

Cause value = 2 IMSI unknown in HLR

This cause is sent to the MS if the MS is not known (registered) in the HLR. This cause code does not affect operation of the GPRS service, although it may be used by a GMM procedure.

Cause value = 3 Illegal MS

This cause is sent to the MS when the network refuses service to the MS either because an identity of the MS is not acceptable to the network or because the MS does not pass the authentication check, i.e. the SRES received from the MS is different from that generated by the network. When used by an MM procedure, except the authentication procedure, this cause does not affect operation of the GPRS service.

Cause value = 4 IMSI unknown in VLR

This cause is sent to the MS when the given IMSI is not known at the VLR.

Cause value = 5 IMEI not accepted

This cause is sent to the MS if the network does not accept emergency call establishment using an IMEI.

Cause value = 6 Illegal ME

This cause is sent to the MS if the ME used is not acceptable to the network, e.g. blacklisted. When used by an MM procedure, this cause does not affect operation of the GPRS service.

---

### G.2 Cause related to subscription options

Cause value = 11 PLMN not allowed

This cause is sent to the MS if it requests location updating in a PLMN where the MS, by subscription or due to operator determined barring is not allowed to operate.

Cause value = 12 Location Area not allowed

This cause is sent to the MS if it requests location updating in a location area where the HPLMN determines that the MS, by subscription, is not allowed to operate.

**NOTE:** If cause #12 is sent to a roaming subscriber the subscriber is denied service even if other PLMNs are available on which registration was possible.

Cause value = 13 Roaming not allowed in this location area

This cause is sent to an MS which requests location updating in a location area of a PLMN which offers roaming to that MS in that Location Area, by subscription.

Cause value = 15 No Suitable Cells In Location Area

This cause is sent to the MS if it requests location updating in a location area where the MS, by subscription, is not allowed to operate, but when it should find another allowed location area in the same PLMN.

NOTE: Cause #15 and cause #12 differ in the fact that cause #12 does not trigger the MS to search for another allowed location area on the same PLMN.

---

## G.3 Causes related to PLMN specific network failures and congestion/Authentication Failures

Cause value = 20 MAC failure

This cause is sent to the network if the USIM detects that the MAC in the AUTHENTICATION REQUEST or AUTHENTICATION\_AND\_CIPHERING REQUEST message is not fresh (see 3GPP TS 33.102 [5a]).

Cause value = 21 Synch failure

This cause is sent to the network if the USIM detects that the SQN in the AUTHENTICATION REQUEST or AUTHENTICATION\_AND\_CIPHERING REQUEST message is out of range (see 3GPP TS 33.102 [5a]).

Cause value = 17 Network failure

This cause is sent to the MS if the MSC cannot service an MS generated request because of PLMN failures, e.g. problems in MAP.

Cause value = 22 Congestion

This cause is sent if the service request cannot be actioned because of congestion (e.g. no channel, facility busy/congested etc.).

Cause value = 23 GSM authentication unacceptable

This cause is sent to the network in Iu mode if a USIM is inserted in the MS and there is no Authentication Parameter AUTN IE present in the AUTHENTICATION REQUEST or AUTHENTICATION\_AND\_CIPHERING REQUEST message.

---

## G.4 Causes related to nature of request

Cause value = 32 Service option not supported

This cause is sent when the MS requests a service/facility in the CM SERVICE REQUEST message which is not supported by the PLMN.

Cause value = 33 Requested service option not subscribed

This cause is sent when the MS requests a service option for which it has no subscription.

Cause value = 34 Service option temporarily out of order

This cause is sent when the MSC cannot service the request because of temporary outage of one or more functions required for supporting the service.

Cause value = 38 Call cannot be identified

This cause is sent when the network cannot identify the call associated with a call re-establishment request.

---

## G.5 Causes related to invalid messages

Cause value = 95 Semantically incorrect message.

See annex H, subclause H.5.10.

Cause value = 96 Invalid mandatory information.

See annex H, subclause H.6.1.

Cause value = 97 Message type non-existent or not implemented.

See annex H, subclause H.6.2.

Cause value = 98 Message not compatible with protocol state.

See annex H, subclause H.6.3.

Cause value = 99 Information element non-existent or not implemented.

See annex H, subclause H.6.4.

Cause value = 100 Conditional IE error.

See annex H, subclause H.6.5.

Cause value = 101 Message not compatible with protocol state.

See annex H, subclause H.6.6.

Cause value = 111 Protocol error, unspecified.

See annex H, subclause H.6.8.

---

## G.6 Additional cause codes for GMM

Cause value = 7 GPRS services not allowed

This cause is sent to the MS when it is not allowed to operate GPRS services.

Cause value = 8 GPRS services and non-GPRS services not allowed

This cause is sent to the MS when it is not allowed to operate either GPRS or non-GPRS services.

Cause value = 9 MS identity cannot be derived by the network

This cause is sent to the MS when the network cannot derive the MS's identity from the P-TMSI in case of inter-SGSN routing area update.

Cause value = 10 Implicitly detached

This cause is sent to the MS either if the network has implicitly detached the MS, e.g. some while after the Mobile reachable timer has expired, or if the GMM context data related to the subscription does not exist in the SGSN e.g. because of a SGSN restart.

Cause value = 14 GPRS services not allowed in this PLMN

This cause is sent to the MS which requests GPRS service in a PLMN which does not offer roaming for GPRS services to that MS.

Cause value = 16 MSC temporarily not reachable

This cause is sent to the MS if it requests a combined GPRS attach or routing area updating in a PLMN where the MSC is temporarily not reachable via the GPRS part of the network.

Cause value = 40 No PDP context activated

This cause is sent to the MS if the MS requests an establishment of the radio access bearers for all active PDP contexts by sending a SERVICE REQUEST message indicating "data" to the network, but the SGSN does not have any active PDP context(s).

---

## Annex H (informative): 3GPP specific cause values for call control

### H.1 Normal class

#### H.1.1 Cause No. 1 "unassigned (unallocated) number"

This cause indicates that the destination requested by the mobile station cannot be reached because, although the number is in a valid format, it is not currently assigned (allocated).

#### H.1.2 Cause No. 3 "no route to destination"

This cause indicates that the called user cannot be reached because the network through which the call has been routed does not serve the destination desired.

#### H.1.3 Cause No. 6 "channel unacceptable"

This cause indicates the channel most recently identified is not acceptable to the sending entity for use in this call.

#### H.1.4 Cause No. 8 "operator determined barring"

This cause indicates that the MS has tried to access a service that the MS's network operator or service provider is not prepared to allow.

#### H.1.5 Cause No.16 "normal call clearing"

This cause indicates that the call is being cleared because one of the users involved in the call has requested that the call be cleared.

Under normal situations, the source of this cause is not the network.

#### H.1.6 Cause No.17 "user busy"

This cause is used when the called user has indicated the inability to accept another call.

It is noted that the user equipment is compatible with the call.

#### H.1.7 Cause No. 18 "no user responding"

This cause is used when a user does not respond to a call establishment message with either an alerting or connect indication within the prescribed period of time allocated (defined by the expiry of either timer T303 or T310).

#### H.1.8 Cause No. 19 "user alerting, no answer"

This cause is used when a user has provided an alerting indication but has not provided a connect indication within a prescribed period of time.



### H.1.9 Cause No. 21 "call rejected"

This cause indicates that the equipment sending this cause does not wish to accept this call, although it could have accepted the call because the equipment sending this cause is neither busy nor incompatible.

### H.1.10 Cause No. 22 "number changed"

This cause is returned to a calling mobile station when the called party number indicated by the calling mobile station is no longer assigned. The new called party number may optionally be included in the diagnostic field. If a network does not support this capability, cause No. 1 "unassigned (unallocated) number" shall be used.

### H.1.11 Cause No. 25 "pre-emption"

This cause is returned to the network when a mobile station clears an active call which is being pre-empted by another call with higher precedence.

### H.1.12 Cause No. 26 "non-selected user clearing"

Not supported. Treated as cause no. 31.

### H.1.13 Cause No. 27 "destination out of order"

This cause indicates that the destination indicated by the mobile station cannot be reached because the interface to the destination is not functioning correctly. The term "not functioning correctly" indicates that a signalling message was unable to be delivered to the remote user; e.g., a physical layer or data link layer failure at the remote user, user equipment off-line, etc.

### H.1.14 Cause No. 28 "invalid number format (incomplete number)"

This cause indicates that the called user cannot be reached because the called party number is not a valid format or is not complete.

### H.1.15 Cause No. 29 "facility rejected"

This cause is returned when a facility requested by user can not be provided by the network.

### H.1.16 Cause No. 30 "response to STATUS ENQUIRY"

This cause is included in STATUS messages if the message is sent in response to a STATUS ENQUIRY message. See also subclause 5.5.3.

### H.1.17 Cause No. 31 "normal, unspecified"

This cause is used to report a normal event only when no other cause in the normal class applies.

---

## H.2 Resource unavailable class

### H.2.1 Cause No. 34 "no circuit/channel available"

This cause indicates that there is no appropriate circuit/channel presently available to handle the call.

## H.2.2 Cause No. 38 "network out of order"

This cause indicates that the network is not functioning correctly and that the condition is likely to last a relatively long period of time; e.g., immediately re-attempting the call is not likely to be successful.

## H.2.3 Cause No. 41 "temporary failure"

This cause indicates that the network is not functioning correctly and that the condition is not likely to last a long period of time; e.g., the mobile station may wish to try another call attempt almost immediately.

## H.2.4 Cause No. 42 "switching equipment congestion"

This cause indicates that the switching equipment generating this cause is experiencing a period of high traffic.

## H.2.5 Cause No. 43 "access information discarded"

This cause indicates that the network could not deliver access information to the remote user as requested; i.e., a user-to-user information, low layer compatibility, high layer compatibility, or sub-address as indicated in the diagnostic.

It is noted that the particular type of access information discarded is optionally included in the diagnostic.

## H.2.6 Cause No. 44 "requested circuit/channel not available"

This cause is returned when the circuit or channel indicated by the requesting entity cannot be provided by the other side of the interface.

## H.2.7 Cause No. 47 "resource unavailable, unspecified"

This cause is used to report a resource unavailable event only when no other cause in the resource unavailable class applies.

---

## H.3 Service or option not available class

### H.3.1 Cause No. 49 "quality of service unavailable"

This cause indicates to the mobile station that the requested quality of service, as defined in ITU-T Recommendation X.213, cannot be provided.

### H.3.2 Cause No. 50 "Requested facility not subscribed"

This cause indicates that the requested supplementary service could not be provided by the network because the user has not completed the necessary administrative arrangements with its supporting networks.

### H.3.3 Cause No. 55 "Incoming calls barred within the CUG"

This cause indicates that although the called party is a member of the CUG for the incoming CUG call, incoming calls are not allowed within this CUG.

### H.3.4 Cause No. 57 "bearer capability not authorized"

This cause indicates that the mobile station has requested a bearer capability which is implemented by the equipment which generated this cause but the mobile station is not authorized to use.

### H.3.5 Cause No. 58 "bearer capability not presently available"

This cause indicates that the mobile station has requested a bearer capability which is implemented by the equipment which generated this cause but which is not available at this time.

### H.3.6 Cause No. 63 "service or option not available, unspecified"

This cause is used to report a service or option not available event only when no other cause in the service or option not available class applies.

### H.3.7 Cause No. 68 "ACM equal to or greater than ACMmax"

This cause is used by the mobile to indicate that call clearing is due to ACM being greater than or equal to ACMmax.

---

## H.4 Service or option not implemented class

### H.4.1 Cause No. 65 "bearer service not implemented"

This cause indicates that the equipment sending this cause does not support the bearer capability requested.

### H.4.2 Cause No. 69 "Requested facility not implemented"

This cause indicates that the equipment sending this cause does not support the requested supplementary service.

### H.4.3 Cause No. 70 "only restricted digital information bearer capability is available"

This cause indicates that one equipment has requested an unrestricted bearer service, but that the equipment sending this cause only supports the restricted version of the requested bearer capability.

### H.4.4 Cause No. 79 "service or option not implemented, unspecified"

This cause is used to report a service or option not implemented event only when no other cause in the service or option not implemented class applies.

---

## H.5 Invalid message (e.g., parameter out of range) class

### H.5.1 Cause No. 81 "invalid transaction identifier value"

This cause indicates that the equipment sending this cause has received a message with a transaction identifier which is not currently in use on the MS-network interface.

## H.5.2 Cause No. 87 "user not member of CUG"

This cause indicates that the called user for the incoming CUG call is not a member of the specified CUG.

## H.5.3 Cause No. 88 "incompatible destination"

This cause indicates that the equipment sending this cause has received a request to establish a call which has low layer compatibility, high layer compatibility, or other compatibility attributes (e.g., data rate) which cannot be accommodated.

## H.5.4 Cause No. 91 "invalid transit network selection"

For further study. Treated as cause no. 95.

## H.5.5 Cause No. 95 "semantically incorrect message"

This cause is used to report receipt of a message with semantically incorrect contents (see subclause 8.8).

---

# H.6 Protocol error (e.g., unknown message) class

## H.6.1 Cause No. 96 "invalid mandatory information"

This cause indicates that the equipment sending this cause has received a message with a non-semantical mandatory IE error (see subclause 8.5).

## H.6.2 Cause No. 97 "message type non-existent or not implemented"

This cause indicates that the equipment sending this cause has received a message with a message type it does not recognize either because this is a message not defined, or defined but not implemented by the equipment sending this cause.

## H.6.3 Cause No. 98 "message type not compatible with protocol state"

This cause indicates that the equipment sending this cause has received a message not compatible with the protocol state (subclause 8.4).

## H.6.4 Cause No. 99 "information element non-existent or not implemented"

This cause indicates that the equipment sending this cause has received a message which includes information elements not recognized because the information element identifier is not defined or it is defined but not implemented by the equipment sending the cause. However, the information element is not required to be present in the message in order for the equipment sending the cause to process the message.

## H.6.5 Cause No. 100 "conditional IE error"

This cause indicates that the equipment sending this cause has received a message with conditional IE errors (see subclause 8.7.2).

## H.6.6 Cause No. 101 "message not compatible with protocol state"

This cause indicates that a message has been received which is incompatible with the protocol state or that a STATUS message has been received indicating an incompatible call state.

## H.6.7 Cause No. 102 "recovery on timer expiry"

This cause indicates that a procedure has been initiated by the expiry of a timer in association with 3GPP TS 24.008 error handling procedures.

## H.6.8 Cause No. 111 "protocol error, unspecified"

This cause is used to report a protocol error event only when no other cause in the protocol error class applies.

---

# H.7 Interworking class

## H.7.1 Cause No. 127 "interworking, unspecified"

This cause indicates that there has been interworking with a network which does not provide causes for actions it takes; thus, the precise cause for a message which is being sent cannot be ascertained.

---

# Annex I (informative): GPRS specific cause values for GPRS Session Management

## I.1 Causes related to nature of request

Cause value = 8 Operator Determined Barring

This cause code is used by the network to indicate that the requested service was rejected by the SGSN due to Operator Determined Barring.

Cause value = 24 MBMS bearer capabilities insufficient for the service

This cause code is used by the network to indicate that an MBMS context activation request was rejected by the network, because the MBMS bearer capabilities are insufficient for the MBMS service.

Cause value = 25 LLC or SNDCP failure (A/Gb mode only)

This cause code is used by the MS indicate that a PDP context is deactivated because of a LLC or SNDCP failure (e.g. if the SM receives a *SNSM-STATUS.request* message with cause "DM received " or " invalid XID response ", see 3GPP TS 44.065 [78])

Cause value = 26 Insufficient resources

This cause code is used by the MS or by the network to indicate that a PDP context activation request, secondary PDP context activation request, PDP context modification request, or MBMS context activation request cannot be accepted due to insufficient resources.

Cause value = 27 Unknown or missing access point name

This cause code is used by the network to indicate that the requested service was rejected by the external packet data network because the access point name was not included although required or if the access point name could not be resolved.

Cause value = 28 Unknown PDP address or PDP type

This cause code is used by the network to indicate that the requested service was rejected by the external packet data network because the PDP address or type could not be recognised.

Cause value = 29 User authentication failed

This cause code is used by the network to indicate that the requested service was rejected by the external packet data network due to a failed user authentication.

Cause value = 30 Activation rejected by GGSN

This cause code is used by the network to indicate that the requested service was rejected by the GGSN.

Cause value = 31 Activation rejected, unspecified

This cause code is used by the network to indicate that the requested service was rejected due to unspecified reasons.

Cause value = 32 Service option not supported

This cause code is used by the network when the MS requests a service which is not supported by the PLMN.

Cause value = 33 Requested service option not subscribed

See Annex G, clause 4.

Cause value = 34 Service option temporarily out of order

See Annex G, clause 4.

Cause value = 35 NSAPI already used

This cause code may be used by a network to indicate that the NSAPI requested by the MS in the PDP context activation request is already used by another active PDP context of this MS.

Never to be sent, but can be received from a R97/R98 network at PDP context activation

Cause value = 36 Regular deactivation

This cause code is used to indicate a regular MS or network initiated PDP context deactivation or a regular network initiated MBMS context deactivation.

Cause value = 37 QoS not accepted

This cause code is used by the MS if the new QoS cannot be accepted that were indicated by the network in the PDP Context Modification procedure.

Cause value = 38 Network failure

This cause code is used by the network to indicate that the PDP context deactivation or the MBMS context deactivation is caused by an error situation in the network.

Cause value = 39 Reactivation requested

This cause code is used by the network to request a PDP context reactivation after a GGSN restart.

Cause value = 40 Feature not supported

This cause code is used by the MS to indicate that the PDP context activation or the MBMS context activation initiated by the network is not supported by the MS.

Cause value = 41 semantic error in the TFT operation.

This cause code is used by the network to indicate that there is a semantic error in the TFT operation included in a secondary PDP context activation request or an MS-initiated PDP context modification.

Cause value = 42 syntactical error in the TFT operation.

This cause code is used by the network to indicate that there is a syntactical error in the TFT operation included in a secondary PDP context activation request or an MS-initiated PDP context modification.

Cause value = 43 unknown PDP context

This cause code is used by the network to indicate that the PDP context identified by the Linked TI IE the secondary PDP context activation request is not active.

Cause value = 44 semantic errors in packet filter(s)

This cause code is used by the network to indicate that there is one or more semantic errors in packet filter(s) of the TFT included in a secondary PDP context activation request or an MS-initiated PDP context modification.

Cause value = 45 syntactical error in packet filter(s)

This cause code is used by the network to indicate that there is one or more syntactical errors in packet filter(s) of the TFT included in a secondary PDP context activation request or an MS-initiated PDP context modification.

Cause value = 46 PDP context without TFT already activated

This cause code is used by the network to indicate that the network has already activated a PDP context without TFT.

Cause value = 47 Multicast group membership time-out

This cause code is used by the network to indicate that the MBMS context is deactivated because the timer supervising the IGMP group membership interval (see RFC 3376 [107], subclause 8.4) or the MLD multicast listener interval (see RFC 2710 [108], subclause 7.4) expired.

Cause value = 112 APN restriction value incompatible with active PDP context.

This cause code is used by the network to indicate that a requested primary PDP context or an MBMS context has an APN restriction value that is not allowed in combination with a currently active PDP context. Restriction values are defined in 3GPP TS 23.060 [74], subclause 15.4.

---

## I.2 Causes related to invalid messages

Cause value = 81 Invalid transaction identifier value.

See annex H, subclause H.5.1.

Cause value = 95 Semantically incorrect message.

See annex H, subclause H.5.5.

Cause value = 96 Invalid mandatory information.

See annex H, subclause H.6.1.

Cause value = 97 Message type non-existent or not implemented.

See annex H, subclause H.6.2.

Cause value = 98 Message not compatible with protocol state.

See annex H, subclause H.6.3.

Cause value = 99 Information element non-existent or not implemented.

See annex H, subclause H.6.4.

Cause value = 100 Conditional IE error.

See annex H, subclause H.6.5.

Cause value = 101 Message not compatible with protocol state.

See annex H, subclause H.6.6.

Cause value = 111 Protocol error, unspecified.

See annex H, subclause H.6.8.

I.3 Void



---

## Annex J (informative): Algorithm to encode frequency list information elements

See 3GPP TS 44.018 [84].

---

## Annex K (informative): Default Codings of Information Elements

The information in this annex does NOT define the value of any IEI for any particular message. This annex exists to aid the design of new messages, in particular with regard to backward compatibility with phase 1 mobile stations.

---

### K.1 Common information elements.

For the common information elements types listed below, the default coding of information element identifier bits is summarized in table K.1/3GPP TS 24.008.

**Table K.1/3GPP TS 24.008: Default information element identifier coding for common information elements**

8	7	6	5	4	3	2	1		Reference clause
1	:	:	:	-	-	-	-	Type 1 info elements	
1	1	1	1	-	-	-	-	Note 1	
0	:	:	:	:	:	:	:	Type 3 & 4 info elements	
0	0	0	1	0	0	0	1	Note 1	
0	0	0	1	0	0	1	1	Location Area Identification	10.5.1.3
0	0	0	1	0	1	1	1	Mobile Identity	10.5.1.4
0	0	0	1	1	0	0	0	Note 1	
0	0	0	1	1	1	1	1	Note 1	
0	0	1	0	0	0	0	0	Mobile Station classmark 3	10.5.1.7
Spare Half Octet									10.5.1.8
All other values are reserved									

NOTE 1: These values were allocated but never used in earlier phases of the protocol.

NOTE 2: For GPRS common information elements no default values are defined:

---

### K.2 Radio Resource management information elements.

See 3GPP TS 44.018 [84], annex K.

---

### K.3 Mobility management information elements.

For the mobility management information elements listed below, the default coding of the information element identifier bits is summarized in table K.3/3GPP TS 24.008.

**Table K.3/3GPP TS 24.008: Default information element identifier coding for mobility management information elements**

								Reference clause
8	7	6	5	4	3	2	1	
								Type 1 info elements
1	0	0	1	-	-	-	-	Note
1	1	0	0	-	-	-	-	Note
1	1	1	0	-	-	-	-	Note
								Type 2 info elements
1	0	1	0	-	-	-	-	Follow-on Proceed
				0	0	0	1	10.5.3.7
				0	0	1	0	10.5.3.10
								Type 3 & 4 info elements
0	1	0	0	0	0	0	1	Note
0	1	0	0	0	0	1	0	Note
0	1	0	0	0	1	0	0	Note
All other values are reserved								

NOTE: These values were allocated but never used in earlier versions of the protocol

---

## K.4 Call control information elements.

For the call control information elements listed below, the default coding of the information element identifiers is defined in table K.4/3GPP TS 24.008.

**Table K.4/3GPP TS 24.008: Default information element identifier coding for call control information elements**

								Reference clause	
8	7	6	5	4	3	2	1		
1	:	:	:	-	-	-	-	Type 1 info elements shift	10.5.4.2 and .3
0	0	1	-	-	-	-	-	Note	
1	0	1	-	-	-	-	-	Repeat indicator	10.5.4.22
1	0	1	0	:	:	:	:	Type 2 information elements	
				0	0	0	0	More data	10.5.4.19
				0	0	0	1	CLIR Suppression	10.5.4.11a
				0	0	1	0	CLIR Invocation	10.5.4.11b
				0	0	1	1	Reverse call setup direction	10.5.4.22a
0	:	:	:	:	:	:	:	Type 3 & 4 info elements	
	0	0	0	0	1	0	0	Bearer capability	10.5.4.5
	0	0	0	1	0	0	0	Cause	10.5.4.11
	0	0	1	0	1	0	0	Note	
	0	0	1	0	1	0	1	Call Control Capabilities	10.5.4.5a
	0	0	1	1	1	0	0	Facility	10.5.4.15
	0	0	1	1	1	1	0	Progress indicator	10.5.4.21
	0	1	0	0	1	0	0	Auxiliary states	10.5.4.4
	0	1	0	0	1	1	1	Note	
	0	1	0	1	1	0	0	Keypad facility	10.5.4.17
	0	1	1	0	1	0	0	Signal	10.5.4.23
	1	0	0	1	1	0	0	Connected number	10.5.4.13
	1	0	0	1	1	0	1	Connected subaddress	10.5.4.14
	1	0	1	1	1	0	0	Calling party BCD number	10.5.4.9
	1	0	1	1	1	0	1	Calling party subaddress	10.5.4.10
	1	0	1	1	1	1	0	Called party BCD number	10.5.4.7
	1	1	0	1	1	0	1	Called party subaddress	10.5.4.8
	1	1	1	0	1	0	0	Redirecting Party BCD	10.5.4.21b
	1	1	1	1	1	0	1	Redirecting Party subaddress	10.5.4.21c
	1	1	1	1	1	0	0	Low layer compatib.	10.5.4.18
	1	1	1	1	1	0	1	High layer compatib.	10.5.4.16
	1	1	1	1	1	1	0	User-user	10.5.4.25
	1	1	1	1	1	1	1	SS version indicator	10.5.4.24

NOTE: These values were allocated but never used in earlier phases of the protocol.

## Annex L (normative): Establishment cause (lu mode only)

### L.1 Mapping of NAS procedure to RRC establishment cause(lu mode only)

When MM requests the establishment of a RR connection, the RRC establishment cause used by the MS shall be selected according to the CS NAS procedure as specified in table L.1.1.

**Table L.1.1/3GPP TS 24.008: Mapping of CS NAS procedure to establishment cause**

<b>CS NAS procedure</b>	<b>RRC Establishment cause (according 3GPP TS 25.331)</b>
Originating CS speech call	Originating Conversational Call
Originating CS data call	Originating Conversational Call
CS Emergency call	Emergency call
Call re-establishment	Call re-establishment
Location update	Registration
IMSI Detach	Detach
MO SMS via CS domain	Originating Low Priority Signalling
Supplementary Services	Originating High Priority Signalling
Answer to circuit switched paging	Set equal to the value of the paging cause used in the reception of paging in the RRC layer
SS part of Location services	Originating High Priority Signalling

When GMM requests the establishment of a PS signalling connection, the RRC establishment cause used by the MS shall be selected according to the PS NAS procedure as specified in Table L.1.2.

Table L.1.2/3GPP TS 24.008: Mapping of PS NAS procedure to establishment cause

PS NAS procedure	RRC Establishment cause (according 3GPP TS 25.331)
GPRS Attach	Registration
Routing Area Update – for the case of "Directed Signalling Connection Re-Establishment (see chapter 4.7.2.5.)	Call Re-Establishment
Routing area Update – all cases other than "Directed Signalling Connection Re-Establishment	Registration
GPRS Detach	Detach
Request to re-establish RABs	Either "Originating Conversational Call" or "Originating Streaming Call" or "Originating Interactive Call" or "Originating Background Call " – depending on the Traffic Class in QoS of the "most demanding" RAB. (see Note 1)
Request to establish a PS signalling connection for MBMS	MBMS reception or MBMS p-t-p RB request
Activate PDP Context	Either "Originating Conversational Call" or "Originating Streaming Call" or "Originating Interactive Call" or "Originating Background Call " – depending on the Traffic Class in QoS of the "most demanding" RAB. (see Note 1) – If Traffic Class in QoS is not "Conversational Class" or "Streaming Class" or "Interactive Class" or "Background Class" but is "Subscribed Traffic Class", then "Originating Subscribed traffic Call" shall be used.
Modify PDP Context	Originating High Priority Signalling
Deactivate PDP Context	Originating High Priority Signalling
MO SMS via PS domain	Originating Low Priority Signalling
SS part of Location services	Originating High Priority Signalling
Answer to packet paging	Set equal to the value of the paging cause used in the reception of paging in the RRC layer
NOTE 1: For classification of "most demanding" Traffic Class the following ranking order applies: "Conversational" followed by "Streaming" followed by "Interactive" followed by "Background", where "Conversational" is the most demanding Traffic class in terms of being delay sensitive. In choosing the "most demanding" Traffic Class all already active PDP Context together with the PDP Context to be activated shall be considered	

NOTE: The RRC establishment cause may be used by the network to prioritise the connection establishment request from the MS at high load situations in the network.

---

## Annex M (normative): Additional Requirements for backward compatibility with PCS 1900 for NA revision 0 ME

This annex provides additional requirements to support network mechanisms for backward compatibility with PCS 1900 for NA revision 0 mobile equipments (applicable until July 1, 1998).

PCS 1900 for NA revision 0 mobile equipments are defined to understand Mobile Network Codes made of up to 2 digits. However federal regulation mandates that a 3-digit MNC shall be allocated by each administration to network operators. Therefore each network operator is identified by a 3-digit Mobile Country Code and a 3-digit Mobile Network Code. An operator whose network code complies to the allocation principle specified for PCS 1900 for NA and wants to achieve for a transition period of time the backward compatibility with PCS 1900 for NA revision 0 mobile equipments shall apply the following:

- The network shall send over the air interface the 3-digit Mobile Country Code and only the two most significant digits of the Mobile Network Code (the value of the "digit" sent instead of the 3rd digit<sup>is</sup> specified in 3GPP TS 24.008, subclause 10.5.1.3) (see note).

When a PCS 1900 for NA (revision greater than 0) mobile equipment recognizes over the air the Mobile Country Code and the two most significant digits of the Mobile Network Code as being the HPLMN codes of the current IMSI, the mobile equipment shall take into account the value of the sixth IMSI digit read from the SIM/USIM. If this value matches to a value contained in the limited set of values for the least significant MNC digit assigned by the number administration bodies for PCS 1900 for NA then the following applies for the mobile equipment:

- The value sent over the air instead of the 3rd MNC digit in the Location Area Identification (for coding see 3GPP TS 24.008, subclause 10.5.1.3) shall be interpreted as the value of the sixth IMSI digit read from the SIM/USIM.

**NOTE:** It is still a network operator option to apply this requirement after July 1, 1998. However, in this case the following shall be considered:

1. Network selection considerations for overlapping networks:

- Networks overlapping to the HPLMN, identified over the radio interface by an identical combination MCC1 MCC2 MCC3 MNC1 MNC2 (possible after July 1, 1998) may be selectable by PCS 1900 for NA mobile equipments revision 0 with the same priority as the HPLMN or presented to the user as the HPLMN.

2. Roaming considerations:

- Roamers (SIM/USIM) from networks identified by an identical combination MCC1 MCC2 MCC3 MNC1 MNC2 (possible after July 1, 1998) when roaming into the operator network with PCS 1900 for NA mobile equipments revision 0, may cause these equipments to exhibit an unpredictable behaviour (e.g. looping in the HPLMN selection and registration procedures).
- Home subscribers (SIM/USIM) roaming with PCS 1900 for NA mobile equipments revision 0 into networks identified by an identical combination MCC1 MCC2 MCC3 MNC1 MNC2 (possible after July 1, 1998), may consider being attached to the HPLMN.

---

## Annex N (normative): Ranking of reject causes for Location Registration (MM and GMM) in a shared network

This annex describes how the reject cause is determined in a shared network with multi-operator core network (MOCN) configuration, when a location registration request from a Network Sharing non-supporting UE is redirected among CN operators via the shared RAN (see 3GPP TS 23.251 [109]) and is rejected by all core networks. In the following, the term 'location registration' is used for location area updating, GPRS attach, combined GPRS attach, routing area updating, and combined routing area updating.

- i) If the location registration request was accepted, or if the location registration request was rejected with a reject cause different from #11, #12, #13, #14, and #15, the MSC or SGSN shall not include a redirection indication in the RANAP DIRECT TRANSFER message transmitting the location registration accept message or location registration reject message to the RNC. According to 3GPP TS 25.413 [19c], the RNC will then forward the location registration accept message or the location registration reject message to the MS.
- ii) If the location registration request was rejected with one of the reject causes #11, #12, #13, #14, and #15, the MSC or SGSN shall include a redirection indication in the RANAP DIRECT TRANSFER message transmitting the location registration reject message to the RNC. According to 3GPP TS 25.413 [19c], the RNC will then initiate the redirection procedure towards the next CN operator and treat the response from the core network according to (i) and (ii).
- iii) If the location registration request was rejected with one of the reject causes #11, #12, #13, #14, and #15 by all CN operators taking part in the network sharing, the RNC shall determine the reject cause with the highest rank from the received reject causes and send a location registration reject message containing this reject cause to the MS.

The ranking of the reject causes, from the lowest rank to the highest rank, is given by:

$$\#11 < \#12 < \#13 < \#14 < \#15.$$

- iv) If the location registration request was rejected with one of the reject causes #11, #12, #13, #14, and #15 by all CN operators taking part in the network sharing in a specific location area, but there is at least one additional CN operator taking part in the network sharing in another location area of the shared network defined by the same common PLMN identity, the RNC shall send a location registration reject message with the reject cause #15 to the MS.



## Annex O (informative): Change Record

Release 4 for 3GPP TS 24.008 v4.0.0 is based on 3GPP TS 24.008 version 3.5.0.

Date	TSG #	TSG Doc.	CR	Rev	Subject/Comment	Old	New
09-2000	TSG-CN-9				New release 4 for 24.008, based on V3.5.0 which was approved at the same Plenary.		
12-2000	NP-09	NP-000448	073	5	CC Enhancements for Codec Selection	3.5.0	4.0.0
12-2000	NP-09	NP-000447	245	3	Emergency Call Additions	3.5.0	4.0.0
12-2000	NP-10	NP-000667	262	1	The Group or Broadcast Call Reference from the mobile station to the network	4.0.0	4.1.0
12-2000	NP-10	NP-000669	264	1	GSM 700 addition into MS classmark & radio access capability IE	4.0.0	4.1.0
12-2000	NP-10	NP-000670	268		Clarification to the network initiated GPRS detach procedure (IMSI detach)	4.0.0	4.1.0
12-2000	NP-10	NP-000670	278		Correction of update status on Authentication Reject	4.0.0	4.1.0
12-2000	NP-10	NP-000671	283		Description Of Timer T3317 on expiry	4.0.0	4.1.0
12-2000	NP-10	NP-000671	286	2	Removal of "recently deactivated" condition for PDP contexts and some references corrections	4.0.0	4.1.0
12-2000	NP-10	NP-000672	290	2	The application of security procedures to emergency calls	4.0.0	4.1.0
12-2000	NP-10	NP-000671	295	1	Updating of Bearer Capability IE	4.0.0	4.1.0
12-2000	NP-10	NP-000673	301		3.1 kHz multimedia calls at 33.6 kbit/s data rate	4.0.0	4.1.0
12-2000	NP-10	NP-000673	303		32 kbit/s UDI/RDI multimedia	4.0.0	4.1.0
12-2000	NP-10	NP-000676	310	1	Change of reference to 26.103 for use of codec bitmap in the Supported Codec List	4.0.0	4.1.0
12-2000	NP-10	NP-000668	311		Introduction of EGPRS for DTM	4.0.0	4.1.0
12-2000	NP-10	NP-000670	312		Clarification of response handling of Service Request	4.0.0	4.1.0
12-2000	NP-10	NP-000670	313		Clarification of RAB re-establishment	4.0.0	4.1.0
12-2000	NP-10	NP-000670	314		APN used for detection of duplicated PDP context activation	4.0.0	4.1.0
12-2000	NP-10	NP-000670	315	1	Unsynchronized PDP contexts handling - MS less	4.0.0	4.1.0
12-2000	NP-10	NP-000671	317		Correction on TFT setting condition	4.0.0	4.1.0
12-2000	NP-10	NP-000672	318		Correction of the timer list	4.0.0	4.1.0
12-2000	NP-10	NP-000670	319		Correction of PDP context duplication handling	4.0.0	4.1.0
12-2000	NP-10	NP-000670	321		DRX parameter range correction	4.0.0	4.1.0
12-2000	NP-10	NP-000671	323		RR connection replaced with PS signalling connection	4.0.0	4.1.0
	Jan-01				Correction of the version and date in the Header title /Page1	4.1.0	4.1.1

Date	TSG #	TSG Doc.	CR	Rev	Subject/Comment	Old	New
03-2001	NP_11	NP-010123	266	2	Addition of type 4 IEs for P-TMSI Signature and GPRS Timer	4.1.1	4.2.0
03-2001	NP_11	NP-010127	281	4	Optional support of UMTS AKA by a GSM only R99 ME	4.1.1	4.2.0
03-2001	NP_11	NP-010116	324	1	Add new cause value on "ODB for the Packet Oriented Services"	4.1.1	4.2.0
03-2001	NP_11	NP-010123	328	1	Correction to MM timer handling	4.1.1	4.2.0
03-2001	NP_11	NP-010151	334	1	Add UMTS 1.28 Mcps TDD capability support to MS CM3	4.1.1	4.2.0
03-2001	NP_11	NP-010123	336		Clarification of the establishment confirm for the signalling connection	4.1.1	4.2.0
03-2001	NP_11	NP-010123	338		Clarification of the location update abnormal cases b) and c) on the MS side	4.1.1	4.2.0
03-2001	NP_11	NP-010205	344	4	unsynchronised PDP contexts - MS less (2)	4.1.1	4.2.0
03-2001	NP_11	NP-010128	345	1	Update of MS classmark 2 and MS Network Capability to support LCS	4.1.1	4.2.0
03-2001	NP_11	NP-010123	348		Correction of GPRS ciphering key sequence number IE1	4.1.1	4.2.0
03-2001	NP_11	NP-010123	350	1	Collisions cases of core network initiated paging and MS initiated GMM specific procedures	4.1.1	4.2.0
03-2001	NP_11	NP-010125	358		Using RAU procedure for MS RAC IE update	4.1.1	4.2.0
03-2001	NP_11	NP-010129	360	1	Connection re-establishment on forward handover without lur	4.1.1	4.2.0
03-2001	NP_11	NP-010147	363	2	Roaming restrictions for GPRS service	4.1.1	4.2.0
03-2001	NP_11	NP-010205	365	3	Correction related to Cause of no CLI	4.1.1	4.2.0
03-2001	NP_11	NP-010129	367	1	Clarification of TFT request during secondary PDP context activation.	4.1.1	4.2.0
03-2001	NP_11	NP-010146	377		Correction of DTM Multislot Capabilities in MS Classmark 3 and MS Radio Classmark	4.1.1	4.2.0
03-2001	NP_11	NP-010147	378		Alignment of MS identity IE length in ATTACH ACCEPT and RAU ACCEPT Messages	4.1.1	4.2.0
03-2001	NP_11	NP-010207	379	1	Mapping of upper layer event to establishment cause	4.1.1	4.2.0
03-2001	NP_11	NP-010207	380	1	Resume at Intersystem change from GSM to UMTS	4.1.1	4.2.0
03-2001	NP_11	NP-010207	381	1	Collision case of CN initiated paging and MS initiated MM specific procedures	4.1.1	4.2.0
03-2001	NP_11	NP-010151	382		Addition of 1.28 Mcps UTRA TDD capability support to MS Radio Access Capability	4.1.1	4.2.0
03-2001	NP_11	NP-010154	383		Add cause value #8(ODB) to the PDP context deactivation initiated by the network	4.1.0	4.2.0
03-2001	NP_11	NP-010155	384	1	Re-transmission of AUTHENTICATION REQUEST and AUTHENTICATION & CIPHERING REQUEST messages	4.1.1	4.2.0
03-2001	NP_11	NP-010205	385	1	MS behaviour for "RB Release followed by RB setup"	4.1.1	4.2.0
03-2001	NP_11	NP-010160	386		Presence of PDP address IE in Activate PDP Context Accept	4.1.1	4.2.0
03-2001	NP_11	NP-010160	387		Correction of Revision Level in MS Classmark and MS Network Capability	4.1.1	4.2.0
03-2001	NP_11	NP-010160	388		Unsync_MSmore_Rel4	4.1.1	4.2.0
03-2001	NP_11	NP-010160	389	1	Correction of incorrect references	4.1.1	4.2.0
03-2001	NP_11	NP-010210	391	1	Equiv handling of PLMN with different PLMN codes	4.1.1	4.2.0
03-2001	NP_11	NP-010208	392		Removal of CODEC type octet in supported CODECS list	4.1.1	4.2.0
06-2001					Editorials. Page 371 was missing, - which is a part of the table 10.5.146 (MS Radio Access Capability IE). Editors note in 4.5.1.3.1 is deleted, and in chapter 4.7.3.2.4 and 4.7.5.2.4 the cause value #8 was swapped back to its original place as it was in v4.1.1.	4.2.0	4.2.1
06-2001	NP_12	NP-010275	333	2	Length of User-user IE	4.2.1	4.3.0
06-2001	NP_12	NP-010355	394		Missing SM cause 40 in table 10.5.6.6	4.2.1	4.3.0
06-2001	NP_12	NP-010272	396	3	Modification to MS's MM states to enable LCS signalling on RR layer	4.2.1	4.3.0
06-2001	NP_12	NP-010352	400		Stored list of equivalent PLMNs and error/abnormal cases	4.2.1	4.3.0
06-2001	NP_12	NP-010351	403	4	CLASSMARK1, 2 and 3 corrections.	4.2.1	4.3.0
06-2001	NP_12	NP-010355	411	2	Clarification of Network Initiated GPRS Detach Procedure	4.2.1	4.3.0
06-2001	NP_12	NP-010275	416	2	Partial Roaming – restriction by location area	4.2.1	4.3.0
06-2001	NP_12	NP-010275	418	2	The priority in the CALL PROCEEDING message for eMLPP supporting network	4.2.1	4.3.0
06-2001	NP_12	NP-010271	419	1	Clean up related to V.23, X.75, X.25 and X.32	4.2.1	4.3.0
06-2001	NP_12	NP-010275	421	1	Handling of MM reject causes 2, 3 and 6 by mobile stations	4.2.1	4.3.0
06-2001	NP_12	NP-010273	422		Extended uplink TBF	4.2.1	4.3.0
06-2001	NP_12	NP-010267	423	1	Correct coding errors in the MS Radio Access Capability IE	4.2.1	4.3.0
06-2001	NP_12	NP-010343	428	1	Alignment of 24.008 authentication procedures with 33.102	4.2.1	4.3.0
06-2001	NP_12	NP-010268	426	1	Introduction of GTT (CTM) support	4.3.0	5.0.0
09-2001	NP-13	NP-010493	444	1	Old RAI handling	5.0.0	5.1.0



Date	TSG #	TSG Doc.	CR	Rev	Subject/Comment	Old	New
					RAU		
09-2002	NP-17	NP-020368	667		Usage of Service Request type 'data'	5.4.0	5.5.0
09-2002	NP-17	NP-020371	668		Introduction of PCO in more session management messages	5.4.0	5.5.0
09-2002	NP-17	NP-020372	669		Request for DNS IPv6 server address	5.4.0	5.5.0
09-2002	NP-17	NP-020371	670		Clean-up of text for the PCO-IE	5.4.0	5.5.0
09-2002	NP-17	NP-020368	673	3	Correction to service request procedure	5.4.0	5.5.0
09-2002	NP-17	NP-020371	675		Indication of successful establishment of Dedicated Signalling PDP context to the UE	5.4.0	5.5.0
09-2002	NP-17	NP-020368	678	1	Routing Area Update at network change	5.4.0	5.5.0
09-2002	NP-17	NP-020371	679	1	Coding of Authorisation Token in Traffic Flow Template	5.4.0	5.5.0
09-2002	NP-17	NP-020382	687		Precedence of different RAU	5.4.0	5.5.0
12-2002	NP-18	NP-020546	697	1	No MT calls after resumption of GPRS in Network Operation Mode I	5.5.0	5.6.0
12-2002	NP-18	NP-020570	698		Inclusion of EDGE RF Power Capability in the CM3 IE	5.5.0	5.6.0
12-2002	NP-18	NP-020670	701	3	Flow Identifier Encoding	5.5.0	5.6.0
12-2002	NP-18	NP-020548	703	1	Clarification of the codec change procedure	5.5.0	5.6.0
12-2002	NP-18	NP-020629	704		Use of 'LLC SAPI not assigned' by the network	5.5.0	5.6.0
12-2002	NP-18	NP-020545	707	1	Cell barring after Network authentication rejection from the UE	5.5.0	5.6.0
12-2002	NP-18	NP-020674	716	4	Downloading of local emergency numbers to the mobile station	5.5.0	5.6.0
12-2002	NP-18	NP-020549	721	1	Correcting errors and making improvements to references	5.5.0	5.6.0
12-2002	NP-18	NP-020547	724		Clarification on revision level	5.5.0	5.6.0
03-2003	NP-19	NP-030042	730		Correction on CC Capabilities IE length	5.6.0	5.7.0
03-2003	NP-19	NP-030055	731	1	Support of UMTS authentication by GERAN only terminals	5.6.0	5.7.0
03-2003	NP-19	NP-030141	736	2	MS RAC for UMTS only terminal	5.6.0	5.7.0
03-2003	NP-19	NP-030055	737	1	High multislot classes for type 1 mobiles	5.6.0	5.7.0
03-2003	NP-19	NP-030054	738	2	Signalling PDP Context Indication to Core Network	5.6.0	5.7.0
03-2003	NP-19	NP-030055	740	1	Missing IE1 definition in locking shift (CC) IE and non-locking shift (CC) IE	5.6.0	5.7.0
03-2003	NP-19	NP-030055	741	1	Combined RAU successful for GPRS only, missing GMM cause IE	5.6.0	5.7.0
03-2003	NP-19	NP-030055	746		Enhanced Power Control (EPC) information in classmark 3	5.6.0	5.7.0
03-2003	NP-19	NP-030062	747		Introduction of USIM in the figure 'Overview mobility management protocol'	5.6.0	5.7.0
03-2003	NP-19	NP-030057	733	1	Interruption of DL user data transmission during P-TMSI reallocation	5.7.0	6.0.0
03-2003	NP-19	NP-030058	739	2	Implementation of new frequency ranges into 24.008	5.7.0	6.0.0
06-2003	NP-20	NP-030284	750		MS RAC encoding	6.0.0	6.1.0
06-2003	NP-20	NP-030269	756	3	Bearer Capability IE	6.0.0	6.1.0
06-2003	NP-20	NP-030273	760		Alignment of parameter "signalling information" with other QoS parameters	6.0.0	6.1.0
06-2003	NP-20	NP-030273	764	1	Cleanup and correction of the PCO-IE	6.0.0	6.1.0
06-2003	NP-20	NP-030271	767	1	Indication of the MS support of "Modulation based multislot class"	6.0.0	6.1.0
06-2003	NP-20	NP-030284	768		Wrong references in SETUP and redirected number/subaddress IEs	6.0.0	6.1.0
06-2003	NP-20	NP-030270	772		Alignment on BC IE coding for FAX between TS24.008 and TS27.001	6.0.0	6.1.0
06-2003	NP-20	NP-030267	776		Unciphered transmission of Authentication and Ciphering Failure in A/Gb mode	6.0.0	6.1.0
06-2003	NP-20	NP-030282	780		Correction of the static conditions for the bearer capability IE contents	6.0.0	6.1.0
06-2003	NP-20	NP-030270	784	1	Clarification of the procedure for the change of DRX parameter	6.0.0	6.1.0
09-2003					ETSI/MCC changed chapter numbering from 10.5.4.5.1 to 10.5.4.4a.1 for Backup BC IE. Wrong since v6.0.0	6.1.0	6.2.0
09-2003	NP-21	NP-030416	787		Correction of the static conditions for the "backup" bearer capability IE contents	6.1.0	6.2.0
09-2003	NP-21	NP-030416	793		Deletion of EFRPLMNAcT	6.1.0	6.2.0
09-2003	NP-21	NP-030416	795	1	Clarification of handover – BC-IE	6.1.0	6.2.0
09-2003	NP-21	NP-030347	797	2	Support of the maximum bit rate for HSDPA	6.1.0	6.2.0
09-2003	NP-21	NP-030420	798		Source of the CS domain specific system information	6.1.0	6.2.0
09-2003	NP-21	NP-030420	799	1	Signaling connection release after GMM procedure	6.1.0	6.2.0
09-2003	NP-21	NP-030406	807	2	Clarification of BC negotiation for multimedia calls	6.1.0	6.2.0
09-2003	NP-21	NP-030405	813	1	Change of DTM core capability	6.1.0	6.2.0
09-2003	NP-21	NP-030416	815	1	CR on introduction of mobile station multislot power classes.	6.1.0	6.2.0
12-2003	NP-22	NP-030485	803	2	TFT error handling	6.2.0	6.3.0
12-2003	NP-22	NP-030485	816		ePLMN list extension	6.2.0	6.3.0
12-2003	NP-22	NP-030485	818	1	SM signalling in case tear down is requested	6.2.0	6.3.0
12-2003	NP-22	NP-030487	819		Addition of multiple TBF capability flag to MS RAC IE	6.2.0	6.3.0
12-2003	NP-22	NP-030485	820		Order of frequency bands in MS Radio Access Capability IE	6.2.0	6.3.0
12-2003	NP-22	NP-030481	822		Correction to the Multislot Power Profile Classes	6.2.0	6.3.0
12-2003	NP-22	NP-030485	823		Correction of timer handling in diagram 4.7.7a	6.2.0	6.3.0

Date	TSG #	TSG Doc.	CR	Rev	Subject/Comment	Old	New
12-2003	NP-22	NP-030485	826		Removal of codepoint for GTP ack mode	6.2.0	6.3.0
12-2003	NP-22	NP-030485	827		SSD and Signalling indication in QoS IE	6.2.0	6.3.0
03-2004	NP-23	NP-040038	831	2	Use of TMSI/IMSI in CM SERVICE REQUEST message in case of emergency call redirection and change of LAI	6.3.0	6.4.0
03-2004	NP-23	NP-040038	832		Clarification on the meaning of MS network capability indicator bits	6.3.0	6.4.0
03-2004	NP-23	NP-040025	836	1	Conditions for PFI usage	6.3.0	6.4.0
03-2004	NP-23	NP-040038	841	2	Added Session Management (SM) Cause Value for APN Type Conflict	6.3.0	6.4.0
03-2004	NP-23	NP-040038	842		Correction of the condition for the tear down of PDP contexts	6.3.0	6.4.0
03-2004	NP-23	NP-040038	844		Status of PFI value after PDP context modification	6.3.0	6.4.0
03-2004	NP-23	NP-040038	845	1	MS reaction upon RRC connection release with cause "Directed signalling connection re-establishment"	6.3.0	6.4.0
03-2004	NP-23	NP-040099	846	3	Handling of key sets	6.3.0	6.4.0
03-2004	NP-23	NP-040038	849	2	Clarification of UE behaviour at network initiated GPRS Detach	6.3.0	6.4.0
03-2004	NP-23	NP-040038	851		MS class behaviour in case of a network initiated detach with detach type "IMSI detach"	6.3.0	6.4.0
06-2004	NP-24	NP-040185	856	1	Clarification of the use of service type 'Location services'	6.4.0	6.5.0
06-2004	NP-24	NP-040186	860	1	Correction of the network initiated in-call modification	6.4.0	6.5.0
06-2004	NP-24	NP-040187	863	1	Suspension of CM layer services during GMM procedures	6.4.0	6.5.0
06-2004	NP-24	NP-040187	866	1	LCS VA capability in MS network capability IE for PS	6.4.0	6.5.0
06-2004	NP-24	NP-040203	869	1	Introduction of Flexible Layer One lu capability	6.4.0	6.5.0
06-2004	NP-24	NP-040203	871	2	Identity request for identity that is not available	6.4.0	6.5.0
06-2004	NP-24	NP-040186	879	2	Reference to 4.7.x.4	6.4.0	6.5.0
06-2004	NP-24	NP-040190	881	1	Handling of key sets at inter-system change	6.4.0	6.5.0
09-2004	NP-25	NP-040432	882	4	Follow-on proceed for the PS domain	6.5.0	6.6.0
09-2004	NP-25	NP-040375	901	3	Clarification on the registered PLMN for UEs that support network sharing in a shared network	6.5.0	6.6.0
09-2004	NP-25	NP-040376	905		Introduction of Downlink Advanced Receiver Performance (DARP) capability	6.5.0	6.6.0
09-2004	NP-25	NP-040377	889	1	Introduction of the MBMS general procedure and states	6.5.0	6.6.0
09-2004	NP-25	NP-040377	890	1	Introduction of the MBMS Context Activation procedure	6.5.0	6.6.0
09-2004	NP-25	NP-040377	891	1	Introduction of the MBMS Context Activation messages	6.5.0	6.6.0
09-2004	NP-25	NP-040377	896		Update of the Service Request procedure - MBMS	6.5.0	6.6.0
09-2004	NP-25	NP-040377	894		Introduction of the MBMS Multicast Service Deactivation procedure - Reuse of PDP context deactivation messages	6.5.0	6.6.0
09-2004	NP-25	NP-040377	895	1	Introduction of the MBMS Multicast Service Deactivation messages - Reuse of PDP context deactivation messages	6.5.0	6.6.0
09-2004	NP-25	NP-040377	898	1	Introduction of MBMS context handling	6.5.0	6.6.0
09-2004	NP-25	NP-040377	897	1	Update of Annex I for MBMS	6.5.0	6.6.0
09-2004	NP-25	NP-040378	904		Introduction of Extended RLC/MAC Control Message segmentation capability	6.5.0	6.6.0
09-2004	NP-25	NP-040378	883	1	Mapping of QoS Traffic Class to RRC Establishment Cause	6.5.0	6.6.0
09-2004	NP-25	NP-040378	852	3	Network Search for recovering from Faulty Networks	6.5.0	6.6.0
09-2004	NP-25	NP-040379	886	2	Correction to list of received N-PDU number in Rau Accept message	6.5.0	6.6.0
12-2004	NP-26	NP-040504	907		MBMS update	6.6.0	6.7.0
12-2004	NP-26	NP-040504	908	2	NSAPI at MBMS context activation	6.6.0	6.7.0
12-2004	NP-26	NP-040510	922		Addition of DTM enhancements capability	6.6.0	6.7.0
12-2004	NP-26	NP-040513	926	2	Location registration in a shared network when multiple PLMNs are broadcast	6.6.0	6.7.0
12-2004	NP-26	NP-040513	927	1	Reject cause ranking during rerouting in MOCN	6.6.0	6.7.0
12-2004	NP-26	NP-040514	910	2	Correction of terminology -GSM and UMTS	6.6.0	6.7.0
12-2004	NP-26	NP-040514	911	1	Paging for GPRS I Services in GSM	6.6.0	6.7.0
12-2004	NP-26	NP-040514	912	1	Service request conditions	6.6.0	6.7.0
12-2004	NP-26	NP-040514	913	1	Service request - Abnormal cases in the MS	6.6.0	6.7.0
12-2004	NP-26	NP-040514	914	2	No follow on proceed indication	6.6.0	6.7.0
12-2004	NP-26	NP-040514	915	3	Mobile identity - No identity	6.6.0	6.7.0
12-2004	NP-26	NP-040514	920	1	Correction of the description of causes #7 and #8 in Annex G.6	6.6.0	6.7.0

Date	TSG #	TSG Doc.	CR	Rev	Subject/Comment	Old	New
12-2004	NP-26	NP-040514	921	1	CC cause reference correction	6.6.0	6.7.0
12-2004	NP-26	NP-040514	923		Handling of zero T3312 timer value	6.6.0	6.7.0
12-2004	NP-26	NP-040514	924		Introduction of new references for DTMF	6.6.0	6.7.0
03-2005	NP-27	NP-050070	933	2	Defining TMGI and MBMS Session Id in the mobile identity field	6.7.0	6.8.0
03-2005	NP-27	NP-050070	934	1	Correct GPRS SM List and MBMS IE Descriptions	6.7.0	6.8.0
03-2005	NP-27	NP-050070	958		Mapping of "MBMS notification response" to RRC establishment cause	6.7.0	6.8.0
03-2005	NP-27	NP-050071	931	1	Synchronization of MBMS context status between UE and SGSN	6.7.0	6.8.0
03-2005	NP-27	NP-050071	954	1	MBMS Session Management clarifications	6.7.0	6.8.0
03-2005	NP-27	NP-050071	956	1	Introduction of MBMS in clause 8	6.7.0	6.8.0
03-2005	NP-27	NP-050076	952	1	Detach for PS and CS during a ongoing CS connection	6.7.0	6.8.0
03-2005	NP-27	NP-050076	951	1	GPRS attach type while in DTM	6.7.0	6.8.0
03-2005	NP-27	NP-050076	953	1	Condition for Combined RAU after a DTM connection	6.7.0	6.8.0
03-2005	NP-27	NP-050076	935	1	Missing Messages in MM and CC Summary Tables	6.7.0	6.8.0
03-2005	NP-27	NP-050076	932		Correction of the heading of subclause 4.7.3.1.6, bullet d.1	6.7.0	6.8.0
03-2005	NP-27	NP-050077	957	2	Modification of MS Behaviour under GPRS Attach with Reject Cause #14	6.7.0	6.8.0
03-2005	NP-27	NP-050083	939	3	Addition of domain specific access control	6.7.0	6.8.0
03-2005	NP-27	NP-050085	950	2	Provision of MS specific UTRAN capabilities for the PS handover from GERAN to UTRAN	6.7.0	6.8.0
06-2005	CP-28	CP-050058	987		GSM 750 corrections	6.8.0	6.9.0
06-2005	CP-28	CP-050062	977	1	Introduction of MBMS support indication to the UE	6.8.0	6.9.0
06-2005	CP-28	CP-050067	982		Correction on handling of forbidden lists	6.8.0	6.9.0
06-2005	CP-28	CP-050069	974	1	Cell Update triggered by low layers	6.8.0	6.9.0
06-2005	CP-28	CP-050069	989		Extension of DTM to high multislot classes	6.8.0	6.9.0
06-2005	CP-28	CP-050069	975		MS initiated RAU for re-negotiation of MS configuration	6.8.0	6.9.0
06-2005	CP-28	CP-050069	973	1	Handling of duplicated RAU on the network side	6.8.0	6.9.0
06-2005	CP-28	CP-050069	978	2	Clarification on locking shift procedure	6.8.0	6.9.0
06-2005	CP-28	CP-050069	984	1	Mobile identity IE length when 'No identity'	6.8.0	6.9.0
06-2005	CP-28	CP-050069	916	4	Attach type and Update type IEs	6.8.0	6.9.0
06-2005	CP-28	CP-050069	972	1	Corrections of designations and references of figures and tables	6.8.0	6.9.0
06-2005	CP-28	CP-050071	990	1	SCUDIF: Introduction of a Network-initiated Service Upgrade capability	6.8.0	6.9.0
06-2005	CP-28	CP-050071	991	1	SCUDIF: Introduction of a Network-initiated Service Upgrade indicator	6.8.0	6.9.0
06-2005	CP-28	CP-050071	983	1	SCUDIF: Introduction of a new timer for service change	6.8.0	6.9.0
06-2005	CP-28	CP-050072	937	3	SETUP Message Enhancement for Voice Video Switching	6.8.0	6.9.0
06-2005	CP-28	CP-050231	962	5	Transparent data call request in dual mode case	6.8.0	6.9.0
09-2005	CP-29	CP-050355	1011	1	Clarification in TFT for the 'parameters list'	6.9.0	6.10.0

Date	TSG #	TSG Doc.	CR	Rev	Subject/Comment	Old	New
09-2005	CP-29	CP-050356	1002	1	Mapping RRC's "MBMS p-t-p RB Request" to a NAS service type	6.9.0	6.10.0
09-2005	CP-29	CP-050356	994	1	MBMS context procedures cleanup	6.9.0	6.10.0
09-2005	CP-29	CP-050356	996		T3390 is not used for MBMS	6.9.0	6.10.0
09-2005	CP-29	CP-050361	1013	1	Support of encryption algorithms in mobile stations	6.9.0	6.10.0
09-2005	CP-29	CP-050361	1015		Correction of terminology	6.9.0	6.10.0
09-2005	CP-29	CP-050449	1005	2	Modifications for PS HO in A/Gb mode	6.9.0	6.10.0
12-2005	CP-30	CP-050535	1031	1	Description of 8-PSK capability on the uplink in MS Classmark 3	6.10.0	6.11.0
12-2005	CP-30	CP-050536	1034		Correction of wrong codepoint in the user-user information IE	6.10.0	6.11.0
12-2005	CP-30	CP-050536	1038		Emergency number length in Emergency Number List IE	6.10.0	6.11.0
12-2005	CP-30	CP-050540	1024		MBMS INACTIVE state does not exist	6.10.0	6.11.0
12-2005	CP-30	CP-050545	1040		Correction of Mobile Identity used in PAGING RESPONSE message	6.10.0	6.11.0
12-2005	CP-30	CP-050546	1018	5	Correction for Service Request of type Data	6.10.0	6.11.0
03-2006	CP-31	CP-060114	1049	4	Correction of domain specific access control	6.11.0	6.12.0
03-2006	CP-31	CP-060115	1051	-	Missing subclause in TS 24.008	6.11.0	6.12.0
03-2006	CP-31	CP-060113	1063	-	Inclusion of support for Repeated SACCH	6.11.0	6.12.0
06-2006	CP-32	CP-060262	1066		Incorrect reference to RFC 3513	6.12.0	6.13.0
06-2006	CP-32	CP-060267	1079	1	Use on cause #12 in VPLMNs	6.12.0	6.13.0
06-2006	CP-32	CP-060267	1080	2	Indication of support for Repeated ACCH	6.12.0	6.13.0
09-2006	CP-33	CP-060454	1102	2	Mitigating the risk of DoS attacks that utilises non-integrity protected NAS messages	6.13.0	6.14.0
09-2006	CP-33	CP-060455	1096	1	Enhanced NSAPI for MBMS Broadcast Mode	6.13.0	6.14.0
09-2006	CP-33	CP-060459	1088	2	Clarification on the handling of T3311 and T3302 timers during DSAC	6.13.0	6.14.0
09-2006	CP-33	CP-060459	1084	1	Procedure at UE after unbarred for both domains on DSAC in NMO I	6.13.0	6.14.0
09-2006	CP-33	CP-060459	1082	1	Postponed RAU if T3312 expires while PS domain is barred	6.13.0	6.14.0

---

## History

<b>Document history</b>		
V6.7.0	January 2005	Publication
V6.8.0	March 2005	Publication
V6.9.0	June 2005	Publication
V6.10.0	September 2005	Publication
V6.11.0	December 2005	Publication
V6.12.0	March 2006	Publication
V6.13.0	June 2006	Publication
V6.14.0	September 2006	Publication