

ETSI TS 124 206 V7.2.0 (2007-06)

Technical Specification

**Digital cellular telecommunications system (Phase 2+);
Universal Mobile Telecommunications System (UMTS);
Voice call continuity between Circuit Switched (CS) and
IP Multimedia Subsystem (IMS);
Stage 3
(3GPP TS 24.206 version 7.2.0 Release 7)**



Reference

RTS/TSGC-0124206v720

Keywords

GSM, UMTS

ETSI

650 Route des Lucioles
F-06921 Sophia Antipolis Cedex - FRANCE

Tel.: +33 4 92 94 42 00 Fax: +33 4 93 65 47 16

Siret N° 348 623 562 00017 - NAF 742 C
Association à but non lucratif enregistrée à la
Sous-Préfecture de Grasse (06) N° 7803/88

Important notice

Individual copies of the present document can be downloaded from:

<http://www.etsi.org>

The present document may be made available in more than one electronic version or in print. In any case of existing or perceived difference in contents between such versions, the reference version is the Portable Document Format (PDF). In case of dispute, the reference shall be the printing on ETSI printers of the PDF version kept on a specific network drive within ETSI Secretariat.

Users of the present document should be aware that the document may be subject to revision or change of status. Information on the current status of this and other ETSI documents is available at

<http://portal.etsi.org/tb/status/status.asp>

If you find errors in the present document, please send your comment to one of the following services:

http://portal.etsi.org/chaicor/ETSI_support.asp

Copyright Notification

No part may be reproduced except as authorized by written permission.
The copyright and the foregoing restriction extend to reproduction in all media.

© European Telecommunications Standards Institute 2007.
All rights reserved.

DECTTM, **PLUGTESTS**TM and **UMTS**TM are Trade Marks of ETSI registered for the benefit of its Members.
TIPHONTM and the **TIPHON logo** are Trade Marks currently being registered by ETSI for the benefit of its Members.
3GPPTM is a Trade Mark of ETSI registered for the benefit of its Members and of the 3GPP Organizational Partners.

Intellectual Property Rights

IPRs essential or potentially essential to the present document may have been declared to ETSI. The information pertaining to these essential IPRs, if any, is publicly available for **ETSI members and non-members**, and can be found in ETSI SR 000 314: *"Intellectual Property Rights (IPRs); Essential, or potentially Essential, IPRs notified to ETSI in respect of ETSI standards"*, which is available from the ETSI Secretariat. Latest updates are available on the ETSI Web server (<http://webapp.etsi.org/IPR/home.asp>).

Pursuant to the ETSI IPR Policy, no investigation, including IPR searches, has been carried out by ETSI. No guarantee can be given as to the existence of other IPRs not referenced in ETSI SR 000 314 (or the updates on the ETSI Web server) which are, or may be, or may become, essential to the present document.

Foreword

This Technical Specification (TS) has been produced by ETSI 3rd Generation Partnership Project (3GPP).

The present document may refer to technical specifications or reports using their 3GPP identities, UMTS identities or GSM identities. These should be interpreted as being references to the corresponding ETSI deliverables.

The cross reference between GSM, UMTS, 3GPP and ETSI identities can be found under <http://webapp.etsi.org/key/queryform.asp>.

Contents

Intellectual Property Rights	2
Foreword.....	2
Foreword.....	5
1 Scope	6
2 References	6
3 Definitions, symbols and abbreviations	7
3.1 Definitions	7
3.2 Abbreviations	7
4 Overview of voice call continuity between the Circuit-Switched (CS) domain and the IP Multimedia (IM) Core Network (CN) subsystem	8
4.1 General	8
4.2 Underlying network capabilities.....	9
4.3 URI and address assignments.....	9
5 Functional entities	10
5.1 Introduction	10
5.2 User Equipment (UE).....	10
5.3 Media Resource Function Controller (MRFC).....	10
5.4 Application Server (AS).....	10
5.5 Media Gateway Control Function (MGCF)	10
6 Roles for registration in the IM CN subsystem	10
6.1 Introduction	10
6.2 VCC UE	11
6.3 VCC application.....	11
7 Roles for call origination.....	11
7.1 Introduction	11
7.2 VCC UE	11
7.3 VMSC	12
7.4 VCC application.....	12
7.4.1 Distinction of requests sent to the VCC application	12
7.4.2 Call origination in the IM CN subsystem	12
7.4.3 Call origination in the CS domain – procedures towards the gsmSCF	13
7.4.4 Call origination in the CS domain – procedures towards IM CN subsystem.....	14
8 Roles for call termination	15
8.1 Introduction	15
8.2 VCC UE	15
8.3 GMSC	15
8.4 VCC application.....	15
8.4.1 Distinction of requests sent to the VCC application	15
8.4.2 Call termination in the IM CN subsystem	16
8.4.3 Call termination in the CS domain – procedures towards the gsmSCF	16
8.4.4 Call termination in the CS domain – procedures towards IM CN subsystem.....	17
9 Roles for domain transfer of a call from the CS domain to the IM CN subsystem.....	18
9.1 Introduction	18
9.2 VCC UE	18
9.3 VCC application.....	19
9.3.1 Distinction of requests sent to the VCC application	19
9.3.2 Domain transfer in the IM CN subsystem	19
9.4 MGCF	19
10 Roles for domain transfer of a call from the IM CN subsystem to the CS domain.....	20

10.1	Introduction	20
10.2	VCC UE	20
10.3	VMSC	21
10.4	VCC application	21
10.4.1	Distinction of requests sent to the VCC application	21
10.4.2	Domain transfer procedures towards the gsmSCF	21
10.4.3	Domain transfer in the IM CN subsystem	22
Annex A (informative): Example signalling flows of voice call continuity between the Circuit-Switched (CS) domain and the IP Multimedia (IM) Core Network (CN) subsystem		23
A.1	Scope of signalling flows	23
A.2	Introduction	23
A.2.1	General	23
A.2.2	Key required to interpret signalling flows	23
A.3	Signalling flows for registration and exchange of mobility status information	24
A.4	Signalling flows for call origination	24
A.4.1	Introduction	24
A.4.2	Signalling flows for origination from the IM CN subsystem	25
A.4.3	Signalling flows for origination from CS domain	30
A.4.4	Signalling flows for origination from CS domain, using ISUP call diversion mechanisms	38
A.4.5	Signalling flows for origination from CS domain with no anchoring	46
A.4.6	Signalling flows for origination from CS domain for a user that is not registered within the IM CN subsystem	47
A.5	Signalling flows for call termination	52
A.5.1	Introduction	52
A.5.2	Signalling flows for termination to the IM CN subsystem	52
A.5.3	Signalling flows for termination to CS domain	58
A.5.4	Signalling flows for termination directed to IM CN subsystem (coming from the CS domain) (using CAMEL)	63
A.5.5	Signalling flow for termination directed to CS domain (coming from the CS domain)	70
A.5.6	Signalling flows with call termination delivery attempt failure to the IM CN subsystem	80
A.5.7	Signalling flow for termination directed to CS domain, unsuccessful delivery, redirect to IM CN Subsystem	82
A.5.8	Signalling flows for termination from CS domain with no anchoring (using CAMEL)	95
A.6	Signalling flows for CS domain to IM CN subsystem transfer	96
A.6.1	Introduction	96
A.6.2	Signalling flows for CS domain to IM CN subsystem transfer	97
A.6.3	Signalling flows for unsuccessful CS domain to IM CN subsystem transfer	104
A.7	Signalling flows for IM CN subsystem to CS domain transfer	105
A.7.1	Introduction	105
A.7.2	Signalling flows for IM CN subsystem to CS domain transfer	106
A.7.3	Signalling flows for unsuccessful IM CN subsystem to CS domain transfer	113
A.7.4	Signalling flows with domain transfer rejection at VMSC (using CAMEL)	115
Annex B (informative): Example of filter criteria		118
B.1	Introduction	118
B.2	Example 1 – Service profile for UE originating for a VCC subscriber	118
B.3	Example 2 – Service profile for UE terminating for a VCC subscriber	119
Annex C (informative): Change history		121
History		123

Foreword

This Technical Specification has been produced by the 3rd Generation Partnership Project (3GPP).

The contents of the present document are subject to continuing work within the TSG and may change following formal TSG approval. Should the TSG modify the contents of the present document, it will be re-released by the TSG with an identifying change of release date and an increase in version number as follows:

Version x.y.z

where:

- x the first digit:
 - 1 presented to TSG for information;
 - 2 presented to TSG for approval;
 - 3 or greater indicates TSG approved document under change control.
- y the second digit is incremented for all changes of substance, i.e. technical enhancements, corrections, updates, etc.
- z the third digit is incremented when editorial only changes have been incorporated in the document.

1 Scope

Voice call continuity allows users to move between the CS domain and the IP Connectivity Access Network (e.g., WLAN interworking) with home IM CN subsystem functionality.

The present document provides the protocol details for voice call continuity between the IP Multimedia (IM) Core Network (CN) subsystem based on the Session Initiation Protocol (SIP) and the Session Description Protocol (SDP) and the protocols of the 3GPP Circuit-Switched (CS) domain (CAP, MAP, ISUP, BICC and the NAS call control protocol for the CS access).

This document makes no VCC specific enhancements to SIP, SIP events or SDP, beyond those specified in 3GPP TS 24.229 [7].

The present document is applicable to User Equipment (UEs), Application Servers (AS) and Media Gateway Control Functions (MGCF) providing voice call continuity capabilities.

2 References

The following documents contain provisions which, through reference in this text, constitute provisions of the present document.

- References are either specific (identified by date of publication, edition number, version number, etc.) or non-specific.
- For a specific reference, subsequent revisions do not apply.
- For a non-specific reference, the latest version applies. In the case of a reference to a 3GPP document (including a GSM document), a non-specific reference implicitly refers to the latest version of that document *in the same Release as the present document*.

- [1] 3GPP TS 22.101: "Service aspects; Service principles".
- [2] 3GPP TS 23.003: "Numbering, addressing and identification".
- [3] 3GPP TS 23.206: "Voice call continuity between Circuit Switched (CS) and IP Multimedia Subsystem (IMS); Stage 2".
- [4] 3GPP TS 23.228: "IP multimedia subsystem; Stage 2".
- [5] 3GPP TS 24.008: "Mobile radio interface layer 3 specification; Core Network protocols; Stage 3".
- [5A] 3GPP TS 24.084: "MultiParty (MPTY) Supplementary Service; Stage 3".
- [6] 3GPP TS 24.167: "3GPP IMS Management Object (MO); Stage 3".
- [6A] 3GPP TS 24.173: "IMS Multimedia telephony service and supplementary services; Stage 3".
- [6B] 3GPP TS 24.216: 'Communication Continuity Management Object (MO)'
- [7] 3GPP TS 24.228 Release 5: "Signalling flows for the IP multimedia call control based on Session Initiation Protocol (SIP) and Session Description Protocol (SDP); Stage 3".
- [8] 3GPP TS 24.229: "IP Multimedia Call Control Protocol based on SIP and SDP".
- [9] 3GPP TS 29.078: "Customised Applications for Mobile network Enhanced Logic (CAMEL) Phase 4; CAMEL Application Part (CAP) specification".
- [10] 3GPP TS 29.163: "Interworking between the IP Multimedia (IM) Core Network (CN) subsystem and Circuit Switched (CS) networks".
- [11] 3GPP TS 29.328: "IP Multimedia Subsystem (IMS) Sh interface; Signalling flows and message contents".

- [12] 3GPP TS 29.329: "Sh interface based on the Diameter protocol; Protocol details".
- [13] ITU-T Recommendation E.164: "The international public telecommunication numbering plan".
- [14] ITU-T Recommendations Q.761 to Q.764 (2000): "Specifications of Signalling System No.7 ISDN User Part (ISUP)".
- [15] ITU-T Recommendations Q.1902.1 to Q.1902.6 (07/2001): "Bearer Independent Call Control".
- [16] Void

3 Definitions, symbols and abbreviations

3.1 Definitions

For the purposes of the present document, the [following] terms and definitions [given in ... and the following] apply.

Retarget: A SIP request is retargeted when the original "target" indicated by the Request-URI is changed to a new "target" by changing the Request-URI.

For the purposes of the present document, the following terms and definitions given in 3GPP TS 23.228 [4] subclauses 5.4.12 apply:

Public Service Identity (PSI)

For the purposes of the present document, the following terms and definitions given in 3GPP TS 23.003 [2] apply:

CS Domain Routeing Number (CSRN)
IP Multimedia Routeing Number (IMRN)
Mobile Station Roaming Number (MSRN)
VCC Domain Transfer Number (VDN)
VCC Domain Transfer URI (VDI)

For the purposes of the present document, the following terms and definitions given in ITU-T E.164 [13] apply:

International public telecommunication number
Public telecommunications number

For the purpose of the present document, the following terms and definitions given in 3GPP TS 23.206 [3] apply:

VCC application

3.2 Abbreviations

For the purposes of the present document, the following abbreviations apply:

AS	Application Server
BICC	Bearer Independent Call Control
CAMEL	Customised Applications for Mobile network Enhanced Logic
CAP	CAMEL Application Part
CCCF	Call Continuity Control Function
CN	Core Network
CS	Circuit Switched
CSAF	CS Adaptation Function
CSCF	Call Session Control Function
CSRN	CS Domain Routeing Number
DSF	Domain Selection Function
DTF	Domain Transfer Function
EDGE	Enhanced Data rates for GSM Evolution
GERAN	GSM EDGE Radio Access Network
GMSC	Gateway MSC

GSM	Global System for Mobile communications
HLR	Home Location Register
HSS	Home Subscriber Server
IM	IP Multimedia
IP	Internet Protocol
IMRN	IP Multimedia Routing Number
ISDN	Integrated Services Digital Network
ISUP	ISDN User Part
I-WLAN	Interworking – WLAN
MAP	Mobile Application Part
MS	Mobile Station
MSC	Mobile Switching Centre
MSISDN	MS international PSTN/ISDN number
MSRN	Mobile Station Roaming Number
NAS	Non-Access Stratum
PSI	Public Service Identity
PSTN	Public Switched Telephone Network
SDP	Session Description Protocol
SIP	Session Initiation Protocol
UE	User Equipment
URI	Uniform Resource Identifier
UTRAN	Universal Terrestrial Radio Access Network
VCC	Voice Call Continuity
VDI	VCC Domain Transfer URI
VDN	VCC Domain Transfer Number
VMSC	Visited MSC
WLAN	Wireless Local Area Network

4 Overview of voice call continuity between the Circuit-Switched (CS) domain and the IP Multimedia (IM) Core Network (CN) subsystem

4.1 General

VCC allows a UE employing on the traditional CS domain accessed via either UTRAN or GERAN, and the IM CN subsystem accessed by a number of access technologies, e.g. I-WLAN, to have calls flexibly delivered over both the CS domain and the IM CN subsystem, and to pass the call from one to the other when access or other conditions alter.

Voice calls originated by VCC subscribers in both the IM CN subsystem and in the CS domain are subject to anchoring in the IM CN subsystem. Similarly voice calls terminated to VCC subscribers are anchored in the IM CN subsystem. When anchoring occurs, such calls have a path to the VCC application from either the CS domain or the IM CN subsystem, so that the VCC application can be used to provide a domain transfer. If a call from a VCC subscriber is not anchored in the IM CN subsystem, domain transfer is not supported for that call.

In order for the above to occur, the following procedures are supplied within this specification:

- procedures for call origination are specified in Clause 7.
- procedures for call termination are specified in Clause 8;
- procedures for transfer of a call from the CS domain to the IM CN subsystem are specified in Clause 9;
- procedures for transfer of a call from the IM CN subsystem to the CS domain are specified in Clause 10; and
- procedures for initialising a VCC application for a specific subscriber before the VCC UE makes or receives calls are specified in Clause 6.

In this version of this document, VCC cannot be applied to emergency calls, and are not therefore anchored.

4.2 Underlying network capabilities

VCC assumes the use of a number of underlying network capabilities:

- 1) provision by the home network operator of VCC specific AS on the IM CN subsystem, as specified in 3GPP TS 24.229 [8];
- 2) signalling within the CS domain (both within the home network and between the home network and any visited network) supported using either ISUP (as defined in ITU-T Recommendations Q.761 to Q.764 [14]) or BICC (as defined in ITU-T Recommendations Q.1902.1 to Q.1902.6 [15]);
- 3) provision of CAMEL Phase 2 or later (as specified in 3GPP TS 29.078 [9]) at the VMSC;
- 4) If CAMEL is used for terminating call procedures, provision of CAMEL Phase 2 or later (as specified in 3GPP TS 29.078 [9]) at the GMSC;
- 5) interworking between CS domain and the IM CN subsystem provided by an MGCF in accordance with 3GPP TS 29.163 [10]; and
- 6) capability of the IP-CAN to support full duplex speech component, for example as used in IMS multimedia telephony.

If CAMEL is not used for terminating call procedures, then network configuration is required to ensure that terminating calls in the CS domain can be anchored (see subclause A.5.5). In this case the HSS(HLR) is configured to provide the IMRN back to any requesting GMSC and subsequent routing to the IM CN subsystem takes place based on this IMRN. As there are no VCC-specific procedures involved, this is not described in clause 7.

VCC can be provided using the following options to provide the data associated with the IMRN to the DTF:

- 1) using a direct communication between the gsmSCF and the CAMEL service function and the DTF; or
- 2) using ISUP call diversion mechanisms. If this mechanism is used it requires a MGCF that supports call diversion. This option requires appropriate peering arrangements to allow for transparency regarding the call diversion related parameters.

4.3 URI and address assignments

In order to support VCC to a subscriber the following URI and address assignments are assumed:

- a) in this version of the document, the VCC UE will be configured with both a VDI and a VDN in order to initiate a domain transfer. 3GPP TS 24.167 [6] specifies an optional mechanism whereby these parameters can be modified;
- b) the VCC UE will be configured to be reachable in both the IM CN subsystem and the CS domain by one to many public telecommunication numbers which should be correlated between the CS domain and IM CN subsystem. This public telecommunication number can be the MSISDN used in the CS domain and (in international form) comprise part of the implicit registration set associated with that VCC UE in the IM CN subsystem, or the VCC application can be configured to provide a functional relationship between separate numbers providing each of these identities;

NOTE: One way of correlating the public telecommunication numbers of the CS domain and the IM CN subsystem is, to set them to the same values.

- c) an IMRN is assigned that can reach a VCC application that can either support the VCC capabilities for that VCC UE, or otherwise locate the VCC application supporting the VCC capabilities for that VCC UE. The IMRNs can be dynamically allocated at the time that the call is rerouted to the IM CN subsystem for VCC purposes or domain transfers from the IM CN subsystem to the CS domain are accepted. The IM CN subsystem is configured to treat the IMRN as a PSI;
- d) the MSISDN will be subject to routing to the IM CN subsystem in order for anchoring to be performed by the VCC application. A CSRN is assigned to be able to route to the VMSC (via an MGCF) such that the CSRN is not subject to the same routing back to the IM CN subsystem and the VCC application. The CSRN can be the MSRN for that call; and

- e) not all calls are suitable for domain transfer, and application of domain transfer to other calls might be against subscriber or operator preferences. 3GPP TS 22.101 [1] Clause 21 provides the requirements for this. Subclause 5.5 of the present document specifies an additional prerequisite for allowing VCC to be applied to calls.

5 Functional entities

5.1 Introduction

This clause associates the functional entities described for the IM CN subsystem and for the CS domain, with the VCC roles described in the stage 2 architecture document (see 3GPP TS 23.206 [3]).

5.2 User Equipment (UE)

To be compliant with this document, a UE shall implement the role of a VCC UE (see subclause 6.2, subclause 7.2, subclause 8.2, subclause 9.2 and subclause 10.2).

5.3 Media Resource Function Controller (MRFC)

There are no roles specific to VCC associated with the MRFC.

5.4 Application Server (AS)

The VCC application provides the following roles:

- a) Domain Transfer Function (DTF) as defined in 3GPP TS 23.206 [3] subclause 5.3.1.2.1;
- b) Domain Selection Function (DSF) as defined in 3GPP TS 23.206 [3] subclause 5.3.1.2.2;
- c) CS Adaptation Function (CSAF) as defined in 3GPP TS 23.206 [3] subclause 5.3.1.2.3;
- d) CAMEL service function as defined in 3GPP TS 23.206 [3] subclause 5.3.1.2.4.

An AS implementing the VCC application shall implement one or more of the roles DTF, DSF or CSAF. The CSAF cooperates with a CAMEL Service Function as defined in 3GPP TS 23.206 [3] subclause 5.3.1.2.4 in order to provide VCC functionality. All four roles can be co-located.

5.5 Media Gateway Control Function (MGCF)

In order to support VCC for any call, the MGCF has to provide signalling interworking and control of the media between the CS domain and the IM CN subsystem. The VCC application can only be configured to operate where appropriate interworking is provided, e.g. a voice call represented by SDP in the IM CN subsystem has an equivalent coding in the transmission media requirement and optionally the ISUP USI parameter in the CS domain.

As the procedures for call termination in the CS domain may involve an MGCF provided by another network operator, the provision of appropriate interworking can extend to peering agreements between operators.

6 Roles for registration in the IM CN subsystem

6.1 Introduction

The VCC application can be configured with any of various options for obtaining information from the IM CN subsystem specified in 3GPP TS 24.229 [8], 3GPP TS 29.328 [11] and 3GPP TS 29.329 [12], for example:

- a) receipt of REGISTER request which causes a third-party REGISTER request to be sent to the VCC application;
- b) receipt of REGISTER request which causes a third-party REGISTER request to be sent to the VCC application. The VCC application then subscribes to the reg event package for that user to obtain information; or
- c) receipt of REGISTER request which causes a third-party REGISTER request to be sent to the VCC application. The VCC application then uses the Sh interface to obtain information.

This document places no requirement on the use of all or any of these mechanisms.

6.2 VCC UE

There are no VCC specific requirements for registration of the VCC UE to the the IM CN subsystem.

NOTE 1: Depending on operator policy, registration to the IM CN subsystem can impact whether calls are delivered to the VCC UE using the IM CN subsystem or using the CS domain.

NOTE 2: The VCC UE performs registration in the IM CN subsystem independent of the UE's state in the CS domain.

6.3 VCC application

The VCC application can obtain information from any received third-party REGISTER request, or any received reg event package, or the Sh interface, that it needs to implement the domain selection policy of the network operator.

If the third-party REGISTER request does not carry a P-Access-Network-Info header provided by the UE, and the VCC application requires this knowledge in for domain selection procedures, the mechanisms by which the VCC application determines the domain are outside the scope of this version of the specification, but could be dependent on configurable parameters in the DSF.

7 Roles for call origination

7.1 Introduction

This clause specifies the procedures for call origination, both where the VCC UE is generating calls in the CS domain and where the VCC UE is generating calls using the IM CN subsystem. Procedures are specified for the VCC UE and the various functional entities within the VCC application, and for the CAMEL service function towards the gsmSCF.

Subclause A.4 gives examples of signalling flows for call origination.

7.2 VCC UE

The VCC UE shall support origination of calls suitable for VCC both via the CS domain (as specified in 3GPP TS 24.008 [5]) and the IM CN subsystem (as specified in 3GPP TS 24.229 [8]).

There are no VCC specific requirements for the origination of calls that may be subject to VCC.

NOTE 1: For INVITE requests initiated by the VCC UE in the IM CN subsystem, the following SIP response codes can indicate failure of the VCC application to process the request with its current characteristics:

- 484 (Address Incomplete);
- 488 (Not Acceptable Here) or 606 (Not Acceptable);
- 503 (Service Unavailable) or 603 (Decline).

NOTE 2: For SETUP messages initiated by the VCC UE in the CS domain, the following cause codes in a response message can indicate failure of the VCC capability to process the request with its current characteristics:

- #21 "Call rejected";
- #28 "Invalid number format (address incomplete);
- #127 "Interworking, unspecified".

7.3 VMSC

There is no VCC specific procedure at the VMSC.

NOTE: the VMSC interacts with CAMEL to proceed with the call origination.

7.4 VCC application

7.4.1 Distinction of requests sent to the VCC application

The VCC application needs to distinguish between the following initial SIP INVITE requests to provide specific functionality relating to call origination:

- SIP INVITE requests routed to the VCC application over either the ISC interface or the Ma interface using the IMRN as a PSI, and therefore distinguished by the presence of the IMRN in the Request-URI header, and which are known by interaction with the gsmSCF functionality to relate to an originating request rather than a domain transfer request or a terminating request. In the procedures below such requests are known as "SIP INVITE requests due to originating IMRN". These requests are routed firstly to the CSAF and then to the DTF; and
- SIP INVITE requests routed to the VCC application over the ISC interface as a result of processing filter criteria at the S-CSCF according to the origination procedures (see 3GPP TS 24.229 [8] subclause 5.4.3.2), are distinguished by the contents of the Request-URI. If the Request-URI contains a VDI, then it is for a domain transfer request. However, absence of a VDI in the Request-URI indicates an origination request. In the procedures below such requests are known as "SIP INVITE requests due to originating filter criteria". These requests are routed firstly to the DTF.

Subclause 8.4.1, subclause 9.3.1 and subclause 10.4.1 detail other procedures for initial INVITE requests with different recognition conditions.

Other SIP initial requests for a dialog, and requests for a SIP standalone transaction can be dealt with in any manner conformant with 3GPP TS 24.229 [8].

The VCC application (CAMEL service function) also processes requests from the gsmSCF via a protocol not defined in this version of the specification.

NOTE: The functionality associated with these requests is described, based on the actions occurring at the interface between VMSC and gsmSCF, and is depending whether it relates to an originating request, containing an ordinary called party number, or relates to a domain transfer request, which contains a VDN as the called party number.

7.4.2 Call origination in the IM CN subsystem

When the DTF receives a SIP INVITE request due to originating filter criteria, the DTF shall:

- 1) check anchoring is possible for this session;

NOTE 1: The conditions that prevent anchoring are a matter for implementation, but can include operator policy on a number of conditions, e.g. roaming of the VCC UE, the present IP-CAN used to access the IM CN subsystem.. In general, the number of calls presented for anchoring on behalf of the same user, and the media characteristics relating to these calls, will not prevent anchoring, as these issues are dealt with at domain transfer.

NOTE 2: Some checks can also form part of the initial filter criteria in the S-CSCF to determine if the SIP INVITE request is sent to the DTF in the first place, e.g. values of the P-Access-Network-Info header header could form part of the initial filter criteria.

- 2) if the session is not subject to anchoring, either:
 - a) forward the SIP INVITE request by acting as a SIP proxy as specified in subclause 5.7.4 of 3GPP TS 24.229 [8], and therefore allow the call to continue without anchoring. The DTF shall not Record-Route on such requests, and the request is not retargetted by changing the Request-URI; or
 - b) reject the SIP INVITE request. The following SIP response codes are recommended:
 - 484 (Address Incomplete), if the Request-URI supplied is not resolvable in the home network (such a Request-URI may have been resolvable in the local network which may be visited by the VCC UE at this time);
 - 488 (Not Acceptable Here) or 606 (Not Acceptable), if some aspect of operator policy precluded anchoring; or
 - 503 (Service Unavailable) or 603 (Decline) for all other conditions;and no further VCC specific procedures are performed on this session; and
- 3) if the session is subject to anchoring, operate as an application server providing 3rd party call control, and specifically as a routing B2BUA, as specified in subclause 5.7.5 of 3GPP TS 24.229 [8] for this request and all future requests and responses in the same dialog with the following additions:
 - copy the Request-URI unchanged from the incoming SIP INVITE request to the outgoing SIP INVITE request;
 - copy all other headers unchanged from the received SIP INVITE request to the outgoing SIP INVITE request; and
 - copy the body unchanged from the received INVITE request to the outgoing SIP INVITE request.

NOTE 3: Call anchoring is performed before all originating services are executed and thus the DTF is invoked as the first AS in the originating initial Filter Criteria. Example initial Filter Criteria can be found in annex B.

7.4.3 Call origination in the CS domain – procedures towards the gsmSCF

When the CAMEL service function receives an indication that the gsmSCF has received a CAMEL IDP relating to an originating call, containing a called party number that is not a VDN, the CAMEL service function shall:

- 1) check anchoring is possible for this call;

NOTE 1: The conditions that prevent anchoring are a matter for implementation, but can include operator policy on a number of conditions, e.g. roaming of the VCC UE, or a matter of lack of resources, e.g. available IMRNs or a lack of translation rules if the called party number is not in an international number format. In general, the number of calls presented for anchoring on behalf of the same user will not prevent anchoring, as these issues are dealt with at domain transfer.

- 2) if the session is not subject to anchoring, cause the gsmSCF to respond with a CAMEL CONTINUE and no further VCC specific procedures are performed on this call; and

NOTE 2: The final decision on the CAP message sent by the gsmSCF depends on the further service logic associated with the service key.

- 3) if the session is subject to anchoring, allocate an IMRN or use the CSAF to allocate an IMRN. The IMRN is such that when the VCC application receives a SIP INVITE request it can derive by inspection that the request is due to an originating IMRN. How IMRNs are allocated may vary from one VCC application to another and is not specified in this version of the specification;
- 4) if the session is subject to anchoring, cause the gsmSCF to respond with a CAMEL CONNECT message, as specified in 3GPP TS 29.078 [9], with the Destination Routing Address set to the IMRN, and optionally, the Original Called Party ID, the Redirecting Party ID; and the Redirection Information.

NOTE 3: The gsmSCF will include further parameters in the CAMEL CONNECT message as appropriate for the service key that was received in the CAMEL IDP.

NOTE 4: The final decision on the CAP message sent by the gsmSCF depends on the further service logic associated with the service key.

7.4.4 Call origination in the CS domain – procedures towards IM CN subsystem

When the CSAF receives SIP INVITE request due to originating IMRN, the CSAF and DTF in combination shall:

- 1) operate as an application server providing 3rd party call control, and specifically as an initiating B2BUA, as specified in subclause 5.7.5 of 3GPP TS 24.229 [8] for this request and all future requests and responses in the same dialog;
- 2) set the Request-URI of the outgoing initial SIP INVITE request to a tel-URI which represents the original called party number of the call as initiated in the CS domain. The tel-URI may be available from information associated with the received IMRN or from the History-Info header;
- 3) set the To header field of the outgoing initial SIP INVITE request to a tel-URI which represents the original called party number of the call as initiated in the CS domain. The tel-URI may be available from information associated with the received IMRN or from the History-Info header;
- 4) if the CSAF has received a History-Info header having an index parameter indicating only one diversion, not include the History-Info header;

NOTE 1: The History-Info header was received as a result of the option of using ISUP call diversion mechanisms to transfer VCC specific information and carries no information relating to a real diversion.

- 5) append the orig parameter to the S-CSCF URI included in the Route header of the outgoing initial SIP INVITE request; and
- 6) set the P-Asserted-Identity header of the outgoing SIP INVITE request and to a tel-URI which represents the calling party number of the call initiated in the CS domain. This is either available from information associated against the received IMRN or is the value as received in P-Asserted-Identity header of the incoming SIP INVITE request.

NOTE 2: It can happen that the P-Asserted-Identity header is not included in the incoming SIP INVITE request.

The CSAF and DTF in combination should in the outgoing SIP requests and SIP responses include the same values as received in the incoming SIP requests and SIP responses in all other headers with the exception given in this subclause and in subclause 5.7.5 of 3GPP TS 24.229 [8].

The DTF will handle the Privacy header in the outgoing SIP INVITE request in the following way. The DTF shall either:

- if a Privacy header is received in the incoming INVITE request, include the Privacy header as received in the incoming INVITE request; or
- if a value is associated to IMRN and indicates that the presentation of the calling party number is restricted in the CS domain, include a Privacy header with the value set to "id".

Editor's note: Other actions are required to be specified, since the VCC AS works as an initiating B2BUA.

Editor's note: The value of the P-Asserted-Identity header needs to be specified.

On completion of the above procedure, the call is anchored in the DTF.

NOTE 3: After completion of anchoring the call in DTF, the allocated IMRN is available for reuse.

8 Roles for call termination

8.1 Introduction

This clause specifies the procedures for call termination, both where the VCC UE is receiving calls in the CS domain and where the VCC UE is receiving calls using the IM CN subsystem. Procedures are specified for the VCC UE and the various functional entities within the VCC application, and if the CAMEL service function is used, for the CAMEL service function towards the gsmSCF.

Subclause A.5 gives examples of signalling flows for call termination.

8.2 VCC UE

The VCC UE shall support termination of calls suitable for VCC both via the CS domain (as specified in 3GPP TS 24.008 [5]) and the IM CN subsystem (as specified in 3GPP TS 24.229 [8]).

There are no VCC specific requirements for the termination of calls that may be subject to VCC.

8.3 GMSC

There is no VCC specific procedure at the GMSC.

NOTE: Call diversion from CS domain to IM CN subsystem is required to proceed call termination. Several techniques are available at the GMSC to implement the call diversion as described in 3GPP TS 23.206 [8] Annex A. Those techniques are implementation options.

8.4 VCC application

8.4.1 Distinction of requests sent to the VCC application

The VCC application needs to distinguish between the following initial SIP INVITE requests to provide specific functionality relating to call termination:

- SIP INVITE requests routed to the VCC application over the ISC interface as a result of processing filter criteria at the S-CSCF according to the termination procedures (see 3GPP TS 24.229 [8] subclause 5.4.3.3), and therefore distinguished by the URI relating to this particular filter criteria appearing in the topmost entry in the Route header. In the procedures below such requests are known as "SIP INVITE requests due to terminating filter criteria". These requests are routed to the DTF and then to the DSF; and
- SIP INVITE requests routed to the VCC application over the Ma or ISC interface using the IMRN as a PSI, and therefore distinguished by the presence of the IMRN in the Request-URI header, which is different from the VDN. In the procedures below such requests are known as "SIP INVITE requests due to terminating IMRN". These requests are routed firstly to the CSAF and then to the DTF and then to the DSF.

Subclause 7.4.1, subclause 9.3.1 and subclause 10.4.1 detail other procedures for initial INVITE requests with different recognition conditions.

Other SIP initial requests for a dialog, and requests for a SIP standalone transaction can be dealt with in any manner conformant with 3GPP TS 24.229 [8].

The CAMEL service function also processes requests from the gsmSCF via a protocol not defined in this version of the specification.

NOTE: The functionality associated with these requests is described, based on the actions occurring at the interface between GMSC and gsmSCF.

8.4.2 Call termination in the IM CN subsystem

When the VCC application receives a SIP INVITE request due to terminating filter criteria:

- 1) the DTF shall check anchoring is possible for this session;

NOTE 1: The conditions that prevent anchoring are a matter for implementation, but can include operator policy on a number of conditions, e.g. roaming of the VCC UE, or a matter of lack of resources, e.g. available CSRN. In general, the number of calls presented for anchoring on behalf of the same user will not prevent anchoring, as these issues are dealt with at handover. If anchoring fails, the call is presented to the user without anchoring.

NOTE 2: Such a check can also form part of the initial filter criteria in the S-CSCF to determine if the SIP INVITE request is sent to the DTF in the first place.

- 2) if the session is not subject to anchoring, the DTF shall forward the SIP INVITE request by acting as a SIP proxy as specified in subclause 5.7.4 of 3GPP TS 24.229 [8]. The DTF shall not Record-Route on such requests and no further VCC specific procedures are performed on this session;

- 3) if the session is subject to anchoring, the DTF shall operate as an application server providing 3rd party call control, and specifically as a routing B2BUA, as specified in subclause 5.7.5 of 3GPP TS 24.229 [8] for this request and all future requests and responses in the same dialog;

- 4) the DSF shall perform domain selection based on:

- operator preferences;
- callee capabilities of the terminating UE, as obtained during registration;
- access network information, as provided in the P-Access-Network-Info header of the terminating UE;
- call states; and
- whether the session has characteristics other than audio media;

NOTE 3: The media characteristics can be derived from SDP information as well as from further capability indications of the terminating UE, such as e.g. callee preferences.

- 5) if the IM CN subsystem is selected by the DSF, the DSF or the combination of the DTF and DSF shall leave the Request-URI unchanged between the incoming SIP INVITE request and the outgoing SIP INVITE request; and
- 6) if the CS domain is selected by the DSF, the DSF shall determine a CSRN optionally using the CSAF and set the headers of the outgoing SIP INVITE request as follows:
 - a) set the Request-URI of the outgoing SIP INVITE request to the CSRN; and
 - b) set the To header field of the outgoing SIP INVITE request to the CSRN;

NOTE 4: The SIP AS that implements the DSF or the combination of the DTF and DSF acting as a B2BUA - which performs the third-party call control - needs to be the last located application server to ensure that all application servers that need to remain in the path of a call after domain transfer will do so. Example initial Filter Criteria can be found in Annex B.

On completion of the above procedure, the call is anchored in the DTF.

In the case where call delivery attempt fails in the selected domain and where the operator policy requires it, the DSF in the VCC application may re-attempt the call setup to the other domain. If this call delivery also fails no further call attempts shall be made.

8.4.3 Call termination in the CS domain – procedures towards the gsmSCF

When the CAMEL service function receives an indication that the gsmSCF has received a CAMEL IDP relating to a terminating call, the CAMEL service function and DTF in combination shall:

- 1) check anchoring is possible for this call;

NOTE 1: The conditions that prevent anchoring are a matter for implementation, but can include operator policy on a number of conditions, e.g. roaming of the VCC UE, or a matter of lack of resources, e.g. available IMRNs. In general, the number of calls presented for anchoring on behalf of the same user will not prevent anchoring, as these issues are dealt with at handover. If anchoring fails, the call is presented to the user without anchoring.

- 2) if the call is not subject to anchoring, cause the gsmSCF to respond with a CAMEL CONTINUE and no further VCC specific procedures are performed on this call; and

NOTE 2: The final decision on the CAP message sent by the gsmSCF depends on the further service logic associated with the service key.

- 3) if the call is subject to anchoring, allocate an IMRN or use CSAF to allocate an IMRN. How IMRNs are allocated may vary from one VCC application to another and is not specified in this version of the specification;

NOTE 3: For call termination, different options on IMRN derivation are available as described in 3GPP TS 23.206 [8] Annex A.

- 4) if the call is subject to anchoring, cause the gsmSCF to respond with a CAMEL CONNECT message with the Destination Routing Address set to the IMRN.

NOTE 4: The gsmSCF will include further parameters in the CAMEL CONNECT message as appropriate for the service key that was received in the CAMEL IDP.

NOTE 5: The final decision on the CAP message sent by the gsmSCF depends on the further service logic associated with the service key.

8.4.4 Call termination in the CS domain – procedures towards IM CN subsystem

When the CSAF receives SIP INVITE request due to terminating IMRN, the CSAF and DTF in combination shall:

NOTE 1: All SIP INVITE requests directed to the VCC application using an IMRN are assumed to be suitable for VCC anchoring, because any checks have been performed in conjunction with the CAMEL procedures.

- 1) operate as an application server providing 3rd party call control, and specifically as a routing B2BUA, as specified in subclause 5.7.5 of 3GPP TS 24.229 [8] for this request and all future requests and responses in the same dialog;

NOTE 2: The SIP AS that implements the DTF acting as a B2BUA - which performs the 3rd party call control - needs to be the last located application server to ensure that all application servers that need to remain in the path of a call after domain transfer will do so. Example initial Filter Criteria can be found in annex B.

- 2) set the Request-URI of the outgoing initial SIP INVITE request to a tel-URI which represents the called party number of the original call as terminated in the CS domain. The tel-URI may be available from the received IMRN or from the "History-Info" header; and
- 3) set the To header field of the outgoing initial SIP INVITE request to a tel-URI which represents the called party number of the original call as terminated in the CS domain. The tel-URI may be available from the received IMRN or from the "History-Info" header.

NOTE 3: If call diversion parameters from the "History-Info" header are used to retrieve the original called party number and the VCC call was subject to call diversion before it was routed to the GMSC, the DTF will restore the original call diversion information. If multiple call diversion has occurred, the redirecting number can be lost.

9 Roles for domain transfer of a call from the CS domain to the IM CN subsystem

9.1 Introduction

This clause specifies the procedures for domain transfer of a call from the CS domain to the IM CN subsystem. Procedures are specified for the VCC UE and the various functional entities within the VCC application.

Subclause A.6 gives examples of signalling flows for domain transfer of a call from the CS domain to the IM CN subsystem.

9.2 VCC UE

If the VCC UE is not engaged in an ongoing MPTY service (as specified in 3GPP TS 24.084 [5A]) that it is in control of and, by evaluating the operator policy (as specified in 3GPP TS 24.216 [6B]) and the radio conditions, determines that an ongoing call in the CS domain needs to be supported over the IM CN subsystem instead, then the VCC UE shall initiate the release of all the ongoing calls in the CS domain that are currently not active. The VCC UE can receive the operator policy via OMA Device Management. When the VCC UE receives the operator policy, it shall take this information in account when selecting the domain (either CS domain or IM CN subsystem) to initiate calls/session and when deciding to perform domain transfer.

If the UE is engaged in more than one ongoing calls/sessions and the domain transfer is restricted in this case by the specific VCC operator policy, such restriction does not apply in the case the VCC UE is losing coverage in the transferring-out domain.

NOTE 1: The UE can continue the domain transfer even if the release of the held calls failed to complete (e.g., due to radio conditions).

By an ongoing call, it is meant a call for which the CC CONNECT message has been sent or received. Afterwards the VCC UE shall send a SIP INVITE request in accordance with 3GPP TS 24.229 [8] subclause 5.1. The VCC UE shall populate the SIP INVITE request as follows:

- 1) the Request-URI set to the VDI;
- 2) the To header field set to the VDI;
- 3) the P-Preferred-Identity header field set to a public telecommunication number in accordance with subclause 4.3; and

Editors Note: It is for FFS how the UE determines which Public User ID's to register and then subsequently use to ensure that requirement in 3) is met.

- 4) the SDP payload set for a single media line with media type "audio", indicating all supported codecs for this media type, in accordance with subclause 6.1.1 and subclause 6.1.2 of 3GPP TS 24.229 [8].

If the VCC UE receives any SIP 4xx – 6xx response to the SIP INVITE request, then domain transfer has not occurred and the call will continue in the CS domain.

NOTE 2: If the VCC UE receives a SIP 480 (Temporarily Unavailable) response to the SIP INVITE request, then this can indicate that the VCC application was unable to correlate the request to a single anchored call in the CS domain.

NOTE 3: If the VCC UE receives a SIP 488 (Not Acceptable Here) response or a 606 (Not Acceptable) response to the SIP INVITE request, then this can indicate that the remote terminal was not able to support the media characteristics of the SIP INVITE request, e.g. because the remote user is in the CS domain and the MGCF/MGW in the path does not support the specified interworking.

When the VCC UE receives a CC DISCONNECT message from the network, the VCC UE shall comply with network initiated call release procedures as specified in 3GPP TS 24.008 [5].

9.3 VCC application

9.3.1 Distinction of requests sent to the VCC application

The VCC application needs to distinguish between the following initial SIP INVITE requests to provide specific functionality relating to domain transfer:

- SIP INVITE requests routed to the VCC application over the ISC interface as a result of processing filter criteria at the S-CSCF according to the origination procedures (see 3GPP TS 24.229 [8] subclause 5.4.3.2), and therefore distinguished by the URI relating to this particular filter criteria appearing in the topmost entry in the Route header, but which contains a VDI belonging to the subscribed user as the Request-URI. In the procedures below such requests are known as "SIP INVITE requests due to VDI". These requests are routed to the DTF.

Subclause 7.4.1, subclause 8.4.1 and subclause 10.4.1 detail other procedures for initial INVITE requests with different recognition conditions.

Other SIP initial requests for a dialog, and requests for a SIP standalone transaction can be dealt with in any manner conformant with 3GPP TS 24.229 [8].

9.3.2 Domain transfer in the IM CN subsystem

When the DTF receives a SIP INVITE request due to VDI, the DTF shall associate the SIP INVITE request with an ongoing SIP dialog. By an ongoing SIP dialog, it is meant a dialog for which a SIP 2xx response to the initial SIP INVITE request has been sent or received. Multiple dialogs relating to the same VCC UE can be anchored, in which case the identification of the associated dialog is subject to the following conditions:

- if only one SIP dialog exists for the user identified in the P-Asserted-Identity header field and a 2xx response has been sent and there is active audio media, then continue the domain transfer procedures;
- if no SIP dialogs exist for the user identified in the P-Asserted-Identity header field where there is active audio media and a SIP 2xx response has been sent, then send a SIP 480 (Temporarily Unavailable) response to reject the SIP INVITE request relating to the domain transfer;
- if more than one SIP dialog exists for the user identified in the P-Asserted-Identity header field and exactly one dialog exists where there is active audio media and a SIP 2xx response has been sent for that dialog, then:
 - if the remaining dialogs have inactive audio media, then the DTF may release the inactive dialogs and continue the domain transfer procedures or the DTF may send a SIP 480 (Temporarily Unavailable) response to reject the SIP INVITE request relating to the domain transfer.

Continuing the domain transfer procedures, the DTF sends a SIP reINVITE request towards the remote user using the existing established dialog. The DTF shall populate the SIP reINVITE request as follows:

- set the Request-URI to the URI contained in the Contact header field returned at the creation of the dialog with the remote user; and
- a new SDP offer, including the media characteristics as received in the SIP INVITE request due to VDI, by following the rules of the 3GPP TS 24.229 [8].

Upon receiving the SIP ACK request from the IM CN Subsystem, the DTF shall initiate release of the old access leg by sending a SIP BYE request toward the MGCF.

9.4 MGCF

There are no VCC specific procedures at the MGCF beyond those specified by 3GPP TS 29.163 [10].

- NOTE: When the SIP BYE request is received, the MGCF translates the SIP BYE request to an ISUP REL message as specified in 3GPP TS 29.163 [10] and forwards this to the VMSC. The VMSC responds with ISUP RLC message and performs network initiated call release as specified in 3GPP TS 24.008 [5].

10 Roles for domain transfer of a call from the IM CN subsystem to the CS domain

10.1 Introduction

This clause specifies the procedures for domain transfer of a call from the IM CN subsystem to the CS domain. Procedures are specified for the VCC UE and the various functional entities within the VCC application, and if the CAMEL service function is used, for the CAMEL service function towards the gsmSCF.

Subclause A.7 gives examples of signalling flows for domain transfer of a call from the IM CN subsystem to the CS domain.

10.2 VCC UE

If the VCC UE is not engaged in an ongoing SIP conferencing service (as specified in 3GPP TS 24.173 [6A]) that it is in control of and, by evaluating the operator policy (as specified in 3GPP TS 24.216 [6B]) and the radio conditions, determines that an ongoing SIP dialog in the IM CN subsystem should be transferred to the CS domain, then the VCC UE shall initiate the release of all the ongoing SIP dialogs in the IM CN subsystem. By an ongoing SIP dialog, it is meant a dialog for which a SIP 2xx response to the initial INVITE request has been sent or received. The VCC UE can receive the operator policy via OMA Device Management. When the VCC UE receives the operator policy, it shall take this information in account when selecting the domain (either CS domain or IM CN subsystem) to initiate calls/session and when deciding to perform domain transfer.

If the UE is engaged in more than one ongoing calls/sessions and the domain transfer is restricted in this case by the specific VCC operator policy, such restriction does not apply in the case the VCC UE is losing coverage in the transferring-out domain.

NOTE 1: The UE can continue the domain transfer even if the release of the held calls failed to complete (e.g., due to radio conditions).

Afterwards the VCC UE shall send a CC SETUP message in accordance with 3GPP TS 24.008 [5]. The VCC UE shall only send this request if the ongoing SIP dialog in the IM CN subsystem has had the dialog accepted, i.e. a SIP 200 (OK) response to the SIP INVITE request has already been sent.

NOTE 2: If the VCC UE has multiple calls in the IM CN subsystem at this time, then these calls could all be anchored. It is the responsibility of the VCC UE to ensure that the domain transfer request can be resolved by the DTF to a single call.

NOTE 3: The current media characteristics of the call in the IM CN subsystem does not preclude domain transfer, as the media characteristics are renegotiated as part of the domain transfer.

The VCC UE shall populate the CC SETUP message as follows:

- 1) the called party BCD number information element set to the VDN; and
- 2) [need to ensure suitable bearer characteristics]

NOTE 4: If the VCC UE receives a release message containing a #20 "Subscriber absent" cause value to the CC SETUP message, then this can indicate that the VCC application was unable to correlate the request to a single anchored call in the IM CN subsystem.

NOTE 5: If the VCC UE receives a release message containing a #127 "Interworking, unspecified" cause value to the CC SETUP message, then this can indicate that the remote terminal was not able to support the media characteristics of the CC SETUP message.

NOTE 6: If the VCC UE receives a release message containing a #63 "Service or option not available" cause value to the CC SETUP message, then this can indicate that the domain transfer was not successful.

10.3 VMSC

There is no VCC specific procedure at the VMSC.

10.4 VCC application

10.4.1 Distinction of requests sent to the VCC application

The VCC application needs to distinguish between the following initial SIP INVITE requests to provide specific functionality relating to domain transfer:

- SIP INVITE requests routed to the VCC application over either the ISC interface or the Ma interface using the IMRN as a PSI, and therefore distinguished by the presence of the IMRN in the Request-URI header, and which are known by interaction with the gsmSCF functionality to relate to a domain transfer request rather than an originating request or terminating request. In the procedures below such requests are known as "SIP INVITE requests due to domain transfer IMRN". These requests are routed to the DTF.

Subclause 7.4.1, subclause 8.4.1 and subclause 9.3.1 detail other procedures for initial INVITE requests with different recognition conditions.

Other SIP initial requests for a dialog, and requests for a SIP standalone transaction can be dealt with in any manner conformant with 3GPP TS 24.229 [8].

The VCC application (CAMEL service function) also processes requests from the gsmSCF via a protocol not defined in this version of the specification.

- NOTE: The functionality associated with these requests is described, based on the actions occurring at the interface between VMSC and gsmSCF, and is depending whether it relates to an originating request, containing an ordinary called party number, or relates to a domain transfer request, which contains a VDN as the called party number.

10.4.2 Domain transfer procedures towards the gsmSCF

When the CAMEL service function receives an indication that the gsmSCF has received a CAMEL IDP relating to an originating call, containing a called party number that is a VDN, the CAMEL service function shall:

- 1) check whether domain transfer is possible;

NOTE 1: The conditions that prevent handover are a matter for implementation, but in general for this check are a matter of lack of resources, e.g. available IMRNs. For other checks the request will be continued so further checks can be performed at the VCC application within the IM CN subsystem.

- 2) if the call is not subject to domain transfer, cause the gsmSCF to respond with a CAMEL RELEASE CALL and no further VCC specific procedures are performed on this call. The following cause codes are recommended:
 - #63 "Service or option not available" if there are insufficient resources, e.g. available IMRNs, to continue the handover;

NOTE 2: The final decision on the CAP message sent by the gsmSCF depends on the further service logic associated with the service key.

- 3) if the call is subject to domain transfer, allocate an IMRN or use CSAF to allocate IMRN. The IMRN is such that when the VCC application receives a SIP INVITE request it can derive by inspection that the request is due to a domain transfer IMRN. How IMRNs are allocated may vary from one VCC application to another and is not specified in this version of the specification;
- 4) if the call is subject to domain transfer, cause the gsmSCF to respond with a CAMEL CONNECT message with the Destination Routing Address set to the IMRN.

NOTE 3: The IMRN assigned for a domain transfer request can be different from the one assigned for CS origination (different target PSI i.e. different subfunction of the VCC application) and can be used as an indication of a domain transfer request.

NOTE 4: The gsmSCF will include further parameters in the CAMEL CONNECT message as appropriate for the service key that was received in the CAMEL IDP.

NOTE 5: The final decision on the CAP message sent by the gsmSCF depends on the further service logic associated with the service key.

10.4.3 Domain transfer in the IM CN subsystem

When the CSAF receives SIP INVITE request due to domain transfer IMRN, the CSAF and DTF in combination shall associate the SIP INVITE request with an ongoing SIP dialog based on information associated with the received IMRN or based on information from the SIP History Info header field and P-Asserted header field and send a SIP reINVITE request towards the remote user using the existing established dialog. By an ongoing SIP dialog, it is meant a dialog for which a SIP 2xx response to the initial SIP INVITE request has been sent or received. Multiple dialogs relating to the same VCC UE can be anchored, in which case the identification of the associated dialog is subject to the following conditions:

- if only one SIP dialog exists for the user identified in the P-Asserted-Identity header field and a SIP 2xx response has been sent and there is active audio media, then continue the domain transfer;
- if no SIP dialogs exist for the user identified in the P-Asserted-Identity header field where there is active audio media and a SIP 2xx response has been sent, then send a SIP 480 (Temporarily Unavailable) response to reject the SIP INVITE request relating to the domain transfer;
- if more than one SIP dialog exists for the user identified in the P-Asserted-Identity header field and exactly one dialog exists where there is active audio media and a SIP 2xx response has been sent for that dialog, then:
 - if the remaining dialogs have inactive audio media, then the DTF may release the inactive dialogs and continue the domain transfer procedures or the DTF may send a SIP 480 (Temporarily Unavailable) response to reject the SIP INVITE request relating to the domain transfer.

Continuing the domain transfer procedures, the DTF shall populate the SIP reINVITE request as follows:

- set the Request-URI to the URI contained in the Contact header field returned at the creation of the dialog with the remote user; and
- a new SDP offer, including the media characteristics as received in the SIP INVITE request due to domain transfer IMRN, by following the rules of the 3GPP TS 24.229 [8].

NOTE: The History-Info header field was received as a result of the option of using ISUP call diversion mechanisms to transfer VCC specific information and carries no information relating to a real diversion.

NOTE 1: On completion of the above procedure, the allocated IMRN is available for reuse.

Upon receiving the SIP ACK request from the IM CN subsystem, the DTF shall initiate release of the old access leg by sending a SIP BYE request toward the S-CSCF for sending to the served VCC UE.

Annex A (informative): Example signalling flows of voice call continuity between the Circuit-Switched (CS) domain and the IP Multimedia (IM) Core Network (CN) subsystem

A.1 Scope of signalling flows

This annex gives examples of signalling flows for voice call continuity between the Circuit-Switched (CS) domain and the IP Multimedia (IM) Core Network (CN) subsystem based on the Session Initiation Protocol (SIP) and SIP Events.

These signalling flows provide detailed signalling flows, which expand on the overview information flows provided in 3GPP TS 23.206 [3].

A.2 Introduction

A.2.1 General

The signalling flows provided in this annex follow the methodology developed in 3GPP TS 24.228 [7]. The following additional considerations apply:

- a) 3GPP TS 24.228 [7] shows separate signalling flows with no configuration hiding between networks, and with configuration hiding between networks. There is no voice call continuity specific functionality associated with this hiding, and therefore such separate signalling flows are not shown in the present document;
- b) 3GPP TS 24.228 [7] does not show the functionality between the S-CSCF and the AS. As voice call continuity depends on the functionality provided by various AS, the signalling flows between S-CSCF and AS are shown in the present document;
- c) 3GPP TS 24.228 [7] breaks down the functionality of the various CSCFs. Such intervening activity in the CSCFs is in general not relevant to showing the functionality within voice call continuity, and therefore the CSCFs are collapsed into a single entity labelled "Intermediate IM CN subsystem entities";
- d) where entities are combined as in c) above, and the signalling flow is directed to such a combined entity, the contents of the signalling flow represent the contents of the sending entity;
- e) where entities are combined as in c) above and the signalling flow originates at such a combined entity, the contents of the signalling flow represent the contents of the receiving entity; and
- f) within the CS domain, both ISUP and BICC can be used. The signalling flows represent only the ISUP signalling flows, and the BICC signalling flows (which can be assumed to be similar with no additional VCC specific content) are not shown.

A.2.2 Key required to interpret signalling flows

The key to interpret signalling flows specified in 3GPP TS 24.228 [7] subclauses 4.1 and 4.2 applies with the additions specified below:

- tel:+1-241-555-3333 represents the IMRN associated with a call made by UE#1.
- sip:dtf1.home1.net represents the address within the originating IM CN subsystem of the AS providing the DTF.
- sip:dtf2.home2.net represent the address within the terminating IM CN subsystem of the AS providing the DTF.
- tel:+1-241-555-4444 represents the CSRN associated with a call made by UE#1.

- tel:+1-212-555-5555 represents the VDN associated with UE#1.
- sip:domain.xfer@dtf1.home1.net represents the VDI associated with UE#1.
- sip:csaf1.home1.net represents the address of the AS providing the CSAF and therefore the address stored against the PSI.

Each signalling flow table contains descriptions for headers where the content of the header is new to that signalling flow, as is already performed in 3GPP TS 24.228 [7].

However, 3GPP TS 24.228 [7] includes extensive descriptions for the contents of various headers following each of the tables representing the contents of the signalling flows. Where the operation of the header is identical to that shown in 3GPP TS 24.228 [7], then such text is not reproduced in the present document.

Additional text may also be found on the contents of headers within 3GPP TS 24.228 [7] in addition to the material shown in the present document.

In order to differentiate between messages for SIP and media, the notation in figure A.2-1 is used.

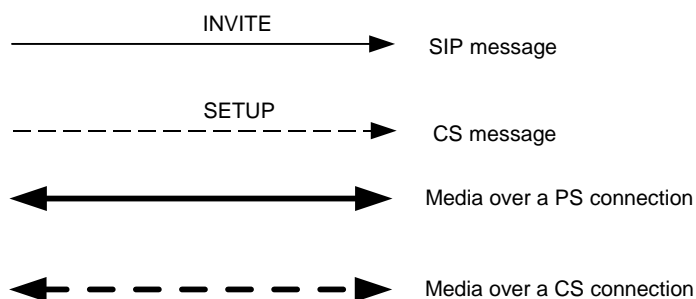

Figure A.2-1: Signalling flow notation

A.3 Signalling flows for registration and exchange of mobility status information

There are no VCC specific signalling flows.

A.4 Signalling flows for call origination

A.4.1 Introduction

The signalling flows for call origination demonstrate how a VCC UE, on originating a call, is anchored for the purposes of a future domain transfer. The following signalling flows are included:

- subclause A.4.2 shows the successful anchoring for a call originated using the IM CN subsystem;
- subclause A.4.3 shows the successful anchoring for a call originated using the CS domain, by routing the call to the IM CN subsystem using CAMEL;
- subclause A.4.4 shows the successful anchoring for a call originated using the CS domain, by routing the call to the IM CN subsystem using CAMEL and routing the call from the VCC application to the terminating subscriber using information received in the SIP History-Info header;
- subclause A.4.5 shows a call originated from the CS domain for which the anchoring is denied; the call is continued in the CS domain; and

- subclause A.4.6 shows the origination of a call in the CS domain that is capable of being subject to VCC when the user is not currently registered within the IMS CN subsystem.

A.4.2 Signalling flows for origination from the IM CN subsystem

Editors note: When stage 2 specification has become clearer regarding how supplementary services shall be provided it may be needed to add an additional AS to test that the services are executed in the same manner indepent from where the session is initiated.

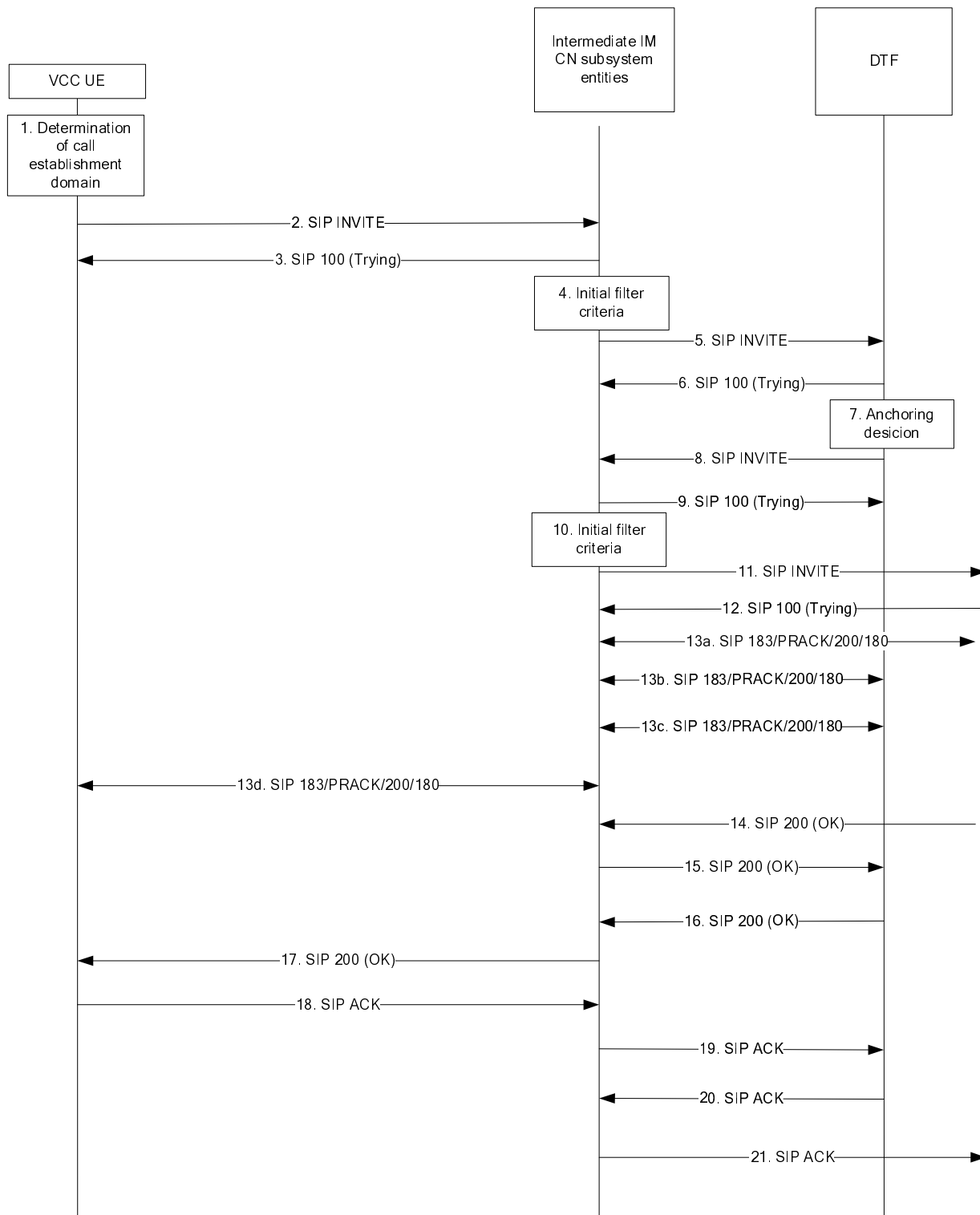

Figure A.4.2-1: Signalling flow for origination from the IM CN subsystem

1. Determination of call establishment domain

As a result of some stimulus to establish a call with full duplex, voice-only call, the VCC UE based on a combination of user policy, and access technology availability, decides to establish the call using the IM CN subsystem.

The VCC UE initiates the IM CN subsystem call towards the destination UE by sending a SIP INVITE request to the intermediate IM CN subsystem entities.

2. SIP INVITE request (VCC UE to intermediate IM CN subsystem entities) - see example in table A.4.2-2

Table A.4.2-2: SIP INVITE request (VCC UE to intermediate IM CN subsystem entities)

```

INVITE tel:+1-212-555-2222 SIP/2.0
Via: SIP/2.0/UDP [5555::aaa:bbb:ccc:ddd]:1357;comp=sigcomp;branch=z9hG4bKnashds7
Max-Forwards: 70
Route: sip:pcscf1.home1.net:7531;lr;comp=sigcomp>, <sip:orig@scscf1.home1.net;lr>
P-Preferred-Identity: <tel: +1-212-555-1111>
P-Access-Network-Info:IEEE-WLAN-802.11b
Privacy: none
From: <tel: +1-212-555-1111>; tag=171828
To: <tel:+1-212-555-2222>
Call-ID: cb03a0s09a2sdfgkjkj490333
Cseq: 127 INVITE
Supported: 100rel; precondition
Require: sec-agree
Proxy-Require: sec-agree
Security-Verify: ipsec-3gpp; q=0.1; alg= hmac-sha-1-96; spi=87654321; port1=7531
Contact: < sip:[5555::aaa:bbb:ccc:ddd]:1357;comp=sigcomp >
Allow: INVITE, ACK, CANCEL, BYE, PRACK, UPDATE
Content-Type: application/sdp
Content-Length: (...)

v=0
o=- 2987933615 2987933615 IN IP6 5555::aaa:bbb:ccc:ddd
s=-
c=IN IP6 5555::aaa:bbb:ccc:ddd
t=0 0
m=audio 3456 RTP/AVP 97 96
b=AS:25.4
a=curr:qos local sendrecv
a=curr:qos remote none
a=des:qos mandatory local sendrecv
a=des:qos none remote sendrecv
a=rtpmap:97 AMR
a=fmtp:97 mode-set=0,2,5,7; mode-change-period=2
a=rtpmap:96 telephone-event
a=maxptime:20

```

Request-URI: the tel-URI of the destination

3. SIP 100 (Trying) response (intermediate IM CN subsystem entities to VCC UE)

The intermediate IM CN subsystem entities respond to the VCC UE with a SIP 100 (Trying) response.

There is no VCC specific content to this response.

4. Evaluation of initial filter criteria

In this example, and by evaluation of the initial filter criteria, as this is an originating SIP INVITE request for a registered VCC user the S-CSCF routes the SIP INVITE request to the DTF.

5. SIP INVITE request (intermediate IM CN subsystem entities to DTF) - see example in table A.4.2-5

The intermediate IM CN subsystem entities send the SIP INVITE request to the DTF.

As part of this operation, the S-CSCF adds the address of the DTF and the original dialog identifier. The S-CSCF will include the original dialog identifier as a part of the second topmost Route header. The Request-URI includes the tel-URI of the destination.

Table A.4.2-5: SIP INVITE request (intermediate IM CN subsystem entities to VCC application)

```

INVITE tel:+1-212-555-2222 SIP/2.0
Via: SIP/2.0/UDP scscf1.home1.net;branch=z9hG4bK332b23.1, SIP/2.0/UDP
    pcscf1.home1.net;branch=z9hG4bK240f34.1, SIP/2.0/UDP
    [5555::aaa:bbb:ccc:ddd]:1357;comp=sigcomp;branch=z9hG4bKnashds7
Max-Forwards: 67
Route: <sip:dtf1.home1.net;lr>,<sip:cb03a0s09a2sdfg1kj490333@scscf1.home1.net;lr>
Record-Route: <sip:scscf1.home1.net>
P-Asserted-Identity: <tel: +1-212-555-1111>
P-Access-Network-Info:
Privacy: none
P-Charging-Vector: icid-value="AyretyU0dm+602IrT5tAFrbHLso=023551024";orig-
ioi=type3ashome1.net>
P-Charging-Function-Addresses: ccf=[5555::b99:c88:d77:e66]; ccf=[5555::a55:b44:c33:d22];
ecf=[5555::1ff:2ee:3dd:4ee]; ecf=[5555::6aa:7bb:8cc:9dd]
From:
To:
Call-ID:
Cseq: 127
Supported:
Contact:
Allow:
Content-Type:
Content-Length: (...)

v=0
o=
s=
c=
t=
m=
b=
a=
a=
a=
a=
a=
a=
a=
a=
a=
a=

```

6. SIP 100 (Trying) response (DTF to intermediate IM CN subsystem entities)

The DTF responds to the intermediate IM CN subsystem entities with a SIP 100 (Trying) response.

There is no VCC specific content to this response.

7. Anchoring decision

The DTF performs the anchoring.

8. SIP INVITE request (DTF to intermediate IM CN subsystem entities) - see example in table A.4.2-8

Since the service execution continues as an originating case the DTF, after executing the anchoring, sends the SIP INVITE request with a Route header that includes the original call identifier in the Route header to the intermediate IM CN subsystem entities.

The DTF works in this case as a routeing B2BUA. In particular, the To and From header fields remain unchanged. It will not include any entry in the Record-Route header. The AS does not change any codecs.

The DTF modifies the message in accordance with routeing B2BUA functionality, e.g. mapping of From, To, Cseq and Call-ID headers from one side of the B2BUA to the other.

Table A.4.2-8: SIP INVITE request (DTF to intermediate IM CN subsystem entities)

```

INVITE tel:+1-212-555-2222 SIP/2.0
Via: SIP/2.0/UDP dtf1.home1.net; branch=z9hG4bK332b23.3;
Max-Forwards: 66
Route: <sip:cb03a0s09a2sdfglkj490333@scscf1.home1.net;lr >
P-Asserted-Identity:
P-Access-Network-Info:
Privacy: none
P-Charging-Vector: icid-value="AyretyU0dm+602IrT5tAFrbHLso=023551024"
P-Charging-Function-Addresses:
From:
To:
Call-ID:
Cseq: 127
Supported:
Contact:<sip:[7777::eee:ddd:ccc:aaa]>
Allow:
Content-Type:
Content-Length: (...)

v=0
o=
s=
c=
t=
m=
b=
a=
a=
a=
a=
a=
a=
a=
a=
a=
a=

```

Request-URI: includes the tel-URI of the destination.

Contact: address of the DTF.

9. SIP 100 (Trying) response (intermediate IM CN subsystem entities to DTF)

The intermediate IM CN subsystem entities respond to the DTF with a SIP 100 (Trying) response.

There is no VCC specific content to this response.

10. Evaluation of initial filter criteria

In this example, the S-CSCF continues the triggering from the next trigger point (originating request registered user) in the initial filter criteria. Since no more triggering is required in the initial filter criteria, the IM CN subsystem will do a ENUM look up and get the SIP-URI for the destination user.

11. SIP INVITE request (intermediate IM CN subsystem entities to terminating side processing) - see example in table A.4.2-11

The intermediate IM CN subsystem sends a SIP INVITE request towards the terminating side.

Table A.4.2-11: SIP INVITE request (intermediate IM CN subsystem entities to terminating side processing)

```

INVITE sip:user2_public1@home2.net SIP/2.0
Via: SIP/2.0/UDP scscf1.home1.net;branch=z9hG4bK332b23.1, SIP/2.0/UDP dtf1.home1.net;
    branch=z9jG4bK332b23.2
Max-Forwards: 65
Record-Route:sip.scscf1.home1.net
P-Asserted-Identity:
Privacy: none
P-Charging-Vector: icid-value="AyretyU0dm+602IrT5tAFrbHLso=023551024",orig-ioi=home1.net
From
To:
Call-ID
Cseq:
Supported:
Contact:
Allow:
Content-Type:
Content-Length: (...)

v=0
o=
s=
c=
t=
m=
b=
a=
a=
a=
a=
a=
a=
a=
a=
a=

```

12. SIP 100 (Trying) response (terminating side processing to intermediate IM CN subsystem entities)

The terminating side processing responds to the to the intermediate IM CN subsystem entities with a SIP 100 (Trying) response.

There is no VCC specific content to this response.

13a-d. SIP 183 (Session Progress) response / SIP PRACK request / SIP 200 (OK) response / SIP 180 (Ringing) response

The SIP endpoints complete SDP offer/answer procedures, including any reservation of bearer resource on the IP-CAN, and any exchange of alerting indication, in accordance with standard basic call procedures. VCC imposes no restriction on this operation.

14. SIP 200 (OK) response (terminating side processing to intermediate IM CN subsystem entities)

The terminating side processing forwards a SIP 200 (OK) response to the intermediate IM CN subsystem entities.

There is no VCC specific content to this response.

15. SIP 200 (OK) response (intermediate IM CN subsystem entities to DTF)

The intermediate IM CN subsystem entities forwards the SIP 200 (OK) response to the DTF.

There is no VCC specific content to this response.

16. SIP 200 (OK) response (DTF to intermediate IM CN subsystem entities)

The DTF forwards the SIP 200 (OK) response to the intermediate IM CN subsystem entities, using the content of the Via header in the received SIP INVITE request (step 5).

The DTF modifies the message in accordance with routing B2BUA functionality, e.g. mapping of From, To, Cseq and Call-ID headers from one side of the B2BUA to the other.

There is no VCC specific content to this response.

17. SIP 200 (OK) response (intermediate IM CN subsystem entities to VCC UE)

The intermediate IM CN subsystem entities forward the SIP 200 (OK) response to the VCC UE.

There is no VCC specific content to this response.

18. SIP ACK request (VCC UE to intermediate IM CN subsystem entities)

The VCC UE completes the dialog creation with a SIP ACK request sent to the intermediate IM CN subsystem entities.

There is no VCC specific content to this request.

19. SIP ACK request-(intermediate IM CN subsystem entities to DTF)

The intermediate IM CN subsystem entities forward the SIP ACK request to the DTF.

There is no VCC specific content to this request.

20. SIP ACK request (DTF to intermediate IM CN subsystem entities)

The DTF forwards the SIP ACK request to the intermediate IM CN subsystem entities.

The DTF modifies the message in accordance with routing B2BUA functionality, e.g. mapping of From, To, Cseq and Call-ID headers from one side of the B2BUA to the other.

There is no VCC specific content to this request.

21. SIP ACK request (intermediate IM CN subsystem entities to terminating side processing)

The intermediate IM CN subsystem entities forward the SIP ACK request to the terminating side processing.

There is no VCC specific content to this request.

A.4.3 Signalling flows for origination from CS domain

Figure A.4.3-1 shows the origination of a call in the CS domain that is capable of being subject to VCC.

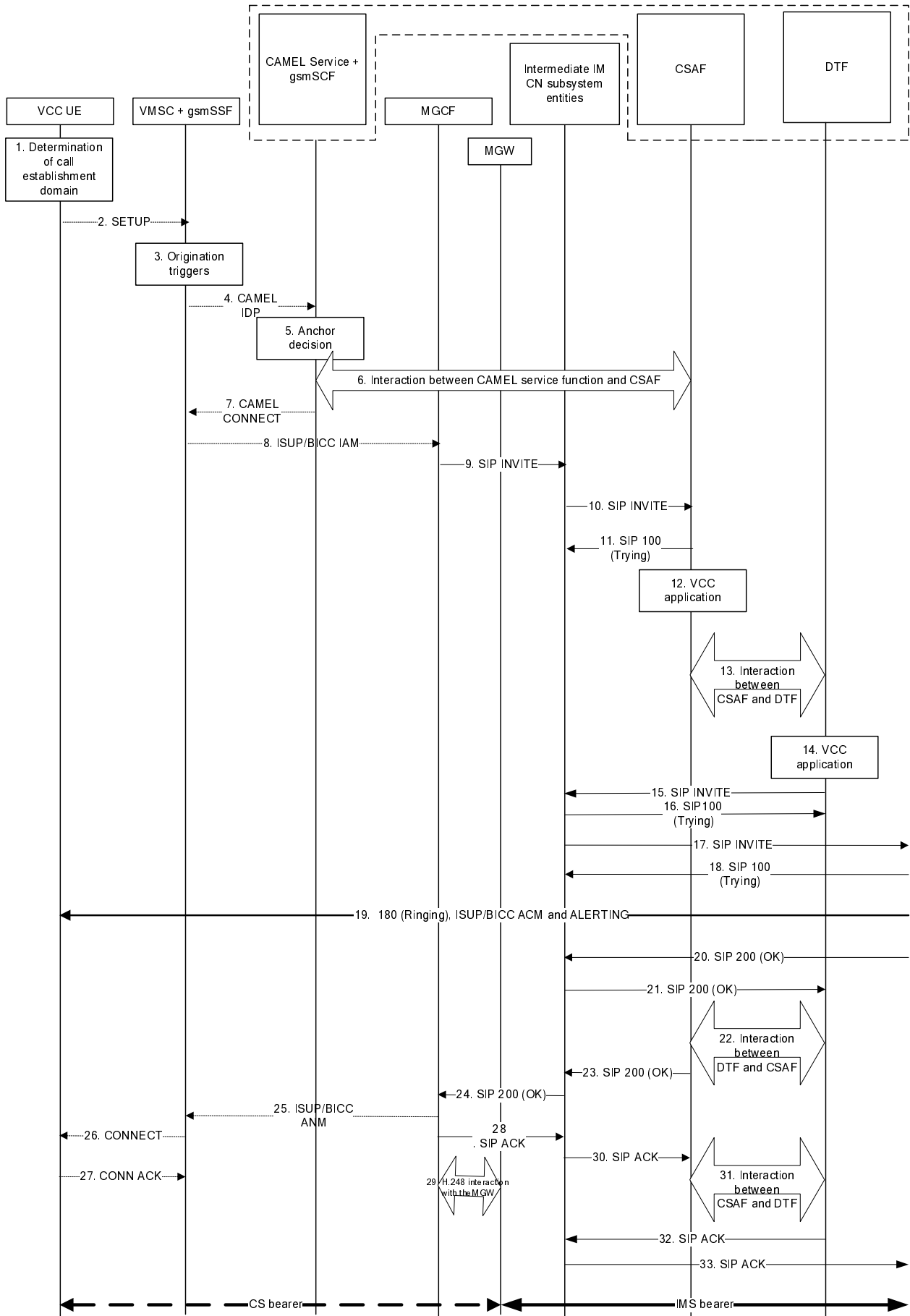

Figure A.4.3-1: CS call origination from the VCC user

The details of the signalling flows are as follows:

1 Determination of call establishment domain

As a result of some stimulus to establish a full-duplex, voice-only call, the VCC UE based on a combination of user policy, and access technology availability, decides to establish the call using the CS domain.

2. SETUP message (VCC UE to VMSC)

After establishment of the MM connection, the VCC UE initiates the CS call towards the destination UE by sending out the SETUP message.

Specifically for this signalling flow, the SETUP message includes:

- Called Party Number information element = [(Numbering plan identifier = ISDN/telephony numbering plan), (type of number = international number), (Number digits = 12125552222)]
- Bearer Capability information element = [(information transfer capability = speech), (speech versions = FR AMR, GSM EFR, GSM FR)]
- Supported Codec List information element = {[(SysID 1 = UMTS), (Codec Bitmap for SysID 1 = UMTS AMR 2)], [(SysID 2 = GSM), (Codec Bitmap for SysID 2 = FR AMR, GSM EFR, GSM FR)]}

The Called Party Number information element identifies the intended recipient of the call, and the Bearer Capability information element and the Supported Codec List information element identify an intended call that can be subject to VCC.

The VMSC knows the calling party number corresponding to the UE.

3. Origination triggers

4. CAMEL IDP (VMSC to gsmSCF)

The VMSC triggers a CAMEL activity which results in sending a CAMEL IDP message to the gsmSCF. The CAMEL IDP message contains at least:

- the calling party number;
- the called party number; and
- that the call is voice only.

5. Anchor decision

The gsmSCF invokes the service logic to determine whether the call needs to be rerouted to IMS for VCC. The CAMEL service function allocates an IMRN and returns it to the gsmSCF.

6. CAMEL service function to CSAF interaction

Communication is required between the CAMEL service function and the CSAF in order to ensure that the nature of the call associated with the IMRN is known by the CSAF. The signalling to support this communication is not specified in this version of the specification.

7. CAMEL CONNECT (gsmSCF to VMSC)

The gsmSCF responds to the CAMEL IDP message with a CAMEL CONNECT message containing:

- the Destination Routeing Address set to the IMRN.

8. ISUP IAM (VMSC to MGCF)

The VMSC initiates the CS call towards the MGCF by sending out the IAM message.

Specifically for this signalling flow, the IAM includes:

- Called Party Number parameter = [(Numbering plan identifier = ISDN/telephony numbering plan), (type of number = international number), (Number digits = 12415553333)]

- Calling Party Number parameter = [(Numbering plan identifier = ISDN/telephony numbering plan), (type of number = international number), (Number digits = 12125551111)]
- USI parameter = 3.1 kHz audio

The Called Party Number parameter represents the IMRN allocated for this call.

9. SIP INVITE request (MGCF to intermediate IM CN subsystem entities) – see example in table A.4.3-9

The MGCF initiates a SIP INVITE request, containing an initial SDP to the intermediate IM CN subsystem entities.

Table A.4.3-9: SIP INVITE request (MGCF to intermediate IM CN subsystem entities)

```
INVITE tel:+1-241-555-3333 SIP/2.0
Via: SIP/2.0/UDP mgcfl.home1.net;branch=z9hG4bK779s24.0
Max-Forwards: 70
Route: <sip:icscf1_s.home1.net;lr>
P-Asserted-Identity: <tel:+1-212-555-1111>
P-Charging-Vector: icid-value="AyretyU0dm+602IrT5tAFrbHLso=023551024"; orig-ioi=home1.net
Privacy: none
From: <tel:+1-212-555-1111>;tag=171828
To: <tel:+1-212-555-3333>
Call-ID: cb03a0s09a2sdfglkj490333
Cseq: 127 INVITE
Supported: 100rel, precondition
Contact: <sip:mgcfl.home1.net>
Allow: INVITE, ACK, CANCEL, BYE, PRACK, UPDATE
Content-Type: application/sdp
Content-Length: (...)

v=0
o=- 2987933615 2987933615 IN IP6 5555::aaa:bbb:ccc:ddd
s=-
c=IN IP6 5555::aaa:bbb:ccc:ddd
t=0 0
m=audio 3456 RTP/AVP 97 96
b=AS:25.4
a=curr:qos local sendrecv
a=curr:qos remote none
a=des:qos mandatory local sendrecv
a=des:qos none remote sendrecv
a=rtpmap:97 AMR
a=fmtp:97 mode-set=0,2,5,7; mode-change-period=2
a=rtpmap:96 telephone-event
a=maxptime:20
```

Request-URI: Contains the IMRN, as obtained from CS Networks signalling.

P-Asserted-Identity: The MGCF inserts the tel-URL containing the subscriber number, as received from the CS network.

SDP The SDP contains a preconfigured set of codecs supported by the MGW based on what is received in the ISUP. The codecs selected are speech codecs, for which VCC can be applied. See table 10a of 3GPP TS 29.163 [10]

10. SIP INVITE request (intermediate IM CN subsystem entities to CSAF) – see example in table A.4.3-10

The IMRN is a PSI. The intermediate IM CN subsystem entities are configured to route this PSI to the CSAF. In this particular case, the I-CSCF performs the routing over the Ma interface. For this example, there is no IBCF before the I-CSCF and no intermediate entities Record-Route the request.

Table A.4.3-10: SIP INVITE request (intermediate IM CN subsystem entities to CSAF)

```

INVITE tel:+1-241-555-3333 SIP/2.0
Via: SIP/2.0/UDP mgcf1.homel.net;branch=z9hG4bK779s24.0, SIP/2.0/UDP
    icscf1_s.homel.net;branch=z9hG4bK312a32.1
Max-Forwards: 69
Route: <sip:csaf1.homel.net;lr>
P-Asserted-Identity:
P-Charging-Vector: icid-value="AyretyU0dm+602IrT5tAFrbHLso=023551024"; orig-ioi=type
    3homel.net; orig-ioi=homel.net
Privacy:
From:
To:
Call-ID:
Cseq:
Supported:
Contact:
Allow:
Content-Type:
Content-Length: (...)

v=
o=
s=
c=
t=
m=
b=
a=
a=
a=
a=
a=
a=
a=
a=
a=
a=

```

11. SIP 100 (Trying) response (CSAF to intermediate IM CN subsystem entities)

There is no VCC specific content to this response.

The CSAF responds to the intermediate IM CN subsystem entities with a SIP 100 (Trying) response.

12. Session anchoring

The CSAF and DTF in combination act as an initiating B2BUA. The CSAF retrieves the original called party number and calling party number associated with the IMRN and places the called party number in the Request-URI and the To header of the outgoing request.

The CSAF and DTF in combination decide that this call will be anchored, based on the type of call and operator preferences.

Editor's note: The following text needs further study.

The DTF found by the IMRN need not be the most appropriate AS to support the handover of the call on behalf of the UE in the IM CN subsystem. In these cases it is possible that the VCC application redirects the call to another applications server which provides the future transfer functions on behalf of the VCC user. How this occurs is outside the scope of this document.

13. Interaction between CSAF and DTF

Information is exchanged between the CSAF and the DTF. The nature of this signalling is outside the scope of this version of the specification. In this example, the subsequent flows assume that a visit has been made to the S-CSCF, in association with the the triggering of initial filter criteria, in order to reach the DTF.

14. VCC application

The CSAF and DTF in combination act as an initiating B2BUA. The DTF anchors the call to provide VCC functionality.

15. SIP INVITE request (DTF to intermediate IM CN subsystem entities) – see example in table A.4.3-15

The DTF forwards the SIP INVITE request to the S-CSCF serving the originating user within the IM CN subsystem. In this case it is assumed that the user is registered within the IM CN subsystem.

The DTF sets the value of the Contact header with the address of the DTF that will provide the transfer functionality needed to support VCC.

The DTF modifies the message in accordance with routing B2BUA functionality, e.g. mapping of From, To, Cseq and Call-ID headers from one side of the B2BUA to the other.

Table A.4.3-15: SIP INVITE request (DTF to intermediate IM CN subsystem entities)

```

INVITE tel:+1-212-555-2222 SIP/2.0
Via: SIP/2.0/UDP dtf1.home1.net;branch=z9hG4bK312a32.1
Max-Forwards: 66
Route: <sip:s-cscf.home1.net;lr;orig>
P-Asserted-Identity:
P-Charging-Vector: icid-value="AyretyU0dm+602IrT5tAFrbHLso=023551024"; orig-ioi=Type
3home1.net
Privacy:
From:
To: <tel:+1-212-555-2222>
Call-ID: dc14b1t10b3teghmlk501444
Cseq:
Supported:
Contact: <sip:dtf1.home1.net>
Allow:
Content-Type:
Content-Length: (...)

v=
o=
s=
c=
t=
m=
b=
a=
a=
a=
a=
a=
a=
a=
a=
a=
a=

```

Contact header: The Contact header represents the contact of the DTF.

16. SIP 100 (Trying) response (intermediate IM CN subsystem entities to DTF)

The intermediate IM CN subsystem entities respond to the DTF with a SIP 100 (Trying) response.

There is no VCC specific content to this response.

17. SIP INVITE request (intermediate IM CN subsystem entities to terminating side processing) – see example in table A.4.3-17

The intermediate IM CN subsystem entities route the SIP INVITE request to the terminating side processing. In this example, there is no intermediate IBCF and none of the intermediate entities Record-Route.

Table A.4.3-17: SIP INVITE request (intermediate IM CN subsystem entities to terminating side processing)

```

INVITE tel:+1-212-555-2222 SIP/2.0
Via: SIP/2.0/UDP scscf1.home1.net;branch=z9hG4bK332b23.1, SIP/2.0/UDP
    dtf1.home1.net;branch=z9hG4bK312a32.1
Max-Forwards: 65
P-Asserted-Identity:
P-Charging-Vector: icid-value="AyretyU0dm+602IrT5tAFrbHLso=023551024"; orig-ioi=home1.net
Privacy:
From:
To:
Call-ID:
Cseq:
Supported:
Contact:
Allow:
Content-Type:
Content-Length: (...)

v=
o=
s=
c=
t=
m=
b=
a=
a=
a=
a=
a=
a=
a=
a=
a=
a=

```

18. SIP 100 (Trying) response (terminating side processing to intermediate IM CN subsystem entities)

The terminating side processing responds to the intermediate IM CN subsystem entities with a SIP 100 (Trying) response.

There is no VCC specific content to this response.

19. SIP 180 (Ringing) response, ISUP ACM and ALERTING message (terminating side processing to VCC UE)

The call is successfully delivered to the terminating UE, which begins alerting the user. Normal SIP, ISUP and access signalling messages are transferred to indicate this is occurring. At or before this time, completion of negotiation of the bearer (e.g. as indicated by SDP in SIP) occurs. There is no VCC specific actions associated with this step.

The DTF and CSAF modify the message in accordance with initiating B2BUA functionality, e.g. mapping of From, To, Cseq and Call-ID headers from one side of the B2BUA to the other.

20. SIP 200 (OK) response (terminating side processing to intermediate IM CN subsystem entities)

A SIP 200 (OK) response is received from the terminating side processing by the intermediate IM CN subsystem entities.

There is no VCC specific content to this response.

21. SIP 200 (OK) response (intermediate IM CN subsystem entities to DTF)

The intermediate IM CN subsystem entities forward the SIP 200 (OK) response to the DTF.

There is no VCC specific content to this response.

22. Interaction between DTF and CSAF

Information is exchanged between the CSAF and the DTF. The nature of this signalling is outside the scope of this version of the specification.

The DTF and CSAF modify the message in accordance with initiating B2BUA functionality, e.g. mapping of From, To, Cseq and Call-ID headers from one side of the B2BUA to the other.

23. SIP 200 (OK) response (CSAF to intermediate IM CN subsystem entities)

The CSAF forwards the SIP (200) OK response back to the intermediate IM CN subsystem entities.

There is no VCC specific content to this response.

24. SIP 200 (OK) response (intermediate IM CN subsystem entities to MGCF)

The intermediate IM CN subsystem entities forward the SIP 200 (OK) response to the MGCF.

There is no VCC specific content to this response.

25. ISUP ANM (MGCF to VMSC)

On receipt of the SIP 200 (OK) response, the MGCF generates an ISUP ANM message and sends this to the VMSC.

There is no VCC specific content to this response.

26. CONNECT message (VMSC to VCC UE)

The VMSC sends a CONNECT message to the VCC UE.

There is no VCC specific content to this response.

27. CONNECT ACKNOWLEDGE message (VCC UE to VMSC)

The VCC UE generates the CONNECT ACKNOWLEDGE message on receipt of the CONNECT message.

There is no VCC specific content to this response.

28. SIP ACK request (MGCF to intermediate IM CN subsystem entities)

The MGCF generates a SIP ACK request on receipt of the SIP 200 (OK) response and sends it back to the intermediate IM CN subsystem entities.

There is no VCC specific content to this response.

29. H.248 interaction with the MGW

The MGCF interacts with the MGW for the necessary resource allocation.

30. SIP ACK request (intermediate IM CN subsystem entities to CSAF)

The intermediate IM CN subsystem entities forward the SIP ACK request to the CSAF.

There is no VCC specific content to this response.

31. Interaction between CSAF and DTF

Information is exchanged between the CSAF and the DTF. The nature of this signalling is outside the scope of this version of the specification.

The DTF and CSAF modify the message in accordance with initiating B2BUA functionality, e.g. mapping of From, To, Cseq and Call-ID headers from one side of the B2BUA to the other.

32. SIP ACK request (DTF to intermediate IM CN subsystem entities)

The DTF forwards the SIP ACK request back to the intermediate IM CN subsystem entities.

There is no VCC specific content to this response.

33. SIP ACK request (intermediate IM CN subsystem entities to terminating side processing)

The intermediate IM CN subsystem entities forward the SIP ACK request to the terminating side processing.

There is no VCC specific content to this response.

A.4.4 Signalling flows for origination from CS domain, using ISUP call diversion mechanisms

Figure A.4.4-1 shows the origination of a call in the CS domain that is capable of being subject to VCC. In the example below it is assumed that the gsmSCF based on the service key returns the parameters Original Called Party ID, Redirecting Party and Redirection information. Further it is assumed that the corresponding ISUP parameters are later on mapped in the MGCF to appropriate SIP header fields.

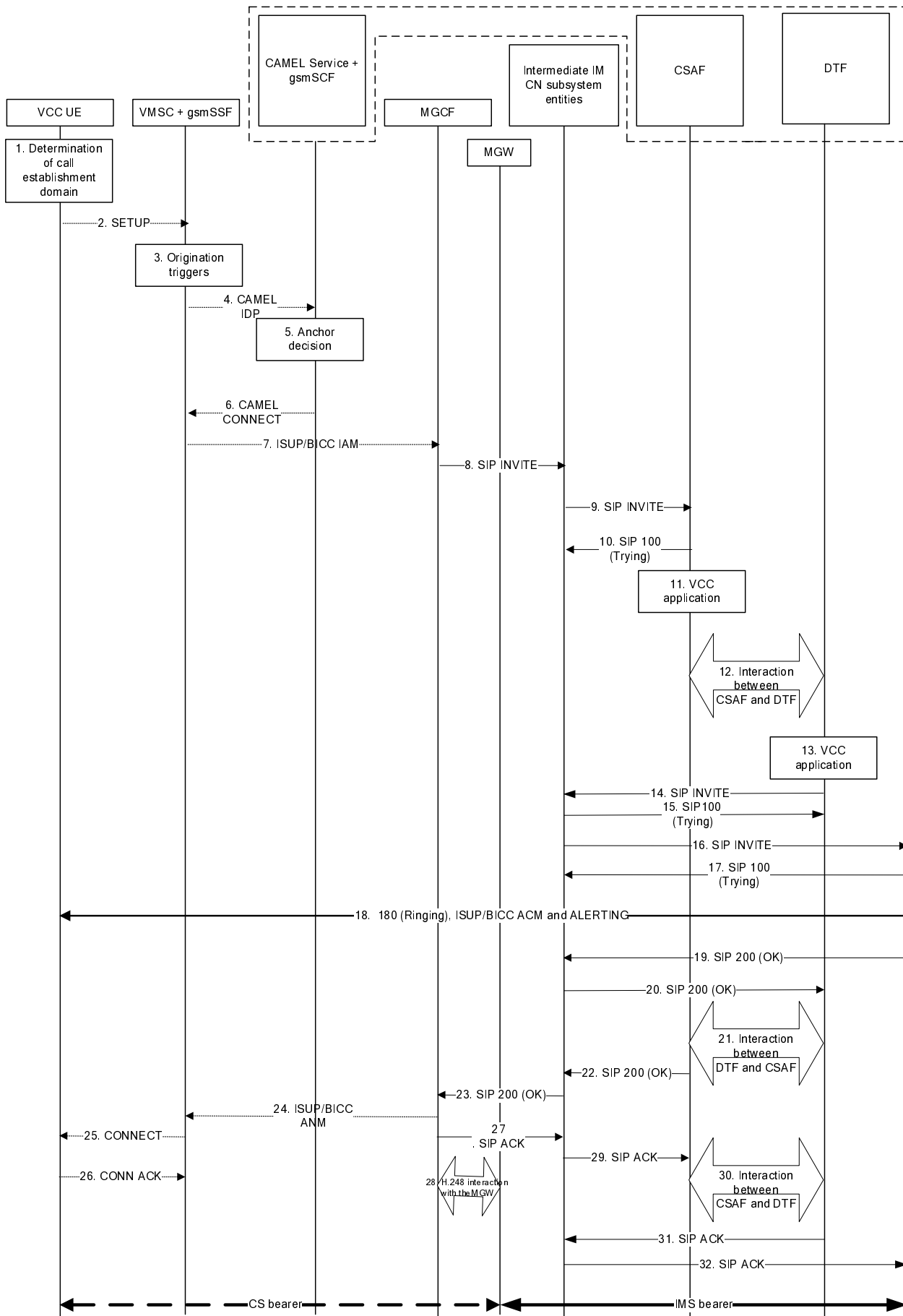

Figure A.4.4-1: CS call origination from the VCC user

The details of the signalling flows are as follows:

1 Determination of call establishment domain

As a result of some stimulus to establish a full-duplex, voice-only call, the VCC UE based on a combination of user policy, and access technology availability, decides to establish the call using the CS domain.

2. SETUP message (VCC UE to VMSC)

After establishment of the MM connection, the VCC UE#1 initiates the CS call towards UE#2 by sending out the SETUP message.

Specifically for this signalling flow, the SETUP message includes:

- Called Party Number information element = [(Numbering plan identifier = ISDN/telephony numbering plan), (type of number = international number), (Number digits = 12125552222)]
- Bearer Capability information element = [(information transfer capability = speech), (speech versions = FR AMR, GSM EFR, GSM FR)]
- Supported Codec List information element = {[(SysID 1 = UMTS), (Codec Bitmap for SysID 1 = UMTS AMR 2)], [(SysID 2 = GSM), (Codec Bitmap for SysID 2 = FR AMR, GSM EFR, GSM FR)]}

The Called Party Number information element identifies the intended recipient of the call, and the Bearer Capability information element and the Supported Codec List information element identify an intended call that can be subject to VCC.

The VMSC knows the calling party number corresponding to the UE.

3. Origination triggers

4. CAMEL IDP (VMSC to CAMEL service function)

On receipt of the SETUP message, the VMSC triggers a CAMEL activity which results in sending a CAMEL IDP message to the gsmSCF. The CAMEL IDP message contains at least:

- the calling party number;
- service key assigned to the subscriber;
- the called party number; and
- that the call is voice only.

5. Anchor decision

The CAMEL service function decides that this call will be anchored, based on the type of call and operator preferences.

6. CAMEL CONNECT (gsmSCF to VMSC)

The CAMEL service function in this example causes the gsmSCF to respond to the CAMEL IDP message with a CAMEL CONNECT message containing:

- the Destination Routing Address set to the IMRN;
- the Original Called Party ID;
- Redirecting Party ID; and
- Redirection Information.

7. ISUP IAM (VMSC to MGCF)

The VMSC initiates the CS call towards the MGCF by sending out the IAM message.

Specifically for this signalling flow, the IAM includes:

- Called Party Number parameter = [(Numbering plan identifier = ISDN/telephony numbering plan), (type of number = international number), (Number digits = 12415553333)]
- Calling Party Number parameter = [(Numbering plan identifier = ISDN/telephony numbering plan), (type of number = international number), (Number digits = 12125551111)]
- USI parameter = 3.1 kHz audio
- Original Called Number parameter = [(Numbering plan identifier = ISDN/telephony numbering plan), (type of number = international number), (Number digits = 12125552222)]
- Redirecting Number parameter = [(Numbering plan identifier = ISDN/telephony numbering plan), (type of number = international number), (Number digits = 12125552222)]
- Redirection information = [(Redirecting indicator = call diverted, all redirection info presentation restricted), (Original redirection reason = unknown), (Redirection counter = 1), Redirecting reason = unknown)]

The Called Party Number parameter represents the IMRN allocated for this call.

8. SIP INVITE request (MGCF to intermediate IM CN subsystem entities) – see example in table A.4.4-8

The MGCF initiates a SIP INVITE request, containing an initial SDP. The MGCF in this example needs to support call diversion.

Table A.4.4-8: SIP INVITE request (MGCF to intermediate IM CN subsystem entities)

```

INVITE tel:+1-241-555-3333 SIP/2.0
Via: SIP/2.0/UDP mgcf1.home1.net;branch=z9hG4bK779s24.0
Max-Forwards: 70
Route: <sip:icscf1_s.home1.net;lr>
P-Asserted-Identity: <tel:+1-212-555-1111>
P-Charging-Vector: icid-value="AyretyU0dm+602IrT5tAFrbHLso=023551024"; orig-ioi=home1.net
Privacy: none
From: <tel:+1-212-555-1111>;tag=171828
To: <tel:+1-212-555-3333>
Call-ID: cb03a0s09a2sdfgklkj490333
Cseq: 127 INVITE
Supported: 100rel, precondition
Contact: <sip:mgcf1.home1.net>
History-Info: <tel:+1-212-555-2222>; index=1, <tel:+1-212-555-2222>;\cause=404; index=1.1
Allow: INVITE, ACK, CANCEL, BYE, PRACK, UPDATE
Content-Type: application/sdp
Content-Length: (...)

v=0
o=- 2987933615 2987933615 IN IP6 5555::aaa:bbb:ccc:ddd
s=-
c=IN IP6 5555::aaa:bbb:ccc:ddd
t=0 0
m=audio 3456 RTP/AVP 97 96
b=AS:25.4
a=crr:qos local sendrecv
a=crr:qos remote none
a=des:qos mandatory local sendrecv
a=des:qos none remote sendrecv
a=rtpmap:97 AMR
a=fmtp:97 mode-set=0,2,5,7; mode-change-period=2
a=rtpmap:96 telephone-event
a=maxptime:20

```

Request-URI: Contains the IMRN, as obtained from CS domain signalling.

P-Asserted-Identity: The MGCF inserts the tel-URL containing the calling party number as received from the CS network.

SDP The SDP contains a preconfigured set of codecs supported by the MGW based on what is received in the ISUP. The codecs selected are speech codecs, for which VCC can be applied. See table 10a of 3GPP TS 29.163 [10].

History-Info: The MGCF inserts the original called party number and an entry for the redirecting number as received from the CS network.

9. SIP INVITE request (intermediate IM CN subsystem entities to CSAF) – see example in table A.4.4-9

The IMRN is a PSI. The intermediate IM CN subsystem entities are configured to route this PSI to the CSAF. In this particular case, the I-CSCF performs the routing over the Ma interface. For this example, there is no IBCF before the I-CSCF and no intermediate entities Record-Route the request.

Table A.4.4-9: SIP INVITE request (intermediate IM CN subsystem entities to CSAF)

```

INVITE tel:+1-212-555-3333 SIP/2.0
Via: SIP/2.0/UDP mgcf1.home1.net;branch=z9hG4bK779s24.0, SIP/2.0/UDP
    icscf1_s.home1.net;branch=z9hG4bK312a32.1
Max-Forwards: 69
Route: <sip:csaf1.home1.net;lr>
P-Asserted-Identity:
P-Charging-Vector: icid-value="AyretyU0dm+602Irt5tAFrbHLso=023551024"; orig-ioi=type
3home1.net; orig-ioi=home1.net
Privacy:
From:
To:
Call-ID:
Cseq:
Supported:
Contact:
History-Info:
Allow:
Content-Type:
Content-Length: (...)

v=
o=
s=
c=
t=
m=
b=
a=
a=
a=
a=
a=
a=
a=
a=
a=

```

10. SIP 100 (Trying) response (CSAF to intermediate IM CN subsystem entities)

There is no VCC specific content to this response.

11. VCC application

The CSAF and DTF in combination act as an initiating B2BUA. The CSAF places the original call party number in the Request-URI and the To header of the outgoing request and removes the History-Info header.

12. Interaction between CSAF and DTF

Information is exchanged between the CSAF and the DTF. The nature of this signalling is outside the scope of this version of the specification. In this example, the subsequent flows assume that a visit has been made to the S-CSCF, in association with the the triggering of initial filter criteria, in order to reach the DTF.

13. VCC application

The CSAF and DTF in combination act as an initiating B2BUA. The DTF anchors the call to provide VCC functionality.

14. SIP INVITE request (DTF to intermediate IM CN subsystem entities) – see example in table A.4.4-14

The DTF forwards the SIP INVITE request to the S-CSCF serving the originating user within the IM CN subsystem. In this case it is assumed that the user is registered within the IM CN subsystem.

The DTF sets the value of the Contact header with the address of the DTF that will provide the transfer functionality needed to support VCC.

The DTF modifies the message in accordance with routing B2BUA functionality, e.g. mapping of From, To, Cseq and Call-ID headers from one side of the B2BUA to the other.

Table A.4.4-14: SIP INVITE request (DTF to intermediate IM CN subsystem entities)

```

INVITE tel:+1-212-555-2222 SIP/2.0
Via: SIP/2.0/UDP dtf1.home1.net;branch=z9hG4bK312a32.1
Max-Forwards: 66
Route: <sip:s-cscf.home1.net;lr>
P-Asserted-Identity:
P-Charging-Vector: icid-value="AyretyU0dm+602IrT5tAFrbHLso=023551024"; orig-loi=Type
3home1.net
Privacy:
From:
To: <tel:+1-212-555-2222>
Call-ID: dc14b1t10b3teghmlk501444
Cseq:
Supported:
Contact: <sip:dtf1.home1.net>
Allow:
Content-Type:
Content-Length: (...)

v=
o=
s=
c=
t=
m=
b=
a=
a=
a=
a=
a=
a=
a=
a=
a=
a=

```

Editor's note: Need to add "orig" parameter to above table.

Contact header: The Contact header represents the contact of the DTF.

15. SIP 100 (Trying) response (intermediate IM CN subsystem entities to DTF)

The intermediate IM CN subsystem entities respond to the DTF with a SIP 100 (Trying) response.

There is no VCC specific content to this response.

16. SIP INVITE request (intermediate IM CN subsystem entities to terminating side processing) – see example in table A.4.4-16

The intermediate IM CN subsystem entities route the SIP INVITE request to the terminating side. In this example, there is no intermediate IBCF and none of the intermediate entities Record-Route.

Table A.4.4-16: SIP INVITE request (intermediate IM CN subsystem entities to terminating side processing)

```

INVITE tel:+1-212-555-2222 SIP/2.0
Via: SIP/2.0/UDP scscf1.home1.net;branch=z9hG4bK332b23.1, SIP/2.0/UDP
    dtf1.home1.net;branch=z9hG4bK312a32.1
Max-Forwards: 65
P-Asserted-Identity:
P-Charging-Vector: icid-value="AyretyU0dm+602IrT5tAFrbHLso=023551024"; orig-ioi=home1.net
Privacy:
From:
To:
Call-ID:
Cseq:
Supported:
Contact:
Allow:
Content-Type:
Content-Length: (...)

v=
o=
s=
c=
t=
m=
b=
a=
a=
a=
a=
a=
a=
a=
a=
a=
a=

```

17. SIP 100 (Trying) response (terminating side processing to intermediate IM CN subsystem entities)

The terminating side processing responds to the intermediate IM CN subsystem entities with a SIP 100 (Trying) response.

There is no VCC specific content to this response.

18. SIP 180 (Ringing) response, ISUP ACM and ALERTING message (terminating side processing to VCC UE)

The call is successfully delivered to the terminating UE, which begins alerting the user. Normal SIP, ISUP and access signalling messages are transferred to indicate this is occurring. At or before this time, completion of negotiation of the bearer (e.g. as indicated by SDP in SIP) occurs. There is no VCC specific actions associated with this step.

The DTF and CSAF modify the message in accordance with initiating B2BUA functionality, e.g. mapping of From, To, Cseq and Call-ID headers from one side of the B2BUA to the other.

19. SIP 200 (OK) response (terminating side processing to intermediate IM CN subsystem entities)

A SIP 200 (OK) response is received from the terminating side processing by the intermediate IM CN subsystem entities.

There is no VCC specific content to this response.

20. SIP 200 (OK) response (intermediate IM CN subsystem entities to DTF)

The intermediate IM CN subsystem entities forward the SIP 200 (OK) response to the DTF.

There is no VCC specific content to this response.

21. Interaction between DTF and CSAF

Information is exchanged between the CSAF and the DTF. The nature of this signalling is outside the scope of this version of the specification.

The DTF and CSAF modify the message in accordance with initiating B2BUA functionality, e.g. mapping of From, To, Cseq and Call-ID headers from one side of the B2BUA to the other.

22. SIP 200 (OK) response (CSAF to intermediate IM CN subsystem entities)

The CSAF forwards the SIP (200) OK response back to the intermediate IM CN subsystem entities.

There is no VCC specific content to this response.

23. SIP 200 (OK) response (intermediate IM CN subsystem entities to MGCF)

The intermediate IM CN subsystem entities forward the SIP 200 (OK) response to the MGCF.

There is no VCC specific content to this response.

24. ISUP ANM (MGCF to VMSC)

On receipt of the SIP 200 (OK) response, the MGCF generates an ISUP ANM message and sends this to the VMSC.

There is no VCC specific content to this response.

25. CONNECT (VMSC to VCC UE)

The VMSC sends a CONNECT message to the VCC UE.

There is no VCC specific content to this response.

26. CONNECT ACKNOWLEDGE (VCC UE to VMSC)

The VCC UE generates the CONNECT ACKNOWLEDGE message on receipt of the CONNECT message.

There is no VCC specific content to this response.

27. SIP ACK request (MGCF to intermediate IM CN subsystem entities)

The MGCF generates a SIP ACK request on receipt of the SIP 200 (OK) response and sends it back to the intermediate IM CN subsystem entities.

There is no VCC specific content to this response.

28. H.248 interaction with the MGW

The MGCF interacts with the MGW for the necessary resource allocation.

29. SIP ACK request (intermediate IM CN subsystem entities to CSAF)

The intermediate IM CN subsystem entities forward the SIP ACK request to the CSAF.

There is no VCC specific content to this response.

30. Interaction between CSAF and DTF

Information is exchanged between the CSAF and the DTF. The nature of this signalling is outside the scope of this version of the specification.

The DTF and CSAF modify the message in accordance with initiating B2BUA functionality, e.g. mapping of From, To, Cseq and Call-ID headers from one side of the B2BUA to the other.

31. SIP ACK request (DTF to intermediate IM CN subsystem entities)

The DTF forwards the SIP ACK request back to the intermediate IM CN subsystem entities.

There is no VCC specific content to this response.

32. SIP ACK request (intermediate IM CN subsystem entities to terminating side processing)

The intermediate IM CN subsystem entities forward the SIP ACK request to the terminating side processing.

There is no VCC specific content to this response.

A.4.5 Signalling flows for origination from CS domain with no anchoring

Figure A.4.5-1 shows the origination of a voice call that is capable of being subject to VCC, with the anchoring of the call in the IM CN subsystem being denied prior to its routing. The voice call is then continued in the CS domain according to standard procedures.

The anchor decision of such origination calls is subject to operator policy.

As the originating voice call is not anchored in the IM CN subsystem, domain transfer will not be supported for that call.

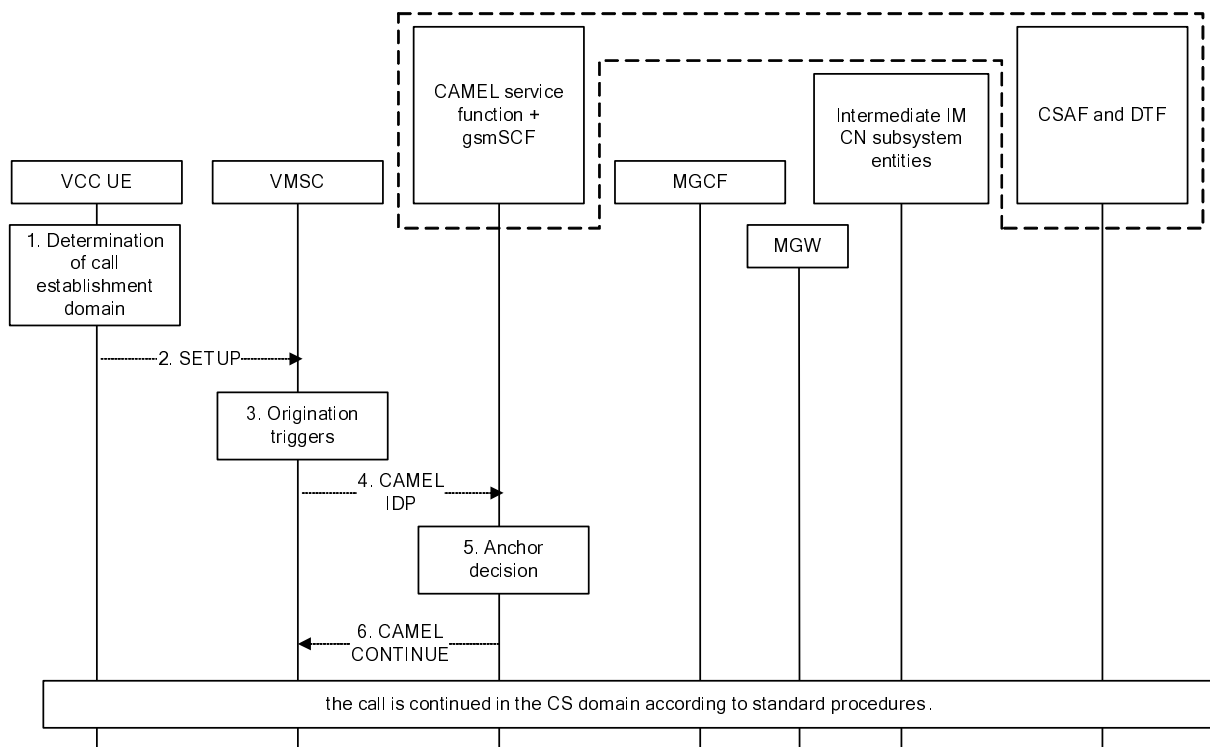

Figure A.4.5-1: call origination from CS with no anchoring

The details of the signalling flows are as follows:

Steps 1 to 4 are identical to the example in subclause A.4.3.

NOTE 1: When processing the originating calls for subscriber requiring CAMEL support (step 3), the VMSC retrieves the originating CAMEL subscriber information from the VLR that identifies the subscriber as having CAMEL services. As a result the gsmSSF of the VMSC triggers a CAMEL activity toward the gsmSCF.

5. Anchor decision

The CAMEL service function denies the anchoring of the originating call according to the operator policy. In this example the called party number is not in the international format and the home IM CN subsystem has no means to translate the called party number into a proper routable format.

6. CAMEL CONTINUE (gsmSCF to VMSC)

The CAMEL service function causes the gsmSCF to respond to the CAMEL IDP message with a CAMEL CONTINUE message. The CAMEL CONTINUE message contains no parameter.

NOTE 2: On the receipt of the CAMEL CONTINUE message, the VMSC resumes the processing, continues the call in the CS domain according to standard procedures and without any modification of the call parameters.

A.4.6 Signalling flows for origination from CS domain for a user that is not registered within the IM CN subsystem

Figure A.4.6-1 shows the origination of a call in the CS domain that is capable of being subject to VCC when the user is not currently registered within the IM CN subsystem.

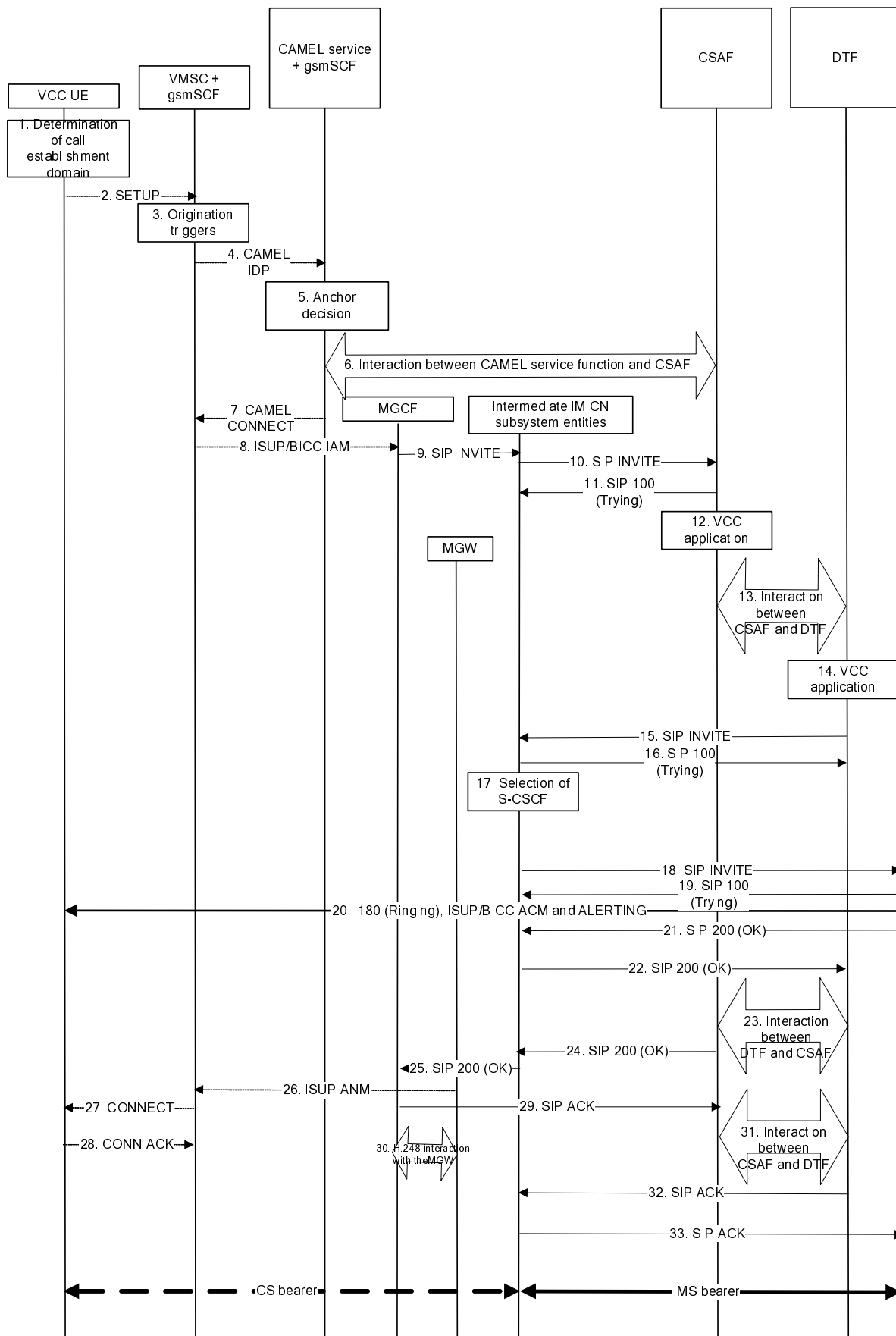

Figure A.4.6-1: CS call origination from the VCC user that is not IMS registered

The details of the signalling flows are as follows:

Steps 1 through 14 are identical to those shown in subclause A.4.3.

15. SIP INVITE request (DTF to intermediate IM CN subsystem entities) – see example in table A.4.6-15

In this example, the VCC user is not registered in the IM CN subsystem. The DTF forwards the SIP INVITE request to the intermediate IM CN subsystem entities, specifically the I-CSCF as for AS originating procedures for unregistered users. The 'orig' parameter is added to the Route header.

The DTF sets the value of the Contact header with the address of the DTF that will provide the transfer functionality needed to support VCC.

The DTF modifies the message in accordance with routing B2BUA functionality, e.g. mapping of From, To, Cseq and Call-ID headers from one side of the B2BUA to the other.

NOTE: The service profile needs to be the same for the originating registered case and the originating unregistered case.

Table A.4.6-15: SIP INVITE request (DTF to intermediate IM CN subsystem entities)

```
INVITE tel:+1-212-555-2222 SIP/2.0
Via: SIP/2.0/UDP dtf1.home1.net;branch=z9hG4bK312a32.1
Max-Forwards: 66
Route: <sip:i-cscf.home1.net;lr;orig>
P-Asserted-Identity:
P-Charging-Vector: icid-value="AyretyU0dm+602IrT5tAFrbHLso=023551024"; orig-ioi=Type
    3home1.net
Privacy:
From:
To: <tel:+1-212-555-2222>
Call-ID: dc14b1t10b3teghmlk501444
Cseq:
Supported:
Contact: <sip:dtf1.home1.net>
Allow:
Content-Type:
Content-Length: (...)

v=
o=
s=
c=
t=
m=
b=
a=
a=
a=
a=
a=
a=
a=
a=
a=
```

Contact header: The Contact header represents the contact of the DTF.

16. SIP 100 (Trying) response (I-CSCF to DTF)

The I-CSCF responds to the DTF with a SIP 100 (Trying) response.

There is no VCC specific content to this response.

17. Intermediate IM CN subsystem processing (selection of S-CSCF)

The intermediate IM CN subsystem entities (I-CSCF) will select a S-CSCF for the unregistered user. The I-CSCF will recognize the 'orig' parameter on the Route header and query the HSS for the originating party in P-Asserted-Identity header. The I-CSCF will select a S-CSCF based upon the user capabilities and the capabilities of the S-CSCFs as currently described in 3GPP TS 24.229 [8] subclause 5.3. The I-CSCF forwards the inrequest to the S-CSCF.

18. SIP INVITE request (intermediate IM CN subsystem entities to terminating side processing) – see example in table A.4.6-18

The intermediate IM CN subsystem entities (S-CSCF) routes the SIP INVITE request to the terminating side processing. In this example, there is no intermediate IBCF and none of the intermediate entities Record-Route.

Table A.4.6-18: SIP INVITE request (intermediate IM CN subsystem entities to terminating side processing)

```

INVITE tel:+1-212-555-2222 SIP/2.0
Via: SIP/2.0/UDP scscf1.home1.net;branch=z9hG4bK332b23.1, SIP/2.0/UDP
      icscf1.home1.net;branch=z9hG4bK332b23.1, SIP/2.0/UDP dtf1.home1.net
      SIP/2.0/UDP;branch=z9hG4bK312a32.1
Max-Forwards: 64
P-Asserted-Identity:
P-Charging-Vector: icid-value="AyretyU0dm+6O2IrT5tAFrbHLso=023551024"; orig-ioi=home1.net
Privacy:
From:
To:
Call-ID:
Cseq:
Supported:
Contact:
Allow:
Content-Type:
Content-Length: (...)

v=
o=
s=
c=
t=
m=
b=
a=
a=
a=
a=
a=
a=
a=
a=
a=
a=

```

19. SIP 100 (Trying) response (terminating side processing to intermediate IM CN subsystem entities)

The terminating side processing responds to the intermediate IM CN subsystem entities with a SIP 100 (Trying) response.

There is no VCC specific content to this response.

20. SIP 180 (Ringing) response, ISUP ACM and ALERTING message (terminating side processing to VCC UE)

The call is successfully delivered to the terminating UE, which begins alerting the user. Normal SIP, ISUP and access signalling messages are transferred to indicate this is occurring. At or before this time, completion of negotiation of the bearer (e.g. as indicated by SDP in SIP) occurs. There is no VCC specific actions associated with this step.

The DTF and CSAF modify the message in accordance with initiating B2BUA functionality, e.g. mapping of From, To, Cseq and Call-ID headers from one side of the B2BUA to the other.

21. SIP 200 (OK) response (terminating side processing to intermediate IM CN subsystem entities)

A SIP 200 (OK) response is received from the terminating side processing by the intermediate IM CN subsystem entities.

There is no VCC specific content to this response.

22. SIP 200 (OK) response (intermediate IM CN subsystem entities to DTF)

The intermediate IM CN subsystem entities forwards the SIP 200 (OK) response to the DTF.

There is no VCC specific content to this response.

23. Interaction between DTF and CSAF

Information is exchanged between the CSAF and the DTF. The nature of this signalling is outside the scope of this version of the specification.

The DTF and CSAF modify the message in accordance with initiating B2BUA functionality, e.g. mapping of From, To, Cseq and Call-ID headers from one side of the B2BUA to the other.

24. SIP 200 (OK) response (CSAF to intermediate IM CN subsystem entities)

The CSAF forwards the SIP (200) OK response back to the intermediate IM CN subsystem entities.

There is no VCC specific content to this response.

25. SIP 200 (OK) response (intermediate IM CN subsystem entities to MGCF)

The intermediate IM CN subsystem entities forward the SIP 200 (OK) response to the MGCF.

There is no VCC specific content to this response.

26. ISUP ANM (MGCF to VMSC)

On receipt of the SIP 200 (OK) response, the MGCF generates an ISUP ANM and sends this to the VMSC.

There is no VCC specific content to this response.

27. CONNECT message (VMSC to VCC UE)

The VMSC sends a CONNECT message to the VCC UE.

There is no VCC specific content to this response.

28. CONNECT ACKNOWLEDGE message (VCC UE to VMSC)

The VCC UE generates the CONNECT ACKNOWLEDGE message on receipt of the CONNECT message.

There is no VCC specific content to this response.

29. SIP ACK request (MGCF to CSAF)

The MGCF generates a SIP ACK request on receipt of the SIP 200 (OK) response and sends it back to the CSAF.

There is no VCC specific content to this response.

30. H.248 interaction with the MGW

The MGCF interacts with the MGW for the necessary resource allocation.

31. Interaction between CSAF and DTF

Information is exchanged between the CSAF and the DTF. The nature of this signalling is outside the scope of this version of the specification.

The DTF and CSAF modify the message in accordance with initiating B2BUA functionality, e.g. mapping of From, To, Cseq and Call-ID headers from one side of the B2BUA to the other.

32. SIP ACK request (DTF to intermediate IM CN subsystem entities)

The DTF forwards the SIP ACK request to the intermediate IM CN subsystem entities.

There is no VCC specific content to this response.

33. SIP ACK request (intermediate IM CN subsystem entities to terminating side processing)

The intermediate IM CN subsystem entities forwards the SIP ACK request to the terminating side processing.

There is no VCC specific content to this response.

A.5 Signalling flows for call termination

A.5.1 Introduction

The signalling flows for call termination demonstrate how a terminating call to a VCC UE is anchored for the purposes of a future domain transfer. The following signalling flows are included:

- subclause A.5.2 shows a terminating call arriving at the IM CN subsystem, where incoming call routing has directed the call to the IM CN subsystem for anchoring and subsequent delivery of the call to the terminating VCC UE;
- subclause A.5.3 shows a terminating call arriving at the IM CN subsystem, where incoming call routing has directed the call to the IM CN subsystem for anchoring, but subsequently rerouted the call back to the CS domain for delivery to the terminating VCC UE;
- subclause A.5.4 shows a terminating call arriving at the CS domain, where CAMEL has been used to redirect the call to the IM CN subsystem for anchoring and subsequent delivery to the terminating VCC UE;
- subclause A.5.5 shows a terminating call arriving at the CS domain, getting routed to, and anchored at the IM CN subsystem, and subsequently routed back to the CS domain for delivery to the terminating VCC UE. The call routing from the CS domain to the IM CN subsystem for anchoring is by the HSS(HLR), through internal network implementation, obtaining the IMRN for routing to the IM CN subsystem;
- subclause A.5.6 shows a terminating call arriving at the IM CN subsystem, where incoming call routing has directed the call to the IM CN subsystem for anchoring, but delivery to the terminating VCC UE in the IM CN subsystem has failed, and redelivery is made to the VCC UE in the CS domain;
- subclause A.5.7 shows a terminating call arriving at the CS domain, getting routed to, and anchored at the IM CN subsystem, and subsequently routed back to the CS domain for delivery to the terminating VCC UE, but delivery fails and redelivery is made to the VCC UE using the IM CN subsystem; and
- subclause A.5.8 shows a terminating call arriving at the CS domain, where CAMEL is used but for which the anchoring is denied; the call is continued and delivered in the CS domain.

A.5.2 Signalling flows for termination to the IM CN subsystem

Figure A.5.2-1 shows the termination of a call that is capable of being subject to VCC, where the calling party call has been routed through the IM CN subsystem and where the called party is terminating in its home IM CN subsystem.

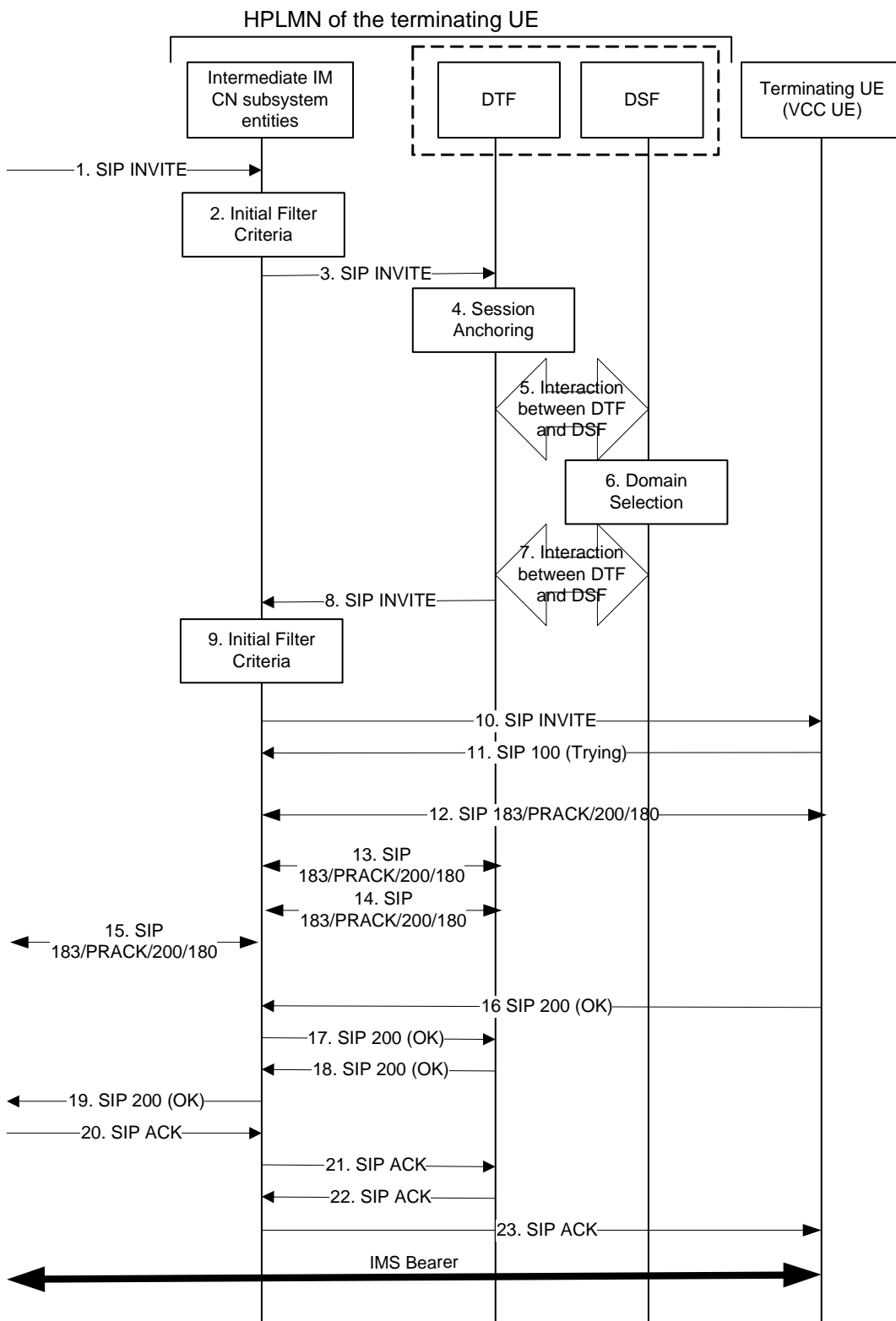

Figure A.5.2-1: Terminating call directed to IM CN subsystem

The details of the signalling flows are as follows:

1. SIP INVITE request (from the originating IM CN subsystem to intermediate IM CN subsystem entities) - see example in table A.5.2-1

In this example the originating UE initiates a voice call through its home IM CN subsystem (home1) with a terminating UE which is VCC capable who is in a different network (home2). There is no specific VCC information in the SIP INVITE request from the originating UE.

The SIP INVITE request is sent by the originating IM CN subsystem to the intermediate IM CN subsystem entities.

Table A.5.2-1: SIP INVITE request (from the originating IM CN subsystem)

```

INVITE sip:user2_public1@home2.net SIP/2.0
Via: SIP/2.0/UDP icscf2_s.home2.net;branch=z9hG4bK871y12.1, SIP/2.0/UDP
    scscf1.home1.net;branch=z9hG4bK332b23.1, SIP/2.0/UDP
    pcscf1.home1.net;branch=z9hG4bK431h23.1, SIP/2.0/UDP
    [5555::aaa:bbb:ccc:ddd]:1357;comp=sigcomp;branch=z9hG4bKnashds7
Max-Forwards: 67
Route: <sip:scscf1.home1.net;lr>
Record-Route: <sip:scscf1.home1.net;lr>, <sip:pcscf1.home1.net;lr>
P-Asserted-Identity: "John Doe" <tel:+1-212-555-1111>
P-Access-Network-Info:
P-Charging-Vector: icid-value="AyretyU0dm+6O2IrT5tAFrbHLso=023551024"; orig-ioi="type
    3ashomel.net"
Privacy: none
Supported: precondition
From: <sip:user1_public1@home1.net>;tag=171828
To: <tel:+1-212-555-2222>
Call-ID: cb03a0s09a2sdfgk490333
Cseq: 127 INVITE
Contact: <sip:[5555::aaa:bbb:ccc:ddd]:1357;comp=sigcomp>
Allow: INVITE, ACK, CANCEL, BYE, PRACK, UPDATE, REFER, MESSAGE
Content-Type: application/sdp
Content-Length: (...)

v=0
o=- 2987933615 2987933615 IN IP6 5555::aaa:bbb:ccc:ddd
s=-
c=IN IP6 5555::aaa:bbb:ccc:ddd
t=0 0
m=audio 3456 RTP/AVP 97 96
b=AS:25.4
a=curr:qos local none
a=curr:qos remote none
a=des:qos mandatory local sendrecv
a=des:qos none remote sendrecv
a=rtpmap:97 AMR
a=fmtp:97 mode-set=0,2,5,7; mode-change-period=2
a=rtpmap:96 telephone-event
a=maxptime:20

```

2. Evaluation of initial filter criteria

In this example, and by evaluation of the initial filter criteria, the terminating user's S-CSCF routes to the address of the DTF, as the received request is a terminating INVITE request.

3. SIP INVITE request (intermediate IM CN subsystem entities to DTF) - see example in table A.5.2-3

The terminating user's S-CSCF adds a set of routing related headers in order to receive the SIP INVITE request back, to route the present request to the DTF and to maintain itself on the route for all subsequent requests.

The intermediate IM CN subsystem entities forward the INVITE request to the DTF.

Table A.5.2-3: SIP INVITE request (intermediate IM CN subsystem entities to DTF)

```

INVITE sip:user2_public1@home2.net SIP/2.0
Via: SIP/2.0/UDP scscf2.home2.net;branch=z9hG4bK332b33.1, SIP/2.0/UDP
    icscf2_s.home2.net;branch=z9hG4bK871y12.1, SIP/2.0/UDP
    scscf1.home1.net;branch=z9hG4bK332b23.1, SIP/2.0/UDP
    pcscf1.home1.net;branch=z9hG4bK431h23.1, SIP/2.0/UDP
    [5555::aaa:bbb:ccc:ddd]:1357;comp=sigcomp;branch=z9hG4bKnashds7
Max-Forwards: 66
Route: <sip:dtf2.home2.net;lr>, <sip:scscf2.home2.net;lr>;dia-id=6574839201
Record-Route: <sip:scscf2.home2.net;lr>, <sip:scscf1.home1.net;lr>, <sip:pcscf1.home1.net;lr>
P-Asserted-Identity:
P-Access-Network-Info:
P-Charging-Vector: icid-value="AyretyU0dm+602Irt5tAFrbHLso=023551024";
orig-ioi="type 3ashome1.net"
Privacy:
Supported:
From:
To:
Call-ID:
Cseq:
Contact:
Allow:
Content-Type:
Content-Length: (...)

v=
o=
s=
c=
t=
m=
b=
a=
a=
a=
a=
a=
a=
a=
a=
a=
a=

```

4. Session anchoring

The DTF decides to perform session anchoring decision based on operator specified criteria.

5. Interaction between the DTF and DSF

Information is exchanged between the DTF and DSF. The nature of this signalling is outside the scope of this version of the specification. Alternative procedures for invoking the DSF are possible, for example, further evaluation of filter criteria when the outgoing request from the DTF after anchoring is sent back to the S-CSCF.

6. The DSF selects the terminating domain

The DSF performs domain selection based on operator and user preferences, registration and call states; in this example the DSF selects the terminating IM CN subsystem to terminate the voice call.

7. Interaction between the DTF and DSF

Information is exchanged between the DTF and DSF. The nature of this signalling is outside the scope of this version of the specification.

8. SIP INVITE request (DTF to intermediate IM CN subsystem entities) - see example in table A.5.2-8

The DTF acts as a routing B2BUA, it initiates the outgoing request and places the called party number in the Request-URI and the To header.

The DTF modifies the message in accordance with routing B2BUA functionality, e.g. mapping of From, To, Cseq and Call-ID headers from one side of the B2BUA to the other.

The DTF sends the SIP INVITE request back to the intermediate IM CN subsystem entities.

Table A.5.2-8: SIP INVITE request (DTF to intermediate IM CN subsystem entities)

```

INVITE sip:user2_public1@home2.net SIP/2.0
Via: SIP/2.0/UDP sip:dtf2.home2.net; branch=z9jG4bK332b23.3, SIP/2.0/UDP
    scscf2.home2.net;branch=z9hG4bK332b23.1, SIP/2.0/UDP
    icscf2_s.home2.net;branch=z9hG4bK871y12.1, SIP/2.0/UDP
    scscf1.home1.net;branch=z9hG4bK332b23.1, SIP/2.0/UDP
    pcscf1.home1.net;branch=z9hG4bK431h23.1, SIP/2.0/UDP
    [5555::aaa:bbb:ccc:ddd]:1357;comp=sigcomp;branch=z9hG4bKnashds7
Max-Forwards: 65
Route: <sip:scscf2.home2.net;lr>;dia-id=6574839201
Record-Route: <sip:dtf2.home2.net;lr>, <sip:scscf2.home2.net;lr>, <sip:scscf1.home1.net;lr>,
    <sip:pcscf1.home1.net;lr>
P-Asserted-Identity:
P-Access-Network-Info:
P-Charging-Vector: icid-value="AyretyU0dm+602Irt5tAFrbHLso=023551024"; orig-icoi="type
    3ashomel.net"
Privacy:
Supported:
From:
To:
Call-ID:
Cseq:
Contact:
Allow:
Content-Type:
Content-Length: (...)

v=
o=
s=
c=
t=
m=
b=
a=
a=
a=
a=
a=
a=
a=
a=
a=
a=

```

9. Evaluation of initial filter criteria

In this example, the S-CSCF continues the triggering from the next trigger point. Since no more triggering is required in the initial filter criteria, the IM CN subsystem will route the SIP INVITE request to the terminating user based on its SIP-URI.

10. SIP INVITE (intermediate IM CN subsystem entities to VCC UE) – see example in table A.5.2-10

The terminating user's intermediate IM CN subsystem entities forward the SIP INVITE request towards the terminating VCC UE.

Table A.5.2-10: SIP INVITE request (intermediate IM CN subsystem entities to VCC UE)

```

INVITE sip:[5555::eee:fff:aaa:bbb]:8805;comp=sigcomp SIP/2.0
Via: SIP/2.0/UDP pcscf2.home2.net:5088;comp=sigcomp;branch=z9hG4bK876t12.1, SIP/2.0/UDP
scscf2.home2.net;branch=z9hG4bK764z87.1, SIP/2.0/UDP sip:dtf2.home2.net;
branch=z9jG4bK332b23.3, SIP/2.0/UDP scscf2.home2.net;branch=z9hG4bK332b23.1, SIP/2.0/UDP
icscf2_s.home2.net;branch=z9hG4bK871y12.1, SIP/2.0/UDP
scscf1.home1.net;branch=z9hG4bK332b23.1, SIP/2.0/UDP
pcscf1.home1.net;branch=z9hG4bK431h23.1, SIP/2.0/UDP
[5555::aaa:bbb:ccc:ddd]:1357;comp=sigcomp;branch=z9hG4bKKnashds7
Max-Forwards: 63
Record-Route: <sip:pcscf2.home2.net:5088;lr;comp=sigcomp>, <sip:scscf2.home2.net;lr>,
<sip:dtf2.home2.net;lr>, <sip:scscf2.home2.net;lr>, <sip:scscf1.home1.net;lr>,
<sip:pcscf1.home1.net;lr>
P-Asserted-Identity:
Privacy:
Supported:
From:
To:
Call-ID:
Cseq:
Require:
Supported:
Contact:
Allow:
P-Called-Party-ID:
P-Media-Authorization:
Content-Type:
Content-Length:

v=
o=
s=
c=
t=
m=
b=
a=
a=
a=
a=
a=
a=
a=
a=
a=

```

11. SIP 100 (Trying) response (VCC UE to intermediate IM CN subsystem entities)

The intermediate VCC UE responds to the intermediate IM CN subsystem entities with a SIP 100 (Trying) response.

There is no VCC specific content to this response.

12, 13, 14 and 15. Reliable exchange of SDP (SIP 183 (Session Progress) response / SIP PRACK request / SIP 200 (OK) response / SIP 180 (Ringing) response)

The SIP endpoints complete SDP offer/answer procedures, including any reservation of bearer resource on the IP-CAN, and any exchange of alerting indication, in accordance with standard basic call procedures. VCC imposes no restriction on this operation.

16. SIP 200 (OK) response (UE to intermediate IM CN subsystem entities)

When the called party answers, the UE sends a SIP 200 (OK) final response to the SIP INVITE request (8) to the intermediate IM CN subsystem entities, and starts the media flow(s) for this session.

There is no VCC specific content to this response.

17. SIP 200 (OK) response (intermediate IM CN subsystem entities to DTF)

The intermediate IM CN subsystem entities forward the SIP 200 (OK) response to the DTF.

There is no VCC specific content to this response.

18. SIP 200 (OK) response (DTF to intermediate IM CN subsystem entities)

The DTF sends the SIP 200 (OK) response back to the intermediate IM CN subsystem entities.

The DTF modifies the message in accordance with routing B2BUA functionality, e.g. mapping of From, To, Cseq and Call-ID headers from one side of the B2BUA to the other.

There is no VCC specific content to this response.

19. SIP 200 (OK) response (to originating IM CN subsystem)

The terminating user's intermediate IM CN subsystem entities, forwards the SIP 200 (OK) final response along the signalling path back to the calling user through the originating IM CN subsystem.

There is no VCC specific content to this response.

20. SIP ACK request (from the originating IM CN subsystem)

The calling user responds to the SIP 200 (OK) final response with an ACK request through the originating IM CN subsystem to the intermediate IM CN subsystem entities of the terminating user.

There is no VCC specific content to this request.

21. SIP ACK request (intermediate IM CN subsystem entities to DTF)

The intermediate IM CN subsystem entities forward the SIP ACK request to the DTF.

There is no VCC specific content to this request.

22. SIP ACK request (DTF to intermediate IM CN subsystem entities)

The DTF sends the SIP ACK request back to the intermediate IM CN subsystem entities.

The DTF modifies the message in accordance with routing B2BUA functionality, e.g. mapping of From, To, Cseq and Call-ID headers from one side of the B2BUA to the other.

There is no VCC specific content to this request.

23. SIP ACK request (intermediate IM CN subsystem entities to VCC UE)

The intermediate IM CN subsystem entities forward the SIP ACK request to the terminating VCC UE.

There is no VCC specific content to this request.

A.5.3 Signalling flows for termination to CS domain

Figure A.5.3-1 shows the termination of a call that is capable of being subject to VCC, where the calling party call has been routed through the IM CN subsystem and where the called party is terminating in its home CS domain.

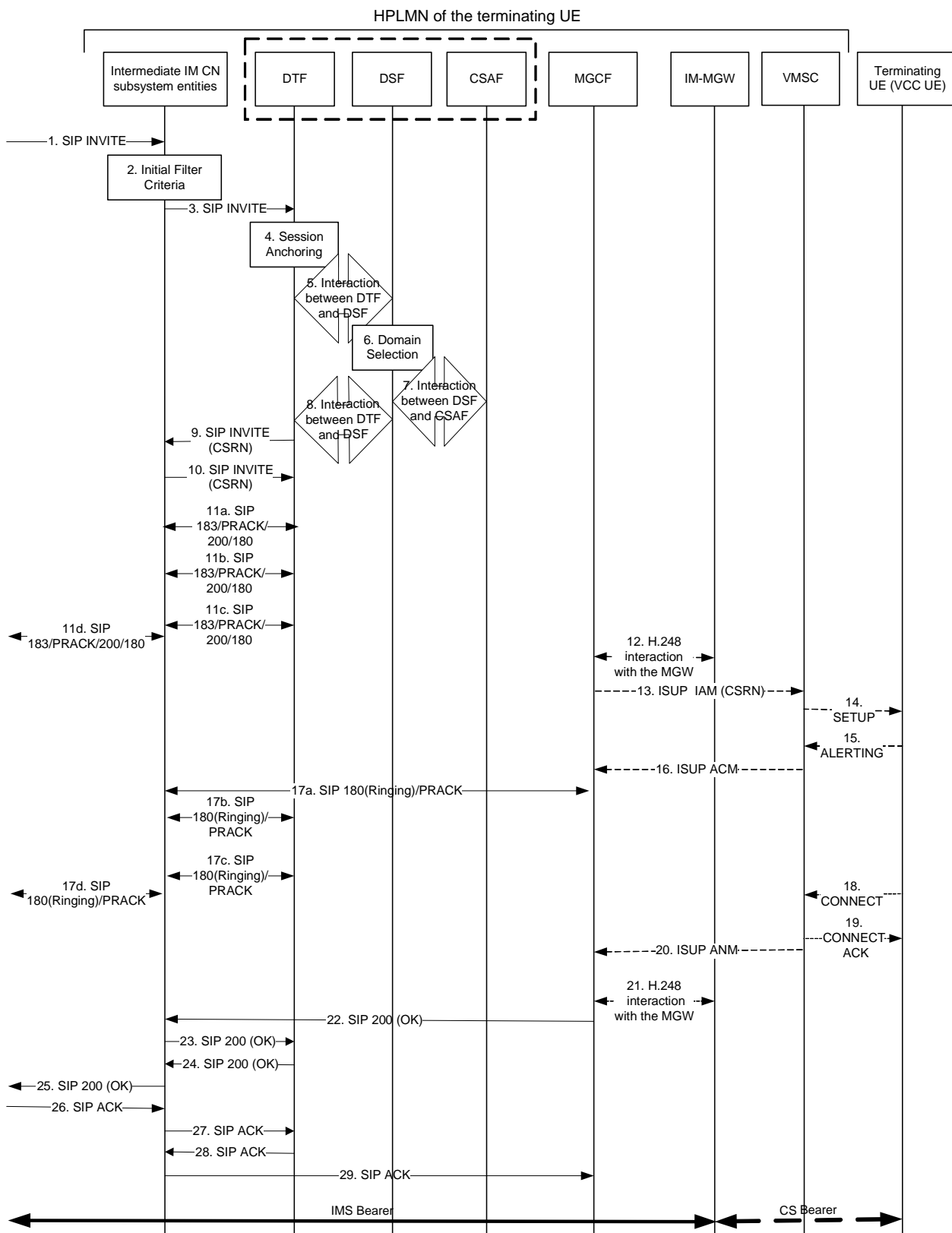

Figure A.5.3-1: Terminating call directed to CS

The details of the signalling flows are as follows:

Steps 1 to 5 are identical to the previous example in subclause A.5.2.

6. The DSF selects the terminating domain

The DSF performs domain selection based on operator and user preferences, registration and call states; in this example the DSF selects the CS domain to terminate the voice call.

7. Interaction between the DSF and CSAF

The DSF in combination with the CSAF determines the CS domain Routeing Number (CSRN).

The CSRN is a dynamic routeing number used for routeing into CS domain, i.e. to find the outgoing MGCF and then the terminating user's VMSC.

The interaction between the DSF and CSAF is outside the scope of this version of the specification.

8. Interaction between the DTF and DSF

In this example, information is exchanged between the DTF and DSF. The nature of this signalling is outside the scope of this version of the specification.

9. SIP INVITE request (DTF to intermediate IM CN subsystem entities) - see example in table A.5.3-9

Since the service execution continues as an terminating case, the DTF initiates a SIP INVITE request with the CSRN as the Request-URI and in the To header, and sends the SIP INVITE request back to the intermediate IM CN subsystem entities.

The DTF modifies the message in accordance with routeing B2BUA functionality, e.g. mapping of From, To, Cseq and Call-ID headers from one side of the B2BUA to the other.

The DTF inserts the original SDP from the originating SIP INVITE request.

Table A.5.3-9: SIP INVITE request (DTF to intermediate IM CN subsystem entities)

```
INVITE tel:+1-241-555-4444 SIP/2.0
Via: SIP/2.0/UDP sip:dtf2.home2.net; branch=z9jG4bK332b23.3, SIP/2.0/UDP
    scscf2.home2.net;branch=z9hG4bK332b23.1, SIP/2.0/UDP
    icscf2_s.home2.net;branch=z9hG4bK871y12.1, SIP/2.0/UDP
    scscf1.home1.net;branch=z9hG4bK332b23.1, SIP/2.0/UDP
    pcscf1.home1.net;branch=z9hG4bK431h23.1, SIP/2.0/UDP
    [5555::aaa:bbb:ccc:ddd]:1357;comp=sigcomp;branch=z9hG4bKknashds7
Max-Forwards: 65
Route: <sip:scscf2.home2.net;lr>;
Record-Route: <sip:dtf2.home2.net;lr>, <sip:scscf2.home2.net;lr>, <sip:scscf1.home1.net;lr>,
    <sip:pcscf1.home1.net;lr>
P-Asserted-Identity: "John Doe" <tel:+1-212-555-1111>
P-Access-Network-Info:
P-Charging-Vector: icid-value="AyretyU0dm+602IrT5tAFrbHLso=023551024"; orig-ioi="type
    3ashome1.net"
Privacy: none
Supported:
From:
To: <tel:+1-241-555-4444>
Call-ID:
Cseq:
Contact:
Allow:
Content-Type:
Content-Length: (...)

v=
o=
s=
c=
t=
m=
b=
a=
a=
a=
a=
a=
a=
a=
a=
a=
```

10. SIP INVITE request (intermediate IM CN subsystem entities to MGCF) - see example in table A.5.3-10

The intermediate IM CN subsystem entities deliver the SIP INVITE request to the MGCF. In this example, the MGCF is reached using a single BGCF.

Table A.5.3-10: SIP INVITE request (intermediate IM CN subsystem entities to MGCF)

```

INVITE tel:+1-241-555-4444 SIP/2.0
Via: SIP/2.0/UDP scscf2.home2.net;branch=z9hG4bK332b23.1, SIP/2.0/UDP sip:dtf2.home2.net;
    branch=z9jG4bK332b23.3, SIP/2.0/UDP scscf2.home2.net;branch=z9hG4bK332b23.1, SIP/2.0/UDP
    icscf2_s.home2.net;branch=z9hG4bK871y12.1, SIP/2.0/UDP
    scscf1.home1.net;branch=z9hG4bK332b23.1, SIP/2.0/UDP
    pcscf1.home1.net;branch=z9hG4bK431h23.1, SIP/2.0/UDP
    [5555::aaa:bbb:ccc:ddd]:1357;comp=sigcomp;branch=z9hG4bKnashds7
Max-Forwards: 63
Route: <sip:mgcf2.home2.net;lr>;
Record-Route: <sip:scscf2.home2.net;lr>, <sip:dtf2.home2.net;lr>, <sip:scscf2.home2.net;lr>,
    <sip:scscf1.home1.net;lr>, <sip:pcscf1.home1.net;lr>
P-Asserted-Identity: "John Doe" <tel:+1-212-555-1111>
P-Access-Network-Info:
P-Charging-Vector: icid-value="AyretyU0dm+602IrT5tAFrbHLso=023551024"; orig-ioi="type
    3ashome1.net"; term-ioi="home2.net"
Privacy:
Supported:
From:
To: <tel:+1-241-555-4444>
Call-ID:
Cseq:
Contact:
Allow:
Content-Type:
Content-Length: (...)

v=
o=
s=
c=
t=
m=
b=
a=
a=
a=
a=
a=
a=
a=
a=
a=
a=

```

11a-11d. SIP 183 (Session Progress) response / SIP PRACK request / SIP 200 (OK) response and Reliable exchange of SDP

Reliable exchange of SDP is initiated using the SIP 183 (Session Progress) response and the SIP PRACK request and response.

12. H.248 interaction with the IM-MGW

When the outgoing MGCF receives a SIP INVITE request with an SDP offer it will first interact with the IM-MGW to pick an outgoing channel and determine media capabilities, then can proceed with further SDP offer/answer with the originating UE and finally will instruct IM-MGW to reserve the resources necessary for the media streams.

13. ISUP IAM (MGCF to VMSC)

The MGCF interworks the SIP INVITE request into ISUP and initiates the ISUP IAM carrying the CSRN towards the VMSC on which the terminating VCC UE is currently registered (for the interworking ISUP / SIP function see 3GPP TS 29.163 [10]).

14. SETUP message (VMSC to terminating VCC UE)

The VMSC can derive from the CSRN the details of the called party and then initiates a paging procedure towards the terminating VCC UE.

After the VCC UE has successfully accessed the network, the VMSC sends to the UE the SETUP message (see 3GPP TS 24.008 [5]). There is no VCC specific information in the SETUP message.

15. ALERTING (terminating UE to VMSC)

For this example, the VMSC allows early local alerting. With the generation of local alerting, ALERTING is sent back from the UE to the VMSC. There is no VCC specific information in the ALERTING message.

16. ISUP ACM (VMSC to MGCF)

17a-17d. ISUP CPG, SIP 180 (Ringing) response and SIP PRACK request (end to end)

On receipt of the ALERTING message from the terminating VCC UE, the VMSC and the MGCF exchange ISUP to indicate that the called party confirmed the call and did start ringing the end user.

The VMSC starts resource allocation towards the terminating VCC UE.

Between VMSC and the IM-MGW resource allocation is also started.

18. CONNECT message (terminating VCC UE to VMSC)

When the user answers the call, the terminating VCC UE sends a CONNECT message to the VMSC. After sending the CONNECT message, the terminating VCC UE is ready to connect to user plane resources.

There is no VCC specific information in the CONNECT message.

19. CONNECT_ACK message (VMSC to terminating VCC UE)

The VMSC connects up the user plane and return CONNECT_ACK message to the terminating UE. Through connect all the way back to originating UE is not initiated.

There is no VCC specific information in the CONNECT_ACK message.

20. ISUP ANM (VMSC to MGCF)

The VMSC having through connected the user plane sends an indication of answer to the MGCF. This is the ISUP ANM.

21. H.248 interaction to start the media flow (MGCF to IM-MGW)

MGCF initiates a H.248 interaction to make the connection in the IM-MGW bi-directional.

22. SIP 200 (OK) final response (MGCF to intermediate IM CN subsystem entities)

Upon the receipt of the ISUP ANM from the MSC, and after the connection of the media flow, the MGCF sends the SIP 200 (OK) final response to the received SIP INVITE request (6) toward the IM CN subsystem. The SIP 200 (OK) response is sent by the MGCF on the behalf the terminating VCC UE over the signalling path to the terminating user's S-CSCF.

There is no VCC specific content to this response.

23. SIP 200 (OK) final response (from intermediate IM CN subsystem entities to DTF)

The intermediate IM CN subsystem entities forward the SIP 200 (OK) final response to the DTF.

There is no VCC specific content to this response.

24. SIP 200 (OK) final response (from DTF to intermediate IM CN subsystem entities)

The SIP 200 (OK) final response is sent back to the terminating user's S-CSCF by the DTF.

The DTF modifies the message in accordance with routing B2BUA functionality, e.g. mapping of From, To, Cseq and Call-ID headers from one side of the B2BUA to the other.

There is no VCC specific content to this response.

25. SIP 200 (OK) final response (intermediate IM CN subsystem entities to originating IM CN subsystem)

The SIP 200 (OK) response is returned to the originating UE through the originating IM CN subsystem, by the terminating user's intermediate IM CN subsystem entities.

There is no VCC specific content to this response.

26. SIP ACK request (from the originating IM CN subsystem to intermediate IM CN subsystem entities)

The originating UE sends the final acknowledgement to the terminating user's IM CN subsystem through the originating IM CN subsystem to the intermediate IM CN subsystem entities of the terminating user.

There is no VCC specific content to this request.

27. SIP ACK request (intermediate IM CN subsystem entities to DTF)

The terminating user intermediate IM CN subsystem entities forward the SIP ACK request to the DTF.

There is no VCC specific content to this request.

28. SIP ACK request (DTF to intermediate IM CN subsystem entities)

The DTF sends the SIP ACK request back to terminating user's intermediate IM CN subsystem entities.

The DTF modifies the message in accordance with routing B2BUA functionality, e.g. mapping of From, To, Cseq and Call-ID headers from one side of the B2BUA to the other.

There is no VCC specific content to this request.

29. SIP ACK request (intermediate IM CN subsystem entities to MGCF)

The terminating user's intermediate IM CN subsystem entities forward the SIP ACK request to the MGCF and that concludes the terminating call signalling.

There is no VCC specific content to this request.

A.5.4 Signalling flows for termination directed to IM CN subsystem (coming from the CS domain) (using CAMEL)

Figure A.5.4-1 shows the termination of a call that is capable of being subject to VCC, where the calling party call is coming from CS and where the called party is terminating in its home IM CN subsystem.

For call termination, the use of CAMEL in the context of VCC is optional. In this example the GMSC support and will use terminating CAMEL service logic.

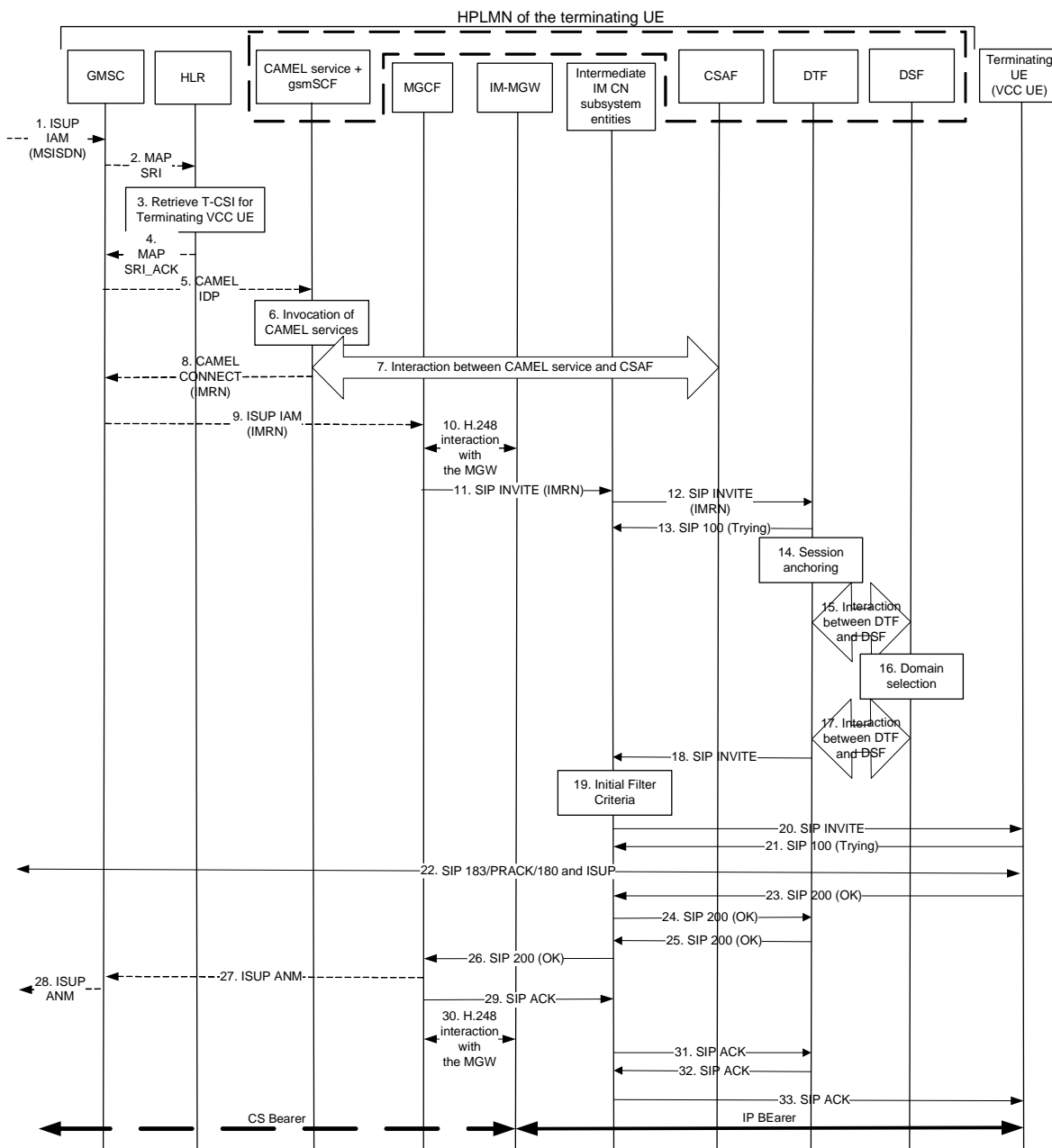

Figure A.5.4-1: Terminating call coming from CS domain (using CAMEL)

The details of the signalling flows are as follows:

1. **ISUP IAM (coming from the originating PLMN through the CS domain)**

In this example, a call request (ISUP IAM) makes an entry from the PLMN of the originating user (calling party) into the home PLMN of the terminating user (called party). The first entry point of the PLMN of the terminating user is the Gateway MSC (GMSC). The call request is a form of an ISUP IAM (Initial Address Message) and contains the called party number (MSISDN)

In this example the MSISDN of the called party is +1-212-123.2222.

2. **MAP Send Routing Information (SRI) (GMSC to HLR)**

On receipt of the incoming call request, the GMSC queries the HLR for routing information.

3. **Retrieval of VCC subscriber information**

The HLR provides information including the T-CSI information element that contains information configured for the VCC subscriber, identifying the subscriber as having terminating CAMEL services. The T-CSI IE also includes the gsmSCF address.

4. MAP Send Routing Information Acknowledgement (SRI ACK) (HLR to GMSC)

The HLR returns the T-CSI information element to the GMSC in response to the query for routing information (SRI). The GMSC now has the address of the gsmSCF.

5. CAMEL IDP (GMSC to gsmSCF)

The GMSC triggers a CAMEL activity which results in sending a CAMEL IDP message to the GSM Service Control Function (gsmSCF). The CAMEL IDP message contains at least:

- the calling party number;
- the called parting number;
- the type of call; and
- information from the T-CSI IE received by the GMSC in the SRI ACK from the HLR. This includes the CAMEL service key.

NOTE: The CAMEL service key can be shared among different CAMEL services, for example, if a VCC subscriber is also a prepaid customer.

6. Reroute to IMS determination

The gsmSCF invokes service logic to determine whether the call needs to be rerouted to IM CN subsystem for VCC.

7. Interaction between CAMEL service and CSAF

Communication is required between the CAMEL service function and the CSAF in order to ensure that the nature of the call associated with the IMRN is known by the CSAF. The signalling to support this communication is not specified in this version of the specification.

8. CAMEL CONNECT (gsmSCF to GMSC)

The gsmSCF to respond to the CAMEL IDP message with a CAMEL CONNECT message containing:

- the Destination Routeing Address set to the IMRN.

The IMRN is subsequently used to route the call to the VCC application through the IM CN subsystem.

9. ISUP IAM (GMSC to MGCF)

The GMSC initiates the CS call towards the MGCF by sending out the ISUP IAM.

Specifically for this signalling flow, the IAM includes:

- called party number parameter = [(Numbering plan identifier = ISDN/telephony numbering plan), (type of number = international number), (Number digits = 12415553333)]
- calling party number parameter = [(Numbering plan identifier = ISDN/telephony numbering plan), (type of number = international number), (Number digits = 12125551111)]
- USI parameter = 3.1 kHz audio

The called party number parameter represents the IMRN allocated for this call.

10. H.248 interaction with the IM-MGW

When the MGCF receives the incoming call from the CS domain it will first interact with the IM-MGW to reserve the resources necessary for the media streams and determines the SDP parameter of the outgoing SIP INVITE request.

11. SIP INVITE request (MGCF to intermediate IM CN subsystem entities) – see example in table A.5.4-11

The MGCF initiates a SIP INVITE request, containing an initial SDP towards the I-CSCF in the home IM CN subsystem of the terminating VCC user. This routing is based on the IMRN.

The Request-URI contains the IMRN, as obtained from CS networks signalling.

The P-Asserted-Identity contains the tel URI of the calling party as received from the CS network.

Based on what is received in the ISUP, the MGCF identifies the incoming call as speech call and includes in the SDP a preconfigured set of codecs supported by the MGW (for more details see 3GPP TS 29.163 [10]).

Table A.5.4-11: SIP INVITE request (MGCF to intermediate IM CN subsystem entities)

```
INVITE tel:+1-241-555-3333 SIP/2.0
Via: SIP/2.0/UDP mgcf2.home1.net;branch=z9hG4bK779s24.0
Max-Forwards: 70
Route: <sip:icscf2.home2.net;lr>
P-Asserted-Identity: <tel:+1-212-555-1111>
P-Charging-Vector: icid-value="AyretyU0dm+6O2IrT5tAFrbHLso=023551024"; orig-ioi="home1.net"
Privacy: none
From: <tel:+1-212-555-1111>;tag=171828
To: <tel:+1-212-555-3333>
Call-ID: cb03a0s09a2sdfgkjl490333
Cseq: 127 INVITE
Supported: 100rel
Contact: <sip:mgcf2.home2.net>
Allow: INVITE, ACK, CANCEL, BYE, PRACK, UPDATE
Content-Type: application/sdp
Content-Length: (...)

v=0
o=- 2987933615 2987933615 IN IP6 5555::aaa:bbb:ccc:ddd
s=-
c=IN IP6 5555::aaa:bbb:ccc:ddd
t=0 0
m=audio 3456 RTP/AVP 97 96
b=AS:25.4
a=curr:qos local sendrecv
a=curr:qos remote none
a=des:qos mandatory local sendrecv
a=des:qos none remote sendrecv
a=rtpmap:97 AMR
a=fmtp:97 mode-set=0,2,5,7; mode-change-period=2
a=rtpmap:96 telephone-event
a=maxptime:20
```

12. SIP INVITE request (intermediate IM CN subsystem entities to DTF) – see example in table A.5.4-12

The IMRN is a PSI. The intermediate IM CN subsystem entities are configured to route requests to this PSI to the DTF. The SIP INVITE request is therefore forwarded to the DTF.

Table A.5.4-12: SIP INVITE request (intermediate IM CN subsystem entities to DTF)

```

INVITE tel:+1-212-555-3333 SIP/2.0
Via: SIP/2.0/UDP mgcf2.home2.net;branch=z9hG4bK779s24.0, SIP/2.0/UDP
    icscf2.home2.net;branch=z9hG4bK312a32.1
Max-Forwards: 69
Route: <sip:dtf2.home2.net;lr>
P-Asserted-Identity:
P-Charging-Vector: icid-value="AyretyU0dm+602IrT5tAFrbHLso=023551024"; orig-ioi="type
3home1.net"; orig-ioi="home1.net"
Privacy:
From:
To:
Call-ID:
Cseq:
Supported:
Contact:
Allow:
Content-Type:
Content-Length: (...)

```

```

v=
o=
s=
c=
t=
m=
b=
a=
a=
a=
a=
a=
a=
a=
a=
a=

```

13. SIP 100 (Trying) response (DTF to intermediate IM CN subsystem entities)

There is no VCC specific content to this response.

14. Session anchoring

In this example, the DTF decides here that this call will be anchored, based on the type of call and operator preferences.

15. Interaction between the DTF and DSF

In this example, information is exchanged between the DTF and DSF. The nature of this signalling is outside the scope of this version of the specification.

16. Domain selection

The CSAF retrieves the original called party number and calling party number associated with the IMRN and DSF performs domain selection based on operator and user preferences, registration and call states; in this example the DSF selects the IM CN subsystem to terminate the call.

17. Interaction between the DTF and DSF

In this example, information is exchanged between the DTF and DSF. The nature of this signalling is outside the scope of this version of the specification.

The DTF acts as a routing B2BUA, thus it initiates the outgoing request and places the called party number in the Request-URI and the To header.

After this step, the IMRN associated with this session is available for reuse.

18. SIP INVITE request (DTF to intermediate IM CN subsystem entities) – see example in table A.5.4-18

The DTF forwards the SIP INVITE request to the S-CSCF serving the terminating user within the IM CN subsystem.

The DTF modifies the message in accordance with routing B2BUA functionality, e.g. mapping of From, To, Cseq and Call-ID headers from one side of the B2BUA to the other.

The DTF sets the value of the Contact header with the address of the DTF that will provide the transfer functionality needed to support VCC.

In the case where the Request-URI of the SIP INVITE request contains a tel-URL, the S-CSCF (next hop) will have to translate to a globally routeable SIP-URI before applying it as Request-URI of the outgoing SIP INVITE request toward the terminating user.

Table A.5.4-18: SIP INVITE request (DTF to intermediate IM CN subsystem entities)

```

INVITE tel:+1-212-555-2222 SIP/2.0
Via: SIP/2.0/UDP dtf2.home2.net; branch=z9hG4bK779s24.0, SIP/2.0/UDP
    mgcf2.home2.net;branch=z9hG4bK779s24.0, SIP/2.0/UDP
    icscf2.home2.net;branch=z9hG4bK312a32.1
Max-Forwards: 68
Route: <sip:s-cscf.home2.net;lr>
P-Asserted-Identity:
P-Charging-Vector: icid-value="AyretyU0dm+602IrT5tAFrbHLso=023551024";
    orig-ioi="Type 3home1.net"
Privacy:
From:
To: <tel:+1-212-555-2222>
Call-ID: dc14b1t10b3teghmlk501444
Cseq:
Supported:
Contact: <sip:dtf2.home2.net>
Allow:
Content-Type:
Content-Length: (...)

v=
o=
s=
c=
t=
m=
b=
a=
a=
a=
a=
a=
a=
a=
a=
a=
a=

```

19. Evaluation of initial filter criteria

In this example, the S-CSCF continues the triggering from the next trigger point. Since no more triggering is required in the initial filter criteria, the IM CN subsystem will route the SIP INVITE request to the terminating user based on its SIP URI.

20. SIP INVITE request (intermediate IM CN subsystem entities to VCC UE) – see example in table A.5.4-20

The terminating user's intermediate IM CN subsystem entities forward the SIP INVITE request towards the terminating VCC UE.

Table A.5.4-20: SIP INVITE request (intermediate IM CN subsystem entities to VCC UE)

```

INVITE sip:[5555::eee:fff:aaa:bbb]:8805;comp=sigcomp SIP/2.0
Via: SIP/2.0/UDP pcscf2.home2.net:5088;comp=sigcomp;branch=z9hG4bK876t12.1, SIP/2.0/UDP
scscf2.home2.net;branch=z9hG4bK764z87.1, SIP/2.0/UDP sip:dtf2.home2.net;
branch=z9jG4bK332b23.3, SIP/2.0/UDP scscf2.home2.net;branch=z9hG4bK332b23.1, SIP/2.0/UDP
icscf2.home2.net;branch=z9hG4bK871y12.1, SIP/2.0/UDP
mgcf2.home2.net;branch=z9hG4bK332b23.1,
Max-Forwards: 67
Record-Route:
P-Asserted-Identity:
Privacy:
From:
To:
Call-ID:
Cseq:
Require:
Supported:
Contact:
Allow:
P-Called-Party-ID:
P-Media-Authorization:
Content-Type:
Content-Length:

v=
o=
s=
c=
t=
m=
b=
a=
a=
a=
a=
a=
a=
a=
a=
a=
a=

```

21. SIP 100 (Trying) response (VCC UE to intermediate IM CN subsystem entities)

The VCC UE responds to the intermediate IM CN subsystem entities with a SIP 100 (Trying) response.

There is no VCC specific content to this response.

22. Reliable exchange of SDP and Ringing/Alerting signalling

The terminating UE accepts the session request and reserves an IP-CAN bearer for the message session media component.

SDP offer/answer exchange can happen between the called party and the MGCF.

End users signals end to end ringing/alerting

23. SIP 200 (OK) response (UE to intermediate IM CN subsystem entities)

When the called party answers, the UE sends a SIP 200 (OK) final response to the SIP INVITE request (16) to the intermediate IM CN subsystem entities, and starts the media flow(s) for this session.

There is no VCC specific content to this response.

24. SIP 200 (OK) response (intermediate IM CN subsystem entities to DTF)

The intermediate IM CN subsystem entities forward the SIP 200 (OK) response to the DTF.

There is no VCC specific content to this response.

25. SIP 200 (OK) response (DTF to intermediate IM CN subsystem entities)

The DTF sends the SIP 200 (OK) response back to the intermediate IM CN subsystem entities.

The DTF modifies the message in accordance with routing B2BUA functionality, e.g. mapping of From, To, Cseq and Call-ID headers from one side of the B2BUA to the other.

There is no VCC specific content to this response.

26. SIP 200 (OK) response (intermediate IM CN subsystem entities to MGCF)

The terminating user's intermediate IM CN subsystem entities forward the SIP 200 (OK) final response to the MGCF.

There is no VCC specific content to this response.

27. ISUP ANM (MGCF to GMSC)

The MGCF indicates the call has been answered back to the GMSC with an ISUP ANM.

There is no VCC specific content in this message.

28. ISUP ANM (GMSC to the originating user's PLMN)

The GMSC forwards the ISUP ANM to the originating user's PLMN.

There is no VCC specific content in this message.

29. SIP ACK request (MGCF to intermediate IM CN subsystem entities)

Having indicated the call has been answered toward the originating user, the MGCF acknowledges the SIP 200 (OK) response with the SIP ACK request to the intermediate IM CN subsystem entities.

There is no VCC specific content to this request.

30. H.248 interaction to start the media flow (MGCF)

MGCF initiates a H.248 interaction to make the connection in the IM-MGW bi-directional.

31. SIP ACK request (intermediate IM CN subsystem entities to DTF)

The intermediate IM CN subsystem entities forward the SIP ACK request to the DTF.

There is no VCC specific content to this request.

32. SIP ACK request (DTF to intermediate IM CN subsystem entities)

The DTF sends the SIP ACK request back to the intermediate IM CN subsystem entities.

The DTF modifies the message in accordance with routing B2BUA functionality, e.g. mapping of From, To, Cseq and Call-ID headers from one side of the B2BUA to the other.

There is no VCC specific content to this request.

33. SIP ACK request (intermediate IM CN subsystem entities to VCC UE)

The intermediate IM CN subsystem entities forward the SIP ACK request to the VCC UE.

There is no VCC specific content to this request.

A.5.5 Signalling flow for termination directed to CS domain (coming from the CS domain)

Figure A.5.5-1 illustrate an example signalling flow of a voice call to a VCC UE coming in through the CS domain, getting anchored to the VCC application within the IM subsystem and then delivered to the terminating VCC UE through the CS domain.

In this example, the terminating UE is in his/her HPLMN.

In this example, this PLMN does not utilise terminating CAMEL service logic. Rather this example illustrates HSS(HLR) directed call diversion to the IM CN subsystem where the HSS(HLR), through internal network implementation, can obtain the IMRN.

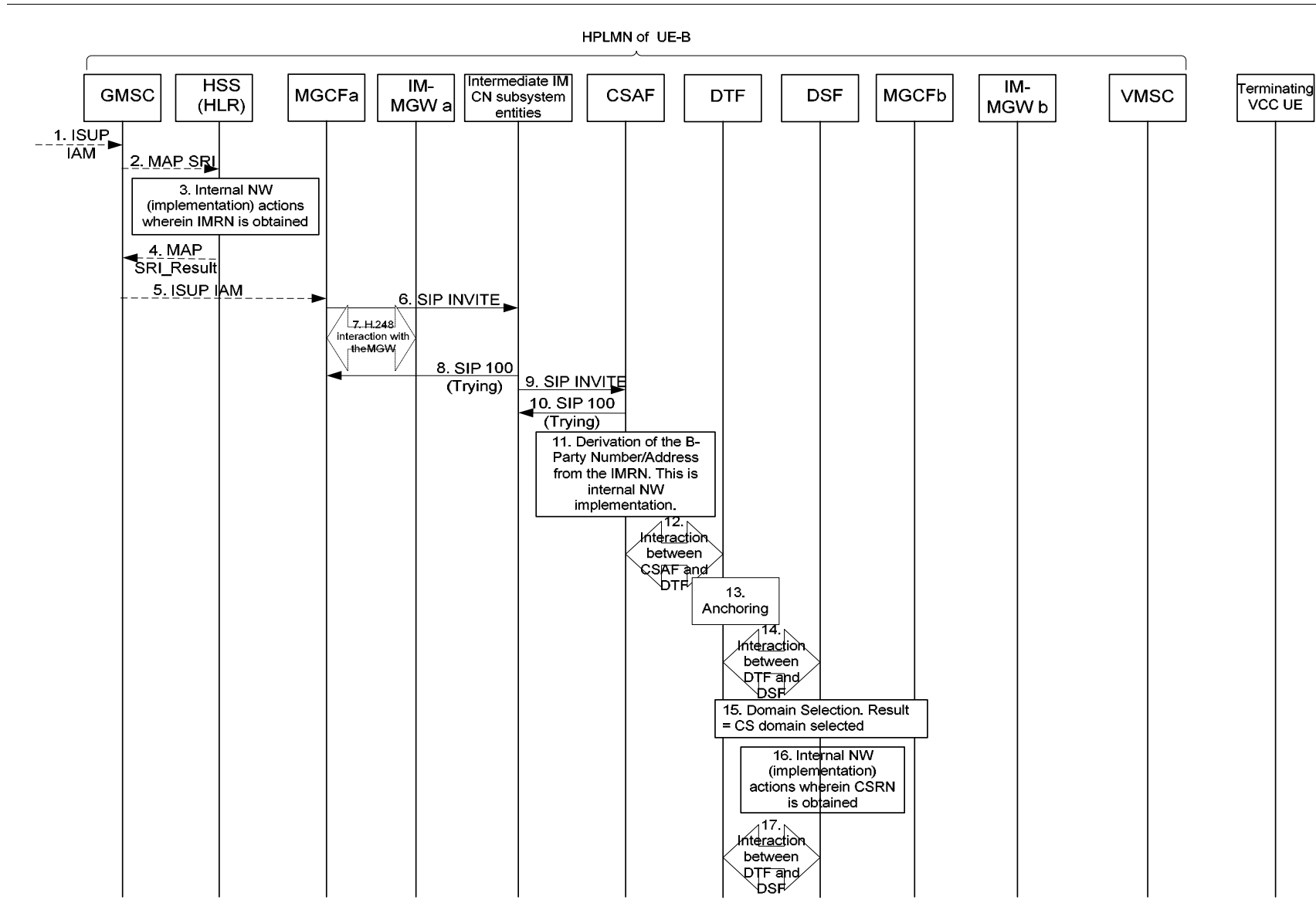

Figure A.5.5-1: Terminating call coming in through CS domain and delivered through the CS domain

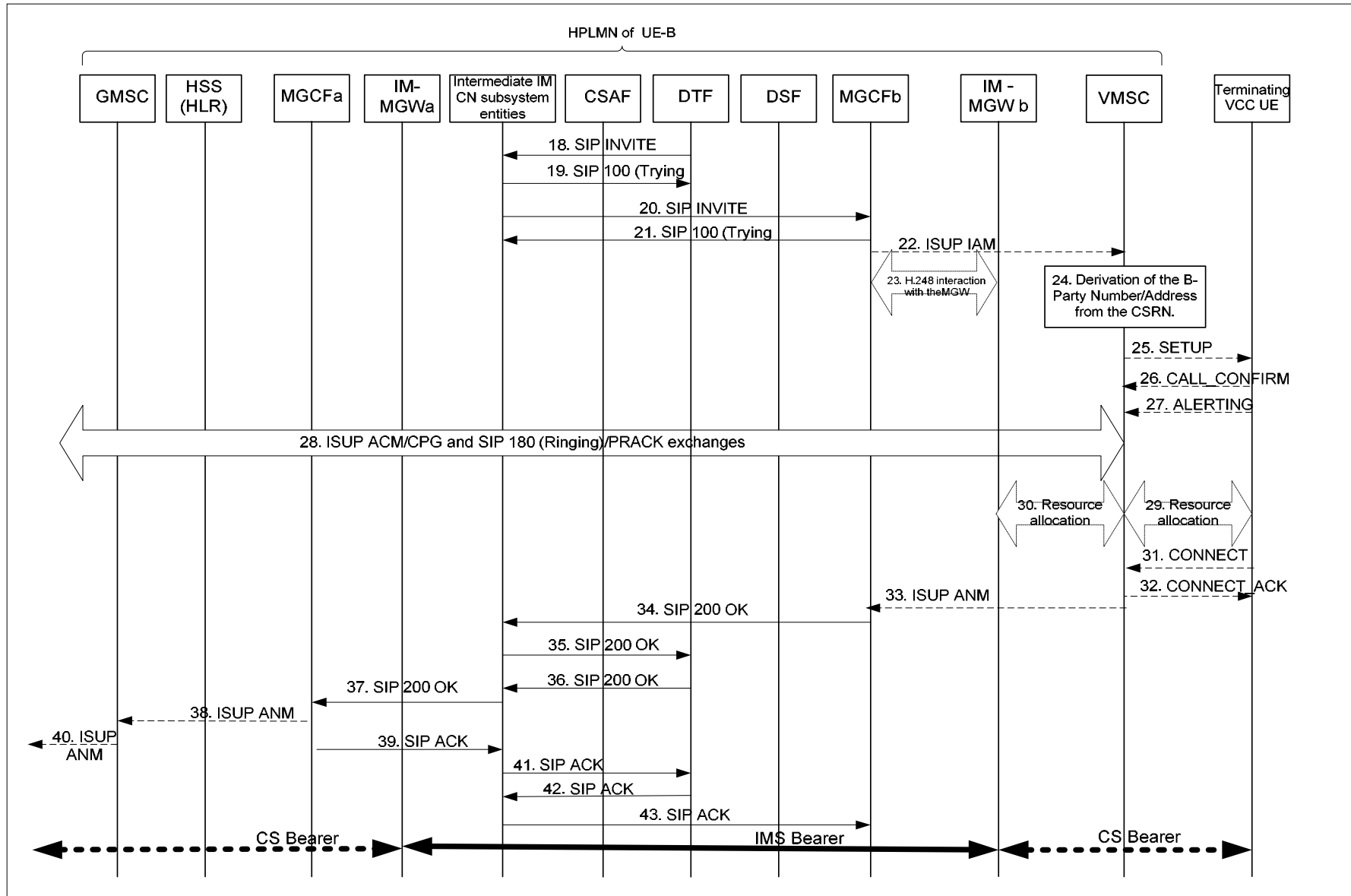

Figure A.5.5-1: Terminating call coming in through CS domain and delivered through the CS domain (continued)

The details of the signalling flows are as follows:

1. ISUP IAM (coming into this PLMN through the CS domain)

A call request makes an entry into this PLMN. First entry point is the GMSC.
This Initial Address Message contains the MSISDN of the called party
In this example the MSISDN is +1-212-123.2222.

2. MAP SEND_ROUTING_INFORMATION (GMSC to HSS/HLR)

GMSC makes a query to the HSS/HLR for routing information for onward routing of the incoming call request.
This GMSC query SEND_ROUTING_INFORMATION contain the MSISDN of the called party.

3. Derivation of IMRN

Internal network actions - not indicated here as those actions are implementation and network dependent – are taken. The result is that (for this example) a decision is made to route the call further onwards into the IM CN subsystem.

In particular an IMRN is obtained in these internal network actions.

For this example the derived IMRN is +1-212-123-3333.

NOTE 1: It is an implementation and network option whether the derivation of the IMRN takes in the decision to anchor the call to the DTF.

4. MAP SEND_ROUTING_INFORMATION_RESULT (HSS/HLR to GMSC)

The HSS/HLR replies to the query by GMSC with the SEND_ROUTING_INFORMATION_RESULT providing with it the IMRN

5. ISUP IAM (GMSC to MGCFa)

GMSC sends out IAM (IMRN). The IMRN is that which will direct the routing of the IAM to the MGCF.
In this example, the IAM (IMRN = +1-241-555-3333) is routed to MGCFa.

6. SIP INVITE request (MGCFa towards the CSAF through the intermediate IM CN subsystem entities) – see example in table A.5.5-6

The MGCF interworks the IAM (IMRN) into the appropriate SIP message and initiates the SIP INVITE request towards the CSAF via the intermediate IM CN subsystem entities.

Table A.5.5-6: SIP INVITE request (MGCFa towards the CSAF through the intermediate IM CN subsystem entities)

```

INVITE tel:+1-241-555-3333 SIP/2.0
Via: SIP/2.0/UDP mgcf1.home1.net;branch=z9hG4bK779s24.0
Max-Forwards: 70
Route: <sip:icscf1_s.home1.net;lr>
P-Asserted-Identity: <tel:+1-212-555-1111>
P-Charging-Vector: icid-value="AyretyU0dm+602IrT5tAFrbHLso=023551024"; orig-ioi=home1.net
Privacy: none
From: <tel:+1-212-555-1111>;tag=171828
To: <tel:+1-212-555-3333>
Call-ID: cb03a0s09a2sdfg1kj490333
Cseq: 127 INVITE
Supported: 100rel
Contact: <sip:mgcf1.home1.net>
Allow: INVITE, ACK, CANCEL, BYE, PRACK, UPDATE
Content-Type: application/sdp
Content-Length: (...)

v=0
o=- 2987933615 2987933615 IN IP6 5555::aaa:bbb:ccc:ddd
s=-
c=IN IP6 5555::aaa:bbb:ccc:ddd
t=0 0
m=audio 3456 RTP/AVP 97 96
b=AS:25.4
a=curr:qos local sendrecv
a=curr:qos remote none
a=des:qos mandatory local sendrecv
a=des:qos none remote sendrecv
a=rtpmap:97 AMR
a=fmtp:97 mode-set=0,2,5,7; mode-change-period=2
a=rtpmap:96 telephone-event
a=maxptime:20

```

7. H.248 interaction with the MGW

The MGCF interacts with the MGW for the necessary resource allocation.

8. SIP 100 (Trying) response (intermediate IM CN subsystem entities to MGCFa)

The intermediate IM CN subsystem entities respond to the MGCFa with a SIP 100 (Trying) response.

There is no VCC specific content to this response.

9. SIP INVITE request (intermediate IM CN subsystem entities to the CSAF) – see example in table A.5.5-9

The IMRN is a PSI. The intermediate IM CN subsystem entities are configured to route this PSI to the CSAF. In this particular case, the I-CSCF performs the routing over the Ma interface. For this example, there is no IBCF before the I-CSCF and no intermediate entities Record-Route the request.

Table A.5.5-9: SIP INVITE request (intermediate IM CN subsystem entities to the CSAF)

```

INVITE tel:+1-241-555-3333 SIP/2.0
Via: SIP/2.0/UDP mgcf1.home1.net;branch=z9hG4bK779s24.0, SIP/2.0/UDP
    icscf1_s.home1.net;branch=z9hG4bK312a32.1
Max-Forwards: 69
Route: <sip:as.home1.net;lr>
P-Asserted-Identity:
P-Charging-Vector: icid-value="AyretyU0dm+602IrT5tAFrbHLso=023551024"; orig-ioi=type
3home1.net; orig-ioi=home1.net
Privacy:
From:
To:
Call-ID:
Cseq:
Supported:
Contact:
Allow:
Content-Type:
Content-Length: (...)

v=
o=
s=
c=
t=
m=
b=
a=
a=
a=
a=
a=
a=
a=
a=
a=

```

10. SIP 100 (Trying) response (CSAF to intermediate IM CN subsystem entities)

The CSAF responds to the intermediate IM CN subsystem entities with a SIP 100 (Trying) response.

There is no VCC specific content to this response.

11. Retrieval of the called party details from IMRN

From the IMRN the CSAF retrieves the called party details. This retrieval process is implementation dependent.

NOTE 2: It is a further implementation dependent option whether the decision to anchor the call such that VCC feature can be made available to the called party is made at this step.

12. Interaction between CSAF and DTF

Information is exchanged between the CSAF and DTF. The nature of this signalling is outside the scope of this version of the specification.

13. Anchoring

The DTF performs the anchoring of the session.

14. Interaction between the DTF and DSF

In this example, information is exchanged between the DTF and DSF. The nature of this signalling is outside the scope of this version of the specification.

15. Domain selection

A decision has now to be made on which domain the terminating call is to be delivered. This decision is implementation specific.

For this example, the decision is to deliver the terminating call through the CS domain.

16. Derivation of the CSRN

Having made the decision of delivering the call (for this example) in the CS domain, the DSF derives the CSRN. The CSRN will allow the call to be routed further into the CS domain. The derivation of the CSRN is implementation specific.

For this example, the CSRN = +1-241-555-4444

17. Interaction between DTF and DSF

Information is exchanged between the DTF and DSF. The nature of this signalling is outside the scope of this version of the specification.

18. SIP INVITE request (DTF to intermediate IM CN subsystem entities) – see example in table A.5.5-18

Having derived the CSRN, the DTF now acts a routeing B2BUA and initiates a SIP INVITE request with the CSRN as the Request-URI. The SIP INVITE request is sent back to the intermediate IM CN subsystem entities.

The DTF modifies the message in accordance with routeing B2BUA functionality, e.g. mapping of From, To, Cseq and Call-ID headers from one side of the B2BUA to the other.

Table A.5.5-18: SIP INVITE request (DTF to intermediate IM CN subsystem entities)

```
INVITE tel:+1-241-555-4444 SIP/2.0
Via: SIP/2.0/UDP;branch=z9hG4bK312a32.1
Max-Forwards: 68
Route: <sip:s-cscf.home1.net;lr>
P-Asserted-Identity:
P-Charging-Vector: icid-value="AyretyU0dm+6O2IrT5tAFrbHLso=023551024"; orig-ioi=Type
  3home1.net
Privacy:
From:
To: <tel:+1-212-555-2222>
Call-ID: dc14b1t10b3teghmlk501444
Cseq:
Supported:
Contact: <sip:dtf2.home2.net>
Allow:
Content-Type:
Content-Length: (...)

v=
o=
s=
c=
t=
m=
b=
a=
a=
a=
a=
a=
a=
a=
a=
a=
a=
```

19. SIP 100 (Trying) response (intermediate IM CN subsystem entities to DTF)

The intermediate IM CN subsystem entities respond to the DTF with a SIP 100 (Trying) response.

There is no VCC specific content to this response.

20. SIP INVITE request (intermediate IM CN subsystem entities to MGCFb)

The intermediate IM CN subsystem delivers the SIP INVITE request to the MGCF. In this example this is a different MCGF than the MGCF which receives the ISUP IAM carrying the IMRN. In this example the SIP INVITE request with the CSRN is directed to MGCFb.

This example signalling flow involving different MGCF further illustrates a pragmatic example of call distribution to different MGCFs of one network.

21. SIP 100 (Trying) response (MGCFb to intermediate IM CN subsystem entities)

The MGCF responds to the intermediate IM CN subsystem entities with a SIP 100 (Trying) response.

There is no VCC specific content to this response.

22. ISUP IAM (MGCFb to VMSC)

The MGCF interworks the SIP INVITE request to the ISUP and initiates the ISUP IAM carrying the CSRN towards the VMSC.

23. H.248 interaction with the MGW

The MGCF interacts with the MGW for the necessary resource allocation.

24. Retrieval of the called party details from CSRN

The VMSC can from the CSRN retrieve the details of the called party and with that initiates a paging procedure towards the terminating UE.

25. SETUP message (VMSC to terminating VCC UE)

After the UE has successfully accessed the network, the VMSC sends to the VCC UE the 24.008 SETUP message.

There is no VCC specific content in this message.

For this example, the VMSC allows early local alerting.

26. CALL_CONFIRM message (Terminating VCC UE to VMSC)

The terminating UE acknowledges and confirms acceptance of the incoming call by sending a CONFIRM back to the VMSC. There is no VCC specific content in this message.

27. ALERTING message (terminating VCC UE to VMSC)

For this example, the VMSC allows early local alerting. With the generation of local alerting, an ALERTING message is sent back from the VCC UE to the VMSC. There is no VCC specific content in this message.

28. ACM, CPG, SIP 180 (Ringing) response and SIP PRACK request (VMSC to MGCFb through IM CN subsystem to the originating end)

On receipt of the ALERTING message from the terminating VCC UE, the VMSC, MGCF, IM CN subsystem and the originating UE exchange ISUP and SIP signalling to indicate that the called party confirmed the call and did start ringing the end user.

29. Resource allocation (MSC to terminating VCC UE and VMSC)

The VMSC starts resource allocation towards the terminating VCC UE.

30. Resource allocation (VMSC to MGWb)

Between VMSC and the IM-MGW resource allocation is also started.

31. CONNECT message (terminating VCC UE to VMSC)

When the user answers the call, the terminating VCC UE sends a CONNECT message to the VMSC. After sending the CONNECT message, the terminating VCC UE is ready to connect to user plane resources.

There is no VCC specific content in this message.

32. CONNECT_ACK message (VMSC to terminating VCC UE)

VMSC connects up the user plane and return a CONNECT_ACKNOWLEDGE message to the terminating VCC UE.

There is no VCC specific content in this message.

Through connect all the way back to originating UE is not initiated.

33. ISUP ANM (VMSC to MGCFb)

The VMSC having through connected the user plane sends an indication of answer to the MGCFb. This is the ISUP ANM.

There is no VCC specific content in this message.

34. SIP 200 (OK) response (MGCFb to intermediate IM CN subsystem entities meant for DTF)

Upon the receipt of the ANM from the VMSC, and after the connection of the media flow, the MGCFb sends the SIP 200 (OK) final response to the received SIP INVITE request (in step 15) back to the DTF via the intermediate IM CN subsystem entities.

There is no VCC specific content to this response.

35. SIP 200 (OK) response (intermediate IM CN subsystem entities to DTF)

The SIP 200 (OK) final response is forwarded to the VCC application, by the intermediate IM CN subsystem entities.

There is no VCC specific content to this response.

36. SIP 200 (OK) response (DTF to intermediate IM CN subsystem entities meant for MGCFa)

The DTF sends the SIP 200 (OK) final response back to the MGCFa relating to the received SIP INVITE request (in step 8). This is sent through the intermediate IM CN subsystem entities.

The DTF modifies the message in accordance with routing B2BUA functionality, e.g. mapping of From, To, Cseq and Call-ID headers from one side of the B2BUA to the other.

There is no VCC specific content to this response.

37. SIP 200 (OK) response (intermediate IM CN subsystem entities delivering to MGCFa)

The SIP 200 (OK) final response is forwarded to the MGCFa by the intermediate IM CN subsystem entities.

There is no VCC specific content to this response.

38. ISUP ANM (MGCFa to GMSC)

The MGCF indicates call has been answered back to the GMSC with ISUP ANM.

There is no VCC specific content in this message.

39. SIP ACK request (MGCFa to intermediate IM CN subsystem entities meant for DTF)

Having indicate the call has been answered to the GMSC, MGCFa acknowledges the SIP 200 (OK) response with the SIP ACK request to the DTF. This is sent through the intermediate IM CN subsystem entities.

There is no VCC specific content to this request.

40. ISUP ANM (GMSC towards originating end)

GMSC sends an indication of call answer towards the originating side.

41. SIP ACK request (intermediate IM CN subsystem entities to DTF)

The intermediate IM CN subsystem entities deliver the SIP ACK request to the DTF.

There is no VCC specific content to this request.

42. SIP ACK request (DTF to intermediate IM CN subsystem entities meant for MGCFb)

DTF in turn acknowledges the MGCFb with the SIP ACK request. This is sent through the intermediate IM CN subsystem entities.

The DTF modifies the message in accordance with routing B2BUA functionality, e.g. mapping of From, To, Cseq and Call-ID headers from one side of the B2BUA to the other.

There is no VCC specific content to this request.

43. SIP ACK request (intermediate IM CN subsystem entities to MGCFb)

The SIP ACK request is delivered to the MGCFb by the intermediate IM CN subsystem entities.

There is no VCC specific content to this request.

A.5.6 Signalling flows with call termination delivery attempt failure to the IM CN subsystem

Figure A.5.6-1 shows the termination of a call that is capable of being subject to VCC, where the call delivery attempt to the IM CN subsystem fails. In this example and following information available at the VCC application, the call termination is re-attempted on the CS domain, 2nd domain available.

In this example, when the VCC Application receives the indication that delivery of the terminating call through the selected IM CN subsystem cannot be completed, the VCC application performs an implementation option to attempt delivery of the terminating call through the CS domain. Use of this implementation option depends on operator policies.

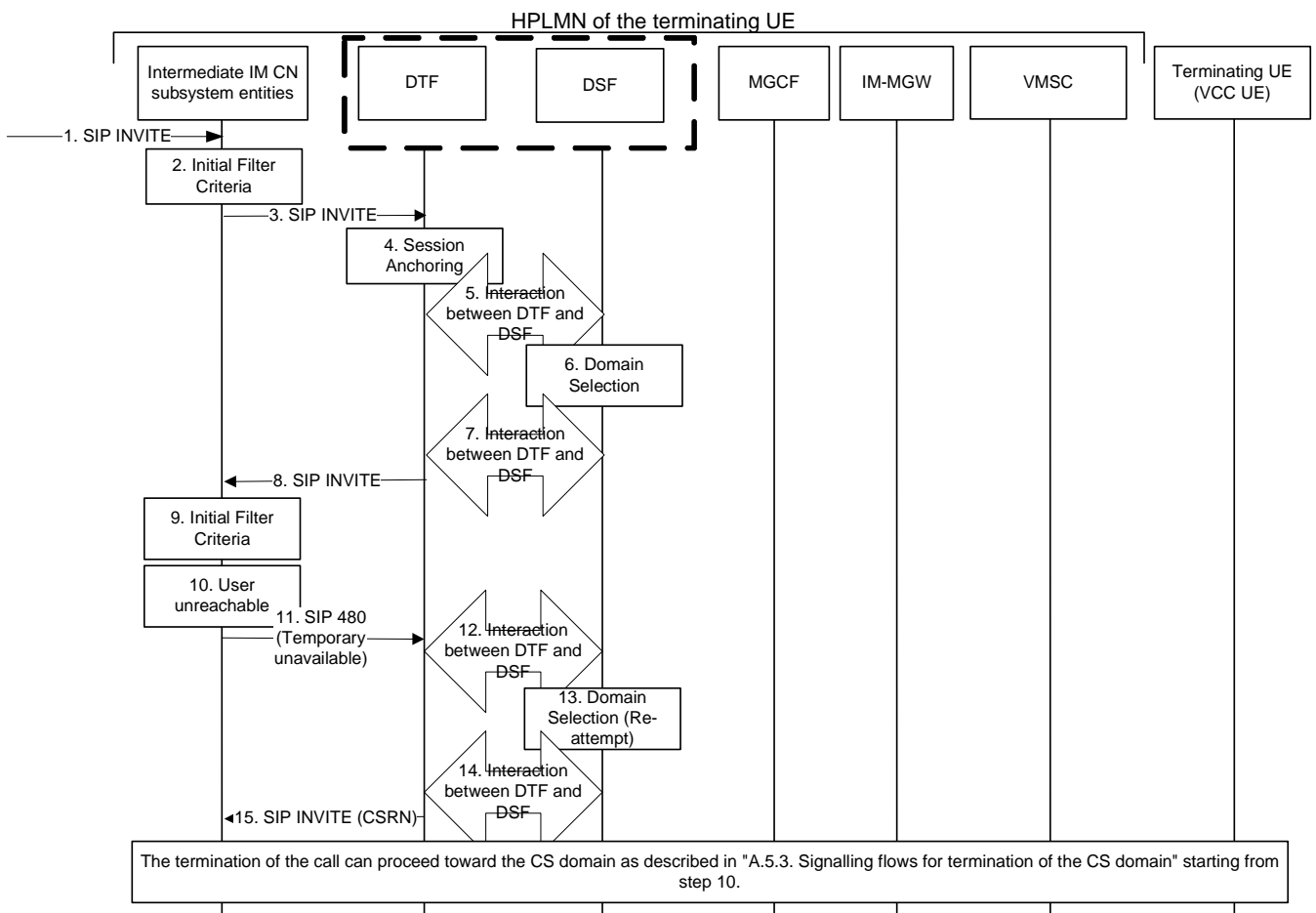

Figure A.5.6-1: Call termination delivery attempt failure to the IM CN subsystem

The details of the signalling flows are as follows:

Steps 1 to 9 are identical to the example in subclause A.5.2.

10. User unreachable

The delivery of the call fails due to an error detected in the termination procedure. This could be due to, for example, destination busy (error code 486), destination service denied (error code 403), destination currently out of coverage (error code 480), or some other error. In this example the intermediate IM CN subsystem returns SIP 480 (Temporarily unavailable) response to the DTF.

11. SIP 480 (Temporarily Unavailable) response (intermediate IM CN subsystem entities to DTF) - see example in table A.5.6-10

The intermediate IM CN subsystem returns SIP 480 (Temporarily Unavailable) response to the DTF.

Table A.5.6-11: SIP 480 (Temporarily Unavailable) response (intermediate IM CN subsystem entities to DTF)

```
SIP/2.0 480 Temporarily unavailable
Via: SIP/2.0/UDP sip:dtf2.home2.net; branch=z9jG4bK332b23.3, SIP/2.0/UDP
    scscf2.home2.net;branch=z9hG4bK332b23.1, pcscf2.home2.net;branch=z9hG4bK431h23.1,
    SIP/2.0/UDP
From:
To:
Call-ID:
Cseq:
Retry-After: 3600
Content-Length: 0
```

12. Interaction between the DTF and DSF

Information is exchanged between the DTF and DSF. The nature of this signalling is outside the scope of this version of the specification.

13. Domain Selection (re-attempt)

In this example the VCC user has been simultaneously registered in IM CN subsystem and in the CS domain (CS attached). This information is known to the DSF, and after the first attempt and failure to deliver the terminated call in the IM CN subsystem, the DSF re-attempts on the second domain available to the terminated user i.e. the CS domain.

NOTE 1: The choice for the DSF to re-attempt the call termination on the second domain available following a failure on the first domain is subject to operator policy.

The DSF determines the CSRN. The CSRN will allow the call to be routed further into the CS domain. In this example the CSRN = +1-241-555-4444

NOTE 2: it is an implementation option as how the DSF determines the CSRN. The DSF may collaborate with the CSAF for determination of the CSRN.

14. Interaction between the DTF and DSF

Information is exchanged between the DTF and DSF. The nature of this signalling is outside the scope of this version of the specification.

15. SIP INVITE request (DTF to intermediate IM CN subsystem entities) - see example in table A.5.6-12

The DTF sends SIP INVITE request with the CSRN as the Request-URI to the intermediate IM CN subsystem entities.

The DTF modifies the message in accordance with routing B2BUA functionality, e.g. mapping of From, To, Cseq and Call-ID headers from one side of the B2BUA to the other.

The DTF inserts the Request-URI of the originating user to the P-Asserted-Identity header in order that the identity of the originating user becomes known to the destination network for the case the SIP INVITE is forwarded to a MGCF.

The DTF inserts the original SDP from the originating SIP INVITE request.

Table A.5.6-15: SIP INVITE request (DTF to intermediate IM CN subsystem entities)

```

INVITE tel:+1-241-555-4444 SIP/2.0
Via: SIP/2.0/UDP sip:dtf2.home2.net; branch=z9jG4bK332b23.3, SIP/2.0/UDP
    scscf2.home2.net;branch=z9hG4bK332b23.1, SIP/2.0/UDP
    icscf2_s.home2.net;branch=z9hG4bK871y12.1, SIP/2.0/UDP
    scscf1.home1.net;branch=z9hG4bK332b23.1, SIP/2.0/UDP
    pcscf1.home1.net;branch=z9hG4bK431h23.1, SIP/2.0/UDP
    [5555::aaa:bbb:ccc:ddd]:1357;comp=sigcomp;branch=z9hG4bKnashds7
Max-Forwards: 65
Route: <sip:scscf2.home2.net;lr>;
Record-Route: <sip:dtf2.home2.net;lr>, <sip:scscf2.home2.net;lr>, <sip:scscf1.home1.net;lr>,
    <sip:pcscf1.home1.net;lr>
P-Asserted-Identity: "John Doe" <sip:user2_public1@home2.net> <tel:+1-212-555-1111>
P-Access-Network-Info:
P-Charging-Vector: icid-value="AyretyU0dm+602Irt5tAFrbHLso=023551024"; orig-ioi="type
    3ashomel.net"
Privacy: none
Supported:
From:
To: <tel:+1-241-555-4444>
Call-ID:
Cseq:
Contact:
Allow:
Content-Type:
Content-Length: (...)

v=
o=
s=
c=
t=
m=
b=
a=
a=
a=
a=
a=
a=
a=
a=
a=
a=

```

The termination of the call can proceed toward the CS domain as described in the subclause A.5.3 starting from the step 13.

A.5.7 Signalling flow for termination directed to CS domain, unsuccessful delivery, redirect to IM CN Subsystem

Figure A.5.7-1 illustrate an example signalling flow of a voice call to a VCC UE coming in through the CS domain. Upon being anchored in the IM CN subsystem the decision on domain selection resulted in the CS domain being the selected domain for call delivery. However, the terminating call cannot be completed and in this example flow the domain selection function of the VCC application is consulted again. The IM CN subsystem is subsequently selected to complete the terminating call.

In this example, the terminating UE is in his/her HPLMN.

In this example, this PLMN does not utilise terminating CAMEL service logic. Rather this example illustrates HSS(HLR) directed call diversion to the IM CN subsystem where the HSS(HLR), through internal network implementation, can obtain the IMRN

In this example, the failure to complete the terminating call establishment is due to the VMSC having initiated the paging procedure fails to get a respond from the UE in the course of normal and extended paging.

In this example, when the MSC fails to complete the terminating call establishment, the MSC shall return the ISUP RELEASE message with an appropriate cause value to the MGCF that will allow the MGCF to map to an appropriate SIP method and indication that indicates that the user is currently not reachable.

Editor's note: It is FFS what cause value the ISUP RELEASE shall carry. It is also FFS which exact SIP 4xx message MGCF shall send.

Editor's note: The determination of the ISUP RELEASE cause values and which SIP 4xx message MGCF sends can require changes to TS 29.163

In this example, when the VCC Application receives the indication that delivery of the terminating call through the selected CS domain cannot be completed, the VCC application performs an implementation option to attempt delivery of the terminating call through the IM CN Subsystem. This implementation option further interacts with operator dependent policies.

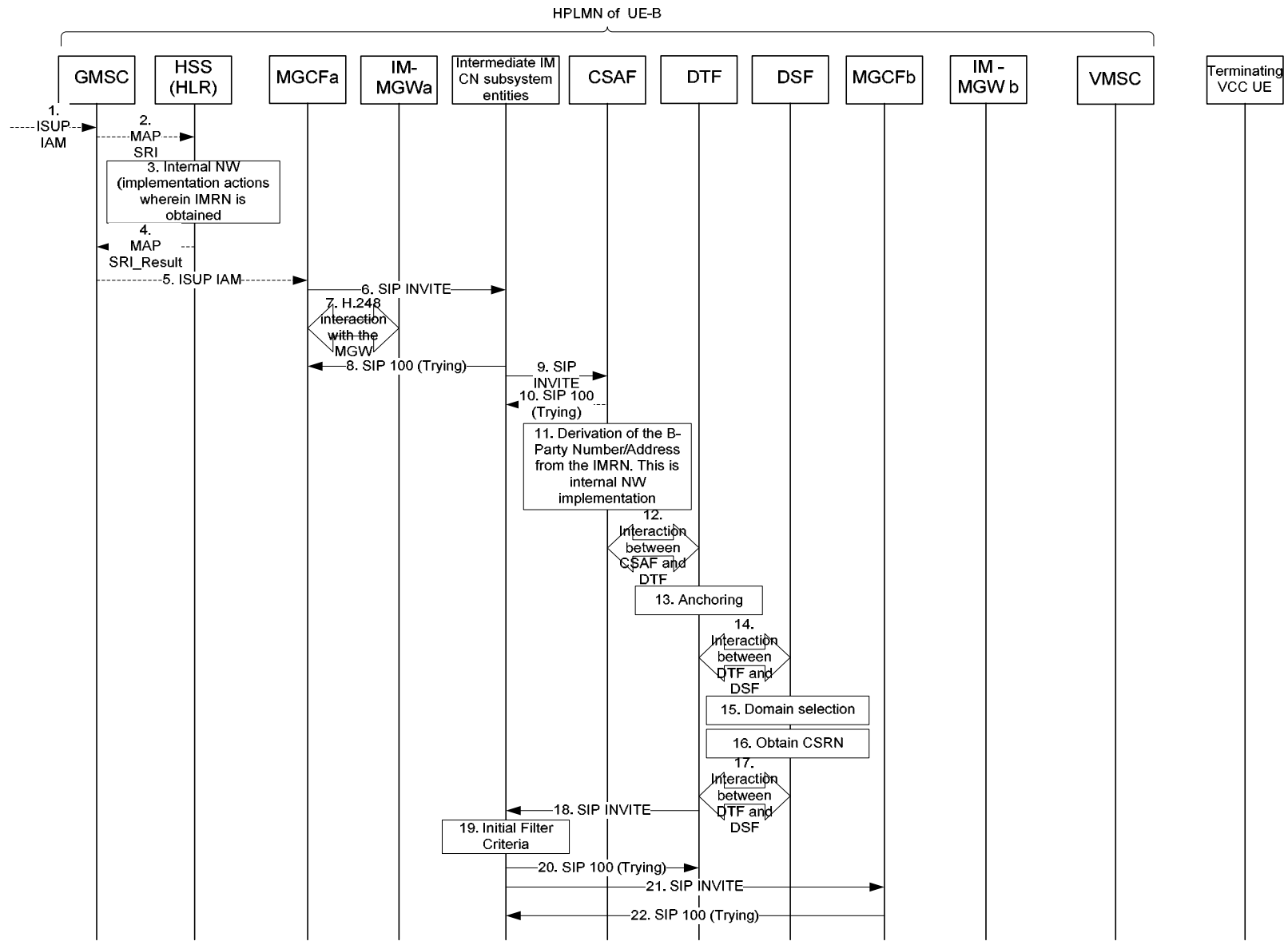

Figure A.5.7-1: Terminating call coming in through CS domain, CS domain selected for call delivery, call delivery unsuccessful, domain for call delivery reselected

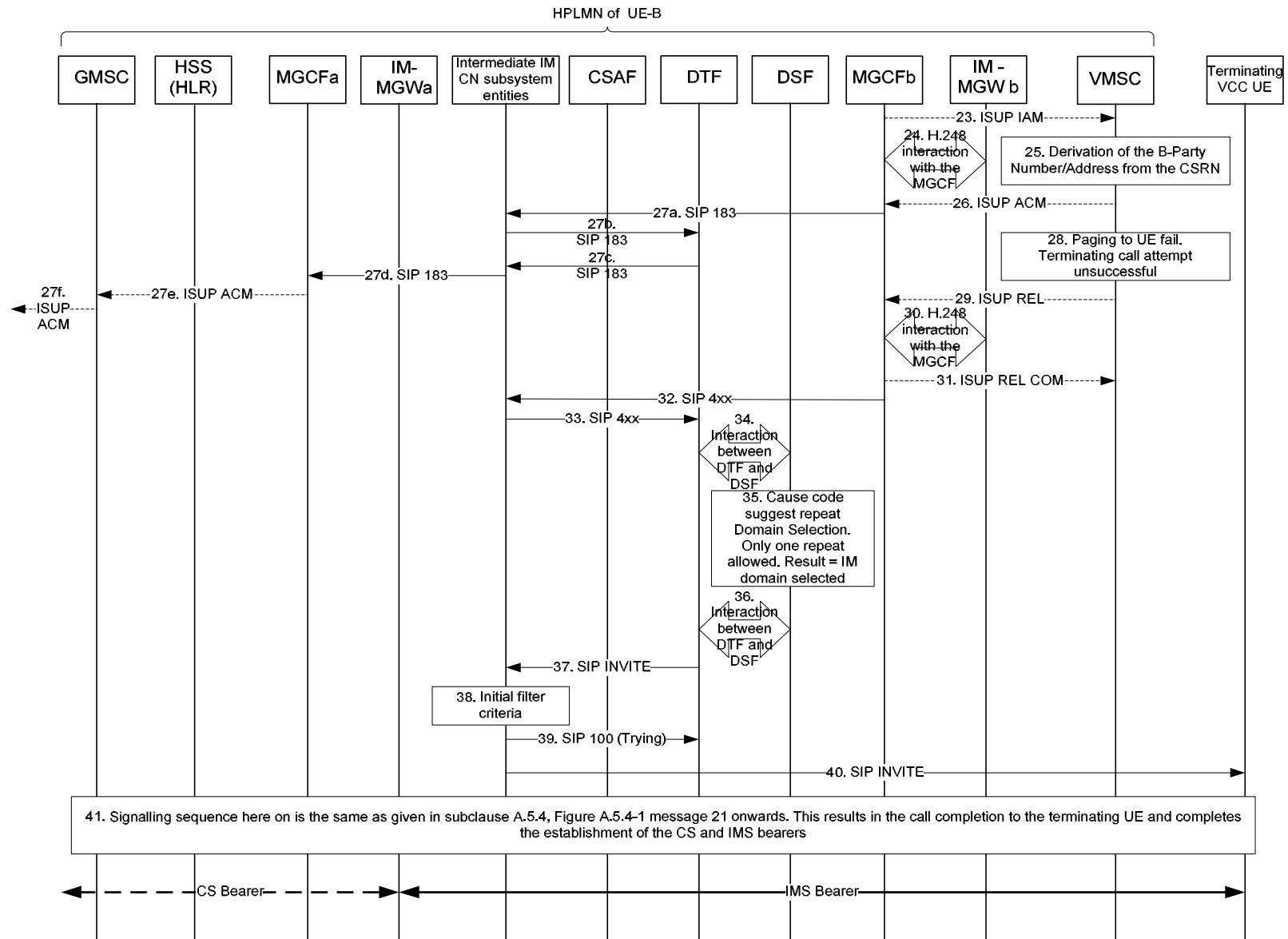

Figure A.5.7-1: Terminating call coming in through CS domain, CS domain selected for call delivery, call delivery unsuccessful, domain for call delivery reselected (continued)

The details of the signalling flows are as follows:

1. ISUP IAM (coming into this PLMN through the CS domain)

A call request makes an entry into this PLMN. First entry point is the GMSC. This ISUP IAM contains the MSISDN of the called party.

In this example the MSISDN is +1-212-123-2222.

2. MAP SEND_ROUTING_INFORMATION (GMSC to HSS/HLR)

GMSC makes a query to the HSS/HLR for routing information for onward routing of the incoming call request. This GMSC query SEND_ROUTING_INFORMATION contain the MSISDN of the called party.

3. Derivation of IMRN

Internal network actions - not indicated here as those actions are implementation and network dependent – are taken. The result is that (for this example) a decision is made to route the call further onwards into the IM CN subsystem.

In particular an IMRN is obtained in these internal network actions.

For this example the derived IMRN is +1-241-555-3333.

NOTE 1: It is an implementation and network option whether the derivation of the IMRN takes in the decision to anchor the call to the DTF.

4. MAP SEND_ROUTING_INFORMATION_RESULT (HSS/HLR to GMSC)

The HSS/HLR replies to the query by GMSC with the SEND_ROUTING_INFORMATION_RESULT providing with it the IMRN

5. ISUP IAM (GMSC to MGCFa)

GMSC sends out IAM (IMRN). The IMRN is that which will direct the routing of the IAM to the MGCF. In this example, the IAM (IMRN = +1-241-555-3333) is routed to MGCFa.

6. SIP INVITE (MGCFa towards the CSAF through the intermediate IM CN subsystem) – see example in table A.5.7-6

The MGCF interworks the IAM (IMRN) into the appropriate SIP message and initiates the SIP INVITE towards the CSAF via the intermediate IM CN subsystem entities.

The MGCF interacts with the MGW for the necessary resource allocation.

Table A.5.7-6: INVITE request

```

INVITE tel:+1-241-555-3333 SIP/2.0
Via: SIP/2.0/UDP mgcf1.home1.net;branch=z9hG4bK779s24.0
Max-Forwards: 70
Route: <sip:icscf1_s.home1.net;lr>
P-Asserted-Identity: <tel:+1-212-555-1111>
P-Charging-Vector: icid-value="AyretyU0dm+602IrT5tAFrbHLso=023551024"; orig-ioi=home1.net
Privacy: none
From: <tel:+1-212-555-1111>;tag=171828
To: <tel:+1-212-555-3333>
Call-ID: cb03a0s09a2sdfg1kj490333
Cseq: 127 INVITE
Supported: 100rel
Contact: <sip:mgcf1.home1.net>
Allow: INVITE, ACK, CANCEL, BYE, PRACK, UPDATE
Content-Type: application/sdp
Content-Length: (...)

v=0
o=- 2987933615 2987933615 IN IP6 5555::aaa:bbb:ccc:ddd
s=-
c=IN IP6 5555::aaa:bbb:ccc:ddd
t=0 0
m=audio 3456 RTP/AVP 97 96
b=AS:25.4
a=curr:gqos local sendrecv
a=curr:gqos remote none
a=des:gqos mandatory local sendrecv
a=des:gqos none remote sendrecv
a=rtpmap:97 AMR
a=fmtp:97 mode-set=0,2,5,7; mode-change-period=2
a=rtpmap:96 telephone-event
a=maxptime:20

```

7. H.248 interaction with the MGW

The MGCF interacts with the MGW for the necessary resource allocation.

8. SIP 100 (Trying) response (Intermediate IM CN subsystem entities to MGCFa)

The intermediate IM CN subsystem entities respond to MGCFa with a SIP 100 (Trying) response.

There is no VCC specific content to this request.

9. SIP INVITE request (intermediate IM CN subsystem entities to the CSAF) – see example in table A.5.7-9

The IMRN is a PSI. The intermediate IM CN subsystem entities are configured to route this PSI to the CSAF. In this particular case, the I-CSCF performs the routing over the Ma interface. For this example, there is no IBCF before the I-CSCF and no intermediate entities Record-Route the request.

Table A.5.7-9: SIP INVITE request (intermediate IM CN subsystem entities to the CSAF)

```

INVITE tel:+1-241-555-3333 SIP/2.0
Via: SIP/2.0/UDP icscf1_s.home1.net;branch=z9hG4bK312a32.1,
SIP/2.0/UDP mgcf1.home1.net;branch=z9hG4bK779s24.0
Max-Forwards: 69
Route: <sip:icscf1_s.home1.net;lr>
P-Asserted-Identity: <tel:+1-212-555-1111>
P-Charging-Vector: icid-value="AyretyU0dm+602IrT5tAFrbHLso=023551024"; orig-ioi=home1.net
Privacy: none
From: <tel:+1-212-555-1111>;tag=171828
To: <tel:+1-212-555-3333>
Call-ID: cb03a0s09a2sdfgklkj490333
Cseq: 127 INVITE
Supported: 100rel
Contact: <sip:mgcf1.home1.net>
Allow: INVITE, ACK, CANCEL, BYE, PRACK, UPDATE
Content-Type: application/sdp
Content-Length: (...)

v=0
o=- 2987933615 2987933615 IN IP6 5555::aaa:bbb:ccc:ddd
s=-
c=IN IP6 5555::aaa:bbb:ccc:ddd
t=0 0
m=audio 3456 RTP/AVP 97 96
b=AS:25.4
a=curr:qos local sendrecv
a=curr:qos remote none
a=des:qos mandatory local sendrecv
a=des:qos none remote sendrecv
a=rtpmap:97 AMR
a=fmtp:97 mode-set=0,2,5,7; mode-change-period=2
a=rtpmap:96 telephone-event
a=maxptime:20

```

10. SIP 100 (Trying) response (CSAF to intermediate IM CN subsystem entities)

The CSAF responds to the intermediate IM CN subsystem entities with a SIP 100 (Trying) response.

11. Retrieval of the called party details from IMRN

From the IMRN the CSAF retrieves the called party details. This retrieval process is implementation dependent.

NOTE 2: It is a further implementation dependent option whether the decision to anchor the call such that VCC feature can be made available to the called party is made at this step.

12. Interaction between CSAF and DTF

Information is exchanged between the CSAF and DTF. The nature of this signalling is outside the scope of this version of the specification.

13. Anchoring

The DTF performs the anchoring of the session.

14. Interaction between the DTF and DSF

In this example, information is exchanged between the DTF and DSF. The nature of this signalling is outside the scope of this version of the specification.

15. Domain selection

A decision has now to be made on which domain the terminating call is to be delivered. This decision is implementation specific.

For this example, the decision is to deliver the terminating call through the CS domain.

16. Derivation of the CSRN

The intermediate IM CN subsystem entities deliver the SIP INVITE request to the MGCF. In this example this is a different MGCF than the the MGCF which receives the ISUP IAM carrying the IMRN. In this example the SIP INVITE request with the CSRN is directed to MGCFb.

This example flow involving different MGCF further illustrates a pragmatic example of call distribution to different MGCFs of one network.

22. SIP 100 (Trying) response (MGCFb to intermediate IM CN subsystem entities)

The MGCFb responds to the intermediate IM CN subsystem entities with a SIP 100 (Trying) response.

There is no VCC specific content to this response.

23. ISUP IAM (MGCFb to VMSC)

The MGCF interworks the SIP INVITE request to the ISUP and initiates the ISUP IAM carrying the CSRN towards the VMSC.

24. H.248 interaction with the MGW

The MGCF interacts with the MGW for the necessary resource allocation.

25. Retrieval of the called party details from CSRN

The VMSC can from the CSRN retrieve the details of the called party and with that initiates a paging procedure towards the terminating UE.

26. ISUP ACM (VMSC to MGCFb)

With the determination that the address is complete and that the terminating UE details are valid the VMSC returns to the MGCF the ISUP ACM message. There is no VCC specific content in this message.

27a -f. Propagation of indication of address complete back to calling side

The SIP endpoints complete SDP offer/answer procedures, and any exchange of alerting indication, in accordance with standard basic call procedures. VCC imposes no restriction on this operation.

MGCFa then sends the ISUP ACM back to the originating side through the GMSC.

28. VMSC concludes that terminating call attempt has failed

MSC conclude that paging procedure has failed when mobile did not respond to normal or extended paging.

29. ISUP REL (VMSC to MGCFb)

VMSC concluding that terminating call is unsuccessful, provides a ISUP REL to the MGCFb. The ISUP REL will carry the reason for release indicating that the terminating call attempt is unsuccessful.

Editor's note: It is FFS what the exact cause the ISUP RELEASE shall carry.

30. H.248 interaction for bearer release

MGCFb interacts with MGWb to release the allocated resources which will now not be needed.

31. ISUP RLC COM (MGCFb to VMSC)

MGCFb having interacted with MGWb to release the resources return ISUP RLC COM to indicate that the MGCFb has now completed its release.

32. SIP 4xx (MGCFb towards DTF through the intermediate IM CN subsystem entities)

MGCFb indicate the release back towards the originator – in this case the DTF. This the MGCFb does by interworking the ISUP message to a SIP 4xx response sent to the intermediate IM CN subsystem entities.

Editor's note: It is FFS what the exact 4xx message the MGCF will send.

33. SIP 4xx (Intermediate IM CN subsystem to DTF)

The SIP 4xx is forwarded to the VCC application by the intermediate IM CN subsystem entities.

34. Interaction between the DTF and DSF

In this example, information is exchanged between the DTF and DSF. The nature of this signalling is outside the scope of this version of the specification.

35. DSF determines next cause of action

In this example, the DSF decides to re-attempt delivery of the terminating call in the IM CN subsystem. This implementation option is further driven by an operator policy that will influence the decision of whether to re-attempt delivering the terminating call and limit the number of re-attempts to guard against unnecessary and endless looping.

36. Interaction between the DTF and DSF

In this example, information is exchanged between the DTF and DSF. The nature of this signalling is outside the scope of this version of the specification.

37. SIP INVITE request (DTF to terminating UE through the intermediate IM CN subsystem entities) – see example in table A.5.7-37

The DTF sends the SIP INVITE request to the intermediate IM CN subsystem entities serving the terminating user within the IM CN subsystem.

The DTF modifies the message in accordance with routing B2BUA functionality, e.g. mapping of From, To, Cseq and Call-ID headers from one side of the B2BUA to the other.

The DTF sets the value of the Contact header with the address of the DTF that will provide the transfer functionality needed to support VCC.

The DTF sets the value of the Route header with SIP URI of S-CSCF including the original dialog identifier.

In the case where the Request-URI of the SIP INVITE request contains a tel-URL, the S-CSCF (next hop) will have to translate to a globally routeable SIP-URI before applying it as Request-URI of the outgoing SIP INVITE request toward the terminating user.

Table A.5.7-37: SIP INVITE request (DTF to intermediate IM CN subsystem entities)

```

INVITE tel:+1-212-555-2222 SIP/2.0
Via: SIP/2.0/UDP dtf2.home2.net
    [5555::aaa:bbb:ccc:ddd]:1357;comp=sigcomp;branch=z9hG4bKnashds7
Max-Forwards: 70
Route: <sip:o-id@s-cscf.home1.net;lr>
Record-Route: <sip:dtf2.home2.net;lr>
P-Asserted-Identity: "John Doe" <tel:+1-212-555-1111>
P-Access-Network-Info:
P-Charging-Vector: icid-value="AyretyU0dm+602IrT5tAFrbHLso=023551024"; orig-ioi="type
    3ashome1.net"
Privacy: none
Supported: precondition
From: <sip:user1_public1@home1.net>;tag=171828
To: <tel:+1-212-555-2222>
Call-ID: cb03a0s09a2sdfglkj490333
Cseq: 127 INVITE
Contact: <sip:[5555::aaa:bbb:ccc:ddd]:1357;comp=sigcomp>
Allow: INVITE, ACK, CANCEL, BYE, PRACK, UPDATE, REFER, MESSAGE
Content-Type: application/sdp
Content-Length: (...)

v=0
o=- 2987933615 2987933615 IN IP6 5555::aaa:bbb:ccc:ddd
s=-
c=IN IP6 5555::aaa:bbb:ccc:ddd
t=0 0
m=audio 3456 RTP/AVP 97 96
b=AS:25.4
a=curr:qos local none
a=curr:qos remote none
a=des:qos mandatory local sendrecv
a=des:qos none remote sendrecv
a=rtpmap:97 AMR
a=fmtp:97 mode-set=0,2,5,7; mode-change-period=2
a=rtpmap:96 telephone-event
a=maxptime:20

```

Contact header: The Contact header represents the contact of the DTF.

38. Evaluation of initial filter criteria

To the S-CSCF that is managing the terminating UE, this will be seen as a new call. the first INVITE to the terminating UE.

NOTE 3: As part of its filter criteria, care is now taken that this SIP INVITE request will not be routed back to the DTF for anchoring decision. Thus the S-CSCF can know that this SIP INVITE request must not be sent back to the DTF thanks to the original dialog identifier that has been newly included in the request.

39. SIP 100 (Trying) response (intermediate IM CN subsystem entities to DTF)

The intermediate IM CN subsystem entities respond to the DTF with a SIP 100 (Trying) response.

There is no VCC specific content in this response.

40. SIP INVITE (intermediate IM CN subsystem entities to VCC UE) – see example in table A.5.7-40

The terminating user's intermediate IM CN subsystem entities will send the SIP INVITE request towards the terminating VCC UE.

Table A.5.7-34: SIP INVITE request (intermediate IM CN subsystem entities to VCC UE)

```

INVITE sip:[5555::eee:fff:aaa:bbb]:8805;comp=sigcomp SIP/2.0
Via: SIP/2.0/UDP pcscf1.home1.net:5088;comp=sigcomp;branch=z9hG4bK876t12.1,
    SIP/2.0/UDP scscf1.home1.net;branch=z9hG4bK764z87.1,
    SIP/2.0/UDP sip:dtf2.home2.net; branch=z9jG4bK332b23.3
Max-Forwards: 68
Route:
Record-Route: <pcscf1.home1.net>, <scscf1.home1.net>, <sip:dtf2.home2.net;lr>
P-Asserted-Identity: "John Doe" <tel:+1-212-555-1111>
P-Access-Network-Info:
P-Charging-Vector: icid-value="AyretyU0dm+602Irt5tAFrbHLso=023551024"; orig-ioi="type
    3ashomel.net"
Privacy: none
Supported: precondition
From: <sip:user1_public1@home1.net>;tag=171828
To: <tel:+1-212-555-2222>
Call-ID: cb03a0s09a2sdfglkj490333
Cseq: 127 INVITE
Contact: <sip:[5555::aaa:bbb:ccc:ddd]:1357;comp=sigcomp>
Allow: INVITE, ACK, CANCEL, BYE, PRACK, UPDATE, REFER, MESSAGE
Content-Type: application/sdp
Content-Length: (...)

v=0
o=- 2987933615 2987933615 IN IP6 5555::aaa:bbb:ccc:ddd
s=-
c=IN IP6 5555::aaa:bbb:ccc:ddd
t=0 0
m=audio 3456 RTP/AVP 97 96
b=AS:25.4
a=curr:gqos local none
a=curr:gqos remote none
a=des:gqos mandatory local sendrecv
a=des:gqos none remote sendrecv
a=rtpmap:97 AMR
a=fmtp:97 mode-set=0,2,5,7; mode-change-period=2
a=rtpmap:96 telephone-event
a=maxptime:20

```

41. Signalling flows completing SIP call to terminating UE and interworked back to originating side

The signalling flows here on till the completion of the call and utilisation of the media resources are in accordance with step 21 through to step 33 of subclause A.5.4, and Figure A.5.4-1.

A.5.8 Signalling flows for termination from CS domain with no anchoring (using CAMEL)

Figure A.5.8-1 shows the termination of a voice call that is capable of being subject to VCC, with the anchoring of the call in the IM CN subsystem being denied prior to its routing. The voice call is then delivered in the CS domain according to standard procedures.

The anchor decision of such terminated calls is subject to operator policy.

As the terminated voice call is not anchored in the IM CN subsystem, domain transfer will not be supported for that call.

NOTE 1: For call termination, the use of CAMEL in the context of VCC is optional. In this example the GMSC support and will use terminating CAMEL service logic.

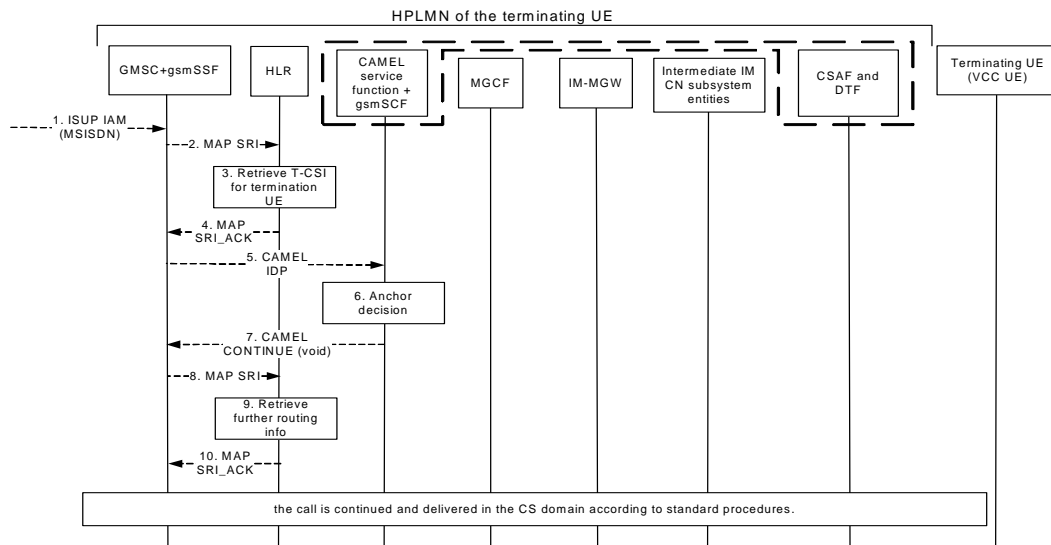

Figure A.5.8-1: call termination from CS domain with no anchoring

The details of the signalling flows are as follows:

Steps 1, 2, 3, 4 and 5 are identical to the example in subclause A.5.4.

NOTE 2: When processing terminating calls, the GMSC interrogates the HLR. In this example the GMSC indicates its support for CAMEL. The GMSC receives back from the HLR the terminating CAMEL subscriber information. As a result the gsmSSF of the GMSC triggers a CAMEL activity toward the gsmSCF.

6. Anchor decision

The CAMEL service function denies the anchoring of the terminating call according to the operator policy. In this example the CAMEL service function is unable to allocate a new IMRN for this call i.e. insufficient IMRN.

7. CAMEL CONTINUE (CAMEL service function to GMSC)

The CAMEL service function causes the gsmSCF to respond to the CAMEL IDP message with a CAMEL CONTINUE message. The CAMEL CONTINUE message contains no parameter.

8, 9 and 10. Further interrogation with the HLR (GMSC to HLR)

Following standard terminating call procedure for CAMEL subscribers, on the receipt of the CAMEL CONTINUE message, the GMSC interrogates the HLR again by including a parameter that indicates the suppression of CAMEL handling. On the receipt of the answer from the HLR, the GMSC resumes the processing and continues the call in the CS domain according to standard procedures.

A.6 Signalling flows for CS domain to IM CN subsystem transfer

A.6.1 Introduction

The signalling flows for CS domain to IM CN subsystem transfer demonstrate how a VCC UE transfers the call from the CS domain to the IM CN subsystem. The following signalling flows are included:

- subclause A.6.2 shows the successful transfer for a call, currently in the CS domain, and which is transferred to the IM CN subsystem; and
- subclause A.6.3 shows the case where a transfer request for a call, currently in the CS domain, cannot be complied with at the VCC application due to the failure to match the request with an anchored call for that user.

A.6.2 Signalling flows for CS domain to IM CN subsystem transfer

Figure A.6.2-1 shows the signalling flows for a domain transfer of the access leg from the CS domain to the IM CN subsystem. This example assumes that the VCC user is currently registered in the IM CN subsystem. If the VCC user is not currently registered in the IM CN subsystem prior to determination of domain transfer, it is required that registration procedures are initiated before updating the access leg.

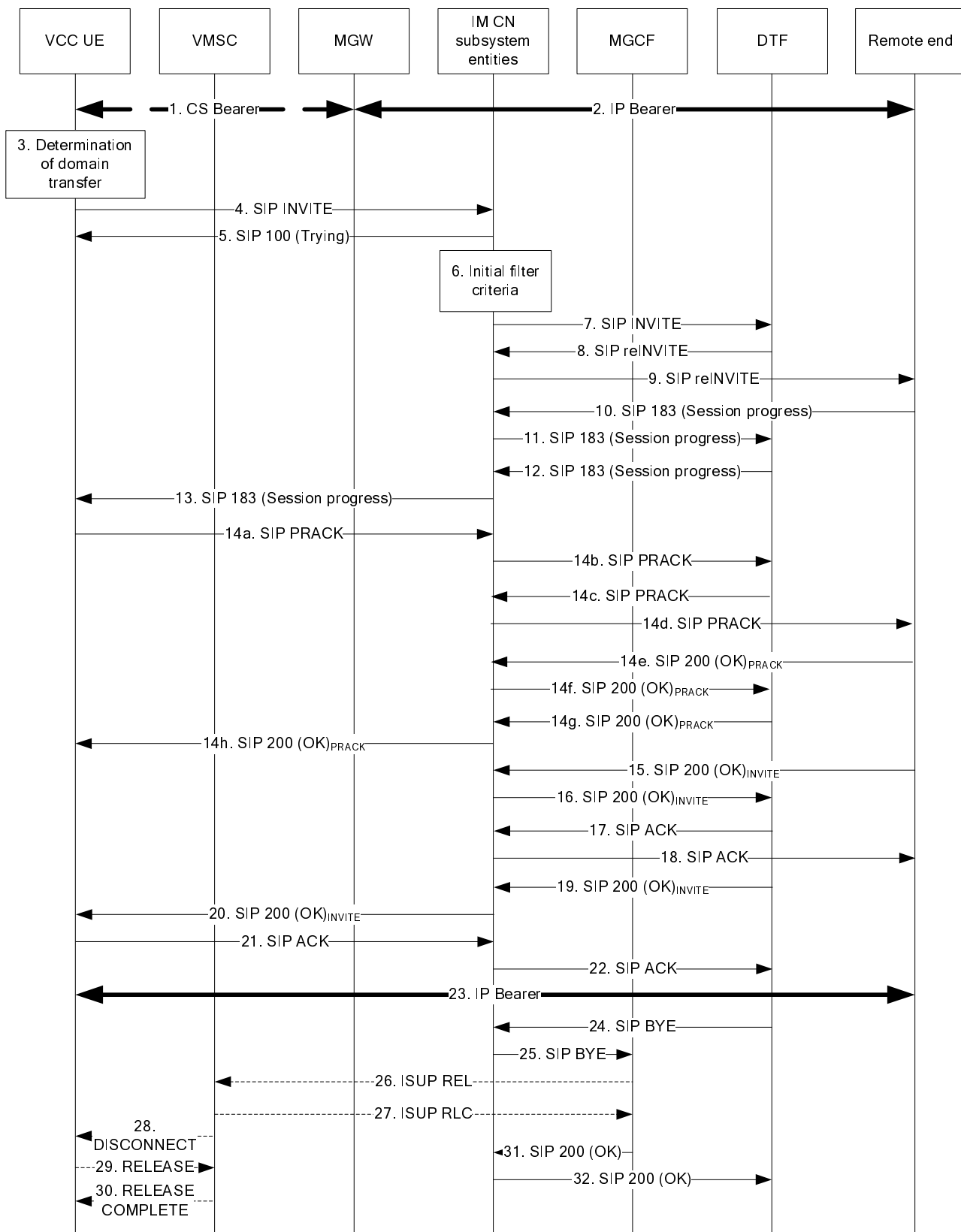

Figure A.6.2-1: CS domain to IM CN subsystem transfer

The details of the signalling flows are as follows:

1. CS bearer (VCC UE to MGW)

The call is ongoing in the CS domain.

2. IP bearer (MGW to remote end)

IP bearer over which the voice call is transmitted toward to the remote end.

3. Determination of domain transfer

As a result of changes in radio conditions or availability of IM services via IPCAN, the VCC UE decides that the ongoing call in the CS domain will be transferred to the IM CN subsystem.

4. SIP INVITE request (VCC UE to intermediate IM CN subsystem entities) – see example in table A.6.2-4

The VCC UE sends a SIP INVITE request to initiate session set up in the IM CN subsystem. The SIP INVITE request is sent from the VCC UE to the home S-CSCF (S-CSCF#1) via P-CSCF#1. The Request-URI header is set to the VDI (which is a PSI pointing at the DTF).

Table A.6.2-4: SIP INVITE request (VCC UE to intermediate IM CN subsystem entities)

```
INVITE sip:domain.xfer@dtf1.home1.net SIP/2.0
Via: SIP/2.0/UDP [5555::aaa:bbb:ccc:ddd]:1357;comp=sigcomp;branch=z9hG4bKnashds7
Max-Forwards: 70
Route: <sip:pcscf1.home1.net:7531;lr;comp=sigcomp>, <sip:scscf1.home1.net;lr>
P-Preferred-Identity: <tel: +1-212-555-1111>
P-Access-Network-Info: IEEE-WLAN-802.11b;
Privacy: none
From: <tel: +1-212-5555-1111>;tag=171828
To: <sip:domain.xfer@dtf1.home1.net>
Call-ID: cb03a0s09a2sdfg1kj490333
Cseq: 127 INVITE
Require: sec-agree
Proxy-Require: sec-agree
Supported: precondition, 100rel
Security-Verify: ipsec-3gpp; q=0.1; alg=hmac-sha-1-96; spi-c=98765432; spi-s=87654321; port-
c=8642; port-s=7531
Contact: <sip:[5555::aaa:bbb:ccc:ddd]:1357;comp=sigcomp>
Allow: INVITE, ACK, CANCEL, BYE, PRACK, UPDATE, REFER, MESSAGE
Content-Type: application/sdp
Content-Length: (...)

v=0
o=- 2987933615 2987933615 IN IP6 5555::aaa:bbb:ccc:ddd
s=-
c=IN IP6 5555::aaa:bbb:ccc:ddd
t=0 0
m=audio 3456 RTP/AVP 97 96
b=AS:25.4
a=curr:qos local none
a=curr:qos remote none
a=des:qos mandatory local sendrecv
a=des:qos none remote sendrecv
a=rtpmap:97 AMR
a=fmtp:97 mode-set=0,2,5,7; mode-change-period=2
a=rtpmap:96 telephone-event
a=maxptime:20
```

5. SIP 100 (Trying) response (intermediate IM CN subsystem entities to VCC UE)

The intermediate IM CN subsystem entities respond to the VCC UE with a SIP 100 (Trying) response.

There is no VCC specific content to this response.

6. Evaluation of filter criteria

In this example, and by evaluation of the initial filter criteria, based on the VDI in the Request-URI header of the originating request for a registered VCC user, the S-CSCF routes the request to the DTF in the VCC application.

7. SIP INVITE request (intermediate IM CN subsystem entities to DTF) – see example in table A.6-7

The SIP INVITE request is forwarded from S-CSCF#1 in the home network to the VCC application which is at an AS. The AS acts as a routing B2BUA.

Table A.6.2-7: SIP INVITE request (intermediate IM CN subsystem entities to VCC application)

```

INVITE sip:domain.xfer@dtfl.homel.net SIP/2.0
Via: SIP/2.0/UDP scscf1.homel.net;branch=z9hG4bK332b23.1
Via: SIP/2.0/UDP pcscf1.homel.net;branch=z9hG4bK240f34.1
Via: SIP/2.0/UDP [5555::aaa:bbb:ccc:ddd]:1357;comp=sigcomp;branch=z9hG4bKnashds7
Max-Forwards: 68
Record-Route: <sip:scscf1.homel.net;lr>, <sip:pcscf1.homel.net;lr>
Route: <sip:domain.xfer@dtfl.homel.net>
P-Asserted-Identity: <tel:+1-212-555-1111>
P-Charging-Vector: icid-value="AyretyU0dm+602IrT5tAFrbHLso=023551024"; orig-ioi=type
3homel.net;
P-Charging-Funtion-Address: ccf=[5555::b99:c88:d77:e66]; ccf=[5555::a55:b44:c33:d22];
ecf=[5555::1ff:2ee:3dd:4cc]; ecf=[5555::6aa:7bb:8cc:9dd]
P-Access-Network-Info: IEEE-WLAN-802.11b;
Privacy: none
From: <tel:+1-212-5555-1111>;tag=171828
To: <sip:domain.xfer@dtfl.homel.net>
Call-ID: cb03a0s09a2sdfgkjl490333
Cseq: 127 INVITE
Supported: precondition, 100rel
Contact: <sip:[5555::aaa:bbb:ccc:ddd]:1357;comp=sigcomp>
Allow: INVITE, ACK, CANCEL, BYE, PRACK, UPDATE, REFER, MESSAGE
Content-Type: application/sdp
Content-Length: (...)

v=0
o=- 2987933615 2987933615 IN IP6 5555::aaa:bbb:ccc:ddd
s=-
c=IN IP6 5555::aaa:bbb:ccc:ddd
t=0 0
m=audio 3456 RTP/AVP 97 96
b=AS:25.4
a=curr:qos local none
a=curr:qos remote none
a=des:qos mandatory local sendrecv
a=des:qos none remote sendrecv
a=rtpmap:97 AMR
a=fmtp:97 mode-set=0,2,5,7; mode-change-period=2
a=rtpmap:96 telephone-event
a=maxptime:20

```

8. SIP reINVITE request (DTF to intermediate IM CN subsystem entities) – see example in table A.6.2-8

The remote end is informed of the change in access leg from CS domain to IM CN subsystem by sending a SIP reINVITE request from the DTF to the intermediate IM CN subsystem entities.

The DTF modifies the message in accordance with routing B2BUA functionality, e.g. mapping of From, To, Cseq and Call-ID headers from one side of the B2BUA to the other.

Table A.6.2-8: SIP reINVITE request (DTF to remote end via intermediate IM CN subsystem entities)

```

INVITE <sip:[5555::eee:fff:aaa:bbb]:8805 SIP/2.0
Via: SIP/2.0/UDP domain.xfer@dtf1.home1.net;branch=z9hG4bK332b23.1
Max-Forwards: 67
Route: <sip:scscf.home1.net;lr>
P-Asserted-Identity: <tel:+1-212-555-1111>
P-Access-Network-Info: IEEE-WLAN-802.11b;
Privacy: none
From: <tel: +1-212-5555-1111>;tag=171828
To: <sip:user2_public1@home2.net>; tag=1234
Call-ID: dc14b1t10b3teghmlk501444
Cseq: 127 INVITE
Supported: precondition, 100rel
Contact: <sip:[7777::eee:ddd:ccc:aaa]>
Allow: INVITE, ACK, CANCEL, BYE, PRACK, UPDATE
Content-Type: application/sdp
Content-Length: (...)

v=0
o=- 2987933615 2987933615 IN IP6 5555::aaa:bbb:ccc:ddd
s=-
c=IN IP6 5555::aaa:bbb:ccc:ddd
t=0 0
m=audio 3456 RTP/AVP 97 96
b=AS:25.4
a=curr:qos local none
a=curr:qos remote none
a=des:qos mandatory local sendrecv
a=des:qos none remote sendrecv
a=rtpmap:97 AMR
a=fmtp:97 mode-set=0,2,5,7; mode-change-period=2
a=rtpmap:96 telephone-event
a=maxptime:20

```

9. **SIP reINVITE request (intermediate IM CN subsystem entities to remote end) – see example in table A.6.2-9**

The intermediate IM CN subsystem entities forwards the SIP reINVITE request to the remote end.

Table A.6.2-9: SIP reINVITE request (intermediate IM CN subsystem entities to remote end)

```

INVITE <sip:[5555::eee:fff:aaa:bbb]:8805 SIP/2.0
Via: SIP/2.0/UDP icscf1.home1.net;branch=z9hG4bK332b23.1, SIP/2.0/UDP
scscf1.home1.net;branch=z9hG4bK240f34.1, SIP/2.0/UDP
domain.xfer@dtf1.home1.net;branch=z9hG4bK332b23.1
Max-Forwards: 66
P-Asserted-Identity: <tel:+1-212-555-1111>
Privacy: none
From: <tel: +1-212-5555-1111>;tag=171828
To: <sip:user2_public1@home2.net>; tag=1234
Call-ID: dc14b1t10b3teghmlk501444
Cseq: 127 INVITE
Supported: precondition, 100rel
Contact: <sip:[7777::eee:ddd:ccc:aaa]>
Allow: INVITE, ACK, CANCEL, BYE, PRACK, UPDATE
Content-Type: application/sdp
Content-Length: (...)

v=0
o=- 2987933615 2987933615 IN IP6 5555::aaa:bbb:ccc:ddd
s=-
c=IN IP6 5555::aaa:bbb:ccc:ddd
t=0 0
m=audio 3456 RTP/AVP 97 96
b=AS:25.4
a=curr:qos local none
a=curr:qos remote none
a=des:qos mandatory local sendrecv
a=des:qos none remote sendrecv
a=rtpmap:97 AMR
a=fmtp:97 mode-set=0,2,5,7; mode-change-period=2
a=rtpmap:96 telephone-event
a=maxptime:20

```

10. **SIP 183 (Session Progress) response (remote end to intermediate IM CN subsystem entities)**

The SIP endpoints complete SDP offer/answer procedures, including any reservation of bearer resource on the IP-CAN, and any exchange of alerting indication, in accordance with standard basic call procedures. VCC imposes no restriction on this operation.

11. SIP 183 (Session Progress) response (intermediate IM CN subsystem entities to DTF)

The SIP endpoints complete SDP offer/answer procedures, including any reservation of bearer resource on the IP-CAN, and any exchange of alerting indication, in accordance with standard basic call procedures. VCC imposes no restriction on this operation.

12. SIP 183 (Session Progress) response (VCC application to intermediate IM CN subsystem entities)

The DTF modifies the message in accordance with routing B2BUA functionality, e.g. mapping of From, To, Cseq and Call-ID headers from one side of the B2BUA to the other.

The 183 (Session Progress) response is forwarded to the VCC UE indicating the supported media at the VCC application so that the VCC UE can start to reserve resources for IP bearer setup.

13. SIP 183 (Session Progress) response (intermediate IM CN subsystem entities to VCC UE)

The intermediate IM CN subsystem entities forward the 183 (Session Progress) response to the VCC UE.

14a – 14h. SIP PRACK request and SIP 200 (OK) response

The SDP offer/answer exchange is completed.

The SIP PRACK request does not carry SDP as the final codec decision is already made as part of the initial offer/answer exchange.

The remote end acknowledges receipt of the SIP PRACK request by sending a SIP 200 (OK) response.

15. SIP 200 (OK) response (remote end to intermediate IM CN subsystem entities)

The remote end acknowledges receipt of the SIP reINVITE request by sending a SIP 200 (OK) response to the intermediate IM CN subsystem entities.

There is no VCC specific content to this response.

16. SIP 200 (OK) response (intermediate IM CN subsystem entities to DTF)

The intermediate IM CN subsystem entities forward the SIP 200 (OK) response to the DTF.

There is no VCC specific content to this response.

17. SIP ACK request (DTF to intermediate IM CN subsystem entities)

The SIP ACK request is sent from the DTF to the intermediate IM CN subsystem entities thus completing session update for the remote leg.

There is no VCC specific content to this response.

18. SIP ACK request (intermediate IM CN subsystem entities to remote end)

The SIP ACK request is forwarded to the remote end via the intermediate IM CN subsystem entities thus completing session update for the remote leg.

There is no VCC specific content to this response.

19. SIP 200 (OK) response (DTF to intermediate IM CN subsystem entities)

Final acknowledgement of receipt of the SIP INVITE request required to change the access leg. This SIP 200 (OK) response indicates successful receipt and processing of the SIP INVITE request which was sent to initiate domain transfer. This response is sent to the intermediate IM CN subsystem entities.

The DTF modifies the message in accordance with routing B2BUA functionality, e.g. mapping of From, To, Cseq and Call-ID headers from one side of the B2BUA to the other.

There is no VCC specific content to this response.

20. SIP 200 (OK) response (intermediate IM CN subsystem entities to VCC UE)

Final acknowledgement of receipt of the SIP INVITE request required to change the access leg. This SIP 200 (OK) response indicates successful receipt and processing of the SIP INVITE request which was sent to initiate domain transfer. The intermediate IM CN subsystem entities forwarded this response to the VCC UE.

There is no VCC specific content to this response.

21. SIP ACK request (VCC UE to intermediate IM CN subsystem entities)

The SIP ACK request is sent from the VCC UE to the intermediate IM CN subsystem entities thus completing session setup for the updated access leg.

There is no VCC specific content to this request.

22. SIP ACK request (intermediate IM CN subsystem entities to DTF)

The SIP ACK request is forwarded by the intermediate IM CN subsystem entities to the DTF thus completing session setup for the updated access leg.

There is no VCC specific content to this request.

23. IP bearer

IP bearer is established between VCC UE and remote end allowing voice call to continue via PS domain.

24. SIP BYE request (DTF to intermediate IM CN subsystem entities)

In order to release the access leg on the transferring-out access leg, the SIP BYE request is sent from the DTF, via the intermediate IM CN subsystem entities.

The DTF modifies the message in accordance with routing B2BUA functionality, e.g. mapping of From, To, Cseq and Call-ID headers from one side of the B2BUA to the other.

There is no VCC specific content to this request.

25. SIP BYE request (intermediate IM CN subsystem entities to MGCF)

The SIP BYE request is forwarded to the MGCF by the intermediate IM CN subsystem entities in order to initiate call release in the CS domain.

There is no VCC specific content to this request.

26. ISUP REL message (MGCF to VMSC)

MGCF converts SIP BYE request to an ISUP REL message sent to the MSC#1 in the home CS network. REL Cause Value No. 16 (Normal clearing) is used.

27. ISUP RLC message (VMSC to MGCF)

The ISUP RLC message is sent by MSC#1 to the MGCF in response to the ISUP REL message.

28. DISCONNECT message (VMSC to VCC UE)

The DISCONNECT message from MSC#1 to the VCC UE includes Cause Value No. 16, thus initiating call clearing.

29. RELEASE message (VCC UE to VMSC)

The VCC UE responds to the DISCONNECT message by sending the RELEASE message to MSC#1 and enters the 'release request' status.

30. RELEASE COMPLETE message (VMSC to VCC UE)

MSC#1 sends the RELEASE COMPLETE message to the VCC UE thus releasing the MM connection.

31. SIP 200 (OK) response (MGCF to intermediate IM CN subsystem entities)

This SIP 200 (OK) response is for the SIP BYE request and is sent to the intermediate IM CN subsystem entities from the MGCF.

There is no VCC specific content to this response.

32. SIP 200 (OK) response (intermediate IM CN subsystem entities to DTF)

This SIP 200 (OK) response is for the SIP BYE request and is forwarded to the DTF by the intermediate IM CN subsystem entities.

There is no VCC specific content to this response.

A.6.3 Signalling flows for unsuccessful CS domain to IM CN subsystem transfer

Figure A.6.3-1 shows the signalling flows for the unsuccessful call transfer when transferring the call from the CS domain to the IM CN subsystem. The assumption is that VCC UE is not roaming and the MGCF is in the subscriber's IM CN subsystem. It is also assumed that VCC UE is already registered to IM CN subsystem network.

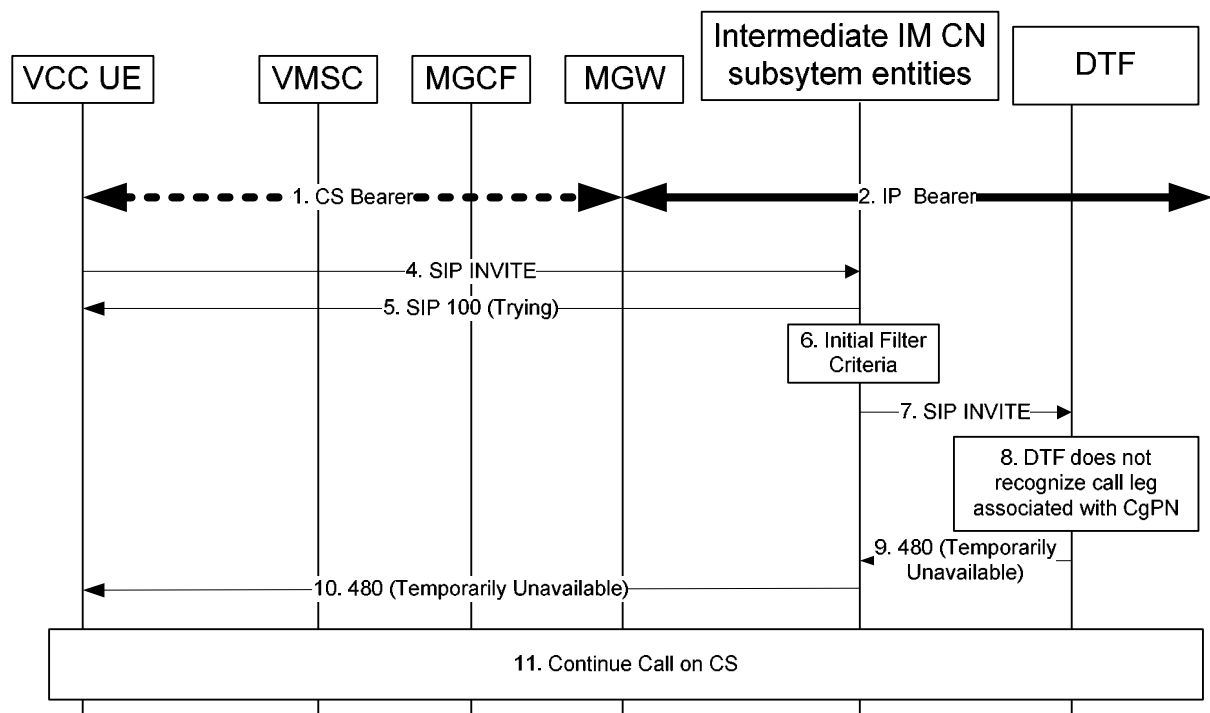

Figure A.6.3-1: Unsuccessful scenario when transferring call from CS to IM CN subsystem

The details of the signalling flows are as follows:

Step 1 through 7 are according to subclause A.6.2.

8. DTF

When DTF receives VDN indicating the domain transfer, it does not recognize the call leg associated with Calling Party Number CgPN or P-Asserted-Identity.

9. SIP 480 (Temporarily Unavailable) response (DTF to intermediate IM CN subsystem entities) – see example in table A.6.3-9

The DTF sends a SIP 480 (Temporarily Unavailable) response to the intermediate IM CN subsystem entities.

Table A.6.3-9: SIP 480 (Temporarily Unavailable) response (DTF to intermediate IM CN subsystem entities)

```
SIP/2.0 480 Temporarily Unavailable
Via: SIP/2.0/UDP scscf1.home1.net;branch=z9hG4bK354216.1, SIP/2.0/UDP
    pcscf1.visited1.net:7531;comp=sigcomp;branch=z9hG4bK240f34.1, SIP/2.0/UDP
    [5555::aaa:bbb:ccc:ddd];comp=sigcomp;branch=z9hG4bKnashds7
Record-Route: <sip:scscf1.home1.net;lr>, <sip:pcscf1.visited1.net:7531;lr;comp=sigcomp>
P-Asserted-Identity: <sip:domain.xfer@dtf1.home1.net>
Privacy: none
From: <sip:domain.xfer@dtf1.home1.net>;tag=1234
To: <tel:+1-212-555-1111>;tag=171828
Call-ID: cb03a0s09a2sdfg1kj490333
Cseq: 127 INVITE
Contact: <sip:[5555::eee:fff:ggg:hhh]>
Content-Length: 0
```

10. SIP 480 (Temporarily Unavailable) response (intermediate IM CN subsystem entities to VCC UE) – see example in table A.6.3-10

The error message is forwarded from intermediate IM CN subsystem entities to VCC UE according to standard procedures.

Table A.6.3-10: SIP 480 (Temporarily Unavailable) response (intermediate IM CN subsystem entities to VCC UE)

```
SIP/2.0 480 Temporarily Unavailable
Via: SIP/2.0/UDP [5555::aaa:bbb:ccc:ddd];branch=z9hG4bKnashds7
Record-Route: <sip:scscf1.home1.net;lr>, <sip:pcscf1.visited1.net:7531;lr;comp=sigcomp>
P-Asserted-Identity: <sip:domain.xfer@stf1.home1.net >
Privacy: none
From: <sip:domain.xfer@dtf1.home1.net>;tag=1234
To: <tel:+1-212-555-1111>;tag=171828
Call-ID: cb03a0s09a2sdfg1kj490333
Cseq: 127 INVITE
Contact: <sip:[5555::eee:fff:ggg:hhh]>
Content-Length: 0
```

11. VCC UE continues the call in CS domain.

A.7 Signalling flows for IM CN subsystem to CS domain transfer

A.7.1 Introduction

The signalling flows for IM CN subsystem to CS domain transfer demonstrate how a VCC UE transfers the call from the IM CN subsystem to the CS domain. The following signalling flows are included:

- subclause A.7.2 shows the successful transfer for a call, currently in the IM CN subsystem, and which is transferred to the CS domain; and
- subclause A.7.3 shows the case where a transfer request for a call, currently in the IM CN subsystem, cannot be complied with at the VCC application due to the failure to match the request with an anchored call for that user.
- subclause A.7.4 shows a domain transfer request from the IM CN subsystem to the CS domain using CAMEL, and which is rejected by the VCC application at the VMSC.

A.7.2 Signalling flows for IM CN subsystem to CS domain transfer

Figure A.7.2-1 shows an example signalling flows for the domain transfer from the IM CN subsystem to the CS domain. The figure assumes that the UE is already registered with the CS domain prior to the decision to initiate transfer and that a call is anchored in the IM CN subsystem and the remote UE can be an IM UE.

In this example, the communication between the CS domain and the DTF to resolve and process the request for domain transfer is supported through CAMEL.

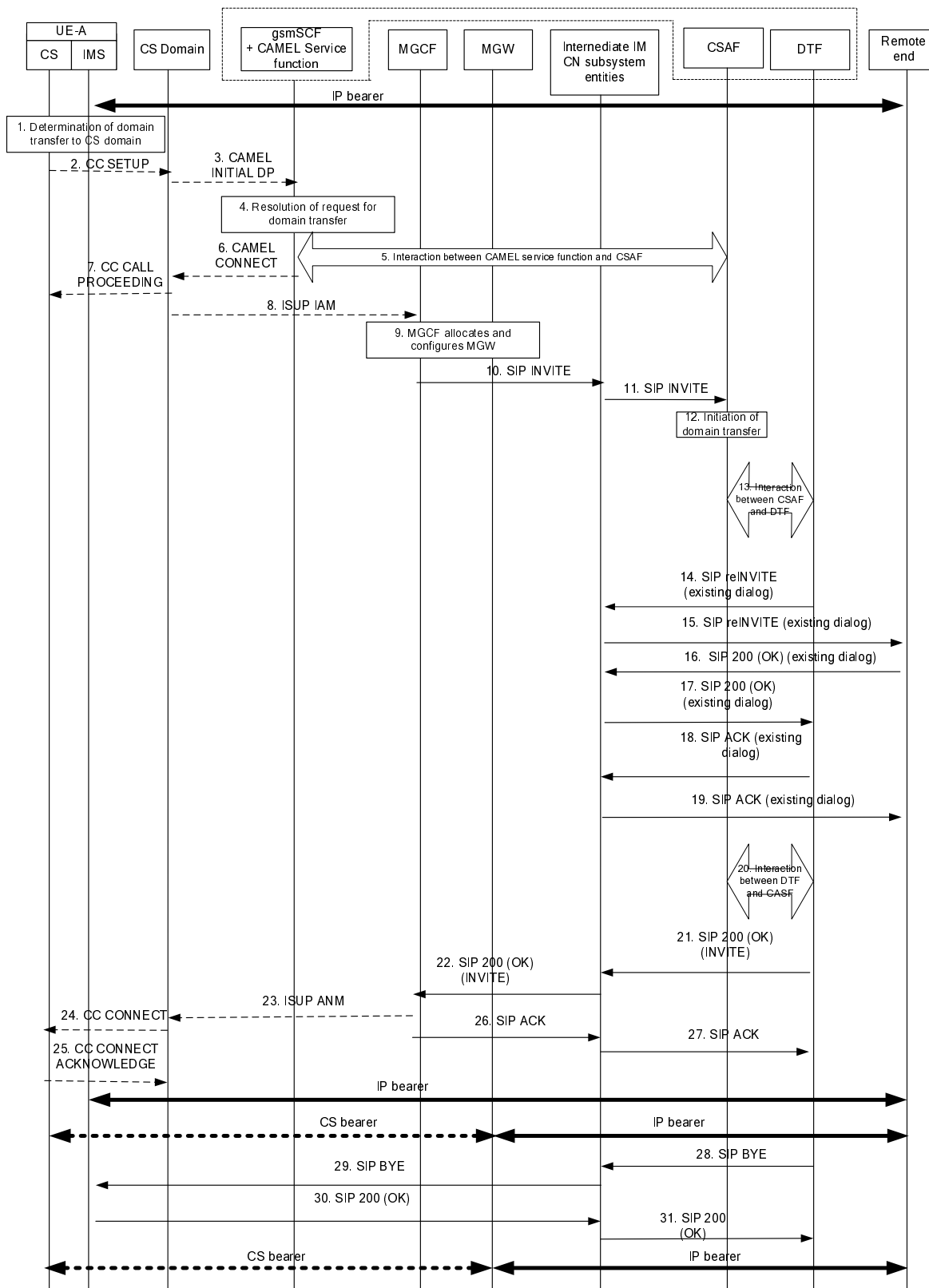

Figure A.7.2-1: IM CN subsystem to CS domain transfer

The details of the signalling flows are as follows:

There is an ongoing IP bearer between the VCC UE and the remote end.

1. Determination of Domain Transfer to CS domain

VCC UE can make a decision for domain transfer. It can be triggered in case that the access technology of VCC UE is changed or the user preference or the operator policy is changed in consequence of the access technology change and so on.

2. CC SETUP messages (VCC UE to MSC)

The VCC UE sends the CS SETUP message towards MSC with the VDN as the called party number.

NOTE 1: VDN (VCC Domain Transfer Number) is not a routeable number towards the VCC application. It is an MSISDN used by the UE to request a domain transfer towards the VCC application.

3. CAMEL INITIAL DP (VMSC to gsmSCF)

On receipt of the SETUP message, the VMSC, in this example signalling flow, triggers a CAMEL activity which results in sending a CAMEL IDP message to the gsmSCF. The CAMEL IDP message contains at least:

- the IMSI ie. 004412345678
- the calling party number ie. 12125551111;
- the called party number that of the VDN, ie. 12415555555

4. Handling of request for domain transfer

The gsmSCF channels the request for domain transfer to the CAMEL service function which determines that the call needs to be rerouted to the IM CN subsystem. The CAMEL service function can optionally assist the CSAF with the allocation of an IMRN.

NOTE 2: The gsmSCF and the CAMEL service function are connected through an unspecified interface left to vendor implementation.

5. Interaction between the CAMEL service function and the CSAF

The CAMEL service function can optionally assist the CSAF with the allocation of an IMRN. In this example, the CSAF accepts the request for domain transfer and assigns an IMRN, (IMRN = 12415553333).

NOTE 3: The signalling to support communication between the the CAMEL service function and CSAF is not specified in this version of the specification.

6. CAMEL CONNECT (gsmSCF to VMSC)

The CAMEL service function causes the gsmSCF to respond to the CAMEL IDP message with a CAMEL CONNECT message containing:

- the IMRN = 12415553333

7. CC CALL PROCEEDING message (VMSC to VCC UE)

As VMSC can now proceed with the call, VMSC indicates the CALL PROCEEDING message back to the UE.

8. ISUP IAM (VMSC to MGCF)

The VMSC initiates the CS call towards the MGCF by sending the IAM with the called party number (i.e. IMRN) to indicate the VCC application.

NOTE 4: The IMRN is a routeable MSISDN number towards the VCC application.

9. MGCF allocates and configures MGW

MGCF retrieves SDP from the ISUP IAM according to the 3GPP TS 29.163 [10]. The MGCF communicates with the IM-MGW to configure the media bearer.

10. SIP INVITE request (MGCF to the intermediate IM CN subsystem entities) – see example in table A.7.2-10

The MGCF initiates a SIP INVITE request towards the I-CSCF in the home IM CN subsystem of the originating VCC user with the PSI of the VCC application as the called party number. The tel-URI format of the IMRN as a

PSI (i.e. VCC application PSI) can be used for routing towards the VCC application in the IM CN subsystem. I-CSCF routes the SIP INVITE request based on one of the standard procedures specified in "PSI based Application Server termination – direct/indirect/DNS routing/service logic" procedures in 3GPP TS 23.228 [4].

The MGCF initiates a SIP INVITE request, containing an initial SDP. 3GPP TS 29.163 [10] specifies the principles of interworking between the 3GPP IM CN subsystem and ISUP based CS network, in order to support IM voice calls.

Table A.7.2-10: SIP INVITE request (MGCF to the intermediate IM CN subsystem entities)

```

INVITE tel: +1-241-555-3333 SIP/2.0
Via: SIP/2.0/UDP mgcf1.home1.net;branch=z9hG4bk731b87
Max-Forwards: 70
Route: <sip:icscf1.home1.net;lr>
P-Asserted-Identity: <tel: +1-212-555-1111>
P-Access-Network-Info: IEEE-WLAN-802.11b;
Privacy: none
From: <tel: +1-212-555-1111>;tag=171828
To: <tel: +1-241-555-3333>
Call-ID: cb03a0s09a2sdfglkj490333
Cseq: 127 INVITE

Supported: 100rel, precondition
Contact: <sip:mgcf1.home1.net>
Allow: INVITE, ACK, CANCEL, BYE, PRACK, UPDATE, REFER, MESSAGE
Content-Type: application/sdp
Content-Length: (...)

v=0
o=- 2987933615 2987933615 IN IP6 5555::aaa:bbb:xxx:yyy
s=-
c=IN IP6 5555::aaa:bbb:xxx:yyy
t=0 0
m=audio 3456 RTP/AVP 97 96
b=AS:25.4
a=curr:qos local none
a=curr:qos remote none
a=des:qos mandatory local sendrecv
a=des:qos none remote sendrecv
a=rtpmap:97 AMR
a=fmtp:97 mode-set=0,2,5,7; mode-change-period=2
a=rtpmap:96 telephone-event
a=maxptime:20

```

Request-URI: Contains the VCC application PSI, as a PSI based on the IMRN obtained from CS network signalling. The VCC application PSI is equivalent to the tel-URI format of the IMRN.

From: Contains the calling party number to indicate the CS part of the caller. (e.g. Tel: +1-1-212-555-1111).

To: Contains the VCC application PSI as the destination address. The actual destination address used for domain transfer from IM CN subsystem to CS domain is kept in the VCC application by the CS originating procedures described in subclause 7 and subclause A.4.

11. SIP INVITE request (intermediate IM CN subsystem entities to the CSAF) – see example in table A.7.2-11

The IM CN subsystem entities route the SIP INVITE request towards the CSAF based on the CSAF PSI.

Table A.7.2-11: SIP INVITE request (intermediate IM CN subsystem entities to the CSAF)

```

INVITE tel: +1-241-555-3333 SIP/2.0
Via: SIP/2.0/UDP scscf1.home1.net;branch=z9hG4bK764z87,
SIP/2.0/UDP icscf1.home1.net;branch=z9hG4bK332b23.1,
SIP/2.0/UDP mgcf1.home1.net;branch=z9hG4bK731b87
Max-Forwards: 68
Route: <sip:csaf1.home1.net;lr>
P-Asserted-Identity: <tel: +1-212-555-1111>
P-Charging-Vector: icid-value='AyretyU0dm+601IrT5tAFrbHLso=023551024'; orig-ioi=home1.net
Privacy: none
From: <tel: +1-212-555-1111>;tag=171828
To: <tel: +1-241-555-3333>
Call-ID: cb03a0s09a2sdfg1kj490333
Cseq: 127 INVITE

Supported: 100rel, precondition
Contact: <sip:mgcf1.home1.net>
Allow: INVITE, ACK, CANCEL, BYE, PRACK, UPDATE, REFER, MESSAGE
Content-Type: application/sdp
Content-Length: (...)

v=0
o=- 2987933615 2987933615 IN IP6 5555::aaa:bbb:xxx:yyy
s=-
c=IN IP6 5555::aaa:bbb:xxx:yyy
t=0 0
m=audio 3456 RTP/AVP 97 96
b=AS:25.4
a=curr:qos local none
a=curr:qos remote none
a=des:qos mandatory local sendrecv
a=des:qos none remote sendrecv
a=rtpmap:97 AMR
a=fmtp:97 mode-set=0,2,5,7; mode-change-period=2
a=rtpmap:96 telephone-event
a=maxptime:20

```

12. VCC application initiates domain transfer

The CSAF and DTF in combination act as a routing B2BUA, associating the incoming SIP INVITE with the ongoing session in the IM CN subsystem..

NOTE 5: During the initial IM CN subsystem origination procedure, the CSAF will keep the called party number and the calling party number for anchoring, domain transfer and so on.

13. Interaction between CSAF and DTF

Information is exchanged between the CSAF and the DTF. The nature of this signalling is outside the scope of this version of the specification.

14. SIP reINVITE request (DTF to the intermediate IM CN subsystem entities) – see example in table A.7.2-14

The DTF forwards the SIP reINVITE request back to the S-CSCF.

The DTF modifies the message in accordance with routing B2BUA functionality, e.g. mapping of From, To, Cseq and Call-ID headers from one side of the B2BUA to the other.

Table A.7.2-14: SIP reINVITE request (VCC application to intermediate IM CN subsystem entities)

```

INVITE sip:[5555::eee:fff:aaa:bbb]:8805;comp=sigcomp SIP/2.0
Via: SIP/2.0/UDP dtf1.home1.net;branch=z9hG4bK764z87,
Max-Forwards: 67
Route: <sip:scscf1.home1.net;lr>

P-Asserted-Identity: <tel: +1-212-555-1111>
P-Charging-Vector: icid-value='AyretyU0dm+601IrT5tAFrbHLso=023551024'; orig-ioi=home1.net
Privacy: none
From: <tel:+1-212-555-1111>;tag=171828
To: <sip:user2_public2@home2.net>;tag=314159
Call-ID: cb03a0s09a2sdfgklkj590123
Cseq: 127 INVITE
Supported: 100rel, precondition
Contact: <sip:[7777::eee:ddd:ccc:aaa]>
Allow: INVITE, ACK, CANCEL, BYE, PRACK, UPDATE, REFER, MESSAGE
Content-Type: application/sdp
Content-Length: (...)

v=0
o=- 2987933615 2987933615 IN IP6 5555::aaa:bbb:xxx:yyy
s=-
c=IN IP6 5555::aaa:bbb:xxx:yyy
t=0 0
m=audio 3456 RTP/AVP 97 96
b=AS:25.4
a=rtpmap:97 AMR
a=fmtp:97 mode-set=0,2,5,7; mode-change-period=2
a=rtpmap:96 telephone-event
a=maxptime:20

```

Request-URI: Contains the SIP-URI represented as an IP address indicating the called party UE, as retrieved from the VCC application.

From: Contains the tel-URI indicating the remote VCC UE-A. A tag has same value in the existing dialog.

To: Contains the SIP-URI of the called party UE.

NOTE 6: If the called party UE is also the VCC UE, To header will be a tel-URI.

Contact: Contains the SIP-URI indicating the VCC application.

15. SIP reINVITE request (intermediate IM CN subsystem entities to remote UE) – see example in table A.7.2-15

The S-CSCF routes the SIP reINVITE request towards the remote end.

Table A.7.2-12: SIP reINVITE request (VCC application to the remote UE through the intermediate IM CN subsystem entities)

```

INVITE sip:[5555::eee:fff:aaa:bbb]:8805;comp=sigcomp SIP/2.0
Via: SIP/2.0/UDP scscf1.home1.net;branch=z9hG4bK332b23.1, SIP/2.0/UDP
dtfl.home1.net;branch=z9hG4bK764z87,
Max-Forwards: 65
Route: <sip:scscf2.home2.net;lr>

P-Asserted-Identity: <tel: +1-212-555-1111>
P-Charging-Vector: icid-value='AyretyU0dm+601IrT5tAFrbHLso=023551024'; orig-ioi=home1.net
Privacy: none
From: <tel:+1-212-555-1111>;tag=171828
To: <sip:user2_public2@home2.net>;tag=314159
Call-ID: cb03a0s09a2sdfglkj590123
Cseq: 127 INVITE
Supported: 100rel, precondition
Contact: <sip:[7777::eee:ddd:ccc:aaa]>
Allow: INVITE, ACK, CANCEL, BYE, PRACK, UPDATE, REFER, MESSAGE
Content-Type: application/sdp
Content-Length: (...)

v=0
o=- 2987933615 2987933615 IN IP6 5555::aaa:bbb:xxx:yyy
s=-
c=IN IP6 5555::aaa:bbb:xxx:yyy
t=0 0
m=audio 3456 RTP/AVP 97 96
b=AS:25.4
a=rtpmap:97 AMR
a=fmtp:97 mode-set=0,2,5,7; mode-change-period=2
a=rtpmap:96 telephone-event
a=maxptime:20

```

16. SIP 200 (OK) response (Remote UE to the intermediate IM CN subsystem entities)

The remote UE indicates the successful completion of the SIP reINVITE request.

There is no VCC specific content to this response.

17. SIP 200 (OK) response (intermediate IM CN subsystem entities to DTF)

Indicate the successful completion of the SIP reINVITE request.

There is no VCC specific content to this response.

18. SIP ACK request (DTF to the intermediate IM CN subsystem entities)

The DTF responds to the SIP 200 (OK) response with a SIP ACK request.

There is no VCC specific content to this request.

19. SIP ACK request (intermediate IM CN subsystem entities to remote UE)

The intermediate IM CN subsystem entities forward the SIP ACK request to the remote UE.

There is no VCC specific content to this request.

20. Interaction between DTF and CSAF

Information is exchanged between the DTF and the CSAF. The nature of this signalling is outside the scope of this version of the specification.

21. SIP 200 (OK) response (CSAF to the intermediate IM CN subsystem entities)

The CSAF indicates the successful completion of the SIP INVITE request generated by the MGCF.

The VCC application modifies the message in accordance with routing B2BUA functionality, e.g. mapping of From, To, Cseq and Call-ID headers from one side of the B2BUA to the other.

There is no VCC specific content to this response.

22. SIP 200 (OK) response (intermediate IM CN subsystem entities to MGCF)

The intermediate IM CN subsystem entities forward the SIP 200 (OK) response to the MGCF.

There is no VCC specific content to this response.

23. ISUP ANM (MGCF to VMSC)**24. CC CONNECT message (VMSC to the CS part of UE-A)****25. CC CONNECT ACK message (CS part of UE-A to the VMSC)****26. SIP ACK request (MGCF to the intermediate IM CN subsystem entities)**

The MGCF generates a SIP ACK request in response to the SIP 200 (OK) response.

There is no VCC specific content to this request.

27. SIP ACK request (intermediate IM CN subsystem entities to CSAF)

The intermediate IM CN subsystem entities forward the SIP ACK request to the CSAF.

There is no VCC specific content to this request.

28. SIP BYE request (DTF to the intermediate IM CN subsystem entities)

On receiving the SIP 200 (OK) response (step 17), the DTF sends a BYE request to the IP multimedia side of the VCC UE via the intermediate IM CN subsystem entities.

There is no VCC specific content to this request.

29. SIP BYE request (intermediate IM CN subsystem entities to VCC UE)

The intermediate IM CN subsystem entities forward the SIP BYE request to the VCC UE.

There is no VCC specific content to this request.

30. SIP 200 (OK) response (VCC UE to the intermediate IM CN subsystem entities)

The IP multimedia part of the VCC UE responds to the SIP BYE request to indicate the successful completion of the domain transfer.

There is no VCC specific content to this response.

31. SIP 200 (OK) response (intermediate IM CN subsystem entities to DTF)

The intermediate IM CN subsystem entities forward the SIP 200 (OK) response to the DTF.

There is no VCC specific content to this response.

A.7.3 Signalling flows for unsuccessful IM CN subsystem to CS domain transfer

Figure A.7.3-1 shows the signalling flows for the unsuccessful call transfer when transferring the call from the IM CN subsystem to the CS domain. The assumption is that VCC UE is not roaming and the MGCF is in the subscriber's IM CN subsystem.

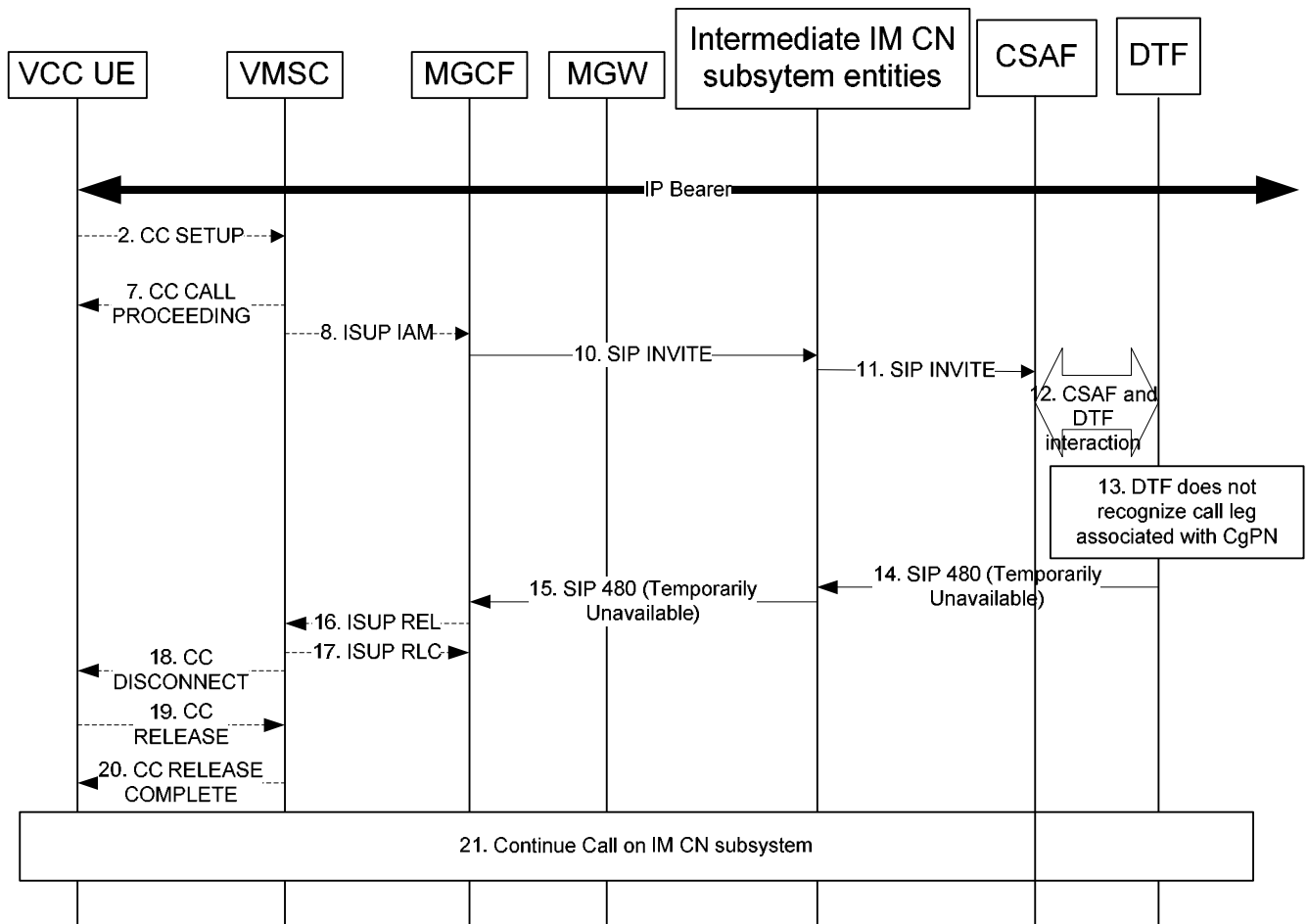

Figure A.7.3-1: unsuccessful call transfer when transferring call from IM CN subsystem to CS domain

The details of the signalling flows are as follows:

Step 1 through 11 are according to subclause A.7.2.

12. CSAF and DTF interaction

Information is exchanged between the CSAF and the DTF. The nature of this signalling is outside the scope of this version of the specification.

13. VCC application

When the DTF receives IMRN indicating the domain transfer, it does not recognize the call leg associated with Calling Party Number CgPN or P-Asserted-Identity.

14. SIP 480 (Temporarily Unavailable) response (DTF to intermediate IM CN subsystem entities) – see example in table A.7.3-14

The DTF sends a SIP 480 (Temporarily Unavailable) response to the intermediate IM CN subsystem entities.

Table A.7.3-14: 480 (Temporarily Unavailable) response (DTF to intermediate IM CN subsystem entities)

```
SIP/2.0 480 Temporarily Unavailable
Via: SIP/2.0/UDP scscf1.home1.net;branch=z9hG4bK354216.1, SIP/2.0/UDP
    icscf1.home1.net;branch=z9hG4bK240f34.1, SIP/2.0/UDP
    mgcf1.home1.net;branch=z9hG4bK731b87
Record-Route: <sip:scscf1.home1.net;lr>
P-Asserted-Identity: <tel:+1-212-555-1111>
Privacy: none
From: <sip:domain.xfer@dtf1.home1.net>, tag=1234
To: <sip:mgcf1.home1.net>; tag=171828
Call-ID: cb03a0s09a2sdfg1kj490333
Cseq: 127 INVITE
Contact: <sip:[5555::eee:fff:ggg:hhh]>
Content-Length: 0
```

15. SIP 480 (Temporarily Unavailable) response (intermediate IM CN subsystem entities to MGCF) – see example in table A.7.3-15

The error message is forwarded from intermediate IM CN subsystem entities to MGCF according to standard procedures.

Table A.7.3-15: SIP 480 (Temporarily Unavailable) response (intermediate IM CN subsystem entities to MGCF)

```
SIP/2.0 480 Temporarily Unavailable
Via: SIP/2.0/UDP mgcf1.home1.net;branch=z9hG4bK731b87
Record-Route: <sip:scscf1.home1.net;lr>
P-Asserted-Identity: <tel:+1-212-555-1111>
Privacy: none
From: <sip:domain.xfer@dtf1.home1.net>, tag=1234
To: <sip:mgcf1.home1.net>; tag=171828
Call-ID: cb03a0s09a2sdfg1kj490333
Cseq: 127 INVITE
Contact: <sip:[5555::eee:fff:ggg:hhh];>
Content-Length: 0
```

16. ISUP REL (MGCF to VMSC)

Upon unsuccessful call setup, MGCF sends REL to VMSC.

17. ISUP RLC (VMSC to MGCF)

VMSC sends RLC to MGCF to confirm the REL.

18. CC DISCONNECT message (VMSC to VCC UE)

VMSC sends the DISCONNECT message to VCC UE.

19. CC RELEASE message (VCC UE to VMSC)

VCC UE acknowledges the DISCONNECT message by sending RELEASE message to VMSC.

20. CC RELEASE COMPLETE message (VMSC to VCC UE)

VMSC sends a RELEASE COMPLETE message to VCC UE to confirm the RELEASE message.

21. VCC UE continues the call in IM CN subsystem

VCC UE continues the call in IM CN subsystem.

A.7.4 Signalling flows with domain transfer rejection at VMSC (using CAMEL)

Figure A.7.4-1 shows the domain transfer attempt from the IM CN subsystem to the CS domain using CAMEL, and which is rejected by the VCC application at the VMSC. The domain transfer request is then abandoned, and the IMS call for which the domain transfer has been requested continues in the IM CN subsystem.

The decision to execute the request from the VCC UE for a domain transfer is subject to operator policy.

NOTE: For domain transfer, the use of CAMEL in the context of VCC is optional. In this example the VMSC supports and uses CAMEL service logic.

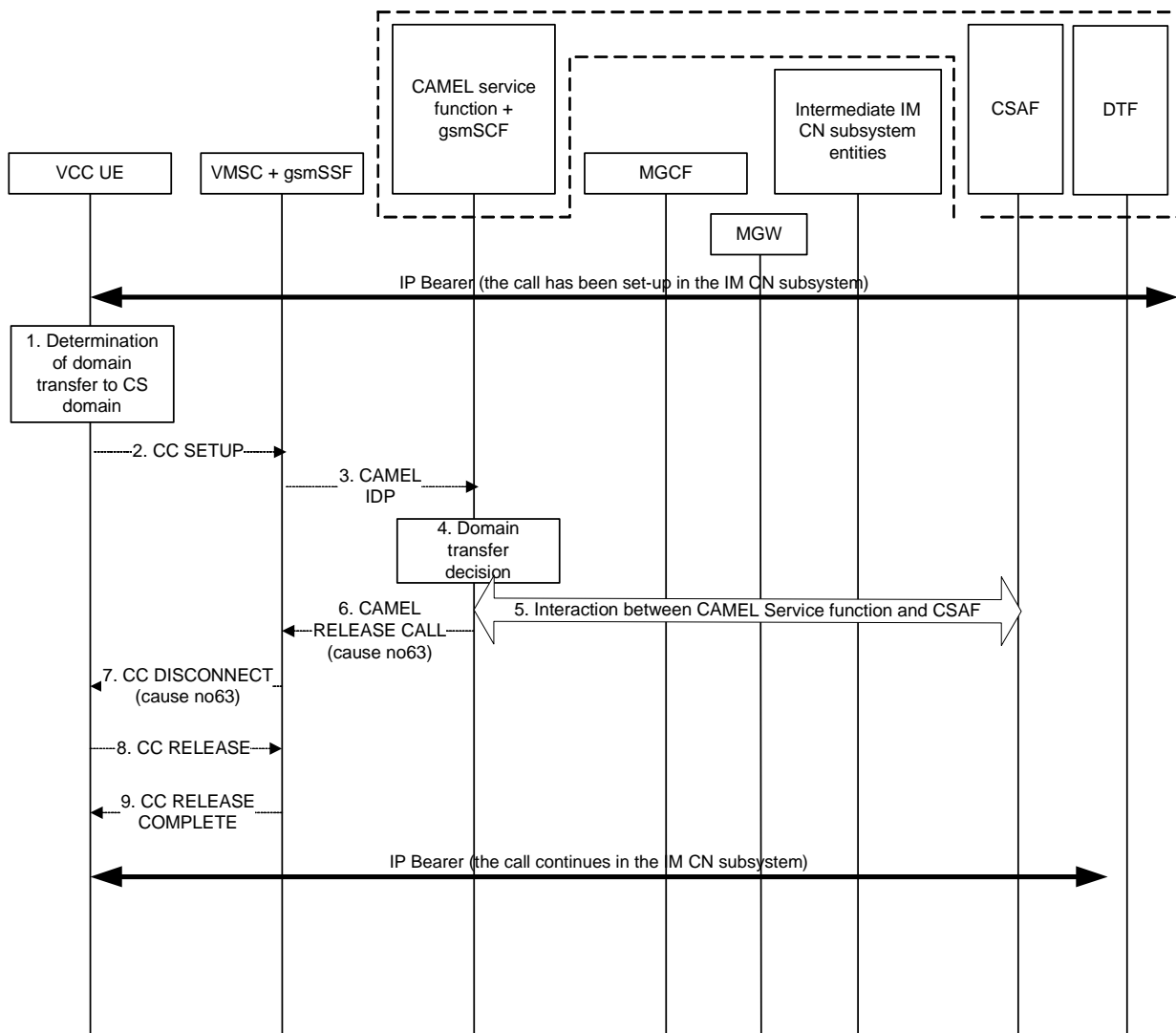

Figure A.7.4-1: Domain transfer rejection at VMSC (using CAMEL)

The details of the signalling flows are as follows:

Steps 1, 2 and 3 are identical to the steps 1, 2 and 3 from the example in subclause A.7.2.

4. **Domain transfer decision**

The gsmSCF channels the request for domain transfer to the CAMEL service function which determines if the call needs to be routed to the IM CN subsystem.

5. **Interaction between CAMEL service function and CSAF**

The CAMEL service function can optionally assist the CSAF with the allocation of an IMRN. The CSAF rejects the domain transfer request from the VCC UE to the CS domain according to the operator policy.

In this example the VDN is not a routeable number towards the IM CN subsystem and the VCC application failed to assign a new IMRN for this call i.e. insufficient IMRN.

6. **CAMEL RELEASE CALL (gsmSCF to VMSC)**

The CAMEL service function causes the gsmSCF to respond to the CAMEL IDP message with a CAMEL RELEASE CALL message. The CAMEL RELEASE CALL message contains a release cause number #63 'Service or option not available, unspecified'.

7, 8 and 9. **DISCONNECT, RELEASE and RELEASE COMPLETE (from and to the VCC UE)**

The VMSC release the call toward the VCC UE; steps 6 to 8 are identical to step 16 to 18 from subclause A.7.3. The cause used in the DISCONNECT is mapped from the CAMEL release cause received by the VMSC.

There is no specific cause for VCC in the DISCONNECT.

The call in the IM CN subsystem for which the domain transfer has been requested continues unchanged in the IM CN subsystem.

Annex B (informative): Example of filter criteria

B.1 Introduction

This annex provides some examples of filter criterion in the S-CSCF within the user profile of a specific public user identity. This filter criterion triggers S-CSCF actions following initial filter criteria evaluation of a SIP request thus resulting in orderly invocation of application servers. These examples are meant to illustrate the placement of the application server fulfilling the role of domain transfer function in a chain of application servers invoked to service an IM session.

B.2 Example 1 – Service profile for UE originating for a VCC subscriber

The example in table B.2-1 illustrates the case of iFC evaluations for originating sessions in the IM CN subsystem initiated by a VCC subscriber who has also subscribed to the Connected Line Presentation (COLP) service. Only the example portion of iFC related to origination of an IM session is provided. Other portions of iFCs for evaluations of other SIP methods leading to actions on other application servers - for instance, for 3rd party registration - are not illustrated in this by example.

For this example the illustration of the iFC is provided in an illustrative tabular form.

For this example, the public user identity is user1_public1@home1.net where home1.net is the URI of the home network.

In this example, the first initial filter criteria triggers the S-CSCF to route the initial SIP INVITE request to the domain transfer function of the VSS AS addressed with the public service identity sip:dtfas.vcc.home1.net. When the SIP INVITE request is then returned from that VCC AS, the next initial filter criteria evaluation will cause the S-CSCF to route a SIP INVITE request to a call service application server for the user subscribed COLP service where that application server is addressed with the public service identity sip:colp.ssas.home1.net.

Table B.2-1: Service profile for UE originating for a VCC subscriber

Service Profile (Public Identity user1_public1@home1.net)	
Initial Filter Criteria	
Priority	0
Service Point Trigger 1	
Method:	INVITE
Session Case:	Originating
Application server:	sip:dtfas.vcc.home1.net
Initial Filter Criteria	
Priority	1
Service Point Trigger 2	
Method:	INVITE
Session Case:	Originating
Application server:	sip:colp.ssas.home1.net

B.3 Example 2 – Service profile for UE terminating for a VCC subscriber

The example in table B.3-1 illustrates the case of iFC evaluations for a terminating session in the IM CN subsystem to a VCC subscriber who has also subscribed to OIP (Originating Identification Presentation) service. Only the example portion of iFC related to termination of an IM session is provided. Other portions of iFCs for evaluations of other SIP methods leading to actions on other application servers - for instance, for 3rd party registration - are not illustrated in this by example.

The provided example iFC illustrates only one method of populating the iFCs whereby the domain transfer function and the domain selection function are treated by separate application servers. This example does not preclude alternate means of invoking the domain selection function, for instance, within the processing of the domain transfer function itself.

Editor's note: Might it be useful to illustrate other examples of invoking the domain transfer and domain selection functions to reflect alternatives as provided in stage 2? That would however, require a separate annex of examples showing the use of filter criteria to invoke application servers in their required order.

For this example the illustration of the iFC is provided in XML form.

For this example, the terminating user has the public user identity user2_public2@home2.net where the home2.net is the URI of the home network.

In this example, this 1st initial Filter Criteria evaluation causes the S-CSCF to route a SIP INVITE request to an application server treating the user's subscribed call related service. In this example, the user's subscribed services are Call Diversion services and OIP service. This call service application server, in this example, is addressed with the public service identity sip:callserv.ssas.home2.net.

When a SIP INVITE request is returns from the call services application server the next initial Filter Criteria evaluation will cause the S-CSCF to route a SIP INVITE request to an AS which performs the role of Domain Transfer Function of a VCC application addressed with the public service identity sip:dtfas.vcc.home2.net. After the anchor decision has been taken and the VCC AS with the domain transfer function role returns a SIP INVITE request, wherein the next iFC evaluation leads the S-CSCF to route a SIP INVITE request to an AS which performs the role of domain selection function addressed with the public service identity sip:dsfas.vcc.home2.net.

Table B.3-1: Service profile for UE terminating for a VCC subscriber

```

<ServiceProfile>
  <PublicIdentity>
    <Identity> sip:user2_public2@home2.net </Identity>
  </PublicIdentity>
  <InitialFilterCriteria>
    <Priority>0</Priority>
    <TriggerPoint>
      <ConditionTypeCNF>0</ConditionTypeCNF>
      <SPT>
        <ConditionNegated>0</ConditionNegated>
        <Group>0</Group>
        <Method>INVITE</Method>
      </SPT>
      <SPT>
        <ConditionNegated>0</ConditionNegated>
        <Group>0</Group>
        <SessionCase>1</SessionCase>
      </SPT>
    </TriggerPoint>
    <ApplicationServer>
      <ServerName>sip:callserv.ssas.home2.net </ServerName>
      <DefaultHandling>0</DefaultHandling>
    </ApplicationServer>
  </InitialFilterCriteria>
  <InitialFilterCriteria>
    <Priority>10</Priority>
    <TriggerPoint>
      <ConditionTypeCNF>0</ConditionTypeCNF>
      <SPT>
        <ConditionNegated>0</ConditionNegated>
        <Group>0</Group>
        <Method>INVITE</Method>
      </SPT>
      <SPT>
        <ConditionNegated>0</ConditionNegated>
        <Group>0</Group>
        <SessionCase>1</SessionCase>
      </SPT>
    </TriggerPoint>
    <ApplicationServer>
      <ServerName>sip:dtfas.vcc.home2.net </ServerName>
      <DefaultHandling>0</DefaultHandling>
    </ApplicationServer>
  </InitialFilterCriteria>
  <InitialFilterCriteria>
    <Priority>100</Priority>
    <TriggerPoint>
      <ConditionTypeCNF>0</ConditionTypeCNF>
      <SPT>
        <ConditionNegated>0</ConditionNegated>
        <Group>0</Group>
        <Method>INVITE</Method>
      </SPT>
      <SPT>
        <ConditionNegated>0</ConditionNegated>
        <Group>0</Group>
        <SessionCase>1</SessionCase>
      </SPT>
    </TriggerPoint>
    <ApplicationServer>
      <ServerName>sip:dsfas.vcc.home2.net </ServerName>
      <DefaultHandling>0</DefaultHandling>
    </ApplicationServer>
  </InitialFilterCriteria>
</ServiceProfile>

```

Annex C (informative): Change history

Change history							
Date	TSG #	TSG Doc.	CR	Rev	Subject/Comment	Old	New
2005-10					Rapporteurs input framework document	0.0.0	0.1.0
2005-11					Implementation of CRs agreed at CT1#40 as follows: C1-051654	0.1.0	0.2.0
2006-01					Implementation of CRs agreed at CT1#40bis as follows: C1-060023, C1-060105, C1-060106	0.2.0	0.3.0
2006-02					Implementation of CRs agreed at CT1#41 as follows: C1-060529, C1-060530	0.3.0	0.4.0
2006-05					Implementation of CRs agreed at CT1#42 as follows: C1-060692, C1-060721, C1-061033, C1-061037, C1-061038, C1-061039, C1-061040, C1-061041, C1-061046	0.4.0	0.5.0
2006-07					Implementation of CRs agreed at CT1#42bis as follows: C1-061281, C1-061282, C1-061283, C1-061284, C1-061285, C1-061286, C1-061287, C1-061288, C1-061289, C1-061292, C1-061362	0.5.0	0.6.0
2006-09					Implementation of CRs agreed at CT1#43 as follows: C1-061447, C1-061648, C1-061775, C1-061776, C1-061778, C1-061781, C1-061782, C1-061785, C1-061786, C1-061793, C1-061794, C1-061795, C1-061874, C1-061877	0.6.0	0.7.0
2006-09					Reissue to correct problem with implementation of C1-061648	0.7.0	0.7.1
2006-09					Version 1.0.0 created for presentation to TSG	0.7.1	1.0.0
2006-11					Implementation of CRs agreed at CT1#44 as follows: C1-062010, C1-062085, C1-062086, C1-062153, C1-062156, C1-062159, C1-062160, C1-062162, C1-062163, C1-062164, C1-062165, C1-062166, C1-062170, C1-062176, C1-062194, C1-062197, C1-062233, C1-062234, C1-062355, C1-062357, C1-062358, C1-062359, C1-062360, C1-062361, C1-062362, C1-062363, C1-062364, C1-062366, C1-062367, C1-062369, C1-062370, C1-062371, C1-062372, C1-062373, C1-062374, C1-062375, C1-062378, C1-062379, C1-062380, C1-062381, C1-062454, C1-062513, C1-062514.	1.0.0	1.1.0
2006-11					Version 2.0.0 created for presentation to CT#34, for approval	1.1.0	2.0.0
2006-11					CT#34 approved version 2.0.0 in CP-060653; version 7.0.0 created by MCC	2.0.0	7.0.0
2007-01					Editorial correction done by MCC	7.0.0	7.0.1
2007-03	CT-35	CP-070147	0001	1	VCC : handling of parallel calls	7.0.1	7.1.0
2007-03	CT-35	CP-070147	0002	1	VCC : Correlation of MSISDN and tel-URI	7.0.1	7.1.0
2007-03	CT-35	CP-070147	0003	1	VCC : Domain Selection Criteria	7.0.1	7.1.0
2007-03	CT-35	CP-070147	0007	1	Domain Transfer	7.0.1	7.1.0
2007-03	CT-35	CP-070147	0008	1	Roles for VCC	7.0.1	7.1.0
2007-03	CT-35	CP-070147	0011	2	Handling of national and short numbers	7.0.1	7.1.0
2007-03	CT-35	CP-070147	0014	2	original dialog id in request of VCC redelivery	7.0.1	7.1.0
2007-03	CT-35	CP-070147	0015	1	P-Preferred-Identity of request for domain transfer of a call from the CS to the IMS	7.0.1	7.1.0
2007-03	CT-35	CP-070147	0024	-	Removal of editor's notes relating to additional signalling	7.0.1	7.1.0
2007-03	CT-35	CP-070147	0025	-	Removal of redundant editor's notes	7.0.1	7.1.0
2007-03	CT-35	CP-070147	0026	1	Conditions for successful domain transfer	7.0.1	7.1.0
2007-03	CT-35	CP-070147	0028	1	Add an additional signalling flow to Annex A for origination from CS domain from a user that is not registered within the IMS CN subsystem	7.0.1	7.1.0
2007-03	CT-35	CP-070147	0029	3	Annex A editorial changes	7.0.1	7.1.0
2007-03	CT-35	CP-070147	0030	-	Annex B editorial changes	7.0.1	7.1.0
2007-03	CT-35	CP-070147	0032	-	Modification of VCC scope section	7.0.1	7.1.0
2007-03	CT-35	CP-070147	0033	1	Define VCC application term	7.0.1	7.1.0
2007-03	CT-35	CP-070147	0034	1	Removal term VoIP	7.0.1	7.1.0
2007-03	CT-35	CP-070147	0035	2	Alignment of call delivery requirements with stage 1	7.0.1	7.1.0
2007-03	CT-35	CP-070147	0037	1	7.4.3 Call origination in the CS domain towards the gsmSCF - IMRN allocation	7.0.1	7.1.0
2007-03	CT-35	CP-070147	0038	1	7.4.4 Call origination in the CS domain towards IM CN subsystem IMRN deallocation	7.0.1	7.1.0
2007-03	CT-35	CP-070147	0039	1	8.4.3 Call termination in the CS domain towards the gsmSCF - IMRN allocation n	7.0.1	7.1.0
2007-03	CT-35	CP-070147	0040	2	10.2 VCC UE behavior when engaged in CONF or MPTY call	7.0.1	7.1.0
2007-03	CT-35	CP-070147	0041	1	10.4.2 Domain transfer procedures towards the gsmSCF - IMRN allocation	7.0.1	7.1.0
2007-03	CT-35	CP-070147	0042	1	10.4.3 Domain transfer in the IM CN subsystem - deallocation of IMRN	7.0.1	7.1.0

2007-03	CT-35	CP-070147	0044	1	A.5.4 Signalling flows for termination directed to IM CN subsystem	7.0.1	7.1.0
2007-06	CT-36	CP-070377	0076	1	Clarification for VCC Flow	7.1.0	7.2.0
2007-06	CT-36	CP-070377	0074	2	VCC Application split into sub-functions for termination call flows	7.1.0	7.2.0
2007-06	CT-36	CP-070377	0072	1	Introduction of operator policy in DTF procedures	7.1.0	7.2.0
2007-06	CT-36	CP-070377	0071	1	Correction of the VCC UE behaviour during DTF	7.1.0	7.2.0
2007-06	CT-36	CP-070377	0069	-	Service profile impact for calls from unregistered user	7.1.0	7.2.0
2007-06	CT-36	CP-070377	0068	1	Changing the reference to TS 24.229 for As initiated call	7.1.0	7.2.0
2007-06	CT-36	CP-070377	0066	1	Section 4.2 alignment with stage 2	7.1.0	7.2.0
2007-06	CT-36	CP-070377	0062	1	Correction to the description in section 4.3	7.1.0	7.2.0
2007-06	CT-36	CP-070377	0061	1	Section 8.4.2 alignment with stage 2	7.1.0	7.2.0
2007-06	CT-36	CP-070377	0060	1	Addition of VCC application sub-functions to signaling flows in annex A.5	7.1.0	7.2.0
2007-06	CT-36	CP-070377	0053	1	Completion of empty subclauses in 24.206	7.1.0	7.2.0
2007-06	CT-36	CP-070377	0052	-	Origination anchoring CAP CONNECT contents option	7.1.0	7.2.0
2007-06	CT-36	CP-070377	0051	1	VCC handling of multiple dialogs during a domain transfer request	7.1.0	7.2.0

History

Document history		
V7.1.0	March 2007	Publication
V7.2.0	June 2007	Publication