

ETSI TS 124 244 V17.0.0 (2022-04)



**Universal Mobile Telecommunications System (UMTS);
LTE;
Wireless LAN control plane protocol for trusted WLAN access
to EPC;
Stage 3
(3GPP TS 24.244 version 17.0.0 Release 17)**



Reference

RTS/TSGC-0124244vh00

Keywords

LTE,UMTS

ETSI

650 Route des Lucioles
F-06921 Sophia Antipolis Cedex - FRANCE

Tel.: +33 4 92 94 42 00 Fax: +33 4 93 65 47 16

Siret N° 348 623 562 00017 - APE 7112B
Association à but non lucratif enregistrée à la
Sous-Préfecture de Grasse (06) N° w061004871

Important notice

The present document can be downloaded from:

<http://www.etsi.org/standards-search>

The present document may be made available in electronic versions and/or in print. The content of any electronic and/or print versions of the present document shall not be modified without the prior written authorization of ETSI. In case of any existing or perceived difference in contents between such versions and/or in print, the prevailing version of an ETSI deliverable is the one made publicly available in PDF format at www.etsi.org/deliver.

Users of the present document should be aware that the document may be subject to revision or change of status.

Information on the current status of this and other ETSI documents is available at

<https://portal.etsi.org/TB/ETSIDeliverableStatus.aspx>

If you find errors in the present document, please send your comment to one of the following services:

<https://portal.etsi.org/People/CommitteeSupportStaff.aspx>

If you find a security vulnerability in the present document, please report it through our
Coordinated Vulnerability Disclosure Program:

<https://www.etsi.org/standards/coordinated-vulnerability-disclosure>

Notice of disclaimer & limitation of liability

The information provided in the present deliverable is directed solely to professionals who have the appropriate degree of experience to understand and interpret its content in accordance with generally accepted engineering or other professional standard and applicable regulations.

No recommendation as to products and services or vendors is made or should be implied.

No representation or warranty is made that this deliverable is technically accurate or sufficient or conforms to any law and/or governmental rule and/or regulation and further, no representation or warranty is made of merchantability or fitness for any particular purpose or against infringement of intellectual property rights.

In no event shall ETSI be held liable for loss of profits or any other incidental or consequential damages.

Any software contained in this deliverable is provided "AS IS" with no warranties, express or implied, including but not limited to, the warranties of merchantability, fitness for a particular purpose and non-infringement of intellectual property rights and ETSI shall not be held liable in any event for any damages whatsoever (including, without limitation, damages for loss of profits, business interruption, loss of information, or any other pecuniary loss) arising out of or related to the use of or inability to use the software.

Copyright Notification

No part may be reproduced or utilized in any form or by any means, electronic or mechanical, including photocopying and microfilm except as authorized by written permission of ETSI.

The content of the PDF version shall not be modified without the written authorization of ETSI.

The copyright and the foregoing restriction extend to reproduction in all media.

© ETSI 2022.
All rights reserved.

Intellectual Property Rights

Essential patents

IPRs essential or potentially essential to normative deliverables may have been declared to ETSI. The declarations pertaining to these essential IPRs, if any, are publicly available for **ETSI members and non-members**, and can be found in ETSI SR 000 314: "*Intellectual Property Rights (IPRs); Essential, or potentially Essential, IPRs notified to ETSI in respect of ETSI standards*", which is available from the ETSI Secretariat. Latest updates are available on the ETSI Web server (<https://ipr.etsi.org/>).

Pursuant to the ETSI Directives including the ETSI IPR Policy, no investigation regarding the essentiality of IPRs, including IPR searches, has been carried out by ETSI. No guarantee can be given as to the existence of other IPRs not referenced in ETSI SR 000 314 (or the updates on the ETSI Web server) which are, or may be, or may become, essential to the present document.

Trademarks

The present document may include trademarks and/or tradenames which are asserted and/or registered by their owners. ETSI claims no ownership of these except for any which are indicated as being the property of ETSI, and conveys no right to use or reproduce any trademark and/or tradename. Mention of those trademarks in the present document does not constitute an endorsement by ETSI of products, services or organizations associated with those trademarks.

DECT™, **PLUGTESTS™**, **UMTS™** and the ETSI logo are trademarks of ETSI registered for the benefit of its Members. **3GPP™** and **LTE™** are trademarks of ETSI registered for the benefit of its Members and of the 3GPP Organizational Partners. **oneM2M™** logo is a trademark of ETSI registered for the benefit of its Members and of the oneM2M Partners. **GSM®** and the GSM logo are trademarks registered and owned by the GSM Association.

Legal Notice

This Technical Specification (TS) has been produced by ETSI 3rd Generation Partnership Project (3GPP).

The present document may refer to technical specifications or reports using their 3GPP identities. These shall be interpreted as being references to the corresponding ETSI deliverables.

The cross reference between 3GPP and ETSI identities can be found under <http://webapp.etsi.org/key/queryform.asp>.

Modal verbs terminology

In the present document "**shall**", "**shall not**", "**should**", "**should not**", "**may**", "**need not**", "**will**", "**will not**", "**can**" and "**cannot**" are to be interpreted as described in clause 3.2 of the [ETSI Drafting Rules](#) (Verbal forms for the expression of provisions).

"**must**" and "**must not**" are **NOT** allowed in ETSI deliverables except when used in direct citation.

Contents

Intellectual Property Rights	2
Legal Notice	2
Modal verbs terminology.....	2
Foreword.....	8
1 Scope	9
2 References	9
3 Definitions and abbreviations.....	9
3.1 Definitions	9
3.2 Abbreviations	10
4 General	10
4.1 Overview	10
4.2 Protocol stack	11
4.2.1 General.....	11
4.2.2 UDP port numbers for WLCP.....	11
4.2.2.1 General	11
4.2.2.2 UE procedure	11
4.2.2.3 TWAG procedure.....	11
4.2.3 IP addresses of WLCP message.....	11
4.2.3.1 General	11
4.2.3.2 UE procedure	12
4.2.3.3 TWAG procedure.....	12
4.2.4 DTLS usage	12
4.3 WLCP layer states when single point-to-point connectivity is used	13
4.3.1 General.....	13
4.3.2 WLCP layer states in the UE	13
4.3.2.1 PDN CONNECTIVITY NOT ESTABLISHED	13
4.3.2.2 PDN CONNECTIVITY ESTABLISHED	13
4.3.2.3 PROCEDURE TRANSACTION INACTIVE	13
4.3.2.4 PROCEDURE TRANSACTION PENDING	13
4.3.3 WLCP layer states in the TWAG.....	14
4.3.3.1 PDN CONNECTIVITY NOT ESTABLISHED	14
4.3.3.2 PDN CONNECTIVITY PENDING.....	14
4.3.3.3 PDN CONNECTIVITY ESTABLISHED	14
4.3.3.4 PDN DISCONNECT PENDING	14
4.3.3.5 PROCEDURE TRANSACTION INACTIVE	14
4.3.3.6 PROCEDURE TRANSACTION PENDING	14
4.3A WLCP layer states when multiple bearer PDN connectivity is used.....	15
4.3A.1 General.....	15
4.3A.2 PDN connectivity and default WLCP bearer contextstates in the UE	15
4.3A.2.1 PDN CONNECTIVITY NOT ESTABLISHED	15
4.3A.2.1A WLCP BEARER CONTEXT INACTIVE.....	15
4.3A.2.2 PDN CONNECTIVITY ESTABLISHED	15
4.3A.2.2A WLCP BEARER CONTEXT ACTIVE.....	15
4.3A.2.3 PROCEDURE TRANSACTION INACTIVE	16
4.3A.2.4 PROCEDURE TRANSACTION PENDING	16
4.3A.2A Dedicated WLCP bearer context states in the UE	16
4.3A.2A.1 Substate WLCP BEARER CONTEXT INACTIVE	16
4.3A.2A.2 Substate WLCP BEARER CONTEXT ACTIVE	16
4.3A.3 WLCP layer PDN connectivity and default WLCP bearer context states in the TWAG.....	16
4.3A.3.1 PDN CONNECTIVITY NOT ESTABLISHED	16
4.3A.3.1A WLCP BEARER CONTEXT INACTIVE.....	17
4.3A.3.2 PDN CONNECTIVITY PENDING.....	17
4.3A.3.2A WLCP BEARER CONTEXT ACTIVE PENDING	17
4.3A.3.3 PDN CONNECTIVITY ESTABLISHED	17

4.3A.3.3A	WLCP BEARER CONTEXT ACTIVE.....	17
4.3A.3.4	PDN DISCONNECT PENDING.....	17
4.3A.3.4A	WLCP BEARER CONTEXT INACTIVE PENDING.....	17
4.3A.3.5	WLCP BEARER MODIFY PENDING.....	17
4.3A.3A	WLCP layer dedicated bearer context states in the TWAG.....	18
4.3A.3A.1	WLCP BEARER CONTEXT INACTIVE.....	18
4.3A.3A.2	WLCP BEARER CONTEXT ACTIVE PENDING.....	18
4.3A.3A.3	WLCP BEARER CONTEXT ACTIVE.....	18
4.3A.3A.4	WLCP BEARER CONTEXT INACTIVE PENDING.....	18
4.3A.3A.5	WLCP BEARER CONTEXT MODIFY PENDING.....	18
4.4	IP address allocation.....	19
5	Wireless LAN control plane protocol Procedures.....	19
5.1	General.....	19
5.1.1	Overview.....	19
5.1.2	Services provided by lower layers.....	19
5.1.3	Principles of address handling for WLCP procedures.....	20
5.1.4	Abnormal cases in the UE.....	20
5.1.5	Abnormal cases in the TWAG.....	20
5.1.6	Handling of APN based congestion control.....	20
5.2	PDN connectivity establishment procedure.....	20
5.2.1	General.....	20
5.2.2	PDN connectivity establishment procedure initiation.....	21
5.2.3	PDN connectivity establishment procedure accepted by the TWAG.....	22
5.2.3.1	PDN connectivity establishment accepted by the UE.....	23
5.2.3.2	PDN connectivity establishment not accepted by the UE.....	23
5.2.4	PDN connectivity procedure not accepted by the TWAG.....	24
5.2.5	Abnormal cases in the UE.....	25
5.2.6	Abnormal cases on the network side.....	25
5.3	TWAG initiated PDN disconnection procedure.....	26
5.3.1	General.....	26
5.3.2	Procedure description.....	26
5.3.3	Abnormal cases in the UE.....	27
5.3.4	Abnormal cases in the TWAG.....	27
5.4	UE requested PDN disconnection procedure.....	27
5.4.1	General.....	27
5.4.2	Procedure description.....	27
5.4.3	Abnormal cases in the UE.....	28
5.4.4	Abnormal cases in the TWAG.....	28
5.5	STATUS message.....	29
5.6	TWAG initiated PDN connectivity modification procedure.....	29
5.6.1	General.....	29
5.6.2	Procedure description.....	30
5.6.3	PDN connectivity modification procedure accepted by the UE.....	30
5.6.4	PDN connectivity modification procedure not accepted by the UE.....	30
5.6.5	Abnormal cases in the UE.....	30
5.6.6	Abnormal cases in the TWAG.....	30
5.7	UE requested PDN connectivity modification procedure.....	31
5.7.1	General.....	31
5.7.2	Procedure description.....	31
5.7.3	PDN connectivity modification procedure accepted by the network.....	31
5.7.4	PDN connectivity modification procedure not accepted by the network.....	31
5.7.5	Abnormal cases in the UE.....	32
5.7.6	Abnormal cases in the TWAG.....	32
5.8	PGW initiated local PDN disconnection in the TWAG.....	32
5.8.1	General.....	32
5.8.2	Procedure description.....	32
5.9	Local PDN disconnection in the UE initiated from 3GPP access.....	32
5.9.1	General.....	32
5.9.2	Procedure description.....	33
5.10	WLCP bearer setup procedure.....	33
5.10.1	General.....	33

5.10.2	Procedure description	33
5.10.2.1	WLCP bearer setup procedure initiated by the TWAG.....	33
5.10.2.2	WLCP bearer setup procedure accepted by the UE	34
5.10.2.3	WLCP bearer setup procedure not accepted by the UE	34
5.10.3	Abnormal cases in the UE	35
5.10.4	Abnormal cases in the TWAG.....	36
5.11	WLCP bearer modify procedure	36
5.11.1	General.....	36
5.11.2	Procedure description	36
5.11.2.1	WLCP bearer modify procedure initiated by the TWAG.....	36
5.11.2.2	WLCP bearer modify procedure accepted by the UE	37
5.11.2.3	WLCP bearer modify procedure not accepted by the UE	37
5.11.3	Abnormal cases in the UE	39
5.11.4	Abnormal cases in the TWAG.....	39
5.12	WLCP bearer release procedure.....	40
5.12.1	General.....	40
5.12.2	Procedure description	40
5.12.2.1	WLCP bearer release procedure initiated by the TWAG	40
5.12.2.2	WLCP bearer release procedure accepted by the UE.....	40
5.12.2.3	WLCP bearer release procedure not accepted by the UE.....	41
5.12.3	Abnormal cases in the UE	41
5.12.4	Abnormal cases in the TWAG.....	41
6	Handling of unknown, unforeseen, and erroneous protocol data.....	41
6.1	General	41
6.2	Message too short.....	42
6.3	Unknown or unforeseen procedure transaction identity or PDN connection ID	42
6.3.1	Procedure transaction identity.....	42
6.3.2	PDN connection ID.....	42
6.4	Unknown or unforeseen message type	43
6.5	Non-semantic mandatory information element errors	43
6.5.1	Common procedures	43
6.5.2	PDN connection management.....	44
6.6	Unknown and unforeseen IEs in the non-imperative message part.....	44
6.6.1	IEs unknown in the message	44
6.6.2	Out of sequence IEs	44
6.6.3	Repeated IEs	44
6.7	Non-imperative message part errors.....	44
6.7.1	General.....	44
6.7.2	Syntactically incorrect optional IEs	45
6.7.3	Conditional IE errors	45
6.8	Messages with semantically incorrect contents.....	45
7	Message functional definitions and contents.....	45
7.1	PDN connectivity request.....	45
7.1.1	Message definition.....	45
7.1.2	Access point name	46
7.1.3	Protocol configuration options.....	46
7.1.4	NBIFOM container	46
7.1.5	UE N3G capability.....	46
7.2	PDN connectivity accept	46
7.2.1	Message definition.....	46
7.2.2	Protocol configuration options.....	47
7.2.3	Cause	47
7.2.4	NBIFOM container	47
7.2.5	WLCP bearer identity	47
7.2.6	Bearer level QoS.....	47
7.2.7	APN-AMBR	47
7.3	PDN connectivity reject	48
7.3.1	Message definition.....	48
7.3.2	Protocol configuration options.....	48
7.3.3	Tw1 value	48

7.4	PDN disconnect request	48
7.4.1	Message definition	48
7.4.2	Protocol configuration options.....	49
7.5	PDN disconnect accept.....	49
7.5.1	Message definition.....	49
7.5.2	Protocol configuration options.....	49
7.6	PDN disconnect reject	49
7.6.1	Message definition.....	49
7.6.2	Protocol configuration options.....	50
7.7	PDN connectivity complete.....	50
7.7.1	Message definition.....	50
7.8	Status message.....	50
7.8.1	Message definition.....	50
7.9	PDN modification request	50
7.9.1	Message definition.....	50
7.9.2	Protocol configuration options.....	51
7.9.3	NBIFOM container	51
7.10	PDN modification accept	51
7.10.1	Message definition.....	51
7.10.2	Protocol configuration options.....	51
7.10.3	NBIFOM container	51
7.11	PDN modification reject.....	52
7.11.1	Message definition.....	52
7.11.2	Protocol configuration options.....	52
7.11.3	NBIFOM container	52
7.12	PDN modification indication.....	52
7.12.1	Message definition.....	52
7.12.2	Protocol configuration options.....	53
7.12.3	NBIFOM container	53
7.13	WLCP bearer setup request	53
7.13.1	Message definition.....	53
7.13.2	Protocol configuration options.....	54
7.14	WLCP bearer setup accept	54
7.14.1	Message definition.....	54
7.14.2	Protocol configuration options.....	54
7.15	WLCP bearer setup reject.....	54
7.15.1	Message definition.....	54
7.15.2	Protocol configuration options.....	55
7.16	WLCP bearer modify request.....	55
7.16.1	Message definition.....	55
7.16.2	Bearer level QoS.....	56
7.16.3	TFT	56
7.16.4	Cause	56
7.16.5	Protocol configuration options.....	56
7.16.6	APN-AMBR	56
7.17	WLCP bearer modify accept	56
7.17.1	Message definition.....	56
7.17.2	Protocol configuration options.....	56
7.18	WLCP bearer modify reject.....	57
7.18.1	Message definition.....	57
7.18.2	Protocol configuration options.....	57
7.19	WLCP bearer release request	57
7.19.1	Message definition.....	57
7.19.2	Protocol configuration options.....	58
7.20	WLCP bearer release accept.....	58
7.20.1	Message definition.....	58
7.20.2	Protocol configuration options.....	58
7.21	WLCP bearer release reject.....	59
7.21.1	Message definition.....	59
7.21.2	Protocol configuration options.....	59
8	General message format and information elements coding.....	59

8.1	General	59
8.2	Message type	60
8.3	Procedure transaction identity	60
8.4	Request type	61
8.5	PDN type	61
8.6	Access point name	61
8.7	Protocol configuration options	61
8.8	PDN address	61
8.9	PDN connection ID	61
8.10	User plane connection ID	62
8.11	Cause	62
8.12	GPRS timer 3	62
8.13	NBIFOM container	62
8.14	UE N3G capability	63
8.15	WLCP bearer identity	63
8.16	EPS quality of service	64
8.17	Traffic flow template	64
8.18	Spare half octet	64
8.19	APN aggregate maximum bit rate	64
9	List of system parameters	64
9.1	Timers	64
Annex A (informative): Cause values for WLCP protocol		66
A.1	Causes related to nature of request	66
A.2	Protocol errors (e.g., unknown message) class	66
Annex B (Informative): IANA UDP port registration form		67
Annex C (informative): Change history		69
History		71

Foreword

This Technical Specification has been produced by the 3rd Generation Partnership Project (3GPP).

The contents of the present document are subject to continuing work within the TSG and may change following formal TSG approval. Should the TSG modify the contents of the present document, it will be re-released by the TSG with an identifying change of release date and an increase in version number as follows:

Version x.y.z

where:

- x the first digit:
 - 1 presented to TSG for information;
 - 2 presented to TSG for approval;
 - 3 or greater indicates TSG approved document under change control.
- y the second digit is incremented for all changes of substance, i.e. technical enhancements, corrections, updates, etc.
- z the third digit is incremented when editorial only changes have been incorporated in the document.

1 Scope

The present document specifies the procedures of the Wireless LAN control plane protocol (WLCP) for trusted WLAN access to EPC which is used between User Equipment (UE) and Trusted WLAN Access Gateway (TWAG) for multi-connection mode as specified in 3GPP TS 23.402 [2].

This document also defines the message format, information elements coding, error handling and system parameters applied by the WLCP protocol.

2 References

The following documents contain provisions which, through reference in this text, constitute provisions of the present document.

- References are either specific (identified by date of publication, edition number, version number, etc.) or non-specific.
- For a specific reference, subsequent revisions do not apply.
- For a non-specific reference, the latest version applies. In the case of a reference to a 3GPP document (including a GSM document), a non-specific reference implicitly refers to the latest version of that document *in the same Release as the present document*.

- [1] 3GPP TR 21.905: "Vocabulary for 3GPP Specifications".
- [2] 3GPP TS 23.402: "Architecture Enhancements for non-3GPP accesses".
- [3] 3GPP TS 24.302: "Access to the 3GPP Evolved Packet Core (EPC) via non-3GPP access networks; Stage 3".
- [4] 3GPP TS 24.008: "Mobile radio interface Layer 3 specification; Core network protocols; Stage 3".
- [5] 3GPP TS 24.301: "Non-Access-Stratum (NAS) protocol for Evolved Packet System (EPS); Stage 3".
- [6] IEEE Std 802-2014: "IEEE Standard for Local and Metropolitan Area Networks: Overview and Architecture", 30th June 2014.
- [7] 3GPP TS 24.007: "Mobile radio interface signalling layer 3; General aspects".
- [8] IETF RFC 768: "User Datagram Protocol"
- [9] 3GPP TS 33.402: "3GPP System Architecture Evolution (SAE); Security aspects of non-3GPP accesses".
- [10] 3GPP TS 24.161: "Network-Based IP Flow Mobility (NBIFOM); Stage 3".
- [11] 3GPP TS 23.380: "IMS Restoration Procedures".
- [12] 3GPP TS 29.274: "Tunnelling Protocol for Control plane (GTPv2-C); Stage 3".

3 Definitions and abbreviations

3.1 Definitions

For the purposes of the present document, the terms and definitions given in 3GPP TR 21.905 [1] and the following apply. A term defined in the present document takes precedence over the definition of the same term, if any, in 3GPP TR 21.905 [1].

PDN connection for emergency bearer services: A PDN connection which was activated with request type "emergency" or "handover of emergency bearer services".

Single point-to-point connectivity: The PDN connectivity service is provided by one point-to-point connectivity between the UE and the TWAG concatenated with S2a bearer(s) between the TWAG and the PDN GW.

Multiple bearer PDN connectivity: The PDN connectivity service is provided by the multiple WLCP bearers per PDN connection where a separate WLCP bearer is established for the default S2a bearer, and for each dedicated S2a bearer established on the S2a interface between the TWAG and the PDN GW.

WLCP bearer: A bearer between the UE and the TWAG which has one-to-one mapping with the S2a bearer.

3.2 Abbreviations

For the purposes of the present document, the abbreviations given in 3GPP TR 21.905 [1] and the following apply. An abbreviation defined in the present document takes precedence over the definition of the same abbreviation, if any, in 3GPP TR 21.905 [1].

APN	Access Point Name
DTLS	Datagram Transport Layer Security
EAP	Extensible Authentication Protocol
EPC	Evolved Packet Core Network
ID	Identifier
IE	Information Element
IEI	Information Element Identifier
LSB	Least Significant Bit
MAC	Media Access Control
MSB	Most Significant Bit
N3G	Non-3GPP Access
NBIFOM	Network-based IP flow mobility
PCO	Protocol Configuration Options
PDN	Packet Data Network
PDN GW	Packet Data Network Gateway
PTI	Procedure Transaction Identity
TWAG	Trusted WLAN Access Gateway
UE	User Equipment
WLAN	Wireless Local Area Network
WLCP	Wireless LAN control plane protocol

4 General

4.1 Overview

WLCP is used between user equipment (UE) and trusted wLAN access gateway (TWAG) for multi-connection mode as specified in 3GPP TS 23.402 [2].

The WLCP comprises procedures for:

- establishment of PDN connections including initial request and handover from a 3GPP access;
- requesting the release of a PDN connection by the UE or notifying the UE of the release of a PDN connection;
- transport of parameters related to PDN connections, such as APN, PDN type, PCO, handover indication, user-plane MAC address of the TWAG etc.;
- IP address allocation; and
- WLCP bearer management including WLCP bearer setup, modification and release when multiple bearer PDN connectivity is used.

Generally, WLCP procedures described in the clause 5 can be performed only after the UE has successfully completed the following steps:

- Authentication and negotiation of the multi-connection mode for the trusted WLAN access as specified in 3GPP TS 24.302 [3]; and
- Establishment of a DTLS connection with the TWAG, according to subclause 4.2.4.

4.2 Protocol stack

4.2.1 General

The protocol stack of WLCP is shown in figure 4.2.1.

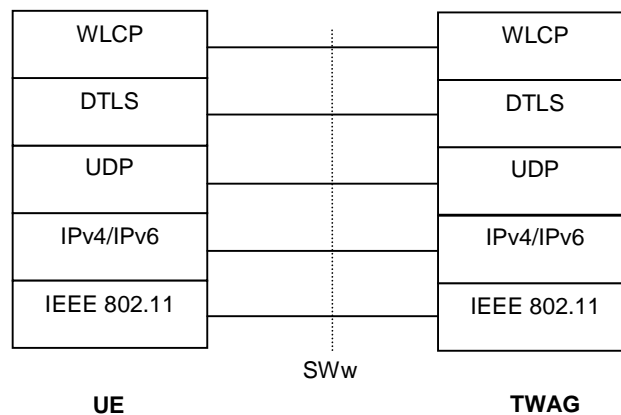

Figure 4.2.1: Protocol stack of WLCP

4.2.2 UDP port numbers for WLCP

4.2.2.1 General

The WLCP messages are transported over UDP layer as specified in IETF RFC 768 [8]. The security is provided by the DTLS layer.

The WLCP UDP Port number is 36411.

4.2.2.2 UE procedure

The UE shall use the WLCP UDP port number as the source UDP port and the destination UDP port of WLCP messages.

4.2.2.3 TWAG procedure

The TWAG shall use the WLCP UDP port number as the source UDP port and the destination UDP port of WLCP messages.

4.2.3 IP addresses of WLCP message

4.2.3.1 General

The WLCP/DTLS/UDP packet shall be carried via IPv6 with link local addressing scope or IPv4 as specified in 3GPP TS 23.402 [2].

4.2.3.2 UE procedure

The UE receives one or two TWAG control-plane addresses during the EAP authentication and authorization procedure as specified in 3GPP TS 24.302 [3] subclause 6.4.2.6.3.

NOTE: If two TWAG control-plane addresses are received, one includes an IPv4 address and the other includes an IPv6 link-local address.

If the UE receives one TWAG control-plane address, the UE shall select the TWAG control-plane address. If the UE receives two TWAG control-plane addresses, the UE shall select one of the TWAG control-plane addresses.

The UE shall use the IP address of the selected TWAG control-plane address as the destination IP address of WLCP messages.

The UE shall apply the following procedures to set the source IP address of the WLCP message:

- if the TWAG IP address for WLCP is an IPv4 address and if the UE supports IPv4, the UE shall obtain an IPv4 address via DHCPv4 to be used as the source IP address for WLCP;
- if the TWAG IP address for WLCP is an IPv6 link-local address and if the UE supports IPv6, the UE shall use the IPv6 link-local address configured on the WLAN interface as the source IP address for WLCP; and
- if the TWAG IP addresses for WLCP are an IPv4 address and an IPv6 link-local address, which IP version the UE selects is implementation dependent.

4.2.3.3 TWAG procedure

When the UE initiates a WLCP procedure:

- the TWAG shall use a TWAG control plane address which was included in TWAG_CP_ADDRESS item provided to the UE during EAP-AKA' authentication as described in 3GPP TS 24.302 [3], as the source IP address for WLCP. If two TWAG control plane addresses were included in TWAG_CP_ADDRESS item provided to the UE during EAP-AKA' authentication as described in 3GPP TS 24.302 [3], the TWAG shall use the TWAG control plane address of the same IP version as the IP version received from the UE in the WLCP message; and
- the TWAG shall use the source IP address received from the UE in the WLCP message as the destination IP address for further WLCP message to the UE.

When the TWAG initiates a WLCP procedure:

- the TWAG shall use a TWAG control plane address which was included in TWAG_CP_ADDRESS item provided to the UE during EAP-AKA' authentication as described in 3GPP TS 24.302 [3], as the source IP address for WLCP. If two TWAG control plane addresses were included in TWAG_CP_ADDRESS item provided to the UE during EAP-AKA' authentication as described in 3GPP TS 24.302 [3], the TWAG shall use the TWAG control plane address of the same IP version as the IP version received from the UE in the WLCP message; and
- the TWAG shall use the source IP address received from the UE in the earlier WLCP message as the destination IP address for further WLCP message to the UE.

4.2.4 DTLS usage

The UE and the TWAG shall use DTLS according to 3GPP TS 33.402 [9].

4.3 WLCP layer states when single point-to-point connectivity is used

4.3.1 General

In this subclause the possible states of WLCP state machine in the UE and in the TWAG are described when single point-to-point PDN connectivity is used. Each PDN connection to EPC is associated with an individual state machine, and single point-to-point connectivity between the UE and the TWAG is used to transport traffic for all S2a bearer(s) of the PDN connection (see 3GPP TS 23.402 [2]).

4.3.2 WLCP layer states in the UE

4.3.2.1 PDN CONNECTIVITY NOT ESTABLISHED

No PDN connectivity to EPC exists over TWAN (see figure 4.3.2.2.1).

4.3.2.2 PDN CONNECTIVITY ESTABLISHED

The PDN connectivity to EPC is established in the UE (see figure 4.3.2.2.1).

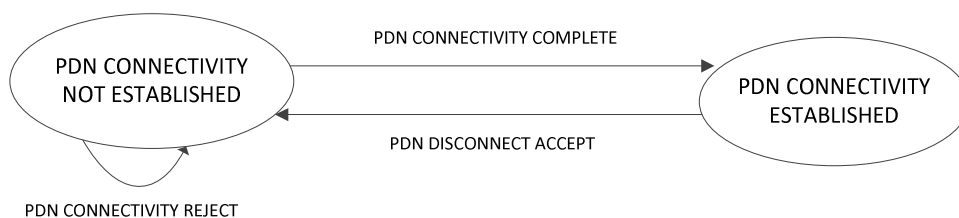

Figure 4.3.2.2.1: The WLCP state machine in the UE (overview)

4.3.2.3 PROCEDURE TRANSACTION INACTIVE

No procedure transaction exists (see figure 4.3.2.4.1).

4.3.2.4 PROCEDURE TRANSACTION PENDING

The UE has initiated a procedure transaction towards the TWAG (see figure 4.3.2.4.1).

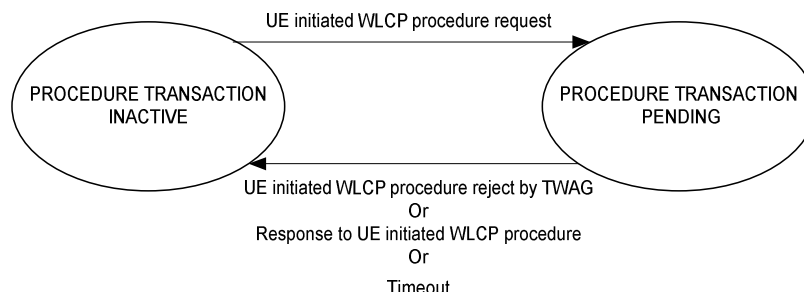

Figure 4.3.2.4.1: The procedure transaction states in the UE (overview)

4.3.3 WLCP layer states in the TWAG

4.3.3.1 PDN CONNECTIVITY NOT ESTABLISHED

No PDN connectivity to EPC exists for the UE (see figure 4.3.3.4.1).

4.3.3.2 PDN CONNECTIVITY PENDING

The TWAG has sent PDN connectivity accept towards the UE (see figure 4.3.3.4.1).

4.3.3.3 PDN CONNECTIVITY ESTABLISHED

The PDN connectivity is established in the TWAG (see figure 4.3.3.4.1).

4.3.3.4 PDN DISCONNECT PENDING

The TWAG has initiated a PDN disconnect towards the UE (see figure 4.3.3.4.1).

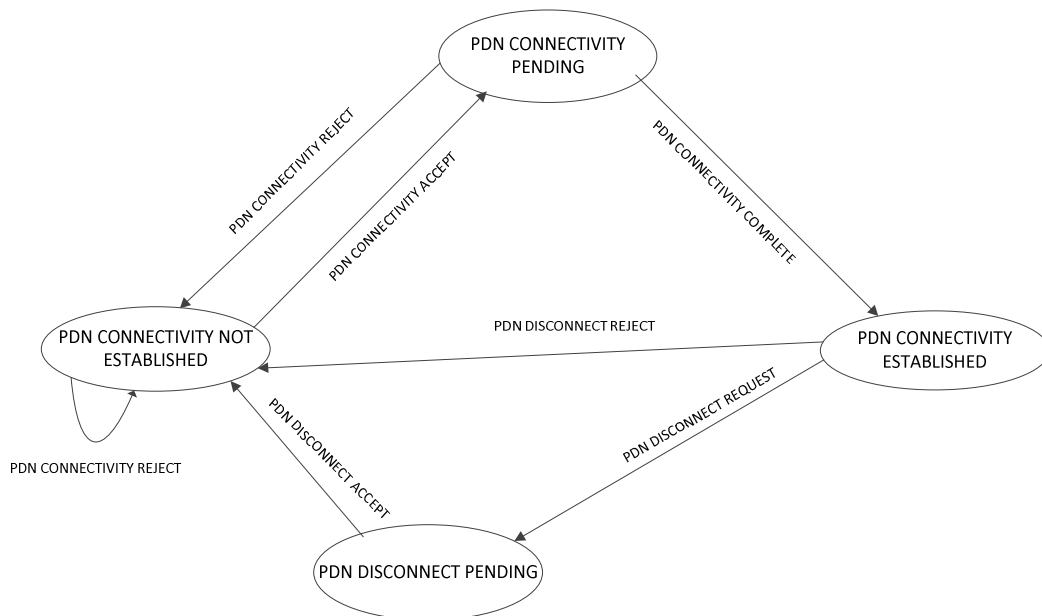

Figure 4.3.3.4.1: The WLCP states for PDN connectivity handling in the TWAG (overview)

4.3.3.5 PROCEDURE TRANSACTION INACTIVE

No procedure transaction exists.

4.3.3.6 PROCEDURE TRANSACTION PENDING

The TWAG has initiated a procedure transaction towards the UE (see figure 4.3.3.6.1).

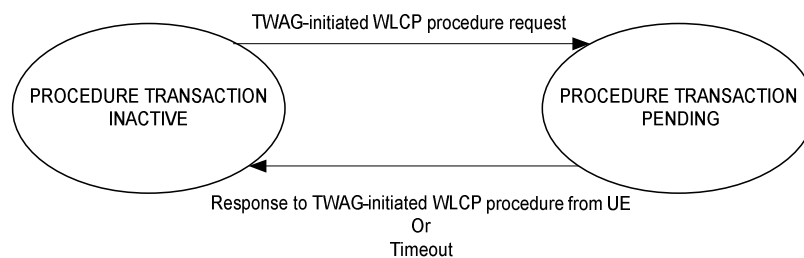

Figure 4.3.3.6.1: The procedure transaction states in the TWAG (overview)

4.3A WLCP layer states when multiple bearer PDN connectivity is used

4.3A.1 General

In this subclause the possible states for WLCP bearer in the UE and in the TWAG are described when multiple bearer PDN connectivity is used. Each WLCP bearer context is associated with an individual state machine. This state machine shall be used when both the UE and the TWAG supports the establishment of multiple WLCP bearers per PDN connection where a separate WLCP bearer is established for the default S2a bearer, and for each dedicated S2a bearer established on the S2a interface (see 3GPP TS 23.402 [2]).

4.3A.2 PDN connectivity and default WLCP bearer context states in the UE

4.3A.2.1 PDN CONNECTIVITY NOT ESTABLISHED

No PDN connectivity to EPC exists over TWAN (see figure 4.3A.2.2.1).

4.3A.2.1A WLCP BEARER CONTEXT INACTIVE

No default WLCP bearer context exists for the UE (see figure 4.3A.2.2.1A).

4.3A.2.2 PDN CONNECTIVITY ESTABLISHED

The PDN connectivity to EPC is established in the UE (see figure 4.3A.2.2.1).

4.3A.2.2A WLCP BEARER CONTEXT ACTIVE

The default WLCP bearer context exists for the UE (see figure 4.3A.2.2.1A).

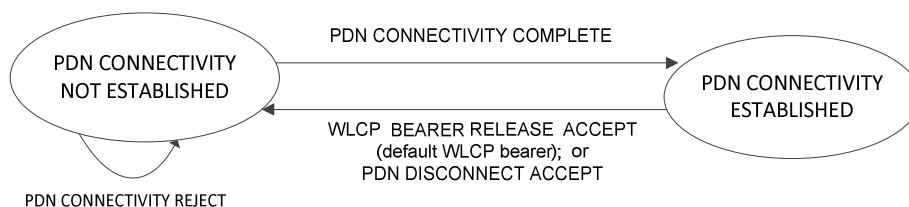

Figure 4.3A.2.2.1: PDN connectivity states in the UE (overview)

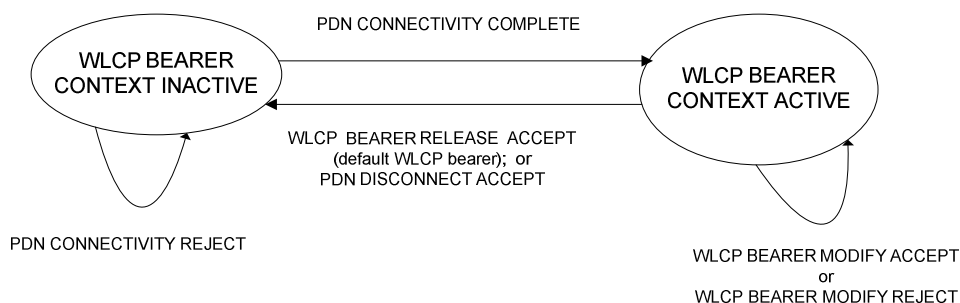

Figure 4.3A.2.2.1A: Default WLCP bearer context states in the UE (overview)

4.3A.2.3 PROCEDURE TRANSACTION INACTIVE

No procedure transaction exists (see figure 4.3A.2.4.1).

4.3A.2.4 PROCEDURE TRANSACTION PENDING

The UE has initiated a procedure transaction towards the TWAG (see figure 4.3A.2.4.1).

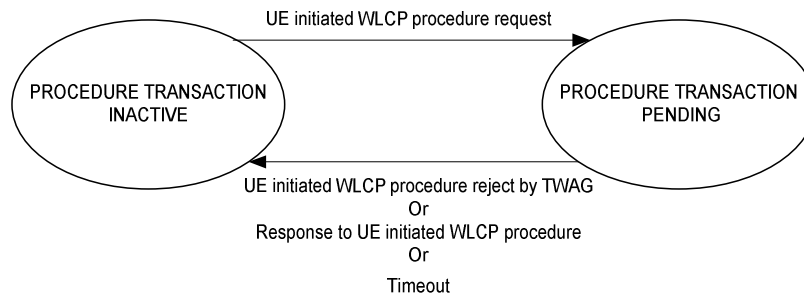

Figure 4.3A.2.4.1: The procedure transaction states in the UE (overview)

4.3A.2A Dedicated WLCP bearer context states in the UE

4.3A.2A.1 Substate WLCP BEARER CONTEXT INACTIVE

No dedicated WLCP bearer context exists (see figure 4.3A.2.2.1).

4.3A.2A.2 Substate WLCP BEARER CONTEXT ACTIVE

The dedicated WLCP bearer context is active in the UE (see figure 4.3A.2.2.1).

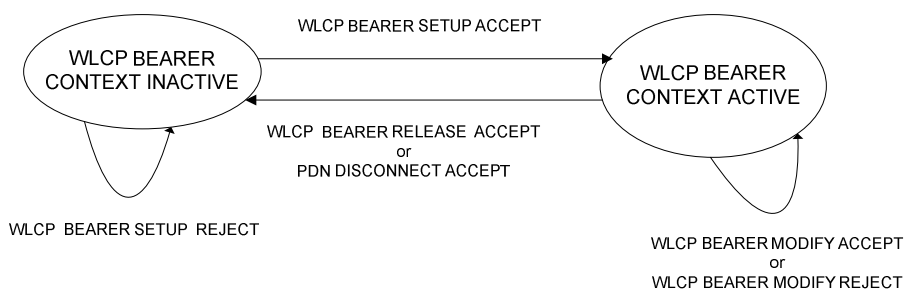

Figure 4.3A.2A.2.1: Dedicated WLCP bearer context states in the UE (overview)

4.3A.3 WLCP layer PDN connectivity and default WLCP bearer context states in the TWAG

4.3A.3.1 PDN CONNECTIVITY NOT ESTABLISHED

No PDN connectivity to EPC exists for the UE (see figure 4.3A.3.5.1).

4.3A.3.1A WLCP BEARER CONTEXT INACTIVE

No WLCP bearer context exists for the UE (see figure 4.3A.3.5.1A).

4.3A.3.2 PDN CONNECTIVITY PENDING

The TWAG has sent PDN connectivity accept towards the UE (see figure 4.3A.3.5.1).

4.3A.3.2A WLCP BEARER CONTEXT ACTIVE PENDING

The TWAG has sent PDN connectivity accept towards the UE (see figure 4.3A.3.5.1).

4.3A.3.3 PDN CONNECTIVITY ESTABLISHED

The PDN connectivity is established in the TWAG (see figure 4.3A.3.5.1).

4.3A.3.3A WLCP BEARER CONTEXT ACTIVE

The WLCP bearer context is active in the TWAG (see figure 4.3A.3.5.1A).

4.3A.3.4 PDN DISCONNECT PENDING

The TWAG has initiated a PDN disconnect towards the UE (see figure 4.3A.3.5.1).

4.3A.3.4A WLCP BEARER CONTEXT INACTIVE PENDING

The TWAG has initiated a PDN disconnect request or WLCP bearer context release for the default WLCP bearer towards the UE (see figure 4.3A.3.5.1A).

4.3A.3.5 WLCP BEARER MODIFY PENDING

The TWAG has initiated a WLCP bearer context modification towards the UE (see figure 4.3A.3.5.1A).

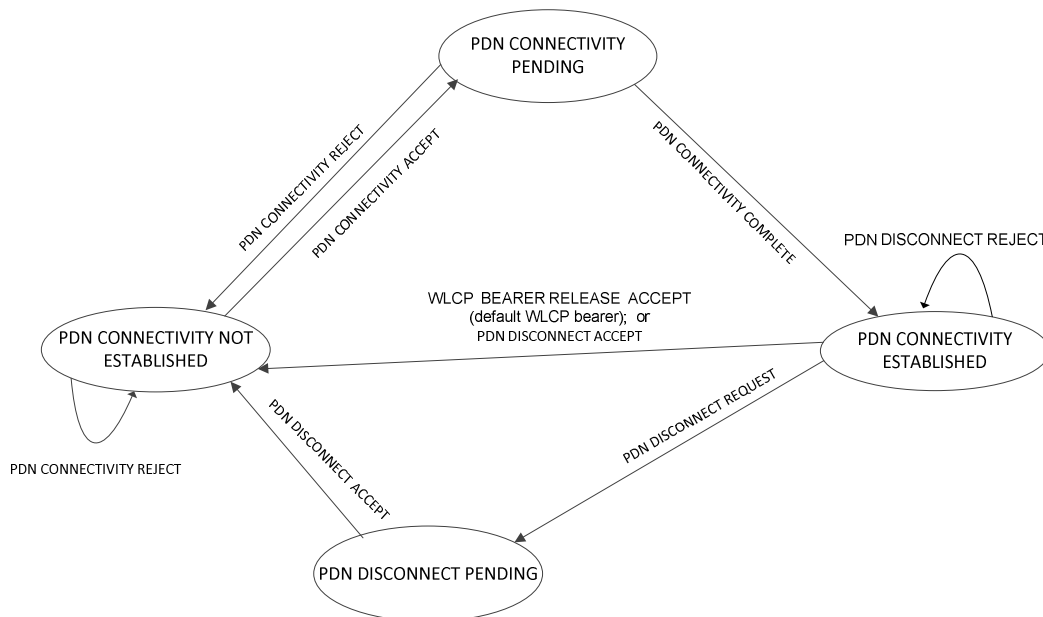

Figure 4.3A.3.5.1: PDN connectivity states in the TWAG (overview)

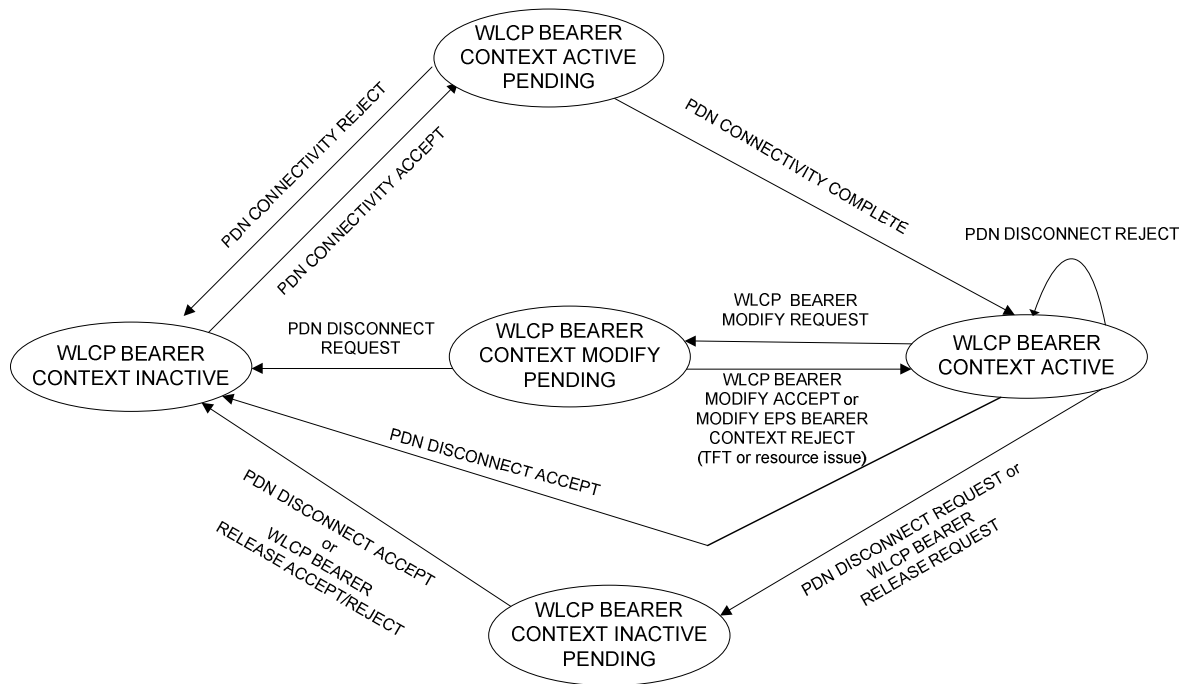

Figure 4.3A.3.5.1A: Default WLCB bearer context states in the TWAG (overview)

4.3A.3A WLCB layer dedicated bearer context states in the TWAG

4.3A.3A.1 WLCB BEARER CONTEXT INACTIVE

No WLCB bearer context exists for the UE (see figure 4.3A.3A.5.1).

4.3A.3A.2 WLCB BEARER CONTEXT ACTIVE PENDING

The TWAG has initiated a WLCB bearer context setup towards the UE (see figure 4.3A.3A.5.1).

4.3A.3A.3 WLCB BEARER CONTEXT ACTIVE

The WLCB bearer context is active in the TWAG (see figure 4.3A.3A.5.1).

4.3A.3A.4 WLCB BEARER CONTEXT INACTIVE PENDING

The TWAG has initiated a WLCB bearer context release towards the UE (see figure 4.3A.3A.5.1).

4.3A.3A.5 WLCB BEARER CONTEXT MODIFY PENDING

The TWAG has initiated a WLCB bearer context modification towards the UE (see figure 4.3A.3A.5.1).

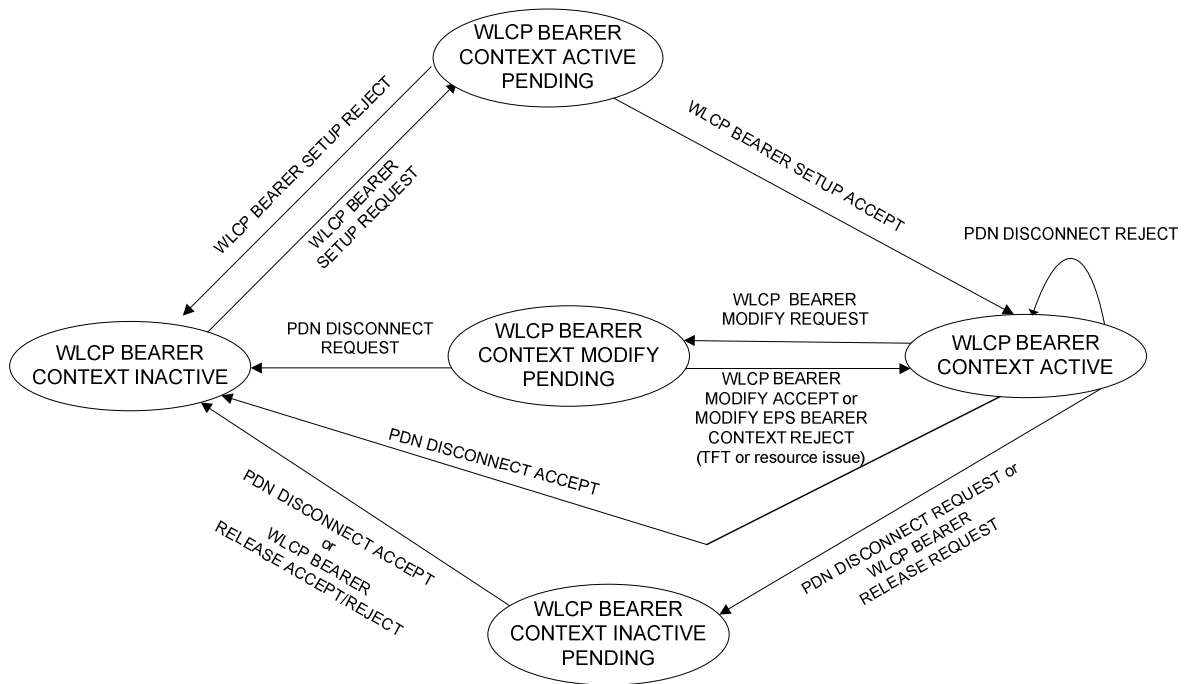

Figure 4.3A.3A.5.1: Dedicated WLCB bearer context states in the TWAG (overview)

4.4 IP address allocation

WLCB provides the following functionalities related to IP address allocation for multi-connection mode:

- requesting PDN type by the UE;
- allocating IPv4 address to the UE; and
- allocating IPv6 interface identifier to the UE.

IPv6 network prefix is assigned via stateless address autoconfiguration method as specified in 3GPP TS 23.402 [2].

Deferred IPv4 address allocation is not supported in the current release of this specification.

5 Wireless LAN control plane protocol Procedures

5.1 General

5.1.1 Overview

This clause describes principles and procedures used for Wireless LAN control plane protocol for PDN connectivity handling in the UE and in the TWAG.

Re-transmission of WLCB messages for ensuring reliability of WLCB procedures is supervised by timers.

5.1.2 Services provided by lower layers

Unless explicitly stated otherwise, WLCB procedures can be performed only if the UE has been authenticated and has successfully negotiated the multi-connection mode for trusted WLAN access as specified in 3GPP TS 24.302 [3].

5.1.3 Principles of address handling for WLCP procedures

WLCP procedures use the PTI as address parameter in the WLCP message header. When the UE or the TWAG initiates a WLCP procedure, it shall include a valid PTI value in the message header (see subclause 8.3).

In the response message, the sending entity shall include the PTI value received with the request message.

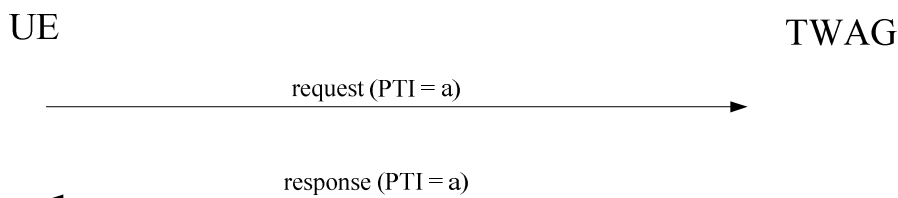

Figure 5.1.3.1: Procedure initiated by the UE

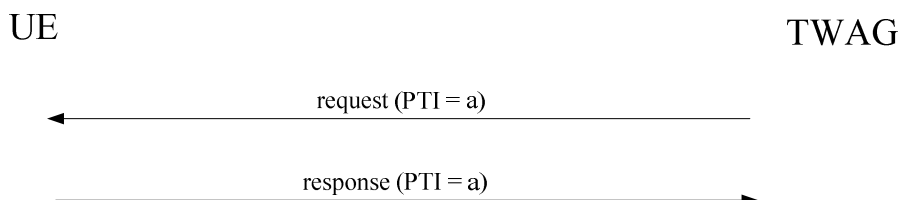

Figure 5.1.3.2: Procedure initiated by the TWAG

5.1.4 Abnormal cases in the UE

No abnormal cases have been identified.

5.1.5 Abnormal cases in the TWAG

The following abnormal cases can be identified:

- a) Failure of EAP-AKA' re-authentication:

When the TWAG receives a failure indication of the re-authentication procedure, the TWAG shall initiate TWAG-initiated PDN disconnection procedure.

5.1.6 Handling of APN based congestion control

As specified in subclause 5.2.4, TWAG can reject PDN connection request for an APN from a UE and provide a T_w1 timer value to the UE.

5.2 PDN connectivity establishment procedure

5.2.1 General

The purpose of the PDN connectivity establishment procedure is to establish PDN connectivity between the UE and the EPC. The procedure is used either to establish the first PDN connection or to establish subsequent PDN connections. When multiple bearer PDN connectivity model is used, the default WLCP bearer is also established. The procedure can be initiated only after successful EAP authentication and authorization has been completed and multi-connection mode of operation has been negotiated, as specified in 3GPP TS 24.302 [3].

The UE and the TWAG may include a Protocol configuration options IE in PDN connectivity establishment procedure if they wish to exchange (protocol) data (e.g. configuration parameters, error codes or messages/events).

If there is already a PDN connection for emergency bearer services established, the UE shall not request another PDN connection for emergency services.

If the UE attached for emergency services, i.e. received an MCM_RESPONSE with the AT_NOTIFICATION attribute indicating success for an MCM_REQUEST with ATTACHMENT_TYPE item set to "emergency attach" or "emergency handover" as specified in 3GPP TS 24.302 [3]:

- the UE shall establish the first PDN connection for emergency services or perform handover of an emergency PDN connection from 3GPP access; and
- the UE shall not request any additional non-emergency PDN connections so long as the UE is attached for emergency services.

5.2.2 PDN connectivity establishment procedure initiation

The UE requests PDN connectivity establishment by sending a PDN CONNECTIVITY REQUEST message to the TWAG.

In order to request connectivity to a PDN using the default APN, the UE includes the Access point name IE in the PDN CONNECTIVITY REQUEST message according to the following conditions:

- if use of a PDN using the default APN requires PAP/CHAP, then the UE should include the Access point name IE; and
- in all other conditions, the UE need not include the Access point name IE.

In order to request connectivity to a non-default APN or to an additional PDN, the UE shall send a PDN CONNECTIVITY REQUEST message to the TWAG including the requested APN.

After sending the PDN CONNECTIVITY REQUEST message the UE shall start timer T3582 and enter the state PROCEDURE TRANSACTION PENDING (see example in figure 5.2.2.1).

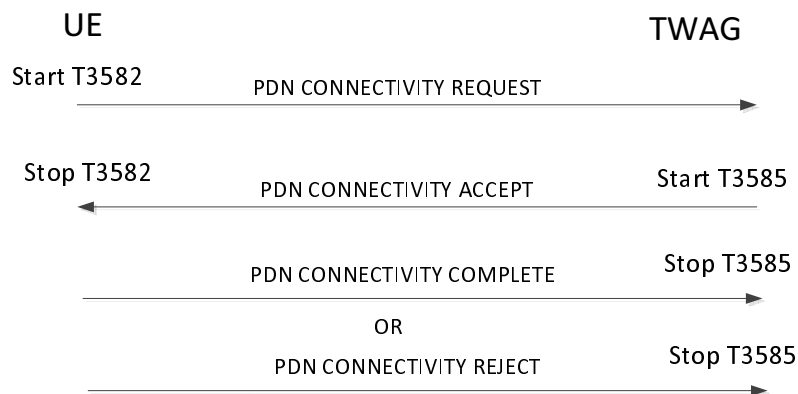

Figure 5.2.2.1: PDN connectivity establishment procedure

The UE shall set the PDN type IE in the PDN CONNECTIVITY REQUEST message to IPv4 if:

- the UE is only IPv4 capable;
- the UE is both IPv4 and IPv6 capable, has been allocated an IPv6 address for this APN and received the ESM cause #52 "single address bearers only allowed" and the request type is "initial request" or "emergency"; or
- the UE is both IPv4 and IPv6 capable, has been allocated an IPv4 address for this APN, received the ESM cause #52 "single address bearers only allowed" and the request type is "handover" or "handover of emergency bearer services", and has not been allocated an IPv6 address for this APN.

The UE shall set the PDN type IE in the PDN CONNECTIVITY REQUEST message to IPv6 if:

- the UE is only IPv6 capable;

- the UE is both IPv4 and IPv6 capable, has been allocated an IPv4 address for this APN and received the ESM cause #52 "single address bearers only allowed" and the request type is "initial request" or "emergency"; or
- the UE is both IPv4 and IPv6 capable, has been allocated an IPv6 address for this APN, received the ESM cause #52 "single address bearers only allowed" and the request type is "handover" or "handover of emergency bearer services", and has not been allocated an IPv4 address for this APN.

The UE shall set the PDN type IE in the PDN CONNECTIVITY REQUEST message to IPv4v6 if:

- the UE is both IPv4 and IPv6 capable and has not been allocated an IP address for this APN and the request type is "initial request" or "emergency";
- the UE capability is unknown in the UE (as in the case when the MT and TE are separated and the capability of the TE is not known in the MT); or
- the UE is both IPv4 and IPv6 capable, has been allocated both IPv4 address and an IPv6 address for this APN and the request type is "handover" or "handover of emergency bearer services".

The UE shall not set the PDN type IE to PDN type value other than IPv4, IPv6 and IPv4v6.

The UE shall set the request type to "initial request" when the UE is establishing a new PDN connectivity. The UE shall set the request type to "handover" when the connectivity to a PDN is to be transferred from a 3GPP access network to the trusted WLAN access network. The UE shall set the request type to "emergency" when the UE is requesting a new PDN connection for emergency bearer services. The UE shall set the request type to "handover of emergency bearer services" when a PDN connection for emergency bearer services is to be transferred from a 3GPP access network to the trusted WLAN access network.

If the UE supports multiple WLCP bearers as specified in 3GPP TS 23.402 [2], the UE shall set the multiple bearer capability indicator bit to "Multiple WLCP bearers supported" in the UE N3G capability IE in the PDN CONNECTIVITY REQUEST message.

5.2.3 PDN connectivity establishment procedure accepted by the TWAG

Upon receipt of the PDN CONNECTIVITY REQUEST message, the TWAG checks if connectivity with the requested PDN can be established. If no requested APN is included in the PDN CONNECTIVITY REQUEST message and the request type is different from "emergency" and from "handover of emergency bearer services", the TWAG shall use the default APN as the requested APN. If the request type is "emergency" or "handover of emergency bearer services", the TWAG uses the APN configured for emergency bearer services or selects the statically configured PDN GW for unauthenticated UEs, if applicable.

If the requested PDN connection can be established, the TWAG shall send a PDN CONNECTIVITY ACCEPT message towards the UE. The TWAG shall retrieve the PTI from the PDN CONNECTIVITY REQUEST message and include it in the PDN CONNECTIVITY ACCEPT message. If the request type is different from "emergency" and from "handover of emergency bearer services", both the network identifier part and the operator identifier part shall be included in the Access Point Name IE. Additionally, the TWAG shall include:

- PDN connection ID to identify the PDN connection between the UE and the TWAG;
- MAC address of the TWAG to the UE. This MAC address is used by the UE and the TWAG to send the user plane packets for this PDN connection; and
- Default WLCP bearer identity if multiple WLCP bearers are used. This default WLCP bearer identity shall be allocated by the TWAG and associated with the default bearer of the PDN connection.

If connectivity with the requested PDN is accepted, but with a restriction of IP version (i.e. both an IPv4 address and an IPv6 prefix is requested, but only one particular IP version, or only single IP version bearers are supported/allowed by the network), cause #50 "PDN type IPv4 only allowed", #51 "PDN type IPv6 only allowed" , or #52 "single address bearers only allowed", respectively, shall be included in the PDN CONNECTIVITY ACCEPT message. Upon sending the message the TWAG shall enter the state PDN CONNECTIVITY PENDING and PROCEDURE TRANSACTION PENDING and start the timer T3585.

If the UE requested PDN type IPv4v6, but the PDN GW configuration or UE subscription dictates the use of IPv4 only or IPv6 only for this APN, the network shall override the PDN type requested by the UE to limit it to a single address PDN type (IPv4 or IPv6). In the PDN CONNECTIVITY ACCEPT message the TWAG shall set the PDN type IE to

either "IPv4" or "IPv6" and the ESM cause value to #50 "PDN type IPv4 only allowed", or #51 "PDN type IPv6 only allowed", respectively. The UE shall not subsequently initiate another UE requested PDN connectivity procedure to the same APN to obtain a PDN type different from the one allowed by the network until:

- a new EAP Authentication procedure is performed (e.g. a new WLAN is selected);
- the PDN type which is used to access to the APN is changed;
- the UE is switched off; or
- the USIM is removed.

If the UE requested PDN type IPv4v6, but the operator uses single addressing per bearer, e.g. due to interworking with nodes of earlier releases, the network shall override the PDN type requested by the UE to a single IP version only. In the PDN CONNECTIVITY ACCEPT message sent to the UE, the TWAG shall set the PDN type IE to either "IPv4" or "IPv6" and the ESM cause value to #52 "single address bearers only allowed". The UE should subsequently request another PDN connection for the other IP version using the PDN connectivity establishment procedure to the same APN with a single address PDN type (IPv4 or IPv6) other than the one already activated.

The TWAG shall set the value of the IP Address IE in the PDN CONNECTIVITY ACCEPT message as follows:

- If the PDN type IE in the PDN CONNECTIVITY ACCEPT message is set to IPv4 or IPv4v6, the PDN Address IE shall contain an IPv4 address for the UE; and
- If the PDN type IE in the PDN CONNECTIVITY ACCEPT message is set to IPv6 or IPv4v6, the PDN Address IE shall contain an IPv6 interface identifier.

Upon receipt of the PDN CONNECTIVITY ACCEPT message, the UE shall check the PTI to identify the UE requested PDN connectivity, stop timer T3582 and enter the state PROCEDURE TRANSACTION INACTIVE. The UE should ensure that the PTI assigned to this procedure is not released immediately. The way to achieve this is implementation dependent. While the PTI value is not released, the UE regards any received PDN CONNECTIVITY ACCEPT message with the same PTI value as a network retransmission.

If the UE receives an IPv6 interface identifier in the PDN CONNECTIVITY ACCEPT message, the UE may wait for the Router Advertisement from the network with the IPv6 prefix information or it may send a Router Solicitation if necessary.

5.2.3.1 PDN connectivity establishment accepted by the UE

If the UE accepts the PDN connection the UE shall send a PDN CONNECTIVITY COMPLETE message and enter the state PDN CONNECTION ESTABLISHED.

Upon receipt of the PDN CONNECTIVITY COMPLETE message, the TWAG shall enter the state PDN CONNECTION ESTABLISHED and stop the timer T3585, if the timer is running (see example in figure 5.2.2.1).

5.2.3.2 PDN connectivity establishment not accepted by the UE

If the UE does not accept the PDN connection the UE shall send a PDN CONNECTIVITY REJECT message and enter the state PDN CONNECTIVITY NOT ESTABLISHED.

The PDN CONNECTIVITY REJECT message contains a cause that typically indicates one of the following cause values:

- #31: request rejected, unspecified; or
- #95 – 111: protocol errors.

Upon receipt of the PDN CONNECTIVITY REJECT message, the TWAG shall enter the state PDN CONNECTIVITY NOT ESTABLISHED and PROCEDURE TRANSACTION INACTIVE and stop the timer T3585, if the timer is running (see example in figure 5.2.2.1).

5.2.4 PDN connectivity procedure not accepted by the TWAG

If connectivity with the requested PDN cannot be accepted by the network, the TWAG shall send a PDN CONNECTIVITY REJECT message to the UE (see example in figure 5.2.4.1). The message shall contain the PTI and a cause value indicating the reason for rejecting the UE-requested PDN connectivity.

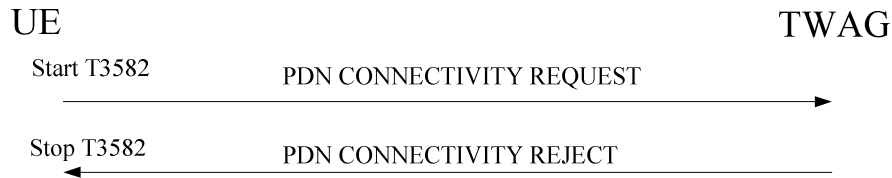

Figure 5.2.4.1: PDN connectivity establishment procedure not accepted by TWAG

The cause IE typically indicates one of the following cause values:

- #8: operator determined barring;
- #26: insufficient resources;
- #27: missing or unknown APN;
- #28: unknown PDN type;
- #29: user authentication failed;
- #30: request rejected by PDN GW;
- #31: request rejected, unspecified;
- #32: service option not supported;
- #33: requested service option not subscribed;
- #34: service option temporarily out of order;
- #35: PTI already in use;
- #38: network failure;
- #50: PDN type IPv4 only allowed;
- #51: PDN type IPv6 only allowed;
- #52: single address bearers only allowed;
- #54: PDN connection does not exist;
- #55: multiple PDN connections for a given APN not allowed;
- #95 – 111: protocol errors;
- #113: Multiple accesses to a PDN connection not allowed;

If the PDN type IE in the PDN CONNECTIVITY REQUEST message is set to a PDN type value other than IPv4, IPv6 and IPv4v6, the TWAG shall set the cause IE to #95 "semantically incorrect message".

If the cause value is #26 "insufficient resources", and the request type is different from "emergency" and from "handover of emergency bearer services", the network may include a value for timer Tw1 in the PDN CONNECTIVITY REJECT message. If the request type is "emergency" or "handover of emergency bearer services", the network shall not include the timer Tw1 in the PDN CONNECTIVITY REJECT message.

Upon receipt of the PDN CONNECTIVITY REJECT message, the UE shall stop timer T3582 and enter the state PROCEDURE TRANSACTION INACTIVE.

If the cause value is #26 "insufficient resources" and the Tw1 value IE is included, the UE shall take different actions depending on the timer value received for timer Tw1:

- i) if the timer value indicates neither zero nor deactivated, the UE shall stop timer Tw1 associated with the corresponding APN, if it is running. The UE shall start timer Tw1 with the value provided in the Tw1 value IE and not send another PDN CONNECTIVITY REQUEST message for the same APN until timer Tw1 expires, the timer Tw1 is stopped or the USIM is removed;
- ii) if the timer value indicates that this timer is deactivated, the UE shall not send another PDN CONNECTIVITY REQUEST message for the same APN until the UE is switched off or the USIM is removed; and
- iii) if the timer value indicates zero, the UE may send another PDN CONNECTIVITY REQUEST message for the same APN;
- iv) if the WLAN radio is disabled when the timer Tw1 is running and if the USIM in the UE remains the same when the WLAN radio is enabled, the UE shall behave as follows when the WLAN radio is enabled:
 - let $t1$ be the time remaining for Tw1 timeout when the WLAN radio was disabled and let t be the time elapsed since the WLAN radio was disabled until the WLAN radio was enabled. If $t1$ is greater than t , then the timer shall be restarted with the value $t1 - t$. If $t1$ is equal to or less than t , then the timer need not be restarted. If the UE is not capable of determining t , then the UE shall restart the timer with the value $t1$.

If the cause value is #26 "insufficient resources" and the Tw1 IE is not included, the UE may send a PDN CONNECTIVITY REQUEST message for the same APN.

5.2.5 Abnormal cases in the UE

The following abnormal cases can be identified:

- a) Expiry of timer T3582:
 - On the first expiry of the timer T3582, the UE shall resend the PDN CONNECTIVITY REQUEST and shall reset and restart timer T3582. This retransmission is repeated four times, i.e. on the fifth expiry of timer T3582, the UE shall abort the procedure, release the PTI allocated for this invocation and enter the state PROCEDURE TRANSACTION INACTIVE;

5.2.6 Abnormal cases on the network side

The following abnormal cases can be identified:

- a) UE initiated PDN connectivity request for an already existing PDN connection:

If the network receives a PDN CONNECTIVITY REQUEST message with the same combination of APN and PDN type as an already existing PDN connection:

- if the information elements in the PDN CONNECTIVITY REQUEST message do not differ from the ones received within the previous PDN CONNECTIVITY REQUEST message, and the TWAG has not received the PDN CONNECTIVITY COMPLETE message from UE, the TWAG shall re-send the PDN CONNECTIVITY ACCEPT message and continue the previous procedure; and
- if one or more information elements in the PDN CONNECTIVITY REQUEST message differ from the ones received within the previous PDN CONNECTIVITY REQUEST message, and multiple PDN connections for a given APN are not allowed, the network may release the existing PDN connection locally without notification to the UE and proceed with the requested PDN connectivity procedure or may reject this PDN connectivity procedure including the cause #55 "multiple PDN connections for a given APN not allowed", in the PDN CONNECTIVITY REJECT message; and

If the network receives a PDN CONNECTIVITY REQUEST message with request type "emergency" and the TWAG has not received the PDN CONNECTIVITY COMPLETE message from UE for the previous PDN connectivity request for emergency bearer services, the network shall resend the PDN CONNECTIVITY ACCEPT message and continue the previous procedure. If there is already a PDN connection for emergency

bearer services existing, the TWAG shall reject the request with ESM cause #55 "multiple PDN connections for a given APN not allowed" or deactivate the existing PDN connection for emergency bearer services locally without notification to the UE and proceed with the requested PDN connectivity procedure.

- b) UE initiated PDN connectivity request with request type "handover" for a PDN connection that does not exist:

If the network receives a PDN CONNECTIVITY REQUEST message for either a default APN or a specific APN with request type set to "handover" and the TWAG does not have any information about that PDN connection, then TWAG shall reject the PDN connectivity request procedure including the cause #54 "PDN connection does not exist", in the PDN CONNECTIVITY REJECT message.

- c) Expiry of timer T3585:

On the first expiry of the timer T3585, the TWAG shall resend the PDN CONNECTIVITY ACCEPT message, reset and restart timer T3585. This retransmission is repeated four times, i.e. on the fifth expiry of timer T3585, the TWAG shall release possibly allocated resources for this activation and shall abort the procedure.

- d) A PDN CONNECTIVITY REQUEST message with request type "handover of emergency bearer services" is received from a UE and the TWAG does not have any information about a P-GW currently providing emergency bearer services for the UE or the TWAG is not configured with an address of a P-GW in the TWAG emergency configuration data:

TWAG shall reject the PDN connectivity request procedure including the ESM cause #54 "PDN connection does not exist", in the PDN CONNECTIVITY REJECT message.

5.3 TWAG initiated PDN disconnection procedure

5.3.1 General

The purpose of the PDN disconnection procedure is to disconnect the UE from a PDN. With this procedure, all resources associated with this PDN connection are released.

5.3.2 Procedure description

The TWAG shall initiate the PDN disconnection procedure by sending a PDN DISCONNECT REQUEST message to the UE, start the timer T3595, and enter the state PDN DISCONNECT PENDING and PROCEDURE TRANSACTION PENDING (see example in figure 5.3.2.1). The PDN DISCONNECT REQUEST message contains a cause typically indicating one of the following:

- #8: operator determined barring;
- #36: regular deactivation;
- #38: network failure; or
- #39: reactivation requested.

The TWAG may include a PCO IE in the PDN DISCONNECT REQUEST message (e.g. configuration parameters, error codes or messages/events).

If the UE is not authenticated when the TWAG initiates the PDN disconnection procedure, the TWAG shall locally disconnect the PDN connection towards the UE without any WLCP signalling between the TWAG and the UE.



Figure 5.3.2.1: PDN disconnect procedure

Upon receipt of the PDN DISCONNECT REQUEST message, the UE shall release all the resources associated with the PDN connection and respond to the TWAG with the PDN DISCONNECT ACCEPT.

Upon sending the PDN DISCONNECT ACCEPT message, the UE shall enter the state PDN CONNECTIVITY NOT ESTABLISHED.

If the PDN DISCONNECT REQUEST message includes cause #39 "reactivation requested" the UE should stop timer Tw1 if it is running for the APN associated with the PDN connection and re-initiate the PDN connectivity procedure for the same APN as the disconnected PDN.

NOTE: User interaction may be necessary in some cases when the UE cannot re-activate the PDN connection automatically.

Upon receipt of the PDN DISCONNECT ACCEPT message, the TWAG shall enter the states PDN CONNECTIVITY NOT ESTABLISHED and PROCEDURE TRANSACTION INACTIVE and stop the timer T3595.

5.3.3 Abnormal cases in the UE

Apart from the case described in subclause 5.1.3, no abnormal cases have been identified.

5.3.4 Abnormal cases in the TWAG

The following abnormal cases can be identified:

a) Expiry of timer T3595:

On the first expiry of the timer T3595, the TWAG shall resend the PDN DISCONNECT REQUEST message and shall reset and restart timer T3595. This retransmission is repeated four times, i.e. on the fifth expiry of timer T3595, the TWAG shall abort the procedure and deactivate the PDN connection locally without any peer-to-peer WLCP signalling between the TWAG and the UE; and

b) Collision of UE-initiated and TWAG-initiated PDN disconnection procedure:

When the TWAG receives a PDN DISCONNECT REQUEST message during the TWAG-initiated PDN disconnection procedure the TWAG shall proceed with the PDN disconnection procedure.

5.4 UE requested PDN disconnection procedure

5.4.1 General

The purpose of the UE requested PDN disconnection procedure is for a UE to request disconnection from one PDN. With this procedure, all resources associated with this PDN connection are released.

5.4.2 Procedure description

In order to request PDN disconnection from a PDN, the UE shall send a PDN DISCONNECT REQUEST message to the TWAG, start the timer T3592 and enter the state PROCEDURE TRANSACTION PENDING (see example in figure 5.4.2.1).

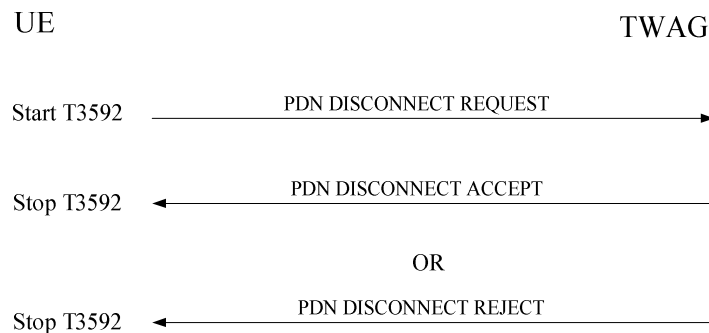

Figure 5.4.2.1: UE requested PDN disconnection procedure

Upon receipt of the PDN DISCONNECT REQUEST message, the TWAG shall release all the resources associated with the PDN connection and respond to the UE with the PDN DISCONNECT ACCEPT message.

Upon receipt of the PDN DISCONNECT ACCEPT message, the UE shall stop the timer T3592, deactivate all resources associated with this PDN connection and enter the states PROCEDURE TRANSACTION INACTIVE and PDN CONNECTIVITY NOT ESTABLISHED.

If the PDN DISCONNECT REQUEST message is not accepted by the network, the TWAG shall send a PDN DISCONNECT REJECT message to the UE. The PDN DISCONNECT REJECT message shall contain the PTI and a cause IE that typically indicates one of the following cause values:

- #35: PTI already in use; and
- #95 – 111: protocol errors.

Upon receipt of the PDN DISCONNECT REJECT message, the UE shall stop the timer T3592, enter the state PROCEDURE TRANSACTION INACTIVE and abort the PDN disconnection procedure. Additionally, the UE shall deactivate all resources associated with this PDN connection locally without peer-to-peer signalling between the UE and the TWAG and enter the state PDN CONNECTIVITY NOT ESTABLISHED.

5.4.3 Abnormal cases in the UE

The following abnormal cases can be identified:

- a) Expiry of timer T3592:

On the first expiry of the timer T3592, the UE shall resend the PDN DISCONNECT REQUEST and shall reset and restart timer T3592. This retransmission is repeated four times, i.e. on the fifth expiry of timer T3592, the UE shall abort the procedure, release all resources associated with this PDN connection locally without peer-to-peer signalling between the UE and the TWAG, release the PTI allocated for this invocation and enter the state PROCEDURE TRANSACTION INACTIVE.

5.4.4 Abnormal cases in the TWAG

The following abnormal cases can be identified:

- a) No PDN connection with the same PTI:

If the PTI included in the PDN DISCONNECT REQUEST message does not belong to an established PDN connection, the TWAG shall reply with a PDN DISCONNECT REJECT message with cause #54 "PDN connection does not exist";

5.5 STATUS message

The purpose of the sending of the STATUS message is to report at any time certain error conditions detected upon receipt of WLCP protocol data. The STATUS message can be sent by both the TWAG and the UE (see example in figure 5.5.1).

If the WLCP entity of the UE receives a STATUS message the UE shall take different actions depending on the received cause value:

#81 (Invalid PTI value);

The UE shall abort any ongoing WLCP procedure related to the received PTI value and stop any related timer.

#97 (Message type non-existent or not implemented);

The UE shall abort any ongoing WLCP procedure related to the PTI and stop any related timer.

On receipt of a STATUS message with any other cause value no state transition and no specific action shall be taken as seen from the WLAN radio interface, i.e. local actions are possible.

If the WLCP entity of the TWAG receives a STATUS message the TWAG shall take different actions depending on the received cause value:

#81 (Invalid PTI value);

The TWAG shall abort any ongoing WLCP procedure related to the received PTI value and stop any related timer.

#97 (Message type non-existent or not implemented);

The TWAG shall abort any ongoing WLCP procedure related to the PTI and stop any related timer.

The local actions to be taken by the TWAG on receipt of an STATUS message with any other cause value are implementation dependent.

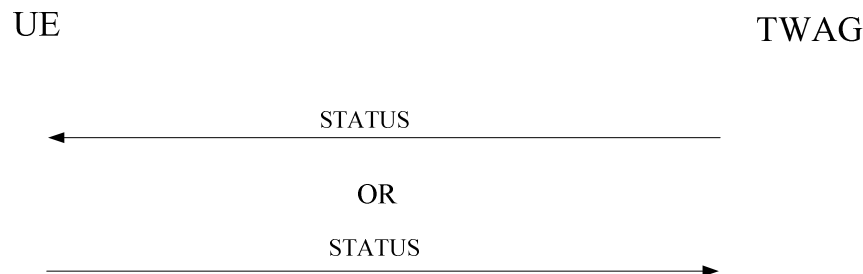

Figure 5.5.1: STATUS message

5.6 TWAG initiated PDN connectivity modification procedure

5.6.1 General

The purpose of the TWAG initiated PDN connectivity modification procedure is for the network to modify the protocol data of the PDN connection (e.g. PCO, routing rule). If this procedure was initiated by a UE requested PDN connectivity modification procedure (see subclause 5.7), the PDN MODIFICATION REQUEST shall contain the procedure transaction identity (PTI) value received by the TWAG in the PDN MODIFICATION INDICATION message.

5.6.2 Procedure description

The TWAG shall initiate the PDN connectivity modification procedure by sending a PDN MODIFICATION REQUEST message to the UE, starting the timer T3586 and enter the state PROCEDURE TRANSACTION PENDING (see example in figure 5.6.2.1).

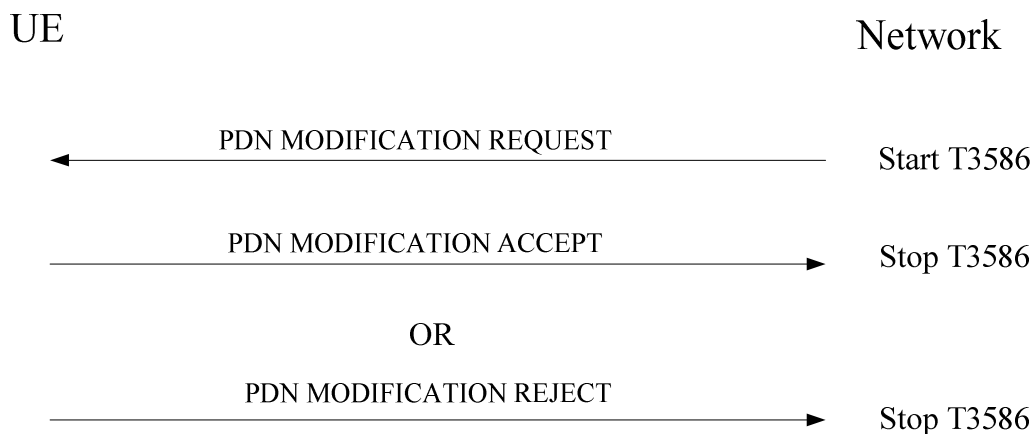

Figure 5.6.2.1: TWAG-initiated PDN connectivity modification procedure

5.6.3 PDN connectivity modification procedure accepted by the UE

Upon receipt of the PDN MODIFICATION REQUEST message, the UE may accept the request from the TWAG by sending a PDN MODIFICATION ACCEPT message to the TWAG. Upon receipt of the PDN MODIFICATION ACCEPT message, the TWAG shall stop the timer T3586.

5.6.4 PDN connectivity modification procedure not accepted by the UE

Upon receipt of the PDN MODIFICATION REQUEST message, the UE may reject the request from the TWAG by sending a PDN MODIFICATION REJECT message to the TWAG.

The PDN MODIFICATION REJECT message contains a cause that typically indicates one of the following cause values:

- #31: request rejected, unspecified; or
- #95 – 111: protocol errors.

5.6.5 Abnormal cases in the UE

Apart from the case described in subclause 5.1.3, no abnormal cases have been identified.

5.6.6 Abnormal cases in the TWAG

The following abnormal cases can be identified:

- a) Expiry of timer T3586:

On the first expiry of the timer T3586, the TWAG shall resend the PDN MODIFICATION REQUEST and shall reset and restart timer T3586. This retransmission is repeated four times, i.e. on the fifth expiry of timer T3586, the TWAG shall abort the procedure and enter the state PDN CONNECTION ESTABLISHED.

The TWAG may continue to use the previous configuration of the PDN connectivity or initiate PDN disconnection procedure.

- b) Collision of TWAG initiated PDN connectivity modification procedure and UE requested PDN disconnection procedure:

When the TWAG receives a PDN DISCONNECT REQUEST message during a TWAG initiated PDN connectivity modification procedure, the TWAG shall terminate the PDN connectivity modification procedure locally and proceed with the PDN disconnect procedure.

5.7 UE requested PDN connectivity modification procedure

5.7.1 General

The purpose of the UE requested PDN connectivity modification procedure is for the UE to request the network to modify the protocol data of the PDN connection (e.g. PCO, routing rule). If accepted by the network, this procedure invokes a TWAG initiated PDN connectivity modification procedure (see subclause 5.6).

5.7.2 Procedure description

In order to request the network to initiate PDN connectivity modification procedure, the UE shall send a PDN MODIFICATION INDICATION message to the TWAG, start timer T3586 and enter the state PDN MODIFICATION PENDING (see example in figure 5.7.2.1).

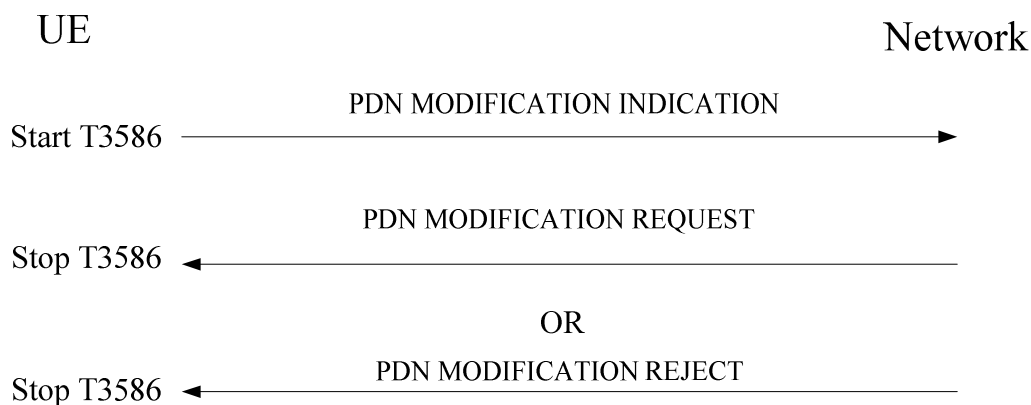

Figure 5.7.2.1: UE requested PDN connectivity modification procedure

5.7.3 PDN connectivity modification procedure accepted by the network

Upon receipt of the PDN MODIFICATION REQUEST message, the UE shall stop the timer T3586.

5.7.4 PDN connectivity modification procedure not accepted by the network

Upon receipt of the PDN MODIFICATION INDICATION message, the network may reject the request from the UE by sending a PDN MODIFICATION REJECT message to the UE.

The PDN MODIFICATION REJECT message contains a cause that typically indicates one of the following cause values:

- #31: request rejected, unspecified; or
- #95 – 111: protocol errors.

5.7.5 Abnormal cases in the UE

The following abnormal cases can be identified:

a) Expiry of timer T3586:

On the first expiry of the timer T3586, the UE shall resend the PDN MODIFICATION INDICATION and shall reset and restart timer T3586. This retransmission is repeated four times, i.e. on the fifth expiry of timer T3586, the UE shall abort the procedure, release the PTI allocated for this activation and enter the state PROCEDURE TRANSACTION INACTIVE.

b) Unknown PDN connection ID

Upon receipt of the PDN MODIFICATION REJECT message including ESM cause #43 "invalid EPS bearer identity", the UE shall release the existing PDN connection locally without peer-to-peer signalling between the UE and the TWAG.

c) Collision of a UE requested PDN connectivity modification procedure and a TWAG initiated PDN disconnection procedure.

When the UE receives a PDN DISCONNECT REQUEST message during the PDN connectivity modification procedure, and the PDN connection ID indicated in the PDN DISCONNECT REQUEST message is the PDN connection ID the UE indicated in the UE requested PDN connectivity modification procedure, then the UE shall abort the UE requested PDN connectivity modification procedure and proceed with the PDN disconnection procedure.

5.7.6 Abnormal cases in the TWAG

Apart from the case described in subclause 5.1.3, no abnormal cases have been identified.

5.8 PGW initiated local PDN disconnection in the TWAG

5.8.1 General

A PDN connection over trusted WLAN can be released locally in the TWAG, i.e. without any peer-to-peer signalling between the TWAG and the UE, based on the trigger from the PGW. This can happen, for example, during the P-CSCF restoration procedure for NBIFOM PDN connections (see 3GPP TS 23.380 [11]).

5.8.2 Procedure description

Upon receiving a request from PGW to release a PDN connection with cause "local release" (see 3GPP TS 29.274 [12]) the TWAG shall:

- release all resources associated with this PDN connection over WLAN; and
- not initiate any peer-to-peer WLCP signalling to the UE.

5.9 Local PDN disconnection in the UE initiated from 3GPP access

5.9.1 General

A PDN connection over trusted WLAN can be released locally in the UE, i.e. without any peer-to-peer signalling between the TWAG and the UE, based on the trigger received via 3GPP access. This can happen, for example, during the P-CSCF restoration procedure for NBIFOM PDN connections (see 3GPP TS 23.380 [11]).

5.9.2 Procedure description

Upon receiving over the 3GPP access:

- a DEACTIVATE EPS BEARER CONTEXT REQUEST message with the EPS bearer context of a default EPS bearer context and ESM cause #39 "reactivation requested" (see 3GPP TS 24.301 [8]); or
- a DETACH REQUEST message with the detach type "re-attach required" (see 3GPP TS 24.301 [8])

to release the resources for a PDN connection over the 3GPP access, the UE shall:

- release all resources associated with this PDN connection over WLAN; and
- not initiate any peer-to-peer WLCP signalling to the TWAG.

5.10 WLCP bearer setup procedure

5.10.1 General

The purpose of the WLCP bearer setup procedure is to establish a dedicated WLCP bearer with specific bearer level QoS and TFT between the UE and the TWAN. The WLCP bearer setup procedure is initiated by the TWAG if:

- the UE is connected to a trusted WLAN using the multi-connection mode (MCM);
- the TWAG receives from the PDN GW a Create Bearer Request message that includes TFT and S2a bearer level QoS parameters; and
- both the UE and TWAG support multiple bearer PDN connectivity and default WLCP bearer identity has been assigned during PDN connection establishment.

5.10.2 Procedure description

5.10.2.1 WLCP bearer setup procedure initiated by the TWAG

The TWAG shall initiate the WLCP bearer setup procedure by sending a WLCP BEARER SETUP REQUEST message to the UE, start the timer T3587, and enter the state WLCP BEARER CONTEXT ACTIVE PENDING (see figure 5.10.2.1.1).

In the WLCP BEARER SETUP REQUEST message, the TWAG shall include:

- WLCP bearer identity to identify the WLCP bearer to be created;
- PDN connection ID to indicate the associated PDN connection for which the WLCP bearer is to be created;
- MAC address of the TWAG to the UE associated with the WLCP bearer to be created. This MAC address is used by the UE and the TWAG to send the user plane packets to the corresponding WLCP bearer; and
- Bearer level QoS and TFT.

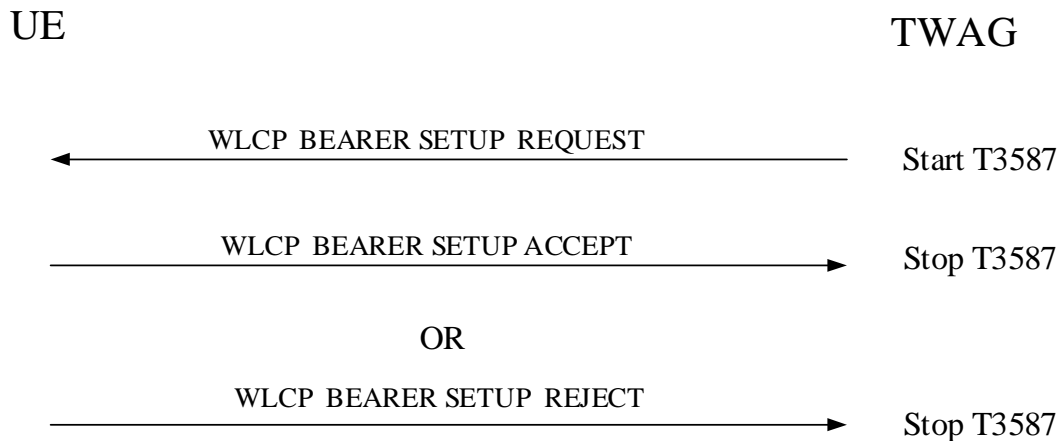

Figure 5.10.2.1.1: WLCB bearer setup procedure

5.10.2.2 WLCB bearer setup procedure accepted by the UE

Upon receipt of the WLCB BEARER SETUP REQUEST message, the UE shall check the received TFT before taking it into use, send a WLCB BEARER SETUP ACCEPT message and enter the state WLCB BEARER CONTEXT ACTIVE. The WLCB BEARER SETUP ACCEPT message shall include the WLCB bearer identity. The UE shall use the received TFT to apply mapping of uplink traffic flows to the WLCB bearer and shall treat any packet filter without explicit direction as being bi-directional.

Upon receipt of the WLCB BEARER SETUP ACCEPT message, the TWAG shall stop the timer T3587 and enter the state WLCB BEARER CONTEXT ACTIVE.

5.10.2.3 WLCB bearer setup procedure not accepted by the UE

Upon receipt of the WLCB BEARER SETUP REQUEST message, the UE may reject the request from the TWAG by sending a WLCB BEARER SETUP REJECT message. The UE shall include the WLCB bearer identity and a cause IE indicating the reason for rejection in the WLCB BEARER SETUP REJECT message.

The cause typically indicates one of the following cause values:

- #26: insufficient resources;
- #31: request rejected, unspecified;
- #41: semantic error in the TFT operation;
- #42: syntactical error in the TFT operation;
- #43: invalid EPS bearer identity;
- #44: semantic error(s) in packet filter(s);
- #45: syntactical error(s) in packet filter(s); or
- #95 – 111: protocol errors.

The UE shall check the TFT in the WLCB BEARER SETUP REQUEST request message for different types of TFT IE errors as follows:

- a) Semantic errors in TFT operations:
 - 1) When the *TFT operation* is an operation other than "Create a new TFT"

The UE shall reject the request with cause #41 "semantic error in the TFT operation".
- b) Syntactical errors in TFT operations:

- 1) When the *TFT operation* = "Create a new TFT" and the packet filter list in the TFT IE is empty.
- 2) When there are other types of syntactical errors in the coding of the TFT IE, such as a mismatch between the number of packet filters subfield, and the number of packet filters in the packet filter list.

The UE shall reject the request with cause #42 "syntactical error in the TFT operation".

c) Semantic errors in packet filters:

- 1) When a packet filter consists of conflicting packet filter components which would render the packet filter ineffective, i.e. no IP packet will ever fit this packet filter. How the UE determines a semantic error in a packet filter is outside the scope of the present document.
- 2) When the resulting TFT does not contain any packet filter for the uplink direction.

The UE shall reject the request with cause #44 "semantic errors in packet filter(s)".

d) Syntactical errors in packet filters:

- 1) When the *TFT operation* = "Create a new TFT" and two or more packet filters in the resultant TFT would have identical packet filter identifiers.
- 2) When the *TFT operation* = "Create a new TFT" and two or more packet filters in all TFTs associated with this WLCP connection would have identical packet filter precedence values.
- 3) When there are other types of syntactical errors in the coding of packet filters, such as the use of a reserved value for a packet filter component identifier.

In cases 1 and 3 the UE shall reject the request with cause #45 "syntactical errors in packet filter(s)".

In case 2, if the old packet filters do not belong to the default WLCP bearer context, the UE shall not diagnose an error, shall further process the request and, if it was processed successfully, shall delete the old packet filters which have identical filter precedence values.

In case 2, if one or more old packet filters belong to the default WLCP bearer context, the UE shall release the relevant WLCP connection.

Upon receipt of the WLCP BEARER SETUP REJECT message in state WLCP BEARER CONTEXT ACTIVE PENDING, the TWAG shall abort the WLCP bearer setup procedure, stop the timer T3587, if the timer is running, and enter the state WLCP BEARER CONTEXT INACTIVE.

5.10.3 Abnormal cases in the UE

The following abnormal cases can be identified:

a) Requested PDN connection ID non-existent

If the requested PDN connection ID included in the WLCP BEARER SETUP REQUEST message is non-existent, the UE shall reply with a WLCP BEARER SETUP REJECT message with cause #54 "PDN connection does not exist".

b) WLCP bearer setup request for an already activated default WLCP bearer

If the UE receives a WLCP BEARER SETUP REQUEST message with a WLCP bearer identity identical to the WLCP bearer identity of an already activated default WLCP bearer, the UE shall delete the existing default WLCP bearer and all the associated dedicated WLCP bearers, if any, and proceed with the requested dedicated WLCP bearer setup

c) WLCP bearer setup request for an already activated dedicated WLCP bearer

If the UE receives a WLCP BEARER SETUP REQUEST message with a WLCP bearer identity identical to the WLCP bearer identity of an already activated dedicated WLCP bearer, the UE shall locally release the existing dedicated WLCP bearer context and proceed with the requested dedicated WLCP bearer setup.

5.10.4 Abnormal cases in the TWAG

The following abnormal cases can be identified:

a) Expiry of timer T3587:

On the first expiry of the timer T3587, the TWAG shall resend the WLCP BEARER SETUP REQUEST and shall reset and restart timer T3587. This retransmission is repeated four times, i.e. on the fifth expiry of timer T3587, the TWAG shall abort the procedure, release any resources allocated for this activation and enter the state WLCP BEARER CONTEXT INACTIVE.

b) Collision of UE requested PDN disconnection procedure and WLCP bearer setup procedure:

When the TWAG receives a PDN DISCONNECT REQUEST message during the WLCP bearer setup procedure, and the WLCP bearer to be setup belongs to the PDN connection the UE wants to disconnect, the TWAG shall terminate the WLCP bearer setup procedure locally, release any resources related to this procedure and proceed with the PDN disconnection procedure.

5.11 WLCP bearer modify procedure

5.11.1 General

The purpose of the WLCP bearer modify procedure is to modify a dedicated WLCP bearer context between the UE and the TWAN. The WLCP bearer modify procedure is initiated by the TWAG if:

- the UE is connected to a trusted WLAN using the multi-connection mode (MCM);
- the TWAG receives from the PDN GW a Update Bearer Request message that includes TFT and updated S2a bearer level QoS parameters; and
- both the UE and TWAG support multiple bearer PDN connectivity and default WLCP bearer identity has been assigned during PDN connection establishment.

5.11.2 Procedure description

5.11.2.1 WLCP bearer modify procedure initiated by the TWAG

The TWAG shall initiate the WLCP bearer modify procedure by sending a WLCP BEARER MODIFY REQUEST message to the UE, start the timer T3588, and enter the state WLCP BEARER CONTEXT MODIFY PENDING (see figure 5.11.2.1.1).

The TWAG shall include the WLCP bearer identity and its associated PDN connection ID in the WLCP BEARER MODIFY REQUEST message to identify the WLCP bearer context to be modified.

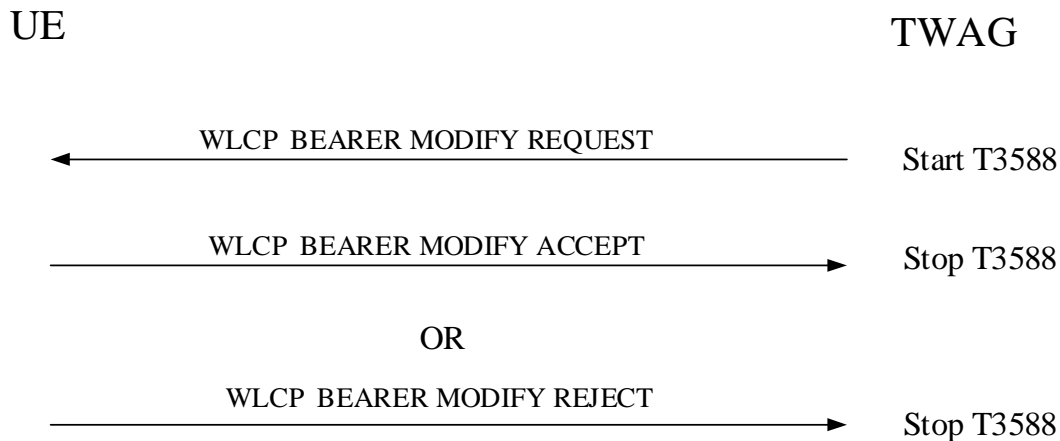

Figure 5.11.2.1.1: WLCB bearer modify procedure

5.11.2.2 WLCB bearer modify procedure accepted by the UE

Upon receipt of the WLCB BEARER MODIFY REQUEST message, the UE shall check the received TFT before taking it into use, send a WLCB BEARER MODIFY ACCEPT message and enter the state WLCB BEARER CONTEXT ACTIVE. The WLCB BEARER MODIFY ACCEPT message shall include the WLCB bearer identity. The UE shall use the received TFT to apply mapping of uplink traffic flows to the WLCB bearer and shall treat any packet filter without explicit direction as being bi-directional.

The UE shall use the received TFT to apply mapping of uplink traffic flows to the WLCB bearer if the TFT contains packet filters for the uplink direction.

Upon receipt of the WLCB BEARER MODIFY ACCEPT message, the TWAG shall stop the timer T3588 and enter the state WLCB BEARER CONTEXT ACTIVE.

5.11.2.3 WLCB bearer modify procedure not accepted by the UE

Upon receipt of the WLCB BEARER MODIFY REQUEST message, the UE may reject the request from the TWAG by sending a WLCB BEARER MODIFY REJECT message. The UE shall include the WLCB bearer identity and a cause IE indicating the reason for rejection in the WLCB BEARER MODIFY REJECT message.

The cause typically indicates one of the following cause values:

- #26: insufficient resources;
- #31: request rejected, unspecified;
- #41: semantic error in the TFT operation;
- #42: syntactical error in the TFT operation;
- #43: invalid WLCB bearer identity;
- #44: semantic error(s) in packet filter(s);
- #45: syntactical error(s) in packet filter(s); or
- #95 – 111: protocol errors.

The UE shall check the TFT in the WLCB BEARER MODIFY REQUEST message for different types of TFT IE errors as follows:

- a) Semantic errors in TFT operations:
 - 1) *TFT operation* = "Create a new TFT" when there is already an existing TFT for the WLCB bearer.

- 2) When the *TFT operation* is an operation other than "Create a new TFT" and there is no TFT for the WLCP bearer.
- 3) *TFT operation* = "Delete packet filters from existing TFT" when it would render the TFT empty.
- 4) *TFT operation* = "Delete existing TFT" for a dedicated WLCP bearer.

In case 4 the UE shall reject the WLCP bearer modify request with cause #41 "semantic error in the TFT operation".

In the other cases the UE shall not diagnose an error and perform the following actions to resolve the inconsistency:

In case 1 the UE shall further process the request and, if it was processed successfully, delete the old TFT.

In case 2 the UE shall:

- process the request and if the TFT operation is "Delete existing TFT" or "Delete packet filters from existing TFT", and if no error according to items b, c, and d was detected, consider the TFT as successfully deleted;
- process the request as an activation request, if the TFT operation is "Add packet filters in existing TFT" or "Replace packet filters in existing TFT".

In case 3, if the packet filters belong to a dedicated WLCP bearer and if no error according to items b, c, and d was detected, the UE shall reject the request with cause #41 "semantic error in the TFT operation".

In case 3, if the packet filters belong to the default WLCP bearer and if no error according to items b, c, and d was detected, the UE shall delete the existing TFT.

b) Syntactical errors in TFT operations:

- 1) When the *TFT operation* = "Create a new TFT", "Add packet filters in existing TFT", "Replace packet filters in existing TFT" or "Delete packet filters from existing TFT" and the packet filter list in the TFT IE is empty.
- 2) *TFT operation* = "Delete existing TFT" or "No TFT operation" with a non-empty packet filter list in the TFT IE.
- 3) *TFT operation* = "Replace packet filters in existing TFT" when the packet filter to be replaced does not exist in the original TFT.
- 4) *TFT operation* = "Delete packet filters from existing TFT" when the packet filter to be deleted does not exist in the original TFT.
- 5) *TFT operation* = "Delete packet filters from existing TFT" with a packet filter list also including packet filters in addition to the packet filter identifiers.
- 6) When there are other types of syntactical errors in the coding of the TFT IE, such as a mismatch between the number of packet filters subfield, and the number of packet filters in the packet filter list.

In case 3 the UE shall not diagnose an error, further process the replace request and, if no error according to items c and d was detected, include the packet filters received to the existing TFT.

In case 4 the UE shall not diagnose an error, further process the deletion request and, if no error according to items c and d was detected, consider the respective packet filter as successfully deleted.

Otherwise the UE shall reject the modification request with ESM cause #42 "syntactical error in the TFT operation".

c) Semantic errors in packet filters:

- 1) When a packet filter consists of conflicting packet filter components which would render the packet filter ineffective, i.e. no IP packet will ever fit this packet filter. How the UE determines a semantic error in a packet filter is outside the scope of the present document.
- 2) When the resulting TFT, which is assigned to a dedicated WLCP bearer context, does not contain any packet filter applicable for the uplink direction among the packet filters created on request from the network.

The UE shall reject the request with cause #44 "semantic errors in packet filter(s)".

d) Syntactical errors in packet filters:

- 1) When the *TFT operation* = "Create a new TFT", "Add packet filters to existing TFT", and two or more packet filters in the resultant TFT would have identical packet filter identifiers.
- 2) When the *TFT operation* = "Create a new TFT", "Add packet filters to existing TFT" or "Replace packet filters in existing TFT", and two or more packet filters among all TFTs associated with this PDN connection would have identical packet filter precedence values.
- 3) When there are other types of syntactical errors in the coding of packet filters, such as the use of a reserved value for a packet filter component identifier.

In case 1, if two or more packet filters with identical packet filter identifiers are contained in the new request, the UE shall reject the request with cause #45 "syntactical errors in packet filter(s)". Otherwise, the UE shall not diagnose an error, further process the new request and, if it was processed successfully, delete the old packet filters which have the identical packet filter identifiers.

In case 2, if the old packet filters do not belong to the default WLCP bearer, the UE shall not diagnose an error, shall further process the new request and, if it was processed successfully, delete the old packet filters which have identical filter precedence values.

In case 2, if one or more old packet filters belong to the default WLCP bearer, the UE shall release the relevant PDN connection. If the relevant PDN connection is the last one that the UE has, the UE shall initiate PDN connectivity establishment procedure to re-establish the PDN connectivity to the network.

Otherwise the UE shall reject the request with cause #45 "syntactical errors in packet filter(s)".

Upon receipt of the WLCP BEARER MODIFY REJECT message with cause value other than #43 "invalid WLCP bearer identity" in state BEARER CONTEXT MODIFY PENDING, the TWAG shall abort the WLCP bearer modify procedure, stop the timer T3588, if the timer is running, and enter the state WLCP BEARER CONTEXT ACTIVE. If the TWAG receives the WLCP BEARER MODIFY REJECT message with cause #43 "invalid WLCP bearer identity", the TWAG locally deactivates the WLCP bearer without peer-to-peer signalling.

5.11.3 Abnormal cases in the UE

No abnormal cases have been identified.

5.11.4 Abnormal cases in the TWAG

The following abnormal cases can be identified:

a) Expiry of timer T3588:

On the first expiry of the timer T3588, the TWAG shall resend the WLCP BEARER MODIFY REQUEST and shall reset and restart timer T3588. This retransmission is repeated four times, i.e. on the fifth expiry of timer T3486, the TWAG shall abort the procedure and enter the state WLCP BEARER CONTEXT ACTIVE.

The TWAG may continue to use the previous WLCP bearer context or initiate a WLCP bearer release procedure.

b) Collision of UE requested PDN disconnection procedure and WLCP bearer modify procedure

When the TWAG receives a PDN DISCONNECT REQUEST message during an WLCP bearer modify procedure, and the WLCP bearer to be modified belongs to the PDN connection the UE wants to disconnect, the TWAG shall terminate the WLCP bearer modify procedure locally, release any resources related to this procedure and proceed with the PDN disconnection procedure.

5.12 WLCP bearer release procedure

5.12.1 General

The purpose of the WLCP bearer release procedure is to release a dedicated WLCP bearer between the UE and the TWAN. The WLCP bearer release procedure is initiated by the TWAG if:

- the UE is connected to a trusted WLAN using the multi-connection mode (MCM);
- both the UE and TWAG support multiple bearer PDN connectivity and default WLCP bearer identity has been assigned during PDN connection establishment; and
- the TWAG receives from the PDN GW a Delete Bearer Request message that a WLCP bearer is to be released and the WLCP bearer to be released is not default WLCP bearer.

NOTE: if the WLCP bearer to be release is default WLCP bearer, the TWAG invokes PDN disconnect procedure to disconnect the PDN connection and release all associated WLCP bearers (see subclause 5.3).

5.12.2 Procedure description

5.12.2.1 WLCP bearer release procedure initiated by the TWAG

The TWAG shall initiate the WLCP bearer release procedure by sending a WLCP BEARER RELEASE REQUEST message to the UE, start the timer T3597, and enter the state WLCP BEARER CONTEXT INACTIVE PENDING (see figure 5.12.2.1.1).

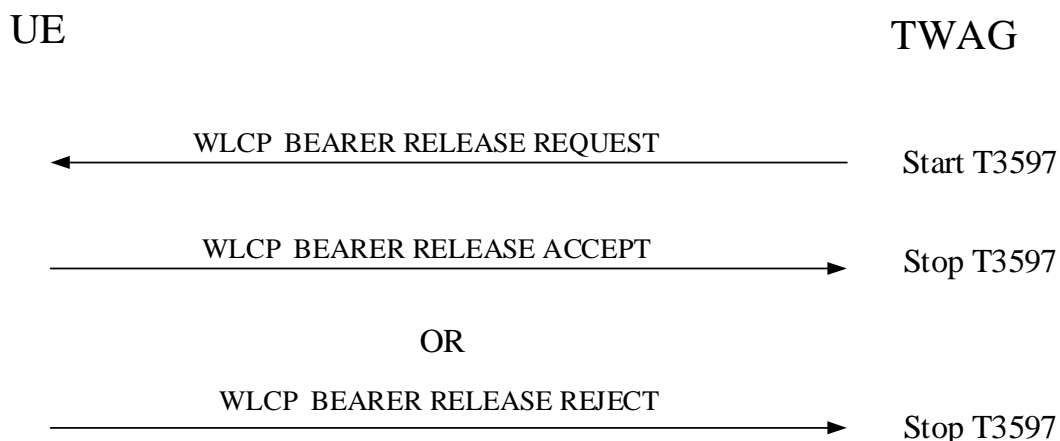

Figure 5.12.2.1.1: WLCP bearer release procedure

The WLCP BEARER RELEASE REQUEST message contains a cause typically indicating one of the following:

- #8: operator determined barring;
- #26: insufficient resources;
- #36: regular deactivation;
- #38: network failure.

5.12.2.2 WLCP bearer release procedure accepted by the UE

Upon receipt of the WLCP BEARER RELEASE REQUEST message, the UE shall delete the WLCP bearer identified by the WLCP bearer identity, send a WLCP BEARER RELEASE ACCEPT message and enter the state WLCP BEARER CONTEXT INACTIVE. The WLCP BEARER RELEASE ACCEPT message shall include the WLCP bearer identity.

Upon receipt of the WLCP BEARER RELEASE ACCEPT message, the TWAG shall stop the timer T3597 and enter the state WLCP BEARER CONTEXT INACTIVE.

5.12.2.3 WLCP bearer release procedure not accepted by the UE

Upon receipt of the WLCP BEARER RELEASE REQUEST message, the UE may reject the request from the TWAG by sending a WLCP BEARER RELEASE REJECT message. The UE shall include the WLCP bearer identity and a cause IE indicating the reason for rejection in the WLCP BEARER RELEASE REJECT message.

The cause typically indicates one of the following cause values:

- #31: request rejected, unspecified;
- #43: invalid WLCP bearer identity;
- #95 – 111: protocol errors.

Upon receipt of the WLCP BEARER RELEASE REJECT message in state WLCP BEARER CONTEXT INACTIVE PENDING, the TWAG shall abort the WLCP bearer release procedure, stop the timer T3597, if the timer is running, and enter the state WLCP BEARER CONTEXT INACTIVE.

5.12.3 Abnormal cases in the UE

The following abnormal case can be identified:

- a) UE is requested to deactivate a default WLCP bearer context

If the UE determines that the WLCP bearer indicated in the WLCP BEARER RELEASE REQUEST message is the default WLCP bearer, then the UE shall respond by performing a UE requested PDN disconnection procedure.

5.12.4 Abnormal cases in the TWAG

The following abnormal cases can be identified:

- a) Expiry of timer T3589

On the first expiry of the timer T3589, the TWAG shall resend the WLCP BEARER RELEASE REQUEST and shall reset and restart timer T3589. This retransmission is repeated four times, i.e. on the fifth expiry of timer T3589, the TWAG shall abort the procedure and deactivate the WLCP bearer context locally.

- b) Collision of UE requested PDN disconnection procedure and WLCP bearer release

When the TWAG receives a PDN DISCONNECT REQUEST message during the WLCP bearer release procedure, and the WLCP bearer indicated in the WLCP BEARER RELEASE REQUEST message is a dedicated WLCP bearer belonging to the PDN connection the UE wants to disconnect, the TWAG shall proceed with both procedures. If the WLCP bearer indicated in the WLCP BEARER RELEASE REQUEST message is the default WLCP bearer, the TWAG shall proceed with the WLCP bearer release procedure.

6 Handling of unknown, unforeseen, and erroneous protocol data

6.1 General

The procedures specified in the present document apply to those messages which pass the checks described in this subclause.

This clause also specifies procedures for the handling of unknown, unforeseen, and erroneous protocol data by the receiving entity. These procedures are called "error handling procedures", but in addition to providing recovery mechanisms for error situations they define a compatibility mechanism for future extensions of the protocols.

Subclauses 6.1 to 6.8 shall be applied in order of precedence, starting with subclause 6.1.

Most error handling procedures are mandatory for the UE.

Detailed error handling procedures in the TWAG are implementation dependent and may vary from PLMN to PLMN. However, when extensions of this protocol are developed, TWAG will be assumed to have the error handling that is indicated in this subclause as mandatory ("shall") and that is indicated as strongly recommended ("should").

Also, the error handling of the TWAG is only considered as mandatory or strongly recommended when certain thresholds for errors are not reached during a dedicated connection.

6.2 Message too short

When the UE receives a WLCP message which is too short to contain a complete message type information element, the UE shall discard the message.

The TWAG shall take the same approach.

6.3 Unknown or unforeseen procedure transaction identity or PDN connection ID

6.3.1 Procedure transaction identity

The following TWAG procedures shall apply for handling an unknown, erroneous, or unforeseen PTI received in a WLCP message:

- a) If the TWAG receives a PDN CONNECTIVITY REQUEST message with a reserved PTI value, the TWAG shall respond with a PDN CONNECTIVITY REJECT message including ESM cause #81 "invalid PTI value";
- b) If the TWAG receives a PDN DISCONNECT REQUEST message with a reserved PTI value, the TWAG shall respond with a PDN DISCONNECT REJECT message including ESM cause #81 "invalid PTI value"; and
- c) If the TWAG receives a WLCP message other than those listed in items a through b above with a reserved PTI value, the TWAG shall ignore the message.

The following UE procedures shall apply for handling an unknown, erroneous, or unforeseen PTI received in a WLCP message:

- a) If the UE receives a PDN CONNECTIVITY REJECT message in which the PTI value is an unassigned or reserved value, or an assigned value that does not match any PTI in use, the UE shall ignore the message;
- b) If the UE receives a PDN DISCONNECT REJECT message in which the PTI value is an unassigned or reserved value, or an assigned value that does not match any PTI in use, the UE shall ignore the message; and
- c) If the UE receives a WLCP message other than those listed in items a through b with a reserved PTI value or an assigned value that does not match any PTI in use, the UE shall ignore the message.

6.3.2 PDN connection ID

The following TWAG procedures shall apply for handling an unknown, erroneous, or unforeseen PDN connection ID received in the header of a WLCP message:

- a) If the TWAG receives a PDN CONNECTIVITY REQUEST message which includes an assigned or reserved PDN connection ID value, the TWAG shall respond with a PDN CONNECTIVITY REJECT message including ESM cause #43 "invalid EPS bearer identity";

- b) If the TWAG receives a PDN DISCONNECT REQUEST message which includes an unassigned or reserved PDN connection ID value, the TWAG shall respond with a PDN DISCONNECT REJECT message including ESM cause #43 "invalid EPS bearer identity"; and
- c) If the TWAG receives a WLCP message other than those listed in items a through b above in which the message includes a reserved PDN connection ID value or an assigned value that does not match an existing PDN connection ID, the TWAG shall ignore the message.

The following UE procedures shall apply for handling an unknown, erroneous, or unforeseen PDN connection ID received in the header of a WLCP message:

- a) If the UE receives a PDN CONNECTIVITY REJECT message which includes an assigned or reserved PDN connection ID value, the UE shall ignore the message;
- b) If the UE receives a PDN DISCONNECT REJECT message which includes an unassigned or reserved PDN connection ID value or an assigned PDN connection ID value which does not match existing PDN connection, the UE shall ignore the message;
- c) If the UE receives a PDN DISCONNECT REQUEST message which includes an unassigned or reserved PDN connection ID value or an assigned PDN connection ID value which does not match existing PDN connection, the UE shall ignore the message; and
- d) If the UE receives a WLCP message other than those listed in items a through c in which the message includes an unassigned or reserved PDN connection ID value or a value that does not match an existing PDN connection ID, the UE shall ignore the message.

6.4 Unknown or unforeseen message type

If UE receives a WLCP message with message type not defined or not implemented, the UE shall return a status message with cause #97 "message type non-existent or not implemented".

If the TWAG receives a WLCP message with message type not defined or not implemented, the TWAG shall ignore the message except that the TWAG should return a status message with cause #97 "message type non-existent or not implemented".

6.5 Non-semantical mandatory information element errors

6.5.1 Common procedures

When on receipt of a message,

- an "imperative message part" error; or
- a "missing mandatory IE" error

is diagnosed or when a message containing:

- a syntactically incorrect mandatory IE;
- an IE unknown in the message, but encoded as "comprehension required" (see 3GPP TS 24.007 [7]); or
- an out of sequence IE encoded as "comprehension required" (see 3GPP TS 24.007 [7]) is received,

the UE shall proceed as follows:

The UE shall return a status message with cause #96 "invalid mandatory information"; and

the TWAG shall proceed as follows:

The TWAG shall either:

- try to treat the message (the exact further actions are implementation dependent); or

- ignore the message except that the TWAG should return a status message with cause #96 "invalid mandatory information".

6.5.2 PDN connection management

The following UE procedures shall apply for handling an error encountered with a mandatory information element in a WLCP message:

- a) If the message is a PDN CONNECTIVITY REQUEST, a PDN CONNECTIVITY REJECT message with ESM cause #96 "invalid mandatory information", shall be returned.
- b) If the message is a PDN DISCONNECT REQUEST, a PDN DISCONNECT ACCEPT message shall be returned. All resources associated with that PDN connection shall be released.

The following TWAG procedures shall apply for handling an error encountered with a mandatory information element in a WLCP message:

- a) If the message is a PDN CONNECTIVITY REQUEST, a PDN CONNECTIVITY REJECT message with ESM cause #96 "invalid mandatory information", shall be returned.
- b) If the message is a PDN DISCONNECT REQUEST, a PDN DISCONNECT REJECT message with ESM cause #96 "invalid mandatory information", shall be returned.

6.6 Unknown and unforeseen IEs in the non-imperative message part

6.6.1 IEs unknown in the message

The UE shall ignore all IEs unknown in a message which are not encoded as "comprehension required" (see 3GPP TS 24.301 [5]).

The TWAG shall take the same approach.

6.6.2 Out of sequence IEs

The UE shall ignore all out of sequence IEs in a message which are not encoded as "comprehension required" (see 3GPP TS 24.301 [5]).

The TWAG shall take the same approach.

6.6.3 Repeated IEs

If an information element with format V, TV, or TLV is repeated in a message in which repetition of the information element is not specified in clause 7 of the present document, the UE shall handle only the contents of the information element appearing first and shall ignore all subsequent repetitions of the information element. When repetition of information elements is specified, the UE shall handle only the contents of specified repeated information elements. If the limit on repetition of information elements is exceeded, the UE shall handle the contents of information elements appearing first up to the limit of repetitions and shall ignore all subsequent repetitions of the information element.

The TWAG shall follow the same procedures.

6.7 Non-imperative message part errors

6.7.1 General

This category includes:

- syntactically incorrect optional IEs; and

- conditional IE errors.

6.7.2 Syntactically incorrect optional IEs

The UE shall treat all optional IEs that are syntactically incorrect in a message as not present in the message.

The TWAG shall take the same approach.

6.7.3 Conditional IE errors

When upon receipt of a WLCP message the UE diagnoses a "missing conditional IE" error or an "unexpected conditional IE" error, or when the UE receives a WLCP message containing at least one syntactically incorrect conditional IE, the UE shall ignore the message and shall return a status message with cause #100 "conditional IE error".

When the TWAG receives a message and diagnoses a "missing conditional IE" error or an "unexpected conditional IE" error or when the TWAG receives a message containing at least one syntactically incorrect conditional IE, the TWAG shall either:

- try to treat the message (the exact further actions are implementation dependent); or
- ignore the message except that the TWAG should return a status message with cause #100 "conditional IE error".

6.8 Messages with semantically incorrect contents

When a message with semantically incorrect contents is received, the UE shall perform the foreseen reactions of the procedural part of the present document (i.e. of clauses 5). If however no such reactions are specified, the UE shall ignore the message except that the UE shall return a status message with cause #95 "semantically incorrect message".

The TWAG should follow the same procedure except that a status message is not normally transmitted.

7 Message functional definitions and contents

7.1 PDN connectivity request

7.1.1 Message definition

This message is sent by the UE to the network to initiate establishment of a PDN connection. See table 7.1.1.1.

Message type: PDN CONNECTIVITY REQUEST

Direction: UE to network

Table 7.1.1.1: PDN CONNECTIVITY REQUEST message content

IEI	Information Element	Type/Reference	Presence	Format	Length
	PDN connectivity request message identity	Message type 8.2	M	V	1
	Procedure transaction identity	Transaction identifier 8.3	M	V	1
	Request type	Request type 8.4	M	V	1/2
	PDN type	PDN type 8.5	M	V	1/2
28	Access point name	Access point name 8.6	O	TLV	3-102
27	Protocol configuration options	Protocol configuration options 8.7	O	TLV	3-253
33	NBIFOM container	NBIFOM container 8.13	O	TLV	3-257
A-	UE N3G capability	UE N3G capability 8.14	O	TV	1

7.1.2 Access point name

This IE is included in the message when the UE wishes to request network connectivity as defined by a certain access point name during the PDN connection establishment procedure.

7.1.3 Protocol configuration options

This IE is included in the message when the UE wishes to transmit (protocol) data (e.g. configuration parameters, error codes or messages/events) to the network.

7.1.4 NBIFOM container

This information element is used to transfer information associated with network-based IP flow mobility, see 3GPP TS 24.161 [10].

7.1.5 UE N3G capability

This IE is included in the message to indicate UE capabilities related to non-3GPP access when the UE is accessing EPC via trusted WLAN access network during the PDN connection establishment procedure.

7.2 PDN connectivity accept

7.2.1 Message definition

This message is sent by the network to the UE to acknowledge activation of a PDN connection. See table 7.2.1.1.

Message type: PDN CONNECTIVITY ACCEPT

Direction: network to UE

Table 7.2.1.1: PDN CONNECTIVITY ACCEPT message content

IEI	Information Element	Type/Reference	Presence	Format	Length
	PDN connectivity accept message identity	Message type 8.2	M	V	1
	Procedure transaction identity	Transaction identifier 8.3	M	V	1
	Access point name	Access point name 8.6	M	LV	2-101
	PDN Address	PDN address 8.8	M	LV	6-14
	PDN connection ID	PDN connection ID 8.9	M	V	1
	User Plane Connection ID	User Plane Connection ID 8.10	M	V	6
27	Protocol configuration options	Protocol configuration options 8.7	O	TLV	3-253
58	Cause	Cause 8.11	O	TV	2
33	NBIFOM container	NBIFOM container 8.13	O	TLV	3-257
B-	WLCP bearer identity	WLCP bearer identity 8.15	O	TV	1
5B	Bearer level QoS	EPS quality of service 8.16	O	TLV	3-15
5E	APN-AMBR	APN aggregate maximum bit rate 8.19	O	TLV	4-8

7.2.2 Protocol configuration options

This IE is included in the message when the network wishes to transmit (protocol) data (e.g. configuration parameters, error codes or messages/events) to the UE.

7.2.3 Cause

The network shall include this IE, if the network allocated a PDN address of a PDN type which is different from the PDN type requested by the UE.

7.2.4 NBIFOM container

This information element is used to transfer information associated with network-based IP flow mobility, see 3GPP TS 24.161 [10].

7.2.5 WLCP bearer identity

This IE is included in the message if multiple bearer PDN connectivity is used and TWAG has assigned a WLCP bearer identity for the default WLCP bearer of the newly activated PDN connection.

7.2.6 Bearer level QoS

This IE is included in the message if multiple bearer PDN connectivity is used and the TWAG requests to provide the QoS for default WLCP bearer.

7.2.7 APN-AMBR

This IE is included in the message if multiple bearer PDN connectivity is used and the TWAG requests to provide the APN-AMBR for the PDN connection.

7.3 PDN connectivity reject

7.3.1 Message definition

This message is sent by the network to the UE to reject activation of a PDN connection. See table 7.3.1.1.

Message type: PDN CONNECTIVITY REJECT

Direction: network to UE

Table 7.3.1.1: PDN CONNECTIVITY REJECT message content

IEI	Information Element	Type/Reference	Presence	Format	Length
	PDN connectivity reject message identity	Message type 8.2	M	V	1
	Procedure transaction identity	Transaction identifier 8.3	M	V	1
	Cause	Cause 8.11	M	V	1
27	Protocol configuration options	Protocol configuration options 8.7	O	TLV	3-253
37	Tw1 value	GPRS timer 3 8.12	O	TLV	3
33	NBIFOM container	NBIFOM container 8.13	O	TLV	3-257

7.3.2 Protocol configuration options

This IE is included in the message when the network wishes to transmit (protocol) data (e.g. configuration parameters, error codes or messages/events) to the UE.

7.3.3 Tw1 value

This IE may be included in the message when the cause is #26 "insufficient resources".

7.4 PDN disconnect request

7.4.1 Message definition

This message is sent by the network or the UE to initiate release of a PDN connection. See table 7.4.1.1.

Message type: PDN DISCONNECT REQUEST

Direction: both

Table 7.4.1.1: PDN DISCONNECT REQUEST message content

IEI	Information Element	Type/Reference	Presence	Format	Length
	PDN disconnect request message identity	Message type 8.2	M	V	1
	Procedure transaction identity	Transaction identifier 8.3	M	V	1
	PDN connection ID	PDN connection ID 8.9	M	V	1
58	Cause	Cause 8.11	O	TV	2
27	Protocol configuration options	Protocol configuration options 8.7	O	TLV	3-253

7.4.2 Protocol configuration options

This IE is included in the message when the UE or the network wishes to transmit (protocol) data (e.g. configuration parameters, error codes or messages/events) to the peer entity.

7.5 PDN disconnect accept

7.5.1 Message definition

This message is sent by the network or the UE to acknowledge release of a PDN connection. See table 7.5.1.1.

Message type: PDN DISCONNECT ACCEPT

Direction: both

Table 7.5.1.1: PDN DISCONNECT ACCEPT message content

IEI	Information Element	Type/Reference	Presence	Format	Length
	PDN connectivity accept message identity	Message type 8.2	M	V	1
	Procedure transaction identity	Transaction identifier 8.3	M	V	1
	PDN connection ID	PDN connection ID 8.9	M	V	1/2
27	Protocol configuration options	Protocol configuration options 8.7	O	TLV	3-253

7.5.2 Protocol configuration options

This IE is included in the message when the UE or the network wishes to transmit (protocol) data (e.g. configuration parameters, error codes or messages/events) to the peer entity.

7.6 PDN disconnect reject

7.6.1 Message definition

This message is sent by the network to the UE to reject release of a PDN connection. See table 7.6.1.1.

Message type: PDN DISCONNECT REJECT

Direction: network to UE

Table 7.6.1.1: PDN DISCONNECT REJECT message content

IEI	Information Element	Type/Reference	Presence	Format	Length
	PDN connectivity reject message identity	Message type 8.2	M	V	1
	Procedure transaction identity	Transaction identifier 8.3	M	V	1
	PDN connection ID	PDN connection ID 8.9	M	V	1
58	Cause	Cause 8.11	M	V	1
27	Protocol configuration options	Protocol configuration options 8.7	O	TLV	3-253

7.6.2 Protocol configuration options

This IE is included in the message when the network wishes to transmit (protocol) data (e.g. configuration parameters, error codes or messages/events) to the UE.

7.7 PDN connectivity complete

7.7.1 Message definition

This message is sent by the UE to acknowledge establishment of a PDN connection. See table 7.7.1.1.

Message type: PDN CONNECTIVITY COMPLETE

Direction: UE to network

Table 7.7.1.1: PDN CONNECTIVITY COMPLETE message content

IEI	Information Element	Type/Reference	Presence	Format	Length
	PDN connectivity complete	Message type 8.2	M	V	1
	Procedure transaction identity	Transaction identifier 8.3	M	V	1
	PDN connection ID	PDN connection ID 8.9	M	V	1

7.8 Status message

7.8.1 Message definition

This message is sent by the network or the UE to report certain error conditions detected upon receipt of WLCP protocol data as specified in subclause 5.5. See table 7.8.1.1.

Message type: STATUS

Direction: both

Table 7.8.1.1: STATUS message content

IEI	Information Element	Type/Reference	Presence	Format	Length
	Status	Message type 8.2	M	V	1
	Procedure transaction identity	Transaction identifier 8.3	M	V	1
	PDN connection ID	PDN connection ID 8.9	M	V	1
	Cause	Cause 8.11	M	V	1

7.9 PDN modification request

7.9.1 Message definition

This message is sent by the network to initiate modification of a PDN connection. See table 7.9.1.1.

Message type: PDN MODIFICATION REQUEST

Direction: network to UE

Table 7.9.1.1: PDN MODIFICATION REQUEST message content

IEI	Information Element	Type/Reference	Presence	Format	Length
	PDN modify request message identity	Message type 8.2	M	V	1
	Procedure transaction identity	Transaction identifier 8.3	M	V	1
	PDN connection ID	PDN connection ID 8.9	M	V	1
27	Protocol configuration options	Protocol configuration options 8.7	O	TLV	3-253
33	NBIFOM container	NBIFOM container 8.13	O	TLV	3-257

7.9.2 Protocol configuration options

This IE is included in the message when the UE or the network wishes to transmit (protocol) data (e.g. configuration parameters, error codes or messages/events) to the peer entity.

7.9.3 NBIFOM container

This information element is used to transfer information associated with network-based IP flow mobility, see 3GPP TS 24.161 [10].

7.10 PDN modification accept

7.10.1 Message definition

This message is sent by the UE to acknowledge modification of a PDN connection. See table 7.10.1.1.

Message type: PDN MODIFICATION ACCEPT

Direction: UE to network

Table 7.10.1.1: PDN MODIFICATION ACCEPT message content

IEI	Information Element	Type/Reference	Presence	Format	Length
	PDN connectivity accept message identity	Message type 8.2	M	V	1
	Procedure transaction identity	Transaction identifier 8.3	M	V	1
	PDN connection ID	PDN connection ID 8.9	M	V	1/2
27	Protocol configuration options	Protocol configuration options 8.7	O	TLV	3-253
33	NBIFOM container	NBIFOM container 8.13	O	TLV	3-257

7.10.2 Protocol configuration options

This IE is included in the message when the UE or the network wishes to transmit (protocol) data (e.g. configuration parameters, error codes or messages/events) to the peer entity.

7.10.3 NBIFOM container

This information element is used to transfer information associated with network-based IP flow mobility, see 3GPP TS 24.161 [10].

7.11 PDN modification reject

7.11.1 Message definition

This message is sent by the network or the UE to reject to modify a PDN connection. See table 7.11.1.1.

Message type: PDN MODIFICATION REJECT

Direction: both

Table 7.11.1.1: PDN MODIFICATION REJECT message content

IEI	Information Element	Type/Reference	Presence	Format	Length
	PDN connectivity reject message identity	Message type 8.2	M	V	1
	Procedure transaction identity	Transaction identifier 8.3	M	V	1
	PDN connection ID	PDN connection ID 8.9	M	V	1
58	Cause	Cause 8.11	M	V	1
27	Protocol configuration options	Protocol configuration options 8.7	O	TLV	3-253
33	NBIFOM container	NBIFOM container 8.13	O	TLV	3-257

7.11.2 Protocol configuration options

This IE is included in the message when the UE or the network wishes to transmit (protocol) data (e.g. configuration parameters, error codes or messages/events) to the UE.

7.11.3 NBIFOM container

This information element is used to transfer information associated with network-based IP flow mobility, see 3GPP TS 24.161 [10].

7.12 PDN modification indication

7.12.1 Message definition

This message is sent by the UE to request the network to initiate PDN connection modification procedure. See table 7.12.1.1.

Message type: PDN MODIFICATION INDICATION

Direction: UE to network

Table 7.12.1.1: PDN MODIFICATION INDICATION message content

IEI	Information Element	Type/Reference	Presence	Format	Length
	PDN modification indication message identity	Message type 8.2	M	V	1
	Procedure transaction identity	Transaction identifier 8.3	M	V	1
	PDN connection ID	PDN connection ID 8.9	M	V	1
27	Protocol configuration options	Protocol configuration options 8.7	O	TLV	3-253
33	NBIFOM container	NBIFOM container 8.13	O	TLV	3-257

7.12.2 Protocol configuration options

This IE is included in the message when the UE wishes to transmit (protocol) data (e.g. configuration parameters, error codes or messages/events) to the UE.

7.12.3 NBIFOM container

This information element is used to transfer information associated with network-based IP flow mobility, see 3GPP TS 24.161 [10].

7.13 WLCP bearer setup request

7.13.1 Message definition

This message is sent by the TWAG to the UE to request activation of a WLCP bearer for the given PDN connection. See table 7.13.1.1.

Message type: WLCP BEARER SETUP REQUEST

Significance: dual

Direction: network to UE

Table 7.13.1.1: WLCP BEARER SETUP REQUEST message content

IEI	Information Element	Type/Reference	Presence	Format	Length
	WLCP bearer setup request message identity	Message type 8.2	M	V	1
	WLCP bearer identity	WLCP bearer identity 8.15	M	V	1/2
	Spare half octet	Spare half octet 8.18	M	V	1/2
	PDN connection ID	PDN connection ID 8.9	M	V	1
	User Plane Connection ID	User Plane Connection ID 8.10	M	V	6
	Bearer level QoS	EPS quality of service 8.16	M	LV	2-14
	TFT	Traffic flow template 8.17	M	LV	2-256
27	Protocol configuration options	Protocol configuration options 8.7	O	TLV	3-253

7.13.2 Protocol configuration options

This IE is included in the message when the UE or the network wishes to transmit (protocol) data (e.g. configuration parameters, error codes or messages/events) to the UE.

7.14 WLCB bearer setup accept

7.14.1 Message definition

This message is sent by the UE to the TWAG to acknowledge activation of a WLCB bearer context associated with the given PDN connection ID. See table 7.14.1.1.

Message type: WLCB BEARER SETUP ACCEPT

Significance: dual

Direction: UE to TWAG

Table 7.14.1.1: WLCB BEARER SETUP ACCEPT message content

IEI	Information Element	Type/Reference	Presence	Format	Length
	WLCB bearer setup accept message identity	Message type 8.2	M	V	1
	Procedure transaction identity	Procedure transaction identity 8.3	M	V	1
	WLCB bearer identity	WLCB bearer identity 8.15	M	V	1/2
	Spare half octet	Spare half octet 8.18	M	V	1/2
27	Protocol configuration options	Protocol configuration options 8.7	O	TLV	3-253

7.14.2 Protocol configuration options

This IE is included in the message when the UE or the network wishes to transmit (protocol) data (e.g. configuration parameters, error codes or messages/events) to the UE.

7.15 WLCB bearer setup reject

7.15.1 Message definition

This message is sent by the UE to the TWAG to reject creation of a WLCB bearer for the given PDN connection. See table 7.15.1.1.

Message type: WLCB BEARER SETUP REJECT

Significance: dual

Direction: UE to TWAG

Table 7.15.1.1: WLCP BEARER SETUP REJECT message content

IEI	Information Element	Type/Reference	Presence	Format	Length
	WLCP bearer setup reject message identity	Message type 8.2	M	V	1
	Procedure transaction identity	Procedure transaction identity 8.3	M	V	1
	WLCP bearer identity	WLCP bearer identity 8.15	M	V	1/2
	Spare half octet	Spare half octet 8.18	M	V	1/2
	Cause	Cause 8.11	M	V	1
27	Protocol configuration options	Protocol configuration options 8.7	O	TLV	3-253

7.15.2 Protocol configuration options

This IE is included in the message when the UE or the network wishes to transmit (protocol) data (e.g. configuration parameters, error codes or messages/events) to the UE.

7.16 WLCP bearer modify request

7.16.1 Message definition

This message is sent by the TWAG to the UE to request modification of a WLCP bearer for the given PDN connection. See table 7.16.1.1.

Message type: WLCP BEARER MODIFY REQUEST

Significance: dual

Direction: network to UE

Table 7.16.1.1: WLCP BEARER MODIFY REQUEST message content

IEI	Information Element	Type/Reference	Presence	Format	Length
	WLCP bearer modify request message identity	Message type 8.2	M	V	1
	Procedure transaction identity	Procedure transaction identity 8.3	M	V	1
	WLCP bearer identity	WLCP bearer identity 8.15	M	V	1/2
	Spare half octet	Spare half octet 8.18	M	V	1/2
	PDN connection ID	PDN connection ID 8.9	M	V	1
	Bearer level QoS	EPS quality of service 8.16	O	LV	2-14
	TFT	Traffic flow template 8.17	O	LV	2-256
58	Cause	Cause 8.11	O	TV	2
27	Protocol configuration options	Protocol configuration options 8.7	O	TLV	3-253
5E	APN-AMBR	APN aggregate maximum bit rate 8.19	O	TLV	4-8

7.16.2 Bearer level QoS

This IE is included in the message when the TWAG requests a change of QoS for the indicated traffic flows.

7.16.3 TFT

This IE is included in the message when the TWAG requests a change of QoS for the indicated traffic flows packet filters.

7.16.4 Cause

This IE is included in the message to indicate the cause for modification.

7.16.5 Protocol configuration options

This IE is included in the message when the UE or the network wishes to transmit (protocol) data (e.g. configuration parameters, error codes or messages/events) to the UE.

7.16.6 APN-AMBR

This IE is included in the message when the TWAG requests to provide the APN-AMBR for the PDN connection and the WLCP bearer identity indicates the default bearer.

7.17 WLCP bearer modify accept

7.17.1 Message definition

This message is sent by the UE to the TWAG to acknowledge modification of a WLCP bearer context associated with the given PDN connection ID. See table 7.17.1.1.

Message type: WLCP BEARER MODIFY ACCEPT

Significance: dual

Direction: UE to TWAG

Table 7.17.1.1: WLCP BEARER MODIFY ACCEPT message content

IEI	Information Element	Type/Reference	Presence	Format	Length
	WLCP bearer modify accept message identity	Message type 8.2	M	V	1
	Procedure transaction identity	Procedure transaction identity 8.3	M	V	1
	WLCP bearer identity	WLCP bearer identity 8.15	M	V	1/2
	Spare half octet	Spare half octet 8.18	M	V	1/2
27	Protocol configuration options	Protocol configuration options 8.7	O	TLV	3-253

7.17.2 Protocol configuration options

This IE is included in the message when the UE or the network wishes to transmit (protocol) data (e.g. configuration parameters, error codes or messages/events) to the UE.

7.18 WLCP bearer modify reject

7.18.1 Message definition

This message is sent by the UE to the TWAG to reject modification of a WLCP bearer for the given PDN connection. See table 7.18.1.1.

Message type: WLCP BEARER MODIFY REJECT

Significance: dual

Direction: UE to TWAG

Table 7.18.1.1: WLCP BEARER MODIFY REJECT message content

IEI	Information Element	Type/Reference	Presence	Format	Length
	WLCP bearer modify reject message identity	Message type 8.2	M	V	1
	Procedure transaction identity	Procedure transaction identity 8.3	M	V	1
	WLCP bearer identity	WLCP bearer identity 8.15	M	V	1/2
	Spare half octet	Spare half octet 8.18	M	V	1/2
	Cause	Cause 8.11	M	V	1
27	Protocol configuration options	Protocol configuration options 8.7	O	TLV	3-253

7.18.2 Protocol configuration options

This IE is included in the message when the UE or the network wishes to transmit (protocol) data (e.g. configuration parameters, error codes or messages/events) to the UE.

7.19 WLCP bearer release request

7.19.1 Message definition

This message is sent by the TWAG to the UE to request release of a WLCP bearer for the given PDN connection. See table 7.19.1.1.

Message type: WLCP BEARER RELEASE REQUEST

Significance: dual

Direction: network to UE

Table 7.19.1.1: WLCP BEARER RELEASE REQUEST message content

IEI	Information Element	Type/Reference	Presence	Format	Length
	WLCP bearer release request message identity	Message type 8.2	M	V	1
	Procedure transaction identity	Procedure transaction identity 8.3	M	V	1
	WLCP bearer identity	WLCP bearer identity 8.15	M	V	1/2
	Spare half octet	Spare half octet 8.18	M	V	1/2
	PDN connection ID	PDN connection ID 8.9	M	V	1
27	Protocol configuration options	Protocol configuration options 8.7	O	TLV	3-253

7.19.2 Protocol configuration options

This IE is included in the message when the UE or the network wishes to transmit (protocol) data (e.g. configuration parameters, error codes or messages/events) to the UE.

7.20 WLCP bearer release accept

7.20.1 Message definition

This message is sent by the UE to the TWAG to acknowledge release of a WLCP bearer context associated with the given PDN connection ID. See table 7.20.1.1.

Message type: WLCP BEARER RELEASE ACCEPT

Significance: dual

Direction: UE to TWAG

Table 7.20.1.1: WLCP BEARER RELEASE ACCEPT message content

IEI	Information Element	Type/Reference	Presence	Format	Length
	WLCP bearer release accept message identity	Message type 8.2	M	V	1
	Procedure transaction identity	Procedure transaction identity 8.3	M	V	1
	WLCP bearer identity	WLCP bearer identity 8.15	M	V	1/2
	Spare half octet	Spare half octet 8.18	M	V	1/2
27	Protocol configuration options	Protocol configuration options 8.7	O	TLV	3-253

7.20.2 Protocol configuration options

This IE is included in the message when the UE or the network wishes to transmit (protocol) data (e.g. configuration parameters, error codes or messages/events) to the UE.

7.21 WLCP bearer release reject

7.21.1 Message definition

This message is sent by the UE to the TWAG to reject release of a WLCP bearer for the given PDN connection. See table 7.21.1.1.

Message type: WLCP BEARER RELEASE REJECT

Significance: dual

Direction: UE to TWAG

Table 7.21.1.1: WLCP BEARER RELEASE REJECT message content

IEI	Information Element	Type/Reference	Presence	Format	Length
	WLCP bearer release reject message identity	Message type 8.2	M	V	1
	Procedure transaction identity	Procedure transaction identity 8.3	M	V	1
	WLCP bearer identity	WLCP bearer identity 8.15	M	V	1/2
	Spare half octet	Spare half octet 8.18	M	V	1/2
	Cause	Cause 8.11	M	V	1
27	Protocol configuration options	Protocol configuration options 8.7	O	TLV	3-253

7.21.2 Protocol configuration options

This IE is included in the message when the UE or the network wishes to transmit (protocol) data (e.g. configuration parameters, error codes or messages/events) to the UE.

8 General message format and information elements coding

8.1 General

The least significant bit of a field is represented by the lowest numbered bit of the highest numbered octet of the field. When the field extends over more than one octet, the order of bit values progressively decreases as the octet number increases.

Figure 8.1.1 shows an example of a field where the most significant bit of the field is marked MSB and the least significant bit of the field is marked LSB.

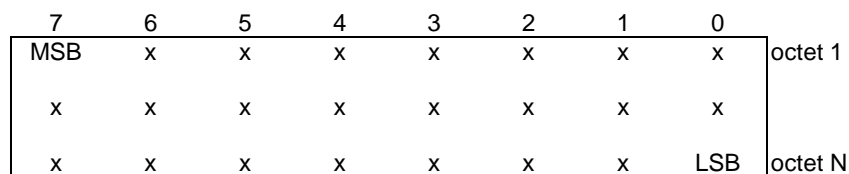

Figure 8.1.1: Example of bit ordering of a field

Within the protocols defined in the present document, the WLCP message consists of the following parts:

- a) Message type;
- b) Procedure transaction identity;
- c) other information elements, as required.

The organization of a message is illustrated in the example shown in figure 8.1.2.

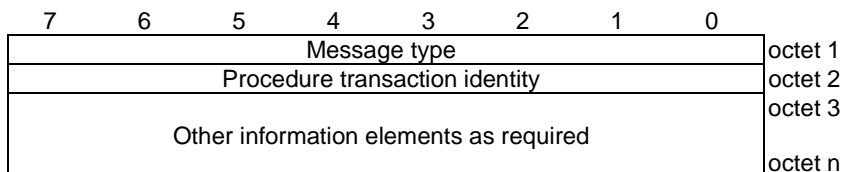

Figure 8.1.2: General message organization example for a WLCP message

Unless specified otherwise in the message descriptions of clause 7, a particular information element shall not be present more than once in a given message.

8.2 Message type

The message type octet is the first octet in a WLCP message. Table 8.2.1 defines the value part of the message type IE used in the WLCP protocol. Bit 6 to 7 are coded as "01" indicating it is a WLCP message.

Table 8.2.1: Message types for WLCP

Bits								
7	6	5	4	3	2	1	0	
1	0	-	-	-	-	-	-	WLCP messages
1	0	0	0	0	0	0	1	PDN connectivity request
1	0	0	0	0	0	1	0	PDN connectivity accept
1	0	0	0	0	0	1	1	PDN connectivity reject
1	0	0	0	0	1	0	0	PDN connectivity complete
1	0	0	0	0	1	0	1	PDN disconnect request
1	0	0	0	0	1	1	0	PDN disconnect accept
1	0	0	0	0	1	1	1	PDN disconnect reject
1	0	0	0	1	0	0	0	PDN modification request
1	0	0	0	1	0	0	1	PDN modification accept
1	0	0	0	1	0	1	0	PDN modification reject
1	0	0	0	1	0	1	1	PDN modification indication
1	0	0	1	0	0	0	1	WLCP bearer setup request
1	0	0	1	0	0	1	0	WLCP bearer setup accept
1	0	0	1	0	0	1	1	WLCP bearer setup reject
1	0	0	1	0	1	0	1	WLCP bearer modify request
1	0	0	1	0	1	1	0	WLCP bearer modify accept
1	0	0	1	0	1	1	1	WLCP bearer modify reject
1	0	0	1	1	0	0	1	WLCP bearer release request
1	0	0	1	1	0	1	0	WLCP bearer release accept
1	0	0	1	1	0	1	1	WLCP bearer release reject
1	0	1	0	1	0	0	0	Status

8.3 Procedure transaction identity

The procedure transaction identity (PTI) octet is the second octet in a WLCP message. The PTI allows distinguishing up to 254 different bi-directional messages flows for a given message type. Such a message flow is called a transaction.

The procedure transaction identity is released when the procedure is completed. Table 8.3.1 defines the value part of the Procedure transaction identity IE used in the WLCP.

Table 8.3.1: Procedure transaction identity

Bits		
7	6	5 4 3 2 1 0
0	0	0 0 0 0 0 0 0 No procedure transaction identity assigned
0	0	0 0 0 0 0 0 1 \
to		} Procedure transaction identity value
1	1	1 1 1 1 1 1 0 /
1	1	1 1 1 1 1 1 1 Reserved

In this version of the protocol the sending entity shall not set the PTI to the value 0. Any entity receiving a request with a PTI set to the value 0 shall consider that as a syntactical error (see subclause 6.5.1).

8.4 Request type

See subclause 10.5.6.17 in 3GPP TS 24.008 [4].

8.5 PDN type

See subclause 9.9.4.10 in 3GPP TS 24.301 [5].

8.6 Access point name

See subclause 10.5.6.1 in 3GPP TS 24.008 [4].

8.7 Protocol configuration options

See subclause 10.5.6.3 in 3GPP TS 24.008 [4].

8.8 PDN address

See subclause 9.9.4.9 in 3GPP TS 24.301 [5].

8.9 PDN connection ID

The purpose of the PDN connection ID is to identify the PDN connection between the UE and the TWAG.

The PDN connection ID information element is coded as shown in figure 8.9.1 and table 8.9.1.

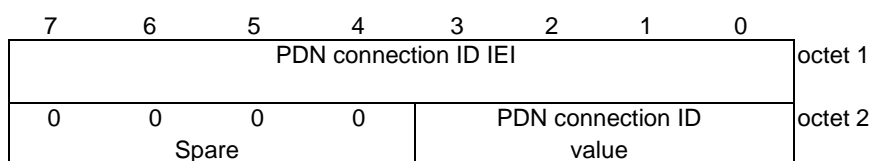

Figure 8.9.1: PDN connection ID information element

Table 8.9.1: PDN connection ID information element

PDN connection ID (bits 1-4)				
3	2	1	0	
0	0	0	0	
to				
0	1	0	0	
Reserved				
0	1	0	1	PDN connection ID value 5
0	1	1	0	PDN connection ID value 6
0	1	1	1	PDN connection ID value 7
1	0	0	0	PDN connection ID value 8
1	0	0	1	PDN connection ID value 9
1	0	1	0	PDN connection ID value 10
1	0	1	1	PDN connection ID value 11
1	1	0	0	PDN connection ID value 12
1	1	0	1	PDN connection ID value 13
1	1	1	0	PDN connection ID value 14
1	1	1	1	PDN connection ID value 15

8.10 User plane connection ID

The purpose of the user plane connection ID is to identify the user plane for

- one PDN connection between the UE and the TWAG when multiple WLCB bearers are not supported; or
- the WLCB bearer of the PDN connection between the UE and TWAG when multiple WLCB bearers are supported.

The user plane connection ID value is the MAC address of the TWAG with a length of 6 octets. The MAC address is defined in subclause 8 of IEEE Std 802 [6].

The user plane connection ID information element is coded as shown in figure 8.10.1.

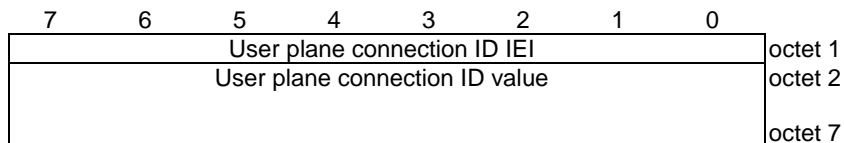

Figure 8.10.1: User plane connection ID information element

8.11 Cause

See subclause 9.9.4.4 in 3GPP TS 24.301 [5].

8.12 GPRS timer 3

See subclause 10.5.7.4a in 3GPP TS 24.008 [4].

8.13 NBIFOM container

See subclause 10.5.6.21 in 3GPP TS 24.008 [4].

8.14 UE N3G capability

The purpose of the UE N3G capability information element is to provide the network with information concerning aspects of the UE capabilities related to trusted non-3GPP access. The contents might affect the manner in which the network handles the operation of the UE.

The UE N3G capability information element is coded as shown in figure 8.14.1 and table 8.14.1.

The UE N3G capability is a type 1 information element.

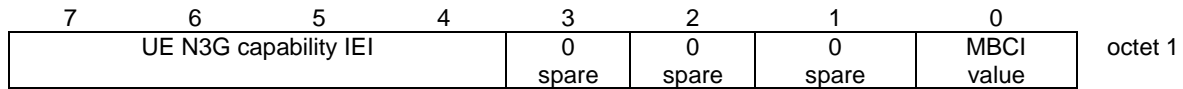

Figure 8.14.1: UE N3G capability information element

Table 8.14.1: UE N3G capability information element

MBCI (Multiple bearer capability indicator)	
0	Multiple WLCP bearers not supported
1	Multiple WLCP bearers supported

8.15 WLCP bearer identity

The purpose of the WLCP bearer identity is to identify the WLCP bearer (default or dedicated) with which one or more packet filters specified in a traffic flow aggregate are associated.

The WLCP bearer identity information element is coded as shown in figure 8.15.1 and table 8.15.1.

The WLCP bearer identity is a type 1 information element.

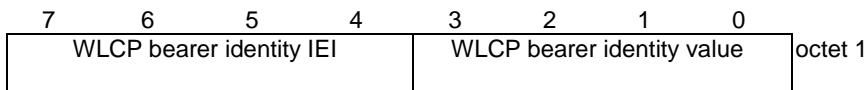

Figure 8.15.1: WLCP bearer identity information element

Table 8.15.1: WLCP bearer identity information element

WLCP bearer identity (bits 0-3)	
0 0 0 0	to Reserved
0 1 0 0	
0 1 0 1	WLCP bearer identity value 5
0 1 1 0	WLCP bearer identity value 6
0 1 1 1	WLCP bearer identity value 7
1 0 0 0	WLCP bearer identity value 8
1 0 0 1	WLCP bearer identity value 9
1 0 1 0	WLCP bearer identity value 10
1 0 1 1	WLCP bearer identity value 11
1 1 0 0	WLCP bearer identity value 12
1 1 0 1	WLCP bearer identity value 13
1 1 1 0	WLCP bearer identity value 14
1 1 1 1	WLCP bearer identity value 15

8.16 EPS quality of service

See subclause 9.9.4.3 in 3GPP TS 24.301 [5].

8.17 Traffic flow template

See subclause 10.5.6.12 in 3GPP TS 24.008 [4].

8.18 Spare half octet

See subclause 9.9.2.9 in 3GPP TS 24.301 [5].

8.19 APN aggregate maximum bit rate

See subclause 9.9.4.2 in 3GPP TS 24.301 [5].

9 List of system parameters

9.1 Timers

Table 9.1.1: WLCP timers – UE side

TIMER	TIMER VALUE	STATE	CAUSE OF START	NORMAL STOP	ON THE 1st, 2nd, 3rd, 4th EXPIRY (NOTE 1)
T3582	8s	PROCEDURE TRANSACTION PENDING	PDN CONNECTIVITY REQUEST sent	PDN CONNECTIVITY ACCEPT received or PDN CONNECTIVITY REJECT received	Retransmission of the same message
T3592	6s	PROCEDURE TRANSACTION PENDING	PDN DISCONNECT REQUEST sent	PDN DISCONNECT ACCEPT received or PDN DISCONNECT REJECT received	Retransmission of the same message
Tw1	NOTE 2	PDN CONNECTIVITY PENDING or SCM_RESPONSE (defined in 3GPP TS 24.302 [3]) reception	PDN CONNECTIVITY REJECT with a timer value for Tw1 received, SCM_RESPONSE (defined in 3GPP TS 24.302 [3]) with a timer value for Tw1 received	PDN DISCONNECT REQUEST with cause #39 "reactivation requested"	None
T3586	8s	PROCEDURE TRANSACTION PENDING	PDN MODIFICATION REQUEST sent	PDN MODIFICATION ACCEPT received or PDN MODIFICATION REJECT received	Retransmission of the same message

NOTE 1: Typically, the procedures are aborted on the fifth expiry of the relevant timer. Exceptions are described in the corresponding procedure description.

NOTE 2: The value of this timer can be provided by the network operator when a request to activate a PDN connection is rejected by the network with a certain cause or when a request to activate a PDN connection in single-connection mode (defined in 3GPP TS 24.302 [3]) is rejected by the network with a certain cause.

Table 9.1.2: WLCP timers – TWAG side

TIMER	TIMER VALUE	STATE	CAUSE OF START	NORMAL STOP	ON THE 1st, 2nd, 3rd, 4th EXPIRY (NOTE 1)
T3585	8s	PDN CONNECTIVITY PENDING PROCEDURE TRANSACTION PENDING	PDN CONNECTIVITY ACCEPT sent	PDN CONNECTIVITY COMPLETE received or PDN CONNECTIVITY REJECT received	Retransmission of the same message
T3595	8s	PDN DISCONNECT PENDING PROCEDURE TRANSACTION PENDING	PDN DISCONNECT REQUEST sent	PDN DISCONNECT ACCEPT received	Retransmission of the same message
T3586	8s	PROCEDURE TRANSACTION PENDING	PDN MODIFICATION REQUEST sent	PDN MODIFICATION ACCEPT received or PDN MODIFICATION REJECT received	Retransmission of the same message
T3587	8s	WLCP BEARER CONTEXT ACTIVE PENDING	WLCP BEARER SETUP REQUEST sent	WLCP BEARER SETUP ACCEPT received or WLCP BEARER SETUP REJECT received	Retransmission of the same message
T3588	8s	WLCP BEARER CONTEXT MODIFY PENDING	WLCP BEARER MODIFY REQUEST sent	WLCP BEARER MODIFY ACCEPT received or WLCP BEARER MODIFY REJECT received	Retransmission of the same message
T3597	8s	WLCP BEARER CONTEXT INACTIVE PENDING	WLCP BEARER RELEASE REQUEST sent	WLCP BEARER RELEASE ACCEPT received or WLCP BEARER RELEASE REJECT received	Retransmission of the same message
NOTE 1: Typically, the procedures are aborted on the fifth expiry of the relevant timer. Exceptions are described in the corresponding procedure description.					

Annex A (informative): Cause values for WLCP protocol

A.1 Causes related to nature of request

For the purposes of the present document, causes related to nature of request defined in subclause Annex B.1 of 3GPP TS 24.301 [5] apply.

A.2 Protocol errors (e.g., unknown message) class

For the purposes of the present document, causes related to nature of request defined in subclause Annex B.2 of 3GPP TS 24.301 [5] apply except the following causes which are redefined for WLCP protocol:

Cause #43 – Invalid WLCP bearer identity

This cause is used by the TWAG or the UE to indicate that the WLCP bearer identity value provided to it is not a valid value for the received message or the PDN connection ID provided in the request is not active.

Annex B (Informative): IANA UDP port registration form

This annex contains information to be provided to IANA for WLCP UDP port registration. The following information are to be used to register WLCP user port number and service name in the "IANA Service Name and Transport Protocol Port Number Registry" and specifically "Service Name and Transport Protocol Port Number Registry".

Resources required	Port number and service name
Transport Protocols	UDP
Service Code	
Service Name	wlcp
Desired Port Number	
Description	<p>Wireless LAN Control plane Protocol (WLCP) is a 3GPP control protocol used by the User Equipment (UE) for access to the Evolved Packet Core via trusted Wireless Local Area Network. It enables the management of the Packet Data Network (PDN) connections between the User Equipment (UE) and the Trusted WLAN Access Gateway (TWAG).</p> <p>Wireless LAN Control plane Protocol (WLCP) uses UDP as a transport protocol.</p>
Reference	3GPP TS 24.244
Defined TXT keys	N/A
If broadcast/multicast is used, how and what for?	Neither broadcast, nor multicast are used.
If UDP is requested, please explain how traffic is limited, and whether the protocol reacts to congestion.	<p>At maximum a few WLCP messages per seconds are expected in communication between a given User Equipment (UE) and a given Trusted WLAN Access Gateway (TWAG).</p> <p>Wireless LAN Control plane Protocol does not support any reaction to congestion.</p>
If UDP is requested, please indicate whether the service is solely for the discovery of hosts supporting this protocol.	Wireless LAN Control plane Protocol is not used solely for discovery of hosts supporting this protocol.
Please explain how your protocol supports versioning.	Wireless LAN Control plane Protocol does not support versioning.
If your request is for more than one transport, please explain in detail how the protocol differs over each transport.	N/A
Please describe how your protocol supports security. Note that presently there is no IETF consensus on when it is appropriate to use a second port for an insecure version of a protocol.	Wireless LAN Control plane Protocol does not support security. It relies on the security mechanisms of the lower layers, including EAP-AKA' authentication and IEEE 802.1x encryption.
Please explain why a unique port assignment is necessary as	An assigned User Port would make network management easier. It is possible that packets containing WLCP messages need to traverse several

<p>opposed to a port in range (49152-65535) or existing port.</p>	<p>firewalls of the network operator during the signalling exchange between the User Equipment (UE) and the Trusted WLAN Access Gateway (TWAG). The firewalls of the network operator are configured to discard packets other than those containing the WLCP messages and other than those authorized by the WLCP messages. If a dynamic ephemeral port is used for WLCP messages, the firewall configuration needs to be updated whenever a new port starts being used for WLCP messages in the Trusted WLAN Access Gateway (TWAG).</p> <p>An assigned User Port would make roaming agreements between network operators easier. If a dynamic port is used, each operator will need to provide the port number used by its TWAG to other operators, then the home operator needs to configure in its AAA sever the list of port numbers (in addition to the IP addresses) of the TWAGs of its roaming partners. If dynamic port is used, the port number can change frequently (while the IP address of the TWAG does not change frequently). Each time the port number changes, the roaming agreement documents needs to be updated. If dynamic port is used, the procedure to update the port numbers on the AAA server can cause a short interruption of the service.</p> <p>As a general principle, 3GPP protocols use assigned User Ports, e.g. GTP-C uses UDP port number 2123, GTP-U uses UDP port number 2152, S1AP uses SCTP port number 36412, X2AP uses SCTP port number 36422. IKEv2 is an example of an IETF protocol between the terminal and a gateway that uses a well-known port number.</p> <p>An assigned UDP port number would simplify the UE implementation. The UDP port number management between the application processor (AP) and the cellular modem would be simplified if the UDP port for WLCP could be set as a well-known port number. Specifically, there would be a need for an additional API between the WLCP client in the AP and the modem to identify the WLCP packets if dynamic ports are used.</p>
<p>Please explain the state of development of your protocol.</p>	<p>Protocol Standard definition. No implementation exists yet.</p>
<p>If SCTP is requested, is there an existing TCP and/or UDP service name or port number assignment? If yes, provide the existing service name and port number.</p>	<p>N/A</p>
<p>What specific SCTP capability is used by the application such that a user who has the choice of both TCP (and/or UDP) and SCTP ports for this application would choose SCTP? See RFC 4960 section 7.1.</p>	<p>N/A</p>
<p>Please provide any other information that would be helpful in understanding how this protocol differs from existing assigned services</p>	<p>This protocol is between the UE (i.e. mobile device) and the Trusted WLAN Gateway. The UDP ports previously assigned to 3GPP were for protocols between network elements.</p>

Annex C (informative): Change history

Change history							
Date	TSG #	TSG Doc.	CR	Rev	Subject/Comment	Old	New
2013-10					Draft skeleton provided		0.0.0
2013-10	CT1#84bis				Includes the following contribution agreed by CT1 at CT1#84bis: C1-134145	0.0.0	0.1.0
2013-11	CT1#85				Includes the following contributions agreed by CT1 at CT#85: C1-134919, C1-134924, C1-135207.	0.1.0	0.2.0
2014-01	CT1#86				Includes the following contributions agreed by CT1 at CT#86: C1-140385, C1-140386, C1-130388, C1-140705.	0.2.0	0.3.0
2014-02	CT-63	CP-140112			Version 1.0.0 created for presentation to plenary for information	0.3.0	1.0.0
2014-04	CT1#86bis				Includes the following contribution agreed by CT1 at CT1#86bis: C1-140813, C1-141260, C1-141262, C1-141265, C1-141266, C1-141267, C1-141309, C1-141580.	1.0.0	1.1.0
2014-05	CT1#87				Includes the following contribution agreed by CT1 at CT1#87: C1-142127, C1-142128, C1-142129, C1-142519.	1.1.0	1.2.0
2014-07	CT1#88				Includes the following contribution agreed by CT1 at CT1#88: C1-142739, C1-143004, C1-143006, C1-143044, C1-143320, C1-143369.	1.2.0	1.3.0
2014-09	CT-65	CP-140631			Version 2.0.0 created for presentation to plenary for approval	1.3.0	2.0.0
2014-09	CT-65	CP-140718			Plenary tdoc revised to include missing cover sheet	1.3.0	2.0.0
2014-09	Post CT-65				Version 12.0.0 created after approval at CT-65	2.0.0	12.0.0
2014-12	CT-66	CP-140840	0001	1	WLCP security	12.0.0	12.1.0
2014-12	CT-66	CP-140840	0003	1	Correct the reference on IPv6 network prefix allocation	12.0.0	12.1.0
2014-12	CT-66	CP-140840	0004		Correct the timer name	12.0.0	12.1.0
2014-12	CT-66	CP-140840	0005		Tx value IE	12.0.0	12.1.0
2014-12	CT-66	CP-140840	0006	2	Update to reference IEEE 802	12.0.0	12.1.0
2014-12	CT-66	CP-140840	0007	1	Procedure transaction identity	12.0.0	12.1.0
2014-12	CT-66	CP-140840	0008	1	Corrections and editorials to WLCP	12.0.0	12.1.0
2015-03	CT-67	CP-150065	0009	1	UDP port number assigned by IANA for WLCP	12.1.0	12.2.0
2015-06	CT-68	CP-150305	0010	1	Timer Tw1	12.2.0	12.3.0
2015-06	CT-68	CP-150305	0011	4	Reference to EAP authentication and authorization procedure	12.2.0	12.3.0
2015-09	CT-69	CP-150522	0015	1	WLCP PDN connectivity modification procedure for P-CSCF restoration	12.3.0	13.0.0
2015-09	CT-69	CP-150519	0016	1	Switch-on and switch-off terms in the context of WLCP for trusted WLAN access to EPC	12.3.0	13.0.0
2015-09	CT-69	CP-150526	0017	1	Routing rule and default access delivery during PDN connectivity establishment procedure	12.3.0	13.0.0
2015-09	CT-69	CP-150526	0018	1	IP flow mobility via WLCP PDN modification procedure	12.3.0	13.0.0
2015-12	CT-70	CP-150701	0019		Cleanup of TWAG-initiated PDN connectivity modification procedure	13.0.0	13.1.0
2015-12	CT-70	CP-150710	0020		Correction of IP address handling during handover to TWAN	13.0.0	13.1.0
2015-12	CT-70	CP-150706	0021		Correction for the UE-initiated PDN connectivity modification procedure	13.0.0	13.1.0
2015-12	CT-70	CP-150696	0022	1	UE backoff Handling for trusted WLAN access to EPC using WLCP	13.0.0	13.1.0
2015-12	CT-70	CP-150706	0024		NBIFOM container correction	13.0.0	13.1.0
2015-12	CT-70	CP-150706	0025	1	Editor's Note on the definition of T3586	13.0.0	13.1.0
2015-12	CT-70	CP-150706	0026		Multiple accesses to a PDN connection not allowed for MCM	13.0.0	13.1.0
2015-12	CT-70	CP-150706	0027		PDN modification message type	13.0.0	13.1.0
2016-03	CT-71	CP-160082	0030	1	Add cause value to WLCP	13.1.0	13.2.0
2016-03	CT-71	CP-160078	0031	1	UE requested PDN connectivity modification procedure	13.1.0	13.2.0
2016-06	CT-72	CP-160325	0033	2	PDN connectivity modification procedure	13.2.0	13.3.0
2016-06	CT-72	CP-160325	0034		Correct the direction of PDN modification accept message	13.2.0	13.3.0
2016-06	CT-72	CP-160325	0035	1	Adding NBIFOM container IE to PDN CONNECTIVITY REJECT message content	13.2.0	13.3.0
2016-06	CT-72	CP-160325	0036	1	Local release of NBIFOM PDN connection for trusted WLAN	13.2.0	13.3.0

Change history							
Date	Meeting	TDoc	CR	Rev	Cat	Subject/Comment	New version
2016-09	CT#73	CP-160507	0032	4	F	non-IP PDN type not applicable in WLCP	13.4.0
2016-12	CT#74	CP-160798	0037	2	B	New emergency PDN connection in TWAN/MCM and handover of emergency PDN connection from 3GPP access to TWAN/MCM	14.0.0
2016-12	CT#74	CP-160798	0039	3	B	Additional PDN connection not allowed via trusted WLAN in MCM when using emergency service	14.0.0
2017-06	CT#76	CP-171092	0040		F	Correction to the NBIFOM container IE	14.1.0
2017-09	CT#77	CP-172123	0041	2	B	Support multiple WLCP bearers	15.0.0
2017-09	CT#77	CP-172123	0044	2	B	WLCP sublayer states for multiple bearer PDN connectivity	15.0.0
2017-09	CT#77	CP-172123	0046	1	B	WLCP bearer setup procedure for QoS differentiation	15.0.0
2017-09	CT#77	CP-172123	0047	1	B	WLCP bearer modification procedure for QoS differentiation	15.0.0
2017-09	CT#77	CP-172123	0048	1	B	WLCP bearer release procedure for QoS differentiation	15.0.0
2017-12	CT#78	CP-173082	0049	2	B	Abnormal case handling for WLCP bearer procedures	15.1.0
2017-12	CT#78	CP-173082	0051		B	TFT checking and error handling in WLCP bearer setup and modify procedures	15.1.0
2017-12	CT#78	CP-173082	0052	4	B	QoS differentiation for WLCP default bearer	15.1.0
2017-12	CT#78	CP-173082	0053	1	B	User plane identity per WLCP bearer	15.1.0
2017-12	CT#78	CP-173082	0054		B	Correction on EPS quality of service IE name	15.1.0
2017-12	CT#78	CP-173082	0055		F	WLCP bearer message name correction	15.1.0
2018-03	CT#79	CP-180091	0050	4	B	WLCP sublayer states and transition for WLCP bearers	15.2.0
2018-03	CT#79	CP-180088	0056		F	Correction on coding of PDN connection ID Information Element	15.2.0
2020-07	SA-88e	-	-	-	-	Update to Rel-16 version (MCC)	16.0.0
2022-03	CT-95e	CP-220224	0057	-	F	IEIs assignment for Bearer level QoS IE and APN-AMBR IE	16.1.0
2022-04	-	-	-	-	-	Update to Rel-17 version (MCC)	17.0.0

History

Document history		
V17.0.0	April 2022	Publication