

ETSI TS 124 333 V14.1.0 (2018-04)



**Universal Mobile Telecommunications System (UMTS);
LTE;
Proximity-services (ProSe) Management Objects (MO)
(3GPP TS 24.333 version 14.1.0 Release 14)**



Reference

RTS/TSGC-0124333ve10

Keywords

LTE,UMTS

ETSI

650 Route des Lucioles
F-06921 Sophia Antipolis Cedex - FRANCE

Tel.: +33 4 92 94 42 00 Fax: +33 4 93 65 47 16

Siret N° 348 623 562 00017 - NAF 742 C
Association à but non lucratif enregistrée à la
Sous-Préfecture de Grasse (06) N° 7803/88

Important notice

The present document can be downloaded from:

<http://www.etsi.org/standards-search>

The present document may be made available in electronic versions and/or in print. The content of any electronic and/or print versions of the present document shall not be modified without the prior written authorization of ETSI. In case of any existing or perceived difference in contents between such versions and/or in print, the only prevailing document is the print of the Portable Document Format (PDF) version kept on a specific network drive within ETSI Secretariat.

Users of the present document should be aware that the document may be subject to revision or change of status.

Information on the current status of this and other ETSI documents is available at

<https://portal.etsi.org/TB/ETSIDeliverableStatus.aspx>

If you find errors in the present document, please send your comment to one of the following services:

<https://portal.etsi.org/People/CommiteeSupportStaff.aspx>

Copyright Notification

No part may be reproduced or utilized in any form or by any means, electronic or mechanical, including photocopying and microfilm except as authorized by written permission of ETSI.

The content of the PDF version shall not be modified without the written authorization of ETSI.

The copyright and the foregoing restriction extend to reproduction in all media.

© ETSI 2018.

All rights reserved.

DECT™, **PLUGTESTS™**, **UMTS™** and the ETSI logo are trademarks of ETSI registered for the benefit of its Members.

3GPP™ and **LTE™** are trademarks of ETSI registered for the benefit of its Members and of the 3GPP Organizational Partners.

oneM2M logo is protected for the benefit of its Members.

GSM® and the GSM logo are trademarks registered and owned by the GSM Association.

Intellectual Property Rights

Essential patents

IPRs essential or potentially essential to normative deliverables may have been declared to ETSI. The information pertaining to these essential IPRs, if any, is publicly available for **ETSI members and non-members**, and can be found in ETSI SR 000 314: "*Intellectual Property Rights (IPRs); Essential, or potentially Essential, IPRs notified to ETSI in respect of ETSI standards*", which is available from the ETSI Secretariat. Latest updates are available on the ETSI Web server (<https://ipr.etsi.org/>).

Pursuant to the ETSI IPR Policy, no investigation, including IPR searches, has been carried out by ETSI. No guarantee can be given as to the existence of other IPRs not referenced in ETSI SR 000 314 (or the updates on the ETSI Web server) which are, or may be, or may become, essential to the present document.

Trademarks

The present document may include trademarks and/or tradenames which are asserted and/or registered by their owners. ETSI claims no ownership of these except for any which are indicated as being the property of ETSI, and conveys no right to use or reproduce any trademark and/or tradename. Mention of those trademarks in the present document does not constitute an endorsement by ETSI of products, services or organizations associated with those trademarks.

Foreword

This Technical Specification (TS) has been produced by ETSI 3rd Generation Partnership Project (3GPP).

The present document may refer to technical specifications or reports using their 3GPP identities, UMTS identities or GSM identities. These should be interpreted as being references to the corresponding ETSI deliverables.

The cross reference between GSM, UMTS, 3GPP and ETSI identities can be found under <http://webapp.etsi.org/key/queryform.asp>.

Modal verbs terminology

In the present document "**shall**", "**shall not**", "**should**", "**should not**", "**may**", "**need not**", "**will**", "**will not**", "**can**" and "**cannot**" are to be interpreted as described in clause 3.2 of the [ETSI Drafting Rules](#) (Verbal forms for the expression of provisions).

"**must**" and "**must not**" are **NOT** allowed in ETSI deliverables except when used in direct citation.

Contents

Intellectual Property Rights	2
Foreword.....	2
Modal verbs terminology.....	2
Foreword.....	8
1 Scope	9
2 References	9
3 Definitions, symbols and abbreviations	9
3.1 Definitions	9
3.2 Abbreviations	10
4 ProSe Direct Services Provisioning MO	10
4.1 Overview	10
4.2 ProSe Direct Services Provisioning MO parameters	11
4.2.1 General.....	11
4.2.2 Node: <X>.....	11
4.2.3 <X>/MonitoringPolicy	12
4.2.4 <X>/MonitoringPolicy/<X>	12
4.2.5 <X>/MonitoringPolicy/<X>/PLMN	12
4.2.6 <X>/MonitoringPolicy/<X>/ValidityTimerT4005	12
4.2.7 <X>/AnnouncingPolicy	12
4.2.8 <X>/AnnouncingPolicy/<X>.....	13
4.2.9 <X>/AnnouncingPolicy/<X>/PLMN	13
4.2.10 <X>/AnnouncingPolicy/<X>/ValidityTimerT4005	13
4.2.11 <X>/AnnouncingPolicy/<X>/Range	13
4.2.12 <X>/ToConRef.....	14
4.2.13 <X>/ToConRef/<X>	14
4.2.14 <X>/ToConRef/<X>/ConRef.....	14
4.2.15 <X>/RestrictedModelAMonitoringPolicy.....	14
4.2.16 <X>/RestrictedModelAMonitoringPolicy/<X>	15
4.2.17 <X>/RestrictedModelAMonitoringPolicy/<X>/PLMN.....	15
4.2.18 <X>/RestrictedModelAMonitoringPolicy/<X>/ValidityTimerT4005.....	15
4.2.19 <X>/RestrictedModelAAnnouncingPolicy	15
4.2.20 <X>/RestrictedModelAAnnouncingPolicy/<X>	15
4.2.21 <X>/RestrictedModelAAnnouncingPolicy/<X>/PLMN	16
4.2.22 <X>/RestrictedModelAAnnouncingPolicy/<X>/ValidityTimerT4005	16
4.2.23 <X>/RestrictedModelAAnnouncingPolicy/<X>/Range	16
4.2.24 <X>/RestrictedModelBDiscovererPolicy.....	17
4.2.25 <X>/RestrictedModelBDiscovererPolicy/<X>.....	17
4.2.26 <X>/RestrictedModelBDiscovererPolicy/<X>/PLMN.....	17
4.2.27 <X>/RestrictedModelBDiscovererPolicy/<X>/ValidityTimerT4005.....	17
4.2.28 <X>/RestrictedModelBDiscovererPolicy/<X>/Range	17
4.2.29 <X>/RestrictedModelBDiscovererPolicy	18
4.2.30 <X>/RestrictedModelBDiscovererPolicy/<X>	18
4.2.31 <X>/RestrictedModelBDiscovererPolicy/<X>/PLMN	18
4.2.32 <X>/RestrictedModelBDiscovererPolicy/<X>/ValidityTimerT4005	19
4.2.33 <X>/RestrictedModelBDiscovererPolicy/<X>/Range	19
4.2.34 <X>/ProSeDiscoveryUEIDInfo	19
4.2.35 <X>/ProSeDiscoveryUEIDInfo/ProSeDiscoveryUEID	19
4.2.36 <X>/ ProSeDiscoveryUEIDInfo/ValidityTimerT4015	20
4.2.37 <X>/Ext.....	20
5 ProSe Public Safety Direct Services Provisioning MO.....	20
5.1 Overview	20
5.2 ProSe Public Safety Direct Services Provisioning MO parameters.....	25
5.2.1 General.....	25

5.2.2	Node: <X>.....	25
5.2.3	<X>/MonitoringPolicy	25
5.2.4	<X>/MonitoringPolicy/<X>	25
5.2.5	<X>/MonitoringPolicy/<X>/PLMN	25
5.2.6	<X>/MonitoringPolicy/<X>/ValidityTimerT4005	26
5.2.7	<X>/AnnouncingPolicy	26
5.2.8	<X>/AnnouncingPolicy/<X>	26
5.2.9	<X>/AnnouncingPolicy/<X>/PLMN	26
5.2.10	<X>/AnnouncingPolicy/<X>/ValidityTimerT4005	26
5.2.11	<X>/AnnouncingPolicy/<X>/Range	27
5.2.12	Void	28
5.2.13	Void	28
5.2.14	Void	28
5.2.15	Void	28
5.2.16	Void	28
5.2.17	Void	28
5.2.18	Void	28
5.2.19	Void	28
5.2.20	Void	28
5.2.21	Void	28
5.2.22	Void	28
5.2.23	Void	28
5.2.24	Void	28
5.2.25	Void	28
5.2.26	Void	28
5.2.27	Void	28
5.2.28	Void	28
5.2.29	Void	28
5.2.30	Void	28
5.2.31	Void	28
5.2.32	Void	28
5.2.33	Void	28
5.2.34	Void	28
5.2.35	<X>/DirectCommunicationPolicy.....	29
5.2.36	<X>/DirectCommunicationPolicy/<X>.....	29
5.2.37	<X>/DirectCommunicationPolicy/<X>/PLMN.....	29
5.2.38	<X>/DirectCommunicationPolicy/<X>/ValidityTimerT4005.....	29
5.2.39	<X>/DirectCommunicationPolicyNotInEUTRAN	29
5.2.40	<X>/DirectCommunicationPolicyNotInEUTRAN/ DirectCommunicationAuthorisationNotInEUTRAN	30
5.2.40A	<X>/DirectCommunicationPolicyNotInEUTRAN/ OneToOneDirectCommunicationAuthorisationNotInEUTRAN.....	30
5.2.41	<X>/DirectCommunicationPolicyNotInEUTRAN/ DirectCommunicationRadioParameters.....	30
5.2.42	<X>/DirectCommunicationPolicyNotInEUTRAN/ DirectCommunicationRadioParameters/<X>	31
5.2.43	<X>/DirectCommunicationPolicyNotInEUTRAN/ DirectCommunicationRadioParameters/<X>/ RadioParametersContents	31
5.2.44	<X>/DirectCommunicationPolicyNotInEUTRAN/ DirectCommunicationRadioParameters/<X>/ GeographicalArea	31
5.2.45	<X>/DirectCommunicationPolicyNotInEUTRAN/ DirectCommunicationRadioParameters/<X>/ GeographicalArea/Polygon.....	31
5.2.46	<X>/DirectCommunicationPolicyNotInEUTRAN/ DirectCommunicationRadioParameters/<X>/ GeographicalArea/Polygon/<X>	32
5.2.47	<X>/DirectCommunicationPolicyNotInEUTRAN/ DirectCommunicationRadioParameters/<X>/ GeographicalArea/Polygon/<X>/Coordinates.....	32
5.2.48	<X>/DirectCommunicationPolicyNotInEUTRAN/ DirectCommunicationRadioParameters/<X>/ GeographicalArea/Polygon/<X>/Coordinates/<X>	32
5.2.49	<X>/DirectCommunicationPolicyNotInEUTRAN/ DirectCommunicationRadioParameters/<X>/ GeographicalArea/Polygon/<X>/Coordinates/<X>/Latitude	32
5.2.50	<X>/DirectCommunicationPolicyNotInEUTRAN/ DirectCommunicationRadioParameters/<X>/ GeographicalArea/Polygon/<X>/Coordinates/<X>/Longitude	33
5.2.51	<X>/GroupParameters	33
5.2.52	<X>/GroupParameters/<X>	33

5.2.53	<X>/GroupParameters/<X>/	AddressType	33
5.2.54	<X>/GroupParameters/<X>/ IPMulticastAddress		34
5.2.55	<X>/GroupParameters/<X>/PKMFAddress		34
5.2.56	<X>/GroupParameters/<X>/SourceIPv4address		34
5.2.57	<X>/GroupParameters/<X>/Layer2GroupID		34
5.2.57A	<X>/GroupParameters/<X>/ApplicationLayerGroupID		35
5.2.58	<X>/UsageInformationReportingConfiguration		35
5.2.59	<X>/UsageInformationReportingConfiguration/ServerAddress		35
5.2.60	<X>/UsageInformationReportingConfiguration/CollectionPeriod		35
5.2.61	<X>/UsageInformationReportingConfiguration/ReportingWindow		35
5.2.62	<X>/UsageInformationReportingConfiguration/ ReportGroupParameters.....		36
5.2.63	<X>/UsageInformationReportingConfiguration/ ReportTimeStampsFirstTransmissionAndReception.....		36
5.2.64	<X>/UsageInformationReportingConfiguration/ ReportDataTransmitted.....		36
5.2.65	<X>/UsageInformationReportingConfiguration/ReportDataReceived		37
5.2.66	<X>/UsageInformationReportingConfiguration/ ReportTimeStampsOutOfCoverage		37
5.2.66A	<X>/UsageInformationReportingConfiguration/ ReportLocationInCoverage.....		38
5.2.66B	<X>/UsageInformationReportingConfiguration/ ReportRadioParameters		38
5.2.67	<X>/ToConRef.....		38
5.2.68	<X>/ToConRef/<X>		39
5.2.69	<X>/ToConRef/<X>/ConRef.....		39
5.2.70	<X>/RestrictedDiscoveryPolicyForNonPS		39
5.2.71	<X>/RestrictedDiscoveryPolicyForNonPS /RestrictedModelAMonitoringPolicy		39
5.2.72	<X>/RestrictedDiscoveryPolicyForNonPS /RestrictedModelAMonitoringPolicy/<X>		39
5.2.73	<X>/RestrictedDiscoveryPolicyForNonPS /RestrictedModelAMonitoringPolicy/<X>/PLMN		40
5.2.74	<X>/RestrictedDiscoveryPolicyForNonPS /RestrictedModelAMonitoringPolicy/<X> /ValidityTimerT4005		40
5.2.75	<X>/RestrictedDiscoveryPolicyForNonPS /RestrictedModelAAnnouncingPolicy		40
5.2.76	<X>/RestrictedDiscoveryPolicyForNonPS /RestrictedModelAAnnouncingPolicy/<X>		40
5.2.77	<X>/RestrictedDiscoveryPolicyForNonPS /RestrictedModelAAnnouncingPolicy/<X>/PLMN.....		41
5.2.78	<X>/RestrictedDiscoveryPolicyForNonPS /RestrictedModelAAnnouncingPolicy/<X> /ValidityTimerT4005		41
5.2.79	<X>/RestrictedDiscoveryPolicyForNonPS /RestrictedModelAAnnouncingPolicy/<X>/Range.....		41
5.2.80	<X>/RestrictedDiscoveryPolicyForNonPS /RestrictedModelBDiscovererPolicy		42
5.2.81	<X>/RestrictedDiscoveryPolicyForNonPS /RestrictedModelBDiscovererPolicy/<X>		42
5.2.82	<X>/RestrictedDiscoveryPolicyForNonPS /RestrictedModelBDiscovererPolicy/<X>/PLMN		42
5.2.83	<X>/RestrictedDiscoveryPolicyForNonPS /RestrictedModelBDiscovererPolicy/<X> /ValidityTimerT4005		42
5.2.84	<X>/RestrictedDiscoveryPolicyForNonPS /RestrictedModelBDiscovererPolicy/<X>/Range		43
5.2.85	<X>/RestrictedDiscoveryPolicyForNonPS /RestrictedModelBDiscovererPolicy.....		43
5.2.86	<X>/RestrictedDiscoveryPolicyForNonPS /RestrictedModelBDiscovererPolicy/<X>		43
5.2.87	<X>/RestrictedDiscoveryPolicyForNonPS /RestrictedModelBDiscovererPolicy/<X>/PLMN.....		43
5.2.88	<X>/RestrictedDiscoveryPolicyForNonPS /RestrictedModelBDiscovererPolicy/<X> /ValidityTimerT4005		44
5.2.89	<X>/RestrictedDiscoveryPolicyForNonPS /RestrictedModelBDiscovererPolicy/<X>/Range.....		44
5.2.90	<X>/RestrictedDiscoveryPolicyForNonPS /ProSeDiscoveryUEIDInfo		44
5.2.91	<X>/RestrictedDiscoveryPolicyForNonPS /ProSeDiscoveryUEIDInfo/ProSeDiscoveryUEID.....		45
5.2.92	<X>/RestrictedDiscoveryPolicyForNonPS /ProSeDiscoveryUEIDInfo/ValidityTimerT4015		45
5.2.93	<X>/PublicSafetyDiscoveryPolicyNotInEUTRAN		45
5.2.94	<X>/PublicSafetyDiscoveryPolicyNotInEUTRAN/ MonitoringAuthorisationNotInEUTRAN.....		45
5.2.95	<X>/PublicSafetyDiscoveryPolicyNotInEUTRAN/ AnnouncingAuthorisationNotInEUTRAN		46
5.2.96	<X>/PublicSafetyDiscoveryPolicyNotInEUTRAN/ DiscovererAuthorisationNotInEUTRAN		46
5.2.97	<X>/PublicSafetyDiscoveryPolicyNotInEUTRAN/ DiscovererAuthorisationNotInEUTRAN.....		46
5.2.98 <X>/PublicSafetyDiscoveryPolicyNotInEUTRAN/ DiscoveryRadioParameters.....		47
5.2.99	<X>/PublicSafetyDiscoveryPolicyNotInEUTRAN/ DiscoveryRadioParameters/<X>		47
5.2.100	<X>/PublicSafetyDiscoveryPolicyNotInEUTRAN/ DiscoveryRadioParameters/<X>/RadioParametersContents.....		47
5.2.101	<X>/PublicSafetyDiscoveryPolicyNotInEUTRAN/ DiscoveryRadioParameters/<X>/GeographicalArea.....		47

5.2.102	<X>/PublicSafetyDiscoveryPolicyNotInEUTRAN/ DiscoveryRadioParameters/<X>/GeographicalArea/Polygon	48
5.2.103	<X>/PublicSafetyDiscoveryPolicyNotInEUTRAN/ DiscoveryRadioParameters/<X>/GeographicalArea/Polygon/<X>	48
5.2.104	<X>/PublicSafetyDiscoveryPolicyNotInEUTRAN/ DiscoveryRadioParameters /<X>/GeographicalArea/Polygon/<X>/Coordinates	48
5.2.105	<X>/PublicSafetyDiscoveryPolicyNotInEUTRAN/ DiscoveryRadioParameters/<X>/GeographicalArea/Polygon/<X>/Coordinates/<X>	48
5.2.106	<X>/PublicSafetyDiscoveryPolicyNotInEUTRAN/ DiscoveryRadioParameters/<X>/GeographicalArea/Polygon/<X>/ Coordinates/<X>/Latitude	49
5.2.107	<X>/PublicSafetyDiscoveryPolicyNotInEUTRAN/ DiscoveryRadioParameters/<X>/GeographicalArea/Polygon/<X>/Coordinates/<X>/Longitude	49
5.2.108	<X>/UEToNetworkRelayPolicy	49
5.2.109	<X>/UEToNetworkRelayPolicy/AuthorisationForRemoteUE	49
5.2.110	Void	50
5.2.111	Void	50
5.2.112	Void	50
5.2.113	<X>/UEToNetworkRelayPolicy/AuthorisationForRelay	50
5.2.113A	<X>/UEToNetworkRelayPolicy/AuthorisationForRelay/ AuthorisedPLMNs	50
5.2.114	<X>/UEToNetworkRelayPolicy/AuthorisationForRelay/ AuthorisedPLMNs/<X>	50
5.2.115	<X>/UEToNetworkRelayPolicy/AuthorisationForRelay/ AuthorisedPLMNs/<X>/PLMN	50
5.2.115A	<X>/UEToNetworkRelayPolicy/AuthorisationForRelay/ AuthorisedPLMNs/<X>/RemoteUEIMEIReport	51
5.2.116	<X>/UEToNetworkRelayPolicy/AuthorisationForRelay/ AuthorisedPLMNs/<X>/ValidityTimerT4005	51
5.2.116A	<X>/UEToNetworkRelayPolicy/AuthorisationForRelay/ DLUnicastTrafficMappingRule	51
5.2.116B	<X>/UEToNetworkRelayPolicy/AuthorisationForRelay/ DLUnicastTrafficMappingRule/<X>	51
5.2.116C	<X>/UEToNetworkRelayPolicy/AuthorisationForRelay/ DLUnicastTrafficMappingRule/<X>/QCI	52
5.2.116D	<X>/UEToNetworkRelayPolicy/AuthorisationForRelay/ DLUnicastTrafficMappingRule/<X>/ProSePerPacketPriority	52
5.2.117	<X>/PublicSafetyDiscoveryParameters	52
5.2.118	<X>/PublicSafetyDiscoveryParameters /GroupMemberDiscoveryParameters	52
5.2.119 <X>/PublicSafetyDiscoveryParameters /GroupMemberDiscoveryParameters/UserInfoID	53
5.2.120 <X>/PublicSafetyDiscoveryParameters /GroupMemberDiscoveryParameters/<X>	53
5.2.121 <X>/PublicSafetyDiscoveryParameters /GroupMemberDiscoveryParameters/<X>/DiscoveryGroupID	53
5.2.121A	<X>/PublicSafetyDiscoveryParameters /GroupMemberDiscoveryParameters/<X>/ApplicationLayerGroupID	53
5.2.121B	<X>/PublicSafetyDiscoveryParameters /GroupMemberDiscoveryParameters/<X>/PKMFAddress	53
5.2.122	<X>/PublicSafetyDiscoveryParameters/RelayDiscoveryParameters	54
5.2.123 <X>/PublicSafetyDiscoveryParameters/RelayDiscoveryParameters /UserInfoID	54
5.2.124	<X>/PublicSafetyDiscoveryParameters/RelayDiscoveryParameters /RemoteUEParameters	54
5.2.125 <X>/PublicSafetyDiscoveryParameters/RelayDiscoveryParameters /RemoteUEParameters/<X>	54
5.2.126 <X>/PublicSafetyDiscoveryParameters/RelayDiscoveryParameters /RemoteUEParameters/<X>/RelayServiceCode	55
5.2.127 <X>/PublicSafetyDiscoveryParameters/RelayDiscoveryParameters /RemoteUEParameters/<X>/UserInfoIDOfRelay	55
5.2.128 <X>/PublicSafetyDiscoveryParameters/RelayDiscoveryParameters /RemoteUEParameters/<X>/IPVersions	55
5.2.129	<X>/PublicSafetyDiscoveryParameters/RelayDiscoveryParameters /RemoteUEParameters/<X>/PKMFAddress	55
5.2.130	<X>/PublicSafetyDiscoveryParameters/RelayDiscoveryParameters /RelayParameters	56
5.2.131 <X>/PublicSafetyDiscoveryParameters/RelayDiscoveryParameters /RelayParameters/<X>	56
5.2.132 <X>/PublicSafetyDiscoveryParameters/RelayDiscoveryParameters /RelayParameters/<X>/RelayServiceCode	56
5.2.133 <X>/PublicSafetyDiscoveryParameters/RelayDiscoveryParameters /RelayParameters/<X>/PDNType	56

5.2.134 <X>/PublicSafetyDiscoveryParameters/RelayDiscoveryParameters /RelayParameters/<X>/APN.....	56
5.2.135 <X>/PublicSafetyDiscoveryParameters/RelayDiscoveryParameters /RelayParameters/<X>/ProSeRelayUEID	57
5.2.136	<X>/PublicSafetyDiscoveryParameters/RelayDiscoveryParameters /RelayParameters/<X>/PKMFAddress	57
5.2.137	<X>/OneToOneDirectCommunicationPolicy	57
5.2.138	<X>/OneToOneDirectCommunicationPolicy /<X>	57
5.2.139	<X>/OneToOneDirectCommunicationPolicy /<X>/PLMN	58
5.2.140	<X>/OneToOneDirectCommunicationPolicy /<X>/ValidityTimerT4005	58
5.2.141	<X>/OneToOneDirectCommunicationParameters.....	58
5.2.142	<X>/OneToOneDirectCommunicationParameters /ApplicationLayerGroup/<X>/Layer2IDForUnicastCommunication.....	58
5.2.142A	<X>/OneToOneDirectCommunicationParameters /PC5SignallingPriority	59
5.2.143	<X>/OneToOneDirectCommunicationParameters /ApplicationLayerGroup/<X>/KMSAddress	59
5.2.143A	<X>/OneToOneDirectCommunicationParameters /ApplicationLayerGroup/<X>/ApplicationLayerGroupID	59
5.2.144	<X>/DiscoveryPolicyForPS	59
5.2.145	<X>/DiscoveryPolicyForPS /ModelAMonitoringPolicy	59
5.2.146	<X>/DiscoveryPolicyForPS /ModelAMonitoringPolicy/<X>	60
5.2.147	<X>/DiscoveryPolicyForPS /ModelAMonitoringPolicy/<X>/PLMN	60
5.2.148	<X>/DiscoveryPolicyForPS /ModelAMonitoringPolicy/<X>/ValidityTimerT4005	60
5.2.149	<X>/DiscoveryPolicyForPS /ModelAAnnouncingPolicy	60
5.2.150	<X>/DiscoveryPolicyForPS /ModelAAnnouncingPolicy/<X>	61
5.2.151	<X>/DiscoveryPolicyForPS /ModelAAnnouncingPolicy/<X>/PLMN	61
5.2.152	<X>/DiscoveryPolicyForPS /ModelAAnnouncingPolicy/<X>/ValidityTimerT4005.....	61
5.2.152A	<X>/DiscoveryPolicyForPS /ModelAAnnouncingPolicy/<X>/Range.....	61
5.2.153	<X>/DiscoveryPolicyForPS /ModelBDiscovererPolicy	62
5.2.154	<X>/DiscoveryPolicyForPS /ModelBDiscovererPolicy/<X>	62
5.2.155	<X>/DiscoveryPolicyForPS /ModelBDiscovererPolicy/<X>/PLMN	62
5.2.156	<X>/DiscoveryPolicyForPS /ModelBDiscovererPolicy/<X>/ValidityTimerT4005	63
5.2.156A	<X>/DiscoveryPolicyForPS /ModelBDiscovererPolicy/<X>/Range	63
5.2.157	<X>/DiscoveryPolicyForPS /ModelBDiscovereePolicy.....	63
5.2.158	<X>/DiscoveryPolicyForPS /ModelBDiscovereePolicy/<X>	63
5.2.159	<X>/DiscoveryPolicyForPS /ModelBDiscovereePolicy/<X>/PLMN	64
5.2.160A	<X>/DiscoveryPolicyForPS /ModelBDiscovereePolicy/<X>/Range.....	64
5.2.160	<X>/RestrictedDiscoveryPolicyForPS /RestrictedModelBDiscovereePolicy/<X>/ValidityTimerT4005	64
5.2.161	<X>/Ext.....	65
6	EPC-level ProSe discovery Provisioning MO.....	65
6.1	Overview	65
6.2	EPC-level ProSe discovery Provisioning MO parameters	65
6.2.1	General.....	65
6.2.2	<X>/ToConRef.....	66
6.2.3	<X>/ToConRef/<X>	66
6.2.4	<X>/ToConRef/<X>/ConRef.....	66
6.2.5	<X>/Ext.....	66
Annex A (informative):	ProSe Direct Services Provisioning MO DDF	67
Annex B (informative):	ProSe Public Safety Direct Services Provisioning MO DDF.....	77
Annex C (informative):	EPC-level ProSe discovery Provisioning MO DDF	118
Annex D (informative):	Change history	120
History		122

Foreword

This Technical Specification has been produced by the 3rd Generation Partnership Project (3GPP).

The contents of the present document are subject to continuing work within the TSG and may change following formal TSG approval. Should the TSG modify the contents of the present document, it will be re-released by the TSG with an identifying change of release date and an increase in version number as follows:

Version x.y.z

where:

- x the first digit:
 - 1 presented to TSG for information;
 - 2 presented to TSG for approval;
 - 3 or greater indicates TSG approved document under change control.
- y the second digit is incremented for all changes of substance, i.e. technical enhancements, corrections, updates, etc.
- z the third digit is incremented when editorial only changes have been incorporated in the document.

1 Scope

The present document defines Management Objects (MO) that are used to configure the ProSe-enabled UE.

The MOs are compatible with the OMA Device Management (DM) protocol specifications, version 1.2 and upwards, and are defined using the OMA DM Device Description Framework (DDF) as described in the Enabler Release Definition OMA-ERELED-DM-V1_2 [3].

The MOs consist of relevant parameters for provisioning and authorisation of ProSe at the ProSe-enabled UE.

The protocol aspects for ProSe are described in 3GPP TS 24.334 [4].

2 References

The following documents contain provisions which, through reference in this text, constitute provisions of the present document.

- References are either specific (identified by date of publication, edition number, version number, etc.) or non-specific.
- For a specific reference, subsequent revisions do not apply.
- For a non-specific reference, the latest version applies. In the case of a reference to a 3GPP document (including a GSM document), a non-specific reference implicitly refers to the latest version of that document *in the same Release as the present document*.

- [1] 3GPP TR 21.905: "Vocabulary for 3GPP Specifications".
- [2] 3GPP TS 23.303: "Proximity-based Services (ProSe); Stage 2".
- [3] OMA-ERELED-DM-V1_2: "Enabler Release Definition for OMA Device Management".
- [4] 3GPP TS 24.334: "Proximity-services (ProSe) User Equipment (UE) to Proximity-services (ProSe) Function Protocol aspects; Stage 3".
- [5] OMA-TS-DM_Protocol-V1_2: "OMA Device Management Protocol".
- [6] 3GPP TS 23.003: "Numbering, addressing and identification".
- [7] 3GPP TS 33.303: "Proximity-based Services (ProSe); Security aspects".
- [8] IETF RFC 3927: "Dynamic Configuration of IPv4 Link-Local Addresses".
- [9] 3GPP TS 23.032: "Universal Geographical Area Description (GAD)".
- [10] 3GPP TS 36.331: "Evolved Universal Terrestrial Radio Access (E-UTRA); Radio Resource Control (RRC) protocol specification".
- [11] OMA-DDS-DM_ConnMO-V1_0-20081107-A: "Standardized Connectivity Management Objects".

3 Definitions, symbols and abbreviations

3.1 Definitions

For the purposes of the present document, the terms and definitions given in 3GPP TR 21.905 [1] and the following apply. A term defined in the present document takes precedence over the definition of the same term, if any, in 3GPP TR 21.905 [1].

For the purposes of the present document, the following terms and definitions given in 3GPP TS 23.303 [2] apply:

ProSe Direct Discovery
ProSe Discovery UE ID
ProSe-enabled UE

For the purposes of the present document, the following terms and definitions given in 3GPP TS 24.334 [4] apply:

Not served by E-UTRAN

3.2 Abbreviations

For the purposes of the present document, the abbreviations given in 3GPP TR 21.905 [1] and the following apply. An abbreviation defined in the present document takes precedence over the definition of the same abbreviation, if any, in 3GPP TR 21.905 [1].

DDF	Device Description Framework
DPF	Direct Services Provisioning Function
FQDN	Fully Qualified Domain Name
MO	Management Object
MSISDN	MS International PSTN/ISDN Number
NAP	Network Access Point
ProSe	Proximity-based Services

4 ProSe Direct Services Provisioning MO

4.1 Overview

The ProSe Direct Services Provisioning MO is used to manage ProSe direct discovery authorisation and provisioning information for a ProSe-enabled non-public safety UE.

The MO identifier is: urn:oma:mo:ext-3gpp-prose-direct-provisioning:1.0.

The UE may initiate the provision of all available information from the DPF, using a client-initiated session Alert message of code "Generic Alert" (see OMA-TS-DM_Protocol-V1_2 [5]). When requesting all available information from the DPF, the "Type" element of the OMA DM generic alert message shall be set to "urn:oma:mo:ext-3gpp-prose-direct-provisioning:1.0:provision", the "LocURI" element (inside the "Source" element) shall be set to the address of the ProSe Direct Services Provisioning MO as specified by OMA-TS-DM_Protocol-V1_2 [5] and the "Data" element is not included.

The OMA DM Access Control List (ACL) property mechanism (see OMA-ERELED-DM-V1_2 [3]) may be used to grant or deny access rights to OMA DM servers in order to modify nodes and leaf objects of the ProSe Direct Services Provisioning MO.

The following nodes and leaf objects are possible in the ProSe Direct Services Provisioning MO as described in figure 4.1.1:

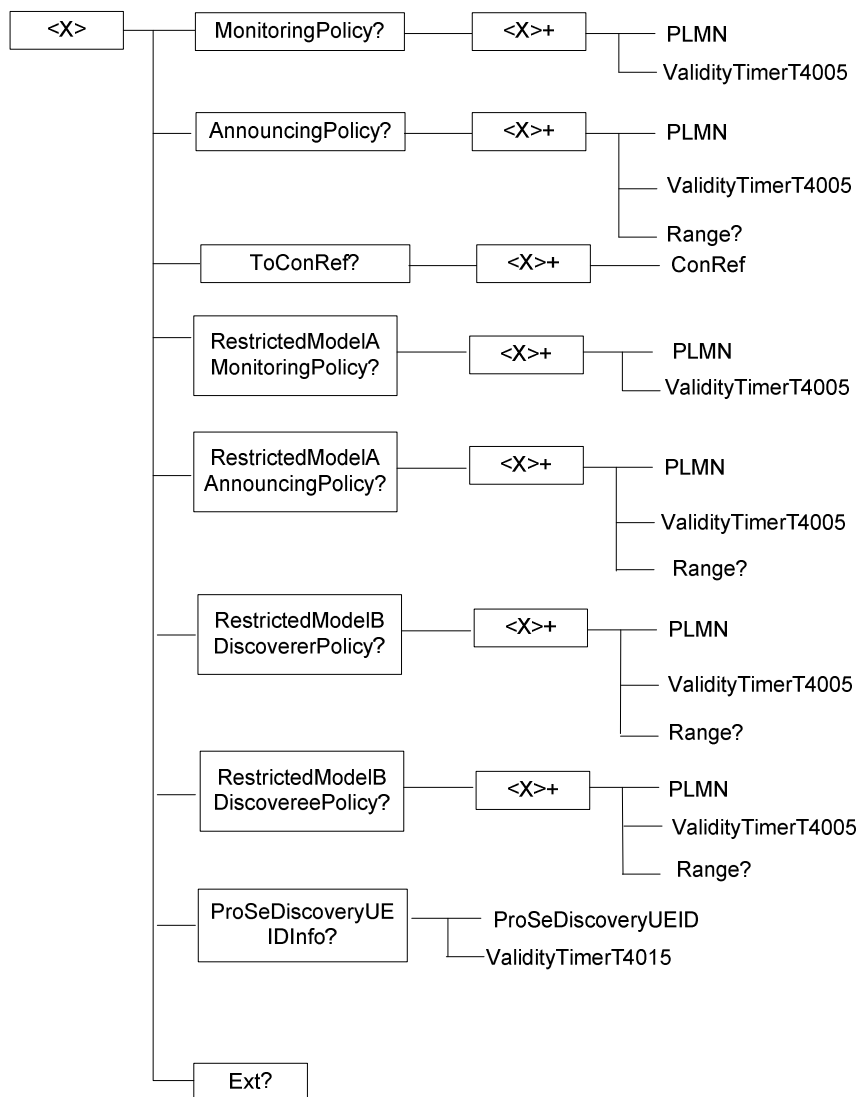

Figure 4.1.1: The ProSe Direct Services Provisioning Management Object

4.2 ProSe Direct Services Provisioning MO parameters

4.2.1 General

This subclause describes the parameters for the ProSe Direct Services Provisioning MO.

4.2.2 Node: <X>

This interior node acts as a placeholder for zero or one account for a fixed node.

- Occurrence: ZeroOrOne
- Format: node
- Access Types: Get
- Values: N/A

4.2.3 <X>/MonitoringPolicy

The MonitoringPolicy node acts as a placeholder for open ProSe direct discovery monitoring authorisation policy.

- Occurrence: ZeroOrOne
- Format: node
- Access Types: Get, Replace
- Values: N/A

4.2.4 <X>/MonitoringPolicy/<X>

This interior node acts as a placeholder for one or more open ProSe direct discovery monitoring authorisation policies.

- Occurrence: OneOrMore
- Format: node
- Access Types: Get, Replace
- Values: N/A

4.2.5 <X>/MonitoringPolicy/<X>/PLMN

The PLMN leaf indicates the PLMN code of the operator in which the UE is authorised to use open ProSe direct discovery monitoring.

- Occurrence: One
- Format: chr
- Access Types: Get, Replace
- Values: <PLMN>

The format of the PLMN is defined by 3GPP TS 23.003 [6].

NOTE: The UE is prohibited from performing open ProSe direct discovery monitoring in any PLMN for which no monitoring authorisation policy is available.

4.2.6 <X>/MonitoringPolicy/<X>/ValidityTimerT4005

The ValidityTimerT4005 leaf indicates in unit of minutes for how long this open ProSe direct discovery monitoring authorisation policy is valid.

- Occurrence: One
- Format: int
- Access Types: Get, Replace
- Values: 1-525600

4.2.7 <X>/AnnouncingPolicy

The AnnouncingPolicy node acts as a placeholder for open ProSe direct discovery announcing authorisation policy.

- Occurrence: ZeroOrOne
- Format: node
- Access Types: Get, Replace

- Values: N/A

4.2.8 <X>/AnnouncingPolicy/<X>

This interior node acts as a placeholder for one or more open ProSe direct discovery announcing authorisation policies.

- Occurrence: OneOrMore
- Format: node
- Access Types: Get, Replace
- Values: N/A

4.2.9 <X>/AnnouncingPolicy/<X>/PLMN

The PLMN leaf indicates the PLMN code of the operator in which the UE is authorised to use open ProSe direct discovery announcing.

- Occurrence: One
- Format: chr
- Access Types: Get, Replace
- Values: <PLMN>

The format of the PLMN is defined by 3GPP TS 23.003 [6].

- NOTE: The UE is prohibited from performing open ProSe direct discovery announcing in any PLMN for which no announcing authorisation policy is available.

4.2.10 <X>/AnnouncingPolicy/<X>/ValidityTimerT4005

The ValidityTimerT4005 leaf indicates in unit of minutes for how long this open ProSe direct discovery announcing authorisation policy is valid.

- Occurrence: One
- Format: int
- Access Types: Get, Replace
- Values: 1-525600

4.2.11 <X>/AnnouncingPolicy/<X>/Range

The Range leaf indicates the authorised announcing range for open ProSe direct discovery in the PLMN in which this announcing authorisation policy applies.

- Occurrence: ZeroOrOne
- Format: int
- Access Types: Get, Replace
- Values: <Range>

Possible values for the Range are specified in table 4.2.11.1.

Table 4.2.11.1: Values of Range leaf

Value	Description
0	Reserved
1	The authorised announcing range is set to: Short.
2	The authorised announcing range is set to: Medium.
3	The authorised announcing range is set to: Long.
4-255	Reserved

4.2.12 <X>/ToConRef

The ToConRef interior node is used to allow application to refer to a collection of connectivity definitions. Several connectivity parameters can be listed for a given application under this interior node.

This interior node contains configuration parameters for establishment of the PDN connection for reaching the HPLMN ProSe Function.

- Occurrence: ZeroOrOne
- Format: node
- Access Types: Get, Replace
- Values: N/A

4.2.13 <X>/ToConRef/<X>

This run-time node acts as a placeholder for each reference to connectivity parameters.

- Occurrence: OneOrMore
- Format: Node
- Access Types: Get, Replace
- Values: N/A

4.2.14 <X>/ToConRef/<X>/ConRef

The ConRef specifies a specific linkage to connectivity parameters.

- Occurrence: One
- Format: Chr
- Access Types: Get, Replace
- Values: <A network access point object>

4.2.15 <X>/RestrictedModelAMonitoringPolicy

The RestrictedModelAMonitoringPolicy node acts as a placeholder for restricted ProSe direct discovery model A monitoring authorisation policy.

- Occurrence: ZeroOrOne
- Format: node
- Access Types: Get, Replace
- Values: N/A

4.2.16 <X>/RestrictedModelAMonitoringPolicy/<X>

This interior node acts as a placeholder for one or more restricted ProSe direct discovery model A monitoring authorisation policies.

- Occurrence: OneOrMore
- Format: node
- Access Types: Get, Replace
- Values: N/A

4.2.17 <X>/RestrictedModelAMonitoringPolicy/<X>/PLMN

The PLMN leaf indicates the PLMN code of the operator in which the UE is authorised to use restricted ProSe direct discovery model A monitoring.

- Occurrence: One
- Format: chr
- Access Types: Get, Replace
- Values: <PLMN>

The format of the PLMN is defined by 3GPP TS 23.003 [6].

- NOTE: The UE is prohibited from performing restricted ProSe direct discovery model A monitoring in any PLMN for which no monitoring authorisation policy is available.

4.2.18 <X>/RestrictedModelAMonitoringPolicy/<X>/ValidityTimerT4005

The ValidityTimerT4005 leaf indicates in unit of minutes for how long this restricted ProSe direct discovery model A monitoring authorisation policy is valid.

- Occurrence: One
- Format: int
- Access Types: Get, Replace
- Values: 1-525600

4.2.19 <X>/RestrictedModelAAnnouncingPolicy

The RestrictedModelAAnnouncingPolicy node acts as a placeholder for restricted ProSe direct discovery model A announcing authorisation policy.

- Occurrence: ZeroOrOne
- Format: node
- Access Types: Get, Replace
- Values: N/A

4.2.20 <X>/RestrictedModelAAnnouncingPolicy/<X>

This interior node acts as a placeholder for one or more restricted ProSe direct discovery model A announcing authorisation policies.

- Occurrence: OneOrMore

- Format: node
- Access Types: Get, Replace
- Values: N/A

4.2.21 <X>/RestrictedModelAAnnouncingPolicy/<X>/PLMN

The PLMN leaf indicates the PLMN code of the operator in which the UE is authorised to use restricted ProSe direct discovery model A announcing.

- Occurrence: One
- Format: chr
- Access Types: Get, Replace
- Values: <PLMN>

The format of the PLMN is defined by 3GPP TS 23.003 [6].

NOTE: The UE is prohibited from performing restricted ProSe direct discovery model A announcing in any PLMN for which no announcing authorisation policy is available.

4.2.22 <X>/RestrictedModelAAnnouncingPolicy/<X>/ValidityTimerT4005

The ValidityTimerT4005 leaf indicates in unit of minutes for how long this restricted ProSe direct discovery model A announcing authorisation policy is valid.

- Occurrence: One
- Format: int
- Access Types: Get, Replace
- Values: 1-525600

4.2.23 <X>/RestrictedModelAAnnouncingPolicy/<X>/Range

The Range leaf indicates the authorised announcing range for restricted ProSe direct discovery model A in the PLMN in which this announcing authorisation policy applies.

- Occurrence: ZeroOrOne
- Format: int
- Access Types: Get, Replace
- Values: <Range>

Possible values for the Range are specified in table 4.2.23.1.

Table 4.2.23.1: Values of Range leaf

Value	Description
0	Reserved
1	The authorised announcing range is set to: Short.
2	The authorised announcing range is set to: Medium.
3	The authorised announcing range is set to: Long.
4-255	Reserved

4.2.24 <X>/RestrictedModelBDiscovererPolicy

The RestrictedModelBDiscovererPolicy node acts as a placeholder for restricted ProSe direct discovery model B discoverer operation authorisation policy.

- Occurrence: ZeroOrOne
- Format: node
- Access Types: Get, Replace
- Values: N/A

4.2.25 <X>/RestrictedModelBDiscovererPolicy/<X>

This interior node acts as a placeholder for one or more restricted ProSe direct discovery model B discoverer operation authorisation policies.

- Occurrence: OneOrMore
- Format: node
- Access Types: Get, Replace
- Values: N/A

4.2.26 <X>/RestrictedModelBDiscovererPolicy/<X>/PLMN

The PLMN leaf indicates the PLMN code of the operator in which the UE is authorised to use restricted ProSe direct discovery model B discoverer operation.

- Occurrence: One
- Format: chr
- Access Types: Get, Replace
- Values: <PLMN>

The format of the PLMN is defined by 3GPP TS 23.003 [6].

NOTE: The UE is prohibited from performing restricted ProSe direct discovery model B discoverer operation in any PLMN for which no discoverer operation authorisation policy is available.

4.2.27 <X>/RestrictedModelBDiscovererPolicy/<X>/ValidityTimerT4005

The ValidityTimerT4005 leaf indicates in unit of minutes for how long this restricted ProSe direct discovery model B discoverer operation authorisation policy is valid.

- Occurrence: One
- Format: int
- Access Types: Get, Replace
- Values: 1-525600

4.2.28 <X>/RestrictedModelBDiscovererPolicy/<X>/Range

The Range leaf indicates the authorised discoverer operation range for restricted ProSe direct discovery model B in the PLMN in which this discoverer operation authorisation policy applies.

- Occurrence: ZeroOrOne

- Format: int
- Access Types: Get, Replace
- Values: <Range>

Possible values for the Range are specified in table 4.2.28.1.

Table 4.2.28.1: Values of Range leaf

Value	Description
0	Reserved
1	The authorised discoverer operation range is set to: Short.
2	The authorised discoverer operation range is set to: Medium.
3	The authorised discoverer operation range is set to: Long.
4-255	Reserved

4.2.29 <X>/RestrictedModelBDiscovereePolicy

The RestrictedModelBDiscovereePolicy node acts as a placeholder for restricted ProSe direct discovery model B discoveree operation authorisation policy.

- Occurrence: ZeroOrOne
- Format: node
- Access Types: Get, Replace
- Values: N/A

4.2.30 <X>/RestrictedModelBDiscovereePolicy/<X>

This interior node acts as a placeholder for one or more restricted ProSe direct discovery model B discoveree operation authorisation policies.

- Occurrence: OneOrMore
- Format: node
- Access Types: Get, Replace
- Values: N/A

4.2.31 <X>/RestrictedModelBDiscovereePolicy/<X>/PLMN

The PLMN leaf indicates the PLMN code of the operator in which the UE is authorised to use restricted ProSe direct discovery model B discoveree operation.

- Occurrence: One
- Format: chr
- Access Types: Get, Replace
- Values: <PLMN>

The format of the PLMN is defined by 3GPP TS 23.003 [6].

NOTE: The UE is prohibited from performing restricted ProSe direct discovery model B discoveree operation in any PLMN for which no discoveree operation authorisation policy is available.

4.2.32 <X>/RestrictedModelBDiscovereePolicy/<X>/ValidityTimerT4005

The ValidityTimerT4005 leaf indicates in unit of minutes for how long this restricted ProSe direct discovery model B discoveree operation authorisation policy is valid.

- Occurrence: One
- Format: int
- Access Types: Get, Replace
- Values: 1-525600

4.2.33 <X>/RestrictedModelBDiscovereePolicy/<X>/Range

The Range leaf indicates the authorised discoveree operation range for restricted ProSe direct discovery model B in the PLMN in which this discoveree operation authorisation policy applies.

- Occurrence: ZeroOrOne
- Format: int
- Access Types: Get, Replace
- Values: <Range>

Possible values for the Range are specified in table 4.2.33.1.

Table 4.2.33.1: Values of Range leaf

Value	Description
0	Reserved
1	The authorised discoveree operation range is set to: Short.
2	The authorised discoveree operation range is set to: Medium.
3	The authorised discoveree operation range is set to: Long.
4-255	Reserved

4.2.34 <X>/ProSeDiscoveryUEIDInfo

The ProSeDiscoveryUEIDInfo node acts as a placeholder for the ProSe Discovery UE ID and its associated validity timer T4015.

- Occurrence: ZeroOrOne
- Format: node
- Access Types: Get, Replace
- Values: N/A

4.2.35 <X>/ProSeDiscoveryUEIDInfo/ProSeDiscoveryUEID

The ProSeDiscoveryUEID leaf contains the ProSe Discovery UE ID assigned to the UE by the HPLMN ProSe Function for restricted ProSe direct discovery.

- Occurrence: One
- Format: chr
- Access Types: Get, Replace
- Values: <ProSeDiscoveryUEID>

The format of the ProSe Discovery UE ID is defined by 3GPP TS 23.003 [6].

4.2.36 <X>/ ProSeDiscoveryUEIDInfo/ValidityTimerT4015

The ValidityTimerT4015 leaf indicates in unit of minutes for how long this ProSe Discovery UE ID is valid.

- Occurrence: One
- Format: int
- Access Types: Get, Replace
- Values: 1-525600

4.2.37 <X>/Ext

The Ext is an interior node for where the vendor specific information about the ProSe Direct Services Provisioning MO is being placed (vendor meaning application vendor, device vendor etc.). Usually the vendor extension is identified by vendor specific name under the ext node. The tree structure under the vendor identifier is not defined and can therefore include one or more un-standardized sub-trees.

- Occurrence: ZeroOrOne
- Format: node
- Access Types: Get
- Values: N/A

5 ProSe Public Safety Direct Services Provisioning MO

5.1 Overview

The ProSe Public Safety Direct Services Provisioning MO is used to manage ProSe direct discovery and ProSe direct communication authorisation and provisioning information for a ProSe-enabled public safety UE.

The MO identifier is: urn:oma:mo:ext-3gpp-prose-public-safety-direct-provisioning:1.0.

The UE may initiate the provision of all available information from the DPF, using a client-initiated session Alert message of code "Generic Alert" (see OMA-TS-DM_Protocol-V1_2 [5]). When requesting all available information from the DPF, the "Type" element of the OMA DM generic alert message shall be set to "urn:oma:mo:ext-3gpp-prose-public-safety-direct-provisioning:1.0:provision", the "LocURI" element (inside the "Source" element) shall be set to the address of the ProSe Public Safety Direct Services Provisioning MO as specified by OMA-TS-DM_Protocol-V1_2 [5] and the "Data" element is not included.

The OMA DM Access Control List (ACL) property mechanism (see OMA-ERELED-DM-V1_2 [3]) may be used to grant or deny access rights to OMA DM servers in order to modify nodes and leaf objects of the ProSe Public Safety Direct Services Provisioning MO.

The following nodes and leaf objects are possible in the ProSe Public Safety Direct Services Provisioning MO as described in figure 5.1.1 and figure 5.1.2, figure 5.1.3, figure 5.1.4, figure 5.1.5, figure 5.1.6, figure 5.1.7, figure 5.1.8, figure 5.1.9, figure 5.1.10 and figure 5.1.11:

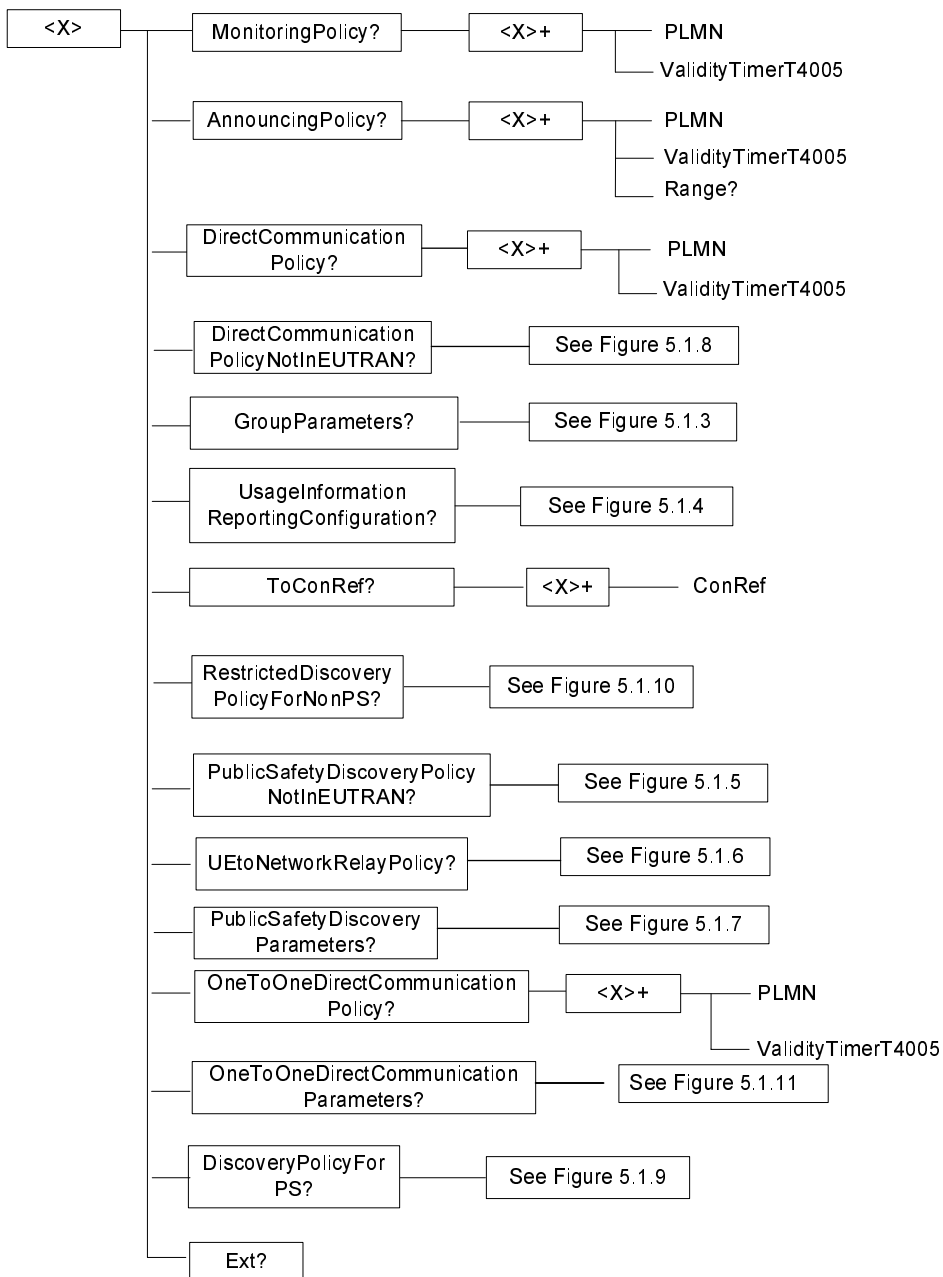

Figure 5.1.1: The ProSe Public Safety Direct Services Provisioning Management Object (1 of 11)

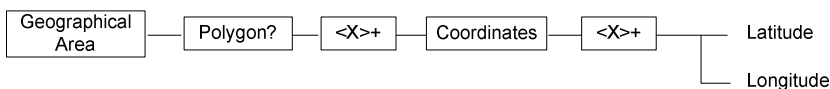

Figure 5.1.2: The ProSe Public Safety Direct Services Provisioning Management Object (2 of 11)

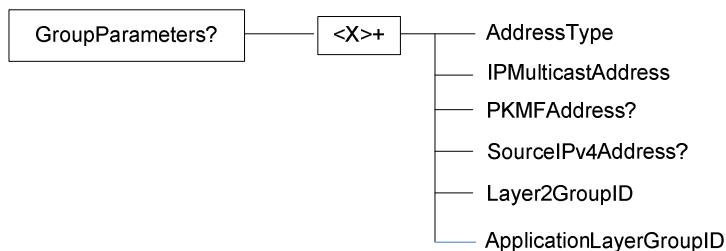

Figure 5.1.3: The ProSe Public Safety Direct Services Provisioning Management Object (3 of 11)

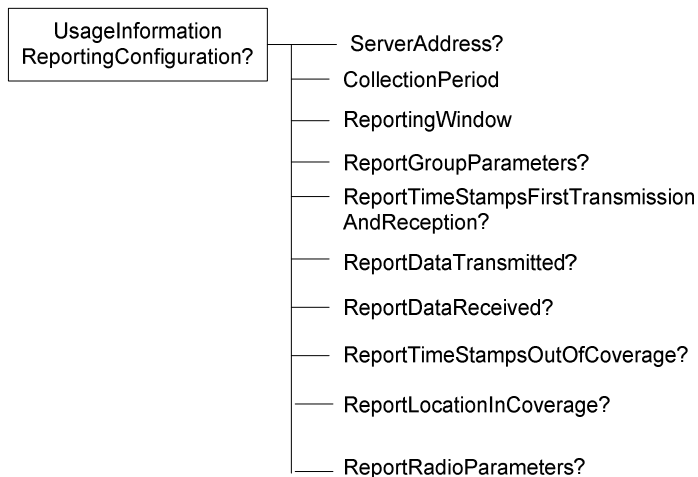

Figure 5.1.4: The ProSe Public Safety Direct Services Provisioning Management Object (4 of 11)

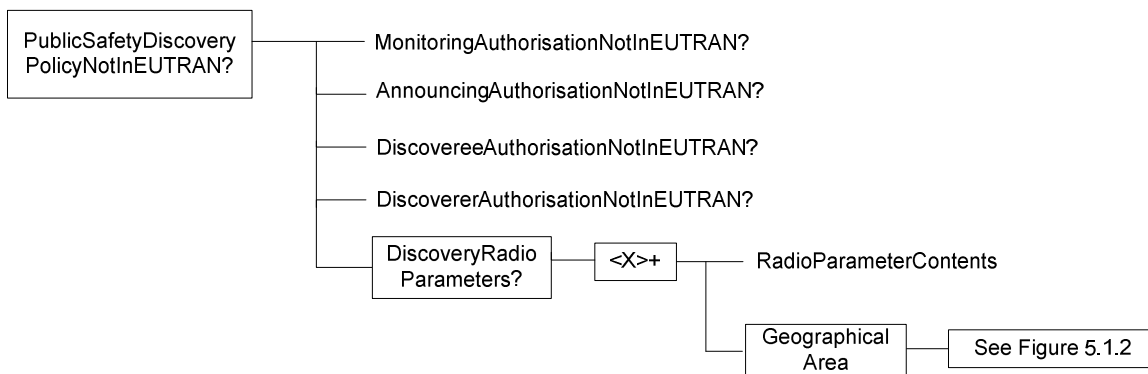

Figure 5.1.5: The ProSe Public Safety Direct Services Provisioning Management Object (5 of 11)

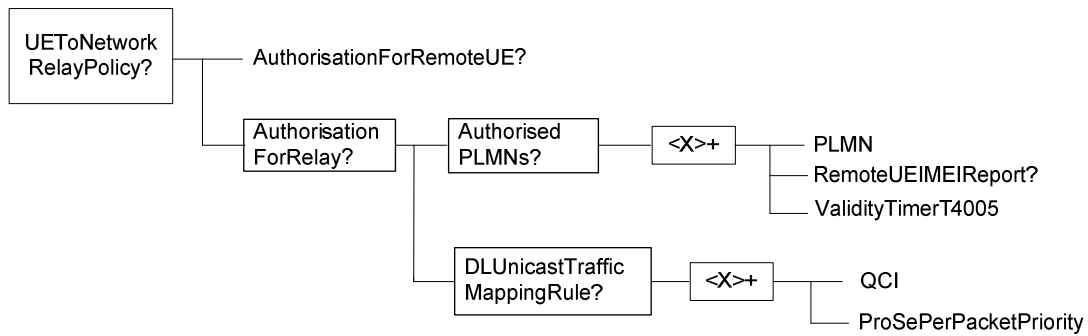

Figure 5.1.6: The ProSe Public Safety Direct Services Provisioning Management Object (6 of 11)

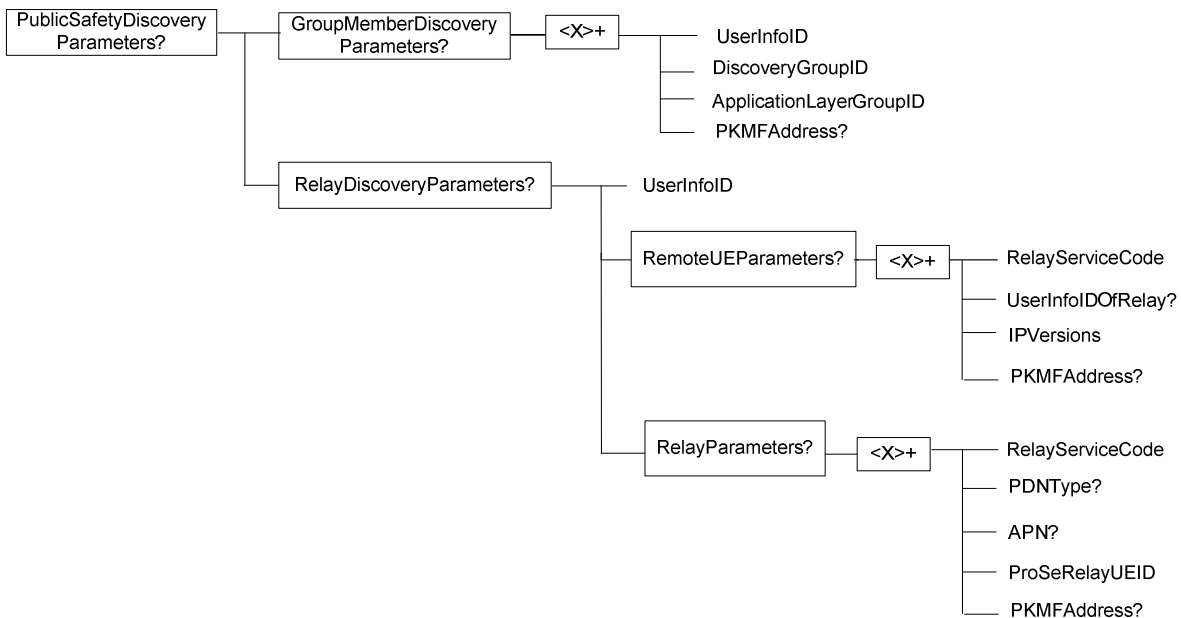

Figure 5.1.7: The ProSe Public Safety Direct Services Provisioning Management Object (7 of 11)

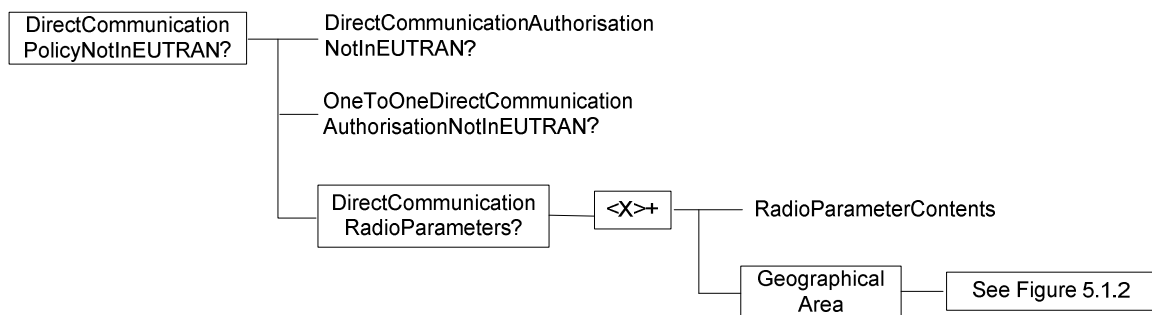

Figure 5.1.8: The ProSe Public Safety Direct Services Provisioning Management Object (8 of 11)

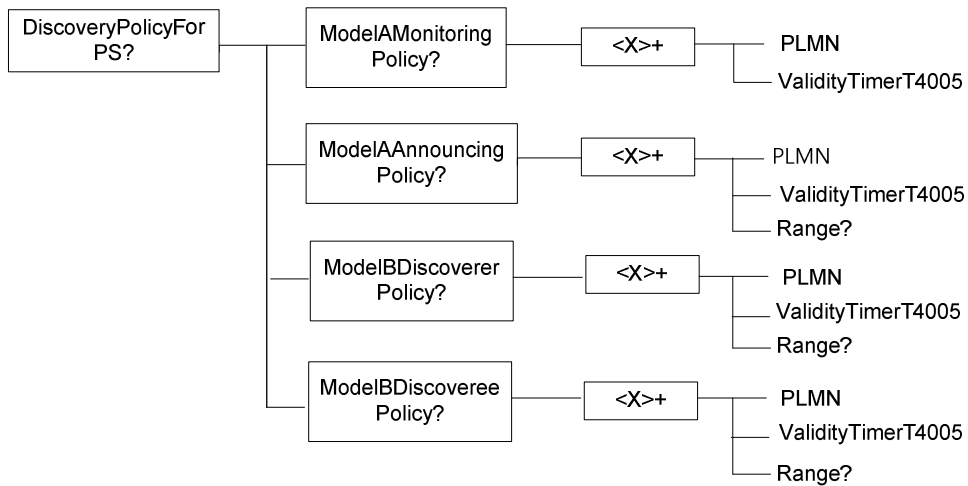

Figure 5.1.9: The ProSe Public Safety Direct Services Provisioning Management Object (9 of 11)

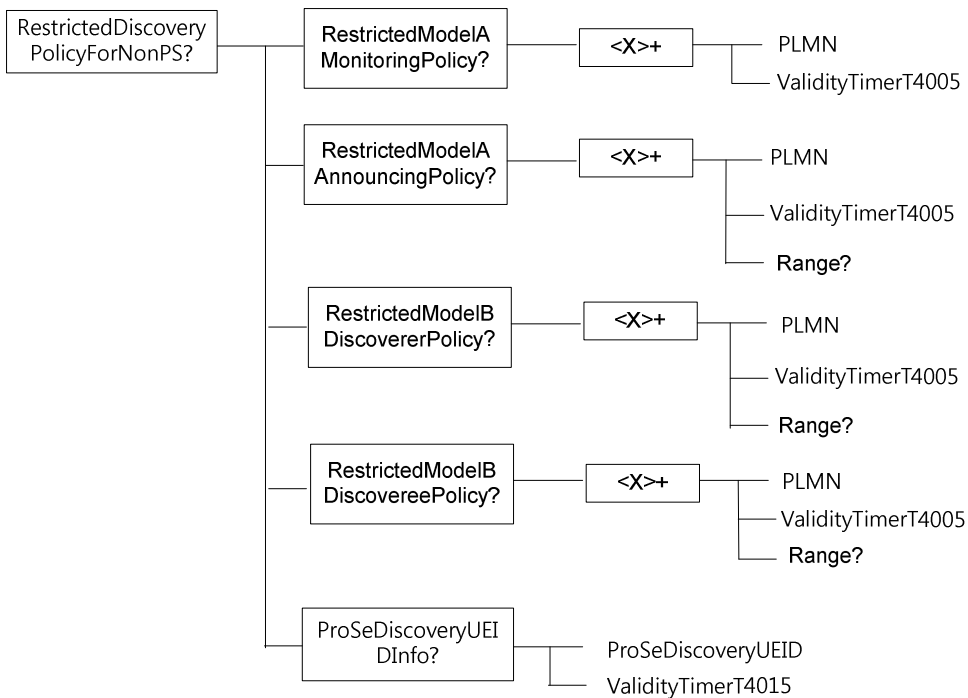

Figure 5.1.10: The ProSe Public Safety Direct Services Provisioning Management Object (10 of 11)

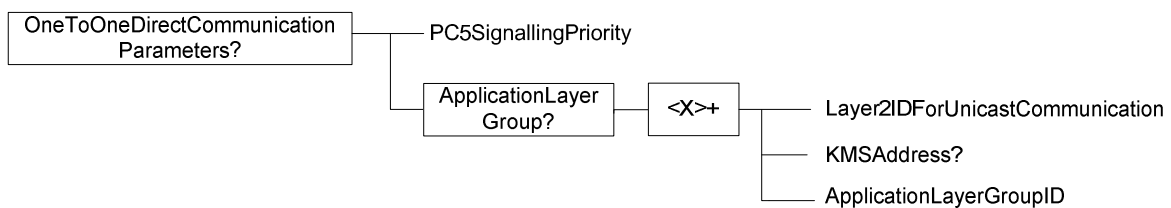

Figure 5.1.11: The ProSe Public Safety Direct Services Provisioning Management Object (11 of 11)

5.2 ProSe Public Safety Direct Services Provisioning MO parameters

5.2.1 General

This clause describes the parameters for the ProSe Public Safety Direct Services Provisioning MO.

5.2.2 Node: <X>

This interior node acts as a placeholder for zero or one account for a fixed node.

- Occurrence: ZeroOrOne
- Format: node
- Access Types: Get
- Values: N/A

5.2.3 <X>/MonitoringPolicy

The MonitoringPolicy node acts as a placeholder for open ProSe direct discovery monitoring authorisation policy for non-public safety use.

- Occurrence: ZeroOrOne
- Format: node
- Access Types: Get, Replace
- Values: N/A

5.2.4 <X>/MonitoringPolicy/<X>

This interior node acts as a placeholder for one or more open ProSe direct discovery monitoring authorisation policies for non-public safety use.

- Occurrence: OneOrMore
- Format: node
- Access Types: Get, Replace
- Values: N/A

5.2.5 <X>/MonitoringPolicy/<X>/PLMN

The PLMN leaf indicates the PLMN code of the operator in which the UE is authorised to use open ProSe direct discovery monitoring for non-public safety use.

- Occurrence: One
- Format: chr
- Access Types: Get, Replace
- Values: <PLMN>

The format of the PLMN is defined by 3GPP TS 23.003 [6].

NOTE: The UE is prohibited from performing open ProSe direct discovery monitoring in any PLMN for which no monitoring authorisation policy is available.

5.2.6 <X>/MonitoringPolicy/<X>/ValidityTimerT4005

The ValidityTimerT4005 leaf indicates in unit of minutes for how long this open ProSe direct discovery monitoring authorisation policy for non-public safety use is valid.

- Occurrence: One
- Format: int
- Access Types: Get, Replace
- Values: 1-525600

5.2.7 <X>/AnnouncingPolicy

The AnnouncingPolicy node acts as a placeholder for open ProSe direct discovery announcing authorisation policy for non-public safety use.

- Occurrence: ZeroOrOne
- Format: node
- Access Types: Get, Replace
- Values: N/A

5.2.8 <X>/AnnouncingPolicy/<X>

This interior node acts as a placeholder for one or more open ProSe direct discovery announcing authorisation policies for non-public safety use.

- Occurrence: OneOrMore
- Format: node
- Access Types: Get, Replace
- Values: N/A

5.2.9 <X>/AnnouncingPolicy/<X>/PLMN

The PLMN leaf indicates the PLMN code of the operator in which the UE is authorised to use open ProSe direct discovery announcing for non-public safety use.

- Occurrence: One
- Format: chr
- Access Types: Get, Replace
- Values: <PLMN>

The format of the PLMN is defined by 3GPP TS 23.003 [6].

NOTE: The UE is prohibited from performing open ProSe direct discovery announcing in any PLMN for which no announcing authorisation policy is available.

5.2.10 <X>/AnnouncingPolicy/<X>/ValidityTimerT4005

The ValidityTimerT4005 leaf indicates in unit of minutes for how long this open ProSe direct discovery announcing authorisation policy for non-public safety use is valid.

- Occurrence: One

- Format: int
- Access Types: Get, Replace
- Values: 1-525600

5.2.11 <X>/AnnouncingPolicy/<X>/Range

The Range leaf indicates the authorised announcing range for open ProSe direct discovery for non-public safety use in the PLMN in which this announcing authorisation policy applies.

- Occurrence: ZeroOrOne
- Format: int
- Access Types: Get, Replace
- Values: <Range>

Possible values for the Range are specified in table 5.2.11.1.

Table 5.2.11.1: Values of Range leaf

Value	Description
0	Reserved
1	The authorised announcing range is set to: Short.
2	The authorised announcing range is set to: Medium.
3	The authorised announcing range is set to: Long.
4-255	Reserved

5.2.12 Void

5.2.13 Void

5.2.14 Void

5.2.15 Void

5.2.16 Void

5.2.17 Void

5.2.18 Void

5.2.19 Void

5.2.20 Void

5.2.21 Void

5.2.22 Void

5.2.23 Void

5.2.24 Void

5.2.25 Void

5.2.26 Void

5.2.27 Void

5.2.28 Void

5.2.29 Void

5.2.30 Void

5.2.31 Void

5.2.32 Void

5.2.33 Void

5.2.34 Void

5.2.35 <X>/DirectCommunicationPolicy

The DirectCommunicationPolicy node acts as a placeholder for one-to-many ProSe direct communication authorisation policy.

- Occurrence: ZeroOrOne
- Format: node
- Access Types: Get, Replace
- Values: N/A

5.2.36 <X>/DirectCommunicationPolicy/<X>

This interior node acts as a placeholder for one or more one-to-many ProSe direct communication authorisation policies.

- Occurrence: OneOrMore
- Format: node
- Access Types: Get, Replace
- Values: N/A

5.2.37 <X>/DirectCommunicationPolicy/<X>/PLMN

The PLMN leaf indicates the PLMN code of the operator in which the UE is authorised to use one-to-many ProSe direct communication.

- Occurrence: One
- Format: chr
- Access Types: Get, Replace
- Values: <PLMN>

The format of the PLMN is defined by 3GPP TS 23.003 [6].

NOTE: The UE is prohibited from performing one-to-many ProSe direct communication in any PLMN for which no monitoring authorisation policy is available.

5.2.38 <X>/DirectCommunicationPolicy/<X>/ValidityTimerT4005

The ValidityTimerT4005 leaf indicates in unit of minutes for how long this authorisation policy is valid.

- Occurrence: One
- Format: int
- Access Types: Get, Replace
- Values: 1-525600

5.2.39 <X>/DirectCommunicationPolicyNotInEUTRAN

The DirectCommunicationPolicyNotInEUTRAN node acts as a placeholder for the description of the direct communication authorisation when the UE is not served by E-UTRAN.

- Occurrence: ZeroOrOne
- Format: node

- Access Types: Get, Replace
- Values: N/A

5.2.40 <X>/DirectCommunicationPolicyNotInEUTRAN/ DirectCommunicationAuthorisationNotInEUTRAN

The DirectCommunicationAuthorisationNotInEUTRAN leaf indicates whether the UE is authorised to perform one-to-many ProSe direct communication when not served by E-UTRAN.

- Occurrence: ZeroOrOne
 - Format: bool
 - Access Types: Get, Replace
 - Values: 0, 1
- 0 Indicates that the UE is not authorised to perform one-to-many ProSe direct communication when not served by E-UTRAN.
- 1 Indicates that the UE is authorised to perform one-to-many ProSe direct communication when not served by E-UTRAN.

5.2.40A <X>/DirectCommunicationPolicyNotInEUTRAN/ OneToOneDirectCommunicationAuthorisationNotInEUTRAN

The OneToOneDirectCommunicationAuthorisationNotInEUTRAN leaf indicates whether the UE is authorised to perform one-to-one ProSe direct communication when not served by E-UTRAN.

- Occurrence: ZeroOrOne
 - Format: bool
 - Access Types: Get, Replace
 - Values: 0, 1
- 0 Indicates that the UE is not authorised to perform one-to-one ProSe direct communication when not served by E-UTRAN.
- 1 Indicates that the UE is authorised to perform one-to-one ProSe direct communication when not served by E-UTRAN.

5.2.41 <X>/DirectCommunicationPolicyNotInEUTRAN/ DirectCommunicationRadioParameters

The DirectCommunicationRadioParameters node acts as a placeholder for the radio parameter information needed for the UE to perform ProSe direct communication when the UE is not served by E-UTRAN.

- Occurrence: ZeroOrMore
- Format: node
- Access Types: Get, Replace
- Values: N/A

5.2.42 <X>/DirectCommunicationPolicyNotInEUTRAN/ DirectCommunicationRadioParameters/<X>

This interior node acts as a place holder for one or more set of radio parameters needed for the UE to perform ProSe direct communication when the UE is not served by E-UTRAN.

- Occurrence: OneOrMore
- Format: node
- Access Types: Get, Replace
- Values: <N/A>

5.2.43 <X>/DirectCommunicationPolicyNotInEUTRAN/ DirectCommunicationRadioParameters/<X>/ RadioParametersContents

The RadioParametersContents leaf contains the radio parameters to be used to perform ProSe direct communication when the UE is not served by E-UTRAN and the UE determines itself to be located in a geographical area associated with these radio parameters.

- Occurrence: One
- Format: bin
- Access Types: Get, Replace
- Values: <RadioParametersContents>

The RadioParameterContents is defined as *SL-Preconfiguration* in clause 9 of 3GPP TS 36.331 [10].

5.2.44 <X>/DirectCommunicationPolicyNotInEUTRAN/ DirectCommunicationRadioParameters/<X>/ GeographicalArea

The GeographicalArea node acts as a placeholder for one or more geographical areas associated with a set of radio parameters. The radio parameters are used by the UE for ProSe direct communication when the UE is not served by E-UTRAN and within an associated geographical area.

- Occurrence: One
- Format: Node
- Access Types: Get, Replace
- Values: N/A

5.2.45 <X>/DirectCommunicationPolicyNotInEUTRAN/ DirectCommunicationRadioParameters/<X>/ GeographicalArea/Polygon

The Polygon node acts as a placeholder for polygon geographical area descriptions.

- Occurrence: ZeroOrOne
- Format: node
- Access Types: Get, Replace
- Values: N/A

5.2.46 <X>/DirectCommunicationPolicyNotInEUTRAN/ DirectCommunicationRadioParameters/<X>/ GeographicalArea/Polygon/<X>

This interior node acts as a placeholder for one or more polygon geographical area descriptions.

- Occurrence: OneOrMore
- Format: node
- Access Types: Get, Replace
- Values: <N/A >

5.2.47 <X>/DirectCommunicationPolicyNotInEUTRAN/ DirectCommunicationRadioParameters/<X>/ GeographicalArea/Polygon/<X>/Coordinates

The Coordinates node acts as a placeholder for geographical coordinates outlining the borders of a polygon geographical area.

- Occurrence: One
- Format: node
- Access Types: Get, Replace
- Values: N/A

5.2.48 <X>/DirectCommunicationPolicyNotInEUTRAN/ DirectCommunicationRadioParameters/<X>/ GeographicalArea/Polygon/<X>/Coordinates/<X>

This interior node acts as a placeholder for one or more geographical coordinates.

- Occurrence: OneOrMore
- Format: node
- Access Types: Get, Replace
- Values: <N/A>

NOTE: The upper limit of 15 specified in 3GPP TS 23.032 [9] for the number of points in a polygon shape does not apply to the number of coordinates in a geographical area described as a polygon for ProSe direct communication.

5.2.49 <X>/DirectCommunicationPolicyNotInEUTRAN/ DirectCommunicationRadioParameters/<X>/ GeographicalArea/Polygon/<X>/Coordinates/<X>/Latitude

The Latitude leaf contains the latitude of a geographical coordinate outlining the border of the polygon geographical area.

- Occurrence: One
- Format: bin
- Access Types: Get, Replace

- Values: <Latitude>

The Latitude is defined in subclause 6.1 of 3GPP TS 23.032 [9].

5.2.50 <X>/DirectCommunicationPolicyNotInEUTRAN/ DirectCommunicationRadioParameters/<X>/ GeographicalArea/Polygon/<X>/Coordinates/<X>/Longitude

The Longitude leaf contains the longitude of a geographical coordinate outlining the border of the polygon geographical area.

- Occurrence: One
- Format: bin
- Access Types: Get, Replace
- Values: <Longitude>

The Longitude is defined in subclause 6.1 of 3GPP TS 23.032 [9].

5.2.51 <X>/GroupParameters

The GroupParameters node acts as a placeholder for one-to-many ProSe direct communication group parameters.

- Occurrence: ZeroOrOne
- Format: node
- Access Types: Get, Replace
- Values: N/A

5.2.52 <X>/GroupParameters/<X>

This interior node acts as a placeholder for one or more set of group parameters for one-to-many ProSe direct communication.

- Occurrence: OneOrMore
- Format: node
- Access Types: Get, Replace
- Values: N/A

5.2.53 <X>/GroupParameters/<X>/ AddressType

The AddressType leaf indicates the IP version of the addresses described by the IPMulticastAddress leaf.

- Occurrence: One
- Format: chr
- Access Types: Get, Replace
- Values: 'IPv4', 'IPv6'

5.2.54 <X>/GroupParameters/<X>/IPMulticastAddress

The IPMulticastAddress leaf indicates the IP multicast address to be used for performing one-to-many ProSe direct communication.

- Occurrence: One
- Format: chr
- Access Types: Get, Replace
- Values: <an IPv4 address>, <an IPv6 address>.

The value of this leaf is an IPv4 address if the AddressType leaf value of the same rule is equal to "IPv4". The value of this leaf is an IPv6 address if the AddressType leaf value of the same rule is equal to "IPv6".

5.2.55 <X>/GroupParameters/<X>/PKMFAddress

The PKMFAddress leaf contains the address of the ProSe Key Management Function that the UE uses to obtain the group security related contents (see 3GPP TS 33.303 [7]).

- Occurrence: ZeroOrOne
- Format: chr
- Access Types: Get, Replace
- Values: <an IPv4 address>, <an IPv6 address>.

The UE shall use the IP address of the HPLMN ProSe Function if this leaf is not provisioned.

5.2.56 <X>/GroupParameters/<X>/SourceIPv4address

The SourceIPv4address leaf indicates the IP source address of the IP address to be used by the UE as a source address. If none is provisioned, then the UE shall use Dynamic Configuration of IPv4 Link-Local Addresses IETF RFC 3927 [8] to obtain a link local address for the Group. The source address refers to the IP address of the data packets destined for the UE.

- Occurrence: ZeroOrOne
- Format: chr
- Access Types: Get, Replace
- Values: <an IPv4 address>, <an IPv6 address>.

The value of this leaf is an IPv4 address.

The absence of this leaf indicates that the UE shall use Dynamic Configuration of IPv4 Link-Local Addresses IETF RFC 3927 [8] to obtain a link local address for the group.

5.2.57 <X>/GroupParameters/<X>/Layer2GroupID

The Layer2GroupID leaf indicates the group ID to be used at layer 2 for performing one-to-many ProSe direct communication.

- Occurrence: One
- Format: chr
- Access Types: Get, Replace
- Values: <Group ID>

5.2.57A <X>/GroupParameters/<X>/ApplicationLayerGroupID

The ApplicationLayerGroupID leaf indicates the Application Layer Group ID identifying an application layer group that the UE belongs to.

- Occurrence: One
- Format: chr
- Access Types: Get, Replace
- Values: < Application Layer Group ID>

5.2.58 <X>/UsageInformationReportingConfiguration

The UsageInformationReportingConfiguration node acts as a placeholder for the description of the configuration to be used by the UE for reporting of usage information.

- Occurrence: ZeroOrOne
- Format: node
- Access Types: Get, Replace
- Values: N/A

5.2.59 <X>/UsageInformationReportingConfiguration/ServerAddress

The ServerAddress leaf contains the address of the server to which the UE shall upload the usage information reports.

- Occurrence: ZeroOrOne
- Format: chr
- Access Types: Get, Replace
- Values: <an IPv4 address>, <an IPv6 address>.

The UE shall upload the usage information reports to the IP address of the HPLMN ProSe Function if this leaf is not provisioned.

5.2.60 <X>/UsageInformationReportingConfiguration/CollectionPeriod

The CollectionPeriod leaf contains the time interval, in unit of minutes, at which the UE shall generate the usage information reports.

- Occurrence: One
- Format: int
- Access Types: Get, Replace
- Values: 0-129600.

Setting the CollectionPeriod leaf to a value of 0 disables generation of usage information reports at the UE.

5.2.61 <X>/UsageInformationReportingConfiguration/ReportingWindow

The ReportingWindow contains the time window, in units of minutes, during which the UE shall upload the usage information report to the server.

- Occurrence: One
- Format: int

- Access Types: Get, Replace
- Values: 0-129600

Setting the ReportingWindow leaf to a value of 0 disables upload of the usage information reports by the UE.

5.2.62 <X>/UsageInformationReportingConfiguration/ ReportGroupParameters

The ReportGroupParameters leaf indicates whether or not the UE shall report the group parameters for one-to-many ProSe direct communication in the usage information.

- Occurrence: ZeroOrOne
 - Format: bool
 - Access Types: Get, Replace
 - Values: 0, 1
- 0 Indicates that the UE shall not report the group parameters for one-to-many ProSe direct communication in the usage information.
- 1 Indicates that the UE shall report the group parameters for one-to-many ProSe direct communication in the usage information.

The default value 0 applies if this leaf is not provisioned.

5.2.63 <X>/UsageInformationReportingConfiguration/ ReportTimeStampsFirstTransmissionAndReception

The ReportTimeStampsFirstTransmissionAndReception leaf indicates whether or not the UE shall report the time stamps of the first transmission/reception during the collection period in the usage information.

- Occurrence: ZeroOrOne
 - Format: bool
 - Access Types: Get, Replace
 - Values: 0, 1
- 0 Indicates that the UE shall not report the time stamps of the first transmission/reception during the collection period in the usage information.
- 1 Indicates that the UE shall report the time stamps of the first transmission/reception during the collection period in the usage information.

The default value 0 applies if this leaf is not provisioned.

5.2.64 <X>/UsageInformationReportingConfiguration/ ReportDataTransmitted

The ReportDataTransmitted leaf indicates whether or not the UE shall report the amount of data transmitted during the collection period in the usage information, and whether with location information.

- Occurrence: ZeroOrOne
- Format: int
- Access Types: Get, Replace
- Values: <ReportDataTransmitted>

Possible values for the ReportDataTransmitted are specified in table 5.2.64.1.

Table 5.2.64.1: Values of ReportDataTransmitted leaf

Value	Description
0	Reserved
1	The UE shall not report the amount of data transmitted during the collection period in the usage information.
2	The UE shall report the amount of data transmitted during the collection period in the usage information without location information.
3	The UE shall report the amount of data transmitted during the collection period in the usage information with location information.
4-255	Reserved

The default value 1 applies if this leaf is not provisioned.

5.2.65 <X>/UsageInformationReportingConfiguration/ReportDataReceived

The ReportDataReceived leaf indicates whether or not the UE shall report the amount of data received during the collection period in the usage information, and whether with location information.

- Occurrence: ZeroOrOne
- Format: int
- Access Types: Get, Replace
- Values: <ReportDataReceived>

Possible values for the ReportDataReceived are specified in table 5.2.65.1.

Table 5.2.65.1: Values of ReportDataReceived leaf

Value	Description
0	Reserved
1	The UE shall not report the amount of data received during the collection period in the usage information.
2	The UE shall report the amount of data received during the collection period in the usage information without location information.
3	The UE shall report the amount of data received during the collection period in the usage information with location information.
4-255	Reserved

The default value 1 applies if this leaf is not provisioned.

5.2.66 <X>/UsageInformationReportingConfiguration/ReportTimeStampsOutOfCoverage

The ReportTimeStampsOutOfCoverage leaf indicates whether or not the UE shall report the time stamps when it went in and out of E-UTRAN coverage during the collection period in the usage information.

- Occurrence: ZeroOrOne
- Format: bool
- Access Types: Get, Replace
- Values: 0, 1

- 0 Indicates that the UE shall not report the time stamps when it went in and out of E-UTRAN coverage during the collection period in the usage information.

- 1 Indicates that the UE shall report the time stamps when it went in and out of E-UTRAN coverage during the collection period in the usage information.

The default value 0 applies if this leaf is not provisioned.

5.2.66A <X>/UsageInformationReportingConfiguration/ ReportLocationInCoverage

The ReportLocationInCoverage leaf indicates whether or not the UE shall report the list of locations of the UE when in E-UTRAN coverage during the collection period in the usage information.

- Occurrence: ZeroOrOne
 - Format: bool
 - Access Types: Get, Replace
 - Values: 0, 1
- 0 Indicates that the UE shall not report the list of locations of the UE when in E-UTRAN coverage during the collection period in the usage information.
 - 1 Indicates that the UE shall report the list of locations of the UE when in E-UTRAN coverage during the collection period in the usage information.

The default value 0 applies if this leaf is not provisioned.

5.2.66B <X>/UsageInformationReportingConfiguration/ ReportRadioParameters

The ReportRadioParameters leaf indicates whether or not the UE shall report the radio parameters used for ProSe direct communication (i.e. indicator of which radio resources used and radio frequency used) during the reporting period in the usage information.

- Occurrence: ZeroOrOne
 - Format: bool
 - Access Types: Get, Replace
 - Values: 0, 1
- 0 Indicates that the UE shall not report the radio parameters used for ProSe direct communication (i.e. indicator of which radio resources used and radio frequency used) during the reporting period in the usage information.
 - 1 Indicates that the UE shall report the radio parameters used for ProSe direct communication (i.e. indicator of which radio resources used and radio frequency used) during the reporting period in the usage information.

The default value 0 applies if this leaf is not provisioned.

5.2.67 <X>/ToConRef

The ToConRef interior node is used to allow application to refer to a collection of connectivity definitions. Several connectivity parameters can be listed for a given application under this interior node.

This interior node contains configuration parameters for establishment of the PDN connection for reaching the HPLMN ProSe Function.

- Occurrence: ZeroOrOne
- Format: node
- Access Types: Get, Replace

- Values: N/A

5.2.68 <X>/ToConRef/<X>

This run-time node acts as a placeholder for each reference to connectivity parameters.

- Occurrence: OneOrMore
- Format: Node
- Access Types: Get, Replace
- Values: N/A

5.2.69 <X>/ToConRef/<X>/ConRef

The ConRef specifies a specific linkage to connectivity parameters.

- Occurrence: One
- Format: Chr
- Access Types: Get, Replace
- Values: <A network access point object>

5.2.70 <X>/RestrictedDiscoveryPolicyForNonPS

The RestrictedDiscoveryPolicyForNonPS node acts as a placeholder for restricted ProSe direct discovery authorisation policies for non-public safety use.

- Occurrence: ZeroOrOne
- Format: node
- Access Types: Get, Replace

5.2.71 <X>/RestrictedDiscoveryPolicyForNonPS /RestrictedModelAMonitoringPolicy

The RestrictedModelAMonitoringPolicy node acts as a placeholder for restricted ProSe direct discovery model A monitoring authorisation policy for non-public safety use.

- Occurrence: ZeroOrOne
- Format: node
- Access Types: Get, Replace
- Values: N/A

5.2.72 <X>/RestrictedDiscoveryPolicyForNonPS /RestrictedModelAMonitoringPolicy/<X>

This interior node acts as a placeholder for one or more restricted ProSe direct discovery model A monitoring authorisation policies for non-public safety use.

- Occurrence: OneOrMore
- Format: node
- Access Types: Get, Replace

- Values: N/A

5.2.73 <X>/RestrictedDiscoveryPolicyForNonPS /RestrictedModelAMonitoringPolicy/<X>/PLMN

The PLMN leaf indicates the PLMN code of the operator in which the UE is authorised to use restricted ProSe direct discovery model A monitoring for non-public safety use.

- Occurrence: One
- Format: chr
- Access Types: Get, Replace
- Values: <PLMN>

The format of the PLMN is defined by 3GPP TS 23.003 [6].

NOTE: The UE is prohibited from performing restricted ProSe direct discovery model A monitoring in any PLMN for which no monitoring authorisation policy is available.

5.2.74 <X>/RestrictedDiscoveryPolicyForNonPS /RestrictedModelAMonitoringPolicy/<X> /ValidityTimerT4005

The ValidityTimerT4005 leaf indicates in unit of minutes for how long this restricted ProSe direct discovery model A monitoring authorisation policy is valid for non-public safety use.

- Occurrence: One
- Format: int
- Access Types: Get, Replace
- Values: 1-525600

5.2.75 <X>/RestrictedDiscoveryPolicyForNonPS /RestrictedModelAAnnouncingPolicy

The RestrictedModelAAnnouncingPolicy node acts as a placeholder for restricted ProSe direct discovery model A announcing authorisation policy for non-public safety use.

- Occurrence: ZeroOrOne
- Format: node
- Access Types: Get, Replace
- Values: N/A

5.2.76 <X>/RestrictedDiscoveryPolicyForNonPS /RestrictedModelAAnnouncingPolicy/<X>

This interior node acts as a placeholder for one or more restricted ProSe direct discovery model A announcing authorisation policies for non-public safety use.

- Occurrence: OneOrMore
- Format: node
- Access Types: Get, Replace

- Values: N/A

5.2.77 <X>/RestrictedDiscoveryPolicyForNonPS /RestrictedModelAAnnouncingPolicy/<X>/PLMN

The PLMN leaf indicates the PLMN code of the operator in which the UE is authorised to use restricted ProSe direct discovery model A announcing for non-public safety use.

- Occurrence: One
- Format: chr
- Access Types: Get, Replace
- Values: <PLMN>

The format of the PLMN is defined by 3GPP TS 23.003 [6].

NOTE: The UE is prohibited from performing restricted ProSe direct discovery model A announcing in any PLMN for which no announcing authorisation policy is available.

5.2.78 <X>/RestrictedDiscoveryPolicyForNonPS /RestrictedModelAAnnouncingPolicy/<X> /ValidityTimerT4005

The ValidityTimerT4005 leaf indicates in unit of minutes for how long this restricted ProSe direct discovery model A announcing authorisation policy for non-public safety use is valid.

- Occurrence: One
- Format: int
- Access Types: Get, Replace
- Values: 1-525600

5.2.79 <X>/RestrictedDiscoveryPolicyForNonPS /RestrictedModelAAnnouncingPolicy/<X>/Range

The Range leaf indicates the authorised announcing range for restricted ProSe direct discovery model A in the PLMN in which this announcing authorisation policy for non-public safety use applies.

- Occurrence: ZeroOrOne
- Format: int
- Access Types: Get, Replace
- Values: <Range>

Possible values for the Range are specified in table 5.2.79.1.

Table 5.2.79.1: Values of Range leaf

Value	Description
0	Reserved
1	The authorised announcing range is set to: Short.
2	The authorised announcing range is set to: Medium.
3	The authorised announcing range is set to: Long.
4-255	Reserved

5.2.80 <X>/RestrictedDiscoveryPolicyForNonPS /RestrictedModelBDiscovererPolicy

The RestrictedModelBDiscovererPolicy node acts as a placeholder for restricted ProSe direct discovery model B discoverer operation authorisation policy for non-public safety use.

- Occurrence: ZeroOrOne
- Format: node
- Access Types: Get, Replace
- Values: N/A

5.2.81 <X>/RestrictedDiscoveryPolicyForNonPS /RestrictedModelBDiscovererPolicy/<X>

This interior node acts as a placeholder for one or more restricted ProSe direct discovery model B discoverer operation authorisation policies for non-public safety use.

- Occurrence: OneOrMore
- Format: node
- Access Types: Get, Replace
- Values: N/A

5.2.82 <X>/RestrictedDiscoveryPolicyForNonPS /RestrictedModelBDiscovererPolicy/<X>/PLMN

The PLMN leaf indicates the PLMN code of the operator in which the UE is authorised to use restricted ProSe direct discovery model B discoverer operation for non-public safety use.

- Occurrence: One
- Format: chr
- Access Types: Get, Replace
- Values: <PLMN>

The format of the PLMN is defined by 3GPP TS 23.003 [6].

NOTE: The UE is prohibited from performing restricted ProSe direct discovery model B discoverer operation in any PLMN for which no discoverer operation authorisation policy is available.

5.2.83 <X>/RestrictedDiscoveryPolicyForNonPS /RestrictedModelBDiscovererPolicy/<X> /ValidityTimerT4005

The ValidityTimerT4005 leaf indicates in unit of minutes for how long this restricted ProSe direct discovery model B discoverer operation authorisation policy for non-public safety use is valid.

- Occurrence: One
- Format: int
- Access Types: Get, Replace
- Values: 1-525600

5.2.84 <X>/RestrictedDiscoveryPolicyForNonPS /RestrictedModelBDiscovererPolicy/<X>/Range

The Range leaf indicates the authorised discoverer operation range for restricted ProSe direct discovery model B in the PLMN in which this discoverer operation authorisation policy for non-public safety use applies.

- Occurrence: ZeroOrOne
- Format: int
- Access Types: Get, Replace
- Values: <Range>

Possible values for the Range are specified in table 5.2.84.1.

Table 5.2.84.1: Values of Range leaf

Value	Description
0	Reserved
1	The authorised discoverer operation range is set to: Short.
2	The authorised discoverer operation range is set to: Medium.
3	The authorised discoverer operation range is set to: Long.
4-255	Reserved

5.2.85 <X>/RestrictedDiscoveryPolicyForNonPS /RestrictedModelBDiscovereePolicy

The RestrictedModelBDiscovereePolicy node acts as a placeholder for restricted ProSe direct discovery model B discoveree operation authorisation policy for non-public safety use.

- Occurrence: ZeroOrOne
- Format: node
- Access Types: Get, Replace
- Values: N/A

5.2.86 <X>/RestrictedDiscoveryPolicyForNonPS /RestrictedModelBDiscovereePolicy/<X>

This interior node acts as a placeholder for one or more restricted ProSe direct discovery model B discoveree operation authorisation policies for non-public safety use.

- Occurrence: OneOrMore
- Format: node
- Access Types: Get, Replace
- Values: N/A

5.2.87 <X>/RestrictedDiscoveryPolicyForNonPS /RestrictedModelBDiscovereePolicy/<X>/PLMN

The PLMN leaf indicates the PLMN code of the operator in which the UE is authorised to use restricted ProSe direct discovery model B discoveree operation for non-public safety use.

- Occurrence: One

- Format: chr
- Access Types: Get, Replace
- Values: <PLMN>

The format of the PLMN is defined by 3GPP TS 23.003 [6].

NOTE: The UE is prohibited from performing restricted ProSe direct discovery model B discoveree operation in any PLMN for which no discoveree operation authorisation policy is available.

5.2.88 <X>/RestrictedDiscoveryPolicyForNonPS /RestrictedModelBDiscovereePolicy/<X> /ValidityTimerT4005

The ValidityTimerT4005 leaf indicates in unit of minutes for how long this restricted ProSe direct discovery model B discoveree operation authorisation policy for non-public safety use is valid.

- Occurrence: One
- Format: int
- Access Types: Get, Replace
- Values: 1-525600

5.2.89 <X>/RestrictedDiscoveryPolicyForNonPS /RestrictedModelBDiscovereePolicy/<X>/Range

The Range leaf indicates the authorised discoveree operation range for restricted ProSe direct discovery model B in the PLMN in which this discoveree operation authorisation policy for non-public safety use applies.

- Occurrence: ZeroOrOne
- Format: int
- Access Types: Get, Replace
- Values: <Range>

Possible values for the Range are specified in table 5.2.89.1.

Table 5.2.89.1: Values of Range leaf

Value	Description
0	Reserved
1	The authorised discoveree operation range is set to: Short.
2	The authorised discoveree operation range is set to: Medium.
3	The authorised discoveree operation range is set to: Long.
4-255	Reserved

5.2.90 <X>/RestrictedDiscoveryPolicyForNonPS /ProSeDiscoveryUEIDInfo

The ProSeDiscoveryUEIDInfo node acts as a placeholder for the ProSe Discovery UE ID and its associated validity timer T4015, which are used for restricted ProSe direct discovery for non-Public Safety use.

- Occurrence: ZeroOrOne
- Format: node
- Access Types: Get, Replace

- Values: N/A

5.2.91 <X>/RestrictedDiscoveryPolicyForNonPS /ProSeDiscoveryUEIDInfo/ProSeDiscoveryUEID

The ProSeDiscoveryUEID leaf contains the ProSe Discovery UE ID assigned to the UE by the HPLMN ProSe Function for restricted ProSe direct discovery for non-Public Safety use.

- Occurrence: One
- Format: chr
- Access Types: Get, Replace
- Values: <ProSeDiscoveryUEID>

The format of the ProSe Discovery UE ID is defined by 3GPP TS 23.003 [6].

5.2.92 <X>/RestrictedDiscoveryPolicyForNonPS /ProSeDiscoveryUEIDInfo/ValidityTimerT4015

The ValidityTimerT4015 leaf indicates in unit of minutes for how long this ProSe Discovery UE ID is valid.

- Occurrence: One
- Format: int
- Access Types: Get, Replace
- Values: 1-525600

5.2.93 <X>/PublicSafetyDiscoveryPolicyNotInEUTRAN

The PublicSafetyDiscoveryPolicyNotInEUTRAN node acts as a placeholder for the description of the direct discovery authorisation when the UE is not served by E-UTRAN.

- Occurrence: ZeroOrOne
- Format: node
- Access Types: Get, Replace
- Values: N/A

5.2.94 <X>/PublicSafetyDiscoveryPolicyNotInEUTRAN/ MonitoringAuthorisationNotInEUTRAN

The MonitoringAuthorisationNotInEUTRAN leaf indicates whether the UE is authorised to perform ProSe direct discovery model A monitoring when not served by E-UTRAN.

- Occurrence: ZeroOrOne
- Format: bool
- Access Types: Get, Replace
- Values: 0, 1

0 Indicates that the UE is not authorised to perform ProSe direct discovery model A monitoring when not served by E-UTRAN.

1 Indicates that the UE is authorised to perform ProSe direct discovery model A monitoring when not served by E-UTRAN.

5.2.95 <X>/PublicSafetyDiscoveryPolicyNotInEUTRAN/ AnnouncingAuthorisationNotInEUTRAN

The AnnouncingAuthorisationNotInEUTRAN leaf indicates whether the UE is authorised to perform ProSe direct discovery model A announcing when not served by E-UTRAN.

- Occurrence: ZeroOrOne
 - Format: bool
 - Access Types: Get, Replace
 - Values: 0, 1
- 0 Indicates that the UE is not authorised to perform ProSe direct discovery model A announcing when not served by E-UTRAN.
- 1 Indicates that the UE is authorised to perform ProSe direct discovery model A announcing when not served by E-UTRAN.

5.2.96 <X>/PublicSafetyDiscoveryPolicyNotInEUTRAN/ DiscovereeAuthorisationNotInEUTRAN

The DiscovereeAuthorisationNotInEUTRAN leaf indicates whether the UE is authorised to perform ProSe direct discovery model B discoveree operation when not served by E-UTRAN.

- Occurrence: ZeroOrOne
 - Format: bool
 - Access Types: Get, Replace
 - Values: 0, 1
- 0 Indicates that the UE is not authorised to perform ProSe direct discovery model B discoveree operation when not served by E-UTRAN.
- 1 Indicates that the UE is authorised to perform ProSe direct discovery model B discoveree operation when not served by E-UTRAN.

5.2.97 <X>/PublicSafetyDiscoveryPolicyNotInEUTRAN/ DiscovererAuthorisationNotInEUTRAN

The DiscovererAuthorisationNotInEUTRAN leaf indicates whether the UE is authorised to perform ProSe direct discovery model B discoverer operation when not served by E-UTRAN.

- Occurrence: ZeroOrOne
 - Format: bool
 - Access Types: Get, Replace
 - Values: 0, 1
- 0 Indicates that the UE is not authorised to perform ProSe direct discovery model B discoverer operation when not served by E-UTRAN.
- 1 Indicates that the UE is authorised to perform ProSe direct discovery model B discoverer operation when not served by E-UTRAN.

5.2.98 <X>/PublicSafetyDiscoveryPolicyNotInEUTRAN/ DiscoveryRadioParameters

The DiscoveryRadioParameters node acts as a placeholder for the radio parameter information needed for the UE to perform ProSe direct discovery when the UE is not served by E-UTRAN.

- Occurrence: ZeroOrMore
- Format: node
- Access Types: Get, Replace
- Values: N/A

5.2.99 <X>/PublicSafetyDiscoveryPolicyNotInEUTRAN/ DiscoveryRadioParameters/<X>

This interior node acts as a placeholder for one or more set of radio parameters needed for the UE to perform ProSe direct discovery when the UE is not served by E-UTRAN.

- Occurrence: OneOrMore
- Format: node
- Access Types: Get, Replace
- Values: <N/A>

5.2.100 <X>/PublicSafetyDiscoveryPolicyNotInEUTRAN/ DiscoveryRadioParameters/<X>/RadioParametersContents

The RadioParametersContents leaf contains the radio parameters to be used to perform ProSe direct discovery when the UE is not served by E-UTRAN and the UE determines itself to be located in a geographical area associated with these radio parameters.

- Occurrence: One
- Format: bin
- Access Types: Get, Replace
- Values: <RadioParametersContents>

The RadioParameterContents is defined as *SL-Preconfiguration* in clause 9 of 3GPP TS 36.331 [10].

5.2.101 <X>/PublicSafetyDiscoveryPolicyNotInEUTRAN/ DiscoveryRadioParameters/<X>/GeographicalArea

The GeographicalArea node acts as a placeholder for one or more geographical areas associated with a set of radio parameters. The radio parameters are used by the UE for ProSe direct discovery when the UE is not served by E-UTRAN and within an associated geographical area.

- Occurrence: One
- Format: Node
- Access Types: Get, Replace
- Values: N/A

5.2.102 <X>/PublicSafetyDiscoveryPolicyNotInEUTRAN/ DiscoveryRadioParameters/<X>/GeographicalArea/Polygon

The Polygon node acts as a placeholder for polygon geographical area descriptions.

- Occurrence: ZeroOrOne
- Format: node
- Access Types: Get, Replace
- Values: N/A

5.2.103 <X>/PublicSafetyDiscoveryPolicyNotInEUTRAN/ DiscoveryRadioParameters/<X>/GeographicalArea/Polygon/<X>

This interior node acts as a placeholder for one or more polygon geographical area descriptions.

- Occurrence: OneOrMore
- Format: node
- Access Types: Get, Replace
- Values: <N/A >

5.2.104 <X>/PublicSafetyDiscoveryPolicyNotInEUTRAN/ DiscoveryRadioParameters /<X>/GeographicalArea/Polygon/<X>/Coordinates

The Coordinates node acts as a placeholder for geographical coordinates outlining the borders of a polygon geographical area.

- Occurrence: One
- Format: node
- Access Types: Get, Replace
- Values: N/A

5.2.105 <X>/PublicSafetyDiscoveryPolicyNotInEUTRAN/ DiscoveryRadioParameters/<X>/GeographicalArea/Polygon/<X>/Co ordinates/<X>

This interior node acts as a placeholder for one or more geographical coordinates.

- Occurrence: OneOrMore
- Format: node
- Access Types: Get, Replace
- Values: <N/A >

NOTE: The upper limit of 15 specified in 3GPP TS 23.032 [9] for the number of points in a polygon shape does not apply to the number of coordinates in a geographical area described as a polygon for ProSe direct communication.

5.2.106 <X>/PublicSafetyDiscoveryPolicyNotInEUTRAN/ DiscoveryRadioParameters/<X>/GeographicalArea/Polygon/<X>/ Coordinates/<X>/Latitude

The Latitude leaf contains the latitude of a geographical coordinate outlining the border of the polygon geographical area.

- Occurrence: One
- Format: bin
- Access Types: Get, Replace
- Values: <Latitude>

The Latitude is defined in subclause 6.1 of 3GPP TS 23.032 [9].

5.2.107 <X>/PublicSafetyDiscoveryPolicyNotInEUTRAN/ DiscoveryRadioParameters/<X>/GeographicalArea/Polygon/<X>/Co ordinates/<X>/Longitude

The Longitude leaf contains the longitude of a geographical coordinate outlining the border of the polygon geographical area.

- Occurrence: One
- Format: bin
- Access Types: Get, Replace
- Values: <Longitude>

The Longitude is defined in subclause 6.1 of 3GPP TS 23.032 [9].

5.2.108 <X>/UEToNetworkRelayPolicy

The UEToNetworkRelayPolicy node acts as a placeholder for ProSe UE-to-network relay authorisation policy.

- Occurrence: ZeroOrOne
- Format: node
- Access Types: Get, Replace
- Values: N/A

5.2.109 <X>/UEToNetworkRelayPolicy/AuthorisationForRemoteUE

The AuthorisationForRemoteUE leaf indicates whether the UE is authorised to act as a remote UE towards a ProSe UE-to-network relay UE.

- Occurrence: ZeroOrOne
- Format: bool
- Access Types: Get, Replace
- Values: 0,1

0 Indicates that the UE is not authorised to act as a remote UE towards a ProSe UE-to-network relay UE.

1 Indicates that the UE is authorised to act as a remote UE towards a ProSe UE-to-network relay UE.

5.2.110 Void

5.2.111 Void

5.2.112 Void

5.2.113 <X>/UEToNetworkRelayPolicy/AuthorisationForRelay

The AuthorisationForRelay node acts as a placeholder for the authorisation policy to act as a ProSe UE-to-network relay.

- Occurrence: ZeroOrOne
- Format: node
- Access Types: Get, Replace
- Values: N/A

5.2.113A <X>/UEToNetworkRelayPolicy/AuthorisationForRelay/ AuthorisedPLMNs

The AuthorisationInPLMN node acts as a placeholder for the per-PLMN authorisation policies to act as a ProSe UE-to-network relay.

- Occurrence: ZeroOrOne
- Format: node
- Access Types: Get, Replace
- Values: N/A

5.2.114 <X>/UEToNetworkRelayPolicy/AuthorisationForRelay/ AuthorisedPLMNs/<X>

This interior node acts as a placeholder for one or more authorisation policies to act as a ProSe UE-to-network relay.

- Occurrence: OneOrMore
- Format: node
- Access Types: Get, Replace
- Values: N/A

5.2.115 <X>/UEToNetworkRelayPolicy/AuthorisationForRelay/ AuthorisedPLMNs/<X>/PLMN

The PLMN leaf indicates the PLMN code of the operator in which the UE is authorised to act as a ProSe UE-to-network relay.

- Occurrence: One
- Format: chr
- Access Types: Get, Replace
- Values: <PLMN>

The format of the PLMN is defined by 3GPP TS 23.003 [6].

5.2.115A<X>/UEToNetworkRelayPolicy/AuthorisationForRelay/ AuthorisedPLMNs/<X>/RemoteUEIMEIReport

The RemoteUEIMEIReport leaf indicates whether the ProSe UE-to-network relay is configured to report the IMEI or IMEISV of remote UE(s) using the relay service provided by this ProSe UE-to-network relay.

- Occurrence: ZeroOrOne
 - Format: int
 - Access Types: Get, Replace
 - Values: 0, 1, 2
- 0 Indicates that the ProSe UE-to-network relay UE is not configured to report the IMEI or IMEISV of remote UE(s) using the relay service provided by this ProSe UE-to-network relay.
 - 1 Indicates that the ProSe UE-to-network relay UE is configured to report the IMEI of the remote UE(s) using the relay service provided by this ProSe UE-to-network relay.
 - 2 Indicates that the ProSe UE-to-network relay UE is configured to report the IMEISV of the remote UE(s) using the relay service provided by this ProSe UE-to-network relay.

The default value of 0 applies if this leaf is omitted.

5.2.116 <X>/UEToNetworkRelayPolicy/AuthorisationForRelay/ AuthorisedPLMNs/<X>/ValidityTimerT4005

The ValidityTimerT4005 leaf indicates in unit of minutes for how long this authorisation policy is valid.

- Occurrence: One
- Format: int
- Access Types: Get, Replace
- Values: 1-525600

5.2.116A<X>/UEToNetworkRelayPolicy/AuthorisationForRelay/ DLUnicastTrafficMappingRule

The DLUnicastTrafficMappingRule node acts as a placeholder for the mapping rules between the QCI of the EPS bearer and the ProSe Per-Packet Priority (PPPP) for downlink unicast traffic to be relayed over the PC5 interface.

- Occurrence: ZeroOrOne
- Format: node
- Access Types: Get, Replace
- Values: N/A

5.2.116B<X>/UEToNetworkRelayPolicy/AuthorisationForRelay/ DLUnicastTrafficMappingRule/<X>

This interior node acts as a placeholder for one or more mapping rules for downlink unicast traffic for a ProSe UE-to-network relay.

- Occurrence: OneOrMore

- Format: node
- Access Types: Get, Replace
- Values: N/A

5.2.116C <X>/UEToNetworkRelayPolicy/AuthorisationForRelay/ DLUnicastTrafficMappingRule/<X>/QCI

The QCI leaf indicates the QCI value of the EPS bearer configured by the mapping rule.

- Occurrence: One
- Format: int
- Access Types: Get, Replace
- Values: 0-255

5.2.116D <X>/UEToNetworkRelayPolicy/AuthorisationForRelay/ DLUnicastTrafficMappingRule/<X>/ProSePerPacketPriority

The ProSePerPacketPriority leaf indicates the ProSe Per-Packet Priority value to which the QCI value associated to the same mapping rule is mapped.

- Occurrence: One
- Format: int
- Access Types: Get, Replace
- Values: 1-8

5.2.117 <X>/PublicSafetyDiscoveryParameters

The PublicSafetyDiscoveryParameters node acts as a placeholder for ProSe direct discovery parameters for public safety use.

- Occurrence: ZeroOrOne
- Format: node
- Access Types: Get, Replace
- Values: N/A

5.2.118 <X>/PublicSafetyDiscoveryParameters /GroupMemberDiscoveryParameters

The GroupMemberDiscoveryParameters node acts as a placeholder for ProSe direct discovery parameters when it is used for Group Member Discovery.

- Occurrence: ZeroOrOne
- Format: node
- Access Types: Get, Replace
- Values: N/A

5.2.119 <X>/PublicSafetyDiscoveryParameters /GroupMemberDiscoveryParameters/UserInfoID

The UserInfoID leaf indicates the user information which is sent by the announcing or discoverer or discoveree UE over the air during Group Member Discovery procedures.

- Occurrence: One
- Format: chr
- Access Types: Get, Replace
- Values: <User Info ID>

5.2.120 <X>/PublicSafetyDiscoveryParameters /GroupMemberDiscoveryParameters/<X>

This interior node acts as a placeholder for one or more sets of ProSe direct discovery parameters when it is used for group member discovery.

- Occurrence: OneOrMore
- Format: node
- Access Types: Get, Replace
- Values: N/A

5.2.121 <X>/PublicSafetyDiscoveryParameters /GroupMemberDiscoveryParameters/<X>/DiscoveryGroupID

The DiscoveryGroupID leaf indicates the group ID of the discovery group that the UE belongs to when group member discovery is performed.

- Occurrence: One
- Format: chr
- Access Types: Get, Replace
- Values: <Group ID>

5.2.121A <X>/PublicSafetyDiscoveryParameters /GroupMemberDiscoveryParameters/<X>/ApplicationLayerGroupID

The ApplicationLayerGroupID leaf indicates the Application Layer Group ID identifying an application layer group that the UE belongs to.

- Occurrence: One
- Format: chr
- Access Types: Get, Replace
- Values: < Application Layer Group ID>

5.2.121B <X>/PublicSafetyDiscoveryParameters /GroupMemberDiscoveryParameters/<X>/PKMFAddress

The PKMFAddress leaf contains the address of the ProSe Key Management Function that the UE uses to obtain the security related contents (see 3GPP TS 33.303 [7]).

- Occurrence: ZeroOrOne
- Format: chr
- Access Types: Get, Replace
- Values: <an IPv4 address>, <an IPv6 address>.

The UE shall use the IP address of the HPLMN ProSe Function if this leaf is not provisioned.

5.2.122 <X>/PublicSafetyDiscoveryParameters/RelayDiscoveryParameters

The RelayDiscoveryParameters node acts as a placeholder for ProSe direct discovery parameters when it is used for ProSe UE-to-network relay discovery.

- Occurrence: ZeroOrOne
- Format: node
- Access Types: Get, Replace
- Values: N/A

5.2.123 <X>/PublicSafetyDiscoveryParameters/RelayDiscoveryParameters/UserInfoID

The UserInfoID leaf indicates the user information which is sent by the announcing or discoverer or discoveree UE over the air during ProSe UE-to-network relay discovery procedures.

- Occurrence: One
- Format: chr
- Access Types: Get, Replace
- Values: <User Info ID>

5.2.124 <X>/PublicSafetyDiscoveryParameters/RelayDiscoveryParameters/RemoteUEParameters

The RemoteUEParameters node acts as a placeholder for ProSe direct discovery parameters at the remote UE for ProSe UE-to-network relay discovery.

- Occurrence: ZeroOrOne
- Format: node
- Access Types: Get, Replace
- Values: N/A

5.2.125 <X>/PublicSafetyDiscoveryParameters/RelayDiscoveryParameters/RemoteUEParameters/<X>

This interior node acts as a placeholder for one or more sets of ProSe direct discovery parameters at the remote UE for ProSe UE-to-network relay discovery.

- Occurrence: OneOrMore
- Format: node
- Access Types: Get, Replace

- Values: N/A

5.2.126 <X>/PublicSafetyDiscoveryParameters/RelayDiscoveryParameters/RemoteUEParameters/<X>/RelayServiceCode

The RelayServiceCode leaf indicates the connectivity service that the ProSe UE-to-network relay provides to public safety applications.

- Occurrence: One
- Format: chr
- Access Types: Get, Replace
- Values: <Relay Service Code>

5.2.127 <X>/PublicSafetyDiscoveryParameters/RelayDiscoveryParameters/RemoteUEParameters/<X>/UserInfoIDOfRelay

The UserInfoIDOfRelay leaf indicates the user information of the ProSe UE-to-network relay that the remote UE seeks to discover during ProSe UE-to-network relay discovery procedures.

- Occurrence: ZeroOrOne
- Format: chr
- Access Types: Get, Replace
- Values: <User Info ID>

5.2.128 <X>/PublicSafetyDiscoveryParameters/RelayDiscoveryParameters/RemoteUEParameters/<X>/IPVersions

The IPVersions leaf indicates the IP version(s) that the remote UE can use for the relay traffic associated with the Relay Service Code.

- Occurrence: One
- Format: chr
- Access Types: Get, Replace
- Values: 'IPv4', 'IPv6', 'IPv4v6'

5.2.129 <X>/PublicSafetyDiscoveryParameters/RelayDiscoveryParameters/RemoteUEParameters/<X>/PKMFAddress

The PKMFAddress leaf contains the address of the ProSe Key Management Function that the UE uses to obtain the security related contents (see 3GPP TS 33.303 [7]).

- Occurrence: ZeroOrOne
- Format: chr
- Access Types: Get, Replace
- Values: <an IPv4 address>, <an IPv6 address>.

The UE shall use the IP address of the HPLMN ProSe Function if this leaf is not provisioned.

5.2.130 <X>/PublicSafetyDiscoveryParameters/RelayDiscoveryParameters/RelayParameters

The RelayParameters node acts as a placeholder for ProSe direct discovery parameters at the ProSe UE-to-network relay.

- Occurrence: ZeroOrOne
- Format: node
- Access Types: Get, Replace
- Values: N/A

5.2.131 <X>/PublicSafetyDiscoveryParameters/RelayDiscoveryParameters/RelayParameters/<X>

This interior node acts as a placeholder for one or more sets of ProSe direct discovery parameters at the ProSe UE-to-network relay.

- Occurrence: OneOrMore
- Format: node
- Access Types: Get, Replace
- Values: N/A

5.2.132 <X>/PublicSafetyDiscoveryParameters/RelayDiscoveryParameters/RelayParameters/<X>/RelayServiceCode

The RelayServiceCode leaf indicates the connectivity service that the ProSe UE-to-network relay provides to public safety applications.

- Occurrence: One
- Format: chr
- Access Types: Get, Replace
- Values: <Relay Service Code>

5.2.133 <X>/PublicSafetyDiscoveryParameters/RelayDiscoveryParameters/RelayParameters/<X>/PDNType

The PDNType leaf indicates the IP version of the PDN connection to be used for the relayed traffic associated with a Relay Service Code.

- Occurrence: ZeroOrOne
- Format: chr
- Access Types: Get, Replace
- Values: 'IPv4', 'IPv6'

5.2.134 <X>/PublicSafetyDiscoveryParameters/RelayDiscoveryParameters/RelayParameters/<X>/APN

The APN leaf indicates the PDN connection that the ProSe UE-to-network relay uses for the relayed traffic associated with a Relay Service Code.

If this leaf is omitted, then the default APN is used for the PDN connectivity.

- Occurrence: ZeroOrOne
- Format: chr
- Access Types: Get, Replace
- Values: < A network access point object >

5.2.135 <X>/PublicSafetyDiscoveryParameters/RelayDiscoveryParameters/RelayParameters/<X>/ProSeRelayUEID

The ProSeRelayUEID leaf indicates the link layer identifier used for direct communication associated with a Relay Service Code.

- Occurrence: One
- Format: chr
- Access Types: Get, Replace
- Values: < ProSe UE ID>

5.2.136 <X>/PublicSafetyDiscoveryParameters/RelayDiscoveryParameters/RelayParameters/<X>/PKMFAddress

The PKMFAddress leaf contains the address of the ProSe Key Management Function that the UE uses to obtain the group security related contents (see 3GPP TS 33.303 [7]).

- Occurrence: ZeroOrOne
- Format: chr
- Access Types: Get, Replace
- Values: <an IPv4 address>, <an IPv6 address>.

The UE shall use the IP address of the HPLMN ProSe Function if this leaf is not provisioned.

5.2.137 <X>/OneToOneDirectCommunicationPolicy

The OneToOneDirectCommunicationPolicy node acts as a placeholder for one-to-one ProSe direct communication authorisation policy.

- Occurrence: ZeroOrOne
- Format: node
- Access Types: Get, Replace
- Values: N/A

5.2.138 <X>/OneToOneDirectCommunicationPolicy/<X>

This interior node acts as a placeholder for one or more one-to-one ProSe direct communication authorisation policies.

- Occurrence: OneOrMore
- Format: node
- Access Types: Get, Replace

- Values: N/A

5.2.139 <X>/OneToOneDirectCommunicationPolicy /<X>/PLMN

The PLMN leaf indicates the PLMN code of the operator in which the UE is authorised to use one-to-one ProSe direct communication.

- Occurrence: One
- Format: chr
- Access Types: Get, Replace
- Values: <PLMN>

The format of the PLMN is defined by 3GPP TS 23.003 [6].

- NOTE: The UE is prohibited from performing one-to-one ProSe direct communication in any PLMN for which no one-to-one ProSe direct communication authorisation policy is available.

5.2.140 <X>/OneToOneDirectCommunicationPolicy /<X>/ValidityTimerT4005

The ValidityTimerT4005 leaf indicates in unit of minutes for how long this authorisation policy is valid.

- Occurrence: One
- Format: int
- Access Types: Get, Replace
- Values: 1-525600

5.2.141 <X>/OneToOneDirectCommunicationParameters

The OneToOneDirectCommunicationParameters node acts as a placeholder for one-to-one ProSe direct communication parameters.

- Occurrence: ZeroOrOne
- Format: node
- Access Types: Get, Replace
- Values: N/A

5.2.142 <X>/OneToOneDirectCommunicationParameters /ApplicationLayerGroup/<X>/Layer2IDForUnicastCommunication

The Layer2IDForUnicastCommunication leaf indicates the link layer identifier used for one-to-one direct communication.

- Occurrence: One
- Format: chr
- Access Types: Get, Replace
- Values: < ProSe UE ID>

5.2.142A <X>/OneToOneDirectCommunicationParameters /PC5SignallingPriority

The PC5SignallingPriority leaf indicates the provisioned ProSe Per-Packet Priority value used for any outgoing PC5 signalling message over a one-to-one direct communication link.

- Occurrence: One
- Format: int
- Access Types: Get, Replace
- Values: 1-8

5.2.143 <X>/OneToOneDirectCommunicationParameters /ApplicationLayerGroup/<X>/KMSAddress

The KMSAddress leaf contains the address of the Key Management Server that the UE uses to obtain the security related contents (see 3GPP TS 33.303 [7]).

- Occurrence: ZeroOrOne
- Format: chr
- Access Types: Get, Replace
- Values: <an IPv4 address>, <an IPv6 address>.

The UE shall use the IP address of the HPLMN ProSe Function if this leaf is not provisioned.

5.2.143A <X>/OneToOneDirectCommunicationParameters /ApplicationLayerGroup/<X>/ApplicationLayerGroupID

The ApplicationLayerGroupID leaf indicates the Application Layer Group ID identifying an application layer group that the UE belongs to.

- Occurrence: One
- Format: chr
- Access Types: Get, Replace
- Values: < Application Layer Group ID>

5.2.144 <X>/DiscoveryPolicyForPS

The DiscoveryPolicyForPS node acts as a placeholder for ProSe direct discovery authorisation policies for public safety use.

- Occurrence: ZeroOrOne
- Format: node
- Access Types: Get, Replace

5.2.145 <X>/DiscoveryPolicyForPS /ModelAMonitoringPolicy

The ModelAMonitoringPolicy node acts as a placeholder for ProSe direct discovery model A monitoring authorisation policy for public safety use.

- Occurrence: ZeroOrOne

- Format: node
- Access Types: Get, Replace
- Values: N/A

5.2.146 <X>/DiscoveryPolicyForPS /ModelAMonitoringPolicy/<X>

This interior node acts as a placeholder for one or more ProSe direct discovery model A monitoring authorisation policies for public safety use.

- Occurrence: OneOrMore
- Format: node
- Access Types: Get, Replace
- Values: N/A

5.2.147 <X>/DiscoveryPolicyForPS /ModelAMonitoringPolicy/<X>/PLMN

The PLMN leaf indicates the PLMN code of the operator in which the UE is authorised to use ProSe direct discovery model A monitoring for public safety use.

- Occurrence: One
- Format: chr
- Access Types: Get, Replace
- Values: <PLMN>

The format of the PLMN is defined by 3GPP TS 23.003 [6].

NOTE: The UE is prohibited from performing ProSe direct discovery model A monitoring for public safety use in any PLMN for which no monitoring authorisation policy is available.

5.2.148 <X>/DiscoveryPolicyForPS /ModelAMonitoringPolicy/<X>/ValidityTimerT4005

The ValidityTimerT4005 leaf indicates in unit of minutes for how long this ProSe direct discovery model A monitoring authorisation policy for public safety use is valid.

- Occurrence: One
- Format: int
- Access Types: Get, Replace
- Values: 1-525600

5.2.149 <X>/DiscoveryPolicyForPS /ModelAAnnouncingPolicy

The ModelAAnnouncingPolicy node acts as a placeholder for ProSe direct discovery model A announcing authorisation policy for public safety use.

- Occurrence: ZeroOrOne
- Format: node

- Access Types: Get, Replace
- Values: N/A

5.2.150 <X>/DiscoveryPolicyForPS /ModelAAnnouncingPolicy/<X>

This interior node acts as a placeholder for one or more ProSe direct discovery model A announcing authorisation policies for public safety use.

- Occurrence: OneOrMore
- Format: node
- Access Types: Get, Replace
- Values: N/A

5.2.151 <X>/DiscoveryPolicyForPS /ModelAAnnouncingPolicy/<X>/PLMN

The PLMN leaf indicates the PLMN code of the operator in which the UE is authorised to use ProSe direct discovery model A announcing for public safety use.

- Occurrence: One
- Format: chr
- Access Types: Get, Replace
- Values: <PLMN>

The format of the PLMN is defined by 3GPP TS 23.003 [6].

- NOTE: The UE is prohibited from performing ProSe direct discovery model A announcing for public safety use in any PLMN for which no announcing authorisation policy is available.

5.2.152 <X>/DiscoveryPolicyForPS /ModelAAnnouncingPolicy/<X>/ValidityTimerT4005

The ValidityTimerT4005 leaf indicates in unit of minutes for how long this ProSe direct discovery model A announcing authorisation policy for public safety use is valid.

- Occurrence: One
- Format: int
- Access Types: Get, Replace
- Values: 1-525600

5.2.152A <X>/DiscoveryPolicyForPS /ModelAAnnouncingPolicy/<X>/Range

The Range leaf indicates the authorised announcing range for ProSe direct discovery model A in the PLMN in which this announcing authorisation policy for public safety use applies.

- Occurrence: ZeroOrOne
- Format: int
- Access Types: Get, Replace

- Values: <Range>

Possible values for the Range are specified in table 5.2.152A.1.

Table 5.2.152A.1: Values of Range leaf

Value	Description
0	Reserved
1	The authorised announcing range is set to: Short.
2	The authorised announcing range is set to: Medium.
3	The authorised announcing range is set to: Long.
4-255	Reserved

5.2.153 <X>/DiscoveryPolicyForPS /ModelBDiscovererPolicy

The ModelBDiscovererPolicy node acts as a placeholder for ProSe direct discovery model B discoverer operation authorisation policy for public safety use.

- Occurrence: ZeroOrOne
- Format: node
- Access Types: Get, Replace
- Values: N/A

5.2.154 <X>/DiscoveryPolicyForPS /ModelBDiscovererPolicy/<X>

This interior node acts as a placeholder for one or more ProSe direct discovery model B discoverer operation authorisation policies for public safety use.

- Occurrence: OneOrMore
- Format: node
- Access Types: Get, Replace
- Values: N/A

5.2.155 <X>/DiscoveryPolicyForPS /ModelBDiscovererPolicy/<X>/PLMN

The PLMN leaf indicates the PLMN code of the operator in which the UE is authorised to use ProSe direct discovery model B discoverer operation for public safety use.

- Occurrence: One
- Format: chr
- Access Types: Get, Replace
- Values: <PLMN>

The format of the PLMN is defined by 3GPP TS 23.003 [6].

NOTE: The UE is prohibited from performing ProSe direct discovery model B discoverer operation for public safety use in any PLMN for which no discoverer operation authorisation policy is available.

5.2.156 <X>/DiscoveryPolicyForPS /ModelBDiscovererPolicy/<X>/ValidityTimerT4005

The ValidityTimerT4005 leaf indicates in unit of minutes for how long this ProSe direct discovery model B discoverer operation authorisation policy for public safety use is valid.

- Occurrence: One
- Format: int
- Access Types: Get, Replace
- Values: 1-525600

5.2.156A <X>/DiscoveryPolicyForPS /ModelBDiscovererPolicy/<X>/Range

The Range leaf indicates the authorised discoverer operation range for ProSe direct discovery model B in the PLMN in which this discoverer operation authorisation policy for public safety use applies.

- Occurrence: ZeroOrOne
- Format: int
- Access Types: Get, Replace
- Values: <Range>

Possible values for the Range are specified in table 5.2.156A.1.

Table 5.2.156A.1: Values of Range leaf

Value	Description
0	Reserved
1	The authorised discoverer operation range is set to: Short.
2	The authorised discoverer operation range is set to: Medium.
3	The authorised discoverer operation range is set to: Long.
4-255	Reserved

5.2.157 <X>/DiscoveryPolicyForPS /ModelBDiscovereePolicy

The ModelBDiscovereePolicy node acts as a placeholder for ProSe direct discovery model B discoveree operation authorisation policy for public safety use.

- Occurrence: ZeroOrOne
- Format: node
- Access Types: Get, Replace
- Values: N/A

5.2.158 <X>/DiscoveryPolicyForPS /ModelBDiscovereePolicy/<X>

This interior node acts as a placeholder for one or more ProSe direct discovery model B discoveree operation authorisation policies for public safety use.

- Occurrence: OneOrMore

- Format: node
- Access Types: Get, Replace
- Values: N/A

5.2.159 <X>/DiscoveryPolicyForPS /ModelBDiscovereePolicy/<X>/PLMN

The PLMN leaf indicates the PLMN code of the operator in which the UE is authorised to use ProSe direct discovery model B discoveree operation for public safety use.

- Occurrence: One
- Format: chr
- Access Types: Get, Replace
- Values: <PLMN>

The format of the PLMN is defined by 3GPP TS 23.003 [6].

NOTE: The UE is prohibited from performing ProSe direct discovery model B discoveree operation in any PLMN for which no discoveree operation authorisation policy for public safety use is available.

5.2.160A <X>/DiscoveryPolicyForPS /ModelBDiscovereePolicy/<X>/Range

The Range leaf indicates the authorised discoveree operation range for ProSe direct discovery model B in the PLMN in which this discoveree operation authorisation policy for public safety use applies.

- Occurrence: ZeroOrOne
- Format: int
- Access Types: Get, Replace
- Values: <Range>

Possible values for the Range are specified in table 5.2.160A.1.

Table 5.2.160A.1: Values of Range leaf

Value	Description
0	Reserved
1	The authorised discoveree operation range is set to: Short.
2	The authorised discoveree operation range is set to: Medium.
3	The authorised discoveree operation range is set to: Long.
4-255	Reserved

5.2.160 <X>/RestrictedDiscoveryPolicyForPS /RestrictedModelBDiscovereePolicy/<X>/ValidityTimerT4005

The ValidityTimerT4005 leaf indicates in unit of minutes for how long this restricted ProSe direct discovery model B discoveree operation authorisation policy is valid.

- Occurrence: One
- Format: int
- Access Types: Get, Replace

- Values: 1-525600

5.2.161 <X>/Ext

The Ext is an interior node for where the vendor specific information about the ProSe Public Safety Direct Services Provisioning MO is being placed (vendor meaning application vendor, device vendor etc.). Usually the vendor extension is identified by vendor specific name under the ext node. The tree structure under the vendor identifier is not defined and can therefore include one or more un-standardized sub-trees.

- Occurrence: ZeroOrOne
- Format: node
- Access Types: Get
- Values: N/A

6 EPC-level ProSe discovery Provisioning MO

6.1 Overview

The EPC-level ProSe discovery Provisioning MO is used to manage configuration parameters related to the EPC-level ProSe discovery.

The MO identifier is: urn:oma:mo:ext-3gpp-EPC-level-prose-discovery-provisioning:1.0.

The UE may initiate the provision of all available information from the DPF, using a client-initiated session Alert message of code "Generic Alert" (see OMA-TS-DM_Protocol-V1_2 [5]). When requesting all available information from the DPF, the "Type" element of the OMA DM generic alert message shall be set to "urn:oma:mo:ext-3gpp-EPC-level-prose-discovery-provisioning:1.0:provision", the "LocURI" element (inside the "Source" element) shall be set to the address of the EPC-level ProSe discovery Provisioning MO as specified by OMA-TS-DM_Protocol-V1_2 [5] and the "Data" element is not included.

The OMA DM Access Control List (ACL) property mechanism (see OMA-ERELD-DM-V1_2 [3]) may be used to grant or deny access rights to OMA DM servers in order to modify nodes and leaf objects of the EPC-level ProSe discovery Provisioning MO.

The following nodes and leaf objects are possible in the EPC-level ProSe discovery Provisioning MO as described in figure 6.1.1:

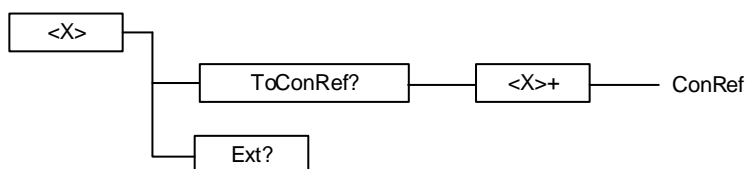

Figure 6.1.1: EPC-level ProSe discovery Provisioning MO

6.2 EPC-level ProSe discovery Provisioning MO parameters

6.2.1 General

This clause describes the parameters for the EPC-level ProSe discovery Provisioning MO.

6.2.2 <X>/ToConRef

The ToConRef interior node is used to allow application to refer to a collection of connectivity definitions. Several connectivity parameters can be listed for a given application under this interior node.

This interior node contains configuration parameters for establishment of the PDN connection for reaching the HPLMN ProSe Function.

- Occurrence: ZeroOrOne
- Format: node
- Access Types: Get, Replace
- Values: N/A

6.2.3 <X>/ToConRef/<X>

This run-time node acts as a placeholder for each reference to connectivity parameters.

- Occurrence: OneOrMore
- Format: Node
- Access Types: Get, Replace
- Values: N/A

6.2.4 <X>/ToConRef/<X>/ConRef

The ConRef specifies a specific linkage to connectivity parameters.

- Occurrence: One
- Format: Chr
- Access Types: Get, Replace
- Values: <A network access point object>

6.2.5 <X>/Ext

The Ext is an interior node for where the vendor specific information about the EPC-level ProSe discovery Provisioning MO is being placed (vendor meaning application vendor, device vendor etc.). Usually the vendor extension is identified by vendor specific name under the ext node. The tree structure under the vendor identifier is not defined and can therefore include one or more un-standardized sub-trees.

- Occurrence: ZeroOrOne
- Format: node
- Access Types: Get
- Values: N/A

Annex A (informative): ProSe Direct Services Provisioning MO DDF

This DDF is the standardized minimal set. A vendor can define its own DDF for the complete device. This DDF can include more features than this minimal standardized version.

```
<?xml version="1.0" encoding="UTF-8"?>
<!DOCTYPE MgmtTree PUBLIC "-//OMA//DTD-DM-DDF 1.2//EN"
"http://www.openmobilealliance.org/tech/DTD/dm_ddf-v1_2.dtd">

<MgmtTree>
  <VerDTD>1.2</VerDTD>
  <Man>--The device manufacturer--</Man>
  <Mod>--The device model--</Mod>

  <Node>
    <NodeName/>
    <DFProperties>
      <AccessType>
        <Get/>
      </AccessType>
      <Description>ProSe Direct Services Provisioning</Description>
      <DFFormat>
        <node/>
      </DFFormat>
      <Occurrence>
        <ZeroOrOne/>
      </Occurrence>
      <DFTitle>The ProSe Direct Services Provisioning Management Object.</DFTitle>
      <DFType>
        <DDFName/>urn:oma:mo:ext-3gpp-prose-direct-provisioning:1.0<DDFName/>
      </DFType>
    </DFProperties>

    <Node>
      <NodeName>MonitoringPolicy</NodeName>
      <!-- The MonitoringPolicy node starts here. -->
      <DFProperties>
        <AccessType>
          <Get/>
          <Replace/>
        </AccessType>
        <DFFormat>
          <node/>
        </DFFormat>
        <Occurrence>
          <ZeroOrOne/>
        </Occurrence>
        <DFTitle>Monitoring authorisation policies for ProSe Direct Services.</DFTitle>
        <DFType>
          <DDFName/>
        </DFType>
      </DFProperties>

    <Node>
      <NodeName></NodeName>
      <DFProperties>
        <AccessType>
          <Get/>
          <Replace/>
        </AccessType>
        <DFFormat>
          <node/>
        </DFFormat>
        <Occurrence>
          <OneOrMore/>
        </Occurrence>
        <DFType>
          <DDFName></DDFName>
        </DFType>
      </DFProperties>

    <Node>
      <NodeName>PLMN</NodeName>
      <DFProperties>
```

```

        <AccessType>
          <Get/>
          <Replace/>
        </AccessType>
        <DFFormat>
          <chr/>
        </DFFormat>
        <Occurrence>
          <One/>
        </Occurrence>
        <DFTitle>PLMN code.</DFTitle>
        <DFType>
          <MIME>text/plain</MIME>
        </DFType>
      </DFProperties>
    </Node>

    <Node>
      <NodeName>ValidityTimerT4005</NodeName>
      <DFProperties>
        <AccessType>
          <Get/>
          <Replace/>
        </AccessType>
        <DFFormat>
          <int/>
        </DFFormat>
        <Occurrence>
          <One/>
        </Occurrence>
        <DFTitle>Validity Timer T4005 for monitoring policy.</DFTitle>
        <DFType>
          <DDFName/>
        </DFType>
      </DFProperties>
    </Node>

  </Node>
</Node>

<Node>
  <NodeName>AnnouncingPolicy</NodeName>
  <!-- The AnnouncingPolicy node starts here. -->
  <DFProperties>
    <AccessType>
      <Get/>
      <Replace/>
    </AccessType>
    <DFFormat>
      <node/>
    </DFFormat>
    <Occurrence>
      <ZeroOrOne/>
    </Occurrence>
    <DFTitle>Announcing authorisation policies for ProSe Direct Services.</DFTitle>
    <DFType>
      <DDFName/>
    </DFType>
  </DFProperties>

  <Node>
    <NodeName></NodeName>
    <DFProperties>
      <AccessType>
        <Get/>
        <Replace/>
      </AccessType>
      <DFFormat>
        <node/>
      </DFFormat>
      <Occurrence>
        <OneOrMore/>
      </Occurrence>
      <DFType>
        <DDFName></DDFName>
      </DFType>
    </DFProperties>
  </Node>

```

```

<Node>
  <NodeName>PLMN</NodeName>
  <DFProperties>
    <AccessType>
      <Get/>
      <Replace/>
    </AccessType>
    <DFFormat>
      <chr/>
    </DFFormat>
    <Occurrence>
      <One/>
    </Occurrence>
    <DFTitle>PLMN code.</DFTitle>
    <DFType>
      <MIME>text/plain</MIME>
    </DFType>
  </DFProperties>
</Node>

<Node>
  <NodeName>ValidityTimerT4005</NodeName>
  <DFProperties>
    <AccessType>
      <Get/>
      <Replace/>
    </AccessType>
    <DFFormat>
      <int/>
    </DFFormat>
    <Occurrence>
      <One/>
    </Occurrence>
    <DFTitle>Validity Timer T4005 for announcing policy.</DFTitle>
    <DFType>
      <DDFName/>
    </DFType>
  </DFProperties>
</Node>

<Node>
  <NodeName>Range</NodeName>
  <DFProperties>
    <AccessType>
      <Get/>
      <Replace/>
    </AccessType>
    <DFFormat>
      <int/>
    </DFFormat>
    <Occurrence>
      <ZeroOrOne/>
    </Occurrence>
    <DFTitle>Authorised range for announcing.</DFTitle>
    <DFType>
      <DDFName/>
    </DFType>
  </DFProperties>
</Node>

</Node>
</Node>

<Node>
  <NodeName>ToConRef</NodeName>
  <DFProperties>
    <AccessType>
      <Get/>
    </AccessType>
    <DFFormat>
      <node/>
    </DFFormat>
    <Occurrence>
      <ZeroOrOne/>
    </Occurrence>
    <DFTitle>collection of connectivity definitions</DFTitle>
    <DFType>

```

```

        <DDFName/>
    </DFType>
</DFProperties>
</Node>
<Node>
    <NodeName/>
    <DFProperties>
        <AccessType>
            <Get/>
            <Replace/>
        </AccessType>
        <DFFormat>
            <node/>
        </DFFormat>
        <Occurrence>
            <OneOrMore/>
        </Occurrence>
        <DFTitle>The name node for one or more connectivity parameters</DFTitle>
        <DFType>
            <DDFName/>
        </DFType>
    </DFProperties>
    <Node>
        <NodeName>ConRef</NodeName>
        <DFProperties>
            <AccessType>
                <Get/>
                <Replace/>
            </AccessType>
            <DFFormat>
                <chr/>
            </DFFormat>
            <Occurrence>
                <One/>
            </Occurrence>
            <DFTitle>Linkage to connectivity parameters</DFTitle>
            <DFType>
                <MIME>text/plain</MIME>
            </DFType>
        </DFProperties>
    </Node>
</Node>
</Node>
</Node>
<Node>
    <NodeName>RestrictedModelAMonitoringPolicy</NodeName>
    <!-- The RestrictedModelAMonitoringPolicy node starts here. -->
    <DFProperties>
        <AccessType>
            <Get/>
            <Replace/>
        </AccessType>
        <DFFormat>
            <node/>
        </DFFormat>
        <Occurrence>
            <ZeroOrOne/>
        </Occurrence>
        <DFTitle>Restricted model A monitoring authorisation policies for ProSe Direct
Services.</DFTitle>
        <DFType>
            <DDFName/>
        </DFType>
    </DFProperties>
    <Node>
        <NodeName></NodeName>
        <DFProperties>
            <AccessType>
                <Get/>
                <Replace/>
            </AccessType>
            <DFFormat>
                <node/>
            </DFFormat>
            <Occurrence>
                <OneOrMore/>
            </Occurrence>
        <DFType>

```

```

        <DDFName></DDFName>
      </DFType>
    </DFProperties>

    <Node>
      <NodeName>PLMN</NodeName>
      <DFProperties>
        <AccessType>
          <Get />
          <Replace />
        </AccessType>
        <DFFormat>
          <chr />
        </DFFormat>
        <Occurrence>
          <One />
        </Occurrence>
        <DFTitle>PLMN code.</DFTitle>
        <DFType>
          <MIME>text/plain</MIME>
        </DFType>
      </DFProperties>
    </Node>

    <Node>
      <NodeName>ValidityTimerT4005</NodeName>
      <DFProperties>
        <AccessType>
          <Get />
          <Replace />
        </AccessType>
        <DFFormat>
          <int />
        </DFFormat>
        <Occurrence>
          <One />
        </Occurrence>
        <DFTitle>Validity Timer T4005 for restricted model A monitoring
policy.</DFTitle>
        <DFType>
          <DDFName />
        </DFType>
      </DFProperties>
    </Node>

  </Node>
</Node>

<Node>
  <NodeName>RestrictedModelAAnnouncingPolicy</NodeName>
  <!-- The RestrictedModelAAnnouncingPolicy node starts here. -->
  <DFProperties>
    <AccessType>
      <Get />
      <Replace />
    </AccessType>
    <DFFormat>
      <node />
    </DFFormat>
    <Occurrence>
      <ZeroOrOne />
    </Occurrence>
    <DFTitle>Restricted model A announcing authorisation policies for ProSe Direct
Services.</DFTitle>
    <DFType>
      <DDFName />
    </DFType>
  </DFProperties>

  <Node>
    <NodeName></NodeName>
    <DFProperties>
      <AccessType>
        <Get />
        <Replace />
      </AccessType>
      <DFFormat>
        <node />
      </DFFormat>
    </DFProperties>
  </Node>

```



```

        </DFFormat>
        <Occurrence>
            <OneOrMore/>
        </Occurrence>
        <DFType>
            <DDFName></DDFName>
        </DFType>
    </DFProperties>

    <Node>
        <NodeName>PLMN</NodeName>
        <DFProperties>
            <AccessType>
                <Get/>
                <Replace/>
            </AccessType>
            <DFFormat>
                <chr/>
            </DFFormat>
            <Occurrence>
                <One/>
            </Occurrence>
            <DFTitle>PLMN code.</DFTitle>
            <DFType>
                <MIME>text/plain</MIME>
            </DFType>
        </DFProperties>
    </Node>

    <Node>
        <NodeName>ValidityTimerT4005</NodeName>
        <DFProperties>
            <AccessType>
                <Get/>
                <Replace/>
            </AccessType>
            <DFFormat>
                <int/>
            </DFFormat>
            <Occurrence>
                <One/>
            </Occurrence>
            <DFTitle>Validity Timer T4005 for restricted model A announcing
policy.</DFTitle>
            <DFType>
                <DDFName/>
            </DFType>
        </DFProperties>
    </Node>

    <Node>
        <NodeName>Range</NodeName>
        <DFProperties>
            <AccessType>
                <Get/>
                <Replace/>
            </AccessType>
            <DFFormat>
                <int/>
            </DFFormat>
            <Occurrence>
                <ZeroOrOne/>
            </Occurrence>
            <DFTitle>Authorised range for restricted model A announcing.</DFTitle>
            <DFType>
                <DDFName/>
            </DFType>
        </DFProperties>
    </Node>

    </Node>
</Node>

<Node>
    <NodeName>RestrictedModelBDiscovererPolicy</NodeName>
    <!-- The RestrictedModelBDiscovererPolicy node starts here. -->
    <DFProperties>
        <AccessType>

```

```

        <Get/>
        <Replace/>
    </AccessType>
    <DFFormat>
        <node/>
    </DFFormat>
    <Occurrence>
        <ZeroOrOne/>
    </Occurrence>
    <DFTitle>Restricted model B discoverer operation authorisation policies for ProSe
Direct Services.</DFTitle>
    <DFType>
        <DDFName/>
    </DFType>
</DFProperties>

<Node>
    <NodeName></NodeName>
    <DFProperties>
        <AccessType>
            <Get/>
            <Replace/>
        </AccessType>
        <DFFormat>
            <node/>
        </DFFormat>
        <Occurrence>
            <OneOrMore/>
        </Occurrence>
        <DFType>
            <DDFName></DDFName>
        </DFType>
    </DFProperties>

<Node>
    <NodeName>PLMN</NodeName>
    <DFProperties>
        <AccessType>
            <Get/>
            <Replace/>
        </AccessType>
        <DFFormat>
            <chr/>
        </DFFormat>
        <Occurrence>
            <One/>
        </Occurrence>
        <DFTitle>PLMN code.</DFTitle>
        <DFType>
            <MIME>text/plain</MIME>
        </DFType>
    </DFProperties>
</Node>

<Node>
    <NodeName>ValidityTimerT4005</NodeName>
    <DFProperties>
        <AccessType>
            <Get/>
            <Replace/>
        </AccessType>
        <DFFormat>
            <int/>
        </DFFormat>
        <Occurrence>
            <One/>
        </Occurrence>
        <DFTitle>Validity Timer T4005 for restricted model B discoverer operation
policy.</DFTitle>
        <DFType>
            <DDFName/>
        </DFType>
    </DFProperties>
</Node>

<Node>
    <NodeName>Range</NodeName>
    <DFProperties>

```

```

        <AccessType>
          <Get/>
          <Replace/>
        </AccessType>
        <DFFormat>
          <int/>
        </DFFormat>
        <Occurrence>
          <ZeroOrOne/>
        </Occurrence>
        <DFTitle>Authorised range for restricted model B discoverer
operation.</DFTitle>
        <DFType>
          <DDFName/>
        </DFType>
      </DFProperties>
    </Node>

  </Node>
</Node>

<Node>
  <NodeName>RestrictedModelBDiscovererPolicy</NodeName>
  <!-- The RestrictedModelBDiscovererPolicy node starts here. -->
  <DFProperties>
    <AccessType>
      <Get/>
      <Replace/>
    </AccessType>
    <DFFormat>
      <node/>
    </DFFormat>
    <Occurrence>
      <ZeroOrOne/>
    </Occurrence>
    <DFTitle>Restricted model B discoverer operation authorisation policies for ProSe
Direct Services.</DFTitle>
    <DFType>
      <DDFName/>
    </DFType>
  </DFProperties>

  <Node>
    <NodeName></NodeName>
    <DFProperties>
      <AccessType>
        <Get/>
        <Replace/>
      </AccessType>
      <DFFormat>
        <node/>
      </DFFormat>
      <Occurrence>
        <OneOrMore/>
      </Occurrence>
      <DFType>
        <DDFName></DDFName>
      </DFType>
    </DFProperties>

  <Node>
    <NodeName>PLMN</NodeName>
    <DFProperties>
      <AccessType>
        <Get/>
        <Replace/>
      </AccessType>
      <DFFormat>
        <chr/>
      </DFFormat>
      <Occurrence>
        <One/>
      </Occurrence>
      <DFTitle>PLMN code.</DFTitle>
      <DFType>
        <MIME>text/plain</MIME>
      </DFType>
    </DFProperties>
  </Node>

```

```

</Node>
<Node>
  <NodeName>ValidityTimerT4005</NodeName>
  <DFProperties>
    <AccessType>
      <Get/>
      <Replace/>
    </AccessType>
    <DFFormat>
      <int/>
    </DFFormat>
    <Occurrence>
      <One/>
    </Occurrence>
    <DFTitle>Validity Timer T4005 for restricted model B discoveree operation
policy.</DFTitle>
  <DFType>
    <DDFName/>
  </DFType>
</DFProperties>
</Node>

<Node>
  <NodeName>Range</NodeName>
  <DFProperties>
    <AccessType>
      <Get/>
      <Replace/>
    </AccessType>
    <DFFormat>
      <int/>
    </DFFormat>
    <Occurrence>
      <ZeroOrOne/>
    </Occurrence>
    <DFTitle>Authorised range for restricted model B discoveree
operation.</DFTitle>
  <DFType>
    <DDFName/>
  </DFType>
</DFProperties>
</Node>

</Node>
</Node>

<Node>
  <NodeName>ProSeDiscoveryUEIDInfo</NodeName>
  <!-- The ProSeDiscoveryUEIDInfo node starts here. -->
  <DFProperties>
    <AccessType>
      <Get/>
      <Replace/>
    </AccessType>
    <DFFormat>
      <node/>
    </DFFormat>
    <Occurrence>
      <ZeroOrOne/>
    </Occurrence>
    <DFTitle>Value and validity timer for ProSe Discovery UE ID.</DFTitle>
  <DFType>
    <DDFName/>
  </DFType>
</DFProperties>

<Node>
  <NodeName>ProSeDiscoveryUEID</NodeName>
  <DFProperties>
    <AccessType>
      <Get/>
      <Replace/>
    </AccessType>
    <DFFormat>
      <chr/>
    </DFFormat>
    <Occurrence>

```

```
        <One/>
      </Occurrence>
      <DFTitle>ProSe Discovery UE ID.</DFTitle>
      <DFType>
        <DDFName></DDFName>
      </DFType>
    </DFProperties>
  </Node>
  <Node>
    <NodeName>ValidityTimerT4015</NodeName>
    <DFProperties>
      <AccessType>
        <Get/>
        <Replace/>
      </AccessType>
      <DFFormat>
        <int/>
      </DFFormat>
      <Occurrence>
        <One/>
      </Occurrence>
      <DFTitle>Validity Timer T4015 for ProSe Discovery UE ID.</DFTitle>
      <DFType>
        <DDFName></DDFName>
      </DFType>
    </DFProperties>
  </Node>
</Node>
<Node>
  <NodeName>Ext</NodeName>
  <DFProperties>
    <AccessType>
      <Get/>
    </AccessType>
    <DFFormat>
      <node/>
    </DFFormat>
    <Occurrence>
      <ZeroOrOne/>
    </Occurrence>
    <DFTitle>A collection of all extension objects.</DFTitle>
    <DFType>
      <DDFName/>
    </DFType>
  </DFProperties>
</Node>
</Node>
</MgmtTree>
```

Annex B (informative): ProSe Public Safety Direct Services Provisioning MO DDF

This DDF is the standardized minimal set. A vendor can define its own DDF for the complete device. This DDF can include more features than this minimal standardized version.

```
<?xml version="1.0" encoding="UTF-8"?>
<!DOCTYPE MgmtTree PUBLIC "-//OMA//DTD-DM-DDF 1.2//EN"
"http://www.openmobilealliance.org/tech/DTD/dm_ddf-v1_2.dtd">

<MgmtTree>
  <VerDTD>1.2</VerDTD>
  <Man>--The device manufacturer--</Man>
  <Mod>--The device model--</Mod>

  <Node>
    <NodeName/>
    <DFProperties>
      <AccessType>
        <Get/>
      </AccessType>
      <Description>ProSe Public Safety Direct Services Provisioning</Description>
      <DFFormat>
        <node/>
      </DFFormat>
      <Occurrence>
        <ZeroOrOne/>
      </Occurrence>
      <DFTitle>The ProSe Public Safety Direct Services Provisioning Management
Object.</DFTitle>
      <DFType>
        <DDFName/>urn:oma:mo:ext-3gpp-prose-public-safety-direct-provisioning:1.0<DDFName/>
      </DFType>
    </DFProperties>

    <Node>
      <NodeName>MonitoringPolicy</NodeName>
      <!-- The MonitoringPolicy node starts here. -->
      <DFProperties>
        <AccessType>
          <Get/>
          <Replace/>
        </AccessType>
        <DFFormat>
          <node/>
        </DFFormat>
        <Occurrence>
          <ZeroOrOne/>
        </Occurrence>
        <DFTitle>Monitoring authorisation policies for ProSe Public Safety Direct
Services.</DFTitle>
        <DFType>
          <DDFName/>
        </DFType>
      </DFProperties>

      <Node>
        <NodeName></NodeName>
        <DFProperties>
          <AccessType>
            <Get/>
            <Replace/>
          </AccessType>
          <DFFormat>
            <node/>
          </DFFormat>
          <Occurrence>
            <OneOrMore/>
          </Occurrence>
          <DFType>
            <DDFName></DDFName>
          </DFType>
        </DFProperties>

      <Node>
```

```

    <NodeName>PLMN</NodeName>
    <DFProperties>
      <AccessType>
        <Get/>
        <Replace/>
      </AccessType>
      <DFFormat>
        <chr/>
      </DFFormat>
      <Occurrence>
        <One/>
      </Occurrence>
      <DFTitle>PLMN code.</DFTitle>
      <DFType>
        <MIME>text/plain</MIME>
      </DFType>
    </DFProperties>
  </Node>

  <Node>
    <NodeName>ValidityTimerT4005</NodeName>
    <DFProperties>
      <AccessType>
        <Get/>
        <Replace/>
      </AccessType>
      <DFFormat>
        <int/>
      </DFFormat>
      <Occurrence>
        <One/>
      </Occurrence>
      <DFTitle>Validity Timer T4005 for monitoring policy.</DFTitle>
      <DFType>
        <DDFName/>
      </DFType>
    </DFProperties>
  </Node>

</Node>
</Node>

<Node>
  <NodeName>AnnouncingPolicy</NodeName>
  <!-- The AnnouncingPolicy node starts here. -->
  <DFProperties>
    <AccessType>
      <Get/>
      <Replace/>
    </AccessType>
    <DFFormat>
      <node/>
    </DFFormat>
    <Occurrence>
      <ZeroOrOne/>
    </Occurrence>
    <DFTitle>Announcing authorisation policies for ProSe Public Safety Direct
Services.</DFTitle>
    <DFType>
      <DDFName/>
    </DFType>
  </DFProperties>

  <Node>
    <NodeName></NodeName>
    <DFProperties>
      <AccessType>
        <Get/>
        <Replace/>
      </AccessType>
      <DFFormat>
        <node/>
      </DFFormat>
      <Occurrence>
        <OneOrMore/>
      </Occurrence>
      <DFType>
        <DDFName></DDFName>
      </DFType>
    </DFProperties>
  </Node>

```

```

        </DFType>
    </DFProperties>

    <Node>
        <NodeName>PLMN</NodeName>
        <DFProperties>
            <AccessType>
                <Get/>
                <Replace/>
            </AccessType>
            <DFFormat>
                <chr/>
            </DFFormat>
            <Occurrence>
                <One/>
            </Occurrence>
            <DFTitle>PLMN code.</DFTitle>
            <DFType>
                <MIME>text/plain</MIME>
            </DFType>
        </DFProperties>
    </Node>

    <Node>
        <NodeName>ValidityTimerT4005</NodeName>
        <DFProperties>
            <AccessType>
                <Get/>
                <Replace/>
            </AccessType>
            <DFFormat>
                <int/>
            </DFFormat>
            <Occurrence>
                <One/>
            </Occurrence>
            <DFTitle>Validity Timer T4005 for announcing policy.</DFTitle>
            <DFType>
                <DDFName/>
            </DFType>
        </DFProperties>
    </Node>

    <Node>
        <NodeName>Range</NodeName>
        <DFProperties>
            <AccessType>
                <Get/>
                <Replace/>
            </AccessType>
            <DFFormat>
                <int/>
            </DFFormat>
            <Occurrence>
                <ZeroOrOne/>
            </Occurrence>
            <DFTitle>Authorised range for announcing.</DFTitle>
            <DFType>
                <DDFName/>
            </DFType>
        </DFProperties>
    </Node>

</Node>
</Node>

<Node>
    <NodeName>DirectCommunicationPolicy</NodeName>
    <!-- The DirectCommunicationPolicy node starts here. -->
    <DFProperties>
        <AccessType>
            <Get/>
            <Replace/>
        </AccessType>
        <DFFormat>
            <node/>

```



```

    </DFFormat>
    <Occurrence>
      <ZeroOrOne/>
    </Occurrence>
    <DFTitle>Direct communication policies for ProSe Public Safety Direct
Services.</DFTitle>
    <DFType>
      <DDFName/>
    </DFType>
  </DFProperties>

  <Node>
    <NodeName></NodeName>
    <DFProperties>
      <AccessType>
        <Get/>
        <Replace/>
      </AccessType>
      <DFFormat>
        <node/>
      </DFFormat>
      <Occurrence>
        <OneOrMore/>
      </Occurrence>
      <DFType>
        <DDFName></DDFName>
      </DFType>
    </DFProperties>

  <Node>
    <NodeName>PLMN</NodeName>
    <DFProperties>
      <AccessType>
        <Get/>
        <Replace/>
      </AccessType>
      <DFFormat>
        <chr/>
      </DFFormat>
      <Occurrence>
        <One/>
      </Occurrence>
      <DFTitle>PLMN code.</DFTitle>
      <DFType>
        <MIME>text/plain</MIME>
      </DFType>
    </DFProperties>
  </Node>

  <Node>
    <NodeName>ValidityTimerT4005</NodeName>
    <DFProperties>
      <AccessType>
        <Get/>
        <Replace/>
      </AccessType>
      <DFFormat>
        <int/>
      </DFFormat>
      <Occurrence>
        <One/>
      </Occurrence>
      <DFTitle>Validity Timer T4005 for direct communication policy.</DFTitle>
      <DFType>
        <DDFName/>
      </DFType>
    </DFProperties>
  </Node>

  </Node>
</Node>

<Node>
  <NodeName>DirectCommunicationPolicyNotInEUTRAN</NodeName>
  <!-- The DirectCommunicationPolicyNotInEUTRAN node starts here. -->
  <DFProperties>
    <AccessType>

```

```

        <Get/>
        <Replace/>
    </AccessType>
    <DFFormat>
        <node/>
    </DFFormat>
    <Occurrence>
        <ZeroOrOne/>
    </Occurrence>
    <DFTitle>DirectCommunication policy when the UE is not in E-UTRAN policies direct
communication of ProSe Public Safety Direct Services.</DFTitle>
    <DFType>
        <DDFName/>
    </DFType>
</DFProperties>

<Node>
    <NodeName>DirectCommunicationAuthorisationNotInEUTRAN</NodeName>
    <DFProperties>
    <AccessType>
        <Get/>
        <Replace/>
    </AccessType>
    <DFFormat>
        <bool/>
    </DFFormat>
    <Occurrence>
        <ZeroOrOne/>
    </Occurrence>
    <DFTitle>Authorisation for direct communication when not in E-UTRAN.</DFTitle>
    <DFType>
        <DDFName/>
    </DFType>
</DFProperties>
</Node>

<Node>
    <NodeName>OneToOneDirectCommunicationAuthorisationNotInEUTRAN</NodeName>
    <DFProperties>
    <AccessType>
        <Get/>
        <Replace/>
    </AccessType>
    <DFFormat>
        <bool/>
    </DFFormat>
    <Occurrence>
        <ZeroOrOne/>
    </Occurrence>
    <DFTitle>Authorisation for one-to-one direct communication when not in E-
UTRAN.</DFTitle>
    <DFType>
        <DDFName/>
    </DFType>
</DFProperties>
</Node>

<Node>
    <NodeName>DirectCommunicationRadioParameters</NodeName>
    <DFProperties>
    <AccessType>
        <Get/>
        <Replace/>
    </AccessType>
    <DFFormat>
        <node/>
    </DFFormat>
    <Occurrence>
        <ZeroOrOne/>
    </Occurrence>
    <DFTitle>Radio parameters for direct communication when not in E-
UTRAN.</DFTitle>
    <DFType>
        <DDFName/>
    </DFType>
</DFProperties>
</Node>

```

```

<NodeName></NodeName>
  <DFProperties>
    <AccessType>
      <Get/>
      <Replace/>
    </AccessType>
    <DFFormat>
      <node/>
    </DFFormat>
    <Occurrence>
      <OneOrMore/>
    </Occurrence>
    <DFType>
      <DDFName></DDFName>
    </DFType>
  </DFProperties>

<Node>
  <NodeName>RadioParametersContents</NodeName>
  <DFProperties>
    <AccessType>
      <Get/>
      <Replace/>
    </AccessType>
    <DFFormat>
      <bin/>
    </DFFormat>
    <Occurrence>
      <One/>
    </Occurrence>
    <DFTitle>Radio parameters defined by RAN WG.</DFTitle>
    <DFType>
      <MIME>text/plain</MIME>
    </DFType>
  </DFProperties>
</Node>

<Node>
  <NodeName>GeographicalArea</NodeName>
  <DFProperties>
    <AccessType>
      <Get/>
      <Replace/>
    </AccessType>
    <DFFormat>
      <node/>
    </DFFormat>
    <Occurrence>
      <One/>
    </Occurrence>
    <DFTitle>Geographical Area.</DFTitle>
    <DFType>
      <MIME>text/plain</MIME>
    </DFType>
  </DFProperties>

  <Node>
    <NodeName>Polygon</NodeName>
    <DFProperties>
      <AccessType>
        <Get/>
        <Replace/>
      </AccessType>
      <DFFormat>
        <node/>
      </DFFormat>
      <Occurrence>
        <ZeroOrOne/>
      </Occurrence>
      <DFTitle>Polygon Area description.</DFTitle>
      <DFType>
        <DDFName/>
      </DFType>
    </DFProperties>

  <Node>
    <NodeName></NodeName>
    <DFProperties>

```

```

    <AccessType>
      <Get/>
      <Replace/>
    </AccessType>
    <DFFormat>
      <node/>
    </DFFormat>
    <Occurrence>
      <OneOrMore/>
    </Occurrence>
    <DFType>
      <DDFName></DDFName>
    </DFType>
  </DFProperties>

<Node>
  <NodeName>Coordinates</NodeName>
  <DFProperties>
    <AccessType>
      <Get/>
      <Replace/>
    </AccessType>
    <DFFormat>
      <chr/>
    </DFFormat>
    <Occurrence>
      <One/>
    </Occurrence>
    <DFTitle>Descriptions for geographical coordinates</DFTitle>
    <DFType>
      <MIME>text/plain</MIME>
    </DFType>
  </DFProperties>

<Node>
  <NodeName></NodeName>
  <DFProperties>
    <AccessType>
      <Get/>
      <Replace/>
    </AccessType>
    <DFFormat>
      <node/>
    </DFFormat>
    <Occurrence>
      <OneOrMore/>
    </Occurrence>
    <DFType>
      <DDFName></DDFName>
    </DFType>
  </DFProperties>

<Node>
  <NodeName>Latitude</NodeName>
  <DFProperties>
    <AccessType>
      <Get/>
      <Replace/>
    </AccessType>
    <DFFormat>
      <chr/>
    </DFFormat>
    <Occurrence>
      <One/>
    </Occurrence>
    <DFTitle>coordinate latitude</DFTitle>
    <DFType>
      <MIME>text/plain</MIME>
    </DFType>
  </DFProperties>
</Node>

<Node>
  <NodeName>Longitude</NodeName>
  <DFProperties>
    <AccessType>
      <Get/>

```

```
        <Replace/>
      </AccessType>
    <DFFormat>
      <chr/>
    </DFFormat>
    <Occurrence>
      <One/>
    </Occurrence>
    <DFTitle>coordinate longitude</DFTitle>
    <DFType>
      <MIME>text/plain</MIME>
    </DFType>
  </DFProperties>
</Node>
</Node>
</Node>
</Node>
</Node>
</Node>
</Node>
</Node>
</Node>
<Node>
  <NodeName>GroupParameters</NodeName>
  <!-- The GroupParameters node starts here. -->
  <DFProperties>
    <AccessType>
      <Get/>
      <Replace/>
    </AccessType>
    <DFFormat>
      <node/>
    </DFFormat>
    <Occurrence>
      <ZeroOrOne/>
    </Occurrence>
    <DFTitle>Group parameters for ProSe Public Safety Direct Services.</DFTitle>
    <DFType>
      <DDFName/>
    </DFType>
  </DFProperties>
</Node>
<Node>
  <NodeName></NodeName>
  <DFProperties>
    <AccessType>
      <Get/>
      <Replace/>
    </AccessType>
    <DFFormat>
      <node/>
    </DFFormat>
    <Occurrence>
      <OneOrMore/>
    </Occurrence>
    <DFType>
      <DDFName></DDFName>
    </DFType>
  </DFProperties>
</Node>
<Node>
  <NodeName>AddressType</NodeName>
  <DFProperties>
    <AccessType>
      <Get/>
      <Replace/>
    </AccessType>
    <DFFormat>
      <chr/>
    </DFFormat>
    <Occurrence>
      <One/>
    </Occurrence>
    <DFTitle>IP version of the IP address.</DFTitle>
    <DFType>
      <MIME>text/plain</MIME>
    </DFType>
  </DFProperties>
</Node>
```

```

    </DFProperties>
  </Node>

  <Node>
    <NodeName>IPMulticastAddress</NodeName>
    <DFProperties>
      <AccessType>
        <Get/>
        <Replace/>
      </AccessType>
      <DFFormat>
        <chr/>
      </DFFormat>
      <Occurrence>
        <One/>
      </Occurrence>
      <DFTitle>IP multicast address.</DFTitle>
      <DFType>
        <DDFName/>
      </DFType>
    </DFProperties>
  </Node>

  <Node>
    <NodeName>PKMFAddress</NodeName>
    <DFProperties>
      <AccessType>
        <Get/>
        <Replace/>
      </AccessType>
      <DFFormat>
        <chr/>
      </DFFormat>
      <Occurrence>
        <ZeroOrOne/>
      </Occurrence>
      <DFTitle>Address of the ProSe Key Management Function.</DFTitle>
      <DFType>
        <DDFName/>
      </DFType>
    </DFProperties>
  </Node>

  <Node>
    <NodeName>SourceIPv4Address</NodeName>
    <DFProperties>
      <AccessType>
        <Get/>
        <Replace/>
      </AccessType>
      <DFFormat>
        <chr/>
      </DFFormat>
      <Occurrence>
        <ZeroOrOne/>
      </Occurrence>
      <DFTitle>Source IPv4 address.</DFTitle>
      <DFType>
        <DDFName/>
      </DFType>
    </DFProperties>
  </Node>

  <Node>
    <NodeName>Layer2GroupID</NodeName>
    <DFProperties>
      <AccessType>
        <Get/>
        <Replace/>
      </AccessType>
      <DFFormat>
        <chr/>
      </DFFormat>
      <Occurrence>
        <One/>
      </Occurrence>
      <DFTitle>The Layer 2 group ID.</DFTitle>

```

```

        <DFType>
          <DDFName/>
        </DFType>
      </DFProperties>
    </Node>

    <Node>
      <NodeName>ApplicationLayerGroupID</NodeName>
      <DFProperties>
        <AccessType>
          <Get/>
          <Replace/>
        </AccessType>
        <DFFormat>
          <chr/>
        </DFFormat>
        <Occurrence>
          <One/>
        </Occurrence>
        <DFTitle>application layer group ID.</DFTitle>
      <DFType>
        <DDFName/>
      </DFType>
    </DFProperties>
  </Node>

</Node>
</Node>

<Node>
  <NodeName>UsageInformationReportingConfiguration</NodeName>
  <!-- The UsageInformatinReportingConfiguration node starts here. -->
  <DFProperties>
    <AccessType>
      <Get/>
      <Replace/>
    </AccessType>
    <DFFormat>
      <node/>
    </DFFormat>
    <Occurrence>
      <ZeroOrOne/>
    </Occurrence>
    <DFTitle>Usage information reporting configuration for ProSe Public Safety Direct
Services.</DFTitle>
  <DFType>
    <DDFName/>
  </DFType>
</DFProperties>

  <Node>
    <NodeName>ServerAddress</NodeName>
    <DFProperties>
      <AccessType>
        <Get/>
        <Replace/>
      </AccessType>
      <DFFormat>
        <chr/>
      </DFFormat>
      <Occurrence>
        <ZeroOrOne/>
      </Occurrence>
      <DFTitle>Server address for reporting charging data.</DFTitle>
    <DFType>
      <DDFName/>
    </DFType>
  </DFProperties>
</Node>

  <Node>
    <NodeName>CollectionPeriod</NodeName>
    <DFProperties>
      <AccessType>
        <Get/>
        <Replace/>

```

```

        </AccessType>
        <DFFormat>
            <int/>
        </DFFormat>
        <Occurrence>
            <One/>
        </Occurrence>
        <DFTitle>Collection period.</DFTitle>
        <DFType>
            <DDFName/>
        </DFType>
    </DFProperties>
</Node>

<Node>
    <nodeName>ReportingWindow</nodeName>
    <DFProperties>
        <AccessType>
            <Get/>
            <Replace/>
        </AccessType>
        <DFFormat>
            <int/>
        </DFFormat>
        <Occurrence>
            <One/>
        </Occurrence>
        <DFTitle>Reporting window.</DFTitle>
        <DFType>
            <DDFName/>
        </DFType>
    </DFProperties>
</Node>

<Node>
    <nodeName>ReportGroupParameters</nodeName>
    <DFProperties>
        <AccessType>
            <Get/>
            <Replace/>
        </AccessType>
        <DFFormat>
            <bool/>
        </DFFormat>
        <Occurrence>
            <ZeroOrOne/>
        </Occurrence>
        <DFTitle>Whether to report group parameters.</DFTitle>
        <DFType>
            <DDFName/>
        </DFType>
    </DFProperties>
</Node>

<Node>
    <nodeName>ReportingTimeStampsFirstTransmissionAndReception</nodeName>
    <DFProperties>
        <AccessType>
            <Get/>
            <Replace/>
        </AccessType>
        <DFFormat>
            <bool/>
        </DFFormat>
        <Occurrence>
            <ZeroOrOne/>
        </Occurrence>
        <DFTitle>Whether to report time stamps for first transmission and
reception.</DFTitle>
        <DFType>
            <DDFName/>
        </DFType>
    </DFProperties>
</Node>

<Node>
    <nodeName>ReportDataTransmitted</nodeName>
    <DFProperties>

```



```

        <AccessType>
          <Get/>
          <Replace/>
        </AccessType>
        <DFFormat>
          <int/>
        </DFFormat>
        <Occurrence>
          <ZeroOrOne/>
        </Occurrence>
        <DFTitle>Whether to report data transmitted.</DFTitle>
        <DFType>
          <DDFName/>
        </DFType>
      </DFProperties>
    </Node>

    <Node>
      <NodeName>ReportDataReceived</NodeName>
      <DFProperties>
        <AccessType>
          <Get/>
          <Replace/>
        </AccessType>
        <DFFormat>
          <int/>
        </DFFormat>
        <Occurrence>
          <ZeroOrOne/>
        </Occurrence>
        <DFTitle>Whether to report data received.</DFTitle>
        <DFType>
          <DDFName/>
        </DFType>
      </DFProperties>
    </Node>

    <Node>
      <NodeName>ReportTimeStampsOutOfCoverage</NodeName>
      <DFProperties>
        <AccessType>
          <Get/>
          <Replace/>
        </AccessType>
        <DFFormat>
          <bool/>
        </DFFormat>
        <Occurrence>
          <ZeroOrOne/>
        </Occurrence>
        <DFTitle>Whether to report time stamps when out of E-UTRAN coverage.</DFTitle>
        <DFType>
          <DDFName/>
        </DFType>
      </DFProperties>
    </Node>

    <Node>
      <NodeName>ReportLocationInCoverage</NodeName>
      <DFProperties>
        <AccessType>
          <Get/>
          <Replace/>
        </AccessType>
        <DFFormat>
          <bool/>
        </DFFormat>
        <Occurrence>
          <ZeroOrOne/>
        </Occurrence>
        <DFTitle>Whether to report list of locations when in E-UTRAN coverage.</DFTitle>
        <DFType>
          <DDFName/>
        </DFType>
      </DFProperties>
    </Node>

    <Node>

```

```

    <NodeName>ReportRadioParameters</NodeName>
    <DFProperties>
      <AccessType>
        <Get/>
        <Replace/>
      </AccessType>
      <DFFormat>
        <bool/>
      </DFFormat>
      <Occurrence>
        <ZeroOrOne/>
      </Occurrence>
      <DFTitle>Whether to report radio parameters used for ProSe direct
communication.</DFTitle>
      <DFType>
        <DDFName/>
      </DFType>
    </DFProperties>
  </Node>
</Node>

<Node>
  <NodeName>ToConRef</NodeName>
  <DFProperties>
    <AccessType>
      <Get/>
    </AccessType>
    <DFFormat>
      <node/>
    </DFFormat>
    <Occurrence>
      <ZeroOrOne/>
    </Occurrence>
    <DFTitle>collection of connectivity definitions</DFTitle>
    <DFType>
      <DDFName/>
    </DFType>
  </DFProperties>
  <Node>
    <NodeName/>
    <DFProperties>
      <AccessType>
        <Get/>
        <Replace/>
      </AccessType>
      <DFFormat>
        <node/>
      </DFFormat>
      <Occurrence>
        <OneOrMore/>
      </Occurrence>
      <DFTitle>The name node for one or more connectivity parameters</DFTitle>
      <DFType>
        <DDFName/>
      </DFType>
    </DFProperties>
  </Node>
  <Node>
    <NodeName>ConRef</NodeName>
    <DFProperties>
      <AccessType>
        <Get/>
        <Replace/>
      </AccessType>
      <DFFormat>
        <chr/>
      </DFFormat>
      <Occurrence>
        <One/>
      </Occurrence>
      <DFTitle>Linkage to connectivity parameters</DFTitle>
      <DFType>
        <MIME>text/plain</MIME>
      </DFType>
    </DFProperties>
  </Node>
</Node>
</Node>

```

```

<Node>
  <NodeName>RestrictedDiscoveryPolicyForNonPS</NodeName>
  <!-- The RestrictedDiscoveryPolicyForNonPS starts here. -->
  <DFProperties>
    <AccessType>
      <Get/>
      <Replace/>
    </AccessType>
    <DFFormat>
      <node/>
    </DFFormat>
    <Occurrence>
      <ZeroOrOne/>
    </Occurrence>
    <DFTitle>Authorisation policies for restricted direct discovery for non-public
safety use.</DFTitle>
    <DFType>
      <DDFName/>
    </DFType>
  </DFProperties>

  <Node>
    <NodeName>RestrictedModelAMonitoringPolicy</NodeName>
    <!-- The RestrictedModelAMonitoringPolicy node starts here. -->
    <DFProperties>
      <AccessType>
        <Get/>
        <Replace/>
      </AccessType>
      <DFFormat>
        <node/>
      </DFFormat>
      <Occurrence>
        <ZeroOrOne/>
      </Occurrence>
      <DFTitle>Restricted model A monitoring authorisation policies for ProSe Direct
Services.</DFTitle>
      <DFType>
        <DDFName/>
      </DFType>
    </DFProperties>

    <Node>
      <NodeName></NodeName>
      <DFProperties>
        <AccessType>
          <Get/>
          <Replace/>
        </AccessType>
        <DFFormat>
          <node/>
        </DFFormat>
        <Occurrence>
          <OneOrMore/>
        </Occurrence>
        <DFType>
          <DDFName></DDFName>
        </DFType>
      </DFProperties>

      <Node>
        <NodeName>PLMN</NodeName>
        <DFProperties>
          <AccessType>
            <Get/>
            <Replace/>
          </AccessType>
          <DFFormat>
            <chr/>
          </DFFormat>
          <Occurrence>
            <One/>
          </Occurrence>
          <DFTitle>PLMN code.</DFTitle>
          <DFType>
            <MIME>text/plain</MIME>
          </DFType>
        </DFProperties>

```

```

    </Node>
    <Node>
      <NodeName>ValidityTimerT4005</NodeName>
      <DFProperties>
        <AccessType>
          <Get/>
          <Replace/>
        </AccessType>
        <DFFormat>
          <int/>
        </DFFormat>
        <Occurrence>
          <One/>
        </Occurrence>
        <DFTitle>Validity Timer T4005 for restricted model A monitoring
policy.</DFTitle>
      <DFType>
        <DDFName/>
      </DFType>
    </DFProperties>
  </Node>
</Node>
</Node>
<Node>
  <NodeName>RestrictedModelAAnnouncingPolicy</NodeName>
  <!-- The RestrictedModelAAnnouncingPolicy node starts here. -->
  <DFProperties>
    <AccessType>
      <Get/>
      <Replace/>
    </AccessType>
    <DFFormat>
      <node/>
    </DFFormat>
    <Occurrence>
      <ZeroOrOne/>
    </Occurrence>
    <DFTitle>Restricted model A announcing authorisation policies for ProSe Direct
Services.</DFTitle>
  <DFType>
    <DDFName/>
  </DFType>
</DFProperties>
<Node>
  <NodeName></NodeName>
  <DFProperties>
    <AccessType>
      <Get/>
      <Replace/>
    </AccessType>
    <DFFormat>
      <node/>
    </DFFormat>
    <Occurrence>
      <OneOrMore/>
    </Occurrence>
    <DFType>
      <DDFName></DDFName>
    </DFType>
  </DFProperties>
<Node>
  <NodeName>PLMN</NodeName>
  <DFProperties>
    <AccessType>
      <Get/>
      <Replace/>
    </AccessType>
    <DFFormat>
      <chr/>
    </DFFormat>
    <Occurrence>
      <One/>
    </Occurrence>
  </DFProperties>

```

```

        <DFTitle>PLMN code.</DFTitle>
        <DFType>
            <MIME>text/plain</MIME>
        </DFType>
    </DFProperties>
</Node>

<Node>
    <NodeName>ValidityTimerT4005</NodeName>
    <DFProperties>
        <AccessType>
            <Get/>
            <Replace/>
        </AccessType>
        <DFFormat>
            <int/>
        </DFFormat>
        <Occurrence>
            <One/>
        </Occurrence>
        <DFTitle>Validity Timer T4005 for restricted model A announcing
policy.</DFTitle>
        <DFType>
            <DDFName/>
        </DFType>
    </DFProperties>
</Node>

<Node>
    <NodeName>Range</NodeName>
    <DFProperties>
        <AccessType>
            <Get/>
            <Replace/>
        </AccessType>
        <DFFormat>
            <int/>
        </DFFormat>
        <Occurrence>
            <ZeroOrOne/>
        </Occurrence>
        <DFTitle>Authorised range for restricted model A announcing.</DFTitle>
        <DFType>
            <DDFName/>
        </DFType>
    </DFProperties>
</Node>

</Node>
</Node>

<Node>
    <NodeName>RestrictedModelBDiscovererPolicy</NodeName>
    <!-- The RestrictedModelBDiscovererPolicy node starts here. -->
    <DFProperties>
        <AccessType>
            <Get/>
            <Replace/>
        </AccessType>
        <DFFormat>
            <node/>
        </DFFormat>
        <Occurrence>
            <ZeroOrOne/>
        </Occurrence>
        <DFTitle>Restricted model B discoverer operation authorisation policies for
ProSe Direct Services.</DFTitle>
        <DFType>
            <DDFName/>
        </DFType>
    </DFProperties>

    <Node>
        <NodeName></NodeName>
        <DFProperties>
            <AccessType>
                <Get/>
                <Replace/>
            </AccessType>
        </DFProperties>
    </Node>

```

```

        </AccessType>
        <DFFormat>
            <node/>
        </DFFormat>
        <Occurrence>
            <OneOrMore/>
        </Occurrence>
        <DFType>
            <DDFName></DDFName>
        </DFType>
    </DFProperties>

    <Node>
        <NodeName>PLMN</NodeName>
        <DFProperties>
            <AccessType>
                <Get/>
                <Replace/>
            </AccessType>
            <DFFormat>
                <chr/>
            </DFFormat>
            <Occurrence>
                <One/>
            </Occurrence>
            <DFTitle>PLMN code.</DFTitle>
            <DFType>
                <MIME>text/plain</MIME>
            </DFType>
        </DFProperties>
    </Node>

    <Node>
        <NodeName>ValidityTimerT4005</NodeName>
        <DFProperties>
            <AccessType>
                <Get/>
                <Replace/>
            </AccessType>
            <DFFormat>
                <int/>
            </DFFormat>
            <Occurrence>
                <One/>
            </Occurrence>
            <DFTitle>Validity Timer T4005 for restricted model B discoverer
operation policy.</DFTitle>
            <DFType>
                <DDFName/>
            </DFType>
        </DFProperties>
    </Node>

    <Node>
        <NodeName>Range</NodeName>
        <DFProperties>
            <AccessType>
                <Get/>
                <Replace/>
            </AccessType>
            <DFFormat>
                <int/>
            </DFFormat>
            <Occurrence>
                <ZeroOrOne/>
            </Occurrence>
            <DFTitle>Authorised range for restricted model B discoverer
operation.</DFTitle>
            <DFType>
                <DDFName/>
            </DFType>
        </DFProperties>
    </Node>

    </Node>
</Node>

<Node>

```

```

<NodeName>RestrictedModelBDiscovereePolicy</NodeName>
<!-- The RestrictedModelBDiscovereePolicy node starts here. -->
<DFProperties>
  <AccessType>
    <Get/>
    <Replace/>
  </AccessType>
  <DFFormat>
    <node/>
  </DFFormat>
  <Occurrence>
    <ZeroOrOne/>
  </Occurrence>
  <DFTitle>Restricted model B discoveree operation authorisation policies for
ProSe Direct Services.</DFTitle>
  <DFType>
    <DDFName/>
  </DFType>
</DFProperties>

<Node>
  <NodeName></NodeName>
  <DFProperties>
    <AccessType>
      <Get/>
      <Replace/>
    </AccessType>
    <DFFormat>
      <node/>
    </DFFormat>
    <Occurrence>
      <OneOrMore/>
    </Occurrence>
    <DFType>
      <DDFName></DDFName>
    </DFType>
  </DFProperties>

  <Node>
    <NodeName>PLMN</NodeName>
    <DFProperties>
      <AccessType>
        <Get/>
        <Replace/>
      </AccessType>
      <DFFormat>
        <chr/>
      </DFFormat>
      <Occurrence>
        <One/>
      </Occurrence>
      <DFTitle>PLMN code.</DFTitle>
      <DFType>
        <MIME>text/plain</MIME>
      </DFType>
    </DFProperties>
  </Node>

  <Node>
    <NodeName>ValidityTimerT4005</NodeName>
    <DFProperties>
      <AccessType>
        <Get/>
        <Replace/>
      </AccessType>
      <DFFormat>
        <int/>
      </DFFormat>
      <Occurrence>
        <One/>
      </Occurrence>
      <DFTitle>Validity Timer T4005 for restricted model B discoveree
operation policy.</DFTitle>
      <DFType>
        <DDFName/>
      </DFType>
    </DFProperties>
  </Node>

```

```

        <Node>
          <NodeName>Range</NodeName>
          <DFProperties>
            <AccessType>
              <Get/>
              <Replace/>
            </AccessType>
            <DFFormat>
              <int/>
            </DFFormat>
            <Occurrence>
              <ZeroOrOne/>
            </Occurrence>
            <DFTitle>Authorised range for restricted model B discoveree
operation.</DFTitle>
          <DFType>
            <DDFName/>
          </DFType>
        </DFProperties>
      </Node>
    </Node>
  </Node>

  <Node>
    <NodeName>ProSeDiscoveryUEIDInfo</NodeName>
    <!-- The ProSeDiscoveryUEIDInfo node starts here. -->
    <DFProperties>
      <AccessType>
        <Get/>
        <Replace/>
      </AccessType>
      <DFFormat>
        <node/>
      </DFFormat>
      <Occurrence>
        <ZeroOrOne/>
      </Occurrence>
      <DFTitle>Value and validity timer for ProSe Discovery UE ID.</DFTitle>
      <DFType>
        <DDFName/>
      </DFType>
    </DFProperties>

    <Node>
      <NodeName>ProSeDiscoveryUEID</NodeName>
      <DFProperties>
        <AccessType>
          <Get/>
          <Replace/>
        </AccessType>
        <DFFormat>
          <chr/>
        </DFFormat>
        <Occurrence>
          <One/>
        </Occurrence>
        <DFTitle>ProSe Discovery UE ID.</DFTitle>
        <DFType>
          <DDFName></DDFName>
        </DFType>
      </DFProperties>
    </Node>

    <Node>
      <NodeName>ValidityTimerT4015</NodeName>
      <DFProperties>
        <AccessType>
          <Get/>
          <Replace/>
        </AccessType>
        <DFFormat>
          <int/>
        </DFFormat>
        <Occurrence>
          <One/>
        </Occurrence>
      </DFProperties>
    </Node>
  </Node>

```



```

        </Occurrence>
        <DFTitle>Validity Timer T4015 for ProSe Discovery UE ID.</DFTitle>
        <DFType>
            <DDFName></DDFName>
        </DFType>
    </DFProperties>
</Node>

</Node>

</Node>

<Node>
    <NodeName>PublicSafetyDiscoveryPolicyNotInEUTRAN</NodeName>
    <!-- The PublicSafetyDiscoveryPolicyNotInEUTRAN node starts here. -->
    <DFProperties>
        <AccessType>
            <Get/>
            <Replace/>
        </AccessType>
        <DFFormat>
            <node/>
        </DFFormat>
        <Occurrence>
            <ZeroOrOne/>
        </Occurrence>
        <DFTitle>Direct Discovery policy when the UE is not in E-UTRAN.</DFTitle>
        <DFType>
            <DDFName/>
        </DFType>
    </DFProperties>

    <Node>
        <NodeName>MonitoringAuthorisationNotInEUTRAN</NodeName>
        <DFProperties>
            <AccessType>
                <Get/>
                <Replace/>
            </AccessType>
            <DFFormat>
                <bool/>
            </DFFormat>
            <Occurrence>
                <ZeroOrOne/>
            </Occurrence>
            <DFTitle>Authorisation for monitoring when not in E-UTRAN.</DFTitle>
            <DFType>
                <DDFName/>
            </DFType>
        </DFProperties>
    </Node>

    <Node>
        <NodeName>AnnouncingAuthorisationNotInEUTRAN</NodeName>
        <DFProperties>
            <AccessType>
                <Get/>
                <Replace/>
            </AccessType>
            <DFFormat>
                <bool/>
            </DFFormat>
            <Occurrence>
                <ZeroOrOne/>
            </Occurrence>
            <DFTitle>Authorisation for announcing when not in E-UTRAN.</DFTitle>
            <DFType>
                <DDFName/>
            </DFType>
        </DFProperties>
    </Node>

    <Node>
        <NodeName>DiscovereeAuthorisationNotInEUTRAN</NodeName>
        <DFProperties>
            <AccessType>

```

```

        <Get/>
        <Replace/>
    </AccessType>
    <DFFormat>
        <bool/>
    </DFFormat>
    <Occurrence>
        <ZeroOrOne/>
    </Occurrence>
    <DFTitle>Authorisation for discoveree operation when not in E-UTRAN.</DFTitle>
    <DFType>
        <DDFName/>
    </DFType>
</DFProperties>
</Node>

<Node>
    <NodeName>DiscovererAuthorisationNotInEUTRAN</NodeName>
    <DFProperties>
    <AccessType>
        <Get/>
        <Replace/>
    </AccessType>
    <DFFormat>
        <bool/>
    </DFFormat>
    <Occurrence>
        <ZeroOrOne/>
    </Occurrence>
    <DFTitle>Authorisation for discoverer operation when not in E-UTRAN.</DFTitle>
    <DFType>
        <DDFName/>
    </DFType>
</DFProperties>
</Node>

<Node>
    <NodeName>DiscoveryRadioParameters</NodeName>
    <DFProperties>
    <AccessType>
        <Get/>
        <Replace/>
    </AccessType>
    <DFFormat>
        <node/>
    </DFFormat>
    <Occurrence>
        <ZeroOrOne/>
    </Occurrence>
    <DFTitle>Radio parameters for direct discovery when not in E-UTRAN.</DFTitle>
    <DFType>
        <DDFName/>
    </DFType>
</DFProperties>

    <Node>
    <NodeName></NodeName>
    <DFProperties>
    <AccessType>
        <Get/>
        <Replace/>
    </AccessType>
    <DFFormat>
        <node/>
    </DFFormat>
    <Occurrence>
        <OneOrMore/>
    </Occurrence>
    <DFType>
        <DDFName></DDFName>
    </DFType>
</DFProperties>

    <Node>
    <NodeName>RadioParametersContents</NodeName>
    <DFProperties>
    <AccessType>
        <Get/>

```

```

        <Replace/>
    </AccessType>
    <DFFormat>
        <bin/>
    </DFFormat>
    <Occurrence>
        <One/>
    </Occurrence>
    <DFTitle>Radio parameters defined by RAN WG.</DFTitle>
    <DFType>
        <MIME>text/plain</MIME>
    </DFType>
    </DFProperties>
</Node>

<Node>
    <NodeName>GeographicalArea</NodeName>
    <DFProperties>
        <AccessType>
            <Get/>
            <Replace/>
        </AccessType>
        <DFFormat>
            <node/>
        </DFFormat>
        <Occurrence>
            <One/>
        </Occurrence>
        <DFTitle>Geographical Area.</DFTitle>
        <DFType>
            <MIME>text/plain</MIME>
        </DFType>
    </DFProperties>

    <Node>
        <NodeName>Polygon</NodeName>
        <DFProperties>
            <AccessType>
                <Get/>
                <Replace/>
            </AccessType>
            <DFFormat>
                <node/>
            </DFFormat>
            <Occurrence>
                <ZeroOrOne/>
            </Occurrence>
            <DFTitle>Polygon Area description.</DFTitle>
            <DFType>
                <DDFName/>
            </DFType>
        </DFProperties>

        <Node>
            <NodeName></NodeName>
            <DFProperties>
                <AccessType>
                    <Get/>
                    <Replace/>
                </AccessType>
                <DFFormat>
                    <node/>
                </DFFormat>
                <Occurrence>
                    <OneOrMore/>
                </Occurrence>
                <DFType>
                    <DDFName></DDFName>
                </DFType>
            </DFProperties>

        <Node>
            <NodeName>Coordinates</NodeName>
            <DFProperties>
                <AccessType>
                    <Get/>
                    <Replace/>
                </AccessType>

```

```

    <DFFormat>
      <chr/>
    </DFFormat>
  <Occurrence>
    <One/>
  </Occurrence>
  <DFTitle>Descriptions for geographical coordinates</DFTitle>
  <DFType>
    <MIME>text/plain</MIME>
  </DFType>
</DFProperties>

<Node>
  <NodeName></NodeName>
  <DFProperties>
    <AccessType>
      <Get/>
      <Replace/>
    </AccessType>
    <DFFormat>
      <node/>
    </DFFormat>
    <Occurrence>
      <OneOrMore/>
    </Occurrence>
    <DFType>
      <DDFName></DDFName>
    </DFType>
  </DFProperties>

  <Node>
    <NodeName>Latitude</NodeName>
    <DFProperties>
      <AccessType>
        <Get/>
        <Replace/>
      </AccessType>
      <DFFormat>
        <chr/>
      </DFFormat>
      <Occurrence>
        <One/>
      </Occurrence>
      <DFTitle>coordinate latitude</DFTitle>
      <DFType>
        <MIME>text/plain</MIME>
      </DFType>
    </DFProperties>
  </Node>

  <Node>
    <NodeName>Longitude</NodeName>
    <DFProperties>
      <AccessType>
        <Get/>
        <Replace/>
      </AccessType>
      <DFFormat>
        <chr/>
      </DFFormat>
      <Occurrence>
        <One/>
      </Occurrence>
      <DFTitle>coordinate longitude</DFTitle>
      <DFType>
        <MIME>text/plain</MIME>
      </DFType>
    </DFProperties>
  </Node>
</Node>
</Node>
</Node>
</Node>
</Node>
</Node>
</Node>
</Node>

```

```

<Node>
  <NodeName>UEToNetworkRelayPolicy</NodeName>
  <!-- The UEToNetworkRelayPolicy node starts here. -->
  <DFProperties>
    <AccessType>
      <Get/>
      <Replace/>
    </AccessType>
    <DFFormat>
      <node/>
    </DFFormat>
    <Occurrence>
      <ZeroOrOne/>
    </Occurrence>
    <DFTitle>UE-to-network relay policy.</DFTitle>
    <DFType>
      <DDFName/>
    </DFType>
  </DFProperties>

  <Node>
    <NodeName>AuthorisationForRemoteUE</NodeName>

    <DFProperties>
      <AccessType>
        <Get/>
        <Replace/>
      </AccessType>
      <DFFormat>
        <bool/>
      </DFFormat>
      <Occurrence>
        <ZeroOrOne/>
      </Occurrence>
      <DFTitle>UE-to-network relay authorisation policy for remote UE.</DFTitle>
      <DFType>
        <DDFName/>
      </DFType>
    </DFProperties>

    <Node>
      <NodeName>RemoteUEIMEIReport</NodeName>
      <DFProperties>
        <AccessType>
          <Get/>
          <Replace/>
        </AccessType>
        <DFFormat>
          <int/>
        </DFFormat>
        <Occurrence>
          <ZeroOrOne/>
        </Occurrence>
        <DFTitle>Whether to report the IMEI or IMEISV of the remote UE(s) using
the relay.</DFTitle>
        <DFType>
          <MIME>text/plain</MIME>
        </DFType>
      </DFProperties>
    </Node>
  </Node>

  <Node>
    <NodeName>AuthorisationForRelay</NodeName>
    <!-- The AuthorisationForRelay node starts here. -->
    <DFProperties>
      <AccessType>
        <Get/>
        <Replace/>
      </AccessType>
      <DFFormat>
        <node/>
      </DFFormat>
      <Occurrence>
        <ZeroOrOne/>
      </Occurrence>

```

```

    <DFTitle>UE-to-network relay authorisation policy for relay.</DFTitle>
    <DFType>
      <DDFName/>
    </DFType>
  </DFProperties>
</Node>
  <NodeName>AuthorisedPLMNs</NodeName>
  <!-- The AuthorisedPLMNs node starts here. -->
  <DFProperties>
    <AccessType>
      <Get/>
      <Replace/>
    </AccessType>
    <DFFormat>
      <node/>
    </DFFormat>
    <Occurrence>
      <ZeroOrOne/>
    </Occurrence>
    <DFTitle>UE-to-network relay authorisation per PLMN policies.</DFTitle>
    <DFType>
      <DDFName/>
    </DFType>
  </DFProperties>

  <Node>
    <NodeName></NodeName>
    <DFProperties>
      <AccessType>
        <Get/>
        <Replace/>
      </AccessType>
      <DFFormat>
        <node/>
      </DFFormat>
      <Occurrence>
        <OneOrMore/>
      </Occurrence>
      <DFType>
        <DDFName></DDFName>
      </DFType>
    </DFProperties>

    <Node>
      <NodeName>PLMN</NodeName>
      <DFProperties>
        <AccessType>
          <Get/>
          <Replace/>
        </AccessType>
        <DFFormat>
          <chr/>
        </DFFormat>
        <Occurrence>
          <One/>
        </Occurrence>
        <DFTitle>PLMN code.</DFTitle>
        <DFType>
          <MIME>text/plain</MIME>
        </DFType>
      </DFProperties>
    </Node>

    <Node>
      <NodeName>ValidityTimerT4005</NodeName>
      <DFProperties>
        <AccessType>
          <Get/>
          <Replace/>
        </AccessType>
        <DFFormat>
          <int/>
        </DFFormat>
        <Occurrence>
          <One/>
        </Occurrence>
        <DFTitle>Validity Timer T4005 for relay authorisation
policy.</DFTitle>

```

```

        <DFType>
          <DDFName/>
        </DFType>
      </DFProperties>
    </Node>
  </Node>
</Node>
<Node>
  <NodeName>DLUnicastTrafficMappingRule</NodeName>
  <DFProperties>
    <AccessType>
      <Get/>
      <Replace/>
    </AccessType>
    <DFFormat>
      <node/>
    </DFFormat>
    <Occurrence>
      <ZeroOrOne/>
    </Occurrence>
    <DFTitle>Mapping rule for downlink unicast traffic.</DFTitle>
    <DFType>
      <DDFName/>
    </DFType>
  </DFProperties>

  <Node>
    <NodeName></NodeName>
    <DFProperties>
      <AccessType>
        <Get/>
        <Replace/>
      </AccessType>
      <DFFormat>
        <node/>
      </DFFormat>
      <Occurrence>
        <OneOrMore/>
      </Occurrence>
      <DFType>
        <DDFName></DDFName>
      </DFType>
    </DFProperties>

    <Node>
      <NodeName>QCI</NodeName>
      <DFProperties>
        <AccessType>
          <Get/>
          <Replace/>
        </AccessType>
        <DFFormat>
          <int/>
        </DFFormat>
        <Occurrence>
          <One/>
        </Occurrence>
        <DFTitle>QCI value used in the mapping rule</DFTitle>
        <DFType>
          <DDFName/>
        </DFType>
      </DFProperties>
    </Node>

    <Node>
      <NodeName>ProSePerPacketPriority</NodeName>
      <DFProperties>
        <AccessType>
          <Get/>
          <Replace/>
        </AccessType>
        <DFFormat>
          <int/>
        </DFFormat>
        <Occurrence>
          <One/>
        </Occurrence>
      </DFProperties>
    </Node>
  </Node>

```

```

        <DFTitle>PPPP value used in the mapping rule</DFTitle>
        <DFType>
          <DDFName/>
        </DFType>
      </DFProperties>
    </Node>
  </Node>
</Node>

<Node>
  <NodeName>PublicSafetyDiscoveryParameters</NodeName>
  <!-- The PublicSafetyDiscoveryParameters starts here. -->
  <DFProperties>
    <AccessType>
      <Get/>
      <Replace/>
    </AccessType>
    <DFFormat>
      <node/>
    </DFFormat>
    <Occurrence>
      <ZeroOrOne/>
    </Occurrence>
    <DFTitle>Parameters for direct discovery for public safety use.</DFTitle>
    <DFType>
      <DDFName/>
    </DFType>
  </DFProperties>

  <Node>
    <NodeName>GroupMemberDiscoveryParameters</NodeName>
    <!-- The GroupMemberDiscoveryParameters node starts here. -->
    <DFProperties>
      <AccessType>
        <Get/>
        <Replace/>
      </AccessType>
      <DFFormat>
        <node/>
      </DFFormat>
      <Occurrence>
        <ZeroOrOne/>
      </Occurrence>
      <DFTitle>Group member discovery parameters.</DFTitle>
      <DFType>
        <DDFName/>
      </DFType>
    </DFProperties>

    <Node>
      <NodeName></NodeName>
      <DFProperties>
        <AccessType>
          <Get/>
          <Replace/>
        </AccessType>
        <DFFormat>
          <node/>
        </DFFormat>
        <Occurrence>
          <OneOrMore/>
        </Occurrence>
        <DFType>
          <DDFName></DDFName>
        </DFType>
      </DFProperties>

      <Node>
        <NodeName>UserInfoID</NodeName>
        <DFProperties>
          <AccessType>
            <Get/>
            <Replace/>
          </AccessType>
          <DFFormat>

```



```

        <chr/>
      </DFFormat>
    </Occurrence>
  </One/>
</Occurrence>
<DFTitle>User Info ID for group member discovery.</DFTitle>
<DFType>
  <DDFName></DDFName>
</DFType>
</DFProperties>
</Node>

<Node>
  <NodeName>DiscoveryGroupID</NodeName>
  <DFProperties>
    <AccessType>
      <Get/>
      <Replace/>
    </AccessType>
    <DFFormat>
      <chr/>
    </DFFormat>
    <Occurrence>
      <One/>
    </Occurrence>
    <DFTitle>Discovery Group ID.</DFTitle>
    <DFType>
      </DFType>
    </DFProperties>
  </Node>

<Node>
  <NodeName>ApplicationLayerGroupID</NodeName>
  <DFProperties>
    <AccessType>
      <Get/>
      <Replace/>
    </AccessType>
    <DFFormat>
      <chr/>
    </DFFormat>
    <Occurrence>
      <One/>
    </Occurrence>
    <DFTitle>ApplicationLayer Group ID.</DFTitle>
    <DFType>
      </DFType>
    </DFProperties>
  </Node>

<Node>
  <NodeName>PKMFAddress</NodeName>
  <DFProperties>
    <AccessType>
      <Get/>
      <Replace/>
    </AccessType>
    <DFFormat>
      <chr/>
    </DFFormat>
    <Occurrence>
      <ZeroOrOne/>
    </Occurrence>
    <DFTitle>Address of the ProSe Key Management Function.</DFTitle>
    <DFType>
      </DFType>
    </DFProperties>
  </Node>

</Node>
</Node>

<Node>
  <NodeName>RelayDiscoveryParameters</NodeName>
  <!-- The RelayDiscoveryParameters node starts here. -->
  <DFProperties>
    <AccessType>
      <Get/>

```

```

        <Replace/>
    </AccessType>
    <DFFormat>
        <node/>
    </DFFormat>
    <Occurrence>
        <ZeroOrOne/>
    </Occurrence>
    <DFTitle>UE-to-network relay discovery parameters.</DFTitle>
    <DFType>
        <DDFName/>
    </DFType>
</DFProperties>

<Node>
    <NodeName>UserInfoID</NodeName>
    <DFProperties>
        <AccessType>
            <Get/>
            <Replace/>
        </AccessType>
        <DFFormat>
            <chr/>
        </DFFormat>
        <Occurrence>
            <One/>
        </Occurrence>
        <DFTitle>User Info ID for group member discovery.</DFTitle>
        <DFType>
            <DDFName></DDFName>
        </DFType>
    </DFProperties>
</Node>

<Node>
    <NodeName>RemoteUEParameters</NodeName>
    <DFProperties>
        <AccessType>
            <Get/>
            <Replace/>
        </AccessType>
        <DFFormat>
            <node/>
        </DFFormat>
        <Occurrence>
            <ZeroOrOne/>
        </Occurrence>
        <DFTitle>Remote UE parameters.</DFTitle>
        <DFType>
            <DDFName></DDFName>
        </DFType>
    </DFProperties>

    <Node>
        <NodeName></NodeName>
        <DFProperties>
            <AccessType>
                <Get/>
                <Replace/>
            </AccessType>
            <DFFormat>
                <node/>
            </DFFormat>
            <Occurrence>
                <OneOrMore/>
            </Occurrence>
            <DFType>
                <DDFName></DDFName>
            </DFType>
        </DFProperties>

    <Node>
        <NodeName>RelayServiceCode</NodeName>
        <DFProperties>
            <AccessType>
                <Get/>
                <Replace/>
            </AccessType>

```

```

        <DFFormat>
          <chr/>
        </DFFormat>
        <Occurrence>
          <One/>
        </Occurrence>
        <DFTitle>Relay Service Code for the connectivity service sought by
the remote UE.</DFTitle>
        <DFType>
          <DDFName></DDFName>
        </DFType>
      </DFProperties>
    </Node>

    <Node>
      <NodeName>UserInfoIDofRelay</NodeName>
      <DFProperties>
        <AccessType>
          <Get/>
          <Replace/>
        </AccessType>
        <DFFormat>
          <chr/>
        </DFFormat>
        <Occurrence>
          <ZeroOrOne/>
        </Occurrence>
        <DFTitle>User Info ID of relay sought by the remote UE.</DFTitle>
        <DFType>
          <DDFName></DDFName>
        </DFType>
      </DFProperties>
    </Node>

    <Node>
      <NodeName>IPVersions</NodeName>
      <DFProperties>
        <AccessType>
          <Get/>
          <Replace/>
        </AccessType>
        <DFFormat>
          <chr/>
        </DFFormat>
        <Occurrence>
          <One/>
        </Occurrence>
        <DFTitle>IP version(s) for the connectivity service associated with
this Relay Service Code.</DFTitle>
        <DFType>
          <DDFName></DDFName>
        </DFType>
      </DFProperties>
    </Node>

    <Node>
      <NodeName>PKMFAddress</NodeName>
      <DFProperties>
        <AccessType>
          <Get/>
          <Replace/>
        </AccessType>
        <DFFormat>
          <chr/>
        </DFFormat>
        <Occurrence>
          <ZeroOrOne/>
        </Occurrence>
        <DFTitle>Address of the ProSe Key Management Function.</DFTitle>
        <DFType>
          <DDFName></DDFName>
        </DFType>
      </DFProperties>
    </Node>
  </Node>

```

```

</Node>
<Node>
  <NodeName>RelayParameters</NodeName>
  <DFProperties>
    <AccessType>
      <Get />
      <Replace />
    </AccessType>
    <DFFormat>
      <node />
    </DFFormat>
    <Occurrence>
      <ZeroOrOne />
    </Occurrence>
    <DFTitle>Relay parameters.</DFTitle>
    <DFType>
      <DDFName></DDFName>
    </DFType>
  </DFProperties>

  <Node>
    <NodeName></NodeName>
    <DFProperties>
      <AccessType>
        <Get />
        <Replace />
      </AccessType>
      <DFFormat>
        <node />
      </DFFormat>
      <Occurrence>
        <OneOrMore />
      </Occurrence>
      <DFType>
        <DDFName></DDFName>
      </DFType>
    </DFProperties>

    <Node>
      <NodeName>RelayServiceCode</NodeName>
      <DFProperties>
        <AccessType>
          <Get />
          <Replace />
        </AccessType>
        <DFFormat>
          <chr />
        </DFFormat>
        <Occurrence>
          <One />
        </Occurrence>
        <DFTitle>Relay Service Code for the connectivity service provided by
the relay UE.</DFTitle>
        <DFType>
          <DDFName></DDFName>
        </DFType>
      </DFProperties>
    </Node>

    <Node>
      <NodeName>PDNType</NodeName>
      <DFProperties>
        <AccessType>
          <Get />
          <Replace />
        </AccessType>
        <DFFormat>
          <chr />
        </DFFormat>
        <Occurrence>
          <ZeroOrOne />
        </Occurrence>
        <DFTitle>PDN Type for connectivity service provided by relay
UE.</DFTitle>
        <DFType>
          <DDFName></DDFName>
        </DFType>
      </DFProperties>
    </Node>
  </Node>

```

```

        </DFProperties>
    </Node>

    <Node>
        <NodeName>APN</NodeName>
        <DFProperties>
            <AccessType>
                <Get/>
                <Replace/>
            </AccessType>
            <DFFormat>
                <chr/>
            </DFFormat>
            <Occurrence>
                <ZeroOrOne/>
            </Occurrence>
            <DFTitle>APN to be used by relay UE for this connectivity
service.</DFTitle>

            <DFType>
                <DDFName></DDFName>
            </DFType>
        </DFProperties>
    </Node>

    <Node>
        <NodeName>ProSeRelayUEID</NodeName>
        <DFProperties>
            <AccessType>
                <Get/>
                <Replace/>
            </AccessType>
            <DFFormat>
                <chr/>
            </DFFormat>
            <Occurrence>
                <One/>
            </Occurrence>
            <DFTitle>ProSe Relay UE ID for this connectivity service.</DFTitle>
            <DFType>
                <DDFName></DDFName>
            </DFType>
        </DFProperties>
    </Node>

    <Node>
        <NodeName>PKMFAAddress</NodeName>
        <DFProperties>
            <AccessType>
                <Get/>
                <Replace/>
            </AccessType>
            <DFFormat>
                <chr/>
            </DFFormat>
            <Occurrence>
                <ZeroOrOne/>
            </Occurrence>
            <DFTitle>Address of the ProSe Key Management Function.</DFTitle>
            <DFType>
                <DDFName></DDFName>
            </DFType>
        </DFProperties>
    </Node>

</Node>

</Node>

</Node>

<Node>
    <NodeName>OneToOneDirectCommunicationPolicy</NodeName>
    <!-- The OneToOneDirectCommunicationPolicy node starts here. -->
    <DFProperties>
        <AccessType>
            <Get/>

```

```

        <Replace/>
    </AccessType>
    <DFFormat>
        <node/>
    </DFFormat>
    <Occurrence>
        <ZeroOrOne/>
    </Occurrence>
    <DFTitle>One-to-one direct communication policies for public safety use.</DFTitle>
    <DFType>
        <DDFName/>
    </DFType>
</DFProperties>

<Node>
    <NodeName></NodeName>
    <DFProperties>
        <AccessType>
            <Get/>
            <Replace/>
        </AccessType>
        <DFFormat>
            <node/>
        </DFFormat>
        <Occurrence>
            <OneOrMore/>
        </Occurrence>
        <DFType>
            <DDFName></DDFName>
        </DFType>
    </DFProperties>

<Node>
    <NodeName>PLMN</NodeName>
    <DFProperties>
        <AccessType>
            <Get/>
            <Replace/>
        </AccessType>
        <DFFormat>
            <chr/>
        </DFFormat>
        <Occurrence>
            <One/>
        </Occurrence>
        <DFTitle>PLMN code.</DFTitle>
        <DFType>
            <MIME>text/plain</MIME>
        </DFType>
    </DFProperties>
</Node>

<Node>
    <NodeName>ValidityTimerT4005</NodeName>
    <DFProperties>
        <AccessType>
            <Get/>
            <Replace/>
        </AccessType>
        <DFFormat>
            <int/>
        </DFFormat>
        <Occurrence>
            <One/>
        </Occurrence>
        <DFTitle>Validity Timer T4005 for direct communication policy.</DFTitle>
        <DFType>
            <DDFName/>
        </DFType>
    </DFProperties>
</Node>

</Node>
</Node>

<Node>
    <NodeName>OneToOneDirectCommunicationParameters</NodeName>

```

```

<!-- The OneToOneDirectCommunicationParameters starts here. -->
<DFProperties>
  <AccessType>
    <Get/>
    <Replace/>
  </AccessType>
  <DFFormat>
    <node/>
  </DFFormat>
  <Occurrence>
    <ZeroOrOne/>
  </Occurrence>
  <DFTitle>Parameters for one-to-one direct communication.</DFTitle>
  <DFType>
    <DDFName/>
  </DFType>
</DFProperties>

<Node>
  <NodeName>PC5SignallingPriority</NodeName>
  <DFProperties>
    <AccessType>
      <Get/>
      <Replace/>
    </AccessType>
    <DFFormat>
      <int/>
    </DFFormat>
    <Occurrence>
      <One/>
    </Occurrence>
    <DFTitle>ProSe Per-Packet Priority for PC5 signalling messages.</DFTitle>
    <DFType>
      <DDFName/>
    </DFType>
  </DFProperties>
</Node>

<Node>
  <NodeName>ApplicationLayerGroup</NodeName>
  <!-- The ApplicationLayerGroup node starts here. -->
  <DFProperties>
    <AccessType>
      <Get/>
      <Replace/>
    </AccessType>
    <DFFormat>
      <node/>
    </DFFormat>
    <Occurrence>
      <ZeroOrOne/>
    </Occurrence>
    <DFTitle>ApplicationLayerGroup unicast communication configurations</DFTitle>
    <DFType>
      <DDFName/>
    </DFType>
  </DFProperties>

  <Node>
    <NodeName></NodeName>
    <DFProperties>
      <AccessType>
        <Get/>
        <Replace/>
      </AccessType>
      <DFFormat>
        <node/>
      </DFFormat>
      <Occurrence>
        <OneOrMore/>
      </Occurrence>
      <DFType>
        <DDFName></DDFName>
      </DFType>
    </DFProperties>
  </Node>

```

```

        <NodeName>Layer2IDForUnicastCommunication</NodeName>
        <DFProperties>
            <AccessType>
                <Get/>
                <Replace/>
            </AccessType>
            <DFFormat>
                <chr/>
            </DFFormat>
            <Occurrence>
                <One/>
            </Occurrence>
            <DFTitle>Layer 2 ID for unicast communication.</DFTitle>
            <DFType>
                <DDFName></DDFName>
            </DFType>
        </DFProperties>
    </Node>

    <Node>
        <NodeName>KMSAddress</NodeName>
        <DFProperties>
            <AccessType>
                <Get/>
                <Replace/>
            </AccessType>
            <DFFormat>
                <chr/>
            </DFFormat>
            <Occurrence>
                <ZeroOrOne/>
            </Occurrence>
            <DFTitle>Address of the Key Management Server.</DFTitle>
            <DFType>
                <DDFName></DDFName>
            </DFType>
        </DFProperties>
    </Node>

    <Node>
        <NodeName>ApplicationLayerGroupID</NodeName>
        <DFProperties>
            <AccessType>
                <Get/>
                <Replace/>
            </AccessType>
            <DFFormat>
                <node/>
            </DFFormat>
            <Occurrence>
                <One/>
            </Occurrence>
            <DFTitle>Application Layer Group ID for one-to-one direct
communication.</DFTitle>
            <DFType>
                <DDFName></DDFName>
            </DFType>
        </DFProperties>
    </Node>

    </Node>
</Node>

<Node>
    <NodeName>DiscoveryPolicyForPS</NodeName>
    <!-- The DiscoveryPolicyForPS starts here. -->
    <DFProperties>
        <AccessType>
            <Get/>
            <Replace/>
        </AccessType>
        <DFFormat>
            <node/>
        </DFFormat>
        <Occurrence>

```



```

        <ZeroOrOne/>
    </Occurrence>
    <DFTitle>Authorisation policies for direct discovery for public safety
use.</DFTitle>
    <DFType>
        <DDFName/>
    </DFType>
</DFProperties>

<Node>
    <NodeName>ModelAMonitoringPolicy</NodeName>
    <!-- The ModelAMonitoringPolicy node starts here. -->
    <DFProperties>
        <AccessType>
            <Get/>
            <Replace/>
        </AccessType>
        <DFFormat>
            <node/>
        </DFFormat>
        <Occurrence>
            <ZeroOrOne/>
        </Occurrence>
        <DFTitle> Model A monitoring authorisation policies for ProSe direct discovery
for public safety use.</DFTitle>
        <DFType>
            <DDFName/>
        </DFType>
    </DFProperties>

    <Node>
        <NodeName></NodeName>
        <DFProperties>
            <AccessType>
                <Get/>
                <Replace/>
            </AccessType>
            <DFFormat>
                <node/>
            </DFFormat>
            <Occurrence>
                <OneOrMore/>
            </Occurrence>
            <DFType>
                <DDFName></DDFName>
            </DFType>
        </DFProperties>

    <Node>
        <NodeName>PLMN</NodeName>
        <DFProperties>
            <AccessType>
                <Get/>
                <Replace/>
            </AccessType>
            <DFFormat>
                <chr/>
            </DFFormat>
            <Occurrence>
                <One/>
            </Occurrence>
            <DFTitle>PLMN code.</DFTitle>
            <DFType>
                <MIME>text/plain</MIME>
            </DFType>
        </DFProperties>
    </Node>

    <Node>
        <NodeName>ValidityTimerT4005</NodeName>
        <DFProperties>
            <AccessType>
                <Get/>
                <Replace/>
            </AccessType>
            <DFFormat>
                <int/>
            </DFFormat>

```

```

        <Occurrence>
          <One/>
        </Occurrence>
        <DFTitle>Validity Timer T4005 for model A monitoring policy for public
safety use.</DFTitle>
        <DFType>
          <DDFName/>
        </DFType>
      </DFProperties>
    </Node>

  </Node>
</Node>

<Node>
  <NodeName>ModelAAnnouncingPolicy</NodeName>
  <!-- The ModelAAnnouncingPolicy node starts here. -->
  <DFProperties>
    <AccessType>
      <Get/>
      <Replace/>
    </AccessType>
    <DFFormat>
      <node/>
    </DFFormat>
    <Occurrence>
      <ZeroOrOne/>
    </Occurrence>
    <DFTitle> Model A announcing authorisation policies for ProSe direct discovery
for public safety use.</DFTitle>
    <DFType>
      <DDFName/>
    </DFType>
  </DFProperties>

  <Node>
    <NodeName></NodeName>
    <DFProperties>
      <AccessType>
        <Get/>
        <Replace/>
      </AccessType>
      <DFFormat>
        <node/>
      </DFFormat>
      <Occurrence>
        <OneOrMore/>
      </Occurrence>
      <DFType>
        <DDFName></DDFName>
      </DFType>
    </DFProperties>

    <Node>
      <NodeName>PLMN</NodeName>
      <DFProperties>
        <AccessType>
          <Get/>
          <Replace/>
        </AccessType>
        <DFFormat>
          <chr/>
        </DFFormat>
        <Occurrence>
          <One/>
        </Occurrence>
        <DFTitle>PLMN code.</DFTitle>
        <DFType>
          <MIME>text/plain</MIME>
        </DFType>
      </DFProperties>
    </Node>

    <Node>
      <NodeName>ValidityTimerT4005</NodeName>
      <DFProperties>
        <AccessType>
          <Get/>

```

```

        <Replace/>
      </AccessType>
    <DFFormat>
      <int/>
    </DFFormat>
    <Occurrence>
      <One/>
    </Occurrence>
    <DFTitle>Validity Timer T4005 for model A announcing policy for public
safety use.</DFTitle>
  <DFType>
    <DDFName/>
  </DFType>
</DFProperties>
</Node>

<Node>
  <NodeName>Range</NodeName>
  <DFProperties>
    <AccessType>
      <Get/>
      <Replace/>
    </AccessType>
    <DFFormat>
      <int/>
    </DFFormat>
    <Occurrence>
      <ZeroOrOne/>
    </Occurrence>
    <DFTitle>Authorised range for model A announcing for public safety
use.</DFTitle>
  <DFType>
    <DDFName/>
  </DFType>
</DFProperties>
</Node>

</Node>
</Node>

<Node>
  <NodeName>ModelBDiscovererPolicy</NodeName>
  <!-- The ModelBDiscovererPolicy node starts here. -->
  <DFProperties>
    <AccessType>
      <Get/>
      <Replace/>
    </AccessType>
    <DFFormat>
      <node/>
    </DFFormat>
    <Occurrence>
      <ZeroOrOne/>
    </Occurrence>
    <DFTitle> Model B discoverer operation authorisation policies for ProSe direct
discovery for public safety use.</DFTitle>
  <DFType>
    <DDFName/>
  </DFType>
</DFProperties>

  <Node>
    <NodeName></NodeName>
    <DFProperties>
      <AccessType>
        <Get/>
        <Replace/>
      </AccessType>
      <DFFormat>
        <node/>
      </DFFormat>
      <Occurrence>
        <OneOrMore/>
      </Occurrence>
      <DFType>
        <DDFName></DDFName>
      </DFType>
    </DFProperties>
  </Node>

```

```

<Node>
  <NodeName>PLMN</NodeName>
  <DFProperties>
    <AccessType>
      <Get/>
      <Replace/>
    </AccessType>
    <DFFormat>
      <chr/>
    </DFFormat>
    <Occurrence>
      <One/>
    </Occurrence>
    <DFTitle>PLMN code.</DFTitle>
    <DFType>
      <MIME>text/plain</MIME>
    </DFType>
  </DFProperties>
</Node>

<Node>
  <NodeName>ValidityTimerT4005</NodeName>
  <DFProperties>
    <AccessType>
      <Get/>
      <Replace/>
    </AccessType>
    <DFFormat>
      <int/>
    </DFFormat>
    <Occurrence>
      <One/>
    </Occurrence>
    <DFTitle>Validity Timer T4005 for model B discoverer operation policy
for public safety use.</DFTitle>
    <DFType>
      <DDFName/>
    </DFType>
  </DFProperties>
</Node>

<Node>
  <NodeName>Range</NodeName>
  <DFProperties>
    <AccessType>
      <Get/>
      <Replace/>
    </AccessType>
    <DFFormat>
      <int/>
    </DFFormat>
    <Occurrence>
      <ZeroOrOne/>
    </Occurrence>
    <DFTitle>Authorised range for model B discoverer operation for public
safety use.</DFTitle>
    <DFType>
      <DDFName/>
    </DFType>
  </DFProperties>
</Node>

</Node>
</Node>

<Node>
  <NodeName>ModelBDiscovererPolicy</NodeName>
  <!-- The ModelBDiscovererPolicy node starts here. -->
  <DFProperties>
    <AccessType>
      <Get/>
      <Replace/>
    </AccessType>
    <DFFormat>
      <node/>
    </DFFormat>
    <Occurrence>

```

```

        <ZeroOrOne/>
      </Occurrence>
      <DFTitle> Model B discoveree operation authorisation policies for ProSe direct
discovery for public safety use.</DFTitle>
      <DFType>
        <DDFName/>
      </DFType>
    </DFProperties>

  <Node>
    <NodeName></NodeName>
    <DFProperties>
      <AccessType>
        <Get/>
        <Replace/>
      </AccessType>
      <DFFormat>
        <node/>
      </DFFormat>
      <Occurrence>
        <OneOrMore/>
      </Occurrence>
      <DFType>
        <DDFName></DDFName>
      </DFType>
    </DFProperties>

  <Node>
    <NodeName>PLMN</NodeName>
    <DFProperties>
      <AccessType>
        <Get/>
        <Replace/>
      </AccessType>
      <DFFormat>
        <chr/>
      </DFFormat>
      <Occurrence>
        <One/>
      </Occurrence>
      <DFTitle>PLMN code.</DFTitle>
      <DFType>
        <MIME>text/plain</MIME>
      </DFType>
    </DFProperties>
  </Node>

  <Node>
    <NodeName>ValidityTimerT4005</NodeName>
    <DFProperties>
      <AccessType>
        <Get/>
        <Replace/>
      </AccessType>
      <DFFormat>
        <int/>
      </DFFormat>
      <Occurrence>
        <One/>
      </Occurrence>
      <DFTitle>Validity Timer T4005 for model B discoveree operation policy
for public safety use.</DFTitle>
      <DFType>
        <DDFName/>
      </DFType>
    </DFProperties>
  </Node>

  <Node>
    <NodeName>Range</NodeName>
    <DFProperties>
      <AccessType>
        <Get/>
        <Replace/>
      </AccessType>
      <DFFormat>
        <int/>
      </DFFormat>

```

```

        <Occurrence>
          <ZeroOrOne/>
        </Occurrence>
        <DFTitle>Authorised range for model B discoveree operation for public
safety use.</DFTitle>
        <DFType>
          <DDFName/>
        </DFType>
      </DFProperties>
    </Node>
  </Node>
</Node>

<Node>
  <NodeName>Ext</NodeName>
  <DFProperties>
    <AccessType>
      <Get/>
    </AccessType>
    <DFFormat>
      <node/>
    </DFFormat>
    <Occurrence>
      <ZeroOrOne/>
    </Occurrence>
    <DFTitle>A collection of all extension objects.</DFTitle>
    <DFType>
      <DDFName/>
    </DFType>
  </DFProperties>
</Node>
</Node>
</MgmtTree>

```

Annex C (informative): EPC-level ProSe discovery Provisioning MO DDF

This DDF is the standardized minimal set. A vendor can define its own DDF for the complete device. This DDF can include more features than this minimal standardized version.

```
<?xml version="1.0" encoding="UTF-8"?>
<!DOCTYPE MgmtTree PUBLIC "-//OMA//DTD-DM-DDF 1.2//EN"
"http://www.openmobilealliance.org/tech/DTD/dm_ddf-v1_2.dtd">

<MgmtTree>
  <VerDTD>1.2</VerDTD>
  <Man>--The device manufacturer--</Man>
  <Mod>--The device model--</Mod>

  <Node>
    <NodeName/>
    <DFProperties>
      <AccessType>
        <Get/>
      </AccessType>
      <Description>EPC-level ProSe discovery Provisioning</Description>
      <DFFormat>
        <node/>
      </DFFormat>
      <Occurrence>
        <ZeroOrOne/>
      </Occurrence>
      <DFTitle>EPC-level ProSe discovery Provisioning MO.</DFTitle>
      <DFType>
        <DDFName/>urn:oma:mo:ext-3gpp-EPC-level-prose-discovery-provisioning:1.0<DDFName/>
      </DFType>
    </DFProperties>

  <Node>
    <NodeName>ToConRef</NodeName>
    <DFProperties>
      <AccessType>
        <Get/>
      </AccessType>
      <DFFormat>
        <node/>
      </DFFormat>
      <Occurrence>
        <ZeroOrOne/>
      </Occurrence>
      <DFTitle>collection of connectivity definitions</DFTitle>
      <DFType>
        <DDFName/>
      </DFType>
    </DFProperties>
    <Node>
      <NodeName/>
      <DFProperties>
        <AccessType>
          <Get/>
          <Replace/>
        </AccessType>
        <DFFormat>
          <node/>
        </DFFormat>
        <Occurrence>
          <OneOrMore/>
        </Occurrence>
        <DFTitle>The name node for one or more connectivity parameters</DFTitle>
        <DFType>
          <DDFName/>
        </DFType>
      </DFProperties>
    </Node>
    <Node>
      <NodeName>ConRef</NodeName>
      <DFProperties>
        <AccessType>
          <Get/>
        </AccessType>
      </DFProperties>
    </Node>
  </Node>
</MgmtTree>
```

```
        <Replace/>
      </AccessType>
    <DFFormat>
      <chr/>
    </DFFormat>
  <Occurrence>
    <One/>
  </Occurrence>
  <DFTitle>Linkage to connectivity parameters</DFTitle>
  <DFType>
    <MIME>text/plain</MIME>
  </DFType>
</DFProperties>
</Node>
</Node>
</Node>
<Node>
  <NodeName>Ext</NodeName>
  <DFProperties>
    <AccessType>
      <Get/>
    </AccessType>
    <DFFormat>
      <node/>
    </DFFormat>
    <Occurrence>
      <ZeroOrOne/>
    </Occurrence>
    <DFTitle>A collection of all extension objects.</DFTitle>
    <DFType>
      <DDFName/>
    </DFType>
  </DFProperties>
</Node>
</Node>
</MgmtTree>
```

Annex D (informative): Change history

Change history							
Date	TSG #	TSG Doc.	CR	Rev	Subject/Comment	Old	New
2014-03					TS skeleton generated for submission at CT1#86bis	-	0.0.0
2014-04	CT1#86bis				Implementation of C1-141571 and C1-141572. Editorial and formatting fixes.	0.0.0	0.1.0
2014-05	CT1#87				Implementation of C1-142200	0.1.0	0.2.0
2014-06	CT-64	CP-140278			Version 1.0.0 submitted to CT-64 for information	0.2.0	1.0.0
2014-07	CT1#88				Implementation of C1-142855, C1-143024, C1-143244, C1-143252 and C1-143318. Fix for Annex B DDF compilation error.	1.0.0	1.1.0
2014-09	CT-65	CP-140629			Version 2.0.0 submitted to CT-65 for approval	1.1.0	2.0.0
2014-09	CT-65	CP-140716			Plenary tdoc revised to include missing cover sheet	1.1.0	2.0.0
2014-09	Post CT-65				Version 12.0.0 created after approval	2.0.0	12.0.0
2014-12	CT-66	CP-140847	0001	1	Announcing range parameter	12.0.0	12.1.0
2014-12	CT-66	CP-140847	0002	3	Update of provisioning parameters for charging reporting configuration in ProSe Public Safety Direct Services Provisioning MO	12.0.0	12.1.0
2014-12	CT-66	CP-140847	0003	1	Update of provisioning parameters for direct communication security in ProSe Public Safety Direct Services Provisioning MO	12.0.0	12.1.0
2014-12	CT-66	CP-140847	0004		Update of range for validity timer T4005 in ProSe MOs	12.0.0	12.1.0
2014-12	CT-66	CP-140847	0005		Prose Service authorisation for MO	12.0.0	12.1.0
2014-12	CT-66	CP-140847	0007		Update of MOs related to radio parameters provisioned for ProSe	12.0.0	12.1.0
2015-03	CT-67	CP-150071	0006	3	Parameters of PDN connection to be used to reach HPLMN ProSe Function	12.1.0	12.2.0
2015-03	CT-67	CP-150071	0013	2	Correction on conditions for activating ProSe direct discovery features	12.1.0	12.2.0
2015-03	CT-67	CP-150071	0014		Removal of Editor's notes on MO identifiers in TS 24.333	12.1.0	12.2.0
2015-03	CT-67	CP-150178	0015	2	Update of RadioParameterContents leaves in ProSe MOs	12.1.0	12.2.0
2015-03	CT-67	CP-150071	0016	3	Update of provisioning parameters for usage information reporting configuration in ProSe Public Safety Direct Services Provisioning MO	12.1.0	12.2.0
2015-03	CT-67	CP-150071	0017		Scope clarification for ProSe direct discovery in TS 24.333 – alternative 1	12.1.0	12.2.0
2015-06	CT-68	CP-150316	0019	1	Correcting titles of configuration parameters carrying NAP object	12.2.0	12.3.0
2015-06	CT-68	CP-150316	0020		GeographicalArea in DirectCommunicationRadioParameters	12.2.0	12.3.0
2015-06	CT-68	CP-150316	0022	1	Correction of ToConRef leaf in ProSe MO	12.2.0	12.3.0
2015-06	CT-68	CP-150316	0024		Correction of 'Not served by E-UTRAN'	12.2.0	12.3.0
2015-09	CT-69	CP-150528	0025	1	Update of ProSe MOs for restricted ProSe direct discovery	12.3.0	13.0.0
2015-12	CT-70	CP-150708	0026		Correction of ProSe Discovery UE ID provisioning and Wrong Reference	13.0.0	13.1.0
2015-12	CT-70	CP-150708	0028	5	Provisioning ProSe parameters for public safety use	13.0.0	13.1.0
2015-12	CT-70	CP-150708	0029	1	Scope Clarification of ProSe Direct discovery when not served by E-UTRAN	13.0.0	13.1.0

2015-12	CT-70	CP-150692	0031		Provisioning MO for ProSe Public Safety Direct Services	13.0.0	13.1.0
2016-03	CT-71	CP-160157	0033	1	ProSe MO update for provisioning ProSe Per-Packet Priority	13.1.0	13.2.0
2016-03	CT-71	CP-160157	0034	1	ProSe MO update for provisioning ProSe Per-Packet Priority and QCI mapping rules	13.1.0	13.2.0
2016-03	CT-71	CP-160157	0035		Addition of provisioning parameter for security of relay discovery	13.1.0	13.2.0
2016-03	CT-71	CP-160157	0036		Removal of Editor's notes on the format of the ProSe Discovery UE ID	13.1.0	13.2.0
2016-03	CT-71	CP-160157	0032	5	Application Layer Group ID and security parameters for MO	13.1.0	13.2.0
2016-06	CT-72	CP-160311	0038	2	Rename on the term 'Restricted Discovery Policy for PS'	13.2.0	13.3.0
2016-06	CT-72	CP-160311	0040		Clean up of TS 24.333	13.2.0	13.3.0
2016-06	CT-72	CP-160311	0041		Removing Per-PLMN Service Authorization for Remote UEs	13.2.0	13.3.0
2016-06	CT-72	CP-160311	0042		Adding IMEI reporting configuration for the relay policy in Public Safety MO	13.2.0	13.3.0

Change history

Date	Meeting	TDoc	CR	Rev	Cat	Subject/Comment	New version
2016-09	CT#73	CP-160493	0043		F	Missing table for range values in public safety model B discoverer policy	13.4.0
2017-03	CT#75	CP-170119	0045	1	F	Correction of LocURI value	13.5.0
2017-03	CT#75	CP-170108	0047		A	Removal of Editor's note on MO identifier	13.5.0
2017-03	CT#75	CP-170119	0048		F	Correction of LocURI value for EPC-level ProSe discovery Provisioning MO	13.5.0
2017-03	SA#75					Upgrade to Rel-14	14.0.0
2018-03	CT#79	CP-180065	0062		F	Clarification on the number of coordinates in a geographical area	14.1.0

History

Document history		
V14.0.0	April 2017	Publication
V14.1.0	April 2018	Publication