

ETSI TS 124 483 V14.3.0 (2018-01)



**LTE;
Mission Critical Services (MCS) Management Object (MO)
(3GPP TS 24.483 version 14.3.0 Release 14)**



ReferenceRTS/TSGC-0124483ve30

KeywordsLTE

ETSI

650 Route des Lucioles
F-06921 Sophia Antipolis Cedex - FRANCE

Tel.: +33 4 92 94 42 00 Fax: +33 4 93 65 47 16

Siret N° 348 623 562 00017 - NAF 742 C
Association à but non lucratif enregistrée à la
Sous-Préfecture de Grasse (06) N° 7803/88

Important notice

The present document can be downloaded from:

<http://www.etsi.org/standards-search>

The present document may be made available in electronic versions and/or in print. The content of any electronic and/or print versions of the present document shall not be modified without the prior written authorization of ETSI. In case of any existing or perceived difference in contents between such versions and/or in print, the only prevailing document is the print of the Portable Document Format (PDF) version kept on a specific network drive within ETSI Secretariat.

Users of the present document should be aware that the document may be subject to revision or change of status.

Information on the current status of this and other ETSI documents is available at

<https://portal.etsi.org/TB/ETSIDeliverableStatus.aspx>

If you find errors in the present document, please send your comment to one of the following services:

<https://portal.etsi.org/People/CommiteeSupportStaff.aspx>

Copyright Notification

No part may be reproduced or utilized in any form or by any means, electronic or mechanical, including photocopying and microfilm except as authorized by written permission of ETSI.

The content of the PDF version shall not be modified without the written authorization of ETSI.

The copyright and the foregoing restriction extend to reproduction in all media.

© ETSI 2018.

All rights reserved.

DECT™, **PLUGTESTS™**, **UMTS™** and the ETSI logo are trademarks of ETSI registered for the benefit of its Members.

3GPP™ and **LTE™** are trademarks of ETSI registered for the benefit of its Members and of the 3GPP Organizational Partners.

oneM2M logo is protected for the benefit of its Members.

GSM® and the GSM logo are trademarks registered and owned by the GSM Association.

Intellectual Property Rights

Essential patents

IPRs essential or potentially essential to the present document may have been declared to ETSI. The information pertaining to these essential IPRs, if any, is publicly available for **ETSI members and non-members**, and can be found in ETSI SR 000 314: "*Intellectual Property Rights (IPRs); Essential, or potentially Essential, IPRs notified to ETSI in respect of ETSI standards*", which is available from the ETSI Secretariat. Latest updates are available on the ETSI Web server (<https://ipr.etsi.org/>).

Pursuant to the ETSI IPR Policy, no investigation, including IPR searches, has been carried out by ETSI. No guarantee can be given as to the existence of other IPRs not referenced in ETSI SR 000 314 (or the updates on the ETSI Web server) which are, or may be, or may become, essential to the present document.

Trademarks

The present document may include trademarks and/or tradenames which are asserted and/or registered by their owners. ETSI claims no ownership of these except for any which are indicated as being the property of ETSI, and conveys no right to use or reproduce any trademark and/or tradename. Mention of those trademarks in the present document does not constitute an endorsement by ETSI of products, services or organizations associated with those trademarks.

Foreword

This Technical Specification (TS) has been produced by ETSI 3rd Generation Partnership Project (3GPP).

The present document may refer to technical specifications or reports using their 3GPP identities, UMTS identities or GSM identities. These should be interpreted as being references to the corresponding ETSI deliverables.

The cross reference between GSM, UMTS, 3GPP and ETSI identities can be found under <http://webapp.etsi.org/key/queryform.asp>.

Modal verbs terminology

In the present document "**shall**", "**shall not**", "**should**", "**should not**", "**may**", "**need not**", "**will**", "**will not**", "**can**" and "**cannot**" are to be interpreted as described in clause 3.2 of the [ETSI Drafting Rules](#) (Verbal forms for the expression of provisions).

"**must**" and "**must not**" are **NOT** allowed in ETSI deliverables except when used in direct citation.

Contents

Intellectual Property Rights	2
Foreword.....	2
Modal verbs terminology.....	2
Foreword.....	17
1 Scope	18
2 References	19
3 Definitions and abbreviations.....	20
3.1 Definitions	20
3.2 Abbreviations	20
4 MCPTT UE configuration MO	20
4.1 General	20
4.2 MCPTT UE configuration MO parameters	21
4.2.1 General.....	21
4.2.2 Node: <x>	21
4.2.3 /<x>/Name	21
4.2.4 /<x>/Ext/	22
4.2.5 /<x>/Common	22
4.2.6 /<x>/Common/PrivateCall	22
4.2.7 /<x>/Common/PrivateCall/MaxCallN10	22
4.2.8 /<x>/Common/MCPTTGroupCall.....	22
4.2.9 /<x>/Common/MCPTTGroupCall/MaxCallN4	23
4.2.10 /<x>/Common/MCPTTGroupCall/MaxTransmissionN5	23
4.2.11 /<x>/Common/MCPTTGroupCall/PrioritizedMCPTTGroup.....	23
4.2.12 /<x>/Common/MCPTTGroupCall/PrioritizedMCPTTGroup/<x>	23
4.2.13 /<x>/Common/MCPTTGroupCall/PrioritizedMCPTTGroup/<x>/MCPTTGroupID	23
4.2.14 /<x>/Common/MCPTTGroupCall/PrioritizedMCPTTGroup/<x>/MCPTTGroupPriorityHierarchy.....	24
4.2.15 /<x>/OnNetwork	24
4.2.16 /<x>/OnNetwork/RelayService.....	24
4.2.17 /<x>/OnNetwork/IPv6Preferred.....	24
4.2.18 /<x>/OnNetwork/RelayedMCPTTGroup.....	25
4.2.19 /<x>/OnNetwork/RelayedMCPTTGroup/<x>	25
4.2.20 /<x>/OnNetwork/RelayedMCPTTGroup/<x>/MCPTTGroupID	25
4.2.21 /<x>/OnNetwork/RelayedMCPTTGroup/<x>/RelayServiceCode	25
5 MCPTT user profile MO.....	25
5.1 General	25
5.2 MCPTT user profile MO parameters.....	28
5.2.1 General.....	28
5.2.2 Node: <x>	28
5.2.3 /<x>/Name	28
5.2.4 /<x>/Ext/	28
5.2.5 /<x>/<x>	28
5.2.6 /<x>/<x>/Common	29
5.2.7 /<x>/<x>/Common/MCPTTUserID	29
5.2.7A /<x>/<x>/Common/MCPTTUserProfileIndex	29
5.2.7B /<x>/<x>/Common/MCPTTUserProfileName.....	29
5.2.7C /<x>/<x>/Common/PreSelectedIndication.....	29
5.2.8 /<x>/<x>/Common/UserAliases.....	30
5.2.8A /<x>/<x>/Common/UserAliases/<x>.....	30
5.2.8B /<x>/<x>/Common/UserAliases/<x>/UserAlias	30
5.2.9 /<x>/<x>/Common/AuthorisedAlias.....	30
5.2.10 /<x>/<x>/Common/ParticipantType	31
5.2.11 /<x>/<x>/Common/Organization.....	31
5.2.12 /<x>/<x>/Common/PrivateCall.....	31

5.2.13	/<x>/<x>/Common/PrivateCall/Authorised	31
5.2.14	/<x>/<x>/Common/PrivateCall/AuthorisedAny	31
5.2.15	/<x>/<x>/Common/PrivateCall/UserList	32
5.2.16	/<x>/<x>/Common/PrivateCall/UserList/<x>	32
5.2.16A	/<x>/<x>/Common/PrivateCall/UserList/<x>/Entry	32
5.2.17	/<x>/<x>/Common/PrivateCall/UserList/<x>/Entry/MCPTTID	32
5.2.18	/<x>/<x>/Common/PrivateCall/UserList/<x>/Entry/DiscoveryGroupID	32
5.2.19	/<x>/<x>/Common/PrivateCall/UserList/<x>/Entry/UserInfoID	33
5.2.19A	/<x>/<x>/Common/PrivateCall/UserList/<x>/Entry/DisplayName	33
5.2.19B	/<x>/<x>/Common/PrivateCall/UserList/<x>/Entry/PrivateCallKMSURI	33
5.2.20	/<x>/<x>/Common/PrivateCall/ManualCommence	33
5.2.21	/<x>/<x>/Common/PrivateCall/AutoCommence	33
5.2.22	/<x>/<x>/Common/PrivateCall/AutoAnswer	34
5.2.23	/<x>/<x>/Common/PrivateCall/FailRestrict	34
5.2.24	/<x>/<x>/Common/PrivateCall/AllowedMediaProtection	34
5.2.25	/<x>/<x>/Common/PrivateCall/AllowedFloorControlProtection	34
5.2.26	/<x>/<x>/Common/PrivateCall/EmergencyCall	35
5.2.27	/<x>/<x>/Common/PrivateCall/EmergencyCall/Authorised	35
5.2.28	/<x>/<x>/Common/PrivateCall/EmergencyCall/CancelPriority	35
5.2.29	/<x>/<x>/Common/PrivateCall/EmergencyCall/MCPTTPrivateRecipient	35
5.2.29A	/<x>/<x>/Common/PrivateCall/EmergencyCall/MCPTTPrivateRecipient/Entry	36
5.2.29B	/<x>/<x>/Common/PrivateCall/EmergencyCall/MCPTTPrivateRecipient/Entry/ID	36
5.2.29C	/<x>/<x>/Common/PrivateCall/EmergencyCall/MCPTTPrivateRecipient/Entry/DiscoveryGroupID	36
5.2.29D	/<x>/<x>/Common/PrivateCall/EmergencyCall/MCPTTPrivateRecipient/Entry/UserInfoID	36
5.2.29E	/<x>/<x>/Common/PrivateCall/EmergencyCall/MCPTTPrivateRecipient/Entry/DisplayName	37
5.2.29F	/<x>/<x>/Common/PrivateCall/EmergencyCall/MCPTTPrivateRecipient/Entry/Usage	37
5.2.30	/<x>/<x>/Common/MCPTTGroupCall	37
5.2.31	/<x>/<x>/Common/MCPTTGroupCall/MaxSimultaneousCallsN6	37
5.2.32	/<x>/<x>/Common/MCPTTGroupCall/EmergencyCall	38
5.2.33	/<x>/<x>/Common/MCPTTGroupCall/EmergencyCall/Enabled	38
5.2.34	/<x>/<x>/Common/MCPTTGroupCall/EmergencyCall/MCPTTGroupInitiation	38
5.2.34A	/<x>/<x>/Common/MCPTTGroupCall/EmergencyCall/MCPTTGroupInitiation/Entry	38
5.2.34B	/<x>/<x>/Common/MCPTTGroupCall/EmergencyCall/MCPTTGroupInitiation/Entry/GroupID	39
5.2.34C/<x>/<x>/Common/MCPTTGroupCall/EmergencyCall/MCPTTGroupInitiation/Entry/DisplayName	39
5.2.34D	/<x>/<x>/Common/MCPTTGroupCall/EmergencyCall/MCPTTGroupInitiation/Entry/Usage	39
5.2.35	/<x>/<x>/Common/MCPTTGroupCall/EmergencyCall/CancelMCPTTGroup	40
5.2.36	/<x>/<x>/Common/MCPTTGroupCall/ImminentPerilCall	40
5.2.37	/<x>/<x>/Common/MCPTTGroupCall/ImminentPerilCall/Authorised	40
5.2.38	/<x>/<x>/Common/MCPTTGroupCall/ImminentPerilCall/Cancel	40
5.2.39	/<x>/<x>/Common/MCPTTGroupCall/ImminentPerilCall/MCPTTGroupInitiation	41
5.2.39A	/<x>/<x>/Common/MCPTTGroupCall/ImminentPerilCall/MCPTTGroupInitiation/Entry	41
5.2.39B	/<x>/<x>/Common/MCPTTGroupCall/ImminentPerilCall/MCPTTGroupInitiation/Entry/GroupID	41
5.2.39C	/<x>/<x>/Common/MCPTTGroupCall/ImminentPerilCall/MCPTTGroupInitiation/DisplayName	41
5.2.39D	/<x>/<x>/Common/MCPTTGroupCall/ImminentPerilCall/MCPTTGroupInitiation/Entry/Usage	42
5.2.40	/<x>/<x>/Common/MCPTTGroupCall/EmergencyAlert	42
5.2.41	/<x>/<x>/Common/MCPTTGroupCall/EmergencyAlert/Authorised	42
5.2.42	/<x>/<x>/Common/MCPTTGroupCall/EmergencyAlert/Cancel	42
5.2.43	Void	43
5.2.43A	/<x>/<x>/Common/MCPTTGroupCall/EmergencyAlert/Entry	43
5.2.43B	/<x>/<x>/Common/MCPTTGroupCall/EmergencyAlert/Entry/ID	43
5.2.43C	Void	43
5.2.43D	/<x>/<x>/Common/MCPTTGroupCall/EmergencyAlert/Entry/DisplayName	43
5.2.43E	/<x>/<x>/Common/MCPTTGroupCall/EmergencyAlert/Entry/Usage	43
5.2.43F	/<x>/<x>/Common/MCPTTGroupCall/Priority	44
5.2.44	Void	44
5.2.45	/<x>/<x>/Common/MCPTTGroupBroadcast	44
5.2.46	/<x>/<x>/Common/MCPTTGroupBroadcast/Authorised	44
5.2.47	/<x>/<x>/Common/UserBroadcast	44
5.2.48	/<x>/<x>/Common/UserBroadcast/Authorised	45
5.2.48A	/<x>/<x>/OnNetwork	45

5.2.48B1	/<x>/<x>/OnNetwork/MCPTTGroupList	45
5.2.48B2	/<x>/<x>/OnNetwork/MCPTTGroupList/<x>	45
5.2.48B3	/<x>/<x>/OnNetwork/MCPTTGroupList/<x>/Entry	45
5.2.48B4	/<x>/<x>/OnNetwork/MCPTTGroupList/<x>/Entry/MCPTTGroupID	46
5.2.48B5	/<x>/<x>/OnNetwork/MCPTTGroupList/<x>/Entry/DisplayName	46
5.2.48C1	/<x>/<x>/OnNetwork/ImplicitAffiliations	46
5.2.48C2	/<x>/<x>/OnNetwork/ImplicitAffiliations/<x>	46
5.2.48C3	/<x>/<x>/OnNetwork/ImplicitAffiliations/<x>/Entry	46
5.2.48C4	/<x>/<x>/OnNetwork/ImplicitAffiliations/<x>/Entry/MCPTTGroupID	47
5.2.48C5	/<x>/<x>/OnNetwork/ImplicitAffiliations/<x>/Entry/DisplayName	47
5.2.48D	/<x>/<x>/OnNetwork/AllowedRegroup	47
5.2.48E	/<x>/<x>/OnNetwork/AllowedPresenceStatus	47
5.2.48F	/<x>/<x>/OnNetwork/AllowedPresence	47
5.2.48G	/<x>/<x>/OnNetwork/EnabledParticipation	48
5.2.48H	/<x>/<x>/OnNetwork/AllowedTransmission	48
5.2.48I	/<x>/<x>/OnNetwork/AllowedManualSwitch	48
5.2.48J	/<x>/<x>/OnNetwork/PrivateCall	48
5.2.48K	/<x>/<x>/OnNetwork/PrivateCall/EmergencyAlert	49
5.2.48L	/<x>/<x>/OnNetwork/PrivateCall/EmergencyAlert/Entry	49
5.2.48M	/<x>/<x>/OnNetwork/PrivateCall/EmergencyAlert/Entry/ID	49
5.2.48N	/<x>/<x>/OnNetwork/PrivateCall/EmergencyAlert/Entry/DisplayName	49
5.2.48O	/<x>/<x>/OnNetwork/PrivateCall/EmergencyAlert/Entry/Usage	49
5.2.48P	/<x>/<x>/OnNetwork/PrivateCall/AllowedCallBackRequest	50
5.2.48Q	/<x>/<x>/OnNetwork/PrivateCall/AllowedCallBackCancelRequest	50
5.2.48R	/<x>/<x>/OnNetwork/PrivateCall/AllowedRemoteInitiatedAmbientListening	50
5.2.48S	/<x>/<x>/OnNetwork/PrivateCall/AllowedLocallyInitiatedAmbientListening	51
5.2.48T	/<x>/<x>/OnNetwork/PrivateCall/AllowedRequestFirstToAnswerCall	51
5.2.48U1	/<x>/<x>/OnNetwork/RemoteGroupSelection	51
5.2.48U2	/<x>/<x>/OnNetwork/RemoteGroupSelection/<x>	51
5.2.48U3	/<x>/<x>/OnNetwork/RemoteGroupSelection/<x>/Entry	51
5.2.48U4	/<x>/<x>/OnNetwork/RemoteGroupSelection/<x>/Entry/MCPTTID	52
5.2.48U5	/<x>/<x>/OnNetwork/RemoteGroupSelection/<x>/Entry/DisplayName	52
5.2.48V1	/<x>/<x>/OnNetwork/GroupServerInfo	52
5.2.48V2	/<x>/<x>/OnNetwork/GroupServerInfo/GMSServList	52
5.2.48V3	/<x>/<x>/OnNetwork/GroupServerInfo/GMSServList/<x>	52
5.2.48V4	/<x>/<x>/OnNetwork/GroupServerInfo/GMSServList/<x>/Entry	53
5.2.48V5	/<x>/<x>/OnNetwork/GroupServerInfo/GMSServList/<x>/Entry/GMSServID	53
5.2.48V6/<x>/<x>/OnNetwork/GroupServerInfo/IDMSTokenEndpointList	53	
5.2.48V7/<x>/<x>/OnNetwork/GroupServerInfo/IDMSTokenEndpointList/<x>	53	
5.2.48V8/<x>/<x>/OnNetwork/GroupServerInfo/IDMSTokenEndpointList/<x>/Entry	53	
5.2.48V9 /<x>/<x>/OnNetwork/GroupServerInfo/IDMSTokenEndpointList/<x>/Entry/IDMSTokenID	54	
5.2.48V10/<x>/<x>/OnNetwork/GroupServerInfo/KMSURIList	54	
5.2.48V11/<x>/<x>/OnNetwork/GroupServerInfo/KMSURIList/<x>	54	
5.2.48V12/<x>/<x>/OnNetwork/GroupServerInfo/KMSURIList/<x>/Entry	54	
5.2.48V13 /<x>/<x>/OnNetwork/GroupServerInfo/KMSURIList/<x>/Entry/KMSURI	55	
5.2.49 /<x>/<x>/OffNetwork	55	
5.2.50 /<x>/<x>/OffNetwork/Authorised	55	
5.2.51 /<x>/<x>/OffNetwork/MCPTTGroupInfo	55	
5.2.52 /<x>/<x>/OffNetwork/MCPTTGroupInfo/<x>	55	
5.2.52A /<x>/<x>/OffNetwork/MCPTTGroupInfo/<x>/Entry	56	
5.2.53 /<x>/<x>/OffNetwork/MCPTTGroupInfo/<x>/Entry/MCPTTGroupID	56	
5.2.53A /<x>/<x>/OffNetwork/MCPTTGroupInfo/<x>/Entry/DisplayName	56	
5.2.54 /<x>/<x>/OffNetwork/AllowedListen	56	
5.2.55 /<x>/<x>/OffNetwork/AllowedTransmission	56	
5.2.56 /<x>/<x>/OffNetwork/EmergencyCallChange	57	
5.2.57 /<x>/<x>/OffNetwork/ImminentPerilCallChange	57	
5.2.58 /<x>/<x>/OffNetwork/UserInfoID	57	
5.2.58A1 /<x>/<x>/OffNetwork/GroupServerInfo	57	
5.2.58A2 /<x>/<x>/OffNetwork/GroupServerInfo/GMSServList	57	
5.2.58A3 /<x>/<x>/OffNetwork/GroupServerInfo/GMSServList/<x>	58	
5.2.58A4 /<x>/<x>/OffNetwork/GroupServerInfo/GMSServList/<x>/Entry	58	
5.2.58A5 /<x>/<x>/OffNetwork/GroupServerInfo/GMSServList/<x>/Entry/GMSServID	58	

5.2.58A6/	<x>/<x>/OffNetwork/GroupServerInfo/IDMSTokenEndpointList	58
5.2.58A7/	<x>/<x>/OffNetwork/GroupServerInfo/IDMSTokenEndpointList/<x>	59
5.2.58A8/	<x>/<x>/OffNetwork/GroupServerInfo/IDMSTokenEndpointList/<x>/Entry	59
5.2.58A9	/<x>/<x>/OffNetwork/GroupServerInfo/IDMSTokenEndpointList/<x>/Entry/IDMSTokenID	59
5.2.58A10/	<x>/<x>/OffNetwork/GroupServerInfo/KMSURIList	59
5.2.58A11/	<x>/<x>/OffNetwork/GroupServerInfo/KMSURIList/<x>	60
5.2.58A12/	<x>/<x>/OffNetwork/GroupServerInfo/KMSURIList/<x>/Entry	60
5.2.58A13	/<x>/<x>/OffNetwork/GroupServerInfo/KMSURIList/<x>/Entry/KMSURI	60
5.2.59	/<x>/Status	60
6	MCS group configuration MO	61
6.1	General	61
6.2	MCS group configuration MO parameters	65
6.2.1	General	65
6.2.2	Node: <x>	65
6.2.3	/<x>/Name	65
6.2.4	/<x>/Ext/	65
6.2.5	/<x>/<x>	65
6.2.6	/<x>/<x>/Common	66
6.2.7	/<x>/<x>/Common/MCPTTGroupID	66
6.2.8	/<x>/<x>/Common/MCPTTGroupAlias	66
6.2.9	/<x>/<x>/Common/MCPTTGroupMemberList	66
6.2.10	/<x>/<x>/Common/MCPTTGroupMemberList/<x>	66
6.2.11	/<x>/<x>/Common/MCPTTGroupMemberList/<x>/MCPTTID	67
6.2.12	/<x>/<x>/Common/MCPTTGroupMemberList/<x>/UserPriority	67
6.2.13	/<x>/<x>/Common/MCPTTGroupMemberList/<x>/ParticipantType	67
6.2.14	Void	67
6.2.15	/<x>/<x>/Common/MCPTTGroupOwner	67
6.2.16	/<x>/<x>/Common/PreferredVoiceCodec	68
6.2.17	/<x>/<x>/Common/MCPTTGroupLevel	68
6.2.18	/<x>/<x>/Common/UserLevel	68
6.2.19	/<x>/<x>/Common/AllowedEmergencyCall	68
6.2.20	/<x>/<x>/Common/AllowedImminentPerilCall	69
6.2.21	/<x>/<x>/Common/AllowedEmergencyAlert	69
6.2.22	/<x>/<x>/Common/MediaProtectionRequired	69
6.2.23	/<x>/<x>/Common/FloorControlProtectionRequired	69
6.2.23A	/<x>/<x>/Common/MediaProtectionSecurityMaterial	70
6.2.23B	/<x>/<x>/Common/MCData	70
6.2.23C	/<x>/<x>/Common/MCData/MediaProtectionRequired	70
6.2.23D	/<x>/<x>/Common/MCData/TxControlProtectionRequired	70
6.2.23E	/<x>/<x>/Common/MCData/MediaProtectionSecurityMaterial	71
6.2.23F	/<x>/<x>/Common/MCData/AllowedSDS	71
6.2.23G	/<x>/<x>/Common/MCData/AllowedFD	71
6.2.23H	/<x>/<x>/Common/MCData/AllowedConvMgmt	71
6.2.23I	/<x>/<x>/Common/MCData/AllowedTxControl	71
6.2.23J	/<x>/<x>/Common/MCData/AllowedRxControl	72
6.2.23K	/<x>/<x>/Common/MCData/AllowedEnhSvc	72
6.2.23L	/<x>/<x>/Common/MCData/EnhSvcOpValues	72
6.2.23M	/<x>/<x>/Common/MCData/EnhSvcOpValues/<x>	72
6.2.23N	/<x>/<x>/Common/MCData/EnhSvcOpValues/<x>/EnhSvcOpValue	72
6.2.23O	/<x>/<x>/Common/MCData/AllowedTransmitDataInGroup	73
6.2.23P	/<x>/<x>/Common/MCData/MaxDataSingleRequest	73
6.2.23Q	/<x>/<x>/Common/MCData/MaxTimeSingleRequest	73
6.2.23R	/<x>/<x>/Common/MCVideo	73
6.2.23S	/<x>/<x>/Common/MCVideo/MediaProtectionRequired	73
6.2.23T	/<x>/<x>/Common/MCVideo/TxControlProtectionRequired	74
6.2.23U	/<x>/<x>/Common/MCVideo/MediaProtectionSecurityMaterial	74
6.2.23V	/<x>/<x>/Common/MCVideo/AllowedAudioCodecs	74
6.2.23W	/<x>/<x>/Common/MCVideo/AllowedAudioCodecs/<x>	74
6.2.23X	/<x>/<x>/Common/MCVideo/AllowedAudioCodecs/<x>/AudioCodec	75
6.2.23Y	/<x>/<x>/Common/MCVideo/AllowedVideoCodecs	75
6.2.23Z	/<x>/<x>/Common/MCVideo/AllowedVideoCodecs/<x>	75

6.2.23AA	/<x>/<x>/Common/MCVideo/AllowedVideoCodecs/<x>/VideoCodec	75
6.2.23AB	/<x>/<x>/Common/MCVideo/AllowedVideoResolutions	75
6.2.23AC	/<x>/<x>/Common/MCVideo/AllowedVideoResolutions/<x>	76
6.2.23AD	/<x>/<x>/Common/MCVideo/AllowedVideoResolutions/<x>/VideoResolution	76
6.2.23AE	/<x>/<x>/Common/MCVideo/AllowedVideoFrameRates	76
6.2.23AF	/<x>/<x>/Common/MCVideo/AllowedVideoFrameRates/<x>	76
6.2.23AG	/<x>/<x>/Common/MCVideo/AllowedVideoFrameRates/<x>/FrameRate	76
6.2.23AH	/<x>/<x>/Common/MCVideo/AllowedUrgentRealTimeMode	77
6.2.23AI	/<x>/<x>/Common/MCVideo/AllowedNonUrgentRealTimeMode	77
6.2.23AJ	/<x>/<x>/Common/MCVideo/AllowedNonRealTimeMode	77
6.2.23AK	/<x>/<x>/Common/MCVideo/ActiveNonRealTimeMode	77
6.2.23AL	/<x>/<x>/Common/MCVideo/MaxTransmitMembers	78
6.2.24	/<x>/<x>/OffNetwork	78
6.2.25	/<x>/<x>/OffNetwork/MCPTTGroupParameter	78
6.2.26	/<x>/<x>/OffNetwork/MCPTTGroupParameter/<x>	78
6.2.27	/<x>/<x>/OffNetwork/MCPTTGroupParameter/<x>/ProSeLayer2GroupID	78
6.2.28	/<x>/<x>/OffNetwork/MCPTTGroupParameter/<x>/IPMulticastAddress	79
6.2.29	/<x>/<x>/OffNetwork/MCPTTGroupParameter/<x>/RelayServiceCode	79
6.2.30	/<x>/<x>/OffNetwork/MCPTTGroupParameter/<x>/IPVersions	79
6.2.31	/<x>/<x>/OffNetwork/EmergencyCallCancel	79
6.2.32	/<x>/<x>/OffNetwork/ImminentPerilCallCancel	80
6.2.33	/<x>/<x>/OffNetwork/HangTime	80
6.2.34	/<x>/<x>/OffNetwork/MaxDuration	80
6.2.34A	/<x>/<x>/OffNetwork/QueueUsage	80
6.2.35	/<x>/<x>/OffNetwork/DefaultPPPP	81
6.2.36	/<x>/<x>/OffNetwork/DefaultPPPP/MCPTTGroupCallSignalling	81
6.2.37	/<x>/<x>/OffNetwork/DefaultPPPP/MCPTTGroupCallMedia	81
6.2.38	/<x>/<x>/OffNetwork/DefaultPPPP/MCPTTEmergencyGroupCallSignalling	81
6.2.39	/<x>/<x>/OffNetwork/DefaultPPPP/MCPTTEmergencyGroupCallMedia	82
6.2.40	/<x>/<x>/OffNetwork/DefaultPPPP/MCPTTImminentPerilGroupCallSignalling	82
6.2.41	/<x>/<x>/OffNetwork/DefaultPPPP/MCPTTImminentPerilGroupCallMedia	82
6.2.42	/<x>/<x>/OffNetwork/MCData	83
6.2.43	/<x>/<x>/OffNetwork/MCData/DefaultPPPP	83
6.2.44	/<x>/<x>/OffNetwork/MCData/DefaultPPPP/MCDataGroupCallSignalling	83
6.2.45	/<x>/<x>/OffNetwork/MCData/DefaultPPPP/MCDataGroupCallMedia	83
6.2.46	/<x>/<x>/OffNetwork/MCVideo	84
6.2.47	/<x>/<x>/OffNetwork/MCVideo/ArbitrationApproach	84
6.2.48	/<x>/<x>/OffNetwork/MCVideo/MaxTransmissions	84
6.2.49	/<x>/<x>/OffNetwork/MCVideo/DefaultPPPP	84
6.2.50	/<x>/<x>/OffNetwork/MCVideo/DefaultPPPP/MCVideoGroupCallSignalling	85
6.2.51	/<x>/<x>/OffNetwork/MCVideo/DefaultPPPP/MCVideoGroupCallMedia	85
6.2.52	/<x>/<x>/OffNetwork/MCVideo/DefaultPPPP/MCVideoEmergencyGroupCallSignalling	85
6.2.53	/<x>/<x>/OffNetwork/MCVideo/DefaultPPPP/MCVideoEmergencyGroupCallMedia	86
6.2.54	/<x>/<x>/OffNetwork/MCVideo/DefaultPPPP/MCVideoImminentPerilGroupCallSignalling	86
6.2.55	/<x>/<x>/OffNetwork/MCVideo/DefaultPPPP/MCVideoImminentPerilGroupCallMedia	86
6.2.56	/<x>/<x>/OffNetwork/MCVideo/MaxDuration	87
6.2.57	/<x>/<x>/OffNetwork/MCVideo/EmergencyCallCancel	87
6.2.58	/<x>/<x>/OffNetwork/MCVideo/ImminentPerilCallCancel	87
7	MCPTT service configuration MO	87
7.1	General	87
7.2	MCPTT service configuration MO parameters	88
7.2.1	General	88
7.2.2	Node: <x>	88
7.2.3	/<x>/Name	89
7.2.4	/<x>/Ext/	89
7.2.5	/<x>/Common	89
7.2.6	/<x>/Common/BroadcastMCPTTGroupCall	89
7.2.7	/<x>/Common/BroadcastMCPTTGroupCall/NumLevelGroupHierarchy	90
7.2.8	/<x>/Common/BroadcastMCPTTGroupCall/NumLevelUserHierarchy	90
7.2.9	/<x>/Common/MinLengthAliasID	90
7.2.10	/<x>/OffNetwork	90

7.2.11	/<x>/OffNetwork/PrivateCall	90
7.2.12	/<x>/OffNetwork/PrivateCall/MaxDuration	91
7.2.13	/<x>/OffNetwork/PrivateCall/HangTime	91
7.2.14	/<x>/OffNetwork/PrivateCall/CancelTimeout	91
7.2.15	/<x>/OffNetwork/EmergencyCall	91
7.2.16	/<x>/OffNetwork/EmergencyCall/MCPTTGroupTimeout	92
7.2.17	/<x>/OffNetwork/NumLevelHierarchy	92
7.2.18	/<x>/OffNetwork/TransmitTimeout	92
7.2.19	/<x>/OffNetwork/TransmissionWarning	92
7.2.20	/<x>/OffNetwork/HangTimeWarning	93
7.2.21	/<x>/OffNetwork/DefaultPPPP	93
7.2.22	/<x>/OffNetwork/DefaultPPPP/MCPTTPrivateCallSignalling	93
7.2.23	/<x>/OffNetwork/DefaultPPPP/MCPTTPrivateCallMedia	93
7.2.24	/<x>/OffNetwork/DefaultPPPP/MCPTTEmergencyPrivateCallSignalling	94
7.2.25	/<x>/OffNetwork/DefaultPPPP/MCPTTEmergencyPrivateCallMedia	94
7.2.26	/<x>/OffNetwork/LogMetadata	94
8	MCS UE initial configuration MO	94
8.1	General	94
8.2	MCS UE initial configuration MO parameters	99
8.2.1	General	99
8.2.2	Node: <x>	99
8.2.3	/<x>/Name	99
8.2.4	/<x>/Ext/	99
8.2.5	/<x>/DefaultUserProfile	100
8.2.6	/<x>/DefaultUserProfile/UserID	100
8.2.7	/<x>/DefaultUserProfile/UserProfileIndex	100
8.2.8	/<x>/OnNetwork	100
8.2.9	/<x>/OnNetwork/GMSURI	101
8.2.9A	/<x>/OnNetwork/GroupCreationXUI	101
8.2.9B	/<x>/OnNetwork/GMSXCAPRootURI	101
8.2.9C	/<x>/OnNetwork/CMSXCAPRootURI	101
8.2.10	/<x>/OnNetwork/Timers	101
8.2.11	/<x>/OnNetwork/Timers/T100	102
8.2.12	/<x>/OnNetwork/Timers/T101	102
8.2.13	/<x>/OnNetwork/Timers/T103	102
8.2.14	/<x>/OnNetwork/Timers/T104	102
8.2.15	/<x>/OnNetwork/Timers/T132	102
8.2.16	/<x>/OnNetwork/HPLMN	103
8.2.17	/<x>/OnNetwork/HPLMN/PLMN	103
8.2.18	/<x>/OnNetwork/HPLMN/Service	103
8.2.19	/<x>/OnNetwork/HPLMN/Service/MCPTTToConRef	103
8.2.20	/<x>/OnNetwork/HPLMN/Service/MCPTTToConRef/<x>	103
8.2.21	/<x>/OnNetwork/HPLMN/Service/MCPTTToConRef/<x>/ConRef	104
8.2.22	/<x>/OnNetwork/HPLMN/Service/MCCCommonCoreToConRef	104
8.2.23	/<x>/OnNetwork/HPLMN/Service/MCCCommonCoreToConRef/<x>	104
8.2.24	/<x>/OnNetwork/HPLMN/Service/MCCCommonCoreToConRef/<x>/ConRef	104
8.2.25	/<x>/OnNetwork/HPLMN/Service/MCIDMToConRef	104
8.2.26	/<x>/OnNetwork/HPLMN/Service/MCIDMToConRef/<x>	105
8.2.27	/<x>/OnNetwork/HPLMN/Service/MCIDMToConRef/<x>/ConRef	105
8.2.28	/<x>/OnNetwork/HPLMN/VPLMN	105
8.2.29	/<x>/OnNetwork/HPLMN/VPLMN/PLMN	105
8.2.30	/<x>/OnNetwork/HPLMN/VPLMN/Service	105
8.2.31	/<x>/OnNetwork/HPLMN/VPLMN/Service/MCPTTToConRef	106
8.2.32	/<x>/OnNetwork/HPLMN/VPLMN/Service/MCPTTToConRef/<x>	106
8.2.33	/<x>/OnNetwork/HPLMN/VPLMN/Service/MCPTTToConRef/<x>/ConRef	106
8.2.34	/<x>/OnNetwork/HPLMN/VPLMN/Service/MCCCommonCoreToConRef	106
8.2.35	/<x>/OnNetwork/HPLMN/VPLMN/Service/MCCCommonCoreToConRef/<x>	106
8.2.36	/<x>/OnNetwork/HPLMN/VPLMN/Service/MCCCommonCoreToConRef/<x>/ConRef	107
8.2.37	/<x>/OnNetwork/HPLMN/VPLMN/Service/MCIDMToConRef	107
8.2.38	/<x>/OnNetwork/HPLMN/VPLMN/Service/MCIDMToConRef/<x>	107
8.2.39	/<x>/OnNetwork/HPLMN/VPLMN/Service/MCIDMToConRef/<x>/ConRef	107

8.2.40	/<x>/OnNetwork/AppServerInfo	108
8.2.41	/<x>/OnNetwork/AppServerInfo/IDMSAuthEndpoint.....	108
8.2.41A	/<x>/OnNetwork/AppServerInfo/IDMSTokenEndpoint	108
8.2.41B	/<x>/OnNetwork/AppServerInfo/HTTPProxy.....	108
8.2.42	/<x>/OnNetwork/AppServerInfo/GMS	108
8.2.43	/<x>/OnNetwork/AppServerInfo/CMS.....	109
8.2.44	/<x>/OnNetwork/AppServerInfo/KMS	109
8.2.44A	/<x>/OnNetwork/AppServerInfo/TLSTunnelAuthMethod.....	109
8.2.44B	/<x>/OnNetwork/AppServerInfo/TLSTunnelAuthMethod/Mutual.....	109
8.2.44C	/<x>/OnNetwork/AppServerInfo/TLSTunnelAuthMethod/X509.....	110
8.2.44D	/<x>/OnNetwork/AppServerInfo/TLSTunnelAuthMethod/Key.....	110
8.2.44E	/<x>/OnNetwork/IntegrityProtection	110
8.2.44F	/<x>/OnNetwork/ConfidentialityProtection.....	110
8.2.45	/<x>/OffNetwork	111
8.2.46	/<x>/OffNetwork/Timers	111
8.2.47	/<x>/OffNetwork/Timers/TFG1	111
8.2.48	/<x>/OffNetwork/Timers/TFG2	111
8.2.49	/<x>/OffNetwork/Timers/TFG3	111
8.2.50	/<x>/OffNetwork/Timers/TFG4	112
8.2.51	/<x>/OffNetwork/Timers/TFG5	112
8.2.52	/<x>/OffNetwork/Timers/TFG11	112
8.2.53	/<x>/OffNetwork/Timers/TFG12	112
8.2.54	/<x>/OffNetwork/Timers/TFG13	113
8.2.54A	/<x>/OffNetwork/Timers/TFG14	113
8.2.55	/<x>/OffNetwork/Timers/TFP1	113
8.2.56	/<x>/OffNetwork/Timers/TFP2	113
8.2.57	/<x>/OffNetwork/Timers/TFP3	114
8.2.58	/<x>/OffNetwork/Timers/TFP4	114
8.2.59	/<x>/OffNetwork/Timers/TFP5	114
8.2.60	/<x>/OffNetwork/Timers/TFP6	114
8.2.61	/<x>/OffNetwork/Timers/TFP7	115
8.2.62	/<x>/OffNetwork/Timers/TFB1.....	115
8.2.63	/<x>/OffNetwork/Timers/TFB2.....	115
8.2.64	/<x>/OffNetwork/Timers/TFB3.....	115
8.2.65	/<x>/OffNetwork/Timers/T201.....	116
8.2.66	/<x>/OffNetwork/Timers/T203.....	116
8.2.67	/<x>/OffNetwork/Timers/T204.....	116
8.2.68	/<x>/OffNetwork/Timers/T205.....	116
8.2.69	/<x>/OffNetwork/Timers/T230.....	116
8.2.70	/<x>/OffNetwork/Timers/T233.....	117
8.2.71	/<x>/OffNetwork/Timers/TFE1	117
8.2.72	/<x>/OffNetwork/Timers/TFE2.....	117
8.2.73	/<x>/OffNetwork/Counters	117
8.2.74	/<x>/OffNetwork/Counters/CFP1	118
8.2.75	/<x>/OffNetwork/Counters/CFP3.....	118
8.2.76	/<x>/OffNetwork/Counters/CFP4.....	118
8.2.77	/<x>/OffNetwork/Counters/CFP6.....	118
8.2.78	/<x>/OffNetwork/Counters/CFP11.....	118
8.2.79	/<x>/OffNetwork/Counters/CFP12.....	119
8.2.80	/<x>/OffNetwork/Counters/C201	119
8.2.81	/<x>/OffNetwork/Counters/C204	119
8.2.82	/<x>/OffNetwork/Counters/C205	119
9	MCDData UE configuration MO.....	120
9.1	General	120
9.2	MCDData UE configuration MO parameters.....	121
9.2.1	General.....	121
9.2.2	Node: <x>	121
9.2.3	/<x>/Name	121
9.2.4	/<x>/Ext/	122
9.2.5	/<x>/Common	122
9.2.6	/<x>/Common/MCDDataGroupTxns	122

9.2.7	/<x>/Common/MCDataGroupTxns/MaxSDSNc4	122
9.2.8	/<x>/Common/MCDataGroupTxns/SDSPresentationPriority	123
9.2.9	/<x>/Common/MCDataGroupTxns/SDSPresentationPriority/<x>	123
9.2.10	/<x>/Common/MCDataGroupTxns/SDSPresentationPriority/<x>/MCDataGroupID	123
9.2.11	/<x>/Common/MCDataGroupTxns/SDSPresentationPriority/<x>/MCDataGroupPriorityHierarchy	123
9.2.12	/<x>/Common/MCDataGroupTxns/MaxFDNc4	123
9.2.13	/<x>/Common/MCDataGroupTxns/FDPresentationPriority	124
9.2.14	/<x>/Common/MCDataGroupTxns/FDPresentationPriority/<x>	124
9.2.15	/<x>/Common/MCDataGroupTxns/FDPresentationPriority/<x>/MCDataGroupID	124
9.2.16	/<x>/Common/MCDataGroupTxns/FDPresentationPriority/<x>/MCDataGroupPriorityHierarchy	124
9.2.17	/<x>/Common/MCDataGroupTxns/ConversationPresentationPriority	125
9.2.18	/<x>/Common/MCDataGroupTxns/ConversationPresentationPriority/<x>	125
9.2.19	/<x>/Common/MCDataGroupTxns/ConversationPresentationPriority/<x>/MCDataGroupID	125
9.2.20	/<x>/Common/MCDataGroupTxns/ConversationPresentationPriority/<x>/MCDataGroupPriorityHierarchy	125
9.2.21	/<x>/Common/MCDataGroupTxns/MaxTCNc4	126
9.2.22	/<x>/Common/MCDataGroupTxns/MaxTCNc5	126
9.2.23	/<x>/Common/MCDataGroupTxns/DataPresentationPriority	126
9.2.24	/<x>/Common/MCDataGroupTxns/DataPresentationPriority/<x>	126
9.2.25	/<x>/Common/MCDataGroupTxns/DataPresentationPriority/<x>/MCDataGroupID	126
9.2.26	/<x>/Common/MCDataGroupTxns/DataPresentationPriority/<x>/MCDataGroupPriorityHierarchy	127
9.2.27	/<x>/Common/MCDataGroupTxns/MaxRCNc4	127
9.2.28	/<x>/Common/MCDataGroupTxns/MaxRCNc5	127
9.2.29	/<x>/OnNetwork	127
9.2.30	/<x>/OnNetwork/RelayService	127
9.2.31	/<x>/OnNetwork/IPv6Preferred	128
9.2.32	/<x>/OnNetwork/RelayedMCDataGroup	128
9.2.33	/<x>/OnNetwork/RelayedMCDataGroup/<x>	128
9.2.34	/<x>/OnNetwork/RelayedMCDataGroup/<x>/MCDataGroupID	128
9.2.35	/<x>/OnNetwork/RelayedMCDataGroup/<x>/RelayServiceCode	129
10	MCData user profile MO	129
10.1	General	129
10.2	MCData user profile MO parameters	132
10.2.1	General	132
10.2.2	Node: <x>	132
10.2.3	/<x>/Name	132
10.2.4	/<x>/Ext/	133
10.2.5	/<x>/<x>	133
10.2.6	/<x>/<x>/Common	133
10.2.7	/<x>/<x>/Common/MCDataUserID	133
10.2.8	/<x>/<x>/Common/MCDataUserProfileIndex	133
10.2.9	/<x>/<x>/Common/MCDataUserProfileName	134
10.2.9A	/<x>/<x>/Common/MCDataUserIDKMSURI	134
10.2.10	/<x>/<x>/Common/PreSelectedIndication	134
10.2.11	/<x>/<x>/Common/UserAliases	134
10.2.12	/<x>/<x>/Common/UserAliases/<x>	135
10.2.13	/<x>/<x>/Common/UserAliases/<x>UserAlias	135
10.2.14	/<x>/<x>/Common/AuthorisedAlias	135
10.2.15	/<x>/<x>/Common/ParticipantType	135
10.2.16	/<x>/<x>/Common/Organization	135
10.2.16A	/<x>/<x>/Common/OnetoOne	136
10.2.16B	/<x>/<x>/Common/OnetoOne/UserList	136
10.2.16C	/<x>/<x>/Common/OnetoOne/UserList/<x>	136
10.2.16D	/<x>/<x>/Common/OnetoOne/UserList/<x>/Entry	136
10.2.16E	/<x>/<x>/Common/OnetoOne/UserList/<x>/Entry/MCDataID	136
10.2.16F	/<x>/<x>/Common/OnetoOne/UserList/<x>/Entry/DiscoveryGroupID	137
10.2.16G	/<x>/<x>/Common/OnetoOne/UserList/<x>/Entry/UserInfoID	137
10.2.16H	/<x>/<x>/Common/OnetoOne/UserList/<x>/Entry/MCDataIDKMSURI	137
10.2.16I	/<x>/<x>/Common/OnetoOne/UserList/<x>/Entry/DisplayName	137
10.2.17	/<x>/<x>/Common/FileDistribution	138
10.2.18	/<x>/<x>/Common/FileDistribution/CancelList	138
10.2.19	/<x>/<x>/Common/FileDistribution/CancelList/<x>	138

10.2.20	/<x>/<x>/Common/FileDistribution/CancelList/<x>/Entry	138
10.2.21	/<x>/<x>/Common/FileDistribution/CancelList/<x>/Entry/MCDataID	138
10.2.21A	/<x>/<x>/Common/FileDistribution/CancelList/<x>/Entry/MCDataIDKMSURI	139
10.2.22	/<x>/<x>/Common/FileDistribution/CancelList/<x>/Entry/DisplayName	139
10.2.23	/<x>/<x>/Common/TxRxControl.....	139
10.2.24	/<x>/<x>/Common/TxRxControl/AuthorisedTransmit	139
10.2.25	/<x>/<x>/Common/TxRxControl/MaxData1To1.....	139
10.2.26	/<x>/<x>/Common/TxRxControl/MaxTime1To1	140
10.2.27	/<x>/<x>/Common/TxRxControl/ReleaseList.....	140
10.2.28	/<x>/<x>/Common/TxRxControl/ReleaseList/<x>	140
10.2.29	/<x>/<x>/Common/TxRxControl/ReleaseList/<x>/Entry	140
10.2.30	/<x>/<x>/Common/TxRxControl/ReleaseList/<x>/Entry/MCDataID	140
10.2.31	/<x>/<x>/Common/TxRxControl/ReleaseList/<x>/Entry/DisplayName	141
10.2.32	/<x>/<x>/Common/MCDataGroupBroadcast	141
10.2.33	/<x>/<x>/Common/MCDataGroupBroadcast/Authorised	141
10.2.34	/<x>/<x>/Common/UserBroadcast	141
10.2.35	/<x>/<x>/Common/UserBroadcast/Authorised.....	141
10.2.36	/<x>/<x>/Common/GroupEmergencyAlert	142
10.2.37	/<x>/<x>/Common/GroupEmergencyAlert/Entry	142
10.2.38	/<x>/<x>/Common/GroupEmergencyAlert/Entry/ID	142
10.2.39	/<x>/<x>/Common/GroupEmergencyAlert/Entry/DisplayName	142
10.2.40	/<x>/<x>/Common/GroupEmergencyAlert/Entry/Usage	142
10.2.41	/<x>/<x>/Common/AllowedActivateAlert	143
10.2.42/<x>/<x>/	Common/AllowedCancelAlert	143
10.2.43	/<x>/<x>/OnNetwork.....	143
10.2.44	/<x>/<x>/OnNetwork/MCDataGroupList.....	143
10.2.45	/<x>/<x>/OnNetwork/MCDataGroupList/<x>.....	143
10.2.46	/<x>/<x>/OnNetwork/MCDataGroupList/<x>/Entry	144
10.2.47	/<x>/<x>/OnNetwork/MCDataGroupList/<x>/Entry/MCDataGroupID	144
10.2.48	/<x>/<x>/OnNetwork/MCDataGroupList/<x>/Entry/DisplayName	144
10.2.49	/<x>/<x>/OnNetwork/MCDataGroupList/<x>/Entry/GMSAppServList	144
10.2.50	/<x>/<x>/OnNetwork/MCDataGroupList/<x>/Entry/GMSAppServList/<x>	144
10.2.51	/<x>/<x>/OnNetwork/MCDataGroupList/<x>/Entry/GMSAppServList/<x>/GMSAppServId	145
10.2.52	/<x>/<x>/OnNetwork/MCDataGroupList/<x>/Entry/IdMSTokenEndPointList	145
10.2.53	/<x>/<x>/OnNetwork/MCDataGroupList/<x>/Entry/IdMSTokenEndPointList/<x>	145
10.2.54/<x>/<x>/	OnNetwork/MCDataGroupList/<x>/Entry/IdMSTokenEndPointList/<x>/IdMSTokenEndPoint.....	145
10.2.54A	/<x>/<x>/OnNetwork/MCDataGroupList/<x>/Entry/MCDataGroupIDKMSURI	146
10.2.55	/<x>/<x>/OnNetwork/MCDataGroupList/<x>/Entry/PresentationPriority	146
10.2.56	/<x>/<x>/OnNetwork/ImplicitAffiliations.....	146
10.2.57	/<x>/<x>/OnNetwork/ImplicitAffiliations/<x>	146
10.2.58	/<x>/<x>/OnNetwork/ImplicitAffiliations/<x>/Entry	147
10.2.59	/<x>/<x>/OnNetwork/ImplicitAffiliations/<x>/Entry/MCDataGroupID	147
10.2.60	/<x>/<x>/OnNetwork/ImplicitAffiliations/<x>/Entry/DisplayName	147
10.2.61	/<x>/<x>/OnNetwork/PresenceStatus	147
10.2.62/<x>/<x>/	OnNetwork/PresenceStatus/<x>.....	147
10.2.63	/<x>/<x>/OnNetwork/PresenceStatus/<x>/Entry	147
10.2.64	/<x>/<x>/OnNetwork/PresenceStatus/<x>/Entry/MCDataID	148
10.2.65	/<x>/<x>/OnNetwork/PresenceStatus/<x>/Entry/DisplayName.....	148
10.2.66	/<x>/<x>/OnNetwork/RemoteGroupChange	148
10.2.67/<x>/<x>/	OnNetwork/RemoteGroupChange/<x>.....	148
10.2.68	/<x>/<x>/OnNetwork/RemoteGroupChange/<x>/Entry	148
10.2.69	/<x>/<x>/OnNetwork/RemoteGroupChange/<x>/Entry/MCDataID	149
10.2.70	/<x>/<x>/OnNetwork/RemoteGroupChange/<x>/Entry/DisplayName.....	149
10.2.71	/<x>/<x>/OnNetwork/MaxAffiliationsN2.....	149
10.2.72	/<x>/<x>/OnNetwork/ConversationManagement.....	149
10.2.73	/<x>/<x>/OnNetwork/ConversationManagement/GroupHangTime	149
10.2.74	/<x>/<x>/OnNetwork/ConversationManagement/GroupHangTime/<x>.....	150
10.2.75	/<x>/<x>/OnNetwork/ConversationManagement/GroupHangTime/<x>/Entry	150
10.2.76	/<x>/<x>/OnNetwork/ConversationManagement/GroupHangTime/<x>/Entry/MCDataGroupID.....	150
10.2.77	/<x>/<x>/OnNetwork/ConversationManagement/GroupHangTime/<x>/Entry/DisplayName	150
10.2.78	/<x>/<x>/OnNetwork/ConversationManagement/GroupHangTime/<x>/Entry/HangTime.....	151
10.2.79	/<x>/<x>/OnNetwork/ConversationManagement/DeliveredDisposition	151

10.2.80	/<x>/<x>/OnNetwork/ConversationManagement/DeliveredDisposition/<x>	151
10.2.81	/<x>/<x>/OnNetwork/ConversationManagement/DeliveredDisposition/<x>/Entry	151
10.2.82	/<x>/<x>/OnNetwork/ConversationManagement/DeliveredDisposition/<x>/Entry/MCDataID	152
10.2.83	/<x>/<x>/OnNetwork/ConversationManagement/DeliveredDisposition/<x>/Entry/DisplayName	152
10.2.84	/<x>/<x>/OnNetwork/ConversationManagement/ReadDisposition	152
10.2.85	/<x>/<x>/OnNetwork/ConversationManagement/ReadDisposition/<x>	152
10.2.86	/<x>/<x>/OnNetwork/ConversationManagement/ReadDisposition/<x>/Entry	152
10.2.87	/<x>/<x>/OnNetwork/ConversationManagement/ReadDisposition/<x>/Entry/MCDataID.....	153
10.2.88	/<x>/<x>/OnNetwork/ConversationManagement/ReadDisposition/<x>/Entry/DisplayName.....	153
10.2.89	/<x>/<x>/OnNetwork/OneToOneEmergencyAlert.....	153
10.2.90	/<x>/<x>/OnNetwork/OneToOneEmergencyAlert/Entry.....	153
10.2.91	/<x>/<x>/OnNetwork/OneToOneEmergencyAlert/Entry/ID.....	153
10.2.92	/<x>/<x>/OnNetwork/OneToOneEmergencyAlert/Entry/DisplayName	154
10.2.93	/<x>/<x>/OnNetwork/OneToOneEmergencyAlert/Entry/Usage	154
10.2.94	/<x>/<x>/OnNetwork/AllowedRegroup	154
10.2.95	/<x>/<x>/OnNetwork/AllowedPresenceStatus	154
10.2.96	/<x>/<x>/OnNetwork/AllowedPresence	155
10.2.97	/<x>/<x>/OnNetwork/AllowedManualSwitch.....	155
10.2.98	/<x>/<x>/OffNetwork	155
10.2.99	/<x>/<x>/OffNetwork/Authorised	155
10.2.100	/<x>/<x>/OffNetwork/MCDataGroupList.....	156
10.2.101	/<x>/<x>/OffNetwork/MCDataGroupList/<x>	156
10.2.102	/<x>/<x>/OffNetwork/MCDataGroupList/<x>/Entry	156
10.2.103	/<x>/<x>/OffNetwork/MCDataGroupList/<x>/Entry/MCDataGroupID	156
10.2.104	/<x>/<x>/OffNetwork/MCDataGroupList/<x>/Entry/DisplayName.....	156
10.2.105	/<x>/<x>/OffNetwork/MCDataGroupList/<x>/Entry/GMSAppServList.....	157
10.2.106	/<x>/<x>/OffNetwork/MCDataGroupList/<x>/>/Entry/GMSAppServList/<x>	157
10.2.107	/<x>/<x>/OffNetwork/MCDataGroupList/<x>/Entry/GMSAppServList/<x>/GMSAppServId.....	157
10.2.108	/<x>/<x>/OffNetwork/MCDataGroupList/<x>/Entry/IdMSTokenEndPointList	157
10.2.109	/<x>/<x>/OffNetwork/MCDataGroupList/<x>/Entry/IdMSTokenEndPointList/<x>	157
10.2.110/<x>	/<x>/<x>/OffNetwork/MCDataGroupList/<x>/Entry/IdMSTokenEndPointList/<x>/IdMSTokenEndPoint..	158
10.2.110A	/<x>/<x>/OffNetwork/MCDataGroupList/<x>/Entry/MCDataGroupIDKMSURI.....	158
10.2.111	/<x>/<x>/OffNetwork/MCDataGroupList/<x>/Entry/PresentationPriority	158
10.2.112	/<x>/<x>/OffNetwork/UserInfoID	158
10.2.113	Void	159
10.2.114	Void	159
10.2.115	Void	159
10.2.116	Void	159
10.2.117	Void	159
10.2.118	Void	159
10.2.119	Void	159
10.2.120	Void	159
10.2.121	/<x>/Status	159
11	MCData service configuration MO	159
11.1	General	159
11.2	MCData service configuration MO parameters.....	160
11.2.1	General.....	160
11.2.2	Node: <x>	160
11.2.3	/<x>/Name	160
11.2.4	/<x>/Ext/	161
11.2.5	/<x>/Common	161
11.2.6	/<x>/Common/TxRxControl.....	161
11.2.7	/<x>/Common/TxRxControl/TimeTempDataWaiting.....	161
11.2.8	/<x>/Common/TxRxControl/TimePeriodicAnnouncement.....	161
11.2.9	/<x>/OffNetwork	162
11.2.10	/<x>/OffNetwork/DefaultPPPP.....	162
11.2.11	/<x>/OffNetwork/DefaultPPPP/MCDataOneToOneCallSignalling	162
11.2.12	/<x>/OffNetwork/DefaultPPPP/MCDataOneToOneCallMedia	162
12	MCVideo UE configuration MO.....	163
12.1	General	163

12.2	MCVideo UE configuration MO parameters	163
12.2.1	General.....	163
12.2.2	Node: <x>	164
12.2.3	/<x>/Name	164
12.2.4	/<x>/Ext/	164
12.2.5	/<x>/Common	164
12.2.5A	/<x>/Common/PrivateCall	164
12.2.5B	/<x>/Common/PrivateCall/MaxCallNc10.....	165
12.2.6	/<x>/Common/MCVideoGroupCall	165
12.2.7	/<x>/Common/MCVideoGroupCall/MaxCallNc4.....	165
12.2.8	/<x>/Common/MCVideoGroupCall/MaxTransmissionNc5	165
12.2.9	/<x>/Common/MCVideoGroupCall/PrioritizedMCVideoGroup	165
12.2.10	/<x>/Common/MCVideoGroupCall/PrioritizedMCVideoGroup/<x>	166
12.2.11	/<x>/Common/MCVideoGroupCall/PrioritizedMCVideoGroup/<x>/MCVideoGroupID.....	166
12.2.12	/<x>/Common/MCVideoGroupCall/PrioritizedMCVideoGroup/<x>/MCVideoGroupPriorityHierarchy	166
12.2.13	/<x>/OnNetwork	166
12.2.14	/<x>/OnNetwork/RelayService.....	166
12.2.15	/<x>/OnNetwork/IPv6Preferred.....	167
12.2.16	/<x>/OnNetwork/RelayedMCVideoGroup	167
12.2.17	/<x>/OnNetwork/RelayedMCVideoGroup/<x>	167
12.2.18	/<x>/OnNetwork/RelayedMCVideoGroup/<x>/MCVideoGroupID	167
12.2.19	/<x>/OnNetwork/RelayedMCVideoGroup/<x>/RelayServiceCode.....	168
13	MCVideo user profile MO	168
13.1	General	168
13.2	MCVideo user profile MO parameters.....	171
13.2.1	General.....	171
13.2.2	Node: <x>	171
13.2.3	/<x>/Name	171
13.2.4	/<x>/Ext/	172
13.2.5	/<x>/<x>	172
13.2.6	/<x>/<x>/Common	172
13.2.7	/<x>/<x>/Common/MCVideoUserID	172
13.2.8	/<x>/<x>/Common/MCVideoUserProfileIndex.....	172
13.2.9	/<x>/<x>/Common/MCVideoUserProfileName	173
13.2.10	/<x>/<x>/Common/PreSelectedIndication.....	173
13.2.11	/<x>/<x>/Common/UserAliases	173
13.2.12	/<x>/<x>/Common/UserAliases/<x>.....	173
13.2.13	/<x>/<x>/Common/UserAliases/<x>/UserAlias	173
13.2.14	/<x>/<x>/Common/AuthorisedAlias.....	174
13.2.15	/<x>/<x>/Common/ParticipantType	174
13.2.16	/<x>/<x>/Common/Organization.....	174
13.2.17	/<x>/<x>/Common/MCVideoGroupBroadcast.....	174
13.2.18	/<x>/<x>/Common/MCVideoGroupBroadcast/Authorised	174
13.2.19	/<x>/<x>/Common/UserBroadcast	175
13.2.20	/<x>/<x>/Common/UserBroadcast/Authorised.....	175
13.2.21	/<x>/<x>/Common/AllowedModifyVideo	175
13.2.22	/<x>/<x>/Common/AllowedRenegotiateCodec	175
13.2.23	/<x>/<x>/Common/AllowedCameraControl.....	176
13.2.24	/<x>/<x>/Common/AllowedRemoteControl.....	176
13.2.25	/<x>/<x>/Common/AllowedDisplayRemoteUE	176
13.2.26	/<x>/<x>/Common/AllowedRemoteCamera	176
13.2.27	/<x>/<x>/Common/AllowedPushVideo.....	177
13.2.28	/<x>/<x>/Common/AllowedAutoSendNotify.....	177
13.2.29	/<x>/<x>/Common/AllowedActivateAlert	177
13.2.30	/<x>/<x>/Common/AllowedCancelAlert.....	177
13.2.31	/<x>/<x>/Common/NotifyList.....	178
13.2.32	/<x>/<x>/Common/NotifyList/<x>	178
13.2.33	/<x>/<x>/Common/NotifyList/<x>/Entry	178
13.2.34	/<x>/<x>/Common/NotifyList/<x>/Entry/MCVideoID	178
13.2.35	/<x>/<x>/Common/NotifyList/<x>/Entry/DisplayName	178
13.2.36	/<x>/<x>/Common/VideoCategories.....	179

13.2.37	/<x>/<x>/Common/VideoCategories/<x>	179
13.2.38	/<x>/<x>/Common/VideoCategories/<x>/VideoCat	179
13.2.38A	/<x>/<x>/Common/MCVideoGroupCall	179
13.2.38B	/<x>/<x>/Common/MCVideoGroupCall/EmergencyCall	179
13.2.38C	/<x>/<x>/Common/MCVideoGroupCall/EmergencyCall/Enabled	179
13.2.38D	/<x>/<x>/Common/MCVideoGroupCall/EmergencyCall/CancelMCVideoGroup	180
13.2.38E	/<x>/<x>/Common/MCVideoGroupCall/ImminentPerilCall	180
13.2.38F	/<x>/<x>/Common/MCVideoGroupCall/ImminentPerilCall/Authorised	180
13.2.38G	/<x>/<x>/Common/MCVideoGroupCall/ImminentPerilCall/Cancel	180
13.2.38H	/<x>/<x>/Common/PrivateCall	181
13.2.38I	/<x>/<x>/Common/PrivateCall/Authorised	181
13.2.38J	/<x>/<x>/Common/PrivateCall/ManualCommence	181
13.2.38K	/<x>/<x>/Common/PrivateCall/AutoCommence	181
13.2.38L	/<x>/<x>/Common/PrivateCall/FailRestrict	181
13.2.39	/<x>/<x>/OnNetwork	182
13.2.40	/<x>/<x>/OnNetwork/MCVideoGroupList	182
13.2.41	/<x>/<x>/OnNetwork/MCVideoGroupList/<x>	182
13.2.42	/<x>/<x>/OnNetwork/MCVideoGroupList/<x>/Entry	182
13.2.43	/<x>/<x>/OnNetwork/MCVideoGroupList/<x>/Entry/MCVideoGroupID	183
13.2.44	/<x>/<x>/OnNetwork/MCVideoGroupList/<x>/Entry/DisplayName	183
13.2.45	/<x>/<x>/OnNetwork/MCVideoGroupList/<x>/Entry/GMSAppServList	183
13.2.46	/<x>/<x>/OnNetwork/MCVideoGroupList/<x>/Entry/GMSAppServList/<x>	183
13.2.47	/<x>/<x>/OnNetwork/MCVideoGroupList/<x>/Entry/GMSAppServList/<x>/GMSAppServId	184
13.2.48	/<x>/<x>/OnNetwork/MCVideoGroupList/<x>/Entry/IdMSTokenEndPointList	184
13.2.49	/<x>/<x>/OnNetwork/MCVideoGroupList/<x>/Entry/IdMSTokenEndPointList/<x>	184
13.2.50/<x>/<x>/OnNetwork/MCVideoGroupList/<x>/Entry/IdMSTokenEndPointList/<x>/IdMSTokenEndPoint...	184	
13.2.51	/<x>/<x>/OnNetwork/MCVideoGroupList/<x>/Entry/PresentationPriority	185
13.2.52	/<x>/<x>/OnNetwork/ImplicitAffiliations	185
13.2.53	/<x>/<x>/OnNetwork/ImplicitAffiliations/<x>	185
13.2.54	/<x>/<x>/OnNetwork/ImplicitAffiliations/<x>/Entry	185
13.2.55	/<x>/<x>/OnNetwork/ImplicitAffiliations/<x>/Entry/MCVideoGroupID	185
13.2.56	/<x>/<x>/OnNetwork/ImplicitAffiliations/<x>/Entry/DisplayName	186
13.2.57	/<x>/<x>/OnNetwork/PresenceStatus	186
13.2.58	/<x>/<x>/OnNetwork/PresenceStatus/<x>	186
13.2.59	/<x>/<x>/OnNetwork/PresenceStatus/<x>/Entry	186
13.2.60	/<x>/<x>/OnNetwork/PresenceStatus/<x>/Entry/MCVideoGroupID	186
13.2.61	/<x>/<x>/OnNetwork/PresenceStatus/<x>/Entry/DisplayName	187
13.2.62	/<x>/<x>/OnNetwork/RemoteGroupChange	187
13.2.63	/<x>/<x>/OnNetwork/RemoteGroupChange/<x>	187
13.2.64	/<x>/<x>/OnNetwork/RemoteGroupChange/<x>/Entry	187
13.2.65	/<x>/<x>/OnNetwork/RemoteGroupChange/<x>/Entry/MCVideoGroupID	187
13.2.66	/<x>/<x>/OnNetwork/RemoteGroupChange/<x>/Entry/DisplayName	188
13.2.67	/<x>/<x>/OnNetwork/MaxAffiliationsNc2	188
13.2.68	/<x>/<x>/OnNetwork/AllowedRegroup	188
13.2.69	/<x>/<x>/OnNetwork/AllowedPresenceStatus	188
13.2.70	/<x>/<x>/OnNetwork/AllowedPresence	188
13.2.71	/<x>/<x>/OnNetwork/AllowedManualSwitch	189
13.2.72	/<x>/<x>/OnNetwork/DeletionPeriod	189
13.2.73	/<x>/<x>/OnNetwork/MaxSimultaneousVideoStreams	189
13.2.74	/<x>/<x>/OnNetwork/MaxSimultaneousVideoStreams/MaxStreams	189
13.2.75	/<x>/<x>/OnNetwork/MaxSimultaneousVideoStreams/AllowedUnlimited	190
13.2.76	/<x>/<x>/OnNetwork/AllowedAutoRecv	190
13.2.77	/<x>/<x>/OnNetwork/AllowedAutoRecvEmergency	190
13.2.78	/<x>/<x>/OnNetwork/AllowedAutoRecvImminentPeril	190
13.2.79	/<x>/<x>/OnNetwork/MandatoryReceiveGroups	191
13.2.80	/<x>/<x>/OnNetwork/MandatoryReceiveGroups/<x>	191
13.2.81	/<x>/<x>/OnNetwork/MandatoryReceiveGroups/<x>/Entry	191
13.2.82	/<x>/<x>/OnNetwork/MandatoryReceiveGroups/<x>/Entry/MCVideoGroupID	191
13.2.83	/<x>/<x>/OnNetwork/MandatoryReceiveGroups/<x>/Entry/DisplayName	191
13.2.84	/<x>/<x>/OnNetwork/AllowedRequestOverride	192
13.2.85	/<x>/<x>/OnNetwork/AllowedSelectOverride	192
13.2.86	/<x>/<x>/OnNetwork/AllowedOverrideGroupCall	192

13.2.87	/<x>/<x>/OnNetwork/MaxTimeSingleTransmit	192
13.2.88	/<x>/<x>/OffNetwork	193
13.2.89	/<x>/<x>/OffNetwork/Authorised	193
13.2.90	/<x>/<x>/OffNetwork/MCVideoGroupList	193
13.2.91	/<x>/<x>/OffNetwork/MCVideoGroupList/<x>	193
13.2.92	/<x>/<x>/OffNetwork/MCVideoGroupList/<x>/Entry	193
13.2.93	/<x>/<x>/OffNetwork/MCVideoGroupList/<x>/Entry/MCVideoGroupID	194
13.2.94	/<x>/<x>/OffNetwork/MCVideoGroupList/<x>/Entry/DisplayName	194
13.2.95	/<x>/<x>/OffNetwork/MCVideoGroupList/<x>/Entry/GMSAppServList	194
13.2.96	/<x>/<x>/OffNetwork/MCVideoGroupList/<x>/Entry/GMSAppServList/<x>	194
13.2.97	/<x>/<x>/OffNetwork/MCVideoGroupList/<x>/Entry/GMSAppServList/<x>/GMSAppServId	195
13.2.98	/<x>/<x>/OffNetwork/MCVideoGroupList/<x>/Entry/IdMSTokenEndPointList	195
13.2.99	/<x>/<x>/OffNetwork/MCVideoGroupList/<x>/Entry/IdMSTokenEndPointList/<x>	195
13.2.100	/<x>/<x>/OffNetwork/MCVideoGroupList/<x>/Entry/IdMSTokenEndPointList/<x>/IdMSTokenEndPoi nt	195
13.2.101	/<x>/<x>/OffNetwork/MCVideoGroupList/<x>/>/Entry/PresentationPriority	196
13.2.102	/<x>/<x>/OffNetwork/UserInfoID	196
13.2.102A	/<x>/<x>/OffNetwork/EmergencyCallChange	196
13.2.102B	/<x>/<x>/OffNetwork/ImminentPerilCallChange	196
13.2.103	/<x>/Status	197
14	MCVideo service configuration MO	197
14.1	General	197
14.2	MCVideo service configuration MO parameters	198
14.2.1	General	198
14.2.2	Node: <x>	198
14.2.3	/<x>/Name	198
14.2.4	/<x>/Ext/	198
14.2.5	/<x>/Common	198
14.2.6	/<x>/Common/BroadcastMCVideoGroupCall	199
14.2.7	/<x>/Common/BroadcastMCVideoGroupCall/NumLevelGroupHierarchy	199
14.2.8	/<x>/Common/BroadcastMCVideoGroupCall/NumLevelUserHierarchy	199
14.2.9	/<x>/Common/MinLengthAliasID	199
14.2.10	/<x>/OffNetwork	200
14.2.11	/<x>/OffNetwork/DefaultPPPP	200
14.2.12	/<x>/OffNetwork/DefaultPPPP/MCVideoPrivateCallSignalling	200
14.2.13	/<x>/OffNetwork/DefaultPPPP/MCVideoPrivateCallMedia	200
14.2.14	/<x>/OffNetwork/DefaultPPPP/MCVideoEmergencyPrivateCallSignalling	200
14.2.15	/<x>/OffNetwork/DefaultPPPP/MCVideoEmergencyPrivateCallMedia	201
14.2.16	/<x>/OffNetwork/PrivateCall	201
14.2.17	/<x>/OffNetwork/PrivateCall/MaxDuration	201
14.2.18	/<x>/OffNetwork/NumLevelHierarchy	201
Annex A (informative):	MCPTT UE configuration MO DDF	203
Annex B (informative):	MCPTT user profile MO DDF	204
Annex C (informative):	MCPTT group configuration MO DDF	205
Annex D (informative):	MCPTT service configuration MO DDF	206
Annex E (informative):	MCPTT UE initial configuration MO DDF	207
Annex F (informative):	MCVideo UE configuration MO DDF	208
Annex G (informative):	MCVideo user profile configuration MO DDF	209
Annex H (informative):	MCVideo service configuration MO DDF	210
Annex I (informative):	MCDData UE configuration MO DDF	211
Annex J (informative):	MCDData user profile configuration MO DDF	212

Annex K (informative): MCDATA service configuration MO DDF.....213
Annex L (informative): Change history214
History216

Foreword

This Technical Specification has been produced by the 3rd Generation Partnership Project (3GPP).

The contents of the present document are subject to continuing work within the TSG and may change following formal TSG approval. Should the TSG modify the contents of the present document, it will be re-released by the TSG with an identifying change of release date and an increase in version number as follows:

Version x.y.z

where:

- x the first digit:
 - 1 presented to TSG for information;
 - 2 presented to TSG for approval;
 - 3 or greater indicates TSG approved document under change control.
- y the second digit is incremented for all changes of substance, i.e. technical enhancements, corrections, updates, etc.
- z the third digit is incremented when editorial only changes have been incorporated in the document.

1 Scope

The present document defines a number of Mission Critical Services (MCSs) Management Objects (MO) that are configured for the UE for the operation of MCSs. The management objects are compatible with OMA Device Management protocol specifications, version 1.2 and upwards, and is defined using the OMA DM Device Description Framework as described in the Enabler Release Definition OMA OMA-ERELD_DM-V1_2 [2].

MCSs are services that require preferential handling compared to normal telecommunication services, e.g. in support of police or fire brigade.

MCSs can be used for public safety applications and also for general commercial applications (e.g., utility companies and railways).

The present document is applicable to an UE supporting on-line, off-line or both on-line and off-line configuration of the configuration management client.

The present document is applicable to an UE supporting off-line configuration of the group management client.

The parameters defined by the management objects in the present document are configured in the UE using on-line configuration over the CSC-4 reference point and using off-line configuration over the CSC-11 and CSC-12 reference points. Other specifications define how these parameters are used in the operation of MCSs, and whether they are applicable to on-network operation or off-network operation, or both:

- 3GPP TS 24.379 [7];
- 3GPP TS 24.380 [8];
- 3GPP TS 24.481 [9];
- 3GPP TS 24.482 [11];
- 3GPP TS 24.484 [12];
- 3GPP TS 24.282 [16];
- 3GPP TS 24.582 [17];
- 3GPP TS 24.281 [18]; and
- 3GPP TS 24.581 [19].

The common network operation means both on-network operation and off-network operation in the present document.

The following management objects are defined in the present document:

- MCPTT UE configuration MO;
- MCPTT user profile MO;
- MCS group configuration MO;
- MCPTT service configuration MO;
- MCS UE initial configuration MO;
- MCDData UE configuration MO;
- MCDData user profile MO;
- MCDData service configuration MO;
- MCVideo UE configuration MO;
- MCVideo user profile MO; and
- MCVideo service configuration MO.

The MOs listed above define repositories of data in the ME.

2 References

The following documents contain provisions which, through reference in this text, constitute provisions of the present document.

- References are either specific (identified by date of publication, edition number, version number, etc.) or non-specific.
- For a specific reference, subsequent revisions do not apply.
- For a non-specific reference, the latest version applies. In the case of a reference to a 3GPP document (including a GSM document), a non-specific reference implicitly refers to the latest version of that document *in the same Release as the present document*.

- [1] 3GPP TR 21.905: "Vocabulary for 3GPP Specifications".
- [2] OMA OMA-ERELD-DM-V1_2-20070209-A: "Enabler Release Definition for OMA Device Management, Version 1.2".
- [3] OMA OMA-TS-DM_Protocol-V1_2: "OMA Device Management Protocol".
- [4] OMA OMA-TS-XDM_Group-V1_1-20120403-A: "Group XDM Specification".
- [5] 3GPP TS 23.003: "Numbering, addressing and identification".
- [6] 3GPP TS 23.303: "Proximity-based Services (ProSe); Stage 2".
- [7] 3GPP TS 24.379: "Mission Critical Push To Talk (MCPTT) call control Protocol specification".
- [8] 3GPP TS 24.380: "Mission Critical Push To Talk (MCPTT) media plane control Protocol specification".
- [9] 3GPP TS 24.481: "Mission Critical Services (MCS) group management Protocol specification".
- [10] 3GPP TS 31.102: "Characteristics of the USIM Application".
- [11] 3GPP TS 24.482: "Mission Critical Services (MCS) identity management Protocol specification".
- [12] 3GPP TS 24.484: "Mission Critical Services (MCS) configuration management Protocol specification".
- [13] IETF RFC 4566 (July 2006): "Session Description Protocol".
- [14] Void.
- [15] 3GPP TS 23.179: "Functional architecture and information flows to support mission critical communication services; Stage 2".
- [16] 3GPP TS 24.282: "Mission Critical Data (MCData) signalling control Protocol specification".
- [17] 3GPP TS 24.582: "Mission Critical Data (MCData) media plane control Protocol specification".
- [18] 3GPP TS 24.281: "Mission Critical Video (MCVideo) signalling control Protocol specification".
- [19] 3GPP TS 24.581: "Mission Critical Video (MCVideo) media plane control Protocol specification".
- [20] 3GPP TS 33.180: "Security of the mission critical service".

3 Definitions and abbreviations

3.1 Definitions

For the purpose of the present document, the following terms and definitions given in 3GPP TS 23.179 [15] apply:

Pre-selected MCPTT user profile

3.2 Abbreviations

For the purposes of the present document, the abbreviations given in 3GPP TR 21.905 [1] and the following apply. An abbreviation defined in the present document takes precedence over the definition of the same abbreviation, if any, in 3GPP TR 21.905 [1].

ACL	Access Control List
CMS	Configuration Management Server
DDF	Device Description Framework
DM	Device Management
GMS	Group Management Server
MCS	Mission Critical Service
MCSs	Mission Critical Services
MCPTT	Mission Critical Push To Talk
ME	Mobile Equipment
MO	Management Object
OMA	Open Mobile Alliance
ProSe	Proximity-based Services
RFC	Request For Comments
URI	Uniform Resource Identifier
URN	Uniform Resource Name
XCAP	XML Configuration Access Protocol
XML	eXtensible Markup Language
XUI	XCAP Unique Identifier

4 MCPTT UE configuration MO

4.1 General

The MCPTT UE configuration Management Object (MO) is used to configure MCPTT Client behaviour for the on-network or off-network MCPTT Service. The MCPTT UE configuration parameters may be stored in the ME, or in the USIM as specified in 3GPP TS 31.102 [10], or in both the ME and the USIM. If both the ME and the USIM contain the same parameters, the values stored in the USIM shall take precedence.

The Management Object Identifier is: urn:oma:mo:ext-3gpp-MCPTT-UE-configuration:1.0.

Protocol compatibility: This MO is compatible with OMA OMA DM 1.2 [3].

The OMA DM ACL property mechanism (see OMA OMA-ERELED-DM-V1_2 [2]) may be used to grant or deny access rights to OMA DM servers in order to modify nodes and leaf objects of the MCPTT UE configuration MO.

The following nodes and leaf objects are possible under the MCPTT UE configuration node as described in figure 4.1.1:

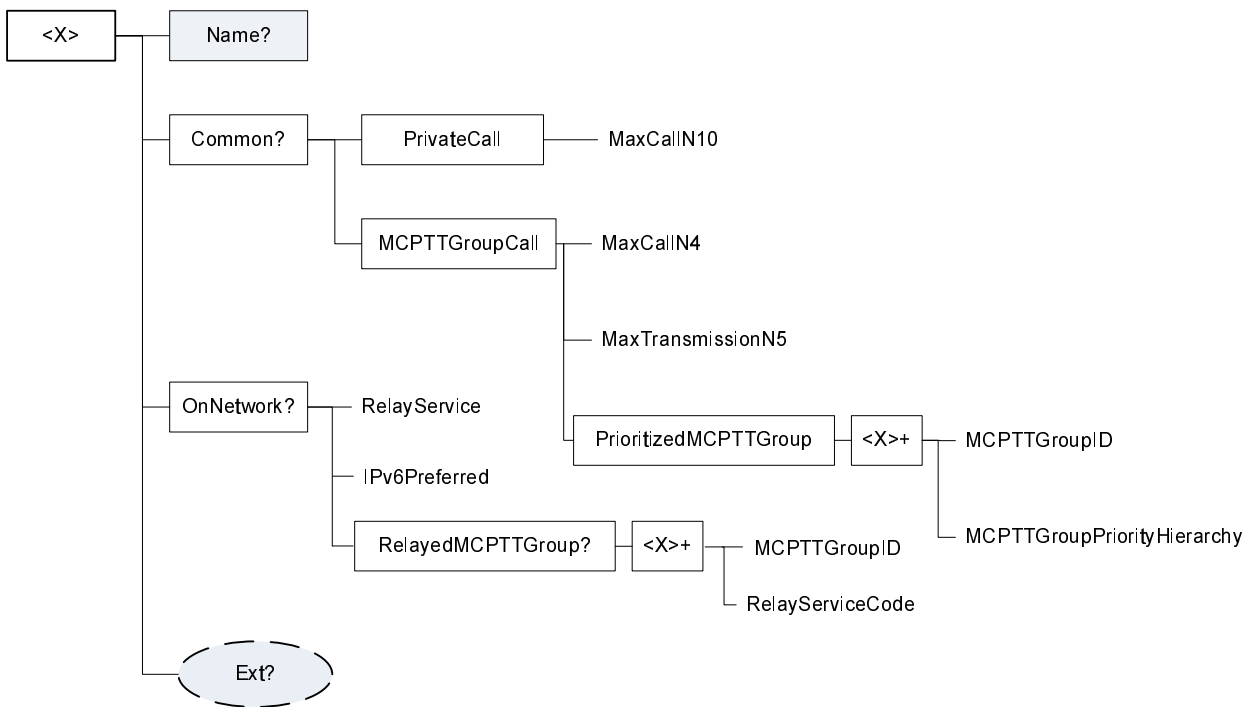

Figure 4.1.1: The MCPTT UE configuration MO

4.2 MCPTT UE configuration MO parameters

4.2.1 General

This clause describes the parameters for the MCPTT UE configuration Management Object (MO).

4.2.2 Node: <x>

Table 4.2.2.1: Node: <x>

<x>

Status	Occurrence	Format	Min. Access Types
Required	OneOrMore	node	Get

This interior node acts as a placeholder for the MCPTT UE configuration Management Object (MO).

For the MCPTT UE configuration MO, the namespace specific string is: "urn:oma:mo:oma-dm-mcptt-ue-configuration:1.0"

- Values: N/A

4.2.3 /<x>/Name

Table 4.2.3.1: /<x>/Name

Name

Status	Occurrence	Format	Min. Access Types
Required	ZeroOrOne	chr	Get

The Name leaf is a name for the MCPTT UE configuration settings.

- Values: <User displayable name>

4.2.4 /<x>/Ext/

Table 4.2.4.1: /<x>/Ext/

Ext

Status	Occurrence	Format	Min. Access Types
Optional	ZeroOrOne	node	Get, Replace

The Ext is an interior node for where the vendor specific information about the MCPTT UE configuration MO is being placed.

Usually the vendor extension is identified by vendor specific name under the ext node and contains the vendor meaning application vendor, device vendor etc. The tree structure under the vendor identified is not defined and can therefore include one or more un-standardized sub-trees.

- Values: N/A

4.2.5 /<x>/Common

Table 4.2.5.1: /<x>/Common

Common

Status	Occurrence	Format	Min. Access Types
Required	ZeroOrOne	node	Get, Replace

This interior node represents a container for the common network operation which means both on-network operation and off-network operation.

4.2.6 /<x>/Common/PrivateCall

Table 4.2.6.1: /<x>/Common/PrivateCall

Common/PrivateCall

Status	Occurrence	Format	Min. Access Types
Required	One	node	Get, Replace

This interior node is a placeholder for the private call configuration.

4.2.7 /<x>/Common/PrivateCall/MaxCallN10

Table 4.2.7.1: /<x>/Common/PrivateCall/MaxCallN10

Common/PrivateCall/MaxCallN10

Status	Occurrence	Format	Min. Access Types
Required	One	int	Get, Replace

This leaf node indicates the maximum number of private calls.

- Values: 0-255

4.2.8 /<x>/Common/MCPTTGroupCall

Table 4.2.8.1: /<x>/Common/MCPTTGroupCall

Common/MCPTTGroupCall

Status	Occurrence	Format	Min. Access Types
Required	One	node	Get, Replace

This interior node is a placeholder for the MCPTT group call configuration.

4.2.9 /<x>/Common/MCPTTGroupCall/MaxCallN4

Table 4.2.9.1: /<x>/Common/MCPTTGroupCall/MaxCallN4

Common/MCPTTGroupCall/MaxCallN4

Status	Occurrence	Format	Min. Access Types
Required	One	int	Get, Replace

This leaf node indicates the maximum number of simultaneous group calls.

- Values: 0-255

4.2.10 /<x>/Common/MCPTTGroupCall/MaxTransmissionN5

Table 4.2.10.1: /<x>/Common/MCPTTGroupCall/MaxTransmissionN5

Common/MCPTTGroupCall/MaxTransmissionN5

Status	Occurrence	Format	Min. Access Types
Required	One	int	Get, Replace

This leaf node indicates the maximum number of transmissions in a group.

- Values: 0-255

4.2.11 /<x>/Common/MCPTTGroupCall/PrioritizedMCPTTGroup

Table 4.2.11.1: /<x>/Common/MCPTTGroupCall/PrioritizedMCPTTGroup

Common/MCPTTGroupCall/PrioritizedMCPTTGroup

Status	Occurrence	Format	Min. Access Types
Required	One	node	Get, Replace

This interior node is a placeholder for the prioritized MCPTT group call configuration.

4.2.12 /<x>/Common/MCPTTGroupCall/PrioritizedMCPTTGroup/<x>

Table 4.2.12.1: /<x>/Common/MCPTTGroupCall/PrioritizedMCPTTGroup/<x>

Common/MCPTTGroupCall/PrioritizedMCPTTGroup /<x>

Status	Occurrence	Format	Min. Access Types
Required	OneOrMore	node	Get, Replace

This interior node is a placeholder for one or more prioritized MCPTT group call configuration.

4.2.13

/<x>/Common/MCPTTGroupCall/PrioritizedMCPTTGroup/<x>/MCPTTGroupID

Table 4.2.13.1: /<x>/Common/MCPTTGroupCall/PrioritizedMCPTTGroup/<x>/MCPTTGroupID

Common/MCPTTGroupCall/PrioritizedMCPTTGroup/<x>/MCPTTGroupID

Status	Occurrence	Format	Min. Access Types
Required	One	chr	Get, Replace

This leaf node indicates the associated MCPTT group ID.

The value is a "uri" attribute specified in OMA OMA-TS-XDM_Group-V1_1 [4].

4.2.14

/<x>/Common/MCPTTGroupCall/PrioritizedMCPTTGroup/<x>/MCPTTGroupPriorityHierarchy

Table 4.2.14.1:

/<x>/Common/MCPTTGroupCall/PrioritizedMCPTTGroup/<x>/MCPTTGroupPriorityHierarchy

Common/MCPTTGroupCall/PrioritizedMCPTTGroup/<x>/MCPTTGroupPriorityHierarchy

Status	Occurrence	Format	Min. Access Types
Required	One	int	Get, Replace

This leaf node indicates the requested presentation priority of group call.

- Values: 0-7

The group with the lowest MCPTTGroupPriorityHierarchy value shall be considered as the group having the lowest priority among the groups.

4.2.15 /<x>/OnNetwork

Table 4.2.15.1: /<x>/OnNetwork

OnNetwork

Status	Occurrence	Format	Min. Access Types
Required	ZeroOrOne	node	Get, Replace

This interior node represents a container for on-network operation.

4.2.16 /<x>/OnNetwork/RelayService

Table 4.2.16.1: /<x>/OnNetwork/RelayService

OnNetwork/RelayService

Status	Occurrence	Format	Min. Access Types
Required	One	bool	Get, Replace

This leaf node indicates the authorisation to use a relay service.

When set to "true" the MCPTT group is allowed to use a relay service.

When set to "false" the MCPTT group is not allowed to use a relay service.

4.2.17 /<x>/OnNetwork/IPv6Preferred

Table 4.2.17.1: /<x>/OnNetwork/IPv6Preferred

OnNetwork/IPv6Preferred

Status	Occurrence	Format	Min. Access Types
Required	One	bool	Get, Replace

This leaf node indicates whether IPv6 is preferred over IPv4 for on-network operation when the MCPTT UE has both IPv4 and IPv6 host configuration.

If the MCPTT UE has both IPv4 and IPv6 host configuration and:

- if IPv6Preferred is set to "true" then the UE uses IPv6 for all on-network signalling and media; otherwise
- if IPv6Preferred is set to "false" then the UE uses IPv4 for all on-network signalling and media.

4.2.18 /<x>/OnNetwork/RelayedMCPTTGroup

Table 4.2.18.1: /<x>/OnNetwork/RelayedMCPTTGroup

OnNetwork/RelayedMCPTTGroup

Status	Occurrence	Format	Min. Access Types
Optional	ZeroOrOne	node	Get, Replace

This interior node is a placeholder for the allowed relayed MCPTT groups.

4.2.19 /<x>/OnNetwork/RelayedMCPTTGroup/<x>

Table 4.2.19.1: /<x>/OnNetwork/RelayedMCPTTGroup/<x>

OnNetwork/RelayedMCPTTGroup/<x>

Status	Occurrence	Format	Min. Access Types
Required	OneOrMore	node	Get, Replace

This interior node is a placeholder for one or more allowed relayed MCPTT groups.

4.2.20 /<x>/OnNetwork/RelayedMCPTTGroup/<x>/MCPTTGroupID

Table 4.2.20.1: /<x>/OnNetwork/RelayedMCPTTGroup/<x>/MCPTTGroupID

OnNetwork/RelayedMCPTTGroup/<x>/MCPTTGroupID

Status	Occurrence	Format	Min. Access Types
Required	One	chr	Get, Replace

This leaf node indicates the associated MCPTT group ID.

The value is a "uri" attribute specified in OMA OMA-TS-XDM_Group-V1_1 [4].

4.2.21 /<x>/OnNetwork/RelayedMCPTTGroup/<x>/RelayServiceCode

Table 4.2.21.1: /<x>/OnNetwork/RelayedMCPTTGroup/<x>/RelayServiceCode

OnNetwork/RelayedMCPTTGroup/<x>/RelayServiceCode

Status	Occurrence	Format	Min. Access Types
Required	One	chr	Get, Replace

This leaf node indicates the connectivity service that the ProSe UE-to-network relay provides to public safety applications as specified in 3GPP TS 23.303 [6].

5 MCPTT user profile MO

5.1 General

The MCPTT user profile configuration Management Object (MO) is used to configure the MCPTT Client behaviour for the on-network or off-network MCPTT Service. The MCPTT UE configuration parameters may be stored in the ME, or in the USIM as specified in 3GPP TS 31.102 [10], or in both the ME and the USIM. If both the ME and the USIM contain the same parameters, the values stored in the USIM shall take precedence.

The Management Object Identifier is: urn:oma:mo:ext-3gpp-MCPTT-user-profile:1.0.

Protocol compatibility: This MO is compatible with OMA OMA DM 1.2 [3].

The OMA DM ACL property mechanism (see OMA OMA-ERELED-DM-V1_2 [2]) may be used to grant or deny access rights to OMA DM servers in order to modify nodes and leaf objects of the MCPTT user profile MO.

The following nodes and leaf objects are possible under the MCPTT user profile node as described in figure 5.1.1 and figure 5.1.2:

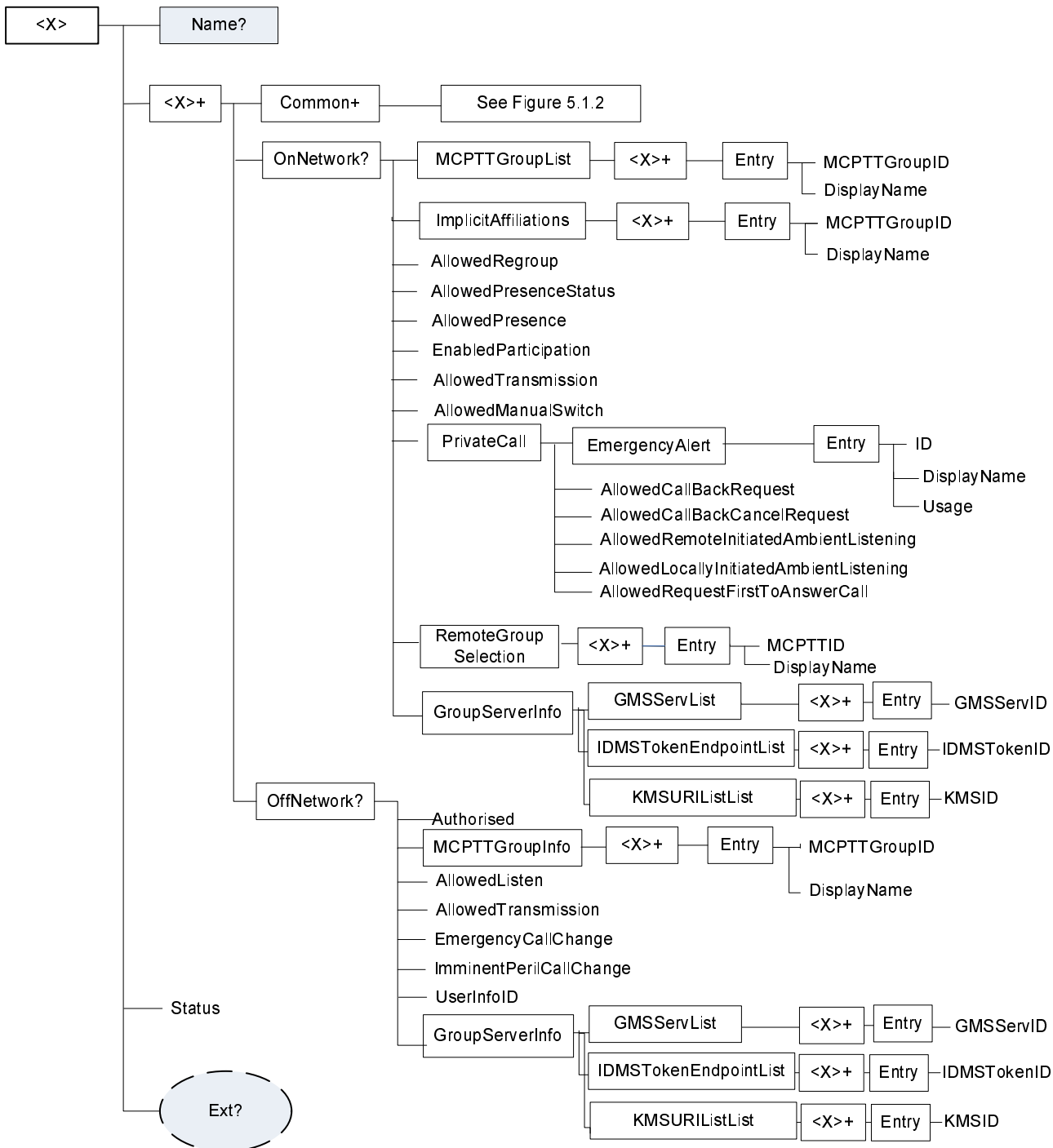

Figure 5.1.1: The MCPTT user profile MO (1 of 2)

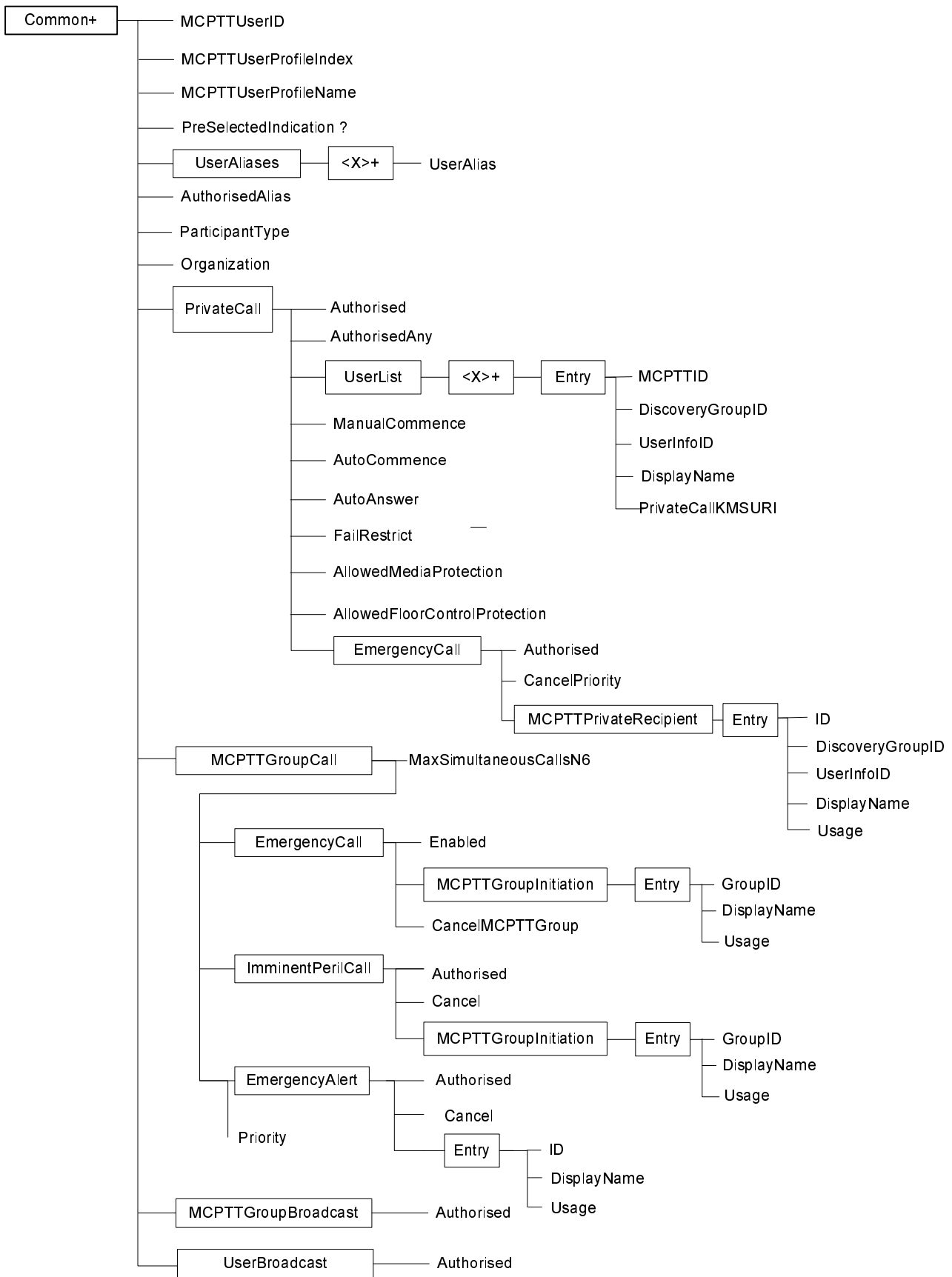

Figure 5.1.2: The MCPTT user profile MO (2 of 2)

5.2 MCPTT user profile MO parameters

5.2.1 General

This clause describes the parameters for the MCPTT user profile Management Object (MO).

5.2.2 Node: <x>

Table 5.2.2.1: Node: <x>

<x>

Status	Occurrence	Format	Min. Access Types
Required	OneOrMore	node	Get

This interior node acts as a placeholder for the MCPTT user profile Management Object (MO).

For the MCPTT user profile MO, the namespace specific string is: "urn:oma:mo:oma-dm-mcptt-user-profile:1.0"

- Values: N/A

5.2.3 /<x>/Name

Table 5.2.3.1: /<x>/Name

Name

Status	Occurrence	Format	Min. Access Types
Required	ZeroOrOne	chr	Get

The Name leaf is a name for the MCPTT user profile settings.

- Values: <User displayable name>

5.2.4 /<x>/Ext/

Table 5.2.4.1: /<x>/Ext/

Ext

Status	Occurrence	Format	Min. Access Types
Optional	ZeroOrOne	node	Get, Replace

The Ext is an interior node for where the vendor specific information about the MCPTT user profile MO is being placed.

Usually the vendor extension is identified by vendor specific name under the ext node and contains the vendor meaning application vendor, device vendor etc. The tree structure under the vendor identified is not defined and can therefore include one or more un-standardized sub-trees.

- Values: N/A

5.2.5 /<x>/<x>

Table 5.2.5.1: /<x>/<x>

<x>

Status	Occurrence	Format	Min. Access Types
Required	OneOrMore	node	Get, Replace

This interior node represents a container for on-network operation and off-network operation.

5.2.6 /<x>/<x>/Common

Table 5.2.6.1: /<x>/<x>/Common

<x>/Common

Status	Occurrence	Format	Min. Access Types
Required	OneOrMore	node	Get, Replace

This interior node represents a container for the common network operation which means both on-network operation and off-network operation.

5.2.7 /<x>/<x>/Common/MCPTTUserID

Table 5.2.7.1: /<x>/<x>/Common/MCPTTUserID

<x>/Common/MCPTTUserID

Status	Occurrence	Format	Min. Access Types
Required	One	chr	Get, Replace

This leaf node indicates an MCPTT user identity (MCPTT ID) which is a globally unique identifier within the MCPTT service that represents the MCPTT user.

5.2.7A /<x>/<x>/Common/MCPTTUserProfileIndex

Table 5.2.7A.1: /<x>/<x>/Common/MCPTTUserProfileIndex

<x>/Common/MCPTTUserProfileIndex

Status	Occurrence	Format	Min. Access Types
Required	One	int	Get, Replace

This leaf node indicates an index for the particular MCPTT user profile.

- Values: 0-255

5.2.7B /<x>/<x>/Common/MCPTTUserProfileName

Table 5.2.7B.1: /<x>/<x>/Common/MCPTTUserProfileName

<x>/Common/MCPTTUserProfileName

Status	Occurrence	Format	Min. Access Types
Optional	One	chr	Get, Replace

This leaf node indicates a profile name for the particular MCPTT user profile.

5.2.7C /<x>/<x>/Common/PreSelectedIndication

Table 5.2.7C.1: /<x>/<x>/Common/PreSelectedIndication

<x>/Common/PreSelectedIndication

Status	Occurrence	Format	Min. Access Types
Optional	ZeroOrOne	null	Get, Replace

This leaf node indicates that this MCPTT user profile MO is designated to be the pre-selected MCPTT user profile as defined by 3GPP TS 23.179 [15]

- Values: null

When this leaf node is present, this MCPTT user profile MO is designated as the pre-selected MCPTT user profile.

When this leaf node is absent, this MCPTT user profile MO is not designated as the pre-selected MCPTT user profile.

If more than one MCPTT user profile MO is specified for the MCPTT user, then only one MCPTT user profile MO for the MCPTT user shall contain the `<x>/Common/PreSelectedIndication` leaf node.

If there is only one MCPTT user profile MO specified for the MCPTT user, then it is optional to include the `<x>/Common/PreSelectedIndication` leaf node.

5.2.8 `<x>/<x>/Common/UserAliases`

Table 5.2.8.1: `<x>/<x>/Common/UserAliases`

`<x>/Common/UserAliases`

Status	Occurrence	Format	Min. Access Types
Required	One	node	Get, Replace

This interior node is a placeholder for a list of aliases of an MCPTT user.

5.2.8A `<x>/<x>/Common/UserAliases/<x>`

Table 5.2.8A.1: `<x>/<x>/Common/UserAliases/<x>`

`<x>/Common/UserAliases/<x>`

Status	Occurrence	Format	Min. Access Types
Required	OneOrMore	node	Get, Replace

This interior node is a placeholder for one or more aliases of an MCPTT user.

5.2.8B `<x>/<x>/Common/UserAliases/<x>/UserAlias`

Table 5.2.8B.1: `<x>/<x>/Common/UserAliases/<x>/UserAlias`

`<x>/Common/UserAliases/<x>/UserAlias`

Status	Occurrence	Format	Min. Access Types
Required	One	chr	Get, Replace

This leaf node indicates an alphanumeric alias of the MCPTT user.

5.2.9 `<x>/<x>/Common/AuthorisedAlias`

Table 5.2.9.1: `<x>/<x>/Common/AuthorisedAlias`

`<x>/Common/AuthorisedAlias`

Status	Occurrence	Format	Min. Access Types
Optional	One	bool	Get, Replace

This leaf node indicates authorisation to create and delete aliases of other MCPTT users and their associated MCPTT user profiles.

When set to "true" the MCPTT user is authorised to create and delete aliases of other MCPTT users and their associated MCPTT user profiles.

When set to "false" the MCPTT user is not authorised to create and delete aliases of other MCPTT user and their associated MCPTT user profiles. This is the default if this leaf node is not present.

5.2.10 /<x>/<x>/Common/ParticipantType

Table 5.2.10.1: /<x>/<x>/Common/ParticipantType

<x>/Common/ParticipantType

Status	Occurrence	Format	Min. Access Types
Required	One	chr	Get, Replace

This leaf node indicates the participant type of the MCPTT user.

The ParticipantType means the functional category of the participant (e.g., first responder, second responder, dispatch, dispatch supervisor), typically defined by the MCPTT administrators.

5.2.11 /<x>/<x>/Common/Organization

Table 5.2.11.1: /<x>/<x>/Common/Organization

<x>/Common/Organization

Status	Occurrence	Format	Min. Access Types
Required	One	chr	Get, Replace

This leaf node indicates the organization an MCPTT user belongs to.

5.2.12 /<x>/<x>/Common/PrivateCall

Table 5.2.12.1: /<x>/<x>/Common/PrivateCall

<x>/Common/PrivateCall

Status	Occurrence	Format	Min. Access Types
Required	One	node	Get, Replace

This interior node is a placeholder for the MCPTT private call configuration.

5.2.13 /<x>/<x>/Common/PrivateCall/Authorised

Table 5.2.13.1: /<x>/<x>/Common/PrivateCall/Authorised

<x>/Common/PrivateCall/Authorised

Status	Occurrence	Format	Min. Access Types
Required	One	bool	Get, Replace

This leaf node indicates the authorisation to make a MCPTT private call.

When set to "true" the MCPTT user is allowed to make a MCPTT private call.

When set to "false" the MCPTT user is not allowed to make a MCPTT private call.

5.2.14 /<x>/<x>/Common/PrivateCall/AuthorisedAny

Table 5.2.14.1: /<x>/<x>/Common/PrivateCall/AuthorisedAny

<x>/Common/PrivateCall/AuthorisedAny

Status	Occurrence	Format	Min. Access Types
Required	One	bool	Get, Replace

This leaf node indicates the authorisation to make a MCPTT private call to any MCPTT user.

When set to "true" any MCPTT user is authorised to make an MCPTT private call to any MCPTT user.

When set to "false" any MCPTT user is not authorised to make an MCPTT private call to any MCPTT user.

5.2.15 /<x>/<x>/Common/PrivateCall/UserList

Table 5.2.15.1: /<x>/<x>/PrivateCall/UserList

<x>/Common/ PrivateCall/UserList

Status	Occurrence	Format	Min. Access Types
Required	One	node	Get, Replace

This interior node is a placeholder for a list of MCPTT user(s) who can be called in a MCPTT private call.

5.2.16 /<x>/<x>/Common/PrivateCall/UserList/<x>

Table 5.2.16.1: /<x>/<x>/Common/PrivateCall/UserList/<x>

<x>/Common/PrivateCall/UserList/<x>

Status	Occurrence	Format	Min. Access Types
Optional	OneOrMore	node	Get, Replace

This interior node is a placeholder for one or more list of MCPTT users who can be called in a MCPTT private call.

5.2.16A /<x>/<x>/Common/PrivateCall/UserList/<x>/Entry

Table 5.2.16A.1: /<x>/<x>/Common/PrivateCall/UserList/<x>/Entry

<x>/Common/PrivateCall/UserList/<x>/Entry

Status	Occurrence	Format	Min. Access Types
Required	One	node	Get, Replace

This interior node is a placeholder for one or more MCPTT users who can be called in a private call.

5.2.17 /<x>/<x>/Common/PrivateCall/UserList/<x>/Entry/MCPTTID

Table 5.2.17.1: /<x>/<x>/Common/PrivateCall/UserList/<x>/Entry/MCPTTID

<x>/Common/PrivateCall/UserList/<x>/Entry/MCPTTID

Status	Occurrence	Format	Min. Access Types
Optional	One	chr	Get, Replace

This leaf node indicates an MCPTT user identity (MCPTT ID) which is a globally unique identifier within the MCPTT service that represents the MCPTT user.

The value is a "uri" attribute specified in OMA OMA-TS-XDM_Group-V1_1 [4].

5.2.18 /<x>/<x>/Common/PrivateCall/UserList/<x>/Entry/DiscoveryGroupID

Table 5.2.18.1: /<x>/<x>/Common/PrivateCall/UserList/<x>/Entry/DiscoveryGroupID

<x>/Common/PrivateCall/UserList/<x>/Entry/DiscoveryGroupID

Status	Occurrence	Format	Min. Access Types
Optional	One	int	Get, Replace

This leaf node indicates a discovery group ID as specified in 3GPP TS 23.303 [6].

The value is used as the discovery group ID in the ProSe discovery procedures as specified in 3GPP TS 23.303 [6].

5.2.19 /<x>/<x>/Common/PrivateCall/UserList/<x>/Entry/UserInfoID

Table 5.2.19.1: /<x>/<x>/Common/PrivateCall/UserList/<x>/Entry/UserInfoID

<x>/Common/PrivateCall/UserList/<x>/Entry/UserInfoID

Status	Occurrence	Format	Min. Access Types
Optional	One	int	Get, Replace

This leaf node indicates a ProSe user info ID as specified in 3GPP TS 23.303 [6].

5.2.19A /<x>/<x>/Common/PrivateCall/UserList/<x>/Entry/DisplayName

Table 5.2.19A.1: /<x>/<x>/Common/PrivateCall/UserList/<x>/Entry/DisplayName

<x>/Common/PrivateCall/UserList/<x>/Entry/DisplayName

Status	Occurrence	Format	Min. Access Types
Optional	One	chr	Get, Replace

This leaf node contains a human readable name.

5.2.19B

/<x>/<x>/Common/PrivateCall/UserList/<x>/Entry/PrivateCallKMSURI

Table 5.2.19B.1: /<x>/<x>/Common/PrivateCall/UserList/<x>/Entry/PrivateCallKMSURI

<x>/Common/PrivateCall/UserList/<x>/Entry/PrivateCallKMSURI

Status	Occurrence	Format	Min. Access Types
Optional	One	chr	Get, Replace

This leaf node indicates the identity (URI) of the KMS associated with the MCPTTID. If the value is empty, the KMS leaf node present in the MCS UE initial configuration MO is used.

5.2.20 /<x>/<x>/Common/PrivateCall/ManualCommence

Table 5.2.20.1: /<x>/<x>/Common/PrivateCall/ManualCommence

<x>/Common/PrivateCall/ManualCommence

Status	Occurrence	Format	Min. Access Types
Required	One	bool	Get, Replace

This leaf node indicates the authorisation to make a MCPTT private call with manual commencement.

When set to "true" the MCPTT user is authorised to make a MCPTT private call in manual commencement mode.

When set to "false" the MCPTT user is not authorised to make a MCPTT private call in manual commencement mode.

5.2.21 /<x>/<x>/Common/PrivateCall/AutoCommence

Table 5.2.21.1: /<x>/<x>/Common/PrivateCall/AutoCommence

<x>/Common/PrivateCall/AutoCommence

Status	Occurrence	Format	Min. Access Types
Required	One	bool	Get, Replace

This leaf node indicates the authorisation to make a MCPTT private call with automatic commencement.

When set to "true" the MCPTT user is authorised to make a MCPTT private call in automatic commencement mode.

When set to "false" the MCPTT user is not authorised to make a MCPTT private call in automatic commencement mode.

5.2.22 /<x>/<x>/Common/PrivateCall/AutoAnswer

Table 5.2.22.1: /<x>/<x>/Common/PrivateCall/AutoAnswer

<x>/Common/PrivateCall/AutoAnswer

Status	Occurrence	Format	Min. Access Types
Required	One	bool	Get, Replace

This leaf node indicates the authorisation of MCPTT user to force automatic answer for a MCPTT private call.

When set to "true" the MCPTT user is authorised to force automatic answer for a MCPTT private call.

When set to "false" the MCPTT user is not authorised to force automatic answer for a MCPTT private call.

5.2.23 /<x>/<x>/Common/PrivateCall/FailRestrict

Table 5.2.23.1: /<x>/<x>/Common/PrivateCall/FailRestrict

<x>/Common/PrivateCall/FailRestrict

Status	Occurrence	Format	Min. Access Types
Required	One	bool	Get, Replace

This leaf node indicates the authorisation to restrict the provision of a notification of call failure reason for a MCPTT private call.

When set to "true" the MCPTT user is authorised to restrict notification of call failure reason for MCPTT private call.

When set to "false" the MCPTT user is not authorised to restrict notification of call failure reason for MCPTT private call.

5.2.24 /<x>/<x>/Common/PrivateCall/AllowedMediaProtection

Table 5.2.24.1: /<x>/<x>/Common/PrivateCall/AllowedMediaProtection

<x>/Common/PrivateCall/AllowedMediaProtection

Status	Occurrence	Format	Min. Access Types
Required	One	bool	Get, Replace

This leaf node indicates authorisation to protect confidentiality and integrity of media for MCPTT private calls.

When set to "true" the MCPTT user is authorised to protect confidentiality and integrity of media for MCPTT private calls.

When set to "false" the MCPTT user is not authorised to protect confidentiality and integrity of media for MCPTT private calls.

The default value is set to "true".

5.2.25 /<x>/<x>/Common/PrivateCall/AllowedFloorControlProtection

Table 5.2.25.1: /<x>/<x>/Common/PrivateCall/AllowedFloorControlProtection

<x>/Common/PrivateCall/AllowedFloorControlProtection

Status	Occurrence	Format	Min. Access Types
Required	One	bool	Get, Replace

This leaf node indicates authorisation to protect confidentiality and integrity of floor control signalling for MCPTT private calls.

When set to "true" the MCPTT user is authorised to protect confidentiality and integrity of floor control signalling for MCPTT private calls.

When set to "false" the MCPTT user is not authorised to protect confidentiality and integrity of floor control signalling for MCPTT private calls.

The default value is set to "true".

5.2.26 /<x>/<x>/Common/PrivateCall/EmergencyCall

Table 5.2.26.1: /<x>/<x>/Common/PrivateCall/EmergencyCall

<x>/Common/PrivateCall/EmergencyCall

Status	Occurrence	Format	Min. Access Types
Required	One	node	Get, Replace

This interior node is a placeholder for the MCPTT emergency call policy.

5.2.27 /<x>/<x>/Common/PrivateCall/EmergencyCall/Authorised

Table 5.2.27.1: /<x>/<x>/Common/PrivateCall/EmergencyCall/Authorised

<x>/Common/PrivateCall/EmergencyCall/Authorised

Status	Occurrence	Format	Min. Access Types
Required	One	bool	Get, Replace

This leaf node indicates the authorisation to make an MCPTT emergency private call.

When set to "true" the MCPTT user is authorised to make an MCPTT emergency private call.

When set to "false" the MCPTT user is not authorised to make an MCPTT emergency private call.

5.2.28 /<x>/<x>/Common/PrivateCall/EmergencyCall/CancelPriority

Table 5.2.28.1: /<x>/<x>/Common/PrivateCall/EmergencyCall/CancelPriority

<x>/Common/PrivateCall/EmergencyCall/CancelPriority

Status	Occurrence	Format	Min. Access Types
Required	One	bool	Get, Replace

This leaf node indicates the authorisation to cancel emergency priority in an MCPTT emergency private call by an authorised MCPTT user.

When set to "true" the MCPTT user is authorised to cancel an emergency priority in an MCPTT private call.

When set to "false" the MCPTT user is not authorised to cancel an emergency priority in an MPCTT private call.

5.2.29

/<x>/<x>/Common/PrivateCall/EmergencyCall/MCPTTPrivateRecipient

Table 5.2.29.1: /<x>/<x>/Common/PrivateCall/EmergencyCall/MCPTTPrivateRecipient

<x>/Common/PrivateCall/EmergencyCall/MCPTTPrivateRecipient

Status	Occurrence	Format	Min. Access Types
Optional	One	node	Get, Replace

This interior node is a placeholder for the MCPTT private recipient for an MCPTT emergency private call.

5.2.29A

`<x>/<x>/Common/PrivateCall/EmergencyCall/MCPTTPrivateRecipient/Entry`

Table 5.2.29A.1: `<x>/<x>/Common/PrivateCall/EmergencyCall/MCPTTPrivateRecipient/Entry`

`<x>/Common/PrivateCall/EmergencyCall/MCPTTPrivateRecipient/Entry`

Status	Occurrence	Format	Min. Access Types
Required	One	node	Get, Replace

This interior node is a placeholder for the details of the MCPTT private recipient for an MCPTT emergency private call.

5.2.29B

`<x>/<x>/Common/PrivateCall/EmergencyCall/MCPTTPrivateRecipient/Entry/ID`

Table 5.2.29B.1: `<x>/<x>/Common/PrivateCall/EmergencyCall/MCPTTPrivateRecipient/Entry/ID`

`<x>/Common/PrivateCall/EmergencyCall/MCPTTPrivateRecipient/Entry/ID`

Status	Occurrence	Format	Min. Access Types
Optional	One	chr	Get, Replace

This leaf node indicates the MCPTT private recipient used upon certain criteria on initiation of an MCPTT emergency private call.

5.2.29C

`<x>/<x>/Common/PrivateCall/EmergencyCall/MCPTTPrivateRecipient/Entry/DiscoveryGroupID`

Table 5.2.29C.1:

`<x>/<x>/Common/PrivateCall/EmergencyCall/MCPTTPrivateRecipient/Entry/DiscoveryGroupID`

`<x>/Common/PrivateCall/EmergencyCall/MCPTTPrivateRecipient/Entry/DiscoveryGroupID`

Status	Occurrence	Format	Min. Access Types
Optional	One	int	Get, Replace

This leaf node indicates the discovery group ID as specified in 3GPP TS 23.303 [6].

5.2.29D

`<x>/<x>/Common/PrivateCall/EmergencyCall/MCPTTPrivateRecipient/Entry/UserInfoID`

Table 5.2.29D.1:

`<x>/<x>/Common/PrivateCall/EmergencyCall/MCPTTPrivateRecipient/Entry/UserInfoID`

`<x>/Common/PrivateCall/EmergencyCall/MCPTTPrivateRecipient/Entry/UserInfoID`

Status	Occurrence	Format	Min. Access Types
Optional	One	int	Get, Replace

This leaf node indicates a ProSe user info ID as specified in 3GPP TS 23.303 [6].

The "UserInfoID" element identifies the MCPTT private recipient when making an off-network private call.

5.2.29E

`<x>/<x>/Common/PrivateCall/EmergencyCall/MCPTTPrivateRecipient/Entry/DisplayName`

Table 5.2.29E.1:

`<x>/<x>/Common/PrivateCall/EmergencyCall/MCPTTPrivateRecipient/Entry/DisplayName`

`<x>/Common/PrivateCall/EmergencyCall/MCPTTPrivateRecipient/Entry/DisplayName`

Status	Occurrence	Format	Min. Access Types
Optional	One	chr	Get, Replace

This leaf node contains a human readable name that corresponds to the MCPTT private recipient ID.

5.2.29F

`<x>/<x>/Common/PrivateCall/EmergencyCall/MCPTTPrivateRecipient/Entry/Usage`

Table 5.2.29F.1: `<x>/<x>/Common/PrivateCall/EmergencyCall/MCPTTPrivateRecipient/Entry/Usage`

`<x>/Common/PrivateCall/EmergencyCall/MCPTTPrivateRecipient/Entry/Usage`

Status	Occurrence	Format	Min. Access Types
Required	One	chr	Get, Replace

This leaf node indicates the criteria to determine when initiation of an MCPTT emergency private call uses the MCPTT private recipient ID.

The valid values are 'LocallyDetermined' and 'UsePreConfigured'.

When set to 'LocallyDetermined' then if the MCPTT user selects an MCPTT ID then use that MCPTT ID for the MCPTT emergency private call, if the MCPTT user does not select a MCPTT ID then use the MCPTT ID identified by the MCPTT private recipient ID in subclause 5.2.29B for an on-network MCPTT emergency private call.

When set to 'UsePreConfigured' then use the MCPTT ID identified by the MCPTT private recipient ID in subclause 5.2.29B for an on-network MCPTT emergency private call.

When set to 'LocallyDetermined' then if the MCPTT user selects an MCPTT user then use the UserInfoID that corresponds to that MCPTT user for the MCPTT emergency private call, if the MCPTT user does not select a MCPTT user then use the User Info ID identified by the UserInfoID in subclause 5.2.29D for an off-network MCPTT emergency private call.

When set to 'UsePreConfigured' then use the User Info ID identified by the UserInfoID in subclause 5.2.29D for an off-network MCPTT emergency private call.

5.2.30 `<x>/<x>/Common/MCPTTGroupCall`Table 5.2.30.1: `<x>/<x>/Common/MCPTTGroupCall`

`<x>/Common/MCPTTGroupCall`

Status	Occurrence	Format	Min. Access Types
Required	One	node	Get, Replace

This interior node is a placeholder for the MCPTT group call configuration.

5.2.31 `<x>/<x>/Common/MCPTTGroupCall/MaxSimultaneousCallsN6`Table 5.2.31.1: `<x>/<x>/Common/MCPTTGroupCall/MaxSimultaneousCallsN6`

`<x>/Common/MCPTTGroupCall/MaxSimultaneousCallsN6`

Status	Occurrence	Format	Min. Access Types
Required	One	int	Get, Replace

This leaf node indicates the maximum number of simultaneously received MCPTT group calls (N6).

5.2.32 /<x>/<x>/Common/MCPTTGroupCall/EmergencyCall

Table 5.2.32.1: /<x>/<x>/Common/MCPTTGroupCall/EmergencyCall

<x>/Common/MCPTTGroupCall/EmergencyCall

Status	Occurrence	Format	Min. Access Types
Required	One	node	Get, Replace

This interior node is a placeholder for the MCPTT emergency call policy.

5.2.33 /<x>/<x>/Common/MCPTTGroupCall/EmergencyCall/Enabled

Table 5.2.33.1: /<x>/<x>/Common/MCPTTGroupCall/EmergencyCall/Enabled

<x>/Common/MCPTTGroupCall/EmergencyCall/Enabled

Status	Occurrence	Format	Min. Access Types
Optional	One	bool	Get, Replace

This leaf node indicates the authorisation to make an MCPTT emergency group call functionality enabled for MCPTT user.

When set to "true" the MCPTT user is authorised to make an MCPTT emergency group call functionality enabled.

When set to "false" the MCPTT user is not authorised to make an MCPTT emergency group call functionality enabled.

5.2.34

/<x>/<x>/Common/MCPTTGroupCall/EmergencyCall/MCPTTGroupInitiation

Table 5.2.34.1: /<x>/<x>/Common/MCPTTGroupCall/EmergencyCall/MCPTTGroupInitiation

<x>/Common/MCPTTGroupCall/EmergencyCall/MCPTTGroupInitiation

Status	Occurrence	Format	Min. Access Types
Required	One	node	Get, Replace

This interior node is a placeholder for the group used on initiation of an MCPTT emergency group call.

5.2.34A

/<x>/<x>/Common/MCPTTGroupCall/EmergencyCall/MCPTTGroupInitiation/Entry

Table 5.2.34A.1: /<x>/<x>/Common/MCPTTGroupCall/EmergencyCall/MCPTTGroupInitiation/Entry

<x>/Common/MCPTTGroupCall/EmergencyCall/MCPTTGroupInitiation/Entry

Status	Occurrence	Format	Min. Access Types
Required	One	node	Get, Replace

This interior node is a placeholder for the details of the group used on initiation of an MCPTT emergency group call.

5.2.34B

`/Common/MCPTTGroupCall/EmergencyCall/MCPTTGroupInitiation/Entry/GroupID`

Table 5.2.34BA.1:

`/Common/MCPTTGroupCall/EmergencyCall/MCPTTGroupInitiation/Entry/GroupID`

`<x>/Common/MCPTTGroupCall/EmergencyCall/MCPTTGroupInitiation/Entry/GroupID`

Status	Occurrence	Format	Min. Access Types
Optional	One	chr	Get, Replace

This leaf node indicates the group used upon certain criteria on initiation of an MCPTT emergency group call.

5.2.34C

`/Common/MCPTTGroupCall/EmergencyCall/MCPTTGroupInitiation/Entry/DisplayName`

Table 5.2.34C.1:

`/Common/MCPTTGroupCall/EmergencyCall/MCPTTGroupInitiation/Entry/DisplayName`

`<x>/Common/MCPTTGroupCall/EmergencyCall/MCPTTGroupInitiation/Entry/DisplayName`

Status	Occurrence	Format	Min. Access Types
Optional	One	chr	Get, Replace

This leaf node contains a human readable name that corresponds to the Group ID.

5.2.34D

`/Common/MCPTTGroupCall/EmergencyCall/MCPTTGroupInitiation/Entry/Usage`

Table 5.2.34D.1:

`/Common/MCPTTGroupCall/EmergencyCall/MCPTTGroupInitiation/Entry/Usage`

`<x>/Common/MCPTTGroupCall/EmergencyCall/MCPTTGroupInitiation/Entry/Usage`

Status	Occurrence	Format	Min. Access Types
Required	One	chr	Get, Replace

This leaf node indicates the criteria to determine when initiation of an MCPTT emergency group call uses the GroupID.

The valid values are 'UseCurrentlySelectedGroup' and 'DedicatedGroup'.

When set to 'UseCurrentlySelectedGroup' then if the MCPTT user has currently selected an MCPTT group then use that MCPTT group for an on-network MCPTT emergency group call, if the MCPTT user does not have a currently selected MCPTT group then use the MCPTT group identified by the GroupID in subclause 5.2.34B for an MCPTT emergency group call.

When set to 'DedicatedGroup' then use the MCPTT group identified by the GroupID in subclause 5.2.34B for an MCPTT emergency group call.

5.2.35

`/<x>/<x>/Common/MCPTTGroupCall/EmergencyCall/CancelMCPTTGroup`

Table 5.2.35.1: `/<x>/<x>/Common/MCPTTGroupCall/EmergencyCall/CancelMCPTTGroup`

`<x>/Common/MCPTTGroupCall/EmergencyCall/CancelMCPTTGroup`

Status	Occurrence	Format	Min. Access Types
Required	One	bool	Get, Replace

This leaf node indicates the authorisation to cancel an in progress MCPTT emergency group call associated with a group.

When set to "true" the MCPTT user is authorised to cancel a MCPTT emergency group call.

When set to "false" the MCPTT user is not authorised to cancel a MCTT emergency group call.

5.2.36 `/<x>/<x>/Common/MCPTTGroupCall/ImminentPerilCall`

Table 5.2.36.1: `/<x>/<x>/Common/MCPTTGroupCall/ImminentPerilCall`

`<x>/Common/MCPTTGroupCall/ImminentPerilCall`

Status	Occurrence	Format	Min. Access Types
Required	One	node	Get, Replace

This interior node is a placeholder for the MCPTT imminent peril call policy.

5.2.37 `/<x>/<x>/Common/MCPTTGroupCall/ImminentPerilCall/Authorised`

Table 5.2.37.1: `/<x>/<x>/Common/MCPTTGroupCall/ImminentPerilCall/Authorised`

`<x>/Common/MCPTTGroupCall/ImminentPerilCall/Authorised`

Status	Occurrence	Format	Min. Access Types
Required	One	bool	Get, Replace

This leaf node indicates the authorisation to make an Imminent Peril group call.

When set to "true" the MCPTT user is authorised to create an MCPTT imminent peril group call.

When set to "false" the MCPTT user is not authorised to create an MCPTT imminent peril group call.

5.2.38 `/<x>/<x>/Common/MCPTTGroupCall/ImminentPerilCall/Cancel`

Table 5.2.38.1: `/<x>/<x>/Common/MCPTTGroupCall/ImminentPerilCall/Cancel`

`<x>/Common/MCPTTGroupCall/ImminentPerilCall/Cancel`

Status	Occurrence	Format	Min. Access Types
Required	One	bool	Get, Replace

This leaf node indicates the authorisation for in-progress MCPTT imminent peril cancellation.

When set to "true" the MCPTT user is authorised to cancel an MCPTT imminent peril call.

When set to "false" the MCPTT user is not authorised to cancel an MCPTT imminent peril call.

5.2.39

`/<x>/<x>/Common/MCPTTGroupCall/ImminentPerilCall/MCPTTGroupInitiation`

Table 5.2.39.1: `/<x>/<x>/Common/MCPTTGroupCall/ImminentPerilCall/MCPTTGroupInitiation`

`<x>/Common/MCPTTGroupCall/ImminentPerilCall/MCPTTGroupInitiation`

Status	Occurrence	Format	Min. Access Types
Optional	One	node	Get, Replace

This interior node is a placeholder for the group used on initiation of an MCPTT imminent peril group call.

5.2.39A

`/<x>/<x>/Common/MCPTTGroupCall/ImminentPerilCall/MCPTTGroupInitiation/Entry`

Table 5.2.39A.1: `/<x>/<x>/Common/MCPTTGroupCall/ImminentPerilCall/MCPTTGroupInitiation/Entry`

`<x>/Common/MCPTTGroupCall/ImminentPerilCall/MCPTTGroupInitiation/Entry`

Status	Occurrence	Format	Min. Access Types
Required	One	node	Get, Replace

This interior node is a placeholder for the details of the group used on initiation of an imminent peril call.

5.2.39B

`/<x>/<x>/Common/MCPTTGroupCall/ImminentPerilCall/MCPTTGroupInitiation/Entry/GroupID`

Table 5.2.39B.1:

`/<x>/<x>/Common/MCPTTGroupCall/ImminentPerilCall/MCPTTGroupInitiation/Entry/GroupID`

`<x>/Common/MCPTTGroupCall/ImminentPerilCall/MCPTTGroupInitiation/Entry/GroupID`

Status	Occurrence	Format	Min. Access Types
Required	One	chr	Get, Replace

This leaf node indicates the group used upon certain criteria on initiation of an MCPTT imminent peril group call.

5.2.39C

`/<x>/<x>/Common/MCPTTGroupCall/ImminentPerilCall/MCPTTGroupInitiation/Entry/DisplayName`

Table 5.2.39C.1:

`/<x>/<x>/Common/MCPTTGroupCall/ImminentPerilCall/MCPTTGroupInitiation/Entry/DisplayName`

`<x>/Common/MCPTTGroupCall/ImminentPerilCall/MCPTTGroupInitiation/Entry/DisplayName`

Status	Occurrence	Format	Min. Access Types
Optional	One	chr	Get, Replace

This leaf node contains a human readable name that corresponds to the Group ID.

5.2.39D

/<x>/<x>/Common/MCPTTGroupCall/ImminentPerilCall/MCPTTGroupInitiation/Entry/Usage

Table 5.2.39D.1:

/<x>/<x>/Common/MCPTTGroupCall/ImminentPerilCall/MCPTTGroupInitiation/Entry/Usage

<x>/Common/MCPTTGroupCall/ImminentPerilCall/MCPTTGroupInitiation/Entry/Usage

Status	Occurrence	Format	Min. Access Types
Required	One	chr	Get, Replace

This leaf node indicates the criteria to determine when initiation of an MCPTT imminent peril group call uses the GroupID.

The valid values are 'UseCurrentlySelectedGroup' and 'DedicatedGroup'.

When set to 'UseCurrentlySelectedGroup' then if the MCPTT user has currently selected an MCPTT group then use that MCPTT group for an on-network MCPTT imminent peril group call, if the MCPTT user does not have a currently selected MCPTT group then use the MCPTT group identified by the GroupID in subclause 5.2.39B for an MCPTT imminent peril group call.

When set to 'DedicatedGroup' then use the MCPTT group identified by the GroupID in subclause 5.2.39B for an MCPTT imminent peril group call.

5.2.40 /<x>/<x>/Common/MCPTTGroupCall/EmergencyAlert

Table 5.2.40.1: /<x>/<x>/Common/MCPTTGroupCall/EmergencyAlert

<x>/Common/MCPTTGroupCall/EmergencyAlert

Status	Occurrence	Format	Min. Access Types
Required	One	node	Get, Replace

This interior node is a placeholder for the MCPTT emergency alert policy.

5.2.41 /<x>/<x>/Common/MCPTTGroupCall/EmergencyAlert/Authorised

Table 5.2.41.1: /<x>/<x>/Common/MCPTTGroupCall/EmergencyAlert/Authorised

<x>/Common/MCPTTGroupCall/EmergencyAlert/Authorised

Status	Occurrence	Format	Min. Access Types
Required	One	bool	Get, Replace

This leaf node indicates the authorisation to activate an MCPTT emergency alert.

When set to "true" the MCPTT user is authorised to make an MCPTT emergency alert.

When set to "false" the MCPTT user is not authorised to make an MCPTT emergency alert.

5.2.42 /<x>/<x>/Common/MCPTTGroupCall/EmergencyAlert/Cancel

Table 5.2.42.1: /<x>/<x>/Common/MCPTTGroupCall/EmergencyAlert/Cancel

<x>/Common/MCPTTGroupCall/EmergencyAlert/Cancel

Status	Occurrence	Format	Min. Access Types
Required	One	bool	Get, Replace

This leaf node indicates the authorisation to cancel an MCPTT emergency alert.

When set to "true" the MCPTT user is authorised to cancel an MCPTT emergency alert.

When set to "false" the MCPTT user is not authorised to cancel an MCPTT emergency alert.

5.2.43 Void

5.2.43A /<x>/<x>/Common/MCPTTGroupCall/EmergencyAlert/Entry

Table 5.2.39A.1: /<x>/<x>/Common/MCPTTGroupCall/EmergencyAlert/Entry

<x>/Common/MCPTTGroupCall/EmergencyAlert/Entry

Status	Occurrence	Format	Min. Access Types
Required	One	node	Get, Replace

This interior node is a placeholder for the details of the MCPTT group of an MCPTT emergency alert.

5.2.43B /<x>/<x>/Common/MCPTTGroupCall/EmergencyAlert/Entry/ID

Table 5.2.43B.1: /<x>/<x>/Common/MCPTTGroupCall/EmergencyAlert/Entry/ID

<x>/Common/MCPTTGroupCall/EmergencyAlert/Entry/ID

Status	Occurrence	Format	Min. Access Types
Required	One	chr	Get, Replace

This leaf node indicates the MCPTT group used upon certain criteria on initiation of an MCPTT emergency alert.

5.2.43C Void

5.2.43D

/<x>/<x>/Common/MCPTTGroupCall/EmergencyAlert/Entry/DisplayName

Table 5.2.43D.1: /<x>/<x>/Common/MCPTTGroupCall/EmergencyAlert/Entry/DisplayName

<x>/Common/MCPTTGroupCall/EmergencyAlert/Entry/DisplayName

Status	Occurrence	Format	Min. Access Types
Optional	One	chr	Get, Replace

This leaf node contains a human readable name that corresponds to the ID.

5.2.43E /<x>/<x>/Common/MCPTTGroupCall/EmergencyAlert/Entry/Usage

Table 5.2.43E.1: /<x>/<x>/Common/MCPTTGroupCall/EmergencyAlert/Entry/Usage

<x>/Common/MCPTTGroupCall/EmergencyAlert/Entry/Usage

Status	Occurrence	Format	Min. Access Types
Required	One	chr	Get, Replace

This leaf node indicates the criteria to determine when initiation of an MCPTT emergency alert uses the ID.

The valid values are 'LocallyDetermined', 'UseCurrentlySelectedGroup', 'UsePreConfigured' and 'DedicatedGroup'.

When set to 'LocallyDetermined' then if the MCPTT user selects an MCPTT ID then use that MCPTT ID for an on-network MCPTT emergency alert, if the MCPTT user does not select a MCPTT ID then use the MCPTT ID identified by the ID in subclause 5.2.43B for an on-network MCPTT emergency alert.

When set to 'UseCurrentlySelectedGroup' then if the MCPTT user has currently selected an MCPTT group then use that MCPTT group for an on-network MCPTT emergency alert, if the MCPTT user does not have a currently selected MCPTT group then use the MCPTT group identified by the ID in subclause 5.2.43B for an MCPTT emergency alert.

When set to 'UsePreConfigured' then use the ID identified by the ID in subclause 5.2.43B for an on-network MCPTT emergency alert.

When set to 'DedicatedGroup' then use the MCPTT group identified by the ID in subclause 5.2.43B for an MCPTT emergency alert.

5.2.43F /<x>/<x>/Common/MCPTTGroupCall/Priority

Table 5.2.43F.1: /<x>/<x>/Common/MCPTTGroupCall/Priority

<x>/Common/MCPTTGroupCall/Priority

Status	Occurrence	Format	Min. Access Types
Required	One	int	Get, Replace

This leaf node indicates the priority of the MCPTT group calls.

- Values: 0-255

The MCPTT group call with the lowest Priority value shall be considered as the MCPTT group call having the lowest level among the MCPTT group calls.

5.2.44 Void

5.2.45 /<x>/<x>/Common/MCPTTGroupBroadcast

Table 5.2.45.1: /<x>/<x>/Common/MCPTTGroupBroadcast

<x>/Common/MCPTTGroupBroadcast

Status	Occurrence	Format	Min. Access Types
Required	One	node	Get, Replace

This interior node is a placeholder for the group-broadcast group policy.

5.2.46 /<x>/<x>/Common/MCPTTGroupBroadcast/Authorised

Table 5.2.46.1: /<x>/<x>/Common/MCPTTGroupBroadcast/Authorised

<x>/Common/MCPTTGroupBroadcast/Authorised

Status	Occurrence	Format	Min. Access Types
Required	One	bool	Get, Replace

This leaf node indicates the authorisation to create a group-broadcast group.

When set to "true" the MCPTT user is authorised to create a group-broadcast group.

When set to "false" the MCPTT user is not authorised to create a group-broadcast group.

5.2.47 /<x>/<x>/Common/UserBroadcast

Table 5.2.47.1: /<x>/<x>/Common/UserBroadcast

<x>/Common/UserBroadcast

Status	Occurrence	Format	Min. Access Types
Required	One	node	Get, Replace

This interior node is a placeholder for the user-broadcast group policy.

5.2.48 /<x>/<x>/Common/UserBroadcast/Authorised

Table 5.2.48.1: /<x>/<x>/Common/UserBroadcast/Authorised

<x>/Common/UserBroadcast/Authorised

Status	Occurrence	Format	Min. Access Types
Required	One	bool	Get, Replace

This leaf node indicates the authorisation to create a user-broadcast group.

When set to "true" the MCPTT user is authorised to create a user-broadcast group.

When set to "false" the MCPTT user is not authorised to create a user-broadcast group.

5.2.48A /<x>/<x>/OnNetwork

Table 5.2.48A.1: /<x>/<x>/OnNetwork

<x>/OnNetwork

Status	Occurrence	Format	Min. Access Types
Required	ZeroOrOne	node	Get, Replace

This interior node represents a container for on-network operation.

5.2.48B1 /<x>/<x>/OnNetwork/MCPTTGroupList

Table 5.2.48B1.1: /<x>/<x>/OnNetwork/MCPTTGroupList

<x>/OnNetwork/MCPTTGroupList

Status	Occurrence	Format	Min. Access Types
Required	One	node	Get, Replace

This interior node is a placeholder for the list of on-network MCPTT groups that the MCPTT user is allowed to affiliate to.

5.2.48B2 /<x>/<x>/OnNetwork/MCPTTGroupList/<x>

Table 5.2.48B2.1: /<x>/<x>/OnNetwork/MCPTTGroupList/<x>

<x>/OnNetwork/MCPTTGroupList/<x>

Status	Occurrence	Format	Min. Access Types
Required	OneOrMore	node	Get, Replace

This interior node is a placeholder for one or more list of on-network MCPTT groups that the MCPTT user is allowed to affiliate to.

5.2.48B3 /<x>/<x>/OnNetwork/MCPTTGroupList/<x>/Entry

Table 5.2.48B3.1: /<x>/<x>/OnNetwork/MCPTTGroupList/<x>/Entry

<x>/OnNetwork/MCPTTGroupList/<x>/Entry

Status	Occurrence	Format	Min. Access Types
Optional	One	node	Get, Replace

This interior node is a placeholder for the details of the on-network MCPTT groups that the MCPTT user is allowed to affiliate to.

5.2.48B4/ <x>/<x>/OnNetwork/MCPTTGroupList/<x>/Entry/MCPTTGroupID

Table 5.2.48B4.1: /<x>/<x>/OnNetwork/MCPTTGroupList/<x>/Entry/MCPTTGroupID

<x>/OnNetwork/MCPTTGroupList/<x>/Entry/MCPTTGroupID

Status	Occurrence	Format	Min. Access Types
Required	One	chr	Get, Replace

This leaf node indicates the MCPTT group ID for the on-network MCPTT group that the MCPTT user is allowed to affiliate to.

The value is a "uri" attribute specified in OMA OMA-TS-XDM_Group-V1_1 [4].

5.2.48B5/ <x>/<x>/OnNetwork/MCPTTGroupList/<x>/Entry/DisplayName

Table 5.2.48B5.1: /<x>/<x>/OnNetwork/MCPTTGroupList/<x>/Entry/DisplayName

<x>/OnNetwork/MCPTTGroupList/<x>/Entry/DisplayName

Status	Occurrence	Format	Min. Access Types
Optional	One	chr	Get, Replace

This leaf node contains a human readable name that corresponds to the MCPTT Group ID.

5.2.48C1 /<x>/<x>/OnNetwork/ImplicitAffiliations

Table 5.2.48C1.1: /<x>/<x>/OnNetwork/ImplicitAffiliations

<x>/OnNetwork/ImplicitAffiliations

Status	Occurrence	Format	Min. Access Types
Required	One	chr	Get, Replace

This interior node is a placeholder for the implicit affiliation configuration.

5.2.48C2 /<x>/<x>/OnNetwork/ImplicitAffiliations/<x>

Table 5.2.48C2.1: /<x>/<x>/OnNetwork/ImplicitAffiliations/<x>

<x>/OnNetwork/ImplicitAffiliations/<x>

Status	Occurrence	Format	Min. Access Types
Required	OneOrMore	node	Get, Replace

This interior node is a placeholder for one or more implicit affiliation configuration.

5.2.48C3 /<x>/<x>/OnNetwork/ImplicitAffiliations/<x>/Entry

Table 5.2.48C3.1: /<x>/<x>/OnNetwork/ImplicitAffiliations/<x>/Entry

<x>/OnNetwork/ImplicitAffiliations/<x>/Entry

Status	Occurrence	Format	Min. Access Types
Optional	One	node	Get, Replace

This interior node is a placeholder for the details of the on-network MCPTT groups that the MCPTT user is implicitly affiliated to.

5.2.48C4 /<x>/<x>/OnNetwork/ImplicitAffiliations/<x>/Entry/MCPTTGroupID

Table 5.2.48C4.1: /<x>/<x>/OnNetwork/ImplicitAffiliations/<x>/ Entry/MCPTTGroupID

<x>/OnNetwork/ImplicitAffiliations/<x>/ Entry/MCPTTGroupID

Status	Occurrence	Format	Min. Access Types
Required	One	chr	Get, Replace

This leaf node indicates a MCPTT group ID to which the MCPTT user is implicitly affiliated to.

The value is a "uri" attribute specified in OMA OMA-TS-XDM_Group-V1_1 [4].

5.2.48C5 /<x>/<x>/OnNetwork/ImplicitAffiliations/<x>/Entry/DisplayName

Table 5.2.48C5.1: /<x>/<x>/OnNetwork/ImplicitAffiliations/<x>/Entry/DisplayName

<x>/OnNetwork/ImplicitAffiliations/<x>/Entry/DisplayName

Status	Occurrence	Format	Min. Access Types
Optional	One	chr	Get, Replace

This leaf node contains a human readable name that corresponds to the MCPTT Group ID.

5.2.48D /<x>/<x>/OnNetwork/AllowedRegroup

Table 5.2.48D.1: /<x>/<x>/OnNetwork/AllowedRegroup

<x>/OnNetwork/AllowedRegroup

Status	Occurrence	Format	Min. Access Types
Required	One	bool	Get, Replace

This leaf node indicates whether the MCPTT user is authorised to perform dynamic regrouping operations.

When set to "true" the MCPTT user is authorised to perform dynamic regrouping operations.

When set to "false" the MCPTT user is not authorised to perform dynamic regrouping operations.

5.2.48E /<x>/<x>/OnNetwork/AllowedPresenceStatus

Table 5.2.48E.1: /<x>/<x>/OnNetwork/AllowedPresenceStatus

<x>/OnNetwork/AllowedPresenceStatus

Status	Occurrence	Format	Min. Access Types
Optional	One	bool	Get, Replace

This leaf node indicates the presence status on the network of this MCPTT user is available.

When set to "true" the presence status on the network of this MCPTT user is available.

When set to "false" the presence status on the network of this MCPTT user is not available. This is the default if this leaf node is not present.

5.2.48F /<x>/<x>/OnNetwork/AllowedPresence

Table 5.2.48F.1: /<x>/<x>/OnNetwork/AllowedPresence

<x>/OnNetwork/AllowedPresence

Status	Occurrence	Format	Min. Access Types
Optional	One	bool	Get, Replace

This leaf node indicates whether the MCPTT user is authorised to obtain whether a particular MCPTT User is present on the network.

When set to "true" the MCPTT user is authorised to obtain whether a particular MCPTT User is present on the network.

When set to "false" the MCPTT user is not authorised to obtain whether a particular MCPTT User is present on the network.

5.2.48G /<x>/<x>/OnNetwork/EnabledParticipation

Table 5.2.48G.1: /<x>/<x>/OnNetwork/EnabledParticipation

<x>/OnNetwork/EnabledParticipation

Status	Occurrence	Format	Min. Access Types
Required	One	bool	Get, Replace

This leaf node indicates whether the MCPTT user is allowed to participate in MCPTT private calls that they are invited to.

When set to "true" the MCPTT user is allowed to participate in MCPTT private calls that they are invited to.

When set to "false" the MCPTT user is not allowed to participate in MCPTT private calls that they are invited to.

5.2.48H /<x>/<x>/OnNetwork/AllowedTransmission

Table 5.2.48H.1: /<x>/<x>/OnNetwork/AllowedTransmission

<x>/OnNetwork/AllowedTransmission

Status	Occurrence	Format	Min. Access Types
Required	One	bool	Get, Replace

This leaf node indicates whether the MCPTT user is authorised to override transmission in a MCPTT private call.

When set to "true" the MCPTT user is authorised to override transmission in a MCPTT private call.

When set to "false" the MCPTT user is not authorised to override transmission in a MCPTT private call.

5.2.48I /<x>/<x>/OnNetwork/AllowedManualSwitch

Table 5.2.48I.1: /<x>/<x>/OnNetwork/AllowedManualSwitch

<x>/OnNetwork/AllowedManualSwitch

Status	Occurrence	Format	Min. Access Types
Required	One	bool	Get, Replace

This leaf node indicates whether the MCPTT user is authorised to manually switch to off-network operation while in on-network operation.

When set to "true" the MCPTT user is authorised to manually switch to off-network operation while in on-network operation.

When set to "false" the MCPTT user is not authorised to manually switch to off-network operation while in on-network operation.

5.2.48J /<x>/<x>/OnNetwork/PrivateCall

Table 5.2.48J.1: /<x>/<x>/OnNetwork/PrivateCall

<x>/OnNetwork/PrivateCall

Status	Occurrence	Format	Min. Access Types
Required	One	node	Get, Replace

This interior node is a placeholder for the MCPTT private call configuration.

5.2.48K /<x>/<x>/OnNetwork/PrivateCall/EmergencyAlert

Table 5.2.48K.1: /<x>/<x>/OnNetwork/PrivateCall/EmergencyAlert

<x>/OnNetwork/PrivateCall/EmergencyAlert

Status	Occurrence	Format	Min. Access Types
Required	One	node	Get, Replace

This interior node is a placeholder for the MCPTT private emergency alert policy.

5.2.48L /<x>/<x>/OnNetwork/PrivateCall/EmergencyAlert/Entry

Table 5.2.48L.1: /<x>/<x>/OnNetwork/PrivateCall/EmergencyAlert/Entry

<x>/OnNetwork/PrivateCall/EmergencyAlert/Entry

Status	Occurrence	Format	Min. Access Types
Required	One	node	Get, Replace

This interior node is a placeholder for the details of an MCPTT private emergency alert for on-network.

5.2.48M /<x>/<x>/OnNetwork/PrivateCall/EmergencyAlert/Entry/ID

Table 5.2.48M.1: /<x>/<x>/OnNetwork/PrivateCall/EmergencyAlert/Entry/ID

<x>/OnNetwork/PrivateCall/EmergencyAlert/Entry/ID

Status	Occurrence	Format	Min. Access Types
Required	One	chr	Get, Replace

This leaf node indicates the MCPTT user ID used upon certain criteria on initiation of an MCPTT private emergency alert for on-network.

5.2.48N

/<x>/<x>/OnNetwork/PrivateCall/EmergencyAlert/Entry/DisplayName

Table 5.2.48N.1: /<x>/<x>/OnNetwork/PrivateCall/EmergencyAlert/Entry/DisplayName

<x>/OnNetwork/PrivateCall/EmergencyAlert/Entry/DisplayName

Status	Occurrence	Format	Min. Access Types
Optional	One	chr	Get, Replace

This leaf node contains a human readable name that corresponds to the ID.

5.2.48O /<x>/<x>/OnNetwork/PrivateCall/EmergencyAlert/Entry/Usage

Table 5.2.48O.1: /<x>/<x>/OnNetwork/PrivateCall/EmergencyAlert/Entry/Usage

<x>/OnNetwork/PrivateCall/EmergencyAlert/Entry/Usage

Status	Occurrence	Format	Min. Access Types

Required	One	chr	Get, Replace
----------	-----	-----	--------------

This leaf node indicates the criteria to determine when initiation of an MCPTT private emergency alert uses the ID.

The valid values are 'LocallyDetermined' and 'UsePreConfigured'.

When set to 'LocallyDetermined' then if the MCPTT user selects an MCPTT ID then use that MCPTT ID for an on-network MCPTT private emergency alert, if the MCPTT user does not select a MCPTT ID then use the MCPTT ID identified by the ID in subclause 5.2.48M for an on-network MCPTT private emergency alert.

When set to 'UsePreConfigured' then use the ID identified by the ID in subclause 5.2.48M for an on-network MCPTT private emergency alert.

5.2.48P /<x>/<x>/OnNetwork/PrivateCall/AllowedCallBackRequest

Table 5.2.48P.1: /<x>/<x>/OnNetwork/PrivateCall/AllowedCallBackRequest

<x>/OnNetwork/PrivateCall/AllowedCallBackRequest

Status	Occurrence	Format	Min. Access Types
Optional	One	bool	Get, Replace

This leaf node indicates whether the MCPTT user is allowed to request a private call call-back.

When set to "true" the MCPTT user is allowed to request a private call call-back.

When set to "false" the MCPTT user is not allowed to request a private call call-back.

5.2.48Q /<x>/<x>/OnNetwork/PrivateCall/AllowedCallBackCancelRequest

Table 5.2.48Q.1: /<x>/<x>/OnNetwork/PrivateCall/AllowedCallBackCancelRequest

<x>/OnNetwork/PrivateCall/AllowedCallBackCancelRequest

Status	Occurrence	Format	Min. Access Types
Optional	One	bool	Get, Replace

This leaf node indicates whether the MCPTT user is allowed to cancel an outstanding private call call-back request.

When set to "true" the MCPTT user is allowed to cancel an outstanding private call call-back request.

When set to "false" the the MCPTT user is not allowed to cancel an outstanding private call call-back request.

5.2.48R

/<x>/<x>/OnNetwork/PrivateCall/AllowedRemoteInitiatedAmbientListening

Table 5.2.48R.1: /<x>/<x>/OnNetwork/PrivateCall/AllowedRemoteInitiatedAmbientListening

<x>/OnNetwork/PrivateCall/AllowedRemoteInitiatedAmbientListening

Status	Occurrence	Format	Min. Access Types
Optional	One	bool	Get, Replace

This leaf node indicates whether the MCPTT user is allowed to request a remote initiated ambient listening call.

When set to "true" the MCPTT user is allowed to request a remote initiated ambient listening call.

When set to "false" the MCPTT user is not allowed to request a remote initiated ambient listening call.

5.2.48S

/<x>/<x>/OnNetwork/PrivateCall/AllowedLocallyInitiatedAmbientListening

Table 5.2.48S.1: /<x>/<x>/OnNetwork/PrivateCall/AllowedLocallyInitiatedAmbientListening

<x>/OnNetwork/PrivateCall/AllowedLocallyInitiatedAmbientListening

Status	Occurrence	Format	Min. Access Types
Optional	One	bool	Get, Replace

This leaf node indicates whether the MCPTT user is allowed to request a locally initiated ambient listening call.

When set to "true" the MCPTT user is allowed to request a locally initiated ambient listening call.

When set to "false" the MCPTT user is not allowed to request a locally initiated ambient listening call.

5.2.48T /<x>/<x>/OnNetwork/PrivateCall/AllowedRequestFirstToAnswerCall

Table 5.2.48T.1: /<x>/<x>/OnNetwork/PrivateCall/AllowedRequestFirstToAnswerCall

<x>/OnNetwork/PrivateCall/AllowedRequestFirstToAnswerCall

Status	Occurrence	Format	Min. Access Types
Optional	One	bool	Get, Replace

This leaf node indicates whether the MCPTT user is allowed to request a first to answer call.

When set to "true" the MCPTT user is allowed to request a first to answer call.

When set to "false" the MCPTT user is not allowed to request a first to answer call.

5.2.48U1 /<x>/<x>/OnNetwork/RemoteGroupSelection

Table 5.2.48U1.1: /<x>/<x>/OnNetwork/RemoteGroupSelection

<x>/OnNetwork/RemoteGroupSelection

Status	Occurrence	Format	Min. Access Types
Required	One	node	Get, Replace

This interior node is a placeholder for the remote group selection configuration.

5.2.48U2 /<x>/<x>/OnNetwork/RemoteGroupSelection/<x>

Table 5.2.48U2.1: /<x>/<x>/OnNetwork/RemoteGroupSelection/<x>

<x>/OnNetwork/RemoteGroupSelection/<x>

Status	Occurrence	Format	Min. Access Types
Required	OneOrMore	node	Get, Replace

This interior node is a placeholder for one or more remote group selection configuration elements.

5.2.48U3 /<x>/<x>/OnNetwork/RemoteGroupSelection/<x>/Entry

Table 5.2.48U3.1: /<x>/<x>/OnNetwork/RemoteGroupSelection/<x>/Entry

<x>/OnNetwork/RemoteGroupSelection/<x>/Entry

Status	Occurrence	Format	Min. Access Types
Optional	One	node	Get, Replace

This interior node is a placeholder for the details of the on-network MCPTT users whose selected MCPTT group is allowed to be remotely changed by the MCPTT user.

5.2.48U4 /<x>/<x>/OnNetwork/RemoteGroupSelection/<x>/Entry/MCPTTID

Table 5.2.48U4.1: /<x>/<x>/OnNetwork/RemoteGroupSelection/<x>/Entry/MCPTTID

<x>/OnNetwork/RemoteGroupSelection/<x>/Entry/MCPTTID

Status	Occurrence	Format	Min. Access Types
Required	One	chr	Get, Replace

This leaf node indicates a MCPTT ID of an MCPTT user whose selected MCPTT group is allowed to be remotely changed by the MCPTT user.

The value is a "uri" attribute specified in OMA OMA-TS-XDM_Group-V1_1 [4].

5.2.48U5

/<x>/<x>/OnNetwork/RemoteGroupSelection/<x>/Entry/DisplayName

Table 5.2.48U5.1: /<x>/<x>/OnNetwork/RemoteGroupSelection/<x>/Entry/DisplayName

<x>/OnNetwork/RemoteGroupSelection/<x>/Entry/DisplayName

Status	Occurrence	Format	Min. Access Types
Optional	One	chr	Get, Replace

This leaf node contains a human readable name that corresponds to the MCPTT ID of the MCPTT user.

5.2.48V1/<x>/<x>/OnNetwork/GroupServerInfo

Table 5.2.48V1.1: /<x>/<x>/OnNetwork/GroupServerInfo

<x>/OnNetwork/GroupServerInfo

Status	Occurrence	Format	Min. Access Types
Required	One	node	Get, Replace

This interior node is a placeholder for the configured identity management and group management servers for the groups contained in the MCPTTGroupList

5.2.48V2/<x>/<x>/OnNetwork/GroupServerInfo/GMSServList

Table 5.2.48V2.1: /<x>/<x>/OnNetwork/GroupServerInfo/GMSServList

<x>/OnNetwork/GroupServerInfo/GMSServList

Status	Occurrence	Format	Min. Access Types
Required	One	node	Get, Replace

This interior node is a placeholder for the list of MCPTT group management server for the groups contained in the MCPTTGroupList.

5.2.48V3/<x>/<x>/OnNetwork/GroupServerInfo/GMSServList/<x>

Table 5.2.48V3.1: /<x>/<x>/OnNetwork/GroupServerInfo/GMSServList/<x>

<x>/OnNetwork/GroupServerInfo/GMSServList/<x>

Status	Occurrence	Format	Min. Access Types
Required	OneOrMore	node	Get, Replace

This interior node is a placeholder for the list of MCPTT group management server for the groups contained in the MCPTTGroupList.

5.2.48V4/ <x>/<x>/OnNetwork/GroupServerInfo/GMSServList/<x>/Entry

Table 5.2.48V4.1: /<x>/<x>/OnNetwork/GroupServerInfo/GMSServList/<x>/Entry

<x>/OnNetwork/GroupServerInfo/GMSServList/<x>/Entry

Status	Occurrence	Format	Min. Access Types
Optional	One	node	Get, Replace

This interior node is a placeholder for identity of the GMS owning a specific group contained in the MCPTTGroupList.

5.2.48V5

/<x>/<x>/OnNetwork/GroupServerInfo/GMSServList/<x>/Entry/GMS ServID

Table 5.2.48V5.1: /<x>/<x>/OnNetwork/GroupServerInfo/GMSServList/<x>/Entry/GMSServID

<x>/OnNetwork/GroupServerInfo/GMSServList/<x>/Entry/GMSServID

Status	Occurrence	Format	Min. Access Types
Required	One	chr	Get, Replace

This leaf node indicates the identity (URI) of the GMS owning a specific group contained in the MCPTTGroupList.

5.2.48V6/ <x>/<x>/OnNetwork/GroupServerInfo/IDMSTokenEndpointList

Table 5.2.48V6.1: /<x>/<x>/OnNetwork/GroupServerInfo/IDMSTokenEndpointList

<x>/OnNetwork/GroupServerInfo/IDMSTokenEndpointList

Status	Occurrence	Format	Min. Access Types
Required	One	node	Get, Replace

This interior node is a placeholder for the list of MCPTT IDMS token endpoints for the groups contained in the MCPTTGroupList.

5.2.48V7/ <x>/<x>/OnNetwork/GroupServerInfo/IDMSTokenEndpointList/<x>

Table 5.2.48V7.1: /<x>/<x>/OnNetwork/GroupServerInfo/IDMSTokenEndpointList/<x>

<x>/OnNetwork/GroupServerInfo/IDMSTokenEndpointList/<x>

Status	Occurrence	Format	Min. Access Types
Optional	OneOrMore	node	Get, Replace

This interior node is a placeholder for the IDMS token endpoint for a specific groups contained in the MCPTTGroupList.

5.2.48V8/ <x>/<x>/OnNetwork/GroupServerInfo/IDMSTokenEndpointList/<x>/Entry

Table 5.2.48V8.1: /<x>/<x>/OnNetwork/GroupServerInfo/IDMSTokenEndpointList/<x>/Entry

<x>/OnNetwork/GroupServerInfo/IDMSTokenEndpointList/<x>/Entry

Status	Occurrence	Format	Min. Access Types
Optional	One	node	Get, Replace

This interior node is a placeholder for the IDMS token endpoint for a specific groups contained in the MCPTTGroupList.

5.2.48V9

`/<x>/<x>/OnNetwork/GroupServerInfo/IDMSTokenEndpointList/<x>/Entry/IDMSTokenID`

Table 5.2.48V9.1:

`/<x>/<x>/OnNetwork/GroupServerInfo/IDMSTokenEndpointList/<x>/Entry/IDMSTokenID`

`<x>/OnNetwork/GroupServerInfo/IDMSTokenEndpointList/<x>/Entry/IDMSTokenID`

Status	Occurrence	Format	Min. Access Types
Required	One	chr	Get, Replace

This leaf node indicates the identity (URI) of the IDMS token endpoint for a specific group contained in the MCPTTGroupList. If the value is empty, the IDMS identities (IDMSAuthEndpoint and IDMSTokenEndpoint) present in the MCS UE initial configuration MO are used.

5.2.48V10/<x>/<x>/OnNetwork/GroupServerInfo/KMSURIList

Table 5.2.48V10.1: /<x>/<x>/OnNetwork/GroupServerInfo/KMSURIList

`<x>/OnNetwork/GroupServerInfo/KMSURIList`

Status	Occurrence	Format	Min. Access Types
Required	One	node	Get, Replace

This interior node is a placeholder for the list of KMS identities (URIs) for the groups contained in the MCPTTGroupList.

5.2.48V11/<x>/<x>/OnNetwork/GroupServerInfo/KMSURIList/<x>

Table 5.2.48V11.1: /<x>/<x>/OnNetwork/GroupServerInfo/KMSURIList/<x>

`<x>/OnNetwork/GroupServerInfo/KMSURIList/<x>`

Status	Occurrence	Format	Min. Access Types
Optional	OneOrMore	node	Get, Replace

This interior node is a placeholder for the KMS identity (URI) for a specific group contained in the MCPTTGroupList.

5.2.48V12/<x>/<x>/OnNetwork/GroupServerInfo/KMSURIList/<x>/Entry

Table 5.2.48V12.1: /<x>/<x>/OnNetwork/GroupServerInfo/KMSURIList/<x>/Entry

`<x>/OnNetwork/GroupServerInfo/KMSURIList/<x>/Entry`

Status	Occurrence	Format	Min. Access Types
Optional	One	node	Get, Replace

This interior node is a placeholder for the KMS identity (URI) for a specific group contained in the MCPTTGroupList.

5.2.48V13

/<x>/<x>/OnNetwork/GroupServerInfo/KMSURIList/<x>/Entry/KMSURI

Table 5.2.48V13.1: /<x>/<x>/OnNetwork/GroupServerInfo/KMSURIList/<x>/Entry/KMSURI

<x>/OnNetwork/GroupServerInfo/KMSURIList/<x>/Entry/KMSURI

Status	Occurrence	Format	Min. Access Types
Required	One	chr	Get, Replace

This leaf node indicates the identity (URI) of the KMS identity (URI) for a specific group contained in the MCPTTGroupList. If the value is empty, the KMS identity (URI) (kms) present in the MCS UE initial configuration MO is used.

5.2.49 /<x>/<x>/OffNetwork

Table 5.2.49.1: /<x>/<x>/OffNetwork

<x>/OffNetwork

Status	Occurrence	Format	Min. Access Types
Required	ZeroOrOne	node	Get, Replace

This interior node represents a container for off-network operation.

5.2.50 /<x>/<x>/OffNetwork/Authorised

Table 5.2.50.1: /<x>/<x>/OffNetwork/Authorised

<x>/OffNetwork/Authorised

Status	Occurrence	Format	Min. Access Types
Required	One	bool	Get, Replace

This leaf node indicates the authorisation for off-network services.

When set to "true" the MCPTT user is authorised for off-network.

When set to "false" the MCPTT user is not authorised for off-network operation.

5.2.51 /<x>/<x>/OffNetwork/MCPTTGroupInfo

Table 5.2.51.1: /<x>/<x>/OffNetwork/MCPTTGroupInfo

<x>/OffNetwork/MCPTTGroupInfo

Status	Occurrence	Format	Min. Access Types
Required	One	node	Get, Replace

This interior node is a placeholder for group information.

5.2.52 /<x>/<x>/OffNetwork/MCPTTGroupInfo/<x>

Table 5.2.52.1: /<x>/<x>/OffNetwork/MCPTTGroupInfo/<x>

<x>/OffNetwork/MCPTTGroupInfo/<x>

Status	Occurrence	Format	Min. Access Types
Required	OneOrMore	node	Get, Replace

This interior node is a placeholder for one or more group information.

5.2.52A /<x>/<x>/OffNetwork/MCPTTGroupInfo/<x>/Entry

Table 5.2.52A.1: /<x>/<x>/OffNetwork/MCPTTGroupInfo/<x>/Entry

<x>/OffNetwork/MCPTTGroupInfo/<x>/Entry

Status	Occurrence	Format	Min. Access Types
Required	One	node	Get, Replace

This interior node is a placeholder for one or more off-network MCPTT groups for use by an MCPTT user.

5.2.53 /<x>/<x>/OffNetwork/MCPTTGroupInfo/<x>/Entry/MCPTTGroupID

Table 5.2.53.1: /<x>/<x>/OffNetwork/MCPTTGroupInfo/<x>/Entry/MCPTTGroupID

<x>/OffNetwork/MCPTTGroupInfo/<x>/Entry/MCPTTGroupID

Status	Occurrence	Format	Min. Access Types
Required	One	int	Get, Replace

This leaf node indicates an off-network MCPTT group for use by an MCPTT user.

5.2.53A /<x>/<x>/OffNetwork/MCPTTGroupInfo/<x>/Entry/DisplayName

Table 5.2.53A.1: /<x>/<x>/OffNetwork/MCPTTGroupInfo/<x>/Entry/DisplayName

<x>/OffNetwork/MCPTTGroupInfo/<x>/Entry/DisplayName

Status	Occurrence	Format	Min. Access Types
Optional	One	chr	Get, Replace

This leaf node contains a human readable name that corresponds to the MCPTT group represented by the MCPTT group ID.

5.2.54 /<x>/<x>/OffNetwork/AllowedListen

Table 5.2.54.1: /<x>/<x>/OffNetwork/AllowedListen

<x>/OffNetwork/AllowedListen

Status	Occurrence	Format	Min. Access Types
Required	One	bool	Get, Replace

This leaf node indicates whether the MCPTT user is allowed to listen both overriding and overridden.

When set to "true" the MCPTT user is allowed to listen both overriding and overridden.

When set to "false" the MCPTT user is not allowed to listen both overriding and overridden.

5.2.55 /<x>/<x>/OffNetwork/AllowedTransmission

Table 5.2.55.1: /<x>/<x>/OffNetwork/AllowedTransmission

<x>/OffNetwork/AllowedTransmission

Status	Occurrence	Format	Min. Access Types
Required	One	bool	Get, Replace

This leaf node indicates whether the MCPTT user is allowed to transmit in case of override (overriding and/or overridden).

When set to "true" the MCPTT user is allowed to transmit in case of override (overriding and/or overridden).

When set to "false" the MCPTT user is not allowed to transmit in case of override (overriding and/or overridden).

5.2.56 /<x>/<x>/OffNetwork/EmergencyCallChange

Table 5.2.56.1: /<x>/<x>/OffNetwork/EmergencyCallChange

<x>/OffNetwork/EmergencyCallChange

Status	Occurrence	Format	Min. Access Types
Required	One	bool	Get, Replace

This leaf node indicates the authorization for a participant to change an off-network group call in-progress to an off-network MCPTT emergency group call.

When set to "true" the MCPTT user is authorised to change an MCPTT emergency group call.

When set to "false" the MCPTT user is not authorised to change an MCPTT emergency group call.

5.2.57 /<x>/<x>/OffNetwork/ImminentPerilCallChange

Table 5.2.57.1: /<x>/<x>/OffNetwork/ImminentPerilCallChange

<x>/OffNetwork/ImminentPerilCallChange

Status	Occurrence	Format	Min. Access Types
Required	One	bool	Get, Replace

This leaf node indicates the authorization for a participant to change an off-network group call in-progress to an off-network MCPTT imminent peril group call.

When set to "true" the MCPTT user is authorised to change an MCPTT imminent peril group call.

When set to "false" the MCPTT user is not authorised to change an MCPTT imminent peril group call.

5.2.58 /<x>/<x>/OffNetwork/UserInfoID

Table 5.2.58.1: /<x>/<x>/OffNetwork/UserInfoID

<x>/OffNetwork/UserInfoID

Status	Occurrence	Format	Min. Access Types
Required	One	chr	Get, Replace

This leaf node indicates the ProSe user info ID as specified in 3GPP TS 23.303 [6].

5.2.58A1 /<x>/<x>/OffNetwork/GroupServerInfo

Table 5.2.58A1.1: /<x>/<x>/OffNetwork/GroupServerInfo

<x>/OffNetwork/GroupServerInfo

Status	Occurrence	Format	Min. Access Types
Required	One	node	Get, Replace

This interior node is a placeholder for the configured identity management and group management servers for the groups contained in the off-network MCPTTGroupList

5.2.58A2 /<x>/<x>/OffNetwork/GroupServerInfo/GMSServList

Table 5.2.58A2.1: /<x>/<x>/OffNetwork/GroupServerInfo/GMSServList

<x>/OffNetwork/GroupServerInfo/GMSServList

Status	Occurrence	Format	Min. Access Types
Required	One	node	Get, Replace

This interior node is a placeholder for the list of MCPTT group management server for the groups contained in the off-network MCPTTGroupList.

5.2.58A3/ <x>/ <x>/OffNetwork/GroupServerInfo/GMSServList/ <x>

Table 5.2.58A3.1: / <x>/ <x>/OffNetwork/GroupServerInfo/GMSServList/ <x>

<x>/OffNetwork/GroupServerInfo/GMSServList/ <x>

Status	Occurrence	Format	Min. Access Types
Required	OneOrMore	node	Get, Replace

This interior node is a placeholder for the list of MCPTT group management server for the groups contained in the off-network MCPTTGroupList.

5.2.58A4/ <x>/ <x>/OffNetwork/GroupServerInfo/GMSServList/ <x>/Entry

Table 5.2.58A4.1: / <x>/ <x>/OffNetwork/GroupServerInfo/GMSServList/ <x>/Entry

<x>/OffNetwork/GroupServerInfo/GMSServList/ <x>/Entry

Status	Occurrence	Format	Min. Access Types
Optional	One	node	Get, Replace

This interior node is a placeholder for identity of the GMS owning a specific group contained in the off-network MCPTTGroupList.

5.2.58A5

/ <x>/ <x>/OffNetwork/GroupServerInfo/GMSServList/ <x>/Entry/GMSServID

Table 5.2.58A5.1: / <x>/ <x>/OffNetwork/GroupServerInfo/GMSServList/ <x>/Entry/GMSServID

<x>/OffNetwork/GroupServerInfo/GMSServList/ <x>/Entry/GMSServID

Status	Occurrence	Format	Min. Access Types
Required	One	chr	Get, Replace

This leaf node indicates the identity (URI) of the GMS owning a specific group contained in the off-network MCPTTGroupList.

5.2.58A6/ <x>/ <x>/OffNetwork/GroupServerInfo/IDMSTokenEndpointList

Table 5.2.58A6.1: / <x>/ <x>/OffNetwork/GroupServerInfo/IDMSTokenEndpointList

<x>/OffNetwork/GroupServerInfo/IDMSTokenEndpointList

Status	Occurrence	Format	Min. Access Types
Required	One	node	Get, Replace

This interior node is a placeholder for the list of MCPTT IDMS token endpoints for the groups contained in the off-network MCPTTGroupList.

5.2.58A7/<x>/<x>/OffNetwork/GroupServerInfo/IDMSTokenEndpointList/<x>

Table 5.2.58A7.1: /<x>/<x>/OffNetwork/GroupServerInfo/IDMSTokenEndpointList/<x>

<x>/OffNetwork/GroupServerInfo/IDMSTokenEndpointList/<x>

Status	Occurrence	Format	Min. Access Types
Optional	One	node	Get, Replace

This interior node is a placeholder for the IDMS token endpoint for a specific group contained in the off-network MCPTTGroupList.

5.2.58A8/<x>/<x>/OffNetwork/GroupServerInfo/IDMSTokenEndpointList/<x>/Entry

Table 5.2.58A8.1: /<x>/<x>/OffNetwork/GroupServerInfo/IDMSTokenEndpointList/<x>/Entry

<x>/OffNetwork/GroupServerInfo/IDMSTokenEndpointList/<x>/Entry

Status	Occurrence	Format	Min. Access Types
Optional	One	node	Get, Replace

This interior node is a placeholder for the IDMS token endpoint for a specific group contained in the off-network MCPTTGroupList.

5.2.58A9

/<x>/<x>/OffNetwork/GroupServerInfo/IDMSTokenEndpointList/<x>/Entry/IDMSTokenID

Table 5.2.58A9.1:**/<x>/<x>/OffNetwork/GroupServerInfo/IDMSTokenEndpointList/<x>/Entry/IDMSTokenID**

<x>/OffNetwork/GroupServerInfo/IDMSTokenEndpointList/<x>/Entry/IDMSTokenID

Status	Occurrence	Format	Min. Access Types
Required	One	chr	Get, Replace

This leaf node indicates the identity (URI) of the IDMS token endpoint for a specific group contained in the off-network MCPTTGroupList. If the value is empty, the IDMS identities (IDMSAuthEndpoint and IDMSTokenEndpoint) present in the MCS UE initial configuration MO are used.

5.2.58A10/<x>/<x>/OffNetwork/GroupServerInfo/KMSURIList

Table 5.2.58A10.1: /<x>/<x>/OffNetwork/GroupServerInfo/KMSURIList

<x>/OffNetwork/GroupServerInfo/KMSURIList

Status	Occurrence	Format	Min. Access Types
Required	One	node	Get, Replace

This interior node is a placeholder for the list of KMS identities (URIs) for the groups contained in the off-network MCPTTGroupList.

5.2.58A11/<x>/<x>/OffNetwork/GroupServerInfo/KMSURIList/<x>

Table 5.2.58A11.1: /<x>/<x>/OffNetwork/GroupServerInfo/KMSURIList/<x>

<x>/OffNetwork/GroupServerInfo/KMSURIList/<x>

Status	Occurrence	Format	Min. Access Types
Optional	One	node	Get, Replace

This interior node is a placeholder for the KMS identity (URI) for a specific group contained in the off-network MCPTTGroupList.

5.2.58A12/<x>/<x>/OffNetwork/GroupServerInfo/KMSURIList/<x>/Entry

Table 5.2.58A12.1: /<x>/<x>/OffNetwork/GroupServerInfo/KMSURIList/<x>/Entry

<x>/OffNetwork/GroupServerInfo/KMSURIList/<x>/Entry

Status	Occurrence	Format	Min. Access Types
Optional	One	node	Get, Replace

This interior node is a placeholder for the KMS identity (URI) for a specific group contained in the off-network MCPTTGroupList.

5.2.58A13

/<x>/<x>/OffNetwork/GroupServerInfo/KMSURIList/<x>/Entry/KMSURI

Table 5.2.58A13.1: /<x>/<x>/OffNetwork/GroupServerInfo/KMSURIList/<x>/Entry/KMSURI

<x>/OffNetwork/GroupServerInfo/KMSURIList/<x>/Entry/KMSURI

Status	Occurrence	Format	Min. Access Types
Required	One	chr	Get, Replace

This leaf node indicates the identity (URI) of the KMS identity (URI) for a specific group contained in the off-network MCPTTGroupList. If the value is empty, the KMS identity (URI) (kms) present in the MCS UE initial configuration MO is used.

5.2.59 /<x>/Status

Table 5.2.59.1: /<x>/Status

Status

Status	Occurrence	Format	Min. Access Types
Optional	One	bool	Get, Replace

This leaf node indicates whether this MCPTT user profile is enabled or disabled.

When set to "true" this MCPTT user profile is enabled.

When set to "false" this MCPTT user profile is disabled.

6 MCS group configuration MO

6.1 General

The MCS group configuration Management Object (MO) is used to configure the MCS Client behaviour for the on-network or off-network MC services. The MCS group configuration parameters may be stored in the ME, or in the USIM as specified in 3GPP TS 31.102 [10], or in both the ME and the USIM. If both the ME and the USIM contain the same parameters, the values stored in the USIM shall take precedence.

NOTE: For historical reasons some of the elements in the MCS group configuration Management Object (MO) use the terminology "MCPTT", however this MO is common to all MCS with some MCPTT specific elements, some MCDATA specific elements and some MCVideo specific elements. Not all elements that contain the terminology "MCPTT" are just MCPTT specific. In the subclauses that follow, it is made clear what aspects are specific to MCPTT and what aspects are specific to all MC services. MCDATA specific elements are contained under "MCDATA" nodes. MCVideo specific elements are contained under "MCVideo" nodes.

The Management Object Identifier is: urn:oma:mo:ext-3gpp-MCPTT-group-configuration:1.0.

Protocol compatibility: This MO is compatible with OMA OMA DM 1.2 [3].

The OMA DM ACL property mechanism (see OMA OMA-ERELD-DM-V1_2 [2]) may be used to grant or deny access rights to OMA DM servers in order to modify nodes and leaf objects of the MCS group configuration MO.

The following nodes and leaf objects are possible under the MCS group configuration node as described in figure 6.1.1:

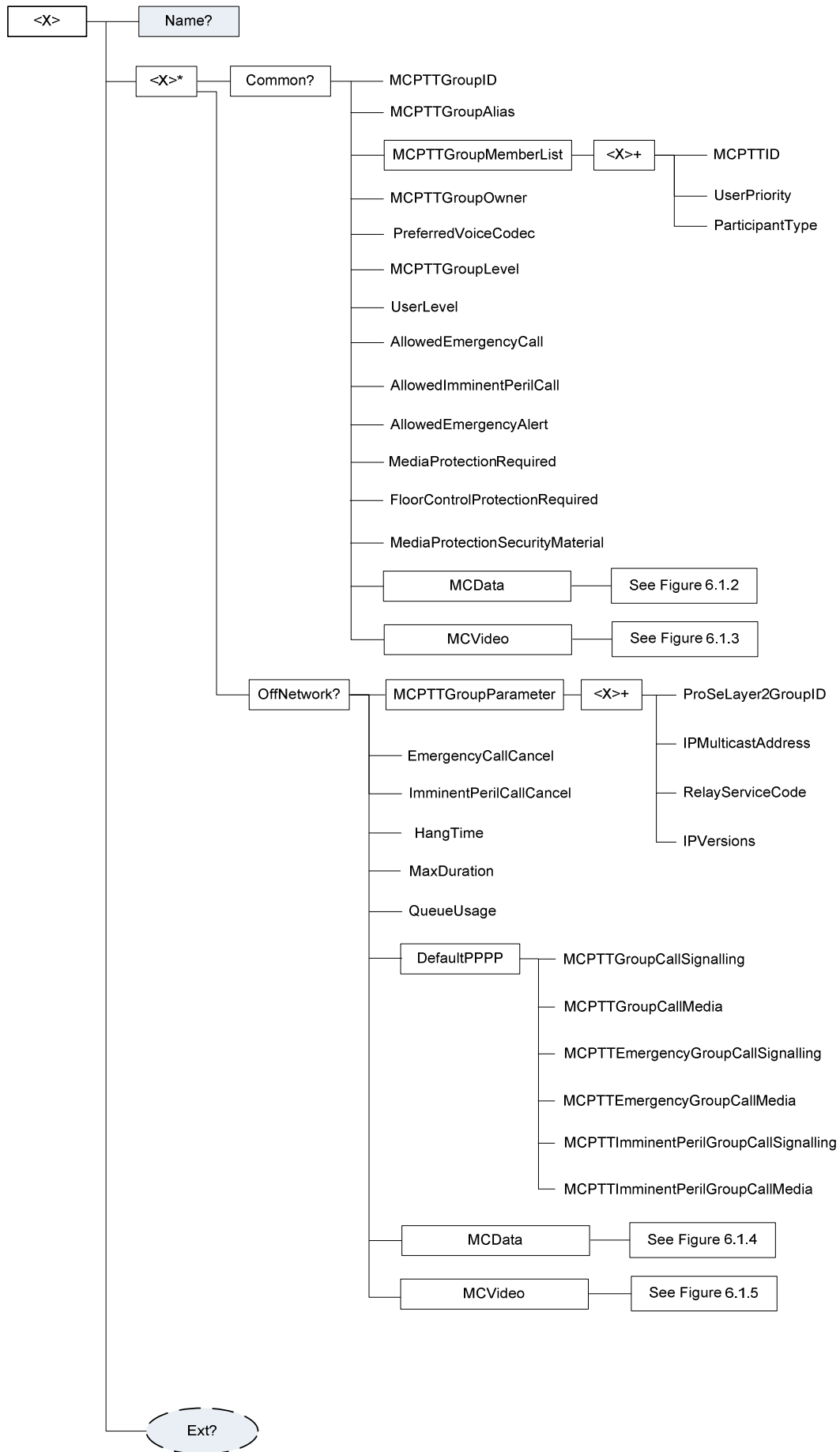

Figure 6.1.1: The MCS group configuration MO (1 of 5)

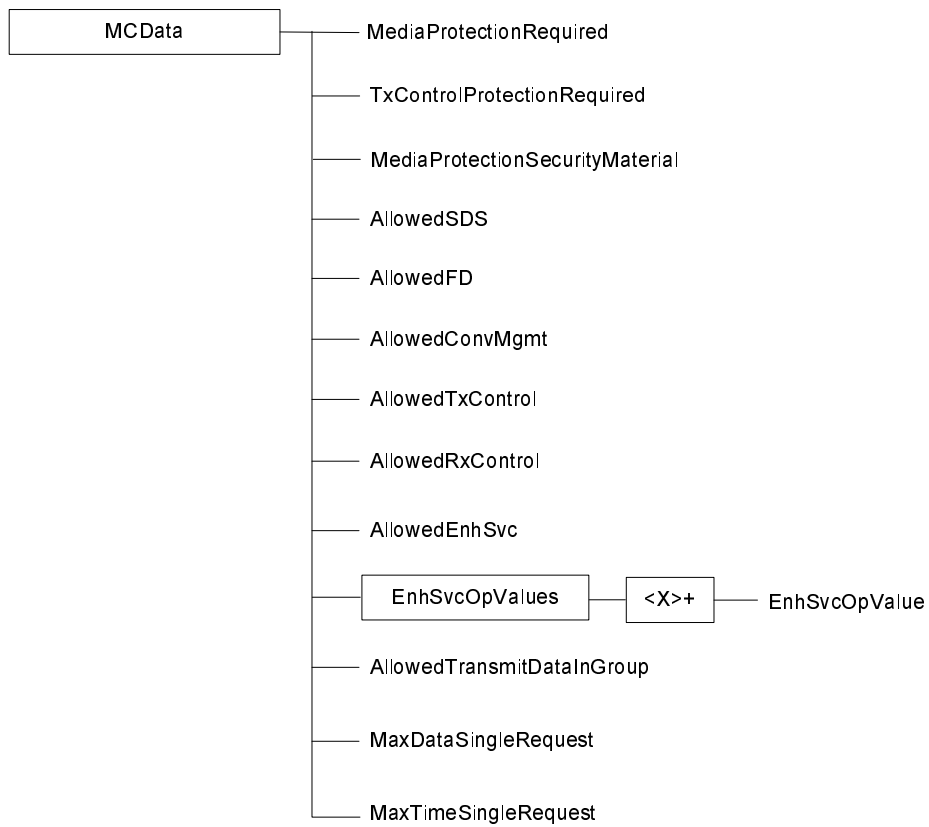

Figure 6.1.2: The MCS group configuration MO (2 of 5)

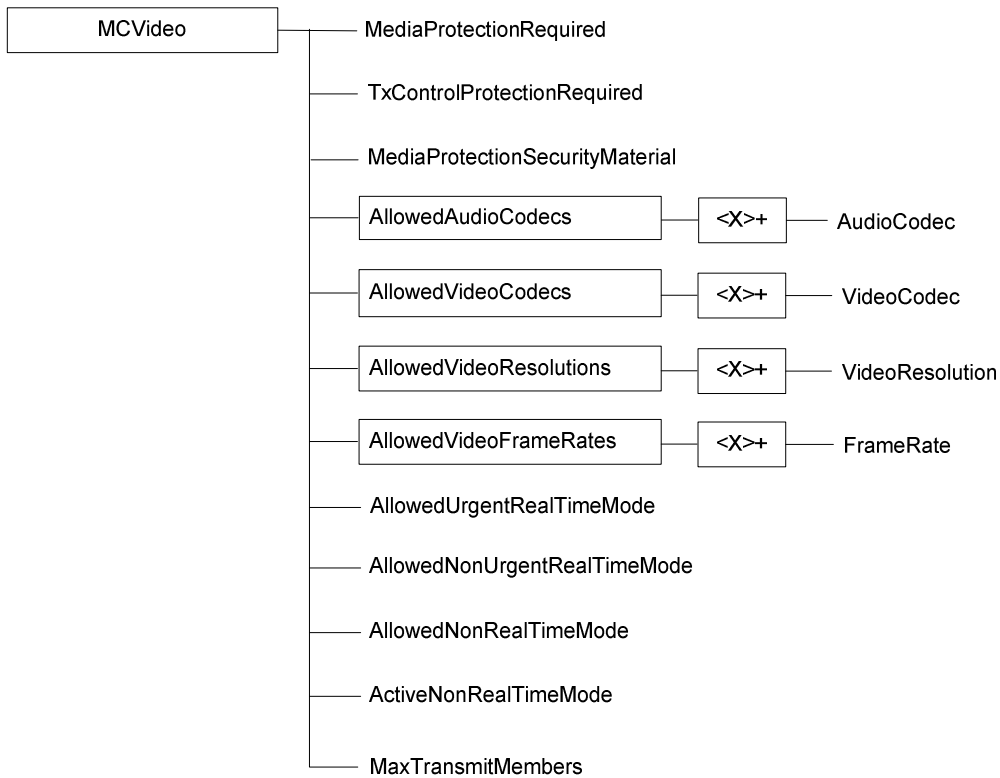

Figure 6.1.3: The MCS group configuration MO (3 of 5)

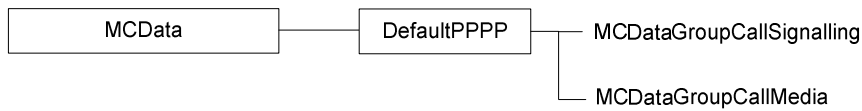

Figure 6.1.4: The MCS group configuration MO (4 of 5)

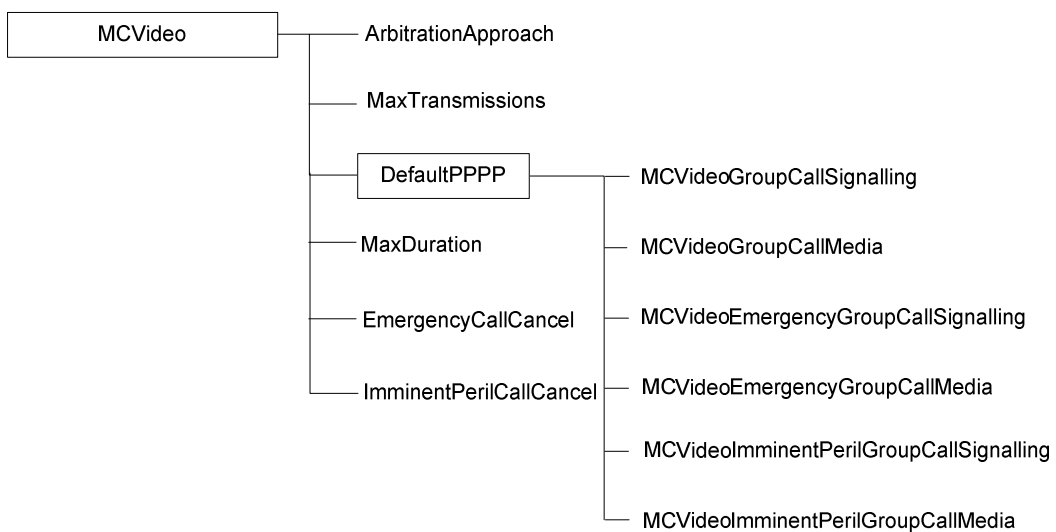

Figure 6.1.5: The MCS group configuration MO (5 of 5)

6.2 MCS group configuration MO parameters

6.2.1 General

This clause describes the parameters for the MCS group configuration Management Object (MO).

6.2.2 Node: <x>

Table 6.2.2.1: Node: <x>

<x>

Status	Occurrence	Format	Min. Access Types
Required	OneOrMore	node	Get

This interior node acts as a placeholder for the MCS group configuration Management Object (MO).

For the MCS group configuration MO, the namespace specific string is: "urn:oma:mo:oma-dm-mcptt-group configuration:1.0"

- Values: N/A

6.2.3 /<x>/Name

Table 6.2.3.1: Node: <x>

Name

Status	Occurrence	Format	Min. Access Types
Required	ZeroOrOne	chr	Get

The Name leaf is a name for the MCS group configuration settings.

- Values: <User displayable name>

6.2.4 /<x>/Ext/

Table 6.2.4.1: /<x>/Ext/

Ext

Status	Occurrence	Format	Min. Access Types
Optional	ZeroOrOne	node	Get, Replace

The Ext is an interior node for where the vendor specific information about the MCSgroup configuration MO is being placed.

Usually the vendor extension is identified by vendor specific name under the ext node and contains the vendor meaning application vendor, device vendor etc. The tree structure under the vendor identified is not defined and can therefore include one or more un-standardized sub-trees.

- Values: N/A

6.2.5 /<x>/<x>

Table 6.2.5.1: /<x>/<x>

<x>

Status	Occurrence	Format	Min. Access Types
Required	ZeroOrMore	node	Get, Replace

This interior node represents a container for on-network operation and off-network operation.

6.2.6 /<x>/<x>/Common

Table 6.2.6.1: /<x>/<x>/Common

<x>/Common

Status	Occurrence	Format	Min. Access Types
Required	ZeroOrOne	node	Get, Replace

This interior node represents a container for the common network operation which means both on-network operation and off-network operation.

6.2.7 /<x>/<x>/Common/MCPTTGroupID

Table 6.2.7.1: /<x>/<x>/Common/MCPTTGroupID

<x>/Common/MCPTTGroupID

Status	Occurrence	Format	Min. Access Types
Required	One	chr	Get, Replace

This leaf node indicates the MCS group ID.

The value is a "uri" attribute specified in OMA OMA-TS-XDM_Group-V1_1 [4].

NOTE: This element is common for all MC services.

6.2.8 /<x>/<x>/Common/MCPTTGroupAlias

Table 6.2.8.1: /<x>/<x>/Common/MCPTTGroupAlias

<x>/Common/MCPTTGroupAlias

Status	Occurrence	Format	Min. Access Types
Required	One	chr	Get, Replace

This leaf node indicates the MCS group alias.

The value is a <display-name> element specified in OMA OMA-TS-XDM_Group-V1_1 [4].

NOTE: This element is common for all MC services.

6.2.9 /<x>/<x>/Common/MCPTTGroupMemberList

Table 6.2.9.1: /<x>/<x>/Common/MCPTTGroupMemberList

<x>/Common/MCPTTGroupMemberList

Status	Occurrence	Format	Min. Access Types
Required	One	node	Get, Replace

This interior node is a placeholder for a list of MCS group members (group membership information).

NOTE: This element is common for all MC services.

6.2.10 /<x>/<x>/Common/MCPTTGroupMemberList/<x>

Table 6.2.10.1: /<x>/<x>/Common/MCPTTGroupMemberList/<x>

<x>/Common/MCPTTGroupMemberList/<x>

Status	Occurrence	Format	Min. Access Types
Required	OneOrMore	node	Get, Replace

This interior node is a placeholder for one or more list(s) of MCS group members.

NOTE: This element is common for all MC services.

6.2.11 /<x>/<x>/Common/MCPTTGroupMemberList/<x>/MCPTTID

Table 6.2.11.1: /<x>/<x>/Common/MCPTTGroupMemberList/<x>/MCPTTID

<x>/Common/MCPTTGroupMemberList/<x>/MCPTTID

Status	Occurrence	Format	Min. Access Types
Required	One	chr	Get, Replace

This leaf node indicates an MCS user identity (MC Service ID) which is a globally unique identifier within the MC service that represents the MCS user.

The value is a "uri" attribute specified in OMA OMA-TS-XDM_Group-V1_1 [4].

NOTE: This element is common for all MC services.

6.2.12 /<x>/<x>/Common/MCPTTGroupMemberList/<x>/UserPriority

Table 6.2.12.1: /<x>/<x>/Common/MCPTTGroupMemberList/<x>/UserPriority

<x>/Common/MCPTTGroupMemberList/<x>/UserPriority

Status	Occurrence	Format	Min. Access Types
Required	One	int	Get, Replace

This leaf node indicates the user priority for the group.

The value is a <user-priority> element specified in 3GPP TS 24.481 [9] subclause 7.2.4.2.

NOTE: This element is common for all MC services.

6.2.13 /<x>/<x>/Common/MCPTTGroupMemberList/<x>/ParticipantType

Table 6.2.13.1: /<x>/<x>/Common/MCPTTGroupMemberList/<x>/ParticipantType

<x>/Common/MCPTTGroupMemberList/<x>/ParticipantType

Status	Occurrence	Format	Min. Access Types
Required	One	chr	Get, Replace

This leaf node indicates the participant type for the group.

The ParticipantType values are defined and configured by the Mission Critical Organisation (e.g.first responder, second responder, dispatcher, dispatch supervisor, MCS administrator).

NOTE: This element is common for all MC services.

6.2.14 Void

6.2.15 /<x>/<x>/Common/MCPTTGroupOwner

Table 6.2.15.1: /<x>/<x>/Common/MCPTTGroupOwner

<x>/Common/MCPTTGroupOwner

Status	Occurrence	Format	Min. Access Types
Required	One	chr	Get, Replace

This leaf node indicates the group's owner (Mission Critical Organisation).

NOTE: This element is common for all MC services.

6.2.16 /<x>/<x>/Common/PreferredVoiceCodec

Table 6.2.16.1: /<x>/<x>/Common/PreferredVoiceCodec

<x>/Common/PreferredVoiceCodec

Status	Occurrence	Format	Min. Access Types
Required	One	chr	Get, Replace

This leaf node indicates the MCPTT preferred voice codec for an MCS group.

The value of the preferred voice codec is a RTP payload format name specified in IETF RFC 4566 [13].

NOTE: This element is specific for MCPTT.

6.2.17 /<x>/<x>/Common/MCPTTGroupLevel

Table 6.2.17.1: /<x>/<x>/Common/MCPTTGroupLevel

<x>/Common/MCPTTGroupLevel

Status	Occurrence	Format	Min. Access Types
Required	One	int	Get, Replace

This leaf node indicates the level within a group hierarchy (only applicable for group-broadcast group).

- Values: 0-255

The group-broadcast group with the lowest MCPTTGroupLevel value shall be considered as the group-broadcast group having the lowest level among the groups.

NOTE: This element is common for all MC services.

6.2.18 /<x>/<x>/Common/UserLevel

Table 6.2.18.1: /<x>/<x>/Common/UserLevel

<x>/Common/UserLevel

Status	Occurrence	Format	Min. Access Types
Required	One	int	Get, Replace

This leaf node indicates the level within user hierarchy (only applicable for user-broadcast group).

The user-broadcast group with the lowest UserLevel value shall be considered as the user-broadcast group having the lowest level among the groups.

NOTE: This element is common for all MC services.

6.2.19 /<x>/<x>/Common/AllowedEmergencyCall

Table 6.2.19.1: /<x>/<x>/Common/AllowedEmergencyCall

<x>/Common/AllowedEmergencyCall

Status	Occurrence	Format	Min. Access Types
Required	One	bool	Get, Replace

This leaf node indicates whether an MCPTT emergency group call is permitted on the MCS group.

When set to "true" the MCPTT emergency group call is allowed on the group.

When set to "false" the MCPTT emergency group call is not allowed on the group.

NOTE: This element is specific for MCPTT.

6.2.20 /<x>/<x>/Common/AllowedImminentPerilCall

Table 6.2.20.1: /<x>/<x>/Common/AllowedImminentPerilCall

<x>/Common/AllowedImminentPerilCall

Status	Occurrence	Format	Min. Access Types
Required	One	bool	Get, Replace

This leaf node indicates whether an MCPTT imminent peril group call is permitted on the MCS group.

When set to "true" the MCPTT imminent peril group call is allowed on the group.

When set to "false" the MCPTT imminent peril group call is not allowed on the group.

NOTE: This element is specific for MCPTT.

6.2.21 /<x>/<x>/Common/AllowedEmergencyAlert

Table 6.2.21.1: /<x>/<x>/Common/AllowedEmergencyAlert

<x>/Common/AllowedEmergencyAlert

Status	Occurrence	Format	Min. Access Types
Required	One	bool	Get, Replace

This leaf node indicates whether an MCPTT emergency alert is possible on the MCS group.

When set to "true" the MCPTT emergency alert is allowed on the group.

When set to "false" the MCPTT emergency alert is not allowed on the group.

NOTE: This element is for specific for MCPTT.

6.2.22 /<x>/<x>/Common/MediaProtectionRequired

Table 6.2.22.1: /<x>/<x>/Common/MediaProtectionRequired

<x>/Common/MediaProtectionRequired

Status	Occurrence	Format	Min. Access Types
Required	One	bool	Get, Replace

This leaf node indicates whether confidentiality and integrity of MCPTT media is required on the MCS group.

When set to "true" confidentiality and integrity of media is required on the group.

When set to "false" confidentiality and integrity of media is not required on the group.

The default value is set to "true".

NOTE: This element is specific for MCPTT.

6.2.23 /<x>/<x>/Common/FloorControlProtectionRequired

Table 6.2.23.1: /<x>/<x>/Common/FloorControlProtectionRequired

<x>/Common/FloorControlProtectionRequired

Status	Occurrence	Format	Min. Access Types
Required	One	bool	Get, Replace

This interior node indicates whether confidentiality and integrity of MCPTT floor control signalling is required on the MCS group.

When set to "true" confidentiality and integrity of floor control signalling is required on the group.

When set to "false" confidentiality and integrity of floor control signalling is not required on the group.

The default value is set to "true".

NOTE: This element is specific for MCPTT.

6.2.23A /<x>/<x>/Common/MediaProtectionSecurityMaterial

Table 6.2.23A.1: /<x>/<x>/Common/MediaProtectionSecurityMaterial

<x>/Common/MediaProtectionSecurityMaterial

Status	Occurrence	Format	Min. Access Types
Required	One	chr	Get, Replace

This leaf node indicates security material (as specified in 3GPP TS 33.180 [20]) for MCPTT media protection in the MCS group.

NOTE: This element is specific for MCPTT.

6.2.23B /<x>/<x>/Common/MCData

Table 6.2.23B.1: /<x>/<x>/Common/MCData

<x>/Common/MCData

Status	Occurrence	Format	Min. Access Types
Required	One	node	Get, Replace

This interior node is a placeholder for a Common MCData group information

6.2.23C /<x>/<x>/Common/MCData/MediaProtectionRequired

Table 6.2.23C.1: /<x>/<x>/Common/MCData/MediaProtectionRequired

<x>/Common/MCData/MediaProtectionRequired

Status	Occurrence	Format	Min. Access Types
Required	One	bool	Get, Replace

This leaf node indicates whether confidentiality and integrity of media is required for MCData transactions on the MCS group.

When set to "true" confidentiality and integrity of MCData media is required on the group.

When set to "false" confidentiality and integrity of MCData media is not required on the group.

The default value is set to "true".

6.2.23D /<x>/<x>/Common/MCData/TxControlProtectionRequired

Table 6.2.23D.1: /<x>/<x>/Common/MCData/TxControlProtectionRequired

<x>/Common/MCData/TxControlProtectionRequired

Status	Occurrence	Format	Min. Access Types
Required	One	bool	Get, Replace

This leaf node indicates whether confidentiality and integrity protection is required for on-network and off-network MCData transmission control signalling on the MCS group

When set to "true" confidentiality and integrity of MCData transmission control signalling is required on the group.

When set to "false" confidentiality and integrity of MCData transmission control signalling is not required on the group.

The default value is set to "true".

6.2.23E /<x>/<x>/Common/MCData/MediaProtectionSecurityMaterial

Table 6.2.23E.1: /<x>/<x>/Common/MCData/MediaProtectionSecurityMaterial

<x>/Common/MCData/MediaProtectionSecurityMaterial

Status	Occurrence	Format	Min. Access Types
Required	One	chr	Get, Replace

This leaf node indicates security material (as specified in 3GPP TS 33.180 [xx]) for MCData media protection in the MCS group.

6.2.23F /<x>/<x>/Common/MCData/AllowedSDS

Table 6.2.23F.1: /<x>/<x>/Common/MCData/AllowedSDS

<x>/Common/MCData/AllowedSDS

Status	Occurrence	Format	Min. Access Types
Required	One	bool	Get, Replace

This leaf node indicates whether Short Data Service (SDS) is enabled for the group.

When set to "true" the Short Data Service (SDS) is allowed on the group.

When set to "false" the Short Data Service (SDS) is not allowed on the group.

6.2.23G /<x>/<x>/Common/MCData/AllowedFD

Table 6.2.23G.1: /<x>/<x>/Common/MCData/AllowedFD

<x>/Common/MCData/AllowedFD

Status	Occurrence	Format	Min. Access Types
Required	One	bool	Get, Replace

This leaf node indicates whether File Distribution (FD) is enabled for the group.

When set to "true" File Distribution (FD) is allowed on the group.

When set to "false" File Distribution (FD) is not allowed on the group.

6.2.23H /<x>/<x>/Common/MCData/AllowedConvMgmt

Table 6.2.23H.1: /<x>/<x>/Common/MCData/AllowedConvMgmt

<x>/Common/MCData/AllowedConvMgmt

Status	Occurrence	Format	Min. Access Types
Required	One	bool	Get, Replace

This leaf node indicates whether conversation management is enabled for the group.

When set to "true" conversation management is allowed on the group.

When set to "false" conversation management is not allowed on the group.

6.2.23I /<x>/<x>/Common/MCData/AllowedTxControl

Table 6.2.23I.1: /<x>/<x>/Common/MCData/AllowedTxControl

<x>/Common/MCData/AllowedTxControl

Status	Occurrence	Format	Min. Access Types
Required	One	bool	Get, Replace

This leaf node indicates whether transmission control is enabled for the group.

When set to "true" transmission control is allowed on the group.

When set to "false" transmission control is not allowed on the group.

6.2.23J /<x>/<x>/Common/MCData/AllowedRxControl

Table 6.2.23J.1: /<x>/<x>/Common/MCData/AllowedRxControl

<x>/Common/MCData/AllowedRxControl

Status	Occurrence	Format	Min. Access Types
Required	One	bool	Get, Replace

This leaf node indicates whether reception control is enabled for the group.

When set to "true" reception control is allowed on the group.

When set to "false" reception control not allowed on the group.

6.2.23K /<x>/<x>/Common/MCData/AllowedEnhSvc

Table 6.2.23K.1: /<x>/<x>/Common/MCData/AllowedEnhSvc

<x>/Common/MCData/AllowedEnhSvc

Status	Occurrence	Format	Min. Access Types
Required	One	bool	Get, Replace

This leaf node indicates whether Enhanced Service is enabled for the group.

When set to "true" Enhanced Service is allowed on the group.

When set to "false" Enhanced Service is not allowed on the group.

6.2.23L /<x>/<x>/Common/MCData/EnhSvcOpValues

Table 6.2.23L.1: /<x>/<x>/Common/MCData/EnhSvcOpValues

<x>/Common/MCData/EnhSvcOpValues

Status	Occurrence	Format	Min. Access Types
Required	One	node	Get, Replace

This interior node is a placeholder for a list of operational values for Enhanced Service.

6.2.23M /<x>/<x>/Common/MCData/EnhSvcOpValues/<x>

Table 6.2.23M.1: /<x>/<x>/Common/MCData/EnhSvcOpValues/<x>

<x>/Common/MCData/EnhSvcOpValues/<x>

Status	Occurrence	Format	Min. Access Types
Optional	OneOrMore	node	Get, Replace

This interior node is a placeholder for one or more list of operational values for Enhanced Service.

6.2.23N /<x>/<x>/Common/MCData/EnhSvcOpValues/<x>/EnhSvcOpValue

Table 6.2.23N.1: /<x>/<x>/Common/MCData/EnhSvcOpValues/<x>/EnhSvcOpValue

<x>/Common/MCData/EnhSvcOpValues/<x>/EnhSvcOpValue

Status	Occurrence	Format	Min. Access Types
Optional	One	chr	Get, Replace

This leaf node indicates an enhanced service operational value.

6.2.23O /<x>/<x>/Common/MCData/AllowedTransmitDataInGroup

Table 6.2.23O.1: /<x>/<x>/Common/MCData/AllowedTransmitDataInGroup

<x>/Common/MCData/AllowedTransmitDataInGroup

Status	Occurrence	Format	Min. Access Types
Required	One	bool	Get, Replace

This leaf node indicates whether an MC data user is permitted to transmit data in the group.

When set to "true" an MC data user is allowed to transmit data in the group.

When set to "false" an MC data user is not allowed to transmit data in the group.

6.2.23P /<x>/<x>/Common/MCData/MaxDataSingleRequest

Table 6.2.23P.1: /<x>/<x>/Common/MCData/MaxDataSingleRequest

<x>/Common/MCData/MaxDataSingleRequest

Status	Occurrence	Format	Min. Access Types
Required	One	int	Get, Replace

This leaf node indicates the maximum amount of data (in megabytes) that an MCData user can transmit in a single request during group communication.

- Values: 0-65535

The MaxData1to1 size is in megabytes..

6.2.23Q /<x>/<x>/Common/MCData/MaxTimeSingleRequest

Table 6.2.23Q.1: /<x>/<x>/Common/MCData/MaxTimeSingleRequest

<x>/Common/MCData/MaxTimeSingleRequest

Status	Occurrence	Format	Min. Access Types
Required	One	int	Get, Replace

This leaf node indicates the maximum amount of time that an MCData user can transmit for in a single request during group communication.

- Values: 0-65535

The MaxTime1To1 time is in seconds.

6.2.23R /<x>/<x>/Common/MCVideo

Table 6.2.23R.1: /<x>/<x>/Common/MCVideo

<x>/Common/MCVideo

Status	Occurrence	Format	Min. Access Types
Required	One	node	Get, Replace

This interior node is a placeholder for a Common MCVideo group information

6.2.23S /<x>/<x>/Common/MCVideo/MediaProtectionRequired

Table 6.2.23S.1: /<x>/<x>/Common/MCVideo/MediaProtectionRequired

<x>/Common/MCVideo/MediaProtectionRequired

Status	Occurrence	Format	Min. Access Types
Required	One	bool	Get, Replace

This leaf node indicates whether confidentiality and integrity of media is required for MCVideo calls on the MCS group.

When set to "true" confidentiality and integrity of MCvideo media is required on the group.

When set to "false" confidentiality and integrity of MCvideo media is not required on the group.

The default value is set to "true".

6.2.23T /<x>/<x>/Common/MCVideo/TxControlProtectionRequired

Table 6.2.23T.1: /<x>/<x>/Common/MCVideo/TxControlProtectionRequired

<x>/Common/MCVideo/TxControlProtectionRequired

Status	Occurrence	Format	Min. Access Types
Required	One	bool	Get, Replace

This leaf node indicates whether confidentiality and integrity protection is required for on-network and off-network MCVideo transmission control signalling on the MCS group

When set to "true" confidentiality and integrity of MCVideo transmission control signalling is required on the group.

When set to "false" confidentiality and integrity of MCVideo transmission control signalling is not required on the group.

The default value is set to "true".

6.2.23U /<x>/<x>/Common/MCVideo/MediaProtectionSecurityMaterial

Table 6.2.23U.1: /<x>/<x>/Common/MCVideo/MediaProtectionSecurityMaterial

<x>/Common/MCVideo/MediaProtectionSecurityMaterial

Status	Occurrence	Format	Min. Access Types
Required	One	chr	Get, Replace

This leaf node indicates security material (as specified in 3GPP TS 33.180 [xx]) for MCVideo media protection in the MCS group.

6.2.23V /<x>/<x>/Common/MCVideo/AllowedAudioCodecs

Table 6.2.23V.1: /<x>/<x>/Common/MCVideo/AllowedAudioCodecs

<x>/Common/MCVideo/AllowedAudioCodecs

Status	Occurrence	Format	Min. Access Types
Required	One	node	Get, Replace

This interior node is a placeholder for a list of allowed audio codecs for MCVideo sessions on the group

6.2.23W /<x>/<x>/Common/MCVideo/AllowedAudioCodecs/<x>

Table 6.2.23W.1: /<x>/<x>/Common/MCVideo/AllowedAudioCodecs/<x>

<x>/Common/MCVideo/AllowedAudioCodecs/<x>

Status	Occurrence	Format	Min. Access Types
Optional	OneOrMore	node	Get, Replace

This interior node is a placeholder for one or more list of allowed audio codecs for MCVideo sessions on the group

6.2.23X /<x>/<x>/Common/MCVideo/AllowedAudioCodecs/<x>/AudioCodec

Table 6.2.23X.1: /<x>/<x>/Common/MCVideo/AllowedAudioCodecs/<x>/AudioCodec

<x>/Common/MCVideo/AllowedAudioCodecs/<x>/AudioCodec

Status	Occurrence	Format	Min. Access Types
Optional	One	chr	Get, Replace

This leaf node indicates the preferred RTP payload format to be used for audio encoding in MCVideo group sessions for the group.

6.2.23Y /<x>/<x>/Common/MCVideo/AllowedVideoCodecs

Table 6.2.23Y.1: /<x>/<x>/Common/MCVideo/AllowedVideoCodecs

<x>/Common/MCVideo/AllowedVideoCodecs

Status	Occurrence	Format	Min. Access Types
Required	One	node	Get, Replace

This interior node is a placeholder for a list of allowed video codecs for MCVideo sessions on the group

6.2.23Z /<x>/<x>/Common/MCVideo/AllowedVideoCodecs/<x>

Table 6.2.23Z.1: /<x>/<x>/Common/MCVideo/AllowedVideoCodecs/<x>

<x>/Common/MCVideo/AllowedVideoCodecs/<x>

Status	Occurrence	Format	Min. Access Types
Optional	OneOrMore	node	Get, Replace

This interior node is a placeholder for one or more list of allowed video codecs for MCVideo sessions on the group

6.2.23AA

/<x>/<x>/Common/MCVideo/AllowedVideoCodecs/<x>/VideoCodec

Table 6.2.23AA.1: /<x>/<x>/Common/MCVideo/AllowedVideoCodecs/<x>/VideoCodec

<x>/Common/MCVideo/AllowedVideoCodecs/<x>/VideoCodec

Status	Occurrence	Format	Min. Access Types
Optional	One	chr	Get, Replace

This leaf node indicates the preferred RTP payload format to be used for video encoding in MCVideo group sessions for the group.

6.2.23AB /<x>/<x>/Common/MCVideo/AllowedVideoResolutions

Table 6.2.23AB.1: /<x>/<x>/Common/MCVideo/AllowedVideoResolutions

<x>/Common/MCVideo/AllowedVideoResolutions

Status	Occurrence	Format	Min. Access Types
Required	One	node	Get, Replace

This interior node is a placeholder for a list of allowed video resolutions used in MCVideo group sessions for the group.

6.2.23AC /<x>/<x>/Common/MCVideo/AllowedVideoResolutions/<x>

Table 6.2.23AC.1: /<x>/<x>/Common/MCVideo/AllowedVideoResolutions/<x>

<x>/Common/MCVideo/AllowedVideoResolutions/<x>

Status	Occurrence	Format	Min. Access Types
Optional	OneOrMore	node	Get, Replace

This interior node is a placeholder for one or more list of allowed video resolutions used in MCVideo group sessions for the group.

6.2.23AD

/<x>/<x>/Common/MCVideo/AllowedVideoResolutions/<x>/VideoResolution

Table 6.2.23AD.1: /<x>/<x>/Common/MCVideo/AllowedVideoResolutions/<x>/VideoResolution

<x>/Common/MCVideo/AllowedVideoResolutions/<x>/VideoResolution

Status	Occurrence	Format	Min. Access Types
Optional	One	chr	Get, Replace

This leaf node indicates a video resolution (number of horizontal pixels x number of vertical pixels) to be used in MCVideo group sessions for the group.

6.2.23AE /<x>/<x>/Common/MCVideo/AllowedVideoFrameRates

Table 6.2.23AE.1: /<x>/<x>/Common/MCVideo/AllowedVideoFrameRates

<x>/Common/MCVideo/AllowedVideoFrameRates

Status	Occurrence	Format	Min. Access Types
Required	One	node	Get, Replace

This interior node is a placeholder for a list of allowed video frame rates to be used in MCVideo group sessions for the group.

6.2.23AF /<x>/<x>/Common/MCVideo/AllowedVideoFrameRates/<x>

Table 6.2.23AF.1: /<x>/<x>/Common/MCVideo/AllowedVideoFrameRates/<x>

<x>/Common/MCVideo/AllowedVideoFrameRates/<x>

Status	Occurrence	Format	Min. Access Types
Optional	OneOrMore	node	Get, Replace

This interior node is a placeholder for one or more list of allowed video frame rates to be used in MCVideo group sessions for the group.

6.2.23AG

/<x>/<x>/Common/MCVideo/AllowedVideoFrameRates/<x>/FrameRate

Table 6.2.23AG.1: /<x>/<x>/Common/MCVideo/AllowedVideoFrameRates/<x>/FrameRate

<x>/Common/MCVideo/AllowedVideoFrameRates/<x>/FrameRate

Status	Occurrence	Format	Min. Access Types
Optional	One	int	Get, Replace

This leaf node indicates a video frame rate (in frames per second) to be used in MCVideo group sessions for the group.

6.2.23AH /<x>/<x>/Common/MCVideo/AllowedUrgentRealTimeMode

Table 6.2.23AH.1: /<x>/<x>/Common/MCVideo/AllowedUrgentRealTimeMode

<x>/Common/MCVideo/AllowedUrgentRealTimeMode

Status	Occurrence	Format	Min. Access Types
Required	One	bool	Get, Replace

This leaf node indicates whether urgent real time mode is allowed for MCVideo sessions on the group.

When set to "true" urgent real-time video mode is allowed for MCVideo sessions on the group.

When set to "false" urgent real-time video mode is not allowed for MCVideo sessions on the group.

6.2.23AI /<x>/<x>/Common/MCVideo/AllowedNonUrgentRealTimeMode

Table 6.2.23AI.1: /<x>/<x>/Common/MCVideo/AllowedNonUrgentRealTimeMode

<x>/Common/MCVideo/AllowedNonUrgentRealTimeMode

Status	Occurrence	Format	Min. Access Types
Required	One	bool	Get, Replace

This leaf node indicates whether non-urgent real time mode is allowed for MCVideo sessions on the group.

When set to "true" non-urgent real-time video mode is allowed for MCVideo sessions on the group.

When set to "false" non-urgent real-time video mode is not allowed for MCVideo sessions on the group.

6.2.23AJ /<x>/<x>/Common/MCVideo/AllowedNonRealTimeMode

Table 6.2.23AJ.1: /<x>/<x>/Common/MCVideo/AllowedNonRealTimeMode

<x>/Common/MCVideo/AllowedNonRealTimeMode

Status	Occurrence	Format	Min. Access Types
Required	One	bool	Get, Replace

This leaf node indicates whether non-real time mode is allowed for MCVideo sessions on the group.

When set to "true" non-real-time video mode is allowed for MCVideo sessions on the group.

When set to "false" non-real-time video mode is not allowed for MCVideo sessions on the group.

6.2.23AK /<x>/<x>/Common/MCVideo/ActiveNonRealTimeMode

Table 6.2.23AK.1: /<x>/<x>/Common/MCVideo/ActiveNonRealTimeMode

<x>/Common/MCVideo/ActiveNonRealTimeMode

Status	Occurrence	Format	Min. Access Types
Required	One	chr	Get, Replace

This leaf node indicates the active non-real-time mode used for MCVideo sessions on the group.

The valid values are:

- a) "urgent-real-time";
- b) "non-urgent-real-time"; and
- c) "non-real-time".

6.2.23AL /<x>/<x>/Common/MCVideo/MaxTransmitMembers

Table 6.2.23AL.1: /<x>/<x>/Common/MCVideo/MaxTransmitMembers

<x>/Common/MCVideo/MaxTransmitMembers

Status	Occurrence	Format	Min. Access Types
Required	One	int	Get, Replace

This leaf node indicates the maximum number of simultaneous transmitting group members for MCVideo sessions on the group.

- Values: 0-65535

6.2.24 /<x>/<x>/OffNetwork

Table 6.2.24.1: /<x>/<x>/OffNetwork

<x>/OffNetwork

Status	Occurrence	Format	Min. Access Types
Required	ZeroOrOne	node	Get, Replace

This interior node represents a container for off-network operation.

6.2.25 /<x>/<x>/OffNetwork/MCPTTGroupParameter

Table 6.2.25.1: /<x>/<x>/OffNetwork/MCPTTGroupParameter

<x>/OffNetwork/MCPTTGroupParameter

Status	Occurrence	Format	Min. Access Types
Required	One	node	Get, Replace

This interior node is a placeholder for the group parameters.

6.2.26 /<x>/<x>/OffNetwork/MCPTTGroupParameter/<x>

Table 6.2.26.1: /<x>/<x>/OffNetwork/MCPTTGroupParameter/<x>

<x>/OffNetwork/MCPTTGroupParameter/<x>

Status	Occurrence	Format	Min. Access Types
Required	OneOrMore	node	Get, Replace

This interior node is a placeholder for one or more group parameters.

6.2.27

/<x>/<x>/OffNetwork/MCPTTGroupParameter/<x>/ProSeLayer2GroupID

Table 6.2.27.1: /<x>/<x>/OffNetwork/MCPTTGroupParameter/<x>/ProSeLayer2GroupID

<x>/OffNetwork/MCPTTGroupParameter/<x>/ProSeLayer2GroupID

Status	Occurrence	Format	Min. Access Types
Required	One	chr	Get, Replace

This leaf node indicates the Prose layer-2 group ID as specified in 3GPP TS 23.303 [6].

NOTE: This element is common for all MC services.

6.2.28

`<x>/<x>/OffNetwork/MCPTTGroupParameter/<x>/IPMulticastAddress`

Table 6.2.28.1: `<x>/<x>/OffNetwork/MCPTTGroupParameter/<x>/IPMulticastAddress`

`<x>/OffNetwork/MCPTTGroupParameter/<x>/IPMulticastAddress`

Status	Occurrence	Format	Min. Access Types
Required	One	chr	Get, Replace

This leaf node indicates the ProSe group IP multicast address as specified in 3GPP TS 23.303 [6].

The value is an IPv4 address or an IPv6 address.

NOTE: This element is common for all MC services.

6.2.29

`<x>/<x>/OffNetwork/MCPTTGroupParameter/<x>/RelayServiceCode`

Table 6.2.29.1: `<x>/<x>/OffNetwork/MCPTTGroupParameter/<x>/RelayServiceCode`

`<x>/OffNetwork/MCPTTGroupParameter/<x>/RelayServiceCode`

Status	Occurrence	Format	Min. Access Types
Required	One	chr	Get, Replace

This leaf node indicates the connectivity service that the ProSe UE-to-network relay provides to public safety applications as specified in 3GPP TS 23.303 [6].

NOTE: This element is common for all MC services.

6.2.30 `<x>/<x>/OffNetwork/MCPTTGroupParameter/<x>/IPVersions`

Table 6.2.30.1: `<x>/<x>/OffNetwork/MCPTTGroupParameter/<x>/IPVersions`

`<x>/OffNetwork/MCPTTGroupParameter/<x>/IPVersions`

Status	Occurrence	Format	Min. Access Types
Required	One	chr	Get, Replace

This leaf node indicates whether IPv4 or IPv6 is used for the MCS group as specified in 3GPP TS 23.303 [6].

The value is "IPv4" or "IPv6".

NOTE: This element is common for all MC services.

6.2.31 `<x>/<x>/OffNetwork/EmergencyCallCancel`

Table 6.2.31.1: `<x>/<x>/OffNetwork/EmergencyCallCancel`

`<x>/OffNetwork/EmergencyCallCancel`

Status	Occurrence	Format	Min. Access Types
Required	One	int	Get, Replace

This leaf node indicates the timeout value for the cancellation of an in progress emergency group call for MCPTT.

- Values: 0-65535

The EmergencyCallCancel time is in seconds.

NOTE: This element is specific for MCPTT.

6.2.32 /<x>/<x>/OffNetwork/ImminentPerilCallCancel

Table 6.2.32.1: /<x>/<x>/OffNetwork/ImminentPerilCallCancel

<x>/OffNetwork/ImminentPerilCallCancel

Status	Occurrence	Format	Min. Access Types
Required	One	int	Get, Replace

This leaf node indicates the timeout value for the cancellation of an in progress MCPTT imminent peril group call.

- Values: 0-65535

The ImminentPerilCallCancel time is in seconds.

NOTE: This element is specific for MCPTT.

6.2.33 /<x>/<x>/OffNetwork/HangTime

Table 6.2.33.1: /<x>/<x>/OffNetwork/HangTime

<x>/OffNetwork/HangTime

Status	Occurrence	Format	Min. Access Types
Required	One	int	Get, Replace

This leaf node indicates the group call hang timer.

- Values: 0-65535

The HangTime is in seconds.

NOTE: This element is specific for MCPTT.

6.2.34 /<x>/<x>/OffNetwork/MaxDuration

Table 6.2.34.1: /<x>/<x>/OffNetwork/MaxDuration

<x>/OffNetwork/MaxDuration

Status	Occurrence	Format	Min. Access Types
Required	One	int	Get, Replace

This leaf node indicates the max duration of group calls.

- Values: 0-65535

The MaxDuration time is in seconds.

NOTE: This element is specific for MCPTT.

6.2.34A /<x>/<x>/OffNetwork/QueueUsage

Table 6.2.34A.1: /<x>/<x>/OffNetwork/QueueUsage

<x>/OffNetwork/QueueUsage

Status	Occurrence	Format	Min. Access Types
Required	One	bool	Get, Replace

This leaf node indicates if queuing is enabled or not.

When set to "true" queuing floor requests is enabled on the group.

When set to "false" queuing floor requests is not enabled on the group.

The default value is set to "true".

NOTE: This element is specific for MCPTT.

6.2.35 /<x>/<x>/OffNetwork/DefaultPPPP

Table 6.2.35.1: /<x>/<x>/OffNetwork/DefaultPPPP

<x>/OffNetwork/DefaultPPPP

Status	Occurrence	Format	Min. Access Types
Required	One	node	Get, Replace

This interior node is a placeholder for the default ProSe Per-Packet Priority (PPPP) configuration.

6.2.36 /<x>/<x>/OffNetwork/DefaultPPPP/MCPTTGroupCallSignalling

Table 6.2.36.1: /<x>/<x>/OffNetwork/DefaultPPPP/MCPTTGroupCallSignalling

<x>/OffNetwork/DefaultPPPP/MCPTTGroupCallSignalling

Status	Occurrence	Format	Min. Access Types
Required	One	int	Get, Replace

This leaf node indicates the default ProSe Per-Packet Priority (PPPP) value (as specified in 3GPP TS 23.303 [6]) for the group call signalling for MCPTT.

- Values: 1-8

The MCPTT user data with the lowest ProSe Per-Packet Priority value shall be considered as the MCPTT user data having the highest priority among the MCPTT user data.

NOTE: This element is specific for MCPTT.

6.2.37 /<x>/<x>/OffNetwork/DefaultPPPP/MCPTTGroupCallMedia

Table 6.2.37.1: /<x>/<x>/OffNetwork/DefaultPPPP/MCPTTGroupCallMedia

<x>/OffNetwork/DefaultPPPP/MCPTTGroupCallMedia

Status	Occurrence	Format	Min. Access Types
Required	One	int	Get, Replace

This leaf node indicates the default ProSe Per-Packet Priority (PPPP) value (as specified in 3GPP TS 23.303 [6]) for the group call media for MCPTT.

- Values: 1-8

The MCPTT user data with the lowest ProSe Per-Packet Priority value shall be considered as the MCPTT user data having the highest priority among the MCPTT user data.

NOTE: This element is specific for MCPTT.

6.2.38

/<x>/<x>/OffNetwork/DefaultPPPP/MCPTTEmergencyGroupCallSignalling

Table 6.2.38.1: /<x>/<x>/OffNetwork/DefaultPPPP/MCPTTEmergencyGroupCallSignalling

<x>/OffNetwork/DefaultPPPP/MCPTTEmergencyGroupCallSignalling

Status	Occurrence	Format	Min. Access Types
Required	One	int	Get, Replace

This leaf node indicates the default ProSe Per-Packet Priority (PPPP) value (as specified in 3GPP TS 23.303 [6]) for the MCPTT emergency group call signalling.

- Values: 1-8

The MCPTT user data with the lowest ProSe Per-Packet Priority value shall be considered as the MCPTT user data having the highest priority among the MCPTT user data.

NOTE: This element is specific for MCPTT.

6.2.39

`<x>/<x>/OffNetwork/DefaultPPPP/MCPTTEmergencyGroupCallMedia`

Table 6.2.39.1: `<x>/<x>/OffNetwork/DefaultPPPP/MCPTTEmergencyGroupCallMedia`

`<x>/OffNetwork/DefaultPPPP/MCPTTEmergencyGroupCallMedia`

Status	Occurrence	Format	Min. Access Types
Required	One	int	Get, Replace

This leaf node indicates the default ProSe Per-Packet Priority (PPPP) value (as specified in 3GPP TS 23.303 [6]) for the MCPTT emergency group call media.

- Values: 1-8

The MCPTT user data with the lowest ProSe Per-Packet Priority value shall be considered as the MCPTT user data having the highest priority among the MCPTT user data.

NOTE: This element is specific for MCPTT.

6.2.40

`<x>/<x>/OffNetwork/DefaultPPPP/MCPTTImminentPerilGroupCallSignalling`

Table 6.2.40.1: `<x>/<x>/OffNetwork/DefaultPPPP/MCPTTImminentPerilGroupCallSignalling`

`<x>/OffNetwork/DefaultPPPP/MCPTTImminentPerilGroupCallSignalling`

Status	Occurrence	Format	Min. Access Types
Required	One	int	Get, Replace

This leaf node indicates the default ProSe Per-Packet Priority (PPPP) value (as specified in 3GPP TS 23.303 [6]) for the MCPTT imminent peril group call signalling.

- Values: 1-8

The MCPTT user data with the lowest ProSe Per-Packet Priority value shall be considered as the MCPTT user data having the highest priority among the MCPTT user data.

NOTE: This element is specific for MCPTT.

6.2.41

`<x>/<x>/OffNetwork/DefaultPPPP/MCPTTImminentPerilGroupCallMedia`

Table 6.2.41.1: `<x>/<x>/OffNetwork/DefaultPPPP/MCPTTImminentPerilGroupCallMedia`

`<x>/OffNetwork/DefaultPPPP/MCPTTImminentPerilGroupCallMedia`

Status	Occurrence	Format	Min. Access Types
Required	One	int	Get, Replace

This leaf node indicates the default ProSe Per-Packet Priority (PPPP) value (as specified in 3GPP TS 23.303 [6]) for the MCPTT imminent peril group call media.

- Values: 1-8

The MCPTT user data with the lowest ProSe Per-Packet Priority value shall be considered as the MCPTT user data having the highest priority among the MCPTT user data.

NOTE: This element is specific for MCPTT.

6.2.42 /<x>/<x>/OffNetwork/MCData

Table 6.2.42.1: /<x>/<x>/OffNetwork/MCData

<x>/OffNetwork/MCData

Status	Occurrence	Format	Min. Access Types
Required	One	node	Get, Replace

This interior node is a placeholder for off-network MCData configuration.

6.2.43 /<x>/<x>/OffNetwork/MCData/DefaultPPPP

Table 6.2.43.1: /<x>/<x>/OffNetwork/MCData/DefaultPPPP

<x>/OffNetwork/MCData/DefaultPPPP

Status	Occurrence	Format	Min. Access Types
Required	One	node	Get, Replace

This interior node is a placeholder for the default ProSe Per-Packet Priority (PPPP) configuration.

6.2.44

/<x>/<x>/OffNetwork/MCData/DefaultPPPP/MCDataGroupCallSignalling

Table 6.2.44.1: /<x>/<x>/OffNetwork/MCData/DefaultPPPP/MCDataGroupCallSignalling

<x>/OffNetwork/MCData/DefaultPPPP/MCDataGroupCallSignalling

Status	Occurrence	Format	Min. Access Types
Required	One	int	Get, Replace

This leaf node indicates the default ProSe Per-Packet Priority (PPPP) value (as specified in 3GPP TS 23.303 [6]) for the group call signalling for MCData..

- Values: 1-8

The MCData user data with the lowest ProSe Per-Packet Priority value shall be considered as the MCData user data having the highest priority among the MCData user data.

6.2.45

/<x>/<x>/OffNetwork/MCData/DefaultPPPP/MCDataGroupCallMedia

Table 6.2.45.1: /<x>/<x>/OffNetwork/MCData/DefaultPPPP/MCDataGroupCallMedia

<x>/OffNetwork/MCData/DefaultPPPP/MCDataGroupCallMedia

Status	Occurrence	Format	Min. Access Types
Required	One	int	Get, Replace

This leaf node indicates the default ProSe Per-Packet Priority (PPPP) value (as specified in 3GPP TS 23.303 [6]) for the group call media for MCDData.

- Values: 1-8

The MCDData user data with the lowest ProSe Per-Packet Priority value shall be considered as the MCDData user data having the highest priority among the MCDData user data.

6.2.46 /<x>/<x>/OffNetwork/MCVideo

Table 6.2.46.1: /<x>/<x>/OffNetwork/MCVideo

<x>/OffNetwork/MCVideo

Status	Occurrence	Format	Min. Access Types
Required	One	node	Get, Replace

This interior node is a placeholder for off-network MCVideo group configuration.

6.2.47 /<x>/<x>/OffNetwork/MCVideo/ArbitrationApproach

Table 6.2.47.1: /<x>/<x>/OffNetwork/MCVideo/ArbitrationApproach

<x>/OffNetwork/MCVideo/ArbitrationApproach

Status	Occurrence	Format	Min. Access Types
Required	One	chr	Get, Replace

This leaf node indicates the arbitration approach used for off-network video transmissions on the group

The valid values are:

- "single" which indicates transmission participants rely on a single participant designated as transmission arbitrator for the arbitration of transmission requests; and
- "self" which indicates each transmission participant arbitrates its own transmission based on its view of the topology;

6.2.48 /<x>/<x>/OffNetwork/MCVideo/MaxTransmissions

Table 6.2.48.1: /<x>/<x>/ OffNetwork/MCVideo/MaxTransmissions

<x>/OffNetwork/MCVideo/MaxTransmissions

Status	Occurrence	Format	Min. Access Types
Required	One	int	Get, Replace

This leaf node indicates maximum number of simultaneous transmissions for off-network MCVideo procedures.

- Values: 0-65535

6.2.49 /<x>/<x>/OffNetwork/MCVideo/DefaultPPPP

Table 6.2.49.1: /<x>/<x>/OffNetwork/MCVideo/DefaultPPPP

<x>/OffNetwork/MCVideo/DefaultPPPP

Status	Occurrence	Format	Min. Access Types
Required	One	node	Get, Replace

This interior node is a placeholder for the default ProSe Per-Packet Priority (PPPP) configuration.

6.2.50

OffNetwork/MCVideo/DefaultPPPP/MCVideoGroupCallSignalling

Table 6.2.50.1: OffNetwork/MCVideo/DefaultPPPP/MCVideoGroupCallSignalling

OffNetwork/MCVideo/DefaultPPPP/MCVideoGroupCallSignalling

Status	Occurrence	Format	Min. Access Types
Required	One	int	Get, Replace

This leaf node indicates the default ProSe Per-Packet Priority (PPPP) value (as specified in 3GPP TS 23.303 [6]) for the group call signalling for MCVideo..

- Values: 1-8

The MCVideo user data with the lowest ProSe Per-Packet Priority value shall be considered as the MCVideo user data having the highest priority among the MCVideo user data.

6.2.51

OffNetwork/MCVideo/DefaultPPPP/MCVideoGroupCallMedia

Table 6.2.51.1: OffNetwork/MCVideo/DefaultPPPP/MCVideoGroupCallMedia

OffNetwork/MCVideo/DefaultPPPP/MCVideoGroupCallMedia

Status	Occurrence	Format	Min. Access Types
Required	One	int	Get, Replace

This leaf node indicates the default ProSe Per-Packet Priority (PPPP) value (as specified in 3GPP TS 23.303 [6]) for the group call media for MCVideo.

- Values: 1-8

The MCVideo user data with the lowest ProSe Per-Packet Priority value shall be considered as the MCVideo user data having the highest priority among the MCVideo user data.

6.2.52

OffNetwork/MCVideo/DefaultPPPP/MCVideoEmergencyGroupCallSignalling

Table 6.2.52.1: OffNetwork/MCVideo/DefaultPPPP/MCVideoEmergencyGroupCallSignalling

OffNetwork/MCVideo/DefaultPPPP/MCVideoEmergencyGroupCallSignalling

Status	Occurrence	Format	Min. Access Types
Required	One	int	Get, Replace

This leaf node indicates the default ProSe Per-Packet Priority (PPPP) value (as specified in 3GPP TS 23.303 [6]) for the MCVideo emergency group call signalling.

- Values: 1-8

The MCVideo user data with the lowest ProSe Per-Packet Priority value shall be considered as the MCVideo user data having the highest priority among the MCVideo user data.

6.2.53

/<x>/<x>/OffNetwork/MCVideo/DefaultPPPP/MCVideoEmergencyGroupCallMedia

Table 6.2.53.1: /<x>/<x>/OffNetwork/MCVideo/DefaultPPPP/MCVideoEmergencyGroupCallMedia

<x>/OffNetwork/MCVideo/DefaultPPPP/MCVideoEmergencyGroupCallMedia

Status	Occurrence	Format	Min. Access Types
Required	One	int	Get, Replace

This leaf node indicates the default ProSe Per-Packet Priority (PPPP) value (as specified in 3GPP TS 23.303 [6]) for the MCVideo emergency group call media.

- Values: 1-8

The MCVideo user data with the lowest ProSe Per-Packet Priority value shall be considered as the MCVideo user data having the highest priority among the MCVideo user data.

6.2.54

/<x>/<x>/OffNetwork/MCVideo/DefaultPPPP/MCVideoImminentPerilGroupCallSignalling

Table 6.2.54.1:

/<x>/<x>/OffNetwork/MCVideo/DefaultPPPP/MCVideoImminentPerilGroupCallSignalling

<x>/OffNetwork/MCVideo/DefaultPPPP/MCVideoImminentPerilGroupCallSignalling

Status	Occurrence	Format	Min. Access Types
Required	One	int	Get, Replace

This leaf node indicates the default ProSe Per-Packet Priority (PPPP) value (as specified in 3GPP TS 23.303 [6]) for the MCVideo imminent peril group call signalling.

- Values: 1-8

The MCVideo user data with the lowest ProSe Per-Packet Priority value shall be considered as the MCVideo user data having the highest priority among the MCVideo user data.

6.2.55

/<x>/<x>/OffNetwork/MCVideo/DefaultPPPP/MCVideoImminentPerilGroupCallMedia

Table 6.2.55.1: /<x>/<x>/OffNetwork/MCVideo/DefaultPPPP/MCVideoImminentPerilGroupCallMedia

<x>/OffNetwork/MCVideo/DefaultPPPP/MCVideoImminentPerilGroupCallMedia

Status	Occurrence	Format	Min. Access Types
Required	One	int	Get, Replace

This leaf node indicates the default ProSe Per-Packet Priority (PPPP) value (as specified in 3GPP TS 23.303 [6]) for the MCVideo imminent peril group call media.

- Values: 1-8

The MCVideo user data with the lowest ProSe Per-Packet Priority value shall be considered as the MCVideo user data having the highest priority among the MCVideo user data.

6.2.56 /<x>/<x>/OffNetwork/MCVideo/MaxDuration

Table 6.2.56.1: /<x>/<x>/OffNetwork/MCVideo/MaxDuration

<x>/OffNetwork/MCVideo/MaxDuration

Status	Occurrence	Format	Min. Access Types
Required	One	int	Get, Replace

This leaf node indicates the max duration of MCVideo group calls.

- Values: 0-65535

The MaxDuration time is in seconds.

6.2.57 /<x>/<x>/OffNetwork/MCVideo/EmergencyCallCancel

Table 6.2.57.1: /<x>/<x>/OffNetwork/MCVideo/EmergencyCallCancel

<x>/OffNetwork/EmergencyCallCancel

Status	Occurrence	Format	Min. Access Types
Required	One	int	Get, Replace

This leaf node indicates the timeout value for the cancellation of an in progress MCVideo emergency group call for MCVideo.

- Values: 0-65535

The EmergencyCallCancel time is in seconds.

6.2.58 /<x>/<x>/OffNetwork/MCVideo/ImminentPerilCallCancel

Table 6.2.58.1: /<x>/<x>/OffNetwork/MCVideo/ImminentPerilCallCancel

<x>/OffNetwork/ImminentPerilCallCancel

Status	Occurrence	Format	Min. Access Types
Required	One	int	Get, Replace

This leaf node indicates the timeout value for the cancellation of an in progress MCVideo imminent peril group call.

- Values: 0-65535

The ImminentPerilCallCancel time is in seconds.

7 MCPTT service configuration MO

7.1 General

The MCPTT service configuration Management Object (MO) is used to configure MCPTT Client behaviour for the on-network or off-network MCPTT Service. The MCPTT service configuration parameters may be stored in the ME, or in the USIM as specified in 3GPP TS 31.102 [10], or in both the ME and the USIM. If both the ME and the USIM contain the same parameters, the values stored in the USIM shall take precedence.

The Management Object Identifier is: urn:oma:mo:ext-3gpp-MCPTT-service-configuration:1.0.

Protocol compatibility: This MO is compatible with OMA OMA DM 1.2 [3].

The OMA DM ACL property mechanism (see OMA OMA-ERELD-DM-V1_2 [2]) may be used to grant or deny access rights to OMA DM servers in order to modify nodes and leaf objects of the MCPTT service configuration MO.

The following nodes and leaf objects are possible under the MCPTT service configuration node as described in figure 7.1.1:

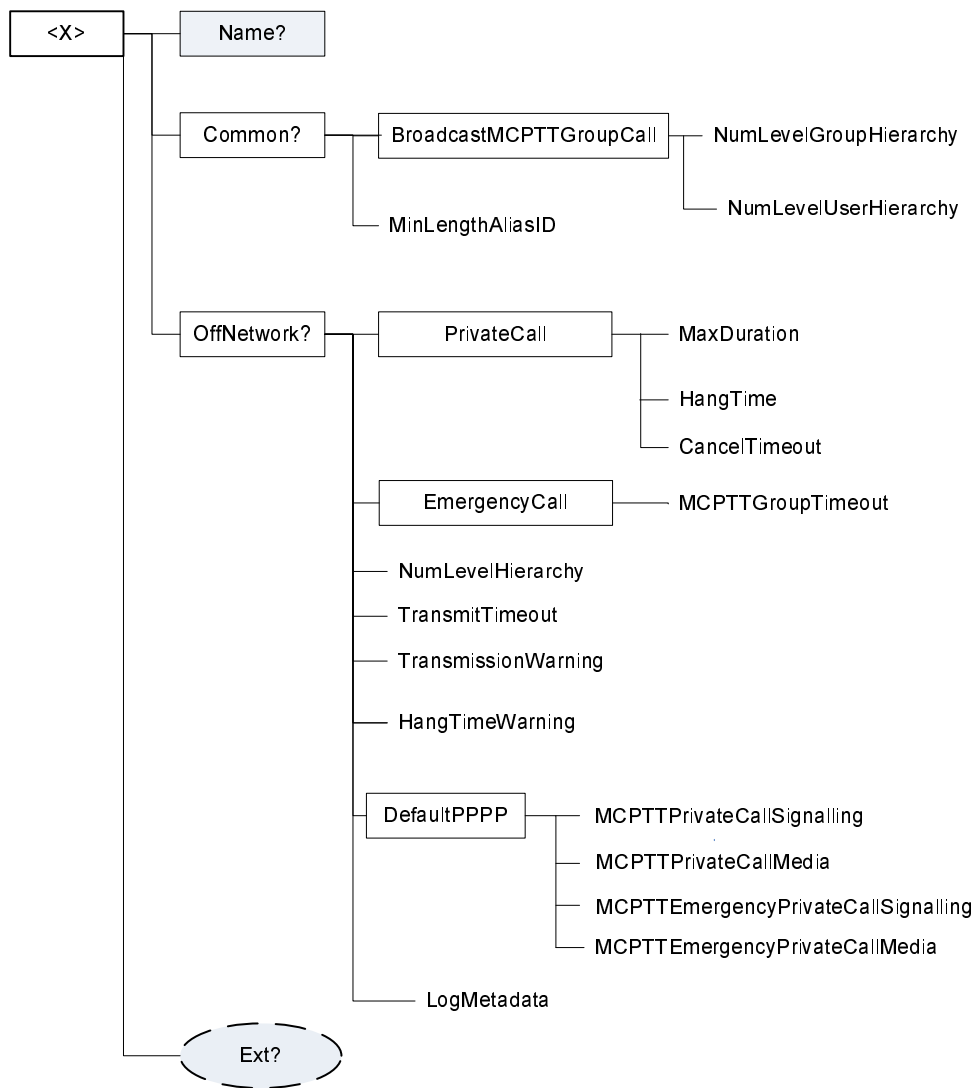

Figure 7.1.1: The MCPTT service configuration MO

7.2 MCPTT service configuration MO parameters

7.2.1 General

This clause describes the parameters for the MCPTT service configuration Management Object (MO).

7.2.2 Node: <x>

Table 7.2.2.1: Node: <x>

<x>

Status	Occurrence	Format	Min. Access Types
Required	OneOrMore	node	Get

This interior node acts as a placeholder for the MCPTT service configuration Management Object (MO).

For the MCPTT service configuration MO, the namespace specific string is: "urn:oma:mo:oma-dm-mcptt-service-configuration:1.0"

- Values: N/A

7.2.3 /<x>/Name

Table 7.2.3.1: /<x>/Name

Name

Status	Occurrence	Format	Min. Access Types
Required	ZeroOrOne	chr	Get

The Name leaf is a name for the MCPTT service configuration settings.

- Values: <User displayable name>

7.2.4 /<x>/Ext/

Table 7.2.4.1: /<x>/Ext/

Ext

Status	Occurrence	Format	Min. Access Types
Optional	ZeroOrOne	node	Get, Replace

The Ext is an interior node for where the vendor specific information about the MCPTT service configuration MO is being placed.

Usually the vendor extension is identified by vendor specific name under the ext node and contains the vendor meaning application vendor, device vendor etc. The tree structure under the vendor identified is not defined and can therefore include one or more un-standardized sub-trees.

- Values: N/A

7.2.5 /<x>/Common

Table 7.2.5.1: /<x>/Common

Common

Status	Occurrence	Format	Min. Access Types
Required	ZeroOrOne	node	Get, Replace

This interior node represents a container for the common network operation which means both on-network operation and off-network operation.

7.2.6 /<x>/Common/BroadcastMCPTTGroupCall

Table 7.2.6.1: /<x>/Common/BroadcastMCPTTGroupCall

Common/BroadcastMCPTTGroupCall

Status	Occurrence	Format	Min. Access Types
Required	One	node	Get, Replace

This interior node is a placeholder for Broadcast MCPTT Group Call configuration.

7.2.7

/<x>/Common/BroadcastMCPTTGroupCall/NumLevelGroupHierarchy

Table 7.2.7.1: /<x>/Common/BroadcastMCPTTGroupCall/NumLevelGroupHierarchy

Common/BroadcastMCPTTGroupCall/NumLevelGroupHierarchy

Status	Occurrence	Format	Min. Access Types
Required	One	int	Get, Replace

This leaf node indicates the number of levels of group hierarchy for group-broadcast groups.

- Values: 0-255

The group-broadcast group with the lowest NumLevelGroupHierarchy value shall be considered as the group-broadcast group having the lowest level among the groups.

7.2.8 /<x>/Common/BroadcastMCPTTGroupCall/NumLevelUserHierarchy

Table 7.2.8.1: /<x>/Common/BroadcastMCPTTGroupCall/NumLevelUserHierarchy

Common/BroadcastMCPTTGroupCall/NumLevelUserHierarchy

Status	Occurrence	Format	Min. Access Types
Required	One	int	Get, Replace

This leaf node indicates the number of levels of user hierarchy for user-broadcast groups.

- Values: 0-255

The user-broadcast group with the lowest NumLevelUserHierarchy value shall be considered as the user-broadcast group the lowest level among the groups.

7.2.9 /<x>/Common/MinLengthAliasID

Table 7.2.9.1: /<x>/Common/MinLengthAliasID

Common/MinLengthAliasID

Status	Occurrence	Format	Min. Access Types
Required	One	int	Get, Replace

This leaf node indicates minimum length of an alphanumeric identifier (i.e., alias) assigned by an MCPTT administrator.

- Values: 0-255

7.2.10 /<x>/OffNetwork

Table 7.2.10.1: /<x>/OffNetwork

OffNetwork

Status	Occurrence	Format	Min. Access Types
Required	ZeroOrOne	node	Get, Replace

This interior node represents a container for off-network operation.

7.2.11 /<x>/OffNetwork/PrivateCall

Table 7.2.11.1: /<x>/OffNetwork/PrivateCall

OffNetwork/PrivateCall

Status	Occurrence	Format	Min. Access Types
Required	One	node	Get, Replace

This interior node is a placeholder for private call configuration.

7.2.12 /<x>/OffNetwork/PrivateCall/MaxDuration

Table 7.2.12.1: /<x>/OffNetwork/PrivateCall/MaxDuration

OffNetwork/PrivateCall/MaxDuration

Status	Occurrence	Format	Min. Access Types
Required	One	int	Get, Replace

This leaf node indicates max private call (with floor control) duration.

- Values: 0-65535

The MaxDuration time is in seconds.

7.2.13 /<x>/OffNetwork/PrivateCall/HangTime

Table 7.2.13.1: /<x>/OffNetwork/PrivateCall/HangTime

OffNetwork/PrivateCall/HangTime

Status	Occurrence	Format	Min. Access Types
Required	One	int	Get, Replace

This leaf node indicates hang timer for private calls (with floor control).

- Values: 0-65535

The HangTime is in seconds.

7.2.14 /<x>/OffNetwork/PrivateCall/CancelTimeout

Table 7.2.14.1: /<x>/OffNetwork/PrivateCall/CancelTimeout

OffNetwork/PrivateCall/CancelTimeout

Status	Occurrence	Format	Min. Access Types
Required	One	int	Get, Replace

This leaf node indicates timeout value for the cancellation of an in progress emergency for an MCPTT private call.

- Values: 0-65535

The CancelTimeout is in seconds.

7.2.15 /<x>/OffNetwork/EmergencyCall

Table 7.2.15.1: /<x>/OffNetwork/EmergencyCall

OffNetwork/EmergencyCall

Status	Occurrence	Format	Min. Access Types
Required	One	node	Get, Replace

This interior node indicates a placeholder for the MCPTT emergency call policy.

7.2.16 /<x>/OffNetwork/EmergencyCall/MCPTTGroupTimeout

Table 7.2.16.1: /<x>/OffNetwork/EmergencyCall/MCPTTGroupTimeout

OffNetwork/EmergencyCall/MCPTTGroupTimeout

Status	Occurrence	Format	Min. Access Types
Required	One	int	Get, Replace

This leaf node indicates time limit for an in progress MCPTT emergency call related to an MCPTT group.

- Values: 0-65535

The GroupTimeout is in seconds.

7.2.17 /<x>/OffNetwork/NumLevelHierarchy

Table 7.2.17.1: /<x>/OffNetwork/NumLevelHierarchy

OffNetwork/NumLevelHierarchy

Status	Occurrence	Format	Min. Access Types
Required	One	int	Get, Replace

This leaf node indicates the number of levels of hierarchy for floor control override in off-network.

- Values: 4-256

The request with the lowest NumLevelHierarchy value shall be considered as the request having the lowest priority level given to override an active transmission among the requests.

7.2.18 /<x>/OffNetwork/TransmitTimeout

Table 7.2.18.1: /<x>/OffNetwork/TransmitTimeout

OffNetwork/TransmitTimeout

Status	Occurrence	Format	Min. Access Types
Required	One	int	Get, Replace

This leaf node indicates transmit time limit from a single request to transmit in a group or private call.

- Values: 0-65535

The TransmitTimeout is in seconds.

7.2.19 /<x>/OffNetwork/TransmissionWarning

Table 7.2.19.1: /<x>/OffNetwork/TransmissionWarning

OffNetwork/TransmissionWarning

Status	Occurrence	Format	Min. Access Types
Required	One	int	Get, Replace

This leaf node indicates configuration of warning time before time limit of transmission is reached (off-network).

- Values: 0-255

The TransmissionWarning time is in seconds.

7.2.20 /<x>/OffNetwork/HangTimeWarning

Table 7.2.20.1: /<x>/OffNetwork/HangTimeWarning

OffNetwork/HangTimeWarning

Status	Occurrence	Format	Min. Access Types
Required	One	int	Get, Replace

This leaf node indicates configuration of warning time before hang time is reached (off-network).

- Values: 0-255

The HangTimeWarning time is in seconds.

7.2.21 /<x>/OffNetwork/DefaultPPPP

Table 7.2.21.1: /<x>/OffNetwork/DefaultPPPP

OffNetwork/DefaultPPPP

Status	Occurrence	Format	Min. Access Types
Required	One	node	Get, Replace

This interior node is a placeholder for the default ProSe Per-Packet Priority (PPPP) configuration.

7.2.22 /<x>/OffNetwork/DefaultPPPP/MCPTTPrivateCallSignalling

Table 7.2.22.1: /<x>/OffNetwork/DefaultPPPP/MCPTTPrivateCallSignalling

OffNetwork/DefaultPPPP/MCPTTPrivateCallSignalling

Status	Occurrence	Format	Min. Access Types
Required	One	int	Get, Replace

This leaf node indicates the default ProSe Per-Packet Priority (PPPP) value (as specified in 3GPP TS 23.303 [6]) for the MCPTT private call signalling.

- Values: 1-8

The MCPTT user data with the lowest ProSe Per-Packet Priority value shall be considered as the MCPTT user data having the highest priority among the MCPTT user data.

7.2.23 /<x>/OffNetwork/DefaultPPPP/MCPTTPrivateCallMedia

Table 7.2.23.1: /<x>/OffNetwork/DefaultPPPP/MCPTTPrivateCallMedia

OffNetwork/DefaultPPPP/MCPTTPrivateCallMedia

Status	Occurrence	Format	Min. Access Types
Required	One	int	Get, Replace

This leaf node indicates the default ProSe Per-Packet Priority (PPPP) value (as specified in 3GPP TS 23.303 [6]) for the MCPTT private call media.

- Values: 1-8

The MCPTT user data with the lowest ProSe Per-Packet Priority value shall be considered as the MCPTT user data having the highest priority among the MCPTT user data.

7.2.24

/<x>/OffNetwork/DefaultPPPP/MCPTTEmergencyPrivateCallSignalling

Table 7.2.24.1: /<x>/OffNetwork/DefaultPPPP/MCPTTEmergencyPrivateCallSignalling

OffNetwork/DefaultPPPP/MCPTTEmergencyPrivateCallSignalling

Status	Occurrence	Format	Min. Access Types
Required	One	int	Get, Replace

This leaf node indicates the default ProSe Per-Packet Priority (PPPP) value (as specified in 3GPP TS 23.303 [6]) for the MCPTT emergency private call signalling.

- Values: 1-8

The MCPTT user data with the lowest ProSe Per-Packet Priority value shall be considered as the MCPTT user data having the highest priority among the MCPTT user data.

7.2.25 /<x>/OffNetwork/DefaultPPPP/MCPTTEmergencyPrivateCallMedia

Table 7.2.25.1: /<x>/OffNetwork/DefaultPPPP/MCPTTEmergencyPrivateCallMedia

OffNetwork/DefaultPPPP/MCPTTEmergencyPrivateCallMedia

Status	Occurrence	Format	Min. Access Types
Required	One	int	Get, Replace

This leaf node indicates the default ProSe Per-Packet Priority (PPPP) value (as specified in 3GPP TS 23.303 [6]) for the MCPTT emergency private call media.

- Values: 1-8

The MCPTT user data with the lowest ProSe Per-Packet Priority value shall be considered as the MCPTT user data having the highest priority among the MCPTT user data.

7.2.26 /<x>/OffNetwork/LogMetadata

Table 7.2.26.1: /<x>/OffNetwork/LogMetadata

OffNetwork/LogMetadata

Status	Occurrence	Format	Min. Access Types
Required	One	bool	Get, Replace

This leaf node indicates whether logging of metadata for MCPTT group calls, MCPTT private calls and non-call activities is permitted.

When set to "true" logging of metadata for MCPTT group calls, MCPTT private calls and non-call activities, is enabled.

When set to "false" logging of metadata for MCPTT group calls, MCPTT private calls and non-call activities, is not enabled.

8 MCS UE initial configuration MO

8.1 General

The MCS UE initial configuration Management Object (MO) is used to configure the MCS Client behaviour for the on-network or off-network MCS Service. The MCS UE initial configuration parameters may be stored in the ME, or in the USIM as specified in 3GPP TS 31.102 [10], or in both the ME and the USIM. If both the ME and the USIM contain the same parameters, the values stored in the USIM shall take precedence.

NOTE: For historical reasons some of the elements in the MCS UE initial MO uses the terminology "MCPTT", however this MO is common to all MCS with some MCPTT specific elements, some MCDATA specific elements and some MCVideo specific elements. Not all elements that contain the terminology "MCPTT" are just MCPTT specific.

The Management Object Identifier is: urn:oma:mo:ext-3gpp-MCPTT-UE-initial-configuration:1.0.

Protocol compatibility: This MO is compatible with OMA OMA DM 1.2 [3].

The OMA DM ACL property mechanism (see OMA OMA-ERELD-DM-V1_2 [2]) may be used to grant or deny access rights to OMA DM servers in order to modify nodes and leaf objects of the MCPTT user profile MO.

The following nodes and leaf objects are possible under the MCPTT node as described in figure 8.1.1, figure 8.1.2, figure 8.1.3 and figure 8.1.4:

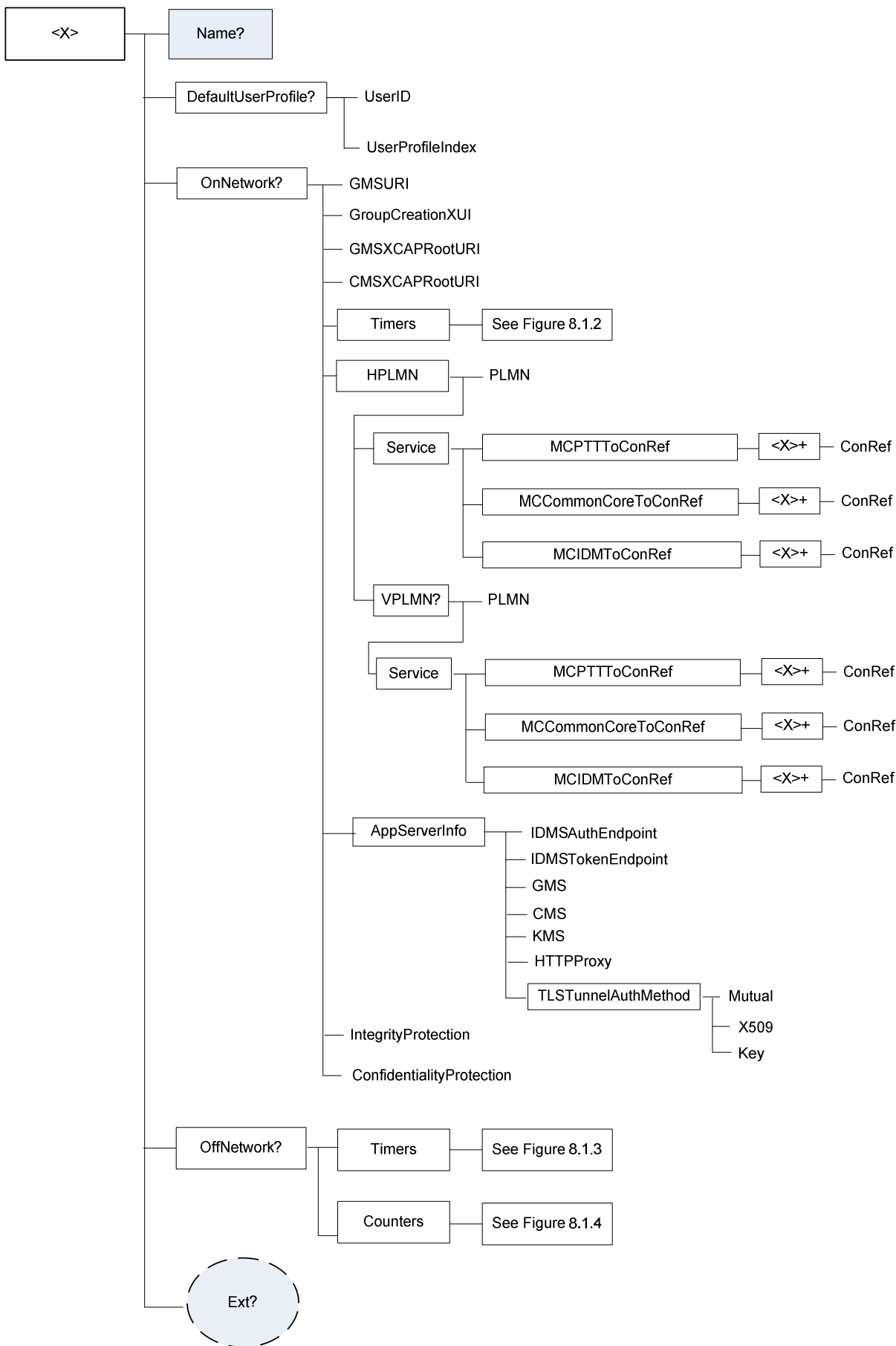

Figure 8.1.1: The MCS UE initial configuration MO (1 of 4)

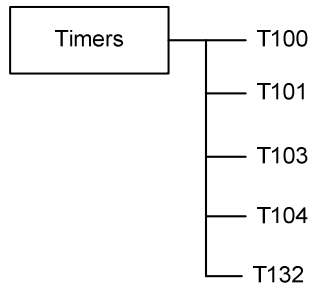

Figure 8.1.2: The MCS UE initial configuration MO (2 of 4)

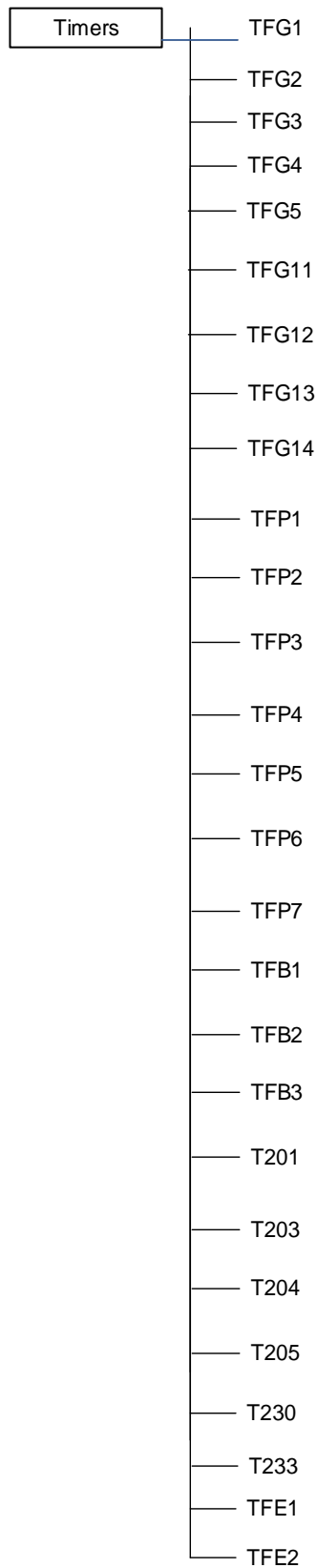

Figure 8.1.3: The MCS UE initial configuration MO (3 of 4)

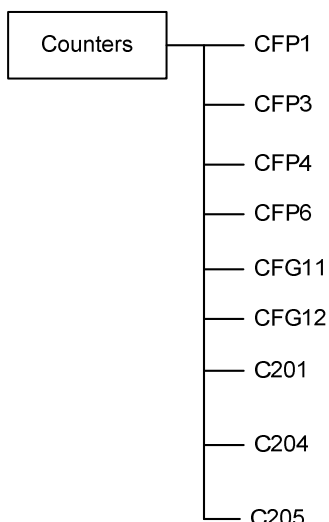

Figure 8.1.4: The MCS UE initial configuration MO (4 of 4)

8.2 MCS UE initial configuration MO parameters

8.2.1 General

This clause describes the parameters for the MCS UE initial configuration Management Object (MO).

8.2.2 Node: <x>

Table 8.2.2.1: Node: <x>

<x>

Status	Occurrence	Format	Min. Access Types
Required	OneOrMore	node	Get

This interior node acts as a placeholder for the MCS UE initial configuration Management Object (MO).

For the MCS UE initial configuration MO, the namespace specific string is: "urn:oma:mo:oma-dm-mcptt-ue-initial-configuration:1.0"

- Values: N/A

8.2.3 /<x>/Name

Table 8.2.3.1: /<x>/Name

Name

Status	Occurrence	Format	Min. Access Types
Required	ZeroOrOne	chr	Get

The Name leaf is a name for the MCPTT UE initial configuration settings.

- Values: <User displayable name>

8.2.4 /<x>/Ext/

Table 8.2.4.1: /<x>/Ext/

Ext

Status	Occurrence	Format	Min. Access Types
Optional	ZeroOrOne	node	Get, Replace

The Ext is an interior node for where the vendor specific information about the MCPTT UE initial configuration MO is being placed.

Usually the vendor extension is identified by vendor specific name under the ext node and contains the vendor meaning application vendor, device vendor etc. The tree structure under the vendor identified is not defined and can therefore include one or more un-standardized sub-trees.

- Values: N/A

8.2.5 /<x>/DefaultUserProfile

Table 8.2.5.1: /<x>/Ext/DefaultUserProfile

DefaultUserProfile

Status	Occurrence	Format	Min. Access Types
Required	ZeroOrOne	node	Get, Replace

This interior node represents a container for the default user profile.

The DefaultUserProfile nodes are:

- the same MCPTT user profile nodes defined in MCPTT user profile MO with a default MCPTT user ID;
- the same MCDData user profile nodes defined in MCDData user profile MO with a default MCDData user ID; or
- the same MCVideo user profile nodes defined in MCVideo user profile MO with a default MCVideo user ID;

8.2.6 /<x>/DefaultUserProfile/UserID

Table 8.2.6.1: /<x>/Ext/DefaultUserProfile/UserID

DefaultUserProfile/UserID

Status	Occurrence	Format	Min. Access Types
Required	One	chr	Get, Replace

This leaf node indicates a default MCS user identity.

8.2.7 /<x>/DefaultUserProfile/UserProfileIndex

Table 8.2.7.1: /<x>/Ext/DefaultUserProfile/UserProfileIndex

DefaultUserProfile/UserProfileIndex

Status	Occurrence	Format	Min. Access Types
Required	One	int	Get, Replace

This leaf node represents an indicator for the particular user profile.

- Values: 0-255

8.2.8 /<x>/OnNetwork

Table 8.2.8.1: /<x>/OnNetwork

OnNetwork

Status	Occurrence	Format	Min. Access Types
Required	ZeroOrOne	node	Get, Replace

This interior node represents a container for on-network operation.

8.2.9 /<x>/OnNetwork/GMSURI

Table 8.2.9.1: <x>/OnNetwork/GMSURI

OnNetwork/GMSURI

Status	Occurrence	Format	Min. Access Types
Required	One	chr	Get, Replace

This leaf node indicates the group management service URI information which contains the public service identity for performing subscription proxy function of the GMS.

The value is a URI as specified in 3GPP TS 23.003 [5].

8.2.9A /<x>/OnNetwork/GroupCreationXUI

Table 8.2.9A.1: <x>/OnNetwork/GroupCreationXUI

OnNetwork/GroupCreationXUI

Status	Occurrence	Format	Min. Access Types
Required	One	chr	Get, Replace

This leaf node indicates the group creation XUI information for creation of groups.

The value is a URI as specified in 3GPP TS 23.003 [5].

8.2.9B /<x>/OnNetwork/GMSXCAPRootURI

Table 8.2.9B.1: <x>/OnNetwork/GMSXCAPRootURI

OnNetwork/GMSXCAPRootURI

Status	Occurrence	Format	Min. Access Types
Required	One	chr	Get, Replace

This leaf node indicates the group management server XCAP Root URI information.

The value is a URI as specified in 3GPP TS 23.003 [5].

8.2.9C /<x>/OnNetwork/CMSXCAPRootURI

Table 8.2.9C.1: <x>/OnNetwork/CMSXCAPRootURI

OnNetwork/CMSXCAPRootURI

Status	Occurrence	Format	Min. Access Types
Required	One	chr	Get, Replace

This leaf node indicates the configuration management server XCAP Root URI information.

The value is a URI as specified in 3GPP TS 23.003 [5].

8.2.10 /<x>/OnNetwork/Timers

Table 8.2.10.1: /<x>/OnNetwork/Timers

OnNetwork/Timers

Status	Occurrence	Format	Min. Access Types
Required	One	node	Get, Replace

This interior node is a placeholder for timer configuration.

8.2.11 /<x>/OnNetwork/Timers/T100

Table 8.2.11.1: /<x>/OnNetwork/Timers/T100

OnNetwork/Timers/T100

Status	Occurrence	Format	Min. Access Types
Required	One	int	Get, Replace

This leaf node indicates the MCPTT timer for floor release as specified in 3GPP TS 24.380 [8].

- Values: 0-255

The T100 is in seconds.

8.2.12 /<x>/OnNetwork/Timers/T101

Table 8.2.12.1: /<x>/OnNetwork/Timers/T101

OnNetwork/Timers/T101

Status	Occurrence	Format	Min. Access Types
Required	One	int	Get, Replace

This leaf node indicates the MCPTT timer for floor request as specified in 3GPP TS 24.380 [8].

- Values: 0-255

The timer T101 is in seconds.

8.2.13 /<x>/OnNetwork/Timers/T103

Table 8.2.13.1: /<x>/OnNetwork/Timers/T103

OnNetwork/Timers/T103

Status	Occurrence	Format	Min. Access Types
Required	One	int	Get, Replace

This leaf node indicates the MCPTT timer for end of RTP media as specified in 3GPP TS 24.380 [8].

- Values: 0-255

The timer T103 is in seconds.

8.2.14 /<x>/OnNetwork/Timers/T104

Table 8.2.14.1: /<x>/OnNetwork/Timers/T104

OnNetwork/Timers/T104

Status	Occurrence	Format	Min. Access Types
Required	One	int	Get, Replace

This leaf node indicates the MCPTT timer for floor queue position request as specified in 3GPP TS 24.380 [8].

- Values: 0-255

The timer T104 is in seconds.

8.2.15 /<x>/OnNetwork/Timers/T132

Table 8.2.15.1: /<x>/OnNetwork/Timers/T132

OnNetwork/Timers/T132

Status	Occurrence	Format	Min. Access Types
Required	One	int	Get, Replace

This leaf node indicates the MCPTT timer for queued request granted MCPTT user action as specified in 3GPP TS 24.380 [8].

- Values: 0-255

The timer T132 is in seconds.

8.2.16 /<x>/OnNetwork/HPLMN

Table 8.2.16.1: /<x>/OnNetwork/HPLMN

OnNetwork/HPLMN

Status	Occurrence	Format	Min. Access Types
Required	One	node	Get, Replace

This interior node is a placeholder for the HPLMN configuration.

8.2.17 /<x>/OnNetwork/HPLMN/PLMN

Table 8.2.17.1: /<x>/OnNetwork/HPLMN/PLMN

OnNetwork/HPLMN/PLMN

Status	Occurrence	Format	Min. Access Types
Required	One	chr	Get, Replace

This leaf node indicates the HPLMN code.

- Values: <PLMN>

The format of the PLMN is defined by 3GPP TS 23.003 [5].

8.2.18 /<x>/OnNetwork/HPLMN/Service

Table 8.2.18.1: /<x>/OnNetwork/HPLMN/Service

OnNetwork/HPLMN/Service

Status	Occurrence	Format	Min. Access Types
Required	One	node	Get, Replace

This interior node indicates the MCS related services on a per HPLMN basis.

8.2.19 /<x>/OnNetwork/HPLMN/Service/MCPTTTtoConRef

Table 8.2.19.1: /<x>/OnNetwork/HPLMN/Service/MCPTTTtoConRef

OnNetwork/HPLMN/Service/MCPTTTtoConRef

Status	Occurrence	Format	Min. Access Types
Required	One	node	Get, Replace

This interior node contains the configuration parameters for establishment of the PDN connection for the MCS service on a per HPLMN basis.

8.2.20 /<x>/OnNetwork/HPLMN/Service/MCPTTTtoConRef/<x>

Table 8.2.20.1: /<x>/OnNetwork/HPLMN/Service/MCPTTTtoConRef/<x>

OnNetwork/HPLMN/Service/MCPTTTtoConRef/<x>

Status	Occurrence	Format	Min. Access Types

Required	OneorMore	node	Get, Replace
----------	-----------	------	--------------

This run-time node acts as a placeholder for each reference to the connectivity parameters on a per HPLMN basis.

8.2.21 /<x>/OnNetwork/HPLMN/Service/MCPTTToConRef/<x>/ConRef

Table 8.2.21.1: /<x>/OnNetwork/HPLMN/Service/MCPTTToConRef/<x>/ConRef

OnNetwork/HPLMN/Service/MCPTTToConRef/<x>/ConRef

Status	Occurrence	Format	Min. Access Types
Required	One	chr	Get, Replace

The ConRef specifies a specific linkage to the connectivity parameters on a per HPLMN basis.

- Values: <A network access point object>

8.2.22 /<x>/OnNetwork/HPLMN/Service/MCCommonCoreToConRef

Table 8.2.22.1: /<x>/OnNetwork/HPLMN/Service/MCCommonCoreToConRef

OnNetwork/HPLMN/Service/MCCommonCoreToConRef

Status	Occurrence	Format	Min. Access Types
Required	One	node	Get, Replace

This interior node contains the configuration parameters for establishment of the PDN connection for the MC common core service on a per HPLMN basis.

8.2.23 /<x>/OnNetwork/HPLMN/Service/MCCommonCoreToConRef/<x>

Table 8.2.23.1: /<x>/OnNetwork/HPLMN/Service/MCCommonCoreToConRef/<x>

OnNetwork/HPLMN/Service/MCCommonCoreToConRef/<x>

Status	Occurrence	Format	Min. Access Types
Required	OneorMore	node	Get, Replace

This run-time node acts as a placeholder for each reference to the connectivity parameters on a per HPLMN basis.

8.2.24

/<x>/OnNetwork/HPLMN/Service/MCCommonCoreToConRef/<x>/ConRef

Table 8.2.24.1: /<x>/OnNetwork/HPLMN/Service/MCCommonCoreToConRef/<x>/ConRef

OnNetwork/HPLMN/Service/MCCommonCoreToConRef/<x>/ConRef

Status	Occurrence	Format	Min. Access Types
Required	One	chr	Get, Replace

The ConRef specifies a specific linkage to the connectivity parameters on a per HPLMN basis.

- Values: <A network access point object>

8.2.25 /<x>/OnNetwork/HPLMN/Service/MCIDMToConRef

Table 8.2.25.1: /<x>/OnNetwork/HPLMN/Service/MCIDMToConRef

OnNetwork/HPLMN/Service/MCIDMToConRef

Status	Occurrence	Format	Min. Access Types
Required	One	node	Get, Replace

This interior node contains the configuration parameters for establishment of the PDN connection for the MC identity management service on a per HPLMN basis.

8.2.26 /<x>/OnNetwork/HPLMN/Service/MCIDMTtoConRef/<x>

Table 8.2.26.1: /<x>/OnNetwork/HPLMN/Service/MCIDMTtoConRef/<x>

OnNetwork/HPLMN/Service/MCIDMTtoConRef/<x>

Status	Occurrence	Format	Min. Access Types
Required	OneorMore	node	Get, Replace

This run-time node acts as a placeholder for each reference to the connectivity parameters on a per HPLMN basis.

8.2.27 /<x>/OnNetwork/HPLMN/Service/MCIDMTtoConRef/<x>/ConRef

Table 8.2.27.1: /<x>/OnNetwork/HPLMN/Service/MCIDMTtoConRef/<x>/ConRef

OnNetwork/HPLMN/Service/MCIDMTtoConRef/<x>/ConRef

Status	Occurrence	Format	Min. Access Types
Required	One	chr	Get, Replace

The ConRef specifies a specific linkage to the connectivity parameters on a per HPLMN basis.

- Values: <A network access point object>

8.2.28 /<x>/OnNetwork/HPLMN/VPLMN

Table 8.2.28.1: /<x>/OnNetwork/HPLMN/VPLMN

OnNetwork/HPLMN/VPLMN

Status	Occurrence	Format	Min. Access Types
Optional	ZeroOrOne	chr	Get, Replace

This interior node is a placeholder for the VPLMN configuration.

8.2.29 /<x>/OnNetwork/HPLMN/VPLMN/PLMN

Table 8.2.29.1: /<x>/OnNetwork/HPLMN/VPLMN/PLMN

OnNetwork/HPLMN/VPLMN/PLMN

Status	Occurrence	Format	Min. Access Types
Required	One	chr	Get, Replace

This leaf node indicates the VPLMN code.

- Values: <PLMN>

The format of the PLMN is defined by 3GPP TS 23.003 [5].

8.2.30 /<x>/OnNetwork/HPLMN/VPLMN/Service

Table 8.2.30.1: /<x>/OnNetwork/HPLMN/VPLMN/Service

OnNetwork/HPLMN/VPLMN/Service

Status	Occurrence	Format	Min. Access Types
Required	One	node	Get, Replace

This interior node indicates the MCS related services on a per VPLMN and HPLMN basis.

8.2.31 /<x>/OnNetwork/HPLMN/VPLMN/Service/MCPTTTToConRef

Table 8.2.31.1: /<x>/OnNetwork/HPLMN/VPLMN/Service/MCPTTTToConRef

OnNetwork/HPLMN/VPLMN/Service/MCPTTTToConRef

Status	Occurrence	Format	Min. Access Types
Required	One	node	Get, Replace

This interior node contains the configuration parameters for establishment of the PDN connection for the MCS service on a per VPLMN and HPLMN basis.

8.2.32 /<x>/OnNetwork/HPLMN/VPLMN/Service/MCPTTTToConRef/<x>

Table 8.2.32.1: /<x>/OnNetwork/HPLMN/Service/MCPTTTToConRef/<x>

OnNetwork/HPLMN/VPLMN/Service/MCPTTTToConRef/<x>

Status	Occurrence	Format	Min. Access Types
Required	OneorMore	node	Get, Replace

This run-time node acts as a placeholder for each reference to the connectivity parameters on a per VPLMN and HPLMN basis.

8.2.33

/<x>/OnNetwork/HPLMN/VPLMN/Service/MCPTTTToConRef/<x>/ConRef

Table 8.2.33.1: /<x>/OnNetwork/HPLMN/VPLMN/Service/MCPTTTToConRef/<x>/ConRef

OnNetwork/HPLMN/VPLMN/Service/MCPTTTToConRef/<x>/ConRef

Status	Occurrence	Format	Min. Access Types
Required	One	chr	Get, Replace

The ConRef specifies a specific linkage to the connectivity parameters on a per VPLMN and HPLMN basis.

- Values: <A network access point object>

8.2.34

/<x>/OnNetwork/HPLMN/VPLMN/Service/MCCommonCoreToConRef

Table 8.2.34.1: /<x>/OnNetwork/HPLMN/VPLMN/Service/MCCommonCoreToConRef

OnNetwork/HPLMN/VPLMN/Service/MCCommonCoreToConRef

Status	Occurrence	Format	Min. Access Types
Required	One	node	Get, Replace

This interior node contains the configuration parameters for establishment of the PDN connection for the MC common core service on a per VPLMN and HPLMN basis.

8.2.35

/<x>/OnNetwork/HPLMN/VPLMN/Service/MCCommonCoreToConRef/<x>

Table 8.2.35.1: /<x>/OnNetwork/HPLMN/VPLMN/Service/MCCommonCoreToConRef/<x>

OnNetwork/HPLMN/VPLMN/Service/MCCommonCoreToConRef/<x>

Status	Occurrence	Format	Min. Access Types

Required	OneorMore	node	Get, Replace
----------	-----------	------	--------------

This run-time node acts as a placeholder for each reference to the connectivity parameters on a per VPLMN and HPLMN basis.

8.2.36

`/<x>/OnNetwork/HPLMN/VPLMN/Service/MCCCommonCoreToConRef/<x>/ConRef`

Table 8.2.36.1: `/<x>/OnNetwork/HPLMN/VPLMN/Service/MCCCommonCoreToConRef/<x>/ConRef`

`OnNetwork/HPLMN/VPLMN/Service/MCCCommonCoreToConRef/<x>/ConRef`

Status	Occurrence	Format	Min. Access Types
Required	One	chr	Get, Replace

The ConRef specifies a specific linkage to the connectivity parameters on a per VPLMN and HPLMN basis.

- Values: <A network access point object>

8.2.37 `/<x>/OnNetwork/HPLMN/VPLMN/Service/MCIDMTToConRef`

Table 8.2.37.1: `/<x>/OnNetwork/HPLMN/VPLMN/Service/MCIDMTToConRef`

`OnNetwork/HPLMN/VPLMN/Service/MCIDMTToConRef`

Status	Occurrence	Format	Min. Access Types
Required	One	node	Get, Replace

This interior node contains the configuration parameters for establishment of the PDN connection for the MC identity management service on a per VPLMN and HPLMN basis.

8.2.38 `/<x>/OnNetwork/HPLMN/VPLMN/Service/MCIDMTToConRef/<x>`

Table 8.2.38.1: `/<x>/OnNetwork/HPLMN/VPLMN/Service/MCIDMTToConRef/<x>`

`OnNetwork/HPLMN/VPLMN/Service/MCIDMTToConRef/<x>`

Status	Occurrence	Format	Min. Access Types
Required	OneorMore	node	Get, Replace

This run-time node acts as a placeholder for each reference to the connectivity parameters on a per VPLMN and HPLMN basis.

8.2.39

`/<x>/OnNetwork/HPLMN/VPLMN/Service/MCIDMTToConRef/<x>/ConRef`

Table 8.2.39.1: `/<x>/OnNetwork/HPLMN/VPLMN/Service/MCIDMTToConRef/<x>/ConRef`

`OnNetwork/HPLMN/VPLMN/Service/MCIDMTToConRef/<x>/ConRef`

Status	Occurrence	Format	Min. Access Types
Required	One	chr	Get, Replace

The ConRef specifies a specific linkage to the connectivity parameters on a per VPLMN and HPLMN basis.

- Values: <A network access point object>

8.2.40 /<x>/OnNetwork/AppServerInfo

Table 8.2.40.1: /<x>/OnNetwork/AppServerInfo

OnNetwork/AppServerInfo

Status	Occurrence	Format	Min. Access Types
Required	One	node	Get, Replace

This interior node is a placeholder for the application plane server identity information configuration.

8.2.41 /<x>/OnNetwork/AppServerInfo/IDMSAuthEndpoint

Table 8.2.41.1: /<x>/OnNetwork/AppServerInfo/IDMSAuthEndpoint

OnNetwork/AppServerInfo/IDMSAuthEndpoint

Status	Occurrence	Format	Min. Access Types
Required	One	chr	Get, Replace

This leaf node indicates the identity management server authorisation endpoint identity information.

The value is a URI as specified in 3GPP TS 23.003 [5].

8.2.41A /<x>/OnNetwork/AppServerInfo/IDMSTokenEndpoint

Table 8.2.41A.1: /<x>/OnNetwork/AppServerInfo/IDMSTokenEndpoint

OnNetwork/AppServerInfo/IDMSTokenEndpoint

Status	Occurrence	Format	Min. Access Types
Required	One	chr	Get, Replace

This leaf node indicates the identity management server token endpoint identity information.

The value is a URI as specified in 3GPP TS 23.003 [5].

8.2.41B /<x>/OnNetwork/AppServerInfo/HTTPProxy

Table 8.2.41B.1: /<x>/OnNetwork/AppServerInfo/HTTPProxy

OnNetwork/AppServerInfo/HTTPProxy

Status	Occurrence	Format	Min. Access Types
Required	One	chr	Get, Replace

This leaf node indicates the HTTP Proxy identity information.

The value is a URI as specified in 3GPP TS 23.003 [5].

8.2.42 /<x>/OnNetwork/AppServerInfo/GMS

Table 8.2.42.1: /<x>/OnNetwork/AppServerInfo/GMS

OnNetwork/AppServerInfo/GMS

Status	Occurrence	Format	Min. Access Types
Required	One	chr	Get, Replace

This leaf node indicates the group management server identity information.

The value is a URI as specified in 3GPP TS 23.003 [5].

8.2.43 /<x>/OnNetwork/AppServerInfo/CMS

Table 8.2.43.1: /<x>/OnNetwork/AppServerInfo/CMS

OnNetwork/AppServerInfo/CMS

Status	Occurrence	Format	Min. Access Types
Required	One	chr	Get, Replace

This leaf node indicates the configuration management server identity information.

The value is a URI as specified in 3GPP TS 23.003 [5].

8.2.44 /<x>/OnNetwork/AppServerInfo/KMS

Table 8.2.44.1: /<x>/OnNetwork/AppServerInfo/KMS

OnNetwork/AppServerInfo/KMS

Status	Occurrence	Format	Min. Access Types
Required	One	chr	Get, Replace

This leaf node indicates key management server identity information.

The value is a URI as specified in 3GPP TS 23.003 [5].

8.2.44A /<x>/OnNetwork/AppServerInfo/TLSTunnelAuthMethod

Table 8.2.44A.1: /<x>/OnNetwork/AppServerInfo/TLSTunnelAuthMethod

OnNetwork/AppServerInfo/TLSTunnelAuthMethod

Status	Occurrence	Format	Min. Access Types
Required	One	node	Get, Replace

This interior node is a placeholder for the TLS tunnel authentication method configuration.

8.2.44B /<x>/OnNetwork/AppServerInfo/TLSTunnelAuthMethod/Mutual

Table 8.2.44B.1: /<x>/OnNetwork/AppServerInfo/TLSTunnelAuthMethod/Mutual

OnNetwork/AppServerInfo/TLSTunnelAuthMethod/Mutual

Status	Occurrence	Format	Min. Access Types
Required	One	bool	Get, Replace

This leaf node indicates whether mutual authentication is used for the TLS tunnel authentication.

When set to "true" mutual authentication is used.

When set to "false" one-way authentication based on the server certificate is used.

The default value is "false".

8.2.44C /<x>/OnNetwork/AppServerInfo/TLSTunnelAuthMethod/X509

Table 8.2.44C.1: /<x>/OnNetwork/AppServerInfo/TLSTunnelAuthMethod/X509

OnNetwork/AppServerInfo/TLSTunnelAuthMethod/X509

Status	Occurrence	Format	Min. Access Types
Optional	One	chr	Get, Replace

This leaf node contains the X.509 certificate for mutual authentication for the TLS tunnel authentication.

8.2.44D /<x>/OnNetwork/AppServerInfo/TLSTunnelAuthMethod/Key

Table 8.2.44D.1: /<x>/OnNetwork/AppServerInfo/TLSTunnelAuthMethod/Key

OnNetwork/AppServerInfo/TLSTunnelAuthMethod/Key

Status	Occurrence	Format	Min. Access Types
Optional	One	chr	Get, Replace

This leaf node contains the pre-shared key for mutual authentication for the TLS tunnel authentication.

8.2.44E /<x>/OnNetwork/IntegrityProtection

Table 8.2.44E.1: /<x>/OnNetwork/IntegrityProtection

OnNetwork/IntegrityProtection

Status	Occurrence	Format	Min. Access Types
Required	One	bool	Get, Replace

This leaf node indicates whether integrity protection is enabled.

When set to "true" integrity protection is enabled.

When set to "false" integrity protection is disabled.

The default value is "true".

8.2.44F /<x>/OnNetwork/ConfidentialityProtection

Table 8.2.44F.1: /<x>/OnNetwork/ConfidentialityProtection

OnNetwork/ConfidentialityProtection

Status	Occurrence	Format	Min. Access Types
Required	One	bool	Get, Replace

This leaf node indicates whether integrity protection is enabled.

When set to "true" confidentiality protection is enabled.

When set to "false" confidentiality protection is disabled.

The default value is "true".

8.2.45 /<x>/OffNetwork

Table 8.2.45.1: /<x>/OffNetwork

OffNetwork

Status	Occurrence	Format	Min. Access Types
Required	ZeroOrOne	node	Get, Replace

This interior node represents a container for the off-network operation.

8.2.46 /<x>/OffNetwork/Timers

Table 8.2.46.1: /<x>/OffNetwork/Timers

OffNetwork/Timers

Status	Occurrence	Format	Min. Access Types
Required	One	node	Get, Replace

This interior node is a placeholder for the timer configuration.

8.2.47 /<x>/OffNetwork/Timers/TFG1

Table 8.2.47.1: /<x>/OffNetwork/Timers/TFG1

OffNetwork/Timers/TFG1

Status	Occurrence	Format	Min. Access Types
Required	One	int	Get, Replace

This leaf node indicates the MCPTT timer for wait for call announcement as specified in 3GPP TS 24.379 [7].

- Values: 0-65535

The timer TFG1 is in milliseconds.

8.2.48 /<x>/OffNetwork/Timers/TFG2

Table 8.2.48.1: /<x>/OffNetwork/Timers/TFG2

OffNetwork/Timers/TFG2

Status	Occurrence	Format	Min. Access Types
Required	One	int	Get, Replace

This leaf node indicates the MCPTT timer for call announcement as specified in 3GPP TS 24.379 [7].

- Values: 0-65535

The timer TFG2 is in milliseconds.

8.2.49 /<x>/OffNetwork/Timers/TFG3

Table 8.2.49.1: /<x>/OffNetwork/Timers/TFG3

OffNetwork/Timers/TFG3

Status	Occurrence	Format	Min. Access Types
Required	One	int	Get, Replace

This leaf node indicates the MCPTT timer for call probe retransmission as specified in 3GPP TS 24.379 [7].

- Values: 0-65535

The timer TFG3 is in milliseconds.

8.2.50 /<x>/OffNetwork/Timers/TFG4

Table 8.2.50.1: /<x>/OffNetwork/Timers/TFG4

OffNetwork/Timers/TFG4

Status	Occurrence	Format	Min. Access Types
Required	One	int	Get, Replace

This leaf node indicates the MCPTT timer for waiting for the MCPTT user as specified in 3GPP TS 24.379 [7].

- Values: 0-60

The timer TFG4 is in seconds.

8.2.51 /<x>/OffNetwork/Timers/TFG5

Table 8.2.51.1: /<x>/OffNetwork/Timers/TFG5

OffNetwork/Timers/TFG5

Status	Occurrence	Format	Min. Access Types
Required	One	int	Get, Replace

This leaf node indicates the MCPTT timer for not present incoming call announcements as specified in 3GPP TS 24.379 [7].

- Values: 0-255

The timer TFG5 is in seconds.

8.2.52 /<x>/OffNetwork/Timers/TFG11

Table 8.2.52.1: /<x>/OffNetwork/Timers/TFG11

OffNetwork/Timers/TFG11

Status	Occurrence	Format	Min. Access Types
Required	One	int	Get, Replace

This leaf node indicates the timer for MCPTT emergency end retransmission as specified in 3GPP TS 24.379 [7].

- Values: 0-65535

The timer TFG11 is in milliseconds.

8.2.53 /<x>/OffNetwork/Timers/TFG12

Table 8.2.53.1: /<x>/OffNetwork/Timers/TFG12

OffNetwork/Timers/TFG12

Status	Occurrence	Format	Min. Access Types
Required	One	int	Get, Replace

This leaf node indicates the timer for MCPTT imminent peril end retransmission as specified in 3GPP TS 24.379 [7].

- Values: 0-65535

The timer TFG12 is in milliseconds.

8.2.54 /<x>/OffNetwork/Timers/TFG13

Table 8.2.54.1: /<x>/OffNetwork/Timers/TFG13

OffNetwork/Timers/TFG13

Status	Occurrence	Format	Min. Access Types
Required	One	int	Get, Replace

This leaf node indicates the MCPTT timer for implicit priority downgrade as specified in 3GPP TS 24.379 [7].

- Values: 0-255

The timer TFG13 is in seconds.

8.2.54A /<x>/OffNetwork/Timers/TFG14

Table 8.2.54A.1: /<x>/OffNetwork/Timers/TFG14

OffNetwork/Timers/TFG14

Status	Occurrence	Format	Min. Access Types
Required	One	int	Get, Replace

This leaf node indicates the MCPTT timer for implicit priority downgrade (imminent peril) as specified in 3GPP TS 24.379 [7].

- Values: 0-255

The timer TFG14 is in seconds.

8.2.55 /<x>/OffNetwork/Timers/TFP1

Table 8.2.55.1: /<x>/OffNetwork/Timers/TFP1

OffNetwork/Timers/TFP1

Status	Occurrence	Format	Min. Access Types
Required	One	int	Get, Replace

This leaf node indicates the MCPTT timer for private call request retransmission as specified in 3GPP TS 24.379 [7].

- Values: 0-65535

The timer TFP1 is in milliseconds.

8.2.56 /<x>/OffNetwork/Timers/TFP2

Table 8.2.56.1: /<x>/OffNetwork/Timers/TFP2

OffNetwork/Timers/TFP2

Status	Occurrence	Format	Min. Access Types
Required	One	int	Get, Replace

This leaf node indicates the MCPTT timer for waiting for call response message as specified in 3GPP TS 24.379 [7].

- Values: 0-60

The timer TFP2 is in seconds.

8.2.57 /<x>/OffNetwork/Timers/TFP3

Table 8.2.57.1: /<x>/OffNetwork/Timers/TFP3

OffNetwork/Timers/TFP3

Status	Occurrence	Format	Min. Access Types
Required	One	int	Get, Replace

This leaf node indicates the MCPTT timer for private call release retransmission as specified in 3GPP TS 24.379 [7].

- Values: 0-65535

The timer TFP3 is in milliseconds.

8.2.58 /<x>/OffNetwork/Timers/TFP4

Table 8.2.58.1: /<x>/OffNetwork/Timers/TFP4

OffNetwork/Timers/TFP4

Status	Occurrence	Format	Min. Access Types
Required	One	int	Get, Replace

This leaf node indicates the MCPTT timer for private call accept retransmission as specified in 3GPP TS 24.379 [7].

- Values: 0-65535

The timer TFP4 is in milliseconds.

8.2.59 /<x>/OffNetwork/Timers/TFP5

Table 8.2.59.1: /<x>/OffNetwork/Timers/TFP5

OffNetwork/Timers/TFP5

Status	Occurrence	Format	Min. Access Types
Required	One	int	Get, Replace

This leaf node indicates the MCPTT timer for call release as specified in 3GPP TS 24.379 [7].

- Values: 0-600

The timer TFP5 is in seconds.

8.2.60 /<x>/OffNetwork/Timers/TFP6

Table 8.2.60.1: /<x>/OffNetwork/Timers/TFP6

OffNetwork/Timers/TFP6

Status	Occurrence	Format	Min. Access Types
Required	One	int	Get, Replace

This leaf node indicates the MCPTT timer for MCPTT emergency private call cancel retransmission as specified in 3GPP TS 24.379 [7].

- Values: 0-65535

The timer TFP6 is in milliseconds.

8.2.61 /<x>/OffNetwork/Timers/TFP7

Table 8.2.61.1: /<x>/OffNetwork/Timers/TFP7

OffNetwork/Timers/TFP7

Status	Occurrence	Format	Min. Access Types
Required	One	int	Get, Replace

This leaf node indicates the MCPTT timer for waiting for any message with same call identifier as specified in 3GPP TS 24.379 [7].

- Values: 0-255

The timer TFP7 is in seconds.

8.2.62 /<x>/OffNetwork/Timers/TFB1

Table 8.2.62.1: /<x>/OffNetwork/Timers/TFB1

OffNetwork/Timers/TFB1

Status	Occurrence	Format	Min. Access Types
Required	One	int	Get, Replace

This leaf node indicates the MCPTT timer for max duration as specified in 3GPP TS 24.379 [7].

- Values: 0-600

The timer TFB1 is in seconds.

8.2.63 /<x>/OffNetwork/Timers/TFB2

Table 8.2.63.1: /<x>/OffNetwork/Timers/TFB2

OffNetwork/Timers/TFB2

Status	Occurrence	Format	Min. Access Types
Required	One	int	Get, Replace

This leaf node indicates the MCPTT timer for broadcast retransmission as specified in 3GPP TS 24.379 [7].

- Values: 0-10

The timer TFB2 is in seconds.

8.2.64 /<x>/OffNetwork/Timers/TFB3

Table 8.2.64.1: /<x>/OffNetwork/Timers/TFB3

OffNetwork/Timers/TFB3

Status	Occurrence	Format	Min. Access Types
Required	One	int	Get, Replace

This leaf node indicates the MCPTT timer for waiting for the MCPTT user as specified in 3GPP TS 24.379 [7].

- Values: 0-60

The timer TFB3 is in seconds.

8.2.65 /<x>/OffNetwork/Timers/T201

Table 8.2.65.1: /<x>/OffNetwork/Timers/T201

OffNetwork/Timers/T201

Status	Occurrence	Format	Min. Access Types
Required	One	int	Get, Replace

This leaf node indicates the MCPTT timer for floor request as specified in 3GPP TS 24.380 [8].

- Values: 0-65535

The timer T201 is in milliseconds.

8.2.66 /<x>/OffNetwork/Timers/T203

Table 8.2.66.1: /<x>/OffNetwork/Timers/T203

OffNetwork/Timers/T203

Status	Occurrence	Format	Min. Access Types
Required	One	int	Get, Replace

This leaf node indicates the MCPTT timer for end of RTP media as specified in 3GPP TS 24.380 [8].

- Values: 0-255

The timer T203 is in seconds.

8.2.67 /<x>/OffNetwork/Timers/T204

Table 8.2.67.1: /<x>/OffNetwork/Timers/T204

OffNetwork/Timers/T204

Status	Occurrence	Format	Min. Access Types
Required	One	int	Get, Replace

This leaf node indicates the MCPTT timer for floor queue position request as specified in 3GPP TS 24.380 [8].

- Values: 0-255

The timer T204 is in seconds.

8.2.68 /<x>/OffNetwork/Timers/T205

Table 8.2.68.1: /<x>/OffNetwork/Timers/T205

OffNetwork/Timers/T205

Status	Occurrence	Format	Min. Access Types
Required	One	int	Get, Replace

This leaf node indicates the MCPTT timer for floor granted request as specified in 3GPP TS 24.380 [8].

- Values: 0-255

The timer T205 is in seconds.

8.2.69 /<x>/OffNetwork/Timers/T230

Table 8.2.69.1: /<x>/OffNetwork/Timers/T230

OffNetwork/Timers/T230

Status	Occurrence	Format	Min. Access Types
Required	One	int	Get, Replace

This leaf node indicates the MCPTT timer for inactivity as specified in 3GPP TS 24.380 [8].

- Values: 0-255

The timer T230 is in seconds.

8.2.70 /<x>/OffNetwork/Timers/T233

Table 8.2.70.1: /<x>/OffNetwork/Timers/T233

OffNetwork/Timers/T233

Status	Occurrence	Format	Min. Access Types
Required	One	int	Get, Replace

This leaf node indicates the MCPTT timer for pending user action as specified in 3GPP TS 24.380 [8].

- Values: 0-255

The timer T233 is in seconds.

8.2.71 /<x>/OffNetwork/Timers/TFE1

Table 8.2.71.1: /<x>/OffNetwork/Timers/TFE1

OffNetwork/Timers/TFE1

Status	Occurrence	Format	Min. Access Types
Required	One	int	Get, Replace

This leaf node indicates the timer for MCPTT emergency alert as specified in 3GPP TS 24.379 [7].

- Values: 0-65535

The timer TFE1 is in seconds.

8.2.72 /<x>/OffNetwork/Timers/TFE2

Table 8.2.72.1: /<x>/OffNetwork/Timers/TFE2

OffNetwork/Timers/TFE2

Status	Occurrence	Format	Min. Access Types
Required	One	int	Get, Replace

This leaf node indicates the timer for MCPTT emergency alert retransmission as specified in 3GPP TS 24.379 [7].

- Values: 0-10

The timer TFE2 is in seconds.

8.2.73 /<x>/OffNetwork/Counters

Table 8.2.73.1: /<x>/OffNetwork/Counters

OffNetwork/Counters

Status	Occurrence	Format	Min. Access Types
Required	One	node	Get, Replace

This interior node is a placeholder for the counter configuration.

8.2.74 /<x>/OffNetwork/Counters/CFP1

Table 8.2.74.1: /<x>/OffNetwork/Counters/CFP1

OffNetwork/Counters/CFP1

Status	Occurrence	Format	Min. Access Types
Required	One	int	Get, Replace

This leaf node indicates the MCPTT counter for private call request retransmission as specified in 3GPP TS 24.379 [7].

- Values: 0-255

8.2.75 /<x>/OffNetwork/Counters/CFP3

Table 8.2.75.1: /<x>/OffNetwork/Counters/CFP3

OffNetwork/Counters/CFP3

Status	Occurrence	Format	Min. Access Types
Required	One	int	Get, Replace

This leaf node indicates the MCPTT counter for private call release retransmission as specified in 3GPP TS 24.379 [7].

- Values: 0-255

8.2.76 /<x>/OffNetwork/Counters/CFP4

Table 8.2.76.1: /<x>/OffNetwork/Counters/CFP4

OffNetwork/Counters/CFP4

Status	Occurrence	Format	Min. Access Types
Required	One	int	Get, Replace

This leaf node indicates the MCPTT counter for private call accept retransmission as specified in 3GPP TS 24.379 [7].

- Values: 0-255

8.2.77 /<x>/OffNetwork/Counters/CFP6

Table 8.2.77.1: /<x>/OffNetwork/Counters/CFP6

OffNetwork/Counters/CFP6

Status	Occurrence	Format	Min. Access Types
Required	One	int	Get, Replace

This leaf node indicates the MCPTT counter for emergency private call cancel retransmission as specified in 3GPP TS 24.379 [7].

- Values: 0-255

8.2.78 /<x>/OffNetwork/Counters/CFP11

Table 8.2.78.1: /<x>/OffNetwork/Counters/CFP11

OffNetwork/Counters/CFP11

Status	Occurrence	Format	Min. Access Types
Required	One	int	Get, Replace

This leaf node indicates the counter for MCPTT group call emergency end retransmission as specified in 3GPP TS 24.379 [7].

- Values: 0-255

8.2.79 /<x>/OffNetwork/Counters/CFP12

Table 8.2.79.1: /<x>/OffNetwork/Counters/CFP12

OffNetwork/Counters/CFP12

Status	Occurrence	Format	Min. Access Types
Required	One	int	Get, Replace

This leaf node indicates the counter for MCPTT imminent peril call emergency end retransmission as specified in 3GPP TS 24.379 [7].

- Values: 0-255

8.2.80 /<x>/OffNetwork/Counters/C201

Table 8.2.80.1: /<x>/OffNetwork/Counters/C201

OffNetwork/Counters/C201

Status	Occurrence	Format	Min. Access Types
Required	One	int	Get, Replace

This leaf node indicates the MCPTT counter for floor request as specified in 3GPP TS 24.380 [8].

- Values: 0-255

8.2.81 /<x>/OffNetwork/Counters/C204

Table 8.2.81.1: /<x>/OffNetwork/Counters/C204

OffNetwork/Counters/C204

Status	Occurrence	Format	Min. Access Types
Required	One	int	Get, Replace

This leaf node indicates the MCPTT counter for floor queue position request as specified in 3GPP TS 24.380 [8].

- Values: 0-255

8.2.82 /<x>/OffNetwork/Counters/C205

Table 8.2.82.1: /<x>/OffNetwork/Counters/C205

OffNetwork/Counters/C205

Status	Occurrence	Format	Min. Access Types
Required	One	int	Get, Replace

This leaf node indicates the MCPTT counter for floor granted request as specified in 3GPP TS 24.380 [8].

- Values: 0-255

9 MCDData UE configuration MO

9.1 General

The MCDData UE configuration Management Object (MO) is used to configure MCDData Client behaviour for the on-network or off-network MCDData Service. The MCDData UE configuration parameters may be stored in the ME, or in the USIM as specified in 3GPP TS 31.102 [10], or in both the ME and the USIM. If both the ME and the USIM contain the same parameters, the values stored in the USIM shall take precedence.

The Management Object Identifier is: urn:oma:mo:ext-3gpp-MCDData-UE-configuration:1.0.

Protocol compatibility: This MO is compatible with OMA OMA DM 1.2 [3].

The OMA DM ACL property mechanism (see OMA OMA-ERELED-DM-V1_2 [2]) may be used to grant or deny access rights to OMA DM servers in order to modify nodes and leaf objects of the MCDData UE configuration MO.

The following nodes and leaf objects are possible under the MCDData UE configuration node as described in figure 9.1.1 and figure 9.1.2:

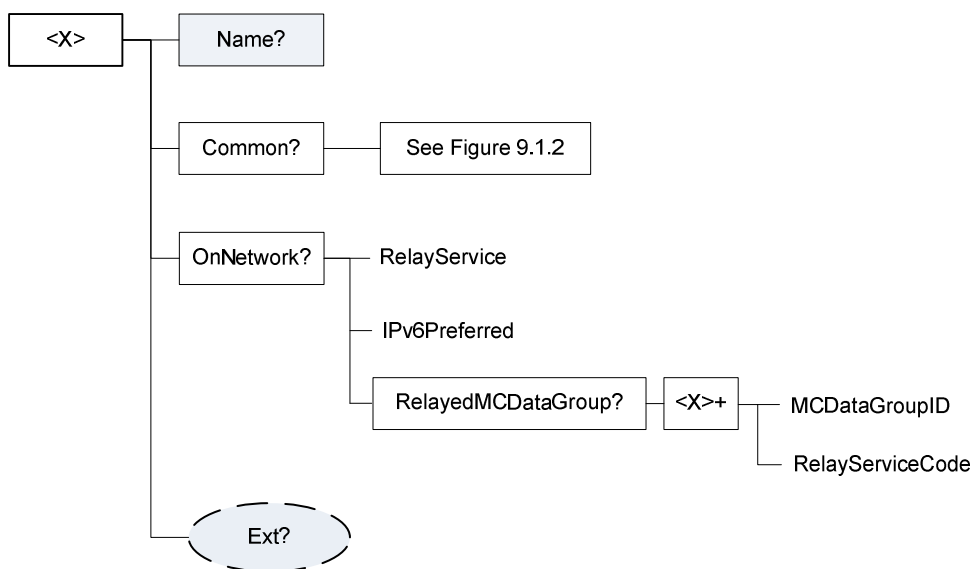

Figure 9.1.1: The MCDData UE configuration MO (1 of 2)

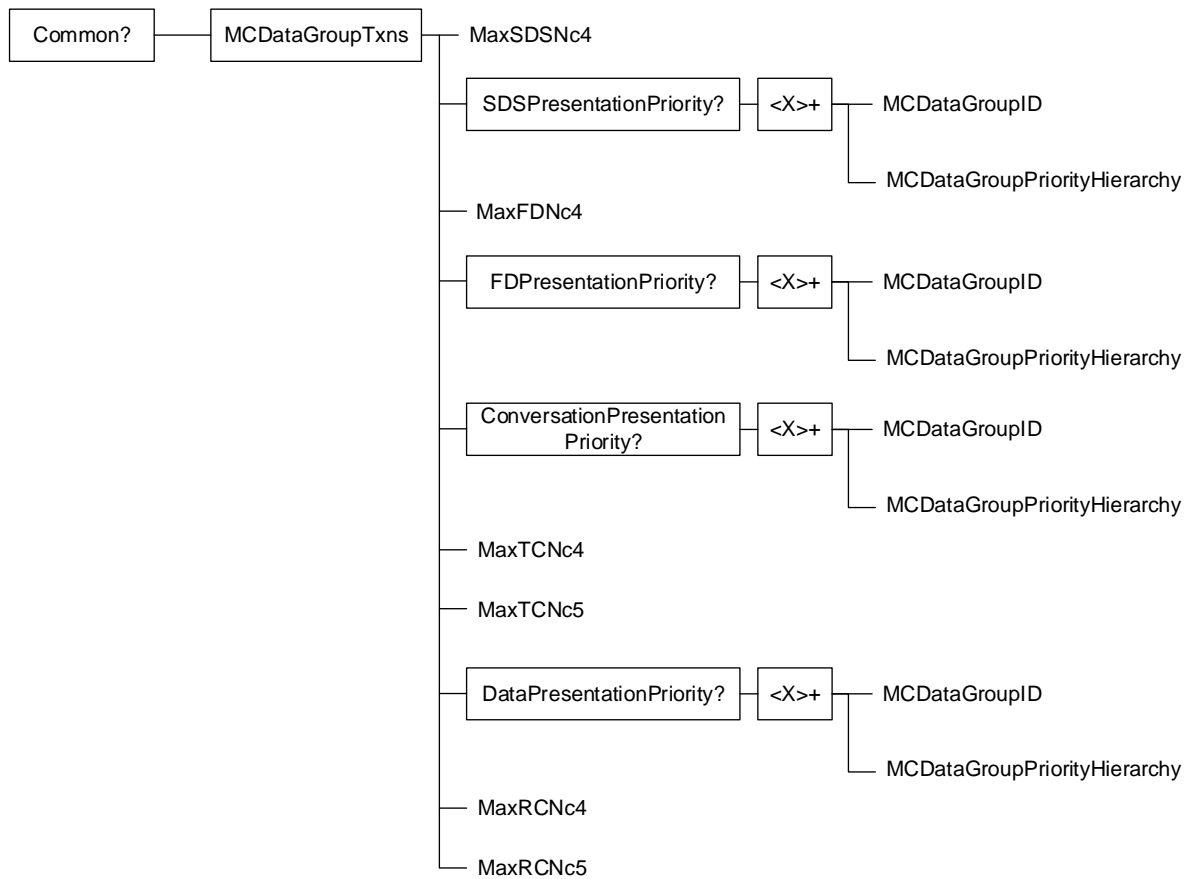

Figure 9.1.2: The MCDATA UE configuration MO (2 of 2)

9.2 MCDATA UE configuration MO parameters

9.2.1 General

This clause describes the parameters for the MCDATA UE configuration Management Object (MO).

9.2.2 Node: <x>

Table 9.2.2.1: Node: <x>

<x>

Status	Occurrence	Format	Min. Access Types
Required	OneOrMore	node	Get

This interior node acts as a placeholder for the MCDATA UE configuration Management Object (MO).

For the MCDATA UE configuration MO, the namespace specific string is: "urn:oma:mo:oma-dm-mcddata-ue-configuration:1.0"

- Values: N/A

9.2.3 /<x>/Name

Table 9.2.3.1: /<x>/Name

Name

Status	Occurrence	Format	Min. Access Types

Required	ZeroOrOne	chr	Get
----------	-----------	-----	-----

The Name leaf is a name for the MCDData UE configuration settings.

- Values: <User displayable name>

9.2.4 /<x>/Ext/

Table 9.2.4.1: /<x>/Ext/

Ext

Status	Occurrence	Format	Min. Access Types
Optional	ZeroOrOne	node	Get, Replace

The Ext is an interior node for where the vendor specific information about the MCDData UE configuration MO is being placed.

Usually the vendor extension is identified by vendor specific name under the ext node and contains the vendor meaning application vendor, device vendor etc. The tree structure under the vendor identified is not defined and can therefore include one or more un-standardized sub-trees.

- Values: N/A

9.2.5 /<x>/Common

Table 9.2.5.1: /<x>/Common

Common

Status	Occurrence	Format	Min. Access Types
Required	ZeroOrOne	node	Get, Replace

This interior node represents a container for the common network operation which means both on-network operation and off-network operation.

9.2.6 /<x>/Common/MCDDataGroupTxns

Table 9.2.6.1: /<x>/Common/MCDDataGroupTxns

Common/MCDDataGroupTxns

Status	Occurrence	Format	Min. Access Types
Required	One	node	Get, Replace

This interior node is a placeholder for the MCDData group transactions configuration.

9.2.7 /<x>/Common/MCDDataGroupTxns/MaxSDSNc4

Table 9.2.7.1: /<x>/Common/MCDDataGroupTxns/MaxSDSNc4

Common/MCDDataGroupTxns/MaxSDSNc4

Status	Occurrence	Format	Min. Access Types
Required	One	int	Get, Replace

This leaf node indicates the maximum number of simultaneous SDS transactions.

- Values: 0-255

9.2.8 `<x>/Common/MCDataGroupTxns/SDSPresentationPriority`

Table 9.2.8.1: `<x>/Common/MCDataGroupTxns/SDSPresentationPriority`

Common/MCDataGroupTxns/SDSPresentationPriority

Status	Occurrence	Format	Min. Access Types
Required	ZeroOrOne	node	Get, Replace

This interior node is a placeholder for the prioritized MCData SDS configuration.

9.2.9 `<x>/Common/MCDataGroupTxns/SDSPresentationPriority/<x>`

Table 9.2.9.1: `<x>/Common/MCDataGroupTxns/SDSPresentationPriority/<x>`

Common/MCDataGroupTxns/SDSPresentationPriority/<x>

Status	Occurrence	Format	Min. Access Types
Required	OneOrMore	node	Get, Replace

This interior node is a placeholder for one or more prioritized MCData SDS configuration.

9.2.10

`<x>/Common/MCDataGroupTxns/SDSPresentationPriority/<x>/MCDataGroupID`

Table 9.2.10.1: `<x>/Common/MCDataGroupTxns/SDSPresentationPriority/<x>/MCDataGroupID`

Common/MCDataGroupTxns/SDSPresentationPriority/<x>/MCDataGroupID

Status	Occurrence	Format	Min. Access Types
Required	One	chr	Get, Replace

This leaf node indicates the associated MCData group ID.

The value is a "uri" attribute specified in OMA OMA-TS-XDM_Group-V1_1 [4].

9.2.11

`<x>/Common/MCDataGroupTxns/SDSPresentationPriority/<x>/MCDataGroupPriorityHierarchy`

Table 9.2.11.1:

`<x>/Common/MCDataGroupTxns/SDSPresentationPriority/<x>/MCDataGroupPriorityHierarchy`

Common/MCDataGroupTxns/SDSPresentationPriority/<x>/MCDataGroupPriorityHierarchy

Status	Occurrence	Format	Min. Access Types
Required	One	int	Get, Replace

This leaf node indicates the requested presentation priority of SDS transactions.

- Values: 0-255

The group with the lowest MCDataGroupPriorityHierarchy value shall be considered as the group having the lowest priority among the groups.

9.2.12 `<x>/Common/MCDataGroupTxns/MaxFDNc4`

Table 9.2.12.1: `<x>/Common/MCDataGroupTxns/MaxFDNc4`

Common/MCDataGroupTxns/MaxFDNc4

Status	Occurrence	Format	Min. Access Types
Required	One	int	Get, Replace

This leaf node indicates the maximum number of simultaneous FD transactions.

- Values: 0-255

9.2.13 /<x>/Common/MCDataGroupTxns/FDPresentationPriority

Table 9.2.13.1: /<x>/Common/MCDataGroupTxns/FDPresentationPriority

Common/MCDataGroupTxns/FDPresentationPriority

Status	Occurrence	Format	Min. Access Types
Required	ZeroOrOne	node	Get, Replace

This interior node is a placeholder for the prioritized MCData FD configuration.

9.2.14 /<x>/Common/MCDataGroupTxns/FDPresentationPriority/<x>

Table 9.2.14.1: /<x>/Common/MCDataGroupTxns/FDPresentationPriority/<x>

Common/MCDataGroupTxns/FDPresentationPriority /<x>

Status	Occurrence	Format	Min. Access Types
Required	OneOrMore	node	Get, Replace

This interior node is a placeholder for one or more prioritized MCData FD configuration.

9.2.15

/<x>/Common/MCDataGroupTxns/FDPresentationPriority/<x>/MCDataGroupID

Table 9.2.15.1: /<x>/Common/MCDataGroupTxns/FDPresentationPriority/<x>/MCDataGroupID

Common/MCDataGroupTxns/FDPresentationPriority/<x>/MCDataGroupID

Status	Occurrence	Format	Min. Access Types
Required	One	chr	Get, Replace

This leaf node indicates the associated MCData group ID.

The value is a "uri" attribute specified in OMA OMA-TS-XDM_Group-V1_1 [4].

9.2.16

/<x>/Common/MCDataGroupTxns/FDPresentationPriority/<x>/MCDataGroupPriorityHierarchy

Table 9.2.16.1:

/<x>/Common/MCDataGroupTxns/FDPresentationPriority/<x>/MCDataGroupPriorityHierarchy

Common/MCDataGroupTxns/FDPresentationPriority/<x>/MCDataGroupPriorityHierarchy

Status	Occurrence	Format	Min. Access Types
Required	One	int	Get, Replace

This leaf node indicates the requested presentation priority of FD transactions.

- Values: 0-255

The group with the lowest MCDataGroupPriorityHierarchy value shall be considered as the group having the lowest priority among the groups.

9.2.17 /<x>/Common/MCDataGroupTxns/ConversationPresentationPriority

Table 9.2.17.1: /<x>/Common/MCDataGroupTxns/ConversationPresentationPriority

Common/MCDataGroupTxns/ConversationPresentationPriority

Status	Occurrence	Format	Min. Access Types
Required	ZeroOrOne	node	Get, Replace

This interior node is a placeholder for the prioritized MCData conversation management configuration.

9.2.18

/<x>/Common/MCDataGroupTxns/ConversationPresentationPriority/<x>

Table 9.2.18.1: /<x>/Common/MCDataGroupTxns/ConversationPresentationPriority/<x>

Common/MCDataGroupTxns/ConversationPresentationPriority /<x>

Status	Occurrence	Format	Min. Access Types
Required	OneOrMore	node	Get, Replace

This interior node is a placeholder for one or more prioritized MCData conversation management configuration.

9.2.19

/<x>/Common/MCDataGroupTxns/ConversationPresentationPriority/<x>/MCDataGroupID

Table 9.2.19.1:

/<x>/Common/MCDataGroupTxns/ConversationPresentationPriority/<x>/MCDataGroupID

Common/MCDataGroupTxns/ConversationPresentationPriority/<x>/MCDataGroupID

Status	Occurrence	Format	Min. Access Types
Required	One	chr	Get, Replace

This leaf node indicates the associated MCData group ID.

The value is a "uri" attribute specified in OMA OMA-TS-XDM_Group-V1_1 [4].

9.2.20

/<x>/Common/MCDataGroupTxns/ConversationPresentationPriority/<x>/MCDataGroupPriorityHierarchy

Table 9.2.20.1:

/<x>/Common/MCDataGroupTxns/ConversationPresentationPriority/<x>/MCDataGroupPriorityHierarchy

Common/MCDataGroupTxns/ConversationPresentationPriority/<x>/MCDataGroupPriorityHierarchy

Status	Occurrence	Format	Min. Access Types
Required	One	int	Get, Replace

This leaf node indicates the requested presentation priority of conversation management transactions.

- Values: 0-255

The group with the lowest MCDataGroupPriorityHierarchy value shall be considered as the group having the lowest priority among the groups.

9.2.21 /<x>/Common/MCDataGroupTxns/MaxTCNc4

Table 9.2.21.1: /<x>/Common/MCDataGroupTxns/MaxTCNc4

Common/MCDataGroupTxns/MaxTCNc4

Status	Occurrence	Format	Min. Access Types
Required	One	int	Get, Replace

This leaf node indicates the maximum number of simultaneous data transmissions.

- Values: 0-255

9.2.22 /<x>/Common/MCDataGroupTxns/MaxTCNc5

Table 9.2.22.1: /<x>/Common/MCDataGroupTxns/MaxTCNc5

Common/MCDataGroupTxns/MaxTCN5

Status	Occurrence	Format	Min. Access Types
Required	One	int	Get, Replace

This leaf node indicates the maximum number of data transmissions in a group.

- Values: 0-255

9.2.23 /<x>/Common/MCDataGroupTxns/DataPresentationPriority

Table 9.2.23.1: /<x>/Common/MCDataGroupTxns/DataPresentationPriority

Common/MCDataGroupTxns/DataPresentationPriority

Status	Occurrence	Format	Min. Access Types
Required	ZeroOrOne	node	Get, Replace

This interior node is a placeholder for the prioritized MCData Transmission Control configuration.

9.2.24 /<x>/Common/MCDataGroupTxns/DataPresentationPriority/<x>

Table 9.2.24.1: /<x>/Common/MCDataGroupTxns/DataPresentationPriority/<x>

Common/MCDataGroupTxns/DataPresentationPriority/<x>

Status	Occurrence	Format	Min. Access Types
Required	OneOrMore	node	Get, Replace

This interior node is a placeholder for one or more prioritized MCData Transmission Control configuration.

9.2.25

/<x>/Common/MCDataGroupTxns/DataPresentationPriority/<x>/MCDataGroupID

Table 9.2.25.1: /<x>/Common/MCDataGroupTxns/DataPresentationPriority/<x>/MCDataGroupID

Common/MCDataGroupTxns/DataPresentationPriority/<x>/MCDataGroupID

Status	Occurrence	Format	Min. Access Types
Required	One	chr	Get, Replace

This leaf node indicates the associated MCData group ID.

The value is a "uri" attribute specified in OMA OMA-TS-XDM_Group-V1_1 [4].

9.2.26

`<x>/Common/MCDataGroupTxns/DataPresentationPriority/<x>/MCDataGroupPriorityHierarchy`

Table 9.2.26.1:

`<x>/Common/MCDataGroupTxns/DataPresentationPriority/<x>/MCDataGroupPriorityHierarchy`

Common/MCDataGroupTxns/DataPresentationPriority/<x>/MCDataGroupPriorityHierarchy

Status	Occurrence	Format	Min. Access Types
Required	One	int	Get, Replace

This leaf node indicates the requested presentation priority of data received.

- Values: 0-255

The group with the lowest MCDataGroupPriorityHierarchy value shall be considered as the group having the lowest priority among the groups.

9.2.27 `<x>/Common/MCDataGroupTxns/MaxRCNc4`**Table 9.2.27.1: `<x>/Common/MCDataGroupTxns/MaxRCNc4`**

Common/MCDataGroupTxns/MaxRCNc4

Status	Occurrence	Format	Min. Access Types
Required	One	int	Get, Replace

This leaf node indicates the maximum number of simultaneous data receptions.

- Values: 0-255

9.2.28 `<x>/Common/MCDataGroupTxns/MaxRCNc5`**Table 9.2.28.1: `<x>/Common/MCDataGroupTxns/MaxRCNc5`**

Common/MCDataGroupTxns/MaxRCN5

Status	Occurrence	Format	Min. Access Types
Required	One	int	Get, Replace

This leaf node indicates the maximum number of data receptions in a group.

- Values: 0-255

9.2.29 `<x>/OnNetwork`**Table 9.2.29.1: `<x>/OnNetwork`**

OnNetwork

Status	Occurrence	Format	Min. Access Types
Required	ZeroOrOne	node	Get, Replace

This interior node represents a container for on-network operation.

9.2.30 `<x>/OnNetwork/RelayService`**Table 9.2.30.1: `<x>/OnNetwork/RelayService`**

OnNetwork/RelayService

Status	Occurrence	Format	Min. Access Types
Required	One	bool	Get, Replace

This leaf node indicates the authorisation to use a relay service.

When set to "true" the MCDData group is allowed to use a relay service.

When set to "false" the MCDData group is not allowed to use a relay service.

9.2.31 /<x>/OnNetwork/IPv6Preferred

Table 9.2.31.1: /<x>/OnNetwork/IPv6Preferred

OnNetwork/IPv6Preferred

Status	Occurrence	Format	Min. Access Types
Required	One	bool	Get, Replace

This leaf node indicates whether IPv6 is preferred over IPv4 for on-network operation when the MCDData UE has both IPv4 and IPv6 host configuration.

If the MCDData UE has both IPv4 and IPv6 host configuration and:

- if IPv6Preferred is set to "true" then the UE uses IPv6 for all on-network signalling and media; otherwise
- if IPv6Preferred is set to "false" then the UE uses IPv4 for all on-network signalling and media.

9.2.32 /<x>/OnNetwork/RelayedMCDDataGroup

Table 9.2.32.1: /<x>/OnNetwork/RelayedMCDDataGroup

OnNetwork/RelayedMCDDataGroup

Status	Occurrence	Format	Min. Access Types
Optional	ZeroOrOne	node	Get, Replace

This interior node is a placeholder for the allowed relayed MCDData groups.

9.2.33 /<x>/OnNetwork/RelayedMCDDataGroup/<x>

Table 9.2.33.1: /<x>/OnNetwork/RelayedMCDDataGroup/<x>

OnNetwork/RelayedMCDDataGroup/<x>

Status	Occurrence	Format	Min. Access Types
Required	OneOrMore	node	Get, Replace

This interior node is a placeholder for one or more allowed relayed MCDData groups.

9.2.34 /<x>/OnNetwork/RelayedMCDDataGroup/<x>/MCDDataGroupID

Table 9.2.34.1: /<x>/OnNetwork/RelayedMCDDataGroup/<x>/MCDDataGroupID

OnNetwork/RelayedMCDDataGroup/<x>/MCDDataGroupID

Status	Occurrence	Format	Min. Access Types
Required	One	chr	Get, Replace

This leaf node indicates the associated MCDData group ID.

The value is a "uri" attribute specified in OMA OMA-TS-XDM_Group-V1_1 [4].

9.2.35 /<x>/OnNetwork/RelayedMCDataGroup/<x>/RelayServiceCode

Table 9.2.35.1: /<x>/OnNetwork/RelayedMCDataGroup/<x>/RelayServiceCode

OnNetwork/RelayedMCDataGroup/<x>/RelayServiceCode

Status	Occurrence	Format	Min. Access Types
Required	One	chr	Get, Replace

This leaf node indicates the connectivity service that the ProSe UE-to-network relay provides to public safety applications as specified in 3GPP TS 23.303 [6].

10 MCData user profile MO

10.1 General

The MCData user profile configuration Management Object (MO) is used to configure the MCData Client behaviour for the on-network or off-network MCData Service. The MCData user profile configuration parameters may be stored in the ME, or in the USIM as specified in 3GPP TS 31.102 [10], or in both the ME and the USIM. If both the ME and the USIM contain the same parameters, the values stored in the USIM shall take precedence.

The Management Object Identifier is: urn:oma:mo:ext-3gpp-MCData-user-profile:1.0.

Protocol compatibility: This MO is compatible with OMA OMA DM 1.2 [3].

The OMA DM ACL property mechanism (see OMA OMA-ERELED-DM-V1_2 [2]) may be used to grant or deny access rights to OMA DM servers in order to modify nodes and leaf objects of the MCData user profile MO.

The following nodes and leaf objects are possible under the MCData user profile node as described in figure 10.1.1, figure 10.1.2 and figure 10.1.3:

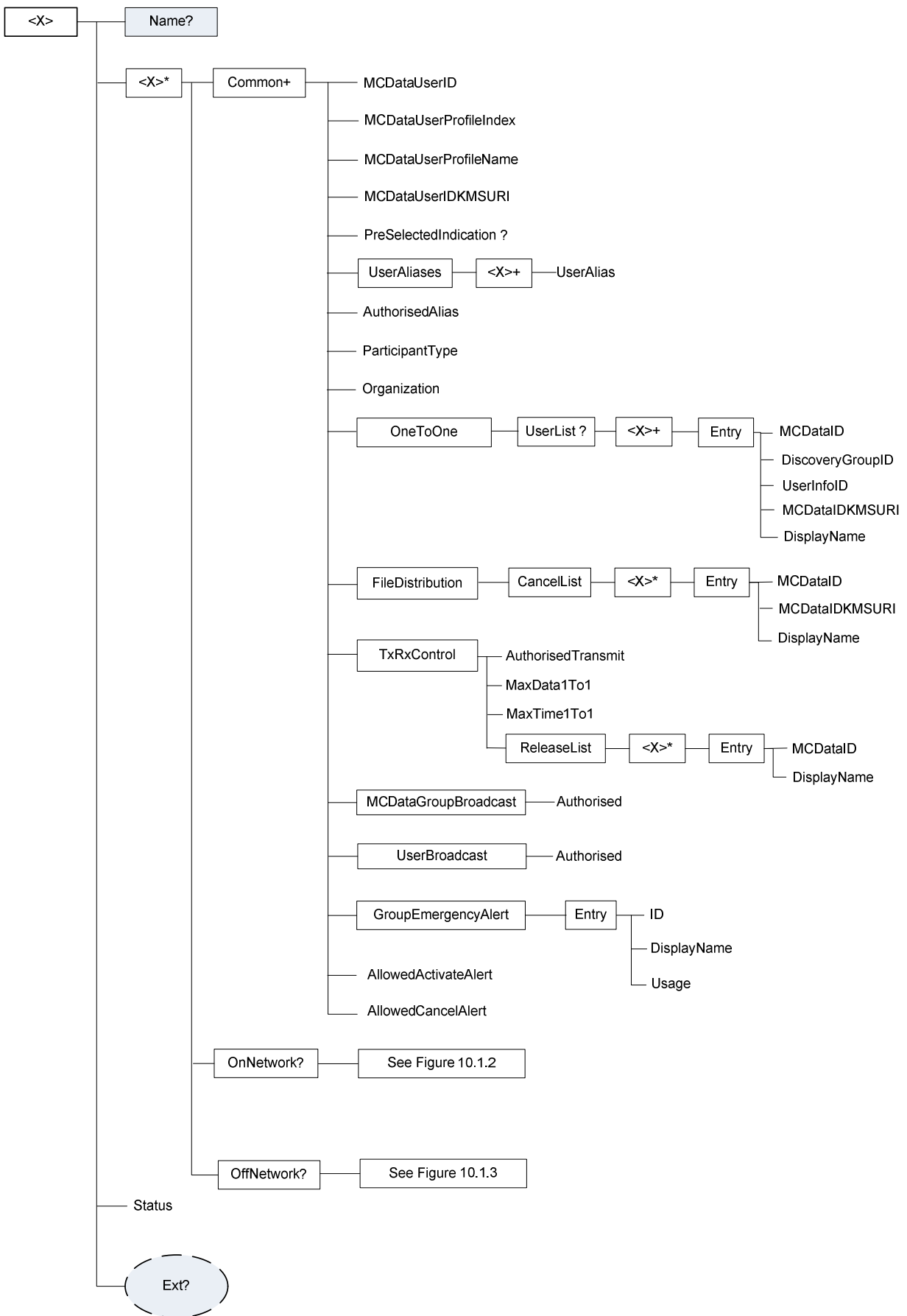

Figure 10.1.1: The MCDATA user profile MO (1 of 3)

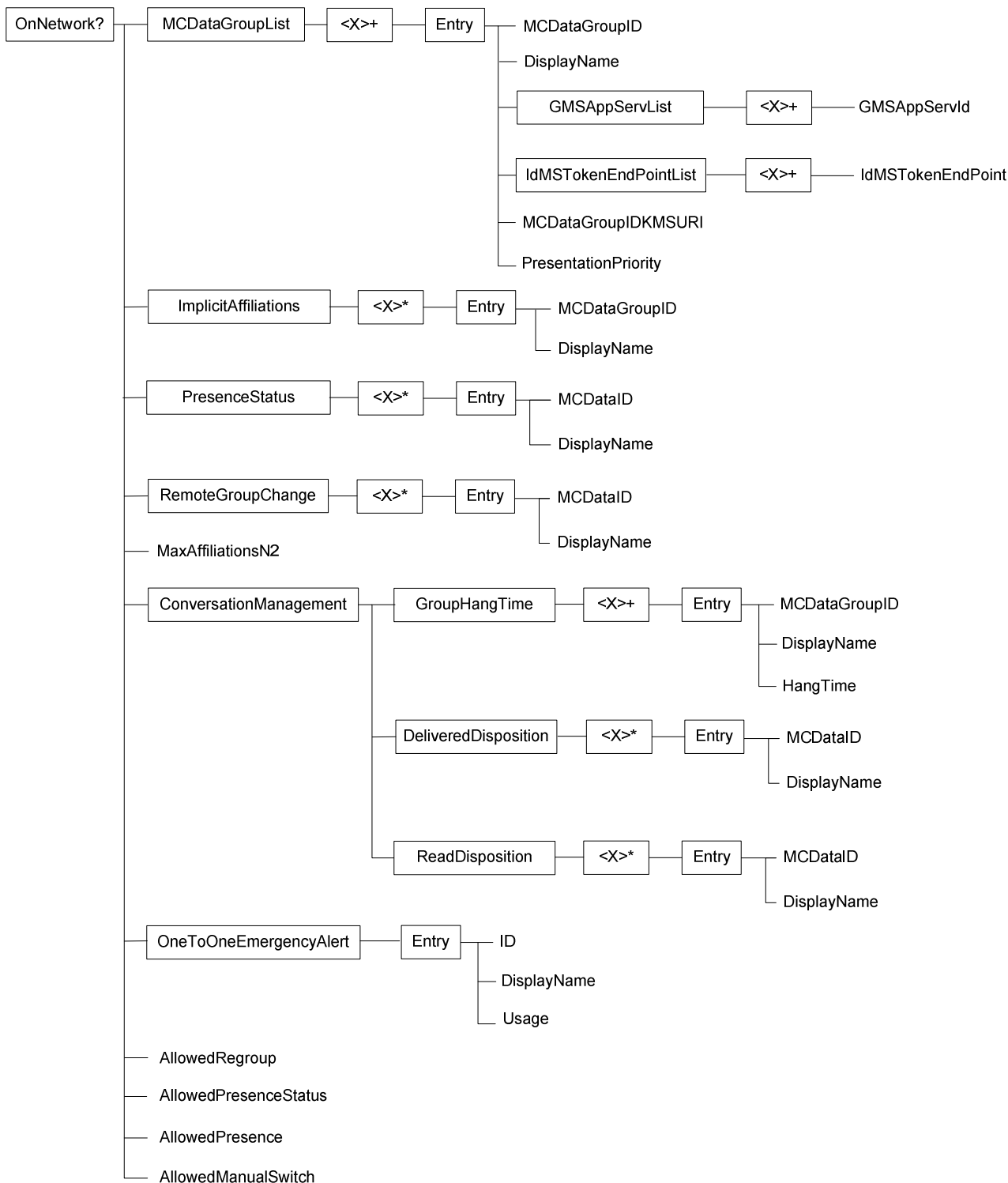

Figure 10.1.2: The MCDATA user profile MO (2 of 3)

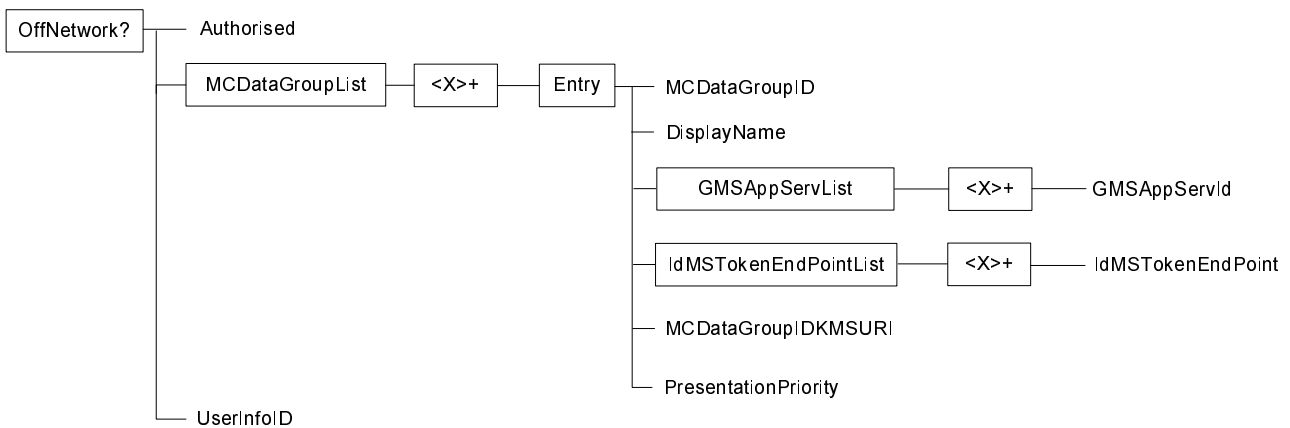

Figure 10.1.3: The MCDATA user profile MO (3 of 3)

10.2 MCDATA user profile MO parameters

10.2.1 General

This clause describes the parameters for the MCDATA user profile Management Object (MO).

10.2.2 Node: <x>

Table 10.2.2.1: Node: <x>

<x>

Status	Occurrence	Format	Min. Access Types
Required	OneOrMore	node	Get

This interior node acts as a placeholder for the MCDATA user profile Management Object (MO).

For the MCDATA user profile MO, the namespace specific string is: "urn:oma:mo:oma-dm-mcdata-user-profile:1.0"

- Values: N/A

10.2.3 /<x>/Name

Table 10.2.3.1: /<x>/Name

Name

Status	Occurrence	Format	Min. Access Types
Required	ZeroOrOne	chr	Get

The Name leaf is a name for the MCDATA user profile settings.

- Values: <User displayable name>

10.2.4 /<x>/Ext/

Table 10.2.4.1: /<x>/Ext/

Ext

Status	Occurrence	Format	Min. Access Types
Optional	ZeroOrOne	node	Get, Replace

The Ext is an interior node for where the vendor specific information about the MCDData user profile MO is being placed.

Usually the vendor extension is identified by vendor specific name under the ext node and contains the vendor meaning application vendor, device vendor etc. The tree structure under the vendor identified is not defined and can therefore include one or more un-standardized sub-trees.

- Values: N/A

10.2.5 /<x>/<x>

Table 10.2.5.1: /<x>/<x>

<x>

Status	Occurrence	Format	Min. Access Types
Required	OneOrMore	node	Get, Replace

This interior node represents a container for on-network operation and off-network operation.

10.2.6 /<x>/<x>/Common

Table 10.2.6.1: /<x>/<x>/Common

<x>/Common

Status	Occurrence	Format	Min. Access Types
Required	OneOrMore	node	Get, Replace

This interior node represents a container for the common network operation which means both on-network operation and off-network operation.

10.2.7 /<x>/<x>/Common/MCDDataUserID

Table 10.2.7.1: /<x>/<x>/Common/MCDDataUserID

<x>/Common/MCDDataUserID

Status	Occurrence	Format	Min. Access Types
Required	One	chr	Get, Replace

This leaf node indicates an MCDData user identity (MCDData ID) which is a globally unique identifier within the MCDData service that represents the MCDData user.

10.2.8 /<x>/<x>/Common/MCDDataUserProfileIndex

Table 10.2.8.1: /<x>/<x>/Common/MCDDataUserProfileIndex

<x>/Common/MCDDataUserProfileIndex

Status	Occurrence	Format	Min. Access Types
Required	One	int	Get, Replace

This leaf node indicates an index for the particular MCDData user profile.

- Values: 0-255

10.2.9 /<x>/<x>/Common/MCDataUserProfileName

Table 10.2.9.1: /<x>/<x>/Common/MCDataUserProfileName

<x>/Common/MCDataUserProfileName

Status	Occurrence	Format	Min. Access Types
Optional	One	chr	Get, Replace

This leaf node indicates a profile name for the particular MCData user profile.

10.2.9A /<x>/<x>/Common/MCDataUserIDKMSURI

Table 10.2.9A.1: /<x>/<x>/Common/MCDataUserIDKMSURI

<x>/Common/MCDataUserIDKMSURI

Status	Occurrence	Format	Min. Access Types
Optional	One	chr	Get, Replace

This leaf node indicates key management server URI for the security domain of the MCData user.

The value is a URI as specified in 3GPP TS 23.003 [5].

10.2.10 /<x>/<x>/Common/PreSelectedIndication

Table 10.2.10.1: /<x>/<x>/Common/PreSelectedIndication

<x>/Common/PreSelectedIndication

Status	Occurrence	Format	Min. Access Types
Optional	ZeroOrOne	null	Get, Replace

This leaf node indicates that this MCData user profile MO is designated to be the pre-selected MCData user profile as defined by 3GPP TS 23.179 [15]

- Values: null

When this leaf node is present, this MCData user profile MO is designated as the pre-selected MCData user profile.

When this leaf node is absent, this MCData user profile MO is not designated as the pre-selected MCData user profile.

If more than one MCData user profile MO is specified for the MCData user, then only one MCData user profile MO for the MCData user shall contain the <x>/Common/PreSelectedIndication leaf node.

If there is only one MCData user profile MO specified for the MCData user, then it is optional to include the <x>/Common/PreSelectedIndication leaf node.

10.2.11 /<x>/<x>/Common/UserAliases

Table 10.2.11.1: /<x>/<x>/Common/UserAliases

<x>/Common/UserAliases

Status	Occurrence	Format	Min. Access Types
Required	One	node	Get, Replace

This interior node is a placeholder for a list of aliases of an MCData user.

10.2.12 /<x>/<x>/Common/UserAliases/<x>

Table 10.2.12.1: /<x>/<x>/Common/UserAliases/<x>

<x>/Common/UserAliases/<x>

Status	Occurrence	Format	Min. Access Types
Required	OneOrMore	node	Get, Replace

This interior node is a placeholder for one or more aliases of an MCDData user.

10.2.13 /<x>/<x>/Common/UserAliases/<x>UserAlias

Table 10.2.13.1: /<x>/<x>/Common/UserAliases/<x>/UserAlias

<x>/Common/UserAliases/<x>/UserAlias

Status	Occurrence	Format	Min. Access Types
Required	One	chr	Get, Replace

This leaf node indicates an alphanumeric alias of the MCDData user.

10.2.14 /<x>/<x>/Common/AuthorisedAlias

Table 10.2.14.1: /<x>/<x>/Common/AuthorisedAlias

<x>/Common/AuthorisedAlias

Status	Occurrence	Format	Min. Access Types
Optional	One	bool	Get, Replace

This leaf node indicates authorisation to create and delete aliases of other MCDData users and their associated MCDData user profiles.

When set to "true" the MCDData user is authorised to create and delete aliases of other MCDData users and their associated MCDData user profiles.

When set to "false" the MCDData user is not authorised to create and delete aliases of other MCDData user and their associated MCDData user profiles. This is the default if this leaf node is not present.

10.2.15 /<x>/<x>/Common/ParticipantType

Table 10.2.15.1: /<x>/<x>/Common/ParticipantType

<x>/Common/ParticipantType

Status	Occurrence	Format	Min. Access Types
Required	One	chr	Get, Replace

This leaf node indicates the participant type of the MCDData user.

The ParticipantType means the functional category of the participant (e.g., first responder, second responder, dispatch, dispatch supervisor), typically defined by the MCDData administrators.

10.2.16 /<x>/<x>/Common/Organization

Table 10.2.16.1: /<x>/<x>/Common/Organization

<x>/Common/Organization

Status	Occurrence	Format	Min. Access Types
Required	One	chr	Get, Replace

This leaf node indicates the organization an MCDData user belongs to.

10.2.16A/ <x>/<x>/Common/OnetoOne

Table 10.2.16A.1: /<x>/<x>/Common/OnetoOne

<x>/Common/OnetoOne

Status	Occurrence	Format	Min. Access Types
Required	One	node	Get, Replace

This interior node is a placeholder for the MCDData on-network or off-network one-to-one communication configuration.

10.2.16B/ <x>/<x>/Common/OnetoOne/UserList

Table 10.2.16B.1: /<x>/<x>/Common/OnetoOne/UserList

<x>/Common/OnetoOne/UserList

Status	Occurrence	Format	Min. Access Types
Required	One	node	Get, Replace

This interior node is a placeholder for a list of MCDData users who can be involved in an on-network or off-network MCDData one-to-one transaction.

10.2.16C /<x>/<x>/Common/OnetoOne/UserList/<x>

Table 10.2.16C.1: /<x>/<x>/Common/OnetoOne/UserList/<x>

<x>/Common/OnetoOne/UserList/<x>

Status	Occurrence	Format	Min. Access Types
Optional	OneOrMore	node	Get, Replace

This interior node is a placeholder for one or more list of MCDData users who can be involved in an on-network or off-network MCDData one-to-one transaction.

10.2.16D /<x>/<x>/Common/OnetoOne/UserList/<x>/Entry

Table 10.2.16D.1: /<x>/<x>/Common/OnetoOne/UserList/<x>/Entry

<x>/Common/OnetoOne/UserList/<x>/Entry

Status	Occurrence	Format	Min. Access Types
Required	One	node	Get, Replace

This interior node is a placeholder for one or more MCDData users who can be involved in an on-network or off-network MCDData one-to-one transaction.

10.2.16E/ <x>/<x>/Common/OnetoOne/UserList/<x>/Entry/MCDDataID

Table 10.2.16E.1: /<x>/<x>/Common/OnetoOne/UserList/<x>/Entry/MCDDataID

<x>/Common/OnetoOne/UserList/<x>/Entry/MCDDataID

Status	Occurrence	Format	Min. Access Types
Optional	One	chr	Get, Replace

This leaf node indicates an MCDData user identity (MCDData ID) which is a globally unique identifier within the MCDData service that represents the MCDData user.

The value is a "uri" attribute specified in OMA OMA-TS-XDM_Group-V1_1 [4].

10.2.16F /<x>/<x>/Common/OnetoOne/UserList/<x>/Entry/DiscoveryGroupID

Table 10.2.16F.1: /<x>/<x>/Common/OnetoOne/UserList/<x>/Entry/DiscoveryGroupID

<x>/Common/OnetoOne/UserList/<x>/Entry/DiscoveryGroupID

Status	Occurrence	Format	Min. Access Types
Optional	One	int	Get, Replace

This leaf node indicates a discovery group ID as specified in 3GPP TS 23.303 [6].

The value is used as the discovery group ID in the ProSe discovery procedures as specified in 3GPP TS 23.303 [6].

10.2.16G /<x>/<x>/Common/OnetoOne/UserList/<x>/Entry/UserInfoID

Table 10.2.16G.1: /<x>/<x>/Common/OnetoOne/UserList/<x>/Entry/UserInfoID

<x>/Common/OnetoOne/UserList/<x>/Entry/UserInfoID

Status	Occurrence	Format	Min. Access Types
Optional	One	int	Get, Replace

This leaf node indicates a ProSe user info ID as specified in 3GPP TS 23.303 [6].

10.2.16H

/<x>/<x>/Common/OnetoOne/UserList/<x>/Entry/MCDDataIDKMSUR
I

Table 10.2.16H.1: /<x>/<x>/Common/OnetoOne/UserList/<x>/Entry/MCDDataUserIDKMSURI

<x>/Common/OnetoOne/UserList/<x>/Entry/MCDDataUserIDKMSURI

Status	Occurrence	Format	Min. Access Types
Optional	One	chr	Get, Replace

This leaf node indicates key management server URI for the security domain of the MCDData user of an MCDData user that the configured MCDData user is authorised to initiate a one-to-one communication with.

The value is a URI as specified in 3GPP TS 23.003 [5].

10.2.16I /<x>/<x>/Common/OnetoOne/UserList/<x>/Entry/DisplayName

Table 10.2.16I.1: /<x>/<x>/Common/OnetoOne/UserList/<x>/Entry/DisplayName

<x>/Common/OnetoOne/UserList/<x>/Entry/DisplayName

Status	Occurrence	Format	Min. Access Types
Optional	One	chr	Get, Replace

This leaf node contains a human readable name.

10.2.17 /<x>/<x>/Common/FileDistribution

Table 10.2.17.1: /<x>/<x>/Common/FileDistribution

<x>/Common/FileDistribution

Status	Occurrence	Format	Min. Access Types
Required	One	node	Get, Replace

This interior node is a placeholder for the MCDData file distribution configuration.

10.2.18 /<x>/<x>/Common/FileDistribution/CancelList

Table 10.2.18.1: /<x>/<x>/Common/FileDistribution/CancelList

<x>/Common/FileDistribution/CancelList

Status	Occurrence	Format	Min. Access Types
Required	One	node	Get, Replace

This interior node is a placeholder for a list of MCDData user(s) this MCDData user is allowed to cancel distribution of files beings sent or waiting to be sent.

10.2.19 /<x>/<x>/Common/FileDistribution/CancelList/<x>

Table 10.2.19.1: /<x>/<x>/Common/FileDistribution/CancelList/<x>

<x>/Common/FileDistribution/CancelList/<x>

Status	Occurrence	Format	Min. Access Types
Optional	ZeroOrMore	node	Get, Replace

This interior node is a placeholder for zero or more list of MCDData users this MCDData user is allowed to cancel distribution of files beings sent or waiting to be sent.

10.2.20 /<x>/<x>/Common/FileDistribution/CancelList/<x>/Entry

Table 10.2.20.1: /<x>/<x>/Common/FileDistribution/CancelList/<x>/Entry

<x>/Common/FileDistribution/CancelList/<x>/Entry

Status	Occurrence	Format	Min. Access Types
Required	One	node	Get, Replace

This interior node is a placeholder for one or more MCDData users this MCDData user is allowed to cancel distribution of files beings sent or waiting to be sent.

10.2.21 /<x>/<x>/Common/FileDistribution/CancelList/<x>/Entry/MCDDataID

Table 10.2.21.1: /<x>/<x>/Common/FileDistribution/CancelList/<x>/Entry/MCDDataID

<x>/Common/FileDistribution/CancelList/<x>/Entry/MCDDataID

Status	Occurrence	Format	Min. Access Types
Optional	One	chr	Get, Replace

This leaf node indicates an MCDData user identity (MCDData ID) which is a globally unique identifier within the MCDData service that represents the MCDData user.

The value is a "uri" attribute specified in OMA OMA-TS-XDM_Group-V1_1 [4].

10.2.21A

`<x>/Common/FileDistribution/CancelList/Entry/MCDataIDKMSURI`

Table 10.2.21A.1: `<x>/Common/FileDistribution/CancelList/Entry/MCDataIDKMSURI`

`<x>/Common/FileDistribution/CancelList/Entry/MCDataIDKMSURI`

Status	Occurrence	Format	Min. Access Types
Optional	One	chr	Get, Replace

This leaf node indicates key management server URI for the security domain of the MCData user of an MCData user that the configured MCData user is authorised to cancel distribution of files being sent or waiting to be sent.

The value is a URI as specified in 3GPP TS 23.003 [5].

10.2.22

`<x>/Common/FileDistribution/CancelList/Entry/DisplayName`

Table 10.2.22.1: `<x>/Common/FileDistribution/CancelList/Entry/DisplayName`

`<x>/Common/FileDistribution/CancelList/Entry/DisplayName`

Status	Occurrence	Format	Min. Access Types
Optional	One	chr	Get, Replace

This leaf node contains a human readable name.

10.2.23 `<x>/Common/TxRxControl`

Table 10.2.23.1: `<x>/Common/TxRxControl`

`<x>/Common/TxRxControl`

Status	Occurrence	Format	Min. Access Types
Required	One	node	Get, Replace

This interior node is a placeholder for the MCData transmission and reception control configuration.

10.2.24 `<x>/Common/TxRxControl/AuthorisedTransmit`

Table 10.2.24.1: `<x>/Common/TxRxControl/AuthorisedTransmit`

`<x>/Common/TxRxControl/AuthorisedTransmit`

Status	Occurrence	Format	Min. Access Types
Required	One	bool	Get, Replace

This leaf node indicates the authorisation to transmit data.

When set to "true" the MCData user is authorised to transmit data.

When set to "false" the MCData user is not authorised to transmit data.

10.2.25 `<x>/Common/TxRxControl/MaxData1To1`

Table 10.2.25.1: `<x>/Common/TxRxControl/MaxData1To1`

`<x>/Common/TxRxControl/MaxData1To1`

Status	Occurrence	Format	Min. Access Types
Required	One	int	Get, Replace

This leaf node indicates the maximum amount of data (in megabytes) that an MCDData user can transmit in a single request during one-to-one communication.

- Values: 0-65535

The MaxData1to1 size is in megabytes..

10.2.26 /<x>/<x>/Common/TxRxControl/MaxTime1To1

Table 10.2.26.1: /<x>/<x>/Common/TxRxControl/MaxTime1To1

<x>/Common/TxRxControl/MaxTime1To1

Status	Occurrence	Format	Min. Access Types
Required	One	int	Get, Replace

This leaf node indicates the maximum amount of time that an MCDData user can transmit for in a single request during one-to-one communication.

- Values: 0-65535

The MaxTime1To1 time is in seconds.

10.2.27 /<x>/<x>/Common/TxRxControl/ReleaseList

Table 10.2.27.1: /<x>/<x>/Common/TxRxControl/ReleaseList

<x>/Common/TxRxControl/ReleaseList

Status	Occurrence	Format	Min. Access Types
Required	One	node	Get, Replace

This interior node is a placeholder for a list of MCDData users that this MCDData user is allowed to request release of an ongoing transmission.

10.2.28 /<x>/<x>/Common/TxRxControl/ReleaseList/<x>

Table 10.2.28.1: /<x>/<x>/Common/TxRxControl/ReleaseList/<x>

<x>/Common/TxRxControl/ReleaseList/<x>

Status	Occurrence	Format	Min. Access Types
Optional	ZeroOrMore	node	Get, Replace

This interior node is a placeholder for zero or more list of MCDData users this MCDData user is allowed to request release of an ongoing transmission.

10.2.29 /<x>/<x>/Common/TxRxControl/ReleaseList/<x>/Entry

Table 10.2.29.1: /<x>/<x>/Common/TxRxControl/ReleaseList/<x>/Entry

<x>/Common/TxRxControl/ReleaseList/<x>/Entry

Status	Occurrence	Format	Min. Access Types
Required	One	node	Get, Replace

This interior node is a placeholder for one or more MCDData users this MCDData user is allowed to request release of an ongoing transmission.

10.2.30 /<x>/<x>/Common/TxRxControl/ReleaseList/<x>/Entry/MCDDataID

Table 10.2.30.1: /<x>/<x>/Common/TxRxControl/ReleaseList/<x>/Entry/MCDDataID

<x>/Common/TxRxControl/ReleaseList/<x>/Entry/MCDDataID

Status	Occurrence	Format	Min. Access Types
Optional	One	chr	Get, Replace

This leaf node indicates an MCDData user identity (MCDData ID) which is a globally unique identifier within the MCDData service that represents the MCDData user.

The value is a "uri" attribute specified in OMA OMA-TS-XDM_Group-V1_1 [4].

10.2.31 /<x>/<x>/Common/TxRxControl/ReleaseList/<x>/Entry/DisplayName

Table 10.2.31.1: /<x>/<x>/ Common/TxRxControl/ReleaseList/<x>/Entry/DisplayName

<x>/Common/TxRxControl/ReleaseList/<x>/Entry/DisplayName

Status	Occurrence	Format	Min. Access Types
Optional	One	chr	Get, Replace

This leaf node contains a human readable name.

10.2.32 /<x>/<x>/Common/MCDDataGroupBroadcast

Table 10.2.32.1: /<x>/<x>/Common/MCDDataGroupBroadcast

<x>/Common/MCDDataGroupBroadcast

Status	Occurrence	Format	Min. Access Types
Required	One	node	Get, Replace

This interior node is a placeholder for the group-broadcast group policy.

10.2.33 /<x>/<x>/Common/MCDDataGroupBroadcast/Authorised

Table 10.2.33.1: /<x>/<x>/Common/MCDDataGroupBroadcast/Authorised

<x>/Common/MCDDataGroupBroadcast/Authorised

Status	Occurrence	Format	Min. Access Types
Required	One	bool	Get, Replace

This leaf node indicates the authorisation to create a group-broadcast group.

When set to "true" the MCDData user is authorised to create a group-broadcast group.

When set to "false" the MCDData user is not authorised to create a group-broadcast group.

10.2.34 /<x>/<x>/Common/UserBroadcast

Table 10.2.34.1: /<x>/<x>/Common/UserBroadcast

<x>/Common/UserBroadcast

Status	Occurrence	Format	Min. Access Types
Required	One	node	Get, Replace

This interior node is a placeholder for the user-broadcast group policy.

10.2.35 /<x>/<x>/Common/UserBroadcast/Authorised

Table 10.2.35.1: /<x>/<x>/Common/UserBroadcast/Authorised

<x>/Common/UserBroadcast/Authorised

Status	Occurrence	Format	Min. Access Types
Required	One	bool	Get, Replace

This leaf node indicates the authorisation to create a user-broadcast group.

When set to "true" the MCDData user is authorised to create a user-broadcast group.

When set to "false" the MCDData user is not authorised to create a user-broadcast group.

10.2.36 `<x>/<x>/Common/GroupEmergencyAlert`

Table 10.2.36.1: `<x>/<x>/Common/GroupEmergencyAlert`

`<x>/Common/GroupEmergencyAlert`

Status	Occurrence	Format	Min. Access Types
Required	One	node	Get, Replace

This interior node is a placeholder for Group Emergency Alert configuration.

10.2.37 `<x>/<x>/Common/GroupEmergencyAlert/Entry`

Table 10.2.37.1: `<x>/<x>/Common/GroupEmergencyAlert/Entry`

`<x>/Common/GroupEmergencyAlert/Entry`

Status	Occurrence	Format	Min. Access Types
Required	One	node	Get, Replace

This interior node is a placeholder for the details of the MCDData group of an MCDData emergency alert.

10.2.38 `<x>/<x>/Common/GroupEmergencyAlert/Entry/ID`

Table 10.2.38.1: `<x>/<x>/Common/GroupEmergencyAlert/Entry/ID`

`<x>/Common/GroupEmergencyAlert/Entry/ID`

Status	Occurrence	Format	Min. Access Types
Required	One	chr	Get, Replace

This leaf node indicates the MCDData group used upon certain criteria on initiation of an MCDData emergency alert.

10.2.39 `<x>/<x>/Common/GroupEmergencyAlert/Entry/DisplayName`

Table 10.2.39.1: `<x>/<x>/Common/GroupEmergencyAlert/Entry/DisplayName`

`<x>/Common/GroupEmergencyAlert/Entry/DisplayName`

Status	Occurrence	Format	Min. Access Types
Optional	One	chr	Get, Replace

This leaf node contains a human readable name that corresponds to the ID.

10.2.40 `<x>/<x>/Common/GroupEmergencyAlert/Entry/Usage`

Table 10.2.40.1: `<x>/<x>/Common/GroupEmergencyAlert/Entry/Usage`

`<x>/Common/GroupEmergencyAlert/Entry/Usage`

Status	Occurrence	Format	Min. Access Types
Required	One	chr	Get, Replace

This leaf node indicates the criteria to determine when initiation of an MCDData emergency alert uses the ID.

The valid values are 'UseCurrentlySelectedGroup' and 'DedicatedGroup'.

When set to 'UseCurrentlySelectedGroup' then if the MCDData user has currently selected an MCDData group then use that MCDData group for an on-network MCDData emergency alert, if the MCDData user does not have a currently selected MCDData group then use the MCDData group identified by the ID in subclause 10.2.38 for an MCDData emergency alert.

When set to 'DedicatedGroup' then use the MCDData group identified by the ID in subclause 10.2.38 for an MCDData emergency alert.

10.2.41 /<x>/<x>/Common/AllowedActivateAlert

Table 10.2.41.1: /<x>/<x>/Common/AllowedActivateAlert

<x>/Common/AllowedActivateAlert

Status	Occurrence	Format	Min. Access Types
Optional	One	bool	Get, Replace

This leaf node indicates whether the MCDData user is authorised to activate an emergency alert

When set to "true" the MCDData user is authorised to activate an emergency alert.

When set to "false" the MCDData user is not authorised to activate an emergency alert.

10.2.42 /<x>/<x>/Common/AllowedCancelAlert

Table 10.2.42.1: /<x>/<x>/Common/AllowedCancelAlert

<x>/Common/AllowedCancelAlert

Status	Occurrence	Format	Min. Access Types
Required	One	bool	Get, Replace

This leaf node indicates whether the MCDData user is allowed to cancel an emergency alert.

When set to "true" the MCDData user is authorised to cancel an emergency alert.

When set to "false" the MCDData user is not authorised to cancel an emergency alert.

10.2.43 /<x>/<x>/OnNetwork

Table 10.2.43.1: /<x>/<x>/OnNetwork

<x>/OnNetwork

Status	Occurrence	Format	Min. Access Types
Required	ZeroOrOne	node	Get, Replace

This interior node represents a container for on-network operation.

10.2.44 /<x>/<x>/OnNetwork/MCDDataGroupList

Table 10.2.44.1: /<x>/<x>/OnNetwork/MCDDataGroupList

<x>/OnNetwork/MCDDataGroupList

Status	Occurrence	Format	Min. Access Types
Required	One	node	Get, Replace

This interior node is a placeholder for the list of on-network MCDData groups that the MCDData user is allowed to use.

10.2.45 /<x>/<x>/OnNetwork/MCDDataGroupList/<x>

Table 10.2.45.1: /<x>/<x>/OnNetwork/MCDDataGroupList/<x>

<x>/OnNetwork/MCDDataGroupList/<x>

Status	Occurrence	Format	Min. Access Types
Required	OneOrMore	node	Get, Replace

This interior node is a placeholder for one or more list of on-network MCDData groups that the MCDData user is allowed to use.

10.2.46 /<x>/<x>/OnNetwork/MCDDataGroupList/<x>/Entry

Table 10.2.46.1: /<x>/<x>/OnNetwork/MCDDataGroupList/<x>/Entry

<x>/OnNetwork/MCDDataGroupList/<x>/Entry

Status	Occurrence	Format	Min. Access Types
Optional	One	node	Get, Replace

This interior node is a placeholder for the details of the on-network MCDData groups that the MCDData user is allowed to use.

10.2.47 /<x>/<x>/OnNetwork/MCDDataGroupList/<x>/Entry/MCDDataGroupID

Table 10.2.47.1: /<x>/<x>/OnNetwork/MCDDataGroupList/<x>/Entry/MCDDataGroupID

<x>/OnNetwork/MCDDataGroupList/<x>/Entry/MCDDataGroupID

Status	Occurrence	Format	Min. Access Types
Required	One	chr	Get, Replace

This leaf node indicates the MCDData group ID for the on-network MCDData group that the MCDData user is allowed to use.

The value is a "uri" attribute specified in OMA OMA-TS-XDM_Group-V1_1 [4].

10.2.48 /<x>/<x>/OnNetwork/MCDDataGroupList/<x>/Entry/DisplayName

Table 10.2.48.1: /<x>/<x>/OnNetwork/MCDDataGroupList/<x>/Entry/DisplayName

<x>/OnNetwork/MCDDataGroupList/<x>/Entry/DisplayName

Status	Occurrence	Format	Min. Access Types
Optional	One	chr	Get, Replace

This leaf node contains a human readable name that corresponds to the MCDData Group ID.

10.2.49 /<x>/<x>/OnNetwork/MCDDataGroupList/<x>/Entry/GMSAppServList

Table 10.2.49.1: /<x>/<x>/OnNetwork/MCDDataGroupList/<x>/Entry/GMSAppServList

<x>/OnNetwork/MCDDataGroupList/<x>/Entry/GMSAppServList

Status	Occurrence	Format	Min. Access Types
Required	One	node	Get, Replace

This interior node is a placeholder for the Group Management Server application plane server identity configuration.

10.2.50

/<x>/<x>/OnNetwork/MCDDataGroupList/<x>/Entry/GMSAppServList/
<x>

Table 10.2.50.1: /<x>/<x>/OnNetwork/MCDDataGroupList/<x>/Entry/GMSAppServList/<x>

<x>/OnNetwork/MCDDataGroupList/<x>/Entry/GMSAppServList/<x>

Status	Occurrence	Format	Min. Access Types
Required	OneOrMore	node	Get, Replace

This interior node is a placeholder for one or more Group Management Server configuration.

10.2.51

`/<x>/<x>/OnNetwork/MCDataGroupList/<x>/Entry/GMSAppServList/
<x>/GMSAppServId`

Table 10.2.51.1:

`/<x>/<x>/OnNetwork/MCDataGroupList/<x>/Entry/GMSAppServList/<x>/GMSAppServId`

`<x>/OnNetwork/MCDataGroupList/<x>/Entry/GMSAppServList/<x>/GMSAppServId`

Status	Occurrence	Format	Min. Access Types
Optional	One	chr	Get, Replace

This leaf node indicates the identity (URI) of the the group management server hosting the MCData Group ID.

10.2.52

`/<x>/<x>/OnNetwork/MCDataGroupList/<x>/Entry/IdMSTokenEndPointList`

Table 10.2.52.1: `/<x>/<x>/OnNetwork/MCDataGroupList/<x>/Entry/IdMSTokenEndPointList`

`<x>/OnNetwork/MCDataGroupList/<x>/Entry/IdMSTokenEndPointList`

Status	Occurrence	Format	Min. Access Types
Required	One	node	Get, Replace

This interior node is a placeholder for the Identity Management Server token endpoints configuration.

10.2.53

`/<x>/<x>/OnNetwork/MCDataGroupList/<x>/Entry/IdMSTokenEndPointList/<x>`

Table 10.2.53.1: `/<x>/<x>/OnNetwork/MCDataGroupList/<x>/Entry/IdMSTokenEndPointList/<x>`

`<x>/OnNetwork/MCDataGroupList/<x>/Entry/IdMSTokenEndPointList/<x>`

Status	Occurrence	Format	Min. Access Types
Required	OneOrMore	node	Get, Replace

This interior node is a placeholder for one or more IDMS token endpoints configuration.

10.2.54

`/<x>/<x>/OnNetwork/MCDataGroupList/<x>/Entry/IdMSTokenEndPointList/<x>/IdMSTokenEndPoint`

Table 10.2.54.1:

`/<x>/<x>/OnNetwork/MCDataGroupList/<x>/Entry/IdMSTokenEndPointList/<x>/IdMSTokenEndPoint`

`<x>/OnNetwork/MCDataGroupList/<x>/Entry/IdMSTokenEndPointList/<x>/IdMSTokenEndPoint`

Status	Occurrence	Format	Min. Access Types
Optional	One	chr	Get, Replace

This leaf node indicates the identity (URI) of the the IDMS token endpoint for the MCData Group ID in the MCDataGroupList. If the value is empty, the IDMS identities (IDMSAuthEndpoint and IDMSTokenEndpoint) present in the MCS UE initial configuration MO are used.

10.2.54A

`/<x>/<x>/OnNetwork/MCDataGroupList/<x>/Entry/MCDataGroupIDKMSURI`

Table 10.2.54A.1: `/<x>/<x>/OnNetwork/MCDataGroupList/<x>/Entry/MCDataGroupIDKMSURI`

`<x>/OnNetwork/MCDataGroupList/<x>/Entry/MCDataGroupIDKMSURI`

Status	Occurrence	Format	Min. Access Types
Required	One	chr	Get, Replace

This leaf node indicates key management server URI for the security domain of the MCData group identity (MCData Group ID) of the on-network MCData group

The value is a URI as specified in 3GPP TS 23.003 [5].

10.2.55

`/<x>/<x>/OnNetwork/MCDataGroupList/<x>/Entry/PresentationPriority`

Table 10.2.55.1: `/<x>/<x>/OnNetwork/MCDataGroupList/<x>/Entry/PresentationPriority`

`<x>/OnNetwork/MCDataGroupList/<x>/Entry/PresentationPriority`

Status	Occurrence	Format	Min. Access Types
Optional	One	int	Get, Replace

This leaf node indicates indicating the presentation priority of the on-network group for the MCData user relative to other on-network groups and on-network users.

- Values: 0-255

The lowest PresentationPriority value shall be considered as the MCData group transaction having the lowest priority for presentation among other group MCData and one-to-one user transactions.

10.2.56 `/<x>/<x>/OnNetwork/ImplicitAffiliations`

Table 10.2.56.1: `/<x>/<x>/OnNetwork/ImplicitAffiliations`

`<x>/OnNetwork/ImplicitAffiliations`

Status	Occurrence	Format	Min. Access Types
Required	One	chr	Get, Replace

This interior node is a placeholder for the implicit affiliation configuration.

10.2.57 `/<x>/<x>/OnNetwork/ImplicitAffiliations/<x>`

Table 10.2.57.1: `/<x>/<x>/OnNetwork/ImplicitAffiliations/<x>`

`<x>/OnNetwork/ImplicitAffiliations/<x>`

Status	Occurrence	Format	Min. Access Types
Required	ZeroOrMore	node	Get, Replace

This interior node is a placeholder for zero or more implicit affiliation configuration.

10.2.58 /<x>/<x>/OnNetwork/ImplicitAffiliations/<x>/Entry

Table 10.2.58.1: /<x>/<x>/OnNetwork/ImplicitAffiliations/<x>/Entry

<x>/OnNetwork/ImplicitAffiliations/<x>/Entry

Status	Occurrence	Format	Min. Access Types
Optional	One	node	Get, Replace

This interior node is a placeholder for the details of the on-network MCDATA groups that the MCDATA user is implicitly affiliated to.

10.2.59 /<x>/<x>/OnNetwork/ImplicitAffiliations/<x>/Entry/MCDATAGroupID

Table 10.2.59.1: /<x>/<x>/OnNetwork/ImplicitAffiliations/<x>/Entry/MCDATAGroupID

<x>/OnNetwork/ImplicitAffiliations/<x>/Entry/MCDATAGroupID

Status	Occurrence	Format	Min. Access Types
Required	One	chr	Get, Replace

This leaf node indicates a MCDATA group ID to which the MCDATA user is implicitly affiliated to.

The value is a "uri" attribute specified in OMA OMA-TS-XDM_Group-V1_1 [4].

10.2.60 /<x>/<x>/OnNetwork/ImplicitAffiliations/<x>/Entry/DisplayName

Table 10.2.60.1: /<x>/<x>/OnNetwork/ImplicitAffiliations/<x>/Entry/DisplayName

<x>/OnNetwork/ImplicitAffiliations/<x>/Entry/DisplayName

Status	Occurrence	Format	Min. Access Types
Optional	One	chr	Get, Replace

This leaf node contains a human readable name that corresponds to the MCDATA Group ID.

10.2.61 /<x>/<x>/OnNetwork/PresenceStatus

Table 10.2.61.1: /<x>/<x>/OnNetwork/PresenceStatus

<x>/OnNetwork/PresenceStatus

Status	Occurrence	Format	Min. Access Types
Required	One	chr	Get, Replace

This interior node is a placeholder for the presence status configuration.

10.2.62 /<x>/<x>/OnNetwork/PresenceStatus/<x>

Table 10.2.62.1: /<x>/<x>/OnNetwork/PresenceStatus/<x>

<x>/OnNetwork/PresenceStatus/<x>

Status	Occurrence	Format	Min. Access Types
Required	ZeroOrMore	node	Get, Replace

This interior node is a placeholder for zero or more presence status configuration.

10.2.63 /<x>/<x>/OnNetwork/PresenceStatus/<x>/Entry

Table 10.2.63.1: /<x>/<x>/OnNetwork/PresenceStatus/<x>/Entry

<x>/OnNetwork/PresenceStatus/<x>/Entry

Status	Occurrence	Format	Min. Access Types
Optional	One	node	Get, Replace

This interior node is a placeholder for the details of the MCDData IDs of MCDData users that the configured MCDData user is authorised to obtain presence status;

10.2.64 /<x>/<x>/OnNetwork/PresenceStatus/<x>/Entry/MCDDataID

Table 10.2.64.1: /<x>/<x>/OnNetwork/PresenceStatus/<x>/Entry/MCDDataID

<x>/OnNetwork/PresenceStatus/<x>/Entry/MCDDataID

Status	Occurrence	Format	Min. Access Types
Required	One	chr	Get, Replace

This leaf node indicates an MCDData ID of an MCDData user that the configured MCDData user is authorised to obtain presence status;

The value is a "uri" attribute specified in OMA OMA-TS-XDM_Group-V1_1 [4].

10.2.65 /<x>/<x>/OnNetwork/PresenceStatus/<x>/Entry/DisplayName

Table 10.2.65.1: /<x>/<x>/OnNetwork/PresenceStatus/<x>/Entry/DisplayName

<x>/OnNetwork/PresenceStatus/<x>/Entry/DisplayName

Status	Occurrence	Format	Min. Access Types
Optional	One	chr	Get, Replace

This leaf node contains a human readable name that corresponds to the MCDData ID.

10.2.66 /<x>/<x>/OnNetwork/RemoteGroupChange

Table 10.2.66.1: /<x>/<x>/OnNetwork/RemoteGroupChange

<x>/OnNetwork/RemoteGroupChange

Status	Occurrence	Format	Min. Access Types
Required	One	chr	Get, Replace

This interior node is a placeholder for the remote group change configuration.

10.2.67 /<x>/<x>/OnNetwork/RemoteGroupChange/<x>

Table 10.2.67.1: /<x>/<x>/OnNetwork/RemoteGroupChange/<x>

<x>/OnNetwork/RemoteGroupChange/<x>

Status	Occurrence	Format	Min. Access Types
Required	ZeroOrMore	node	Get, Replace

This interior node is a placeholder for zero or more remote group change configuration.

10.2.68 /<x>/<x>/OnNetwork/RemoteGroupChange/<x>/Entry

Table 10.2.68.1: /<x>/<x>/OnNetwork/RemoteGroupChange/<x>/Entry

<x>/OnNetwork/RemoteGroupChange/<x>/Entry

Status	Occurrence	Format	Min. Access Types
Optional	One	node	Get, Replace

This interior node is a placeholder for the details of the MCDData IDs of MCDData users whose selected groups are authorised to be remotely changed by the configured MCDData user;

10.2.69 /<x>/<x>/OnNetwork/RemoteGroupChange/<x>/Entry/MCDataID

Table 10.2.69.1: /<x>/<x>/OnNetwork/RemoteGroupChange/<x>/Entry/MCDataID

<x>/OnNetwork/RemoteGroupChange/<x>/Entry/MCDataID

Status	Occurrence	Format	Min. Access Types
Required	One	chr	Get, Replace

This leaf node indicates an MCData ID of an MCData user whose selected groups are authorised to be remotely changed by the configured MCData user;

The value is a "uri" attribute specified in OMA OMA-TS-XDM_Group-V1_1 [4].

10.2.70 /<x>/<x>/OnNetwork/RemoteGroupChange/<x>/Entry/DisplayName

Table 10.2.70.1: /<x>/<x>/OnNetwork/RemoteGroupChange/<x>/Entry/DisplayName

<x>/OnNetwork/RemoteGroupChange/<x>/Entry/DisplayName

Status	Occurrence	Format	Min. Access Types
Optional	One	chr	Get, Replace

This leaf node contains a human readable name that corresponds to the MCData ID.

10.2.71 /<x>/<x>/OnNetwork/MaxAffiliationsN2

Table 10.2.71.1: /<x>/<x>/OnNetwork/MaxAffiliationsN2

<x>/OnNetwork/MaxAffiliationsN2

Status	Occurrence	Format	Min. Access Types
Optional	One	int	Get, Replace

This leaf node indicates the maximum number of MCData groups that the MCData user is authorised to affiliate with.

- Values: 0-65535

10.2.72 /<x>/<x>/OnNetwork/ConversationManagement

Table 10.2.72.1: /<x>/<x>/OnNetwork/ConversationManagement

<x>/OnNetwork/ConversationManagement

Status	Occurrence	Format	Min. Access Types
Required	One	node	Get, Replace

This interior node is a placeholder for conversation management configuration

10.2.73 /<x>/<x>/OnNetwork/ConversationManagement/GroupHangTime

Table 10.2.73.1: /<x>/<x>/OnNetwork/ConversationManagement/GroupHangTime

<x>/OnNetwork/ConversationManagement/GroupHangTime

Status	Occurrence	Format	Min. Access Types
Required	One	node	Get, Replace

This interior node is a placeholder for group hang time configuration

10.2.74

`<x>/<x>/OnNetwork/ConversationManagement/GroupHangTime/<x>`
`>`

Table 10.2.74.1: `<x>/<x>/OnNetwork/ConversationManagement/GroupHangTime/<x>`

`<x>/OnNetwork/ConversationManagement/GroupHangTime/<x>`

Status	Occurrence	Format	Min. Access Types
Required	OneOrMore	node	Get, Replace

This interior node is a placeholder for one or more hang time configurations.

10.2.75

`<x>/<x>/OnNetwork/ConversationManagement/GroupHangTime/<x>`
`>/Entry`

Table 10.2.75.1: `<x>/<x>/OnNetwork/ConversationManagement/GroupHangTime/<x>/Entry`

`<x>/OnNetwork/ConversationManagement/GroupHangTime/<x>/Entry`

Status	Occurrence	Format	Min. Access Types
Optional	One	node	Get, Replace

This interior node is a placeholder for the conversation hang time configuration associated with the configured MCDData group, for the MCDData user.

10.2.76

`<x>/<x>/OnNetwork/ConversationManagement/GroupHangTime/<x>`
`>/Entry/MCDDataGroupID`

Table 10.2.76.1:

`<x>/<x>/OnNetwork/ConversationManagement/GroupHangTime/<x>/Entry/MCDDataGroupID`

`<x>/OnNetwork/ConversationManagement/GroupHangTime/<x>/Entry/MCDDataGroupID`

Status	Occurrence	Format	Min. Access Types
Required	One	chr	Get, Replace

This leaf node indicates the MCDData group ID for the on-network MCDData group.

The value is a "uri" attribute specified in OMA OMA-TS-XDM_Group-V1_1 [4].

10.2.77

`<x>/<x>/OnNetwork/ConversationManagement/GroupHangTime/<x>`
`>/Entry/DisplayName`

Table 10.2.77.1:

`<x>/<x>/OnNetwork/ConversationManagement/GroupHangTime/<x>/Entry/DisplayName`

`<x>/OnNetwork/ConversationManagement/GroupHangTime/<x>/Entry/DisplayName`

Status	Occurrence	Format	Min. Access Types
Optional	One	chr	Get, Replace

This leaf node contains a human readable name that corresponds to the MCDData Group ID.

10.2.78

`<x>/OnNetwork/ConversationManagement/GroupHangTime/<x>/Entry/HangTime`

Table 10.2.78.1: `<x>/OnNetwork/ConversationManagement/GroupHangTime/<x>/Entry/HangTime`

`<x>/OnNetwork/ConversationManagement/GroupHangTime/<x>/Entry/HangTime`

Status	Occurrence	Format	Min. Access Types
Required	One	int	Get, Replace

This leaf node indicates the group call hang timer of the MCDData group for conversation management, for the MCDData user.

- Values: 0-65535

The HangTime is in seconds.

10.2.79

`<x>/OnNetwork/ConversationManagement/DeliveredDisposition`

Table 10.2.79.1: `<x>/OnNetwork/ConversationManagement/DeliveredDisposition`

`<x>/OnNetwork/ConversationManagement/DeliveredDisposition`

Status	Occurrence	Format	Min. Access Types
Required	One	node	Get, Replace

This interior node is a placeholder for delivered disposition configuration

10.2.80

`<x>/OnNetwork/ConversationManagement/DeliveredDisposition/<x>`

Table 10.2.80.1: `<x>/OnNetwork/ConversationManagement/DeliveredDisposition/<x>`

`<x>/OnNetwork/ConversationManagement/DeliveredDisposition/<x>`

Status	Occurrence	Format	Min. Access Types
Required	ZeroOrMore	node	Get, Replace

This interior node is a placeholder for zero or more delivered disposition configurations.

10.2.81

`<x>/OnNetwork/ConversationManagement/DeliveredDisposition/<x>/Entry`

Table 10.2.81.1: `<x>/OnNetwork/ConversationManagement/DeliveredDisposition/<x>/Entry`

`<x>/OnNetwork/ConversationManagement/DeliveredDisposition/<x>/Entry`

Status	Occurrence	Format	Min. Access Types
Optional	One	node	Get, Replace

This interior node is a placeholder for the delivered disposition configuration associated with the MCDData user, indicating an MCDData ID of an MCDData user who is to be sent a message delivered disposition notification in addition to the message sender;

10.2.82

`/<x>/<x>/OnNetwork/ConversationManagement/DeliveredDisposition/<x>/Entry/MCDataID`

Table 10.2.82.1:

`/<x>/<x>/OnNetwork/ConversationManagement/DeliveredDisposition/<x>/Entry/MCDataID`

`<x>/OnNetwork/ConversationManagement/DeliveredDisposition/<x>/Entry/MCDataID`

Status	Occurrence	Format	Min. Access Types
Required	One	chr	Get, Replace

This leaf node indicates the MCData ID for the on-network MCData user.

The value is a "uri" attribute specified in OMA OMA-TS-XDM_Group-V1_1 [4].

10.2.83

`/<x>/<x>/OnNetwork/ConversationManagement/DeliveredDisposition/<x>/Entry/DisplayName`

Table 10.2.83.1:

`/<x>/<x>/OnNetwork/ConversationManagement/DeliveredDisposition/<x>/Entry/DisplayName`

`<x>/OnNetwork/ConversationManagement/DeliveredDisposition/<x>/Entry/DisplayName`

Status	Occurrence	Format	Min. Access Types
Optional	One	chr	Get, Replace

This leaf node contains a human readable name that corresponds to the MCData ID.

10.2.84 `/<x>/<x>/OnNetwork/ConversationManagement/ReadDisposition`**Table 10.2.84.1: `/<x>/<x>/OnNetwork/ConversationManagement/ReadDisposition`**

`<x>/OnNetwork/ConversationManagement/ReadDisposition`

Status	Occurrence	Format	Min. Access Types
Required	One	node	Get, Replace

This interior node is a placeholder for read disposition configuration

10.2.85

`/<x>/<x>/OnNetwork/ConversationManagement/ReadDisposition/<x>`
`>`

Table 10.2.85.1: `/<x>/<x>/OnNetwork/ConversationManagement/ReadDisposition/<x>`

`<x>/OnNetwork/ConversationManagement/ReadDisposition/<x>`

Status	Occurrence	Format	Min. Access Types
Required	ZeroOrMore	node	Get, Replace

This interior node is a placeholder for zero or more read disposition configurations.

10.2.86

`/<x>/<x>/OnNetwork/ConversationManagement/ReadDisposition/<x>`
`>/Entry`

Table 10.2.86.1: `/<x>/<x>/OnNetwork/ConversationManagement/ReadDisposition/<x>/Entry`

`<x>/OnNetwork/ConversationManagement/ReadDisposition/<x>/Entry`

Status	Occurrence	Format	Min. Access Types
Optional	One	node	Get, Replace

This interior node is a placeholder for the read disposition configuration associated with the MCDData user, indicating an MCDData ID of an MCDData user who is to be sent a message read disposition notification in addition to the message sender;

10.2.87

`<x>/<x>/OnNetwork/ConversationManagement/ReadDisposition/<x>/Entry/MCDDataID`

Table 10.2.87.1: `<x>/<x>/OnNetwork/ConversationManagement/ReadDisposition/<x>/Entry/MCDDataID`

`<x>/OnNetwork/ConversationManagement/ReadDisposition/<x>/Entry/MCDDataID`

Status	Occurrence	Format	Min. Access Types
Required	One	chr	Get, Replace

This leaf node indicates the MCDData ID for the on-network MCDData user.

The value is a "uri" attribute specified in OMA OMA-TS-XDM_Group-V1_1 [4].

10.2.88

`<x>/<x>/OnNetwork/ConversationManagement/ReadDisposition/<x>/Entry/DisplayName`

Table 10.2.88.1:

`<x>/<x>/OnNetwork/ConversationManagement/ReadDisposition/<x>/Entry/DisplayName`

`<x>/OnNetwork/ConversationManagement/ReadDisposition/<x>/Entry/DisplayName`

Status	Occurrence	Format	Min. Access Types
Optional	One	chr	Get, Replace

This leaf node contains a human readable name that corresponds to the MCDData ID.

10.2.89 `<x>/<x>/OnNetwork/OneToOneEmergencyAlert`

Table 10.2.89.1: `<x>/<x>/OnNetwork/OneToOneEmergencyAlert`

`<x>/OnNetwork/OneToOneEmergencyAlert`

Status	Occurrence	Format	Min. Access Types
Required	One	node	Get, Replace

This interior node is a placeholder for on-network one-to-one emergency alert configuration.

10.2.90 `<x>/<x>/OnNetwork/OneToOneEmergencyAlert/Entry`

Table 10.2.90.1: `<x>/<x>/OnNetwork/OneToOneEmergencyAlert/Entry`

`<x>/OnNetwork/OneToOneEmergencyAlert/Entry`

Status	Occurrence	Format	Min. Access Types
Required	One	node	Get, Replace

This interior node is a placeholder for the details of the MCDData ID of an MCDData emergency alert.

10.2.91 `<x>/<x>/OnNetwork/OneToOneEmergencyAlert/Entry/ID`

Table 10.2.91.1: `<x>/<x>/OnNetwork/OneToOneEmergencyAlert/Entry/ID`

`<x>/OnNetwork/OneToOneEmergencyAlert/Entry/ID`

Status	Occurrence	Format	Min. Access Types
Required	One	chr	Get, Replace

This leaf node indicates the MCDData user ID used upon certain criteria on initiation of a one-to-one MCDData emergency alert.

10.2.92 /<x>/<x>/OnNetwork/OneToOneEmergencyAlert/Entry/DisplayName

Table 10.2.92.1: /<x>/<x>/OnNetwork/OneToOneEmergencyAlert/Entry/DisplayName

<x>/OnNetwork/OneToOneEmergencyAlert/Entry/DisplayName

Status	Occurrence	Format	Min. Access Types
Optional	One	chr	Get, Replace

This leaf node contains a human readable name that corresponds to the ID.

10.2.93 /<x>/<x>/OnNetwork/OneToOneEmergencyAlert/Entry/Usage

Table 10.2.93.1: /<x>/<x>/OnNetwork/OneToOneEmergencyAlert/Entry/Usage

<x>/OnNetwork/OneToOneEmergencyAlert/Entry/Usage

Status	Occurrence	Format	Min. Access Types
Required	One	chr	Get, Replace

This leaf node indicates the criteria to determine when initiation of an MCDData emergency alert uses the ID.

The valid values are 'LocallyDetermined' and 'UsePreConfigured'.

When set to 'LocallyDetermined' then if the MCDData user selects an MCDData ID then use that MCDData ID for an on-network MCDData emergency alert, if the MCDData user does not select a MCDData ID then use the MCDData ID identified by the ID in subclause 10.2.91 for an on-network MCDData emergency alert.

When set to 'UsePreConfigured' then use the ID identified by the ID in subclause 10.2.91 for an on-network MCDData emergency alert.

10.2.94 /<x>/<x>/OnNetwork/AllowedRegroup

Table 10.2.94.1: /<x>/<x>/OnNetwork/AllowedRegroup

<x>/OnNetwork/AllowedRegroup

Status	Occurrence	Format	Min. Access Types
Required	One	bool	Get, Replace

This leaf node indicates whether the MCDData user is authorised to perform dynamic regrouping operations.

When set to "true" the MCDData user is authorised to perform dynamic regrouping operations.

When set to "false" the MCDData user is not authorised to perform dynamic regrouping operations.

10.2.95 /<x>/<x>/OnNetwork/AllowedPresenceStatus

Table 10.2.95.1: /<x>/<x>/OnNetwork/AllowedPresenceStatus

<x>/OnNetwork/AllowedPresenceStatus

Status	Occurrence	Format	Min. Access Types
Optional	One	bool	Get, Replace

This leaf node indicates the presence status on the network of this MCDData user is available.

When set to "true" the presence status on the network of this MCDData user is available.

When set to "false" the presence status on the network of this MCDData user is not available. This is the default if this leaf node is not present.

10.2.96 /<x>/<x>/OnNetwork/AllowedPresence

Table 10.2.96.1: /<x>/<x>/OnNetwork/AllowedPresence

<x>/OnNetwork/AllowedPresence

Status	Occurrence	Format	Min. Access Types
Optional	One	bool	Get, Replace

This leaf node indicates whether the MCDData user is authorised to obtain whether a particular MCDData User is present on the network.

When set to "true" the MCDData user is authorised to obtain whether a particular MCDData User is present on the network.

When set to "false" the MCDData user is not authorised to obtain whether a particular MCDData User is present on the network.

10.2.97 /<x>/<x>/OnNetwork/AllowedManualSwitch

Table 10.2.97.1: /<x>/<x>/OnNetwork/AllowedManualSwitch

<x>/OnNetwork/AllowedManualSwitch

Status	Occurrence	Format	Min. Access Types
Required	One	bool	Get, Replace

This leaf node indicates whether the MCDData user is authorised to manually switch to off-network operation while in on-network operation.

When set to "true" the MCDData user is authorised to manually switch to off-network operation while in on-network operation.

When set to "false" the MCDData user is not authorised to manually switch to off-network operation while in on-network operation.

10.2.98 /<x>/<x>/OffNetwork

Table 10.2.98.1: /<x>/<x>/OffNetwork

<x>/OffNetwork

Status	Occurrence	Format	Min. Access Types
Required	ZeroOrOne	node	Get, Replace

This interior node represents a container for off-network operation.

10.2.99 /<x>/<x>/OffNetwork/Authorised

Table 10.2.99.1: /<x>/<x>/OffNetwork/Authorised

<x>/OffNetwork/Authorised

Status	Occurrence	Format	Min. Access Types
Required	One	bool	Get, Replace

This leaf node indicates the authorisation for off-network services.

When set to "true" the MCDData user is authorised for off-network.

When set to "false" the MCDData user is not authorised for off-network operation.

10.2.100 /<x>/<x>/OffNetwork/MCDataGroupList

Table 10.2.100.1: /<x>/<x>/OffNetwork/MCDataGroupList

<x>/OffNetwork/MCDataGroupList

Status	Occurrence	Format	Min. Access Types
Required	One	node	Get, Replace

This interior node is a placeholder for the list of off-network MCData groups that the MCData user is allowed to use.

10.2.101 /<x>/<x>/OffNetwork/MCDataGroupList/<x>

Table 10.2.101.1: /<x>/<x>/OffNetwork/MCDataGroupList/<x>

<x>/OffNetwork/MCDataGroupList/<x>

Status	Occurrence	Format	Min. Access Types
Required	OneOrMore	node	Get, Replace

This interior node is a placeholder for one or more list of off-network MCData groups that the MCData user is allowed to use.

10.2.102 /<x>/<x>/OffNetwork/MCDataGroupList/<x>/Entry

Table 10.2.102.1: /<x>/<x>/OffNetwork/MCDataGroupList/<x>/Entry

<x>/OffNetwork/MCDataGroupList/<x>/Entry

Status	Occurrence	Format	Min. Access Types
Optional	One	node	Get, Replace

This interior node is a placeholder for the details of the off-network MCData groups that the MCData user is allowed to use.

10.2.103 /<x>/<x>/OffNetwork/MCDataGroupList/<x>/Entry/MCDataGroupID

Table 10.2.103.1: /<x>/<x>/OffNetwork/MCDataGroupList/<x>/Entry/MCDataGroupID

<x>/OffNetwork/MCDataGroupList/<x>/Entry/MCDataGroupID

Status	Occurrence	Format	Min. Access Types
Required	One	chr	Get, Replace

This leaf node indicates the MCData group ID for the off-network MCData group that the MCData user is allowed to use.

The value is a "uri" attribute specified in OMA OMA-TS-XDM_Group-V1_1 [4].

10.2.104 /<x>/<x>/OffNetwork/MCDataGroupList/<x>/Entry/DisplayName

Table 10.2.104.1: /<x>/<x>/OffNetwork/MCDataGroupList/<x>/Entry/DisplayName

<x>/OffNetwork/MCDataGroupList/<x>/Entry/DisplayName

Status	Occurrence	Format	Min. Access Types
Optional	One	chr	Get, Replace

This leaf node contains a human readable name that corresponds to the MCData Group ID.

10.2.105 /<x>/<x>/OffNetwork/MCDataGroupList/<x>/Entry/GMSAppServList

Table 10.2.105.1: /<x>/<x>/OffNetwork/MCDataGroupList/<x>/Entry/GMSAppServList

<x>/OffNetwork/MCDataGroupList/<x>/Entry/GMSAppServList

Status	Occurrence	Format	Min. Access Types
Required	One	node	Get, Replace

This interior node is a placeholder for the Group Management Server application plane server identity configuration.

10.2.106

/<x>/<x>/OffNetwork/MCDataGroupList/<x>/>/Entry/GMSAppServList/<x>

Table 10.2.106.1: /<x>/<x>/OffNetwork/MCDataGroupList/<x>/Entry/GMSAppServList/<x>

<x>/OffNetwork/MCDataGroupList/<x>/Entry/GMSAppServList/<x>

Status	Occurrence	Format	Min. Access Types
Required	OneOrMore	node	Get, Replace

This interior node is a placeholder for one or more Group Management Server configuration.

10.2.107

/<x>/<x>/OffNetwork/MCDataGroupList/<x>/Entry/GMSAppServList/<x>/GMSAppServId

Table 10.2.107.1:**/<x>/<x>/OffNetwork/MCDataGroupList/<x>/Entry/GMSAppServList/<x>/GMSAppServId**

<x>/OffNetwork/MCDataGroupList/<x>/Entry/GMSAppServList/<x>/GMSAppServId

Status	Occurrence	Format	Min. Access Types
Optional	One	chr	Get, Replace

This leaf node indicates the identity (URI) of the the group management server hosting the MCData Group ID.

10.2.108

/<x>/<x>/OffNetwork/MCDataGroupList/<x>/Entry/IdMSTokenEndPointList

Table 10.2.108.1: /<x>/<x>/OffNetwork/MCDataGroupList/<x>/Entry/IdMSTokenEndPointList

<x>/OffNetwork/MCDataGroupList/<x>/Entry/IdMSTokenEndPointList

Status	Occurrence	Format	Min. Access Types
Required	One	node	Get, Replace

This interior node is a placeholder for the Identity Management Server token endpoints configuration..

10.2.109

/<x>/<x>/OffNetwork/MCDataGroupList/<x>/Entry/IdMSTokenEndPointList/<x>

Table 10.2.109.1: /<x>/<x>/OffNetwork/MCDataGroupList/<x>/Entry/IdMSTokenEndPointList/<x>

<x>/OffNetwork/MCDataGroupList/<x>/Entry/IdMSTokenEndPointList/<x>

Status	Occurrence	Format	Min. Access Types

Required	OneOrMore	node	Get, Replace
----------	-----------	------	--------------

This interior node is a placeholder for one or more IDMS token endpoints configuration.

10.2.110

`/<x>/<x>/OffNetwork/MCDataGroupList/<x>/Entry/IdMSTokenEndPointList/<x>/IdMSTokenEndPoint`

Table 10.2.110.1:

`/<x>/<x>/OffNetwork/MCDataGroupList/<x>/Entry/IdMSTokenEndPointList/<x>/IdMSTokenEndPoint`

`<x>/OffNetwork/MCDataGroupList/<x>/Entry/IdMSTokenEndPointList/<x>/IdMSTokenEndPoint`

Status	Occurrence	Format	Min. Access Types
Optional	One	chr	Get, Replace

This leaf node indicates the identity (URI) of the the IDMS token endpoint for the MCData Group ID in the MCDataGroupList. If the value is empty, the IDMS identities (IDMSAuthEndpoint and IDMSTokenEndpoint) present in the MCS UE initial configuration MO are used.

10.2.110A

`/<x>/<x>/OffNetwork/MCDataGroupList/<x>/Entry/MCDataGroupIDKMSURI`

Table 10.2.110A.1: `/<x>/<x>/OffNetwork/MCDataGroupList/<x>/Entry/MCDataGroupIDKMSURI`

`<x>/OffNetwork/MCDataGroupList/<x>/Entry/MCDataGroupIDKMSURI`

Status	Occurrence	Format	Min. Access Types
Required	One	chr	Get, Replace

This leaf node indicates key management server URI for the security domain of the MCData group identity (MCData Group ID) of the off-network MCData group

The value is a URI as specified in 3GPP TS 23.003 [5].

10.2.111

`/<x>/<x>/OffNetwork/MCDataGroupList/<x>/Entry/PresentationPriority`

Table 10.2.111.1: `/<x>/<x>/OffNetwork/MCDataGroupList/<x>/Entry/PresentationPriority`

`<x>/OffNetwork/MCDataGroupList/<x>/Entry/PresentationPriority`

Status	Occurrence	Format	Min. Access Types
Optional	One	int	Get, Replace

This leaf node indicates indicating the presentation priority of the off-network group for the MCData user relative to other off-network groups and off-network users.

- Values: 0-255

The lowest PresentationPriority value shall be considered as the MCData group transaction having the lowest priority for presentation among other group MCData and one-to-one user transactions.

10.2.112 `/<x>/<x>/OffNetwork/UserInfoID`

Table 10.2.112.1: `/<x>/<x>/OffNetwork/UserInfoID`

`<x>/OffNetwork/UserInfoID`

Status	Occurrence	Format	Min. Access Types
Required	One	chr	Get, Replace

This leaf node indicates the ProSe user info ID as specified in 3GPP TS 23.303 [6].

10.2.113 Void

10.2.114 Void

10.2.115 Void

10.2.116 Void

10.2.117 Void

10.2.118 Void

10.2.119 Void

10.2.120 Void

10.2.121 /<x>/Status

Table 10.2.121.1: /<x>/Status

Status

Status	Occurrence	Format	Min. Access Types
Optional	One	bool	Get, Replace

This leaf node indicates whether this MCDData user profile is enabled or disabled.

When set to "true" this MCDData user profile is enabled.

When set to "false" this MCDData user profile is disabled.

11 MCDData service configuration MO

11.1 General

The MCDData service configuration Management Object (MO) is used to configure MCDData Client behaviour for the on-network or off-network MCDData Service. The MCDData service configuration parameters may be stored in the ME, or in the USIM as specified in 3GPP TS 31.102 [10], or in both the ME and the USIM. If both the ME and the USIM contain the same parameters, the values stored in the USIM shall take precedence.

The Management Object Identifier is: urn:oma:mo:ext-3gpp-MCDData-service-configuration:1.0.

Protocol compatibility: This MO is compatible with OMA OMA DM 1.2 [3].

The OMA DM ACL property mechanism (see OMA OMA-ERELED-DM-V1_2 [2]) may be used to grant or deny access rights to OMA DM servers in order to modify nodes and leaf objects of the MCDData service configuration MO.

The following nodes and leaf objects are possible under the MCDData service configuration node as described in figure 11.1.1:

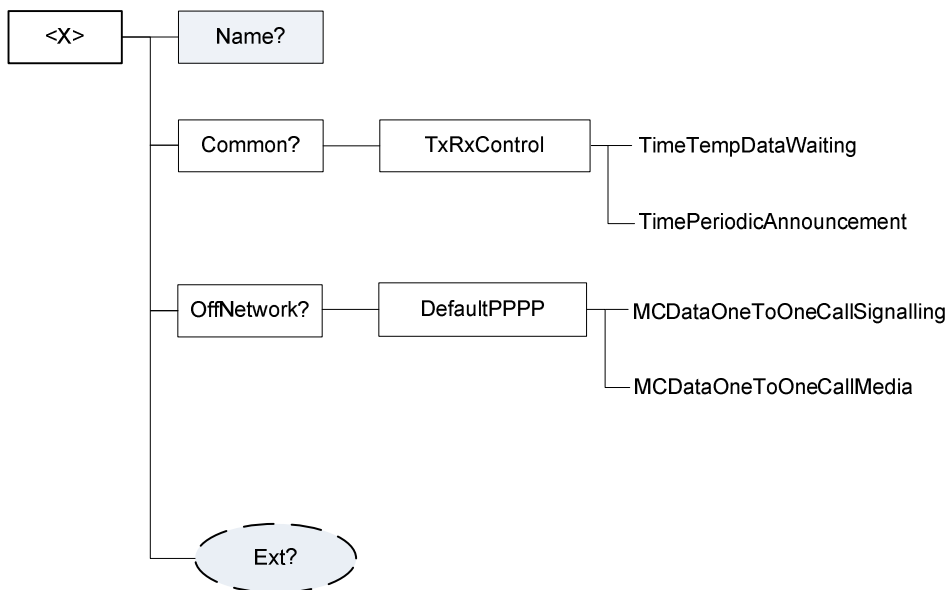

Figure 11.1.1: The MCDATA service configuration MO

11.2 MCDATA service configuration MO parameters

11.2.1 General

This clause describes the parameters for the MCDATA service configuration Management Object (MO).

11.2.2 Node: <x>

Table 11.2.2.1: Node: <x>

<x>

Status	Occurrence	Format	Min. Access Types
Required	OneOrMore	node	Get

This interior node acts as a placeholder for the MCDATA service configuration Management Object (MO).

For the MCDATA service configuration MO, the namespace specific string is: "urn:oma:mo:oma-dm-mcdata-service configuration:1.0"

- Values: N/A

11.2.3 /<x>/Name

Table 11.2.3.1: /<x>/Name

Name

Status	Occurrence	Format	Min. Access Types
Required	ZeroOrOne	chr	Get

The Name leaf is a name for the MCDATA service configuration settings.

- Values: <User displayable name>

11.2.4 /<x>/Ext/

Table 11.2.4.1: /<x>/Ext/

Ext

Status	Occurrence	Format	Min. Access Types
Optional	ZeroOrOne	node	Get, Replace

The Ext is an interior node for where the vendor specific information about the MCDData service configuration MO is being placed.

Usually the vendor extension is identified by vendor specific name under the ext node and contains the vendor meaning application vendor, device vendor etc. The tree structure under the vendor identified is not defined and can therefore include one or more un-standardized sub-trees.

- Values: N/A

11.2.5 /<x>/Common

Table 11.2.5.1: /<x>/Common

Common

Status	Occurrence	Format	Min. Access Types
Required	ZeroOrOne	node	Get, Replace

This interior node represents a container for the common network operation which means both on-network operation and off-network operation.

11.2.6 /<x>/Common/TxRxControl

Table 11.2.6.1: /<x>/Common/TxRxControl

Common/TxRxControl

Status	Occurrence	Format	Min. Access Types
Required	One	node	Get, Replace

This interior node is a placeholder for transmission and reception control configuration.

11.2.7 /<x>/Common/TxRxControl/TimeTempDataWaiting

Table 11.2.7.1: /<x>/Common/TxRxControl/TimeTempDataWaiting

Common/TxRxControl/TimeTempDataWaiting

Status	Occurrence	Format	Min. Access Types
Required	One	int	Get, Replace

This leaf node indicates the time limit for the temporarily stored data that is waiting to be delivered to a receiving user.

- Values: 0-65535

The TimeTempDataWaiting is in minutes.

11.2.8 /<x>/Common/TxRxControl/TimePeriodicAnnouncement

Table 11.2.8.1: /<x>/Common/TxRxControl/TimePeriodicAnnouncement

Common/TxRxControl/TimePeriodicAnnouncement

Status	Occurrence	Format	Min. Access Types
Required	One	int	Get, Replace

This leaf node indicates the timer for the periodic announcement which contains a list of available recently invited data group communications.

- Values: 0-65535

The TimePeriodicAnnouncement is in minutes.

11.2.9 /<x>/OffNetwork

Table 11.2.9.1: /<x>/OffNetwork

OffNetwork

Status	Occurrence	Format	Min. Access Types
Required	ZeroOrOne	node	Get, Replace

This interior node represents a container for off-network operation.

11.2.10 /<x>/OffNetwork/DefaultPPPP

Table 11.2.10.1: /<x>/OffNetwork/DefaultPPPP

OffNetwork/DefaultPPPP

Status	Occurrence	Format	Min. Access Types
Required	One	node	Get, Replace

This interior node is a placeholder for the default ProSe Per-Packet Priority (PPPP) configuration.

11.2.11 /<x>/OffNetwork/DefaultPPPP/MCDataOneToOneCallSignalling

Table 11.2.11.1: /<x>/OffNetwork/DefaultPPPP/MCDataOneToOneCallSignalling

OffNetwork/DefaultPPPP/MCDataOneToOneCallSignalling

Status	Occurrence	Format	Min. Access Types
Required	One	int	Get, Replace

This leaf node indicates the default ProSe Per-Packet Priority (PPPP) value (as specified in 3GPP TS 23.303 [6]) for the MCData one-to-one call signalling.

- Values: 1-8

The MCData user data with the lowest ProSe Per-Packet Priority value shall be considered as the MCData user data having the highest priority among the MCData user data.

11.2.12 /<x>/OffNetwork/DefaultPPPP/MCDataOneToOneCallMedia

Table 11.2.12.1: /<x>/OffNetwork/DefaultPPPP/MCDataOneToOneCallMedia

OffNetwork/DefaultPPPP/MCDataOneToOneCallMedia

Status	Occurrence	Format	Min. Access Types
Required	One	int	Get, Replace

This leaf node indicates the default ProSe Per-Packet Priority (PPPP) value (as specified in 3GPP TS 23.303 [6]) for the MCData private call media.

- Values: 1-8

The MCData user data with the lowest ProSe Per-Packet Priority value shall be considered as the MCData user data having the highest priority among the MCData user data.

12 MCVideo UE configuration MO

12.1 General

The MCVideo UE configuration Management Object (MO) is used to configure MCVideo Client behaviour for the on-network or off-network MCVideo Service. The MCVideo UE configuration parameters may be stored in the ME, or in the USIM as specified in 3GPP TS 31.102 [10], or in both the ME and the USIM. If both the ME and the USIM contain the same parameters, the values stored in the USIM shall take precedence.

The Management Object Identifier is: urn:oma:mo:ext-3gpp-MCVideo-UE-configuration:1.0.

Protocol compatibility: This MO is compatible with OMA OMA DM 1.2 [3].

The OMA DM ACL property mechanism (see OMA OMA-ERELED-DM-V1_2 [2]) may be used to grant or deny access rights to OMA DM servers in order to modify nodes and leaf objects of the MCVideo UE configuration MO.

The following nodes and leaf objects are possible under the MCVideo UE configuration node as described in figure 12.1.1:

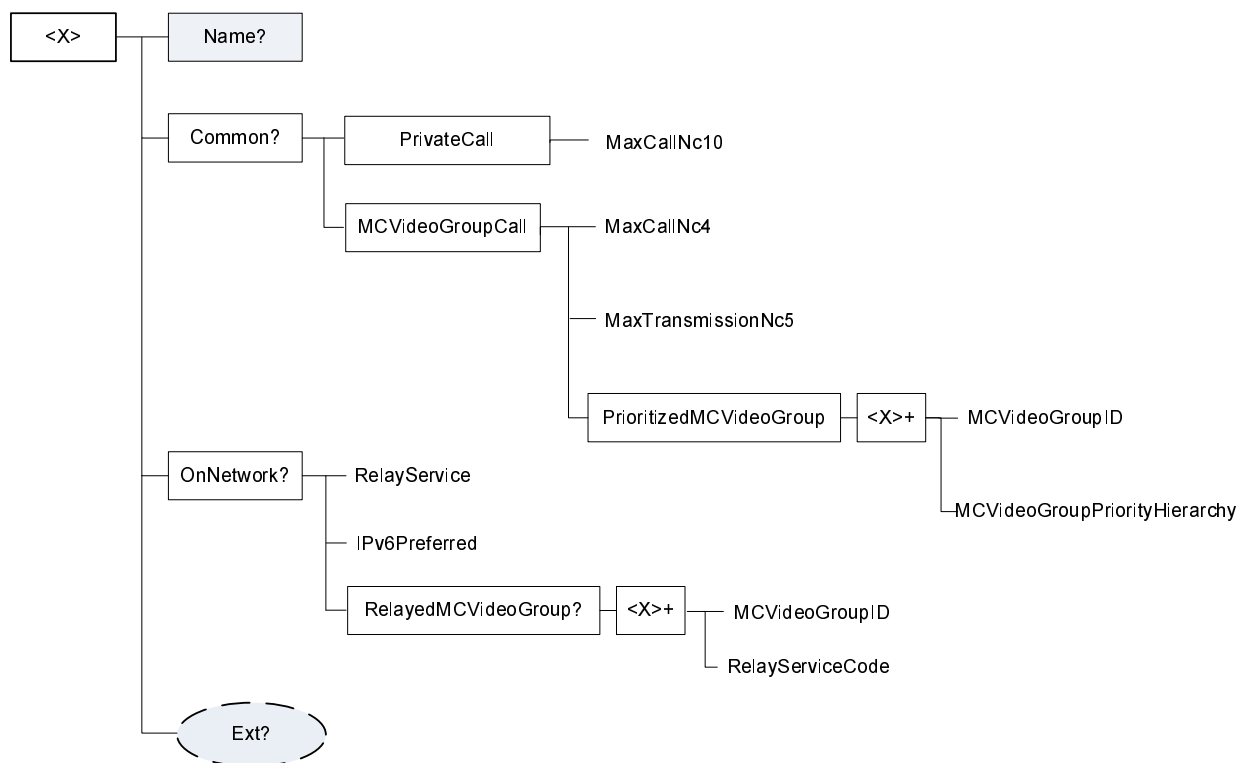

Figure 12.1.1: The MCVideo UE configuration MO

12.2 MCVideo UE configuration MO parameters

12.2.1 General

This clause describes the parameters for the MCVideo UE configuration Management Object (MO).

12.2.2 Node: <x>

Table 12.2.2.1: Node: <x>

<x>

Status	Occurrence	Format	Min. Access Types
Required	OneOrMore	node	Get

This interior node acts as a placeholder for the MCVideo UE configuration Management Object (MO).

For the MCVideo UE configuration MO, the namespace specific string is: "urn:oma:mo:oma-dm-mcvideo-ue-configuration:1.0"

- Values: N/A

12.2.3 /<x>/Name

Table 12.2.3.1: /<x>/Name

Name

Status	Occurrence	Format	Min. Access Types
Required	ZeroOrOne	chr	Get

The Name leaf is a name for the MCVideo UE configuration settings.

- Values: <User displayable name>

12.2.4 /<x>/Ext/

Table 12.2.4.1: /<x>/Ext/

Ext

Status	Occurrence	Format	Min. Access Types
Optional	ZeroOrOne	node	Get, Replace

The Ext is an interior node for where the vendor specific information about the MCVideo UE configuration MO is being placed.

Usually the vendor extension is identified by vendor specific name under the ext node and contains the vendor meaning application vendor, device vendor etc. The tree structure under the vendor identified is not defined and can therefore include one or more un-standardized sub-trees.

- Values: N/A

12.2.5 /<x>/Common

Table 12.2.5.1: /<x>/Common

Common

Status	Occurrence	Format	Min. Access Types
Required	ZeroOrOne	node	Get, Replace

This interior node represents a container for the common network operation which means both on-network operation and off-network operation.

12.2.5A /<x>/Common/PrivateCall

Table 12.2.5A.1: /<x>/Common/PrivateCall

Common/PrivateCall

Status	Occurrence	Format	Min. Access Types

Required	One	node	Get, Replace
----------	-----	------	--------------

This interior node is a placeholder for the private call configuration.

12.2.5B /<x>/Common/PrivateCall/MaxCallNc10

Table 12.2.5B.1: /<x>/Common/PrivateCall/MaxCallNc10

Common/PrivateCall/MaxCallN10

Status	Occurrence	Format	Min. Access Types
Required	One	int	Get, Replace

This leaf node indicates the maximum number of private calls.

- Values: 0-255

12.2.6 /<x>/Common/MCVideoGroupCall

Table 12.2.6.1: /<x>/Common/MCVideoGroupCall

Common/MCVideoGroupCall

Status	Occurrence	Format	Min. Access Types
Required	One	node	Get, Replace

This interior node is a placeholder for the MCVideo group call configuration.

12.2.7 /<x>/Common/MCVideoGroupCall/MaxCallNc4

Table 12.2.7.1: /<x>/Common/MCVideoGroupCall/MaxCallNc4

Common/MCVideoGroupCall/MaxCallNc4

Status	Occurrence	Format	Min. Access Types
Required	One	int	Get, Replace

This leaf node indicates the maximum number of simultaneous MCVideo group calls.

- Values: 0-255

12.2.8 /<x>/Common/MCVideoGroupCall/MaxTransmissionNc5

Table 12.2.8.1: /<x>/Common/MCVideoGroupCall/MaxTransmissionNc5

Common/MCVideoGroupCall/MaxTransmissionNc5

Status	Occurrence	Format	Min. Access Types
Required	One	int	Get, Replace

This leaf node indicates the maximum number of video transmissions in a group.

- Values: 0-255

12.2.9 /<x>/Common/MCVideoGroupCall/PrioritizedMCVideoGroup

Table 12.2.9.1: /<x>/Common/MCVideoGroupCall/PrioritizedMCVideoGroup

Common/MCVideoGroupCall/PrioritizedMCVideoGroup

Status	Occurrence	Format	Min. Access Types
Required	One	node	Get, Replace

This interior node is a placeholder for the prioritized MCVideo group call configuration.

12.2.10 /<x>/Common/MCVideoGroupCall/PrioritizedMCVideoGroup/<x>

Table 12.2.10.1: /<x>/Common/MCVideoGroupCall/PrioritizedMCVideoGroup/<x>

Common/MCVideoGroupCall/PrioritizedMCVideoGroup /<x>

Status	Occurrence	Format	Min. Access Types
Required	OneOrMore	node	Get, Replace

This interior node is a placeholder for one or more prioritized MCVideo group call configuration.

12.2.11

/<x>/Common/MCVideoGroupCall/PrioritizedMCVideoGroup/<x>/MCVideoGroupID

Table 12.2.11.1: /<x>/Common/MCVideoGroupCall/PrioritizedMCVideoGroup/<x>/MCVideoGroupID

Common/MCVideoGroupCall/PrioritizedMCVideoGroup/<x>/MCVideoGroupID

Status	Occurrence	Format	Min. Access Types
Required	One	chr	Get, Replace

This leaf node indicates the associated MCVideo group ID.

The value is a "uri" attribute specified in OMA OMA-TS-XDM_Group-V1_1 [4].

12.2.12

/<x>/Common/MCVideoGroupCall/PrioritizedMCVideoGroup/<x>/MCVideoGroupPriorityHierarchy

Table 12.2.12.1:

/<x>/Common/MCVideoGroupCall/PrioritizedMCVideoGroup/<x>/MCVideoGroupPriorityHierarchy

Common/MCVideoGroupCall/PrioritizedMCVideoGroup/<x>/MCVideoGroupPriorityHierarchy

Status	Occurrence	Format	Min. Access Types
Required	One	int	Get, Replace

This leaf node indicates the requested presentation priority of MCVideo group call.

- Values: 0-255

The group with the lowest MCVideoGroupPriorityHierarchy value shall be considered as the group having the lowest priority among the groups.

12.2.13 /<x>/OnNetwork

Table 12.2.13.1: /<x>/OnNetwork

OnNetwork

Status	Occurrence	Format	Min. Access Types
Required	ZeroOrOne	node	Get, Replace

This interior node represents a container for on-network operation.

12.2.14 /<x>/OnNetwork/RelayService

Table 12.2.14.1: /<x>/OnNetwork/RelayService

OnNetwork/RelayService

Status	Occurrence	Format	Min. Access Types
Required	One	bool	Get, Replace

This leaf node indicates the authorisation to use a relay service.

When set to "true" the MCVideo group is allowed to use a relay service.

When set to "false" the MCVideo group is not allowed to use a relay service.

12.2.15 /<x>/OnNetwork/IPv6Preferred

Table 12.2.15.1: /<x>/OnNetwork/IPv6Preferred

OnNetwork/IPv6Preferred

Status	Occurrence	Format	Min. Access Types
Required	One	bool	Get, Replace

This leaf node indicates whether IPv6 is preferred over IPv4 for on-network operation when the MCVideo UE has both IPv4 and IPv6 host configuration.

If the MCVideo UE has both IPv4 and IPv6 host configuration and:

- if IPv6Preferred is set to "true" then the UE uses IPv6 for all on-network signalling and media; otherwise
- if IPv6Preferred is set to "false" then the UE uses IPv4 for all on-network signalling and media.

12.2.16 /<x>/OnNetwork/RelayedMCVideoGroup

Table 12.2.16.1: /<x>/OnNetwork/RelayedMCVideoGroup

OnNetwork/RelayedMCVideoGroup

Status	Occurrence	Format	Min. Access Types
Optional	ZeroOrOne	node	Get, Replace

This interior node is a placeholder for the allowed relayed MCVideo groups.

12.2.17 /<x>/OnNetwork/RelayedMCVideoGroup/<x>

Table 12.2.17.1: /<x>/OnNetwork/RelayedMCVideoGroup/<x>

OnNetwork/RelayedMCVideoGroup/<x>

Status	Occurrence	Format	Min. Access Types
Required	OneOrMore	node	Get, Replace

This interior node is a placeholder for one or more allowed relayed MCVideo groups.

12.2.18 /<x>/OnNetwork/RelayedMCVideoGroup/<x>/MCVideoGroupID

Table 12.2.18.1: /<x>/OnNetwork/RelayedMCVideoGroup/<x>/MCVideoGroupID

OnNetwork/RelayedMCVideoGroup/<x>/MCVideoGroupID

Status	Occurrence	Format	Min. Access Types
Required	One	chr	Get, Replace

This leaf node indicates the associated MCVideo group ID.

The value is a "uri" attribute specified in OMA OMA-TS-XDM_Group-V1_1 [4].

12.2.19 /<x>/OnNetwork/RelayedMCVideoGroup/<x>/RelayServiceCode

Table 12.2.19.1: /<x>/OnNetwork/RelayedMCVideoGroup/<x>/RelayServiceCode

OnNetwork/RelayedMCVideoGroup/<x>/RelayServiceCode

Status	Occurrence	Format	Min. Access Types
Required	One	chr	Get, Replace

This leaf node indicates the connectivity service that the ProSe UE-to-network relay provides to public safety applications as specified in 3GPP TS 23.303 [6].

13 MCVideo user profile MO

13.1 General

The MCVideo user profile configuration Management Object (MO) is used to configure the MCVideo Client behaviour for the on-network or off-network MCVideo Service. The MCVideo user profile configuration parameters may be stored in the ME, or in the USIM as specified in 3GPP TS 31.102 [10], or in both the ME and the USIM. If both the ME and the USIM contain the same parameters, the values stored in the USIM shall take precedence.

The Management Object Identifier is: urn:oma:mo:ext-3gpp-MCVideo-user-profile:1.0.

Protocol compatibility: This MO is compatible with OMA OMA DM 1.2 [3].

The OMA DM ACL property mechanism (see OMA OMA-ERELED-DM-V1_2 [2]) may be used to grant or deny access rights to OMA DM servers in order to modify nodes and leaf objects of the MCVideo user profile MO.

The following nodes and leaf objects are possible under the MCVideo user profile node as described in figure 13.1.1, figure 13.1.2 and figure 13.1.3:

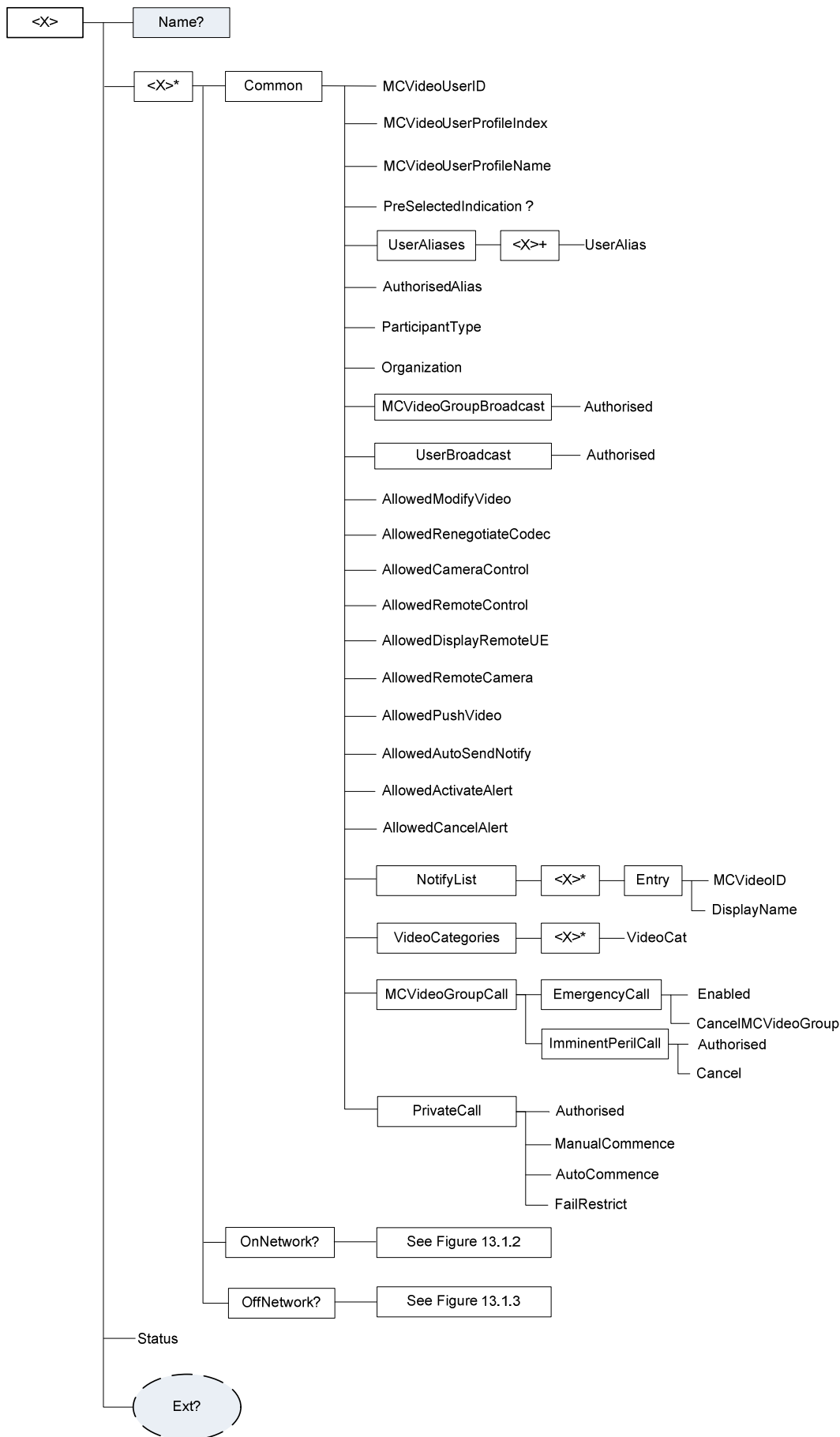

Figure 13.1.1: The MCVideo user profile MO (1 of 3)

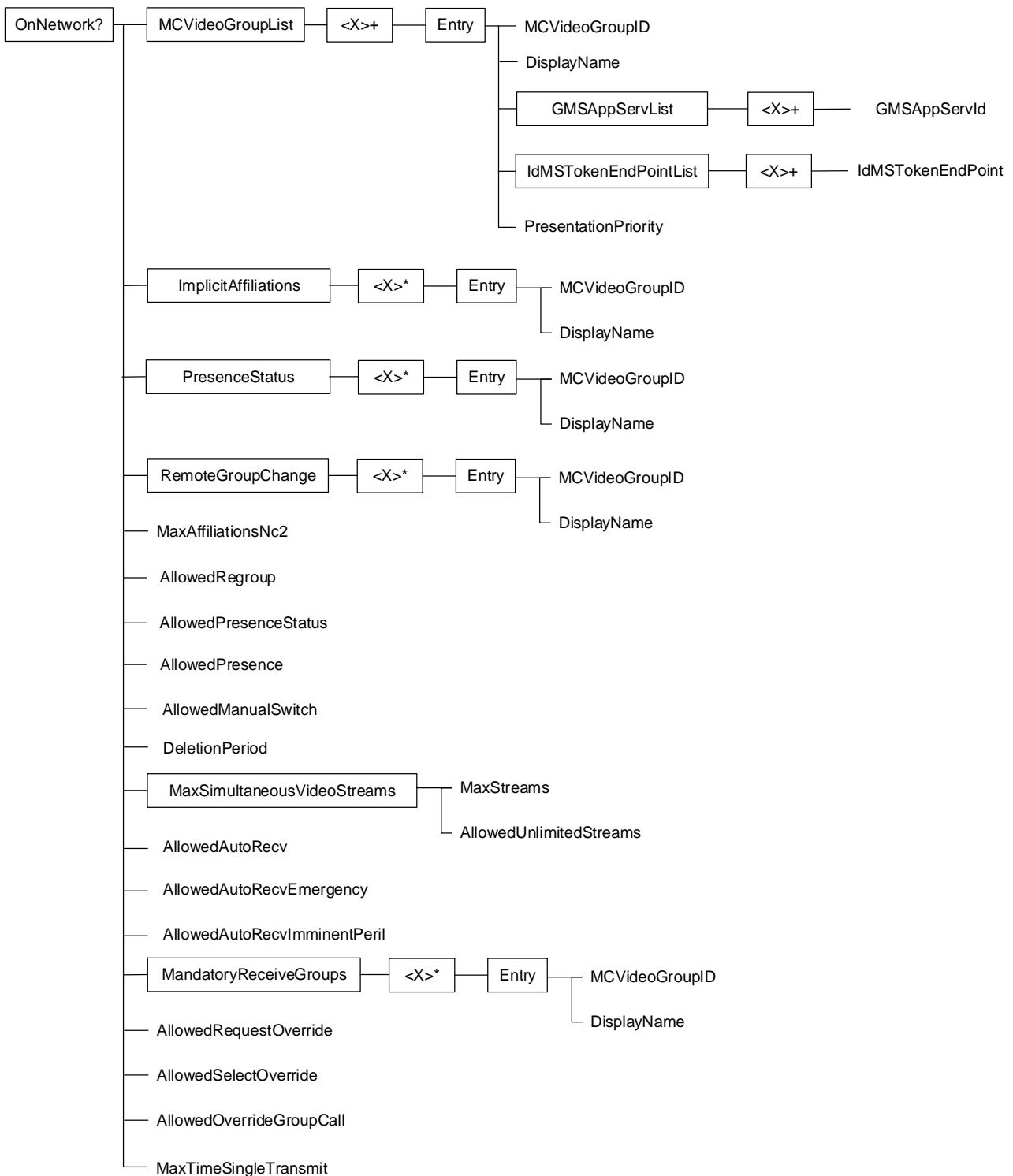

Figure 13.1.2: The MCVideo user profile MO (2 of 3)

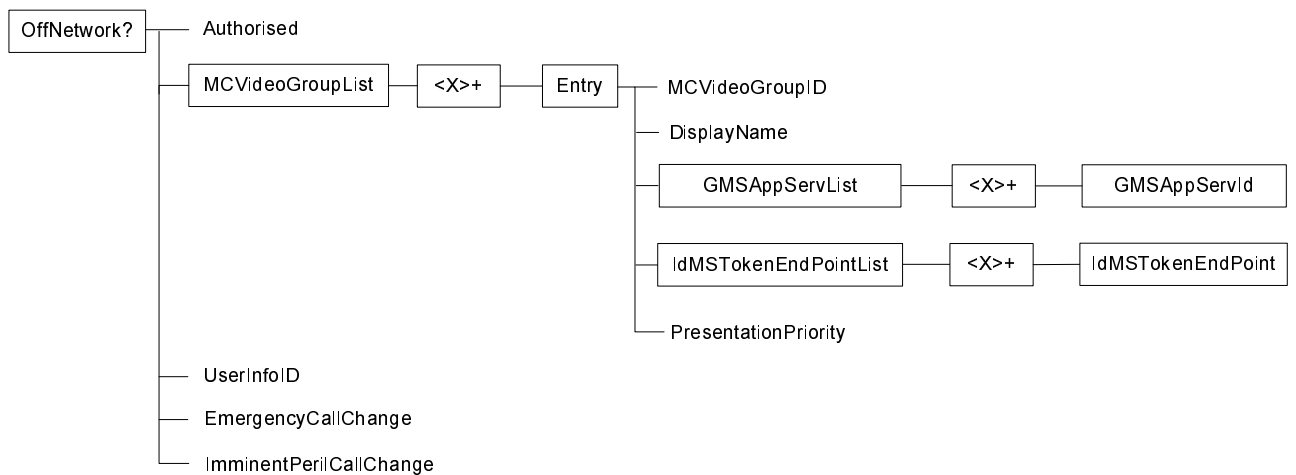

Figure 13.1.3: The MCVideo user profile MO (3 of 3)

13.2 MCVideo user profile MO parameters

13.2.1 General

This clause describes the parameters for the MCVideo user profile Management Object (MO).

13.2.2 Node: <x>

Table 13.2.2.1: Node: <x>

<x>

Status	Occurrence	Format	Min. Access Types
Required	OneOrMore	node	Get

This interior node acts as a placeholder for the MCVideo user profile Management Object (MO).

For the MCVideo user profile MO, the namespace specific string is: "urn:oma:mo:oma-dm-mcvideo-user-profile:1.0"

- Values: N/A

13.2.3 /<x>/Name

Table 13.2.3.1: /<x>/Name

Name

Status	Occurrence	Format	Min. Access Types
Required	ZeroOrOne	chr	Get

The Name leaf is a name for the MCVideo user profile settings.

- Values: <User displayable name>

13.2.4 /<x>/Ext/

Table 13.2.4.1: /<x>/Ext/

Ext

Status	Occurrence	Format	Min. Access Types
Optional	ZeroOrOne	node	Get, Replace

The Ext is an interior node for where the vendor specific information about the MCVideo user profile MO is being placed.

Usually the vendor extension is identified by vendor specific name under the ext node and contains the vendor meaning application vendor, device vendor etc. The tree structure under the vendor identified is not defined and can therefore include one or more un-standardized sub-trees.

- Values: N/A

13.2.5 /<x>/<x>

Table 13.2.5.1: /<x>/<x>

<x>

Status	Occurrence	Format	Min. Access Types
Required	ZeroOrMore	node	Get, Replace

This interior node represents a container for on-network operation and off-network operation.

13.2.6 /<x>/<x>/Common

Table 13.2.6.1: /<x>/<x>/Common

<x>/Common

Status	Occurrence	Format	Min. Access Types
Required	OneOrMore	node	Get, Replace

This interior node represents a container for the common network operation which means both on-network operation and off-network operation.

13.2.7 /<x>/<x>/Common/MCVideoUserID

Table 13.2.7.1: /<x>/<x>/Common/MCVideoUserID

<x>/Common/MCVideoUserID

Status	Occurrence	Format	Min. Access Types
Required	One	chr	Get, Replace

This leaf node indicates an MCVideo user identity (MCVideo ID) which is a globally unique identifier within the MCVideo service that represents the MCVideo user.

13.2.8 /<x>/<x>/Common/MCVideoUserProfileIndex

Table 13.2.8.1: /<x>/<x>/Common/MCVideoUserProfileIndex

<x>/Common/MCVideoUserProfileIndex

Status	Occurrence	Format	Min. Access Types
Required	One	int	Get, Replace

This leaf node indicates an index for the particular MCVideo user profile.

- Values: 0-255

13.2.9 /<x>/<x>/Common/MCVideoUserName

Table 13.2.9.1: /<x>/<x>/Common/MCVideoUserName

<x>/Common/MCVideoUserName

Status	Occurrence	Format	Min. Access Types
Optional	One	chr	Get, Replace

This leaf node indicates a profile name for the particular MCVideo user profile.

13.2.10 /<x>/<x>/Common/PreSelectedIndication

Table 13.2.10.1: /<x>/<x>/Common/PreSelectedIndication

<x>/Common/PreSelectedIndication

Status	Occurrence	Format	Min. Access Types
Optional	ZeroOrOne	null	Get, Replace

This leaf node indicates that this MCVideo user profile MO is designated to be the pre-selected MCVideo user profile as defined by 3GPP TS 23.179 [15]

- Values: null

When this leaf node is present, this MCVideo user profile MO is designated as the pre-selected MCVideo user profile.

When this leaf node is absent, this MCVideo user profile MO is not designated as the pre-selected MCVideo user profile.

If more than one MCVideo user profile MO is specified for the MCVideo user, then only one MCVideo user profile MO for the MCVideo user shall contain the <x>/Common/PreSelectedIndication leaf node.

If there is only one MCVideo user profile MO specified for the MCVideo user, then it is optional to include the <x>/Common/PreSelectedIndication leaf node.

13.2.11 /<x>/<x>/Common/UserAliases

Table 13.2.11.1: /<x>/<x>/Common/UserAliases

<x>/Common/UserAliases

Status	Occurrence	Format	Min. Access Types
Required	One	node	Get, Replace

This interior node is a placeholder for a list of aliases of an MCVideo user.

13.2.12 /<x>/<x>/Common/UserAliases/<x>

Table 13.2.12.1: /<x>/<x>/Common/UserAliases/<x>

<x>/Common/UserAliases/<x>

Status	Occurrence	Format	Min. Access Types
Required	OneOrMore	node	Get, Replace

This interior node is a placeholder for one or more aliases of an MCVideo user.

13.2.13 /<x>/<x>/Common/UserAliases/<x>/UserAlias

Table 13.2.13.1: /<x>/<x>/Common/UserAliases/<x>/UserAlias

<x>/Common/UserAliases/<x>/UserAlias

Status	Occurrence	Format	Min. Access Types
Required	One	chr	Get, Replace

This leaf node indicates an alphanumeric alias of the MCVideo user.

13.2.14 /<x>/<x>/Common/AuthorisedAlias

Table 13.2.14.1: /<x>/<x>/Common/AuthorisedAlias

<x>/Common/AuthorisedAlias

Status	Occurrence	Format	Min. Access Types
Optional	One	bool	Get, Replace

This leaf node indicates authorisation to create and delete aliases of other MCVideo users and their associated MCVideo user profiles.

When set to "true" the MCVideo user is authorised to create and delete aliases of other MCVideo users and their associated MCVideo user profiles.

When set to "false" the MCVideo user is not authorised to create and delete aliases of other MCVideo user and their associated MCVideo user profiles. This is the default if this leaf node is not present.

13.2.15 /<x>/<x>/Common/ParticipantType

Table 13.2.15.1: /<x>/<x>/Common/ParticipantType

<x>/Common/ParticipantType

Status	Occurrence	Format	Min. Access Types
Required	One	chr	Get, Replace

This leaf node indicates the participant type of the MCVideo user.

The ParticipantType means the functional category of the participant (e.g., first responder, second responder, dispatch, dispatch supervisor), typically defined by the MCVideo administrators.

13.2.16 /<x>/<x>/Common/Organization

Table 13.2.16.1: /<x>/<x>/Common/Organization

<x>/Common/Organization

Status	Occurrence	Format	Min. Access Types
Required	One	chr	Get, Replace

This leaf node indicates the organization an MCVideo user belongs to.

13.2.17 /<x>/<x>/Common/MCVideoGroupBroadcast

Table 13.2.17.1: /<x>/<x>/Common/MCVideoGroupBroadcast

<x>/Common/MCVideoGroupBroadcast

Status	Occurrence	Format	Min. Access Types
Required	One	node	Get, Replace

This interior node is a placeholder for the group-broadcast group policy.

13.2.18 /<x>/<x>/Common/MCVideoGroupBroadcast/Authorised

Table 13.2.18.1: /<x>/<x>/Common/MCVideoGroupBroadcast/Authorised

<x>/Common/MCVideoGroupBroadcast/Authorised

Status	Occurrence	Format	Min. Access Types
Required	One	bool	Get, Replace

This leaf node indicates the authorisation to create a group-broadcast group.

When set to "true" the MCVideo user is authorised to create a group-broadcast group.

When set to "false" the MCVideo user is not authorised to create a group-broadcast group.

13.2.19 /<x>/<x>/Common/UserBroadcast

Table 13.2.19.1: /<x>/<x>/Common/UserBroadcast

<x>/Common/UserBroadcast

Status	Occurrence	Format	Min. Access Types
Required	One	node	Get, Replace

This interior node is a placeholder for the user-broadcast group policy.

13.2.20 /<x>/<x>/Common/UserBroadcast/Authorised

Table 13.2.20.1: /<x>/<x>/Common/UserBroadcast/Authorised

<x>/Common/UserBroadcast/Authorised

Status	Occurrence	Format	Min. Access Types
Required	One	bool	Get, Replace

This leaf node indicates the authorisation to create a user-broadcast group.

When set to "true" the MCVideo user is authorised to create a user-broadcast group.

When set to "false" the MCVideo user is not authorised to create a user-broadcast group.

13.2.21 /<x>/<x>/Common/AllowedModifyVideo

Table 13.2.21.1: /<x>/<x>/Common/AllowedModifyVideo

<x>/Common/AllowedModifyVideo

Status	Occurrence	Format	Min. Access Types
Required	One	bool	Get, Replace

This leaf node indicates whether the MCVideo user is authorised to modify the video settings of the transmitted video stream of another MCVideo user.

When set to "true" the MCVideo user is authorised to modify the video settings of the transmitted video stream of another MCVideo user.

When set to "false" the MCVideo user is not authorised to modify the video settings of the transmitted video stream of another MCVideo user.

13.2.22 /<x>/<x>/Common/AllowedRenegotiateCodec

Table 13.2.22.1: /<x>/<x>/Common/AllowedRenegotiateCodec

<x>/Common/AllowedRenegotiateCodec

Status	Occurrence	Format	Min. Access Types
Required	One	bool	Get, Replace

This leaf node indicates whether the MCVideo user is authorised to renegotiate a codec during a video transmission.

When set to "true" the MCVideo user is authorised to renegotiate a codec during a video transmission.

When set to "false" the MCVideo user is not authorised to renegotiate a codec during a video transmission.

13.2.23 /<x>/<x>/Common/AllowedCameraControl

Table 13.2.23.1: /<x>/<x>/Common/AllowedCameraControl

<x>/Common/AllowedCameraControl

Status	Occurrence	Format	Min. Access Types
Required	One	bool	Get, Replace

This leaf node indicates whether the MCVideo user is authorised to remotely control the video capabilities or parameters for a camera on an MCVideo UE.

When set to "true" the MCVideo user is authorised to remotely control the video capabilities or parameters for a camera on an MCVideo UE.

When set to "false" the MCVideo user is not authorised to remotely control the video capabilities or parameters for a camera on an MCVideo UE.

13.2.24 /<x>/<x>/Common/AllowedRemoteControl

Table 13.2.24.1: /<x>/<x>/Common/AllowedRemoteControl

<x>/Common/AllowedRemoteControl

Status	Occurrence	Format	Min. Access Types
Required	One	bool	Get, Replace

This leaf node indicates whether the MCVideo user is authorised to remotely control the video capabilities or parameters of a remote MCVideo UE.

When set to "true" the MCVideo user is authorised to remotely control the video capabilities or parameters of a remote MCVideo UE.

When set to "false" the MCVideo user is not authorised to remotely control the video capabilities or parameters of a remote MCVideo UE.

13.2.25 /<x>/<x>/Common/AllowedDisplayRemoteUE

Table 13.2.25.1: /<x>/<x>/Common/AllowedDisplayRemoteUE

<x>/Common/AllowedDisplayRemoteUE

Status	Occurrence	Format	Min. Access Types
Required	One	bool	Get, Replace

This leaf node indicates whether the MCVideo user is authorised to receive and display the capabilities of a remote MCVideo UE.

When set to "true" the MCVideo user is authorised to receive and display the capabilities of a remote MCVideo UE.

When set to "false" the MCVideo user is not authorised to receive and display the capabilities of a remote MCVideo UE.

13.2.26 /<x>/<x>/Common/AllowedRemoteCamera

Table 13.2.26.1: /<x>/<x>/Common/AllowedRemoteCamera

<x>/Common/AllowedRemoteCamera

Status	Occurrence	Format	Min. Access Types
Required	One	bool	Get, Replace

This leaf node indicates whether the MCVideo user is authorised to remotely activate another MCVideo user's camera.

When set to "true" the MCVideo user is authorised to remotely activate another MCVideo user's camera.

When set to "false" the MCVideo user is not authorised to remotely activate another MCVideo user's camera.

13.2.27 /<x>/<x>/Common/AllowedPushVideo

Table 13.2.27.1: /<x>/<x>/Common/AllowedPushVideo

<x>/Common/AllowedPushVideo

Status	Occurrence	Format	Min. Access Types
Required	One	bool	Get, Replace

This leaf node indicates whether the MCVideo user is authorised to push a video to another MCVideo user.

When set to "true" the MCVideo user is authorised to push a video to another MCVideo user.

When set to "false" the MCVideo user is not authorised to push a video to another MCVideo user.

13.2.28 /<x>/<x>/Common/AllowedAutoSendNotify

Table 13.2.28.1: /<x>/<x>/Common/AllowedAutoSendNotify

<x>/Common/AllowedAutoSendNotify

Status	Occurrence	Format	Min. Access Types
Required	One	bool	Get, Replace

This leaf node indicates whether the MCVideo user is authorised to enable and disable the automatic sending of a notification to a second MCVideo user that a video is being pushed to a third MCVideo user.

When set to "true" the MCVideo user is authorised to enable and disable the automatic sending of a notification to a second MCVideo user that a video is being pushed to a third MCVideo user.

When set to "false" the MCVideo user is not authorised to enable and disable the automatic sending of a notification to a second MCVideo user that a video is being pushed to a third MCVideo user.

13.2.29 /<x>/<x>/Common/AllowedActivateAlert

Table 13.2.29.1: /<x>/<x>/Common/AllowedActivateAlert

<x>/Common/AllowedActivateAlert

Status	Occurrence	Format	Min. Access Types
Required	One	bool	Get, Replace

This leaf node indicates whether the MCVideo user is authorised to activate an emergency alert.

When set to "true" the MCVideo user is authorised to activate an emergency alert.

When set to "false" the MCVideo user is not authorised to activate an emergency alert.

13.2.30 /<x>/<x>/Common/AllowedCancelAlert

Table 13.2.30.1: /<x>/<x>/Common/AllowedCancelAlert

<x>/Common/AllowedCancelAlert

Status	Occurrence	Format	Min. Access Types
Required	One	bool	Get, Replace

This leaf node indicates whether the MCVideo user is allowed to cancel an emergency alert.

When set to "true" the MCVideo user is authorised to cancel an emergency alert.

When set to "false" the MCVideo user is not authorised to cancel an emergency alert.

13.2.31 /<x>/<x>/Common/NotifyList

Table 13.2.31.1: /<x>/<x>/Common/NotifyList

<x>/Common/NotifyList

Status	Occurrence	Format	Min. Access Types
Required	One	node	Get, Replace

This interior node is a placeholder for a list of MCVideo users for whom to receive notifications about video being pushed to them.

13.2.32 /<x>/<x>/Common/NotifyList/<x>

Table 13.2.32.1: /<x>/<x>/Common/NotifyList/<x>

<x>/Common/NotifyList/<x>

Status	Occurrence	Format	Min. Access Types
Optional	ZeroOrMore	node	Get, Replace

This interior node is a placeholder for zero or more list of MCVideo users for whom to receive notifications about video being pushed to them.

13.2.33 /<x>/<x>/Common/NotifyList/<x>/Entry

Table 13.2.33.1: /<x>/<x>/Common/NotifyList/<x>/Entry

<x>/Common/NotifyList/<x>/Entry

Status	Occurrence	Format	Min. Access Types
Required	One	node	Get, Replace

This interior node is a placeholder for one or more MCVideo users for whom to receive notifications about video being pushed to them.

13.2.34 /<x>/<x>/Common/NotifyList/<x>/Entry/MCVideoID

Table 13.2.34.1: /<x>/<x>/Common/NotifyList/<x>/Entry/MCVideoID

<x>/Common/NotifyList/<x>/Entry/MCVideoID

Status	Occurrence	Format	Min. Access Types
Optional	One	chr	Get, Replace

This leaf node indicates an MCVideo user identity (MCVideo ID) which is a globally unique identifier within the MCVideo service that represents the MCVideo user.

The value is a "uri" attribute specified in OMA OMA-TS-XDM_Group-V1_1 [4].

13.2.35 /<x>/<x>/Common/NotifyList/<x>/Entry/DisplayName

Table 13.2.35.1: /<x>/<x>/Common/NotifyList/<x>/Entry/DisplayName

<x>/Common/NotifyList/<x>/Entry/DisplayName

Status	Occurrence	Format	Min. Access Types
Optional	One	chr	Get, Replace

This leaf node contains a human readable name.

13.2.36 /<x>/<x>/Common/VideoCategories

Table 13.2.36.1: /<x>/<x>/Common/VideoCategories

<x>/Common/VideoCategories

Status	Occurrence	Format	Min. Access Types
Required	One	node	Get, Replace

This interior node is a placeholder for a list of specific video categories to receive

13.2.37 /<x>/<x>/Common/VideoCategories/<x>

Table 13.2.37.1: /<x>/<x>/Common/VideoCategories/<x>

<x>/Common/VideoCategories/<x>

Status	Occurrence	Format	Min. Access Types
Required	ZeroOrMore	node	Get, Replace

This interior node is a placeholder for one or more specific video categories to receive.

If the list is empty, then all video categories are acceptable to the MCVideo user.

13.2.38 /<x>/<x>/Common/VideoCategories/<x>/VideoCat

Table 13.2.38.1: /<x>/<x>/Common/VideoCategories/<x>/VideoCat

<x>/Common/VideoCategories/<x>/VideoCat

Status	Occurrence	Format	Min. Access Types
Required	One	chr	Get, Replace

This leaf node indicates an alphanumeric video category

13.2.38A/<x>/<x>/Common/MCVideoGroupCall

Table 13.2.38A.1: /<x>/<x>/Common/MCVideoGroupCall

<x>/Common/MCVideoGroupCall

Status	Occurrence	Format	Min. Access Types
Required	One	node	Get, Replace

This interior node is a placeholder for the MCVideo group call configuration.

13.2.38B/<x>/<x>/Common/MCVideoGroupCall/EmergencyCall

Table 13.2. 38B.1: /<x>/<x>/Common/MCVideoGroupCall/EmergencyCall

<x>/Common/MCVideoGroupCall/EmergencyCall

Status	Occurrence	Format	Min. Access Types
Required	One	node	Get, Replace

This interior node is a placeholder for the MCVideo emergency call policy.

13.2.38C /<x>/<x>/Common/MCVideoGroupCall/EmergencyCall/Enabled

Table 13.2.38C.1: /<x>/<x>/Common/MCVideoGroupCall/EmergencyCall/Enabled

<x>/Common/MCVideoGroupCall/EmergencyCall/Enabled

Status	Occurrence	Format	Min. Access Types

Optional	One	bool	Get, Replace
----------	-----	------	--------------

This leaf node indicates the authorisation to make an MCVideo emergency group call functionality enabled for MCVideo user.

When set to "true" the MCVideo user is authorised to make an MCVideo emergency group call functionality enabled.

When set to "false" the MCVideo user is not authorised to make an MCVideo emergency group call functionality enabled.

13.2.38D

`<x>/<x>/Common/MCVideoGroupCall/EmergencyCall/CancelMCVideoGroup`

Table 13.2.38D.1: `<x>/<x>/Common/MCVideoGroupCall/EmergencyCall/CancelMCVideoGroup`

`<x>/Common/MCVideoGroupCall/EmergencyCall/CancelMCVideoGroup`

Status	Occurrence	Format	Min. Access Types
Required	One	bool	Get, Replace

This leaf node indicates the authorisation to cancel an in progress MCVideo emergency group call associated with a group.

When set to "true" the MCVideo user is authorised to cancel a MCVideo emergency group call.

When set to "false" the MCVideo user is not authorised to cancel a MCTT emergency group call.

13.2.38E `<x>/<x>/Common/MCVideoGroupCall/ImminentPerilCall`

Table 13.2.38E.1: `<x>/<x>/Common/MCVideoGroupCall/ImminentPerilCall`

`<x>/Common/MCVideoGroupCall/ImminentPerilCall`

Status	Occurrence	Format	Min. Access Types
Required	One	node	Get, Replace

This interior node is a placeholder for the MCVideo imminent peril call policy.

13.2.38F `<x>/<x>/Common/MCVideoGroupCall/ImminentPerilCall/Authorised`

Table 13.2.38F.1: `<x>/<x>/Common/MCVideoGroupCall/ImminentPerilCall/Authorised`

`<x>/Common/MCVideoGroupCall/ImminentPerilCall/Authorised`

Status	Occurrence	Format	Min. Access Types
Required	One	bool	Get, Replace

This leaf node indicates the authorisation to make an Imminent Peril group call.

When set to "true" the MCVideo user is authorised to create an MCVideo imminent peril group call.

When set to "false" the MCVideo user is not authorised to create an MCVideo imminent peril group call.

13.2.38G `<x>/<x>/Common/MCVideoGroupCall/ImminentPerilCall/Cancel`

Table 13.2.38G.1: `<x>/<x>/Common/MCVideoGroupCall/ImminentPerilCall/Cancel`

`<x>/Common/MCVideoGroupCall/ImminentPerilCall/Cancel`

Status	Occurrence	Format	Min. Access Types
Required	One	bool	Get, Replace

This leaf node indicates the authorisation for in-progress MCVideo imminent peril cancellation.

When set to "true" the MCVideo user is authorised to cancel an MCVideo imminent peril call.

When set to "false" the MCVideo user is not authorised to cancel an MCVideo imminent peril call.

13.2.38H /<x>/<x>/Common/PrivateCall

Table 13.2.38H.1: /<x>/<x>/Common/PrivateCall

<x>/Common/PrivateCall

Status	Occurrence	Format	Min. Access Types
Required	One	node	Get, Replace

This interior node is a placeholder for the MCVideo private call configuration.

13.2.38I /<x>/<x>/Common/PrivateCall/Authorised

Table 13.2.38I.1: /<x>/<x>/Common/PrivateCall/Authorised

<x>/Common/PrivateCall/Authorised

Status	Occurrence	Format	Min. Access Types
Required	One	bool	Get, Replace

This leaf node indicates the authorisation to make a MCVideo private call.

13.2.38J /<x>/<x>/Common/PrivateCall/ManualCommence

Table 13.2.38J.1: /<x>/<x>/Common/PrivateCall/ManualCommence

<x>/Common/PrivateCall/ManualCommence

Status	Occurrence	Format	Min. Access Types
Required	One	bool	Get, Replace

This leaf node indicates the authorisation to make a MCVideo private call with manual commencement.

When set to "true" the MCVideo user is authorised to make a MCVideo private call in manual commencement mode.

When set to "false" the MCVideo user is not authorised to make a MCVideo private call in manual commencement mode.

13.2.38K /<x>/<x>/Common/PrivateCall/AutoCommence

Table 13.2.38K.1: /<x>/<x>/Common/PrivateCall/AutoCommence

<x>/Common/PrivateCall/AutoCommence

Status	Occurrence	Format	Min. Access Types
Required	One	bool	Get, Replace

This leaf node indicates the authorisation to make a MCVideo private call with automatic commencement.

When set to "true" the MCVideo user is authorised to make a MCVideo private call in automatic commencement mode.

When set to "false" the MCVideo user is not authorised to make a MCVideo private call in automatic commencement mode.

13.2.38L /<x>/<x>/Common/PrivateCall/FailRestrict

Table 13.2.38L.1: /<x>/<x>/Common/PrivateCall/FailRestrict

<x>/Common/PrivateCall/FailRestrict

Status	Occurrence	Format	Min. Access Types

Required	One	bool	Get, Replace
----------	-----	------	--------------

This leaf node indicates the authorisation to restrict the provision of a notification of call failure reason for a MCVideo private call.

When set to "true" the MCVideo user is authorised to restrict notification of call failure reason for MCVideo private call.

When set to "false" the MCVideo user is not authorised to restrict notification of call failure reason for MCVideo private call.

13.2.39 /<x>/<x>/OnNetwork

Table 13.2.39.1: /<x>/<x>/OnNetwork

<x>/OnNetwork

Status	Occurrence	Format	Min. Access Types
Required	ZeroOrOne	node	Get, Replace

This interior node represents a container for on-network operation.

13.2.40 /<x>/<x>/OnNetwork/MCVideoGroupList

Table 13.2.40.1: /<x>/<x>/OnNetwork/MCVideoGroupList

<x>/OnNetwork/MCVideoGroupList

Status	Occurrence	Format	Min. Access Types
Required	One	node	Get, Replace

This interior node is a placeholder for the list of on-network MCVideo groups that the MCVideo user is allowed to use.

13.2.41 /<x>/<x>/OnNetwork/MCVideoGroupList/<x>

Table 13.2.41.1: /<x>/<x>/OnNetwork/MCVideoGroupList/<x>

<x>/OnNetwork/MCVideoGroupList/<x>

Status	Occurrence	Format	Min. Access Types
Required	OneOrMore	node	Get, Replace

This interior node is a placeholder for one or more list of on-network MCVideo groups that the MCVideo user is allowed to use.

13.2.42 /<x>/<x>/OnNetwork/MCVideoGroupList/<x>/Entry

Table 13.2.42.1: /<x>/<x>/OnNetwork/MCVideoGroupList/<x>/Entry

<x>/OnNetwork/MCVideoGroupList/<x>/Entry

Status	Occurrence	Format	Min. Access Types
Optional	One	node	Get, Replace

This interior node is a placeholder for the details of the on-network MCVideo groups that the MCVideo user is allowed to use.

13.2.43

`<x>/<x>/OnNetwork/MCVideoGroupList/<x>/Entry/MCVideoGroupID`

Table 13.2.43.1: `<x>/<x>/OnNetwork/MCVideoGroupList/<x>/Entry/MCVideoGroupID`

`<x>/OnNetwork/MCVideoGroupList/<x>/Entry/MCVideoGroupID`

Status	Occurrence	Format	Min. Access Types
Required	One	chr	Get, Replace

This leaf node indicates the MCVideo group ID for the on-network MCVideo group that the MCVideo user is allowed to use.

The value is a "uri" attribute specified in OMA OMA-TS-XDM_Group-V1_1 [4].

13.2.44 `<x>/<x>/OnNetwork/MCVideoGroupList/<x>/Entry/DisplayName`

Table 13.2.44.1: `<x>/<x>/OnNetwork/MCVideoGroupList/<x>/Entry/DisplayName`

`<x>/OnNetwork/MCVideoGroupList/<x>/Entry/DisplayName`

Status	Occurrence	Format	Min. Access Types
Optional	One	chr	Get, Replace

This leaf node contains a human readable name that corresponds to the MCVideo Group ID.

13.2.45

`<x>/<x>/OnNetwork/MCVideoGroupList/<x>/Entry/GMSAppServList`

Table 13.2.45.1: `<x>/<x>/OnNetwork/MCVideoGroupList/<x>/Entry/GMSAppServList`

`<x>/OnNetwork/MCVideoGroupList/<x>/Entry/GMSAppServList`

Status	Occurrence	Format	Min. Access Types
Required	One	node	Get, Replace

This interior node is a placeholder for the Group Management Server application plane server identity configuration.

13.2.46

`<x>/<x>/OnNetwork/MCVideoGroupList/<x>/Entry/GMSAppServList/<x>`

Table 13.2.46.1: `<x>/<x>/OnNetwork/MCVideoGroupList/<x>/Entry/GMSAppServList/<x>`

`<x>/OnNetwork/MCVideoGroupList/<x>/Entry/GMSAppServList/<x>`

Status	Occurrence	Format	Min. Access Types
Required	OneOrMore	node	Get, Replace

This interior node is a placeholder for one or more Group Management Server configuration.

13.2.47

`/<x>/<x>/OnNetwork/MCVideoGroupList/<x>/Entry/GMSAppServList/<x>/GMSAppServId`

Table 13.2.47.1:

`/<x>/<x>/OnNetwork/MCVideoGroupList/<x>/Entry/GMSAppServList/<x>/GMSAppServId`

`<x>/OnNetwork/MCVideoGroupList/<x>/Entry/GMSAppServList/<x>/GMSAppServId`

Status	Occurrence	Format	Min. Access Types
Optional	One	chr	Get, Replace

This leaf node indicates the identity (URI) of the the group management server hosting the MCVideo Group ID.

13.2.48

`/<x>/<x>/OnNetwork/MCVideoGroupList/<x>/Entry/IdMSTokenEndPointList`

Table 13.2.48.1: `/<x>/<x>/OnNetwork/MCVideoGroupList/<x>/Entry/IdMSTokenEndPointList`

`<x>/OnNetwork/MCVideoGroupList/<x>/Entry/IdMSTokenEndPointList`

Status	Occurrence	Format	Min. Access Types
Required	One	node	Get, Replace

This interior node is a placeholder for the Identity Management Server application plane server identity configuration.

13.2.49

`/<x>/<x>/OnNetwork/MCVideoGroupList/<x>/Entry/IdMSTokenEndPointList/<x>`

Table 13.2.49.1: `/<x>/<x>/OnNetwork/MCVideoGroupList/<x>/Entry/IdMSTokenEndPointList/<x>`

`<x>/OnNetwork/MCVideoGroupList/<x>/Entry/IdMSTokenEndPointList/<x>`

Status	Occurrence	Format	Min. Access Types
Required	OneOrMore	node	Get, Replace

This interior node is a placeholder for one or more Identity Management Server configuration.

13.2.50

`/<x>/<x>/OnNetwork/MCVideoGroupList/<x>/Entry/IdMSTokenEndPointList/<x>/IdMSTokenEndPoint`

Table 13.2.50.1:

`/<x>/<x>/OnNetwork/MCVideoGroupList/<x>/Entry/IdMSTokenEndPointList/<x>/IdMSTokenEndPoint`

`<x>/OnNetwork/MCVideoGroupList/<x>/Entry/IdMSTokenEndPointList/<x>/IdMSTokenEndPoint`

Status	Occurrence	Format	Min. Access Types
Optional	One	chr	Get, Replace

This leaf node indicates the identity (URI) of the the identity management server hosting the MCVideo Group ID.

13.2.51

`/<x>/<x>/OnNetwork/MCVideoGroupList/<x>/Entry/PresentationPriority`

Table 13.2.51.1: `/<x>/<x>/OnNetwork/MCVideoGroupList/<x>/Entry/PresentationPriority`

`<x>/OnNetwork/MCVideoGroupList/<x>/Entry/PresentationPriority`

Status	Occurrence	Format	Min. Access Types
Optional	One	int	Get, Replace

This leaf node indicates indicating the presentation priority of the on-network group for the MCVideo user relative to other on-network groups and on-network users.

- Values: 0-255

The lowest PresentationPriority value shall be considered as the MCVideo group transaction having the lowest priority for presentation among other group MCVideo and one-to-one user transactions.

13.2.52 `/<x>/<x>/OnNetwork/ImplicitAffiliations`

Table 13.2.52.1: `/<x>/<x>/OnNetwork/ImplicitAffiliations`

`<x>/OnNetwork/ImplicitAffiliations`

Status	Occurrence	Format	Min. Access Types
Required	One	chr	Get, Replace

This interior node is a placeholder for the implicit affiliation configuration.

13.2.53 `/<x>/<x>/OnNetwork/ImplicitAffiliations/<x>`

Table 13.2.53.1: `/<x>/<x>/OnNetwork/ImplicitAffiliations/<x>`

`<x>/OnNetwork/ImplicitAffiliations/<x>`

Status	Occurrence	Format	Min. Access Types
Required	ZeroOrMore	node	Get, Replace

This interior node is a placeholder for zero or more implicit affiliation configuration.

13.2.54 `/<x>/<x>/OnNetwork/ImplicitAffiliations/<x>/Entry`

Table 13.2.54.1: `/<x>/<x>/OnNetwork/ImplicitAffiliations/<x>/Entry`

`<x>/OnNetwork/ImplicitAffiliations/<x>/Entry`

Status	Occurrence	Format	Min. Access Types
Optional	One	node	Get, Replace

This interior node is a placeholder for the details of the on-network MCVideo groups that the MCVideo user is implicitly affiliated to.

13.2.55 `/<x>/<x>/OnNetwork/ImplicitAffiliations/<x>/Entry/MCVideoGroupID`

Table 13.2.55.1: `/<x>/<x>/OnNetwork/ImplicitAffiliations/<x>/Entry/MCVideoGroupID`

`<x>/OnNetwork/ImplicitAffiliations/<x>/Entry/MCVideoGroupID`

Status	Occurrence	Format	Min. Access Types
Required	One	chr	Get, Replace

This leaf node indicates a MCVideo group ID to which the MCVideo user is implicitly affiliated to.

The value is a "uri" attribute specified in OMA OMA-TS-XDM_Group-V1_1 [4].

13.2.56 /<x>/<x>/OnNetwork/ImplicitAffiliations/<x>/Entry/DisplayName

Table 13.2.56.1: /<x>/<x>/OnNetwork/ImplicitAffiliations/<x>/Entry/DisplayName

<x>/OnNetwork/ImplicitAffiliations/<x>/Entry/DisplayName

Status	Occurrence	Format	Min. Access Types
Optional	One	chr	Get, Replace

This leaf node contains a human readable name that corresponds to the MCVideo Group ID.

13.2.57 /<x>/<x>/OnNetwork/PresenceStatus

Table 13.2.57.1: /<x>/<x>/OnNetwork/PresenceStatus

<x>/OnNetwork/PresenceStatus

Status	Occurrence	Format	Min. Access Types
Required	One	chr	Get, Replace

This interior node is a placeholder for the presence status configuration.

13.2.58 /<x>/<x>/OnNetwork/PresenceStatus/<x>

Table 13.2.58.1: /<x>/<x>/OnNetwork/PresenceStatus/<x>

<x>/OnNetwork/PresenceStatus/<x>

Status	Occurrence	Format	Min. Access Types
Required	ZeroOrMore	node	Get, Replace

This interior node is a placeholder for zero or more presence status configuration.

13.2.59 /<x>/<x>/OnNetwork/PresenceStatus/<x>/Entry

Table 13.2.59.1: /<x>/<x>/OnNetwork/PresenceStatus/<x>/Entry

<x>/OnNetwork/PresenceStatus/<x>/Entry

Status	Occurrence	Format	Min. Access Types
Optional	One	node	Get, Replace

This interior node is a placeholder for the details of the MCVideo IDs of MCVideo users that the configured MCVideo user is authorised to obtain presence status;

13.2.60 /<x>/<x>/OnNetwork/PresenceStatus/<x>/Entry/MCVideoGroupID

Table 13.2.60.1: /<x>/<x>/OnNetwork/PresenceStatus/<x>/Entry/MCVideoGroupID

<x>/OnNetwork/PresenceStatus/<x>/Entry/MCVideoGroupID

Status	Occurrence	Format	Min. Access Types
Required	One	chr	Get, Replace

This leaf node indicates an MCVideo ID of an MCVideo user that the configured MCVideo user is authorised to obtain presence status;

The value is a "uri" attribute specified in OMA OMA-TS-XDM_Group-V1_1 [4].

13.2.61 /<x>/<x>/OnNetwork/PresenceStatus/<x>/Entry/DisplayName

Table 13.2.61.1: /<x>/<x>/OnNetwork/PresenceStatus/<x>/Entry/DisplayName

<x>/OnNetwork/PresenceStatus/<x>/Entry/DisplayName

Status	Occurrence	Format	Min. Access Types
Optional	One	chr	Get, Replace

This leaf node contains a human readable name that corresponds to the MCVideo ID.

13.2.62 /<x>/<x>/OnNetwork/RemoteGroupChange

Table 13.2.62.1: /<x>/<x>/OnNetwork/RemoteGroupChange

<x>/OnNetwork/RemoteGroupChange

Status	Occurrence	Format	Min. Access Types
Required	One	chr	Get, Replace

This interior node is a placeholder for the remote group change configuration.

13.2.63 /<x>/<x>/OnNetwork/RemoteGroupChange/<x>

Table 13.2.63.1: /<x>/<x>/OnNetwork/RemoteGroupChange/<x>

<x>/OnNetwork/RemoteGroupChange/<x>

Status	Occurrence	Format	Min. Access Types
Required	ZeroOrMore	node	Get, Replace

This interior node is a placeholder for zero or more remote group change configuration.

13.2.64 /<x>/<x>/OnNetwork/RemoteGroupChange/<x>/Entry

Table 13.2.64.1: /<x>/<x>/OnNetwork/RemoteGroupChange/<x>/Entry

<x>/OnNetwork/RemoteGroupChange/<x>/Entry

Status	Occurrence	Format	Min. Access Types
Optional	One	node	Get, Replace

This interior node is a placeholder for the details of the MCVideo IDs of MCVideo users whose selected groups are authorised to be remotely changed by the configured MCVideo user;

13.2.65

/<x>/<x>/OnNetwork/RemoteGroupChange/<x>/Entry/MCVideoGroupID

Table 13.2.65.1: /<x>/<x>/OnNetwork/RemoteGroupChange/<x>/Entry/MCVideoGroupID

<x>/OnNetwork/RemoteGroupChange/<x>/Entry/MCVideoGroupID

Status	Occurrence	Format	Min. Access Types
Required	One	chr	Get, Replace

This leaf node indicates an MCVideo ID of an MCVideo user whose selected groups are authorised to be remotely changed by the configured MCVideo user;

The value is a "uri" attribute specified in OMA OMA-TS-XDM_Group-V1_1 [4].

13.2.66 /<x>/<x>/OnNetwork/RemoteGroupChange/<x>/Entry/DisplayName

Table 13.2.66.1: /<x>/<x>/OnNetwork/RemoteGroupChange/<x>/Entry/DisplayName

<x>/OnNetwork/RemoteGroupChange/<x>/Entry/DisplayName

Status	Occurrence	Format	Min. Access Types
Optional	One	chr	Get, Replace

This leaf node contains a human readable name that corresponds to the MCVideo ID.

13.2.67 /<x>/<x>/OnNetwork/MaxAffiliationsNc2

Table 13.2.67.1: /<x>/<x>/OnNetwork/MaxAffiliationsNc2

<x>/OnNetwork/MaxAffiliationsNc2

Status	Occurrence	Format	Min. Access Types
Optional	One	int	Get, Replace

This leaf node indicates the maximum number of MCVideo groups that the MCVideo user is authorised to affiliate with.

- Values: 0-65535

13.2.68 /<x>/<x>/OnNetwork/AllowedRegroup

Table 13.2.68.1: /<x>/<x>/OnNetwork/AllowedRegroup

<x>/OnNetwork/AllowedRegroup

Status	Occurrence	Format	Min. Access Types
Required	One	bool	Get, Replace

This leaf node indicates whether the MCVideo user is authorised to perform dynamic regrouping operations.

When set to "true" the MCVideo user is authorised to perform dynamic regrouping operations.

When set to "false" the MCVideo user is not authorised to perform dynamic regrouping operations.

13.2.69 /<x>/<x>/OnNetwork/AllowedPresenceStatus

Table 13.2.69.1: /<x>/<x>/OnNetwork/AllowedPresenceStatus

<x>/OnNetwork/AllowedPresenceStatus

Status	Occurrence	Format	Min. Access Types
Optional	One	bool	Get, Replace

This leaf node indicates the presence status on the network of this MCVideo user is available.

When set to "true" the presence status on the network of this MCVideo user is available.

When set to "false" the presence status on the network of this MCVideo user is not available. This is the default if this leaf node is not present.

13.2.70 /<x>/<x>/OnNetwork/AllowedPresence

Table 13.2.70.1: /<x>/<x>/OnNetwork/AllowedPresence

<x>/OnNetwork/AllowedPresence

Status	Occurrence	Format	Min. Access Types
Optional	One	bool	Get, Replace

This leaf node indicates whether the MCVideo user is authorised to obtain whether a particular MCVideo User is present on the network.

When set to "true" the MCVideo user is authorised to obtain whether a particular MCVideo User is present on the network.

When set to "false" the MCVideo user is not authorised to obtain whether a particular MCVideo User is present on the network. This is the default if this leaf node is not present.

13.2.71 /<x>/<x>/OnNetwork/AllowedManualSwitch

Table 13.2.71.1: /<x>/<x>/OnNetwork/AllowedManualSwitch

<x>/OnNetwork/AllowedManualSwitch

Status	Occurrence	Format	Min. Access Types
Required	One	bool	Get, Replace

This leaf node indicates whether the MCVideo user is authorised to manually switch to off-network operation while in on-network operation.

When set to "true" the MCVideo user is authorised to manually switch to off-network operation while in on-network operation.

When set to "false" the MCVideo user is not authorised to manually switch to off-network operation while in on-network operation.

13.2.72 /<x>/<x>/OnNetwork/DeletionPeriod

Table 13.2.72.1: /<x>/<x>/OnNetwork/DeletionPeriod

<x>/OnNetwork/DeletionPeriod

Status	Occurrence	Format	Min. Access Types
Required	One	int	Get, Replace

This leaf node indicates the period (in hours) after which MCVideo data on an MCVideo UE is to be deleted if no action is taken by an authorized MCVideo user.

- Values: 0-65535

13.2.73 /<x>/<x>/OnNetwork/MaxSimultaneousVideoStreams

Table 13.2.73.1: /<x>/<x>/OnNetwork/MaxSimultaneousVideoStreams

<x>/OnNetwork/MaxSimultaneousVideoStreams

Status	Occurrence	Format	Min. Access Types
Required	One	node	Get, Replace

This interior node is a placeholder for maximum number of simultaneous video streams that can be received.

13.2.74 /<x>/<x>/OnNetwork/MaxSimultaneousVideoStreams/MaxStreams

Table 13.2.74.1: /<x>/<x>/OnNetwork/MaxSimultaneousVideoStreams/MaxStreams

<x>/OnNetwork/MaxSimultaneousVideoStreams/MaxStreams

Status	Occurrence	Format	Min. Access Types
Optional	One	int	Get, Replace

This leaf node indicates the maximum number of simultaneous video streams that can be received.

- Values: 0-65535

13.2.75

`<x>/OnNetwork/MaxSimultaneousVideoStreams/AllowedUnlimited`

Table 13.2.75.1: `<x>/OnNetwork/MaxSimultaneousVideoStreams/AllowedUnlimited`

`<x>/OnNetwork/MaxSimultaneousVideoStreams/AllowedUnlimited`

Status	Occurrence	Format	Min. Access Types
Required	One	bool	Get, Replace

This leaf node indicates whether the MCVideo user can receive an unlimited number of simultaneous video streams.

When set to "true" the MCVideo user is allowed to receive an unlimited number of simultaneous video streams .

When set to "false" the MCVideo user is not allowed to receive an unlimited number of simultaneous video streams.

When set to "true", the value in the MaxStreams element (if present) is ignored.

13.2.76 `<x>/OnNetwork/AllowedAutoRecv`

Table 13.2.76.1: `<x>/OnNetwork/AllowedAutoRecv`

`<x>/OnNetwork/AllowedAutoRecv`

Status	Occurrence	Format	Min. Access Types
Required	One	bool	Get, Replace

This leaf node indicates whether the MCVideo user is authorised to automatically receive video communications.

When set to "true" the MCVideo user is authorised to automatically receive video communications.

When set to "false" the MCVideo user is not authorised to automatically receive video communications.

13.2.77 `<x>/OnNetwork/AllowedAutoRecvEmergency`

Table 13.2.77.1: `<x>/OnNetwork/AllowedAutoRecvEmergency`

`<x>/OnNetwork/AllowedAutoRecvEmergency`

Status	Occurrence	Format	Min. Access Types
Required	One	bool	Get, Replace

This leaf node indicates whether the MCVideo user is authorised to automatically receive emergency video streams.

When set to "true" the MCVideo user is authorised to automatically receive emergency video streams.

When set to "false" the MCVideo user is not authorised to automatically receive emergency video streams.

13.2.78 `<x>/OnNetwork/AllowedAutoRecvImminentPeril`

Table 13.2.78.1: `<x>/OnNetwork/AllowedAutoRecvImminentPeril`

`<x>/OnNetwork/AllowedAutoRecvImminentPeril`

Status	Occurrence	Format	Min. Access Types
Required	One	bool	Get, Replace

This leaf node indicates whether the MCVideo user is authorised to automatically receive imminent peril video streams.

When set to "true" the MCVideo user is authorised to automatically receive imminent peril video streams.

When set to "false" the MCVideo user is not authorised to automatically receive imminent peril video streams.

13.2.79 `<x>/OnNetwork/MandatoryReceiveGroups`

Table 13.2.79.1: `<x>/OnNetwork/MandatoryReceiveGroups`

`<x>/OnNetwork/MandatoryReceiveGroups`

Status	Occurrence	Format	Min. Access Types
Required	One	node	Get, Replace

This interior node is a placeholder for the list of on-network MCVideo groups for which video can be automatically/mandatorily received.

13.2.80 `<x>/OnNetwork/MandatoryReceiveGroups/<x>`

Table 13.2.80.1: `<x>/OnNetwork/MCVideoGroupList/<x>`

`<x>/OnNetwork/MandatoryReceiveGroups/<x>`

Status	Occurrence	Format	Min. Access Types
Required	ZeroOrMore	node	Get, Replace

This interior node is a placeholder for zero or more list of on-network MCVideo groups for which video can be automatically/mandatorily received.

13.2.81 `<x>/OnNetwork/MandatoryReceiveGroups/<x>/Entry`

Table 13.2.81.1: `<x>/OnNetwork/MCVideoGroupList/<x>/Entry`

`<x>/OnNetwork/MandatoryReceiveGroups/<x>/Entry`

Status	Occurrence	Format	Min. Access Types
Optional	One	node	Get, Replace

This interior node is a placeholder for the details of an on-network MCVideo group for which video can be automatically/mandatorily received.

13.2.82

`<x>/OnNetwork/MandatoryReceiveGroups/<x>/Entry/MCVideoGroupID`

Table 13.2.82.1: `<x>/OnNetwork/MandatoryReceiveGroups/<x>/Entry/MCVideoGroupID`

`<x>/OnNetwork/MandatoryReceiveGroups/<x>/Entry/MCVideoGroupID`

Status	Occurrence	Format	Min. Access Types
Required	One	chr	Get, Replace

This leaf node indicates the MCVideo group ID for the on-network MCVideo group for which video can be automatically/mandatorily received.

The value is a "uri" attribute specified in OMA OMA-TS-XDM_Group-V1_1 [4].

13.2.83

`<x>/OnNetwork/MandatoryReceiveGroups/<x>/Entry/DisplayName`

Table 13.2.83.1: `<x>/OnNetwork/MCVideoGroupList/<x>/Entry/DisplayName`

`<x>/OnNetwork/MandatoryReceiveGroups/<x>/Entry/DisplayName`

Status	Occurrence	Format	Min. Access Types

Optional	One	chr	Get, Replace
----------	-----	-----	--------------

This leaf node contains a human readable name that corresponds to the MCVideo Group ID.

13.2.84 /<x>/<x>/OnNetwork/AllowedRequestOverride

Table 13.2.84.1: /<x>/<x>/OnNetwork/AllowedRequestOverride

<x>/OnNetwork/AllowedRequestOverride

Status	Occurrence	Format	Min. Access Types
Required	One	bool	Get, Replace

This leaf node indicates whether the MCVideo user is authorised to request to override an active MCVideo transmission.

When set to "true" the MCVideo user is authorised to request to override an active MCVideo transmission.

When set to "false" the MCVideo user is not authorised to request to override an active MCVideo transmission.

13.2.85 /<x>/<x>/OnNetwork/AllowedSelectOverride

Table 13.2.85.1: /<x>/<x>/OnNetwork/AllowedSelectOverride

<x>/OnNetwork/AllowedSelectOverride

Status	Occurrence	Format	Min. Access Types
Required	One	bool	Get, Replace

This leaf node indicates whether the MCVideo user is authorised to select MCVideo transmissions that can be overridden.

When set to "true" the MCVideo user is authorised to select MCVideo transmissions that can be overridden.

When set to "false" the MCVideo user is not authorised to select MCVideo transmissions that can be overridden.

13.2.86 /<x>/<x>/OnNetwork/AllowedOverrideGroupCall

Table 13.2.86.1: /<x>/<x>/OnNetwork/AllowedOverrideGroupCall

<x>/OnNetwork/AllowedOverrideGroupCall

Status	Occurrence	Format	Min. Access Types
Required	One	bool	Get, Replace

This leaf node indicates whether the MCVideo user is authorised to allow MCVideo private communications to override active MCVideo group communications

When set to "true" the MCVideo user is authorised to allow MCVideo private communications to override active MCVideo group communications.

When set to "false" the MCVideo user is not authorised to allow MCVideo private communications to override active MCVideo group communications.

13.2.87 /<x>/<x>/OnNetwork/MaxTimeSingleTransmit

Table 13.2.87.1: /<x>/<x>/OnNetwork/MaxTimeSingleTransmit

<x>/OnNetwork/MaxTimeSingleTransmit

Status	Occurrence	Format	Min. Access Types
Required	One	int	Get, Replace

This leaf node indicates the maximum length of time that an MCVideo user can transmit for a single video transmission.

- Values: 0-65535

The MaxTimeSingleTransmit time is in seconds.

13.2.88 /<x>/<x>/OffNetwork

Table 13.2.88.1: /<x>/<x>/OffNetwork

<x>/OffNetwork

Status	Occurrence	Format	Min. Access Types
Required	ZeroOrOne	node	Get, Replace

This interior node represents a container for off-network operation.

13.2.89 /<x>/<x>/OffNetwork/Authorised

Table 13.2.89.1: /<x>/<x>/OffNetwork/Authorised

<x>/OffNetwork/Authorised

Status	Occurrence	Format	Min. Access Types
Required	One	bool	Get, Replace

This leaf node indicates the authorisation for off-network services.

When set to "true" the MCVideo user is authorised for off-network operation.

When set to "false" the MCVideo user is not authorised for off-network operation.

13.2.90 /<x>/<x>/OffNetwork/MCVideoGroupList

Table 13.2.90.1: /<x>/<x>/OffNetwork/MCVideoGroupList

<x>/OffNetwork/MCVideoGroupList

Status	Occurrence	Format	Min. Access Types
Required	One	node	Get, Replace

This interior node is a placeholder for the list of off-network MCVideo groups that the MCVideo user is allowed to use.

13.2.91 /<x>/<x>/OffNetwork/MCVideoGroupList/<x>

Table 13.2.91.1: /<x>/<x>/OffNetwork/MCVideoGroupList/<x>

<x>/OffNetwork/MCVideoGroupList/<x>

Status	Occurrence	Format	Min. Access Types
Required	OneOrMore	node	Get, Replace

This interior node is a placeholder for one or more list of off-network MCVideo groups that the MCVideo user is allowed to use.

13.2.92 /<x>/<x>/OffNetwork/MCVideoGroupList/<x>/Entry

Table 13.2.92.1: /<x>/<x>/OffNetwork/MCVideoGroupList/<x>/Entry

<x>/OffNetwork/MCVideoGroupList/<x>/Entry

Status	Occurrence	Format	Min. Access Types
Optional	One	node	Get, Replace

This interior node is a placeholder for the details of the off-network MCVideo groups that the MCVideo user is allowed to use.

13.2.93

`<x>/<x>/OffNetwork/MCVideoGroupList/<x>/Entry/MCVideoGroupID`

Table 13.2.93.1: `<x>/<x>/OffNetwork/MCVideoGroupList/<x>/Entry/MCVideoGroupID`

`<x>/OffNetwork/MCVideoGroupList/<x>/Entry/MCVideoGroupID`

Status	Occurrence	Format	Min. Access Types
Required	One	chr	Get, Replace

This leaf node indicates the MCVideo group ID for the off-network MCVideo group that the MCVideo user is allowed to use.

The value is a "uri" attribute specified in OMA OMA-TS-XDM_Group-V1_1 [4].

13.2.94 `<x>/<x>/OffNetwork/MCVideoGroupList/<x>/Entry/DisplayName`

Table 13.2.94.1: `<x>/<x>/OffNetwork/MCVideoGroupList/<x>/Entry/DisplayName`

`<x>/OffNetwork/MCVideoGroupList/<x>/Entry/DisplayName`

Status	Occurrence	Format	Min. Access Types
Optional	One	chr	Get, Replace

This leaf node contains a human readable name that corresponds to the MCVideo Group ID.

13.2.95

`<x>/<x>/OffNetwork/MCVideoGroupList/<x>/Entry/GMSAppServList`

Table 13.2.95.1: `<x>/<x>/OffNetwork/MCVideoGroupList/<x>/Entry/GMSAppServList`

`<x>/OffNetwork/MCVideoGroupList/<x>/Entry/GMSAppServList`

Status	Occurrence	Format	Min. Access Types
Required	One	node	Get, Replace

This interior node is a placeholder for the Group Management Server application plane server identity configuration.

13.2.96

`<x>/<x>/OffNetwork/MCVideoGroupList/<x>/Entry/GMSAppServList/<x>`

Table 13.2.96.1: `<x>/<x>/OffNetwork/MCVideoGroupList/<x>/Entry/GMSAppServList/<x>`

`<x>/OffNetwork/MCVideoGroupList/<x>/Entry/GMSAppServList/<x>`

Status	Occurrence	Format	Min. Access Types
Required	OneOrMore	node	Get, Replace

This interior node is a placeholder for one or more Group Management Server configuration.

13.2.97

`/<x>/<x>/OffNetwork/MCVideoGroupList/<x>/Entry/GMSAppServList/<x>/GMSAppServId`

Table 13.2.97.1:

`/<x>/<x>/OffNetwork/MCVideoGroupList/<x>/Entry/GMSAppServList/<x>/GMSAppServId`

`<x>/OffNetwork/MCVideoGroupList/<x>/Entry/GMSAppServList/<x>/GMSAppServId`

Status	Occurrence	Format	Min. Access Types
Optional	One	chr	Get, Replace

This leaf node indicates the identity (URI) of the the group management server hosting the MCVideo Group ID.

13.2.98

`/<x>/<x>/OffNetwork/MCVideoGroupList/<x>/Entry/IdMSTokenEndPointList`

Table 13.2.98.1: `/<x>/<x>/OffNetwork/MCVideoGroupList/<x>/Entry/IdMSTokenEndPointList`

`<x>/OffNetwork/MCVideoGroupList/<x>/Entry/IdMSTokenEndPointList`

Status	Occurrence	Format	Min. Access Types
Required	One	node	Get, Replace

This interior node is a placeholder for the Identity Management Server application plane server identity configuration.

13.2.99

`/<x>/<x>/OffNetwork/MCVideoGroupList/<x>/Entry/IdMSTokenEndPointList/<x>`

Table 13.2.99.1: `/<x>/<x>/OffNetwork/MCVideoGroupList/<x>/Entry/IdMSTokenEndPointList/<x>`

`<x>/OffNetwork/MCVideoGroupList/<x>/Entry/IdMSTokenEndPointList/<x>`

Status	Occurrence	Format	Min. Access Types
Required	OneOrMore	node	Get, Replace

This interior node is a placeholder for one or more Identity Management Server configuration.

13.2.100

`/<x>/<x>/OffNetwork/MCVideoGroupList/<x>/Entry/IdMSTokenEndPointList/<x>/IdMSTokenEndPoint`

Table 13.2.100.1:

`/<x>/<x>/OffNetwork/MCVideoGroupList/<x>/Entry/IdMSTokenEndPointList/<x>/IdMSTokenEndPoint`

`<x>/OffNetwork/MCVideoGroupList/<x>/Entry/IdMSTokenEndPointList/<x>/IdMSTokenEndPoint`

Status	Occurrence	Format	Min. Access Types
Optional	One	chr	Get, Replace

This leaf node indicates the identity (URI) of the the identity management server hosting the MCVideo Group ID.

13.2.101

`<x>/<x>/OffNetwork/MCVideoGroupList/<x>/>/Entry/PresentationPriority`

Table 13.2.101.1: `<x>/<x>/OffNetwork/MCVideoGroupList/<x>/>/Entry/PresentationPriority`

`<x>/OffNetwork/MCVideoGroupList/<x>/Entry/PresentationPriority`

Status	Occurrence	Format	Min. Access Types
Optional	One	int	Get, Replace

This leaf node indicates indicating the presentation priority of the off-network group for the MCVideo user relative to other off-network groups and off-network users.

- Values: 0-255

The lowest PresentationPriority value shall be considered as the MCVideo group transaction having the lowest priority for presentation among other group MCVideo and one-to-one user transactions.

13.2.102 `<x>/<x>/OffNetwork/UserInfoID`

Table 13.2.102.1: `<x>/<x>/OffNetwork/UserInfoID`

`<x>/OffNetwork/UserInfoID`

Status	Occurrence	Format	Min. Access Types
Required	One	chr	Get, Replace

This leaf node indicates the ProSe user info ID as specified in 3GPP TS 23.303 [6].

13.2.102A `<x>/<x>/OffNetwork/EmergencyCallChange`

Table 13.2.102A.1: `<x>/<x>/OffNetwork/EmergencyCallChange`

`<x>/OffNetwork/EmergencyCallChange`

Status	Occurrence	Format	Min. Access Types
Required	One	bool	Get, Replace

This leaf node indicates the authorization for a participant to change an off-network group call in-progress to an off-network MCVideo emergency group call.

When set to "true" the MCVideo user is authorised to change an MCVideo emergency group call.

When set to "false" the MCVideo user is not authorised to change an MCVideo emergency group call.

13.2.102B `<x>/<x>/OffNetwork/ImminentPerilCallChange`

Table 13.2.102B.1: `<x>/<x>/OffNetwork/ImminentPerilCallChange`

`<x>/OffNetwork/ImminentPerilCallChange`

Status	Occurrence	Format	Min. Access Types
Required	One	bool	Get, Replace

This leaf node indicates the authorization for a participant to change an off-network group call in-progress to an off-network MCVideo imminent peril group call.

When set to "true" the MCVideo user is authorised to change an MCVideo imminent peril group call.

When set to "false" the MCVideo user is not authorised to change an MCVideo imminent peril group call.

13.2.103 /<x>/Status

Table 13.2.103.1: /<x>/Status

Status

Status	Occurrence	Format	Min. Access Types
Optional	One	bool	Get, Replace

This leaf node indicates whether this MCVideo user profile is enabled or disabled.

When set to "true" this MCVideo user profile is enabled.

When set to "false" this MCVideo user profile is disabled.

14 MCVideo service configuration MO

14.1 General

The MCVideo service configuration Management Object (MO) is used to configure MCVideo Client behaviour for the on-network or off-network MCVideo Service. The MCVideo service configuration parameters may be stored in the ME, or in the USIM as specified in 3GPP TS 31.102 [10], or in both the ME and the USIM. If both the ME and the USIM contain the same parameters, the values stored in the USIM shall take precedence.

The Management Object Identifier is: urn:oma:mo:ext-3gpp-MCVideo-service-configuration:1.0.

Protocol compatibility: This MO is compatible with OMA OMA DM 1.2 [3].

The OMA DM ACL property mechanism (see OMA OMA-ERELD-DM-V1_2 [2]) may be used to grant or deny access rights to OMA DM servers in order to modify nodes and leaf objects of the MCVideo service configuration MO.

The following nodes and leaf objects are possible under the MCVideo service configuration node as described in figure 14.1.1:

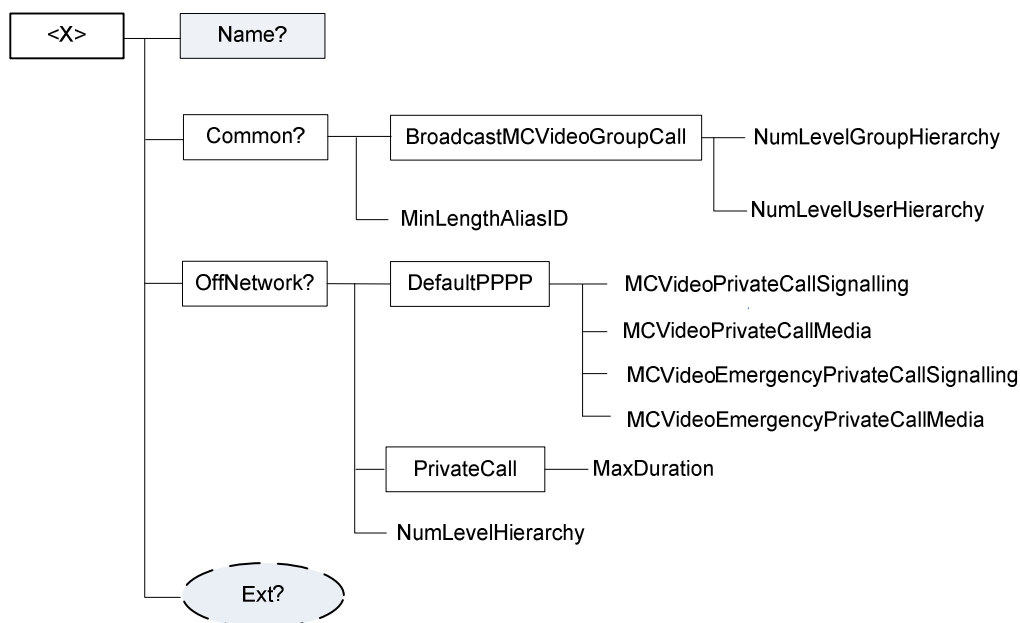

Figure 14.1.1: The MCVideo service configuration MO

14.2 MCVideo service configuration MO parameters

14.2.1 General

This clause describes the parameters for the MCVideo service configuration Management Object (MO).

14.2.2 Node: <x>

Table 14.2.2.1: Node: <x>

<x>

Status	Occurrence	Format	Min. Access Types
Required	OneOrMore	node	Get

This interior node acts as a placeholder for the MCVideo service configuration Management Object (MO).

For the MCVideo service configuration MO, the namespace specific string is: "urn:oma:mo:oma-dm-mcvideo-service-configuration:1.0"

- Values: N/A

14.2.3 /<x>/Name

Table 14.2.3.1: /<x>/Name

Name

Status	Occurrence	Format	Min. Access Types
Required	ZeroOrOne	chr	Get

The Name leaf is a name for the MCVideo service configuration settings.

- Values: <User displayable name>

14.2.4 /<x>/Ext/

Table 14.2.4.1: /<x>/Ext/

Ext

Status	Occurrence	Format	Min. Access Types
Optional	ZeroOrOne	node	Get, Replace

The Ext is an interior node for where the vendor specific information about the MCVideo service configuration MO is being placed.

Usually the vendor extension is identified by vendor specific name under the ext node and contains the vendor meaning application vendor, device vendor etc. The tree structure under the vendor identified is not defined and can therefore include one or more un-standardized sub-trees.

- Values: N/A

14.2.5 /<x>/Common

Table 14.2.5.1: /<x>/Common

Common

Status	Occurrence	Format	Min. Access Types
Required	ZeroOrOne	node	Get, Replace

This interior node represents a container for the common network operation which means both on-network operation and off-network operation.

14.2.6 /<x>/Common/BroadcastMCVideoGroupCall

Table 14.2.6.1: /<x>/Common/BroadcastMCVideoGroupCall

Common/BroadcastMCVideoGroupCall

Status	Occurrence	Format	Min. Access Types
Required	One	node	Get, Replace

This interior node is a placeholder for Broadcast MCVideo Group Call configuration.

14.2.7

/<x>/Common/BroadcastMCVideoGroupCall/NumLevelGroupHierarchy

Table 14.2.7.1: /<x>/Common/BroadcastMCVideoGroupCall/NumLevelGroupHierarchy

Common/BroadcastMCVideoGroupCall/NumLevelGroupHierarchy

Status	Occurrence	Format	Min. Access Types
Required	One	int	Get, Replace

This leaf node indicates the number of levels of group hierarchy for group-broadcast groups.

- Values: 0-255

The group-broadcast group with the lowest NumLevelGroupHierarchy value shall be considered as the group-broadcast group having the lowest level among the groups.

14.2.8

/<x>/Common/BroadcastMCVideoGroupCall/NumLevelUserHierarchy

Table 14.2.8.1: /<x>/Common/BroadcastMCVideoGroupCall/NumLevelUserHierarchy

Common/BroadcastMCVideoGroupCall/NumLevelUserHierarchy

Status	Occurrence	Format	Min. Access Types
Required	One	int	Get, Replace

This leaf node indicates the number of levels of user hierarchy for user-broadcast groups.

- Values: 0-255

The user-broadcast group with the lowest NumLevelUserHierarchy value shall be considered as the user-broadcast group the lowest level among the groups.

14.2.9 /<x>/Common/MinLengthAliasID

Table 14.2.9.1: /<x>/Common/MinLengthAliasID

Common/MinLengthAliasID

Status	Occurrence	Format	Min. Access Types
Required	One	int	Get, Replace

This leaf node indicates minimum length of an alphanumeric identifier (i.e., alias) assigned by an MCVideo administrator.

- Values: 0-255

14.2.10 /<x>/OffNetwork

Table 14.2.10.1: /<x>/OffNetwork

OffNetwork

Status	Occurrence	Format	Min. Access Types
Required	ZeroOrOne	node	Get, Replace

This interior node represents a container for off-network operation.

14.2.11 /<x>/OffNetwork/DefaultPPPP

Table 14.2.11.1: /<x>/OffNetwork/DefaultPPPP

OffNetwork/DefaultPPPP

Status	Occurrence	Format	Min. Access Types
Required	One	node	Get, Replace

This interior node is a placeholder for the default ProSe Per-Packet Priority (PPPP) configuration.

14.2.12 /<x>/OffNetwork/DefaultPPPP/MCVideoPrivateCallSignalling

Table 14.2.12.1: /<x>/OffNetwork/DefaultPPPP/MCVideoPrivateCallSignalling

OffNetwork/DefaultPPPP/MCVideoPrivateCallSignalling

Status	Occurrence	Format	Min. Access Types
Required	One	int	Get, Replace

This leaf node indicates the default ProSe Per-Packet Priority (PPPP) value (as specified in 3GPP TS 23.303 [6]) for the MCVideo private call signalling.

- Values: 1-8

The MCVideo user data with the lowest ProSe Per-Packet Priority value shall be considered as the MCVideo user data having the highest priority among the MCVideo user data.

14.2.13 /<x>/OffNetwork/DefaultPPPP/MCVideoPrivateCallMedia

Table 14.2.13.1: /<x>/OffNetwork/DefaultPPPP/MCVideoPrivateCallMedia

OffNetwork/DefaultPPPP/MCVideoPrivateCallMedia

Status	Occurrence	Format	Min. Access Types
Required	One	int	Get, Replace

This leaf node indicates the default ProSe Per-Packet Priority (PPPP) value (as specified in 3GPP TS 23.303 [6]) for the MCVideo private call media.

- Values: 1-8

The MCVideo user data with the lowest ProSe Per-Packet Priority value shall be considered as the MCVideo user data having the highest priority among the MCVideo user data.

14.2.14

/<x>/OffNetwork/DefaultPPPP/MCVideoEmergencyPrivateCallSignalling

Table 14.2.14.1: /<x>/OffNetwork/DefaultPPPP/MCVideoEmergencyPrivateCallSignalling

OffNetwork/DefaultPPPP/MCVideoEmergencyPrivateCallSignalling

Status	Occurrence	Format	Min. Access Types

Required	One	int	Get, Replace
----------	-----	-----	--------------

This leaf node indicates the default ProSe Per-Packet Priority (PPPP) value (as specified in 3GPP TS 23.303 [6]) for the MCVideo emergency private call signalling.

- Values: 1-8

The MCVideo user data with the lowest ProSe Per-Packet Priority value shall be considered as the MCVideo user data having the highest priority among the MCVideo user data.

14.2.15 /<x>/OffNetwork/DefaultPPPP/MCVideoEmergencyPrivateCallMedia

Table 14.2.15.1: /<x>/OffNetwork/DefaultPPPP/MCVideoEmergencyPrivateCallMedia

OffNetwork/DefaultPPPP/MCVideoEmergencyPrivateCallMedia

Status	Occurrence	Format	Min. Access Types
Required	One	int	Get, Replace

This leaf node indicates the default ProSe Per-Packet Priority (PPPP) value (as specified in 3GPP TS 23.303 [6]) for the MCVideo emergency private call media.

- Values: 1-8

The MCVideo user data with the lowest ProSe Per-Packet Priority value shall be considered as the MCVideo user data having the highest priority among the MCVideo user data.

14.2.16 /<x>/OffNetwork/PrivateCall

Table 14.2.16.1: /<x>/OffNetwork/PrivateCall

OffNetwork/PrivateCall

Status	Occurrence	Format	Min. Access Types
Required	One	node	Get, Replace

This interior node is a placeholder for private call configuration.

14.2.17 /<x>/OffNetwork/PrivateCall/MaxDuration

Table 14.2.17.1: /<x>/OffNetwork/PrivateCall/MaxDuration

OffNetwork/PrivateCall/MaxDuration

Status	Occurrence	Format	Min. Access Types
Required	One	int	Get, Replace

This leaf node indicates max private call duration.

- Values: 0-65535

The MaxDuration time is in seconds.

14.2.18 /<x>/OffNetwork/NumLevelHierarchy

Table 14.2.18.1: /<x>/OffNetwork/NumLevelHierarchy

OffNetwork/NumLevelHierarchy

Status	Occurrence	Format	Min. Access Types
Required	One	int	Get, Replace

This leaf node indicates the number of levels of hierarchy for transmission control override in off-network.

- Values: 4-256

The request with the lowest NumLevelHierarchy value shall be considered as the request having the lowest priority level given to override an active transmission among the requests.

Annex A (informative): MCPTT UE configuration MO DDF

This DDF is the standardized minimal set. A vendor can define it's own DDF for the complete device. This DDF can include more features than this minimal standardized version. The DDF is included as an XML file.

Annex B (informative): MCPTT user profile MO DDF

This DDF is the standardized minimal set. A vendor can define it's own DDF for the complete device. This DDF can include more features than this minimal standardized version. The DDF is included as an XML file.

Annex C (informative): MCPTT group configuration MO DDF

This DDF is the standardized minimal set. A vendor can define it's own DDF for the complete device. This DDF can include more features than this minimal standardized version. The DDF is included as an XML file.

Annex D (informative): MCPTT service configuration MO DDF

This DDF is the standardized minimal set. A vendor can define it's own DDF for the complete device. This DDF can include more features than this minimal standardized version. The DDF is included as an XML file.

Annex E (informative): MCPTT UE initial configuration MO DDF

This DDF is the standardized minimal set. A vendor can define it's own DDF for the complete device. This DDF can include more features than this minimal standardized version. The DDF is included as an XML file.

Annex F (informative): MCVideo UE configuration MO DDF

This DDF is the standardized minimal set. A vendor can define its own DDF for the complete device. This DDF can include more features than this minimal standardized version. The DDF is included as an XML file.

Annex G (informative): MCVideo user profile configuration MO DDF

This DDF is the standardized minimal set. A vendor can define its own DDF for the complete device. This DDF can include more features than this minimal standardized version. The DDF is included as an XML file.

Annex H (informative): MCVideo service configuration MO DDF

This DDF is the standardized minimal set. A vendor can define its own DDF for the complete device. This DDF can include more features than this minimal standardized version. The DDF is included as an XML file.

Annex I (informative): MCData UE configuration MO DDF

This DDF is the standardized minimal set. A vendor can define its own DDF for the complete device. This DDF can include more features than this minimal standardized version. The DDF is included as an XML file.

Annex J (informative): MCData user profile configuration MO DDF

This DDF is the standardized minimal set. A vendor can define its own DDF for the complete device. This DDF can include more features than this minimal standardized version. The DDF is included as an XML file.

Annex K (informative): MCData service configuration MO DDF

This DDF is the standardized minimal set. A vendor can define its own DDF for the complete device. This DDF can include more features than this minimal standardized version. The DDF is included as an XML file.

Annex L (informative): Change history

Change history							
Date	TSG #	TSG Doc.	CR	Rev	Subject/Comment	Old	New
2015-07					Initial proposal to CT1	-	0.0.0
2015-08					Included skeleton from C1ah-150016 and scope from C1ah-150038 agreed at CT1#92bis	0.0.0	0.10
2015-08					Included CRs C1-152964 and C1-152965 agreed at CT1#93	0.1.0	0.2.0
2015-08					Revision number changed due to cover sheet modifications	0.2.0	0.2.1
2015-09					Modifying the cover sheet to add the TS number. Changes by the rapporteur.	0.2.1	0.2.2
2015-10					Included CRs C1-153754, and C1-153755 agreed at CT1#94	0.2.2	0.3.0
2016-01					Included CRs C1-160352, C1-160474, C1-160475, C1-160476, C1-160477 and C1-160478 agreed at CT1#95bis	0.3.0	0.4.0
2016-01					Editorial and formatting fixes	0.4.0	0.4.1
2016-02					Included CRs C1-161077, C1-161078, C1-161231, C1-161324, C1-161326, C1-161327, C1-161509 and C1-161510 agreed at CT1#96 Editorial and formatting fixes by the rapporteur.	0.4.1	0.5.0
2016-03	CT-71	CP-160056			Version 1.0.0 created for presentation for information and approval	0.5.0	1.0.0
2016-03	CT-71				Version 13.0.0 created after approval	1.0.0	13.0.0
2016-03					An editorial change from TS rapporteur	13.0.0	13.0.10
2016-06	CT-72	CP-160322	0002	1	Corrections to the scope of MCPTT Management Object (MO)	13.0.1	13.1.0
2016-06	CT-72	CP-160322	0003	3	Correction for MCPTT UE configuration management object (MO)	13.0.1	13.1.0
2016-06	CT-72	CP-160322	0004	3	Correction for MCPTT user profile management object (MO)	13.0.1	13.1.0
2016-06	CT-72	CP-160322	0005	2	Correction for MCPTT group configuration management object (MO)	13.0.1	13.1.0
2016-06	CT-72	CP-160322	0006	1	Correction for MCPTT service configuration management object (MO)	13.0.1	13.1.0
2016-06	CT-72	CP-160322	0007	3	Correction for MCPTT UE initial configuration management object (MO)	13.0.1	13.1.0
2016-06	CT-72	CP-160322	0011		Correction for security configuration parameters in MCPTT management object (MO)	13.0.1	13.1.0

Change history							
Date	Meeting	TDoc	CR	Rev	Cat	Subject/Comment	New version
2016-09	CT#73	CP-160565	0013	3	F	Correction for configuration parameters in MCPTT user profile management object (MO)	13.2.0
2016-09	CT#73	CP-160503	0014	1	F	Correction for group related parameters in MCPTT UE initial configuration management object (MO)	13.2.0
2016-09	CT#73	CP-160503	0015	1	F	Correction for security material parameter in MCPTT group configuration management object (MO)	13.2.0
2016-09	CT#73	CP-160503	0016		F	Correction for "MCPTTGroupPriorityHierarchy" value in MCPTT UE configuration management object (MO)	24.383 13.2.0
2016-12	CT#74					Change of spec number from 24.383 to 24.483 with wider scope and changed title	24.483 13.2.1
2016-12	CT#74	CP-160733	0018	1	F	Identity management endpoint UE initial configuration MO correction (24.383 CR)	13.3.0
2016-12	CT#74	CP-160733	0019	1	F	Correction for ProSe related configuration parameters (24.383 CR)	13.3.0
2016-12	CT#74	CP-160733	0020	3	F	Correction for MCPTT Private Call and Group Call in MCPTT user profile management (MO) (24.383 CR)	13.3.0
2016-12	CT#74	CP-160733	0021		F	Modify number of levels for priority hierarchy (24.383 CR)	13.3.0
2016-12	CT#74	CP-160733	0022	1	F	Identification of pre-selected MCPTT user profile in MCPTT user profile managed object. (24.383 CR)	13.3.0
2016-12	CT#74	CP-160734	0023	2	F	Off-network configuration parameter for queue (24.383 CR)	13.3.0
2017-03	CT#75	CP-170117	0001	2	F	Scope alignment with TS 24.483 title	13.4.0
2017-03	CT#75	CP-170117	0004		F	Corrections to upper limits	13.4.0
2017-03	CT#75	CP-170127	0002	1	F	Modifying references in TS 24.483 to cater for rel-14 Stage 2 and Stage 3 mission critical restructure	14.0.0
2017-03	CT#75	CP-170127	0003	1	F	Corrections and clean-up for 24.483	14.0.0
2017-03	CT#75	CP-170125	0005	1	B	MCPTT user profile MO modifications in support of private call call-back	14.0.0
2017-06	CT#76	CP-171080	0006		B	Updating general parts of TS 24.483 for MCDData, MCVideo and the initial configuration MO	14.1.0
2017-06	CT#76	CP-171080	0007	2	B	Modifications to the Group Configuration MO for MCDData and MCVideo	14.1.0
2017-06	CT#76	CP-171081	0008	1	B	MCVideo UE configuration MO	14.1.0
2017-06	CT#76	CP-171081	0009	2	B	MCVideo user profile configuration MO	14.1.0
2017-06	CT#76	CP-171081	0010		B	MCVideo service configuration MO	14.1.0
2017-06	CT#76	CP-171080	0011	2	B	MCDData UE configuration MO	14.1.0
2017-06	CT#76	CP-171080	0012	2	B	MCDData user profile configuration MO	14.1.0
2017-06	CT#76	CP-171080	0013	1	B	MCDData service configuration MO	14.1.0
2017-06	CT#76	CP-171114	0014	1	B	eMCPTT user profile MO updates	14.1.0
2017-06	CT#76	CP-171113	0016	1	A	AllowedFloorControlProtection configuration parameter	14.1.0
2017-06	CT#76	CP-171113	0018		A	QueueUsage configuration parameter	14.1.0
2017-06	CT#76	CP-171082	0019	1	F	Correction of User Aliases configuration parameter in the MCPTT user profile MO	14.1.0
2017-09	CT#77	CP-172101	0020	1	B	User profile MO additions for eMCPTT	14.2.0
2017-09	CT#77	CP-172096	0022	1	A	Clause 4 - Correction of occurrences of parameters	14.2.0
2017-09	CT#77	CP-172104	0025		F	Clause 6 - Correction of occurrences of parameters	14.2.0
2017-09	CT#77	CP-172102	0026	1	F	Clause 9 - Correction of occurrences of parameters	14.2.0
2017-09	CT#77	CP-172143	0028	2	F	Specify KMS-URI configuration for MCDATA in the MCDData User Profile Management Object.	14.2.0
2017-09	CT#77	CP-172144	0029	2	F	Clause 10 - Correction of names and formats of some parameters	14.2.0
2017-09	CT#77	CP-172104	0030		F	Clause 12 - Correction of occurrences of parameters	14.2.0
2017-09	CT#77	CP-172104	0031		F	Clause 13 - Correction of occurrences of parameters and their graphical representation	14.2.0
2017-09	CT#77	CP-172096	0032	2	A	Clause 8 – Inclusion of missing timer TFG14	14.2.0
2017-09	CT#77	CP-172096	0034	1	A	Include missing elements in MCPTT UE initial configuration MO	14.2.0
2017-09	CT#77	CP-172134	0037		F	DDF files for TS 24.483	14.2.0
2017-12	CT#78	CP-173066	0039	1	F	Off-network MCVideo configurations	14.3.0

History

Document history		
V14.0.0	April 2017	Publication
V14.1.0	July 2017	Publication
V14.2.0	October 2017	Publication
V14.3.0	January 2018	Publication