

ETSI TS 124 483 V16.4.0 (2020-08)



**LTE;
Mission Critical Services (MCS) Management Object (MO)
(3GPP TS 24.483 version 16.4.0 Release 16)**



Reference

RTS/TSGC-0124483vg40

Keywords

LTE

ETSI

650 Route des Lucioles
F-06921 Sophia Antipolis Cedex - FRANCE

Tel.: +33 4 92 94 42 00 Fax: +33 4 93 65 47 16

Siret N° 348 623 562 00017 - NAF 742 C
Association à but non lucratif enregistrée à la
Sous-Préfecture de Grasse (06) N° 7803/88

Important notice

The present document can be downloaded from:

<http://www.etsi.org/standards-search>

The present document may be made available in electronic versions and/or in print. The content of any electronic and/or print versions of the present document shall not be modified without the prior written authorization of ETSI. In case of any existing or perceived difference in contents between such versions and/or in print, the prevailing version of an ETSI deliverable is the one made publicly available in PDF format at www.etsi.org/deliver.

Users of the present document should be aware that the document may be subject to revision or change of status.

Information on the current status of this and other ETSI documents is available at

<https://portal.etsi.org/TB/ETSIDeliverableStatus.aspx>

If you find errors in the present document, please send your comment to one of the following services:

<https://portal.etsi.org/People/CommitteeSupportStaff.aspx>

Copyright Notification

No part may be reproduced or utilized in any form or by any means, electronic or mechanical, including photocopying and microfilm except as authorized by written permission of ETSI.

The content of the PDF version shall not be modified without the written authorization of ETSI.

The copyright and the foregoing restriction extend to reproduction in all media.

© ETSI 2020.

All rights reserved.

DECT™, **PLUGTESTS™**, **UMTS™** and the ETSI logo are trademarks of ETSI registered for the benefit of its Members.

3GPP™ and **LTE™** are trademarks of ETSI registered for the benefit of its Members and of the 3GPP Organizational Partners.

oneM2M™ logo is a trademark of ETSI registered for the benefit of its Members and of the oneM2M Partners.

GSM® and the GSM logo are trademarks registered and owned by the GSM Association.

Intellectual Property Rights

Essential patents

IPRs essential or potentially essential to normative deliverables may have been declared to ETSI. The information pertaining to these essential IPRs, if any, is publicly available for **ETSI members and non-members**, and can be found in ETSI SR 000 314: *"Intellectual Property Rights (IPRs); Essential, or potentially Essential, IPRs notified to ETSI in respect of ETSI standards"*, which is available from the ETSI Secretariat. Latest updates are available on the ETSI Web server (<https://ipr.etsi.org/>).

Pursuant to the ETSI IPR Policy, no investigation, including IPR searches, has been carried out by ETSI. No guarantee can be given as to the existence of other IPRs not referenced in ETSI SR 000 314 (or the updates on the ETSI Web server) which are, or may be, or may become, essential to the present document.

Trademarks

The present document may include trademarks and/or tradenames which are asserted and/or registered by their owners. ETSI claims no ownership of these except for any which are indicated as being the property of ETSI, and conveys no right to use or reproduce any trademark and/or tradename. Mention of those trademarks in the present document does not constitute an endorsement by ETSI of products, services or organizations associated with those trademarks.

Legal Notice

This Technical Specification (TS) has been produced by ETSI 3rd Generation Partnership Project (3GPP).

The present document may refer to technical specifications or reports using their 3GPP identities. These shall be interpreted as being references to the corresponding ETSI deliverables.

The cross reference between 3GPP and ETSI identities can be found under <http://webapp.etsi.org/key/queryform.asp>.

Modal verbs terminology

In the present document "**shall**", "**shall not**", "**should**", "**should not**", "**may**", "**need not**", "**will**", "**will not**", "**can**" and "**cannot**" are to be interpreted as described in clause 3.2 of the [ETSI Drafting Rules](#) (Verbal forms for the expression of provisions).

"**must**" and "**must not**" are **NOT** allowed in ETSI deliverables except when used in direct citation.

Contents

Intellectual Property Rights	2
Legal Notice	2
Modal verbs terminology.....	2
Foreword.....	32
1 Scope	33
2 References	34
3 Definitions and abbreviations.....	35
3.1 Definitions	35
3.2 Abbreviations	35
4 MCPTT UE configuration MO	35
4.1 General	35
4.2 MCPTT UE configuration MO parameters	36
4.2.1 General.....	36
4.2.2 Node: <x>	36
4.2.3 /<x>/Name	36
4.2.4 /<x>/Ext/	37
4.2.5 /<x>/Common	37
4.2.6 /<x>/Common/PrivateCall	37
4.2.7 /<x>/Common/PrivateCall/MaxCallN10	37
4.2.8 /<x>/Common/MCPTTGroupCall.....	37
4.2.9 /<x>/Common/MCPTTGroupCall/MaxCallN4	38
4.2.10 /<x>/Common/MCPTTGroupCall/MaxTransmissionN5	38
4.2.11 /<x>/Common/MCPTTGroupCall/PrioritizedMCPTTGroup.....	38
4.2.12 /<x>/Common/MCPTTGroupCall/PrioritizedMCPTTGroup/<x>	38
4.2.13 /<x>/Common/MCPTTGroupCall/PrioritizedMCPTTGroup/<x>/MCPTTGroupID	39
4.2.14 /<x>/Common/MCPTTGroupCall/PrioritizedMCPTTGroup/ <x>/MCPTTGroupPriorityHierarchy.....	39
4.2.15 /<x>/OnNetwork	39
4.2.16 /<x>/OnNetwork/RelayService.....	39
4.2.17 /<x>/OnNetwork/IPv6Preferred.....	40
4.2.18 /<x>/OnNetwork/RelayedMCPTTGroup.....	40
4.2.19 /<x>/OnNetwork/RelayedMCPTTGroup/<x>	40
4.2.20 /<x>/OnNetwork/RelayedMCPTTGroup/<x>/MCPTTGroupID	40
4.2.21 /<x>/OnNetwork/RelayedMCPTTGroup/<x>/RelayServiceCode	40
5 MCPTT user profile MO.....	41
5.1 General	41
5.2 MCPTT user profile MO parameters.....	46
5.2.1 General.....	46
5.2.2 Node: <x>	46
5.2.3 /<x>/Name	46
5.2.4 /<x>/Ext/	46
5.2.5 /<x>/<x>	46
5.2.6 /<x>/<x>/Common	47
5.2.7 /<x>/<x>/Common/MCPTTUserID.....	47
5.2.7A /<x>/<x>/Common/MCPTTUserProfileIndex	47
5.2.7B /<x>/<x>/Common/MCPTTUserProfileName.....	47
5.2.7C /<x>/<x>/Common/PreSelectedIndication.....	47
5.2.8 /<x>/<x>/Common/UserAliases.....	48
5.2.8A /<x>/<x>/Common/UserAliases/<x>.....	48
5.2.8B /<x>/<x>/Common/UserAliases/<x>/ UserAlias	48
5.2.9 /<x>/<x>/Common/AuthorisedAlias.....	48
5.2.10 /<x>/<x>/Common/ParticipantType	49
5.2.11 /<x>/<x>/Common/Organization.....	49
5.2.12 /<x>/<x>/Common/PrivateCall.....	49

5.2.13	/<x>/<x>/Common/PrivateCall/Authorised	49
5.2.14	/<x>/<x>/Common/PrivateCall/AuthorisedAny	49
5.2.15	/<x>/<x>/Common/PrivateCall/UserList	50
5.2.16	/<x>/<x>/Common/PrivateCall/UserList/<x>	50
5.2.16A	/<x>/<x>/Common/PrivateCall/UserList/<x>/Entry	50
5.2.17	/<x>/<x>/Common/PrivateCall/UserList/<x>/Entry/MCPTTID	50
5.2.18	/<x>/<x>/Common/PrivateCall/UserList/<x>/Entry/DiscoveryGroupID	51
5.2.19	/<x>/<x>/Common/PrivateCall/UserList/<x>/Entry/UserInfoID	51
5.2.19A	/<x>/<x>/Common/PrivateCall/UserList/<x>/Entry/DisplayName	51
5.2.19B	/<x>/<x>/Common/PrivateCall/UserList/<x>/Entry/PrivateCallKMSURI	51
5.2.20	/<x>/<x>/Common/PrivateCall/ManualCommence	51
5.2.21	/<x>/<x>/Common/PrivateCall/AutoCommence	52
5.2.22	/<x>/<x>/Common/PrivateCall/AutoAnswer	52
5.2.23	/<x>/<x>/Common/PrivateCall/FailRestrict	52
5.2.24	/<x>/<x>/Common/PrivateCall/AllowedMediaProtection	52
5.2.25	/<x>/<x>/Common/PrivateCall/AllowedFloorControlProtection	53
5.2.26	/<x>/<x>/Common/PrivateCall/EmergencyCall	53
5.2.27	/<x>/<x>/Common/PrivateCall/EmergencyCall/Authorised	53
5.2.28	/<x>/<x>/Common/PrivateCall/EmergencyCall/CancelPriority	53
5.2.29	/<x>/<x>/Common/PrivateCall/EmergencyCall/MCPTTPrivateRecipient	54
5.2.29A	/<x>/<x>/Common/PrivateCall/EmergencyCall/MCPTTPrivateRecipient/Entry	54
5.2.29B	/<x>/<x>/Common/PrivateCall/EmergencyCall/ MCPTTPrivateRecipient/Entry/ID	54
5.2.29C	/<x>/<x>/Common/PrivateCall/EmergencyCall/ MCPTTPrivateRecipient/Entry/DiscoveryGroupID	54
5.2.29D	/<x>/<x>/Common/PrivateCall/EmergencyCall/ MCPTTPrivateRecipient/Entry/UserInfoID	55
5.2.29E	/<x>/<x>/Common/PrivateCall/EmergencyCall/ MCPTTPrivateRecipient/Entry/DisplayName	55
5.2.29F	/<x>/<x>/Common/PrivateCall/EmergencyCall/ MCPTTPrivateRecipient/Entry/Usage	55
5.2.30	/<x>/<x>/Common/MCPTTGroupCall	56
5.2.31	/<x>/<x>/Common/MCPTTGroupCall/MaxSimultaneousCallsN6	56
5.2.32	/<x>/<x>/Common/MCPTTGroupCall/EmergencyCall	56
5.2.33	/<x>/<x>/Common/MCPTTGroupCall/EmergencyCall/Enabled	56
5.2.34	/<x>/<x>/Common/MCPTTGroupCall/EmergencyCall/ MCPTTGroupInitiation	56
5.2.34A	/<x>/<x>/Common/MCPTTGroupCall/EmergencyCall/ MCPTTGroupInitiation/Entry	57
5.2.34B	/<x>/<x>/Common/MCPTTGroupCall/EmergencyCall/ MCPTTGroupInitiation/Entry/GroupID	57
5.2.34C	/<x>/<x>/Common/MCPTTGroupCall/EmergencyCall/ MCPTTGroupInitiation/Entry/DisplayName	57
5.2.34D	/<x>/<x>/Common/MCPTTGroupCall/EmergencyCall/ MCPTTGroupInitiation/Entry/Usage	57
5.2.35	/<x>/<x>/Common/MCPTTGroupCall/EmergencyCall/ CancelMCPTTGroup	58
5.2.36	/<x>/<x>/Common/MCPTTGroupCall/ImminentPerilCall	58
5.2.37	/<x>/<x>/Common/MCPTTGroupCall/ImminentPerilCall/Authorised	58
5.2.38	/<x>/<x>/Common/MCPTTGroupCall/ImminentPerilCall/Cancel	58
5.2.39	/<x>/<x>/Common/MCPTTGroupCall/ImminentPerilCall/MCPTTGroupInitiation	59
5.2.39A	/<x>/<x>/Common/MCPTTGroupCall/ImminentPerilCall/MCPTTGroupInitiation/Entry	59
5.2.39B	/<x>/<x>/Common/MCPTTGroupCall/ ImminentPerilCall/MCPTTGroupInitiation/Entry/GroupID	59
5.2.39C	/<x>/<x>/Common/MCPTTGroupCall/ImminentPerilCall/ MCPTTGroupInitiation/DisplayName	59
5.2.39D	/<x>/<x>/Common/MCPTTGroupCall/ ImminentPerilCall/MCPTTGroupInitiation/Entry/Usage	60
5.2.40	/<x>/<x>/Common/MCPTTGroupCall/EmergencyAlert	60
5.2.41	/<x>/<x>/Common/MCPTTGroupCall/EmergencyAlert/Authorised	60
5.2.42	/<x>/<x>/Common/MCPTTGroupCall/EmergencyAlert/Cancel	60
5.2.43	Void	61
5.2.43A	/<x>/<x>/Common/MCPTTGroupCall/EmergencyAlert/Entry	61
5.2.43B	/<x>/<x>/Common/MCPTTGroupCall/EmergencyAlert/Entry/ID	61
5.2.43C	Void	61
5.2.43D	/<x>/<x>/Common/MCPTTGroupCall/EmergencyAlert/Entry/DisplayName	61
5.2.43E	/<x>/<x>/Common/MCPTTGroupCall/EmergencyAlert/Entry/Usage	61
5.2.43F	/<x>/<x>/Common/MCPTTGroupCall/Priority	62
5.2.44	Void	62
5.2.45	/<x>/<x>/Common/MCPTTGroupBroadcast	62
5.2.46	/<x>/<x>/Common/MCPTTGroupBroadcast/ Authorised	62
5.2.47	/<x>/<x>/Common/UserBroadcast	62
5.2.48	/<x>/<x>/Common/UserBroadcast/ Authorised	63
5.2.48A	/<x>/<x>/OnNetwork	63
5.2.48B1	/<x>/<x>/OnNetwork/MCPTTGroupList	63

5.2.48B2	/<x>/<x>/OnNetwork/MCPTTGroupList/<x>	63
5.2.48B3	/<x>/<x>/OnNetwork/MCPTTGroupList/<x>/Entry	63
5.2.48B4	/<x>/<x>/OnNetwork/MCPTTGroupList/<x>/Entry/MCPTTGroupID	64
5.2.48B4A	/<x>/<x>/OnNetwork/MCPTTGroupList/<x>/Entry/RulesForAffiliation	64
5.2.48B4A1	/<x>/<x>/OnNetwork/MCPTTGroupList/<x>/Entry/RulesForAffiliation/ListOfLocationCriteria/	64
5.2.48B4A2 /<x>/<x>/OnNetwork/MCPTTGroupList/<x>/Entry/RulesForAffiliation/ListOfLocationCriteria/<x>	64
5.2.48B4A3	/<x>/<x>/OnNetwork/MCPTTGroupList/<x>/Entry/RulesForAffiliation/ListOfLocationCriteria/<x>/Ent ry	65
5.2.48B4A4	/<x>/<x>/OnNetwork/MCPTTGroupList/<x>/Entry/RulesForAffiliation/ListOfLocationCriteria/<x>/Ent ry/EnterSpecificArea	65
5.2.48B4A5	/<x>/<x>/OnNetwork/MCPTTGroupList/<x>/Entry/RulesForAffiliation/ListOfLocationCriteria/<x>/Ent ry/EnterSpecificArea/PolygonArea	65
5.2.48B4A6	/<x>/<x>/OnNetwork/MCPTTGroupList/<x>/Entry/RulesForAffiliation/ListOfLocationCriteria/<x>/Ent ry/EnterSpecificArea/PolygonArea/Corner	65
5.2.48B4A7	/<x>/<x>/OnNetwork/MCPTTGroupList/<x>/Entry/RulesForAffiliation/ListOfLocationCriteria/<x>/Ent ry/EnterSpecificArea/PolygonArea/Corner/PointCoordinateType	66
5.2.48B4A8	/<x>/<x>/OnNetwork/MCPTTGroupList/<x>/Entry/RulesForAffiliation/ListOfLocationCriteria/<x>/Ent ry/EnterSpecificArea/PolygonArea/Corner/PointCoordinateType/Longitude	66
5.2.48B4A9	/<x>/<x>/OnNetwork/MCPTTGroupList/<x>/Entry/RulesForAffiliation/ListOfLocationCriteria/<x>/Ent ry/EnterSpecificArea/PolygonArea/Corner/PointCoordinateType/Latitude	66
5.2.48B4A10	/<x>/<x>/OnNetwork/MCPTTGroupList/<x>/Entry/RulesForAffiliation/ListOfLocationCriteria/<x>/Ent ry/EnterSpecificArea/EllipsoidArcArea	67
5.2.48B4A11	/<x>/<x>/OnNetwork/MCPTTGroupList/<x>/Entry/RulesForAffiliation/ListOfLocationCriteria/<x>/Ent ry/EnterSpecificArea/EllipsoidArcArea/Center	67
5.2.48B4A12	/<x>/<x>/OnNetwork/MCPTTGroupList/<x>/Entry/RulesForAffiliation/ListOfLocationCriteria/<x>/Ent ry/EnterSpecificArea/EllipsoidArcArea/Center/PointCoordinateType	67
5.2.48B4A13	/<x>/<x>/OnNetwork/MCPTTGroupList/<x>/Entry/RulesForAffiliation/ListOfLocationCriteria/<x>/Ent ry/EnterSpecificArea/EllipsoidArcArea/Center/PointCoordinateType/Longitude	68
5.2.48B4A14	/<x>/<x>/OnNetwork/MCPTTGroupList/<x>/Entry/RulesForAffiliation/ListOfLocationCriteria/<x>/Ent ry/EnterSpecificArea/EllipsoidArcArea/Center/PointCoordinateType/Latitude	68
5.2.48B4A15	/<x>/<x>/OnNetwork/MCPTTGroupList/<x>/Entry/RulesForAffiliation/ListOfLocationCriteria/<x>/Ent ry/EnterSpecificArea/EllipsoidArcArea/Radius	68
5.2.48B4A16	/<x>/<x>/OnNetwork/MCPTTGroupList/<x>/Entry/RulesForAffiliation/ListOfLocationCriteria/<x>/Ent ry/EnterSpecificArea/EllipsoidArcArea/OffsetAngle	69
5.2.48B4A17	/<x>/<x>/OnNetwork/MCPTTGroupList/<x>/Entry/RulesForAffiliation/ListOfLocationCriteria/<x>/Ent ry/EnterSpecificArea/EllipsoidArcArea/IncludedAngle	69
5.2.48B4A18	/<x>/<x>/OnNetwork/MCPTTGroupList/<x>/Entry/RulesForAffiliation/ListOfLocationCriteria/<x>/Ent ry/EnterSpecificArea/Speed	69
5.2.48B4A19	/<x>/<x>/OnNetwork/MCPTTGroupList/<x>/Entry/RulesForAffiliation/ListOfLocationCriteria/<x>/Ent ry/EnterSpecificArea/Speed/MinimumSpeed	70
5.2.48B4A20	/<x>/<x>/OnNetwork/MCPTTGroupList/<x>/Entry/RulesForAffiliation/ListOfLocationCriteria/<x>/Ent ry/EnterSpecificArea/Speed/MaximumSpeed	70

5.2.48B4A21	/<x>/<x>/OnNetwork/MCPTTGroupList/<x>/Entry/RulesForAffiliation/ListOfLocationCriteria/<x>/Entry/EnterSpecificArea/Heading	70
5.2.48B4A22	/<x>/<x>/OnNetwork/MCPTTGroupList/<x>/Entry/RulesForAffiliation/ListOfLocationCriteria/<x>/Entry/EnterSpecificArea/Heading/MinimumHeading	71
5.2.48B4A23	/<x>/<x>/OnNetwork/MCPTTGroupList/<x>/Entry/RulesForAffiliation/ListOfLocationCriteria/<x>/Entry/EnterSpecificArea/Heading/MaximumHeading	71
5.2.48B4A24	/<x>/<x>/OnNetwork/MCPTTGroupList/<x>/Entry/RulesForAffiliation/ListOfLocationCriteria/<x>/Entry/ExitSpecificArea	71
5.2.48B4A25	/<x>/<x>/OnNetwork/MCPTTGroupList/<x>/Entry/RulesForAffiliation/ListOfLocationCriteria/<x>/Entry/ExitSpecificArea/PolygonArea	72
5.2.48B4A26	/<x>/<x>/OnNetwork/MCPTTGroupList/<x>/Entry/RulesForAffiliation/ListOfLocationCriteria/<x>/Entry/ExitSpecificArea/PolygonArea/Corner	72
5.2.48B4A27	/<x>/<x>/OnNetwork/MCPTTGroupList/<x>/Entry/RulesForAffiliation/ListOfLocationCriteria/<x>/Entry/ExitSpecificArea/PolygonArea/Corner/PointCoordinateType	72
5.2.48B4A28	/<x>/<x>/OnNetwork/MCPTTGroupList/<x>/Entry/RulesForAffiliation/ListOfLocationCriteria/<x>/Entry/ExitSpecificArea/PolygonArea/Corner/PointCoordinateType/Longitude	72
5.2.48B4A29	/<x>/<x>/OnNetwork/MCPTTGroupList/<x>/Entry/RulesForAffiliation/ListOfLocationCriteria/<x>/Entry/ExitSpecificArea/PolygonArea/Corner/PointCoordinateType/Latitude	73
5.2.48B4A30	/<x>/<x>/OnNetwork/MCPTTGroupList/<x>/Entry/RulesForAffiliation/ListOfLocationCriteria/<x>/Entry/ExitSpecificArea/EllipsoidArcArea	73
5.2.48B4A31	/<x>/<x>/OnNetwork/MCPTTGroupList/<x>/Entry/RulesForAffiliation/ListOfLocationCriteria/<x>/Entry/ExitSpecificArea/EllipsoidArcArea/Center	73
5.2.48B4A32	/<x>/<x>/OnNetwork/MCPTTGroupList/<x>/Entry/RulesForAffiliation/ListOfLocationCriteria/<x>/Entry/ExitSpecificArea/EllipsoidArcArea/Center/PointCoordinateType	74
5.2.48B4A33	/<x>/<x>/OnNetwork/MCPTTGroupList/<x>/Entry/RulesForAffiliation/ListOfLocationCriteria/<x>/Entry/ExitSpecificArea/EllipsoidArcArea/Center/PointCoordinateType/Longitude	74
5.2.48B4A34	/<x>/<x>/OnNetwork/MCPTTGroupList/<x>/Entry/RulesForAffiliation/ListOfLocationCriteria/<x>/Entry/ExitSpecificArea/EllipsoidArcArea/Center/PointCoordinateType/Latitude	74
5.2.48B4A35	/<x>/<x>/OnNetwork/MCPTTGroupList/<x>/Entry/RulesForAffiliation/ListOfLocationCriteria/<x>/Entry/ExitSpecificArea/EllipsoidArcArea/Radius	75
5.2.48B4A36	/<x>/<x>/OnNetwork/MCPTTGroupList/<x>/Entry/RulesForAffiliation/ListOfLocationCriteria/<x>/Entry/ExitSpecificArea/EllipsoidArcArea/OffsetAngle	75
5.2.48B4A37	/<x>/<x>/OnNetwork/MCPTTGroupList/<x>/Entry/RulesForAffiliation/ListOfLocationCriteria/<x>/Entry/ExitSpecificArea/EllipsoidArcArea/IncludedAngle	75
5.2.48B4A38	/<x>/<x>/OnNetwork/MCPTTGroupList/<x>/Entry/RulesForAffiliation/ListOfLocationCriteria/<x>/Entry/ExitSpecificArea/Speed	76
5.2.48B4A39	/<x>/<x>/OnNetwork/MCPTTGroupList/<x>/Entry/RulesForAffiliation/ListOfLocationCriteria/<x>/Entry/ExitSpecificArea/Speed/MinimumSpeed	76
5.2.48B4A40	/<x>/<x>/OnNetwork/MCPTTGroupList/<x>/Entry/RulesForAffiliation/ListOfLocationCriteria/<x>/Entry/ExitSpecificArea/Speed/MaximumSpeed	76

5.2.48B4A41	/<x>/<x>/OnNetwork/MCPTTGroupList/<x>/Entry/RulesForAffiliation/ListOfLocationCriteria/<x>/Entry/ExitSpecificArea/Heading	77
5.2.48B4A42	/<x>/<x>/OnNetwork/MCPTTGroupList/<x>/Entry/RulesForAffiliation/ListOfLocationCriteria/<x>/Entry/ExitSpecificArea/Heading/MinimumHeading	77
5.2.48B4A43	/<x>/<x>/OnNetwork/MCPTTGroupList/<x>/Entry/RulesForAffiliation/ListOfLocationCriteria/<x>/Entry/ExitSpecificArea/Heading/MaximumHeading	77
5.2.48B4A44	./<x>/<x>/OnNetwork/MCPTTGroupList/<x>/Entry/RulesForAffiliation/ListOfActiveFunctionalAliases	78
5.2.48B4A45	/<x>/<x>/OnNetwork/MCPTTGroupList/<x>/Entry/RulesForAffiliation/ListOfActiveFunctionalAliases/<x>	78
5.2.48B4A46	/<x>/<x>/OnNetwork/MCPTTGroupList/<x>/Entry/RulesForAffiliation/ListOfActiveFunctionalAliases/<x>/Entry	78
5.2.48B4A47	/<x>/<x>/OnNetwork/MCPTTGroupList/<x>/Entry/RulesForAffiliation/ListOfActiveFunctionalAliases/<x>/Entry/FunctionalAlias	78
5.2.48B4B	/<x>/<x>/OnNetwork/MCPTTGroupList/<x>/Entry/RulesForDeaffiliation	79
5.2.48B4B1	/<x>/<x>/OnNetwork/MCPTTGroupList/<x>/Entry/RulesForDeaffiliation/ListOfLocationCriteria/	79
5.2.48B4B2	.../<x>/<x>/OnNetwork/MCPTTGroupList/<x>/Entry/RulesForDeaffiliation/ListOfLocationCriteria/<x>	79
5.2.48B4B3	/<x>/<x>/OnNetwork/MCPTTGroupList/<x>/Entry/RulesForDeaffiliation/ListOfLocationCriteria/<x>/Entry	79
5.2.48B4B4	/<x>/<x>/OnNetwork/MCPTTGroupList/<x>/Entry/RulesForDeaffiliation/ListOfLocationCriteria/<x>/Entry/EnterSpecificArea	80
5.2.48B4B5	/<x>/<x>/OnNetwork/MCPTTGroupList/<x>/Entry/RulesForDeaffiliation/ListOfLocationCriteria/<x>/Entry/EnterSpecificArea/PolygonArea	80
5.2.48B4B6	/<x>/<x>/OnNetwork/MCPTTGroupList/<x>/Entry/RulesForDeaffiliation/ListOfLocationCriteria/<x>/Entry/EnterSpecificArea/PolygonArea/Corner	80
5.2.48B4B7	/<x>/<x>/OnNetwork/MCPTTGroupList/<x>/Entry/RulesForDeaffiliation/ListOfLocationCriteria/<x>/Entry/EnterSpecificArea/PolygonArea/Corner/PointCoordinateType	80
5.2.48B4B8	/<x>/<x>/OnNetwork/MCPTTGroupList/<x>/Entry/RulesForDeaffiliation/ListOfLocationCriteria/<x>/Entry/EnterSpecificArea/PolygonArea/Corner/PointCoordinateType/Longitude	81
5.2.48B4B9	/<x>/<x>/OnNetwork/MCPTTGroupList/<x>/Entry/RulesForAffiliation/ListOfLocationCriteria/<x>/Entry/EnterSpecificArea/PolygonArea/Corner/PointCoordinateType/Latitude	81
5.2.48B4B10	/<x>/<x>/OnNetwork/MCPTTGroupList/<x>/Entry/RulesForDeaffiliation/ListOfLocationCriteria/<x>/Entry/EnterSpecificArea/EllipsoidArcArea	81
5.2.48B4A11	/<x>/<x>/OnNetwork/MCPTTGroupList/<x>/Entry/RulesForDeaffiliation/ListOfLocationCriteria/<x>/Entry/EnterSpecificArea/EllipsoidArcArea/Center	82
5.2.48B4B12	/<x>/<x>/OnNetwork/MCPTTGroupList/<x>/Entry/RulesForDeaffiliation/ListOfLocationCriteria/<x>/Entry/EnterSpecificArea/EllipsoidArcArea/Center/PointCoordinateType	82
5.2.48B4B13	/<x>/<x>/OnNetwork/MCPTTGroupList/<x>/Entry/RulesForDeaffiliation/ListOfLocationCriteria/<x>/Entry/EnterSpecificArea/EllipsoidArcArea/Center/PointCoordinateType/Longitude	82
5.2.48B4B14	/<x>/<x>/OnNetwork/MCPTTGroupList/<x>/Entry/RulesForDeaffiliation/ListOfLocationCriteria/<x>/Entry/EnterSpecificArea/EllipsoidArcArea/Center/PointCoordinateType/Latitude	83

5.2.48B4B15	/<x>/<x>/OnNetwork/MCPTTGroupList/<x>/Entry/RulesForDeaffiliation/ListOfLocationCriteria/<x>/Entry/EnterSpecificArea/EllipsoidArcArea/Radius	83
5.2.48B4B16	/<x>/<x>/OnNetwork/MCPTTGroupList/<x>/Entry/RulesForDeaffiliation/ListOfLocationCriteria/<x>/Entry/EnterSpecificArea/EllipsoidArcArea/OffsetAngle.....	83
5.2.48B4B17	/<x>/<x>/OnNetwork/MCPTTGroupList/<x>/Entry/RulesForDeaffiliation/ListOfLocationCriteria/<x>/Entry/EnterSpecificArea/EllipsoidArcArea/IncludedAngle.....	84
5.2.48B4B18	/<x>/<x>/OnNetwork/MCPTTGroupList/<x>/Entry/RulesFordeaffiliation/ListOfLocationCriteria/<x>/Entry/EnterSpecificArea/Speed.....	84
5.2.48B4B19	/<x>/<x>/OnNetwork/MCPTTGroupList/<x>/Entry/RulesForDeaffiliation/ListOfLocationCriteria/<x>/Entry/EnterSpecificArea/Speed/MinimumSpeed	84
5.2.48B4B20	/<x>/<x>/OnNetwork/MCPTTGroupList/<x>/Entry/RulesForDeaffiliation/ListOfLocationCriteria/<x>/Entry/EnterSpecificArea/Speed/MaximumSpeed	85
5.2.48B4B21	/<x>/<x>/OnNetwork/MCPTTGroupList/<x>/Entry/RulesForDeaffiliation/ListOfLocationCriteria/<x>/Entry/EnterSpecificArea/Heading	85
5.2.48B4B22	/<x>/<x>/OnNetwork/MCPTTGroupList/<x>/Entry/RulesForDeaffiliation/ListOfLocationCriteria/<x>/Entry/EnterSpecificArea/Heading/MinimumHeading	85
5.2.48B4B23	/<x>/<x>/OnNetwork/MCPTTGroupList/<x>/Entry/RulesForDeaffiliation/ListOfLocationCriteria/<x>/Entry/EnterSpecificArea/Heading/MaximumHeading.....	86
5.2.48B4B24	/<x>/<x>/OnNetwork/MCPTTGroupList/<x>/Entry/RulesForDeaffiliation/ListOfLocationCriteria/<x>/Entry/ExitSpecificArea	86
5.2.48B4B25	/<x>/<x>/OnNetwork/MCPTTGroupList/<x>/Entry/RulesForDeaffiliation/ListOfLocationCriteria/<x>/Entry/ExitSpecificArea/PolygonArea	86
5.2.48B4B26	/<x>/<x>/OnNetwork/MCPTTGroupList/<x>/Entry/RulesForDeaffiliation/ListOfLocationCriteria/<x>/Entry/ExitSpecificArea/PolygonArea/Corner	87
5.2.48B4B27	/<x>/<x>/OnNetwork/MCPTTGroupList/<x>/Entry/RulesForDeaffiliation/ListOfLocationCriteria/<x>/Entry/ExitSpecificArea/PolygonArea/Corner/PointCoordinateType	87
5.2.48B4B28	/<x>/<x>/OnNetwork/MCPTTGroupList/<x>/Entry/RulesForDeaffiliation/ListOfLocationCriteria/<x>/Entry/ExitSpecificArea/PolygonArea/Corner/PointCoordinateType/Longitude	87
5.2.48B4B29	/<x>/<x>/OnNetwork/MCPTTGroupList/<x>/Entry/RulesForDeaffiliation/ListOfLocationCriteria/<x>/Entry/ExitSpecificArea/PolygonArea/Corner/PointCoordinateType/Latitude.....	88
5.2.48B4B30	/<x>/<x>/OnNetwork/MCPTTGroupList/<x>/Entry/RulesForDeaffiliation/ListOfLocationCriteria/<x>/Entry/ExitSpecificArea/EllipsoidArcArea	88
5.2.48B4B31	/<x>/<x>/OnNetwork/MCPTTGroupList/<x>/Entry/RulesForDeaffiliation/ListOfLocationCriteria/<x>/Entry/ExitSpecificArea/EllipsoidArcArea/Center.....	88
5.2.48B4B32	/<x>/<x>/OnNetwork/MCPTTGroupList/<x>/Entry/RulesForDeaffiliation/ListOfLocationCriteria/<x>/Entry/ExitSpecificArea/EllipsoidArcArea/Center/PointCoordinateType	89
5.2.48B4B33	/<x>/<x>/OnNetwork/MCPTTGroupList/<x>/Entry/RulesForDeaffiliation/ListOfLocationCriteria/<x>/Entry/ExitSpecificArea/EllipsoidArcArea/Center/PointCoordinateType/Longitude	89
5.2.48B4B34	/<x>/<x>/OnNetwork/MCPTTGroupList/<x>/Entry/RulesForDeaffiliation/ListOfLocationCriteria/<x>/Entry/ExitSpecificArea/EllipsoidArcArea/Center/PointCoordinateType/Latitude	89

5.2.48B4B35	/<x>/<x>/OnNetwork/MCPTTGroupList/<x>/Entry/RulesForDeaffiliation/ListOfLocationCriteria/<x>/Entry/ExitSpecificArea/EllipsoidArcArea/Radius	90
5.2.48B4B36	/<x>/<x>/OnNetwork/MCPTTGroupList/<x>/Entry/RulesForDeaffiliation/ListOfLocationCriteria/<x>/Entry/ExitSpecificArea/EllipsoidArcArea/OffsetAngle	90
5.2.48B4B37	/<x>/<x>/OnNetwork/MCPTTGroupList/<x>/Entry/RulesForDeaffiliation/ListOfLocationCriteria/<x>/Entry/ExitSpecificArea/EllipsoidArcArea/IncludedAngle.....	90
5.2.48B4B38	/<x>/<x>/OnNetwork/MCPTTGroupList/<x>/Entry/RulesForDeaffiliation/ListOfLocationCriteria/<x>/Entry/ExitSpecificArea/Speed.....	91
5.2.48B4B39	/<x>/<x>/OnNetwork/MCPTTGroupList/<x>/Entry/RulesForDeaffiliation/ListOfLocationCriteria/<x>/Entry/ExitSpecificArea/Speed/MinimumSpeed	91
5.2.48B4B40	/<x>/<x>/OnNetwork/MCPTTGroupList/<x>/Entry/RulesForDeaffiliation/ListOfLocationCriteria/<x>/Entry/ExitSpecificArea/Speed/MaximumSpeed	91
5.2.48B4B41	/<x>/<x>/OnNetwork/MCPTTGroupList/<x>/Entry/RulesForDeaffiliation/ListOfLocationCriteria/<x>/Entry/ExitSpecificArea/Heading.....	92
5.2.48B4B42	/<x>/<x>/OnNetwork/MCPTTGroupList/<x>/Entry/RulesForDeaffiliation/ListOfLocationCriteria/<x>/Entry/ExitSpecificArea/Heading/MinimumHeading	92
5.2.48B4B43	/<x>/<x>/OnNetwork/MCPTTGroupList/<x>/Entry/RulesForDeaffiliation/ListOfLocationCriteria/<x>/Entry/ExitSpecificArea/Heading/MaximumHeading	92
5.2.48B4B44	./<x>/<x>/OnNetwork/MCPTTGroupList/<x>/Entry/RulesForDeaffiliation/ListOfActiveFunctionalAliases.....	93
5.2.48B4B45	./<x>/<x>/OnNetwork/MCPTTGroupList/<x>/Entry/RulesForDeaffiliation/ListOfActiveFunctionalAliases/<x>	93
5.2.48B4B46	./<x>/<x>/OnNetwork/MCPTTGroupList/<x>/Entry/RulesForDeaffiliation/ListOfActiveFunctionalAliases/<x>/Entry	93
5.2.48B4B47	./<x>/<x>/OnNetwork/MCPTTGroupList/<x>/Entry/RulesForDeaffiliation/ListOfActiveFunctionalAliases/<x>/Entry/FunctionalAlias	93
5.2.48B5	/<x>/<x>/OnNetwork/MCPTTGroupList/<x>/Entry/DisplayName	94
5.2.48B6/<x>/<x>/OnNetwork/MCPTTGroupList/<x>/Entry/ManualDeAffiliationNotAllowedIfRulesAreMet	94
5.2.48C1	/<x>/<x>/OnNetwork/ImplicitAffiliations	94
5.2.48C2	/<x>/<x>/OnNetwork/ImplicitAffiliations/<x>	94
5.2.48C3	/<x>/<x>/OnNetwork/ImplicitAffiliations/<x>/Entry	94
5.2.48C4	/<x>/<x>/OnNetwork/ImplicitAffiliations/<x>/Entry/ MCPTTGroupID	95
5.2.48C5	/<x>/<x>/OnNetwork/ImplicitAffiliations/<x>/Entry/DisplayName	95
5.2.48D	/<x>/<x>/OnNetwork/AllowedRegroup	95
5.2.48E	/<x>/<x>/OnNetwork/AllowedPresenceStatus	95
5.2.48F	/<x>/<x>/OnNetwork/AllowedPresence	95
5.2.48G	/<x>/<x>/OnNetwork/EnabledParticipation	96
5.2.48H	/<x>/<x>/OnNetwork/AllowedTransmission.....	96
5.2.48I	/<x>/<x>/OnNetwork/AllowedManualSwitch.....	96
5.2.48J	/<x>/<x>/OnNetwork/PrivateCall.....	96
5.2.48K	/<x>/<x>/OnNetwork/PrivateCall/EmergencyAlert.....	97
5.2.48L	/<x>/<x>/OnNetwork/PrivateCall/EmergencyAlert/Entry.....	97
5.2.48M	/<x>/<x>/OnNetwork/PrivateCall/EmergencyAlert/Entry/ID	97
5.2.48N	/<x>/<x>/OnNetwork/PrivateCall/EmergencyAlert/Entry/DisplayName	97
5.2.48O	/<x>/<x>/OnNetwork/PrivateCall/EmergencyAlert/Entry/Usage.....	97
5.2.48P	/<x>/<x>/OnNetwork/PrivateCall/AllowedCallBackRequest.....	98
5.2.48Q	/<x>/<x>/OnNetwork/PrivateCall/AllowedCallBackCancelRequest	98

5.2.48R	/<x>/<x>/OnNetwork/PrivateCall/AllowedRemoteInitiatedAmbientListening	98
5.2.48S	/<x>/<x>/OnNetwork/PrivateCall/AllowedLocallyInitiatedAmbientListening	99
5.2.48T	/<x>/<x>/OnNetwork/PrivateCall/AllowedRequestFirstToAnswerCall	99
5.2.48U1	/<x>/<x>/OnNetwork/RemoteGroupSelection.....	99
5.2.48U2	/<x>/<x>/OnNetwork/RemoteGroupSelection/<x>.....	99
5.2.48U3	/<x>/<x>/OnNetwork/RemoteGroupSelection/<x>/Entry	99
5.2.48U4	/<x>/<x>/OnNetwork/RemoteGroupSelection/<x>/Entry/MCPTTID	100
5.2.48U5	/<x>/<x>/OnNetwork/RemoteGroupSelection/<x>/Entry/DisplayName	100
5.2.48V1	/<x>/<x>/OnNetwork/GroupServerInfo.....	100
5.2.48V2	/<x>/<x>/OnNetwork/GroupServerInfo/GMSServList	100
5.2.48V3	/<x>/<x>/OnNetwork/GroupServerInfo/GMSServList/<x>	100
5.2.48V4	/<x>/<x>/OnNetwork/GroupServerInfo/GMSServList/<x>/Entry	101
5.2.48V5	/<x>/<x>/OnNetwork/GroupServerInfo/GMSServList/<x>/Entry/GMSServID	101
5.2.48V6/<x>/<x>/	OnNetwork/GroupServerInfo/IDMSTokenEndpointList	101
5.2.48V7/<x>/<x>/	OnNetwork/GroupServerInfo/IDMSTokenEndpointList/<x>	101
5.2.48V8/<x>/<x>/	OnNetwork/GroupServerInfo/IDMSTokenEndpointList/<x>/Entry	101
5.2.48V9	/<x>/<x>/OnNetwork/GroupServerInfo/IDMSTokenEndpointList/<x>/Entry/IDMSTokenID	102
5.2.48V10/<x>/<x>/	OnNetwork/GroupServerInfo/KMSURIList.....	102
5.2.48V11/<x>/<x>/	OnNetwork/GroupServerInfo/KMSURIList/<x>	102
5.2.48V12/<x>/<x>/	OnNetwork/GroupServerInfo/KMSURIList/<x>/Entry.....	102
5.2.48V13	/<x>/<x>/OnNetwork/GroupServerInfo/KMSURIList/<x>/Entry/KMSURI	103
5.2.48V14/<x>/<x>/	OnNetwork/GroupServerInfo/PresentationPriorityList	103
5.2.48V15/<x>/<x>/	OnNetwork/GroupServerInfo/PresentationPriorityList/<x>	103
5.2.48V16/<x>/<x>/	OnNetwork/GroupServerInfo/PresentationPriorityList/<x>/Entry	103
5.2.48V17	/<x>/<x>/OnNetwork/GroupServerInfo/PresentationPriority	103
5.2.48W1	/<x>/<x>/OnNetwork/AllowedRequestRemoteInitPrivateCall.....	104
5.2.48W2	/<x>/<x>/OnNetwork/AllowedRequestRemoteInitGroupCall.....	104
5.2.48W3	/<x>/<x>/OnNetwork/FunctionalAliasList	104
5.2.48W4	/<x>/<x>/OnNetwork/FunctionalAliasList/<x>	104
5.2.48W5	/<x>/<x>/OnNetwork/FunctionalAliasList/<x>/Entry	105
5.2.48W6	/<x>/<x>/OnNetwork/FunctionalAliasList/<x>/Entry/FunctionalAlias	105
5.2.48W6A	/<x>/<x>/OnNetwork/FunctionalAliasList/<x>/Entry/LocationCriteriaForActivation	105
5.2.48W6A1	/<x>/<x>/OnNetwork/FunctionalAliasList/<x>/Entry/LocationCriteriaForActivation/EnterSpecificArea	105
5.2.48W6A2	/<x>/<x>/OnNetwork/FunctionalAliasList/<x>/Entry/LocationCriteriaForActivation/EnterSpecificArea/PolygonArea	105
5.2.48W6A3	/<x>/<x>/OnNetwork/FunctionalAliasList/<x>/Entry/LocationCriteriaForActivation/EnterSpecificArea/PolygonArea/Corner	106
5.2.48W6A3A/<x>/<x>/OnNetwork/FunctionalAliasList/<x>/Entry/LocationCriteriaForActivation/EnterSpecificArea/PolygonArea/Corner/PointCoordinateType	106
5.2.48W6A4	/<x>/<x>/OnNetwork/FunctionalAliasList/<x>/Entry/LocationCriteriaForActivation/EnterSpecificArea/PolygonArea/Corner/PointCoordinateType/Longitude.....	106
5.2.48W6A5	/<x>/<x>/OnNetwork/FunctionalAliasList/<x>/Entry/LocationCriteriaForActivation/EnterSpecificArea/PolygonArea/Corner/PointCoordinateType/Latitude	107
5.2.48W6A6	/<x>/<x>/OnNetwork/FunctionalAliasList/<x>/Entry/LocationCriteriaForActivation/EnterSpecificArea/EllipsoidArcArea	107
5.2.48W6A7	/<x>/<x>/OnNetwork/FunctionalAliasList/<x>/Entry/LocationCriteriaForActivation/EnterSpecificArea/EllipsoidArcArea/Center.....	107
5.2.48W6A7A	/<x>/<x>/OnNetwork/FunctionalAliasList/<x>/Entry/LocationCriteriaForActivation/EnterSpecificArea/EllipsoidArcArea/Center/PointCoordinateType	107
5.2.48W6A8	/<x>/<x>/OnNetwork/FunctionalAliasList/<x>/Entry/LocationCriteriaForActivation/EnterSpecificArea/EllipsoidArcArea/Center/PointCoordinateType/Longitude	108
5.2.48W6A9	/<x>/<x>/OnNetwork/FunctionalAliasList/<x>/Entry/LocationCriteriaForActivation/EnterSpecificArea/EllipsoidArcArea/Center/PointCoordinateType/Latitude	108
5.2.48W6A10/<x>/<x>/	OnNetwork/FunctionalAliasList/<x>/Entry/LocationCriteriaForActivation/EnterSpecificArea/EllipsoidArcArea/Radius.....	108
5.2.48W6A11/<x>/<x>/	OnNetwork/FunctionalAliasList/<x>/Entry/LocationCriteriaForActivation/EnterSpecificArea/EllipsoidArcArea/OffsetAngle.....	109

5.2.48W6A12/<x>/<x>/OnNetwork/FunctionalAliasList/<x>/ Entry/LocationCriteriaForActivation/EnterSpecificArea/ EllipsoidArcArea/IncludedAngle.....	109	
5.2.48W6A12A /<x>/<x>/OnNetwork/FunctionalAliasList/<x>/Entry/LocationCriteriaForActivation/EnterSpecificArea /Speed	109	
5.2.48W6A12B /<x>/<x>/OnNetwork/FunctionalAliasList/<x>/Entry/LocationCriteriaForActivation/EnterSpecificArea /Speed/MinimumSpeed.....	110	
5.2.48W6A12C /<x>/<x>/OnNetwork/FunctionalAliasList/<x>/Entry/LocationCriteriaForActivation/EnterSpecificArea /Speed/MaximumSpeed	110	
5.2.48W6A12D /<x>/<x>/OnNetwork/FunctionalAliasList/<x>/Entry/LocationCriteriaForActivation/EnterSpecificArea /Heading.....	110	
5.2.48W6A12E/<x>/<x>/OnNetwork/FunctionalAliasList/<x>/Entry/LocationCriteriaForActivation/EnterSpecificArea/ Heading/MinimumHeading	111	
5.2.48W6A12F/<x>/<x>/OnNetwork/FunctionalAliasList/<x>/Entry/LocationCriteriaForActivation/EnterSpecificArea/ Heading/MaximumHeading.....	111	
5.2.48W6A13/<x>/<x>/OnNetwork/FunctionalAliasList/<x>/ Entry/LocationCriteriaForActivation/ExitSpecificArea	111	
5.2.48W6A14/<x>/<x>/OnNetwork/FunctionalAliasList/<x>/ Entry/LocationCriteriaForActivation/ExitSpecificArea/PolygonArea	111	
5.2.48W6A15/<x>/<x>/OnNetwork/FunctionalAliasList/<x>/ Entry/LocationCriteriaForActivation/ExitSpecificArea/PolygonArea/Corner	112	
5.2.48W6A15A	/<x>/<x>/OnNetwork/FunctionalAliasList/<x>/Entry/ LocationCriteriaForActivation/ExitSpecificArea/PolygonArea/ Corner/PointCoordinateType.....	112
5.2.48W6A16/<x>/<x>/OnNetwork/FunctionalAliasList/<x>/ Entry/LocationCriteriaForActivation/ExitSpecificArea/PolygonArea/Corner/PointCoordinateType/L ongitude	112	
5.2.48W6A17/<x>/<x>/OnNetwork/FunctionalAliasList/<x>/ Entry/LocationCriteriaForActivation/ExitSpecificArea/PolygonArea/ Corner/PointCoordinateType/Latitude.....	113	
5.2.48W6A18/<x>/<x>/OnNetwork/FunctionalAliasList/<x>/ Entry/LocationCriteriaForActivation/ExitSpecificArea/EllipsoidArcArea	113	
5.2.48W6A19/<x>/<x>/OnNetwork/FunctionalAliasList/<x>/ Entry/LocationCriteriaForActivation/ExitSpecificArea/EllipsoidArcArea/Center.....	113	
5.2.48W6A19A /<x>/<x>/OnNetwork/FunctionalAliasList/<x>/Entry/LocationCriteriaForActivation/ExitSpecificArea/ EllipsoidArcArea/Center/PointCoordinateType	113	
5.2.48W6A20/<x>/<x>/OnNetwork/FunctionalAliasList/<x>/ Entry/LocationCriteriaForActivation/ExitSpecificArea/EllipsoidArcArea/Center/PointCoordinateTy pe/Longitude	114	
5.2.48W6A21/<x>/<x>/OnNetwork/FunctionalAliasList/<x>/ Entry/LocationCriteriaForActivation/ExitSpecificArea/EllipsoidArcArea/Center/PointCoordinateTy pe/Latitude	114	
5.2.48W6A22/<x>/<x>/OnNetwork/FunctionalAliasList/<x>/ Entry/LocationCriteriaForActivation/ExitSpecificArea/EllipsoidArcArea/Radius	114	
5.2.48W6A23/<x>/<x>/OnNetwork/FunctionalAliasList/<x>/ Entry/LocationCriteriaForActivation/ExitSpecificArea/EllipsoidArcArea/OffsetAngle.....	115	
5.2.48W6A24/<x>/<x>/OnNetwork/FunctionalAliasList/<x>/ Entry/LocationCriteriaForActivation/ExitSpecificArea/EllipsoidArcArea/IncludedAngle.....	115	
5.2.48W6A24A	/<x>/<x>/OnNetwork/FunctionalAliasList/<x>/Entry/ LocationCriteriaForActivation/ExitSpecificArea/Speed	115
5.2.48W6A24B /<x>/<x>/OnNetwork/FunctionalAliasList/<x>/Entry/LocationCriteriaForActivation/ExitSpecificArea/ Speed/MinimumSpeed.....	115	
5.2.48W6A24C /<x>/<x>/OnNetwork/FunctionalAliasList/<x>/Entry/LocationCriteriaForActivation/ExitSpecificArea/ Speed/MaximumSpeed	116	
5.2.48W6A24D /<x>/<x>/OnNetwork/FunctionalAliasList/<x>/Entry/LocationCriteriaForActivation/ExitSpecificArea/ Heading.....	116	
5.2.48W6A24E. /<x>/<x>/OnNetwork/FunctionalAliasList/<x>/Entry/LocationCriteriaForActivation/ExitSpecificArea/ Heading/MinimumHeading	116	
5.2.48W6A24F. /<x>/<x>/OnNetwork/FunctionalAliasList/<x>/Entry/LocationCriteriaForActivation/ExitSpecificArea/ Heading/MaximumHeading.....	117	
5.2.48W6B /<x>/<x>/OnNetwork/FunctionalAliasList/<x>/ Entry/LocationCriteriaForDeactivation	117	
5.2.48W6B1 /<x>/<x>/OnNetwork/FunctionalAliasList/<x>/ Entry/LocationCriteriaForDeactivation/EnterSpecificArea.....	117	

5.2.48W6B2	/<x>/<x>/OnNetwork/FunctionalAliasList/<x>/ Entry/LocationCriteriaForDeactivation/EnterSpecificArea/PolygonArea.....	117
5.2.48W6B3	/<x>/<x>/OnNetwork/FunctionalAliasList/<x>/ Entry/LocationCriteriaForDeactivation/EnterSpecificArea/PolygonArea/Corner.....	118
5.2.48W6B3A	/<x>/<x>/OnNetwork/FunctionalAliasList/<x>/Entry/LocationCriteriaForDeactivation/EnterSpecificArea/ a/PolygonArea/Corner/PointCoordinateType	118
5.2.48W6B4	/<x>/<x>/OnNetwork/FunctionalAliasList/<x>/ Entry/LocationCriteriaForDeactivation/EnterSpecificArea/PolygonArea/Corner/PointCoordinateType/ e/Longitude	118
5.2.48W6B5	/<x>/<x>/OnNetwork/FunctionalAliasList/<x>/ Entry/LocationCriteriaForDeactivation/EnterSpecificArea/PolygonArea/Corner/PointCoordinateType/ e/Latitude	119
5.2.48W6B6	/<x>/<x>/OnNetwork/FunctionalAliasList/<x>/ Entry/LocationCriteriaForDeactivation/EnterSpecificArea/EllipsoidArcArea.....	119
5.2.48W6B7	/<x>/<x>/OnNetwork/FunctionalAliasList/<x>/ Entry/LocationCriteriaForDeactivation/EnterSpecificArea/EllipsoidArcArea/Center	119
5.2.48W6B7A	/<x>/<x>/OnNetwork/FunctionalAliasList/<x>/Entry/LocationCriteriaForDeactivation/EnterSpecificArea/ a/EllipsoidArcArea/Center/PointCoordinateType	119
5.2.48W6B8	/<x>/<x>/OnNetwork/FunctionalAliasList/<x>/ Entry/LocationCriteriaForDeactivation/EnterSpecificArea/EllipsoidArcArea/Center/PointCoordinate Type/Longitude.....	120
5.2.48W6B9	/<x>/<x>/OnNetwork/FunctionalAliasList/<x>/ Entry/LocationCriteriaForDeactivation/EnterSpecificArea/EllipsoidArcArea/Center/PointCoordinate Type/Latitude.....	120
5.2.48W6B10	/<x>/<x>/OnNetwork/FunctionalAliasList/<x>/ Entry/LocationCriteriaForDeactivation/EnterSpecificArea/ EllipsoidArcArea/Radius.....	120
5.2.48W6B11	/<x>/<x>/OnNetwork/FunctionalAliasList/<x>/ Entry/LocationCriteriaForDeactivation/EnterSpecificArea/EllipsoidArcArea/OffsetAngle	121
5.2.48W6B12	/<x>/<x>/OnNetwork/FunctionalAliasList/<x>/ Entry/LocationCriteriaForDeactivation/EnterSpecificArea/EllipsoidArcArea/IncludedAngle	121
5.2.48W6B12A	/<x>/<x>/OnNetwork/FunctionalAliasList/<x>/Entry/LocationCriteriaForDeactivation/EnterSpecificArea/ Speed.....	121
5.2.48W6B12B	/<x>/<x>/OnNetwork/FunctionalAliasList/<x>/Entry/LocationCriteriaForDeactivation/EnterSpecificArea/ Speed/MinimumSpeed	122
5.2.48W6B12C	/<x>/<x>/OnNetwork/FunctionalAliasList/<x>/Entry/LocationCriteriaForDeactivation/EnterSpecificArea/ Speed/MaximumSpeed	122
5.2.48W6B12D	/<x>/<x>/OnNetwork/FunctionalAliasList/<x>/Entry/LocationCriteriaForDeactivation/EnterSpecificArea/ Heading	122
5.2.48W6B12E	/<x>/<x>/OnNetwork/FunctionalAliasList/<x>/Entry/LocationCriteriaForDeactivation/EnterSpecificArea/ Heading/MinimumHeading.....	123
5.2.48W6B12F	/<x>/<x>/OnNetwork/FunctionalAliasList/<x>/Entry/LocationCriteriaForDeactivation/EnterSpecificArea/ Heading/MaximumHeading.....	123
5.2.48W6B13	/<x>/<x>/OnNetwork/FunctionalAliasList/<x>/ Entry/LocationCriteriaForDeactivation/ExitSpecificArea	123
5.2.48W6B14	/<x>/<x>/OnNetwork/FunctionalAliasList/<x>/ Entry/LocationCriteriaForDeactivation/ExitSpecificArea/PolygonArea.....	123
5.2.48W6B15	/<x>/<x>/OnNetwork/FunctionalAliasList/<x>/ Entry/LocationCriteriaForDeactivation/ExitSpecificArea/PolygonArea/Corner	124
5.2.48W6B15A	/<x>/<x>/OnNetwork/FunctionalAliasList/<x>/Entry/LocationCriteriaForDeactivation/ExitSpecificArea/ a/PolygonArea/Corner/PointCoordinateType	124
5.2.48W6B16	/<x>/<x>/OnNetwork/FunctionalAliasList/<x>/ Entry/LocationCriteriaForDeactivation/ExitSpecificArea/PolygonArea/Corner/PointCoordinateType /Longitude.....	124
5.2.48W6B17	/<x>/<x>/OnNetwork/FunctionalAliasList/<x>/ Entry/LocationCriteriaForDeactivation/ExitSpecificArea/PolygonArea/Corner/PointCoordinateType /Latitude.....	125
5.2.48W6B18	/<x>/<x>/OnNetwork/FunctionalAliasList/<x>/ Entry/LocationCriteriaForDeactivation/ExitSpecificArea/EllipsoidArcArea.....	125
5.2.48W6B19	/<x>/<x>/OnNetwork/FunctionalAliasList/<x>/ Entry/LocationCriteriaForDeactivation/ExitSpecificArea/EllipsoidArcArea/Center	125
5.2.48W6B19A	/<x>/<x>/OnNetwork/FunctionalAliasList/<x>/Entry/LocationCriteriaForDeactivation/ExitSpecificArea/ a/EllipsoidArcArea/Center/PointCoordinateType	125

5.2.48W6B20/<x>/<x>/OnNetwork/FunctionalAliasList/<x>/ Entry/LocationCriteriaForDeactivation/ExitSpecificArea/EllipsoidArcArea/Center/PointCoordinate Type/Longitude.....	126
5.2.48W6B21/<x>/<x>/OnNetwork/FunctionalAliasList/<x>/ Entry/LocationCriteriaForDeactivation/ExitSpecificArea/EllipsoidArcArea/Center/PointCoordinate Type/Latitude.....	126
5.2.48W6B22/<x>/<x>/OnNetwork/FunctionalAliasList/<x>/ Entry/LocationCriteriaForDeactivation/ExitSpecificArea/EllipsoidArcArea/Radius.....	126
5.2.48W6B23/<x>/<x>/OnNetwork/FunctionalAliasList/<x>/ Entry/LocationCriteriaForDeactivation/ExitSpecificArea/EllipsoidArcArea/OffsetAngle	127
5.2.48W6B24/<x>/<x>/OnNetwork/FunctionalAliasList/<x>/ Entry/LocationCriteriaForDeactivation/ExitSpecificArea/EllipsoidArcArea/IncludedAngle	127
5.2.48W6B24A /<x>/<x>/OnNetwork/FunctionalAliasList/<x>/Entry/LocationCriteriaForDeactivation/ExitSpecificArea/Speed.....	127
5.2.48W6B24B ./<x>/<x>/OnNetwork/FunctionalAliasList/<x>/Entry/LocationCriteriaForDeactivation/ExitSpecificArea/Speed/MinimumSpeed	128
5.2.48W6B24C ./<x>/<x>/OnNetwork/FunctionalAliasList/<x>/Entry/LocationCriteriaForDeactivation/ExitSpecificArea/Speed/MaximumSpeed	128
5.2.48W6B24D /<x>/<x>/OnNetwork/FunctionalAliasList/<x>/Entry/LocationCriteriaForDeactivation/ExitSpecificArea/Heading.....	128
5.2.48W6B24E ./<x>/<x>/OnNetwork/FunctionalAliasList/<x>/Entry/LocationCriteriaForDeactivation/ExitSpecificArea/Heading/MinimumHeading	129
5.2.48W6B24F/<x>/<x>/OnNetwork/FunctionalAliasList/<x>/Entry/LocationCriteriaForDeactivation/ExitSpecificArea/Heading/MaximumHeading.....	129
5.2.48W6C /<x>/<x>/OnNetwork/FunctionalAliasList/<x>/ Entry/ManualDeactivationNotAllowedIfLocationCriteriaMet	129
5.2.48W7 /<x>/<x>/OnNetwork/FunctionalAliasList/<x>/ Entry/DisplayName	129
5.2.48W7A /<x>/<x>/OnNetwork/FunctionalAliasList/<x>/ Entry/MaxSimultaneousEmergencyGroupCalls	130
5.2.48W8 /<x>/<x>/OnNetwork/AllowedQueryFunctionalAliasOtherUser	130
5.2.48W9 /<x>/<x>/OnNetwork/AllowedTakeoverFunctionalAliasOtherUser	130
5.2.48W10 /<x>/<x>/OnNetwork/AllowedLocationInfoWhenTalking.....	130
5.2.48X /<x>/<x>/OnNetwork/AuthorisedIncomingAny	131
5.2.48Y1 /<x>/<x>/OnNetwork/UserList.....	131
5.2.48Y2 /<x>/<x>/OnNetwork/UserList/<x>	131
5.2.48Y3 /<x>/<x>/OnNetwork/UserList/<x>/Entry	131
5.2.48Y4 /<x>/<x>/OnNetwork/UserList/<x>/Entry/MCPTTID.....	131
5.2.48Y5 /<x>/<x>/OnNetwork/UserList/<x>/Entry/PrivateCallKMSURI	132
5.2.48Z /<x>/<x>/OnNetwork/AuthorisedReceiveNonAcknowledged	132
5.2.49 /<x>/<x>/OffNetwork	132
5.2.50 /<x>/<x>/OffNetwork/Authorised	132
5.2.51 /<x>/<x>/OffNetwork/MCPTTGroupInfo	133
5.2.52 /<x>/<x>/OffNetwork/MCPTTGroupInfo/<x>	133
5.2.52A /<x>/<x>/OffNetwork/MCPTTGroupInfo/<x>/Entry	133
5.2.53 /<x>/<x>/OffNetwork/MCPTTGroupInfo/<x>/Entry/MCPTTGroupID.....	133
5.2.53A /<x>/<x>/OffNetwork/MCPTTGroupInfo/<x>/Entry/DisplayName.....	133
5.2.54 /<x>/<x>/OffNetwork/AllowedListen.....	133
5.2.55 /<x>/<x>/OffNetwork/AllowedTransmission	134
5.2.56 /<x>/<x>/OffNetwork/EmergencyCallChange	134
5.2.57 /<x>/<x>/OffNetwork/ImminentPerilCallChange	134
5.2.58 /<x>/<x>/OffNetwork/UserInfoID	134
5.2.58A1 /<x>/<x>/OffNetwork/GroupServerInfo	135
5.2.58A2 /<x>/<x>/OffNetwork/GroupServerInfo/GMSServList.....	135
5.2.58A3 /<x>/<x>/OffNetwork/GroupServerInfo/GMSServList/<x>	135
5.2.58A4 /<x>/<x>/OffNetwork/GroupServerInfo/GMSServList/<x>/Entry	135
5.2.58A5 /<x>/<x>/OffNetwork/GroupServerInfo/GMSServList/<x>/Entry/GMSServID	135
5.2.58A6/<x>/<x>/OffNetwork/GroupServerInfo/IDMSTokenEndpointList.....	136
5.2.58A7/<x>/<x>/OffNetwork/GroupServerInfo/IDMSTokenEndpointList/<x>	136
5.2.58A8/<x>/<x>/OffNetwork/GroupServerInfo/IDMSTokenEndpointList/<x>/Entry.....	136
5.2.58A9 /<x>/<x>/OffNetwork/GroupServerInfo/IDMSTokenEndpointList/<x>/Entry/IDMSTokenID.....	136
5.2.58A10/<x>/<x>/OffNetwork/GroupServerInfo/KMSURIList	137
5.2.58A11/<x>/<x>/OffNetwork/GroupServerInfo/KMSURIList/<x>	137
5.2.58A12/<x>/<x>/OffNetwork/GroupServerInfo/KMSURIList/<x>/Entry.....	137

5.2.58A13	/<x>/<x>/OffNetwork/GroupServerInfo/KMSURIList/<x>/Entry/KMSURI	137
5.2.58A14	/<x>/<x>/OffNetwork/GroupServerInfo/PresentationPriorityList	138
5.2.58A15	/<x>/<x>/OffNetwork/GroupServerInfo/PresentationPriorityList/<x>	138
5.2.58A16	/<x>/<x>/OffNetwork/GroupServerInfo/PresentationPriorityList/<x>/Entry	138
5.2.58A17	/<x>/<x>/OffNetwork/GroupServerInfo/PresentationPriority	138
5.2.59	/<x>/Status	138
6	MCS group configuration MO	139
6.1	General	139
6.2	MCS group configuration MO parameters	142
6.2.1	General	142
6.2.2	Node: <x>	142
6.2.3	/<x>/Name	143
6.2.4	/<x>/Ext/	143
6.2.5	/<x>/<x>	143
6.2.6	/<x>/<x>/Common	143
6.2.7	/<x>/<x>/Common/MCPTTGroupID	143
6.2.8	/<x>/<x>/Common/MCPTTGroupAlias	144
6.2.9	/<x>/<x>/Common/MCPTTGroupMemberList	144
6.2.10	/<x>/<x>/Common/MCPTTGroupMemberList/<x>	144
6.2.11	/<x>/<x>/Common/MCPTTGroupMemberList/<x>/MCPTTID	144
6.2.12	/<x>/<x>/Common/MCPTTGroupMemberList/<x>/UserPriority	144
6.2.13	/<x>/<x>/Common/MCPTTGroupMemberList/<x>/ParticipantType	145
6.2.14	Void	145
6.2.15	/<x>/<x>/Common/MCPTTGroupOwner	145
6.2.16	/<x>/<x>/Common/PreferredVoiceCodec	145
6.2.17	/<x>/<x>/Common/MCPTTGroupLevel	145
6.2.18	/<x>/<x>/Common/UserLevel	146
6.2.19	/<x>/<x>/Common/AllowedEmergencyCall	146
6.2.20	/<x>/<x>/Common/AllowedImminentPerilCall	146
6.2.21	/<x>/<x>/Common/AllowedEmergencyAlert	146
6.2.22	/<x>/<x>/Common/MediaProtectionRequired	147
6.2.23	/<x>/<x>/Common/FloorControlProtectionRequired	147
6.2.23A	/<x>/<x>/Common/MediaProtectionSecurityMaterial	147
6.2.23B	/<x>/<x>/Common/MCData	147
6.2.23C	/<x>/<x>/Common/MCData/MediaProtectionRequired	148
6.2.23D	/<x>/<x>/Common/MCData/TxControlProtectionRequired	148
6.2.23E	/<x>/<x>/Common/MCData/MediaProtectionSecurityMaterial	148
6.2.23F	/<x>/<x>/Common/MCData/AllowedSDS	148
6.2.23G	/<x>/<x>/Common/MCData/AllowedFD	149
6.2.23H	/<x>/<x>/Common/MCData/AllowedConvMgmt	149
6.2.23I	/<x>/<x>/Common/MCData/AllowedTxControl	149
6.2.23J	/<x>/<x>/Common/MCData/AllowedRxControl	149
6.2.23K	/<x>/<x>/Common/MCData/AllowedEnhSvc	149
6.2.23L	/<x>/<x>/Common/MCData/EnhSvcOpValues	150
6.2.23M	/<x>/<x>/Common/MCData/EnhSvcOpValues/<x>	150
6.2.23N	/<x>/<x>/Common/MCData/EnhSvcOpValues/<x>/EnhSvcOpValue	150
6.2.23NA	/<x>/<x>/Common/MCData/EnhSvcOpValues/<x>/EnhSvcOpID	150
6.2.23O	/<x>/<x>/Common/MCData/AllowedTransmitDataInGroup	150
6.2.23P	/<x>/<x>/Common/MCData/MaxDataSingleRequest	151
6.2.23Q	/<x>/<x>/Common/MCData/MaxTimeSingleRequest	151
6.2.23R	/<x>/<x>/Common/MCVideo	151
6.2.23S	/<x>/<x>/Common/MCVideo/MediaProtectionRequired	151
6.2.23T	/<x>/<x>/Common/MCVideo/TxControlProtectionRequired	152
6.2.23U	/<x>/<x>/Common/MCVideo/MediaProtectionSecurityMaterial	152
6.2.23V	/<x>/<x>/Common/MCVideo/AllowedAudioCodecs	152
6.2.23W	/<x>/<x>/Common/MCVideo/AllowedAudioCodecs/<x>	152
6.2.23X	/<x>/<x>/Common/MCVideo/AllowedAudioCodecs/<x>/AudioCodec	152
6.2.23Y	/<x>/<x>/Common/MCVideo/AllowedVideoCodecs	153
6.2.23Z	/<x>/<x>/Common/MCVideo/AllowedVideoCodecs/<x>	153
6.2.23AA	/<x>/<x>/Common/MCVideo/AllowedVideoCodecs/<x>/VideoCodec	153
6.2.23AB	/<x>/<x>/Common/MCVideo/AllowedVideoResolutions	153

6.2.23AC	/<x>/<x>/Common/MCVideo/AllowedVideoResolutions/<x>.....	153
6.2.23AD	/<x>/<x>/Common/MCVideo/AllowedVideoResolutions/<x>/VideoResolution.....	154
6.2.23AE	/<x>/<x>/Common/MCVideo/AllowedVideoFrameRates.....	154
6.2.23AF	/<x>/<x>/Common/MCVideo/AllowedVideoFrameRates/<x>.....	154
6.2.23AG	/<x>/<x>/Common/MCVideo/AllowedVideoFrameRates/<x>/FrameRate.....	154
6.2.23AH	/<x>/<x>/Common/MCVideo/AllowedUrgentRealTimeMode.....	154
6.2.23AI	/<x>/<x>/Common/MCVideo/AllowedNonUrgentRealTimeMode.....	155
6.2.23AJ	/<x>/<x>/Common/MCVideo/AllowedNonRealTimeMode.....	155
6.2.23AK	/<x>/<x>/Common/MCVideo/ActiveNonRealTimeMode.....	155
6.2.23AL	/<x>/<x>/Common/MCVideo/MaxTransmitMembers.....	155
6.2.24	/<x>/<x>/OffNetwork.....	156
6.2.25	/<x>/<x>/OffNetwork/MCPTTGroupParameter.....	156
6.2.26	/<x>/<x>/OffNetwork/MCPTTGroupParameter/<x>.....	156
6.2.27	/<x>/<x>/OffNetwork/MCPTTGroupParameter/<x>/ProSeLayer2GroupID.....	156
6.2.28	/<x>/<x>/OffNetwork/MCPTTGroupParameter/<x>/IPMulticastAddress.....	156
6.2.29	/<x>/<x>/OffNetwork/MCPTTGroupParameter/<x>/RelayServiceCode.....	157
6.2.30	/<x>/<x>/OffNetwork/MCPTTGroupParameter/<x>/IPVersions.....	157
6.2.31	/<x>/<x>/OffNetwork/EmergencyCallCancel.....	157
6.2.32	/<x>/<x>/OffNetwork/ImminentPerilCallCancel.....	157
6.2.33	/<x>/<x>/OffNetwork/HangTime.....	158
6.2.34	/<x>/<x>/OffNetwork/MaxDuration.....	158
6.2.34A	/<x>/<x>/OffNetwork/QueueUsage.....	158
6.2.35	/<x>/<x>/OffNetwork/DefaultPPPP.....	158
6.2.36	/<x>/<x>/OffNetwork/DefaultPPPP/MCPTTGroupCallSignalling.....	159
6.2.37	/<x>/<x>/OffNetwork/DefaultPPPP/MCPTTGroupCallMedia.....	159
6.2.38	/<x>/<x>/OffNetwork/DefaultPPPP/MCPTTEmergencyGroupCallSignalling.....	159
6.2.39	/<x>/<x>/OffNetwork/DefaultPPPP/MCPTTEmergencyGroupCallMedia.....	160
6.2.40	/<x>/<x>/OffNetwork/DefaultPPPP/MCPTTImminentPerilGroupCallSignalling.....	160
6.2.41	/<x>/<x>/OffNetwork/DefaultPPPP/MCPTTImminentPerilGroupCallMedia.....	160
6.2.42	/<x>/<x>/OffNetwork/MCData.....	161
6.2.43	/<x>/<x>/OffNetwork/MCData/DefaultPPPP.....	161
6.2.44	/<x>/<x>/OffNetwork/MCData/DefaultPPPP/MCDataGroupCallSignalling.....	161
6.2.45	/<x>/<x>/OffNetwork/MCData/DefaultPPPP/MCDataGroupCallMedia.....	161
6.2.46	/<x>/<x>/OffNetwork/MCVideo.....	162
6.2.47	/<x>/<x>/OffNetwork/MCVideo/ArbitrationApproach.....	162
6.2.48	/<x>/<x>/OffNetwork/MCVideo/MaxTransmissions.....	162
6.2.49	/<x>/<x>/OffNetwork/MCVideo/DefaultPPPP.....	162
6.2.50	/<x>/<x>/OffNetwork/MCVideo/DefaultPPPP/MCVideoGroupCallSignalling.....	162
6.2.51	/<x>/<x>/OffNetwork/MCVideo/DefaultPPPP/MCVideoGroupCallMedia.....	163
6.2.52	/<x>/<x>/OffNetwork/MCVideo/DefaultPPPP/MCVideoEmergencyGroupCallSignalling.....	163
6.2.53	/<x>/<x>/OffNetwork/MCVideo/DefaultPPPP/MCVideoEmergencyGroupCallMedia.....	163
6.2.54	/<x>/<x>/OffNetwork/MCVideo/DefaultPPPP/MCVideoImminentPerilGroupCallSignalling.....	164
6.2.55	/<x>/<x>/OffNetwork/MCVideo/DefaultPPPP/MCVideoImminentPerilGroupCallMedia.....	164
6.2.56	/<x>/<x>/OffNetwork/MCVideo/MaxDuration.....	164
6.2.57	/<x>/<x>/OffNetwork/MCVideo/EmergencyCallCancel.....	164
6.2.58	/<x>/<x>/OffNetwork/MCVideo/ImminentPerilCallCancel.....	165
7	MCPTT service configuration MO.....	165
7.1	General.....	165
7.2	MCPTT service configuration MO parameters.....	166
7.2.1	General.....	166
7.2.2	Node: <x>.....	166
7.2.3	/<x>/Name.....	167
7.2.4	/<x>/Ext/.....	167
7.2.5	/<x>/Common.....	167
7.2.6	/<x>/Common/BroadcastMCPTTGroupCall.....	167
7.2.7	/<x>/Common/BroadcastMCPTTGroupCall/NumLevelGroupHierarchy.....	167
7.2.8	/<x>/Common/BroadcastMCPTTGroupCall/NumLevelUserHierarchy.....	168
7.2.9	/<x>/Common/MinLengthAliasID.....	168
7.2.10	/<x>/OffNetwork.....	168
7.2.11	/<x>/OffNetwork/PrivateCall.....	168
7.2.12	/<x>/OffNetwork/PrivateCall/MaxDuration.....	168

7.2.13	/<x>/OffNetwork/PrivateCall/HangTime	169
7.2.14	/<x>/OffNetwork/PrivateCall/CancelTimeout	169
7.2.15	/<x>/OffNetwork/EmergencyCall	169
7.2.16	/<x>/OffNetwork/EmergencyCall/MCPTTGroupTimeout	169
7.2.17	/<x>/OffNetwork/NumLevelHierarchy	170
7.2.18	/<x>/OffNetwork/TransmitTimeout	170
7.2.19	/<x>/OffNetwork/TransmissionWarning	170
7.2.20	/<x>/OffNetwork/HangTimeWarning	170
7.2.21	/<x>/OffNetwork/DefaultPPPP	171
7.2.22	/<x>/OffNetwork/DefaultPPPP/MCPTTPrivateCallSignalling	171
7.2.23	/<x>/OffNetwork/DefaultPPPP/MCPTTPrivateCallMedia	171
7.2.24	/<x>/OffNetwork/DefaultPPPP/MCPTTEmergencyPrivateCallSignalling	171
7.2.25	/<x>/OffNetwork/DefaultPPPP/MCPTTEmergencyPrivateCallMedia	172
7.2.26	/<x>/OffNetwork/LogMetadata	172
8	MCS UE initial configuration MO	172
8.1	General	172
8.2	MCS UE initial configuration MO parameters	176
8.2.1	General	176
8.2.2	Node: <x>	176
8.2.3	/<x>/Name	177
8.2.4	/<x>/Ext/	177
8.2.5	/<x>/DefaultUserProfile	177
8.2.6	/<x>/DefaultUserProfile/UserID	177
8.2.7	/<x>/DefaultUserProfile/UserProfileIndex	178
8.2.8	/<x>/OnNetwork	178
8.2.9	/<x>/OnNetwork/GMSURI	178
8.2.9A	/<x>/OnNetwork/GroupCreationXUI	178
8.2.9B	/<x>/OnNetwork/GMSXCAPRootURI	178
8.2.9C	/<x>/OnNetwork/CMSXCAPRootURI	179
8.2.10	/<x>/OnNetwork/Timers	179
8.2.11	/<x>/OnNetwork/Timers/T100	179
8.2.12	/<x>/OnNetwork/Timers/T101	179
8.2.13	/<x>/OnNetwork/Timers/T103	179
8.2.14	/<x>/OnNetwork/Timers/T104	180
8.2.15	/<x>/OnNetwork/Timers/T132	180
8.2.16	/<x>/OnNetwork/HPLMN	180
8.2.17	/<x>/OnNetwork/HPLMN/PLMN	180
8.2.18	/<x>/OnNetwork/HPLMN/Service	181
8.2.19	/<x>/OnNetwork/HPLMN/Service/MCPTTToConRef	181
8.2.20	/<x>/OnNetwork/HPLMN/Service/MCPTTToConRef/<x>	181
8.2.21	/<x>/OnNetwork/HPLMN/Service/MCPTTToConRef/<x>/ConRef	181
8.2.22	/<x>/OnNetwork/HPLMN/Service/MCCCommonCoreToConRef	181
8.2.23	/<x>/OnNetwork/HPLMN/Service/MCCCommonCoreToConRef/<x>	181
8.2.24	/<x>/OnNetwork/HPLMN/Service/MCCCommonCoreToConRef/<x>/ConRef	182
8.2.25	/<x>/OnNetwork/HPLMN/Service/MCIDMToConRef	182
8.2.26	/<x>/OnNetwork/HPLMN/Service/MCIDMToConRef/<x>	182
8.2.27	/<x>/OnNetwork/HPLMN/Service/MCIDMToConRef/<x>/ConRef	182
8.2.28	/<x>/OnNetwork/HPLMN/VPLMN	182
8.2.29	/<x>/OnNetwork/HPLMN/VPLMN/PLMN	183
8.2.30	/<x>/OnNetwork/HPLMN/VPLMN/Service	183
8.2.31	/<x>/OnNetwork/HPLMN/VPLMN/Service/MCPTTToConRef	183
8.2.32	/<x>/OnNetwork/HPLMN/VPLMN/Service/MCPTTToConRef/<x>	183
8.2.33	/<x>/OnNetwork/HPLMN/VPLMN/Service/MCPTTToConRef/<x>/ConRef	183
8.2.34	/<x>/OnNetwork/HPLMN/VPLMN/Service/MCCCommonCoreToConRef	184
8.2.35	/<x>/OnNetwork/HPLMN/VPLMN/Service/MCCCommonCoreToConRef/<x>	184
8.2.36	/<x>/OnNetwork/HPLMN/VPLMN/Service/MCCCommonCoreToConRef/<x>/ConRef	184
8.2.37	/<x>/OnNetwork/HPLMN/VPLMN/Service/MCIDMToConRef	184
8.2.38	/<x>/OnNetwork/HPLMN/VPLMN/Service/MCIDMToConRef/<x>	185
8.2.39	/<x>/OnNetwork/HPLMN/VPLMN/Service/MCIDMToConRef/<x>/ConRef	185
8.2.40	/<x>/OnNetwork/AppServerInfo	185
8.2.41	/<x>/OnNetwork/AppServerInfo/IDMSAuthEndpoint	185

8.2.41A	/<x>/OnNetwork/AppServerInfo/IDMSTokenEndpoint	185
8.2.41B	/<x>/OnNetwork/AppServerInfo/HTTPProxy	186
8.2.42	/<x>/OnNetwork/AppServerInfo/GMS	186
8.2.43	/<x>/OnNetwork/AppServerInfo/CMS	186
8.2.44	/<x>/OnNetwork/AppServerInfo/KMS	186
8.2.44A	/<x>/OnNetwork/AppServerInfo/TLSTunnelAuthMethod	187
8.2.44B	/<x>/OnNetwork/AppServerInfo/TLSTunnelAuthMethod/Mutual	187
8.2.44C	/<x>/OnNetwork/AppServerInfo/TLSTunnelAuthMethod/X509	187
8.2.44D	/<x>/OnNetwork/AppServerInfo/TLSTunnelAuthMethod/Key	187
8.2.44E	/<x>/OnNetwork/IntegrityProtection	187
8.2.44F	/<x>/OnNetwork/ConfidentialityProtection	188
8.2.44G1	/<x>/OnNetwork/MCPTTServiceDetails	188
8.2.44G2	/<x>/OnNetwork/MCPTTServiceDetails/IPv6Required	188
8.2.44G3	/<x>/OnNetwork/MCPTTServiceDetails/ServerURI	188
8.2.44G4	/<x>/OnNetwork/MCVideoServiceDetails	189
8.2.44G5	/<x>/OnNetwork/MCVideoServiceDetails/IPv6Required	189
8.2.44G6	/<x>/OnNetwork/MCVideoServiceDetails/ServerURI	189
8.2.44G7	/<x>/OnNetwork/MCDataServiceDetails	189
8.2.44G8	/<x>/OnNetwork/MCDataServiceDetails/IPv6Required	190
8.2.44G9	/<x>/OnNetwork/MCDataServiceDetails/ServerURI	190
8.2.45	/<x>/OffNetwork	190
8.2.46	/<x>/OffNetwork/Timers	190
8.2.47	/<x>/OffNetwork/Timers/TFG1	190
8.2.48	/<x>/OffNetwork/Timers/TFG2	191
8.2.49	/<x>/OffNetwork/Timers/TFG3	191
8.2.50	/<x>/OffNetwork/Timers/TFG4	191
8.2.51	/<x>/OffNetwork/Timers/TFG5	191
8.2.52	/<x>/OffNetwork/Timers/TFG11	192
8.2.53	/<x>/OffNetwork/Timers/TFG12	192
8.2.54	/<x>/OffNetwork/Timers/TFG13	192
8.2.54A	/<x>/OffNetwork/Timers/TFG14	192
8.2.55	/<x>/OffNetwork/Timers/TFP1	193
8.2.56	/<x>/OffNetwork/Timers/TFP2	193
8.2.57	/<x>/OffNetwork/Timers/TFP3	193
8.2.58	/<x>/OffNetwork/Timers/TFP4	193
8.2.59	/<x>/OffNetwork/Timers/TFP5	194
8.2.60	/<x>/OffNetwork/Timers/TFP6	194
8.2.61	/<x>/OffNetwork/Timers/TFP7	194
8.2.61A	/<x>/OffNetwork/Timers/TFP9	194
8.2.62	/<x>/OffNetwork/Timers/TFB1	195
8.2.63	/<x>/OffNetwork/Timers/TFB2	195
8.2.64	/<x>/OffNetwork/Timers/TFB3	195
8.2.65	/<x>/OffNetwork/Timers/T201	195
8.2.66	/<x>/OffNetwork/Timers/T203	195
8.2.67	/<x>/OffNetwork/Timers/T204	196
8.2.68	/<x>/OffNetwork/Timers/T205	196
8.2.69	Void	196
8.2.70	/<x>/OffNetwork/Timers/T233	196
8.2.71	/<x>/OffNetwork/Timers/TFE1	196
8.2.72	/<x>/OffNetwork/Timers/TFE2	197
8.2.73	/<x>/OffNetwork/Counters	197
8.2.74	/<x>/OffNetwork/Counters/CFP1	197
8.2.75	/<x>/OffNetwork/Counters/CFP3	197
8.2.76	/<x>/OffNetwork/Counters/CFP4	198
8.2.77	/<x>/OffNetwork/Counters/CFP6	198
8.2.78	/<x>/OffNetwork/Counters/CFG11	198
8.2.79	/<x>/OffNetwork/Counters/CFG12	198
8.2.80	/<x>/OffNetwork/Counters/C201	198
8.2.81	/<x>/OffNetwork/Counters/C204	199
8.2.82	/<x>/OffNetwork/Counters/C205	199
9	MCDData UE configuration MO	199

9.1	General	199
9.2	MCDData UE configuration MO parameters.....	200
9.2.1	General.....	200
9.2.2	Node: <x>	201
9.2.3	/<x>/Name	201
9.2.4	/<x>/Ext/	201
9.2.5	/<x>/Common	201
9.2.6	/<x>/Common/MCDDataGroupTxns	201
9.2.7	/<x>/Common/MCDDataGroupTxns/MaxSDSNc4	202
9.2.8	/<x>/Common/MCDDataGroupTxns/SDSPresentationPriority	202
9.2.9	/<x>/Common/MCDDataGroupTxns/SDSPresentationPriority/<x>.....	202
9.2.10	/<x>/Common/MCDDataGroupTxns/SDSPresentationPriority/<x>/MCDDataGroupID	202
9.2.11	/<x>/Common/MCDDataGroupTxns/SDSPresentationPriority/ <x>/MCDDataGroupPriorityHierarchy....	202
9.2.12	/<x>/Common/MCDDataGroupTxns/MaxFDNc4	203
9.2.13	/<x>/Common/MCDDataGroupTxns/FDPresentationPriority	203
9.2.14	/<x>/Common/MCDDataGroupTxns/FDPresentationPriority/<x>.....	203
9.2.15	/<x>/Common/MCDDataGroupTxns/FDPresentationPriority/<x>/MCDDataGroupID.....	203
9.2.16	/<x>/Common/MCDDataGroupTxns/FDPresentationPriority/ <x>/MCDDataGroupPriorityHierarchy	204
9.2.17	/<x>/Common/MCDDataGroupTxns/ConversationPresentationPriority	204
9.2.18	/<x>/Common/MCDDataGroupTxns/ConversationPresentationPriority/<x>.....	204
9.2.19	/<x>/Common/MCDDataGroupTxns/ConversationPresentationPriority/<x>/MCDDataGroupID.....	204
9.2.20	/<x>/Common/MCDDataGroupTxns/ ConversationPresentationPriority/<x>/MCDDataGroupPriorityHierarchy	205
9.2.21	/<x>/Common/MCDDataGroupTxns/MaxTCNc4	205
9.2.22	/<x>/Common/MCDDataGroupTxns/MaxTCNc5	205
9.2.23	/<x>/Common/MCDDataGroupTxns/DataPresentationPriority	205
9.2.24	/<x>/Common/MCDDataGroupTxns/DataPresentationPriority/<x>	205
9.2.25	/<x>/Common/MCDDataGroupTxns/DataPresentationPriority/<x>/MCDDataGroupID	206
9.2.26	/<x>/Common/MCDDataGroupTxns/DataPresentationPriority/ <x>/MCDDataGroupPriorityHierarchy ...	206
9.2.27	/<x>/Common/MCDDataGroupTxns/MaxRCNc4	206
9.2.28	/<x>/Common/MCDDataGroupTxns/MaxRCNc5	206
9.2.29	/<x>/OnNetwork	207
9.2.30	/<x>/OnNetwork/RelayService.....	207
9.2.31	/<x>/OnNetwork/IPv6Preferred.....	207
9.2.32	/<x>/OnNetwork/RelayedMCDDataGroup	207
9.2.33	/<x>/OnNetwork/RelayedMCDDataGroup/<x>.....	207
9.2.34	/<x>/OnNetwork/RelayedMCDDataGroup/<x>/MCDDataGroupID	208
9.2.35	/<x>/OnNetwork/RelayedMCDDataGroup/<x>/RelayServiceCode	208
10	MCDData user profile MO	208
10.1	General	208
10.2	MCDData user profile MO parameters	211
10.2.1	General.....	211
10.2.2	Node: <x>	211
10.2.3	/<x>/Name	212
10.2.4	/<x>/Ext/	212
10.2.5	/<x>/<x>	212
10.2.6	/<x>/<x>/Common	212
10.2.7	/<x>/<x>/Common/MCDDataUserID	212
10.2.8	/<x>/<x>/Common/MCDDataUserProfileIndex.....	213
10.2.9	/<x>/<x>/Common/MCDDataUserProfileName	213
10.2.9A	/<x>/<x>/Common/MCDDataUserIDKMSURI	213
10.2.10	/<x>/<x>/Common/PreSelectedIndication.....	213
10.2.11	/<x>/<x>/Common/UserAliases	214
10.2.12	/<x>/<x>/Common/UserAliases/<x>.....	214
10.2.13	/<x>/<x>/Common/UserAliases/<x>UserAlias	214
10.2.14	/<x>/<x>/Common/AuthorisedAlias.....	214
10.2.15	/<x>/<x>/Common/ParticipantType	214
10.2.16	/<x>/<x>/Common/Organization.....	215
10.2.16A	/<x>/<x>/Common/OnetoOne	215
10.2.16B	/<x>/<x>/Common/OnetoOne/UserList	215
10.2.16C	/<x>/<x>/Common/OnetoOne/UserList/<x>.....	215

10.2.16D	/<x>/<x>/Common/OnetoOne/UserList/<x>/Entry	215
10.2.16E	/<x>/<x>/Common/OnetoOne/UserList/<x>/Entry/MCDataID	216
10.2.16F	/<x>/<x>/Common/OnetoOne/UserList/<x>/Entry/DiscoveryGroupID	216
10.2.16G	/<x>/<x>/Common/OnetoOne/UserList/<x>/Entry/UserInfoID	216
10.2.16H	/<x>/<x>/Common/OnetoOne/UserList/<x>/Entry/MCDataIDKMSURI	216
10.2.16I	/<x>/<x>/Common/OnetoOne/UserList/<x>/Entry/DisplayName	216
10.2.16J	/<x>/<x>/Common/OnetoOne/UserList/<x>/Entry/IPInformation	217
10.2.16K	/<x>/<x>/Common/OnetoOne/UserList/<x>/Entry/IPInformation/<x>	217
10.2.16L	/<x>/<x>/Common/OnetoOne/UserList/<x>/Entry/IPInformation/<x>Entry	217
10.2.16M	/<x>/<x>/Common/OnetoOne/UserList/<x>/Entry/IPInformation/<x>Entry/IPv4Information	217
10.2.16N	/<x>/<x>/Common/OnetoOne/UserList/<x>/Entry/IPInformation/<x>Entry/IPv6Information	218
10.2.16O	/<x>/<x>/Common/OnetoOne/UserList/<x>/Entry/IPInformation/<x>Entry/FQDN	218
10.2.17	/<x>/<x>/Common/FileDistribution	218
10.2.18	/<x>/<x>/Common/FileDistribution/CancelList	218
10.2.19	/<x>/<x>/Common/FileDistribution/CancelList/<x>	219
10.2.20	/<x>/<x>/Common/FileDistribution/CancelList/<x>Entry	219
10.2.21	/<x>/<x>/Common/FileDistribution/CancelList/<x>Entry/MCDataID	219
10.2.21A	/<x>/<x>/Common/FileDistribution/CancelList/<x>Entry/MCDataIDKMSURI	219
10.2.22	/<x>/<x>/Common/FileDistribution/CancelList/<x>Entry/DisplayName	219
10.2.23	/<x>/<x>/Common/TxRxControl	220
10.2.24	/<x>/<x>/Common/TxRxControl/AuthorisedTransmit	220
10.2.25	/<x>/<x>/Common/TxRxControl/MaxData1To1	220
10.2.26	/<x>/<x>/Common/TxRxControl/MaxTime1To1	220
10.2.27	/<x>/<x>/Common/TxRxControl/ReleaseList	221
10.2.28	/<x>/<x>/Common/TxRxControl/ReleaseList/<x>	221
10.2.29	/<x>/<x>/Common/TxRxControl/ReleaseList/<x>Entry	221
10.2.30	/<x>/<x>/Common/TxRxControl/ReleaseList/<x>Entry/MCDataID	221
10.2.31	/<x>/<x>/Common/TxRxControl/ReleaseList/<x>Entry/DisplayName	221
10.2.32	/<x>/<x>/Common/MCDataGroupBroadcast	222
10.2.33	/<x>/<x>/Common/MCDataGroupBroadcast/Authorised	222
10.2.34	/<x>/<x>/Common/UserBroadcast	222
10.2.35	/<x>/<x>/Common/UserBroadcast/Authorised	222
10.2.36	/<x>/<x>/Common/GroupEmergencyAlert	222
10.2.37	/<x>/<x>/Common/GroupEmergencyAlert/Entry	223
10.2.38	/<x>/<x>/Common/GroupEmergencyAlert/Entry/ID	223
10.2.39	/<x>/<x>/Common/GroupEmergencyAlert/Entry/DisplayName	223
10.2.40	/<x>/<x>/Common/GroupEmergencyAlert/Entry/Usage	223
10.2.41	/<x>/<x>/Common/AllowedActivateAlert	223
10.2.42	/<x>/<x>/Common/AllowedCancelAlert	224
10.2.43	/<x>/<x>/OnNetwork	224
10.2.44	/<x>/<x>/OnNetwork/MCDataGroupList	224
10.2.45	/<x>/<x>/OnNetwork/MCDataGroupList/<x>	224
10.2.46	/<x>/<x>/OnNetwork/MCDataGroupList/<x>Entry	224
10.2.47	/<x>/<x>/OnNetwork/MCDataGroupList/<x>Entry/MCDataGroupID	225
10.2.48	/<x>/<x>/OnNetwork/MCDataGroupList/<x>Entry/DisplayName	225
10.2.49	/<x>/<x>/OnNetwork/MCDataGroupList/<x>Entry/GMSAppServList	225
10.2.50	/<x>/<x>/OnNetwork/MCDataGroupList/<x>Entry/GMSAppServList/<x>	225
10.2.51	/<x>/<x>/OnNetwork/MCDataGroupList/<x>Entry/GMSAppServList/<x>/GMSAppServId	225
10.2.52	/<x>/<x>/OnNetwork/MCDataGroupList/<x>Entry/IdMSTokenEndPointList	226
10.2.53	/<x>/<x>/OnNetwork/MCDataGroupList/<x>Entry/IdMSTokenEndPointList/<x>	226
10.2.54	/<x>/<x>/OnNetwork/MCDataGroupList/<x>Entry/ IdMSTokenEndPointList/<x>/IdMSTokenEndPoint	226
10.2.54A	/<x>/<x>/OnNetwork/MCDataGroupList/<x>Entry/ MCDataGroupIDKMSURI	226
10.2.55	/<x>/<x>/OnNetwork/MCDataGroupList/<x>Entry/ PresentationPriority	227
10.2.55A	/<x>/<x>/OnNetwork/MCDataGroupList/<x>Entry/ RulesForAffiliation	227
10.2.55A1	/<x>/<x>/OnNetwork/MCDataGroupList/<x>Entry/ RulesForAffiliation/ListOfLocationCriteria/	227
10.2.55A2	/<x>/<x>/OnNetwork/MCDataGroupList/<x>Entry/ RulesForAffiliation/ListOfLocationCriteria/<x>	227
10.2.55A3	/<x>/<x>/OnNetwork/MCDataGroupList/<x>Entry/ RulesForAffiliation/ListOfLocationCriteria/<x>Entry	228
10.2.55A4	/<x>/<x>/OnNetwork/MCDataGroupList/<x>Entry/ RulesForAffiliation/ListOfLocationCriteria/<x>Entry/ EnterSpecificArea	228

10.2.55A5	/<x>/<x>/OnNetwork/MCDataGroupList/<x>/Entry/ RulesForAffiliation/ListOfLocationCriteria/<x>/Entry/ EnterSpecificArea/PolygonArea	228
10.2.55A6	/<x>/<x>/OnNetwork/MCDataGroupList/<x>/Entry/ RulesForAffiliation/ListOfLocationCriteria/<x>/Entry/ EnterSpecificArea/PolygonArea/Corner	228
10.2.55A7	/<x>/<x>/OnNetwork/MCDataGroupList/<x>/Entry/ RulesForAffiliation/ListOfLocationCriteria/<x>/Entry/ EnterSpecificArea/PolygonArea/Corner/PointCoordinateType	229
10.2.55A8	/<x>/<x>/OnNetwork/MCDataGroupList/<x>/Entry/ RulesForAffiliation/ListOfLocationCriteria/<x>/Entry/ EnterSpecificArea/PolygonArea/Corner/PointCoordinateType/ Longitude	229
10.2.55A9	/<x>/<x>/OnNetwork/MCDataGroupList/<x>/Entry/ RulesForAffiliation/ListOfLocationCriteria/<x>/Entry/ EnterSpecificArea/PolygonArea/Corner/PointCoordinateType/ Latitude	229
10.2.55A10	/<x>/<x>/OnNetwork/MCDataGroupList/<x>/Entry/ RulesForAffiliation/ListOfLocationCriteria/<x>/Entry/ EnterSpecificArea/EllipsoidArcArea	230
10.2.55A11	/<x>/<x>/OnNetwork/MCDataGroupList/<x>/Entry/ RulesForAffiliation/ListOfLocationCriteria/<x>/Entry/ EnterSpecificArea/EllipsoidArcArea/Center ...	230
10.2.55A12	/<x>/<x>/OnNetwork/MCDataGroupList/<x>/Entry/ RulesForAffiliation/ListOfLocationCriteria/<x>/Entry/ EnterSpecificArea/EllipsoidArcArea/Center/PointCoordinateType	230
10.2.55A13	/<x>/<x>/OnNetwork/MCDataGroupList/<x>/Entry/ RulesForAffiliation/ListOfLocationCriteria/<x>/Entry/ EnterSpecificArea/EllipsoidArcArea/Center/PointCoordinateType/ Longitude	231
10.2.55A14	/<x>/<x>/OnNetwork/MCDataGroupList/<x>/Entry/ RulesForAffiliation/ListOfLocationCriteria/<x>/Entry/ EnterSpecificArea/EllipsoidArcArea/Center/PointCoordinateType/ Latitude	231
10.2.55A15	/<x>/<x>/OnNetwork/MCDataGroupList/<x>/Entry/ RulesForAffiliation/ListOfLocationCriteria/<x>/Entry/ EnterSpecificArea/EllipsoidArcArea/Radius ...	231
10.2.55A16	/<x>/<x>/OnNetwork/MCDataGroupList/<x>/Entry/ RulesForAffiliation/ListOfLocationCriteria/<x>/Entry/ EnterSpecificArea/EllipsoidArcArea/OffsetAngle	232
10.2.55A17	/<x>/<x>/OnNetwork/MCDataGroupList/<x>/Entry/ RulesForAffiliation/ListOfLocationCriteria/<x>/Entry/ EnterSpecificArea/EllipsoidArcArea/IncludedAngle	232
10.2.55A18	/<x>/<x>/OnNetwork/MCDataGroupList/<x>/Entry/ RulesForAffiliation/ListOfLocationCriteria/<x>/Entry/ EnterSpecificArea/Speed	232
10.2.55A19	/<x>/<x>/OnNetwork/MCDataGroupList/<x>/Entry/ RulesForAffiliation/ListOfLocationCriteria/<x>/Entry/ EnterSpecificArea/Speed/MinimumSpeed	233
10.2.55A20	/<x>/<x>/OnNetwork/MCDataGroupList/<x>/Entry/ RulesForAffiliation/ListOfLocationCriteria/<x>/Entry/ EnterSpecificArea/Speed/MaximumSpeed	233
10.2.55A21	/<x>/<x>/OnNetwork/MCDataGroupList/<x>/Entry/ RulesForAffiliation/ListOfLocationCriteria/<x>/Entry/ EnterSpecificArea/Heading	233
10.2.55A22	/<x>/<x>/OnNetwork/MCDataGroupList/<x>/Entry/ RulesForAffiliation/ListOfLocationCriteria/<x>/Entry/ EnterSpecificArea/Heading/MinimumHeading	234
10.2.55A23	/<x>/<x>/OnNetwork/MCDataGroupList/<x>/Entry/ RulesForAffiliation/ListOfLocationCriteria/<x>/Entry/ EnterSpecificArea/Heading/MaximumHeading	234
10.2.55A24	/<x>/<x>/OnNetwork/MCDataGroupList/<x>/Entry/ RulesForAffiliation/ListOfLocationCriteria/<x>/Entry/ ExitSpecificArea	234
10.2.55A25	/<x>/<x>/OnNetwork/MCDataGroupList/<x>/Entry/ RulesForAffiliation/ListOfLocationCriteria/<x>/Entry/ ExitSpecificArea/PolygonArea	235
10.2.55A26	/<x>/<x>/OnNetwork/MCDataGroupList/<x>/Entry/ RulesForAffiliation/ListOfLocationCriteria/<x>/Entry/ ExitSpecificArea/PolygonArea/Corner	235
10.2.55A27	/<x>/<x>/OnNetwork/MCDataGroupList/<x>/Entry/ RulesForAffiliation/ListOfLocationCriteria/<x>/Entry/ ExitSpecificArea/PolygonArea/Corner/PointCoordinateType	235
10.2.55A28	/<x>/<x>/OnNetwork/MCDataGroupList/<x>/Entry/ RulesForAffiliation/ListOfLocationCriteria/<x>/Entry/ ExitSpecificArea/PolygonArea/Corner/PointCoordinateType/ Longitude	236

10.2.55A29	/<x>/<x>/OnNetwork/MCDataGroupList/<x>/Entry/ RulesForAffiliation/ListOfLocationCriteria/<x>/Entry/ ExitSpecificArea/PolygonArea/Corner/PointCoordinateType/ Latitude	236
10.2.55A30	/<x>/<x>/OnNetwork/MCDataGroupList/<x>/Entry/ RulesForAffiliation/ListOfLocationCriteria/<x>/Entry/ ExitSpecificArea/EllipsoidArcArea	236
10.2.55A31	/<x>/<x>/OnNetwork/MCDataGroupList/<x>/Entry/ RulesForAffiliation/ListOfLocationCriteria/<x>/Entry/ ExitSpecificArea/EllipsoidArcArea/Center	237
10.2.55A32	/<x>/<x>/OnNetwork/MCDataGroupList/<x>/Entry/ RulesForAffiliation/ListOfLocationCriteria/<x>/Entry/ ExitSpecificArea/EllipsoidArcArea/Center/PointCoordinateType	237
10.2.55A33	/<x>/<x>/OnNetwork/MCDataGroupList/<x>/Entry/ RulesForAffiliation/ListOfLocationCriteria/<x>/Entry/ ExitSpecificArea/EllipsoidArcArea/Center/PointCoordinateType/ Longitude	237
10.2.55A34	/<x>/<x>/OnNetwork/MCDataGroupList/<x>/Entry/ RulesForAffiliation/ListOfLocationCriteria/<x>/Entry/ ExitSpecificArea/EllipsoidArcArea/Center/PointCoordinateType/ Latitude	238
10.2.55A35	/<x>/<x>/OnNetwork/MCDataGroupList/<x>/Entry/ RulesForAffiliation/ListOfLocationCriteria/<x>/Entry/ ExitSpecificArea/EllipsoidArcArea/Radius	238
10.2.55A36	/<x>/<x>/OnNetwork/MCDataGroupList/<x>/Entry/ RulesForAffiliation/ListOfLocationCriteria/<x>/Entry/ ExitSpecificArea/EllipsoidArcArea/OffsetAngle	238
10.2.55A37	/<x>/<x>/OnNetwork/MCDataGroupList/<x>/Entry/ RulesForAffiliation/ListOfLocationCriteria/<x>/Entry/ ExitSpecificArea/EllipsoidArcArea/IncludedAngle	239
10.2.55A38	/<x>/<x>/OnNetwork/MCDataGroupList/<x>/Entry/ RulesForAffiliation/ListOfLocationCriteria/<x>/Entry/ ExitSpecificArea/Speed	239
10.2.55A39	/<x>/<x>/OnNetwork/MCDataGroupList/<x>/Entry/ RulesForAffiliation/ListOfLocationCriteria/<x>/Entry/ ExitSpecificArea/Speed/MinimumSpeed	239
10.2.55A40	/<x>/<x>/OnNetwork/MCDataGroupList/<x>/Entry/ RulesForAffiliation/ListOfLocationCriteria/<x>/Entry/ ExitSpecificArea/Speed/MaximumSpeed	240
10.2.55A41	/<x>/<x>/OnNetwork/MCDataGroupList/<x>/Entry/ RulesForAffiliation/ListOfLocationCriteria/<x>/Entry/ ExitSpecificArea/Heading	240
10.2.55A42	/<x>/<x>/OnNetwork/MCDataGroupList/<x>/Entry/ RulesForAffiliation/ListOfLocationCriteria/<x>/Entry/ ExitSpecificArea/Heading/MinimumHeading	240
10.2.55A43	/<x>/<x>/OnNetwork/MCDataGroupList/<x>/Entry/ RulesForAffiliation/ListOfLocationCriteria/<x>/Entry/ ExitSpecificArea/Heading/MaximumHeading	241
10.2.55A44	/<x>/<x>/OnNetwork/MCDataGroupList/<x>/Entry/ RulesForAffiliation/ListOfActiveFunctionalAliases	241
10.2.55A45	/<x>/<x>/OnNetwork/MCDataGroupList/<x>/Entry/ RulesForAffiliation/ListOfActiveFunctionalAliases/<x>	241
10.2.55A46	/<x>/<x>/OnNetwork/MCDataGroupList/<x>/Entry/ RulesForAffiliation/ListOfActiveFunctionalAliasesCriteria/<x>/Entry	241
10.2.55A47	/<x>/<x>/OnNetwork/MCDataGroupList/<x>/Entry/ RulesForAffiliation/ListOfActiveFunctionalAliases/<x>/Entry/ FunctionalAlias	242
10.2.55B	/<x>/<x>/OnNetwork/MCDataGroupList/<x>/Entry/ RulesForDeaffiliation	242
10.2.55B1	/<x>/<x>/OnNetwork/MCDataGroupList/<x>/Entry/ RulesForDeaffiliation/ListOfLocationCriteria/	242
10.2.55B2	/<x>/<x>/OnNetwork/MCDataGroupList/<x>/Entry/ RulesForDeaffiliation/ListOfLocationCriteria/<x>	242
10.2.55B3	/<x>/<x>/OnNetwork/MCDataGroupList/<x>/Entry/ RulesForDeaffiliation/ListOfLocationCriteria/<x>/Entry	243
10.2.55B4	/<x>/<x>/OnNetwork/MCDataGroupList/<x>/Entry/ RulesForDeaffiliation/ListOfLocationCriteria/<x>/Entry/ EnterSpecificArea	243
10.2.55B5	/<x>/<x>/OnNetwork/MCDataGroupList/<x>/Entry/ RulesForDeaffiliation/ListOfLocationCriteria/<x>/Entry/ EnterSpecificArea/PolygonArea	243
10.2.55B6	/<x>/<x>/OnNetwork/MCDataGroupList/<x>/Entry/ RulesForDeaffiliation/ListOfLocationCriteria/<x>/Entry/ EnterSpecificArea/PolygonArea/Corner	243
10.2.55B7	/<x>/<x>/OnNetwork/MCDataGroupList/<x>/Entry/ RulesForDeaffiliation/ListOfLocationCriteria/<x>/Entry/ EnterSpecificArea/PolygonArea/Corner/PointCoordinateType	244

10.2.55B8	/<x>/<x>/OnNetwork/MCDataGroupList/<x>/Entry/ RulesForDeaffiliation/ListOfLocationCriteria/<x>/Entry/ EnterSpecificArea/PolygonArea/Corner/PointCoordinateType/ Longitude	244
10.2.55B9	/<x>/<x>/OnNetwork/MCDataGroupList/<x>/Entry/ RulesForDeaffiliation/ListOfLocationCriteria/<x>/Entry/ EnterSpecificArea/PolygonArea/Corner/PointCoordinateType/ Latitude	244
10.2.55B10	/<x>/<x>/OnNetwork/MCDataGroupList/<x>/Entry/ RulesForDeaffiliation/ListOfLocationCriteria/<x>/Entry/ EnterSpecificArea/EllipsoidArcArea.....	245
10.2.55B11	/<x>/<x>/OnNetwork/MCDataGroupList/<x>/Entry/ RulesForDeaffiliation/ListOfLocationCriteria/<x>/Entry/ EnterSpecificArea/EllipsoidArcArea/Center	245
10.2.55B12	/<x>/<x>/OnNetwork/MCDataGroupList/<x>/Entry/ RulesForDeaffiliation/ListOfLocationCriteria/<x>/Entry/ EnterSpecificArea/EllipsoidArcArea/Center/PointCoordinateType.....	245
10.2.55B13	/<x>/<x>/OnNetwork/MCDataGroupList/<x>/Entry/ RulesForDeaffiliation/ListOfLocationCriteria/<x>/Entry/ EnterSpecificArea/EllipsoidArcArea/Center/PointCoordinateType/ Longitude	246
10.2.55B14	/<x>/<x>/OnNetwork/MCDataGroupList/<x>/Entry/ RulesForDeaffiliation/ListOfLocationCriteria/<x>/Entry/ EnterSpecificArea/EllipsoidArcArea/Center/PointCoordinateType/ Latitude	246
10.2.55B15	/<x>/<x>/OnNetwork/MCDataGroupList/<x>/Entry/ RulesForDeaffiliation/ListOfLocationCriteria/<x>/Entry/ EnterSpecificArea/EllipsoidArcArea/Radius.....	246
10.2.55B16	/<x>/<x>/OnNetwork/MCDataGroupList/<x>/Entry/ RulesForDeaffiliation/ListOfLocationCriteria/<x>/Entry/ EnterSpecificArea/EllipsoidArcArea/OffsetAngle	247
10.2.55B17	/<x>/<x>/OnNetwork/MCDataGroupList/<x>/Entry/ RulesForDeaffiliation/ListOfLocationCriteria/<x>/Entry/ EnterSpecificArea/EllipsoidArcArea/IncludedAngle	247
10.2.55B18	/<x>/<x>/OnNetwork/MCDataGroupList/<x>/Entry/ RulesFordeaffiliation/ListOfLocationCriteria/<x>/Entry /EnterSpecificArea/Speed.....	247
10.2.55B19	/<x>/<x>/OnNetwork/MCDataGroupList/<x>/Entry/ RulesForDeaffiliation/ListOfLocationCriteria/<x>/Entry/ EnterSpecificArea/Speed/MinimumSpeed ...	248
10.2.55B20	/<x>/<x>/OnNetwork/MCDataGroupList/<x>/Entry/ RulesForDeaffiliation/ListOfLocationCriteria/<x>/Entry/ EnterSpecificArea/Speed/MaximumSpeed...	248
10.2.55B21	/<x>/<x>/OnNetwork/MCDataGroupList/<x>/Entry/ RulesForDeaffiliation/ListOfLocationCriteria/<x>/Entry/ EnterSpecificArea/Heading	248
10.2.55B22	/<x>/<x>/OnNetwork/MCDataGroupList/<x>/Entry/ RulesForDeaffiliation/ListOfLocationCriteria/<x>/Entry/ EnterSpecificArea/Heading/MinimumHeading	249
10.2.55B23	/<x>/<x>/OnNetwork/MCDataGroupList/<x>/Entry/ RulesForDeaffiliation/ListOfLocationCriteria/<x>/Entry/ EnterSpecificArea/Heading/MaximumHeading	249
10.2.55B24	/<x>/<x>/OnNetwork/MCDataGroupList/<x>/Entry/ RulesForDeaffiliation/ListOfLocationCriteria/<x>/Entry/ ExitSpecificArea.....	249
10.2.55B25	/<x>/<x>/OnNetwork/MCDataGroupList/<x>/Entry/ RulesForDeaffiliation/ListOfLocationCriteria/<x>/Entry/ ExitSpecificArea/PolygonArea.....	250
10.2.55B26	/<x>/<x>/OnNetwork/MCDataGroupList/<x>/Entry/ RulesForDeaffiliation/ListOfLocationCriteria/<x>/Entry/ ExitSpecificArea/PolygonArea/Corner.....	250
10.2.55B27	/<x>/<x>/OnNetwork/MCDataGroupList/<x>/Entry/ RulesForDeaffiliation/ListOfLocationCriteria/<x>/Entry/ ExitSpecificArea/PolygonArea/Corner/PointCoordinateType	250
10.2.55B28	/<x>/<x>/OnNetwork/MCDataGroupList/<x>/Entry/ RulesForDeaffiliation/ListOfLocationCriteria/<x>/Entry/ ExitSpecificArea/PolygonArea/Corner/PointCoordinateType/ Longitude	251
10.2.55B29	/<x>/<x>/OnNetwork/MCDataGroupList/<x>/Entry/ RulesForDeaffiliation/ListOfLocationCriteria/<x>/Entry/ ExitSpecificArea/PolygonArea/Corner/PointCoordinateType/ Latitude	251
10.2.55B30	/<x>/<x>/OnNetwork/MCDataGroupList/<x>/Entry/ RulesForDeaffiliation/ListOfLocationCriteria/<x>/Entry/ ExitSpecificArea/EllipsoidArcArea.....	251
10.2.55B31	/<x>/<x>/OnNetwork/MCDataGroupList/<x>/Entry/ RulesForDeaffiliation/ListOfLocationCriteria/<x>/Entry/ ExitSpecificArea/EllipsoidArcArea/Center ..	252

10.2.55B32	/<x>/<x>/OnNetwork/MCDataGroupList/<x>/Entry/ RulesForDeaffiliation/ListOfLocationCriteria/<x>/Entry/ ExitSpecificArea/EllipsoidArcArea/Center/PointCoordinateType.....	252
10.2.55B33	/<x>/<x>/OnNetwork/MCDataGroupList/<x>/Entry/ RulesForDeaffiliation/ListOfLocationCriteria/<x>/Entry/ ExitSpecificArea/EllipsoidArcArea/Center/PointCoordinateType/ Longitude	252
10.2.55B34	/<x>/<x>/OnNetwork/MCDataGroupList/<x>/Entry/ RulesForDeaffiliation/ListOfLocationCriteria/<x>/Entry/ /ExitSpecificArea/EllipsoidArcArea/Center/PointCoordinateType/ Latitude	253
10.2.55B35	/<x>/<x>/OnNetwork/MCDataGroupList/<x>/Entry/ RulesForDeaffiliation/ListOfLocationCriteria/<x>/Entry/ ExitSpecificArea/EllipsoidArcArea/Radius.....	253
10.2.55B36	/<x>/<x>/OnNetwork/MCDataGroupList/<x>/Entry/ RulesForDeaffiliation/ListOfLocationCriteria/<x>/Entry/ ExitSpecificArea/EllipsoidArcArea/OffsetAngle	253
10.2.55B37	/<x>/<x>/OnNetwork/MCDataGroupList/<x>/Entry/ RulesForDeaffiliation/ListOfLocationCriteria/<x>/Entry/ ExitSpecificArea/EllipsoidArcArea/IncludedAngle	254
10.2.55B38	/<x>/<x>/OnNetwork/MCDataGroupList/<x>/Entry/ RulesForDeaffiliation/ListOfLocationCriteria/<x>/Entry/ ExitSpecificArea/Speed	254
10.2.55B39	/<x>/<x>/OnNetwork/MCDataGroupList/<x>/Entry/ RulesForDeaffiliation/ListOfLocationCriteria/<x>/Entry/ ExitSpecificArea/Speed/MinimumSpeed	254
10.2.55B40	/<x>/<x>/OnNetwork/MCDataGroupList/<x>/Entry/ RulesForDeaffiliation/ListOfLocationCriteria/<x>/Entry/ ExitSpecificArea/Speed/MaximumSpeed.....	255
10.2.55B41	/<x>/<x>/OnNetwork/MCDataGroupList/<x>/Entry/ RulesForDeaffiliation/ListOfLocationCriteria/<x>/Entry/ ExitSpecificArea/Heading	255
10.2.55B42	/<x>/<x>/OnNetwork/MCDataGroupList/<x>/Entry/ RulesForDeaffiliation/ListOfLocationCriteria/<x>/Entry/ ExitSpecificArea/Heading/MinimumHeading	255
10.2.55B43	/<x>/<x>/OnNetwork/MCDataGroupList/<x>/Entry/ RulesForDeaffiliation/ListOfLocationCriteria/<x>/Entry/ ExitSpecificArea/Heading/MaximumHeading	256
10.2.55B44	/<x>/<x>/OnNetwork/MCDataGroupList/<x>/Entry/ RulesForDeaffiliation/ListOfActiveFunctionalAliases.....	256
10.2.55B45	/<x>/<x>/OnNetwork/MCDataGroupList/<x>/Entry/ RulesForDeaffiliation/ListOfActiveFunctionalAliases/<x>	256
10.2.55B46	/<x>/<x>/OnNetwork/MCDataGroupList/<x>/Entry/ RulesForDeaffiliation/ListOfActiveFunctionalAliases/<x>/Entry	256
10.2.55B47	/<x>/<x>/OnNetwork/MCDataGroupList/<x>/Entry/ RulesForDeaffiliation/ListOfActiveFunctionalAliases/<x>/Entry/ FunctionalAlias.....	257
10.2.55B48	/<x>/<x>/OnNetwork/MCDataGroupList/<x>/Entry/ ManualDeAffiliationNotAllowedIfAffiliationRulesAreMet	257
10.2.56	/<x>/<x>/OnNetwork/ImplicitAffiliations.....	257
10.2.57	/<x>/<x>/OnNetwork/ImplicitAffiliations/<x>	257
10.2.58	/<x>/<x>/OnNetwork/ImplicitAffiliations/<x>/Entry	257
10.2.59	/<x>/<x>/OnNetwork/ImplicitAffiliations/<x>/Entry/MCDataGroupID	258
10.2.60	/<x>/<x>/OnNetwork/ImplicitAffiliations/<x>/Entry/DisplayName	258
10.2.61	/<x>/<x>/OnNetwork/PresenceStatus	258
10.2.62	/<x>/<x>/OnNetwork/PresenceStatus/<x>.....	258
10.2.63	/<x>/<x>/OnNetwork/PresenceStatus/<x>/Entry	258
10.2.64	/<x>/<x>/OnNetwork/PresenceStatus/<x>/Entry/MCDataID	259
10.2.65	/<x>/<x>/OnNetwork/PresenceStatus/<x>/Entry/DisplayName.....	259
10.2.66	/<x>/<x>/OnNetwork/RemoteGroupChange	259
10.2.67	/<x>/<x>/OnNetwork/RemoteGroupChange/<x>.....	259
10.2.68	/<x>/<x>/OnNetwork/RemoteGroupChange/<x>/Entry	259
10.2.69	/<x>/<x>/OnNetwork/RemoteGroupChange/<x>/Entry/MCDataID	259
10.2.70	/<x>/<x>/OnNetwork/RemoteGroupChange/<x>/Entry/DisplayName.....	260
10.2.71	/<x>/<x>/OnNetwork/MaxAffiliationsN2	260
10.2.72	/<x>/<x>/OnNetwork/ConversationManagement.....	260
10.2.73	/<x>/<x>/OnNetwork/ConversationManagement/GroupHangTime	260
10.2.74	/<x>/<x>/OnNetwork/ConversationManagement/GroupHangTime/<x>.....	260
10.2.75	/<x>/<x>/OnNetwork/ConversationManagement/GroupHangTime/<x>/Entry.....	261

10.2.76	/<x>/<x>/OnNetwork/ConversationManagement/GroupHangTime/<x>/Entry/MCDataGroupID	261
10.2.77	/<x>/<x>/OnNetwork/ConversationManagement/GroupHangTime/<x>/Entry/DisplayName	261
10.2.78	/<x>/<x>/OnNetwork/ConversationManagement/GroupHangTime/<x>/Entry/HangTime	261
10.2.79	/<x>/<x>/OnNetwork/ConversationManagement/DeliveredDisposition	262
10.2.80	/<x>/<x>/OnNetwork/ConversationManagement/DeliveredDisposition/<x>	262
10.2.81	/<x>/<x>/OnNetwork/ConversationManagement/DeliveredDisposition/<x>/Entry	262
10.2.82	/<x>/<x>/OnNetwork/ConversationManagement/DeliveredDisposition/<x>/Entry/MCDataID	262
10.2.83	/<x>/<x>/OnNetwork/ConversationManagement/DeliveredDisposition/<x>/Entry/DisplayName	263
10.2.84	/<x>/<x>/OnNetwork/ConversationManagement/ReadDisposition	263
10.2.85	/<x>/<x>/OnNetwork/ConversationManagement/ReadDisposition/<x>	263
10.2.86	/<x>/<x>/OnNetwork/ConversationManagement/ReadDisposition/<x>/Entry	263
10.2.87	/<x>/<x>/OnNetwork/ConversationManagement/ReadDisposition/<x>/Entry/MCDataID	263
10.2.88	/<x>/<x>/OnNetwork/ConversationManagement/ReadDisposition/<x>/Entry/DisplayName	264
10.2.89	/<x>/<x>/OnNetwork/OneToOneEmergencyAlert	264
10.2.90	/<x>/<x>/OnNetwork/OneToOneEmergencyAlert/Entry	264
10.2.91	/<x>/<x>/OnNetwork/OneToOneEmergencyAlert/Entry/ID	264
10.2.92	/<x>/<x>/OnNetwork/OneToOneEmergencyAlert/Entry/DisplayName	264
10.2.93	/<x>/<x>/OnNetwork/OneToOneEmergencyAlert/Entry/Usage	265
10.2.94	/<x>/<x>/OnNetwork/AllowedRegroup	265
10.2.95	/<x>/<x>/OnNetwork/AllowedPresenceStatus	265
10.2.96	/<x>/<x>/OnNetwork/AllowedPresence	265
10.2.97	/<x>/<x>/OnNetwork/AllowedManualSwitch	266
10.2.97A	/<x>/<x>/OnNetwork/MCDataContentServerURI	266
10.2.97B	/<x>/<x>/OnNetwork/FunctionalAliasList	266
10.2.97B1	/<x>/<x>/OnNetwork/FunctionalAliasList/<x>	266
10.2.97B2	/<x>/<x>/OnNetwork/FunctionalAliasList/<x>/Entry	266
10.2.97B3	/<x>/<x>/OnNetwork/FunctionalAliasList/<x>/Entry/FunctionalAlias	267
10.2.97B3A	/<x>/<x>/OnNetwork/FunctionalAliasList/<x>/Entry/DisplayName	267
10.2.97B3B	/<x>/<x>/OnNetwork/FunctionalAliasList/<x>/Entry/LocationCriteriaForActivation	267
10.2.97B3B1	/<x>/<x>/OnNetwork/FunctionalAliasList/<x>/Entry/ LocationCriteriaForActivation/EnterSpecificArea	267
10.2.97B3B2	/<x>/<x>/OnNetwork/FunctionalAliasList/<x>/Entry/ LocationCriteriaForActivation/EnterSpecificArea/PolygonArea	268
10.2.97B3B3	/<x>/<x>/OnNetwork/FunctionalAliasList/<x>/Entry/ LocationCriteriaForActivation/EnterSpecificArea/PolygonArea/Corner	268
10.2.97B3B4	/<x>/<x>/OnNetwork/FunctionalAliasList/<x>/Entry/ LocationCriteriaForActivation/EnterSpecificArea/PolygonArea/Corner/PointCoordinateType	268
10.2.97B3B5	/<x>/<x>/OnNetwork/FunctionalAliasList/<x>/Entry/ LocationCriteriaForActivation/EnterSpecificArea/PolygonArea/ Corner/PointCoordinateType/Longitude	269
10.2.97B3B6	/<x>/<x>/OnNetwork/FunctionalAliasList/<x>/Entry/ LocationCriteriaForActivation/EnterSpecificArea/PolygonArea/ Corner/PointCoordinateType/Latitude	269
10.2.97B3B7	/<x>/<x>/OnNetwork/FunctionalAliasList/<x>/Entry/ LocationCriteriaForActivation/EnterSpecificArea/EllipsoidArcArea	269
10.2.97B3B8	/<x>/<x>/OnNetwork/FunctionalAliasList/<x>/Entry/ LocationCriteriaForActivation/EnterSpecificArea/EllipsoidArcArea/Center	270
10.2.97B3B9	/<x>/<x>/OnNetwork/FunctionalAliasList/<x>/Entry/ LocationCriteriaForActivation/EnterSpecificArea/EllipsoidArcArea/Center/PointCoordinateType	270
10.2.97B3B10	/<x>/<x>/OnNetwork/FunctionalAliasList/<x>/Entry/ LocationCriteriaForActivation/EnterSpecificArea/EllipsoidArcArea/ Center/PointCoordinateType/Longitude	270
10.2.97B3B11	/<x>/<x>/OnNetwork/FunctionalAliasList/<x>/Entry/ LocationCriteriaForActivation/EnterSpecificArea/EllipsoidArcArea/ Center/PointCoordinateType/Latitude	271
10.2.97B3B12	/<x>/<x>/OnNetwork/FunctionalAliasList/<x>/Entry/ LocationCriteriaForActivation/EnterSpecificArea/EllipsoidArcArea/Radius	271
10.2.97B3B13	/<x>/<x>/OnNetwork/FunctionalAliasList/<x>/Entry/ LocationCriteriaForActivation/EnterSpecificArea/EllipsoidArcArea/OffsetAngle	271
10.2.97B3B14	/<x>/<x>/OnNetwork/FunctionalAliasList/<x>/Entry/ LocationCriteriaForActivation/EnterSpecificArea/EllipsoidArcArea/IncludedAngle	272

10.2.97B3B15 /<x>/<x>/OnNetwork/FunctionalAliasList/<x>/Entry/ LocationCriteriaForActivation/EnterSpecificArea/Speed	272
10.2.97B3B16 /<x>/<x>/OnNetwork/FunctionalAliasList/<x>/Entry/ LocationCriteriaForActivation/EnterSpecificArea/Speed/ MinimumSpeed	272
10.2.97B3B17 /<x>/<x>/OnNetwork/FunctionalAliasList/<x>/Entry/ LocationCriteriaForActivation/EnterSpecificArea/Speed/ MaximumSpeed	273
10.2.97B3B18 /<x>/<x>/OnNetwork/FunctionalAliasList/<x>/Entry/ LocationCriteriaForActivation/EnterSpecificArea/Heading.....	273
10.2.97B3B19 /<x>/<x>/OnNetwork/FunctionalAliasList/<x>/Entry/ LocationCriteriaForActivation/EnterSpecificArea/Heading/ MinimumHeading	273
10.2.97B3B20 /<x>/<x>/OnNetwork/FunctionalAliasList/<x>/Entry/ LocationCriteriaForActivation/EnterSpecificArea/Heading/ MaximumHeading.....	274
10.2.97B3B21 /<x>/<x>/OnNetwork/FunctionalAliasList/<x>/Entry/ LocationCriteriaForActivation/ExitSpecificArea	274
10.2.97B3B22 /<x>/<x>/OnNetwork/FunctionalAliasList/<x>/ Entry/LocationCriteriaForActivation/ExitSpecificArea/PolygonArea	274
10.2.97B3B23 /<x>/<x>/OnNetwork/FunctionalAliasList/<x>/Entry/ LocationCriteriaForActivation/ExitSpecificArea/PolygonArea/ Corner	274
10.2.97B3B24 /<x>/<x>/OnNetwork/FunctionalAliasList/<x>/Entry/ LocationCriteriaForActivation/ExitSpecificArea/PolygonArea/ Corner/PointCoordinateType.....	275
10.2.97B3B25 /<x>/<x>/OnNetwork/FunctionalAliasList/<x>/Entry/ LocationCriteriaForActivation/ExitSpecificArea/PolygonArea/ Corner/PointCoordinateType/Longitude	275
10.2.97B3B26 /<x>/<x>/OnNetwork/FunctionalAliasList/<x>/Entry/L ocationCriteriaForActivation/ExitSpecificArea/PolygonArea/ Corner/PointCoordinateType/Latitude ...	275
10.2.97B3B27 /<x>/<x>/OnNetwork/FunctionalAliasList/<x>/Entry/ LocationCriteriaForActivation/ExitSpecificArea/EllipsoidArcArea	276
10.2.97B3B28 /<x>/<x>/OnNetwork/FunctionalAliasList/<x>/Entry/ LocationCriteriaForActivation/ExitSpecificArea/EllipsoidArcArea/ Center	276
10.2.97B3B29 /<x>/<x>/OnNetwork/FunctionalAliasList/<x>/Entry/ LocationCriteriaForActivation/ExitSpecificArea/EllipsoidArcArea/ Center/PointCoordinateType	276
10.2.97B3B30 /<x>/<x>/OnNetwork/FunctionalAliasList/<x>/Entry/ LocationCriteriaForActivation/ExitSpecificArea/EllipsoidArcArea/ Center/PointCoordinateType/Longitude	277
10.2.97B3B31 /<x>/<x>/OnNetwork/FunctionalAliasList/<x>/Entry/ LocationCriteriaForActivation/ExitSpecificArea/EllipsoidArcArea/ Center/PointCoordinateType/Latitude	277
10.2.97B3B32 /<x>/<x>/OnNetwork/FunctionalAliasList/<x>/Entry/ LocationCriteriaForActivation/ExitSpecificArea/EllipsoidArcArea/ Radius	277
10.2.97B3B33 /<x>/<x>/OnNetwork/FunctionalAliasList/<x>/Entry/ LocationCriteriaForActivation/ExitSpecificArea/EllipsoidArcArea/ OffsetAngle	278
10.2.97B3B34 /<x>/<x>/OnNetwork/FunctionalAliasList/<x>/Entry/ LocationCriteriaForActivation/ExitSpecificArea/EllipsoidArcArea/ IncludedAngle	278
10.2.97B3B35 /<x>/<x>/OnNetwork/FunctionalAliasList/<x>/Entry/ LocationCriteriaForActivation/ExitSpecificArea/Speed	278
10.2.97B3B36 /<x>/<x>/OnNetwork/FunctionalAliasList/<x>/Entry/ LocationCriteriaForActivation/ExitSpecificArea/Speed/ MinimumSpeed.....	279
10.2.97B3B37 /<x>/<x>/OnNetwork/FunctionalAliasList/<x>/Entry/ LocationCriteriaForActivation/ExitSpecificArea/Speed/ MaximumSpeed	279
10.2.97B3B38 /<x>/<x>/OnNetwork/FunctionalAliasList/<x>/Entry/ LocationCriteriaForActivation/ExitSpecificArea/Heading.....	279
10.2.97B3B39 /<x>/<x>/OnNetwork/FunctionalAliasList/<x>/Entry/ LocationCriteriaForActivation/ExitSpecificArea/Heading/ MinimumHeading	280
10.2.97B3B40 /<x>/<x>/OnNetwork/FunctionalAliasList/<x>/Entry/ LocationCriteriaForActivation/ExitSpecificArea/Heading/ MaximumHeading.....	280
10.2.97B3C /<x>/<x>/OnNetwork/FunctionalAliasList/<x>/Entry/ LocationCriteriaForDeactivation	280
10.2.97B3C1 /<x>/<x>/OnNetwork/FunctionalAliasList/<x>/Entry/ LocationCriteriaForDeactivation/EnterSpecificArea.....	281
10.2.97B3C2 /<x>/<x>/OnNetwork/FunctionalAliasList/<x>/Entry/ LocationCriteriaForDeactivation/EnterSpecificArea/PolygonArea.....	281
10.2.97B3C3 /<x>/<x>/OnNetwork/FunctionalAliasList/<x>/Entry/ LocationCriteriaForDeactivation/EnterSpecificArea/PolygonArea/ Corner.....	281

10.2.97B3C4	/<x>/<x>/OnNetwork/FunctionalAliasList/<x>/Entry/ LocationCriteriaForDeactivation/EnterSpecificArea/PolygonArea/ Corner/PointCoordinateType	281
10.2.97B3C5	/<x>/<x>/OnNetwork/FunctionalAliasList/<x>/Entry/ LocationCriteriaForDeactivation/EnterSpecificArea/PolygonArea/ Corner/PointCoordinateType/Longitude	282
10.2.97B3C6	/<x>/<x>/OnNetwork/FunctionalAliasList/<x>/Entry/ LocationCriteriaForDeactivation/EnterSpecificArea/PolygonArea/ Corner/PointCoordinateType/Latitude.....	282
10.2.97B3C7	/<x>/<x>/OnNetwork/FunctionalAliasList/<x>/Entry/ LocationCriteriaForDeactivation/EnterSpecificArea/EllipsoidArcArea.....	282
10.2.97B3C8	/<x>/<x>/OnNetwork/FunctionalAliasList/<x>/Entry/ LocationCriteriaForDeactivation/EnterSpecificArea/EllipsoidArcArea/ Center	283
10.2.97B3C9	/<x>/<x>/OnNetwork/FunctionalAliasList/<x>/Entry/ LocationCriteriaForDeactivation/EnterSpecificArea/EllipsoidArcArea/ Center/PointCoordinateType...	283
10.2.97B3C10	/<x>/<x>/OnNetwork/FunctionalAliasList/<x>/Entry/ LocationCriteriaForDeactivation/EnterSpecificArea/EllipsoidArcArea/ Center/PointCoordinateType/Longitude	283
10.2.97B3C11	/<x>/<x>/OnNetwork/FunctionalAliasList/<x>/Entry/ LocationCriteriaForDeactivation/EnterSpecificArea/EllipsoidArcArea/ Center/PointCoordinateType/Latitude	284
10.2.97B3C12	/<x>/<x>/OnNetwork/FunctionalAliasList/<x>/Entry/ LocationCriteriaForDeactivation/EnterSpecificArea/EllipsoidArcArea/ Radius.....	284
10.2.97B3C13	/<x>/<x>/OnNetwork/FunctionalAliasList/<x>/Entry/ LocationCriteriaForDeactivation/EnterSpecificArea/EllipsoidArcArea/ OffsetAngle	284
10.2.97B3C14	/<x>/<x>/OnNetwork/FunctionalAliasList/<x>/Entry/ LocationCriteriaForDeactivation/EnterSpecificArea/EllipsoidArcArea/ IncludedAngle	285
10.2.97B3C15	/<x>/<x>/OnNetwork/FunctionalAliasList/<x>/Entry/ LocationCriteriaForDeactivation/EnterSpecificArea/Speed	285
10.2.97B3C16	/<x>/<x>/OnNetwork/FunctionalAliasList/<x>/Entry/ LocationCriteriaForDeactivation/EnterSpecificArea/Speed/ MinimumSpeed	285
10.2.97B3C17	/<x>/<x>/OnNetwork/FunctionalAliasList/<x>/Entry/ LocationCriteriaForDeactivation/EnterSpecificArea/Speed/ MaximumSpeed.....	286
10.2.97B3C18	/<x>/<x>/OnNetwork/FunctionalAliasList/<x>/Entry/ LocationCriteriaForDeactivation/EnterSpecificArea/Heading	286
10.2.97B3C19	/<x>/<x>/OnNetwork/FunctionalAliasList/<x>/Entry/ LocationCriteriaForDeactivation/EnterSpecificArea/Heading/ MinimumHeading.....	286
10.2.97B3C20	/<x>/<x>/OnNetwork/FunctionalAliasList/<x>/Entry/ LocationCriteriaForDeactivation/EnterSpecificArea/Heading/ MaximumHeading	287
10.2.97B3C21	/<x>/<x>/OnNetwork/FunctionalAliasList/<x>/Entry/ LocationCriteriaForDeactivation/ExitSpecificArea.....	287
10.2.97B3C22	/<x>/<x>/OnNetwork/FunctionalAliasList/<x>/Entry/ LocationCriteriaForDeactivation/ExitSpecificArea/PolygonArea.....	287
10.2.97B3C23	/<x>/<x>/OnNetwork/FunctionalAliasList/<x>/Entry/ LocationCriteriaForDeactivation/ExitSpecificArea/PolygonArea/ Corner.....	288
10.2.97B3C24	/<x>/<x>/OnNetwork/FunctionalAliasList/<x>/Entry/ LocationCriteriaForDeactivation/ExitSpecificArea/PolygonArea/ Corner/PointCoordinateType	288
10.2.97B3C25	/<x>/<x>/OnNetwork/FunctionalAliasList/<x>/Entry/ LocationCriteriaForDeactivation/ExitSpecificArea/PolygonArea/ Corner/PointCoordinateType/Longitude	288
10.2.97B3C26	/<x>/<x>/OnNetwork/FunctionalAliasList/<x>/Entry/ LocationCriteriaForDeactivation/ExitSpecificArea/PolygonArea/ Corner/PointCoordinateType/Latitude.....	289
10.2.97B3C27	/<x>/<x>/OnNetwork/FunctionalAliasList/<x>/Entry/ LocationCriteriaForDeactivation/ExitSpecificArea/EllipsoidArcArea.....	289
10.2.97B3C28	/<x>/<x>/OnNetwork/FunctionalAliasList/<x>/Entry/ LocationCriteriaForDeactivation/ExitSpecificArea/EllipsoidArcArea/ Center	289
10.2.97B3C29	/<x>/<x>/OnNetwork/FunctionalAliasList/<x>/Entry/ LocationCriteriaForDeactivation/ExitSpecificArea/EllipsoidArcArea/ Center/PointCoordinateType.....	290
10.2.97B3C30	/<x>/<x>/OnNetwork/FunctionalAliasList/<x>/Entry/ LocationCriteriaForDeactivation/ExitSpecificArea/EllipsoidArcArea/ Center/PointCoordinateType/Longitude	290

10.2.97B3C31	<x>/<x>/OnNetwork/FunctionalAliasList/<x>/Entry/ LocationCriteriaForDeactivation/ExitSpecificArea/EllipsoidArcArea/ Center/PointCoordinateType/Latitude	290
10.2.97B3C32	<x>/<x>/OnNetwork/FunctionalAliasList/<x>/Entry/ LocationCriteriaForDeactivation/ExitSpecificArea/EllipsoidArcArea/ Radius.....	291
10.2.97B3C33	<x>/<x>/OnNetwork/FunctionalAliasList/<x>/Entry/ LocationCriteriaForDeactivation/ExitSpecificArea/EllipsoidArcArea/ OffsetAngle	291
10.2.97B3C34	<x>/<x>/OnNetwork/FunctionalAliasList/<x>/Entry/ LocationCriteriaForDeactivation/ExitSpecificArea/EllipsoidArcArea/ IncludedAngle	291
10.2.97B3C35	<x>/<x>/OnNetwork/FunctionalAliasList/<x>/Entry/ LocationCriteriaForDeactivation/ExitSpecificArea/Speed	292
10.2.97B3C36	<x>/<x>/OnNetwork/FunctionalAliasList/<x>/Entry/ LocationCriteriaForDeactivation/ExitSpecificArea/Speed/ MinimumSpeed	292
10.2.97B3C37	<x>/<x>/OnNetwork/FunctionalAliasList/<x>/Entry/ LocationCriteriaForDeactivation/ExitSpecificArea/Speed/ MaximumSpeed.....	292
10.2.97B3C38	<x>/<x>/OnNetwork/FunctionalAliasList/<x>/Entry/ LocationCriteriaForDeactivation/ExitSpecificArea/Heading	293
10.2.97B3C39	<x>/<x>/OnNetwork/FunctionalAliasList/<x>/Entry/ LocationCriteriaForDeactivation/ExitSpecificArea/Heading/ MinimumHeading.....	293
10.2.97B3C40	<x>/<x>/OnNetwork/FunctionalAliasList/<x>/Entry/ LocationCriteriaForDeactivation/ExitSpecificArea/Heading/ MaximumHeading	293
10.2.97B3D	<x>/<x>/OnNetwork/FunctionalAliasList/<x>/Entry/ ManualDeactivationNotAllowedIfLocationCriteriaMet.....	294
10.2.97C	<x>/<x>/OnNetwork/AllowedQueryFunctionalAliasOtherUser.....	294
10.2.97D	<x>/<x>/OnNetwork/AllowedTakeoverFunctionalAliasOtherUser.....	294
10.2.97E	<x>/<x>/OnNetwork/MessageStoreHostname	294
10.2.97F	<x>/<x>/OnNetwork/AuthorisedIncomingAny	295
10.2.97G	<x>/<x>/OnNetwork/IncomingUserList.....	295
10.2.97G1	<x>/<x>/OnNetwork/IncomingUserList/<x>	295
10.2.97G2	<x>/<x>/OnNetwork/IncomingUserList/<x>/Entry	295
10.2.97G3	<x>/<x>/OnNetwork/IncomingUserList/<x>/Entry/MCDataID	295
10.2.97G4	<x>/<x>/OnNetwork/IncomingUserList/<x>/Entry/MCDataDKMSURI.....	296
10.2.98	<x>/<x>/OffNetwork	296
10.2.99	<x>/<x>/OffNetwork/Authorised	296
10.2.100	<x>/<x>/OffNetwork/MCDataGroupList	296
10.2.101	<x>/<x>/OffNetwork/MCDataGroupList/<x>	296
10.2.102	<x>/<x>/OffNetwork/MCDataGroupList/<x>/Entry	297
10.2.103	<x>/<x>/OffNetwork/MCDataGroupList/<x>/Entry/MCDataGroupID	297
10.2.104	<x>/<x>/OffNetwork/MCDataGroupList/<x>/Entry/DisplayName.....	297
10.2.105	<x>/<x>/OffNetwork/MCDataGroupList/<x>/Entry/GMSAppServList.....	297
10.2.106	<x>/<x>/OffNetwork/MCDataGroupList/<x>/>/Entry/GMSAppServList/<x>	297
10.2.107	<x>/<x>/OffNetwork/MCDataGroupList/<x>/Entry/GMSAppServList/<x>/GMSAppServId.....	298
10.2.108	<x>/<x>/OffNetwork/MCDataGroupList/<x>/Entry/IdMSTokenEndPointList	298
10.2.109	<x>/<x>/OffNetwork/MCDataGroupList/<x>/Entry/IdMSTokenEndPointList/<x>	298
10.2.110	<x>/<x>/OffNetwork/MCDataGroupList/<x>/Entry/ IdMSTokenEndPointList/<x>/IdMSTokenEndPoint	298
10.2.110A	<x>/<x>/OffNetwork/MCDataGroupList/<x>/Entry/MCDataGroupDKMSURI.....	299
10.2.111	<x>/<x>/OffNetwork/MCDataGroupList/<x>/Entry/PresentationPriority	299
10.2.112	<x>/<x>/OffNetwork/UserInfoID	299
10.2.113	Void	300
10.2.114	Void	300
10.2.115	Void	300
10.2.116	Void	300
10.2.117	Void	300
10.2.118	Void	300
10.2.119	Void	300
10.2.120	Void	300
10.2.121	<x>/Status	300
11	MCData service configuration MO	300
11.1	General	300
11.2	MCData service configuration MO parameters.....	301

11.2.1	General.....	301
11.2.2	Node: <x>	301
11.2.3	/<x>/Name	301
11.2.4	/<x>/Ext/	302
11.2.5	/<x>/Common	302
11.2.6	/<x>/Common/TxRxControl.....	302
11.2.7	/<x>/Common/TxRxControl/TimeTempDataWaiting	302
11.2.8	/<x>/Common/TxRxControl/TimePeriodicAnnouncement.....	302
11.2.9	/<x>/OffNetwork	303
11.2.10	/<x>/OffNetwork/DefaultPPPP.....	303
11.2.11	/<x>/OffNetwork/DefaultPPPP/MCDataOneToOneCallSignalling	303
11.2.12	/<x>/OffNetwork/DefaultPPPP/MCDataOneToOneCallMedia	303
12	MCVideo UE configuration MO.....	304
12.1	General	304
12.2	MCVideo UE configuration MO parameters	304
12.2.1	General.....	304
12.2.2	Node: <x>	305
12.2.3	/<x>/Name	305
12.2.4	/<x>/Ext/	305
12.2.5	/<x>/Common	305
12.2.5A	/<x>/Common/PrivateCall	305
12.2.5B	/<x>/Common/PrivateCall/MaxCallNc10.....	306
12.2.6	/<x>/Common/MCVideoGroupCall	306
12.2.7	/<x>/Common/MCVideoGroupCall/MaxCallNc4.....	306
12.2.8	/<x>/Common/MCVideoGroupCall/MaxTransmissionNc5	306
12.2.9	/<x>/Common/MCVideoGroupCall/PrioritizedMCVideoGroup	306
12.2.10	/<x>/Common/MCVideoGroupCall/PrioritizedMCVideoGroup/<x>	307
12.2.11	/<x>/Common/MCVideoGroupCall/PrioritizedMCVideoGroup/<x>/MCVideoGroupID.....	307
12.2.12	/<x>/Common/MCVideoGroupCall/ PrioritizedMCVideoGroup/<x>/MCVideoGroupPriorityHierarchy.....	307
12.2.13	/<x>/OnNetwork	307
12.2.14	/<x>/OnNetwork/RelayService.....	307
12.2.15	/<x>/OnNetwork/IPv6Preferred.....	308
12.2.16	/<x>/OnNetwork/RelayedMCVideoGroup.....	308
12.2.17	/<x>/OnNetwork/RelayedMCVideoGroup/<x>	308
12.2.18	/<x>/OnNetwork/RelayedMCVideoGroup/<x>/MCVideoGroupID	308
12.2.19	/<x>/OnNetwork/RelayedMCVideoGroup/<x>/RelayServiceCode.....	309
13	MCVideo user profile MO	309
13.1	General	309
13.2	MCVideo user profile MO parameters.....	312
13.2.1	General.....	312
13.2.2	Node: <x>	312
13.2.3	/<x>/Name	312
13.2.4	/<x>/Ext/	313
13.2.5	/<x>/<x>	313
13.2.6	/<x>/<x>/Common	313
13.2.7	/<x>/<x>/Common/MCVideoUserID	313
13.2.8	/<x>/<x>/Common/MCVideoUserProfileIndex.....	313
13.2.9	/<x>/<x>/Common/MCVideoUserProfileName	314
13.2.10	/<x>/<x>/Common/PreSelectedIndication.....	314
13.2.11	/<x>/<x>/Common/UserAliases	314
13.2.12	/<x>/<x>/Common/UserAliases/<x>.....	314
13.2.13	/<x>/<x>/Common/UserAliases/<x>/UserAlias	314
13.2.14	/<x>/<x>/Common/AuthorisedAlias	315
13.2.15	/<x>/<x>/Common/ParticipantType	315
13.2.16	/<x>/<x>/Common/Organization.....	315
13.2.17	/<x>/<x>/Common/MCVideoGroupBroadcast.....	315
13.2.18	/<x>/<x>/Common/MCVideoGroupBroadcast/Authorised	315
13.2.19	/<x>/<x>/Common/UserBroadcast	316
13.2.20	/<x>/<x>/Common/UserBroadcast/Authorised.....	316

13.2.21	/<x>/<x>/Common/AllowedModifyVideo	316
13.2.22	/<x>/<x>/Common/AllowedRenegotiateCodec	316
13.2.23	/<x>/<x>/Common/AllowedCameraControl.....	317
13.2.24	/<x>/<x>/Common/AllowedRemoteControl.....	317
13.2.25	/<x>/<x>/Common/AllowedDisplayRemoteUE	317
13.2.26	/<x>/<x>/Common/AllowedRemoteCamera	317
13.2.27	/<x>/<x>/Common/AllowedPushVideo.....	318
13.2.28	/<x>/<x>/Common/AllowedAutoSendNotify	318
13.2.29	/<x>/<x>/Common/AllowedActivateAlert	318
13.2.30	/<x>/<x>/Common/AllowedCancelAlert	318
13.2.31	/<x>/<x>/Common/NotifyList.....	319
13.2.32	/<x>/<x>/Common/NotifyList/<x>	319
13.2.33	/<x>/<x>/Common/NotifyList/<x>/Entry	319
13.2.34	/<x>/<x>/Common/NotifyList/<x>/Entry/MCVideoID	319
13.2.35	/<x>/<x>/Common/NotifyList/<x>/Entry/DisplayName	319
13.2.36	/<x>/<x>/Common/VideoCategories.....	320
13.2.37	/<x>/<x>/Common/VideoCategories/<x>	320
13.2.38	/<x>/<x>/Common/VideoCategories/<x>/VideoCat	320
13.2.38A	/<x>/<x>/Common/MCVideoGroupCall	320
13.2.38B	/<x>/<x>/Common/MCVideoGroupCall/EmergencyCall	320
13.2.38C	/<x>/<x>/Common/MCVideoGroupCall/EmergencyCall/Enabled	320
13.2.38D	/<x>/<x>/Common/MCVideoGroupCall/EmergencyCall/CancelMCVideoGroup	321
13.2.38E	/<x>/<x>/Common/MCVideoGroupCall/ImminentPerilCall	321
13.2.38F	/<x>/<x>/Common/MCVideoGroupCall/ImminentPerilCall/Authorised.....	321
13.2.38G	/<x>/<x>/Common/MCVideoGroupCall/ImminentPerilCall/Cancel	321
13.2.38H	/<x>/<x>/Common/PrivateCall.....	322
13.2.38I	/<x>/<x>/Common/PrivateCall/Authorised	322
13.2.38J	/<x>/<x>/Common/PrivateCall/ManualCommence.....	322
13.2.38K	/<x>/<x>/Common/PrivateCall/AutoCommence.....	322
13.2.38L	/<x>/<x>/Common/PrivateCall/FailRestrict	322
13.2.38M	/<x>/<x>/Common/ReceptionPriority	323
13.2.39	/<x>/<x>/OnNetwork.....	323
13.2.40	/<x>/<x>/OnNetwork/MCVideoGroupList.....	323
13.2.41	/<x>/<x>/OnNetwork/MCVideoGroupList/<x>.....	323
13.2.42	/<x>/<x>/OnNetwork/MCVideoGroupList/<x>/Entry.....	324
13.2.43	/<x>/<x>/OnNetwork/MCVideoGroupList/<x>/Entry/MCVideoGroupID	324
13.2.44	/<x>/<x>/OnNetwork/MCVideoGroupList/<x>/Entry/DisplayName	324
13.2.45	/<x>/<x>/OnNetwork/MCVideoGroupList/<x>/Entry/GMSAppServList	324
13.2.46	/<x>/<x>/OnNetwork/MCVideoGroupList/<x>/Entry/GMSAppServList/<x>	324
13.2.47	/<x>/<x>/OnNetwork/MCVideoGroupList/<x>/Entry/GMSAppServList/<x>/GMSAppServId	325
13.2.48	/<x>/<x>/OnNetwork/MCVideoGroupList/<x>/Entry/IdMSTokenEndPointList.....	325
13.2.49	/<x>/<x>/OnNetwork/MCVideoGroupList/<x>/Entry/IdMSTokenEndPointList/<x>	325
13.2.50	/<x>/<x>/OnNetwork/MCVideoGroupList/<x>/ Entry/IdMSTokenEndPointList/<x>/IdMSTokenEndPoint	325
13.2.51	/<x>/<x>/OnNetwork/MCVideoGroupList/<x>/Entry/PresentationPriority.....	326
13.2.52	/<x>/<x>/OnNetwork/ImplicitAffiliations.....	326
13.2.53	/<x>/<x>/OnNetwork/ImplicitAffiliations/<x>	326
13.2.54	/<x>/<x>/OnNetwork/ImplicitAffiliations/<x>/Entry	326
13.2.55	/<x>/<x>/OnNetwork/ImplicitAffiliations/<x>/Entry/MCVideoGroupID.....	326
13.2.56	/<x>/<x>/OnNetwork/ImplicitAffiliations/<x>/Entry/DisplayName	327
13.2.57	/<x>/<x>/OnNetwork/PresenceStatus	327
13.2.58	/<x>/<x>/OnNetwork/PresenceStatus/<x>	327
13.2.59	/<x>/<x>/OnNetwork/PresenceStatus/<x>/Entry	327
13.2.60	/<x>/<x>/OnNetwork/PresenceStatus/<x>/Entry/MCVideoGroupID.....	327
13.2.61	/<x>/<x>/OnNetwork/PresenceStatus/<x>/Entry/DisplayName.....	328
13.2.62	/<x>/<x>/OnNetwork/RemoteGroupChange	328
13.2.63	/<x>/<x>/OnNetwork/RemoteGroupChange/<x>	328
13.2.64	/<x>/<x>/OnNetwork/RemoteGroupChange/<x>/Entry	328
13.2.65	/<x>/<x>/OnNetwork/RemoteGroupChange/<x>/Entry/MCVideoGroupID	328
13.2.66	/<x>/<x>/OnNetwork/RemoteGroupChange/<x>/Entry/DisplayName.....	329
13.2.67	/<x>/<x>/OnNetwork/MaxAffiliationsNc2	329
13.2.68	/<x>/<x>/OnNetwork/AllowedRegroup	329

13.2.69	/<x>/<x>/OnNetwork/AllowedPresenceStatus	329
13.2.70	/<x>/<x>/OnNetwork/AllowedPresence	329
13.2.71	/<x>/<x>/OnNetwork/AllowedManualSwitch	330
13.2.72	/<x>/<x>/OnNetwork/DeletionPeriod	330
13.2.73	/<x>/<x>/OnNetwork/MaxSimultaneousVideoStreams	330
13.2.74	/<x>/<x>/OnNetwork/MaxSimultaneousVideoStreams/MaxStreams	330
13.2.75	/<x>/<x>/OnNetwork/MaxSimultaneousVideoStreams/AllowedUnlimited.....	331
13.2.76	/<x>/<x>/OnNetwork/AllowedAutoRecv	331
13.2.77	/<x>/<x>/OnNetwork/AllowedAutoRecvEmergency	331
13.2.78	/<x>/<x>/OnNetwork/AllowedAutoRecvImminentPeril	331
13.2.79	/<x>/<x>/OnNetwork/MandatoryReceiveGroups	332
13.2.80	/<x>/<x>/OnNetwork/MandatoryReceiveGroups/<x>	332
13.2.81	/<x>/<x>/OnNetwork/MandatoryReceiveGroups/<x>/Entry	332
13.2.82	/<x>/<x>/OnNetwork/MandatoryReceiveGroups/<x>/Entry/MCVideoGroupID	332
13.2.83	/<x>/<x>/OnNetwork/MandatoryReceiveGroups/<x>/Entry/DisplayName.....	332
13.2.84	/<x>/<x>/OnNetwork/AllowedRequestOverride	333
13.2.85	/<x>/<x>/OnNetwork/AllowedSelectOverride	333
13.2.86	/<x>/<x>/OnNetwork/AllowedOverrideGroupCall	333
13.2.87	/<x>/<x>/OnNetwork/MaxTimeSingleTransmit	333
13.2.88	/<x>/<x>/OffNetwork	334
13.2.89	/<x>/<x>/OffNetwork/Authorised	334
13.2.90	/<x>/<x>/OffNetwork/MCVideoGroupList	334
13.2.91	/<x>/<x>/OffNetwork/MCVideoGroupList/<x>	334
13.2.92	/<x>/<x>/OffNetwork/MCVideoGroupList/<x>/Entry	334
13.2.93	/<x>/<x>/OffNetwork/MCVideoGroupList/<x>/Entry/MCVideoGroupID	335
13.2.94	/<x>/<x>/OffNetwork/MCVideoGroupList/<x>/Entry/DisplayName	335
13.2.95	/<x>/<x>/OffNetwork/MCVideoGroupList/<x>/Entry/GMSAppServList	335
13.2.96	/<x>/<x>/OffNetwork/MCVideoGroupList/<x>/Entry/GMSAppServList/<x>.....	335
13.2.97	/<x>/<x>/OffNetwork/MCVideoGroupList/<x>/Entry/GMSAppServList/<x>/GMSAppServId	336
13.2.98	/<x>/<x>/OffNetwork/MCVideoGroupList/<x>/Entry/IdMSTokenEndPointList	336
13.2.99	/<x>/<x>/OffNetwork/MCVideoGroupList/<x>/Entry/IdMSTokenEndPointList/<x>	336
13.2.100	/<x>/<x>/OffNetwork/MCVideoGroupList/<x>/Entry/IdMSTokenEndPointList/<x>/IdMSTokenEndPoint	336
13.2.101	/<x>/<x>/OffNetwork/MCVideoGroupList/<x>/Entry/PresentationPriority	337
13.2.102	/<x>/<x>/OffNetwork/UserInfoID	337
13.2.102A	/<x>/<x>/OffNetwork/EmergencyCallChange	337
13.2.102B	/<x>/<x>/OffNetwork/ImminentPerilCallChange	337
13.2.103	/<x>/Status	338
14	MCVideo service configuration MO	338
14.1	General	338
14.2	MCVideo service configuration MO parameters	339
14.2.1	General.....	339
14.2.2	Node: <x>	339
14.2.3	/<x>/Name	339
14.2.4	/<x>/Ext/	339
14.2.5	/<x>/Common	339
14.2.6	/<x>/Common/BroadcastMCVideoGroupCall	340
14.2.7	/<x>/Common/BroadcastMCVideoGroupCall/NumLevelGroupHierarchy	340
14.2.8	/<x>/Common/BroadcastMCVideoGroupCall/NumLevelUserHierarchy	340
14.2.9	/<x>/Common/MinLengthAliasID.....	340
14.2.10	/<x>/OffNetwork	341
14.2.11	/<x>/OffNetwork/DefaultPPPP.....	341
14.2.12	/<x>/OffNetwork/DefaultPPPP/MCVideoPrivateCallSignalling	341
14.2.13	/<x>/OffNetwork/DefaultPPPP/MCVideoPrivateCallMedia.....	341
14.2.14	/<x>/OffNetwork/DefaultPPPP/MCVideoEmergencyPrivateCallSignalling	341
14.2.15	/<x>/OffNetwork/DefaultPPPP/MCVideoEmergencyPrivateCallMedia.....	342
14.2.16	/<x>/OffNetwork/PrivateCall	342
14.2.17	/<x>/OffNetwork/PrivateCall/MaxDuration	342
14.2.18	/<x>/OffNetwork/NumLevelHierarchy	342
Annex A (informative):	MCPTT UE configuration MO DDF	344

Annex B (informative):	MCPTT user profile MO DDF	345
Annex C (informative):	MCS group configuration MO DDF	346
Annex D (informative):	MCPTT service configuration MO DDF	347
Annex E (informative):	MCS UE initial configuration MO DDF	348
Annex F (informative):	MCVideo UE configuration MO DDF	349
Annex G (informative):	MCVideo user profile configuration MO DDF	350
Annex H (informative):	MCVideo service configuration MO DDF	351
Annex I (informative):	MCDATA UE configuration MO DDF	352
Annex J (informative):	MCDATA user profile configuration MO DDF	353
Annex K (informative):	MCDATA service configuration MO DDF	354
Annex L (informative):	Change history	355
History		358

Foreword

This Technical Specification has been produced by the 3rd Generation Partnership Project (3GPP).

The contents of the present document are subject to continuing work within the TSG and may change following formal TSG approval. Should the TSG modify the contents of the present document, it will be re-released by the TSG with an identifying change of release date and an increase in version number as follows:

Version x.y.z

where:

- x the first digit:
 - 1 presented to TSG for information;
 - 2 presented to TSG for approval;
 - 3 or greater indicates TSG approved document under change control.
- y the second digit is incremented for all changes of substance, i.e. technical enhancements, corrections, updates, etc.
- z the third digit is incremented when editorial only changes have been incorporated in the document.

1 Scope

The present document defines a number of Mission Critical Services (MCSs) Management Objects (MO) that are configured for the UE for the operation of MCSs. The management objects are compatible with OMA Device Management protocol specifications, version 1.2 and upwards, and is defined using the OMA DM Device Description Framework as described in the Enabler Release Definition OMA OMA-ERELED_DM-V1_2 [2].

MCSs are services that require preferential handling compared to normal telecommunication services, e.g. in support of police or fire brigade.

MCSs can be used for public safety applications and also for general commercial applications (e.g., utility companies and railways).

The present document is applicable to an UE supporting on-line, off-line or both on-line and off-line configuration of the configuration management client.

The present document is applicable to an UE supporting off-line configuration of the group management client.

The parameters defined by the management objects in the present document are configured in the UE using on-line configuration over the CSC-4 reference point and using off-line configuration over the CSC-11 and CSC-12 reference points. Other specifications define how these parameters are used in the operation of MCSs, and whether they are applicable to on-network operation or off-network operation, or both:

- 3GPP TS 24.379 [7];
- 3GPP TS 24.380 [8];
- 3GPP TS 24.481 [9];
- 3GPP TS 24.482 [11];
- 3GPP TS 24.484 [12];
- 3GPP TS 24.282 [16];
- 3GPP TS 24.582 [17];
- 3GPP TS 24.281 [18]; and
- 3GPP TS 24.581 [19].

The common network operation means both on-network operation and off-network operation in the present document.

The following management objects are defined in the present document:

- MCPTT UE configuration MO;
- MCPTT user profile MO;
- MCS group configuration MO;
- MCPTT service configuration MO;
- MCS UE initial configuration MO;
- MCDData UE configuration MO;
- MCDData user profile MO;
- MCDData service configuration MO;
- MCVideo UE configuration MO;
- MCVideo user profile MO; and
- MCVideo service configuration MO.

The MOs listed above define repositories of data in the ME.

2 References

The following documents contain provisions which, through reference in this text, constitute provisions of the present document.

- References are either specific (identified by date of publication, edition number, version number, etc.) or non-specific.
- For a specific reference, subsequent revisions do not apply.
- For a non-specific reference, the latest version applies. In the case of a reference to a 3GPP document (including a GSM document), a non-specific reference implicitly refers to the latest version of that document *in the same Release as the present document*.

- [1] 3GPP TR 21.905: "Vocabulary for 3GPP Specifications".
- [2] OMA OMA-ERELD-DM-V1_2-20070209-A: "Enabler Release Definition for OMA Device Management, Version 1.2".
- [3] OMA OMA-TS-DM_Protocol-V1_2: "OMA Device Management Protocol".
- [4] OMA OMA-TS-XDM_Group-V1_1-20120403-A: "Group XDM Specification".
- [5] 3GPP TS 23.003: "Numbering, addressing and identification".
- [6] 3GPP TS 23.303: "Proximity-based Services (ProSe); Stage 2".
- [7] 3GPP TS 24.379: "Mission Critical Push To Talk (MCPTT) call control Protocol specification".
- [8] 3GPP TS 24.380: "Mission Critical Push To Talk (MCPTT) media plane control Protocol specification".
- [9] 3GPP TS 24.481: "Mission Critical Services (MCS) group management Protocol specification".
- [10] 3GPP TS 31.102: "Characteristics of the USIM Application".
- [11] 3GPP TS 24.482: "Mission Critical Services (MCS) identity management Protocol specification".
- [12] 3GPP TS 24.484: "Mission Critical Services (MCS) configuration management Protocol specification".
- [13] IETF RFC 4566 (July 2006): "Session Description Protocol".
- [14] Void.
- [15] 3GPP TS 23.179: "Functional architecture and information flows to support mission critical communication services; Stage 2".
- [16] 3GPP TS 24.282: "Mission Critical Data (MCData) signalling control Protocol specification".
- [17] 3GPP TS 24.582: "Mission Critical Data (MCData) media plane control Protocol specification".
- [18] 3GPP TS 24.281: "Mission Critical Video (MCVideo) signalling control Protocol specification".
- [19] 3GPP TS 24.581: "Mission Critical Video (MCVideo) media plane control Protocol specification".
- [20] 3GPP TS 33.180: "Security of the mission critical service".

3 Definitions and abbreviations

3.1 Definitions

For the purpose of the present document, the following terms and definitions given in 3GPP TS 23.179 [15] apply:

Pre-selected MCPTT user profile

3.2 Abbreviations

For the purposes of the present document, the abbreviations given in 3GPP TR 21.905 [1] and the following apply. An abbreviation defined in the present document takes precedence over the definition of the same abbreviation, if any, in 3GPP TR 21.905 [1].

ACL	Access Control List
CMS	Configuration Management Server
DDF	Device Description Framework
DM	Device Management
GMS	Group Management Server
MCS	Mission Critical Service
MCSs	Mission Critical Services
MCPTT	Mission Critical Push To Talk
ME	Mobile Equipment
MO	Management Object
OMA	Open Mobile Alliance
ProSe	Proximity-based Services
RFC	Request For Comments
URI	Uniform Resource Identifier
URN	Uniform Resource Name
XCAP	XML Configuration Access Protocol
XML	eXtensible Markup Language
XUI	XCAP Unique Identifier

4 MCPTT UE configuration MO

4.1 General

The MCPTT UE configuration Management Object (MO) is used to configure MCPTT Client behaviour for the on-network or off-network MCPTT Service. The MCPTT UE configuration parameters may be stored in the ME, or in the USIM as specified in 3GPP TS 31.102 [10], or in both the ME and the USIM. If both the ME and the USIM contain the same parameters, the values stored in the USIM shall take precedence.

The Management Object Identifier is: urn:oma:mo:ext-3gpp-MCPTT-UE-configuration:1.0.

Protocol compatibility: This MO is compatible with OMA OMA DM 1.2 [3].

The OMA DM ACL property mechanism (see OMA OMA-ERELED-DM-V1_2 [2]) may be used to grant or deny access rights to OMA DM servers in order to modify nodes and leaf objects of the MCPTT UE configuration MO.

The following nodes and leaf objects are possible under the MCPTT UE configuration node as described in figure 4.1.1:

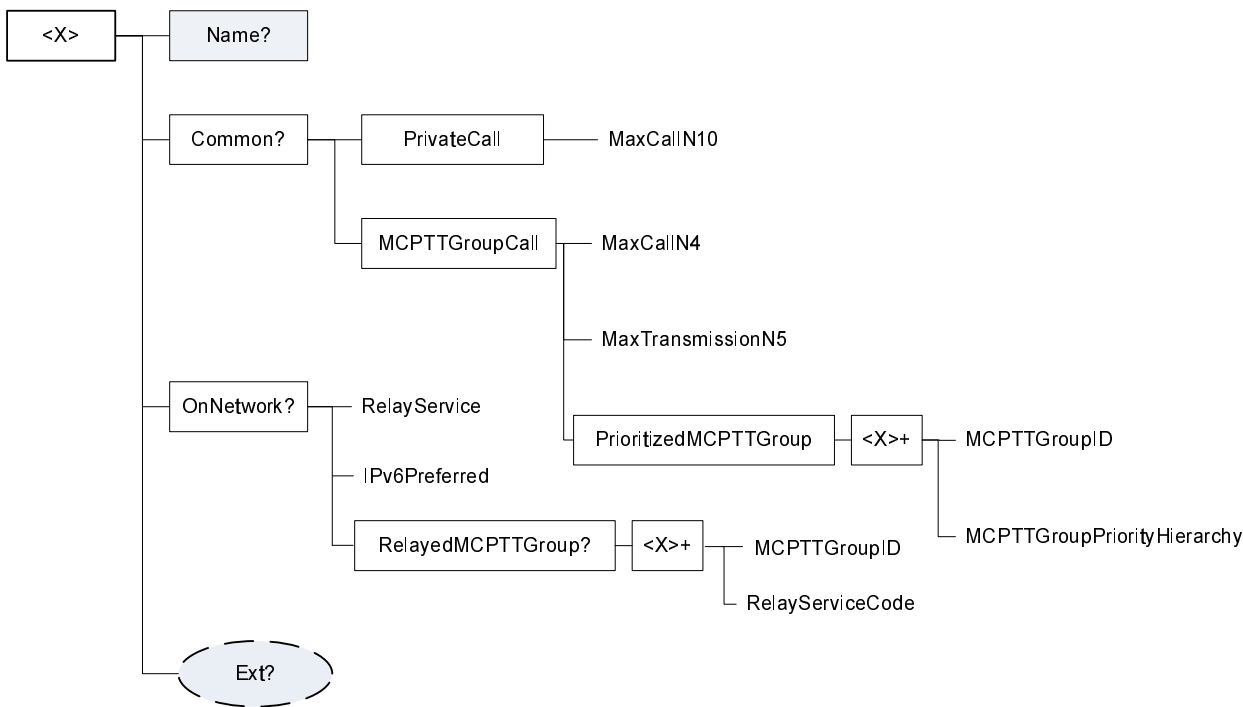

Figure 4.1.1: The MCPTT UE configuration MO

4.2 MCPTT UE configuration MO parameters

4.2.1 General

This clause describes the parameters for the MCPTT UE configuration Management Object (MO).

4.2.2 Node: <x>

Table 4.2.2.1: Node: <x>

<x>

Status	Occurrence	Format	Min. Access Types
Required	OneOrMore	node	Get

This interior node acts as a placeholder for the MCPTT UE configuration Management Object (MO).

For the MCPTT UE configuration MO, the namespace specific string is: "urn:oma:mo:oma-dm-mcptt-ue-configuration:1.0"

- Values: N/A

4.2.3 /<x>/Name

Table 4.2.3.1: /<x>/Name

Name

Status	Occurrence	Format	Min. Access Types
Required	ZeroOrOne	chr	Get

The Name leaf is a name for the MCPTT UE configuration settings.

- Values: <User displayable name>

4.2.4 /<x>/Ext/

Table 4.2.4.1: /<x>/Ext/

Ext

Status	Occurrence	Format	Min. Access Types
Optional	ZeroOrOne	node	Get, Replace

The Ext is an interior node for where the vendor specific information about the MCPTT UE configuration MO is being placed.

Usually the vendor extension is identified by vendor specific name under the ext node and contains the vendor meaning application vendor, device vendor etc. The tree structure under the vendor identified is not defined and can therefore include one or more un-standardized sub-trees.

- Values: N/A

4.2.5 /<x>/Common

Table 4.2.5.1: /<x>/Common

Common

Status	Occurrence	Format	Min. Access Types
Required	ZeroOrOne	node	Get, Replace

This interior node represents a container for the common network operation which means both on-network operation and off-network operation.

4.2.6 /<x>/Common/PrivateCall

Table 4.2.6.1: /<x>/Common/PrivateCall

Common/PrivateCall

Status	Occurrence	Format	Min. Access Types
Required	One	node	Get, Replace

This interior node is a placeholder for the private call configuration.

4.2.7 /<x>/Common/PrivateCall/MaxCallN10

Table 4.2.7.1: /<x>/Common/PrivateCall/MaxCallN10

Common/PrivateCall/MaxCallN10

Status	Occurrence	Format	Min. Access Types
Required	One	int	Get, Replace

This leaf node indicates the maximum number of private calls.

- Values: 0-255

4.2.8 /<x>/Common/MCPTTGroupCall

Table 4.2.8.1: /<x>/Common/MCPTTGroupCall

Common/MCPTTGroupCall

Status	Occurrence	Format	Min. Access Types
Required	One	node	Get, Replace

This interior node is a placeholder for the MCPTT group call configuration.

4.2.9 `<x>/Common/MCPTTGroupCall/MaxCallN4`

Table 4.2.9.1: `<x>/Common/MCPTTGroupCall/MaxCallN4`

Common/MCPTTGroupCall/MaxCallN4

Status	Occurrence	Format	Min. Access Types
Required	One	int	Get, Replace

This leaf node indicates the maximum number of simultaneous group calls.

- Values: 0-255

4.2.10 `<x>/Common/MCPTTGroupCall/MaxTransmissionN5`

Table 4.2.10.1: `<x>/Common/MCPTTGroupCall/MaxTransmissionN5`

Common/MCPTTGroupCall/MaxTransmissionN5

Status	Occurrence	Format	Min. Access Types
Required	One	int	Get, Replace

This leaf node indicates the maximum number of transmissions in a group.

- Values: 0-255

4.2.11 `<x>/Common/MCPTTGroupCall/PrioritizedMCPTTGroup`

Table 4.2.11.1: `<x>/Common/MCPTTGroupCall/PrioritizedMCPTTGroup`

Common/MCPTTGroupCall/PrioritizedMCPTTGroup

Status	Occurrence	Format	Min. Access Types
Required	One	node	Get, Replace

This interior node is a placeholder for the prioritized MCPTT group call configuration.

4.2.12 `<x>/Common/MCPTTGroupCall/PrioritizedMCPTTGroup/<x>`

Table 4.2.12.1: `<x>/Common/MCPTTGroupCall/PrioritizedMCPTTGroup/<x>`

Common/MCPTTGroupCall/PrioritizedMCPTTGroup `<x>`

Status	Occurrence	Format	Min. Access Types
Required	OneOrMore	node	Get, Replace

This interior node is a placeholder for one or more prioritized MCPTT group call configuration.

4.2.13

`<x>/Common/MCPTTGroupCall/PrioritizedMCPTTGroup/<x>/MCPTTGroupID`

Table 4.2.13.1: `<x>/Common/MCPTTGroupCall/PrioritizedMCPTTGroup/<x>/MCPTTGroupID`

Common/MCPTTGroupCall/PrioritizedMCPTTGroup/<x>/MCPTTGroupID

Status	Occurrence	Format	Min. Access Types
Required	One	chr	Get, Replace

This leaf node indicates the associated MCPTT group ID.

The value is a "uri" attribute specified in OMA OMA-TS-XDM_Group-V1_1 [4].

4.2.14 `<x>/Common/MCPTTGroupCall/PrioritizedMCPTTGroup/<x>/MCPTTGroupPriorityHierarchy`

Table 4.2.14.1:

`<x>/Common/MCPTTGroupCall/PrioritizedMCPTTGroup/<x>/MCPTTGroupPriorityHierarchy`

Common/MCPTTGroupCall/PrioritizedMCPTTGroup/<x>/MCPTTGroupPriorityHierarchy

Status	Occurrence	Format	Min. Access Types
Required	One	int	Get, Replace

This leaf node indicates the requested presentation priority of group call.

- Values: 0-7

The group with the lowest MCPTTGroupPriorityHierarchy value shall be considered as the group having the lowest priority among the groups.

4.2.15 `<x>/OnNetwork`

Table 4.2.15.1: `<x>/OnNetwork`

OnNetwork

Status	Occurrence	Format	Min. Access Types
Required	ZeroOrOne	node	Get, Replace

This interior node represents a container for on-network operation.

4.2.16 `<x>/OnNetwork/RelayService`

Table 4.2.16.1: `<x>/OnNetwork/RelayService`

OnNetwork/RelayService

Status	Occurrence	Format	Min. Access Types
Required	One	bool	Get, Replace

This leaf node indicates the authorisation to use a relay service.

When set to "true" the MCPTT group is allowed to use a relay service.

When set to "false" the MCPTT group is not allowed to use a relay service.

4.2.17 /<x>/OnNetwork/IPv6Preferred

Table 4.2.17.1: /<x>/OnNetwork/IPv6Preferred

OnNetwork/IPv6Preferred

Status	Occurrence	Format	Min. Access Types
Required	One	bool	Get, Replace

This leaf node indicates whether IPv6 is preferred over IPv4 for on-network operation when the MCPTT UE has both IPv4 and IPv6 host configuration.

If the MCPTT UE has both IPv4 and IPv6 host configuration and:

- if IPv6Preferred is set to "true" then the UE uses IPv6 for all on-network signalling and media; otherwise
- if IPv6Preferred is set to "false" then the UE uses IPv4 for all on-network signalling and media.

4.2.18 /<x>/OnNetwork/RelayedMCPTTGroup

Table 4.2.18.1: /<x>/OnNetwork/RelayedMCPTTGroup

OnNetwork/RelayedMCPTTGroup

Status	Occurrence	Format	Min. Access Types
Optional	ZeroOrOne	node	Get, Replace

This interior node is a placeholder for the allowed relayed MCPTT groups.

4.2.19 /<x>/OnNetwork/RelayedMCPTTGroup/<x>

Table 4.2.19.1: /<x>/OnNetwork/RelayedMCPTTGroup/<x>

OnNetwork/RelayedMCPTTGroup/<x>

Status	Occurrence	Format	Min. Access Types
Required	OneOrMore	node	Get, Replace

This interior node is a placeholder for one or more allowed relayed MCPTT groups.

4.2.20 /<x>/OnNetwork/RelayedMCPTTGroup/<x>/MCPTTGroupID

Table 4.2.20.1: /<x>/OnNetwork/RelayedMCPTTGroup/<x>/MCPTTGroupID

OnNetwork/RelayedMCPTTGroup/<x>/MCPTTGroupID

Status	Occurrence	Format	Min. Access Types
Required	One	chr	Get, Replace

This leaf node indicates the associated MCPTT group ID.

The value is a "uri" attribute specified in OMA OMA-TS-XDM_Group-V1_1 [4].

4.2.21 /<x>/OnNetwork/RelayedMCPTTGroup/<x>/RelayServiceCode

Table 4.2.21.1: /<x>/OnNetwork/RelayedMCPTTGroup/<x>/RelayServiceCode

OnNetwork/RelayedMCPTTGroup/<x>/RelayServiceCode

Status	Occurrence	Format	Min. Access Types
Required	One	chr	Get, Replace

This leaf node indicates the connectivity service that the ProSe UE-to-network relay provides to public safety applications as specified in 3GPP TS 23.303 [6].

5 MCPTT user profile MO

5.1 General

The MCPTT user profile configuration Management Object (MO) is used to configure the MCPTT Client behaviour for the on-network or off-network MCPTT Service. The MCPTT UE configuration parameters may be stored in the ME, or in the USIM as specified in 3GPP TS 31.102 [10], or in both the ME and the USIM. If both the ME and the USIM contain the same parameters, the values stored in the USIM shall take precedence.

The Management Object Identifier is: urn:oma:mo:ext-3gpp-MCPTT-user-profile:1.0.

Protocol compatibility: This MO is compatible with OMA OMA DM 1.2 [3].

The OMA DM ACL property mechanism (see OMA OMA-ERELD-DM-V1_2 [2]) may be used to grant or deny access rights to OMA DM servers in order to modify nodes and leaf objects of the MCPTT user profile MO.

The following nodes and leaf objects are possible under the MCPTT user profile node as described in figure 5.1.1, figure 5.1.2, figure 5.1.3, figure 5.1.4, figure 5.1.5, figure 5.1.6, figure 5.1.7, and figure 5.1.8.

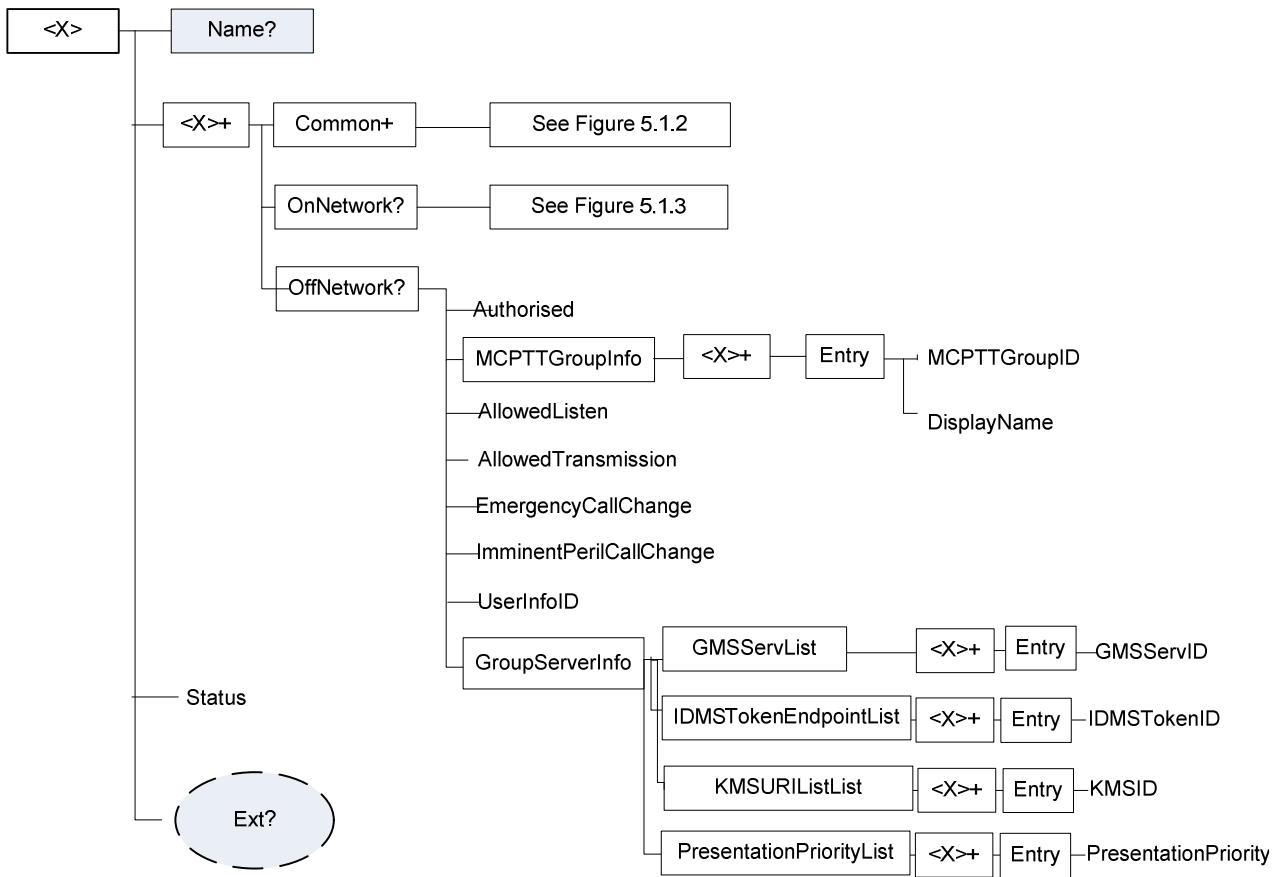

Figure 5.1.1: The MCPTT user profile MO (1 of 3)

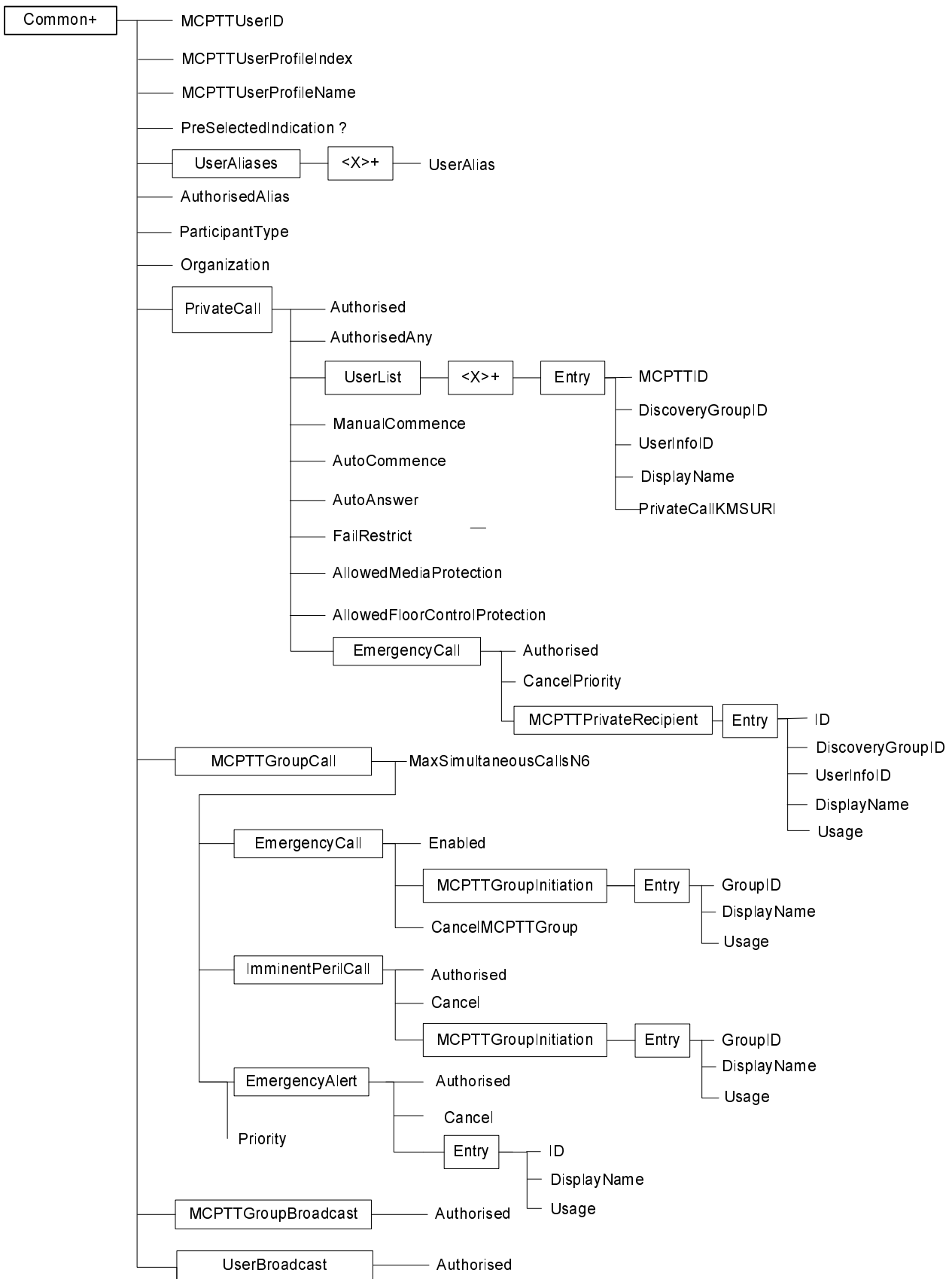

Figure 5.1.2: The MCPTT user profile MO (2 of 3)

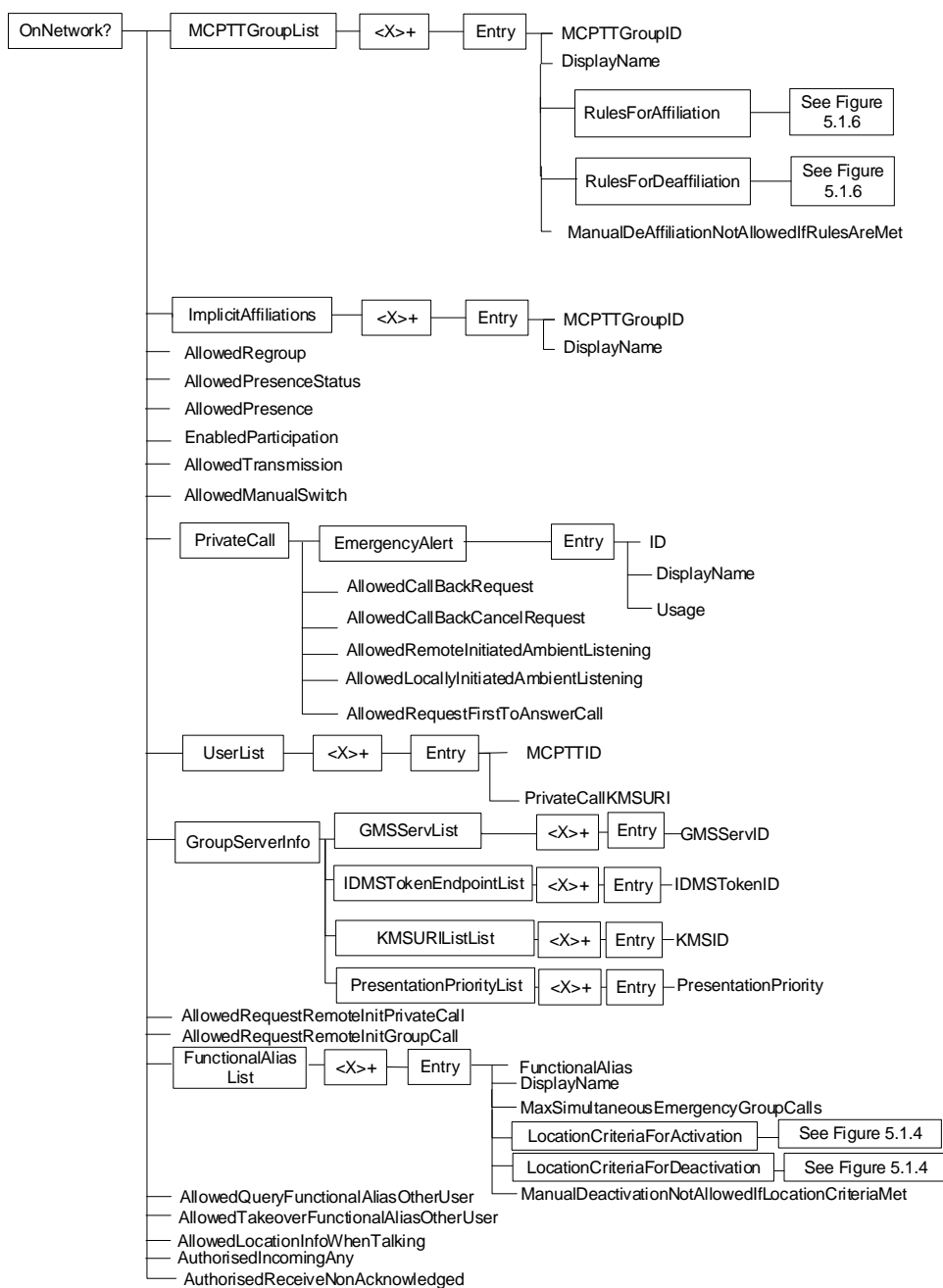

Figure 5.1.3: The MCPTT user profile MO (3 of 3)

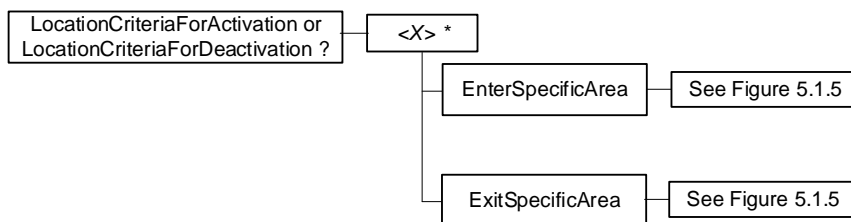

Figure 5.1.4: LocationCriteriaForActivation and LocationCriteriaForDeactivation

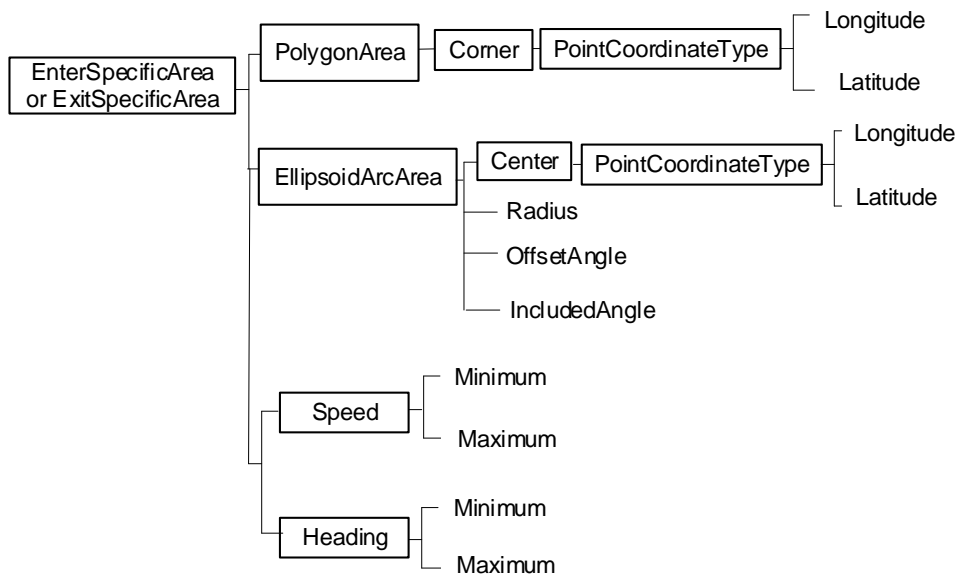

Figure 5.1.5: EnterSpecificArea and ExitSpecificArea

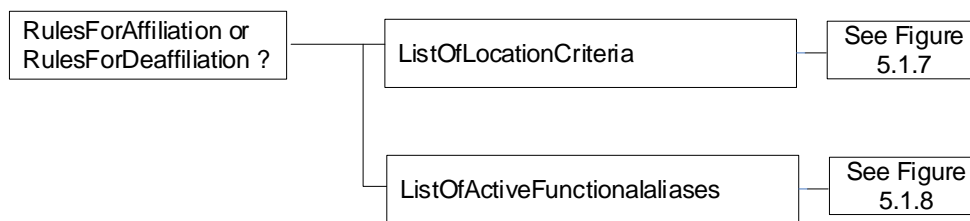

Figure 5.1.6: RulesForAffiliation and RulesForDeaffiliation

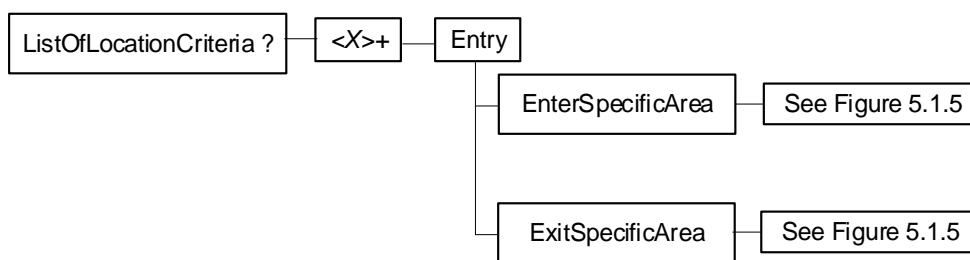

Figure 5.1.7: ListOfLocationCriteria

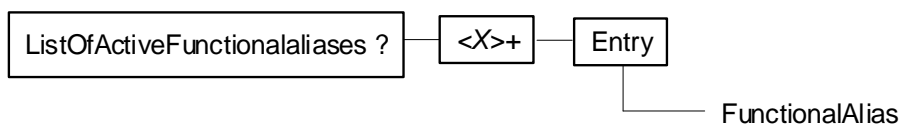

Figure 5.1.8: ListOfFunctionalaliases

5.2 MCPTT user profile MO parameters

5.2.1 General

This clause describes the parameters for the MCPTT user profile Management Object (MO).

5.2.2 Node: <x>

Table 5.2.2.1: Node: <x>

<x>

Status	Occurrence	Format	Min. Access Types
Required	OneOrMore	node	Get

This interior node acts as a placeholder for the MCPTT user profile Management Object (MO).

For the MCPTT user profile MO, the namespace specific string is: "urn:oma:mo:oma-dm-mcptt-user-profile:1.0"

- Values: N/A

5.2.3 /<x>/Name

Table 5.2.3.1: /<x>/Name

Name

Status	Occurrence	Format	Min. Access Types
Required	ZeroOrOne	chr	Get

The Name leaf is a name for the MCPTT user profile settings.

- Values: <User displayable name>

5.2.4 /<x>/Ext/

Table 5.2.4.1: /<x>/Ext/

Ext

Status	Occurrence	Format	Min. Access Types
Optional	ZeroOrOne	node	Get, Replace

The Ext is an interior node for where the vendor specific information about the MCPTT user profile MO is being placed.

Usually the vendor extension is identified by vendor specific name under the ext node and contains the vendor meaning application vendor, device vendor etc. The tree structure under the vendor identified is not defined and can therefore include one or more un-standardized sub-trees.

- Values: N/A

5.2.5 /<x>/<x>

Table 5.2.5.1: /<x>/<x>

<x>

Status	Occurrence	Format	Min. Access Types
Required	OneOrMore	node	Get, Replace

This interior node represents a container for on-network operation and off-network operation.

5.2.6 /<x>/<x>/Common

Table 5.2.6.1: /<x>/<x>/Common

<x>/Common

Status	Occurrence	Format	Min. Access Types
Required	OneOrMore	node	Get, Replace

This interior node represents a container for the common network operation which means both on-network operation and off-network operation.

5.2.7 /<x>/<x>/Common/MCPTTUserID

Table 5.2.7.1: /<x>/<x>/Common/MCPTTUserID

<x>/Common/MCPTTUserID

Status	Occurrence	Format	Min. Access Types
Required	One	chr	Get, Replace

This leaf node indicates an MCPTT user identity (MCPTT ID) which is a globally unique identifier within the MCPTT service that represents the MCPTT user.

5.2.7A /<x>/<x>/Common/MCPTTUserProfileIndex

Table 5.2.7A.1: /<x>/<x>/Common/MCPTTUserProfileIndex

<x>/Common/MCPTTUserProfileIndex

Status	Occurrence	Format	Min. Access Types
Required	One	int	Get, Replace

This leaf node indicates an index for the particular MCPTT user profile.

- Values: 0-255

5.2.7B /<x>/<x>/Common/MCPTTUserProfileName

Table 5.2.7B.1: /<x>/<x>/Common/MCPTTUserProfileName

<x>/Common/MCPTTUserProfileName

Status	Occurrence	Format	Min. Access Types
Optional	One	chr	Get, Replace

This leaf node indicates a profile name for the particular MCPTT user profile.

5.2.7C /<x>/<x>/Common/PreSelectedIndication

Table 5.2.7C.1: /<x>/<x>/Common/PreSelectedIndication

<x>/Common/PreSelectedIndication

Status	Occurrence	Format	Min. Access Types
Optional	ZeroOrOne	null	Get, Replace

This leaf node indicates that this MCPTT user profile MO is designated to be the pre-selected MCPTT user profile as defined by 3GPP TS 23.179 [15]

- Values: null

When this leaf node is present, this MCPTT user profile MO is designated as the pre-selected MCPTT user profile.

When this leaf node is absent, this MCPTT user profile MO is not designated as the pre-selected MCPTT user profile.

If more than one MCPTT user profile MO is specified for the MCPTT user, then only one MCPTT user profile MO for the MCPTT user shall contain the `<x>/Common/PreSelectedIndication` leaf node.

If there is only one MCPTT user profile MO specified for the MCPTT user, then it is optional to include the `<x>/Common/PreSelectedIndication` leaf node.

5.2.8 `<x>/<x>/Common/UserAliases`

Table 5.2.8.1: `<x>/<x>/Common/UserAliases`

`<x>/Common/UserAliases`

Status	Occurrence	Format	Min. Access Types
Required	One	node	Get, Replace

This interior node is a placeholder for a list of aliases of an MCPTT user.

5.2.8A `<x>/<x>/Common/UserAliases/<x>`

Table 5.2.8A.1: `<x>/<x>/Common/UserAliases/<x>`

`<x>/Common/UserAliases/<x>`

Status	Occurrence	Format	Min. Access Types
Required	OneOrMore	node	Get, Replace

This interior node is a placeholder for one or more aliases of an MCPTT user.

5.2.8B `<x>/<x>/Common/UserAliases/<x>/UserAlias`

Table 5.2.8B.1: `<x>/<x>/Common/UserAliases/<x>/UserAlias`

`<x>/Common/UserAliases/<x>/UserAlias`

Status	Occurrence	Format	Min. Access Types
Required	One	chr	Get, Replace

This leaf node indicates an alphanumeric alias of the MCPTT user.

5.2.9 `<x>/<x>/Common/AuthorisedAlias`

Table 5.2.9.1: `<x>/<x>/Common/AuthorisedAlias`

`<x>/Common/AuthorisedAlias`

Status	Occurrence	Format	Min. Access Types
Optional	One	bool	Get, Replace

This leaf node indicates authorisation to create and delete aliases of other MCPTT users and their associated MCPTT user profiles.

When set to "true" the MCPTT user is authorised to create and delete aliases of other MCPTT users and their associated MCPTT user profiles.

When set to "false" the MCPTT user is not authorised to create and delete aliases of other MCPTT user and their associated MCPTT user profiles. This is the default if this leaf node is not present.

5.2.10 /<x>/<x>/Common/ParticipantType

Table 5.2.10.1: /<x>/<x>/Common/ParticipantType

<x>/Common/ParticipantType

Status	Occurrence	Format	Min. Access Types
Required	One	chr	Get, Replace

This leaf node indicates the participant type of the MCPTT user.

The ParticipantType means the functional category of the participant (e.g., first responder, second responder, dispatch, dispatch supervisor), typically defined by the MCPTT administrators.

5.2.11 /<x>/<x>/Common/Organization

Table 5.2.11.1: /<x>/<x>/Common/Organization

<x>/Common/Organization

Status	Occurrence	Format	Min. Access Types
Required	One	chr	Get, Replace

This leaf node indicates the organization an MCPTT user belongs to.

5.2.12 /<x>/<x>/Common/PrivateCall

Table 5.2.12.1: /<x>/<x>/Common/PrivateCall

<x>/Common/PrivateCall

Status	Occurrence	Format	Min. Access Types
Required	One	node	Get, Replace

This interior node is a placeholder for the MCPTT private call configuration.

5.2.13 /<x>/<x>/Common/PrivateCall/Authorised

Table 5.2.13.1: /<x>/<x>/Common/PrivateCall/Authorised

<x>/Common/PrivateCall/Authorised

Status	Occurrence	Format	Min. Access Types
Required	One	bool	Get, Replace

This leaf node indicates the authorisation to make a MCPTT private call.

When set to "true" the MCPTT user is allowed to make a MCPTT private call.

When set to "false" the MCPTT user is not allowed to make a MCPTT private call.

5.2.14 /<x>/<x>/Common/PrivateCall/AuthorisedAny

Table 5.2.14.1: /<x>/<x>/Common/PrivateCall/AuthorisedAny

<x>/Common/PrivateCall/AuthorisedAny

Status	Occurrence	Format	Min. Access Types
Required	One	bool	Get, Replace

Required	One	bool	Get, Replace
----------	-----	------	--------------

This leaf node indicates the authorisation to make a MCPTT private call to any MCPTT user.

When set to "true" any MCPTT user is authorised to make an MCPTT private call to any MCPTT user.

When set to "false" any MCPTT user is not authorised to make an MCPTT private call to any MCPTT user.

5.2.15 /<x>/<x>/Common/PrivateCall/UserList

Table 5.2.15.1: /<x>/<x>/PrivateCall/UserList

<x>/Common/ PrivateCall/UserList

Status	Occurrence	Format	Min. Access Types
Required	One	node	Get, Replace

This interior node is a placeholder for a list of MCPTT user(s) who can be called in a MCPTT private call.

5.2.16 /<x>/<x>/Common/PrivateCall/UserList/<x>

Table 5.2.16.1: /<x>/<x>/Common/PrivateCall/UserList/<x>

<x>/Common/PrivateCall/UserList/<x>

Status	Occurrence	Format	Min. Access Types
Optional	OneOrMore	node	Get, Replace

This interior node is a placeholder for one or more list of MCPTT users who can be called in a MCPTT private call.

5.2.16A /<x>/<x>/Common/PrivateCall/UserList/<x>/Entry

Table 5.2.16A.1: /<x>/<x>/Common/PrivateCall/UserList/<x>/Entry

<x>/Common/PrivateCall/UserList/<x>/Entry

Status	Occurrence	Format	Min. Access Types
Required	One	node	Get, Replace

This interior node is a placeholder for one or more MCPTT users who can be called in a private call.

5.2.17 /<x>/<x>/Common/PrivateCall/UserList/<x>/Entry/MCPTTID

Table 5.2.17.1: /<x>/<x>/Common/PrivateCall/UserList/<x>/Entry/MCPTTID

<x>/Common/PrivateCall/UserList/<x>/Entry/MCPTTID

Status	Occurrence	Format	Min. Access Types
Optional	One	chr	Get, Replace

This leaf node indicates an MCPTT user identity (MCPTT ID) which is a globally unique identifier within the MCPTT service that represents the MCPTT user.

The value is a "uri" attribute specified in OMA OMA-TS-XDM_Group-V1_1 [4].

5.2.18 /<x>/<x>/Common/PrivateCall/UserList/<x>/Entry/DiscoveryGroupID

Table 5.2.18.1: /<x>/<x>/Common/PrivateCall/UserList/<x>/Entry/DiscoveryGroupID

<x>/Common/PrivateCall/UserList/<x>/Entry/DiscoveryGroupID

Status	Occurrence	Format	Min. Access Types
Optional	One	int	Get, Replace

This leaf node indicates a discovery group ID as specified in 3GPP TS 23.303 [6].

The value is used as the discovery group ID in the ProSe discovery procedures as specified in 3GPP TS 23.303 [6].

5.2.19 /<x>/<x>/Common/PrivateCall/UserList/<x>/Entry/UserInfoID

Table 5.2.19.1: /<x>/<x>/Common/PrivateCall/UserList/<x>/Entry/UserInfoID

<x>/Common/PrivateCall/UserList/<x>/Entry/UserInfoID

Status	Occurrence	Format	Min. Access Types
Optional	One	int	Get, Replace

This leaf node indicates a ProSe user info ID as specified in 3GPP TS 23.303 [6].

5.2.19A /<x>/<x>/Common/PrivateCall/UserList/<x>/Entry/DisplayName

Table 5.2.19A.1: /<x>/<x>/Common/PrivateCall/UserList/<x>/Entry/DisplayName

<x>/Common/PrivateCall/UserList/<x>/Entry/DisplayName

Status	Occurrence	Format	Min. Access Types
Optional	One	chr	Get, Replace

This leaf node contains a human readable name.

5.2.19B

/<x>/<x>/Common/PrivateCall/UserList/<x>/Entry/PrivateCallKMSURI

Table 5.2.19B.1: /<x>/<x>/Common/PrivateCall/UserList/<x>/Entry/PrivateCallKMSURI

<x>/Common/PrivateCall/UserList/<x>/Entry/PrivateCallKMSURI

Status	Occurrence	Format	Min. Access Types
Optional	One	chr	Get, Replace

This leaf node indicates the identity (URI) of the KMS associated with the MCPTTID. If the value is empty, the KMS leaf node present in the MCS UE initial configuration MO is used.

5.2.20 /<x>/<x>/Common/PrivateCall/ManualCommence

Table 5.2.20.1: /<x>/<x>/Common/PrivateCall/ManualCommence

<x>/Common/PrivateCall/ManualCommence

Status	Occurrence	Format	Min. Access Types
Required	One	bool	Get, Replace

This leaf node indicates the authorisation to make a MCPTT private call with manual commencement.

When set to "true" the MCPTT user is authorised to make a MCPTT private call in manual commencement mode.

When set to "false" the MCPTT user is not authorised to make a MCPTT private call in manual commencement mode.

5.2.21 /<x>/<x>/Common/PrivateCall/AutoCommence

Table 5.2.21.1: /<x>/<x>/Common/PrivateCall/AutoCommence

<x>/Common/PrivateCall/AutoCommence

Status	Occurrence	Format	Min. Access Types
Required	One	bool	Get, Replace

This leaf node indicates the authorisation to make a MCPTT private call with automatic commencement.

When set to "true" the MCPTT user is authorised to make a MCPTT private call in automatic commencement mode.

When set to "false" the MCPTT user is not authorised to make a MCPTT private call in automatic commencement mode.

5.2.22 /<x>/<x>/Common/PrivateCall/AutoAnswer

Table 5.2.22.1: /<x>/<x>/Common/PrivateCall/AutoAnswer

<x>/Common/PrivateCall/AutoAnswer

Status	Occurrence	Format	Min. Access Types
Required	One	bool	Get, Replace

This leaf node indicates the authorisation of MCPTT user to force automatic answer for a MCPTT private call.

When set to "true" the MCPTT user is authorised to force automatic answer for a MCPTT private call.

When set to "false" the MCPTT user is not authorised to force automatic answer for a MCPTT private call.

5.2.23 /<x>/<x>/Common/PrivateCall/FailRestrict

Table 5.2.23.1: /<x>/<x>/Common/PrivateCall/FailRestrict

<x>/Common/PrivateCall/FailRestrict

Status	Occurrence	Format	Min. Access Types
Required	One	bool	Get, Replace

This leaf node indicates the authorisation to restrict the provision of a notification of call failure reason for a MCPTT private call.

When set to "true" the MCPTT user is authorised to restrict notification of call failure reason for MCPTT private call.

When set to "false" the MCPTT user is not authorised to restrict notification of call failure reason for MCPTT private call.

5.2.24 /<x>/<x>/Common/PrivateCall/AllowedMediaProtection

Table 5.2.24.1: /<x>/<x>/Common/PrivateCall/AllowedMediaProtection

<x>/Common/PrivateCall/AllowedMediaProtection

Status	Occurrence	Format	Min. Access Types
Required	One	bool	Get, Replace

This leaf node indicates authorisation to protect confidentiality and integrity of media for MCPTT private calls.

When set to "true" the MCPTT user is authorised to protect confidentiality and integrity of media for MCPTT private calls.

When set to "false" the MCPTT user is not authorised to protect confidentiality and integrity of media for MCPTT private calls.

The default value is set to "true".

5.2.25 /<x>/<x>/Common/PrivateCall/AllowedFloorControlProtection

Table 5.2.25.1: /<x>/<x>/Common/PrivateCall/AllowedFloorControlProtection

<x>/Common/PrivateCall/AllowedFloorControlProtection

Status	Occurrence	Format	Min. Access Types
Required	One	bool	Get, Replace

This leaf node indicates authorisation to protect confidentiality and integrity of floor control signalling for MCPTT private calls.

When set to "true" the MCPTT user is authorised to protect confidentiality and integrity of floor control signalling for MCPTT private calls.

When set to "false" the MCPTT user is not authorised to protect confidentiality and integrity of floor control signalling for MCPTT private calls.

The default value is set to "true".

5.2.26 /<x>/<x>/Common/PrivateCall/EmergencyCall

Table 5.2.26.1: /<x>/<x>/Common/PrivateCall/EmergencyCall

<x>/Common/PrivateCall/EmergencyCall

Status	Occurrence	Format	Min. Access Types
Required	One	node	Get, Replace

This interior node is a placeholder for the MCPTT emergency call policy.

5.2.27 /<x>/<x>/Common/PrivateCall/EmergencyCall/Authorised

Table 5.2.27.1: /<x>/<x>/Common/PrivateCall/EmergencyCall/Authorised

<x>/Common/PrivateCall/EmergencyCall/Authorised

Status	Occurrence	Format	Min. Access Types
Required	One	bool	Get, Replace

This leaf node indicates the authorisation to make an MCPTT emergency private call.

When set to "true" the MCPTT user is authorised to make an MCPTT emergency private call.

When set to "false" the MCPTT user is not authorised to make an MCPTT emergency private call.

5.2.28 /<x>/<x>/Common/PrivateCall/EmergencyCall/CancelPriority

Table 5.2.28.1: /<x>/<x>/Common/PrivateCall/EmergencyCall/CancelPriority

<x>/Common/PrivateCall/EmergencyCall/CancelPriority

Status	Occurrence	Format	Min. Access Types
Required	One	bool	Get, Replace

This leaf node indicates the authorisation to cancel emergency priority in an MCPTT emergency private call by an authorised MCPTT user.

When set to "true" the MCPTT user is authorised to cancel an emergency priority in an MCPTT private call.

When set to "false" the MCPTT user is not authorised to cancel an emergency priority in an MPCTT private call.

5.2.29

`<x>/<x>/Common/PrivateCall/EmergencyCall/MCPTTPrivateRecipient`

Table 5.2.29.1: `<x>/<x>/Common/PrivateCall/EmergencyCall/MCPTTPrivateRecipient`

`<x>/Common/PrivateCall/EmergencyCall/MCPTTPrivateRecipient`

Status	Occurrence	Format	Min. Access Types
Optional	One	node	Get, Replace

This interior node is a placeholder for the MCPTT private recipient for an MCPTT emergency private call.

5.2.29A

`<x>/<x>/Common/PrivateCall/EmergencyCall/MCPTTPrivateRecipient/Entry`

Table 5.2.29A.1: `<x>/<x>/Common/PrivateCall EmergencyCall/MCPTTPrivateRecipient/Entry`

`<x>/Common/PrivateCall/EmergencyCall/MCPTTPrivateRecipient/Entry`

Status	Occurrence	Format	Min. Access Types
Required	One	node	Get, Replace

This interior node is a placeholder for the details of the MCPTT private recipient for an MCPTT emergency private call.

5.2.29B `<x>/<x>/Common/PrivateCall/EmergencyCall/MCPTTPrivateRecipient/Entry/ID`

Table 5.2.29B.1: `<x>/<x>/Common/PrivateCall/EmergencyCall/MCPTTPrivateRecipient/Entry/ID`

`<x>/Common/PrivateCall/EmergencyCall/MCPTTPrivateRecipient/Entry/ID`

Status	Occurrence	Format	Min. Access Types
Optional	One	chr	Get, Replace

This leaf node indicates the MCPTT private recipient used upon certain criteria on initiation of an MCPTT emergency private call.

5.2.29C `<x>/<x>/Common/PrivateCall/EmergencyCall/MCPTTPrivateRecipient/Entry/DiscoveryGroupID`

Table 5.2.29C.1:

`<x>/<x>/Common/PrivateCall/EmergencyCall/MCPTTPrivateRecipient/Entry/DiscoveryGroupID`

`<x>/Common/PrivateCall/EmergencyCall/MCPTTPrivateRecipient/Entry/DiscoveryGroupID`

Status	Occurrence	Format	Min. Access Types
--------	------------	--------	-------------------

Optional	One	int	Get, Replace
----------	-----	-----	--------------

This leaf node indicates the discovery group ID as specified in 3GPP TS 23.303 [6].

5.2.29D /<x>/<x>/Common/PrivateCall/EmergencyCall/ MCPTTPrivateRecipient/Entry/UserInfoID

Table 5.2.29D.1:

/<x>/<x>/Common/PrivateCall/EmergencyCall/MCPTTPrivateRecipient/Entry/UserInfoID

<x>/Common/PrivateCall/EmergencyCall/MCPTTPrivateRecipient/Entry/UserInfoID

Status	Occurrence	Format	Min. Access Types
Optional	One	int	Get, Replace

This leaf node indicates a ProSe user info ID as specified in 3GPP TS 23.303 [6].

The "UserInfoID" element identifies the MCPTT private recipient when making an off-network private call.

5.2.29E /<x>/<x>/Common/PrivateCall/EmergencyCall/ MCPTTPrivateRecipient/Entry/DisplayName

Table 5.2.29E.1:

/<x>/<x>/Common/PrivateCall/EmergencyCall/MCPTTPrivateRecipient/Entry/DisplayName

<x>/Common/PrivateCall/EmergencyCall/MCPTTPrivateRecipient/Entry/DisplayName

Status	Occurrence	Format	Min. Access Types
Optional	One	chr	Get, Replace

This leaf node contains a human readable name that corresponds to the MCPTT private recipient ID.

5.2.29F /<x>/<x>/Common/PrivateCall/EmergencyCall/ MCPTTPrivateRecipient/Entry/Usage

Table 5.2.29F.1: /<x>/<x>/Common/PrivateCall/EmergencyCall/MCPTTPrivateRecipient/Entry/Usage

<x>/Common/PrivateCall/EmergencyCall/MCPTTPrivateRecipient/Entry/Usage

Status	Occurrence	Format	Min. Access Types
Required	One	chr	Get, Replace

This leaf node indicates the criteria to determine when initiation of an MCPTT emergency private call uses the MCPTT private recipient ID.

The valid values are 'LocallyDetermined' and 'UsePreConfigured'.

When set to 'LocallyDetermined' then if the MCPTT user selects an MCPTT ID then use that MCPTT ID for the MCPTT emergency private call, if the MCPTT user does not select a MCPTT ID then use the MCPTT ID identified by the MCPTT private recipient ID in subclause 5.2.29B for an on-network MCPTT emergency private call.

When set to 'UsePreConfigured' then use the MCPTT ID identified by the MCPTT private recipient ID in subclause 5.2.29B for an on-network MCPTT emergency private call.

When set to 'LocallyDetermined' then if the MCPTT user selects an MCPTT user then use the UserInfoID that corresponds to that MCPTT user for the MCPTT emergency private call, if the MCPTT user does not select a MCPTT user then use the User Info ID identified by the UserInfoID in subclause 5.2.29D for an off-network MCPTT emergency private call.

When set to 'UsePreConfigured' then use the User Info ID identified by the UserInfoID in subclause 5.2.29D for an off-network MCPTT emergency private call.

5.2.30 /<x>/<x>/Common/MCPTTGroupCall

Table 5.2.30.1: /<x>/<x>/Common/MCPTTGroupCall

<x>/Common/MCPTTGroupCall

Status	Occurrence	Format	Min. Access Types
Required	One	node	Get, Replace

This interior node is a placeholder for the MCPTT group call configuration.

5.2.31 /<x>/<x>/Common/MCPTTGroupCall/MaxSimultaneousCallsN6

Table 5.2.31.1: /<x>/<x>/Common/MCPTTGroupCall/MaxSimultaneousCallsN6

<x>/Common/MCPTTGroupCall/MaxSimultaneousCallsN6

Status	Occurrence	Format	Min. Access Types
Required	One	int	Get, Replace

This leaf node indicates the maximum number of simultaneously received MCPTT group calls (N6).

5.2.32 /<x>/<x>/Common/MCPTTGroupCall/EmergencyCall

Table 5.2.32.1: /<x>/<x>/Common/MCPTTGroupCall/EmergencyCall

<x>/Common/MCPTTGroupCall/EmergencyCall

Status	Occurrence	Format	Min. Access Types
Required	One	node	Get, Replace

This interior node is a placeholder for the MCPTT emergency call policy.

5.2.33 /<x>/<x>/Common/MCPTTGroupCall/EmergencyCall/Enabled

Table 5.2.33.1: /<x>/<x>/Common/MCPTTGroupCall/EmergencyCall/Enabled

<x>/Common/MCPTTGroupCall/EmergencyCall/Enabled

Status	Occurrence	Format	Min. Access Types
Optional	One	bool	Get, Replace

This leaf node indicates the authorisation to make an MCPTT emergency group call functionality enabled for MCPTT user.

When set to "true" the MCPTT user is authorised to make an MCPTT emergency group call functionality enabled.

When set to "false" the MCPTT user is not authorised to make an MCPTT emergency group call functionality enabled.

5.2.34 /<x>/<x>/Common/MCPTTGroupCall/EmergencyCall/MCPTTGroupInitiation

Table 5.2.34.1: /<x>/<x>/Common/MCPTTGroupCall/EmergencyCall/MCPTTGroupInitiation

<x>/Common/MCPTTGroupCall/EmergencyCall/MCPTTGroupInitiation

Status	Occurrence	Format	Min. Access Types
Required	One	node	Get, Replace

This interior node is a placeholder for the group used on initiation of an MCPTT emergency group call.

5.2.34A /<x>/<x>/Common/MCPTTGroupCall/EmergencyCall/MCPTTGroupInitiation/Entry

Table 5.2.34A.1: /<x>/<x>/Common/MCPTTGroupCall/EmergencyCall/MCPTTGroupInitiation/Entry

<x>/Common/MCPTTGroupCall/EmergencyCall/MCPTTGroupInitiation/Entry

Status	Occurrence	Format	Min. Access Types
Required	One	node	Get, Replace

This interior node is a placeholder for the details of the group used on initiation of an MCPTT emergency group call.

5.2.34B /<x>/<x>/Common/MCPTTGroupCall/EmergencyCall/MCPTTGroupInitiation/Entry/GroupID

Table 5.2.34BA.1:

/<x>/<x>/Common/MCPTTGroupCall/EmergencyCall/MCPTTGroupInitiation/Entry/GroupID

<x>/Common/MCPTTGroupCall/EmergencyCall/MCPTTGroupInitiation/Entry/GroupID

Status	Occurrence	Format	Min. Access Types
Optional	One	chr	Get, Replace

This leaf node indicates the group used upon certain criteria on initiation of an MCPTT emergency group call.

5.2.34C /<x>/<x>/Common/MCPTTGroupCall/EmergencyCall/MCPTTGroupInitiation/Entry/DisplayName

Table 5.2.34C.1:

/<x>/<x>/Common/MCPTTGroupCall/EmergencyCall/MCPTTGroupInitiation/Entry/DisplayName

<x>/Common/MCPTTGroupCall/EmergencyCall/MCPTTGroupInitiation/Entry/DisplayName

Status	Occurrence	Format	Min. Access Types
Optional	One	chr	Get, Replace

This leaf node contains a human readable name that corresponds to the Group ID.

5.2.34D /<x>/<x>/Common/MCPTTGroupCall/EmergencyCall/MCPTTGroupInitiation/Entry/Usage

Table 5.2.34D.1:

/<x>/<x>/Common/MCPTTGroupCall/EmergencyCall/MCPTTGroupInitiation/Entry/Usage

<x>/Common/MCPTTGroupCall/EmergencyCall/MCPTTGroupInitiation/Entry/Usage

Status	Occurrence	Format	Min. Access Types
Required	One	chr	Get, Replace

This leaf node indicates the criteria to determine when initiation of an MCPTT emergency group call uses the GroupID.

The valid values are 'UseCurrentlySelectedGroup' and 'DedicatedGroup'.

When set to 'UseCurrentlySelectedGroup' then if the MCPTT user has currently selected an MCPTT group then use that MCPTT group for an on-network MCPTT emergency group call, if the MCPTT user does not have a currently selected MCPTT group then use the MCPTT group identified by the GroupID in subclause 5.2.34B for an MCPTT emergency group call.

When set to 'DedicatedGroup' then use the MCPTT group identified by the GroupID in subclause 5.2.34B for an MCPTT emergency group call.

5.2.35 /<x>/<x>/Common/MCPTTGroupCall/EmergencyCall/CancelMCPTTGroup

Table 5.2.35.1: /<x>/<x>/Common/MCPTTGroupCall/EmergencyCall/CancelMCPTTGroup

<x>/Common/MCPTTGroupCall/EmergencyCall/CancelMCPTTGroup

Status	Occurrence	Format	Min. Access Types
Required	One	bool	Get, Replace

This leaf node indicates the authorisation to cancel an in progress MCPTT emergency group call associated with a group.

When set to "true" the MCPTT user is authorised to cancel a MCPTT emergency group call.

When set to "false" the MCPTT user is not authorised to cancel a MCTT emergency group call.

5.2.36 /<x>/<x>/Common/MCPTTGroupCall/ImminentPerilCall

Table 5.2.36.1: /<x>/<x>/Common/MCPTTGroupCall/ImminentPerilCall

<x>/Common/MCPTTGroupCall/ImminentPerilCall

Status	Occurrence	Format	Min. Access Types
Required	One	node	Get, Replace

This interior node is a placeholder for the MCPTT imminent peril call policy.

5.2.37 /<x>/<x>/Common/MCPTTGroupCall/ImminentPerilCall/Authorised

Table 5.2.37.1: /<x>/<x>/Common/MCPTTGroupCall/ImminentPerilCall/Authorised

<x>/Common/MCPTTGroupCall/ImminentPerilCall/Authorised

Status	Occurrence	Format	Min. Access Types
Required	One	bool	Get, Replace

This leaf node indicates the authorisation to make an Imminent Peril group call.

When set to "true" the MCPTT user is authorised to create an MCPTT imminent peril group call.

When set to "false" the MCPTT user is not authorised to create an MCPTT imminent peril group call.

5.2.38 /<x>/<x>/Common/MCPTTGroupCall/ImminentPerilCall/Cancel

Table 5.2.38.1: /<x>/<x>/Common/MCPTTGroupCall/ImminentPerilCall/Cancel

<x>/Common/MCPTTGroupCall/ImminentPerilCall/Cancel

Status	Occurrence	Format	Min. Access Types
Required	One	bool	Get, Replace

This leaf node indicates the authorisation for in-progress MCPTT imminent peril cancelation.

When set to "true" the MCPTT user is authorised to cancel an MCPTT imminent peril call.

When set to "false" the MCPTT user is not authorised to cancel an MCPTT imminent peril call.

5.2.39

/<x>/<x>/Common/MCPTTGroupCall/ImminentPerilCall/MCPTTGroupInitiation

Table 5.2.39.1: /<x>/<x>/Common/MCPTTGroupCall/ImminentPerilCall/MCPTTGroupInitiation

<x>/Common/MCPTTGroupCall/ImminentPerilCall/MCPTTGroupInitiation

Status	Occurrence	Format	Min. Access Types
Optional	One	node	Get, Replace

This interior node is a placeholder for the group used on initiation of an MCPTT imminent peril group call.

5.2.39A

/<x>/<x>/Common/MCPTTGroupCall/ImminentPerilCall/MCPTTGroupInitiation/Entry

Table 5.2.39A.1: /<x>/<x>/Common/MCPTTGroupCall/ImminentPerilCall/MCPTTGroupInitiation/Entry

<x>/Common/MCPTTGroupCall/ImminentPerilCall/MCPTTGroupInitiation/Entry

Status	Occurrence	Format	Min. Access Types
Required	One	node	Get, Replace

This interior node is a placeholder for the details of the group used on initiation of an imminent peril call.

5.2.39B /<x>/<x>/Common/MCPTTGroupCall/ImminentPerilCall/MCPTTGroupInitiation/Entry/GroupID

Table 5.2.39B.1:

/<x>/<x>/Common/MCPTTGroupCall/ImminentPerilCall/MCPTTGroupInitiation/Entry/GroupID

<x>/Common/MCPTTGroupCall/ImminentPerilCall/MCPTTGroupInitiation/Entry/GroupID

Status	Occurrence	Format	Min. Access Types
Required	One	chr	Get, Replace

This leaf node indicates the group used upon certain criteria on initiation of an MCPTT imminent peril group call.

5.2.39C /<x>/<x>/Common/MCPTTGroupCall/ImminentPerilCall/MCPTTGroupInitiation/DisplayName

Table 5.2.39C.1:

/<x>/<x>/Common/MCPTTGroupCall/ImminentPerilCall/MCPTTGroupInitiation/Entry/DisplayName

<x>/Common/MCPTTGroupCall/ImminentPerilCall/MCPTTGroupInitiation/Entry/DisplayName

Status	Occurrence	Format	Min. Access Types
Optional	One	chr	Get, Replace

This leaf node contains a human readable name that corresponds to the Group ID.

5.2.39D /<x>/<x>/Common/MCPTTGroupCall/ImminentPerilCall/MCPTTGroupInitiation/Entry/Usage

Table 5.2.39D.1:

/<x>/<x>/Common/MCPTTGroupCall/ImminentPerilCall/MCPTTGroupInitiation/Entry/Usage

<x>/Common/MCPTTGroupCall/ImminentPerilCall/MCPTTGroupInitiation/Entry/Usage

Status	Occurrence	Format	Min. Access Types
Required	One	chr	Get, Replace

This leaf node indicates the criteria to determine when initiation of an MCPTT imminent peril group call uses the GroupID.

The valid values are 'UseCurrentlySelectedGroup' and 'DedicatedGroup'.

When set to 'UseCurrentlySelectedGroup' then if the MCPTT user has currently selected an MCPTT group then use that MCPTT group for an on-network MCPTT imminent peril group call, if the MCPTT user does not have a currently selected MCPTT group then use the MCPTT group identified by the GroupID in subclause 5.2.39B for an MCPTT imminent peril group call.

When set to 'DedicatedGroup' then use the MCPTT group identified by the GroupID in subclause 5.2.39B for an MCPTT imminent peril group call.

5.2.40 /<x>/<x>/Common/MCPTTGroupCall/EmergencyAlert

Table 5.2.40.1: /<x>/<x>/Common/MCPTTGroupCall/EmergencyAlert

<x>/Common/MCPTTGroupCall/EmergencyAlert

Status	Occurrence	Format	Min. Access Types
Required	One	node	Get, Replace

This interior node is a placeholder for the MCPTT emergency alert policy.

5.2.41 /<x>/<x>/Common/MCPTTGroupCall/EmergencyAlert/Authorised

Table 5.2.41.1: /<x>/<x>/Common/MCPTTGroupCall/EmergencyAlert/Authorised

<x>/Common/MCPTTGroupCall/EmergencyAlert/Authorised

Status	Occurrence	Format	Min. Access Types
Required	One	bool	Get, Replace

This leaf node indicates the authorisation to activate an MCPTT emergency alert.

When set to "true" the MCPTT user is authorised to make an MCPTT emergency alert.

When set to "false" the MCPTT user is not authorised to make an MCPTT emergency alert.

5.2.42 /<x>/<x>/Common/MCPTTGroupCall/EmergencyAlert/Cancel

Table 5.2.42.1: /<x>/<x>/Common/MCPTTGroupCall/EmergencyAlert/Cancel

<x>/Common/MCPTTGroupCall/EmergencyAlert/Cancel

Status	Occurrence	Format	Min. Access Types
Required	One	bool	Get, Replace

This leaf node indicates the authorisation to cancel an MCPTT emergency alert.

When set to "true" the MCPTT user is authorised to cancel an MCPTT emergency alert.

When set to "false" the MCPTT user is not authorised to cancel an MCPTT emergency alert.

5.2.43 Void

5.2.43A /<x>/<x>/Common/MCPTTGroupCall/EmergencyAlert/Entry

Table 5.2.39A.1: /<x>/<x>/Common/MCPTTGroupCall/EmergencyAlert/Entry

<x>/Common/MCPTTGroupCall/EmergencyAlert/Entry

Status	Occurrence	Format	Min. Access Types
Required	One	node	Get, Replace

This interior node is a placeholder for the details of the MCPTT group of an MCPTT emergency alert.

5.2.43B /<x>/<x>/Common/MCPTTGroupCall/EmergencyAlert/Entry/ID

Table 5.2.43B.1: /<x>/<x>/Common/MCPTTGroupCall/EmergencyAlert/Entry/ID

<x>/Common/MCPTTGroupCall/EmergencyAlert/Entry/ID

Status	Occurrence	Format	Min. Access Types
Required	One	chr	Get, Replace

This leaf node indicates the MCPTT group used upon certain criteria on initiation of an MCPTT emergency alert.

5.2.43C Void

5.2.43D

/<x>/<x>/Common/MCPTTGroupCall/EmergencyAlert/Entry/DisplayName

Table 5.2.43D.1: /<x>/<x>/Common/MCPTTGroupCall/EmergencyAlert/Entry/DisplayName

<x>/Common/MCPTTGroupCall/EmergencyAlert/Entry/DisplayName

Status	Occurrence	Format	Min. Access Types
Optional	One	chr	Get, Replace

This leaf node contains a human readable name that corresponds to the ID.

5.2.43E /<x>/<x>/Common/MCPTTGroupCall/EmergencyAlert/Entry/Usage

Table 5.2.43E.1: /<x>/<x>/Common/MCPTTGroupCall/EmergencyAlert/Entry/Usage

<x>/Common/MCPTTGroupCall/EmergencyAlert/Entry/Usage

Status	Occurrence	Format	Min. Access Types
Required	One	chr	Get, Replace

This leaf node indicates the criteria to determine when initiation of an MCPTT emergency alert uses the ID.

The valid values are 'LocallyDetermined', 'UseCurrentlySelectedGroup', 'UsePreConfigured' and 'DedicatedGroup'.

When set to 'LocallyDetermined' then if the MCPTT user selects an MCPTT ID then use that MCPTT ID for an on-network MCPTT emergency alert, if the MCPTT user does not select a MCPTT ID then use the MCPTT ID identified by the ID in subclause 5.2.43B for an on-network MCPTT emergency alert.

When set to 'UseCurrentlySelectedGroup' then if the MCPTT user has currently selected an MCPTT group then use that MCPTT group for an on-network MCPTT emergency alert, if the MCPTT user does not have a currently selected MCPTT group then use the MCPTT group identified by the ID in subclause 5.2.43B for an MCPTT emergency alert.

When set to 'UsePreConfigured' then use the ID identified by the ID in subclause 5.2.43B for an on-network MCPTT emergency alert.

When set to 'DedicatedGroup' then use the MCPTT group identified by the ID in subclause 5.2.43B for an MCPTT emergency alert.

5.2.43F /<x>/<x>/Common/MCPTTGroupCall/Priority

Table 5.2.43F.1: /<x>/<x>/Common/MCPTTGroupCall/Priority

<x>/Common/MCPTTGroupCall/Priority

Status	Occurrence	Format	Min. Access Types
Required	One	int	Get, Replace

This leaf node indicates the priority of the MCPTT group calls.

- Values: 0-255

The MCPTT group call with the lowest Priority value shall be considered as the MCPTT group call having the lowest level among the MCPTT group calls.

5.2.44 Void

5.2.45 /<x>/<x>/Common/MCPTTGroupBroadcast

Table 5.2.45.1: /<x>/<x>/Common/MCPTTGroupBroadcast

<x>/Common/MCPTTGroupBroadcast

Status	Occurrence	Format	Min. Access Types
Required	One	node	Get, Replace

This interior node is a placeholder for the group-broadcast group policy.

5.2.46 /<x>/<x>/Common/MCPTTGroupBroadcast/Authorised

Table 5.2.46.1: /<x>/<x>/Common/MCPTTGroupBroadcast/Authorised

<x>/Common/MCPTTGroupBroadcast/Authorised

Status	Occurrence	Format	Min. Access Types
Required	One	bool	Get, Replace

This leaf node indicates the authorisation to create a group-broadcast group.

When set to "true" the MCPTT user is authorised to create a group-broadcast group.

When set to "false" the MCPTT user is not authorised to create a group-broadcast group.

5.2.47 /<x>/<x>/Common/UserBroadcast

Table 5.2.47.1: /<x>/<x>/Common/UserBroadcast

<x>/Common/UserBroadcast

Status	Occurrence	Format	Min. Access Types
Required	One	node	Get, Replace

This interior node is a placeholder for the user-broadcast group policy.

5.2.48 /<x>/<x>/Common/UserBroadcast/Authorised

Table 5.2.48.1: /<x>/<x>/Common/UserBroadcast/Authorised

<x>/Common/UserBroadcast/Authorised

Status	Occurrence	Format	Min. Access Types
Required	One	bool	Get, Replace

This leaf node indicates the authorisation to create a user-broadcast group.

When set to "true" the MCPTT user is authorised to create a user-broadcast group.

When set to "false" the MCPTT user is not authorised to create a user-broadcast group.

5.2.48A /<x>/<x>/OnNetwork

Table 5.2.48A.1: /<x>/<x>/OnNetwork

<x>/OnNetwork

Status	Occurrence	Format	Min. Access Types
Required	ZeroOrOne	node	Get, Replace

This interior node represents a container for on-network operation.

5.2.48B1 /<x>/<x>/OnNetwork/MCPTTGroupList

Table 5.2.48B1.1: /<x>/<x>/OnNetwork/MCPTTGroupList

<x>/OnNetwork/MCPTTGroupList

Status	Occurrence	Format	Min. Access Types
Required	One	node	Get, Replace

This interior node is a placeholder for the list of on-network MCPTT groups that the MCPTT user is allowed to affiliate to.

5.2.48B2 /<x>/<x>/OnNetwork/MCPTTGroupList/<x>

Table 5.2.48B2.1: /<x>/<x>/OnNetwork/MCPTTGroupList/<x>

<x>/OnNetwork/MCPTTGroupList/<x>

Status	Occurrence	Format	Min. Access Types
Required	OneOrMore	node	Get, Replace

This interior node is a placeholder for one or more list of on-network MCPTT groups that the MCPTT user is allowed to affiliate to.

5.2.48B3 /<x>/<x>/OnNetwork/MCPTTGroupList/<x>/Entry

Table 5.2.48B3.1: /<x>/<x>/OnNetwork/MCPTTGroupList/<x>/Entry

<x>/OnNetwork/MCPTTGroupList/<x>/Entry

Status	Occurrence	Format	Min. Access Types
Optional	One	node	Get, Replace

This interior node is a placeholder for the details of the on-network MCPTT groups that the MCPTT user is allowed to affiliate to.

5.2.48B4/ <x>/<x>/OnNetwork/MCPTTGroupList/<x>/Entry/MCPTTGroupID

Table 5.2.48B4.1: /<x>/<x>/OnNetwork/MCPTTGroupList/<x>/Entry/MCPTTGroupID

<x>/OnNetwork/MCPTTGroupList/<x>/Entry/MCPTTGroupID

Status	Occurrence	Format	Min. Access Types
Required	One	chr	Get, Replace

This leaf node indicates the MCPTT group ID for the on-network MCPTT group that the MCPTT user is allowed to affiliate to.

The value is a "uri" attribute specified in OMA OMA-TS-XDM_Group-V1_1 [4].

5.2.48B4A

/<x>/<x>/OnNetwork/MCPTTGroupList/<x>/Entry/RulesForAffiliation

Table 5.2.48B4A.1: /<x>/<x>/OnNetwork/MCPTTGroupList/<x>/Entry/RulesForAffiliation

<x>/OnNetwork/MCPTTGroupList/<x>/Entry/RulesForAffiliation

Status	Occurrence	Format	Min. Access Types
Optional	ZeroOrMore	node	Get, Replace

This interior node is a placeholder for the rules that control automatic affiliation.

5.2.48B4A1

/<x>/<x>/OnNetwork/MCPTTGroupList/<x>/Entry/RulesForAffiliation
/ListOfLocationCriteria/

Table 5.2.48B4A1.1:

/<x>/<x>/OnNetwork/MCPTTGroupList/<x>/Entry/RulesForAffiliation/ListOfLocationCriteria

<x>/OnNetwork/MCPTTGroupList/<x>/Entry/RulesForAffiliation/ListOfLocationCriteria

Status	Occurrence	Format	Min. Access Types
Optional	One	node	Get, Replace

This interior node is a placeholder for the location portion of the rules that control automatic affiliation.

5.2.48B4A2

/<x>/<x>/OnNetwork/MCPTTGroupList/<x>/Entry/RulesForAffiliation
/ListOfLocationCriteria/<x>

Table 5.2.48B84A2.1:

/<x>/<x>/OnNetwork/MCPTTGroupList/<x>/Entry/RulesForAffiliation/ListOfLocationCriteria/<x>

<x>/OnNetwork/MCPTTGroupList/<x>/Entry/RulesForAffiliation/ListOfLocationCriteria/<x>

Status	Occurrence	Format	Min. Access Types
Optional	ZeroOrMore	node	Get, Replace

This interior node is a placeholder for the location portion of the rules that control automatic affiliation.

5.2.48B4A3

`/<x>/<x>/OnNetwork/MCPTTGroupList/<x>/Entry/RulesForAffiliation/ListOfLocationCriteria/<x>/Entry`

Table 5.2.48B4A3.1:

`/<x>/<x>/OnNetwork/MCPTTGroupList/<x>/Entry/RulesForAffiliation/ListOfLocationCriteria/<x>/Entry`

`<x>/OnNetwork/MCPTTGroupList/<x>/Entry/RulesForAffiliation/ListOfLocationCriteria/<x>/Entry`

Status	Occurrence	Format	Min. Access Types
Optional	One	node	Get, Replace

This interior node is a placeholder for the location portion of the rules that control automatic affiliation.

5.2.48B4A4

`/<x>/<x>/OnNetwork/MCPTTGroupList/<x>/Entry/RulesForAffiliation/ListOfLocationCriteria/<x>/Entry/EnterSpecificArea`

Table 5.2.48B4A4.1:

`/<x>/<x>/OnNetwork/MCPTTGroupList/<x>/Entry/RulesForAffiliation/ListOfLocationCriteria/<x>/Entry/EnterSpecificArea`

`<x>/OnNetwork/MCPTTGroupList/<x>/Entry/RulesForAffiliation/ListOfLocationCriteria/<x>/Entry/EnterSpecificArea`

Status	Occurrence	Format	Min. Access Types
Optional	One	node	Get, Replace

This interior node contains a geographical area which when entered by the MC service UE triggers evaluation of the rules..

5.2.48B4A5

`/<x>/<x>/OnNetwork/MCPTTGroupList/<x>/Entry/RulesForAffiliation/ListOfLocationCriteria/<x>/Entry/EnterSpecificArea/PolygonArea`

Table 5.2.48B4A5.1: `/<x>/<x>/OnNetwork/MCPTTGroupList/<x>/Entry/RulesForAffiliation/ListOfLocationCriteria/<x>/Entry/EnterSpecificArea/PolygonArea`

`<x>/OnNetwork/MCPTTGroupList/<x>/Entry/RulesForAffiliation/ListOfLocationCriteria/<x>/Entry/EnterSpecificArea/PolygonArea`

Status	Occurrence	Format	Min. Access Types
Optional	One	node	Get, Replace

This interior node contains a geographical area described by a polygon.

5.2.48B4A6

`/<x>/<x>/OnNetwork/MCPTTGroupList/<x>/Entry/RulesForAffiliation/ListOfLocationCriteria/<x>/Entry/EnterSpecificArea/PolygonArea/Corner`

Table 5.2.48B4A6.1: `/<x>/<x>/OnNetwork/MCPTTGroupList/<x>/Entry/RulesForAffiliation/ListOfLocationCriteria/<x>/Entry/EnterSpecificArea/PolygonArea/Corner`

`<x>/OnNetwork/MCPTTGroupList/<x>/Entry/RulesForAffiliation/ListOfLocationCriteria/<x>/Entry/EnterSpecificArea/PolygonArea/Corner`

Status	Occurrence	Format	Min. Access Types
Required	Three to fifteen	node	Get, Replace

This interior node contains the coordinates of the corners which define a polygon.

5.2.48B4A7

`/<x>/<x>/OnNetwork/MCPTTGroupList/<x>/Entry/RulesForAffiliation/ListOfLocationCriteria/<x>/Entry/EnterSpecificArea/PolygonArea/Corner/PointCoordinateType`

Table 5.2.48B4A7.1:

`/<x>/<x>/OnNetwork/MCPTTGroupList/<x>/Entry/RulesForAffiliation/ListOfLocationCriteria/<x>/Entry/EnterSpecificArea/PolygonArea/Corner/PointCoordinateType`

`<x>/OnNetwork/MCPTTGroupList/<x>/Entry/RulesForAffiliation/ListOfLocationCriteria/<x>/Entry/EnterSpecificArea/PolygonArea/Corner/PointCoordinateType`

Status	Occurrence	Format	Min. Access Types
Required	One	node	Get, Replace

This interior node contains the type of the coordinates.

5.2.48B4A8

`/<x>/<x>/OnNetwork/MCPTTGroupList/<x>/Entry/RulesForAffiliation/ListOfLocationCriteria/<x>/Entry/EnterSpecificArea/PolygonArea/Corner/PointCoordinateType/Longitude`

Table 5.2.48B4A8.1:

`/<x>/<x>/OnNetwork/MCPTTGroupList/<x>/Entry/RulesForAffiliation/ListOfLocationCriteria/<x>/Entry/EnterSpecificArea/PolygonArea/Corner/PointCoordinateType/Longitude`

`<x>/OnNetwork/MCPTTGroupList/<x>/Entry/RulesForAffiliation/ListOfLocationCriteria/<x>/Entry/EnterSpecificArea/PolygonArea/Corner/PointCoordinateType/Longitude /`

Status	Occurrence	Format	Min. Access Types
Required	One	int	Get, Replace

This leaf node contains the longitudinal coordinate of a corner.

5.2.48B4A9

`/<x>/<x>/OnNetwork/MCPTTGroupList/<x>/Entry/RulesForAffiliation/ListOfLocationCriteria/<x>/Entry/EnterSpecificArea/PolygonArea/Corner/PointCoordinateType/Latitude`

Table 5.2.48B4A9.1:

`/<x>/<x>/OnNetwork/MCPTTGroupList/<x>/Entry/RulesForAffiliation/ListOfLocationCriteria/<x>/Entry/EnterSpecificArea/PolygonArea/Corner/PointCoordinateType/Latitude`

`<x>/OnNetwork/MCPTTGroupList/<x>/Entry/RulesForAffiliation/ListOfLocationCriteria/<x>/Entry/EnterSpecificArea/PolygonArea/Corner/PointCoordinateType/Latitude`

Status	Occurrence	Format	Min. Access Types
Required	One	int	Get, Replace

This leaf node contains the latitudinal coordinate of a corner.

5.2.48B4A10

`<x>/<x>/OnNetwork/MCPTTGroupList/<x>/Entry/RulesForAffiliation/ListOfLocationCriteria/<x>/Entry/EnterSpecificArea/EllipsoidArcArea`

Table 5.2.48B4A10.1:

`<x>/<x>/OnNetwork/MCPTTGroupList/<x>/Entry/RulesForAffiliation/ListOfLocationCriteria/<x>/Entry/EnterSpecificArea/EllipsoidArcArea`

`<x>/OnNetwork/MCPTTGroupList/<x>/Entry/RulesForAffiliation/ListOfLocationCriteria/<x>/Entry/EnterSpecificArea/EllipsoidArcArea`

Status	Occurrence	Format	Min. Access Types
Optional	ZeroOrOne	node	Get, Replace

This interior node contains a geographical area described by an ellipsoid arc.

5.2.48B4A11

`<x>/<x>/OnNetwork/MCPTTGroupList/<x>/Entry/RulesForAffiliation/ListOfLocationCriteria/<x>/Entry/EnterSpecificArea/EllipsoidArcArea/Center`

Table 5.2.48B4A11.1: `<x>/<x>/OnNetwork/MCPTTGroupList/<x>/Entry/RulesForAffiliation/ListOfLocationCriteria/<x>/Entry/EnterSpecificArea/EllipsoidArcArea/Center`

`<x>/OnNetwork/MCPTTGroupList/<x>/Entry/RulesForAffiliation/ListOfLocationCriteria/<x>/Entry/EnterSpecificArea/EllipsoidArcArea/Center`

Status	Occurrence	Format	Min. Access Types
Required	One	node	Get, Replace

This interior node contains the coordinates of the center point of the ellipsoid arc.

5.2.48B4A12

`<x>/<x>/OnNetwork/MCPTTGroupList/<x>/Entry/RulesForAffiliation/ListOfLocationCriteria/<x>/Entry/EnterSpecificArea/EllipsoidArcArea/Center/PointCoordinateType`

Table 5.2.48B4A12.1:

`<x>/<x>/OnNetwork/MCPTTGroupList/<x>/Entry/RulesForAffiliation/ListOfLocationCriteria/<x>/Entry/EnterSpecificArea/EllipsoidArcArea/Center/PointCoordinateType`

`<x>/OnNetwork/MCPTTGroupList/<x>/Entry/RulesForAffiliation/ListOfLocationCriteria/<x>/Entry/EnterSpecificArea/EllipsoidArcArea/Center/PointCoordinateType`

Status	Occurrence	Format	Min. Access Types
Required	One	node	Get, Replace

This interior node contains the coordinates of the center point of the ellipsoid arc.

5.2.48B4A13

`<x>/<x>/OnNetwork/MCPTTGroupList/<x>/Entry/RulesForAffiliation/ListOfLocationCriteria/<x>/Entry/EnterSpecificArea/EllipsoidArcArea/Center/PointCoordinateType/Longitude`

Table 5.2.48B4A13.1:

`<x>/<x>/OnNetwork/MCPTTGroupList/<x>/Entry/RulesForAffiliation/ListOfLocationCriteria/<x>/Entry/EnterSpecificArea/EllipsoidArcArea/Center/PointCoordinateType/Longitude`

`<x>/OnNetwork/MCPTTGroupList/<x>/Entry/RulesForAffiliation/ListOfLocationCriteria/<x>/Entry/EnterSpecificArea/EllipsoidArcArea/Center/PointCoordinateType/ Longitude /`

Status	Occurrence	Format	Min. Access Types
Required	One	int	Get, Replace

This leaf node contains the longitudinal coordinate of the center.

5.2.48B4A14

`<x>/<x>/OnNetwork/MCPTTGroupList/<x>/Entry/RulesForAffiliation/ListOfLocationCriteria/<x>/Entry/EnterSpecificArea/EllipsoidArcArea/Center/PointCoordinateType/Latitude`

Table 5.2.48B4A14.1:

`<x>/<x>/OnNetwork/MCPTTGroupList/<x>/Entry/RulesForAffiliation/ListOfLocationCriteria/<x>/Entry/EnterSpecificArea/EllipsoidArcArea/Center/PointCoordinateType/Latitude`

`<x>/OnNetwork/MCPTTGroupList/<x>/Entry/RulesForAffiliation/ListOfLocationCriteria/<x>/Entry/EnterSpecificArea/EllipsoidArcArea/Center/PointCoordinateType/Latitude`

Status	Occurrence	Format	Min. Access Types
Required	One	int	Get, Replace

This leaf node contains the latitudinal coordinate of a center.

5.2.48B4A15

`<x>/<x>/OnNetwork/MCPTTGroupList/<x>/Entry/RulesForAffiliation/ListOfLocationCriteria/<x>/Entry/EnterSpecificArea/EllipsoidArcArea/Radius`

Table 5.2.48B4A15.1:

`<x>/<x>/OnNetwork/MCPTTGroupList/<x>/Entry/RulesForAffiliation/ListOfLocationCriteria/<x>/Entry/EnterSpecificArea/EllipsoidArcArea/Radius`

`<x>/OnNetwork/MCPTTGroupList/<x>/Entry/RulesForAffiliation/ListOfLocationCriteria/<x>/Entry/EnterSpecificArea/EllipsoidArcArea/Center/Radius`

Status	Occurrence	Format	Min. Access Types
Required	One	int	Get, Replace

This leaf node contains the radius of the ellipsoid arc.

5.2.48B4A16

`/<x>/<x>/OnNetwork/MCPTTGroupList/<x>/Entry/RulesForAffiliation/ListOfLocationCriteria/<x>/Entry/EnterSpecificArea/EllipsoidArcArea/OffsetAngle`

Table 5.2.48B4A16.1:

`/<x>/<x>/OnNetwork/MCPTTGroupList/<x>/Entry/RulesForAffiliation/ListOfLocationCriteria/<x>/Entry/EnterSpecificArea/EllipsoidArcArea/OffsetAngle`

`<x>/OnNetwork/MCPTTGroupList/<x>/Entry/RulesForAffiliation/ListOfLocationCriteria/<x>/Entry/EnterSpecificArea/EllipsoidArcArea/OffsetAngle`

Status	Occurrence	Format	Min. Access Types
Required	One	int	Get, Replace

This leaf node contains the offset angle of the ellipsoid arc.

5.2.48B4A17

`/<x>/<x>/OnNetwork/MCPTTGroupList/<x>/Entry/RulesForAffiliation/ListOfLocationCriteria/<x>/Entry/EnterSpecificArea/EllipsoidArcArea/IncludedAngle`

Table 5.2.48B4A17.1:

`/<x>/<x>/OnNetwork/MCPTTGroupList/<x>/Entry/RulesForAffiliation/ListOfLocationCriteria/<x>/Entry/EnterSpecificArea/EllipsoidArcArea/IncludedAngle`

`<x>/OnNetwork/MCPTTGroupList/<x>/Entry/RulesForAffiliation/ListOfLocationCriteria/<x>/Entry/EnterSpecificArea/EllipsoidArcArea/IncludedAngle`

Status	Occurrence	Format	Min. Access Types
Required	One	int	Get, Replace

This leaf node contains the included angle of the ellipsoid arc.

5.2.48B4A18

`/<x>/<x>/OnNetwork/MCPTTGroupList/<x>/Entry/RulesForAffiliation/ListOfLocationCriteria/<x>/Entry/EnterSpecificArea/Speed`

Table 5.2.48B4A18.1:

`/<x>/<x>/OnNetwork/MCPTTGroupList/<x>/Entry/RulesForAffiliation/ListOfLocationCriteria/<x>/Entry/EnterSpecificArea/Speed`

`<x>/OnNetwork/MCPTTGroupList/<x>/Entry/RulesForAffiliation/ListOfLocationCriteria/<x>/Entry/EnterSpecificArea/Speed`

Status	Occurrence	Format	Min. Access Types
Optional	One	node	Get, Replace

This interior node contains the speed.

5.2.48B4A19

/<x>/<x>/OnNetwork/MCPTTGroupList/<x>/Entry/RulesForAffiliation/ListOfLocationCriteria/<x>/Entry/EnterSpecificArea/Speed/MinimumSpeed

Table 5.2.48B4A19.1:

/<x>/<x>/OnNetwork/MCPTTGroupList/<x>/Entry/RulesForAffiliation/ListOfLocationCriteria/<x>/Entry/EnterSpecificArea/Speed/MinimumSpeed

<x>/OnNetwork/MCPTTGroupList/<x>/Entry/RulesForAffiliation/ListOfLocationCriteria/<x>/Entry/EnterSpecificArea/Speed/

Status	Occurrence	Format	Min. Access Types
Required	One	int	Get, Replace

This leaf node contains the minimum speed.

- Values: non-negative integer in units of kilometers/hour.

5.2.48B4A20

/<x>/<x>/OnNetwork/MCPTTGroupList/<x>/Entry/RulesForAffiliation/ListOfLocationCriteria/<x>/Entry/EnterSpecificArea/Speed/MaximumSpeed

Table 5.2.48B4A20.1:

/<x>/<x>/OnNetwork/MCPTTGroupList/<x>/Entry/RulesForAffiliation/ListOfLocationCriteria/<x>/Entry/EnterSpecificArea/Speed/MaximumSpeed

<x>/OnNetwork/MCPTTGroupList/<x>/Entry/RulesForAffiliation/ListOfLocationCriteria/<x>/Entry/EnterSpecificArea/Speed/

Status	Occurrence	Format	Min. Access Types
Required	One	int	Get, Replace

This leaf node contains the maximum speed.

- Values: non-negative integer in units of kilometers/hour.

5.2.48B4A21

/<x>/<x>/OnNetwork/MCPTTGroupList/<x>/Entry/RulesForAffiliation/ListOfLocationCriteria/<x>/Entry/EnterSpecificArea/Heading

Table 5.2.48B4A21.1:

/<x>/<x>/OnNetwork/MCPTTGroupList/<x>/Entry/RulesForAffiliation/ListOfLocationCriteria/<x>/Entry/EnterSpecificArea/Heading

<x>/OnNetwork/MCPTTGroupList/<x>/Entry/RulesForAffiliation/ListOfLocationCriteria/<x>/Entry/EnterSpecificArea/Heading

Status	Occurrence	Format	Min. Access Types
Optional	One	node	Get, Replace

This interior node contains the heading.

5.2.48B4A22

/<x>/<x>/OnNetwork/MCPTTGroupList/<x>/Entry/RulesForAffiliation/ListOfLocationCriteria/<x>/Entry/EnterSpecificArea/Heading/MinimumHeading

Table 5.2.48B4A22.1:

/<x>/<x>/OnNetwork/MCPTTGroupList/<x>/Entry/RulesForAffiliation/ListOfLocationCriteria/<x>/Entry/EnterSpecificArea/Heading/MinimumHeading

<x>/OnNetwork/MCPTTGroupList/<x>/Entry/RulesForAffiliation/ListOfLocationCriteria/<x>/Entry/EnterSpecificArea/Heading

Status	Occurrence	Format	Min. Access Types
Required	One	int	Get, Replace

This leaf node contains the minimum heading.

- Values: 0-359

5.2.48B4A23

/<x>/<x>/OnNetwork/MCPTTGroupList/<x>/Entry/RulesForAffiliation/ListOfLocationCriteria/<x>/Entry/EnterSpecificArea/Heading/MaximumHeading

Table 5.2.48B4A23.1:

/<x>/<x>/OnNetwork/MCPTTGroupList/<x>/Entry/RulesForAffiliation/ListOfLocationCriteria/<x>/Entry/EnterSpecificArea/Heading/MaximumHeading

<x>/OnNetwork/MCPTTGroupList/<x>/Entry/RulesForAffiliation/ListOfLocationCriteria/<x>/Entry/EnterSpecificArea/Heading

Status	Occurrence	Format	Min. Access Type
Required	One	int	Get, Replace

This leaf node contains the maximum heading.

- Values: 0-359

5.2.48B4A24

/<x>/<x>/OnNetwork/MCPTTGroupList/<x>/Entry/RulesForAffiliation/ListOfLocationCriteria/<x>/Entry/ExitSpecificArea

Table 5.2.48B4A24.1:

/<x>/<x>/OnNetwork/MCPTTGroupList/<x>/Entry/RulesForAffiliation/ListOfLocationCriteria/<x>/Entry/ExitSpecificArea

<x>/OnNetwork/MCPTTGroupList/<x>/Entry/RulesForAffiliation/ListOfLocationCriteria/<x>/Entry/ExitSpecificArea
a

Status	Occurrence	Format	Min. Access Types
Optional	One	node	Get, Replace

This interior node contains a geographical area which when entered by the MC service UE triggers evaluation of the rules..

5.2.48B4A25

`/<x>/<x>/OnNetwork/MCPTTGroupList/<x>/Entry/RulesForAffiliation/ListOfLocationCriteria/<x>/Entry/ExitSpecificArea/PolygonArea`

Table 5.2.48B4A25.1: `/<x>/<x>/OnNetwork/MCPTTGroupList/<x>/Entry/RulesForAffiliation/ListOfLocationCriteria/<x>/Entry/ExitSpecificArea/PolygonArea`

`<x>/OnNetwork/MCPTTGroupList/<x>/Entry/RulesForAffiliation/ListOfLocationCriteria/<x>/Entry/ExitSpecificArea/PolygonArea`

Status	Occurrence	Format	Min. Access Types
Optional	One	node	Get, Replace

This interior node contains a geographical area described by a polygon.

5.2.48B4A26

`/<x>/<x>/OnNetwork/MCPTTGroupList/<x>/Entry/RulesForAffiliation/ListOfLocationCriteria/<x>/Entry/ExitSpecificArea/PolygonArea/Corner`

Table 5.2.48B4A26.1: `/<x>/<x>/OnNetwork/MCPTTGroupList/<x>/Entry/RulesForAffiliation/ListOfLocationCriteria/<x>/Entry/ExitSpecificArea/PolygonArea/Corner`

`<x>/OnNetwork/MCPTTGroupList/<x>/Entry/RulesForAffiliation/ListOfLocationCriteria/<x>/Entry/ExitSpecificArea/PolygonArea/Corner`

Status	Occurrence	Format	Min. Access Types
Required	Three to fifteen	node	Get, Replace

This interior node contains the coordinates of the corners which define a polygon.

5.2.48B4A27

`/<x>/<x>/OnNetwork/MCPTTGroupList/<x>/Entry/RulesForAffiliation/ListOfLocationCriteria/<x>/Entry/ExitSpecificArea/PolygonArea/Corner/PointCoordinateType`

Table 5.2.48B4A27.1:

`/<x>/<x>/OnNetwork/MCPTTGroupList/<x>/Entry/RulesForAffiliation/ListOfLocationCriteria/<x>/Entry/ExitSpecificArea/PolygonArea/Corner/PointCoordinateType`

`<x>/OnNetwork/MCPTTGroupList/<x>/Entry/RulesForAffiliation/ListOfLocationCriteria/<x>/Entry/ExitSpecificArea/PolygonArea/Corner/PointCoordinateType`

Status	Occurrence	Format	Min. Access Types
Required	One	node	Get, Replace

This interior node contains the type of the coordinates.

5.2.48B4A28

`/<x>/<x>/OnNetwork/MCPTTGroupList/<x>/Entry/RulesForAffiliation/ListOfLocationCriteria/<x>/Entry/ExitSpecificArea/PolygonArea/Corner/PointCoordinateType/Longitude`

Table 5.2.48B4A28.1:

`/<x>/<x>/OnNetwork/MCPTTGroupList/<x>/Entry/RulesForAffiliation/ListOfLocationCriteria/<x>/Entry/ExitSpecificArea/PolygonArea/Corner/PointCoordinateType/Longitude`

`<x>/OnNetwork/MCPTTGroupList/<x>/Entry/RulesForAffiliation/ListOfLocationCriteria/<x>/Entry/ExitSpecificArea/PolygonArea/Corner/PointCoordinateType/ Longitude /`

Status	Occurrence	Format	Min. Access Types
Required	One	int	Get, Replace

This leaf node contains the longitudinal coordinate of a corner.

5.2.48B4A29

`/<x>/<x>/OnNetwork/MCPTTGroupList/<x>/Entry/RulesForAffiliation/ListOfLocationCriteria/<x>/Entry/ExitSpecificArea/PolygonArea/Corner/PointCoordinateType/Latitude`

Table 5.2.48B4A29.1:

`/<x>/<x>/OnNetwork/MCPTTGroupList/<x>/Entry/RulesForAffiliation/ListOfLocationCriteria/<x>/Entry/ExitSpecificArea/PolygonArea/Corner/PointCoordinateType/Latitude`

`<x>/OnNetwork/MCPTTGroupList/<x>/Entry/RulesForAffiliation/ListOfLocationCriteria/<x>/Entry/ExitSpecificArea/PolygonArea/Corner/PointCoordinateType/Latitude`

Status	Occurrence	Format	Min. Access Types
Required	One	int	Get, Replace

This leaf node contains the latitudinal coordinate of a corner.

5.2.48B4A30

`/<x>/<x>/OnNetwork/MCPTTGroupList/<x>/Entry/RulesForAffiliation/ListOfLocationCriteria/<x>/Entry/ExitSpecificArea/EllipsoidArcArea`

Table 5.2.48B4A30.1:

`/<x>/<x>/OnNetwork/MCPTTGroupList/<x>/Entry/RulesForAffiliation/ListOfLocationCriteria/<x>/Entry/ExitSpecificArea/EllipsoidArcArea`

`<x>/OnNetwork/MCPTTGroupList/<x>/Entry/RulesForAffiliation/ListOfLocationCriteria/<x>/Entry/ExitSpecificArea/EllipsoidArcArea`

Status	Occurrence	Format	Min. Access Types
Optional	ZeroOrOne	node	Get, Replace

This interior node contains a geographical area described by an ellipsoid arc.

5.2.48B4A31

`/<x>/<x>/OnNetwork/MCPTTGroupList/<x>/Entry/RulesForAffiliation/ListOfLocationCriteria/<x>/Entry/ExitSpecificArea/EllipsoidArcArea/Center`

Table 5.2.48B4A31.1: `/<x>/<x>/OnNetwork/MCPTTGroupList/<x>/Entry/RulesForAffiliation/ListOfLocationCriteria/<x>/Entry/ExitSpecificArea/EllipsoidArcArea/Center`

`<x>/OnNetwork/MCPTTGroupList/<x>/Entry/RulesForAffiliation/ListOfLocationCriteria/<x>/Entry/ExitSpecificArea/EllipsoidArcArea/Center`

Status	Occurrence	Format	Min. Access Types
Required	One	node	Get, Replace

This interior node contains the coordinates of the center point of the ellipsoid arc.

5.2.48B4A32

`/<x>/<x>/OnNetwork/MCPTTGroupList/<x>/Entry/RulesForAffiliation/ListOfLocationCriteria/<x>/Entry/ExitSpecificArea/EllipsoidArcArea/Center/PointCoordinateType`

Table 5.2.48B4A32.1:

`/<x>/<x>/OnNetwork/MCPTTGroupList/<x>/Entry/RulesForAffiliation/ListOfLocationCriteria/<x>/Entry/ExitSpecificArea/EllipsoidArcArea/Center/PointCoordinateType`

`<x>/OnNetwork/MCPTTGroupList/<x>/Entry/RulesForAffiliation/ListOfLocationCriteria/<x>/Entry/ExitSpecificArea/EllipsoidArcArea/Center/PointCoordinateType`

Status	Occurrence	Format	Min. Access Types
Required	One	node	Get, Replace

This interior node contains the coordinates of the center point of the ellipsoid arc.

5.2.48B4A33

`/<x>/<x>/OnNetwork/MCPTTGroupList/<x>/Entry/RulesForAffiliation/ListOfLocationCriteria/<x>/Entry/ExitSpecificArea/EllipsoidArcArea/Center/PointCoordinateType/Longitude`

Table 5.2.48B4A33.1:

`/<x>/<x>/OnNetwork/MCPTTGroupList/<x>/Entry/RulesForAffiliation/ListOfLocationCriteria/<x>/Entry/ExitSpecificArea/EllipsoidArcArea/Center/PointCoordinateType/Longitude`

`<x>/OnNetwork/MCPTTGroupList/<x>/Entry/RulesForAffiliation/ListOfLocationCriteria/<x>/Entry/ExitSpecificArea/EllipsoidArcArea/Center/PointCoordinateType/ Longitude /`

Status	Occurrence	Format	Min. Access Types
Required	One	int	Get, Replace

This leaf node contains the longitudinal coordinate of the center.

5.2.48B4A34

`/<x>/<x>/OnNetwork/MCPTTGroupList/<x>/Entry/RulesForAffiliation/ListOfLocationCriteria/<x>/Entry/ExitSpecificArea/EllipsoidArcArea/Center/PointCoordinateType/Latitude`

Table 5.2.48B4A34.1:

`/<x>/<x>/OnNetwork/MCPTTGroupList/<x>/Entry/RulesForAffiliation/ListOfLocationCriteria/<x>/Entry/ExitSpecificArea/EllipsoidArcArea/Center/PointCoordinateType/Latitude`

`<x>/OnNetwork/MCPTTGroupList/<x>/Entry/RulesForAffiliation/ListOfLocationCriteria/<x>/Entry/ExitSpecificArea/EllipsoidArcArea/Center/PointCoordinateType/Latitude`

Status	Occurrence	Format	Min. Access Types
Required	One	int	Get, Replace

This leaf node contains the latitudinal coordinate of a center.

5.2.48B4A35

`/<x>/<x>/OnNetwork/MCPTTGroupList/<x>/Entry/RulesForAffiliation/ListOfLocationCriteria/<x>/Entry/ExitSpecificArea/EllipsoidArcArea/Radius`

Table 5.2.48B4A35.1:

`/<x>/<x>/OnNetwork/MCPTTGroupList/<x>/Entry/RulesForAffiliation/ListOfLocationCriteria/<x>/Entry/ExitSpecificArea/EllipsoidArcArea/Radius`

`<x>/OnNetwork/MCPTTGroupList/<x>/Entry/RulesForAffiliation/ListOfLocationCriteria/<x>/Entry/ExitSpecificArea/EllipsoidArcArea/Center/Radius`

Status	Occurrence	Format	Min. Access Types
Required	One	int	Get, Replace

This leaf node contains the radius of the ellipsoid arc.

5.2.48B4A36

`/<x>/<x>/OnNetwork/MCPTTGroupList/<x>/Entry/RulesForAffiliation/ListOfLocationCriteria/<x>/Entry/ExitSpecificArea/EllipsoidArcArea/OffsetAngle`

Table 5.2.48B4A36.1:

`/<x>/<x>/OnNetwork/MCPTTGroupList/<x>/Entry/RulesForAffiliation/ListOfLocationCriteria/<x>/Entry/ExitSpecificArea/EllipsoidArcArea/OffsetAngle`

`<x>/OnNetwork/MCPTTGroupList/<x>/Entry/RulesForAffiliation/ListOfLocationCriteria/<x>/Entry/ExitSpecificArea/EllipsoidArcArea/OffsetAngle`

Status	Occurrence	Format	Min. Access Types
Required	One	int	Get, Replace

This leaf node contains the offset angle of the ellipsoid arc.

5.2.48B4A37

`/<x>/<x>/OnNetwork/MCPTTGroupList/<x>/Entry/RulesForAffiliation/ListOfLocationCriteria/<x>/Entry/ExitSpecificArea/EllipsoidArcArea/IncludedAngle`

Table 5.2.48B4A37.1:

`/<x>/<x>/OnNetwork/MCPTTGroupList/<x>/Entry/RulesForAffiliation/ListOfLocationCriteria/<x>/Entry/ExitSpecificArea/EllipsoidArcArea/IncludedAngle`

`<x>/OnNetwork/MCPTTGroupList/<x>/Entry/RulesForAffiliation/ListOfLocationCriteria/<x>/Entry/ExitSpecificArea/EllipsoidArcArea/IncludedAngle`

Status	Occurrence	Format	Min. Access Types
Required	One	int	Get, Replace

This leaf node contains the included angle of the ellipsoid arc.

5.2.48B4A38

/<x>/<x>/OnNetwork/MCPTTGroupList/<x>/Entry/RulesForAffiliation/ListOfLocationCriteria/<x>/Entry/ExitSpecificArea/Speed

Table 5.2.48B4A38.1:

/<x>/<x>/OnNetwork/MCPTTGroupList/<x>/Entry/RulesForAffiliation/ListOfLocationCriteria/<x>/Entry/ExitSpecificArea/Speed

<x>/OnNetwork/MCPTTGroupList/<x>/Entry/RulesForAffiliation/ListOfLocationCriteria/<x>/Entry/ExitSpecificArea/Speed

Status	Occurrence	Format	Min. Access Types
Optional	One	node	Get, Replace

This interior node contains the speed.

5.2.48B4A39

/<x>/<x>/OnNetwork/MCPTTGroupList/<x>/Entry/RulesForAffiliation/ListOfLocationCriteria/<x>/Entry/ExitSpecificArea/Speed/MinimumSpeed

Table 5.2.48B4A39.1:

/<x>/<x>/OnNetwork/MCPTTGroupList/<x>/Entry/RulesForAffiliation/ListOfLocationCriteria/<x>/Entry/ExitSpecificArea/Speed/MinimumSpeed

<x>/OnNetwork/MCPTTGroupList/<x>/Entry/RulesForAffiliation/ListOfLocationCriteria/<x>/Entry/ExitSpecificArea/Speed/MinimumSpeed

Status	Occurrence	Format	Min. Access Types
Required	One	int	Get, Replace

This leaf node contains the minimum speed.

- Values: non-negative integer in units of kilometers/hour.

5.2.48B4A40

/<x>/<x>/OnNetwork/MCPTTGroupList/<x>/Entry/RulesForAffiliation/ListOfLocationCriteria/<x>/Entry/ExitSpecificArea/Speed/MaximumSpeed

Table 5.2.48B4A40.1:

/<x>/<x>/OnNetwork/MCPTTGroupList/<x>/Entry/RulesForAffiliation/ListOfLocationCriteria/<x>/Entry/ExitSpecificArea/Speed/MaximumSpeed

<x>/OnNetwork/MCPTTGroupList/<x>/Entry/RulesForAffiliation/ListOfLocationCriteria/<x>/Entry/ExitSpecificArea/Speed/MaximumSpeed

Status	Occurrence	Format	Min. Access Types
Required	One	int	Get, Replace

This leaf node contains the maximum speed.

- Values: non-negative integer in units of kilometers/hour.

5.2.48B4A41

`/<x>/<x>/OnNetwork/MCPTTGroupList/<x>/Entry/RulesForAffiliation/ListOfLocationCriteria/<x>/Entry/ExitSpecificArea/Heading`

Table 5.2.48B4A41.1:

`/<x>/<x>/OnNetwork/MCPTTGroupList/<x>/Entry/RulesForAffiliation/ListOfLocationCriteria/<x>/Entry/ExitSpecificArea/Heading`

`<x>/OnNetwork/MCPTTGroupList/<x>/Entry/RulesForAffiliation/ListOfLocationCriteria/<x>/Entry/ExitSpecificArea/Heading`

Status	Occurrence	Format	Min. Access Types
Optional	One	node	Get, Replace

This interior node contains the heading.

5.2.48B4A42

`/<x>/<x>/OnNetwork/MCPTTGroupList/<x>/Entry/RulesForAffiliation/ListOfLocationCriteria/<x>/Entry/ExitSpecificArea/Heading/MinimumHeading`

Table 5.2.48B4A42.1:

`/<x>/<x>/OnNetwork/MCPTTGroupList/<x>/Entry/RulesForAffiliation/ListOfLocationCriteria/<x>/Entry/ExitSpecificArea/Heading/MinimumHeading`

`<x>/OnNetwork/MCPTTGroupList/<x>/Entry/RulesForAffiliation/ListOfLocationCriteria/<x>/Entry/ExitSpecificArea/Heading/`

Status	Occurrence	Format	Min. Access Types
Required	One	int	Get, Replace

This leaf node contains the minimum heading.

- Values: 0-359

5.2.48B4A43

`/<x>/<x>/OnNetwork/MCPTTGroupList/<x>/Entry/RulesForAffiliation/ListOfLocationCriteria/<x>/Entry/ExitSpecificArea/Heading/MaximumHeading`

Table 5.2.48B4A43.1:

`/<x>/<x>/OnNetwork/MCPTTGroupList/<x>/Entry/RulesForAffiliation/ListOfLocationCriteria/<x>/Entry/ExitSpecificArea/Heading/MaximumHeading`

`<x>/OnNetwork/MCPTTGroupList/<x>/Entry/RulesForAffiliation/ListOfLocationCriteria/<x>/Entry/ExitSpecificArea/Heading/`

Status	Occurrence	Format	Min. Access Types
Required	One	int	Get, Replace

This leaf node contains the maximum heading.

- Values: 0-359

5.2.48B4A44

`/<x>/<x>/OnNetwork/MCPTTGroupList/<x>/Entry/RulesForAffiliation/ListOfActiveFunctionalAliases`

Table 5.2.48B4A44.1:

`/<x>/<x>/OnNetwork/MCPTTGroupList/<x>/Entry/RulesForAffiliation/ListOfActiveFunctionalAliases`

`<x>/OnNetwork/MCPTTGroupList/<x>/Entry/RulesForAffiliation/ListOfActiveFunctionalAliases`

Status	Occurrence	Format	Min. Access Types
Optional	One	node	Get, Replace

This interior node is a placeholder for the functional alias part of rules that control automatic affiliation.

5.2.48B4A45

`/<x>/<x>/OnNetwork/MCPTTGroupList/<x>/Entry/RulesForAffiliation/ListOfActiveFunctionalAliases/<x>`

Table 5.2.48B4A45.1:

`/<x>/<x>/OnNetwork/MCPTTGroupList/<x>/Entry/RulesForAffiliation/ListOfActiveFunctionalAliases/<x>`

`<x>/OnNetwork/MCPTTGroupList/<x>/Entry/RulesForAffiliation/ListOfActiveFunctionalAliases/<x>`

Status	Occurrence	Format	Min. Access Types
Optional	OneOrMore	node	Get, Replace

This interior node is a placeholder for the functional alias part of rules that control automatic affiliation.

5.2.48B4A46

`/<x>/<x>/OnNetwork/MCPTTGroupList/<x>/Entry/RulesForAffiliation/ListOfActiveFunctionalAliases/<x>/Entry`

Table 5.2.48B4A46.1:

`/<x>/<x>/OnNetwork/MCPTTGroupList/<x>/Entry/RulesForAffiliation/ListOfActiveFunctionalAliases/<x>/Entry`

`<x>/OnNetwork/MCPTTGroupList/<x>/Entry/RulesForAffiliation/ListOfActiveFunctionalAliases/<x>/Entry`

Status	Occurrence	Format	Min. Access Types
Optional	One	node	Get, Replace

This interior node is a placeholder for the functional alias part of rules that control automatic affiliation.

5.2.48B4A47

`/<x>/<x>/OnNetwork/MCPTTGroupList/<x>/Entry/RulesForAffiliation/ListOfActiveFunctionalAliases/<x>/Entry/FunctionalAlias`

Table 5.2.48B4A47.1:

`/<x>/<x>/OnNetwork/MCPTTGroupList/<x>/Entry/RulesForAffiliation/ListOfActiveFunctionalAliases/<x>/Entry/FunctionalAlias`

`<x>/OnNetwork/MCPTTGroupList/<x>/Entry/RulesForAffiliation/ListOfActiveFunctionalAliases/<x>/Entry/FunctionalAlias`

Status	Occurrence	Format	Min. Access Types
Required	One	chr	Get, Replace

This leaf node contains a functional alias.

5.2.48B4B

`/<x>/<x>/OnNetwork/MCPTTGroupList/<x>/Entry/RulesForDeaffiliation`

Table 5.2.48B4A.1: `/<x>/<x>/OnNetwork/MCPTTGroupList/<x>/Entry/RulesForDeaffiliation`

`<x>/OnNetwork/MCPTTGroupList/<x>/Entry/RulesForDeaffiliation`

Status	Occurrence	Format	Min. Access Types
Optional	ZeroOrMore	node	Get, Replace

This interior node is a placeholder for the rules that control automatic deaffiliation.

5.2.48B4B1

`/<x>/<x>/OnNetwork/MCPTTGroupList/<x>/Entry/RulesForDeaffiliation/ListOfLocationCriteria/`

Table 5.2.48B4A1.1:

`/<x>/<x>/OnNetwork/MCPTTGroupList/<x>/Entry/RulesForDeaffiliation/ListOfLocationCriteria`

`<x>/OnNetwork/MCPTTGroupList/<x>/Entry/RulesForDeaffiliation/ListOfLocationCriteria`

Status	Occurrence	Format	Min. Access Types
Optional	One	node	Get, Replace

This interior node is a placeholder for the location portion of the rules that control deautomatic affiliation.

5.2.48B4B2

`/<x>/<x>/OnNetwork/MCPTTGroupList/<x>/Entry/RulesForDeaffiliation/ListOfLocationCriteria/<x>`

Table 5.2.48B84B2.1:

`/<x>/<x>/OnNetwork/MCPTTGroupList/<x>/Entry/RulesForDeaffiliation/ListOfLocationCriteria/<x>`

`<x>/OnNetwork/MCPTTGroupList/<x>/Entry/RulesForDeaffiliation/ListOfLocationCriteria/<x>`

Status	Occurrence	Format	Min. Access Types
Optional	ZeroOrMore	node	Get, Replace

This interior node is a placeholder for the location portion of the rules that control automatic deaffiliation.

5.2.48B4B3

`/<x>/<x>/OnNetwork/MCPTTGroupList/<x>/Entry/RulesForDeaffiliation/ListOfLocationCriteria/<x>/Entry`

Table 5.2.48B4B3.1:

`/<x>/<x>/OnNetwork/MCPTTGroupList/<x>/Entry/RulesForDeaffiliation/ListOfLocationCriteria/<x>/Entry`

`<x>/OnNetwork/MCPTTGroupList/<x>/Entry/RulesForDeaffiliation/ListOfLocationCriteria/<x>/Entry`

Status	Occurrence	Format	Min. Access Types
Optional	One	node	Get, Replace

This interior node is a placeholder for the location portion of the rules that control automatic deaffiliation.

5.2.48B4B4

`/<x>/<x>/OnNetwork/MCPTTGroupList/<x>/Entry/RulesForDeaffiliation/ListOfLocationCriteria/<x>/Entry/EnterSpecificArea`

Table 5.2.48B4B4.1:

`/<x>/<x>/OnNetwork/MCPTTGroupList/<x>/Entry/RulesForDeaffiliation/ListOfLocationCriteria/<x>/Entry/EnterSpecificArea`

`<x>/OnNetwork/MCPTTGroupList/<x>/Entry/RulesForDeaffiliation/ListOfLocationCriteria/<x>/Entry/EnterSpecificArea`

Status	Occurrence	Format	Min. Access Types
Optional	One	node	Get, Replace

This interior node contains a geographical area which, when entered by the MC service UE triggers evaluation of the rules..

5.2.48B4B5

`/<x>/<x>/OnNetwork/MCPTTGroupList/<x>/Entry/RulesForDeaffiliation/ListOfLocationCriteria/<x>/Entry/EnterSpecificArea/PolygonArea`

Table 5.2.48B4B5.1: `/<x>/<x>/OnNetwork/MCPTTGroupList/<x>/Entry/RulesForDeaffiliation/ListOfLocationCriteria/<x>/Entry/EnterSpecificArea/PolygonArea`

`<x>/OnNetwork/MCPTTGroupList/<x>/Entry/RulesForDeaffiliation/ListOfLocationCriteria/<x>/Entry/EnterSpecificArea/PolygonArea`

Status	Occurrence	Format	Min. Access Types
Optional	One	node	Get, Replace

This interior node contains a geographical area described by a polygon.

5.2.48B4B6

`/<x>/<x>/OnNetwork/MCPTTGroupList/<x>/Entry/RulesForDeaffiliation/ListOfLocationCriteria/<x>/Entry/EnterSpecificArea/PolygonArea/Corner`

Table 5.2.48B4B6.1: `/<x>/<x>/OnNetwork/MCPTTGroupList/<x>/Entry/RulesForDeaffiliation/ListOfLocationCriteria/<x>/Entry/EnterSpecificArea/PolygonArea/Corner`

`<x>/OnNetwork/MCPTTGroupList/<x>/Entry/RulesForDeaffiliation/ListOfLocationCriteria/<x>/Entry/EnterSpecificArea/PolygonArea/Corner`

Status	Occurrence	Format	Min. Access Types
Required	Three to fifteen	node	Get, Replace

This interior node contains the coordinates of the corners which define a polygon.

5.2.48B4B7

`/<x>/<x>/OnNetwork/MCPTTGroupList/<x>/Entry/RulesForDeaffiliation/ListOfLocationCriteria/<x>/Entry/EnterSpecificArea/PolygonArea/Corner/PointCoordinateType`

Table 5.2.48B4B7.1:

`/<x>/<x>/OnNetwork/MCPTTGroupList/<x>/Entry/RulesFordeaffiliation/ListOfLocationCriteria/<x>/Entry/EnterSpecificArea/PolygonArea/Corner/PointCoordinateType`

`<x>/OnNetwork/MCPTTGroupList/<x>/Entry/RulesForDeaffiliation/ListOfLocationCriteria/<x>/Entry/EnterSpecificArea/PolygonArea/Corner/PointCoordinateType`

Status	Occurrence	Format	Min. Access Types

Required	One	node	Get, Replace
----------	-----	------	--------------

This interior node contains the type of the coordinates.

5.2.48B4B8

/<x>/<x>/OnNetwork/MCPTTGroupList/<x>/Entry/RulesForDeaffiliation/ListOfLocationCriteria/<x>/Entry/EnterSpecificArea/PolygonArea/Corner/PointCoordinateType/Longitude

Table 5.2.48B4B8.1:

/<x>/<x>/OnNetwork/MCPTTGroupList/<x>/Entry/RulesForDeaffiliation/ListOfLocationCriteria/<x>/Entry/EnterSpecificArea/PolygonArea/Corner/PointCoordinateType/Longitude

<x>/OnNetwork/MCPTTGroupList/<x>/Entry/RulesForDeaffiliation/ListOfLocationCriteria/<x>/Entry/EnterSpecificArea/PolygonArea/Corner/PointCoordinateType/ Longitude /

Status	Occurrence	Format	Min. Access Types
Required	One	int	Get, Replace

This leaf node contains the longitudinal coordinate of a corner.

5.2.48B4B9

/<x>/<x>/OnNetwork/MCPTTGroupList/<x>/Entry/RulesForAffiliation/ListOfLocationCriteria/<x>/Entry/EnterSpecificArea/PolygonArea/Corner/PointCoordinateType/Latitude

Table 5.2.48B4B9.1:

/<x>/<x>/OnNetwork/MCPTTGroupList/<x>/Entry/RulesForAffiliation/ListOfLocationCriteria/<x>/Entry/EnterSpecificArea/PolygonArea/Corner/PointCoordinateType/Latitude

<x>/OnNetwork/MCPTTGroupList/<x>/Entry/RulesForAffiliation/ListOfLocationCriteria/<x>/Entry/EnterSpecificArea/PolygonArea/Corner/PointCoordinateType/Latitude

Status	Occurrence	Format	Min. Access Types
Required	One	int	Get, Replace

This leaf node contains the latitudinal coordinate of a corner.

5.2.48B4B10

/<x>/<x>/OnNetwork/MCPTTGroupList/<x>/Entry/RulesForDeaffiliation/ListOfLocationCriteria/<x>/Entry/EnterSpecificArea/EllipsoidArcArea

Table 5.2.48B4B10.1:

/<x>/<x>/OnNetwork/MCPTTGroupList/<x>/Entry/RulesForDeaffiliation/ListOfLocationCriteria/<x>/Entry/EnterSpecificArea/EllipsoidArcArea

<x>/OnNetwork/MCPTTGroupList/<x>/Entry/RulesForDeaffiliation/ListOfLocationCriteria/<x>/Entry/EnterSpecificArea/EllipsoidArcArea

Status	Occurrence	Format	Min. Access Types
Optional	ZeroOrOne	node	Get, Replace

This interior node contains a geographical area described by an ellipsoid arc.

5.2.48B4A11

`/<x>/<x>/OnNetwork/MCPTTGroupList/<x>/Entry/RulesForDeaffiliation/ListOfLocationCriteria/<x>/Entry/EnterSpecificArea/EllipsoidArcArea/Center`

Table 5.2.48B4B11.1: `/<x>/<x>/OnNetwork/MCPTTGroupList/<x>/Entry/RulesForDeaffiliation/ListOfLocationCriteria/<x>/Entry/EnterSpecificArea/EllipsoidArcArea/Center`

`<x>/OnNetwork/MCPTTGroupList/<x>/Entry/RulesForDeaffiliation/ListOfLocationCriteria/<x>/Entry/EnterSpecificArea/EllipsoidArcArea/Center`

Status	Occurrence	Format	Min. Access Types
Required	One	node	Get, Replace

This interior node contains the coordinates of the center point of the ellipsoid arc.

5.2.48B4B12

`/<x>/<x>/OnNetwork/MCPTTGroupList/<x>/Entry/RulesForDeaffiliation/ListOfLocationCriteria/<x>/Entry/EnterSpecificArea/EllipsoidArcArea/Center/PointCoordinateType`

Table 5.2.48B4B12.1:

`/<x>/<x>/OnNetwork/MCPTTGroupList/<x>/Entry/RulesForDeaffiliation/ListOfLocationCriteria/<x>/Entry/EnterSpecificArea/EllipsoidArcArea/Center/PointCoordinateType`

`<x>/OnNetwork/MCPTTGroupList/<x>/Entry/RulesForDeaffiliation/ListOfLocationCriteria/<x>/Entry/EnterSpecificArea/EllipsoidArcArea/Center/PointCoordinateType`

Status	Occurrence	Format	Min. Access Types
Required	One	node	Get, Replace

This interior node contains the coordinates of the center point of the ellipsoid arc.

5.2.48B4B13

`/<x>/<x>/OnNetwork/MCPTTGroupList/<x>/Entry/RulesForDeaffiliation/ListOfLocationCriteria/<x>/Entry/EnterSpecificArea/EllipsoidArcArea/Center/PointCoordinateType/Longitude`

Table 5.2.48B4B13.1:

`/<x>/<x>/OnNetwork/MCPTTGroupList/<x>/Entry/RulesForDeaffiliation/ListOfLocationCriteria/<x>/Entry/EnterSpecificArea/EllipsoidArcArea/Center/PointCoordinateType/Longitude`

`<x>/OnNetwork/MCPTTGroupList/<x>/Entry/RulesForDeaffiliation/ListOfLocationCriteria/<x>/Entry/EnterSpecificArea/EllipsoidArcArea/Center/PointCoordinateType/ Longitude /`

Status	Occurrence	Format	Min. Access Types
Required	One	int	Get, Replace

This leaf node contains the longitudinal coordinate of the center.

5.2.48B4B14

`/<x>/<x>/OnNetwork/MCPTTGroupList/<x>/Entry/RulesForDeaffiliation/ListOfLocationCriteria/<x>/Entry/EnterSpecificArea/EllipsoidArcArea/Center/PointCoordinateType/Latitude`

Table 5.2.48B4B14.1:

`/<x>/<x>/OnNetwork/MCPTTGroupList/<x>/Entry/RulesForDeaffiliation/ListOfLocationCriteria/<x>/Entry/EnterSpecificArea/EllipsoidArcArea/Center/PointCoordinateType/Latitude`

`<x>/OnNetwork/MCPTTGroupList/<x>/Entry/RulesForDeaffiliation/ListOfLocationCriteria/<x>/Entry/EnterSpecificArea/EllipsoidArcArea/Center/PointCoordinateType/Latitude`

Status	Occurrence	Format	Min. Access Types
Required	One	int	Get, Replace

This leaf node contains the latitudinal coordinate of a center.

5.2.48B4B15

`/<x>/<x>/OnNetwork/MCPTTGroupList/<x>/Entry/RulesForDeaffiliation/ListOfLocationCriteria/<x>/Entry/EnterSpecificArea/EllipsoidArcArea/Radius`

Table 5.2.48B4B15.1:

`/<x>/<x>/OnNetwork/MCPTTGroupList/<x>/Entry/RulesForDeaffiliation/ListOfLocationCriteria/<x>/Entry/EnterSpecificArea/EllipsoidArcArea/Radius`

`<x>/OnNetwork/MCPTTGroupList/<x>/Entry/RulesForDeaffiliation/ListOfLocationCriteria/<x>/Entry/EnterSpecificArea/EllipsoidArcArea/Center/Radius`

Status	Occurrence	Format	Min. Access Types
Required	One	int	Get, Replace

This leaf node contains the radius of the ellipsoid arc.

5.2.48B4B16

`/<x>/<x>/OnNetwork/MCPTTGroupList/<x>/Entry/RulesForDeaffiliation/ListOfLocationCriteria/<x>/Entry/EnterSpecificArea/EllipsoidArcArea/OffsetAngle`

Table 5.2.48B4B16.1:

`/<x>/<x>/OnNetwork/MCPTTGroupList/<x>/Entry/RulesForDeaffiliation/ListOfLocationCriteria/<x>/Entry/EnterSpecificArea/EllipsoidArcArea/OffsetAngle`

`<x>/OnNetwork/MCPTTGroupList/<x>/Entry/RulesForDeaffiliation/ListOfLocationCriteria/<x>/Entry/EnterSpecificArea/EllipsoidArcArea/OffsetAngle`

Status	Occurrence	Format	Min. Access Types
Required	One	int	Get, Replace

This leaf node contains the offset angle of the ellipsoid arc.

5.2.48B4B17

/<x>/<x>/OnNetwork/MCPTTGroupList/<x>/Entry/RulesForDeaffiliation/ListOfLocationCriteria/<x>/Entry/EnterSpecificArea/EllipsoidArcArea/IncludedAngle

Table 5.2.48B4B17.1:

/<x>/<x>/OnNetwork/MCPTTGroupList/<x>/Entry/RulesForDeaffiliation/ListOfLocationCriteria/<x>/Entry/EnterSpecificArea/EllipsoidArcArea/IncludedAngle

<x>/OnNetwork/MCPTTGroupList/<x>/Entry/RulesForDeaffiliation/ListOfLocationCriteria/<x>/Entry/EnterSpecificArea/EllipsoidArcArea/IncludedAngle

Status	Occurrence	Format	Min. Access Types
Required	One	int	Get, Replace

This leaf node contains the included angle of the ellipsoid arc.

5.2.48B4B18

/<x>/<x>/OnNetwork/MCPTTGroupList/<x>/Entry/RulesFordeaffiliation/ListOfLocationCriteria/<x>/Entry/EnterSpecificArea/Speed

Table 5.2.48B4B18.1:

/<x>/<x>/OnNetwork/MCPTTGroupList/<x>/Entry/RulesForDeaffiliation/ListOfLocationCriteria/<x>/Entry/EnterSpecificArea/Speed

<x>/OnNetwork/MCPTTGroupList/<x>/Entry/RulesForDeaffiliation/ListOfLocationCriteria/<x>/Entry/EnterSpecificArea/Speed

Status	Occurrence	Format	Min. Access Types
Optional	One	node	Get, Replace

This interior node contains the speed.

5.2.48B4B19

/<x>/<x>/OnNetwork/MCPTTGroupList/<x>/Entry/RulesForDeaffiliation/ListOfLocationCriteria/<x>/Entry/EnterSpecificArea/Speed/MinimumSpeed

Table 5.2.48B4B19.1:

/<x>/<x>/OnNetwork/MCPTTGroupList/<x>/Entry/RulesForDeaffiliation/ListOfLocationCriteria/<x>/Entry/EnterSpecificArea/Speed/MinimumSpeed

<x>/OnNetwork/MCPTTGroupList/<x>/Entry/RulesForDeaffiliation/ListOfLocationCriteria/<x>/Entry/EnterSpecificArea/Speed

Status	Occurrence	Format	Min. Access Types
Required	One	int	Get, Replace

This leaf node contains the minimum speed.

- Values: non-negative integer in units of kilometers/hour.

5.2.48B4B20

`/<x>/<x>/OnNetwork/MCPTTGroupList/<x>/Entry/RulesForDeaffiliation/ListOfLocationCriteria/<x>/Entry/EnterSpecificArea/Speed/MaximumSpeed`

Table 5.2.48B4B20.1:

`/<x>/<x>/OnNetwork/MCPTTGroupList/<x>/Entry/RulesForDeaffiliation/ListOfLocationCriteria/<x>/Entry/EnterSpecificArea/Speed/MaximumSpeed`

`<x>/OnNetwork/MCPTTGroupList/<x>/Entry/RulesForDeaffiliation/ListOfLocationCriteria/<x>/Entry/EnterSpecificArea/Speed`

Status	Occurrence	Format	Min. Access Types
Required	One	int	Get, Replace

This leaf node contains the maximum speed.

- Values: non-negative integer in units of kilometers/hour.

5.2.48B4B21

`/<x>/<x>/OnNetwork/MCPTTGroupList/<x>/Entry/RulesForDeaffiliation/ListOfLocationCriteria/<x>/Entry/EnterSpecificArea/Heading`

Table 5.2.48B4B21.1:

`/<x>/<x>/OnNetwork/MCPTTGroupList/<x>/Entry/RulesForDeaffiliation/ListOfLocationCriteria/<x>/Entry/EnterSpecificArea/Heading`

`<x>/OnNetwork/MCPTTGroupList/<x>/Entry/RulesForDeaffiliation/ListOfLocationCriteria/<x>/Entry/EnterSpecificArea/Heading`

Status	Occurrence	Format	Min. Access Types
Optional	One	node	Get, Replace

This interior node contains the heading.

5.2.48B4B22

`/<x>/<x>/OnNetwork/MCPTTGroupList/<x>/Entry/RulesForDeaffiliation/ListOfLocationCriteria/<x>/Entry/EnterSpecificArea/Heading/MinimumHeading`

Table 5.2.48B4B22.1:

`/<x>/<x>/OnNetwork/MCPTTGroupList/<x>/Entry/RulesForDeaffiliation/ListOfLocationCriteria/<x>/Entry/EnterSpecificArea/Heading/MinimumHeading`

`<x>/OnNetwork/MCPTTGroupList/<x>/Entry/RulesForDeaffiliation/ListOfLocationCriteria/<x>/Entry/EnterSpecificArea/Heading`

Status	Occurrence	Format	Min. Access Types
Required	One	int	Get, Replace

This leaf node contains the minimum heading.

- Values: 0-359

5.2.48B4B23

`/<x>/<x>/OnNetwork/MCPTTGroupList/<x>/Entry/RulesForDeaffiliation/ListOfLocationCriteria/<x>/Entry/EnterSpecificArea/Heading/MaximumHeading`

Table 5.2.48B4B23.1:

`/<x>/<x>/OnNetwork/MCPTTGroupList/<x>/Entry/RulesForDeaffiliation/ListOfLocationCriteria/<x>/Entry/EnterSpecificArea/Heading/MaximumHeading`

`<x>/OnNetwork/MCPTTGroupList/<x>/Entry/RulesForDeaffiliation/ListOfLocationCriteria/<x>/Entry/EnterSpecificArea/Heading`

Status	Occurrence	Format	Min. Access Types
Required	One	int	Get, Replace

This leaf node contains the maximum heading.

- Values: 0-359

5.2.48B4B24

`/<x>/<x>/OnNetwork/MCPTTGroupList/<x>/Entry/RulesForDeaffiliation/ListOfLocationCriteria/<x>/Entry/ExitSpecificArea`

Table 5.2.48B4B24.1:

`/<x>/<x>/OnNetwork/MCPTTGroupList/<x>/Entry/RulesForDeaffiliation/ListOfLocationCriteria/<x>/Entry/ExitSpecificArea`

`<x>/OnNetwork/MCPTTGroupList/<x>/Entry/RulesForDeaffiliation/ListOfLocationCriteria/<x>/Entry/ExitSpecificArea`

Status	Occurrence	Format	Min. Access Types
Optional	One	node	Get, Replace

This interior node contains a geographical area which when entered by the MC service UE triggers evaluation of the rules..

5.2.48B4B25

`/<x>/<x>/OnNetwork/MCPTTGroupList/<x>/Entry/RulesForDeaffiliation/ListOfLocationCriteria/<x>/Entry/ExitSpecificArea/PolygonArea`

Table 5.2.48B4B25.1: `/<x>/<x>/OnNetwork/MCPTTGroupList/<x>/Entry/RulesForDeaffiliation/ListOfLocationCriteria/<x>/Entry/ExitSpecificArea/PolygonArea`

`<x>/OnNetwork/MCPTTGroupList/<x>/Entry/RulesForDeaffiliation/ListOfLocationCriteria/<x>/Entry/ExitSpecificArea/PolygonArea`

Status	Occurrence	Format	Min. Access Types
Optional	One	node	Get, Replace

This interior node contains a geographical area described by a polygon.

5.2.48B4B26

`/<x>/<x>/OnNetwork/MCPTTGroupList/<x>/Entry/RulesForDeaffiliation/ListOfLocationCriteria/<x>/Entry/ExitSpecificArea/PolygonArea/Corner`

Table 5.2.48B4B26.1: `/<x>/<x>/OnNetwork/MCPTTGroupList/<x>/Entry/RulesForDeaffiliation/ListOfLocationCriteria/<x>/Entry/ExitSpecificArea/PolygonArea/Corner`

`<x>/OnNetwork/MCPTTGroupList/<x>/Entry/RulesForDeaffiliation/ListOfLocationCriteria/<x>/Entry/ExitSpecificArea/PolygonArea/Corner`

Status	Occurrence	Format	Min. Access Types
Required	Three to fifteen	node	Get, Replace

This interior node contains the coordinates of the corners which define a polygon.

5.2.48B4B27

`/<x>/<x>/OnNetwork/MCPTTGroupList/<x>/Entry/RulesForDeaffiliation/ListOfLocationCriteria/<x>/Entry/ExitSpecificArea/PolygonArea/Corner/PointCoordinateType`

Table 5.2.48B4B27.1:

`/<x>/<x>/OnNetwork/MCPTTGroupList/<x>/Entry/RulesForDeaffiliation/ListOfLocationCriteria/<x>/Entry/ExitSpecificArea/PolygonArea/Corner/PointCoordinateType`

`<x>/OnNetwork/MCPTTGroupList/<x>/Entry/RulesForDeaffiliation/ListOfLocationCriteria/<x>/Entry/ExitSpecificArea/PolygonArea/Corner/PointCoordinateType`

Status	Occurrence	Format	Min. Access Types
Required	One	node	Get, Replace

This interior node contains the type of the coordinates.

5.2.48B4B28

`/<x>/<x>/OnNetwork/MCPTTGroupList/<x>/Entry/RulesForDeaffiliation/ListOfLocationCriteria/<x>/Entry/ExitSpecificArea/PolygonArea/Corner/PointCoordinateType/Longitude`

Table 5.2.48B4B28.1:

`/<x>/<x>/OnNetwork/MCPTTGroupList/<x>/Entry/RulesForDeaffiliation/ListOfLocationCriteria/<x>/Entry/ExitSpecificArea/PolygonArea/Corner/PointCoordinateType/Longitude`

`<x>/OnNetwork/MCPTTGroupList/<x>/Entry/RulesForDeaffiliation/ListOfLocationCriteria/<x>/Entry/ExitSpecificArea/PolygonArea/Corner/PointCoordinateType/Longitude`

Status	Occurrence	Format	Min. Access Types
Required	One	int	Get, Replace

This leaf node contains the longitudinal coordinate of a corner.

5.2.48B4B29

`/<x>/<x>/OnNetwork/MCPTTGroupList/<x>/Entry/RulesForDeaffiliation/ListOfLocationCriteria/<x>/Entry/ExitSpecificArea/PolygonArea/Corner/PointCoordinateType/Latitude`

Table 5.2.48B4B29.1:

`/<x>/<x>/OnNetwork/MCPTTGroupList/<x>/Entry/RulesForDeaffiliation/ListOfLocationCriteria/<x>/Entry/ExitSpecificArea/PolygonArea/Corner/PointCoordinateType/Latitude`

`<x>/OnNetwork/MCPTTGroupList/<x>/Entry/RulesForDeaffiliation/ListOfLocationCriteria/<x>/Entry/ExitSpecificArea/PolygonArea/Corner/PointCoordinateType/Latitude`

Status	Occurrence	Format	Min. Access Types
Required	One	int	Get, Replace

This leaf node contains the latitudinal coordinate of a corner.

5.2.48B4B30

`/<x>/<x>/OnNetwork/MCPTTGroupList/<x>/Entry/RulesForDeaffiliation/ListOfLocationCriteria/<x>/Entry/ExitSpecificArea/EllipsoidArcArea`

Table 5.2.48B4B30.1:

`/<x>/<x>/OnNetwork/MCPTTGroupList/<x>/Entry/RulesForDeaffiliation/ListOfLocationCriteria/<x>/Entry/ExitSpecificArea/EllipsoidArcArea`

`<x>/OnNetwork/MCPTTGroupList/<x>/Entry/RulesForDeaffiliation/ListOfLocationCriteria/<x>/Entry/ExitSpecificArea/EllipsoidArcArea`

Status	Occurrence	Format	Min. Access Types
Optional	ZeroOrOne	node	Get, Replace

This interior node contains a geographical area described by an ellipsoid arc.

5.2.48B4B31

`/<x>/<x>/OnNetwork/MCPTTGroupList/<x>/Entry/RulesForDeaffiliation/ListOfLocationCriteria/<x>/Entry/ExitSpecificArea/EllipsoidArcArea/Center`

Table 5.2.48B431.1: `/<x>/<x>/OnNetwork/MCPTTGroupList/<x>/Entry/RulesForDeaffiliation/ListOfLocationCriteria/<x>/Entry/ExitSpecificArea/EllipsoidArcArea/Center`

`<x>/OnNetwork/MCPTTGroupList/<x>/Entry/RulesForDeaffiliation/ListOfLocationCriteria/<x>/Entry/ExitSpecificArea/EllipsoidArcArea/Center`

Status	Occurrence	Format	Min. Access Types
Required	One	node	Get, Replace

This interior node contains the coordinates of the center point of the ellipsoid arc.

5.2.48B4B32

`/<x>/<x>/OnNetwork/MCPTTGroupList/<x>/Entry/RulesForDeaffiliation/ListOfLocationCriteria/<x>/Entry/ExitSpecificArea/EllipsoidArcArea/Center/PointCoordinateType`

Table 5.2.48B4B32.1:

`/<x>/<x>/OnNetwork/MCPTTGroupList/<x>/Entry/RulesForDeaffiliation/ListOfLocationCriteria/<x>/Entry/ExitSpecificArea/EllipsoidArcArea/Center/PointCoordinateType`

`<x>/OnNetwork/MCPTTGroupList/<x>/Entry/RulesForDeaffiliation/ListOfLocationCriteria/<x>/Entry/ExitSpecificArea/EllipsoidArcArea/Center/PointCoordinateType`

Status	Occurrence	Format	Min. Access Types
Required	One	node	Get, Replace

This interior node contains the coordinates of the center point of the ellipsoid arc.

5.2.48B4B33

`/<x>/<x>/OnNetwork/MCPTTGroupList/<x>/Entry/RulesForDeaffiliation/ListOfLocationCriteria/<x>/Entry/ExitSpecificArea/EllipsoidArcArea/Center/PointCoordinateType/Longitude`

Table 5.2.48B4B33.1:

`/<x>/<x>/OnNetwork/MCPTTGroupList/<x>/Entry/RulesForDeaffiliation/ListOfLocationCriteria/<x>/Entry/ExitSpecificArea/EllipsoidArcArea/Center/PointCoordinateType/Longitude`

`<x>/OnNetwork/MCPTTGroupList/<x>/Entry/RulesForDeaffiliation/ListOfLocationCriteria/<x>/Entry/ExitSpecificArea/EllipsoidArcArea/Center/PointCoordinateType/ Longitude /`

Status	Occurrence	Format	Min. Access Types
Required	One	int	Get, Replace

This leaf node contains the longitudinal coordinate of the center.

5.2.48B4B34

`/<x>/<x>/OnNetwork/MCPTTGroupList/<x>/Entry/RulesForDeaffiliation/ListOfLocationCriteria/<x>/Entry/ExitSpecificArea/EllipsoidArcArea/Center/PointCoordinateType/Latitude`

Table 5.2.48B4B34.1:

`/<x>/<x>/OnNetwork/MCPTTGroupList/<x>/Entry/RulesForDeaffiliation/ListOfLocationCriteria/<x>/Entry/ExitSpecificArea/EllipsoidArcArea/Center/PointCoordinateType/Latitude`

`<x>/OnNetwork/MCPTTGroupList/<x>/Entry/RulesForDeaffiliation/ListOfLocationCriteria/<x>/Entry/ExitSpecificArea/EllipsoidArcArea/Center/PointCoordinateType/Latitude`

Status	Occurrence	Format	Min. Access Types
Required	One	int	Get, Replace

This leaf node contains the latitudinal coordinate of a center.

5.2.48B4B35

/<x>/<x>/OnNetwork/MCPTTGroupList/<x>/Entry/RulesForDeaffiliation/ListOfLocationCriteria/<x>/Entry/ExitSpecificArea/EllipsoidArcArea/Radius

Table 5.2.48B4B35.1:

/<x>/<x>/OnNetwork/MCPTTGroupList/<x>/Entry/RulesForDeaffiliation/ListOfLocationCriteria/<x>/Entry/ExitSpecificArea/EllipsoidArcArea/Radius

<x>/OnNetwork/MCPTTGroupList/<x>/Entry/RulesForDeaffiliation/ListOfLocationCriteria/<x>/Entry/ExitSpecificArea/EllipsoidArcArea/Center/Radius

Status	Occurrence	Format	Min. Access Types
Required	One	int	Get, Replace

This leaf node contains the radius of the ellipsoid arc.

5.2.48B4B36

/<x>/<x>/OnNetwork/MCPTTGroupList/<x>/Entry/RulesForDeaffiliation/ListOfLocationCriteria/<x>/Entry/ExitSpecificArea/EllipsoidArcArea/OffsetAngle

Table 5.2.48B4B36.1:

/<x>/<x>/OnNetwork/MCPTTGroupList/<x>/Entry/RulesForDeaffiliation/ListOfLocationCriteria/<x>/Entry/ExitSpecificArea/EllipsoidArcArea/OffsetAngle

<x>/OnNetwork/MCPTTGroupList/<x>/Entry/RulesForDeaffiliation/ListOfLocationCriteria/<x>/Entry/ExitSpecificArea/EllipsoidArcArea/OffsetAngle

Status	Occurrence	Format	Min. Access Types
Required	One	int	Get, Replace

This leaf node contains the offset angle of the ellipsoid arc.

5.2.48B4B37

/<x>/<x>/OnNetwork/MCPTTGroupList/<x>/Entry/RulesForDeaffiliation/ListOfLocationCriteria/<x>/Entry/ExitSpecificArea/EllipsoidArcArea/IncludedAngle

Table 5.2.48B4B37.1:

/<x>/<x>/OnNetwork/MCPTTGroupList/<x>/Entry/RulesForDeaffiliation/ListOfLocationCriteria/<x>/Entry/ExitSpecificArea/EllipsoidArcArea/IncludedAngle

<x>/OnNetwork/MCPTTGroupList/<x>/Entry/RulesForDeaffiliation/ListOfLocationCriteria/<x>/Entry/ExitSpecificArea/EllipsoidArcArea/IncludedAngle

Status	Occurrence	Format	Min. Access Types
Required	One	int	Get, Replace

This leaf node contains the included angle of the ellipsoid arc.

5.2.48B4B38

`/<x>/<x>/OnNetwork/MCPTTGroupList/<x>/Entry/RulesForDeaffiliation/ListOfLocationCriteria/<x>/Entry/ExitSpecificArea/Speed`

Table 5.2.48B4B38.1:

`/<x>/<x>/OnNetwork/MCPTTGroupList/<x>/Entry/RulesForDeaffiliation/ListOfLocationCriteria/<x>/Entry/ExitSpecificArea/Speed`

`<x>/OnNetwork/MCPTTGroupList/<x>/Entry/RulesForDeaffiliation/ListOfLocationCriteria/<x>/Entry/ExitSpecificArea/Speed`

Status	Occurrence	Format	Min. Access Types
Optional	One	node	Get, Replace

This interior node contains the speed.

5.2.48B4B39

`/<x>/<x>/OnNetwork/MCPTTGroupList/<x>/Entry/RulesForDeaffiliation/ListOfLocationCriteria/<x>/Entry/ExitSpecificArea/Speed/MinimumSpeed`

Table 5.2.48B4B39.1:

`/<x>/<x>/OnNetwork/MCPTTGroupList/<x>/Entry/RulesForDeaffiliation/ListOfLocationCriteria/<x>/Entry/ExitSpecificArea/Speed/MinimumSpeed`

`<x>/OnNetwork/MCPTTGroupList/<x>/Entry/RulesForDeaffiliation/ListOfLocationCriteria/<x>/Entry/ExitSpecificArea/Speed/`

Status	Occurrence	Format	Min. Access Types
Required	One	int	Get, Replace

This leaf node contains the minimum speed.

- Values: non-negative integer in units of kilometers/hour.

5.2.48B4B40

`/<x>/<x>/OnNetwork/MCPTTGroupList/<x>/Entry/RulesForDeaffiliation/ListOfLocationCriteria/<x>/Entry/ExitSpecificArea/Speed/MaximumSpeed`

Table 5.2.48B4B40.1:

`/<x>/<x>/OnNetwork/MCPTTGroupList/<x>/Entry/RulesForDeaffiliation/ListOfLocationCriteria/<x>/Entry/ExitSpecificArea/Speed/MaximumSpeed`

`<x>/OnNetwork/MCPTTGroupList/<x>/Entry/RulesForDeaffiliation/ListOfLocationCriteria/<x>/Entry/ExitSpecificArea/Speed/`

Status	Occurrence	Format	Min. Access Types
Required	One	int	Get, Replace

This leaf node contains the maximum speed.

- Values: non-negative integer in units of kilometers/hour.

5.2.48B4B41

`/<x>/<x>/OnNetwork/MCPTTGroupList/<x>/Entry/RulesForDeaffiliation/ListOfLocationCriteria/<x>/Entry/ExitSpecificArea/Heading`

Table 5.2.48B4B41.1:

`/<x>/<x>/OnNetwork/MCPTTGroupList/<x>/Entry/RulesForDeaffiliation/ListOfLocationCriteria/<x>/Entry/ExitSpecificArea/Heading`

`<x>/OnNetwork/MCPTTGroupList/<x>/Entry/RulesForDeaffiliation/ListOfLocationCriteria/<x>/Entry/ExitSpecificArea/Heading`

Status	Occurrence	Format	Min. Access Types
Optional	One	node	Get, Replace

This interior node contains the heading.

5.2.48B4B42

`/<x>/<x>/OnNetwork/MCPTTGroupList/<x>/Entry/RulesForDeaffiliation/ListOfLocationCriteria/<x>/Entry/ExitSpecificArea/Heading/MinimumHeading`

Table 5.2.48B4B42.1:

`/<x>/<x>/OnNetwork/MCPTTGroupList/<x>/Entry/RulesForDeaffiliation/ListOfLocationCriteria/<x>/Entry/ExitSpecificArea/Heading/MinimumHeading`

`<x>/OnNetwork/MCPTTGroupList/<x>/Entry/RulesForDeaffiliation/ListOfLocationCriteria/<x>/Entry/ExitSpecificArea/Heading/MinimumHeading`

Status	Occurrence	Format	Min. Access Types
Required	One	int	Get, Replace

This leaf node contains the minimum heading.

- Values: 0-359

5.2.48B4B43

`/<x>/<x>/OnNetwork/MCPTTGroupList/<x>/Entry/RulesForDeaffiliation/ListOfLocationCriteria/<x>/Entry/ExitSpecificArea/Heading/MaximumHeading`

Table 5.2.48B4B43.1:

`/<x>/<x>/OnNetwork/MCPTTGroupList/<x>/Entry/RulesForDeaffiliation/ListOfLocationCriteria/<x>/Entry/ExitSpecificArea/Heading/MaximumHeading`

`<x>/OnNetwork/MCPTTGroupList/<x>/Entry/RulesForDeaffiliation/ListOfLocationCriteria/<x>/Entry/ExitSpecificArea/Heading/MaximumHeading`

Status	Occurrence	Format	Min. Access Types
Required	One	int	Get, Replace

This leaf node contains the maximum heading.

- Values: 0-359

5.2.48B4B44

`<x>/<x>/OnNetwork/MCPTTGroupList/<x>/Entry/RulesForDeaffiliation/ListOfActiveFunctionalAliases`

Table 5.2.48B4B44.1:

`<x>/<x>/OnNetwork/MCPTTGroupList/<x>/Entry/RulesForDeaffiliation/ListOfActiveFunctionalAliases`

`<x>/OnNetwork/MCPTTGroupList/<x>/Entry/RulesForAffiliation/ListOfActiveFunctionalAliases`

Status	Occurrence	Format	Min. Access Types
Optional	One	node	Get, Replace

This interior node is a placeholder for the functional alias part of rules that control automatic deaffiliation.

5.2.48B4B45

`<x>/<x>/OnNetwork/MCPTTGroupList/<x>/Entry/RulesForDeaffiliation/ListOfActiveFunctionalAliases/<x>`

Table 5.2.48B4B45.1:

`<x>/<x>/OnNetwork/MCPTTGroupList/<x>/Entry/RulesForDeaffiliation/ListOfActiveFunctionalAliases/<x>`

`<x>/OnNetwork/MCPTTGroupList/<x>/Entry/RulesForDeaffiliation/ListOfActiveFunctionalAliases/<x>`

Status	Occurrence	Format	Min. Access Types
Optional	OneOrMore	node	Get, Replace

This interior node is a placeholder for the functional alias part of rules that control automatic deaffiliation.

5.2.48B4B46

`<x>/<x>/OnNetwork/MCPTTGroupList/<x>/Entry/RulesForDeaffiliation/ListOfActiveFunctionalAliases/<x>/Entry`

Table 5.2.48B4B46.1:

`<x>/<x>/OnNetwork/MCPTTGroupList/<x>/Entry/RulesForDeaffiliation/ListOfActiveFunctionalAliases/<x>/Entry`

`<x>/OnNetwork/MCPTTGroupList/<x>/Entry/RulesForDeaffiliation/ListOfActiveFunctionalAliases/<x>/Entry`

Status	Occurrence	Format	Min. Access Types
Optional	One	node	Get, Replace

This interior node is a placeholder for the functional alias part of rules that control automatic deaffiliation.

5.2.48B4B47

`<x>/<x>/OnNetwork/MCPTTGroupList/<x>/Entry/RulesForDeaffiliation/ListOfActiveFunctionalAliases/<x>/Entry/FunctionalAlias`

Table 5.2.48B4B47.1:

`<x>/<x>/OnNetwork/MCPTTGroupList/<x>/Entry/RulesForDeaffiliation/ListOfActiveFunctionalAliases/<x>/Entry/FunctionalAlias`

`<x>/OnNetwork/MCPTTGroupList/<x>/Entry/RulesForDeaffiliation/ListOfActiveFunctionalAliases/<x>/Entry/FunctionalAlias`

Status	Occurrence	Format	Min. Access Types
Required	One	chr	Get, Replace

This leaf node contains a functional alias.

5.2.48B5/ <x>/<x>/OnNetwork/MCPTTGroupList/<x>/Entry/DisplayName

Table 5.2.48B5.1: /<x>/<x>/OnNetwork/MCPTTGroupList/<x>/Entry/DisplayName

<x>/OnNetwork/MCPTTGroupList/<x>/Entry/DisplayName

Status	Occurrence	Format	Min. Access Types
Optional	One	chr	Get, Replace

This leaf node contains a human readable name that corresponds to the MCPTT Group ID.

5.2.48B6

/<x>/<x>/OnNetwork/MCPTTGroupList/<x>/Entry/ManualDeAffiliationNotAllowedIfRulesAreMet

Table 5.2.48B4B6.1:**/<x>/<x>/OnNetwork/MCPTTGroupList/<x>/Entry/ManualDeAffiliationNotAllowedIfRulesAreMet**

<x>/OnNetwork/MCPTTGroupList/<x>/Entry/ManualDeAffiliationNotAllowedIfRulesAreMet

Status	Occurrence	Format	Min. Access Types
Optional	ZeroOrOne	bool	Get, Replace

This leaf node indicates whether the MCPTT user is authorised to deaffiliate if the location criteria is met.

5.2.48C1 /<x>/<x>/OnNetwork/ImplicitAffiliations

Table 5.2.48C1.1: /<x>/<x>/OnNetwork/ImplicitAffiliations

<x>/OnNetwork/ImplicitAffiliations

Status	Occurrence	Format	Min. Access Types
Required	One	node	Get, Replace

This interior node is a placeholder for the implicit affiliation configuration.

5.2.48C2 /<x>/<x>/OnNetwork/ImplicitAffiliations/<x>

Table 5.2.48C2.1: /<x>/<x>/OnNetwork/ImplicitAffiliations/<x>

<x>/OnNetwork/ImplicitAffiliations/<x>

Status	Occurrence	Format	Min. Access Types
Required	OneOrMore	node	Get, Replace

This interior node is a placeholder for one or more implicit affiliation configuration.

5.2.48C3 /<x>/<x>/OnNetwork/ImplicitAffiliations/<x>/Entry

Table 5.2.48C3.1: /<x>/<x>/OnNetwork/ImplicitAffiliations/<x>/Entry

<x>/OnNetwork/ImplicitAffiliations/<x>/Entry

Status	Occurrence	Format	Min. Access Types
Optional	One	node	Get, Replace

This interior node is a placeholder for the details of the on-network MCPTT groups that the MCPTT user is implicitly affiliated to.

5.2.48C4 /<x>/<x>/OnNetwork/ImplicitAffiliations/<x>/Entry/MCPTTGroupID

Table 5.2.48C4.1: /<x>/<x>/OnNetwork/ImplicitAffiliations/<x>/ Entry/MCPTTGroupID

<x>/OnNetwork/ImplicitAffiliations/<x>/ Entry/MCPTTGroupID

Status	Occurrence	Format	Min. Access Types
Required	One	chr	Get, Replace

This leaf node indicates a MCPTT group ID to which the MCPTT user is implicitly affiliated to.

The value is a "uri" attribute specified in OMA OMA-TS-XDM_Group-V1_1 [4].

5.2.48C5 /<x>/<x>/OnNetwork/ImplicitAffiliations/<x>/Entry/DisplayName

Table 5.2.48C5.1: /<x>/<x>/OnNetwork/ImplicitAffiliations/<x>/Entry/DisplayName

<x>/OnNetwork/ImplicitAffiliations/<x>/Entry/DisplayName

Status	Occurrence	Format	Min. Access Types
Optional	One	chr	Get, Replace

This leaf node contains a human readable name that corresponds to the MCPTT Group ID.

5.2.48D /<x>/<x>/OnNetwork/AllowedRegroup

Table 5.2.48D.1: /<x>/<x>/OnNetwork/AllowedRegroup

<x>/OnNetwork/AllowedRegroup

Status	Occurrence	Format	Min. Access Types
Required	One	bool	Get, Replace

This leaf node indicates whether the MCPTT user is authorised to perform dynamic regrouping operations.

When set to "true" the MCPTT user is authorised to perform dynamic regrouping operations.

When set to "false" the MCPTT user is not authorised to perform dynamic regrouping operations.

5.2.48E /<x>/<x>/OnNetwork/AllowedPresenceStatus

Table 5.2.48E.1: /<x>/<x>/OnNetwork/AllowedPresenceStatus

<x>/OnNetwork/AllowedPresenceStatus

Status	Occurrence	Format	Min. Access Types
Optional	One	bool	Get, Replace

This leaf node indicates the presence status on the network of this MCPTT user is available.

When set to "true" the presence status on the network of this MCPTT user is available.

When set to "false" the presence status on the network of this MCPTT user is not available. This is the default if this leaf node is not present.

5.2.48F /<x>/<x>/OnNetwork/AllowedPresence

Table 5.2.48F.1: /<x>/<x>/OnNetwork/AllowedPresence

<x>/OnNetwork/AllowedPresence

Status	Occurrence	Format	Min. Access Types
Optional	One	bool	Get, Replace

This leaf node indicates whether the MCPTT user is authorised to obtain whether a particular MCPTT User is present on the network.

When set to "true" the MCPTT user is authorised to obtain whether a particular MCPTT User is present on the network.

When set to "false" the MCPTT user is not authorised to obtain whether a particular MCPTT User is present on the network.

5.2.48G /<x>/<x>/OnNetwork/EnabledParticipation

Table 5.2.48G.1: /<x>/<x>/OnNetwork/EnabledParticipation

<x>/OnNetwork/EnabledParticipation

Status	Occurrence	Format	Min. Access Types
Required	One	bool	Get, Replace

This leaf node indicates whether the MCPTT user is allowed to participate in MCPTT private calls that they are invited to.

When set to "true" the MCPTT user is allowed to participate in MCPTT private calls that they are invited to.

When set to "false" the MCPTT user is not allowed to participate in MCPTT private calls that they are invited to.

5.2.48H /<x>/<x>/OnNetwork/AllowedTransmission

Table 5.2.48H.1: /<x>/<x>/OnNetwork/AllowedTransmission

<x>/OnNetwork/AllowedTransmission

Status	Occurrence	Format	Min. Access Types
Required	One	bool	Get, Replace

This leaf node indicates whether the MCPTT user is authorised to override transmission in a MCPTT private call.

When set to "true" the MCPTT user is authorised to override transmission in a MCPTT private call.

When set to "false" the MCPTT user is not authorised to override transmission in a MCPTT private call.

5.2.48I /<x>/<x>/OnNetwork/AllowedManualSwitch

Table 5.2.48I.1: /<x>/<x>/OnNetwork/AllowedManualSwitch

<x>/OnNetwork/AllowedManualSwitch

Status	Occurrence	Format	Min. Access Types
Required	One	bool	Get, Replace

This leaf node indicates whether the MCPTT user is authorised to manually switch to off-network operation while in on-network operation.

When set to "true" the MCPTT user is authorised to manually switch to off-network operation while in on-network operation.

When set to "false" the MCPTT user is not authorised to manually switch to off-network operation while in on-network operation.

5.2.48J /<x>/<x>/OnNetwork/PrivateCall

Table 5.2.48J.1: /<x>/<x>/OnNetwork/PrivateCall

<x>/OnNetwork/PrivateCall

Status	Occurrence	Format	Min. Access Types

Required	One	node	Get, Replace
----------	-----	------	--------------

This interior node is a placeholder for the MCPTT private call configuration.

5.2.48K /<x>/<x>/OnNetwork/PrivateCall/EmergencyAlert

Table 5.2.48K.1: /<x>/<x>/OnNetwork/PrivateCall/EmergencyAlert

<x>/OnNetwork/PrivateCall/EmergencyAlert

Status	Occurrence	Format	Min. Access Types
Required	One	node	Get, Replace

This interior node is a placeholder for the MCPTT private emergency alert policy.

5.2.48L /<x>/<x>/OnNetwork/PrivateCall/EmergencyAlert/Entry

Table 5.2.48L.1: /<x>/<x>/OnNetwork/PrivateCall/EmergencyAlert/Entry

<x>/OnNetwork/PrivateCall/EmergencyAlert/Entry

Status	Occurrence	Format	Min. Access Types
Required	One	node	Get, Replace

This interior node is a placeholder for the details of an MCPTT private emergency alert for on-network.

5.2.48M /<x>/<x>/OnNetwork/PrivateCall/EmergencyAlert/Entry/ID

Table 5.2.48M.1: /<x>/<x>/OnNetwork/PrivateCall/EmergencyAlert/Entry/ID

<x>/OnNetwork/PrivateCall/EmergencyAlert/Entry/ID

Status	Occurrence	Format	Min. Access Types
Required	One	chr	Get, Replace

This leaf node indicates the MCPTT user ID used upon certain criteria on initiation of an MCPTT private emergency alert for on-network.

5.2.48N /<x>/<x>/OnNetwork/PrivateCall/EmergencyAlert/Entry/DisplayName

Table 5.2.48N.1: /<x>/<x>/OnNetwork/PrivateCall/EmergencyAlert/Entry/DisplayName

<x>/OnNetwork/PrivateCall/EmergencyAlert/Entry/DisplayName

Status	Occurrence	Format	Min. Access Types
Optional	One	chr	Get, Replace

This leaf node contains a human readable name that corresponds to the ID.

5.2.48O /<x>/<x>/OnNetwork/PrivateCall/EmergencyAlert/Entry/Usage

Table 5.2.48O.1: /<x>/<x>/OnNetwork/PrivateCall/EmergencyAlert/Entry/Usage

<x>/OnNetwork/PrivateCall/EmergencyAlert/Entry/Usage

Status	Occurrence	Format	Min. Access Types
Required	One	chr	Get, Replace

This leaf node indicates the criteria to determine when initiation of an MCPTT private emergency alert uses the ID.

The valid values are 'LocallyDetermined' and 'UsePreConfigured'.

When set to 'LocallyDetermined' then if the MCPTT user selects an MCPTT ID then use that MCPTT ID for an on-network MCPTT private emergency alert, if the MCPTT user does not select a MCPTT ID then use the MCPTT ID identified by the ID in subclause 5.2.48M for an on-network MCPTT private emergency alert.

When set to 'UsePreConfigured' then use the ID identified by the ID in subclause 5.2.48M for an on-network MCPTT private emergency alert.

5.2.48P /<x>/<x>/OnNetwork/PrivateCall/AllowedCallBackRequest

Table 5.2.48P.1: /<x>/<x>/OnNetwork/PrivateCall/AllowedCallBackRequest

<x>/OnNetwork/PrivateCall/AllowedCallBackRequest

Status	Occurrence	Format	Min. Access Types
Optional	One	bool	Get, Replace

This leaf node indicates whether the MCPTT user is allowed to request a private call call-back.

When set to "true" the MCPTT user is allowed to request a private call call-back.

When set to "false" the MCPTT user is not allowed to request a private call call-back.

5.2.48Q /<x>/<x>/OnNetwork/PrivateCall/AllowedCallBackCancelRequest

Table 5.2.48Q.1: /<x>/<x>/OnNetwork/PrivateCall/AllowedCallBackCancelRequest

<x>/OnNetwork/PrivateCall/AllowedCallBackCancelRequest

Status	Occurrence	Format	Min. Access Types
Optional	One	bool	Get, Replace

This leaf node indicates whether the MCPTT user is allowed to cancel an outstanding private call call-back request.

When set to "true" the MCPTT user is allowed to cancel an outstanding private call call-back request.

When set to "false" the the MCPTT user is not allowed to cancel an outstanding private call call-back request.

5.2.48R

/<x>/<x>/OnNetwork/PrivateCall/AllowedRemoteInitiatedAmbientListening

Table 5.2.48R.1: /<x>/<x>/OnNetwork/PrivateCall/AllowedRemoteInitiatedAmbientListening

<x>/OnNetwork/PrivateCall/AllowedRemoteInitiatedAmbientListening

Status	Occurrence	Format	Min. Access Types
Optional	One	bool	Get, Replace

This leaf node indicates whether the MCPTT user is allowed to request a remote initiated ambient listening call.

When set to "true" the MCPTT user is allowed to request a remote initiated ambient listening call.

When set to "false" the MCPTT user is not allowed to request a remote initiated ambient listening call.

5.2.48S

/<x>/<x>/OnNetwork/PrivateCall/AllowedLocallyInitiatedAmbientListening

Table 5.2.48S.1: /<x>/<x>/OnNetwork/PrivateCall/AllowedLocallyInitiatedAmbientListening

<x>/OnNetwork/PrivateCall/AllowedLocallyInitiatedAmbientListening

Status	Occurrence	Format	Min. Access Types
Optional	One	bool	Get, Replace

This leaf node indicates whether the MCPTT user is allowed to request a locally initiated ambient listening call.

When set to "true" the MCPTT user is allowed to request a locally initiated ambient listening call.

When set to "false" the MCPTT user is not allowed to request a locally initiated ambient listening call.

5.2.48T /<x>/<x>/OnNetwork/PrivateCall/AllowedRequestFirstToAnswerCall

Table 5.2.48T.1: /<x>/<x>/OnNetwork/PrivateCall/AllowedRequestFirstToAnswerCall

<x>/OnNetwork/PrivateCall/AllowedRequestFirstToAnswerCall

Status	Occurrence	Format	Min. Access Types
Optional	One	bool	Get, Replace

This leaf node indicates whether the MCPTT user is allowed to request a first to answer call.

When set to "true" the MCPTT user is allowed to request a first to answer call.

When set to "false" the MCPTT user is not allowed to request a first to answer call.

5.2.48U1 /<x>/<x>/OnNetwork/RemoteGroupSelection

Table 5.2.48U1.1: /<x>/<x>/OnNetwork/RemoteGroupSelection

<x>/OnNetwork/RemoteGroupSelection

Status	Occurrence	Format	Min. Access Types
Required	One	node	Get, Replace

This interior node is a placeholder for the remote group selection configuration.

5.2.48U2 /<x>/<x>/OnNetwork/RemoteGroupSelection/<x>

Table 5.2.48U2.1: /<x>/<x>/OnNetwork/RemoteGroupSelection/<x>

<x>/OnNetwork/RemoteGroupSelection/<x>

Status	Occurrence	Format	Min. Access Types
Required	OneOrMore	node	Get, Replace

This interior node is a placeholder for one or more remote group selection configuration elements.

5.2.48U3 /<x>/<x>/OnNetwork/RemoteGroupSelection/<x>/Entry

Table 5.2.48U3.1: /<x>/<x>/OnNetwork/RemoteGroupSelection/<x>/Entry

<x>/OnNetwork/RemoteGroupSelection/<x>/Entry

Status	Occurrence	Format	Min. Access Types
Optional	One	node	Get, Replace

This interior node is a placeholder for the details of the on-network MCPTT users whose selected MCPTT group is allowed to be remotely changed by the MCPTT user.

5.2.48U4 /<x>/<x>/OnNetwork/RemoteGroupSelection/<x>/Entry/MCPTTID

Table 5.2.48U4.1: /<x>/<x>/OnNetwork/RemoteGroupSelection/<x>/Entry/MCPTTID

<x>/OnNetwork/RemoteGroupSelection/<x>/Entry/MCPTTID

Status	Occurrence	Format	Min. Access Types
Required	One	chr	Get, Replace

This leaf node indicates a MCPTT ID of an MCPTT user whose selected MCPTT group is allowed to be remotely changed by the MCPTT user.

The value is a "uri" attribute specified in OMA OMA-TS-XDM_Group-V1_1 [4].

5.2.48U5

/<x>/<x>/OnNetwork/RemoteGroupSelection/<x>/Entry/DisplayName

Table 5.2.48U5.1: /<x>/<x>/OnNetwork/RemoteGroupSelection/<x>/Entry/DisplayName

<x>/OnNetwork/RemoteGroupSelection/<x>/Entry/DisplayName

Status	Occurrence	Format	Min. Access Types
Optional	One	chr	Get, Replace

This leaf node contains a human readable name that corresponds to the MCPTT ID of the MCPTT user.

5.2.48V1/<x>/<x>/OnNetwork/GroupServerInfo

Table 5.2.48V1.1: /<x>/<x>/OnNetwork/GroupServerInfo

<x>/OnNetwork/GroupServerInfo

Status	Occurrence	Format	Min. Access Types
Required	One	node	Get, Replace

This interior node is a placeholder for the configured identity management an group management servers for the groups contained in the MCPTTGroupList

5.2.48V2/<x>/<x>/OnNetwork/GroupServerInfo/GMSServList

Table 5.2.48V2.1: /<x>/<x>/OnNetwork/GroupServerInfo/GMSServList

<x>/OnNetwork/GroupServerInfo/GMSServList

Status	Occurrence	Format	Min. Access Types
Required	One	node	Get, Replace

This interior node is a placeholder for the list of MCPTT group management server for the groups contained in the MCPTTGroupList.

5.2.48V3/<x>/<x>/OnNetwork/GroupServerInfo/GMSServList/<x>

Table 5.2.48V3.1: /<x>/<x>/OnNetwork/GroupServerInfo/GMSServList/<x>

<x>/OnNetwork/GroupServerInfo/GMSServList/<x>

Status	Occurrence	Format	Min. Access Types
Required	OneOrMore	node	Get, Replace

This interior node is a placeholder for the list of MCPTT group management server for the groups contained in the MCPTTGroupList.

5.2.48V4/ <x>/<x>/OnNetwork/GroupServerInfo/GMSServList/<x>/Entry

Table 5.2.48V4.1: /<x>/<x>/OnNetwork/GroupServerInfo/GMSServList/<x>/Entry

<x>/OnNetwork/GroupServerInfo/GMSServList/<x>/Entry

Status	Occurrence	Format	Min. Access Types
Optional	One	node	Get, Replace

This interior node is a placeholder for identity of the GMS owning a specific group contained in the MCPTTGroupList.

5.2.48V5

/<x>/<x>/OnNetwork/GroupServerInfo/GMSServList/<x>/Entry/GMSServID

Table 5.2.48V5.1: /<x>/<x>/OnNetwork/GroupServerInfo/GMSServList/<x>/Entry/GMSServID

<x>/OnNetwork/GroupServerInfo/GMSServList/<x>/Entry/GMSServID

Status	Occurrence	Format	Min. Access Types
Required	One	chr	Get, Replace

This leaf node indicates the identity (URI) of the GMS owning a specific group contained in the MCPTTGroupList.

5.2.48V6/ <x>/<x>/OnNetwork/GroupServerInfo/IDMSTokenEndpointList

Table 5.2.48V6.1: /<x>/<x>/OnNetwork/GroupServerInfo/IDMSTokenEndpointList

<x>/OnNetwork/GroupServerInfo/IDMSTokenEndpointList

Status	Occurrence	Format	Min. Access Types
Required	One	node	Get, Replace

This interior node is a placeholder for the list of MCPTT IDMS token endpoints for the groups contained in the MCPTTGroupList.

5.2.48V7/ <x>/<x>/OnNetwork/GroupServerInfo/IDMSTokenEndpointList/<x>

Table 5.2.48V7.1: /<x>/<x>/OnNetwork/GroupServerInfo/IDMSTokenEndpointList/<x>

<x>/OnNetwork/GroupServerInfo/IDMSTokenEndpointList/<x>

Status	Occurrence	Format	Min. Access Types
Optional	OneOrMore	node	Get, Replace

This interior node is a placeholder for the IDMS token endpoint for a specific groups contained in the MCPTTGroupList.

5.2.48V8/ <x>/<x>/OnNetwork/GroupServerInfo/IDMSTokenEndpointList/<x>/Entry

Table 5.2.48V8.1: /<x>/<x>/OnNetwork/GroupServerInfo/IDMSTokenEndpointList/<x>/Entry

<x>/OnNetwork/GroupServerInfo/IDMSTokenEndpointList/<x>/Entry

Status	Occurrence	Format	Min. Access Types
Optional	One	node	Get, Replace

This interior node is a placeholder for the IDMS token endpoint for a specific groups contained in the MCPTTGroupList.

5.2.48V9

`/<x>/<x>/OnNetwork/GroupServerInfo/IDMSTokenEndpointList/<x>/Entry/IDMSTokenID`

Table 5.2.48V9.1:

`/<x>/<x>/OnNetwork/GroupServerInfo/IDMSTokenEndpointList/<x>/Entry/IDMSTokenID`

`<x>/OnNetwork/GroupServerInfo/IDMSTokenEndpointList/<x>/Entry/IDMSTokenID`

Status	Occurrence	Format	Min. Access Types
Required	One	chr	Get, Replace

This leaf node indicates the identity (URI) of the IDMS token endpoint for a specific group contained in the MCPTTGroupList. If the value is empty, the IDMS identities (IDMSAuthEndpoint and IDMSTokenEndpoint) present in the MCS UE initial configuration MO are used.

5.2.48V10/<x>/<x>/OnNetwork/GroupServerInfo/KMSURIList

Table 5.2.48V10.1: /<x>/<x>/OnNetwork/GroupServerInfo/KMSURIList

`<x>/OnNetwork/GroupServerInfo/KMSURIList`

Status	Occurrence	Format	Min. Access Types
Required	One	node	Get, Replace

This interior node is a placeholder for the list of KMS identities (URIs) for the groups contained in the MCPTTGroupList.

5.2.48V11/<x>/<x>/OnNetwork/GroupServerInfo/KMSURIList/<x>

Table 5.2.48V11.1: /<x>/<x>/OnNetwork/GroupServerInfo/KMSURIList/<x>

`<x>/OnNetwork/GroupServerInfo/KMSURIList/<x>`

Status	Occurrence	Format	Min. Access Types
Optional	OneOrMore	node	Get, Replace

This interior node is a placeholder for the KMS identity (URI) for a specific group contained in the MCPTTGroupList.

5.2.48V12/<x>/<x>/OnNetwork/GroupServerInfo/KMSURIList/<x>/Entry

Table 5.2.48V12.1: /<x>/<x>/OnNetwork/GroupServerInfo/KMSURIList/<x>/Entry

`<x>/OnNetwork/GroupServerInfo/KMSURIList/<x>/Entry`

Status	Occurrence	Format	Min. Access Types
Optional	One	node	Get, Replace

This interior node is a placeholder for the KMS identity (URI) for a specific group contained in the MCPTTGroupList.

5.2.48V13

`/<x>/<x>/OnNetwork/GroupServerInfo/KMSURIList/<x>/Entry/KMSURI`

Table 5.2.48V13.1: `/<x>/<x>/OnNetwork/GroupServerInfo/KMSURIList/<x>/Entry/KMSURI`

`<x>/OnNetwork/GroupServerInfo/KMSURIList/<x>/Entry/KMSURI`

Status	Occurrence	Format	Min. Access Types
Required	One	chr	Get, Replace

This leaf node indicates the identity (URI) of the KMS identity (URI) for a specific group contained in the MCPTTGroupList. If the value is empty, the KMS identity (URI) (kms) present in the MCS UE initial configuration MO is used.

5.2.48V14/`<x>/<x>/OnNetwork/GroupServerInfo/PresentationPriorityList`

Table 5.2.48V14.1: `/<x>/<x>/OnNetwork/GroupServerInfo/PresentationPriorityList`

`<x>/OnNetwork/GroupServerInfo/PresentationPriorityList`

Status	Occurrence	Format	Min. Access Types
Required	One	node	Get, Replace

This interior node is a placeholder for the list of presentation priority for the groups contained in the MCPTTGroupList.

5.2.48V15/`<x>/<x>/OnNetwork/GroupServerInfo/PresentationPriorityList/<x>`

Table 5.2.48V15.1: `/<x>/<x>/OnNetwork/GroupServerInfo/PresentationPriorityList/<x>`

`<x>/OnNetwork/GroupServerInfo/PresentationPriorityList/<x>`

Status	Occurrence	Format	Min. Access Types
Optional	OneOrMore	node	Get, Replace

This interior node is a placeholder for the presentation priority for a specific group contained in the MCPTTGroupList.

5.2.48V16/`<x>/<x>/OnNetwork/GroupServerInfo/PresentationPriorityList/<x>/Entry`

Table 5.2.48V16.1: `/<x>/<x>/OnNetwork/GroupServerInfo/PresentationPriorityList/<x>/Entry`

`<x>/OnNetwork/GroupServerInfo/PresentationPriorityList/<x>/Entry`

Status	Occurrence	Format	Min. Access Types
Optional	One	node	Get, Replace

This interior node is a placeholder for the presentation priority for a specific group contained in the MCPTTGroupList.

5.2.48V17 `/<x>/<x>/OnNetwork/GroupServerInfo/PresentationPriority`

Table 5.2.48v17.1: `/<x>/<x>/OnNetwork/GroupServerInfo /PresentationPriority`

`<x>/OnNetwork/GroupServerInfo/PresentationPriority`

Status	Occurrence	Format	Min. Access Types
Optional	One	int	Get, Replace

This leaf node indicates the presentation priority of the on-network group for the MCPTT user relative to other on-network groups and on-network users.

- Values: 0-255

The lowest PresentationPriority value shall be considered as the MCPTT group transaction having the lowest priority for presentation among other group MCPTT and one-to-one user transactions.

5.2.48W1 /<x>/<x>/OnNetwork/AllowedRequestRemoteInitPrivateCall

Table 5.2.48W1.1: /<x>/<x>/OnNetwork/AllowedRequestRemoteInitPrivateCall

<x>/OnNetwork/AllowedRequestRemoteInitPrivateCall

Status	Occurrence	Format	Min. Access Types
Required	One	bool	Get, Replace

This leaf node indicates whether the MCPTT user is authorised to request a remotely initiated private call.

When set to "true" the MCPTT user is authorised to request remotely initiated private calls.

When set to "false" the MCPTT user is not authorised to request remotely initiated private calls.

5.2.48W2 /<x>/<x>/OnNetwork/AllowedRequestRemoteInitGroupCall

Table 5.2.48W2.1: /<x>/<x>/OnNetwork/AllowedRequestRemoteInitGroupCall

<x>/OnNetwork/AllowedRequestRemoteInitGroupCall

Status	Occurrence	Format	Min. Access Types
Required	One	bool	Get, Replace

This leaf node indicates whether the MCPTT user is authorised to request a remotely initiated group call.

When set to "true" the MCPTT user is authorised to request remotely initiated group calls.

When set to "false" the MCPTT user is not authorised to request remotely initiated group calls.

5.2.48W3 /<x>/<x>/OnNetwork/FunctionalAliasList

Table 5.2.48W3.1: /<x>/<x>/OnNetwork/FunctionalAliasList

<x>/OnNetwork/FunctionalAliasList

Status	Occurrence	Format	Min. Access Types
Required	One	node	Get, Replace

This interior node is a placeholder for the functional alias configuration.

5.2.48W4 /<x>/<x>/OnNetwork/FunctionalAliasList/<x>

Table 5.2.48W4.1: /<x>/<x>/OnNetwork/FunctionalAliasList/<x>

<x>/OnNetwork/FunctionalAliasList/<x>

Status	Occurrence	Format	Min. Access Types
Required	OneOrMore	node	Get, Replace

This interior node is a placeholder for one or more functional alias configuration elements.

5.2.48W5 /<x>/<x>/OnNetwork/FunctionalAliasList/<x>/Entry

Table 5.2.48W5.1: /<x>/<x>/OnNetwork/FunctionalAliasList/<x>/Entry

<x>/OnNetwork/FunctionalAliasList/<x>/Entry

Status	Occurrence	Format	Min. Access Types
Optional	One	node	Get, Replace

This interior node is a placeholder for the details of the functional alias.

5.2.48W6

/<x>/<x>/OnNetwork/FunctionalAliasList/<x>/Entry/FunctionalAlias

Table 5.2.48W6.1: /<x>/<x>/OnNetwork/FunctionalAliasList/<x>/Entry/MCPTTID

<x>/OnNetwork/FunctionalAliasList/<x>/Entry/FunctionalAlias

Status	Occurrence	Format	Min. Access Types
Required	One	chr	Get, Replace

This leaf node indicates a functional alias that can be activated by the MCPTT user.

The value is a "uri" attribute specified in OMA OMA-TS-XDM_Group-V1_1 [4].

5.2.48W6A

/<x>/<x>/OnNetwork/FunctionalAliasList/<x>/Entry/LocationCriteriaForActivation

Table 5.2.48W6A.1: /<x>/<x>/OnNetwork/FunctionalAliasList/<x>/Entry/LocationCriteriaForActivation

<x>/OnNetwork/FunctionalAliasList/<x>/Entry/LocationCriteriaForActivation

Status	Occurrence	Format	Min. Access Types
Optional	ZeroOrOne	node	Get, Replace

This interior node contains the location criteria for activation of a functional alias.

5.2.48W6A1 /<x>/<x>/OnNetwork/FunctionalAliasList/<x>/Entry/LocationCriteriaForActivation/EnterSpecificArea

Table 5.2.48W6A1.1:

/<x>/<x>/OnNetwork/FunctionalAliasList/<x>/Entry/LocationCriteriaForActivation/EnterSpecificArea

<x>/OnNetwork/FunctionalAliasList/<x>/Entry/LocationCriteriaForActivation/EnterSpecificArea

Status	Occurrence	Format	Min. Access Types
Optional	ZeroOrMore	node	Get, Replace

This interior node contains a geographical area which when entered by the MC service UE triggers the functional alias activation.

5.2.48W6A2 /<x>/<x>/OnNetwork/FunctionalAliasList/<x>/Entry/LocationCriteriaForActivation/EnterSpecificArea/PolygonArea

Table 5.2.48W6A2.1:

/<x>/<x>/OnNetwork/FunctionalAliasList/<x>/Entry/LocationCriteriaForActivation/EnterSpecificArea/PolygonArea

<x>/OnNetwork/FunctionalAliasList/<x>/Entry/LocationCriteriaForActivation/EnterSpecificArea/PolygonArea

Status	Occurrence	Format	Min. Access Types
Optional	ZeroOrOne	node	Get, Replace

This interior node contains a geographical area described by a polygon.

5.2.48W6A3 /<x>/<x>/OnNetwork/FunctionalAliasList/<x>/Entry/LocationCriteriaForActivation/EnterSpecificArea/PolygonArea/Corner

Table 5.2.48W6A3.1:

/<x>/<x>/OnNetwork/FunctionalAliasList/<x>/Entry/LocationCriteriaForActivation/EnterSpecificArea/PolygonArea/Corner

<x>/OnNetwork/FunctionalAliasList/<x>/Entry/LocationCriteriaForActivation/EnterSpecificArea/PolygonArea/Corner

Status	Occurrence	Format	Min. Access Types
Required	ThreeToFifteen	node	Get, Replace

This interior node contains the coordinates of the corners which define a polygon.

5.2.48W6A3A /<x>/<x>/OnNetwork/FunctionalAliasList/<x>/Entry/LocationCriteriaForActivation/EnterSpecificArea/PolygonArea/Corner/PointCoordinateType

Table 5.2.48W6A3A.1:

/<x>/<x>/OnNetwork/FunctionalAliasList/<x>/Entry/LocationCriteriaForActivation/EnterSpecificArea/PolygonArea/Corner/PointCoordinateType

<x>/OnNetwork/FunctionalAliasList/<x>/Entry/LocationCriteriaForActivation/EnterSpecificArea/PolygonArea/Corner/PointCoordinateType

Status	Occurrence	Format	Min. Access Types
Required	One	node	Get, Replace

This interior node contains the coordinates of the center point of the ellipsoid arc.

5.2.48W6A4 /<x>/<x>/OnNetwork/FunctionalAliasList/<x>/Entry/LocationCriteriaForActivation/EnterSpecificArea/PolygonArea/Corner/PointCoordinateType/Longitude

Table 5.2.48W6A4.1:

/<x>/<x>/OnNetwork/FunctionalAliasList/<x>/Entry/LocationCriteriaForActivation/EnterSpecificArea/PolygonArea/Corner/PointCoordinateType/Longitude

<x>/OnNetwork/FunctionalAliasList/<x>/Entry/LocationCriteriaForActivation/EnterSpecificArea/PolygonArea/Corner/PointCoordinateType/Longitude

Status	Occurrence	Format	Min. Access Types
Required	One	int	Get, Replace

This leaf node contains the longitudinal coordinate of a corner.

- Values: 0-16777215

5.2.48W6A5 /<x>/<x>/OnNetwork/FunctionalAliasList/<x>/Entry/LocationCriteriaForActivation/EnterSpecificArea/PolygonArea/Corner/PointCoordinateType /Latitude

Table 5.2.48W6A5.1:

/<x>/<x>/OnNetwork/FunctionalAliasList/<x>/Entry/LocationCriteriaForActivation/EnterSpecificArea/PolygonArea/Corner/PointCoordinateType/Latitude

<x>/OnNetwork/FunctionalAliasList/<x>/Entry/LocationCriteriaForActivation/EnterSpecificArea/PolygonArea/Corner/PointCoordinateType/Latitude

Status	Occurrence	Format	Min. Access Types
Required	One	int	Get, Replace

This leaf node contains the latitudinal coordinate of a corner.

- Values: 0-16777215

5.2.48W6A6 /<x>/<x>/OnNetwork/FunctionalAliasList/<x>/Entry/LocationCriteriaForActivation/EnterSpecificArea/EllipsoidArcArea

Table 5.2.48W6A6.1:

/<x>/<x>/OnNetwork/FunctionalAliasList/<x>/Entry/LocationCriteriaForActivation/EnterSpecificArea/EllipsoidArcArea

<x>/OnNetwork/FunctionalAliasList/<x>/Entry/LocationCriteriaForActivation/EnterSpecificArea/EllipsoidArcArea

Status	Occurrence	Format	Min. Access Types
Optional	ZeroOrOne	node	Get, Replace

This interior node contains a geographical area described by an ellipsoid arc.

5.2.48W6A7 /<x>/<x>/OnNetwork/FunctionalAliasList/<x>/Entry/LocationCriteriaForActivation/EnterSpecificArea/EllipsoidArcArea/Center

Table 5.2.48W6A7.1:

/<x>/<x>/OnNetwork/FunctionalAliasList/<x>/Entry/LocationCriteriaForActivation/EnterSpecificArea/EllipsoidArcArea/Center

<x>/OnNetwork/FunctionalAliasList/<x>/Entry/LocationCriteriaForActivation/EnterSpecificArea/EllipsoidArcArea/Center

Status	Occurrence	Format	Min. Access Types
Required	One	node	Get, Replace

This interior node contains the coordinates of the center point of the ellipsoid arc.

5.2.48W6A7A

/<x>/<x>/OnNetwork/FunctionalAliasList/<x>/Entry/LocationCriteriaForActivation/EnterSpecificArea/EllipsoidArcArea/Center/PointCoordinateType

Table 5.2.48W6A7A.1:

/<x>/<x>/OnNetwork/FunctionalAliasList/<x>/Entry/LocationCriteriaForActivation/EnterSpecificArea/EllipsoidArcArea/Center/PointCoordinateType

<x>/<x>/OnNetwork/FunctionalAliasList/<x>/Entry/LocationCriteriaForActivation/EnterSpecificArea/EllipsoidArcArea/Center/PointCoordinateType

Status	Occurrence	Format	Min. Access Types
Required	One	node	Get, Replace

This interior node contains the coordinates of the center point of the ellipsoid arc.

5.2.48W6A8 /<x>/<x>/OnNetwork/FunctionalAliasList/<x>/Entry/LocationCriteriaForActivation/EnterSpecificArea/EllipsoidArcArea/Center/PointCoordinateType/Longitude

Table 5.2.48W6A8.1:

/<x>/<x>/OnNetwork/FunctionalAliasList/<x>/Entry/LocationCriteriaForActivation/EnterSpecificArea/EllipsoidArcArea/Center/PointCoordinateType/Longitude

<x>/OnNetwork/FunctionalAliasList/<x>/Entry/LocationCriteriaForActivation/EnterSpecificArea/EllipsoidArcArea/Center/PointCoordinateType/Longitude

Status	Occurrence	Format	Min. Access Types
Required	One	int	Get, Replace

This leaf node contains the longitudinal coordinate of the center.

- Values: 0-16777215

5.2.48W6A9 /<x>/<x>/OnNetwork/FunctionalAliasList/<x>/Entry/LocationCriteriaForActivation/EnterSpecificArea/EllipsoidArcArea/Center/PointCoordinateType/Latitude

Table 5.2.48W6A9.1:

/<x>/<x>/OnNetwork/FunctionalAliasList/<x>/Entry/LocationCriteriaForActivation/EnterSpecificArea/EllipsoidArcArea/Center/PointCoordinateType/Latitude

<x>/OnNetwork/FunctionalAliasList/<x>/Entry/LocationCriteriaForActivation/EnterSpecificArea/EllipsoidArcArea/Center/PointCoordinateType/Latitude

Status	Occurrence	Format	Min. Access Types
Required	One	int	Get, Replace

This leaf node contains the latitudinal coordinate of the center.

- Values: 0-16777215

5.2.48W6A10 /<x>/<x>/OnNetwork/FunctionalAliasList/<x>/Entry/LocationCriteriaForActivation/EnterSpecificArea/EllipsoidArcArea/Radius

Table 5.2.48W6A10.1:

/<x>/<x>/OnNetwork/FunctionalAliasList/<x>/Entry/LocationCriteriaForActivation/EnterSpecificArea/EllipsoidArcArea/Radius

<x>/OnNetwork/FunctionalAliasList/<x>/Entry/LocationCriteriaForActivation/EnterSpecificArea/EllipsoidArcArea/Radius

Status	Occurrence	Format	Min. Access Types
Required	One	int	Get, Replace

This leaf node contains the radius of the ellipsoid arc.

- Values: non-negative integer

5.2.48W6A11/<x>/<x>/OnNetwork/FunctionalAliasList/<x>/Entry/LocationCriteriaForActivation/EnterSpecificArea/EllipsoidArcArea/OffsetAngle

Table 5.2.48W6A11.1:

/<x>/<x>/OnNetwork/FunctionalAliasList/<x>/Entry/LocationCriteriaForActivation/EnterSpecificArea/EllipsoidArcArea/OffsetAngle

<x>/OnNetwork/FunctionalAliasList/<x>/Entry/LocationCriteriaForActivation/EnterSpecificArea/EllipsoidArcArea/OffsetAngle

Status	Occurrence	Format	Min. Access Types
Required	One	int	Get, Replace

This leaf node contains the offset angle of the ellipsoid arc.

- Values: 0-255

5.2.48W6A12/<x>/<x>/OnNetwork/FunctionalAliasList/<x>/Entry/LocationCriteriaForActivation/EnterSpecificArea/EllipsoidArcArea/IncludedAngle

Table 5.2.48W6A12.1:

/<x>/<x>/OnNetwork/FunctionalAliasList/<x>/Entry/LocationCriteriaForActivation/EnterSpecificArea/EllipsoidArcArea/IncludedAngle

<x>/OnNetwork/FunctionalAliasList/<x>/Entry/LocationCriteriaForActivation/EnterSpecificArea/EllipsoidArcArea/IncludedAngle

Status	Occurrence	Format	Min. Access Types
Required	One	int	Get, Replace

This leaf node contains the included angle of the ellipsoid arc.

- Values: 0-255

5.2.48W6A12A

/<x>/<x>/OnNetwork/FunctionalAliasList/<x>/Entry/LocationCriteriaForActivation/EnterSpecificArea/Speed

Table 5.2.48W6A12A.1:

/<x>/<x>/OnNetwork/FunctionalAliasList/<x>/Entry/LocationCriteriaForActivation/EnterSpecificArea/Speed

<x>/OnNetwork/FunctionalAliasList/<x>/Entry/LocationCriteriaForActivation/EnterSpecificArea/Speed

Status	Occurrence	Format	Min. Access Types
Optional	One	node	Get, Replace

This interior node contains the speed.

5.2.48W6A12B

`/<x>/<x>/OnNetwork/FunctionalAliasList/<x>/Entry/LocationCriteriaForActivation/EnterSpecificArea/Speed/MinimumSpeed`

Table 5.2.48W6A12B.1:

`/<x>/<x>/OnNetwork/FunctionalAliasList/<x>/Entry/LocationCriteriaForActivation/EnterSpecificArea/Speed/MinimumSpeed`

`<x>/OnNetwork/FunctionalAliasList/<x>/Entry/LocationCriteriaForActivation/EnterSpecificArea/Speed/MinimumSpeed`

Status	Occurrence	Format	Min. Access Types
Required	One	int	Get, Replace

This leaf node contains the minimum speed.

- Values: non-negative integer in units of kilometers/hour.

5.2.48W6A12C

`/<x>/<x>/OnNetwork/FunctionalAliasList/<x>/Entry/LocationCriteriaForActivation/EnterSpecificArea/Speed/MaximumSpeed`

Table 5.2.48W6A12C.1:

`/<x>/<x>/OnNetwork/FunctionalAliasList/<x>/Entry/LocationCriteriaForActivation/EnterSpecificArea/Speed/MaximumSpeed`

`<x>/OnNetwork/FunctionalAliasList/<x>/Entry/LocationCriteriaForActivation/EnterSpecificArea/Speed/MaximumSpeed`

Status	Occurrence	Format	Min. Access Types
Required	One	int	Get, Replace

This leaf node contains the maximum speed.

- Values: non-negative integer in units of kilometers/hour.

5.2.48W6A12D

`/<x>/<x>/OnNetwork/FunctionalAliasList/<x>/Entry/LocationCriteriaForActivation/EnterSpecificArea/Heading`

Table 5.2.48W6A12D.1:

`/<x>/<x>/OnNetwork/FunctionalAliasList/<x>/Entry/LocationCriteriaForActivation/EnterSpecificArea/Heading`

`<x>/OnNetwork/FunctionalAliasList/<x>/Entry/LocationCriteriaForActivation/EnterSpecificArea/Heading`

Status	Occurrence	Format	Min. Access Types
Optional	One	node	Get, Replace

This interior node contains the heading.

5.2.48W6A12E

`/<x>/<x>/OnNetwork/FunctionalAliasList/<x>/Entry/LocationCriteriaForActivation/EnterSpecificArea/Heading/MinimumHeading`

Table 5.2.48W6A12E.1:

`/<x>/<x>/OnNetwork/FunctionalAliasList/<x>/Entry/LocationCriteriaForActivation/EnterSpecificArea/Heading/MinimumHeading`

`<x>/OnNetwork/FunctionalAliasList/<x>/Entry/LocationCriteriaForActivation/EnterSpecificArea/Heading/MinimumHeading`

Status	Occurrence	Format	Min. Access Types
Required	One	int	Get, Replace

This leaf node contains the minimum heading.

- Values: 0-359

5.2.48W6A12F

`/<x>/<x>/OnNetwork/FunctionalAliasList/<x>/Entry/LocationCriteriaForActivation/EnterSpecificArea/Heading/MaximumHeading`

Table 5.2.48W6A12F.1:

`/<x>/<x>/OnNetwork/FunctionalAliasList/<x>/Entry/LocationCriteriaForActivation/EnterSpecificArea/Heading/MaximumHeading`

`<x>/OnNetwork/FunctionalAliasList/<x>/Entry/LocationCriteriaForActivation/EnterSpecificArea/Heading/MaximumHeading`

Status	Occurrence	Format	Min. Access Types
Required	One	int	Get, Replace

This leaf node contains the maximum heading.

- Values: 0-359

5.2.48W6A13/`<x>/<x>/OnNetwork/FunctionalAliasList/<x>/Entry/LocationCriteriaForActivation/ExitSpecificArea`

Table 5.2.48W6A13.1:

`/<x>/<x>/OnNetwork/FunctionalAliasList/<x>/Entry/LocationCriteriaForActivation/EnterSpecificArea`

`<x>/OnNetwork/FunctionalAliasList/<x>/Entry/LocationCriteriaForActivation/EnterSpecificArea`

Status	Occurrence	Format	Min. Access Types
Optional	ZeroOrMore	node	Get, Replace

This interior node contains a geographical area which when exited by the MC service UE triggers the functional alias activation.

5.2.48W6A14/`<x>/<x>/OnNetwork/FunctionalAliasList/<x>/Entry/LocationCriteriaForActivation/ExitSpecificArea/PolygonArea`

Table 5.2.48W6A14.1:

`/<x>/<x>/OnNetwork/FunctionalAliasList/<x>/Entry/LocationCriteriaForActivation/ExitSpecificArea/PolygonArea`

`<x>/OnNetwork/FunctionalAliasList/<x>/Entry/LocationCriteriaForActivation/ExitSpecificArea/PolygonArea`

Status	Occurrence	Format	Min. Access Types
Optional	ZeroOrOne	node	Get, Replace

This interior node contains a geographical area described by a polygon.

5.2.48W6A15/<x>/<x>/OnNetwork/FunctionalAliasList/<x>/Entry/LocationCriteriaForActivation/ExitSpecificArea/PolygonArea/Corner

Table 5.2.48W6A15.1:

/<x>/<x>/OnNetwork/FunctionalAliasList/<x>/Entry/LocationCriteriaForActivation/ExitSpecificArea/PolygonArea/Corner

<x>/OnNetwork/FunctionalAliasList/<x>/Entry/LocationCriteriaForActivation/ExitSpecificArea/PolygonArea/Corner

Status	Occurrence	Format	Min. Access Types
Required	ThreeToFifteen	node	Get, Replace

This interior node contains the coordinates of the corners which define a polygon.

5.2.48W6A15A /<x>/<x>/OnNetwork/FunctionalAliasList/<x>/Entry/LocationCriteriaForActivation/ExitSpecificArea/PolygonArea/Corner/PointCoordinateType

Table 5.2.48W6A15A.1:

/<x>/<x>/OnNetwork/FunctionalAliasList/<x>/Entry/LocationCriteriaForActivation/ExitSpecificArea/PolygonArea/Corner/PointCoordinateType

<x>/OnNetwork/FunctionalAliasList/<x>/Entry/LocationCriteriaForActivation/ExitSpecificArea/PolygonArea/Corner/PointCoordinateType

Status	Occurrence	Format	Min. Access Types
Required	One	node	Get, Replace

This interior node contains the type of the coordinates.

5.2.48W6A16/<x>/<x>/OnNetwork/FunctionalAliasList/<x>/Entry/LocationCriteriaForActivation/ExitSpecificArea/PolygonArea/Corner/PointCoordinateType/Longitude

Table 5.2.48W6A16.1:

/<x>/<x>/OnNetwork/FunctionalAliasList/<x>/Entry/LocationCriteriaForActivation/ExitSpecificArea/PolygonArea/Corner/PointCoordinateType/Longitude

<x>/OnNetwork/FunctionalAliasList/<x>/Entry/LocationCriteriaForActivation/ExitSpecificArea/PolygonArea/Corner/PointCoordinateType/Longitude

Status	Occurrence	Format	Min. Access Types
Required	One	int	Get, Replace

This leaf node contains the longitudinal coordinate of a corner.

- Values: 0-16777215

5.2.48W6A17/OnNetwork/FunctionalAliasList/Entry/LocationCriteriaForActivation/ExitSpecificArea/PolygonArea/Corner/PointCoordinateType/Latitude

Table 5.2.48W6A17.1:

/OnNetwork/FunctionalAliasList/Entry/LocationCriteriaForActivation/ExitSpecificArea/PolygonArea/Corner/PointCoordinateType/Latitude

OnNetwork/FunctionalAliasList/Entry/LocationCriteriaForActivation/ExitSpecificArea/PolygonArea/Corner/PointCoordinateType/Latitude

Status	Occurrence	Format	Min. Access Types
Required	One	int	Get, Replace

This leaf node contains the latitudinal coordinate of a corner.

- Values: 0-16777215

5.2.48W6A18/OnNetwork/FunctionalAliasList/Entry/LocationCriteriaForActivation/ExitSpecificArea/EllipsoidArcArea

Table 5.2.48W6A18.1:

/OnNetwork/FunctionalAliasList/Entry/LocationCriteriaForActivation/ExitSpecificArea/EllipsoidArcArea

OnNetwork/FunctionalAliasList/Entry/LocationCriteriaForActivation/ExitSpecificArea/EllipsoidArcArea

Status	Occurrence	Format	Min. Access Types
Optional	ZeroOrOne	node	Get, Replace

This interior node contains a geographical area described by an ellipsoid arc.

5.2.48W6A19/OnNetwork/FunctionalAliasList/Entry/LocationCriteriaForActivation/ExitSpecificArea/EllipsoidArcArea/Center

Table 5.2.48W6A19.1:

/OnNetwork/FunctionalAliasList/Entry/LocationCriteriaForActivation/ExitSpecificArea/EllipsoidArcArea/Center

OnNetwork/FunctionalAliasList/Entry/LocationCriteriaForActivation/ExitSpecificArea/EllipsoidArcArea/Center

Status	Occurrence	Format	Min. Access Types
Required	One	node	Get, Replace

This interior node contains the coordinates of the center point of the ellipsoid arc.

5.2.48W6A19A/OnNetwork/FunctionalAliasList/Entry/LocationCriteriaForActivation/ExitSpecificArea/EllipsoidArcArea/Center/PointCoordinateType

Table 5.2.48W6A19A.1:

/OnNetwork/FunctionalAliasList/Entry/LocationCriteriaForActivation/ExitSpecificArea/EllipsoidArcArea/Center/PointCoordinateType

OnNetwork/FunctionalAliasList/Entry/LocationCriteriaForActivation/ExitSpecificArea/EllipsoidArcArea/Center/PointCoordinateType

Status	Occurrence	Format	Min. Access Types
Required	One	node	Get, Replace

This interior node contains the coordinates of the center point of the ellipsoid arc.

5.2.48W6A20/<x>/<x>/OnNetwork/FunctionalAliasList/<x>/Entry/LocationCriteriaForActivation/ExitSpecificArea/EllipsoidArcArea/Center/PointCoordinateType/Longitude

Table 5.2.48W6A20.1:

/<x>/<x>/OnNetwork/FunctionalAliasList/<x>/Entry/LocationCriteriaForActivation/ExitSpecificArea/EllipsoidArcArea/Center/PointCoordinateType/Longitude

<x>/OnNetwork/FunctionalAliasList/<x>/Entry/LocationCriteriaForActivation/ExitSpecificArea/EllipsoidArcArea/Center/PointCoordinateType/Longitude

Status	Occurrence	Format	Min. Access Types
Required	One	int	Get, Replace

This leaf node contains the longitudinal coordinate of the center.

- Values: 0-16777215

5.2.48W6A21/<x>/<x>/OnNetwork/FunctionalAliasList/<x>/Entry/LocationCriteriaForActivation/ExitSpecificArea/EllipsoidArcArea/Center/PointCoordinateType/Latitude

Table 5.2.48W6A21.1:

/<x>/<x>/OnNetwork/FunctionalAliasList/<x>/Entry/LocationCriteriaForActivation/ExitSpecificArea/EllipsoidArcArea/Center/PointCoordinateType/Latitude

<x>/OnNetwork/FunctionalAliasList/<x>/Entry/LocationCriteriaForActivation/ExitSpecificArea/EllipsoidArcArea/Center/PointCoordinateType/Latitude

Status	Occurrence	Format	Min. Access Types
Required	One	int	Get, Replace

This leaf node contains the latitudinal coordinate of the center.

- Values: 0-16777215

5.2.48W6A22/<x>/<x>/OnNetwork/FunctionalAliasList/<x>/Entry/LocationCriteriaForActivation/ExitSpecificArea/EllipsoidArcArea/Radius

Table 5.2.48W6A22.1:

/<x>/<x>/OnNetwork/FunctionalAliasList/<x>/Entry/LocationCriteriaForActivation/ExitSpecificArea/EllipsoidArcArea/Radius

<x>/OnNetwork/FunctionalAliasList/<x>/Entry/LocationCriteriaForActivation/ExitSpecificArea/EllipsoidArcArea/Radius

Status	Occurrence	Format	Min. Access Types
Required	One	int	Get, Replace

This leaf node contains the radius of the ellipsoid arc.

- Values: non-negative integer

5.2.48W6A23/<x>/<x>/OnNetwork/FunctionalAliasList/<x>/Entry/LocationCriteriaForActivation/ExitSpecificArea/EllipsoidArcArea/OffsetAngle

Table 5.2.48W6A23.1:

/<x>/<x>/OnNetwork/FunctionalAliasList/<x>/Entry/LocationCriteriaForActivation/ExitSpecificArea/EllipsoidArcArea/OffsetAngle

<x>/OnNetwork/FunctionalAliasList/<x>/Entry/LocationCriteriaForActivation/ExitSpecificArea/EllipsoidArcArea/OffsetAngle

Status	Occurrence	Format	Min. Access Types
Required	One	int	Get, Replace

This leaf node contains the offset angle of the ellipsoid arc.

- Values: 0-255

5.2.48W6A24/<x>/<x>/OnNetwork/FunctionalAliasList/<x>/Entry/LocationCriteriaForActivation/ExitSpecificArea/EllipsoidArcArea/IncludedAngle

Table 5.2.48W6A24.1:

/<x>/<x>/OnNetwork/FunctionalAliasList/<x>/Entry/LocationCriteriaForActivation/ExitSpecificArea/EllipsoidArcArea/IncludedAngle

<x>/OnNetwork/FunctionalAliasList/<x>/Entry/LocationCriteriaForActivation/ExitSpecificArea/EllipsoidArcArea/IncludedAngle

Status	Occurrence	Format	Min. Access Types
Required	One	int	Get, Replace

This leaf node contains the included angle of the ellipsoid arc.

- Values: 0-255

5.2.48W6A24A /<x>/<x>/OnNetwork/FunctionalAliasList/<x>/Entry/LocationCriteriaForActivation/ExitSpecificArea/Speed

Table 5.2.48W6A24A.1:

/<x>/<x>/OnNetwork/FunctionalAliasList/<x>/Entry/LocationCriteriaForActivation/ExitSpecificArea/Speed

<x>/OnNetwork/FunctionalAliasList/<x>/Entry/LocationCriteriaForActivation/ExitSpecificArea/Speed

Status	Occurrence	Format	Min. Access Types
Optional	One	node	Get, Replace

This interior node contains the speed.

5.2.48W6A24B

/<x>/<x>/OnNetwork/FunctionalAliasList/<x>/Entry/LocationCriteriaForActivation/ExitSpecificArea/Speed/MinimumSpeed

Table 5.2.48W6A24B.1:

/<x>/<x>/OnNetwork/FunctionalAliasList/<x>/Entry/LocationCriteriaForActivation/ExitSpecificArea/Speed/MinimumSpeed

<x>/OnNetwork/FunctionalAliasList/<x>/Entry/LocationCriteriaForActivation/ExitSpecificArea/Speed/MinimumSpeed

Status	Occurrence	Format	Min. Access Types
Required	One	int	Get, Replace

This leaf node contains the minimum speed.

- Values: non-negative integer in units of kilometers/hour.

5.2.48W6A24C

`/<x>/<x>/OnNetwork/FunctionalAliasList/<x>/Entry/LocationCriteriaForActivation/ExitSpecificArea/Speed/MaximumSpeed`

Table 5.2.48W6A24C.1:

`/<x>/<x>/OnNetwork/FunctionalAliasList/<x>/Entry/LocationCriteriaForActivation/ExitSpecificArea/Speed/MaximumSpeed`

`<x>/OnNetwork/FunctionalAliasList/<x>/Entry/LocationCriteriaForActivation/ExitSpecificArea/Speed/MaximumSpeed`

Status	Occurrence	Format	Min. Access Types
Required	One	int	Get, Replace

This leaf node contains the maximum speed.

- Values: non-negative integer in units of kilometers/hour.

5.2.48W6A24D

`/<x>/<x>/OnNetwork/FunctionalAliasList/<x>/Entry/LocationCriteriaForActivation/ExitSpecificArea/Heading`

Table 5.2.48W6A24D.1:

`/<x>/<x>/OnNetwork/FunctionalAliasList/<x>/Entry/LocationCriteriaForActivation/ExitSpecificArea/Heading`

`<x>/OnNetwork/FunctionalAliasList/<x>/Entry/LocationCriteriaForActivation/ExitSpecificArea/Heading`

Status	Occurrence	Format	Min. Access Types
Optional	One	node	Get, Replace

This interior node contains the heading.

5.2.48W6A24E

`/<x>/<x>/OnNetwork/FunctionalAliasList/<x>/Entry/LocationCriteriaForActivation/ExitSpecificArea/Heading/MinimumHeading`

Table 5.2.48W6A24E.1:

`/<x>/<x>/OnNetwork/FunctionalAliasList/<x>/Entry/LocationCriteriaForActivation/ExitSpecificArea/Heading/MinimumHeading`

`<x>/OnNetwork/FunctionalAliasList/<x>/Entry/LocationCriteriaForActivation/ExitSpecificArea/Heading/MinimumHeading`

Status	Occurrence	Format	Min. Access Types
Required	One	int	Get, Replace

This leaf node contains the minimum heading.

- Values: 0-359

5.2.48W6A24F

`<x>/<x>/OnNetwork/FunctionalAliasList/<x>/Entry/LocationCriteriaForActivation/ExitSpecificArea/Heading/MaximumHeading`

Table 5.2.48W6A24E.1:

`<x>/<x>/OnNetwork/FunctionalAliasList/<x>/Entry/LocationCriteriaForActivation/ExitSpecificArea/Heading/MaximumHeading`

`<x>/OnNetwork/FunctionalAliasList/<x>/Entry/LocationCriteriaForActivation/ExitSpecificArea/Heading/MaximumHeading`

Status	Occurrence	Format	Min. Access Types
Required	One	int	Get, Replace

This leaf node contains the maximum heading.

- Values: 0-359

5.2.48W6B `<x>/<x>/OnNetwork/FunctionalAliasList/<x>/Entry/LocationCriteriaForDeactivation`

Table 5.2.48W6D.1:

`<x>/<x>/OnNetwork/FunctionalAliasList/<x>/Entry/LocationCriteriaForDeactivation`

`<x>/OnNetwork/FunctionalAliasList/<x>/Entry/LocationCriteriaForDeactivation`

Status	Occurrence	Format	Min. Access Types
Optional	ZeroOrOne	node	Get, Replace

This interior node contains the location criteria for de-activation of a functional alias.

5.2.48W6B1 `<x>/<x>/OnNetwork/FunctionalAliasList/<x>/Entry/LocationCriteriaForDeactivation/EnterSpecificArea`

Table 5.2.48W6B1.1:

`<x>/<x>/OnNetwork/FunctionalAliasList/<x>/Entry/LocationCriteriaForDeactivation/EnterSpecificArea`

`<x>/OnNetwork/FunctionalAliasList/<x>/Entry/LocationCriteriaForDeactivation/EnterSpecificArea`

Status	Occurrence	Format	Min. Access Types
Optional	ZeroOrMore	node	Get, Replace

This interior node contains a geographical area which when entered by the MC service UE triggers the functional alias de-activation.

5.2.48W6B2 `<x>/<x>/OnNetwork/FunctionalAliasList/<x>/Entry/LocationCriteriaForDeactivation/EnterSpecificArea/PolygonArea`

Table 5.2.48W6B2.1:

`<x>/<x>/OnNetwork/FunctionalAliasList/<x>/Entry/LocationCriteriaForDeactivation/EnterSpecificArea/PolygonArea`

`<x>/OnNetwork/FunctionalAliasList/<x>/Entry/LocationCriteriaForDeactivation/EnterSpecificArea/PolygonArea`

Status	Occurrence	Format	Min. Access Types
Optional	ZeroOrOne	node	Get, Replace

This interior node contains a geographical area described by a polygon.

5.2.48W6B3 /<x>/<x>/OnNetwork/FunctionalAliasList/<x>/Entry/LocationCriteriaForDeactivation/EnterSpecificArea/PolygonArea/Corner

Table 5.2.48W6B3.1:

/<x>/<x>/OnNetwork/FunctionalAliasList/<x>/Entry/LocationCriteriaForDeactivation/EnterSpecificArea/PolygonArea/Corner

<x>/OnNetwork/FunctionalAliasList/<x>/Entry/LocationCriteriaForDeactivation/EnterSpecificArea/PolygonArea/Corner

Status	Occurrence	Format	Min. Access Types
Required	ThreeToFifteen	node	Get, Replace

This interior node contains the coordinates of the corners which define a polygon.

5.2.48W6B3A

/<x>/<x>/OnNetwork/FunctionalAliasList/<x>/Entry/LocationCriteriaForDeactivation/EnterSpecificArea/PolygonArea/Corner/PointCoordinateType

Table 5.2.48W6B3A.1:

/<x>/<x>/OnNetwork/FunctionalAliasList/<x>/Entry/LocationCriteriaForDeactivation/EnterSpecificArea/PolygonArea/Corner/PointCoordinateType

<x>/OnNetwork/FunctionalAliasList/<x>/Entry/LocationCriteriaForDeactivation/EnterSpecificArea/PolygonArea/Corner/PointCoordinateType

Status	Occurrence	Format	Min. Access Types
Required	One	node	Get, Replace

This interior node contains the coordinates of the center point of the ellipsoid arc.

5.2.48W6B4 /<x>/<x>/OnNetwork/FunctionalAliasList/<x>/Entry/LocationCriteriaForDeactivation/EnterSpecificArea/PolygonArea/Corner/PointCoordinateType/Longitude

Table 5.2.48W6B4.1:

/<x>/<x>/OnNetwork/FunctionalAliasList/<x>/Entry/LocationCriteriaForDeactivation/EnterSpecificArea/PolygonArea/Corner/PointCoordinateType/Longitude

<x>/OnNetwork/FunctionalAliasList/<x>/Entry/LocationCriteriaForDeactivation/EnterSpecificArea/PolygonArea/Corner/PointCoordinateType/Longitude

Status	Occurrence	Format	Min. Access Types
Required	One	int	Get, Replace

This leaf node contains the longitudinal coordinate of a corner.

- Values: 0-16777215

5.2.48W6B5 /<x>/<x>/OnNetwork/FunctionalAliasList/<x>/Entry/LocationCriteriaForDeactivation/EnterSpecificArea/PolygonArea/Corner/PointCoordinateType/Latitude

Table 5.2.48W6B5.1:

/<x>/<x>/OnNetwork/FunctionalAliasList/<x>/Entry/LocationCriteriaForDeactivation/EnterSpecificArea/ PolygonArea/Corner/PointCoordinateType/Latitude

<x>/OnNetwork/FunctionalAliasList/<x>/Entry/LocationCriteriaForDeactivation/EnterSpecificArea/PolygonArea/Corner/PointCoordinateType/Latitude

Status	Occurrence	Format	Min. Access Types
Required	One	int	Get, Replace

This leaf node contains the latitudinal coordinate of a corner.

- Values: 0-16777215

5.2.48W6B6 /<x>/<x>/OnNetwork/FunctionalAliasList/<x>/Entry/LocationCriteriaForDeactivation/EnterSpecificArea/EllipsoidArcArea

Table 5.2.48W6B6.1:

/<x>/<x>/OnNetwork/FunctionalAliasList/<x>/Entry/LocationCriteriaForDeactivation/EnterSpecificArea/ EllipsoidArcArea

<x>/OnNetwork/FunctionalAliasList/<x>/Entry/LocationCriteriaForDeactivation/EnterSpecificArea/EllipsoidArcArea

Status	Occurrence	Format	Min. Access Types
Optional	ZeroOrOne	node	Get, Replace

This interior node contains a geographical area described by an ellipsoid arc.

5.2.48W6B7 /<x>/<x>/OnNetwork/FunctionalAliasList/<x>/Entry/LocationCriteriaForDeactivation/EnterSpecificArea/EllipsoidArcArea/Center

Table 5.2.48W6B7.1:

/<x>/<x>/OnNetwork/FunctionalAliasList/<x>/Entry/LocationCriteriaForDeactivation/EnterSpecificArea/ EllipsoidArcArea/Center

<x>/OnNetwork/FunctionalAliasList/<x>/Entry/LocationCriteriaForDeactivation/EnterSpecificArea/EllipsoidArcArea/ Center

Status	Occurrence	Format	Min. Access Types
Required	One	node	Get, Replace

This interior node contains the coordinates of the center point of the ellipsoid arc.

5.2.48W6B7A

/<x>/<x>/OnNetwork/FunctionalAliasList/<x>/Entry/LocationCriteriaForDeactivation/EnterSpecificArea/EllipsoidArcArea/Center/PointCoordinateType

Table 5.2.48W6B7A.1:

/<x>/<x>/OnNetwork/FunctionalAliasList/<x>/Entry/LocationCriteriaForDeactivation/EnterSpecificArea/ EllipsoidArcArea/Center/PointCoordinateType

<x>/OnNetwork/FunctionalAliasList/<x>/Entry/LocationCriteriaForDeactivation/EnterSpecificArea/EllipsoidArcArea/Center/PointCoordinateType

Status	Occurrence	Format	Min. Access Types
Required	One	node	Get, Replace

This interior node contains the coordinates of the center point of the ellipsoid arc.

5.2.48W6B8 /<x>/<x>/OnNetwork/FunctionalAliasList/<x>/Entry/LocationCriteriaForDeactivation/EnterSpecificArea/EllipsoidArcArea/Center/PointCoordinateType/Longitude

Table 5.2.48W6B8.1:

/<x>/<x>/OnNetwork/FunctionalAliasList/<x>/Entry/LocationCriteriaForDeactivation/EnterSpecificArea/EllipsoidArcArea/Center/PointCoordinateType/Longitude

<x>/OnNetwork/FunctionalAliasList/<x>/Entry/LocationCriteriaForDeactivation/EnterSpecificArea/EllipsoidArcArea/Center/PointCoordinateType/Longitude

Status	Occurrence	Format	Min. Access Types
Required	One	int	Get, Replace

This leaf node contains the longitudinal coordinate of the center.

- Values: 0-16777215

5.2.48W6B9 /<x>/<x>/OnNetwork/FunctionalAliasList/<x>/Entry/LocationCriteriaForDeactivation/EnterSpecificArea/EllipsoidArcArea/Center/PointCoordinateType/Latitude

Table 5.2.48W6B9.1:

/<x>/<x>/OnNetwork/FunctionalAliasList/<x>/Entry/LocationCriteriaForDeactivation/EnterSpecificArea/EllipsoidArcArea/Center/PointCoordinateType/Latitude

<x>/OnNetwork/FunctionalAliasList/<x>/Entry/LocationCriteriaForDeactivation/EnterSpecificArea/EllipsoidArcArea/Center/PointCoordinateType/Latitude

Status	Occurrence	Format	Min. Access Types
Required	One	int	Get, Replace

This leaf node contains the latitudinal coordinate of the center.

- Values: 0-16777215

5.2.48W6B10/<x>/<x>/OnNetwork/FunctionalAliasList/<x>/Entry/LocationCriteriaForDeactivation/EnterSpecificArea/EllipsoidArcArea/Radius

Table 5.2.48W6B10.1:

/<x>/<x>/OnNetwork/FunctionalAliasList/<x>/Entry/LocationCriteriaForDeactivation/EnterSpecificArea/EllipsoidArcArea/Radius

<x>/OnNetwork/FunctionalAliasList/<x>/Entry/LocationCriteriaForDeactivation/EnterSpecificArea/EllipsoidArcArea/Radius

Status	Occurrence	Format	Min. Access Types
Required	One	int	Get, Replace

This leaf node contains the radius of the ellipsoid arc.

- Values: non-negative integer

5.2.48W6B11/<x>/<x>/OnNetwork/FunctionalAliasList/<x>/Entry/LocationCriteriaForDeactivation/EnterSpecificArea/EllipsoidArcArea/OffsetAngle

Table 5.2.48W6B11.1:

<x>/<x>/OnNetwork/FunctionalAliasList/<x>/Entry/LocationCriteriaForDeactivation/EnterSpecificArea/EllipsoidArcArea/OffsetAngle

<x>/OnNetwork/FunctionalAliasList/<x>/Entry/LocationCriteriaForDeactivation/EnterSpecificArea/EllipsoidArcArea/OffsetAngle

Status	Occurrence	Format	Min. Access Types
Required	One	int	Get, Replace

This leaf node contains the offset angle of the ellipsoid arc.

- Values: 0-255

5.2.48W6B12/<x>/<x>/OnNetwork/FunctionalAliasList/<x>/Entry/LocationCriteriaForDeactivation/EnterSpecificArea/EllipsoidArcArea/IncludedAngle

Table 5.2.48W6B12.1:

<x>/<x>/OnNetwork/FunctionalAliasList/<x>/Entry/LocationCriteriaForDeactivation/EnterSpecificArea/EllipsoidArcArea/IncludedAngle

<x>/OnNetwork/FunctionalAliasList/<x>/Entry/LocationCriteriaForDeactivation/EnterSpecificArea/EllipsoidArcArea/IncludedAngle

Status	Occurrence	Format	Min. Access Types
Required	One	int	Get, Replace

This leaf node contains the included angle of the ellipsoid arc.

- Values: 0-255

5.2.48W6B12A
/<x>/<x>/OnNetwork/FunctionalAliasList/<x>/Entry/LocationCriteriaForDeactivation/EnterSpecificArea/Speed

Table 5.2.48W6B12A.1:

<x>/<x>/OnNetwork/FunctionalAliasList/<x>/Entry/LocationCriteriaForDeactivation/EnterSpecificArea/Speed

<x>/OnNetwork/FunctionalAliasList/<x>/Entry/LocationCriteriaForDeactivation/EnterSpecificArea/Speed

Status	Occurrence	Format	Min. Access Types
Optional	One	node	Get, Replace

This interior node contains the speed.

5.2.48W6B12B

/<x>/<x>/OnNetwork/FunctionalAliasList/<x>/Entry/LocationCriteriaForDeactivation/EnterSpecificArea/Speed/MinimumSpeed

Table 5.2.48W6B12B.1:

/<x>/<x>/OnNetwork/FunctionalAliasList/<x>/Entry/LocationCriteriaForDeactivation/EnterSpecificArea/Speed/MinimumSpeed

<x>/OnNetwork/FunctionalAliasList/<x>/Entry/LocationCriteriaForDeactivation/EnterSpecificArea/Speed/MinimumSpeed

Status	Occurrence	Format	Min. Access Types
Required	One	int	Get, Replace

This leaf node contains the minimum speed.

- Values: non-negative integer in units of kilometers/hour.

5.2.48W6B12C

/<x>/<x>/OnNetwork/FunctionalAliasList/<x>/Entry/LocationCriteriaForDeactivation/EnterSpecificArea/Speed/MaximumSpeed

Table 5.2.48W6B12C.1:

/<x>/<x>/OnNetwork/FunctionalAliasList/<x>/Entry/LocationCriteriaForDeactivation/EnterSpecificArea/Speed/MaximumSpeed

<x>/OnNetwork/FunctionalAliasList/<x>/Entry/LocationCriteriaForDeactivation/EnterSpecificArea/Speed/MaximumSpeed

Status	Occurrence	Format	Min. Access Types
Required	One	int	Get, Replace

This leaf node contains the maximum speed.

- Values: non-negative integer in units of kilometers/hour.

5.2.48W6B12D

/<x>/<x>/OnNetwork/FunctionalAliasList/<x>/Entry/LocationCriteriaForDeactivation/EnterSpecificArea/Heading

Table 10.2.97B3C18.1:

/<x>/<x>/OnNetwork/FunctionalAliasList/<x>/Entry/LocationCriteriaForDeactivation/EnterSpecificArea/Heading

<x>/OnNetwork/FunctionalAliasList/<x>/Entry/LocationCriteriaForDeactivation/EnterSpecificArea/Heading

Status	Occurrence	Format	Min. Access Types
Optional	One	node	Get, Replace

This interior node contains the heading.

5.2.48W6B12E

`/<x>/<x>/OnNetwork/FunctionalAliasList/<x>/Entry/LocationCriteriaForDeactivation/EnterSpecificArea/Heading/MinimumHeading`

Table 5.2.48W6B12E.1:

`/<x>/<x>/OnNetwork/FunctionalAliasList/<x>/Entry/LocationCriteriaForDeactivation/EnterSpecificArea/Heading/MinimumHeading`

`<x>/OnNetwork/FunctionalAliasList/<x>/Entry/LocationCriteriaForDeactivation/EnterSpecificArea/Heading/MinimumHeading`

Status	Occurrence	Format	Min. Access Types
Required	One	int	Get, Replace

This leaf node contains the minimum heading.

- Values: 0-359

5.2.48W6B12F

`/<x>/<x>/OnNetwork/FunctionalAliasList/<x>/Entry/LocationCriteriaForDeactivation/EnterSpecificArea/Heading/MaximumHeading`

Table 5.2.48W6B12F.1:

`/<x>/<x>/OnNetwork/FunctionalAliasList/<x>/Entry/LocationCriteriaForDeactivation/EnterSpecificArea/Heading/MaximumHeading`

`<x>/OnNetwork/FunctionalAliasList/<x>/Entry/LocationCriteriaForDeactivation/EnterSpecificArea/Heading/MaximumHeading`

Status	Occurrence	Format	Min. Access Types
Required	One	int	Get, Replace

This leaf node contains the maximum heading.

- Values: 0-359

5.2.48W6B13/`<x>/<x>/OnNetwork/FunctionalAliasList/<x>/Entry/LocationCriteriaForDeactivation/ExitSpecificArea`

Table 5.2.48W6B13.1:

`/<x>/<x>/OnNetwork/FunctionalAliasList/<x>/Entry/LocationCriteriaForDeactivation/EnterSpecificArea`

`<x>/OnNetwork/FunctionalAliasList/<x>/Entry/LocationCriteriaForDeactivation/EnterSpecificArea`

Status	Occurrence	Format	Min. Access Types
Optional	ZeroOrMore	node	Get, Replace

This interior node contains a geographical area which when exited by the MC service UE triggers the functional alias de-activation.

5.2.48W6B14/`<x>/<x>/OnNetwork/FunctionalAliasList/<x>/Entry/LocationCriteriaForDeactivation/ExitSpecificArea/PolygonArea`

Table 5.2.48W6B14.1:

`/<x>/<x>/OnNetwork/FunctionalAliasList/<x>/Entry/LocationCriteriaForDeactivation/ExitSpecificArea/PolygonArea`

`<x>/OnNetwork/FunctionalAliasList/<x>/Entry/LocationCriteriaForDeactivation/ExitSpecificArea/PolygonArea`

Status	Occurrence	Format	Min. Access Types
Optional	ZeroOrOne	node	Get, Replace

This interior node contains a geographical area described by a polygon.

5.2.48W6B15/
Entry/LocationCriteriaForDeactivation/ExitSpecificArea/PolygonArea/Corner

Table 5.2.48W6B15.1:

Entry/LocationCriteriaForDeactivation/ExitSpecificArea/PolygonArea/Corner

Corner

Status	Occurrence	Format	Min. Access Types
Required	ThreeToFifteen	node	Get, Replace

This interior node contains the coordinates of the corners which define a polygon.

5.2.48W6B15A

Entry/LocationCriteriaForDeactivation/ExitSpecificArea/PolygonArea/Corner/PointCoordinateType

Table 5.2.48W6B15A.1:

Entry/LocationCriteriaForDeactivation/ExitSpecificArea/PolygonArea/Corner/PointCoordinateType

Corner/PointCoordinateType

Status	Occurrence	Format	Min. Access Types
Required	One	node	Get, Replace

This interior node contains the coordinates of the center point of the ellipsoid arc.

5.2.48W6B16/
Entry/LocationCriteriaForDeactivation/ExitSpecificArea/PolygonArea/Corner/PointCoordinateType/Longitude

Table 5.2.48W6B16.1:

Entry/LocationCriteriaForDeactivation/ExitSpecificArea/PolygonArea/Corner/PointCoordinateType/Longitude

Corner/PointCoordinateType/Longitude

Status	Occurrence	Format	Min. Access Types
Required	One	int	Get, Replace

This leaf node contains the longitudinal coordinate of a corner.

- Values: 0-16777215

5.2.48W6B17/OnNetwork/FunctionalAliasList/Entry/LocationCriteriaForDeactivation/ExitSpecificArea/PolygonArea/Corner/PointCoordinateType/Latitude

Table 5.2.48W6B17.1:

/OnNetwork/FunctionalAliasList/Entry/LocationCriteriaForDeactivation/ExitSpecificArea/PolygonArea/Corner/PointCoordinateType/Latitude

OnNetwork/FunctionalAliasList/Entry/LocationCriteriaForDeactivation/ExitSpecificArea/PolygonArea/Corner/PointCoordinateType/Latitude

Status	Occurrence	Format	Min. Access Types
Required	One	int	Get, Replace

This leaf node contains the latitudinal coordinate of a corner.

- Values: 0-16777215

5.2.48W6B18/OnNetwork/FunctionalAliasList/Entry/LocationCriteriaForDeactivation/ExitSpecificArea/EllipsoidArcArea

Table 5.2.48W6B18.1:

/OnNetwork/FunctionalAliasList/Entry/LocationCriteriaForDeactivation/ExitSpecificArea/EllipsoidArcArea

OnNetwork/FunctionalAliasList/Entry/LocationCriteriaForDeactivation/ExitSpecificArea/EllipsoidArcArea

Status	Occurrence	Format	Min. Access Types
Optional	ZeroOrOne	node	Get, Replace

This interior node contains a geographical area described by an ellipsoid arc.

5.2.48W6B19/OnNetwork/FunctionalAliasList/Entry/LocationCriteriaForDeactivation/ExitSpecificArea/EllipsoidArcArea/Center

Table 5.2.48W6B19.1:

/OnNetwork/FunctionalAliasList/Entry/LocationCriteriaForDeactivation/ExitSpecificArea/EllipsoidArcArea/Center

OnNetwork/FunctionalAliasList/Entry/LocationCriteriaForDeactivation/ExitSpecificArea/EllipsoidArcArea/Center

Status	Occurrence	Format	Min. Access Types
Required	One	node	Get, Replace

This interior node contains the coordinates of the center point of the ellipsoid arc.

5.2.48W6B19A

/OnNetwork/FunctionalAliasList/Entry/LocationCriteriaForDeactivation/ExitSpecificArea/EllipsoidArcArea/Center/PointCoordinateType

Table 5.2.48W6B19A.1:

/OnNetwork/FunctionalAliasList/Entry/LocationCriteriaForDeactivation/ExitSpecificArea/EllipsoidArcArea/Center/PointCoordinateType

OnNetwork/FunctionalAliasList/Entry/LocationCriteriaForDeactivation/ExitSpecificArea/EllipsoidArcArea/Center/PointCoordinateType

Status	Occurrence	Format	Min. Access Types
Required	One	node	Get, Replace

This interior node contains the coordinates of the center point of the ellipsoid arc.

5.2.48W6B20/<x>/<x>/OnNetwork/FunctionalAliasList/<x>/Entry/LocationCriteriaForDeactivation/ExitSpecificArea/EllipsoidArcArea/Center/PointCoordinateType/Longitude

Table 5.2.48W6B20.1:

<x>/<x>/OnNetwork/FunctionalAliasList/<x>/Entry/LocationCriteriaForDeactivation/ExitSpecificArea/EllipsoidArcArea/Center/PointCoordinateType/Longitude

<x>/OnNetwork/FunctionalAliasList/<x>/Entry/LocationCriteriaForDeactivation/ExitSpecificArea/EllipsoidArcArea/Center/PointCoordinateType/Longitude

Status	Occurrence	Format	Min. Access Types
Required	One	int	Get, Replace

This leaf node contains the longitudinal coordinate of the center.

- Values: 0-16777215

5.2.48W6B21/<x>/<x>/OnNetwork/FunctionalAliasList/<x>/Entry/LocationCriteriaForDeactivation/ExitSpecificArea/EllipsoidArcArea/Center/PointCoordinateType/Latitude

Table 5.2.48W6B21.1:

<x>/<x>/OnNetwork/FunctionalAliasList/<x>/Entry/LocationCriteriaForDeactivation/ExitSpecificArea/EllipsoidArcArea/Center/PointCoordinateType/Latitude

<x>/OnNetwork/FunctionalAliasList/<x>/Entry/LocationCriteriaForDeactivation/ExitSpecificArea/EllipsoidArcArea/Center/PointCoordinateType/Latitude

Status	Occurrence	Format	Min. Access Types
Required	One	int	Get, Replace

This leaf node contains the latitudinal coordinate of the center.

- Values: 0-16777215

5.2.48W6B22/<x>/<x>/OnNetwork/FunctionalAliasList/<x>/Entry/LocationCriteriaForDeactivation/ExitSpecificArea/EllipsoidArcArea/Radius

Table 5.2.48W6B22.1:

<x>/<x>/OnNetwork/FunctionalAliasList/<x>/Entry/LocationCriteriaForDeactivation/ExitSpecificArea/EllipsoidArcArea/Radius

<x>/OnNetwork/FunctionalAliasList/<x>/Entry/LocationCriteriaForDeactivation/ExitSpecificArea/EllipsoidArcArea/Radius

Status	Occurrence	Format	Min. Access Types
Required	One	int	Get, Replace

This leaf node contains the radius of the ellipsoid arc.

- Values: non-negative integer

5.2.48W6B23/<x>/<x>/OnNetwork/FunctionalAliasList/<x>/Entry/LocationCriteriaForDeactivation/ExitSpecificArea/EllipsoidArcArea/OffsetAngle

Table 5.2.48W6B23.1:

/<x>/<x>/OnNetwork/FunctionalAliasList/<x>/Entry/LocationCriteriaForDeactivation/ExitSpecificArea/EllipsoidArcArea/OffsetAngle

<x>/OnNetwork/FunctionalAliasList/<x>/Entry/LocationCriteriaForDeactivation/ExitSpecificArea/EllipsoidArcArea/OffsetAngle

Status	Occurrence	Format	Min. Access Types
Required	One	int	Get, Replace

This leaf node contains the offset angle of the ellipsoid arc.

- Values: 0-255

5.2.48W6B24/<x>/<x>/OnNetwork/FunctionalAliasList/<x>/Entry/LocationCriteriaForDeactivation/ExitSpecificArea/EllipsoidArcArea/IncludedAngle

Table 5.2.48W6B24.1:

/<x>/<x>/OnNetwork/FunctionalAliasList/<x>/Entry/LocationCriteriaForDeactivation/ExitSpecificArea/EllipsoidArcArea/IncludedAngle

<x>/OnNetwork/FunctionalAliasList/<x>/Entry/LocationCriteriaForDeactivation/ExitSpecificArea/EllipsoidArcArea/IncludedAngle

Status	Occurrence	Format	Min. Access Types
Required	One	int	Get, Replace

This leaf node contains the included angle of the ellipsoid arc.

- Values: 0-255

5.2.48W6B24A

/<x>/<x>/OnNetwork/FunctionalAliasList/<x>/Entry/LocationCriteriaForDeactivation/ExitSpecificArea/Speed

Table 5.2.48W6B24A.1:

/<x>/<x>/OnNetwork/FunctionalAliasList/<x>/Entry/LocationCriteriaForDeactivation/ExitSpecificArea/Speed

<x>/OnNetwork/FunctionalAliasList/<x>/Entry/LocationCriteriaForDeactivation/ExitSpecificArea/Speed

Status	Occurrence	Format	Min. Access Types
Optional	One	node	Get, Replace

This interior node contains the speed.

5.2.48W6B24B

`/<x>/<x>/OnNetwork/FunctionalAliasList/<x>/Entry/LocationCriteriaForDeactivation/ExitSpecificArea/Speed/MinimumSpeed`

Table 5.2.48W6B24B.1:

`/<x>/<x>/OnNetwork/FunctionalAliasList/<x>/Entry/LocationCriteriaForDeactivation/ExitSpecificArea/Speed/MinimumSpeed`

`<x>/OnNetwork/FunctionalAliasList/<x>/Entry/LocationCriteriaForDeactivation/ExitSpecificArea/Speed/MinimumSpeed`

Status	Occurrence	Format	Min. Access Types
Required	One	int	Get, Replace

This leaf node contains the minimum speed.

- Values: non-negative integer in units of kilometers/hour.

5.2.48W6B24C

`/<x>/<x>/OnNetwork/FunctionalAliasList/<x>/Entry/LocationCriteriaForDeactivation/ExitSpecificArea/Speed/MaximumSpeed`

Table 5.2.48W6B24C.1:

`/<x>/<x>/OnNetwork/FunctionalAliasList/<x>/Entry/LocationCriteriaForDeactivation/ExitSpecificArea/Speed/MaximumSpeed`

`<x>/OnNetwork/FunctionalAliasList/<x>/Entry/LocationCriteriaForDeactivation/ExitSpecificArea/Speed/MaximumSpeed`

Status	Occurrence	Format	Min. Access Types
Required	One	int	Get, Replace

This leaf node contains the maximum speed.

- Values: non-negative integer in units of kilometers/hour.

5.2.48W6B24D

`/<x>/<x>/OnNetwork/FunctionalAliasList/<x>/Entry/LocationCriteriaForDeactivation/ExitSpecificArea/Heading`

Table 5.2.48W6B24D.1:

`/<x>/<x>/OnNetwork/FunctionalAliasList/<x>/Entry/LocationCriteriaForDeactivation/ExitSpecificArea/Heading`

`<x>/OnNetwork/FunctionalAliasList/<x>/Entry/LocationCriteriaForDeactivation/ExitSpecificArea/Heading`

Status	Occurrence	Format	Min. Access Types
Optional	One	node	Get, Replace

This interior node contains the heading.

5.2.48W6B24E

`/<x>/<x>/OnNetwork/FunctionalAliasList/<x>/Entry/LocationCriteriaForDeactivation/ExitSpecificArea/Heading/MinimumHeading`

Table 5.2.48W6B24E.1:

`/<x>/<x>/OnNetwork/FunctionalAliasList/<x>/Entry/LocationCriteriaForDeactivation/ExitSpecificArea/Heading/MinimumHeading`

`<x>/OnNetwork/FunctionalAliasList/<x>/Entry/LocationCriteriaForDeactivation/ExitSpecificArea/Heading/MinimumHeading`

Status	Occurrence	Format	Min. Access Types
Required	One	int	Get, Replace

This leaf node contains the minimum heading.

- Values: 0-359

5.2.48W6B24F

`/<x>/<x>/OnNetwork/FunctionalAliasList/<x>/Entry/LocationCriteriaForDeactivation/ExitSpecificArea/Heading/MaximumHeading`

Table 5.2.48W6B24F.1:

`/<x>/<x>/OnNetwork/FunctionalAliasList/<x>/Entry/LocationCriteriaForDeactivation/ExitSpecificArea/Heading/MaximumHeading`

`<x>/OnNetwork/FunctionalAliasList/<x>/Entry/LocationCriteriaForDeactivation/ExitSpecificArea/Heading/MaximumHeading`

Status	Occurrence	Format	Min. Access Types
Required	One	int	Get, Replace

This leaf node contains the maximum heading.

- Values: 0-359

5.2.48W6C/`<x>/<x>/OnNetwork/FunctionalAliasList/<x>/Entry/ManualDeactivationNotAllowedIfLocationCriteriaMet`

Table 5.2.48W6E.1:

`/<x>/<x>/OnNetwork/FunctionalAliasList/<x>/Entry/ManualDeactivationNotAllowedIfLocationCriteriaMet`

`<x>/OnNetwork/FunctionalAliasList/<x>/Entry/ManualDeactivationNotAllowedIfLocationCriteriaMet`

Status	Occurrence	Format	Min. Access Types
Optional	ZeroOrOne	bool	Get, Replace

This leaf node indicates whether the MCPTT user is authorised to de-activate a functional alias if the location criteria is met.

5.2.48W7 `/<x>/<x>/OnNetwork/FunctionalAliasList/<x>/Entry/DisplayName`Table 5.2.48W7.1: `/<x>/<x>/OnNetwork/FunctionalAliasList/<x>/Entry/DisplayName`

`<x>/OnNetwork/FunctionalAliasList/<x>/Entry/DisplayName`

Status	Occurrence	Format	Min. Access Types
Optional	One	chr	Get, Replace

This leaf node contains a human readable name that corresponds to a functional alias that can be activated by the MCPTT user.

5.2.48W7A /<x>/<x>/OnNetwork/FunctionalAliasList/<x>/Entry/MaxSimultaneousEmergencyGroupCalls

Table 5.2.48W7A.1: /<x>/<x>/OnNetwork/FunctionalAliasList/<x>/Entry/MaxSimultaneousEmergencyGroupCalls

<x>/OnNetwork/FunctionalAliasList/<x>/Entry/MaxSimultaneousEmergencyGroupCalls

Status	Occurrence	Format	Min. Access Types
Optional	One	int	Get, Replace

This leaf node indicates the maximum number of simultaneous emergency group calls for a functional alias.

5.2.48W8 /<x>/<x>/OnNetwork/AllowedQueryFunctionalAliasOtherUser

Table 5.2.48W8.1: /<x>/<x>/OnNetwork/AllowedQueryFunctionalAliasOtherUser

<x>/OnNetwork/AllowedQueryFunctionalAliasOtherUser

Status	Occurrence	Format	Min. Access Types
Required	One	bool	Get, Replace

This leaf node indicates whether the MCPTT user is authorised query the functional alias(es) activated by another MCPTT user.

When set to "true" the MCPTT user is authorised to query the functional alias(es) activated by another MCPTT user.

When set to "false" the MCPTT user is not authorised to query the functional alias(es) activated by another MCPTT user.

5.2.48W9 /<x>/<x>/OnNetwork/AllowedTakeoverFunctionalAliasOtherUser

Table 5.2.48W9.1: /<x>/<x>/OnNetwork/AllowedTakeoverFunctionalAliasOtherUser

<x>/OnNetwork/AllowedTakeoverFunctionalAliasOtherUser

Status	Occurrence	Format	Min. Access Types
Required	One	bool	Get, Replace

This leaf node indicates whether the MCPTT user is authorised to take over the functional alias(es) previously activated by another MCPTT user.

When set to "true" the MCPTT user is authorised to take over the functional alias(es) previously activated by another MCPTT user.

When set to "false" the MCPTT user is not authorised to take over the functional alias(es) previously activated by another MCPTT user.

5.2.48W10 /<x>/<x>/OnNetwork/AllowedLocationInfoWhenTalking

Table 5.2.48W10.1: /<x>/<x>/OnNetwork/AllowedLocationInfoWhenTalking

<x>/OnNetwork/AllowedLocationInfoWhenTalking

Status	Occurrence	Format	Min. Access Types
Required	One	bool	Get, Replace

This leaf node indicates whether the MCPTT user is authorised to send its location information when it is requesting the floor.

When set to "true" the MCPTT user is authorised to send its location information when it is requesting the floor.

When set to "false" the MCPTT user is not authorised to send its location information when it is requesting the floor.

5.2.48X /<x>/<x>/OnNetwork/AuthorisedIncomingAny

Table 5.2.48.1: /<x>/<x>/OnNetwork/AuthorisedIncomingAny

<x>/OnNetwork/AuthorisedIncomingAny

Status	Occurrence	Format	Min. Access Types
Required	One	bool	Get, Replace

This leaf node indicates the authorisation to receive a MCPTT private call by any MCPTT user.

When set to "true" the MCPTT user is authorised to receive an MCPTT private call by any MCPTT user.

When set to "false" the MCPTT user is not authorised to receive an MCPTT private call by any MCPTT user.

5.2.48Y1/<x>/<x>/OnNetwork/UserList

Table 5.2.48Y1.1: /<x>/<x>/OnNetwork/UserList

<x>/ OnNetwork/UserList

Status	Occurrence	Format	Min. Access Types
Required	One	node	Get, Replace

This interior node is a placeholder for a list of MCPTT user(s) who can call this particular user in a MCPTT private call.

5.2.48Y2/<x>/<x>/OnNetwork/UserList/<x>

Table 5.2.48Y2.1: /<x>/<x>/OnNetwork/UserList/<x>

<x>/OnNetwork/UserList/<x>

Status	Occurrence	Format	Min. Access Types
Optional	OneOrMore	node	Get, Replace

This interior node is a placeholder for one or more list of MCPTT users who can call this particular user in a MCPTT private call.

5.2.48Y3/<x>/<x>/OnNetwork/UserList/<x>/Entry

Table 5.2.48Y3.1: /<x>/<x>/OnNetwork/UserList/<x>/Entry

<x>/OnNetwork/UserList/<x>/Entry

Status	Occurrence	Format	Min. Access Types
Required	One	node	Get, Replace

This interior node is a placeholder for one or more MCPTT users who can call the particular user in a private call.

5.2.48Y4/<x>/<x>/OnNetwork/UserList/<x>/Entry/MCPTTID

Table 5.2.48Y4.1: /<x>/<x>/OnNetwork/UserList/<x>/Entry/MCPTTID

<x>/OnNetwork/UserList/<x>/Entry/MCPTTID

Status	Occurrence	Format	Min. Access Types
Optional	One	chr	Get, Replace

This leaf node indicates an MCPTT user identity (MCPTT ID) which is a globally unique identifier within the MCPTT service that represents the MCPTT user.

The value is a "uri" attribute specified in OMA OMA-TS-XDM_Group-V1_1 [4].

5.2.48Y5/ <x>/<x>/OnNetwork/UserList/<x>/Entry/PrivateCallKMSURI

Table 5.2.48Y5.1: /<x>/<x>/OnNetwork/UserList/<x>/Entry/PrivateCallKMSURI

<x>/OnNetwork/UserList/<x>/Entry/PrivateCallKMSURI

Status	Occurrence	Format	Min. Access Types
Optional	One	chr	Get, Replace

This leaf node indicates the identity (URI) of the KMS associated with the MCPTTID. If the value is empty, the KMS leaf node present in the MCS UE initial configuration MO is used.

5.2.48Z /<x>/<x>/OnNetwork/AuthorisedReceiveNonAcknowledged

Table 5.2.48Z.1: /<x>/<x>/OnNetwork/AuthorisedReceiveNonAcknowledged

<x>/OnNetwork/AuthorisedReceiveNonAcknowledged

Status	Occurrence	Format	Min. Access Types
Required	One	bool	Get, Replace

This leaf node indicates the authorisation to receive the list of non-acknowledged MCPTT users to a group session invitation.

When set to "true" the MCPTT user is authorised to receive information about the MCPTT Users that did not acknowledge a group session invitation.

When set to "false" the MCPTT user is not authorised to receive information about MCPTT Users that did not acknowledge a group session invitation.

5.2.49 /<x>/<x>/OffNetwork

Table 5.2.49.1: /<x>/<x>/OffNetwork

<x>/OffNetwork

Status	Occurrence	Format	Min. Access Types
Required	ZeroOrOne	node	Get, Replace

This interior node represents a container for off-network operation.

5.2.50 /<x>/<x>/OffNetwork/Authorised

Table 5.2.50.1: /<x>/<x>/OffNetwork/Authorised

<x>/OffNetwork/Authorised

Status	Occurrence	Format	Min. Access Types
Required	One	bool	Get, Replace

This leaf node indicates the authorisation for off-network services.

When set to "true" the MCPTT user is authorised for off-network.

When set to "false" the MCPTT user is not authorised for off-network operation.

5.2.51 /<x>/<x>/OffNetwork/MCPTTGroupInfo

Table 5.2.51.1: /<x>/<x>/OffNetwork/MCPTTGroupInfo

<x>/OffNetwork/MCPTTGroupInfo

Status	Occurrence	Format	Min. Access Types
Required	One	node	Get, Replace

This interior node is a placeholder for group information.

5.2.52 /<x>/<x>/OffNetwork/MCPTTGroupInfo/<x>

Table 5.2.52.1: /<x>/<x>/OffNetwork/MCPTTGroupInfo/<x>

<x>/OffNetwork/MCPTTGroupInfo/<x>

Status	Occurrence	Format	Min. Access Types
Required	OneOrMore	node	Get, Replace

This interior node is a placeholder for one or more group information.

5.2.52A /<x>/<x>/OffNetwork/MCPTTGroupInfo/<x>/Entry

Table 5.2.52A.1: /<x>/<x>/OffNetwork/MCPTTGroupInfo/<x>/Entry

<x>/OffNetwork/MCPTTGroupInfo/<x>/Entry

Status	Occurrence	Format	Min. Access Types
Required	One	node	Get, Replace

This interior node is a placeholder for one or more off-network MCPTT groups for use by an MCPTT user.

5.2.53 /<x>/<x>/OffNetwork/MCPTTGroupInfo/<x>/Entry/MCPTTGroupID

Table 5.2.53.1: /<x>/<x>/OffNetwork/MCPTTGroupInfo/<x>/Entry/MCPTTGroupID

<x>/OffNetwork/MCPTTGroupInfo/<x>/Entry/MCPTTGroupID

Status	Occurrence	Format	Min. Access Types
Required	One	int	Get, Replace

This leaf node indicates an off-network MCPTT group for use by an MCPTT user.

5.2.53A /<x>/<x>/OffNetwork/MCPTTGroupInfo/<x>/Entry/DisplayName

Table 5.2.53A.1: /<x>/<x>/OffNetwork/MCPTTGroupInfo/<x>/Entry/DisplayName

<x>/OffNetwork/MCPTTGroupInfo/<x>/Entry/DisplayName

Status	Occurrence	Format	Min. Access Types
Optional	One	chr	Get, Replace

This leaf node contains a human readable name that corresponds to the MCPTT group represented by the MCPTT group ID.

5.2.54 /<x>/<x>/OffNetwork/AllowedListen

Table 5.2.54.1: /<x>/<x>/OffNetwork/AllowedListen

<x>/OffNetwork/AllowedListen

Status	Occurrence	Format	Min. Access Types
Required	One	bool	Get, Replace

This leaf node indicates whether the MCPTT user is allowed to listen both overriding and overridden.

When set to "true" the MCPTT user is allowed to listen both overriding and overridden.

When set to "false" the MCPTT user is not allowed to listen both overriding and overridden.

5.2.55 /<x>/<x>/OffNetwork/AllowedTransmission

Table 5.2.55.1: /<x>/<x>/OffNetwork/AllowedTransmission

<x>/OffNetwork/AllowedTransmission

Status	Occurrence	Format	Min. Access Types
Required	One	bool	Get, Replace

This leaf node indicates whether the MCPTT user is allowed to transmit in case of override (overriding and/or overridden).

When set to "true" the MCPTT user is allowed to transmit in case of override (overriding and/or overridden).

When set to "false" the MCPTT user is not allowed to transmit in case of override (overriding and/or overridden).

5.2.56 /<x>/<x>/OffNetwork/EmergencyCallChange

Table 5.2.56.1: /<x>/<x>/OffNetwork/EmergencyCallChange

<x>/OffNetwork/EmergencyCallChange

Status	Occurrence	Format	Min. Access Types
Required	One	bool	Get, Replace

This leaf node indicates the authorization for a participant to change an off-network group call in-progress to an off-network MCPTT emergency group call.

When set to "true" the MCPTT user is authorised to change an MCPTT emergency group call.

When set to "false" the MCPTT user is not authorised to change an MCPTT emergency group call.

5.2.57 /<x>/<x>/OffNetwork/ImminentPerilCallChange

Table 5.2.57.1: /<x>/<x>/OffNetwork/ImminentPerilCallChange

<x>/OffNetwork/ImminentPerilCallChange

Status	Occurrence	Format	Min. Access Types
Required	One	bool	Get, Replace

This leaf node indicates the authorization for a participant to change an off-network group call in-progress to an off-network MCPTT imminent peril group call.

When set to "true" the MCPTT user is authorised to change an MCPTT imminent peril group call.

When set to "false" the MCPTT user is not authorised to change an MCPTT imminent peril group call.

5.2.58 /<x>/<x>/OffNetwork/UserInfoID

Table 5.2.58.1: /<x>/<x>/OffNetwork/UserInfoID

<x>/OffNetwork/UserInfoID

Status	Occurrence	Format	Min. Access Types
Required	One	chr	Get, Replace

This leaf node indicates the ProSe user info ID as specified in 3GPP TS 23.303 [6].

5.2.58A1/ <x>/ <x>/OffNetwork/GroupServerInfo

Table 5.2.58A1.1: / <x>/ <x>/OffNetwork/GroupServerInfo

<x>/OffNetwork/GroupServerInfo

Status	Occurrence	Format	Min. Access Types
Required	One	node	Get, Replace

This interior node is a placeholder for the configured identity management an group management servers for the groups contained in the off-network MCPTTGroupList

5.2.58A2/ <x>/ <x>/OffNetwork/GroupServerInfo/GMSServList

Table 5.2.58A2.1: / <x>/ <x>/OffNetwork/GroupServerInfo/GMSServList

<x>/OffNetwork/GroupServerInfo/GMSServList

Status	Occurrence	Format	Min. Access Types
Required	One	node	Get, Replace

This interior node is a placeholder for the list of MCPTT group management server for the groups contained in the off-network MCPTTGroupList.

5.2.58A3/ <x>/ <x>/OffNetwork/GroupServerInfo/GMSServList/ <x>

Table 5.2.58A3.1: / <x>/ <x>/OffNetwork/GroupServerInfo/GMSServList/ <x>

<x>/OffNetwork/GroupServerInfo/GMSServList/ <x>

Status	Occurrence	Format	Min. Access Types
Required	OneOrMore	node	Get, Replace

This interior node is a placeholder for the list of MCPTT group management server for the groups contained in the off-network MCPTTGroupList.

5.2.58A4/ <x>/ <x>/OffNetwork/GroupServerInfo/GMSServList/ <x>/Entry

Table 5.2.58A4.1: / <x>/ <x>/OffNetwork/GroupServerInfo/GMSServList/ <x>/Entry

<x>/OffNetwork/GroupServerInfo/GMSServList/ <x>/Entry

Status	Occurrence	Format	Min. Access Types
Optional	One	node	Get, Replace

This interior node is a placeholder for identity of the GMS owning a specific group contained in the off-network MCPTTGroupList.

5.2.58A5

/ <x>/ <x>/OffNetwork/GroupServerInfo/GMSServList/ <x>/Entry/GMSServID

Table 5.2.58A5.1: / <x>/ <x>/OffNetwork/GroupServerInfo/GMSServList/ <x>/Entry/GMSServID

<x>/OffNetwork/GroupServerInfo/GMSServList/ <x>/Entry/GMSServID

Status	Occurrence	Format	Min. Access Types

Required	One	chr	Get, Replace
----------	-----	-----	--------------

This leaf node indicates the identity (URI) of the GMS owning a specific group contained in the off-network MCPTTGroupList.

5.2.58A6/ <x>/ <x>/OffNetwork/GroupServerInfo/IDMSTokenEndpointList

Table 5.2.58A6.1: / <x>/ <x>/OffNetwork/GroupServerInfo/IDMSTokenEndpointList

<x>/OffNetwork/GroupServerInfo/IDMSTokenEndpointList

Status	Occurrence	Format	Min. Access Types
Required	One	node	Get, Replace

This interior node is a placeholder for the list of MCPTT IDMS token endpoints for the groups contained in the off-network MCPTTGroupList.

5.2.58A7/ <x>/ <x>/OffNetwork/GroupServerInfo/IDMSTokenEndpointList/ <x>

Table 5.2.58A7.1: / <x>/ <x>/OffNetwork/GroupServerInfo/IDMSTokenEndpointList/ <x>

<x>/OffNetwork/GroupServerInfo/IDMSTokenEndpointList/ <x>

Status	Occurrence	Format	Min. Access Types
Optional	One	node	Get, Replace

This interior node is a placeholder for the IDMS token endpoint for a specific group contained in the off-network MCPTTGroupList.

5.2.58A8/ <x>/ <x>/OffNetwork/GroupServerInfo/IDMSTokenEndpointList/ <x>/Entry

Table 5.2.58A8.1: / <x>/ <x>/OffNetwork/GroupServerInfo/IDMSTokenEndpointList/ <x>/Entry

<x>/OffNetwork/GroupServerInfo/IDMSTokenEndpointList/ <x>/Entry

Status	Occurrence	Format	Min. Access Types
Optional	One	node	Get, Replace

This interior node is a placeholder for the IDMS token endpoint for a specific group contained in the off-network MCPTTGroupList.

5.2.58A9

/ <x>/ <x>/OffNetwork/GroupServerInfo/IDMSTokenEndpointList/ <x>/Entry/IDMSTokenID

Table 5.2.58A9.1:

/ <x>/ <x>/OffNetwork/GroupServerInfo/IDMSTokenEndpointList/ <x>/Entry/IDMSTokenID

<x>/OffNetwork/GroupServerInfo/IDMSTokenEndpointList/ <x>/Entry/IDMSTokenID

Status	Occurrence	Format	Min. Access Types
Required	One	chr	Get, Replace

This leaf node indicates the identity (URI) of the IDMS token endpoint for a specific group contained in the off-network MCPTTGroupList. If the value is empty, the IDMS identities (IDMSAuthEndpoint and IDMSTokenEndpoint) present in the MCS UE initial configuration MO are used.

5.2.58A10/<x>/<x>/OffNetwork/GroupServerInfo/KMSURIList

Table 5.2.58A10.1: /<x>/<x>/OffNetwork/GroupServerInfo/KMSURIList

<x>/OffNetwork/GroupServerInfo/KMSURIList

Status	Occurrence	Format	Min. Access Types
Required	One	node	Get, Replace

This interior node is a placeholder for the list of KMS identities (URIs) for the groups contained in the off-network MCPTTGroupList.

5.2.58A11/<x>/<x>/OffNetwork/GroupServerInfo/KMSURIList/<x>

Table 5.2.58A11.1: /<x>/<x>/OffNetwork/GroupServerInfo/KMSURIList/<x>

<x>/OffNetwork/GroupServerInfo/KMSURIList/<x>

Status	Occurrence	Format	Min. Access Types
Optional	One	node	Get, Replace

This interior node is a placeholder for the KMS identity (URI) for a specific group contained in the off-network MCPTTGroupList.

5.2.58A12/<x>/<x>/OffNetwork/GroupServerInfo/KMSURIList/<x>/Entry

Table 5.2.58A12.1: /<x>/<x>/OffNetwork/GroupServerInfo/KMSURIList/<x>/Entry

<x>/OffNetwork/GroupServerInfo/KMSURIList/<x>/Entry

Status	Occurrence	Format	Min. Access Types
Optional	One	node	Get, Replace

This interior node is a placeholder for the KMS identity (URI) for a specific group contained in the off-network MCPTTGroupList.

5.2.58A13

/<x>/<x>/OffNetwork/GroupServerInfo/KMSURIList/<x>/Entry/KMSURI

Table 5.2.58A13.1: /<x>/<x>/OffNetwork/GroupServerInfo/KMSURIList/<x>/Entry/KMSURI

<x>/OffNetwork/GroupServerInfo/KMSURIList/<x>/Entry/KMSURI

Status	Occurrence	Format	Min. Access Types
Required	One	chr	Get, Replace

This leaf node indicates the identity (URI) of the KMS identity (URI) for a specific group contained in the off-network MCPTTGroupList. If the value is empty, the KMS identity (URI) (kms) present in the MCS UE initial configuration MO is used.

5.2.58A14/ <x>/ <x>/OffNetwork/GroupServerInfo/PresentationPriorityList

Table 5.2.58A14.1: / <x>/ <x>/OffNetwork/GroupServerInfo/PresentationPriorityList

<x>/OffNetwork/GroupServerInfo/PresentationPriorityList

Status	Occurrence	Format	Min. Access Types
Required	One	node	Get, Replace

This interior node is a placeholder for the list of presentation priorities for the groups contained in the off-network MCPTTGroupList.

5.2.58A15/ <x>/ <x>/OffNetwork/GroupServerInfo/PresentationPriorityList/ <x>

Table 5.2.58A15.1: / <x>/ <x>/OffNetwork/GroupServerInfo/PresentationPriorityList/ <x>

<x>/OffNetwork/GroupServerInfo/PresentationPriorityList/ <x>

Status	Occurrence	Format	Min. Access Types
Optional	One	node	Get, Replace

This interior node is a placeholder for the presentation priority for a specific group contained in the off-network MCPTTGroupList.

5.2.58A16/ <x>/ <x>/OffNetwork/GroupServerInfo/PresentationPriorityList/ <x>/Entry

Table 5.2.58A16.1: / <x>/ <x>/OffNetwork/GroupServerInfo/PresentationPriorityList/ <x>/Entry

<x>/OffNetwork/GroupServerInfo/PresentationPriorityList/ <x>/Entry

Status	Occurrence	Format	Min. Access Types
Optional	One	node	Get, Replace

This interior node is a placeholder for the presentation priority for a specific group contained in the off-network MCPTTGroupList.

5.2.58A17 / <x>/ <x>/OffNetwork/GroupServerInfo/PresentationPriority

Table 5.2.58A17.1: / <x>/ <x>/OffNetwork/GroupServerInfo/PresentationPriority

<x>/OffNetwork/GroupServerInfo/PresentationPriority

Status	Occurrence	Format	Min. Access Types
Optional	One	int	Get, Replace

This leaf node indicates the presentation priority of the off-network group for the MCPTT user relative to other off-network groups and off-network users.

- Values: 0-255

The lowest PresentationPriority value shall be considered as the MCPTT group transaction having the lowest priority for presentation among other group MCPTT and one-to-one user transactions.

5.2.59 / <x>/Status

Table 5.2.59.1: / <x>/Status

Status

Status	Occurrence	Format	Min. Access Types
Optional	One	bool	Get, Replace

This leaf node indicates whether this MCPTT user profile is enabled or disabled.

When set to "true" this MCPTT user profile is enabled.

When set to "false" this MCPTT user profile is disabled.

6 MCS group configuration MO

6.1 General

The MCS group configuration Management Object (MO) is used to configure the MCS Client behaviour for the on-network or off-network MC services. The MCS group configuration parameters may be stored in the ME, or in the USIM as specified in 3GPP TS 31.102 [10], or in both the ME and the USIM. If both the ME and the USIM contain the same parameters, the values stored in the USIM shall take precedence.

NOTE: For historical reasons some of the elements in the MCS group configuration Management Object (MO) use the terminology "MCPTT", however this MO is common to all MCS with some MCPTT specific elements, some MCDATA specific elements and some MCVideo specific elements. Not all elements that contain the terminology "MCPTT" are just MCPTT specific. In the subclauses that follow, it is made clear what aspects are specific to MCPTT and what aspects are specific to all MC services. MCDATA specific elements are contained under "MCDATA" nodes. MCVideo specific elements are contained under "MCVideo" nodes.

The Management Object Identifier is: urn:oma:mo:ext-3gpp-MCPTT-group-configuration:1.0.

Protocol compatibility: This MO is compatible with OMA OMA DM 1.2 [3].

The OMA DM ACL property mechanism (see OMA OMA-ERELD-DM-V1_2 [2]) may be used to grant or deny access rights to OMA DM servers in order to modify nodes and leaf objects of the MCS group configuration MO.

The following nodes and leaf objects are possible under the MCS group configuration node as described in figure 6.1.1:



Figure 6.1.1: The MCS group configuration MO (1 of 5)

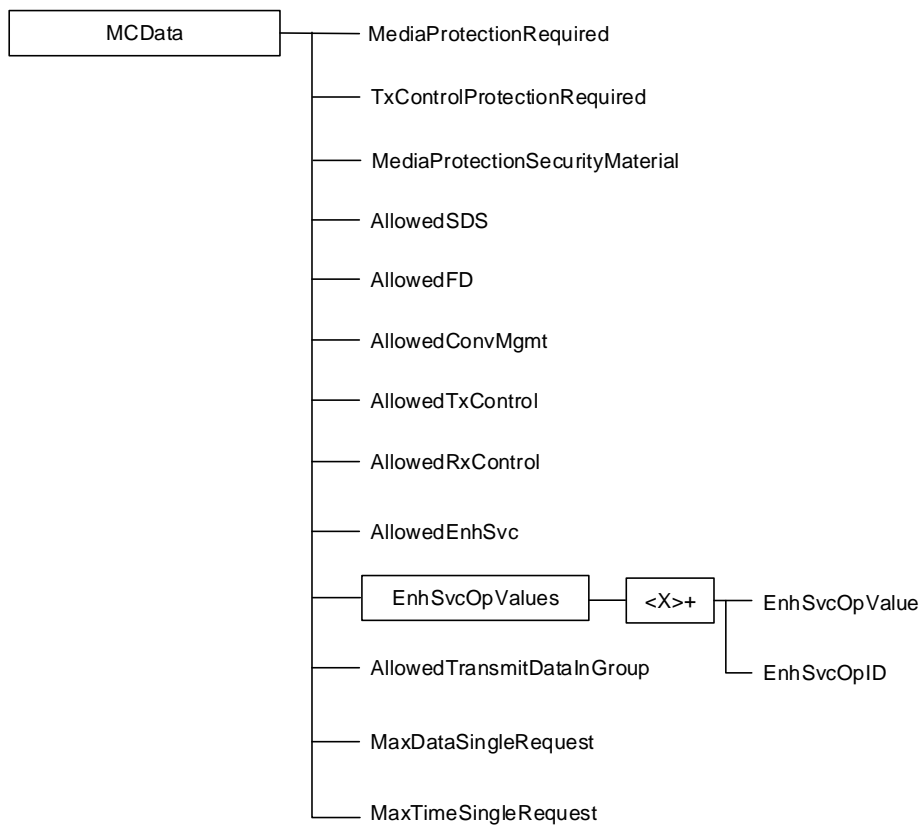

Figure 6.1.2: The MCS group configuration MO (2 of 5)

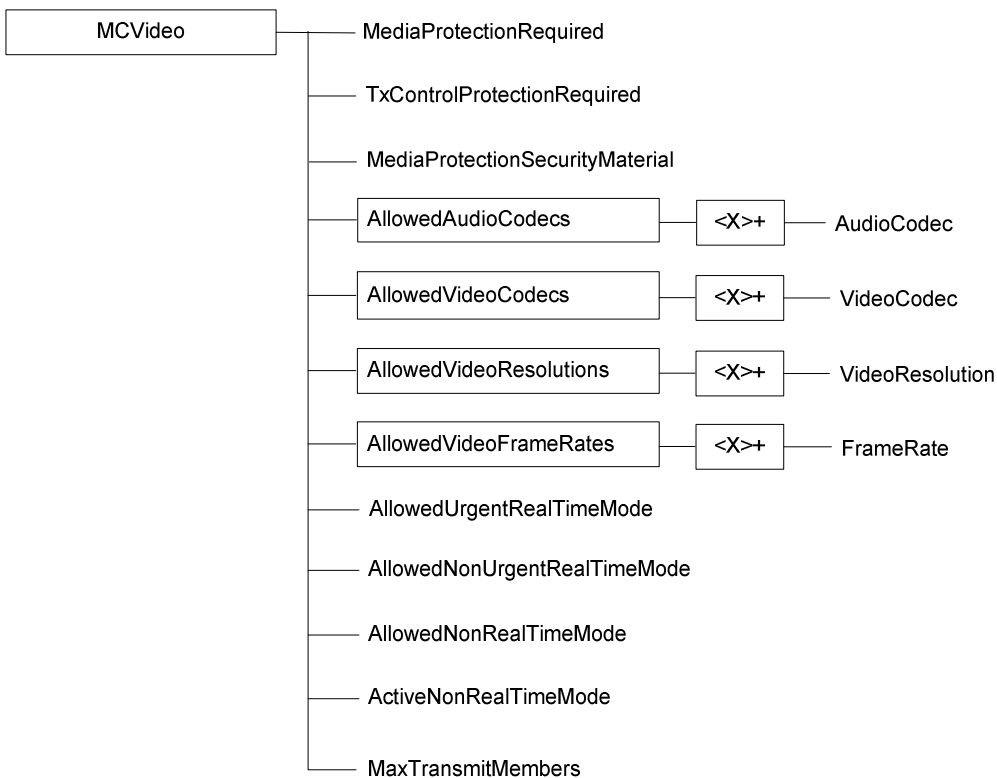

Figure 6.1.3: The MCS group configuration MO (3 of 5)

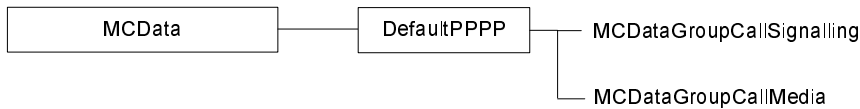

Figure 6.1.4: The MCS group configuration MO (4 of 5)

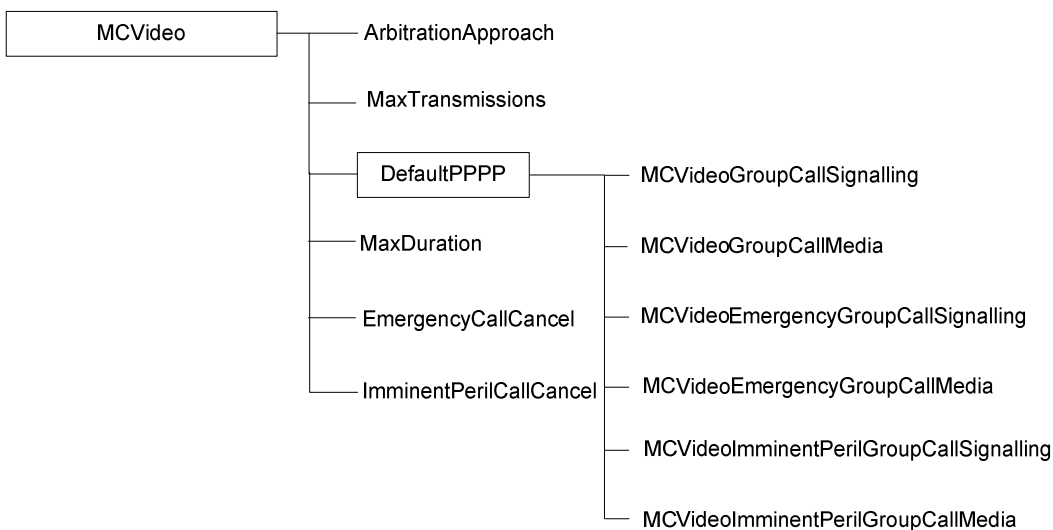

Figure 6.1.5: The MCS group configuration MO (5 of 5)

6.2 MCS group configuration MO parameters

6.2.1 General

This clause describes the parameters for the MCS group configuration Management Object (MO).

6.2.2 Node: <x>

Table 6.2.2.1: Node: <x>

<x>

Status	Occurrence	Format	Min. Access Types
Required	OneOrMore	node	Get

This interior node acts as a placeholder for the MCS group configuration Management Object (MO).

For the MCS group configuration MO, the namespace specific string is: "urn:oma:mo:oma-dm-mcptt-group configuration:1.0"

- Values: N/A

6.2.3 /<x>/Name

Table 6.2.3.1: Node: <x>

Name

Status	Occurrence	Format	Min. Access Types
Required	ZeroOrOne	chr	Get

The Name leaf is a name for the MCS group configuration settings.

- Values: <User displayable name>

6.2.4 /<x>/Ext/

Table 6.2.4.1: /<x>/Ext/

Ext

Status	Occurrence	Format	Min. Access Types
Optional	ZeroOrOne	node	Get, Replace

The Ext is an interior node for where the vendor specific information about the MCSgroup configuration MO is being placed.

Usually the vendor extension is identified by vendor specific name under the ext node and contains the vendor meaning application vendor, device vendor etc. The tree structure under the vendor identified is not defined and can therefore include one or more un-standardized sub-trees.

- Values: N/A

6.2.5 /<x>/<x>

Table 6.2.5.1: /<x>/<x>

<x>

Status	Occurrence	Format	Min. Access Types
Required	ZeroOrMore	node	Get, Replace

This interior node represents a container for on-network operation and off-network operation.

6.2.6 /<x>/<x>/Common

Table 6.2.6.1: /<x>/<x>/Common

<x>/Common

Status	Occurrence	Format	Min. Access Types
Required	ZeroOrOne	node	Get, Replace

This interior node represents a container for the common network operation which means both on-network operation and off-network operation.

6.2.7 /<x>/<x>/Common/MCPTTGroupID

Table 6.2.7.1: /<x>/<x>/Common/MCPTTGroupID

<x>/Common/MCPTTGroupID

Status	Occurrence	Format	Min. Access Types
Required	One	chr	Get, Replace

This leaf node indicates the MCS group ID.

The value is a "uri" attribute specified in OMA OMA-TS-XDM_Group-V1_1 [4].

NOTE: This element is common for all MC services.

6.2.8 /<x>/<x>/Common/MCPTTGroupAlias

Table 6.2.8.1: /<x>/<x>/Common/MCPTTGroupAlias

<x>/Common/MCPTTGroupAlias

Status	Occurrence	Format	Min. Access Types
Required	One	chr	Get, Replace

This leaf node indicates the MCS group alias.

The value is a <display-name> element specified in OMA OMA-TS-XDM_Group-V1_1 [4].

NOTE: This element is common for all MC services.

6.2.9 /<x>/<x>/Common/MCPTTGroupMemberList

Table 6.2.9.1: /<x>/<x>/Common/MCPTTGroupMemberList

<x>/Common/MCPTTGroupMemberList

Status	Occurrence	Format	Min. Access Types
Required	One	node	Get, Replace

This interior node is a placeholder for a list of MCS group members (group membership information).

NOTE: This element is common for all MC services.

6.2.10 /<x>/<x>/Common/MCPTTGroupMemberList/<x>

Table 6.2.10.1: /<x>/<x>/Common/MCPTTGroupMemberList/<x>

<x>/Common/MCPTTGroupMemberList/<x>

Status	Occurrence	Format	Min. Access Types
Required	OneOrMore	node	Get, Replace

This interior node is a placeholder for one or more list(s) of MCS group members.

NOTE: This element is common for all MC services.

6.2.11 /<x>/<x>/Common/MCPTTGroupMemberList/<x>/MCPTTID

Table 6.2.11.1: /<x>/<x>/Common/MCPTTGroupMemberList/<x>/MCPTTID

<x>/Common/MCPTTGroupMemberList/<x>/MCPTTID

Status	Occurrence	Format	Min. Access Types
Required	One	chr	Get, Replace

This leaf node indicates an MCS user identity (MC Service ID) which is a globally unique identifier within the MC service that represents the MCS user.

The value is a "uri" attribute specified in OMA OMA-TS-XDM_Group-V1_1 [4].

NOTE: This element is common for all MC services.

6.2.12 /<x>/<x>/Common/MCPTTGroupMemberList/<x>/UserPriority

Table 6.2.12.1: /<x>/<x>/Common/MCPTTGroupMemberList/<x>/UserPriority

<x>/Common/MCPTTGroupMemberList/<x>/UserPriority

Status	Occurrence	Format	Min. Access Types

Required	One	int	Get, Replace
----------	-----	-----	--------------

This leaf node indicates the user priority for the group.

The value is a <user-priority> element specified in 3GPP TS 24.481 [9] subclause 7.2.4.2.

NOTE: This element is common for all MC services.

6.2.13 /<x>/<x>/Common/MCPTTGroupMemberList/<x>/ParticipantType

Table 6.2.13.1: /<x>/<x>/Common/MCPTTGroupMemberList/<x>/ParticipantType

<x>/Common/MCPTTGroupMemberList/<x>/ParticipantType

Status	Occurrence	Format	Min. Access Types
Required	One	chr	Get, Replace

This leaf node indicates the participant type for the group.

The ParticipantType values are defined and configured by the Mission Critical Organisation (e.g.first responder, second responder, dispatcher, dispatch supervisor, MCS administrator).

NOTE: This element is common for all MC services.

6.2.14 Void

6.2.15 /<x>/<x>/Common/MCPTTGroupOwner

Table 6.2.15.1: /<x>/<x>/Common/MCPTTGroupOwner

<x>/Common/MCPTTGroupOwner

Status	Occurrence	Format	Min. Access Types
Required	One	chr	Get, Replace

This leaf node indicates the group's owner (Mission Critical Organisation).

NOTE: This element is common for all MC services.

6.2.16 /<x>/<x>/Common/PreferredVoiceCodec

Table 6.2.16.1: /<x>/<x>/Common/PreferredVoiceCodec

<x>/Common/PreferredVoiceCodec

Status	Occurrence	Format	Min. Access Types
Required	One	chr	Get, Replace

This leaf node indicates the MCPTT preferred voice codec for an MCS group.

The value of the preferred voice codec is a RTP payload format name specified in IETF RFC 4566 [13].

NOTE: This element is specific for MCPTT.

6.2.17 /<x>/<x>/Common/MCPTTGroupLevel

Table 6.2.17.1: /<x>/<x>/Common/MCPTTGroupLevel

<x>/Common/MCPTTGroupLevel

Status	Occurrence	Format	Min. Access Types
Required	One	int	Get, Replace

This leaf node indicates the level within a group hierarchy (only applicable for group-broadcast group).

- Values: 0-255

The group-broadcast group with the lowest MCPTTGroupLevel value shall be considered as the group-broadcast group having the lowest level among the groups.

NOTE: This element is common for all MC services.

6.2.18 /<x>/<x>/Common/UserLevel

Table 6.2.18.1: /<x>/<x>/Common/UserLevel

<x>/Common/UserLevel

Status	Occurrence	Format	Min. Access Types
Required	One	int	Get, Replace

This leaf node indicates the level within user hierarchy (only applicable for user-broadcast group).

The user-broadcast group with the lowest UserLevel value shall be considered as the user-broadcast group having the lowest level among the groups.

NOTE: This element is common for all MC services.

6.2.19 /<x>/<x>/Common/AllowedEmergencyCall

Table 6.2.19.1: /<x>/<x>/Common/AllowedEmergencyCall

<x>/Common/AllowedEmergencyCall

Status	Occurrence	Format	Min. Access Types
Required	One	bool	Get, Replace

This leaf node indicates whether an MCPTT emergency group call is permitted on the MCS group.

When set to "true" the MCPTT emergency group call is allowed on the group.

When set to "false" the MCPTT emergency group call is not allowed on the group.

NOTE: This element is specific for MCPTT.

6.2.20 /<x>/<x>/Common/AllowedImminentPerilCall

Table 6.2.20.1: /<x>/<x>/Common/AllowedImminentPerilCall

<x>/Common/AllowedImminentPerilCall

Status	Occurrence	Format	Min. Access Types
Required	One	bool	Get, Replace

This leaf node indicates whether an MCPTT imminent peril group call is permitted on the MCS group.

When set to "true" the MCPTT imminent peril group call is allowed on the group.

When set to "false" the MCPTT imminent peril group call is not allowed on the group.

NOTE: This element is specific for MCPTT.

6.2.21 /<x>/<x>/Common/AllowedEmergencyAlert

Table 6.2.21.1: /<x>/<x>/Common/AllowedEmergencyAlert

<x>/Common/AllowedEmergencyAlert

Status	Occurrence	Format	Min. Access Types
Required	One	bool	Get, Replace

This leaf node indicates whether an MCPTT emergency alert is possible on the MCS group.

When set to "true" the MCPTT emergency alert is allowed on the group.

When set to "false" the MCPTT emergency alert is not allowed on the group.

NOTE: This element is for specific for MCPTT.

6.2.22 /<x>/<x>/Common/MediaProtectionRequired

Table 6.2.22.1: /<x>/<x>/Common/MediaProtectionRequired

<x>/Common/MediaProtectionRequired

Status	Occurrence	Format	Min. Access Types
Required	One	bool	Get, Replace

This leaf node indicates whether confidentiality and integrity of MCPTT media is required on the MCS group.

When set to "true" confidentiality and integrity of media is required on the group.

When set to "false" confidentiality and integrity of media is not required on the group.

The default value is set to "true".

NOTE: This element is specific for MCPTT.

6.2.23 /<x>/<x>/Common/FloorControlProtectionRequired

Table 6.2.23.1: /<x>/<x>/Common/FloorControlProtectionRequired

<x>/Common/FloorControlProtectionRequired

Status	Occurrence	Format	Min. Access Types
Required	One	bool	Get, Replace

This leaf node indicates whether confidentiality and integrity of MCPTT floor control signalling is required on the MCS group.

When set to "true" confidentiality and integrity of floor control signalling is required on the group.

When set to "false" confidentiality and integrity of floor control signalling is not required on the group.

The default value is set to "true".

NOTE: This element is specific for MCPTT.

6.2.23A /<x>/<x>/Common/MediaProtectionSecurityMaterial

Table 6.2.23A.1: /<x>/<x>/Common/MediaProtectionSecurityMaterial

<x>/Common/MediaProtectionSecurityMaterial

Status	Occurrence	Format	Min. Access Types
Required	One	chr	Get, Replace

This leaf node indicates security material (as specified in 3GPP TS 33.180 [20]) for MCPTT media protection in the MCS group.

NOTE: This element is specific for MCPTT.

6.2.23B /<x>/<x>/Common/MCData

Table 6.2.23B.1: /<x>/<x>/Common/MCData

<x>/Common/MCData

Status	Occurrence	Format	Min. Access Types
Required	One	node	Get, Replace

This interior node is a placeholder for a Common MCDData group information

6.2.23C /<x>/<x>/Common/MCDData/MediaProtectionRequired

Table 6.2.23C.1: /<x>/<x>/Common/MCDData/MediaProtectionRequired

<x>/Common/MCDData/MediaProtectionRequired

Status	Occurrence	Format	Min. Access Types
Required	One	bool	Get, Replace

This leaf node indicates whether confidentiality and integrity of media is required for MCDData transactions on the MCS group.

When set to "true" confidentiality and integrity of MCDData media is required on the group.

When set to "false" confidentiality and integrity of MCDData media is not required on the group.

The default value is set to "true".

6.2.23D /<x>/<x>/Common/MCDData/TxControlProtectionRequired

Table 6.2.23D.1: /<x>/<x>/Common/MCDData/TxControlProtectionRequired

<x>/Common/MCDData/TxControlProtectionRequired

Status	Occurrence	Format	Min. Access Types
Required	One	bool	Get, Replace

This leaf node indicates whether confidentiality and integrity protection is required for on-network and off-network MCDData transmission control signalling on the MCS group

When set to "true" confidentiality and integrity of MCDData transmission control signalling is required on the group.

When set to "false" confidentiality and integrity of MCDData transmission control signalling is not required on the group.

The default value is set to "true".

6.2.23E /<x>/<x>/Common/MCDData/MediaProtectionSecurityMaterial

Table 6.2.23E.1: /<x>/<x>/Common/MCDData/MediaProtectionSecurityMaterial

<x>/Common/MCDData/MediaProtectionSecurityMaterial

Status	Occurrence	Format	Min. Access Types
Required	One	chr	Get, Replace

This leaf node indicates security material (as specified in 3GPP TS 33.180 [xx]) for MCDData media protection in the MCS group.

6.2.23F /<x>/<x>/Common/MCDData/AllowedSDS

Table 6.2.23F.1: /<x>/<x>/Common/MCDData/AllowedSDS

<x>/Common/MCDData/AllowedSDS

Status	Occurrence	Format	Min. Access Types
Required	One	bool	Get, Replace

This leaf node indicates whether Short Data Service (SDS) is enabled for the group.

When set to "true" the Short Data Service (SDS) is allowed on the group.

When set to "false" the Short Data Service (SDS) is not allowed on the group.

6.2.23G /<x>/<x>/Common/MCData/AllowedFD

Table 6.2.23G.1: /<x>/<x>/Common/MCData/AllowedFD

<x>/Common/MCData/AllowedFD

Status	Occurrence	Format	Min. Access Types
Required	One	bool	Get, Replace

This leaf node indicates whether File Distribution (FD) is enabled for the group.

When set to "true" File Distribution (FD) is allowed on the group.

When set to "false" File Distribution (FD) is not allowed on the group.

6.2.23H /<x>/<x>/Common/MCData/AllowedConvMgmt

Table 6.2.23H.1: /<x>/<x>/Common/MCData/AllowedConvMgmt

<x>/Common/MCData/AllowedConvMgmt

Status	Occurrence	Format	Min. Access Types
Required	One	bool	Get, Replace

This leaf node indicates whether conversation management is enabled for the group.

When set to "true" conversation management is allowed on the group.

When set to "false" conversation management is not allowed on the group.

6.2.23I /<x>/<x>/Common/MCData/AllowedTxControl

Table 6.2.23I.1: /<x>/<x>/Common/MCData/AllowedTxControl

<x>/Common/MCData/AllowedTxControl

Status	Occurrence	Format	Min. Access Types
Required	One	bool	Get, Replace

This leaf node indicates whether transmission control is enabled for the group.

When set to "true" transmission control is allowed on the group.

When set to "false" transmission control is not allowed on the group.

6.2.23J /<x>/<x>/Common/MCData/AllowedRxControl

Table 6.2.23J.1: /<x>/<x>/Common/MCData/AllowedRxControl

<x>/Common/MCData/AllowedRxControl

Status	Occurrence	Format	Min. Access Types
Required	One	bool	Get, Replace

This leaf node indicates whether reception control is enabled for the group.

When set to "true" reception control is allowed on the group.

When set to "false" reception control not allowed on the group.

6.2.23K /<x>/<x>/Common/MCData/AllowedEnhSvc

Table 6.2.23K.1: /<x>/<x>/Common/MCData/AllowedEnhSvc

<x>/Common/MCData/AllowedEnhSvc

Status	Occurrence	Format	Min. Access Types

Required	One	bool	Get, Replace
----------	-----	------	--------------

This leaf node indicates whether Enhanced Service is enabled for the group.

When set to "true" Enhanced Service is allowed on the group.

When set to "false" Enhanced Service is not allowed on the group.

6.2.23L /<x>/<x>/Common/MCData/EnhSvcOpValues

Table 6.2.23L.1: /<x>/<x>/Common/MCData/EnhSvcOpValues

<x>/Common/MCData/EnhSvcOpValues

Status	Occurrence	Format	Min. Access Types
Required	One	node	Get, Replace

This interior node is a placeholder for a list of operational values for Enhanced Service.

6.2.23M /<x>/<x>/Common/MCData/EnhSvcOpValues/<x>

Table 6.2.23M.1: /<x>/<x>/Common/MCData/EnhSvcOpValues/<x>

<x>/Common/MCData/EnhSvcOpValues/<x>

Status	Occurrence	Format	Min. Access Types
Optional	OneOrMore	node	Get, Replace

This interior node is a placeholder for one or more list of operational values for Enhanced Service.

6.2.23N /<x>/<x>/Common/MCData/EnhSvcOpValues/<x>/EnhSvcOpValue

Table 6.2.23N.1: /<x>/<x>/Common/MCData/EnhSvcOpValues/<x>/EnhSvcOpValue

<x>/Common/MCData/EnhSvcOpValues/<x>/EnhSvcOpValue

Status	Occurrence	Format	Min. Access Types
Optional	One	chr	Get, Replace

This leaf node indicates an enhanced service operational value.

6.2.23NA /<x>/<x>/Common/MCData/EnhSvcOpValues/<x>/EnhSvcOpID

Table 6.2.23NA.1: /<x>/<x>/Common/MCData/EnhSvcOpValues/<x>/EnhSvcOpID

<x>/Common/MCData/EnhSvcOpValues/<x>/EnhSvcOpID

Status	Occurrence	Format	Min. Access Types
Optional	One	int	Get, Replace

This leaf node indicates a unique id associated with enhanced service operational value.

6.2.23O /<x>/<x>/Common/MCData/AllowedTransmitDataInGroup

Table 6.2.23O.1: /<x>/<x>/Common/MCData/AllowedTransmitDataInGroup

<x>/Common/MCData/AllowedTransmitDataInGroup

Status	Occurrence	Format	Min. Access Types
Required	One	bool	Get, Replace

This leaf node indicates whether an MC data user is permitted to transmit data in the group.

When set to "true" an MC data user is allowed to transmit data in the group.

When set to "false" an MC data user is not allowed to transmit data in the group.

6.2.23P /<x>/<x>/Common/MCData/MaxDataSingleRequest

Table 6.2.23P.1: /<x>/<x>/Common/MCData/MaxDataSingleRequest

<x>/Common/MCData/MaxDataSingleRequest

Status	Occurrence	Format	Min. Access Types
Required	One	int	Get, Replace

This leaf node indicates the maximum amount of data (in megabytes) that an MCData user can transmit in a single request during group communication.

- Values: 0-65535

The MaxData1to1 size is in megabytes..

6.2.23Q /<x>/<x>/Common/MCData/MaxTimeSingleRequest

Table 6.2.23Q.1: /<x>/<x>/Common/MCData/MaxTimeSingleRequest

<x>/Common/MCData/MaxTimeSingleRequest

Status	Occurrence	Format	Min. Access Types
Required	One	int	Get, Replace

This leaf node indicates the maximum amount of time that an MCData user can transmit for in a single request during group communication.

- Values: 0-65535

The MaxTime1To1 time is in seconds.

6.2.23R /<x>/<x>/Common/MCVideo

Table 6.2.23R.1: /<x>/<x>/Common/MCVideo

<x>/Common/MCVideo

Status	Occurrence	Format	Min. Access Types
Required	One	node	Get, Replace

This interior node is a placeholder for a Common MCVideo group information

6.2.23S /<x>/<x>/Common/MCVideo/MediaProtectionRequired

Table 6.2.23S.1: /<x>/<x>/Common/MCVideo/MediaProtectionRequired

<x>/Common/MCVideo/MediaProtectionRequired

Status	Occurrence	Format	Min. Access Types
Required	One	bool	Get, Replace

This leaf node indicates whether confidentiality and integrity of media is required for MCVideo calls on the MCS group.

When set to "true" confidentiality and integrity of MCvideo media is required on the group.

When set to "false" confidentiality and integrity of MCvideo media is not required on the group.

The default value is set to "true".

6.2.23T /<x>/<x>/Common/MCVideo/TxControlProtectionRequired

Table 6.2.23T.1: /<x>/<x>/Common/MCVideo/TxControlProtectionRequired

<x>/Common/MCVideo/TxControlProtectionRequired

Status	Occurrence	Format	Min. Access Types
Required	One	bool	Get, Replace

This leaf node indicates whether confidentiality and integrity protection is required for on-network and off-network MCVideo transmission control signalling on the MCS group

When set to "true" confidentiality and integrity of MCVideo transmission control signalling is required on the group.

When set to "false" confidentiality and integrity of MCVideo transmission control signalling is not required on the group.

The default value is set to "true".

6.2.23U /<x>/<x>/Common/MCVideo/MediaProtectionSecurityMaterial

Table 6.2.23U.1: /<x>/<x>/Common/MCVideo/MediaProtectionSecurityMaterial

<x>/Common/MCVideo/MediaProtectionSecurityMaterial

Status	Occurrence	Format	Min. Access Types
Required	One	chr	Get, Replace

This leaf node indicates security material (as specified in 3GPP TS 33.180 [xx]) for MCVideo media protection in the MCS group.

6.2.23V /<x>/<x>/Common/MCVideo/AllowedAudioCodecs

Table 6.2.23V.1: /<x>/<x>/Common/MCVideo/AllowedAudioCodecs

<x>/Common/MCVideo/AllowedAudioCodecs

Status	Occurrence	Format	Min. Access Types
Required	One	node	Get, Replace

This interior node is a placeholder for a list of allowed audio codecs for MCVideo sessions on the group

6.2.23W /<x>/<x>/Common/MCVideo/AllowedAudioCodecs/<x>

Table 6.2.23W.1: /<x>/<x>/Common/MCVideo/AllowedAudioCodecs/<x>

<x>/Common/MCVideo/AllowedAudioCodecs/<x>

Status	Occurrence	Format	Min. Access Types
Optional	OneOrMore	node	Get, Replace

This interior node is a placeholder for one or more list of allowed audio codecs for MCVideo sessions on the group

6.2.23X /<x>/<x>/Common/MCVideo/AllowedAudioCodecs/<x>/AudioCodec

Table 6.2.23X.1: /<x>/<x>/Common/MCVideo/AllowedAudioCodecs/<x>/AudioCodec

<x>/Common/MCVideo/AllowedAudioCodecs/<x>/AudioCodec

Status	Occurrence	Format	Min. Access Types
Optional	One	chr	Get, Replace

This leaf node indicates the preferred RTP payload format to be used for audio encoding in MCVideo group sessions for the group.

6.2.23Y /<x>/<x>/Common/MCVideo/AllowedVideoCodecs

Table 6.2.23Y.1: /<x>/<x>/Common/MCVideo/AllowedVideoCodecs

<x>/Common/MCVideo/AllowedVideoCodecs

Status	Occurrence	Format	Min. Access Types
Required	One	node	Get, Replace

This interior node is a placeholder for a list of allowed video codecs for MCVideo sessions on the group

6.2.23Z /<x>/<x>/Common/MCVideo/AllowedVideoCodecs/<x>

Table 6.2.23Z.1: /<x>/<x>/Common/MCVideo/AllowedVideoCodecs/<x>

<x>/Common/MCVideo/AllowedVideoCodecs/<x>

Status	Occurrence	Format	Min. Access Types
Optional	OneOrMore	node	Get, Replace

This interior node is a placeholder for one or more list of allowed video codecs for MCVideo sessions on the group

6.2.23AA

/<x>/<x>/Common/MCVideo/AllowedVideoCodecs/<x>/VideoCodec

Table 6.2.23AA.1: /<x>/<x>/Common/MCVideo/AllowedVideoCodecs/<x>/VideoCodec

<x>/Common/MCVideo/AllowedVideoCodecs/<x>/VideoCodec

Status	Occurrence	Format	Min. Access Types
Optional	One	chr	Get, Replace

This leaf node indicates the preferred RTP payload format to be used for video encoding in MCVideo group sessions for the group.

6.2.23AB /<x>/<x>/Common/MCVideo/AllowedVideoResolutions

Table 6.2.23AB.1: /<x>/<x>/Common/MCVideo/AllowedVideoResolutions

<x>/Common/MCVideo/AllowedVideoResolutions

Status	Occurrence	Format	Min. Access Types
Required	One	node	Get, Replace

This interior node is a placeholder for a list of allowed video resolutions used in MCVideo group sessions for the group.

6.2.23AC /<x>/<x>/Common/MCVideo/AllowedVideoResolutions/<x>

Table 6.2.23AC.1: /<x>/<x>/Common/MCVideo/AllowedVideoResolutions/<x>

<x>/Common/MCVideo/AllowedVideoResolutions/<x>

Status	Occurrence	Format	Min. Access Types
Optional	OneOrMore	node	Get, Replace

This interior node is a placeholder for one or more list of allowed video resolutions used in MCVideo group sessions for the group.

6.2.23AD

`<x>/<x>/Common/MCVideo/AllowedVideoResolutions/<x>/VideoResolution`

Table 6.2.23AD.1: `<x>/<x>/Common/MCVideo/AllowedVideoResolutions/<x>/VideoResolution`

`<x>/Common/MCVideo/AllowedVideoResolutions/<x>/VideoResolution`

Status	Occurrence	Format	Min. Access Types
Optional	One	chr	Get, Replace

This leaf node indicates a video resolution (number of horizontal pixels x number of vertical pixels) to be used in MCVideo group sessions for the group.

6.2.23AE `<x>/<x>/Common/MCVideo/AllowedVideoFrameRates`

Table 6.2.23AE.1: `<x>/<x>/Common/MCVideo/AllowedVideoFrameRates`

`<x>/Common/MCVideo/AllowedVideoFrameRates`

Status	Occurrence	Format	Min. Access Types
Required	One	node	Get, Replace

This interior node is a placeholder for a list of allowed video frame rates to be used in MCVideo group sessions for the group.

6.2.23AF `<x>/<x>/Common/MCVideo/AllowedVideoFrameRates/<x>`

Table 6.2.23AF.1: `<x>/<x>/Common/MCVideo/AllowedVideoFrameRates/<x>`

`<x>/Common/MCVideo/AllowedVideoFrameRates/<x>`

Status	Occurrence	Format	Min. Access Types
Optional	OneOrMore	node	Get, Replace

This interior node is a placeholder for one or more list of allowed video frame rates to be used in MCVideo group sessions for the group.

6.2.23AG

`<x>/<x>/Common/MCVideo/AllowedVideoFrameRates/<x>/FrameRate`

Table 6.2.23AG.1: `<x>/<x>/Common/MCVideo/AllowedVideoFrameRates/<x>/FrameRate`

`<x>/Common/MCVideo/AllowedVideoFrameRates/<x>/FrameRate`

Status	Occurrence	Format	Min. Access Types
Optional	One	int	Get, Replace

This leaf node indicates a video frame rate (in frames per second) to be used in MCVideo group sessions for the group.

6.2.23AH `<x>/<x>/Common/MCVideo/AllowedUrgentRealTimeMode`

Table 6.2.23AH.1: `<x>/<x>/Common/MCVideo/AllowedUrgentRealTimeMode`

`<x>/Common/MCVideo/AllowedUrgentRealTimeMode`

Status	Occurrence	Format	Min. Access Types
Required	One	bool	Get, Replace

This leaf node indicates whether urgent real time mode is allowed for MCVideo sessions on the group.

When set to "true" urgent real-time video mode is allowed for MCVideo sessions on the group.

When set to "false" urgent real-time video mode is not allowed for MCVideo sessions on the group.

6.2.23AI /<x>/<x>/Common/MCVideo/AllowedNonUrgentRealTimeMode

Table 6.2.23AI.1: /<x>/<x>/Common/MCVideo/AllowedNonUrgentRealTimeMode

<x>/Common/MCVideo/AllowedNonUrgentRealTimeMode

Status	Occurrence	Format	Min. Access Types
Required	One	bool	Get, Replace

This leaf node indicates whether non-urgent real time mode is allowed for MCVideo sessions on the group.

When set to "true" non-urgent real-time video mode is allowed for MCVideo sessions on the group.

When set to "false" non-urgent real-time video mode is not allowed for MCVideo sessions on the group.

6.2.23AJ /<x>/<x>/Common/MCVideo/AllowedNonRealTimeMode

Table 6.2.23AJ.1: /<x>/<x>/Common/MCVideo/AllowedNonRealTimeMode

<x>/Common/MCVideo/AllowedNonRealTimeMode

Status	Occurrence	Format	Min. Access Types
Required	One	bool	Get, Replace

This leaf node indicates whether non-real time mode is allowed for MCVideo sessions on the group.

When set to "true" non-real-time video mode is allowed for MCVideo sessions on the group.

When set to "false" non-real-time video mode is not allowed for MCVideo sessions on the group.

6.2.23AK /<x>/<x>/Common/MCVideo/ActiveNonRealTimeMode

Table 6.2.23AK.1: /<x>/<x>/Common/MCVideo/ActiveNonRealTimeMode

<x>/Common/MCVideo/ActiveNonRealTimeMode

Status	Occurrence	Format	Min. Access Types
Required	One	chr	Get, Replace

This leaf node indicates the active non-real-time mode used for MCVideo sessions on the group.

The valid values are:

- "urgent-real-time";
- "non-urgent-real-time"; and
- "non-real-time".

6.2.23AL /<x>/<x>/Common/MCVideo/MaxTransmitMembers

Table 6.2.23AL.1: /<x>/<x>/Common/MCVideo/MaxTransmitMembers

<x>/Common/MCVideo/MaxTransmitMembers

Status	Occurrence	Format	Min. Access Types
Required	One	int	Get, Replace

This leaf node indicates the maximum number of simultaneous transmitting group members for MCVideo sessions on the group.

- Values: 0-65535

6.2.24 /<x>/<x>/OffNetwork

Table 6.2.24.1: /<x>/<x>/OffNetwork

<x>/OffNetwork

Status	Occurrence	Format	Min. Access Types
Required	ZeroOrOne	node	Get, Replace

This interior node represents a container for off-network operation.

6.2.25 /<x>/<x>/OffNetwork/MCPTTGroupParameter

Table 6.2.25.1: /<x>/<x>/OffNetwork/MCPTTGroupParameter

<x>/OffNetwork/MCPTTGroupParameter

Status	Occurrence	Format	Min. Access Types
Required	One	node	Get, Replace

This interior node is a placeholder for the group parameters.

6.2.26 /<x>/<x>/OffNetwork/MCPTTGroupParameter/<x>

Table 6.2.26.1: /<x>/<x>/OffNetwork/MCPTTGroupParameter/<x>

<x>/OffNetwork/MCPTTGroupParameter/<x>

Status	Occurrence	Format	Min. Access Types
Required	OneOrMore	node	Get, Replace

This interior node is a placeholder for one or more group parameters.

6.2.27

/<x>/<x>/OffNetwork/MCPTTGroupParameter/<x>/ProSeLayer2GroupID

Table 6.2.27.1: /<x>/<x>/OffNetwork/MCPTTGroupParameter/<x>/ProSeLayer2GroupID

<x>/OffNetwork/MCPTTGroupParameter/<x>/ProSeLayer2GroupID

Status	Occurrence	Format	Min. Access Types
Required	One	chr	Get, Replace

This leaf node indicates the Prose layer-2 group ID as specified in 3GPP TS 23.303 [6].

NOTE: This element is common for all MC services.

6.2.28

/<x>/<x>/OffNetwork/MCPTTGroupParameter/<x>/IPMulticastAddress

Table 6.2.28.1: /<x>/<x>/OffNetwork/MCPTTGroupParameter/<x>/IPMulticastAddress

<x>/OffNetwork/MCPTTGroupParameter/<x>/IPMulticastAddress

Status	Occurrence	Format	Min. Access Types
Required	One	chr	Get, Replace

This leaf node indicates the ProSe group IP multicast address as specified in 3GPP TS 23.303 [6].

The value is an IPv4 address or an IPv6 address.

NOTE: This element is common for all MC services.

6.2.29

`<x>/<x>/OffNetwork/MCPTTGroupParameter/<x>/RelayServiceCode`

Table 6.2.29.1: `<x>/<x>/OffNetwork/MCPTTGroupParameter/<x>/RelayServiceCode`

`<x>/OffNetwork/MCPTTGroupParameter/<x>/RelayServiceCode`

Status	Occurrence	Format	Min. Access Types
Required	One	chr	Get, Replace

This leaf node indicates the connectivity service that the ProSe UE-to-network relay provides to public safety applications as specified in 3GPP TS 23.303 [6].

NOTE: This element is common for all MC services.

6.2.30 `<x>/<x>/OffNetwork/MCPTTGroupParameter/<x>/IPVersions`

Table 6.2.30.1: `<x>/<x>/OffNetwork/MCPTTGroupParameter/<x>/IPVersions`

`<x>/OffNetwork/MCPTTGroupParameter/<x>/IPVersions`

Status	Occurrence	Format	Min. Access Types
Required	One	chr	Get, Replace

This leaf node indicates whether IPv4 or IPv6 is used for the MCS group as specified in 3GPP TS 23.303 [6].

The value is "IPv4" or "IPv6".

NOTE: This element is common for all MC services.

6.2.31 `<x>/<x>/OffNetwork/EmergencyCallCancel`

Table 6.2.31.1: `<x>/<x>/OffNetwork/EmergencyCallCancel`

`<x>/OffNetwork/EmergencyCallCancel`

Status	Occurrence	Format	Min. Access Types
Required	One	int	Get, Replace

This leaf node indicates the timeout value for the cancellation of an in progress emergency group call for MCPTT.

- Values: 0-65535

The EmergencyCallCancel time is in seconds.

NOTE: This element is specific for MCPTT.

6.2.32 `<x>/<x>/OffNetwork/ImminentPerilCallCancel`

Table 6.2.32.1: `<x>/<x>/OffNetwork/ImminentPerilCallCancel`

`<x>/OffNetwork/ImminentPerilCallCancel`

Status	Occurrence	Format	Min. Access Types
Required	One	int	Get, Replace

This leaf node indicates the timeout value for the cancellation of an in progress MCPTT imminent peril group call.

- Values: 0-65535

The ImminentPerilCallCancel time is in seconds.

NOTE: This element is specific for MCPTT.

6.2.33 /<x>/<x>/OffNetwork/HangTime

Table 6.2.33.1: /<x>/<x>/OffNetwork/HangTime

<x>/OffNetwork/HangTime

Status	Occurrence	Format	Min. Access Types
Required	One	int	Get, Replace

This leaf node indicates the group call hang timer.

- Values: 0-65535

The HangTime is in seconds.

NOTE: This element is specific for MCPTT.

6.2.34 /<x>/<x>/OffNetwork/MaxDuration

Table 6.2.34.1: /<x>/<x>/OffNetwork/MaxDuration

<x>/OffNetwork/MaxDuration

Status	Occurrence	Format	Min. Access Types
Required	One	int	Get, Replace

This leaf node indicates the max duration of group calls.

- Values: 0-65535

The MaxDuration time is in seconds.

NOTE: This element is specific for MCPTT.

6.2.34A /<x>/<x>/OffNetwork/QueueUsage

Table 6.2.34A.1: /<x>/<x>/OffNetwork/QueueUsage

<x>/OffNetwork/QueueUsage

Status	Occurrence	Format	Min. Access Types
Required	One	bool	Get, Replace

This leaf node indicates if queuing is enabled or not.

When set to "true" queuing floor requests is enabled on the group.

When set to "false" queuing floor requests is not enabled on the group.

The default value is set to "true".

NOTE: This element is specific for MCPTT.

6.2.35 /<x>/<x>/OffNetwork/DefaultPPPP

Table 6.2.35.1: /<x>/<x>/OffNetwork/DefaultPPPP

<x>/OffNetwork/DefaultPPPP

Status	Occurrence	Format	Min. Access Types
Required	One	node	Get, Replace

This interior node is a placeholder for the default ProSe Per-Packet Priority (PPPP) configuration.

6.2.36 /<x>/<x>/OffNetwork/DefaultPPPP/MCPTTGroupCallSignalling

Table 6.2.36.1: /<x>/<x>/OffNetwork/DefaultPPPP/MCPTTGroupCallSignalling

<x>/OffNetwork/DefaultPPPP/MCPTTGroupCallSignalling

Status	Occurrence	Format	Min. Access Types
Required	One	int	Get, Replace

This leaf node indicates the default ProSe Per-Packet Priority (PPPP) value (as specified in 3GPP TS 23.303 [6]) for the group call signalling for MCPTT.

- Values: 1-8

The MCPTT user data with the lowest ProSe Per-Packet Priority value shall be considered as the MCPTT user data having the highest priority among the MCPTT user data.

NOTE: This element is specific for MCPTT.

6.2.37 /<x>/<x>/OffNetwork/DefaultPPPP/MCPTTGroupCallMedia

Table 6.2.37.1: /<x>/<x>/OffNetwork/DefaultPPPP/MCPTTGroupCallMedia

<x>/OffNetwork/DefaultPPPP/MCPTTGroupCallMedia

Status	Occurrence	Format	Min. Access Types
Required	One	int	Get, Replace

This leaf node indicates the default ProSe Per-Packet Priority (PPPP) value (as specified in 3GPP TS 23.303 [6]) for the group call media for MCPTT.

- Values: 1-8

The MCPTT user data with the lowest ProSe Per-Packet Priority value shall be considered as the MCPTT user data having the highest priority among the MCPTT user data.

NOTE: This element is specific for MCPTT.

6.2.38

/<x>/<x>/OffNetwork/DefaultPPPP/MCPTTEmergencyGroupCallSignalling

Table 6.2.38.1: /<x>/<x>/OffNetwork/DefaultPPPP/MCPTTEmergencyGroupCallSignalling

<x>/OffNetwork/DefaultPPPP/MCPTTEmergencyGroupCallSignalling

Status	Occurrence	Format	Min. Access Types
Required	One	int	Get, Replace

This leaf node indicates the default ProSe Per-Packet Priority (PPPP) value (as specified in 3GPP TS 23.303 [6]) for the MCPTT emergency group call signalling.

- Values: 1-8

The MCPTT user data with the lowest ProSe Per-Packet Priority value shall be considered as the MCPTT user data having the highest priority among the MCPTT user data.

NOTE: This element is specific for MCPTT.

6.2.39

`<x>/<x>/OffNetwork/DefaultPPPP/MCPTTEmergencyGroupCallMedia`

Table 6.2.39.1: `<x>/<x>/OffNetwork/DefaultPPPP/MCPTTEmergencyGroupCallMedia`

`<x>/OffNetwork/DefaultPPPP/MCPTTEmergencyGroupCallMedia`

Status	Occurrence	Format	Min. Access Types
Required	One	int	Get, Replace

This leaf node indicates the default ProSe Per-Packet Priority (PPPP) value (as specified in 3GPP TS 23.303 [6]) for the MCPTT emergency group call media.

- Values: 1-8

The MCPTT user data with the lowest ProSe Per-Packet Priority value shall be considered as the MCPTT user data having the highest priority among the MCPTT user data.

NOTE: This element is specific for MCPTT.

6.2.40

`<x>/<x>/OffNetwork/DefaultPPPP/MCPTTImminentPerilGroupCallSignalling`

Table 6.2.40.1: `<x>/<x>/OffNetwork/DefaultPPPP/MCPTTImminentPerilGroupCallSignalling`

`<x>/OffNetwork/DefaultPPPP/MCPTTImminentPerilGroupCallSignalling`

Status	Occurrence	Format	Min. Access Types
Required	One	int	Get, Replace

This leaf node indicates the default ProSe Per-Packet Priority (PPPP) value (as specified in 3GPP TS 23.303 [6]) for the MCPTT imminent peril group call signalling.

- Values: 1-8

The MCPTT user data with the lowest ProSe Per-Packet Priority value shall be considered as the MCPTT user data having the highest priority among the MCPTT user data.

NOTE: This element is specific for MCPTT.

6.2.41

`<x>/<x>/OffNetwork/DefaultPPPP/MCPTTImminentPerilGroupCallMedia`

Table 6.2.41.1: `<x>/<x>/OffNetwork/DefaultPPPP/MCPTTImminentPerilGroupCallMedia`

`<x>/OffNetwork/DefaultPPPP/MCPTTImminentPerilGroupCallMedia`

Status	Occurrence	Format	Min. Access Types
Required	One	int	Get, Replace

This leaf node indicates the default ProSe Per-Packet Priority (PPPP) value (as specified in 3GPP TS 23.303 [6]) for the MCPTT imminent peril group call media.

- Values: 1-8

The MCPTT user data with the lowest ProSe Per-Packet Priority value shall be considered as the MCPTT user data having the highest priority among the MCPTT user data.

NOTE: This element is specific for MCPTT.

6.2.42 /<x>/<x>/OffNetwork/MCData

Table 6.2.42.1: /<x>/<x>/OffNetwork/MCData

<x>/OffNetwork/MCData

Status	Occurrence	Format	Min. Access Types
Required	One	node	Get, Replace

This interior node is a placeholder for off-network MCData configuration.

6.2.43 /<x>/<x>/OffNetwork/MCData/DefaultPPPP

Table 6.2.43.1: /<x>/<x>/OffNetwork/MCData/DefaultPPPP

<x>/OffNetwork/MCData/DefaultPPPP

Status	Occurrence	Format	Min. Access Types
Required	One	node	Get, Replace

This interior node is a placeholder for the default ProSe Per-Packet Priority (PPPP) configuration.

6.2.44

/<x>/<x>/OffNetwork/MCData/DefaultPPPP/MCDataGroupCallSignalling

Table 6.2.44.1: /<x>/<x>/OffNetwork/MCData/DefaultPPPP/MCDataGroupCallSignalling

<x>/OffNetwork/MCData/DefaultPPPP/MCDataGroupCallSignalling

Status	Occurrence	Format	Min. Access Types
Required	One	int	Get, Replace

This leaf node indicates the default ProSe Per-Packet Priority (PPPP) value (as specified in 3GPP TS 23.303 [6]) for the group call signalling for MCData..

- Values: 1-8

The MCData user data with the lowest ProSe Per-Packet Priority value shall be considered as the MCData user data having the highest priority among the MCData user data.

6.2.45

/<x>/<x>/OffNetwork/MCData/DefaultPPPP/MCDataGroupCallMedia

Table 6.2.45.1: /<x>/<x>/OffNetwork/MCData/DefaultPPPP/MCDataGroupCallMedia

<x>/OffNetwork/MCData/DefaultPPPP/MCDataGroupCallMedia

Status	Occurrence	Format	Min. Access Types
Required	One	int	Get, Replace

This leaf node indicates the default ProSe Per-Packet Priority (PPPP) value (as specified in 3GPP TS 23.303 [6]) for the group call media for MCData.

- Values: 1-8

The MCData user data with the lowest ProSe Per-Packet Priority value shall be considered as the MCData user data having the highest priority among the MCData user data.

6.2.46 /<x>/<x>/OffNetwork/MCVideo

Table 6.2.46.1: /<x>/<x>/OffNetwork/MCVideo

<x>/OffNetwork/MCVideo

Status	Occurrence	Format	Min. Access Types
Required	One	node	Get, Replace

This interior node is a placeholder for off-network MCVideo group configuration.

6.2.47 /<x>/<x>/OffNetwork/MCVideo/ArbitrationApproach

Table 6.2.47.1: /<x>/<x>/OffNetwork/MCVideo/ArbitrationApproach

<x>/OffNetwork/MCVideo/ArbitrationApproach

Status	Occurrence	Format	Min. Access Types
Required	One	chr	Get, Replace

This leaf node indicates the arbitration approach used for off-network video transmissions on the group

The valid values are:

- "single" which indicates transmission participants rely on a single participant designated as transmission arbitrator for the arbitration of transmission requests; and
- "self" which indicates each transmission participant arbitrates its own transmission based on its view of the topology;

6.2.48 /<x>/<x>/OffNetwork/MCVideo/MaxTransmissions

Table 6.2.48.1: /<x>/<x>/ OffNetwork/MCVideo/MaxTransmissions

<x>/OffNetwork/MCVideo/MaxTransmissions

Status	Occurrence	Format	Min. Access Types
Required	One	int	Get, Replace

This leaf node indicates maximum number of simultaneous transmissions for off-network MCVideo procedures.

- Values: 0-65535

6.2.49 /<x>/<x>/OffNetwork/MCVideo/DefaultPPPP

Table 6.2.49.1: /<x>/<x>/OffNetwork/MCVideo/DefaultPPPP

<x>/OffNetwork/MCVideo/DefaultPPPP

Status	Occurrence	Format	Min. Access Types
Required	One	node	Get, Replace

This interior node is a placeholder for the default ProSe Per-Packet Priority (PPPP) configuration.

6.2.50

/<x>/<x>/OffNetwork/MCVideo/DefaultPPPP/MCVideoGroupCallSignalling

Table 6.2.50.1: /<x>/<x>/OffNetwork/MCVideo/DefaultPPPP/MCVideoGroupCallSignalling

<x>/OffNetwork/MCVideo/DefaultPPPP/MCVideoGroupCallSignalling

Status	Occurrence	Format	Min. Access Types
Required	One	int	Get, Replace

This leaf node indicates the default ProSe Per-Packet Priority (PPPP) value (as specified in 3GPP TS 23.303 [6]) for the group call signalling for MCVideo..

- Values: 1-8

The MCVideo user data with the lowest ProSe Per-Packet Priority value shall be considered as the MCVideo user data having the highest priority among the MCVideo user data.

6.2.51

`<x>/<x>/OffNetwork/MCVideo/DefaultPPPP/MCVideoGroupCallMedia`

Table 6.2.51.1: `<x>/<x>/OffNetwork/MCVideo/DefaultPPPP/MCVideoGroupCallMedia`

`<x>/OffNetwork/MCVideo/DefaultPPPP/MCVideoGroupCallMedia`

Status	Occurrence	Format	Min. Access Types
Required	One	int	Get, Replace

This leaf node indicates the default ProSe Per-Packet Priority (PPPP) value (as specified in 3GPP TS 23.303 [6]) for the group call media for MCVideo.

- Values: 1-8

The MCVideo user data with the lowest ProSe Per-Packet Priority value shall be considered as the MCVideo user data having the highest priority among the MCVideo user data.

6.2.52

`<x>/<x>/OffNetwork/MCVideo/DefaultPPPP/MCVideoEmergencyGroupCallSignalling`

Table 6.2.52.1: `<x>/<x>/OffNetwork/MCVideo/DefaultPPPP/MCVideoEmergencyGroupCallSignalling`

`<x>/OffNetwork/MCVideo/DefaultPPPP/MCVideoEmergencyGroupCallSignalling`

Status	Occurrence	Format	Min. Access Types
Required	One	int	Get, Replace

This leaf node indicates the default ProSe Per-Packet Priority (PPPP) value (as specified in 3GPP TS 23.303 [6]) for the MCVideo emergency group call signalling.

- Values: 1-8

The MCVideo user data with the lowest ProSe Per-Packet Priority value shall be considered as the MCVideo user data having the highest priority among the MCVideo user data.

6.2.53

`<x>/<x>/OffNetwork/MCVideo/DefaultPPPP/MCVideoEmergencyGroupCallMedia`

Table 6.2.53.1: `<x>/<x>/OffNetwork/MCVideo/DefaultPPPP/MCVideoEmergencyGroupCallMedia`

`<x>/OffNetwork/MCVideo/DefaultPPPP/MCVideoEmergencyGroupCallMedia`

Status	Occurrence	Format	Min. Access Types
Required	One	int	Get, Replace

This leaf node indicates the default ProSe Per-Packet Priority (PPPP) value (as specified in 3GPP TS 23.303 [6]) for the MCVideo emergency group call media.

- Values: 1-8

The MCVideo user data with the lowest ProSe Per-Packet Priority value shall be considered as the MCVideo user data having the highest priority among the MCVideo user data.

6.2.54

`/<x>/<x>/OffNetwork/MCVideo/DefaultPPPP/MCVideoImminentPerilGroupCallSignalling`

Table 6.2.54.1:

`/<x>/<x>/OffNetwork/MCVideo/DefaultPPPP/MCVideoImminentPerilGroupCallSignalling`

`<x>/OffNetwork/MCVideo/DefaultPPPP/MCVideoImminentPerilGroupCallSignalling`

Status	Occurrence	Format	Min. Access Types
Required	One	int	Get, Replace

This leaf node indicates the default ProSe Per-Packet Priority (PPPP) value (as specified in 3GPP TS 23.303 [6]) for the MCVideo imminent peril group call signalling.

- Values: 1-8

The MCVideo user data with the lowest ProSe Per-Packet Priority value shall be considered as the MCVideo user data having the highest priority among the MCVideo user data.

6.2.55

`/<x>/<x>/OffNetwork/MCVideo/DefaultPPPP/MCVideoImminentPerilGroupCallMedia`

Table 6.2.55.1: `/<x>/<x>/OffNetwork/MCVideo/DefaultPPPP/MCVideoImminentPerilGroupCallMedia`

`<x>/OffNetwork/MCVideo/DefaultPPPP/MCVideoImminentPerilGroupCallMedia`

Status	Occurrence	Format	Min. Access Types
Required	One	int	Get, Replace

This leaf node indicates the default ProSe Per-Packet Priority (PPPP) value (as specified in 3GPP TS 23.303 [6]) for the MCVideo imminent peril group call media.

- Values: 1-8

The MCVideo user data with the lowest ProSe Per-Packet Priority value shall be considered as the MCVideo user data having the highest priority among the MCVideo user data.

6.2.56 `/<x>/<x>/OffNetwork/MCVideo/MaxDuration`

Table 6.2.56.1: `/<x>/<x>/OffNetwork/MCVideo/MaxDuration`

`<x>/OffNetwork/MCVideo/MaxDuration`

Status	Occurrence	Format	Min. Access Types
Required	One	int	Get, Replace

This leaf node indicates the max duration of MCVideo group calls.

- Values: 0-65535

The MaxDuration time is in seconds.

6.2.57 `/<x>/<x>/OffNetwork/MCVideo/EmergencyCallCancel`

Table 6.2.57.1: `/<x>/<x>/OffNetwork/MCVideo/EmergencyCallCancel`

`<x>/OffNetwork/EmergencyCallCancel`

Status	Occurrence	Format	Min. Access Types

Required	One	int	Get, Replace
----------	-----	-----	--------------

This leaf node indicates the timeout value for the cancellation of an in progress MCVideo emergency group call for MCVideo.

- Values: 0-65535

The EmergencyCallCancel time is in seconds.

6.2.58 /<x>/<x>/OffNetwork/MCVideo/ImminentPerilCallCancel

Table 6.2.58.1: /<x>/<x>/OffNetwork/MCVideo/ImminentPerilCallCancel

<x>/OffNetwork/ImminentPerilCallCancel

Status	Occurrence	Format	Min. Access Types
Required	One	int	Get, Replace

This leaf node indicates the timeout value for the cancellation of an in progress MCVideo imminent peril group call.

- Values: 0-65535

The ImminentPerilCallCancel time is in seconds.

7 MCPTT service configuration MO

7.1 General

The MCPTT service configuration Management Object (MO) is used to configure MCPTT Client behaviour for the on-network or off-network MCPTT Service. The MCPTT service configuration parameters may be stored in the ME, or in the USIM as specified in 3GPP TS 31.102 [10], or in both the ME and the USIM. If both the ME and the USIM contain the same parameters, the values stored in the USIM shall take precedence.

The Management Object Identifier is: urn:oma:mo:ext-3gpp-MCPTT-service-configuration:1.0.

Protocol compatibility: This MO is compatible with OMA OMA DM 1.2 [3].

The OMA DM ACL property mechanism (see OMA OMA-ERELED-DM-V1_2 [2]) may be used to grant or deny access rights to OMA DM servers in order to modify nodes and leaf objects of the MCPTT service configuration MO.

The following nodes and leaf objects are possible under the MCPTT service configuration node as described in figure 7.1.1:

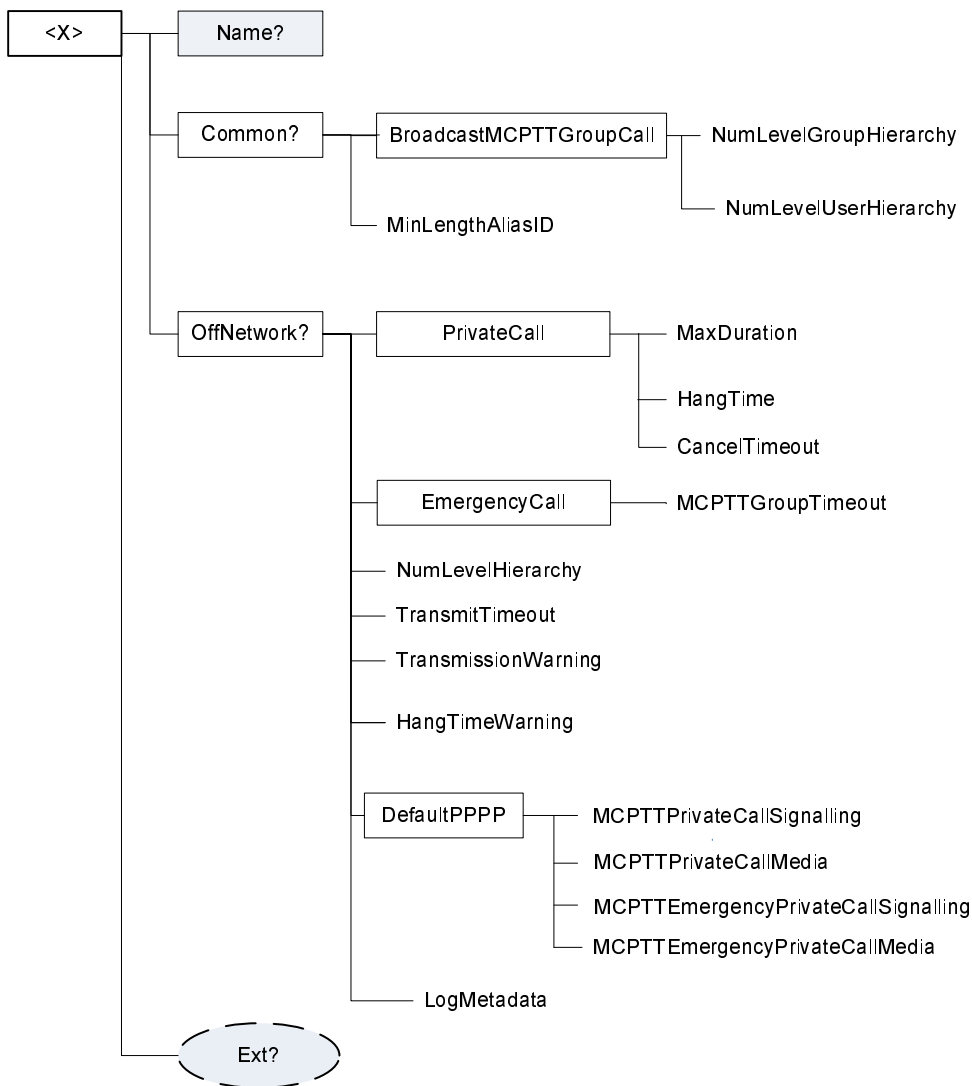

Figure 7.1.1: The MCPTT service configuration MO

7.2 MCPTT service configuration MO parameters

7.2.1 General

This clause describes the parameters for the MCPTT service configuration Management Object (MO).

7.2.2 Node: <x>

Table 7.2.2.1: Node: <x>

<x>

Status	Occurrence	Format	Min. Access Types
Required	OneOrMore	node	Get

This interior node acts as a placeholder for the MCPTT service configuration Management Object (MO).

For the MCPTT service configuration MO, the namespace specific string is: "urn:oma:mo:oma-dm-mcptt-service configuration:1.0"

- Values: N/A

7.2.3 /<x>/Name

Table 7.2.3.1: /<x>/Name

Name

Status	Occurrence	Format	Min. Access Types
Required	ZeroOrOne	chr	Get

The Name leaf is a name for the MCPTT service configuration settings.

- Values: <User displayable name>

7.2.4 /<x>/Ext/

Table 7.2.4.1: /<x>/Ext/

Ext

Status	Occurrence	Format	Min. Access Types
Optional	ZeroOrOne	node	Get, Replace

The Ext is an interior node for where the vendor specific information about the MCPTT service configuration MO is being placed.

Usually the vendor extension is identified by vendor specific name under the ext node and contains the vendor meaning application vendor, device vendor etc. The tree structure under the vendor identified is not defined and can therefore include one or more un-standardized sub-trees.

- Values: N/A

7.2.5 /<x>/Common

Table 7.2.5.1: /<x>/Common

Common

Status	Occurrence	Format	Min. Access Types
Required	ZeroOrOne	node	Get, Replace

This interior node represents a container for the common network operation which means both on-network operation and off-network operation.

7.2.6 /<x>/Common/BroadcastMCPTTGroupCall

Table 7.2.6.1: /<x>/Common/BroadcastMCPTTGroupCall

Common/BroadcastMCPTTGroupCall

Status	Occurrence	Format	Min. Access Types
Required	One	node	Get, Replace

This interior node is a placeholder for Broadcast MCPTT Group Call configuration.

7.2.7

/<x>/Common/BroadcastMCPTTGroupCall/NumLevelGroupHierarchy

Table 7.2.7.1: /<x>/Common/BroadcastMCPTTGroupCall/NumLevelGroupHierarchy

Common/BroadcastMCPTTGroupCall/NumLevelGroupHierarchy

Status	Occurrence	Format	Min. Access Types
Required	One	int	Get, Replace

This leaf node indicates the number of levels of group hierarchy for group-broadcast groups.

- Values: 0-255

The group-broadcast group with the lowest NumLevelGroupHierarchy value shall be considered as the group-broadcast group having the lowest level among the groups.

7.2.8 /<x>/Common/BroadcastMCPTTGroupCall/NumLevelUserHierarchy

Table 7.2.8.1: /<x>/Common/BroadcastMCPTTGroupCall/NumLevelUserHierarchy

Common/BroadcastMCPTTGroupCall/NumLevelUserHierarchy

Status	Occurrence	Format	Min. Access Types
Required	One	int	Get, Replace

This leaf node indicates the number of levels of user hierarchy for user-broadcast groups.

- Values: 0-255

The user-broadcast group with the lowest NumLevelUserHierarchy value shall be considered as the user-broadcast group the lowest level among the groups.

7.2.9 /<x>/Common/MinLengthAliasID

Table 7.2.9.1: /<x>/Common/MinLengthAliasID

Common/MinLengthAliasID

Status	Occurrence	Format	Min. Access Types
Required	One	int	Get, Replace

This leaf node indicates minimum length of an alphanumeric identifier (i.e., alias) assigned by an MCPTT administrator.

- Values: 0-255

7.2.10 /<x>/OffNetwork

Table 7.2.10.1: /<x>/OffNetwork

OffNetwork

Status	Occurrence	Format	Min. Access Types
Required	ZeroOrOne	node	Get, Replace

This interior node represents a container for off-network operation.

7.2.11 /<x>/OffNetwork/PrivateCall

Table 7.2.11.1: /<x>/OffNetwork/PrivateCall

OffNetwork/PrivateCall

Status	Occurrence	Format	Min. Access Types
Required	One	node	Get, Replace

This interior node is a placeholder for private call configuration.

7.2.12 /<x>/OffNetwork/PrivateCall/MaxDuration

Table 7.2.12.1: /<x>/OffNetwork/PrivateCall/MaxDuration

OffNetwork/PrivateCall/MaxDuration

Status	Occurrence	Format	Min. Access Types
--------	------------	--------	-------------------

Required	One	int	Get, Replace
----------	-----	-----	--------------

This leaf node indicates max private call (with floor control) duration.

- Values: 0-65535

The MaxDuration time is in seconds.

7.2.13 /<x>/OffNetwork/PrivateCall/HangTime

Table 7.2.13.1: /<x>/OffNetwork/PrivateCall/HangTime

OffNetwork/PrivateCall/HangTime

Status	Occurrence	Format	Min. Access Types
Required	One	int	Get, Replace

This leaf node indicates hang timer for private calls (with floor control).

- Values: 0-65535

The HangTime is in seconds.

7.2.14 /<x>/OffNetwork/PrivateCall/CancelTimeout

Table 7.2.14.1: /<x>/OffNetwork/PrivateCall/CancelTimeout

OffNetwork/PrivateCall/CancelTimeout

Status	Occurrence	Format	Min. Access Types
Required	One	int	Get, Replace

This leaf node indicates timeout value for the cancellation of an in progress emergency for an MCPTT private call.

- Values: 0-65535

The CancelTimeout is in seconds.

7.2.15 /<x>/OffNetwork/EmergencyCall

Table 7.2.15.1: /<x>/OffNetwork/EmergencyCall

OffNetwork/EmergencyCall

Status	Occurrence	Format	Min. Access Types
Required	One	node	Get, Replace

This interior node indicates a placeholder for the MCPTT emergency call policy.

7.2.16 /<x>/OffNetwork/EmergencyCall/MCPTTGroupTimeout

Table 7.2.16.1: /<x>/OffNetwork/EmergencyCall/MCPTTGroupTimeout

OffNetwork/EmergencyCall/MCPTTGroupTimeout

Status	Occurrence	Format	Min. Access Types
Required	One	int	Get, Replace

This leaf node indicates time limit for an in progress MCPTT emergency call related to an MCPTT group.

- Values: 0-65535

The GroupTimeout is in seconds.

7.2.17 /<x>/OffNetwork/NumLevelHierarchy

Table 7.2.17.1: /<x>/OffNetwork/NumLevelHierarchy

OffNetwork/NumLevelHierarchy

Status	Occurrence	Format	Min. Access Types
Required	One	int	Get, Replace

This leaf node indicates the number of levels of hierarchy for floor control override in off-network.

- Values: 4-256

The request with the lowest NumLevelHierarchy value shall be considered as the request having the lowest priority level given to override an active transmission among the requests.

7.2.18 /<x>/OffNetwork/TransmitTimeout

Table 7.2.18.1: /<x>/OffNetwork/TransmitTimeout

OffNetwork/TransmitTimeout

Status	Occurrence	Format	Min. Access Types
Required	One	int	Get, Replace

This leaf node indicates transmit time limit from a single request to transmit in a group or private call.

- Values: 0-65535

The TransmitTimeout is in seconds.

7.2.19 /<x>/OffNetwork/TransmissionWarning

Table 7.2.19.1: /<x>/OffNetwork/TransmissionWarning

OffNetwork/TransmissionWarning

Status	Occurrence	Format	Min. Access Types
Required	One	int	Get, Replace

This leaf node indicates configuration of warning time before time limit of transmission is reached (off-network).

- Values: 0-255

The TransmissionWarning time is in seconds.

7.2.20 /<x>/OffNetwork/HangTimeWarning

Table 7.2.20.1: /<x>/OffNetwork/HangTimeWarning

OffNetwork/HangTimeWarning

Status	Occurrence	Format	Min. Access Types
Required	One	int	Get, Replace

This leaf node indicates configuration of warning time before hang time is reached (off-network).

- Values: 0-255

The HangTimeWarning time is in seconds.

7.2.21 /<x>/OffNetwork/DefaultPPPP

Table 7.2.21.1: /<x>/OffNetwork/DefaultPPPP

OffNetwork/DefaultPPPP

Status	Occurrence	Format	Min. Access Types
Required	One	node	Get, Replace

This interior node is a placeholder for the default ProSe Per-Packet Priority (PPPP) configuration.

7.2.22 /<x>/OffNetwork/DefaultPPPP/MCPTTPrivateCallSignalling

Table 7.2.22.1: /<x>/OffNetwork/DefaultPPPP/MCPTTPrivateCallSignalling

OffNetwork/DefaultPPPP/MCPTTPrivateCallSignalling

Status	Occurrence	Format	Min. Access Types
Required	One	int	Get, Replace

This leaf node indicates the default ProSe Per-Packet Priority (PPPP) value (as specified in 3GPP TS 23.303 [6]) for the MCPTT private call signalling.

- Values: 1-8

The MCPTT user data with the lowest ProSe Per-Packet Priority value shall be considered as the MCPTT user data having the highest priority among the MCPTT user data.

7.2.23 /<x>/OffNetwork/DefaultPPPP/MCPTTPrivateCallMedia

Table 7.2.23.1: /<x>/OffNetwork/DefaultPPPP/MCPTTPrivateCallMedia

OffNetwork/DefaultPPPP/MCPTTPrivateCallMedia

Status	Occurrence	Format	Min. Access Types
Required	One	int	Get, Replace

This leaf node indicates the default ProSe Per-Packet Priority (PPPP) value (as specified in 3GPP TS 23.303 [6]) for the MCPTT private call media.

- Values: 1-8

The MCPTT user data with the lowest ProSe Per-Packet Priority value shall be considered as the MCPTT user data having the highest priority among the MCPTT user data.

7.2.24

/<x>/OffNetwork/DefaultPPPP/MCPTTEmergencyPrivateCallSignalling

Table 7.2.24.1: /<x>/OffNetwork/DefaultPPPP/MCPTTEmergencyPrivateCallSignalling

OffNetwork/DefaultPPPP/MCPTTEmergencyPrivateCallSignalling

Status	Occurrence	Format	Min. Access Types
Required	One	int	Get, Replace

This leaf node indicates the default ProSe Per-Packet Priority (PPPP) value (as specified in 3GPP TS 23.303 [6]) for the MCPTT emergency private call signalling.

- Values: 1-8

The MCPTT user data with the lowest ProSe Per-Packet Priority value shall be considered as the MCPTT user data having the highest priority among the MCPTT user data.

7.2.25 /<x>/OffNetwork/DefaultPPPP/MCPTTEmergencyPrivateCallMedia

Table 7.2.25.1: /<x>/OffNetwork/DefaultPPPP/MCPTTEmergencyPrivateCallMedia

OffNetwork/DefaultPPPP/MCPTTEmergencyPrivateCallMedia

Status	Occurrence	Format	Min. Access Types
Required	One	int	Get, Replace

This leaf node indicates the default ProSe Per-Packet Priority (PPPP) value (as specified in 3GPP TS 23.303 [6]) for the MCPTT emergency private call media.

- Values: 1-8

The MCPTT user data with the lowest ProSe Per-Packet Priority value shall be considered as the MCPTT user data having the highest priority among the MCPTT user data.

7.2.26 /<x>/OffNetwork/LogMetadata

Table 7.2.26.1: /<x>/OffNetwork/LogMetadata

OffNetwork/LogMetadata

Status	Occurrence	Format	Min. Access Types
Required	One	bool	Get, Replace

This leaf node indicates whether logging of metadata for MCPTT group calls, MCPTT private calls and non-call activities is permitted.

When set to "true" logging of metadata for MCPTT group calls, MCPTT private calls and non-call activities, is enabled.

When set to "false" logging of metadata for MCPTT group calls, MCPTT private calls and non-call activities, is not enabled.

8 MCS UE initial configuration MO

8.1 General

The MCS UE initial configuration Management Object (MO) is used to configure the MCS Client behaviour for the on-network or off-network MCS Service. The MCS UE initial configuration parameters may be stored in the ME, or in the USIM as specified in 3GPP TS 31.102 [10], or in both the ME and the USIM. If both the ME and the USIM contain the same parameters, the values stored in the USIM shall take precedence.

NOTE: For historical reasons some of the elements in the MCS UE initial MO uses the terminology "MCPTT", however this MO is common to all MCS with some MCPTT specific elements, some MCDATA specific elements and some MCVideo specific elements. Not all elements that contain the terminology "MCPTT" are just MCPTT specific.

The Management Object Identifier is: urn:oma:mo:ext-3gpp-MCPTT-UE-initial-configuration:1.0.

Protocol compatibility: This MO is compatible with OMA OMA DM 1.2 [3].

The OMA DM ACL property mechanism (see OMA OMA-ERELED-DM-V1_2 [2]) may be used to grant or deny access rights to OMA DM servers in order to modify nodes and leaf objects of the MCPTT user profile MO.

The following nodes and leaf objects are possible under the MCPTT node as described in figure 8.1.1, figure 8.1.2, figure 8.1.3 and figure 8.1.4:

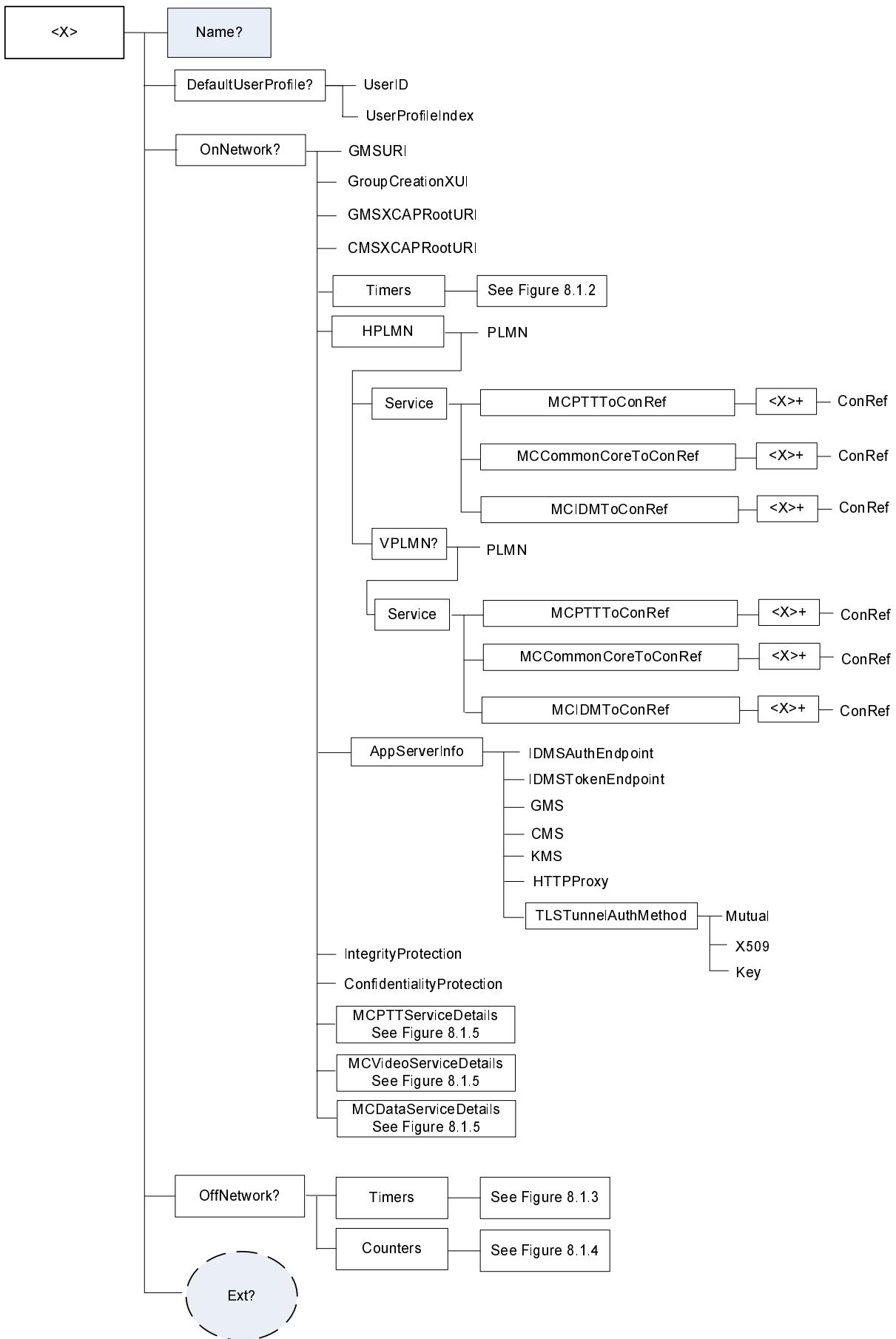

Figure 8.1.1: The MCS UE initial configuration MO (1 of 5)

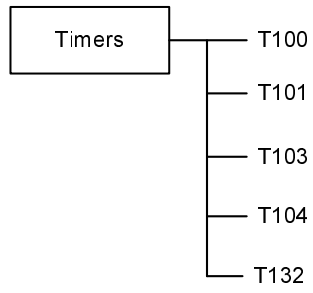

Figure 8.1.2: The MCS UE initial configuration MO (2 of 5)

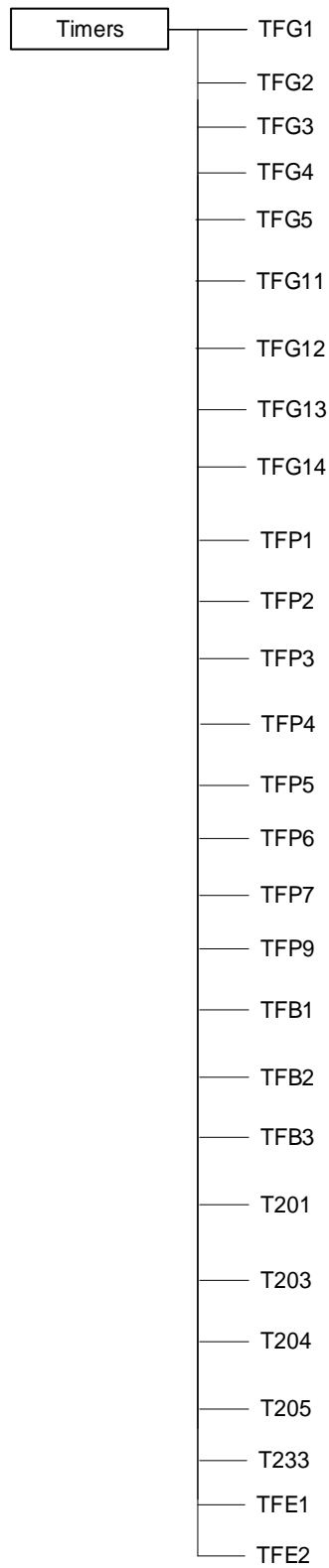

Figure 8.1.3: The MCS UE initial configuration MO (3 of 5)

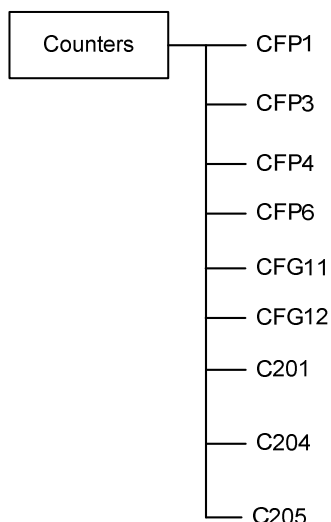

Figure 8.1.4: The MCS UE initial configuration MO (4 of 5)

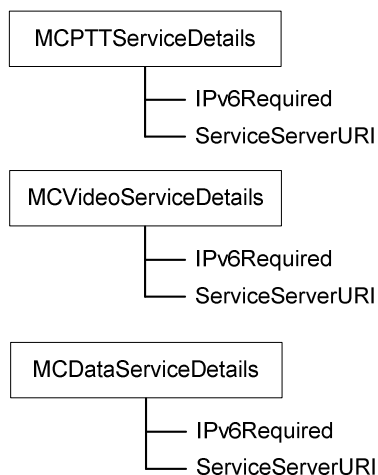

Figure 8.1.5: The MCS UE initial configuration MO (5 of 5)

8.2 MCS UE initial configuration MO parameters

8.2.1 General

This clause describes the parameters for the MCS UE initial configuration Management Object (MO).

8.2.2 Node: <x>

Table 8.2.2.1: Node: <x>

<x>

Status	Occurrence	Format	Min. Access Types
Required	OneOrMore	node	Get

This interior node acts as a placeholder for the MCS UE initial configuration Management Object (MO).

For the MCS UE initial configuration MO, the namespace specific string is: "urn:oma:mo:oma-dm-mcptt-ue-initial-configuration:1.0"

- Values: N/A

8.2.3 /<x>/Name

Table 8.2.3.1: /<x>/Name

Name

Status	Occurrence	Format	Min. Access Types
Required	ZeroOrOne	chr	Get

The Name leaf is a name for the MCPTT UE initial configuration settings.

- Values: <User displayable name>

8.2.4 /<x>/Ext/

Table 8.2.4.1: /<x>/Ext/

Ext

Status	Occurrence	Format	Min. Access Types
Optional	ZeroOrOne	node	Get, Replace

The Ext is an interior node for where the vendor specific information about the MCPTT UE initial configuration MO is being placed.

Usually the vendor extension is identified by vendor specific name under the ext node and contains the vendor meaning application vendor, device vendor etc. The tree structure under the vendor identified is not defined and can therefore include one or more un-standardized sub-trees.

- Values: N/A

8.2.5 /<x>/DefaultUserProfile

Table 8.2.5.1: /<x>/Ext/DefaultUserProfile

DefaultUserProfile

Status	Occurrence	Format	Min. Access Types
Required	ZeroOrOne	node	Get, Replace

This interior node represents a container for the default user profile.

The DefaultUserProfile nodes are:

- the same MCPTT user profile nodes defined in MCPTT user profile MO with a default MCPTT user ID;
- the same MCDData user profile nodes defined in MCDData user profile MO with a default MCDData user ID; or
- the same MCVideo user profile nodes defined in MCVideo user profile MO with a default MCVideo user ID;

8.2.6 /<x>/DefaultUserProfile/UserID

Table 8.2.6.1: /<x>/Ext/DefaultUserProfile/UserID

DefaultUserProfile/UserID

Status	Occurrence	Format	Min. Access Types
Required	One	chr	Get, Replace

This leaf node indicates a default MCS user identity.

8.2.7 /<x>/DefaultUserProfile/UserProfileIndex

Table 8.2.7.1: /<x>/Ext/DefaultUserProfile/UserProfileIndex

DefaultUserProfile/UserProfileIndex

Status	Occurrence	Format	Min. Access Types
Required	One	int	Get, Replace

This leaf node represents an indicator for the particular user profile.

- Values: 0-255

8.2.8 /<x>/OnNetwork

Table 8.2.8.1: /<x>/OnNetwork

OnNetwork

Status	Occurrence	Format	Min. Access Types
Required	ZeroOrOne	node	Get, Replace

This interior node represents a container for on-network operation.

8.2.9 /<x>/OnNetwork/GMSURI

Table 8.2.9.1: <x>/OnNetwork/GMSURI

OnNetwork/GMSURI

Status	Occurrence	Format	Min. Access Types
Required	One	chr	Get, Replace

This leaf node indicates the group management service URI information which contains the public service identity for performing subscription proxy function of the GMS.

The value is a URI as specified in 3GPP TS 23.003 [5].

8.2.9A /<x>/OnNetwork/GroupCreationXUI

Table 8.2.9A.1: <x>/OnNetwork/GroupCreationXUI

OnNetwork/GroupCreationXUI

Status	Occurrence	Format	Min. Access Types
Required	One	chr	Get, Replace

This leaf node indicates the group creation XUI information for creation of groups.

The value is a URI as specified in 3GPP TS 23.003 [5].

8.2.9B /<x>/OnNetwork/GMSXCAPRootURI

Table 8.2.9B.1: <x>/OnNetwork/GMSXCAPRootURI

OnNetwork/GMSXCAPRootURI

Status	Occurrence	Format	Min. Access Types
Required	One	chr	Get, Replace

This leaf node indicates the group management server XCAP Root URI information.

The value is a URI as specified in 3GPP TS 23.003 [5].

8.2.9C /<x>/OnNetwork/CMSXCAPRootURI

Table 8.2.9C.1: <x>/OnNetwork/CMSXCAPRootURI

OnNetwork/CMSXCAPRootURI

Status	Occurrence	Format	Min. Access Types
Required	One	chr	Get, Replace

This leaf node indicates the configuration management server XCAP Root URI information.

The value is a URI as specified in 3GPP TS 23.003 [5].

8.2.10 /<x>/OnNetwork/Timers

Table 8.2.10.1: /<x>/OnNetwork/Timers

OnNetwork/Timers

Status	Occurrence	Format	Min. Access Types
Required	One	node	Get, Replace

This interior node is a placeholder for timer configuration.

8.2.11 /<x>/OnNetwork/Timers/T100

Table 8.2.11.1: /<x>/OnNetwork/Timers/T100

OnNetwork/Timers/T100

Status	Occurrence	Format	Min. Access Types
Required	One	int	Get, Replace

This leaf node indicates the MCPTT timer for floor release as specified in 3GPP TS 24.380 [8].

- Values: 0-255

The T100 is in seconds.

8.2.12 /<x>/OnNetwork/Timers/T101

Table 8.2.12.1: /<x>/OnNetwork/Timers/T101

OnNetwork/Timers/T101

Status	Occurrence	Format	Min. Access Types
Required	One	int	Get, Replace

This leaf node indicates the MCPTT timer for floor request as specified in 3GPP TS 24.380 [8].

- Values: 0-255

The timer T101 is in seconds.

8.2.13 /<x>/OnNetwork/Timers/T103

Table 8.2.13.1: /<x>/OnNetwork/Timers/T103

OnNetwork/Timers/T103

Status	Occurrence	Format	Min. Access Types
Required	One	int	Get, Replace

This leaf node indicates the MCPTT timer for end of RTP media as specified in 3GPP TS 24.380 [8].

- Values: 0-255

The timer T103 is in seconds.

8.2.14 /<x>/OnNetwork/Timers/T104

Table 8.2.14.1: /<x>/OnNetwork/Timers/T104

OnNetwork/Timers/T104

Status	Occurrence	Format	Min. Access Types
Required	One	int	Get, Replace

This leaf node indicates the MCPTT timer for floor queue position request as specified in 3GPP TS 24.380 [8].

- Values: 0-255

The timer T104 is in seconds.

8.2.15 /<x>/OnNetwork/Timers/T132

Table 8.2.15.1: /<x>/OnNetwork/Timers/T132

OnNetwork/Timers/T132

Status	Occurrence	Format	Min. Access Types
Required	One	int	Get, Replace

This leaf node indicates the MCPTT timer for queued request granted MCPTT user action as specified in 3GPP TS 24.380 [8].

- Values: 0-255

The timer T132 is in seconds.

8.2.16 /<x>/OnNetwork/HPLMN

Table 8.2.16.1: /<x>/OnNetwork/HPLMN

OnNetwork/HPLMN

Status	Occurrence	Format	Min. Access Types
Required	One	node	Get, Replace

This interior node is a placeholder for the HPLMN configuration.

8.2.17 /<x>/OnNetwork/HPLMN/PLMN

Table 8.2.17.1: /<x>/OnNetwork/HPLMN/PLMN

OnNetwork/HPLMN/PLMN

Status	Occurrence	Format	Min. Access Types
Required	One	chr	Get, Replace

This leaf node indicates the HPLMN code.

- Values: <PLMN>

The format of the PLMN is defined by 3GPP TS 23.003 [5].

8.2.18 /<x>/OnNetwork/HPLMN/Service

Table 8.2.18.1: /<x>/OnNetwork/HPLMN/Service

OnNetwork/HPLMN/Service

Status	Occurrence	Format	Min. Access Types
Required	One	node	Get, Replace

This interior node indicates the MCS related services on a per HPLMN basis.

8.2.19 /<x>/OnNetwork/HPLMN/Service/MCPTTTToConRef

Table 8.2.19.1: /<x>/OnNetwork/HPLMN/Service/MCPTTTToConRef

OnNetwork/HPLMN/Service/MCPTTTToConRef

Status	Occurrence	Format	Min. Access Types
Required	One	node	Get, Replace

This interior node contains the configuration parameters for establishment of the PDN connection for the MCS service on a per HPLMN basis.

8.2.20 /<x>/OnNetwork/HPLMN/Service/MCPTTTToConRef/<x>

Table 8.2.20.1: /<x>/OnNetwork/HPLMN/Service/MCPTTTToConRef/<x>

OnNetwork/HPLMN/Service/MCPTTTToConRef/<x>

Status	Occurrence	Format	Min. Access Types
Required	OneorMore	node	Get, Replace

This run-time node acts as a placeholder for each reference to the connectivity parameters on a per HPLMN basis.

8.2.21 /<x>/OnNetwork/HPLMN/Service/MCPTTTToConRef/<x>/ConRef

Table 8.2.21.1: /<x>/OnNetwork/HPLMN/Service/MCPTTTToConRef/<x>/ConRef

OnNetwork/HPLMN/Service/MCPTTTToConRef/<x>/ConRef

Status	Occurrence	Format	Min. Access Types
Required	One	chr	Get, Replace

The ConRef specifies a specific linkage to the connectivity parameters on a per HPLMN basis.

- Values: <A network access point object>

8.2.22 /<x>/OnNetwork/HPLMN/Service/MCCommonCoreToConRef

Table 8.2.22.1: /<x>/OnNetwork/HPLMN/Service/MCCommonCoreToConRef

OnNetwork/HPLMN/Service/MCCommonCoreToConRef

Status	Occurrence	Format	Min. Access Types
Required	One	node	Get, Replace

This interior node contains the configuration parameters for establishment of the PDN connection for the MC common core service on a per HPLMN basis.

8.2.23 /<x>/OnNetwork/HPLMN/Service/MCCommonCoreToConRef/<x>

Table 8.2.23.1: /<x>/OnNetwork/HPLMN/Service/MCCommonCoreToConRef/<x>

OnNetwork/HPLMN/Service/MCCommonCoreToConRef/<x>

Status	Occurrence	Format	Min. Access Types
Required	OneorMore	node	Get, Replace

This run-time node acts as a placeholder for each reference to the connectivity parameters on a per HPLMN basis.

8.2.24

`/<x>/OnNetwork/HPLMN/Service/MCCommonCoreToConRef/<x>/ConRef`

Table 8.2.24.1: `/<x>/OnNetwork/HPLMN/Service/MCCommonCoreToConRef/<x>/ConRef`

`OnNetwork/HPLMN/Service/MCCommonCoreToConRef/<x>/ConRef`

Status	Occurrence	Format	Min. Access Types
Required	One	chr	Get, Replace

The ConRef specifies a specific linkage to the connectivity parameters on a per HPLMN basis.

- Values: <A network access point object>

8.2.25 `/<x>/OnNetwork/HPLMN/Service/MCIDMTToConRef`

Table 8.2.25.1: `/<x>/OnNetwork/HPLMN/Service/MCIDMTToConRef`

`OnNetwork/HPLMN/Service/MCIDMTToConRef`

Status	Occurrence	Format	Min. Access Types
Required	One	node	Get, Replace

This interior node contains the configuration parameters for establishment of the PDN connection for the MC identity management service on a per HPLMN basis.

8.2.26 `/<x>/OnNetwork/HPLMN/Service/MCIDMTToConRef/<x>`

Table 8.2.26.1: `/<x>/OnNetwork/HPLMN/Service/MCIDMTToConRef/<x>`

`OnNetwork/HPLMN/Service/MCIDMTToConRef/<x>`

Status	Occurrence	Format	Min. Access Types
Required	OneorMore	node	Get, Replace

This run-time node acts as a placeholder for each reference to the connectivity parameters on a per HPLMN basis.

8.2.27 `/<x>/OnNetwork/HPLMN/Service/MCIDMTToConRef/<x>/ConRef`

Table 8.2.27.1: `/<x>/OnNetwork/HPLMN/Service/MCIDMTToConRef/<x>/ConRef`

`OnNetwork/HPLMN/Service/MCIDMTToConRef/<x>/ConRef`

Status	Occurrence	Format	Min. Access Types
Required	One	chr	Get, Replace

The ConRef specifies a specific linkage to the connectivity parameters on a per HPLMN basis.

- Values: <A network access point object>

8.2.28 `/<x>/OnNetwork/HPLMN/VPLMN`

Table 8.2.28.1: `/<x>/OnNetwork/HPLMN/VPLMN`

`OnNetwork/HPLMN/VPLMN`

Status	Occurrence	Format	Min. Access Types

Optional	ZeroOrOne	node	Get, Replace
----------	-----------	------	--------------

This interior node is a placeholder for the VPLMN configuration.

8.2.29 /<x>/OnNetwork/HPLMN/VPLMN/PLMN

Table 8.2.29.1: /<x>/OnNetwork/HPLMN/VPLMN/PLMN

OnNetwork/HPLMN/VPLMN/PLMN

Status	Occurrence	Format	Min. Access Types
Required	One	chr	Get, Replace

This leaf node indicates the VPLMN code.

- Values: <PLMN>

The format of the PLMN is defined by 3GPP TS 23.003 [5].

8.2.30 /<x>/OnNetwork/HPLMN/VPLMN/Service

Table 8.2.30.1: /<x>/OnNetwork/HPLMN/VPLMN/Service

OnNetwork/HPLMN/VPLMN/Service

Status	Occurrence	Format	Min. Access Types
Required	One	node	Get, Replace

This interior node indicates the MCS related services on a per VPLMN and HPLMN basis.

8.2.31 /<x>/OnNetwork/HPLMN/VPLMN/Service/MCPTTTtoConRef

Table 8.2.31.1: /<x>/OnNetwork/HPLMN/VPLMN/Service/MCPTTTtoConRef

OnNetwork/HPLMN/VPLMN/Service/MCPTTTtoConRef

Status	Occurrence	Format	Min. Access Types
Required	One	node	Get, Replace

This interior node contains the configuration parameters for establishment of the PDN connection for the MCS service on a per VPLMN and HPLMN basis.

8.2.32 /<x>/OnNetwork/HPLMN/VPLMN/Service/MCPTTTtoConRef/<x>

Table 8.2.32.1: /<x>/OnNetwork/HPLMN/Service/MCPTTTtoConRef/<x>

OnNetwork/HPLMN/VPLMN/Service/MCPTTTtoConRef/<x>

Status	Occurrence	Format	Min. Access Types
Required	OneorMore	node	Get, Replace

This run-time node acts as a placeholder for each reference to the connectivity parameters on a per VPLMN and HPLMN basis.

8.2.33

/<x>/OnNetwork/HPLMN/VPLMN/Service/MCPTTTtoConRef/<x>/ConRef

Table 8.2.33.1: /<x>/OnNetwork/HPLMN/VPLMN/Service/MCPTTTtoConRef/<x>/ConRef

OnNetwork/HPLMN/VPLMN/Service/MCPTTTtoConRef/<x>/ConRef

Status	Occurrence	Format	Min. Access Types
Required	One	chr	Get, Replace

The ConRef specifies a specific linkage to the connectivity parameters on a per VPLMN and HPLMN basis.

- Values: <A network access point object>

8.2.34

`/<x>/OnNetwork/HPLMN/VPLMN/Service/MCCommonCoreToConRef`

Table 8.2.34.1: `/<x>/OnNetwork/HPLMN/VPLMN/Service/MCCommonCoreToConRef`

OnNetwork/HPLMN/VPLMN/Service/MCCommonCoreToConRef

Status	Occurrence	Format	Min. Access Types
Required	One	node	Get, Replace

This interior node contains the configuration parameters for establishment of the PDN connection for the MC common core service on a per VPLMN and HPLMN basis.

8.2.35

`/<x>/OnNetwork/HPLMN/VPLMN/Service/MCCommonCoreToConRef/<x>`

Table 8.2.35.1: `/<x>/OnNetwork/HPLMN/VPLMN/Service/MCCommonCoreToConRef/<x>`

OnNetwork/HPLMN/VPLMN/Service/MCCommonCoreToConRef/<x>

Status	Occurrence	Format	Min. Access Types
Required	OneorMore	node	Get, Replace

This run-time node acts as a placeholder for each reference to the connectivity parameters on a per VPLMN and HPLMN basis.

8.2.36

`/<x>/OnNetwork/HPLMN/VPLMN/Service/MCCommonCoreToConRef/<x>/ConRef`

Table 8.2.36.1: `/<x>/OnNetwork/HPLMN/VPLMN/Service/MCCommonCoreToConRef/<x>/ConRef`

OnNetwork/HPLMN/VPLMN/Service/MCCommonCoreToConRef/<x>/ConRef

Status	Occurrence	Format	Min. Access Types
Required	One	chr	Get, Replace

The ConRef specifies a specific linkage to the connectivity parameters on a per VPLMN and HPLMN basis.

- Values: <A network access point object>

8.2.37 `/<x>/OnNetwork/HPLMN/VPLMN/Service/MCIDMToConRef`

Table 8.2.37.1: `/<x>/OnNetwork/HPLMN/VPLMN/Service/MCIDMToConRef`

OnNetwork/HPLMN/VPLMN/Service/MCIDMToConRef

Status	Occurrence	Format	Min. Access Types
Required	One	node	Get, Replace

This interior node contains the configuration parameters for establishment of the PDN connection for the MC identity management service on a per VPLMN and HPLMN basis.

8.2.38 /<x>/OnNetwork/HPLMN/VPLMN/Service/MCIDMTtoConRef/<x>

Table 8.2.38.1: /<x>/OnNetwork/HPLMN/VPLMN/Service/MCIDMTtoConRef/<x>

OnNetwork/HPLMN/VPLMN/Service/MCIDMTtoConRef/<x>

Status	Occurrence	Format	Min. Access Types
Required	OneorMore	node	Get, Replace

This run-time node acts as a placeholder for each reference to the connectivity parameters on a per VPLMN and HPLMN basis.

8.2.39

/<x>/OnNetwork/HPLMN/VPLMN/Service/MCIDMTtoConRef/<x>/ConRef

Table 8.2.39.1: /<x>/OnNetwork/HPLMN/VPLMN/Service/MCIDMTtoConRef/<x>/ConRef

OnNetwork/HPLMN/VPLMN/Service/MCIDMTtoConRef/<x>/ConRef

Status	Occurrence	Format	Min. Access Types
Required	One	chr	Get, Replace

The ConRef specifies a specific linkage to the connectivity parameters on a per VPLMN and HPLMN basis.

- Values: <A network access point object>

8.2.40 /<x>/OnNetwork/AppServerInfo

Table 8.2.40.1: /<x>/OnNetwork/AppServerInfo

OnNetwork/AppServerInfo

Status	Occurrence	Format	Min. Access Types
Required	One	node	Get, Replace

This interior node is a placeholder for the application plane server identity information configuration.

8.2.41 /<x>/OnNetwork/AppServerInfo/IDMSAuthEndpoint

Table 8.2.41.1: /<x>/OnNetwork/AppServerInfo/IDMSAuthEndpoint

OnNetwork/AppServerInfo/IDMSAuthEndpoint

Status	Occurrence	Format	Min. Access Types
Required	One	chr	Get, Replace

This leaf node indicates the identity management server authorisation endpoint identity information.

The value is a URI as specified in 3GPP TS 23.003 [5].

8.2.41A /<x>/OnNetwork/AppServerInfo/IDMSTokenEndpoint

Table 8.2.41A.1: /<x>/OnNetwork/AppServerInfo/IDMSTokenEndpoint

OnNetwork/AppServerInfo/IDMSTokenEndpoint

Status	Occurrence	Format	Min. Access Types
Required	One	chr	Get, Replace

This leaf node indicates the identity management server token endpoint identity information.

The value is a URI as specified in 3GPP TS 23.003 [5].

8.2.41B /<x>/OnNetwork/AppServerInfo/HTTPProxy

Table 8.2.41B.1: /<x>/OnNetwork/AppServerInfo/HTTPProxy

OnNetwork/AppServerInfo/HTTPProxy

Status	Occurrence	Format	Min. Access Types
Required	One	chr	Get, Replace

This leaf node indicates the HTTP Proxy identity information.

The value is a URI as specified in 3GPP TS 23.003 [5].

8.2.42 /<x>/OnNetwork/AppServerInfo/GMS

Table 8.2.42.1: /<x>/OnNetwork/AppServerInfo/GMS

OnNetwork/AppServerInfo/GMS

Status	Occurrence	Format	Min. Access Types
Required	One	chr	Get, Replace

This leaf node indicates the group management server identity information.

The value is a URI as specified in 3GPP TS 23.003 [5].

8.2.43 /<x>/OnNetwork/AppServerInfo/CMS

Table 8.2.43.1: /<x>/OnNetwork/AppServerInfo/CMS

OnNetwork/AppServerInfo/CMS

Status	Occurrence	Format	Min. Access Types
Required	One	chr	Get, Replace

This leaf node indicates the configuration management server identity information.

The value is a URI as specified in 3GPP TS 23.003 [5].

8.2.44 /<x>/OnNetwork/AppServerInfo/KMS

Table 8.2.44.1: /<x>/OnNetwork/AppServerInfo/KMS

OnNetwork/AppServerInfo/KMS

Status	Occurrence	Format	Min. Access Types
Required	One	chr	Get, Replace

This leaf node indicates key management server identity information.

The value is a URI as specified in 3GPP TS 23.003 [5].

8.2.44A /<x>/OnNetwork/AppServerInfo/TLSTunnelAuthMethod

Table 8.2.44A.1: /<x>/OnNetwork/AppServerInfo/TLSTunnelAuthMethod

OnNetwork/AppServerInfo/TLSTunnelAuthMethod

Status	Occurrence	Format	Min. Access Types
Required	One	node	Get, Replace

This interior node is a placeholder for the TLS tunnel authentication method configuration.

8.2.44B /<x>/OnNetwork/AppServerInfo/TLSTunnelAuthMethod/Mutual

Table 8.2.44B.1: /<x>/OnNetwork/AppServerInfo/TLSTunnelAuthMethod/Mutual

OnNetwork/AppServerInfo/TLSTunnelAuthMethod/Mutual

Status	Occurrence	Format	Min. Access Types
Required	One	bool	Get, Replace

This leaf node indicates whether mutual authentication is used for the TLS tunnel authentication.

When set to "true" mutual authentication is used.

When set to "false" one-way authentication based on the server certificate is used.

The default value is "false".

8.2.44C /<x>/OnNetwork/AppServerInfo/TLSTunnelAuthMethod/X509

Table 8.2.44C.1: /<x>/OnNetwork/AppServerInfo/TLSTunnelAuthMethod/X509

OnNetwork/AppServerInfo/TLSTunnelAuthMethod/X509

Status	Occurrence	Format	Min. Access Types
Optional	One	chr	Get, Replace

This leaf node contains the X.509 certificate for mutual authentication for the TLS tunnel authentication.

8.2.44D /<x>/OnNetwork/AppServerInfo/TLSTunnelAuthMethod/Key

Table 8.2.44D.1: /<x>/OnNetwork/AppServerInfo/TLSTunnelAuthMethod/Key

OnNetwork/AppServerInfo/TLSTunnelAuthMethod/Key

Status	Occurrence	Format	Min. Access Types
Optional	One	chr	Get, Replace

This leaf node contains the pre-shared key for mutual authentication for the TLS tunnel authentication.

8.2.44E /<x>/OnNetwork/IntegrityProtection

Table 8.2.44E.1: /<x>/OnNetwork/IntegrityProtection

OnNetwork/IntegrityProtection

Status	Occurrence	Format	Min. Access Types
Required	One	bool	Get, Replace

This leaf node indicates whether integrity protection is enabled.

When set to "true" integrity protection is enabled.

When set to "false" integrity protection is disabled.

The default value is "true".

8.2.44F /<x>/OnNetwork/ConfidentialityProtection

Table 8.2.44F.1: /<x>/OnNetwork/ConfidentialityProtection

OnNetwork/ConfidentialityProtection

Status	Occurrence	Format	Min. Access Types
Required	One	bool	Get, Replace

This leaf node indicates whether integrity protection is enabled.

When set to "true" confidentiality protection is enabled.

When set to "false" confidentiality protection is disabled.

The default value is "true".

8.2.44G1 /<x>/OnNetwork/MCPTTServiceDetails

Table 8.2.44G1.1: /<x>/OnNetwork/MCPTTServiceDetails

OnNetwork/MCPTTServiceDetails

Status	Occurrence	Format	Min. Access Types
Required	One	node	Get, Replace

This interior node is a placeholder for the details of the MCPTT service.

8.2.44G2 /<x>/OnNetwork/MCPTTServiceDetails/IPv6Required

Table 8.2.44G2.1: /<x>/OnNetwork/MCPTTServiceDetails/IPv6Required

OnNetwork/MCPTTServiceDetails/IPv6Required

Status	Occurrence	Format	Min. Access Types
Required	One	Bool	Get, Replace

This leaf node indicates whether IP version 6 is required to use to access the MCPTT service.

When set to "true", IPv6 shall be used to access the service.

When set to "false", IPv4 shall be used to access the service.

8.2.44G3 /<x>/OnNetwork/MCPTTServiceDetails/ServerURI

Table 8.2.44G3.1: /<x>/OnNetwork/MCPTTServiceDetails/ServerURI

OnNetwork/MCPTTServiceDetails/ServerURI

Status	Occurrence	Format	Min. Access Types

Required	One	Chr	Get, Replace
----------	-----	-----	--------------

This leaf node indicates the URI to use to access the MCPTT service.

The value is a URI as specified in 3GPP TS 23.003 [5].

8.2.44G4 /<x>/OnNetwork/MCVideoServiceDetails

Table 8.2.44G4.1: /<x>/OnNetwork/MCVideoServiceDetails

OnNetwork/MCVideoServiceDetails

Status	Occurrence	Format	Min. Access Types
Required	One	node	Get, Replace

This interior node is a placeholder for the details of the MCVideo service.

8.2.44G5 /<x>/OnNetwork/MCVideoServiceDetails/IPv6Required

Table 8.2.44G5.1: /<x>/OnNetwork/MCVideoServiceDetails/IPv6Required

OnNetwork/MCVideoServiceDetails/IPv6Required

Status	Occurrence	Format	Min. Access Types
Required	One	Bool	Get, Replace

This leaf node indicates the IP version to use to access the MCVideo service.

When set to "true", IPv6 shall be used to access the service.

When set to "false", IPv4 shall be used to access the service.

8.2.44G6 /<x>/OnNetwork/MCVideoServiceDetails/ServerURI

Table 8.2.44G6.1: /<x>/OnNetwork/MCVideoServiceDetails/ServerURI

OnNetwork/MCVideoServiceDetails/ServerURI

Status	Occurrence	Format	Min. Access Types
Required	One	Chr	Get, Replace

This leaf node indicates the URI to use to access the MCVideo service.

The value is a URI as specified in 3GPP TS 23.003 [5].

8.2.44G7 /<x>/OnNetwork/MCDataServiceDetails

Table 8.2.44G7.1: /<x>/OnNetwork/MCDataServiceDetails

OnNetwork/MCDataServiceDetails

Status	Occurrence	Format	Min. Access Types
Required	One	node	Get, Replace

This interior node is a placeholder for the details of the MCData service.

8.2.44G8 /<x>/OnNetwork/MCDataServiceDetails/IPv6Required

Table 8.2.44G8.1: /<x>/OnNetwork/MCDataServiceDetails/IPv6Required

OnNetwork/MCDataServiceDetails/IPv6Required

Status	Occurrence	Format	Min. Access Types
Required	One	Bool	Get, Replace

This leaf node indicates the IP version to use to access the MCData service.

When set to "true", IPv6 shall be used to access the service.

When set to "false", IPv4 shall be used to access the service.

8.2.44G9 /<x>/OnNetwork/MCDataServiceDetails/ServerURI

Table 8.2.44G9.1: /<x>/OnNetwork/MCDataServiceDetails/ServerURI

OnNetwork/MCDataServiceDetails/ServerURI

Status	Occurrence	Format	Min. Access Types
Required	One	Chr	Get, Replace

This leaf node indicates the URI to use to access the MCData service.

The value is a URI as specified in 3GPP TS 23.003 [5].

8.2.45 /<x>/OffNetwork

Table 8.2.45.1: /<x>/OffNetwork

OffNetwork

Status	Occurrence	Format	Min. Access Types
Required	ZeroOrOne	node	Get, Replace

This interior node represents a container for the off-network operation.

8.2.46 /<x>/OffNetwork/Timers

Table 8.2.46.1: /<x>/OffNetwork/Timers

OffNetwork/Timers

Status	Occurrence	Format	Min. Access Types
Required	One	node	Get, Replace

This interior node is a placeholder for the timer configuration.

8.2.47 /<x>/OffNetwork/Timers/TFG1

Table 8.2.47.1: /<x>/OffNetwork/Timers/TFG1

OffNetwork/Timers/TFG1

Status	Occurrence	Format	Min. Access Types
Required	One	int	Get, Replace

This leaf node indicates the MCPTT timer for wait for call announcement as specified in 3GPP TS 24.379 [7].

- Values: 0-65535

The timer TFG1 is in milliseconds.

8.2.48 /<x>/OffNetwork/Timers/TFG2

Table 8.2.48.1: /<x>/OffNetwork/Timers/TFG2

OffNetwork/Timers/TFG2

Status	Occurrence	Format	Min. Access Types
Required	One	int	Get, Replace

This leaf node indicates the MCPTT timer for call announcement as specified in 3GPP TS 24.379 [7].

- Values: 0-65535

The timer TFG2 is in milliseconds.

8.2.49 /<x>/OffNetwork/Timers/TFG3

Table 8.2.49.1: /<x>/OffNetwork/Timers/TFG3

OffNetwork/Timers/TFG3

Status	Occurrence	Format	Min. Access Types
Required	One	int	Get, Replace

This leaf node indicates the MCPTT timer for call probe retransmission as specified in 3GPP TS 24.379 [7].

- Values: 0-65535

The timer TFG3 is in milliseconds.

8.2.50 /<x>/OffNetwork/Timers/TFG4

Table 8.2.50.1: /<x>/OffNetwork/Timers/TFG4

OffNetwork/Timers/TFG4

Status	Occurrence	Format	Min. Access Types
Required	One	int	Get, Replace

This leaf node indicates the MCPTT timer for waiting for the MCPTT user as specified in 3GPP TS 24.379 [7].

- Values: 0-60

The timer TFG4 is in seconds.

8.2.51 /<x>/OffNetwork/Timers/TFG5

Table 8.2.51.1: /<x>/OffNetwork/Timers/TFG5

OffNetwork/Timers/TFG5

Status	Occurrence	Format	Min. Access Types
Required	One	int	Get, Replace

This leaf node indicates the MCPTT timer for not present incoming call announcements as specified in 3GPP TS 24.379 [7].

- Values: 0-255

The timer TFG5 is in seconds.

8.2.52 /<x>/OffNetwork/Timers/TFG11

Table 8.2.52.1: /<x>/OffNetwork/Timers/TFG11

OffNetwork/Timers/TFG11

Status	Occurrence	Format	Min. Access Types
Required	One	int	Get, Replace

This leaf node indicates the timer for MCPTT emergency end retransmission as specified in 3GPP TS 24.379 [7].

- Values: 0-65535

The timer TFG11 is in milliseconds.

8.2.53 /<x>/OffNetwork/Timers/TFG12

Table 8.2.53.1: /<x>/OffNetwork/Timers/TFG12

OffNetwork/Timers/TFG12

Status	Occurrence	Format	Min. Access Types
Required	One	int	Get, Replace

This leaf node indicates the timer for MCPTT imminent peril end retransmission as specified in 3GPP TS 24.379 [7].

- Values: 0-65535

The timer TFG12 is in milliseconds.

8.2.54 /<x>/OffNetwork/Timers/TFG13

Table 8.2.54.1: /<x>/OffNetwork/Timers/TFG13

OffNetwork/Timers/TFG13

Status	Occurrence	Format	Min. Access Types
Required	One	int	Get, Replace

This leaf node indicates the MCPTT timer for implicit priority downgrade as specified in 3GPP TS 24.379 [7].

- Values: 0-255

The timer TFG13 is in seconds.

8.2.54A /<x>/OffNetwork/Timers/TFG14

Table 8.2.54A.1: /<x>/OffNetwork/Timers/TFG14

OffNetwork/Timers/TFG14

Status	Occurrence	Format	Min. Access Types
Required	One	int	Get, Replace

This leaf node indicates the MCPTT timer for implicit priority downgrade (imminent peril) as specified in 3GPP TS 24.379 [7].

- Values: 0-255

The timer TFG14 is in seconds.

8.2.55 /<x>/OffNetwork/Timers/TFP1

Table 8.2.55.1: /<x>/OffNetwork/Timers/TFP1

OffNetwork/Timers/TFP1

Status	Occurrence	Format	Min. Access Types
Required	One	int	Get, Replace

This leaf node indicates the MCPTT timer for private call request retransmission as specified in 3GPP TS 24.379 [7].

- Values: 0-65535

The timer TFP1 is in milliseconds.

8.2.56 /<x>/OffNetwork/Timers/TFP2

Table 8.2.56.1: /<x>/OffNetwork/Timers/TFP2

OffNetwork/Timers/TFP2

Status	Occurrence	Format	Min. Access Types
Required	One	int	Get, Replace

This leaf node indicates the MCPTT timer for waiting for the MCPTT user to respond to the setup request message when manual commencement mode is used as specified in 3GPP TS 24.379 [7].

- Values: 0-60

The timer TFP2 is in seconds.

8.2.57 /<x>/OffNetwork/Timers/TFP3

Table 8.2.57.1: /<x>/OffNetwork/Timers/TFP3

OffNetwork/Timers/TFP3

Status	Occurrence	Format	Min. Access Types
Required	One	int	Get, Replace

This leaf node indicates the MCPTT timer for private call release retransmission as specified in 3GPP TS 24.379 [7].

- Values: 0-65535

The timer TFP3 is in milliseconds.

8.2.58 /<x>/OffNetwork/Timers/TFP4

Table 8.2.58.1: /<x>/OffNetwork/Timers/TFP4

OffNetwork/Timers/TFP4

Status	Occurrence	Format	Min. Access Types
Required	One	int	Get, Replace

This leaf node indicates the MCPTT timer for private call accept retransmission as specified in 3GPP TS 24.379 [7].

- Values: 0-65535

The timer TFP4 is in milliseconds.

8.2.59 /<x>/OffNetwork/Timers/TFP5

Table 8.2.59.1: /<x>/OffNetwork/Timers/TFP5

OffNetwork/Timers/TFP5

Status	Occurrence	Format	Min. Access Types
Required	One	int	Get, Replace

This leaf node indicates the MCPTT timer for call release as specified in 3GPP TS 24.379 [7].

- Values: 0-600

The timer TFP5 is in seconds.

8.2.60 /<x>/OffNetwork/Timers/TFP6

Table 8.2.60.1: /<x>/OffNetwork/Timers/TFP6

OffNetwork/Timers/TFP6

Status	Occurrence	Format	Min. Access Types
Required	One	int	Get, Replace

This leaf node indicates the MCPTT timer for MCPTT emergency private call cancel retransmission as specified in 3GPP TS 24.379 [7].

- Values: 0-65535

The timer TFP6 is in milliseconds.

8.2.61 /<x>/OffNetwork/Timers/TFP7

Table 8.2.61.1: /<x>/OffNetwork/Timers/TFP7

OffNetwork/Timers/TFP7

Status	Occurrence	Format	Min. Access Types
Required	One	int	Get, Replace

This leaf node indicates the MCPTT timer for waiting for any message with same call identifier as specified in 3GPP TS 24.379 [7].

- Values: 0-255

The timer TFP7 is in seconds.

8.2.61A /<x>/OffNetwork/Timers/TFP9

Table 8.2.61A: /<x>/OffNetwork/Timers/TFP9

OffNetwork/Timers/TFP9

Status	Occurrence	Format	Min. Access Types
Required	One	int	Get, Replace

This leaf node indicates the MCPTT timer for waiting for call response message as specified in 3GPP TS 24.379 [7].

- Values: 0-60

The timer TFP9 is in seconds.

8.2.62 /<x>/OffNetwork/Timers/TFB1

Table 8.2.62.1: /<x>/OffNetwork/Timers/TFB1

OffNetwork/Timers/TFB1

Status	Occurrence	Format	Min. Access Types
Required	One	int	Get, Replace

This leaf node indicates the MCPTT timer for max duration as specified in 3GPP TS 24.379 [7].

- Values: 0-600

The timer TFB1 is in seconds.

8.2.63 /<x>/OffNetwork/Timers/TFB2

Table 8.2.63.1: /<x>/OffNetwork/Timers/TFB2

OffNetwork/Timers/TFB2

Status	Occurrence	Format	Min. Access Types
Required	One	int	Get, Replace

This leaf node indicates the MCPTT timer for broadcast retransmission as specified in 3GPP TS 24.379 [7].

- Values: 0-10

The timer TFB2 is in seconds.

8.2.64 /<x>/OffNetwork/Timers/TFB3

Table 8.2.64.1: /<x>/OffNetwork/Timers/TFB3

OffNetwork/Timers/TFB3

Status	Occurrence	Format	Min. Access Types
Required	One	int	Get, Replace

This leaf node indicates the MCPTT timer for waiting for the MCPTT user as specified in 3GPP TS 24.379 [7].

- Values: 0-60

The timer TFB3 is in seconds.

8.2.65 /<x>/OffNetwork/Timers/T201

Table 8.2.65.1: /<x>/OffNetwork/Timers/T201

OffNetwork/Timers/T201

Status	Occurrence	Format	Min. Access Types
Required	One	int	Get, Replace

This leaf node indicates the MCPTT timer for floor request as specified in 3GPP TS 24.380 [8].

- Values: 0-65535

The timer T201 is in milliseconds.

8.2.66 /<x>/OffNetwork/Timers/T203

Table 8.2.66.1: /<x>/OffNetwork/Timers/T203

OffNetwork/Timers/T203

Status	Occurrence	Format	Min. Access Types
Required	One	int	Get, Replace

This leaf node indicates the MCPTT timer for end of RTP media as specified in 3GPP TS 24.380 [8].

- Values: 0-255

The timer T203 is in seconds.

8.2.67 /<x>/OffNetwork/Timers/T204

Table 8.2.67.1: /<x>/OffNetwork/Timers/T204

OffNetwork/Timers/T204

Status	Occurrence	Format	Min. Access Types
Required	One	int	Get, Replace

This leaf node indicates the MCPTT timer for floor queue position request as specified in 3GPP TS 24.380 [8].

- Values: 0-65535

The timer T204 is in milliseconds.

8.2.68 /<x>/OffNetwork/Timers/T205

Table 8.2.68.1: /<x>/OffNetwork/Timers/T205

OffNetwork/Timers/T205

Status	Occurrence	Format	Min. Access Types
Required	One	int	Get, Replace

This leaf node indicates the MCPTT timer for floor granted request as specified in 3GPP TS 24.380 [8].

- Values: 0-65535

The timer T205 is in milliseconds.

8.2.69 Void

8.2.70 /<x>/OffNetwork/Timers/T233

Table 8.2.70.1: /<x>/OffNetwork/Timers/T233

OffNetwork/Timers/T233

Status	Occurrence	Format	Min. Access Types
Required	One	int	Get, Replace

This leaf node indicates the MCPTT timer for pending user action as specified in 3GPP TS 24.380 [8].

- Values: 0-255

The timer T233 is in seconds.

8.2.71 /<x>/OffNetwork/Timers/TFE1

Table 8.2.71.1: /<x>/OffNetwork/Timers/TFE1

OffNetwork/Timers/TFE1

Status	Occurrence	Format	Min. Access Types
Required	One	int	Get, Replace

This leaf node indicates the timer for MCPTT emergency alert as specified in 3GPP TS 24.379 [7].

- Values: 0-65535

The timer TFE1 is in seconds.

8.2.72 /<x>/OffNetwork/Timers/TFE2

Table 8.2.72.1: /<x>/OffNetwork/Timers/TFE2

OffNetwork/Timers/TFE2

Status	Occurrence	Format	Min. Access Types
Required	One	int	Get, Replace

This leaf node indicates the timer for MCPTT emergency alert retransmission as specified in 3GPP TS 24.379 [7].

- Values: 0-10

The timer TFE2 is in seconds.

8.2.73 /<x>/OffNetwork/Counters

Table 8.2.73.1: /<x>/OffNetwork/Counters

OffNetwork/Counters

Status	Occurrence	Format	Min. Access Types
Required	One	node	Get, Replace

This interior node is a placeholder for the counter configuration.

8.2.74 /<x>/OffNetwork/Counters/CFP1

Table 8.2.74.1: /<x>/OffNetwork/Counters/CFP1

OffNetwork/Counters/CFP1

Status	Occurrence	Format	Min. Access Types
Required	One	int	Get, Replace

This leaf node indicates the MCPTT counter for private call request retransmission as specified in 3GPP TS 24.379 [7].

- Values: 0-255

8.2.75 /<x>/OffNetwork/Counters/CFP3

Table 8.2.75.1: /<x>/OffNetwork/Counters/CFP3

OffNetwork/Counters/CFP3

Status	Occurrence	Format	Min. Access Types
Required	One	int	Get, Replace

This leaf node indicates the MCPTT counter for private call release retransmission as specified in 3GPP TS 24.379 [7].

- Values: 0-255

8.2.76 /<x>/OffNetwork/Counters/CFP4

Table 8.2.76.1: /<x>/OffNetwork/Counters/CFP4

OffNetwork/Counters/CFP4

Status	Occurrence	Format	Min. Access Types
Required	One	int	Get, Replace

This leaf node indicates the MCPTT counter for private call accept retransmission as specified in 3GPP TS 24.379 [7].

- Values: 0-255

8.2.77 /<x>/OffNetwork/Counters/CFP6

Table 8.2.77.1: /<x>/OffNetwork/Counters/CFP6

OffNetwork/Counters/CFP6

Status	Occurrence	Format	Min. Access Types
Required	One	int	Get, Replace

This leaf node indicates the MCPTT counter for emergency private call cancel retransmission as specified in 3GPP TS 24.379 [7].

- Values: 0-255

8.2.78 /<x>/OffNetwork/Counters/CFG11

Table 8.2.78.1: /<x>/OffNetwork/Counters/CFG11

OffNetwork/Counters/CFG11

Status	Occurrence	Format	Min. Access Types
Required	One	int	Get, Replace

This leaf node indicates the counter for MCPTT group call emergency end retransmission as specified in 3GPP TS 24.379 [7].

- Values: 0-255

8.2.79 /<x>/OffNetwork/Counters/CFG12

Table 8.2.79.1: /<x>/OffNetwork/Counters/CFG12

OffNetwork/Counters/CFG12

Status	Occurrence	Format	Min. Access Types
Required	One	int	Get, Replace

This leaf node indicates the counter for MCPTT imminent peril call emergency end retransmission as specified in 3GPP TS 24.379 [7].

- Values: 0-255

8.2.80 /<x>/OffNetwork/Counters/C201

Table 8.2.80.1: /<x>/OffNetwork/Counters/C201

OffNetwork/Counters/C201

Status	Occurrence	Format	Min. Access Types
Required	One	int	Get, Replace

This leaf node indicates the MCPTT counter for floor request as specified in 3GPP TS 24.380 [8].

- Values: 0-255

8.2.81 /<x>/OffNetwork/Counters/C204

Table 8.2.81.1: /<x>/OffNetwork/Counters/C204

OffNetwork/Counters/C204

Status	Occurrence	Format	Min. Access Types
Required	One	int	Get, Replace

This leaf node indicates the MCPTT counter for floor queue position request as specified in 3GPP TS 24.380 [8].

- Values: 0-255

8.2.82 /<x>/OffNetwork/Counters/C205

Table 8.2.82.1: /<x>/OffNetwork/Counters/C205

OffNetwork/Counters/C205

Status	Occurrence	Format	Min. Access Types
Required	One	int	Get, Replace

This leaf node indicates the MCPTT counter for floor granted request as specified in 3GPP TS 24.380 [8].

- Values: 0-255

9 MCDData UE configuration MO

9.1 General

The MCDData UE configuration Management Object (MO) is used to configure MCDData Client behaviour for the on-network or off-network MCDData Service. The MCDData UE configuration parameters may be stored in the ME, or in the USIM as specified in 3GPP TS 31.102 [10], or in both the ME and the USIM. If both the ME and the USIM contain the same parameters, the values stored in the USIM shall take precedence.

The Management Object Identifier is: urn:oma:mo:ext-3gpp-MCDData-UE-configuration:1.0.

Protocol compatibility: This MO is compatible with OMA OMA DM 1.2 [3].

The OMA DM ACL property mechanism (see OMA OMA-ERELD-DM-V1_2 [2]) may be used to grant or deny access rights to OMA DM servers in order to modify nodes and leaf objects of the MCDData UE configuration MO.

The following nodes and leaf objects are possible under the MCDData UE configuration node as described in figure 9.1.1 and figure 9.1.2:

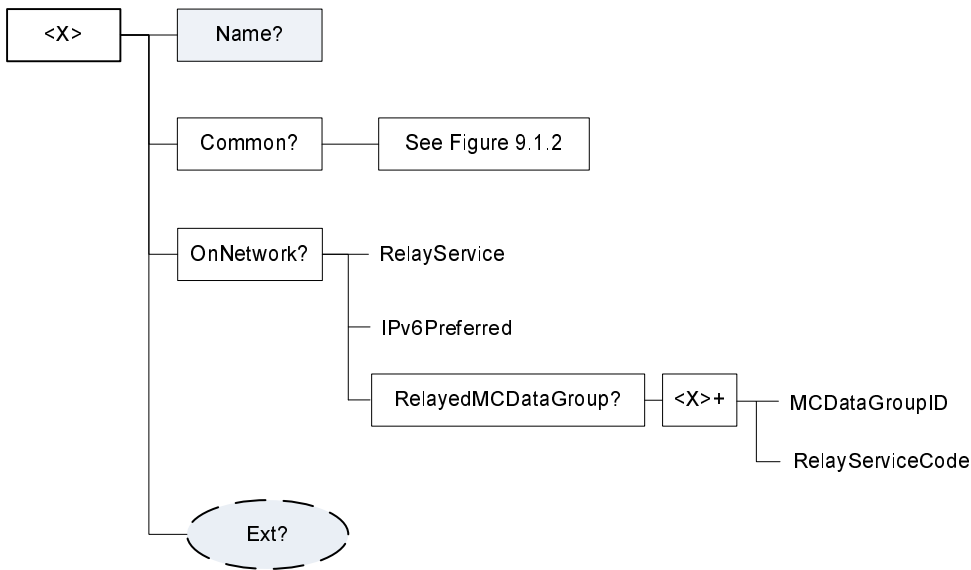

Figure 9.1.1: The MCDData UE configuration MO (1 of 2)



Figure 9.1.2: The MCDData UE configuration MO (2 of 2)

9.2 MCDData UE configuration MO parameters

9.2.1 General

This clause describes the parameters for the MCDData UE configuration Management Object (MO).

9.2.2 Node: <x>

Table 9.2.2.1: Node: <x>

<x>

Status	Occurrence	Format	Min. Access Types
Required	OneOrMore	node	Get

This interior node acts as a placeholder for the MCDData UE configuration Management Object (MO).

For the MCDData UE configuration MO, the namespace specific string is: "urn:oma:mo:oma-dm-mcdata-ue-configuration:1.0"

- Values: N/A

9.2.3 /<x>/Name

Table 9.2.3.1: /<x>/Name

Name

Status	Occurrence	Format	Min. Access Types
Required	ZeroOrOne	chr	Get

The Name leaf is a name for the MCDData UE configuration settings.

- Values: <User displayable name>

9.2.4 /<x>/Ext/

Table 9.2.4.1: /<x>/Ext/

Ext

Status	Occurrence	Format	Min. Access Types
Optional	ZeroOrOne	node	Get, Replace

The Ext is an interior node for where the vendor specific information about the MCDData UE configuration MO is being placed.

Usually the vendor extension is identified by vendor specific name under the ext node and contains the vendor meaning application vendor, device vendor etc. The tree structure under the vendor identified is not defined and can therefore include one or more un-standardized sub-trees.

- Values: N/A

9.2.5 /<x>/Common

Table 9.2.5.1: /<x>/Common

Common

Status	Occurrence	Format	Min. Access Types
Required	ZeroOrOne	node	Get, Replace

This interior node represents a container for the common network operation which means both on-network operation and off-network operation.

9.2.6 /<x>/Common/MCDDataGroupTxns

Table 9.2.6.1: /<x>/Common/MCDDataGroupTxns

Common/MCDDataGroupTxns

Status	Occurrence	Format	Min. Access Types

Required	One	node	Get, Replace
----------	-----	------	--------------

This interior node is a placeholder for the MCDData group transactions configuration.

9.2.7 `<x>/Common/MCDDataGroupTxns/MaxSDSNc4`

Table 9.2.7.1: `<x>/Common/MCDDataGroupTxns/MaxSDSNc4`

Common/MCDDataGroupTxns/MaxSDSNc4

Status	Occurrence	Format	Min. Access Types
Required	One	int	Get, Replace

This leaf node indicates the maximum number of simultaneous SDS transactions.

- Values: 0-255

9.2.8 `<x>/Common/MCDDataGroupTxns/SDSPresentationPriority`

Table 9.2.8.1: `<x>/Common/MCDDataGroupTxns/SDSPresentationPriority`

Common/MCDDataGroupTxns/SDSPresentationPriority

Status	Occurrence	Format	Min. Access Types
Required	ZeroOrOne	node	Get, Replace

This interior node is a placeholder for the prioritized MCDData SDS configuration.

9.2.9 `<x>/Common/MCDDataGroupTxns/SDSPresentationPriority/<x>`

Table 9.2.9.1: `<x>/Common/MCDDataGroupTxns/SDSPresentationPriority/<x>`

Common/MCDDataGroupTxns/SDSPresentationPriority/<x>

Status	Occurrence	Format	Min. Access Types
Required	OneOrMore	node	Get, Replace

This interior node is a placeholder for one or more prioritized MCDData SDS configuration.

9.2.10

`<x>/Common/MCDDataGroupTxns/SDSPresentationPriority/<x>/MCDDataGroupID`

Table 9.2.10.1: `<x>/Common/MCDDataGroupTxns/SDSPresentationPriority/<x>/MCDDataGroupID`

Common/MCDDataGroupTxns/SDSPresentationPriority/<x>/MCDDataGroupID

Status	Occurrence	Format	Min. Access Types
Required	One	chr	Get, Replace

This leaf node indicates the associated MCDData group ID.

The value is a "uri" attribute specified in OMA OMA-TS-XDM_Group-V1_1 [4].

9.2.11 `<x>/Common/MCDDataGroupTxns/SDSPresentationPriority/<x>/MCDDataGroupPriorityHierarchy`

Table 9.2.11.1:

`<x>/Common/MCDDataGroupTxns/SDSPresentationPriority/<x>/MCDDataGroupPriorityHierarchy`

Common/MCDDataGroupTxns/SDSPresentationPriority/<x>/MCDDataGroupPriorityHierarchy

Status	Occurrence	Format	Min. Access Types
--------	------------	--------	-------------------

Required	One	int	Get, Replace
----------	-----	-----	--------------

This leaf node indicates the requested presentation priority of SDS transactions.

- Values: 0-255

The group with the lowest MCDDataGroupPriorityHierarchy value shall be considered as the group having the lowest priority among the groups.

9.2.12 `<x>/Common/MCDDataGroupTxns/MaxFDNc4`

Table 9.2.12.1: `<x>/Common/MCDDataGroupTxns/MaxFDNc4`

Common/MCDDataGroupTxns/MaxFDNc4

Status	Occurrence	Format	Min. Access Types
Required	One	int	Get, Replace

This leaf node indicates the maximum number of simultaneous FD transactions.

- Values: 0-255

9.2.13 `<x>/Common/MCDDataGroupTxns/FDPresentationPriority`

Table 9.2.13.1: `<x>/Common/MCDDataGroupTxns/FDPresentationPriority`

Common/MCDDataGroupTxns/FDPresentationPriority

Status	Occurrence	Format	Min. Access Types
Required	ZeroOrOne	node	Get, Replace

This interior node is a placeholder for the prioritized MCDData FD configuration.

9.2.14 `<x>/Common/MCDDataGroupTxns/FDPresentationPriority/<x>`

Table 9.2.14.1: `<x>/Common/MCDDataGroupTxns/FDPresentationPriority/<x>`

Common/MCDDataGroupTxns/FDPresentationPriority `<x>`

Status	Occurrence	Format	Min. Access Types
Required	OneOrMore	node	Get, Replace

This interior node is a placeholder for one or more prioritized MCDData FD configuration.

9.2.15

`<x>/Common/MCDDataGroupTxns/FDPresentationPriority/<x>/MCDDataGroupID`

Table 9.2.15.1: `<x>/Common/MCDDataGroupTxns/FDPresentationPriority/<x>/MCDDataGroupID`

Common/MCDDataGroupTxns/FDPresentationPriority/`<x>`/MCDDataGroupID

Status	Occurrence	Format	Min. Access Types
Required	One	chr	Get, Replace

This leaf node indicates the associated MCDData group ID.

The value is a "uri" attribute specified in OMA OMA-TS-XDM_Group-V1_1 [4].

9.2.16 /<x>/Common/MCDataGroupTxns/FDPresentationPriority/ <x>/MCDataGroupPriorityHierarchy

Table 9.2.16.1:

/<x>/Common/MCDataGroupTxns/FDPresentationPriority/<x>/MCDataGroupPriorityHierarchy

Common/MCDataGroupTxns/FDPresentationPriority/<x>/MCDataGroupPriorityHierarchy

Status	Occurrence	Format	Min. Access Types
Required	One	int	Get, Replace

This leaf node indicates the requested presentation priority of FD transactions.

- Values: 0-255

The group with the lowest MCDataGroupPriorityHierarchy value shall be considered as the group having the lowest priority among the groups.

9.2.17 /<x>/Common/MCDataGroupTxns/ConversationPresentationPriority

Table 9.2.17.1: /<x>/Common/MCDataGroupTxns/ConversationPresentationPriority

Common/MCDataGroupTxns/ConversationPresentationPriority

Status	Occurrence	Format	Min. Access Types
Required	ZeroOrOne	node	Get, Replace

This interior node is a placeholder for the prioritized MCData conversation management configuration.

9.2.18

/<x>/Common/MCDataGroupTxns/ConversationPresentationPriority/ <X>

Table 9.2.18.1: /<x>/Common/MCDataGroupTxns/ConversationPresentationPriority/<x>

Common/MCDataGroupTxns/ConversationPresentationPriority /<x>

Status	Occurrence	Format	Min. Access Types
Required	OneOrMore	node	Get, Replace

This interior node is a placeholder for one or more prioritized MCData conversation management configuration.

9.2.19

/<x>/Common/MCDataGroupTxns/ConversationPresentationPriority/ <x>/MCDataGroupID

Table 9.2.19.1:

/<x>/Common/MCDataGroupTxns/ConversationPresentationPriority/<x>/MCDataGroupID

Common/MCDataGroupTxns/ConversationPresentationPriority/<x>/MCDataGroupID

Status	Occurrence	Format	Min. Access Types
Required	One	chr	Get, Replace

This leaf node indicates the associated MCData group ID.

The value is a "uri" attribute specified in OMA OMA-TS-XDM_Group-V1_1 [4].

9.2.20 /<x>/Common/MCDataGroupTxns/ ConversationPresentationPriority/<x>/MCDataGroupPriorityHierarchy

Table 9.2.20.1:

/<x>/Common/MCDataGroupTxns/ConversationPresentationPriority/<x>/MCDataGroupPriorityHierarchy

Common/MCDataGroupTxns/ConversationPresentationPriority/<x>/MCDataGroupPriorityHierarchy

Status	Occurrence	Format	Min. Access Types
Required	One	int	Get, Replace

This leaf node indicates the requested presentation priority of conversation management transactions.

- Values: 0-255

The group with the lowest MCDataGroupPriorityHierarchy value shall be considered as the group having the lowest priority among the groups.

9.2.21 /<x>/Common/MCDataGroupTxns/MaxTCNc4

Table 9.2.21.1: /<x>/Common/MCDataGroupTxns/MaxTCNc4

Common/MCDataGroupTxns/MaxTCNc4

Status	Occurrence	Format	Min. Access Types
Required	One	int	Get, Replace

This leaf node indicates the maximum number of simultaneous data transmissions.

- Values: 0-255

9.2.22 /<x>/Common/MCDataGroupTxns/MaxTCNc5

Table 9.2.22.1: /<x>/Common/MCDataGroupTxns/MaxTCNc5

Common/MCDataGroupTxns/MaxTCN5

Status	Occurrence	Format	Min. Access Types
Required	One	int	Get, Replace

This leaf node indicates the maximum number of data transmissions in a group.

- Values: 0-255

9.2.23 /<x>/Common/MCDataGroupTxns/DataPresentationPriority

Table 9.2.23.1: /<x>/Common/MCDataGroupTxns/DataPresentationPriority

Common/MCDataGroupTxns/DataPresentationPriority

Status	Occurrence	Format	Min. Access Types
Required	ZeroOrOne	node	Get, Replace

This interior node is a placeholder for the prioritized MCData Transmission Control configuration.

9.2.24 /<x>/Common/MCDataGroupTxns/DataPresentationPriority/<x>

Table 9.2.24.1: /<x>/Common/MCDataGroupTxns/DataPresentationPriority/<x>

Common/MCDataGroupTxns/DataPresentationPriority/<x>

Status	Occurrence	Format	Min. Access Types
Required	OneOrMore	node	Get, Replace

This interior node is a placeholder for one or more prioritized MCDData Transmission Control configuration.

9.2.25

`<x>/Common/MCDDataGroupTxns/DataPresentationPriority/<x>/MCDDataGroupID`

Table 9.2.25.1: `<x>/Common/MCDDataGroupTxns/DataPresentationPriority/<x>/MCDDataGroupID`

Common/MCDDataGroupTxns/DataPresentationPriority/<x>/MCDDataGroupID

Status	Occurrence	Format	Min. Access Types
Required	One	chr	Get, Replace

This leaf node indicates the associated MCDData group ID.

The value is a "uri" attribute specified in OMA OMA-TS-XDM_Group-V1_1 [4].

9.2.26 `<x>/Common/MCDDataGroupTxns/DataPresentationPriority/<x>/MCDDataGroupPriorityHierarchy`

Table 9.2.26.1:

`<x>/Common/MCDDataGroupTxns/DataPresentationPriority/<x>/MCDDataGroupPriorityHierarchy`

Common/MCDDataGroupTxns/DataPresentationPriority/<x>/MCDDataGroupPriorityHierarchy

Status	Occurrence	Format	Min. Access Types
Required	One	int	Get, Replace

This leaf node indicates the requested presentation priority of data received.

- Values: 0-255

The group with the lowest MCDDataGroupPriorityHierarchy value shall be considered as the group having the lowest priority among the groups.

9.2.27 `<x>/Common/MCDDataGroupTxns/MaxRCNc4`

Table 9.2.27.1: `<x>/Common/MCDDataGroupTxns/MaxRCNc4`

Common/MCDDataGroupTxns/MaxRCNc4

Status	Occurrence	Format	Min. Access Types
Required	One	int	Get, Replace

This leaf node indicates the maximum number of simultaneous data receptions.

- Values: 0-255

9.2.28 `<x>/Common/MCDDataGroupTxns/MaxRCNc5`

Table 9.2.28.1: `<x>/Common/MCDDataGroupTxns/MaxRCNc5`

Common/MCDDataGroupTxns/MaxRCN5

Status	Occurrence	Format	Min. Access Types
Required	One	int	Get, Replace

This leaf node indicates the maximum number of data receptions in a group.

- Values: 0-255

9.2.29 /<x>/OnNetwork

Table 9.2.29.1: /<x>/OnNetwork

OnNetwork

Status	Occurrence	Format	Min. Access Types
Required	ZeroOrOne	node	Get, Replace

This interior node represents a container for on-network operation.

9.2.30 /<x>/OnNetwork/RelayService

Table 9.2.30.1: /<x>/OnNetwork/RelayService

OnNetwork/RelayService

Status	Occurrence	Format	Min. Access Types
Required	One	bool	Get, Replace

This leaf node indicates the authorisation to use a relay service.

When set to "true" the MCDData group is allowed to use a relay service.

When set to "false" the MCDData group is not allowed to use a relay service.

9.2.31 /<x>/OnNetwork/IPv6Preferred

Table 9.2.31.1: /<x>/OnNetwork/IPv6Preferred

OnNetwork/IPv6Preferred

Status	Occurrence	Format	Min. Access Types
Required	One	bool	Get, Replace

This leaf node indicates whether IPv6 is preferred over IPv4 for on-network operation when the MCDData UE has both IPv4 and IPv6 host configuration.

If the MCDData UE has both IPv4 and IPv6 host configuration and:

- if IPv6Preferred is set to "true" then the UE uses IPv6 for all on-network signalling and media; otherwise
- if IPv6Preferred is set to "false" then the UE uses IPv4 for all on-network signalling and media.

9.2.32 /<x>/OnNetwork/RelayedMCDDataGroup

Table 9.2.32.1: /<x>/OnNetwork/RelayedMCDDataGroup

OnNetwork/RelayedMCDDataGroup

Status	Occurrence	Format	Min. Access Types
Optional	ZeroOrOne	node	Get, Replace

This interior node is a placeholder for the allowed relayed MCDData groups.

9.2.33 /<x>/OnNetwork/RelayedMCDDataGroup/<x>

Table 9.2.33.1: /<x>/OnNetwork/RelayedMCDDataGroup/<x>

OnNetwork/RelayedMCDDataGroup/<x>

Status	Occurrence	Format	Min. Access Types
Required	OneOrMore	node	Get, Replace

This interior node is a placeholder for one or more allowed relayed MCDData groups.

9.2.34 /<x>/OnNetwork/RelayedMCDDataGroup/<x>/MCDDataGroupID

Table 9.2.34.1: /<x>/OnNetwork/RelayedMCDDataGroup/<x>/MCDDataGroupID

OnNetwork/RelayedMCDDataGroup/<x>/MCDDataGroupID

Status	Occurrence	Format	Min. Access Types
Required	One	chr	Get, Replace

This leaf node indicates the associated MCDData group ID.

The value is a "uri" attribute specified in OMA OMA-TS-XDM_Group-V1_1 [4].

9.2.35 /<x>/OnNetwork/RelayedMCDDataGroup/<x>/RelayServiceCode

Table 9.2.35.1: /<x>/OnNetwork/RelayedMCDDataGroup/<x>/RelayServiceCode

OnNetwork/RelayedMCDDataGroup/<x>/RelayServiceCode

Status	Occurrence	Format	Min. Access Types
Required	One	chr	Get, Replace

This leaf node indicates the connectivity service that the ProSe UE-to-network relay provides to public safety applications as specified in 3GPP TS 23.303 [6].

10 MCDData user profile MO

10.1 General

The MCDData user profile configuration Management Object (MO) is used to configure the MCDData Client behaviour for the on-network or off-network MCDData Service. The MCDData user profile configuration parameters may be stored in the ME, or in the USIM as specified in 3GPP TS 31.102 [10], or in both the ME and the USIM. If both the ME and the USIM contain the same parameters, the values stored in the USIM shall take precedence.

The Management Object Identifier is: urn:oma:mo:ext-3gpp-MCDData-user-profile:1.0.

Protocol compatibility: This MO is compatible with OMA OMA DM 1.2 [3].

The OMA DM ACL property mechanism (see OMA OMA-ERELED-DM-V1_2 [2]) may be used to grant or deny access rights to OMA DM servers in order to modify nodes and leaf objects of the MCDData user profile MO.

The following nodes and leaf objects are possible under the MCDData user profile node as described in figures 10.1.1, through 10.1.3, and figure 10.1.4:

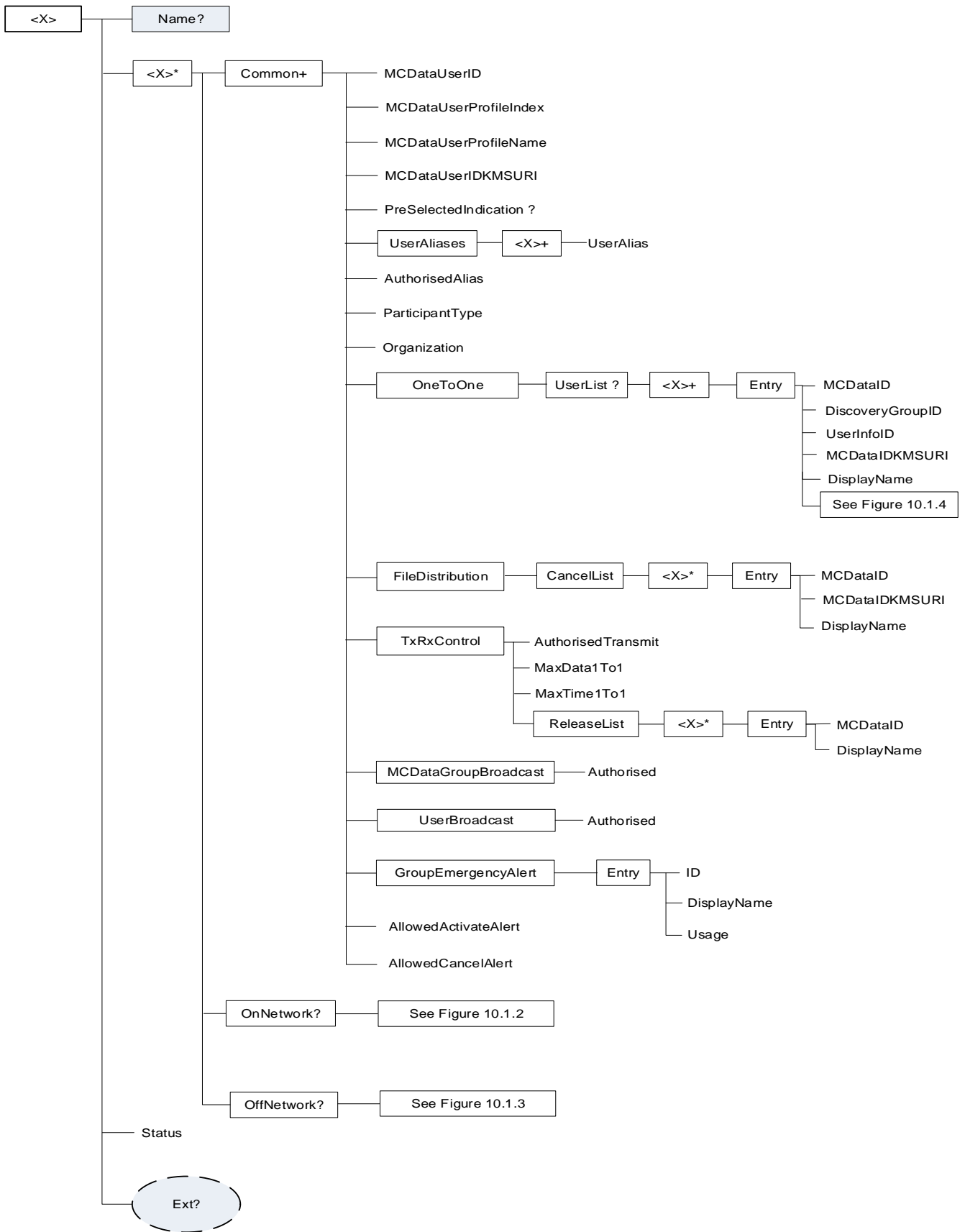

Figure 10.1.1: The MCDATA user profile MO (1 of 4)

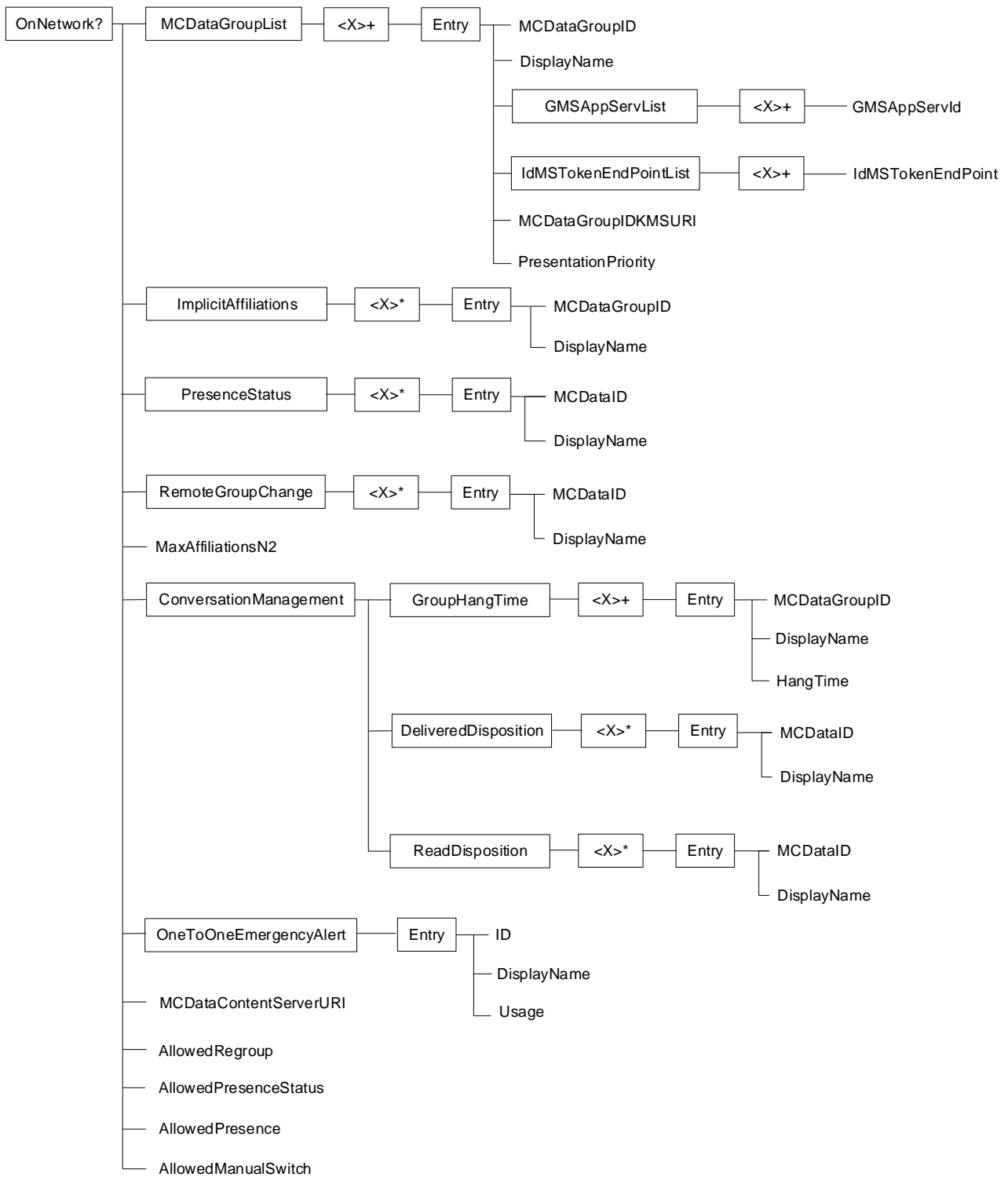

Figure 10.1.2: The MCDATA user profile MO (2 of 4)

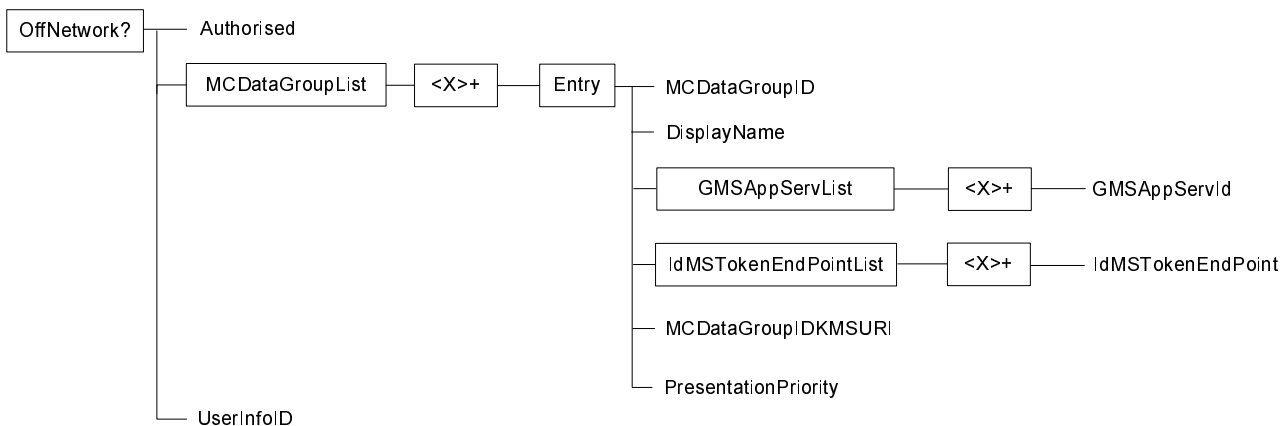

Figure 10.1.3: The MCDATA user profile MO (3 of 4)

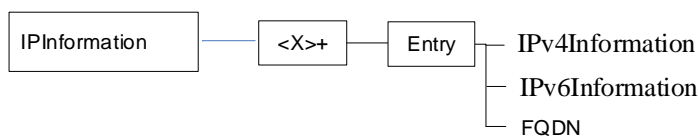

Figure 10.1.4: The MCDATA user profile MO (4 of 4)

10.2 MCDATA user profile MO parameters

10.2.1 General

This clause describes the parameters for the MCDATA user profile Management Object (MO).

10.2.2 Node: <x>

Table 10.2.2.1: Node: <x>

<x>

Status	Occurrence	Format	Min. Access Types
Required	OneOrMore	node	Get

This interior node acts as a placeholder for the MCDATA user profile Management Object (MO).

For the MCDATA user profile MO, the namespace specific string is: "urn:oma:mo:oma-dm-mcdata-user-profile:1.0"

- Values: N/A

10.2.3 /<x>/Name

Table 10.2.3.1: /<x>/Name

Name

Status	Occurrence	Format	Min. Access Types
Required	ZeroOrOne	chr	Get

The Name leaf is a name for the MCDData user profile settings.

- Values: <User displayable name>

10.2.4 /<x>/Ext/

Table 10.2.4.1: /<x>/Ext/

Ext

Status	Occurrence	Format	Min. Access Types
Optional	ZeroOrOne	node	Get, Replace

The Ext is an interior node for where the vendor specific information about the MCDData user profile MO is being placed.

Usually the vendor extension is identified by vendor specific name under the ext node and contains the vendor meaning application vendor, device vendor etc. The tree structure under the vendor identified is not defined and can therefore include one or more un-standardized sub-trees.

- Values: N/A

10.2.5 /<x>/<x>

Table 10.2.5.1: /<x>/<x>

<x>

Status	Occurrence	Format	Min. Access Types
Required	OneOrMore	node	Get, Replace

This interior node represents a container for on-network operation and off-network operation.

10.2.6 /<x>/<x>/Common

Table 10.2.6.1: /<x>/<x>/Common

<x>/Common

Status	Occurrence	Format	Min. Access Types
Required	OneOrMore	node	Get, Replace

This interior node represents a container for the common network operation which means both on-network operation and off-network operation.

10.2.7 /<x>/<x>/Common/MCDDataUserID

Table 10.2.7.1: /<x>/<x>/Common/MCDDataUserID

<x>/Common/MCDDataUserID

Status	Occurrence	Format	Min. Access Types
Required	One	chr	Get, Replace

This leaf node indicates an MCDData user identity (MCDData ID) which is a globally unique identifier within the MCDData service that represents the MCDData user.

10.2.8 /<x>/<x>/Common/MCDataUserProfileIndex

Table 10.2.8.1: /<x>/<x>/Common/MCDataUserProfileIndex

<x>/Common/MCDataUserProfileIndex

Status	Occurrence	Format	Min. Access Types
Required	One	int	Get, Replace

This leaf node indicates an index for the particular MCData user profile.

- Values: 0-255

10.2.9 /<x>/<x>/Common/MCDataUserProfileName

Table 10.2.9.1: /<x>/<x>/Common/MCDataUserProfileName

<x>/Common/MCDataUserProfileName

Status	Occurrence	Format	Min. Access Types
Optional	One	chr	Get, Replace

This leaf node indicates a profile name for the particular MCData user profile.

10.2.9A /<x>/<x>/Common/MCDataUserIDKMSURI

Table 10.2.9A.1: /<x>/<x>/Common/MCDataUserIDKMSURI

<x>/Common/MCDataUserIDKMSURI

Status	Occurrence	Format	Min. Access Types
Optional	One	chr	Get, Replace

This leaf node indicates key management server URI for the security domain of the MCData user.

The value is a URI as specified in 3GPP TS 23.003 [5].

10.2.10 /<x>/<x>/Common/PreSelectedIndication

Table 10.2.10.1: /<x>/<x>/Common/PreSelectedIndication

<x>/Common/PreSelectedIndication

Status	Occurrence	Format	Min. Access Types
Optional	ZeroOrOne	null	Get, Replace

This leaf node indicates that this MCData user profile MO is designated to be the pre-selected MCData user profile as defined by 3GPP TS 23.179 [15]

- Values: null

When this leaf node is present, this MCData user profile MO is designated as the pre-selected MCData user profile.

When this leaf node is absent, this MCData user profile MO is not designated as the pre-selected MCData user profile.

If more than one MCData user profile MO is specified for the MCData user, then only one MCData user profile MO for the MCData user shall contain the <x>/Common/PreSelectedIndication leaf node.

If there is only one MCData user profile MO specified for the MCData user, then it is optional to include the <x>/Common/PreSelectedIndication leaf node.

10.2.11 /<x>/<x>/Common/UserAliases

Table 10.2.11.1: /<x>/<x>/Common/UserAliases

<x>/Common/UserAliases

Status	Occurrence	Format	Min. Access Types
Required	One	node	Get, Replace

This interior node is a placeholder for a list of aliases of an MCDData user.

10.2.12 /<x>/<x>/Common/UserAliases/<x>

Table 10.2.12.1: /<x>/<x>/Common/UserAliases/<x>

<x>/Common/UserAliases/<x>

Status	Occurrence	Format	Min. Access Types
Required	OneOrMore	node	Get, Replace

This interior node is a placeholder for one or more aliases of an MCDData user.

10.2.13 /<x>/<x>/Common/UserAliases/<x>UserAlias

Table 10.2.13.1: /<x>/<x>/Common/UserAliases/<x>/UserAlias

<x>/Common/UserAliases/<x>/UserAlias

Status	Occurrence	Format	Min. Access Types
Required	One	chr	Get, Replace

This leaf node indicates an alphanumeric alias of the MCDData user.

10.2.14 /<x>/<x>/Common/AuthorisedAlias

Table 10.2.14.1: /<x>/<x>/Common/AuthorisedAlias

<x>/Common/AuthorisedAlias

Status	Occurrence	Format	Min. Access Types
Optional	One	bool	Get, Replace

This leaf node indicates authorisation to create and delete aliases of other MCDData users and their associated MCDData user profiles.

When set to "true" the MCDData user is authorised to create and delete aliases of other MCDData users and their associated MCDData user profiles.

When set to "false" the MCDData user is not authorised to create and delete aliases of other MCDData user and their associated MCDData user profiles. This is the default if this leaf node is not present.

10.2.15 /<x>/<x>/Common/ParticipantType

Table 10.2.15.1: /<x>/<x>/Common/ParticipantType

<x>/Common/ParticipantType

Status	Occurrence	Format	Min. Access Types
Required	One	chr	Get, Replace

This leaf node indicates the participant type of the MCDData user.

The ParticipantType means the functional category of the participant (e.g., first responder, second responder, dispatch, dispatch supervisor), typically defined by the MCDData administrators.

10.2.16 /<x>/<x>/Common/Organization

Table 10.2.16.1: /<x>/<x>/Common/Organization

<x>/Common/Organization

Status	Occurrence	Format	Min. Access Types
Required	One	chr	Get, Replace

This leaf node indicates the organization an MCDData user belongs to.

10.2.16A/<x>/<x>/Common/OnetoOne

Table 10.2.16A.1: /<x>/<x>/Common/OnetoOne

<x>/Common/OnetoOne

Status	Occurrence	Format	Min. Access Types
Required	One	node	Get, Replace

This interior node is a placeholder for the MCDData on-network or off-network one-to-one communication configuration.

10.2.16B/<x>/<x>/Common/OnetoOne/UserList

Table 10.2.16B.1: /<x>/<x>/Common/OnetoOne/UserList

<x>/Common/OnetoOne/UserList

Status	Occurrence	Format	Min. Access Types
Required	One	node	Get, Replace

This interior node is a placeholder for a list of MCDData users who can be involved in an on-network or off-network MCDData one-to-one transaction.

10.2.16C /<x>/<x>/Common/OnetoOne/UserList/<x>

Table 10.2.16C.1: /<x>/<x>/Common/OnetoOne/UserList/<x>

<x>/Common/OnetoOne/UserList/<x>

Status	Occurrence	Format	Min. Access Types
Optional	OneOrMore	node	Get, Replace

This interior node is a placeholder for one or more list of MCDData users who can be involved in an on-network or off-network MCDData one-to-one transaction.

10.2.16D /<x>/<x>/Common/OnetoOne/UserList/<x>/Entry

Table 10.2.16D.1: /<x>/<x>/Common/OnetoOne/UserList/<x>/Entry

<x>/Common/OnetoOne/UserList/<x>/Entry

Status	Occurrence	Format	Min. Access Types
Required	One	node	Get, Replace

This interior node is a placeholder for one or more MCDData users who can be involved in an on-network or off-network MCDData one-to-one transaction.

10.2.16E /<x>/<x>/Common/OnetoOne/UserList/<x>/Entry/MCDataID

Table 10.2.16E.1: /<x>/<x>/Common/OnetoOne/UserList/<x>/Entry/MCDataID

<x>/Common/OnetoOne/UserList/<x>/Entry/MCDataID

Status	Occurrence	Format	Min. Access Types
Optional	One	chr	Get, Replace

This leaf node indicates an MCData user identity (MCData ID) which is a globally unique identifier within the MCData service that represents the MCData user.

The value is a "uri" attribute specified in OMA OMA-TS-XDM_Group-V1_1 [4].

10.2.16F /<x>/<x>/Common/OnetoOne/UserList/<x>/Entry/DiscoveryGroupID

Table 10.2.16F.1: /<x>/<x>/Common/OnetoOne/UserList/<x>/Entry/DiscoveryGroupID

<x>/Common/OnetoOne/UserList/<x>/Entry/DiscoveryGroupID

Status	Occurrence	Format	Min. Access Types
Optional	One	int	Get, Replace

This leaf node indicates a discovery group ID as specified in 3GPP TS 23.303 [6].

The value is used as the discovery group ID in the ProSe discovery procedures as specified in 3GPP TS 23.303 [6].

10.2.16G /<x>/<x>/Common/OnetoOne/UserList/<x>/Entry/UserInfoID

Table 10.2.16G.1: /<x>/<x>/Common/OnetoOne/UserList/<x>/Entry/UserInfoID

<x>/Common/OnetoOne/UserList/<x>/Entry/UserInfoID

Status	Occurrence	Format	Min. Access Types
Optional	One	int	Get, Replace

This leaf node indicates a ProSe user info ID as specified in 3GPP TS 23.303 [6].

10.2.16H

/<x>/<x>/Common/OnetoOne/UserList/<x>/Entry/MCDataIDKMSUR
|

Table 10.2.16H.1: /<x>/<x>/Common/OnetoOne/UserList/<x>/Entry/MCDataUserIDKMSURI

<x>/Common/OnetoOne/UserList/<x>/Entry/MCDataUserIDKMSURI

Status	Occurrence	Format	Min. Access Types
Optional	One	chr	Get, Replace

This leaf node indicates key management server URI for the security domain of the MCData user of an MCData user that the configured MCData user is authorised to initiate a one-to-one communication with.

The value is a URI as specified in 3GPP TS 23.003 [5].

10.2.16I /<x>/<x>/Common/OnetoOne/UserList/<x>/Entry/DisplayName

Table 10.2.16I.1: /<x>/<x>/Common/OnetoOne/UserList/<x>/Entry/DisplayName

<x>/Common/OnetoOne/UserList/<x>/Entry/DisplayName

Status	Occurrence	Format	Min. Access Types
Optional	One	chr	Get, Replace

This leaf node contains a human readable name.

10.2.16J /<x>/<x>/Common/OnetoOne/UserList/<x>/Entry/IPInformation

Table 10.2.16J.1: /<x>/<x>/Common/OnetoOne/UserList/<x>/Entry/IPInformation

<x>/Common/OnetoOne/UserList/<x>/Entry/IPInformation

Status	Occurrence	Format	Min. Access Types
Optional	One	node	Get, Replace

This interior node is a placeholder for one or more list of IPInformation data that can be used in the setup of an IP Connectivity session for a specific MCDData user in a one-to-one communication.

10.2.16K /<x>/<x>/Common/OnetoOne/UserList/<x>/Entry/IPInformation/<x>

Table 10.2.16K.1: /<x>/<x>/Common/OnetoOne/UserList/<x>/Entry/IPInformation/<x>

<x>/Common/OnetoOne/UserList/<x>/Entry/IPInformation/<x>

Status	Occurrence	Format	Min. Access Types
Optional	OneOrMore	node	Get, Replace

This interior node is a placeholder for one or more list of IPInformation data that can be used in the setup of an IP Connectivity session for a specific MCDData user in a one-to-one communication.

10.2.16L

/<x>/<x>/Common/OnetoOne/UserList/<x>/Entry/IPInformation/<x>
Entry

Table 10.2.16L.1: /<x>/<x>/Common/OnetoOne/UserList/<x>/Entry/IPInformation/<x>/Entry

<x>/Common/OnetoOne/UserList/<x>/Entry/IPInformation/<x>/Entry

Status	Occurrence	Format	Min. Access Types
Required	One	node	Get, Replace

This interior node is a placeholder for one or more list of IPInformation data that can be used in the setup of an IP Connectivity session for a specific MCDData user in a one-to-one communication.

10.2.16M

/<x>/<x>/Common/OnetoOne/UserList/<x>/Entry/IPInformation/<x>
Entry/IPv4Information

Table 10.2.16M.1:

/<x>/<x>/Common/OnetoOne/UserList/<x>/Entry/IPInformation/<x>/Entry/IPv4Information

<x>/Common/OnetoOne/UserList/<x>/Entry/IPInformation/<x>/Entry/IPv4Information

Status	Occurrence	Format	Min. Access Types
Optional	One	chr	Get, Replace

This leaf node indicates an IPv4 host address or an IPv4 network that can be addressed on an IP Connectivity session in a one-to-one communication for a specific MCDData ID.

10.2.16N

**/<x>/<x>/Common/OnetoOne/UserList/<x>/Entry/IPInformation/<x>
Entry/IPv6Information**

Table 10.2.16N.1:

/<x>/<x>/Common/OnetoOne/UserList/<x>/Entry/IPInformation/<x>/Entry/IPv6Information

<x>/Common/OnetoOne/UserList/<x>/Entry/IPInformation/<x>/Entry/IPv6Information

Status	Occurrence	Format	Min. Access Types
Optional	One	chr	Get, Replace

This leaf node indicates an IPv6 host address or an IPv6 network that can be addressed on an IP Connectivity session in a one-to-one communication for a specific MCDData ID.

10.2.16O

**/<x>/<x>/Common/OnetoOne/UserList/<x>/Entry/IPInformation/<x>
Entry/FQDN**

Table 10.2.16O.1: /<x>/<x>/Common/OnetoOne/UserList/<x>/Entry/IPInformation/<x>/Entry/FQDN

<x>/Common/OnetoOne/UserList/<x>/Entry/IPInformation/<x>/Entry/FQDN

Status	Occurrence	Format	Min. Access Types
Optional	One	chr	Get, Replace

This leaf node indicates a fully qualified domain name for a specific host or domain that can be addressed on an IP Connectivity session in a one-to-one communication for a specific MCDData ID.

10.2.17 /<x>/<x>/Common/FileDistribution

Table 10.2.17.1: /<x>/<x>/Common/FileDistribution

<x>/Common/FileDistribution

Status	Occurrence	Format	Min. Access Types
Required	One	node	Get, Replace

This interior node is a placeholder for the MCDData file distribution configuration.

10.2.18 /<x>/<x>/Common/FileDistribution/CancelList

Table 10.2.18.1: /<x>/<x>/Common/FileDistribution/CancelList

<x>/Common/FileDistribution/CancelList

Status	Occurrence	Format	Min. Access Types
Required	One	node	Get, Replace

This interior node is a placeholder for a list of MCDData user(s) this MCDData user is allowed to cancel distribution of files beings sent or waiting to be sent.

10.2.19 /<x>/<x>/Common/FileDistribution/CancelList/<x>

Table 10.2.19.1: /<x>/<x>/Common/FileDistribution/CancelList/<x>

<x>/Common/FileDistribution/CancelList/<x>

Status	Occurrence	Format	Min. Access Types
Optional	ZeroOrMore	node	Get, Replace

This interior node is a placeholder for zero or more list of MCDData users this MCDData user is allowed to cancel distribution of files beings sent or waiting to be sent.

10.2.20 /<x>/<x>/Common/FileDistribution/CancelList/<x>/Entry

Table 10.2.20.1: /<x>/<x>/Common/FileDistribution/CancelList/<x>/Entry

<x>/Common/FileDistribution/CancelList/<x>/Entry

Status	Occurrence	Format	Min. Access Types
Required	One	node	Get, Replace

This interior node is a placeholder for one or more MCDData users this MCDData user is allowed to cancel distribution of files beings sent or waiting to be sent.

10.2.21 /<x>/<x>/Common/FileDistribution/CancelList/<x>/Entry/MCDDataID

Table 10.2.21.1: /<x>/<x>/Common/FileDistribution/CancelList/<x>/Entry/MCDDataID

<x>/Common/FileDistribution/CancelList/<x>/Entry/MCDDataID

Status	Occurrence	Format	Min. Access Types
Optional	One	chr	Get, Replace

This leaf node indicates an MCDData user identity (MCDData ID) which is a globally unique identifier within the MCDData service that represents the MCDData user.

The value is a "uri" attribute specified in OMA OMA-TS-XDM_Group-V1_1 [4].

10.2.21A

/<x>/<x>/Common/FileDistribution/CancelList/<x>/Entry/MCDDataIDKMSURI

Table 10.2.21A.1: /<x>/<x>/Common/FileDistribution/CancelList/<x>/Entry/MCDDataIDKMSURI

<x>/Common/FileDistribution/CancelList/<x>/Entry/MCDDataIDKMSURI

Status	Occurrence	Format	Min. Access Types
Optional	One	chr	Get, Replace

This leaf node indicates key management server URI for the security domain of the MCDData user of an MCDData user that the configured MCDData user is authorised to cancel distribution of files being sent or waiting to be sent.

The value is a URI as specified in 3GPP TS 23.003 [5].

10.2.22

/<x>/<x>/Common/FileDistribution/CancelList/<x>/Entry/DisplayName

Table 10.2.22.1: /<x>/<x>/ Common/FileDistribution/CancelList/<x>/Entry/DisplayName

<x>/Common/FileDistribution/CancelList/<x>/Entry/DisplayName

Status	Occurrence	Format	Min. Access Types

Optional	One	chr	Get, Replace
----------	-----	-----	--------------

This leaf node contains a human readable name.

10.2.23 /<x>/<x>/Common/TxRxControl

Table 10.2.23.1: /<x>/<x>/Common/TxRxControl

<x>/Common/TxRxControl

Status	Occurrence	Format	Min. Access Types
Required	One	node	Get, Replace

This interior node is a placeholder for the MCDData transmission and reception control configuration.

10.2.24 /<x>/<x>/Common/TxRxControl/AuthorisedTransmit

Table 10.2.24.1: /<x>/<x>/Common/TxRxControl/AuthorisedTransmit

<x>/Common/TxRxControl/AuthorisedTransmit

Status	Occurrence	Format	Min. Access Types
Required	One	bool	Get, Replace

This leaf node indicates the authorisation to transmit data.

When set to "true" the MCDData user is authorised to transmit data.

When set to "false" the MCDData user is not authorised to transmit data.

10.2.25 /<x>/<x>/Common/TxRxControl/MaxData1To1

Table 10.2.25.1: /<x>/<x>/Common/TxRxControl/MaxData1To1

<x>/Common/TxRxControl/MaxData1To1

Status	Occurrence	Format	Min. Access Types
Required	One	int	Get, Replace

This leaf node indicates the maximum amount of data (in megabytes) that an MCDData user can transmit in a single request during one-to-one communication.

- Values: 0-65535

The MaxData1to1 size is in megabytes..

10.2.26 /<x>/<x>/Common/TxRxControl/MaxTime1To1

Table 10.2.26.1: /<x>/<x>/Common/TxRxControl/MaxTime1To1

<x>/Common/TxRxControl/MaxTime1To1

Status	Occurrence	Format	Min. Access Types
Required	One	int	Get, Replace

This leaf node indicates the maximum amount of time that an MCDData user can transmit for in a single request during one-to-one communication.

- Values: 0-65535

The MaxTime1To1 time is in seconds.

10.2.27 /<x>/<x>/Common/TxRxControl/ReleaseList

Table 10.2.27.1: /<x>/<x>/Common/TxRxControl/ReleaseList

<x>/Common/TxRxControl/ReleaseList

Status	Occurrence	Format	Min. Access Types
Required	One	node	Get, Replace

This interior node is a placeholder for a list of MCDData users that this MCDData user is allowed to request release of an ongoing transmission.

10.2.28 /<x>/<x>/Common/TxRxControl/ReleaseList/<x>

Table 10.2.28.1: /<x>/<x>/Common/TxRxControl/ReleaseList/<x>

<x>/Common/TxRxControl/ReleaseList/<x>

Status	Occurrence	Format	Min. Access Types
Optional	ZeroOrMore	node	Get, Replace

This interior node is a placeholder for zero or more list of MCDData users this MCDData user is allowed to request release of an ongoing transmission.

10.2.29 /<x>/<x>/Common/TxRxControl/ReleaseList/<x>/Entry

Table 10.2.29.1: /<x>/<x>/Common/TxRxControl/ReleaseList/<x>/Entry

<x>/Common/TxRxControl/ReleaseList/<x>/Entry

Status	Occurrence	Format	Min. Access Types
Required	One	node	Get, Replace

This interior node is a placeholder for one or more MCDData users this MCDData user is allowed to request release of an ongoing transmission.

10.2.30 /<x>/<x>/Common/TxRxControl/ReleaseList/<x>/Entry/MCDDataID

Table 10.2.30.1: /<x>/<x>/Common/TxRxControl/ReleaseList/<x>/Entry/MCDDataID

<x>/Common/TxRxControl/ReleaseList/<x>/Entry/MCDDataID

Status	Occurrence	Format	Min. Access Types
Optional	One	chr	Get, Replace

This leaf node indicates an MCDData user identity (MCDData ID) which is a globally unique identifier within the MCDData service that represents the MCDData user.

The value is a "uri" attribute specified in OMA OMA-TS-XDM_Group-V1_1 [4].

10.2.31 /<x>/<x>/Common/TxRxControl/ReleaseList/<x>/Entry/DisplayName

Table 10.2.31.1: /<x>/<x>/ Common/TxRxControl/ReleaseList/<x>/Entry/DisplayName

<x>/Common/TxRxControl/ReleaseList/<x>/Entry/DisplayName

Status	Occurrence	Format	Min. Access Types
Optional	One	chr	Get, Replace

This leaf node contains a human readable name.

10.2.32 /<x>/<x>/Common/MCDataGroupBroadcast

Table 10.2.32.1: /<x>/<x>/Common/MCDataGroupBroadcast

<x>/Common/MCDataGroupBroadcast

Status	Occurrence	Format	Min. Access Types
Required	One	node	Get, Replace

This interior node is a placeholder for the group-broadcast group policy.

10.2.33 /<x>/<x>/Common/MCDataGroupBroadcast/Authorised

Table 10.2.33.1: /<x>/<x>/Common/MCDataGroupBroadcast/Authorised

<x>/Common/MCDataGroupBroadcast/Authorised

Status	Occurrence	Format	Min. Access Types
Required	One	bool	Get, Replace

This leaf node indicates the authorisation to create a group-broadcast group.

When set to "true" the MCData user is authorised to create a group-broadcast group.

When set to "false" the MCData user is not authorised to create a group-broadcast group.

10.2.34 /<x>/<x>/Common/UserBroadcast

Table 10.2.34.1: /<x>/<x>/Common/UserBroadcast

<x>/Common/UserBroadcast

Status	Occurrence	Format	Min. Access Types
Required	One	node	Get, Replace

This interior node is a placeholder for the user-broadcast group policy.

10.2.35 /<x>/<x>/Common/UserBroadcast/Authorised

Table 10.2.35.1: /<x>/<x>/Common/UserBroadcast/Authorised

<x>/Common/UserBroadcast/Authorised

Status	Occurrence	Format	Min. Access Types
Required	One	bool	Get, Replace

This leaf node indicates the authorisation to create a user-broadcast group.

When set to "true" the MCData user is authorised to create a user-broadcast group.

When set to "false" the MCData user is not authorised to create a user-broadcast group.

10.2.36 /<x>/<x>/Common/GroupEmergencyAlert

Table 10.2.36.1: /<x>/<x>/Common/GroupEmergencyAlert

<x>/Common/GroupEmergencyAlert

Status	Occurrence	Format	Min. Access Types
Required	One	node	Get, Replace

This interior node is a placeholder for Group Emergency Alert configuration.

10.2.37 /<x>/<x>/Common/GroupEmergencyAlert/Entry

Table 10.2.37.1: /<x>/<x>/Common/GroupEmergencyAlert/Entry

<x>/Common/GroupEmergencyAlert/Entry

Status	Occurrence	Format	Min. Access Types
Required	One	node	Get, Replace

This interior node is a placeholder for the details of the MCDData group of an MCDData emergency alert.

10.2.38 /<x>/<x>/Common/GroupEmergencyAlert/Entry/ID

Table 10.2.38.1: /<x>/<x>/Common/GroupEmergencyAlert/Entry/ID

<x>/Common/GroupEmergencyAlert/Entry/ID

Status	Occurrence	Format	Min. Access Types
Required	One	chr	Get, Replace

This leaf node indicates the MCDData group used upon certain criteria on initiation of an MCDData emergency alert.

10.2.39 /<x>/<x>/Common/GroupEmergencyAlert/Entry/DisplayName

Table 10.2.39.1: /<x>/<x>/Common/GroupEmergencyAlert/Entry/DisplayName

<x>/Common/GroupEmergencyAlert/Entry/DisplayName

Status	Occurrence	Format	Min. Access Types
Optional	One	chr	Get, Replace

This leaf node contains a human readable name that corresponds to the ID.

10.2.40 /<x>/<x>/Common/GroupEmergencyAlert/Entry/Usage

Table 10.2.40.1: /<x>/<x>/Common/GroupEmergencyAlert/Entry/Usage

<x>/Common/GroupEmergencyAlert/Entry/Usage

Status	Occurrence	Format	Min. Access Types
Required	One	chr	Get, Replace

This leaf node indicates the criteria to determine when initiation of an MCDData emergency alert uses the ID.

The valid values are 'UseCurrentlySelectedGroup' and 'DedicatedGroup'.

When set to 'UseCurrentlySelectedGroup' then if the MCDData user has currently selected an MCDData group then use that MCDData group for an on-network MCDData emergency alert, if the MCDData user does not have a currently selected MCDData group then use the MCDData group identified by the ID in subclause 10.2.38 for an MCDData emergency alert.

When set to 'DedicatedGroup' then use the MCDData group identified by the ID in subclause 10.2.38 for an MCDData emergency alert.

10.2.41 /<x>/<x>/Common/AllowedActivateAlert

Table 10.2.41.1: /<x>/<x>/Common/AllowedActivateAlert

<x>/Common/AllowedActivateAlert

Status	Occurrence	Format	Min. Access Types
Optional	One	bool	Get, Replace

This leaf node indicates whether the MCDData user is authorised to activate an emergency alert

When set to "true" the MCDData user is authorised to activate an emergency alert.

When set to "false" the MCDData user is not authorised to activate an emergency alert.

10.2.42 /<x>/<x>/Common/AllowedCancelAlert

Table 10.2.42.1: /<x>/<x>/Common/AllowedCancelAlert

<x>/Common/AllowedCancelAlert

Status	Occurrence	Format	Min. Access Types
Required	One	bool	Get, Replace

This leaf node indicates whether the MCDData user is allowed to cancel an emergency alert.

When set to "true" the MCDData user is authorised to cancel an emergency alert.

When set to "false" the MCDData user is not authorised to cancel an emergency alert.

10.2.43 /<x>/<x>/OnNetwork

Table 10.2.43.1: /<x>/<x>/OnNetwork

<x>/OnNetwork

Status	Occurrence	Format	Min. Access Types
Required	ZeroOrOne	node	Get, Replace

This interior node represents a container for on-network operation.

10.2.44 /<x>/<x>/OnNetwork/MCDDataGroupList

Table 10.2.44.1: /<x>/<x>/OnNetwork/MCDDataGroupList

<x>/OnNetwork/MCDDataGroupList

Status	Occurrence	Format	Min. Access Types
Required	One	node	Get, Replace

This interior node is a placeholder for the list of on-network MCDData groups that the MCDData user is allowed to use.

10.2.45 /<x>/<x>/OnNetwork/MCDDataGroupList/<x>

Table 10.2.45.1: /<x>/<x>/OnNetwork/MCDDataGroupList/<x>

<x>/OnNetwork/MCDDataGroupList/<x>

Status	Occurrence	Format	Min. Access Types
Required	OneOrMore	node	Get, Replace

This interior node is a placeholder for one or more list of on-network MCDData groups that the MCDData user is allowed to use.

10.2.46 /<x>/<x>/OnNetwork/MCDDataGroupList/<x>/Entry

Table 10.2.46.1: /<x>/<x>/OnNetwork/MCDDataGroupList/<x>/Entry

<x>/OnNetwork/MCDDataGroupList/<x>/Entry

Status	Occurrence	Format	Min. Access Types
Optional	One	node	Get, Replace

This interior node is a placeholder for the details of the on-network MCDData groups that the MCDData user is allowed to use.

10.2.47 /<x>/<x>/OnNetwork/MCDataGroupList/<x>/Entry/MCDataGroupID

Table 10.2.47.1: /<x>/<x>/OnNetwork/MCDataGroupList/<x>/Entry/MCDataGroupID

<x>/OnNetwork/MCDataGroupList/<x>/Entry/MCDataGroupID

Status	Occurrence	Format	Min. Access Types
Required	One	chr	Get, Replace

This leaf node indicates the MCData group ID for the on-network MCData group that the MCData user is allowed to use.

The value is a "uri" attribute specified in OMA OMA-TS-XDM_Group-V1_1 [4].

10.2.48 /<x>/<x>/OnNetwork/MCDataGroupList/<x>/Entry/DisplayName

Table 10.2.48.1: /<x>/<x>/OnNetwork/MCDataGroupList/<x>/Entry/DisplayName

<x>/OnNetwork/MCDataGroupList/<x>/Entry/DisplayName

Status	Occurrence	Format	Min. Access Types
Optional	One	chr	Get, Replace

This leaf node contains a human readable name that corresponds to the MCData Group ID.

10.2.49 /<x>/<x>/OnNetwork/MCDataGroupList/<x>/Entry/GMSAppServList

Table 10.2.49.1: /<x>/<x>/OnNetwork/MCDataGroupList/<x>/Entry/GMSAppServList

<x>/OnNetwork/MCDataGroupList/<x>/Entry/GMSAppServList

Status	Occurrence	Format	Min. Access Types
Required	One	node	Get, Replace

This interior node is a placeholder for the Group Management Server application plane server identity configuration.

10.2.50

/<x>/<x>/OnNetwork/MCDataGroupList/<x>/Entry/GMSAppServList/
<x>

Table 10.2.50.1: /<x>/<x>/OnNetwork/MCDataGroupList/<x>/Entry/GMSAppServList/<x>

<x>/OnNetwork/MCDataGroupList/<x>/Entry/GMSAppServList/<x>

Status	Occurrence	Format	Min. Access Types
Required	OneOrMore	node	Get, Replace

This interior node is a placeholder for one or more Group Management Server configuration.

10.2.51

/<x>/<x>/OnNetwork/MCDataGroupList/<x>/Entry/GMSAppServList/
<x>/GMSAppServId

Table 10.2.51.1:**/<x>/<x>/OnNetwork/MCDataGroupList/<x>/Entry/GMSAppServList/<x>/GMSAppServId**

<x>/OnNetwork/MCDataGroupList/<x>/Entry/GMSAppServList/<x>/GMSAppServId

Status	Occurrence	Format	Min. Access Types
Optional	One	chr	Get, Replace

This leaf node indicates the identity (URI) of the the group management server hosting the MCDData Group ID.

10.2.52

`/<x>/<x>/OnNetwork/MCDDataGroupList/<x>/Entry/IdMSTokenEndPointList`

Table 10.2.52.1: `/<x>/<x>/OnNetwork/MCDDataGroupList/<x>/Entry/IdMSTokenEndPointList`

`<x>/OnNetwork/MCDDataGroupList/<x>/Entry/IdMSTokenEndPointList`

Status	Occurrence	Format	Min. Access Types
Required	One	node	Get, Replace

This interior node is a placeholder for the Identity Management Server token endpoints configuration.

10.2.53

`/<x>/<x>/OnNetwork/MCDDataGroupList/<x>/Entry/IdMSTokenEndPointList/<x>`

Table 10.2.53.1: `/<x>/<x>/OnNetwork/MCDDataGroupList/<x>/Entry/IdMSTokenEndPointList/<x>`

`<x>/OnNetwork/MCDDataGroupList/<x>/Entry/IdMSTokenEndPointList/<x>`

Status	Occurrence	Format	Min. Access Types
Required	OneOrMore	node	Get, Replace

This interior node is a placeholder for one or more IDMS token endpoints configuration.

10.2.54 `/<x>/<x>/OnNetwork/MCDDataGroupList/<x>/Entry/IdMSTokenEndPointList/<x>/IdMSTokenEndPoint`

Table 10.2.54.1:

`/<x>/<x>/OnNetwork/MCDDataGroupList/<x>/Entry/IdMSTokenEndPointList/<x>/IdMSTokenEndPoint`

`<x>/OnNetwork/MCDDataGroupList/<x>/Entry/IdMSTokenEndPointList/<x>/IdMSTokenEndPoint`

Status	Occurrence	Format	Min. Access Types
Optional	One	chr	Get, Replace

This leaf node indicates the identity (URI) of the the IDMS token endpoint for the MCDData Group ID in the MCDDataGroupList. If the value is empty, the IDMS identities (IDMSAuthEndpoint and IDMSTokenEndpoint) present in the MCS UE initial configuration MO are used.

10.2.54A `/<x>/<x>/OnNetwork/MCDDataGroupList/<x>/Entry/MCDDataGroupIDKMSURI`

Table 10.2.54A.1: `/<x>/<x>/OnNetwork/MCDDataGroupList/<x>/Entry/MCDDataGroupIDKMSURI`

`<x>/OnNetwork/MCDDataGroupList/<x>/Entry/MCDDataGroupIDKMSURI`

Status	Occurrence	Format	Min. Access Types
Required	One	chr	Get, Replace

This leaf node indicates key management server URI for the security domain of the MCDData group identity (MCDData Group ID) of the on-network MCDData group

The value is a URI as specified in 3GPP TS 23.003 [5].

10.2.55 /<x>/<x>/OnNetwork/MCDataGroupList/<x>/Entry/ PresentationPriority

Table 10.2.55.1: /<x>/<x>/OnNetwork/MCDataGroupList/<x>/Entry/PresentationPriority

<x>/OnNetwork/MCDataGroupList/<x>/Entry/PresentationPriority

Status	Occurrence	Format	Min. Access Types
Optional	One	int	Get, Replace

This leaf node indicates indicating the presentation priority of the on-network group for the MCData user relative to other on-network groups and on-network users.

- Values: 0-255

The lowest PresentationPriority value shall be considered as the MCData group transaction having the lowest priority for presentation among other group MCData and one-to-one user transactions.

10.2.55A

/<x>/<x>/OnNetwork/MCDataGroupList/<x>/Entry/ RulesForAffiliation

Table 10.2.55A.1: /<x>/<x>/OnNetwork/MCDataGroupList/<x>/Entry/RulesForAffiliation

<x>/OnNetwork/MCDataGroupList/<x>/Entry/RulesForAffiliation

Status	Occurrence	Format	Min. Access Types
Optional	ZeroOrMore	node	Get, Replace

This interior node is a placeholder for the rules that control automatic affiliation.

10.2.55A1

/<x>/<x>/OnNetwork/MCDataGroupList/<x>/Entry/ RulesForAffiliation/ListOfLocationCriteria/

Table 10.2.55A1.1:

/<x>/<x>/OnNetwork/MCDataGroupList/<x>/Entry/RulesForAffiliation/ListOfLocationCriteria

<x>/OnNetwork/MCDataGroupList/<x>/Entry/RulesForAffiliation/ListOfLocationCriteria

Status	Occurrence	Format	Min. Access Types
Optional	One	node	Get, Replace

This interior node is a placeholder for the location portion of the rules that control automatic affiliation.

10.2.55A2

/<x>/<x>/OnNetwork/MCDataGroupList/<x>/Entry/ RulesForAffiliation/ListOfLocationCriteria/<x>

Table 10.2.55A2.1:

/<x>/<x>/OnNetwork/MCDataGroupList/<x>/Entry/RulesForAffiliation/ListOfLocationCriteria/<x>

<x>/OnNetwork/MCDataGroupList/<x>/Entry/RulesForAffiliation/ListOfLocationCriteria/<x>

Status	Occurrence	Format	Min. Access Types
Optional	ZeroOrMore	node	Get, Replace

This interior node is a placeholder for the location portion of the rules that control automatic affiliation.

10.2.55A3

/<x>/<x>/OnNetwork/MCDataGroupList/<x>/Entry/
RulesForAffiliation/ListOfLocationCriteria/<x>/Entry

Table 10.2.55A3.1:

/<x>/<x>/OnNetwork/MCDataGroupList/<x>/Entry/RulesForAffiliation/ListOfLocationCriteria/<x>/Entry

<x>/OnNetwork/MCDataGroupList/<x>/Entry/RulesForAffiliation/ListOfLocationCriteria/<x>/Entry

Status	Occurrence	Format	Min. Access Types
Optional	One	node	Get, Replace

This interior node is a placeholder for the location portion of the rules that control automatic affiliation.

10.2.55A4

/<x>/<x>/OnNetwork/MCDataGroupList/<x>/Entry/
RulesForAffiliation/ListOfLocationCriteria/<x>/Entry/
EnterSpecificArea

Table 10.2.55A4.1:

/<x>/<x>/OnNetwork/MCDataGroupList/<x>/Entry/RulesForAffiliation/ListOfLocationCriteria/<x>/Entry/
/EnterSpecificArea

<x>/OnNetwork/MCDataGroupList/<x>/Entry/RulesForAffiliation/ListOfLocationCriteria/<x>/Entry/EnterSpecificArea

Status	Occurrence	Format	Min. Access Types
Optional	One	node	Get, Replace

This interior node contains a geographical area which when entered by the MC service UE triggers evaluation of the rules..

10.2.55A5

/<x>/<x>/OnNetwork/MCDataGroupList/<x>/Entry/
RulesForAffiliation/ListOfLocationCriteria/<x>/Entry/
EnterSpecificArea/PolygonArea

Table 10.2.55A5.1: /<x>/<x>/OnNetwork/MCDataGroupList/<x>/Entry/RulesForAffiliation/
ListOfLocationCriteria/<x>/Entry/EnterSpecificArea/PolygonArea

<x>/OnNetwork/MCDataGroupList/<x>/Entry/RulesForAffiliation/ListOfLocationCriteria/<x>/Entry/EnterSpecificArea/PolygonArea

Status	Occurrence	Format	Min. Access Types
Optional	One	node	Get, Replace

This interior node contains a geographical area described by a polygon.

10.2.55A6

/<x>/<x>/OnNetwork/MCDataGroupList/<x>/Entry/
RulesForAffiliation/ListOfLocationCriteria/<x>/Entry/
EnterSpecificArea/PolygonArea/Corner

Table 10.2.55A6.1: /<x>/<x>/OnNetwork/MCDataGroupList/<x>/Entry/RulesForAffiliation/
ListOfLocationCriteria/<x>/Entry/EnterSpecificArea/PolygonArea/Corner

<x>/OnNetwork/MCDataGroupList/<x>/Entry/RulesForAffiliation/ListOfLocationCriteria/<x>/Entry/EnterSpecificArea/PolygonArea/Corner

Status	Occurrence	Format	Min. Access Types

Required	Three to fifteen	node	Get, Replace
----------	------------------	------	--------------

This interior node contains the coordinates of the corners which define a polygon.

10.2.55A7

`/<x>/<x>/OnNetwork/MCDataGroupList/<x>/Entry/
RulesForAffiliation/ListOfLocationCriteria/<x>/Entry/
EnterSpecificArea/PolygonArea/Corner/PointCoordinateType`

Table 10.2.55A7.1:

`/<x>/<x>/OnNetwork/MCDataGroupList/<x>/Entry/RulesForAffiliation/ListOfLocationCriteria/<x>/Entry/
/EnterSpecificArea/PolygonArea/Corner/PointCoordinateType`

`<x>/OnNetwork/MCDataGroupList/<x>/Entry/RulesForAffiliation/ListOfLocationCriteria/<x>/Entry/EnterSpecificA
rea/PolygonArea/Corner/PointCoordinateType`

Status	Occurrence	Format	Min. Access Types
Required	One	node	Get, Replace

This interior node contains the type of the coordinates.

10.2.55A8

`/<x>/<x>/OnNetwork/MCDataGroupList/<x>/Entry/
RulesForAffiliation/ListOfLocationCriteria/<x>/Entry/
EnterSpecificArea/PolygonArea/Corner/PointCoordinateType/
Longitude`

Table 10.2.55A8.1:

`/<x>/<x>/OnNetwork/MCDataGroupList/<x>/Entry/RulesForAffiliation/ListOfLocationCriteria/<x>/Entry/
/EnterSpecificArea/PolygonArea/Corner/PointCoordinateType/Longitude`

`<x>/OnNetwork/MCDataGroupList/<x>/Entry/RulesForAffiliation/ListOfLocationCriteria/<x>/Entry/EnterSpecificA
rea/PolygonArea/Corner/PointCoordinateType/ Longitude /`

Status	Occurrence	Format	Min. Access Types
Required	One	int	Get, Replace

This leaf node contains the longitudinal coordinate of a corner.

10.2.55A9

`/<x>/<x>/OnNetwork/MCDataGroupList/<x>/Entry/
RulesForAffiliation/ListOfLocationCriteria/<x>/Entry/
EnterSpecificArea/PolygonArea/Corner/PointCoordinateType/
Latitude`

Table 10.2.55A9.1:

`/<x>/<x>/OnNetwork/MCDataGroupList/<x>/Entry/RulesForAffiliation/ListOfLocationCriteria/<x>/Entry/
/EnterSpecificArea/PolygonArea/Corner/PointCoordinateType/Latitude`

`<x>/OnNetwork/MCDataGroupList/<x>/Entry/RulesForAffiliation/ListOfLocationCriteria/<x>/Entry/EnterSpecificA
rea/PolygonArea/Corner/PointCoordinateType/Latitude`

Status	Occurrence	Format	Min. Access Types
Required	One	int	Get, Replace

This leaf node contains the latitudinal coordinate of a corner.

10.2.55A10

/<x>/<x>/OnNetwork/MCDataGroupList/<x>/Entry/
RulesForAffiliation/ListOfLocationCriteria/<x>/Entry/
EnterSpecificArea/EllipsoidArcArea

Table 10.2.55A10.1:

/<x>/<x>/OnNetwork/MCDataGroupList/<x>/Entry/RulesForAffiliation/ListOfLocationCriteria/<x>/Entry/
/EnterSpecificArea/EllipsoidArcArea

<x>/OnNetwork/MCDataGroupList/<x>/Entry/RulesForAffiliation/ListOfLocationCriteria/<x>/Entry/EnterSpecific
Area/EllipsoidArcArea

Status	Occurrence	Format	Min. Access Types
Optional	ZeroOrOne	node	Get, Replace

This interior node contains a geographical area described by an ellipsoid arc.

10.2.55A11

/<x>/<x>/OnNetwork/MCDataGroupList/<x>/Entry/
RulesForAffiliation/ListOfLocationCriteria/<x>/Entry/
EnterSpecificArea/EllipsoidArcArea/Center

Table 10.2.55A11.1: /<x>/<x>/OnNetwork/MCDataGroupList/<x>/Entry/RulesForAffiliation/
ListOfLocationCriteria/<x>/Entry/EnterSpecificArea/EllipsoidArcArea/Center

<x>/OnNetwork/MCDataGroupList/<x>/Entry/RulesForAffiliation/ListOfLocationCriteria/<x>/Entry/EnterSpecific
Area/EllipsoidArcArea/Center

Status	Occurrence	Format	Min. Access Types
Required	One	node	Get, Replace

This interior node contains the coordinates of the center point of the ellipsoid arc.

10.2.55A12

/<x>/<x>/OnNetwork/MCDataGroupList/<x>/Entry/
RulesForAffiliation/ListOfLocationCriteria/<x>/Entry/
EnterSpecificArea/EllipsoidArcArea/Center/PointCoordinateType

Table 10.2.55A12.1:

/<x>/<x>/OnNetwork/MCDataGroupList/<x>/Entry/RulesForAffiliation/ListOfLocationCriteria/<x>/Entry/
/EnterSpecificArea/EllipsoidArcArea/Center/PointCoordinateType

<x>/OnNetwork/MCDataGroupList/<x>/Entry/RulesForAffiliation/ListOfLocationCriteria/<x>/Entry/EnterSpecific
Area/EllipsoidArcArea/Center/PointCoordinateType

Status	Occurrence	Format	Min. Access Types
Required	One	node	Get, Replace

This interior node contains the coordinates of the center point of the ellipsoid arc.

10.2.55A13

/<x>/<x>/OnNetwork/MCDataGroupList/<x>/Entry/
 RulesForAffiliation/ListOfLocationCriteria/<x>/Entry/
 EnterSpecificArea/EllipsoidArcArea/Center/PointCoordinateType/
 Longitude

Table 10.2.55A13.1:

/<x>/<x>/OnNetwork/MCDataGroupList/<x>/Entry/RulesForAffiliation/ListOfLocationCriteria/<x>/Entry/
 /EnterSpecificArea/EllipsoidArcArea/Center/PointCoordinateType/Longitude

<x>/OnNetwork/MCDataGroupList/<x>/Entry/RulesForAffiliation/ListOfLocationCriteria/<x>/Entry/EnterSpecific
 Area/EllipsoidArcArea/Center/PointCoordinateType/ Longitude /

Status	Occurrence	Format	Min. Access Types
Required	One	int	Get, Replace

This leaf node contains the longitudinal coordinate of the center.

10.2.55A14

/<x>/<x>/OnNetwork/MCDataGroupList/<x>/Entry/
 RulesForAffiliation/ListOfLocationCriteria/<x>/Entry/
 EnterSpecificArea/EllipsoidArcArea/Center/PointCoordinateType/
 Latitude

Table 10.2.55A14.1:

/<x>/<x>/OnNetwork/MCDataGroupList/<x>/Entry/RulesForAffiliation/ListOfLocationCriteria/<x>/Entry/
 /EnterSpecificArea/EllipsoidArcArea/Center/PointCoordinateType/Latitude

<x>/OnNetwork/MCDataGroupList/<x>/Entry/RulesForAffiliation/ListOfLocationCriteria/<x>/Entry/EnterSpecific
 Area/EllipsoidArcArea/Center/PointCoordinateType/Latitude

Status	Occurrence	Format	Min. Access Types
Required	One	int	Get, Replace

This leaf node contains the latitudinal coordinate of a center.

10.2.55A15

/<x>/<x>/OnNetwork/MCDataGroupList/<x>/Entry/
 RulesForAffiliation/ListOfLocationCriteria/<x>/Entry/
 EnterSpecificArea/EllipsoidArcArea/Radius

Table 10.2.55A15.1:

/<x>/<x>/OnNetwork/MCDataGroupList/<x>/Entry/RulesForAffiliation/ListOfLocationCriteria/<x>/Entry/
 /EnterSpecificArea/EllipsoidArcArea/Radius

<x>/OnNetwork/MCDataGroupList/<x>/Entry/RulesForAffiliation/ListOfLocationCriteria/<x>/Entry/EnterSpecific
 Area/EllipsoidArcArea/Center/Radius

Status	Occurrence	Format	Min. Access Types
Required	One	int	Get, Replace

This leaf node contains the radius of the ellipsoid arc.

10.2.55A16

/<x>/<x>/OnNetwork/MCDataGroupList/<x>/Entry/
RulesForAffiliation/ListOfLocationCriteria/<x>/Entry/
EnterSpecificArea/EllipsoidArcArea/OffsetAngle

Table 10.2.55A16.1:

/<x>/<x>/OnNetwork/MCDataGroupList/<x>/Entry/RulesForAffiliation/ListOfLocationCriteria/<x>/Entry/
/EnterSpecificArea/EllipsoidArcArea/OffsetAngle

<x>/OnNetwork/MCDataGroupList/<x>/Entry/RulesForAffiliation/ListOfLocationCriteria/<x>/Entry/EnterSpecific
Area/EllipsoidArcArea/OffsetAngle

Status	Occurrence	Format	Min. Access Types
Required	One	int	Get, Replace

This leaf node contains the offset angle of the ellipsoid arc.

10.2.55A17

/<x>/<x>/OnNetwork/MCDataGroupList/<x>/Entry/
RulesForAffiliation/ListOfLocationCriteria/<x>/Entry/
EnterSpecificArea/EllipsoidArcArea/IncludedAngle

Table 10.2.55A17.1:

/<x>/<x>/OnNetwork/MCDataGroupList/<x>/Entry/RulesForAffiliation/ListOfLocationCriteria/<x>/Entry/
/EnterSpecificArea/EllipsoidArcArea/IncludedAngle

<x>/OnNetwork/MCDataGroupList/<x>/Entry/RulesForAffiliation/ListOfLocationCriteria/<x>/Entry/EnterSpecific
Area/EllipsoidArcArea/IncludedAngle

Status	Occurrence	Format	Min. Access Types
Required	One	int	Get, Replace

This leaf node contains the included angle of the ellipsoid arc.

10.2.55A18

/<x>/<x>/OnNetwork/MCDataGroupList/<x>/Entry/
RulesForAffiliation/ListOfLocationCriteria/<x>/Entry/
EnterSpecificArea/Speed

Table 10.2.55A18.1:

/<x>/<x>/OnNetwork/MCDataGroupList/<x>/Entry/RulesForAffiliation/ListOfLocationCriteria/<x>/Entry/
/EnterSpecificArea/Speed

<x>/OnNetwork/MCDataGroupList/<x>/Entry/RulesForAffiliation/ListOfLocationCriteria/<x>/Entry/EnterSpecific
Area/Speed

Status	Occurrence	Format	Min. Access Types
Optional	One	node	Get, Replace

This interior node contains the speed.

10.2.55A19

/<x>/<x>/OnNetwork/MCDataGroupList/<x>/Entry/
RulesForAffiliation/ListOfLocationCriteria/<x>/Entry/
EnterSpecificArea/Speed/MinimumSpeed

Table 10.2.55A19.1:

/<x>/<x>/OnNetwork/MCDataGroupList/<x>/Entry/RulesForAffiliation/ListOfLocationCriteria/<x>/Entry/
/EnterSpecificArea/Speed/MinimumSpeed

<x>/OnNetwork/MCDataGroupList/<x>/Entry/RulesForAffiliation/ListOfLocationCriteria/<x>/Entry/EnterSpecific
Area/Speed/MinimumSpeed

Status	Occurrence	Format	Min. Access Types
Required	One	int	Get, Replace

This leaf node contains the minimum speed.

- Values: non-negative integer in units of kilometers/hour.

10.2.55A20

/<x>/<x>/OnNetwork/MCDataGroupList/<x>/Entry/
RulesForAffiliation/ListOfLocationCriteria/<x>/Entry/
EnterSpecificArea/Speed/MaximumSpeed

Table 10.2.55A20.1:

/<x>/<x>/OnNetwork/MCDataGroupList/<x>/Entry/RulesForAffiliation/ListOfLocationCriteria/<x>/Entry/
/EnterSpecificArea/Speed/MaximumSpeed

<x>/OnNetwork/MCDataGroupList/<x>/Entry/RulesForAffiliation/ListOfLocationCriteria/<x>/Entry/EnterSpecific
Area/Speed/MaximumSpeed

Status	Occurrence	Format	Min. Access Types
Required	One	int	Get, Replace

This leaf node contains the maximum speed.

- Values: non-negative integer in units of kilometers/hour.

10.2.55A21

/<x>/<x>/OnNetwork/MCDataGroupList/<x>/Entry/
RulesForAffiliation/ListOfLocationCriteria/<x>/Entry/
EnterSpecificArea/Heading

Table 10.2.55A21.1:

/<x>/<x>/OnNetwork/MCDataGroupList/<x>/Entry/RulesForAffiliation/ListOfLocationCriteria/<x>/Entry/
/EnterSpecificArea/Heading

<x>/OnNetwork/MCDataGroupList/<x>/Entry/RulesForAffiliation/ListOfLocationCriteria/<x>/Entry/EnterSpecific
Area/Heading

Status	Occurrence	Format	Min. Access Types
Optional	One	node	Get, Replace

This interior node contains the heading.

10.2.55A22

/<x>/<x>/OnNetwork/MCDataGroupList/<x>/Entry/
RulesForAffiliation/ListOfLocationCriteria/<x>/Entry/
EnterSpecificArea/Heading/MinimumHeading

Table 10.2.55A22.1:

/<x>/<x>/OnNetwork/MCDataGroupList/<x>/Entry/RulesForAffiliation/ListOfLocationCriteria/<x>/Entry/
/EnterSpecificArea/Heading/MinimumHeading

<x>/OnNetwork/MCDataGroupList/<x>/Entry/RulesForAffiliation/ListOfLocationCriteria/<x>/Entry/EnterSpecific
Area/Heading/MinimumHeading

Status	Occurrence	Format	Min. Access Types
Required	One	int	Get, Replace

This leaf node contains the minimum heading.

- Values: 0-359

10.2.55A23

/<x>/<x>/OnNetwork/MCDataGroupList/<x>/Entry/
RulesForAffiliation/ListOfLocationCriteria/<x>/Entry/
EnterSpecificArea/Heading/MaximumHeading

Table 10.2.55A23.1:

/<x>/<x>/OnNetwork/MCDataGroupList/<x>/Entry/RulesForAffiliation/ListOfLocationCriteria/<x>/Entry/
/EnterSpecificArea/Heading/MaximumHeading

<x>/OnNetwork/MCDataGroupList/<x>/Entry/RulesForAffiliation/ListOfLocationCriteria/<x>/Entry/EnterSpecific
Area/Heading/MaximumHeading

Status	Occurrence	Format	Min. Access Types
Required	One	int	Get, Replace

This leaf node contains the maximum heading.

- Values: 0-359

10.2.55A24

/<x>/<x>/OnNetwork/MCDataGroupList/<x>/Entry/
RulesForAffiliation/ListOfLocationCriteria/<x>/Entry/
ExitSpecificArea

Table 10.2.55A24.1:

/<x>/<x>/OnNetwork/MCDataGroupList/<x>/Entry/RulesForAffiliation/ListOfLocationCriteria/<x>/Entry/
/ExitSpecificArea

<x>/OnNetwork/MCDataGroupList/<x>/Entry/RulesForAffiliation/ListOfLocationCriteria/<x>/Entry/ExitSpecificAr
ea

Status	Occurrence	Format	Min. Access Types
Optional	One	node	Get, Replace

This interior node contains a geographical area which when entered by the MC service UE triggers
evaluation of the rules..

10.2.55A25

`<x>/<x>/OnNetwork/MCDataGroupList/<x>/Entry/
RulesForAffiliation/ListOfLocationCriteria/<x>/Entry/
ExitSpecificArea/PolygonArea`

**Table 10.2.55A25.1: `<x>/<x>/OnNetwork/MCDataGroupList/<x>/Entry/RulesForAffiliation/
ListOfLocationCriteria/<x>/Entry/ExitSpecificArea/PolygonArea`**

`<x>/OnNetwork/MCDataGroupList/<x>/Entry/RulesForAffiliation/ListOfLocationCriteria/<x>/Entry/ExitSpecificAr
ea/PolygonArea`

Status	Occurrence	Format	Min. Access Types
Optional	One	node	Get, Replace

This interior node contains a geographical area described by a polygon.

10.2.55A26

`<x>/<x>/OnNetwork/MCDataGroupList/<x>/Entry/
RulesForAffiliation/ListOfLocationCriteria/<x>/Entry/
ExitSpecificArea/PolygonArea/Corner`

**Table 10.2.55A26.1: `<x>/<x>/OnNetwork/MCDataGroupList/<x>/Entry/RulesForAffiliation/
ListOfLocationCriteria/<x>/Entry/ExitSpecificArea/PolygonArea/Corner`**

`<x>/OnNetwork/MCDataGroupList/<x>/Entry/RulesForAffiliation/ListOfLocationCriteria/<x>/Entry/ExitSpecificAr
ea/PolygonArea/Corner`

Status	Occurrence	Format	Min. Access Types
Required	Three to fifteen	node	Get, Replace

This interior node contains the coordinates of the corners which define a polygon.

10.2.55A27

`<x>/<x>/OnNetwork/MCDataGroupList/<x>/Entry/
RulesForAffiliation/ListOfLocationCriteria/<x>/Entry/
ExitSpecificArea/PolygonArea/Corner/PointCoordinateType`

Table 10.2.55A27.1:

`<x>/<x>/OnNetwork/MCDataGroupList/<x>/Entry/RulesForAffiliation/ListOfLocationCriteria/<x>/Entry/
/ExitSpecificArea/PolygonArea/Corner/PointCoordinateType`

`<x>/OnNetwork/MCDataGroupList/<x>/Entry/RulesForAffiliation/ListOfLocationCriteria/<x>/Entry/ExitSpecificAr
ea/PolygonArea/Corner/PointCoordinateType`

Status	Occurrence	Format	Min. Access Types
Required	One	node	Get, Replace

This interior node contains the type of the coordinates.

10.2.55A28

/<x>/<x>/OnNetwork/MCDataGroupList/<x>/Entry/
RulesForAffiliation/ListOfLocationCriteria/<x>/Entry/
ExitSpecificArea/PolygonArea/Corner/PointCoordinateType/
Longitude

Table 10.2.55A28.1:

/<x>/<x>/OnNetwork/MCDataGroupList/<x>/Entry/RulesForAffiliation/ListOfLocationCriteria/<x>/Entry/
/ExitSpecificArea/PolygonArea/Corner/PointCoordinateType/Longitude

<x>/OnNetwork/MCDataGroupList/<x>/Entry/RulesForAffiliation/ListOfLocationCriteria/<x>/Entry/ExitSpecificAr
ea/PolygonArea/Corner/PointCoordinateType/ Longitude /

Status	Occurrence	Format	Min. Access Types
Required	One	int	Get, Replace

This leaf node contains the longitudinal coordinate of a corner.

10.2.55A29

/<x>/<x>/OnNetwork/MCDataGroupList/<x>/Entry/
RulesForAffiliation/ListOfLocationCriteria/<x>/Entry/
ExitSpecificArea/PolygonArea/Corner/PointCoordinateType/
Latitude

Table 10.2.55A29.1:

/<x>/<x>/OnNetwork/MCDataGroupList/<x>/Entry/RulesForAffiliation/ListOfLocationCriteria/<x>/Entry/
/ExitSpecificArea/PolygonArea/Corner/PointCoordinateType/Latitude

<x>/OnNetwork/MCDataGroupList/<x>/Entry/RulesForAffiliation/ListOfLocationCriteria/<x>/Entry/ExitSpecificAr
ea/PolygonArea/Corner/PointCoordinateType/Latitude

Status	Occurrence	Format	Min. Access Types
Required	One	int	Get, Replace

This leaf node contains the latitudinal coordinate of a corner.

10.2.55A30

/<x>/<x>/OnNetwork/MCDataGroupList/<x>/Entry/
RulesForAffiliation/ListOfLocationCriteria/<x>/Entry/
ExitSpecificArea/EllipsoidArcArea

Table 10.2.55A30.1:

/<x>/<x>/OnNetwork/MCDataGroupList/<x>/Entry/RulesForAffiliation/ListOfLocationCriteria/<x>/Entry/
/ExitSpecificArea/EllipsoidArcArea

<x>/OnNetwork/MCDataGroupList/<x>/Entry/RulesForAffiliation/ListOfLocationCriteria/<x>/Entry/ExitSpecificA
rea/EllipsoidArcArea

Status	Occurrence	Format	Min. Access Types
Optional	ZeroOrOne	node	Get, Replace

This interior node contains a geographical area described by an ellipsoid arc.

10.2.55A31

/<x>/<x>/OnNetwork/MCDataGroupList/<x>/Entry/
RulesForAffiliation/ListOfLocationCriteria/<x>/Entry/
ExitSpecificArea/EllipsoidArcArea/Center

**Table 10.2.55A31.1: /<x>/<x>/OnNetwork/MCDataGroupList/<x>/Entry/RulesForAffiliation/
ListOfLocationCriteria/<x>/Entry/ExitSpecificArea/EllipsoidArcArea/Center**

<x>/OnNetwork/MCDataGroupList/<x>/Entry/RulesForAffiliation/ListOfLocationCriteria/<x>/Entry/ExitSpecificA
rea/EllipsoidArcArea/Center

Status	Occurrence	Format	Min. Access Types
Required	One	node	Get, Replace

This interior node contains the coordinates of the center point of the ellipsoid arc.

10.2.55A32

/<x>/<x>/OnNetwork/MCDataGroupList/<x>/Entry/
RulesForAffiliation/ListOfLocationCriteria/<x>/Entry/
ExitSpecificArea/EllipsoidArcArea/Center/PointCoordinateType

Table 10.2.55A32.1:

**/<x>/<x>/OnNetwork/MCDataGroupList/<x>/Entry/RulesForAffiliation/ListOfLocationCriteria/<x>/Entry
/ExitSpecificArea/EllipsoidArcArea/Center/PointCoordinateType**

<x>/OnNetwork/MCDataGroupList/<x>/Entry/RulesForAffiliation/ListOfLocationCriteria/<x>/Entry/ExitSpecificA
rea/EllipsoidArcArea/Center/PointCoordinateType

Status	Occurrence	Format	Min. Access Types
Required	One	node	Get, Replace

This interior node contains the coordinates of the center point of the ellipsoid arc.

10.2.55A33

/<x>/<x>/OnNetwork/MCDataGroupList/<x>/Entry/
RulesForAffiliation/ListOfLocationCriteria/<x>/Entry/
ExitSpecificArea/EllipsoidArcArea/Center/PointCoordinateType/
Longitude

Table 10.2.55A33.1:

**/<x>/<x>/OnNetwork/MCDataGroupList/<x>/Entry/RulesForAffiliation/ListOfLocationCriteria/<x>/Entry
/ExitSpecificArea/EllipsoidArcArea/Center/PointCoordinateType/Longitude**

<x>/OnNetwork/MCDataGroupList/<x>/Entry/RulesForAffiliation/ListOfLocationCriteria/<x>/Entry/ExitSpecificA
rea/EllipsoidArcArea/Center/PointCoordinateType/ Longitude /

Status	Occurrence	Format	Min. Access Types
Required	One	int	Get, Replace

This leaf node contains the longitudinal coordinate of the center.

10.2.55A34

/<x>/<x>/OnNetwork/MCDataGroupList/<x>/Entry/
 RulesForAffiliation/ListOfLocationCriteria/<x>/Entry/
 ExitSpecificArea/EllipsoidArcArea/Center/PointCoordinateType/
 Latitude

Table 10.2.55A34.1:

/<x>/<x>/OnNetwork/MCDataGroupList/<x>/Entry/RulesForAffiliation/ListOfLocationCriteria/<x>/Entry/
 /ExitSpecificArea/EllipsoidArcArea/Center/PointCoordinateType/Latitude

<x>/OnNetwork/MCDataGroupList/<x>/Entry/RulesForAffiliation/ListOfLocationCriteria/<x>/Entry/ExitSpecificA
 rea/EllipsoidArcArea/Center/PointCoordinateType/Latitude

Status	Occurrence	Format	Min. Access Types
Required	One	int	Get, Replace

This leaf node contains the latitudinal coordinate of a center.

10.2.55A35

/<x>/<x>/OnNetwork/MCDataGroupList/<x>/Entry/
 RulesForAffiliation/ListOfLocationCriteria/<x>/Entry/
 ExitSpecificArea/EllipsoidArcArea/Radius

Table 10.2.55A35.1:

/<x>/<x>/OnNetwork/MCDataGroupList/<x>/Entry/RulesForAffiliation/ListOfLocationCriteria/<x>/Entry/
 /ExitSpecificArea/EllipsoidArcArea/Radius

<x>/OnNetwork/MCDataGroupList/<x>/Entry/RulesForAffiliation/ListOfLocationCriteria/<x>/Entry/ExitSpecificA
 rea/EllipsoidArcArea/Center/Radius

Status	Occurrence	Format	Min. Access Types
Required	One	int	Get, Replace

This leaf node contains the radius of the ellipsoid arc.

10.2.55A36

/<x>/<x>/OnNetwork/MCDataGroupList/<x>/Entry/
 RulesForAffiliation/ListOfLocationCriteria/<x>/Entry/
 ExitSpecificArea/EllipsoidArcArea/OffsetAngle

Table 10.2.55A36.1:

/<x>/<x>/OnNetwork/MCDataGroupList/<x>/Entry/RulesForAffiliation/ListOfLocationCriteria/<x>/Entry/
 /ExitSpecificArea/EllipsoidArcArea/OffsetAngle

<x>/OnNetwork/MCDataGroupList/<x>/Entry/RulesForAffiliation/ListOfLocationCriteria/<x>/Entry/ExitSpecificA
 rea/EllipsoidArcArea/OffsetAngle

Status	Occurrence	Format	Min. Access Types
Required	One	int	Get, Replace

This leaf node contains the offset angle of the ellipsoid arc.

10.2.55A37

/<x>/<x>/OnNetwork/MCDataGroupList/<x>/Entry/
RulesForAffiliation/ListOfLocationCriteria/<x>/Entry/
ExitSpecificArea/EllipsoidArcArea/IncludedAngle

Table 10.2.55A37.1:

/<x>/<x>/OnNetwork/MCDataGroupList/<x>/Entry/RulesForAffiliation/ListOfLocationCriteria/<x>/Entry/
/ExitSpecificArea/EllipsoidArcArea/IncludedAngle

<x>/OnNetwork/MCDataGroupList/<x>/Entry/RulesForAffiliation/ListOfLocationCriteria/<x>/Entry/ExitSpecificA
rea/EllipsoidArcArea/IncludedAngle

Status	Occurrence	Format	Min. Access Types
Required	One	int	Get, Replace

This leaf node contains the included angle of the ellipsoid arc.

10.2.55A38

/<x>/<x>/OnNetwork/MCDataGroupList/<x>/Entry/
RulesForAffiliation/ListOfLocationCriteria/<x>/Entry/
ExitSpecificArea/Speed

Table 10.2.55A38.1:

/<x>/<x>/OnNetwork/MCDataGroupList/<x>/Entry/RulesForAffiliation/ListOfLocationCriteria/<x>/Entry/
/ExitSpecificArea/Speed

<x>/OnNetwork/MCDataGroupList/<x>/Entry/RulesForAffiliation/ListOfLocationCriteria/<x>/Entry/ExitSpecificA
rea/Speed

Status	Occurrence	Format	Min. Access Types
Optional	One	node	Get, Replace

This interior node contains the speed.

10.2.55A39

/<x>/<x>/OnNetwork/MCDataGroupList/<x>/Entry/
RulesForAffiliation/ListOfLocationCriteria/<x>/Entry/
ExitSpecificArea/Speed/MinimumSpeed

Table 10.2.55A39.1:

/<x>/<x>/OnNetwork/MCDataGroupList/<x>/Entry/RulesForAffiliation/ListOfLocationCriteria/<x>/Entry/
/ExitSpecificArea/Speed/MinimumSpeed

<x>/OnNetwork/MCDataGroupList/<x>/Entry/RulesForAffiliation/ListOfLocationCriteria/<x>/Entry/ExitSpecificA
rea/Speed/MinimumSpeed

Status	Occurrence	Format	Min. Access Types
Required	One	int	Get, Replace

This leaf node contains the minimum speed.

- Values: non-negative integer in units of kilometers/hour.

10.2.55A40

/<x>/<x>/OnNetwork/MCDataGroupList/<x>/Entry/
RulesForAffiliation/ListOfLocationCriteria/<x>/Entry/
ExitSpecificArea/Speed/MaximumSpeed

Table 10.2.55A40.1:

/<x>/<x>/OnNetwork/MCDataGroupList/<x>/Entry/RulesForAffiliation/ListOfLocationCriteria/<x>/Entry/
/ExitSpecificArea/Speed/MaximumSpeed

<x>/OnNetwork/MCDataGroupList/<x>/Entry/RulesForAffiliation/ListOfLocationCriteria/<x>/Entry/ExitSpecificA
rea/Speed/MaximumSpeed

Status	Occurrence	Format	Min. Access Types
Required	One	int	Get, Replace

This leaf node contains the maximum speed.

- Values: non-negative integer in units of kilometers/hour.

10.2.55A41

/<x>/<x>/OnNetwork/MCDataGroupList/<x>/Entry/
RulesForAffiliation/ListOfLocationCriteria/<x>/Entry/
ExitSpecificArea/Heading

Table 5. 10.2.55A41.1:

/<x>/<x>/OnNetwork/MCDataGroupList/<x>/Entry/RulesForAffiliation/ListOfLocationCriteria/<x>/Entry/
/ExitSpecificArea/Heading

<x>/OnNetwork/MCDataGroupList/<x>/Entry/RulesForAffiliation/ListOfLocationCriteria/<x>/Entry/ExitSpecificA
rea/Heading

Status	Occurrence	Format	Min. Access Types
Optional	One	node	Get, Replace

This interior node contains the heading.

10.2.55A42

/<x>/<x>/OnNetwork/MCDataGroupList/<x>/Entry/
RulesForAffiliation/ListOfLocationCriteria/<x>/Entry/
ExitSpecificArea/Heading/MinimumHeading

Table 10.2.55A42.1:

/<x>/<x>/OnNetwork/MCDataGroupList/<x>/Entry/RulesForAffiliation/ListOfLocationCriteria/<x>/Entry/
/ExitSpecificArea/Heading/MinimumHeading

<x>/OnNetwork/MCDataGroupList/<x>/Entry/RulesForAffiliation/ListOfLocationCriteria/<x>/Entry/ExitSpecificA
rea/Heading/MinimumHeading

Status	Occurrence	Format	Min. Access Types
Required	One	int	Get, Replace

This leaf node contains the minimum heading.

- Values: 0-359

10.2.55A43

/<x>/<x>/OnNetwork/MCDataGroupList/<x>/Entry/
RulesForAffiliation/ListOfLocationCriteria/<x>/Entry/
ExitSpecificArea/Heading/MaximumHeading

Table 10.2.55A43.1:

/<x>/<x>/OnNetwork/MCDataGroupList/<x>/Entry/RulesForAffiliation/ListOfLocationCriteria/<x>/Entry/
/ExitSpecificArea/Heading/MaximumHeading

<x>/OnNetwork/MCDataGroupList/<x>/Entry/RulesForAffiliation/ListOfLocationCriteria/<x>/Entry/ExitSpecificA
rea/Heading/MaximumHeading

Status	Occurrence	Format	Min. Access Types
Required	One	int	Get, Replace

This leaf node contains the maximum heading.

- Values: 0-359

10.2.55A44

/<x>/<x>/OnNetwork/MCDataGroupList/<x>/Entry/
RulesForAffiliation/ListOfActiveFunctionalAliases

Table 10.2.55A44.1:

/<x>/<x>/OnNetwork/MCDataGroupList/<x>/Entry/RulesForAffiliation/ListOfActiveFunctionalAliases

<x>/OnNetwork/MCDataGroupList/<x>/Entry/RulesForAffiliation/ListOfActiveFunctionalAliases

Status	Occurrence	Format	Min. Access Types
Optional	One	node	Get, Replace

This interior node is a placeholder for the functional alias part of rules that control automatic affiliation.

10.2.55A45

/<x>/<x>/OnNetwork/MCDataGroupList/<x>/Entry/
RulesForAffiliation/ListOfActiveFunctionalAliases/<x>

Table 10.2.55A45.1:

/<x>/<x>/OnNetwork/MCDataGroupList/<x>/Entry/RulesForAffiliation/ListOfActiveFunctionalAliases/<
x>

<x>/OnNetwork/MCDataGroupList/<x>/Entry/RulesForAffiliation/ListOfActiveFunctionalAliases/<x>

Status	Occurrence	Format	Min. Access Types
Optional	OneOrMore	node	Get, Replace

This interior node is a placeholder for the functional alias part of rules that control automatic affiliation.

10.2.55A46

/<x>/<x>/OnNetwork/MCDataGroupList/<x>/Entry/
RulesForAffiliation/ListOfActiveFunctionalAliasesCriteria/<x>/Entry

Table 10.2.55A46.1:

/<x>/<x>/OnNetwork/MCDataGroupList/<x>/Entry/RulesForAffiliation/ListOfActiveFunctionalAliasesC
riteria/<x>/Entry

<x>/OnNetwork/MCDataGroupList/<x>/Entry/RulesForAffiliation/ListOfActiveFunctionalAliases/<x>/Entry

Status	Occurrence	Format	Min. Access Types
Optional	One	node	Get, Replace

This interior node is a placeholder for the functional alias part of rules that control automatic affiliation.

10.2.55A47

`/<x>/<x>/OnNetwork/MCDataGroupList/<x>/Entry/
RulesForAffiliation/ListOfActiveFunctionalAliases/<x>/Entry/
FunctionalAlias`

Table 10.2.55A47.1:

`/<x>/<x>/OnNetwork/MCDataGroupList/<x>/Entry/RulesForAffiliation/ListOfActiveFunctionalAliases/<x>/Entry/FunctionalAlias`

`<x>/OnNetwork/MCDataGroupList/<x>/Entry/RulesForAffiliation/ListOfActiveFunctionalAliases/<x>/Entry/FunctionalAlias`

Status	Occurrence	Format	Min. Access Types
Required	One	chr	Get, Replace

This leaf node contains a functional alias.

10.2.55B

`/<x>/<x>/OnNetwork/MCDataGroupList/<x>/Entry/
RulesForDeaffiliation`

Table 10.2.55B.1: /<x>/<x>/OnNetwork/MCDataGroupList/<x>/Entry/RulesForDeaffiliation

`<x>/OnNetwork/MCDataGroupList/<x>/Entry/RulesForDeaffiliation`

Status	Occurrence	Format	Min. Access Types
Optional	ZeroOrMore	node	Get, Replace

This interior node is a placeholder for the rules that control automatic deaffiliation.

10.2.55B1

`/<x>/<x>/OnNetwork/MCDataGroupList/<x>/Entry/
RulesForDeaffiliation/ListOfLocationCriteria/`

Table 10.2.55B1.1:

`/<x>/<x>/OnNetwork/MCDataGroupList/<x>/Entry/RulesForDeaffiliation/ListOfLocationCriteria`

`<x>/OnNetwork/MCDataGroupList/<x>/Entry/RulesForDeaffiliation/ListOfLocationCriteria`

Status	Occurrence	Format	Min. Access Types
Optional	One	node	Get, Replace

This interior node is a placeholder for the location portion of the rules that control deautomatic affiliation.

10.2.55B2

`/<x>/<x>/OnNetwork/MCDataGroupList/<x>/Entry/
RulesForDeaffiliation/ListOfLocationCriteria/<x>`

Table 10.2.55B2.1:

`/<x>/<x>/OnNetwork/MCDataGroupList/<x>/Entry/RulesForDeaffiliation/ListOfLocationCriteria/<x>`

`<x>/OnNetwork/MCDataGroupList/<x>/Entry/RulesForDeaffiliation/ListOfLocationCriteria/<x>`

Status	Occurrence	Format	Min. Access Types
Optional	ZeroOrMore	node	Get, Replace

This interior node is a placeholder for the location portion of the rules that control automatic deaffiliation.

10.2.55B3

`<x>/<x>/OnNetwork/MCDataGroupList/<x>/Entry/
RulesForDeaffiliation/ListOfLocationCriteria/<x>/Entry`

Table 10.2.55B3.1:

`<x>/<x>/OnNetwork/MCDataGroupList/<x>/Entry/RulesForDeaffiliation/ListOfLocationCriteria/<x>/Entry`

`<x>/OnNetwork/MCDataGroupList/<x>/Entry/RulesForDeaffiliation/ListOfLocationCriteria/<x>/Entry`

Status	Occurrence	Format	Min. Access Types
Optional	One	node	Get, Replace

This interior node is a placeholder for the location portion of the rules that control automatic deaffiliation.

10.2.55B4

`<x>/<x>/OnNetwork/MCDataGroupList/<x>/Entry/
RulesForDeaffiliation/ListOfLocationCriteria/<x>/Entry/
EnterSpecificArea`

Table 10.2.55B4.1:

`<x>/<x>/OnNetwork/MCDataGroupList/<x>/Entry/RulesForDeaffiliation/ListOfLocationCriteria/<x>/Entry/EnterSpecificArea`

`<x>/OnNetwork/MCDataGroupList/<x>/Entry/RulesForDeaffiliation/ListOfLocationCriteria/<x>/Entry/EnterSpecificArea`

Status	Occurrence	Format	Min. Access Types
Optional	One	node	Get, Replace

This interior node contains a geographical area which, when entered by the MC service UE triggers evaluation of the rules..

10.2.55B5

`<x>/<x>/OnNetwork/MCDataGroupList/<x>/Entry/
RulesForDeaffiliation/ListOfLocationCriteria/<x>/Entry/
EnterSpecificArea/PolygonArea`

Table 10.2.55B5.1: `<x>/<x>/OnNetwork/MCDataGroupList/<x>/Entry/RulesForDeaffiliation/ListOfLocationCriteria/<x>/Entry/EnterSpecificArea/PolygonArea`

`<x>/OnNetwork/MCDataGroupList/<x>/Entry/RulesForDeaffiliation/ListOfLocationCriteria/<x>/Entry/EnterSpecificArea/PolygonArea`

Status	Occurrence	Format	Min. Access Types
Optional	One	node	Get, Replace

This interior node contains a geographical area described by a polygon.

10.2.55B6

`<x>/<x>/OnNetwork/MCDataGroupList/<x>/Entry/
RulesForDeaffiliation/ListOfLocationCriteria/<x>/Entry/
EnterSpecificArea/PolygonArea/Corner`

Table 10.2.55B6.1: `<x>/<x>/OnNetwork/MCDataGroupList/<x>/Entry/RulesForDeaffiliation/ListOfLocationCriteria/<x>/Entry/EnterSpecificArea/PolygonArea/Corner`

`<x>/OnNetwork/MCDataGroupList/<x>/Entry/RulesForDeaffiliation/ListOfLocationCriteria/<x>/Entry/EnterSpecificArea/PolygonArea/Corner`

Status	Occurrence	Format	Min. Access Types
Required	Three to fifteen	node	Get, Replace

This interior node contains the coordinates of the corners which define a polygon.

10.2.55B7

`/<x>/<x>/OnNetwork/MCDataGroupList/<x>/Entry/
RulesForDeaffiliation/ListOfLocationCriteria/<x>/Entry/
EnterSpecificArea/PolygonArea/Corner/PointCoordinateType`

Table 10.2.55B7.1:

`/<x>/<x>/OnNetwork/MCDataGroupList/<x>/Entry/RulesFordeaffiliation/ListOfLocationCriteria/<x>/Ent
ry/EnterSpecificArea/PolygonArea/Corner/PointCoordinateType`

`<x>/OnNetwork/MCDataGroupList/<x>/Entry/RulesForDeaffiliation/ListOfLocationCriteria/<x>/Entry/EnterSpecific
Area/PolygonArea/Corner/PointCoordinateType`

Status	Occurrence	Format	Min. Access Types
Required	One	node	Get, Replace

This interior node contains the type of the coordinates.

10.2.55B8

`/<x>/<x>/OnNetwork/MCDataGroupList/<x>/Entry/
RulesForDeaffiliation/ListOfLocationCriteria/<x>/Entry/
EnterSpecificArea/PolygonArea/Corner/PointCoordinateType/
Longitude`

Table 10.2.55B8.1:

`/<x>/<x>/OnNetwork/MCDataGroupList/<x>/Entry/RulesForDeaffiliation/ListOfLocationCriteria/<x>/En
try/EnterSpecificArea/PolygonArea/Corner/PointCoordinateType/Longitude`

`<x>/OnNetwork/MCDataGroupList/<x>/Entry/RulesForDeaffiliation/ListOfLocationCriteria/<x>/Entry/EnterSpecific
Area/PolygonArea/Corner/PointCoordinateType/ Longitude /`

Status	Occurrence	Format	Min. Access Types
Required	One	int	Get, Replace

This leaf node contains the longitudinal coordinate of a corner.

10.2.55B9

`/<x>/<x>/OnNetwork/MCDataGroupList/<x>/Entry/
RulesForDeaffiliation/ListOfLocationCriteria/<x>/Entry/
EnterSpecificArea/PolygonArea/Corner/PointCoordinateType/
Latitude`

Table 10.2.55B9.1:

`/<x>/<x>/OnNetwork/MCDataGroupList/<x>/Entry/RulesForAffiliation/ListOfLocationCriteria/<x>/Entry
/EnterSpecificArea/PolygonArea/Corner/PointCoordinateType/Latitude`

`<x>/OnNetwork/MCDataGroupList/<x>/Entry/RulesForAffiliation/ListOfLocationCriteria/<x>/Entry/EnterSpecificA
rea/PolygonArea/Corner/PointCoordinateType/Latitude`

Status	Occurrence	Format	Min. Access Types
Required	One	int	Get, Replace

This leaf node contains the latitudinal coordinate of a corner.

10.2.55B10

/<x>/<x>/OnNetwork/MCDataGroupList/<x>/Entry/
RulesForDeaffiliation/ListOfLocationCriteria/<x>/Entry/
EnterSpecificArea/EllipsoidArcArea

Table 10.2.55B10.1:

/<x>/<x>/OnNetwork/MCDataGroupList/<x>/Entry/RulesForDeaffiliation/ListOfLocationCriteria/<x>/En
try/EnterSpecificArea/EllipsoidArcArea

<x>/OnNetwork/MCDataGroupList/<x>/Entry/RulesForDeaffiliation/ListOfLocationCriteria/<x>/Entry/EnterSpecif
icArea/EllipsoidArcArea

Status	Occurrence	Format	Min. Access Types
Optional	ZeroOrOne	node	Get, Replace

This interior node contains a geographical area described by an ellipsoid arc.

10.2.55B11

/<x>/<x>/OnNetwork/MCDataGroupList/<x>/Entry/
RulesForDeaffiliation/ListOfLocationCriteria/<x>/Entry/
EnterSpecificArea/EllipsoidArcArea/Center

Table 10.2.55B11.1: /<x>/<x>/OnNetwork/MCDataGroupList/<x>/Entry/RulesForDeaffiliation/
ListOfLocationCriteria/<x>/Entry/EnterSpecificArea/EllipsoidArcArea/Center

<x>/OnNetwork/MCDataGroupList/<x>/Entry/RulesForDeaffiliation/ListOfLocationCriteria/<x>/Entry/EnterSpecif
icArea/EllipsoidArcArea/Center

Status	Occurrence	Format	Min. Access Types
Required	One	node	Get, Replace

This interior node contains the coordinates of the center point of the ellipsoid arc.

10.2.55B12

/<x>/<x>/OnNetwork/MCDataGroupList/<x>/Entry/
RulesForDeaffiliation/ListOfLocationCriteria/<x>/Entry/
EnterSpecificArea/EllipsoidArcArea/Center/PointCoordinateType

Table 10.2.55B12.1:

/<x>/<x>/OnNetwork/MCDataGroupList/<x>/Entry/RulesForDeaffiliation/ListOfLocationCriteria/<x>/En
try/EnterSpecificArea/EllipsoidArcArea/Center/PointCoordinateType

<x>/OnNetwork/MCDataGroupList/<x>/Entry/RulesForDeaffiliation/ListOfLocationCriteria/<x>/Entry/EnterSpecif
icArea/EllipsoidArcArea/Center/PointCoordinateType

Status	Occurrence	Format	Min. Access Types
Required	One	node	Get, Replace

This interior node contains the coordinates of the center point of the ellipsoid arc.

10.2.55B13

/<x>/<x>/OnNetwork/MCDataGroupList/<x>/Entry/
 RulesForDeaffiliation/ListOfLocationCriteria/<x>/Entry/
 EnterSpecificArea/EllipsoidArcArea/Center/PointCoordinateType/
 Longitude

Table 10.2.55B13.1:

/<x>/<x>/OnNetwork/MCDataGroupList/<x>/Entry/RulesForDeaffiliation/ListOfLocationCriteria/<x>/En
 try/EnterSpecificArea/EllipsoidArcArea/Center/PointCoordinateType/Longitude

<x>/OnNetwork/MCDataGroupList/<x>/Entry/RulesForDeaffiliation/ListOfLocationCriteria/<x>/Entry/EnterSpecif
 icArea/EllipsoidArcArea/Center/PointCoordinateType/ Longitude /

Status	Occurrence	Format	Min. Access Types
Required	One	int	Get, Replace

This leaf node contains the longitudinal coordinate of the center.

10.2.55B14

/<x>/<x>/OnNetwork/MCDataGroupList/<x>/Entry/
 RulesForDeaffiliation/ListOfLocationCriteria/<x>/Entry/
 EnterSpecificArea/EllipsoidArcArea/Center/PointCoordinateType/
 Latitude

Table 10.2.55B14.1:

/<x>/<x>/OnNetwork/MCDataGroupList/<x>/Entry/RulesForDeaffiliation/ListOfLocationCriteria/<x>/En
 try/EnterSpecificArea/EllipsoidArcArea/Center/PointCoordinateType/Latitude

<x>/OnNetwork/MCDataGroupList/<x>/Entry/RulesForDeaffiliation/ListOfLocationCriteria/<x>/Entry/EnterSpecif
 icArea/EllipsoidArcArea/Center/PointCoordinateType/Latitude

Status	Occurrence	Format	Min. Access Types
Required	One	int	Get, Replace

This leaf node contains the latitudinal coordinate of a center.

10.2.55B15

/<x>/<x>/OnNetwork/MCDataGroupList/<x>/Entry/
 RulesForDeaffiliation/ListOfLocationCriteria/<x>/Entry/
 EnterSpecificArea/EllipsoidArcArea/Radius

Table 10.2.55B15.1:

/<x>/<x>/OnNetwork/MCDataGroupList/<x>/Entry/RulesForDeaffiliation/ListOfLocationCriteria/<x>/En
 try/EnterSpecificArea/EllipsoidArcArea/Radius

<x>/OnNetwork/MCDataGroupList/<x>/Entry/RulesForDeaffiliation/ListOfLocationCriteria/<x>/Entry/EnterSpecif
 icArea/EllipsoidArcArea/Center/Radius

Status	Occurrence	Format	Min. Access Types
Required	One	int	Get, Replace

This leaf node contains the radius of the ellipsoid arc.

10.2.55B16

/<x>/<x>/OnNetwork/MCDataGroupList/<x>/Entry/
RulesForDeaffiliation/ListOfLocationCriteria/<x>/Entry/
EnterSpecificArea/EllipsoidArcArea/OffsetAngle

Table 10.2.55B16.1:

/<x>/<x>/OnNetwork/MCDataGroupList/<x>/Entry/RulesForDeaffiliation/ListOfLocationCriteria/<x>/En
try/EnterSpecificArea/EllipsoidArcArea/OffsetAngle

<x>/OnNetwork/MCDataGroupList/<x>/Entry/RulesForDeaffiliation/ListOfLocationCriteria/<x>/Entry/EnterSpecif
icArea/EllipsoidArcArea/OffsetAngle

Status	Occurrence	Format	Min. Access Types
Required	One	int	Get, Replace

This leaf node contains the offset angle of the ellipsoid arc.

10.2.55B17

/<x>/<x>/OnNetwork/MCDataGroupList/<x>/Entry/
RulesForDeaffiliation/ListOfLocationCriteria/<x>/Entry/
EnterSpecificArea/EllipsoidArcArea/IncludedAngle

Table 10.2.55B17.1:

/<x>/<x>/OnNetwork/MCDataGroupList/<x>/Entry/RulesForDeaffiliation/ListOfLocationCriteria/<x>/En
try/EnterSpecificArea/EllipsoidArcArea/IncludedAngle

<x>/OnNetwork/MCDataGroupList/<x>/Entry/RulesForDeaffiliation/ListOfLocationCriteria/<x>/Entry/EnterSpecif
icArea/EllipsoidArcArea/IncludedAngle

Status	Occurrence	Format	Min. Access Types
Required	One	int	Get, Replace

This leaf node contains the included angle of the ellipsoid arc.

10.2.55B18

/<x>/<x>/OnNetwork/MCDataGroupList/<x>/Entry/
RulesFordeaffiliation/ListOfLocationCriteria/<x>/Entry
/EnterSpecificArea/Speed

Table 10.2.55B18.1:

/<x>/<x>/OnNetwork/MCDataGroupList/<x>/Entry/RulesForDeaffiliation/ListOfLocationCriteria/<x>/En
try/EnterSpecificArea/Speed

<x>/OnNetwork/MCDataGroupList/<x>/Entry/RulesForDeaffiliation/ListOfLocationCriteria/<x>/Entry/EnterSpecif
icArea/Speed

Status	Occurrence	Format	Min. Access Types
Optional	One	node	Get, Replace

This interior node contains the speed.

10.2.55B19

/<x>/<x>/OnNetwork/MCDataGroupList/<x>/Entry/
RulesForDeaffiliation/ListOfLocationCriteria/<x>/Entry/
EnterSpecificArea/Speed/MinimumSpeed

Table 10.2.55B19.1:

/<x>/<x>/OnNetwork/MCDataGroupList/<x>/Entry/RulesForDeaffiliation/ListOfLocationCriteria/<x>/En
try/EnterSpecificArea/Speed/MinimumSpeed

<x>/OnNetwork/MCDataGroupList/<x>/Entry/RulesForDeaffiliation/ListOfLocationCriteria/<x>/Entry/EnterSpecif
icArea/Speed/MinimumSpeed

Status	Occurrence	Format	Min. Access Types
Required	One	int	Get, Replace

This leaf node contains the minimum speed.

- Values: non-negative integer in units of kilometers/hour.

10.2.55B20

/<x>/<x>/OnNetwork/MCDataGroupList/<x>/Entry/
RulesForDeaffiliation/ListOfLocationCriteria/<x>/Entry/
EnterSpecificArea/Speed/MaximumSpeed

Table 10.2.55B20.1:

/<x>/<x>/OnNetwork/MCDataGroupList/<x>/Entry/RulesForDeaffiliation/ListOfLocationCriteria/<x>/En
try/EnterSpecificArea/Speed/MaximumSpeed

<x>/OnNetwork/MCDataGroupList/<x>/Entry/RulesForDeaffiliation/ListOfLocationCriteria/<x>/Entry/EnterSpecif
icArea/Speed/MaximumSpeed

Status	Occurrence	Format	Min. Access Types
Required	One	int	Get, Replace

This leaf node contains the maximum speed.

- Values: non-negative integer in units of kilometers/hour.

10.2.55B21

/<x>/<x>/OnNetwork/MCDataGroupList/<x>/Entry/
RulesForDeaffiliation/ListOfLocationCriteria/<x>/Entry/
EnterSpecificArea/Heading

Table 10.2.55B21.1:

/<x>/<x>/OnNetwork/MCDataGroupList/<x>/Entry/RulesForDeaffiliation/ListOfLocationCriteria/<x>/En
try/EnterSpecificArea/Heading

<x>/OnNetwork/MCDataGroupList/<x>/Entry/RulesForDeaffiliation/ListOfLocationCriteria/<x>/Entry/EnterSpecif
icArea/Heading

Status	Occurrence	Format	Min. Access Types
Optional	One	node	Get, Replace

This interior node contains the heading.

10.2.55B22

/<x>/<x>/OnNetwork/MCDataGroupList/<x>/Entry/
RulesForDeaffiliation/ListOfLocationCriteria/<x>/Entry/
EnterSpecificArea/Heading/MinimumHeading

Table 10.2.55B22.1:

/<x>/<x>/OnNetwork/MCDataGroupList/<x>/Entry/RulesForDeaffiliation/ListOfLocationCriteria/<x>/En
try/EnterSpecificArea/Heading/MinimumHeading

<x>/OnNetwork/MCDataGroupList/<x>/Entry/RulesForDeaffiliation/ListOfLocationCriteria/<x>/Entry/EnterSpecif
icArea/Heading/MinimumHeading

Status	Occurrence	Format	Min. Access Types
Required	One	int	Get, Replace

This leaf node contains the minimum heading.

- Values: 0-359

10.2.55B23

/<x>/<x>/OnNetwork/MCDataGroupList/<x>/Entry/
RulesForDeaffiliation/ListOfLocationCriteria/<x>/Entry/
EnterSpecificArea/Heading/MaximumHeading

Table 10.2.55B23.1:

/<x>/<x>/OnNetwork/MCDataGroupList/<x>/Entry/RulesForDeaffiliation/ListOfLocationCriteria/<x>/En
try/EnterSpecificArea/Heading/MaximumHeading

<x>/OnNetwork/MCDataGroupList/<x>/Entry/RulesForDeaffiliation/ListOfLocationCriteria/<x>/Entry/EnterSpecif
icArea/Heading/Maximum

Status	Occurrence	Format	Min. Access Types
Required	One	int	Get, Replace

This leaf node contains the maximum heading.

- Values: 0-359

10.2.55B24

/<x>/<x>/OnNetwork/MCDataGroupList/<x>/Entry/
RulesForDeaffiliation/ListOfLocationCriteria/<x>/Entry/
ExitSpecificArea

Table 10.2.55B24.1:

/<x>/<x>/OnNetwork/MCDataGroupList/<x>/Entry/RulesForDeaffiliation/ListOfLocationCriteria/<x>/En
try/ExitSpecificArea

<x>/OnNetwork/MCDataGroupList/<x>/Entry/RulesForDeaffiliation/ListOfLocationCriteria/<x>/Entry/ExitSpecific
Area

Status	Occurrence	Format	Min. Access Types
Optional	One	node	Get, Replace

This interior node contains a geographical area which when entered by the MC service UE triggers evaluation of the rules..

10.2.55B25

/<x>/<x>/OnNetwork/MCDataGroupList/<x>/Entry/
RulesForDeaffiliation/ListOfLocationCriteria/<x>/Entry/
ExitSpecificArea/PolygonArea

**Table 10.2.55B25.1: /<x>/<x>/OnNetwork/MCDataGroupList/<x>/Entry/RulesForDeaffiliation/
ListOfLocationCriteria/<x>/Entry/ExitSpecificArea/PolygonArea**

<x>/OnNetwork/MCDataGroupList/<x>/Entry/RulesForDeaffiliation/ListOfLocationCriteria/<x>/Entry/ExitSpecific
Area/PolygonArea

Status	Occurrence	Format	Min. Access Types
Optional	One	node	Get, Replace

This interior node contains a geographical area described by a polygon.

10.2.55B26

/<x>/<x>/OnNetwork/MCDataGroupList/<x>/Entry/
RulesForDeaffiliation/ListOfLocationCriteria/<x>/Entry/
ExitSpecificArea/PolygonArea/Corner

**Table 10.2.55B26.1: /<x>/<x>/OnNetwork/MCDataGroupList/<x>/Entry/RulesForDeaffiliation/
ListOfLocationCriteria/<x>/Entry/ExitSpecificArea/PolygonArea/Corner**

<x>/OnNetwork/MCDataGroupList/<x>/Entry/RulesForDeaffiliation/ListOfLocationCriteria/<x>/Entry/ExitSpecific
Area/PolygonArea/Corner

Status	Occurrence	Format	Min. Access Types
Required	Three to fifteen	node	Get, Replace

This interior node contains the coordinates of the corners which define a polygon.

10.2.55B27

/<x>/<x>/OnNetwork/MCDataGroupList/<x>/Entry/
RulesForDeaffiliation/ListOfLocationCriteria/<x>/Entry/
ExitSpecificArea/PolygonArea/Corner/PointCoordinateType

**Table 10.2.55B27.1:
/<x>/<x>/OnNetwork/MCDataGroupList/<x>/Entry/RulesForDeaffiliation/ListOfLocationCriteria/<x>/En
try/ExitSpecificArea/PolygonArea/Corner/PointCoordinateType**

<x>/OnNetwork/MCDataGroupList/<x>/Entry/RulesForDeaffiliation/ListOfLocationCriteria/<x>/Entry/ExitSpecific
Area/PolygonArea/Corner/PointCoordinateType

Status	Occurrence	Format	Min. Access Types
Required	One	node	Get, Replace

This interior node contains the type of the coordinates.

10.2.55B28

/<x>/<x>/OnNetwork/MCDataGroupList/<x>/Entry/
RulesForDeaffiliation/ListOfLocationCriteria/<x>/Entry/
ExitSpecificArea/PolygonArea/Corner/PointCoordinateType/
Longitude

Table 10.2.55B28.1:

/<x>/<x>/OnNetwork/MCDataGroupList/<x>/Entry/RulesForDeaffiliation/ListOfLocationCriteria/<x>/En
try/ExitSpecificArea/PolygonArea/Corner/PointCoordinateType/Longitude

<x>/OnNetwork/MCDataGroupList/<x>/Entry/RulesForDeaffiliation/ListOfLocationCriteria/<x>/Entry/ExitSpecific
Area/PolygonArea/Corner/PointCoordinateType/ Longitude /

Status	Occurrence	Format	Min. Access Types
Required	One	int	Get, Replace

This leaf node contains the longitudinal coordinate of a corner.

10.2.55B29

/<x>/<x>/OnNetwork/MCDataGroupList/<x>/Entry/
RulesForDeaffiliation/ListOfLocationCriteria/<x>/Entry/
ExitSpecificArea/PolygonArea/Corner/PointCoordinateType/
Latitude

Table 10.2.55B29.1:

/<x>/<x>/OnNetwork/MCDataGroupList/<x>/Entry/RulesForDeaffiliation/ListOfLocationCriteria/<x>/En
try/ExitSpecificArea/PolygonArea/Corner/PointCoordinateType/Latitude

<x>/OnNetwork/MCDataGroupList/<x>/Entry/RulesForDeaffiliation/ListOfLocationCriteria/<x>/Entry/ExitSpecific
Area/PolygonArea/Corner/PointCoordinateType/Latitude

Status	Occurrence	Format	Min. Access Types
Required	One	int	Get, Replace

This leaf node contains the latitudinal coordinate of a corner.

10.2.55B30

/<x>/<x>/OnNetwork/MCDataGroupList/<x>/Entry/
RulesForDeaffiliation/ListOfLocationCriteria/<x>/Entry/
ExitSpecificArea/EllipsoidArcArea

Table 10.2.55B30.1:

/<x>/<x>/OnNetwork/MCDataGroupList/<x>/Entry/RulesForDeaffiliation/ListOfLocationCriteria/<x>/En
try/ExitSpecificArea/EllipsoidArcArea

<x>/OnNetwork/MCDataGroupList/<x>/Entry/RulesForDeaffiliation/ListOfLocationCriteria/<x>/Entry/ExitSpecific
Area/EllipsoidArcArea

Status	Occurrence	Format	Min. Access Types
Optional	ZeroOrOne	node	Get, Replace

This interior node contains a geographical area described by an ellipsoid arc.

10.2.55B31

/<x>/<x>/OnNetwork/MCDataGroupList/<x>/Entry/
RulesForDeaffiliation/ListOfLocationCriteria/<x>/Entry/
ExitSpecificArea/EllipsoidArcArea/Center

Table 10.2.55B31.1:
/<x>/<x>/OnNetwork/MCDataGroupList/<x>/Entry/RulesForDeaffiliation/
ListOfLocationCriteria/<x>/Entry/ExitSpecificArea/EllipsoidArcArea/Center

<x>/OnNetwork/MCDataGroupList/<x>/Entry/RulesForDeaffiliation/ListOfLocationCriteria/<x>/Entry/ExitSpecific
Area/EllipsoidArcArea/Center

Status	Occurrence	Format	Min. Access Types
Required	One	node	Get, Replace

This interior node contains the coordinates of the center point of the ellipsoid arc.

10.2.55B32

/<x>/<x>/OnNetwork/MCDataGroupList/<x>/Entry/
RulesForDeaffiliation/ListOfLocationCriteria/<x>/Entry/
ExitSpecificArea/EllipsoidArcArea/Center/PointCoordinateType

Table 10.2.55B32.1:
/<x>/<x>/OnNetwork/MCDataGroupList/<x>/Entry/RulesForDeaffiliation/ListOfLocationCriteria/<x>/En
try/ExitSpecificArea/EllipsoidArcArea/Center/PointCoordinateType

<x>/OnNetwork/MCDataGroupList/<x>/Entry/RulesForDeaffiliation/ListOfLocationCriteria/<x>/Entry/ExitSpecific
Area/EllipsoidArcArea/Center/PointCoordinateType

Status	Occurrence	Format	Min. Access Types
Required	One	node	Get, Replace

This interior node contains the coordinates of the center point of the ellipsoid arc.

10.2.55B33

/<x>/<x>/OnNetwork/MCDataGroupList/<x>/Entry/
RulesForDeaffiliation/ListOfLocationCriteria/<x>/Entry/
ExitSpecificArea/EllipsoidArcArea/Center/PointCoordinateType/
Longitude

Table 10.2.55B33.1:
/<x>/<x>/OnNetwork/MCDataGroupList/<x>/Entry/RulesForDeaffiliation/ListOfLocationCriteria/<x>/En
try/ExitSpecificArea/EllipsoidArcArea/Center/PointCoordinateType/Longitude

<x>/OnNetwork/MCDataGroupList/<x>/Entry/RulesForDeaffiliation/ListOfLocationCriteria/<x>/Entry/ExitSpecific
Area/EllipsoidArcArea/Center/PointCoordinateType/ Longitude /

Status	Occurrence	Format	Min. Access Types
Required	One	int	Get, Replace

This leaf node contains the longitudinal coordinate of the center.

10.2.55B34

/<x>/<x>/OnNetwork/MCDataGroupList/<x>/Entry/
RulesForDeaffiliation/ListOfLocationCriteria/<x>/Entry/
/ExitSpecificArea/EllipsoidArcArea/Center/PointCoordinateType/
Latitude

Table 10.2.55B34.1:

/<x>/<x>/OnNetwork/MCDataGroupList/<x>/Entry/RulesForDeaffiliation/ListOfLocationCriteria/<x>/En
try/ExitSpecificArea/EllipsoidArcArea/Center/PointCoordinateType/Latitude

<x>/OnNetwork/MCDataGroupList/<x>/Entry/RulesForDeaffiliation/ListOfLocationCriteria/<x>/Entry/ExitSpecific
Area/EllipsoidArcArea/Center/PointCoordinateType/Latitude

Status	Occurrence	Format	Min. Access Types
Required	One	int	Get, Replace

This leaf node contains the latitudinal coordinate of a center.

10.2.55B35

/<x>/<x>/OnNetwork/MCDataGroupList/<x>/Entry/
RulesForDeaffiliation/ListOfLocationCriteria/<x>/Entry/
ExitSpecificArea/EllipsoidArcArea/Radius

Table 10.2.55B35.1:

/<x>/<x>/OnNetwork/MCDataGroupList/<x>/Entry/RulesForDeaffiliation/ListOfLocationCriteria/<x>/En
try/ExitSpecificArea/EllipsoidArcArea/Radius

<x>/OnNetwork/MCDataGroupList/<x>/Entry/RulesForDeaffiliation/ListOfLocationCriteria/<x>/Entry/ExitSpecific
Area/EllipsoidArcArea/Center/Radius

Status	Occurrence	Format	Min. Access Types
Required	One	int	Get, Replace

This leaf node contains the radius of the ellipsoid arc.

10.2.55B36

/<x>/<x>/OnNetwork/MCDataGroupList/<x>/Entry/
RulesForDeaffiliation/ListOfLocationCriteria/<x>/Entry/
ExitSpecificArea/EllipsoidArcArea/OffsetAngle

Table 10.2.55B36.1:

/<x>/<x>/OnNetwork/MCDataGroupList/<x>/Entry/RulesForDeaffiliation/ListOfLocationCriteria/<x>/En
try/ExitSpecificArea/EllipsoidArcArea/OffsetAngle

<x>/OnNetwork/MCDataGroupList/<x>/Entry/RulesForDeaffiliation/ListOfLocationCriteria/<x>/Entry/ExitSpecific
Area/EllipsoidArcArea/OffsetAngle

Status	Occurrence	Format	Min. Access Types
Required	One	int	Get, Replace

This leaf node contains the offset angle of the ellipsoid arc.

10.2.55B37

/<x>/<x>/OnNetwork/MCDataGroupList/<x>/Entry/
RulesForDeaffiliation/ListOfLocationCriteria/<x>/Entry/
ExitSpecificArea/EllipsoidArcArea/IncludedAngle

Table 10.2.55B37.1:

/<x>/<x>/OnNetwork/MCDataGroupList/<x>/Entry/RulesForDeaffiliation/ListOfLocationCriteria/<x>/En
try/ExitSpecificArea/EllipsoidArcArea/IncludedAngle

<x>/OnNetwork/MCDataGroupList/<x>/Entry/RulesForDeaffiliation/ListOfLocationCriteria/<x>/Entry/ExitSpecific
Area/EllipsoidArcArea/IncludedAngle

Status	Occurrence	Format	Min. Access Types
Required	One	int	Get, Replace

This leaf node contains the included angle of the ellipsoid arc.

10.2.55B38

/<x>/<x>/OnNetwork/MCDataGroupList/<x>/Entry/
RulesForDeaffiliation/ListOfLocationCriteria/<x>/Entry/
ExitSpecificArea/Speed

Table 10.2.55B38.1:

/<x>/<x>/OnNetwork/MCDataGroupList/<x>/Entry/RulesForDeaffiliation/ListOfLocationCriteria/<x>/En
try/ExitSpecificArea/Speed

<x>/OnNetwork/MCDataGroupList/<x>/Entry/RulesForDeaffiliation/ListOfLocationCriteria/<x>/Entry/ExitSpecific
Area/Speed

Status	Occurrence	Format	Min. Access Types
Optional	One	node	Get, Replace

This interior node contains the speed.

10.2.55B39

/<x>/<x>/OnNetwork/MCDataGroupList/<x>/Entry/
RulesForDeaffiliation/ListOfLocationCriteria/<x>/Entry/
ExitSpecificArea/Speed/MinimumSpeed

Table 10.2.55B39.1:

/<x>/<x>/OnNetwork/MCDataGroupList/<x>/Entry/RulesForDeaffiliation/ListOfLocationCriteria/<x>/En
try/ExitSpecificArea/Speed/MinimumSpeed

<x>/OnNetwork/MCDataGroupList/<x>/Entry/RulesForDeaffiliation/ListOfLocationCriteria/<x>/Entry/ExitSpecific
Area/Speed/MinimumSpeed

Status	Occurrence	Format	Min. Access Types
Required	One	int	Get, Replace

This leaf node contains the minimum speed.

- Values: non-negative integer in units of kilometers/hour.

10.2.55B40

/<x>/<x>/OnNetwork/MCDataGroupList/<x>/Entry/
RulesForDeaffiliation/ListOfLocationCriteria/<x>/Entry/
ExitSpecificArea/Speed/MaximumSpeed

Table 10.2.55B40.1:

/<x>/<x>/OnNetwork/MCDataGroupList/<x>/Entry/RulesForDeaffiliation/ListOfLocationCriteria/<x>/En
try/ExitSpecificArea/Speed/MaximumSpeed

<x>/OnNetwork/MCDataGroupList/<x>/Entry/RulesForDeaffiliation/ListOfLocationCriteria/<x>/Entry/ExitSpecific
Area/Speed/MaximumSpeed

Status	Occurrence	Format	Min. Access Types
Required	One	int	Get, Replace

This leaf node contains the maximum speed.

- Values: non-negative integer in units of kilometers/hour.

10.2.55B41

/<x>/<x>/OnNetwork/MCDataGroupList/<x>/Entry/
RulesForDeaffiliation/ListOfLocationCriteria/<x>/Entry/
ExitSpecificArea/Heading

Table 10.2.55B41.1:

/<x>/<x>/OnNetwork/MCDataGroupList/<x>/Entry/RulesForDeaffiliation/ListOfLocationCriteria/<x>/En
try/ExitSpecificArea/Heading

<x>/OnNetwork/MCDataGroupList/<x>/Entry/RulesForDeaffiliation/ListOfLocationCriteria/<x>/Entry/ExitSpecific
Area/Heading

Status	Occurrence	Format	Min. Access Types
Optional	One	node	Get, Replace

This interior node contains the heading.

10.2.55B42

/<x>/<x>/OnNetwork/MCDataGroupList/<x>/Entry/
RulesForDeaffiliation/ListOfLocationCriteria/<x>/Entry/
ExitSpecificArea/Heading/MinimumHeading

Table 10.2.55B42.1:

/<x>/<x>/OnNetwork/MCDataGroupList/<x>/Entry/RulesForDeaffiliation/ListOfLocationCriteria/<x>/En
try/ExitSpecificArea/Heading/MinimumHeading

<x>/OnNetwork/MCDataGroupList/<x>/Entry/RulesForDeaffiliation/ListOfLocationCriteria/<x>/Entry/ExitSpecific
Area/Heading/MinimumHeading

Status	Occurrence	Format	Min. Access Types
Required	One	int	Get, Replace

This leaf node contains the minimum heading.

- Values: in the range 0-359.

10.2.55B43

/<x>/<x>/OnNetwork/MCDataGroupList/<x>/Entry/
RulesForDeaffiliation/ListOfLocationCriteria/<x>/Entry/
ExitSpecificArea/Heading/MaximumHeading

Table 10.2.55B43.1:

/<x>/<x>/OnNetwork/MCDataGroupList/<x>/Entry/RulesForDeaffiliation/ListOfLocationCriteria/<x>/En
try/ExitSpecificArea/Heading/MaximumHeading

<x>/OnNetwork/MCDataGroupList/<x>/Entry/RulesForDeaffiliation/ListOfLocationCriteria/<x>/Entry/ExitSpecific
Area/Heading/MaximumHeading

Status	Occurrence	Format	Min. Access Types
Required	One	int	Get, Replace

This leaf node contains the maximum heading.

- Values: 0-359

10.2.55B44

/<x>/<x>/OnNetwork/MCDataGroupList/<x>/Entry/
RulesForDeaffiliation/ListOfActiveFunctionalAliases

Table 10.2.55B44.1:

/<x>/<x>/OnNetwork/MCDataGroupList/<x>/Entry/RulesForDeaffiliation/ListOfActiveFunctionalAliase
s

<x>/OnNetwork/MCDataGroupList/<x>/Entry/RulesForAffiliation/ListOfActiveFunctionalAliases

Status	Occurrence	Format	Min. Access Types
Optional	One	node	Get, Replace

This interior node is a placeholder for the functional alias part of rules that control automatic deaffiliation.

10.2.55B45

/<x>/<x>/OnNetwork/MCDataGroupList/<x>/Entry/
RulesForDeaffiliation/ListOfActiveFunctionalAliases/<x>

Table 10.2.55B45.1:

/<x>/<x>/OnNetwork/MCDataGroupList/<x>/Entry/RulesForDeaffiliation/ListOfActiveFunctionalAliase
s/<x>

<x>/OnNetwork/MCDataGroupList/<x>/Entry/RulesForDeaffiliation/ListOfActiveFunctionalAliases/<x>

Status	Occurrence	Format	Min. Access Types
Optional	OneOrMore	node	Get, Replace

This interior node is a placeholder for the functional alias part of rules that control automatic deaffiliation.

10.2.55B46

/<x>/<x>/OnNetwork/MCDataGroupList/<x>/Entry/
RulesForDeaffiliation/ListOfActiveFunctionalAliases/<x>/Entry

Table 10.2.55B46.1:

/<x>/<x>/OnNetwork/MCDataGroupList/<x>/Entry/RulesForDeaffiliation/ListOfActiveFunctionalAliase
s/<x>/Entry

<x>/OnNetwork/MCDataGroupList/<x>/Entry/RulesForDeaffiliation/ListOfActiveFunctionalAliases/<x>/Entry

Status	Occurrence	Format	Min. Access Types
Optional	One	node	Get, Replace

This interior node is a placeholder for the functional alias part of rules that control automatic deaffiliation.

10.2.55B47

`/<x>/<x>/OnNetwork/MCDataGroupList/<x>/Entry/
RulesForDeaffiliation/ListOfActiveFunctionalAliases/<x>/Entry/
FunctionalAlias`

Table 10.2.55B47.1:

`/<x>/<x>/OnNetwork/MCDataGroupList/<x>/Entry/RulesForDeaffiliation/ListOfActiveFunctionalAliases/<x>/Entry/FunctionalAlias`

`<x>/OnNetwork/MCDataGroupList/<x>/Entry/RulesForDeaffiliation/ListOfActiveFunctionalAliases/<x>/Entry/FunctionalAlias`

Status	Occurrence	Format	Min. Access Types
Required	One	chr	Get, Replace

This leaf node contains a functional alias.

10.2.55B48

`/<x>/<x>/OnNetwork/MCDataGroupList/<x>/Entry/
ManualDeAffiliationNotAllowedIfAffiliationRulesAreMet`

Table 10.2.55B48.1:

`/<x>/<x>/OnNetwork/MCDataGroupList/<x>/Entry/ManualDeAffiliationNotAllowedIfAffiliationRulesAreMet`

`<x>/OnNetwork/MCDataGroupList/<x>/Entry/ManualDeAffiliationNotAllowedIfAffiliationRulesAreMet`

Status	Occurrence	Format	Min. Access Types
Optional	ZeroOrOne	bool	Get, Replace

This leaf node indicates whether the MCData user is authorised to deaffiliate if the location criteria is met.

10.2.56 `/<x>/<x>/OnNetwork/ImplicitAffiliations`

Table 10.2.56.1: `/<x>/<x>/OnNetwork/ImplicitAffiliations`

`<x>/OnNetwork/ImplicitAffiliations`

Status	Occurrence	Format	Min. Access Types
Required	One	node	Get, Replace

This interior node is a placeholder for the implicit affiliation configuration.

10.2.57 `/<x>/<x>/OnNetwork/ImplicitAffiliations/<x>`

Table 10.2.57.1: `/<x>/<x>/OnNetwork/ImplicitAffiliations/<x>`

`<x>/OnNetwork/ImplicitAffiliations/<x>`

Status	Occurrence	Format	Min. Access Types
Required	ZeroOrMore	node	Get, Replace

This interior node is a placeholder for zero or more implicit affiliation configuration.

10.2.58 `/<x>/<x>/OnNetwork/ImplicitAffiliations/<x>/Entry`

Table 10.2.58.1: `/<x>/<x>/OnNetwork/ImplicitAffiliations/<x>/Entry`

`<x>/OnNetwork/ImplicitAffiliations/<x>/Entry`

Status	Occurrence	Format	Min. Access Types

Optional	One	node	Get, Replace
----------	-----	------	--------------

This interior node is a placeholder for the details of the on-network MCDData groups that the MCDData user is implicitly affiliated to.

10.2.59 /<x>/<x>/OnNetwork/ImplicitAffiliations/<x>/Entry/MCDDataGroupID

Table 10.2.59.1: /<x>/<x>/OnNetwork/ImplicitAffiliations/<x>/Entry/MCDDataGroupID

<x>/OnNetwork/ImplicitAffiliations/<x>/Entry/MCDDataGroupID

Status	Occurrence	Format	Min. Access Types
Required	One	chr	Get, Replace

This leaf node indicates a MCDData group ID to which the MCDData user is implicitly affiliated to.

The value is a "uri" attribute specified in OMA OMA-TS-XDM_Group-V1_1 [4].

10.2.60 /<x>/<x>/OnNetwork/ImplicitAffiliations/<x>/Entry/DisplayName

Table 10.2.60.1: /<x>/<x>/OnNetwork/ImplicitAffiliations/<x>/Entry/DisplayName

<x>/OnNetwork/ImplicitAffiliations/<x>/Entry/DisplayName

Status	Occurrence	Format	Min. Access Types
Optional	One	chr	Get, Replace

This leaf node contains a human readable name that corresponds to the MCDData Group ID.

10.2.61 /<x>/<x>/OnNetwork/PresenceStatus

Table 10.2.61.1: /<x>/<x>/OnNetwork/PresenceStatus

<x>/OnNetwork/PresenceStatus

Status	Occurrence	Format	Min. Access Types
Required	One	node	Get, Replace

This interior node is a placeholder for the presence status configuration.

10.2.62 /<x>/<x>/OnNetwork/PresenceStatus/<x>

Table 10.2.62.1: /<x>/<x>/OnNetwork/PresenceStatus/<x>

<x>/OnNetwork/PresenceStatus/<x>

Status	Occurrence	Format	Min. Access Types
Required	ZeroOrMore	node	Get, Replace

This interior node is a placeholder for zero or more presence status configuration.

10.2.63 /<x>/<x>/OnNetwork/PresenceStatus/<x>/Entry

Table 10.2.63.1: /<x>/<x>/OnNetwork/PresenceStatus/<x>/Entry

<x>/OnNetwork/PresenceStatus/<x>/Entry

Status	Occurrence	Format	Min. Access Types
Optional	One	node	Get, Replace

This interior node is a placeholder for the details of the MCDData IDs of MCDData users that the configured MCDData user is authorised to obtain presence status;

10.2.64 /<x>/<x>/OnNetwork/PresenceStatus/<x>/Entry/MCDataID

Table 10.2.64.1: /<x>/<x>/OnNetwork/PresenceStatus/<x>/Entry/MCDataID

<x>/OnNetwork/PresenceStatus/<x>/Entry/MCDataID

Status	Occurrence	Format	Min. Access Types
Required	One	chr	Get, Replace

This leaf node indicates an MCData ID of an MCData user that the configured MCData user is authorised to obtain presence status;

The value is a "uri" attribute specified in OMA OMA-TS-XDM_Group-V1_1 [4].

10.2.65 /<x>/<x>/OnNetwork/PresenceStatus/<x>/Entry/DisplayName

Table 10.2.65.1: /<x>/<x>/OnNetwork/PresenceStatus/<x>/Entry/DisplayName

<x>/OnNetwork/PresenceStatus/<x>/Entry/DisplayName

Status	Occurrence	Format	Min. Access Types
Optional	One	chr	Get, Replace

This leaf node contains a human readable name that corresponds to the MCData ID.

10.2.66 /<x>/<x>/OnNetwork/RemoteGroupChange

Table 10.2.66.1: /<x>/<x>/OnNetwork/RemoteGroupChange

<x>/OnNetwork/RemoteGroupChange

Status	Occurrence	Format	Min. Access Types
Required	One	node	Get, Replace

This interior node is a placeholder for the remote group change configuration.

10.2.67 /<x>/<x>/OnNetwork/RemoteGroupChange/<x>

Table 10.2.67.1: /<x>/<x>/OnNetwork/RemoteGroupChange/<x>

<x>/OnNetwork/RemoteGroupChange/<x>

Status	Occurrence	Format	Min. Access Types
Required	ZeroOrMore	node	Get, Replace

This interior node is a placeholder for zero or more remote group change configuration.

10.2.68 /<x>/<x>/OnNetwork/RemoteGroupChange/<x>/Entry

Table 10.2.68.1: /<x>/<x>/OnNetwork/RemoteGroupChange/<x>/Entry

<x>/OnNetwork/RemoteGroupChange/<x>/Entry

Status	Occurrence	Format	Min. Access Types
Optional	One	node	Get, Replace

This interior node is a placeholder for the details of the MCData IDs of MCData users whose selected groups are authorised to be remotely changed by the configured MCData user;

10.2.69 /<x>/<x>/OnNetwork/RemoteGroupChange/<x>/Entry/MCDataID

Table 10.2.69.1: /<x>/<x>/OnNetwork/RemoteGroupChange/<x>/Entry/MCDataID

<x>/OnNetwork/RemoteGroupChange/<x>/Entry/MCDataID

Status	Occurrence	Format	Min. Access Types
Optional	One	chr	Get, Replace

Required	One	chr	Get, Replace
----------	-----	-----	--------------

This leaf node indicates an MCDData ID of an MCDData user whose selected groups are authorised to be remotely changed by the configured MCDData user;

The value is a "uri" attribute specified in OMA OMA-TS-XDM_Group-V1_1 [4].

10.2.70 /<x>/<x>/OnNetwork/RemoteGroupChange/<x>/Entry/DisplayName

Table 10.2.70.1: /<x>/<x>/OnNetwork/RemoteGroupChange/<x>/Entry/DisplayName

<x>/OnNetwork/RemoteGroupChange/<x>/Entry/DisplayName

Status	Occurrence	Format	Min. Access Types
Optional	One	chr	Get, Replace

This leaf node contains a human readable name that corresponds to the MCDData ID.

10.2.71 /<x>/<x>/OnNetwork/MaxAffiliationsN2

Table 10.2.71.1: /<x>/<x>/OnNetwork/MaxAffiliationsN2

<x>/OnNetwork/MaxAffiliationsN2

Status	Occurrence	Format	Min. Access Types
Optional	One	int	Get, Replace

This leaf node indicates the maximum number of MCDData groups that the MCDData user is authorised to affiliate with.

- Values: 0-65535

10.2.72 /<x>/<x>/OnNetwork/ConversationManagement

Table 10.2.72.1: /<x>/<x>/OnNetwork/ConversationManagement

<x>/OnNetwork/ConversationManagement

Status	Occurrence	Format	Min. Access Types
Required	One	node	Get, Replace

This interior node is a placeholder for conversation management configuration

10.2.73 /<x>/<x>/OnNetwork/ConversationManagement/GroupHangTime

Table 10.2.73.1: /<x>/<x>/OnNetwork/ConversationManagement/GroupHangTime

<x>/OnNetwork/ConversationManagement/GroupHangTime

Status	Occurrence	Format	Min. Access Types
Required	One	node	Get, Replace

This interior node is a placeholder for group hang time configuration

10.2.74

/<x>/<x>/OnNetwork/ConversationManagement/GroupHangTime/<x>
>

Table 10.2.74.1: /<x>/<x>/OnNetwork/ConversationManagement/GroupHangTime/<x>

<x>/OnNetwork/ConversationManagement/GroupHangTime/<x>

Status	Occurrence	Format	Min. Access Types
Required	OneOrMore	node	Get, Replace

This interior node is a placeholder for one or more hang time configurations.

10.2.75

`<x>/<x>/OnNetwork/ConversationManagement/GroupHangTime/<x>/Entry`

Table 10.2.75.1: `<x>/<x>/OnNetwork/ConversationManagement/GroupHangTime/<x>/Entry`

`<x>/OnNetwork/ConversationManagement/GroupHangTime/<x>/Entry`

Status	Occurrence	Format	Min. Access Types
Optional	One	node	Get, Replace

This interior node is a placeholder for the conversation hang time configuration associated with the configured MCDData group, for the MCDData user.

10.2.76

`<x>/<x>/OnNetwork/ConversationManagement/GroupHangTime/<x>/Entry/MCDDataGroupID`

Table 10.2.76.1:

`<x>/<x>/OnNetwork/ConversationManagement/GroupHangTime/<x>/Entry/MCDDataGroupID`

`<x>/OnNetwork/ConversationManagement/GroupHangTime/<x>/Entry/MCDDataGroupID`

Status	Occurrence	Format	Min. Access Types
Required	One	chr	Get, Replace

This leaf node indicates the MCDData group ID for the on-network MCDData group.

The value is a "uri" attribute specified in OMA OMA-TS-XDM_Group-V1_1 [4].

10.2.77

`<x>/<x>/OnNetwork/ConversationManagement/GroupHangTime/<x>/Entry/DisplayName`

Table 10.2.77.1:

`<x>/<x>/OnNetwork/ConversationManagement/GroupHangTime/<x>/Entry/DisplayName`

`<x>/OnNetwork/ConversationManagement/GroupHangTime/<x>/Entry/DisplayName`

Status	Occurrence	Format	Min. Access Types
Optional	One	chr	Get, Replace

This leaf node contains a human readable name that corresponds to the MCDData Group ID.

10.2.78

`<x>/<x>/OnNetwork/ConversationManagement/GroupHangTime/<x>/Entry/HangTime`

Table 10.2.78.1: `<x>/<x>/OnNetwork/ConversationManagement/GroupHangTime/<x>/Entry/HangTime`

`<x>/OnNetwork/ConversationManagement/GroupHangTime/<x>/Entry/HangTime`

Status	Occurrence	Format	Min. Access Types
Required	One	int	Get, Replace

This leaf node indicates the group call hang timer of the MCDData group for conversation management, for the MCDData user.

- Values: 0-65535

The HangTime is in seconds.

10.2.79

`<x>/<x>/OnNetwork/ConversationManagement/DeliveredDisposition`

Table 10.2.79.1: `<x>/<x>/OnNetwork/ConversationManagement/DeliveredDisposition`

`<x>/OnNetwork/ConversationManagement/DeliveredDisposition`

Status	Occurrence	Format	Min. Access Types
Required	One	node	Get, Replace

This interior node is a placeholder for delivered disposition configuration

10.2.80

`<x>/<x>/OnNetwork/ConversationManagement/DeliveredDisposition/<x>`

Table 10.2.80.1: `<x>/<x>/OnNetwork/ConversationManagement/DeliveredDisposition/<x>`

`<x>/OnNetwork/ConversationManagement/DeliveredDisposition/<x>`

Status	Occurrence	Format	Min. Access Types
Required	ZeroOrMore	node	Get, Replace

This interior node is a placeholder for zero or more delivered disposition configurations.

10.2.81

`<x>/<x>/OnNetwork/ConversationManagement/DeliveredDisposition/<x>/Entry`

Table 10.2.81.1: `<x>/<x>/OnNetwork/ConversationManagement/DeliveredDisposition/<x>/Entry`

`<x>/OnNetwork/ConversationManagement/DeliveredDisposition/<x>/Entry`

Status	Occurrence	Format	Min. Access Types
Optional	One	node	Get, Replace

This interior node is a placeholder for the delivered disposition configuration associated with the MCDData user, indicating an MCDData ID of an MCDData user who is to be sent a message delivered disposition notification in addition to the message sender;

10.2.82

`<x>/<x>/OnNetwork/ConversationManagement/DeliveredDisposition/<x>/Entry/MCDDataID`

Table 10.2.82.1:

`<x>/<x>/OnNetwork/ConversationManagement/DeliveredDisposition/<x>/Entry/MCDDataID`

`<x>/OnNetwork/ConversationManagement/DeliveredDisposition/<x>/Entry/MCDDataID`

Status	Occurrence	Format	Min. Access Types
Required	One	chr	Get, Replace

This leaf node indicates the MCDData ID for the on-network MCDData user.

The value is a "uri" attribute specified in OMA OMA-TS-XDM_Group-V1_1 [4].

10.2.83 /<x>/<x>/OnNetwork/ConversationManagement/DeliveredDisposition/<x>/Entry/DisplayName

Table 10.2.83.1:

/<x>/<x>/OnNetwork/ConversationManagement/DeliveredDisposition/<x>/Entry/DisplayName

<x>/OnNetwork/ConversationManagement/DeliveredDisposition/<x>/Entry/DisplayName

Status	Occurrence	Format	Min. Access Types
Optional	One	chr	Get, Replace

This leaf node contains a human readable name that corresponds to the MCDData ID.

10.2.84 /<x>/<x>/OnNetwork/ConversationManagement/ReadDisposition

Table 10.2.84.1: /<x>/<x>/OnNetwork/ConversationManagement/ReadDisposition

<x>/OnNetwork/ConversationManagement/ReadDisposition

Status	Occurrence	Format	Min. Access Types
Required	One	node	Get, Replace

This interior node is a placeholder for read disposition configuration

10.2.85

/<x>/<x>/OnNetwork/ConversationManagement/ReadDisposition/<x>
>

Table 10.2.85.1: /<x>/<x>/OnNetwork/ConversationManagement/ReadDisposition/<x>

<x>/OnNetwork/ConversationManagement/ReadDisposition/<x>

Status	Occurrence	Format	Min. Access Types
Required	ZeroOrMore	node	Get, Replace

This interior node is a placeholder for zero or more read disposition configurations.

10.2.86

/<x>/<x>/OnNetwork/ConversationManagement/ReadDisposition/<x>
>/Entry

Table 10.2.86.1: /<x>/<x>/OnNetwork/ConversationManagement/ReadDisposition/<x>/Entry

<x>/OnNetwork/ConversationManagement/ReadDisposition/<x>/Entry

Status	Occurrence	Format	Min. Access Types
Optional	One	node	Get, Replace

This interior node is a placeholder for the read disposition configuration associated with the MCDData user, indicating an MCDData ID of an MCDData user who is to be sent a message read disposition notification in addition to the message sender;

10.2.87

/<x>/<x>/OnNetwork/ConversationManagement/ReadDisposition/<x>
>/Entry/MCDDataID

Table 10.2.87.1: /<x>/<x>/OnNetwork/ConversationManagement/ReadDisposition/<x>/Entry/MCDDataID

<x>/OnNetwork/ConversationManagement/ReadDisposition/<x>/Entry/MCDDataID

Status	Occurrence	Format	Min. Access Types
Required	One	chr	Get, Replace

This leaf node indicates the MCDData ID for the on-network MCDData user.

The value is a "uri" attribute specified in OMA OMA-TS-XDM_Group-V1_1 [4].

10.2.88

`<x>/<x>/OnNetwork/ConversationManagement/ReadDisposition/<x>/Entry/DisplayName`

Table 10.2.88.1:

`<x>/<x>/OnNetwork/ConversationManagement/ReadDisposition/<x>/Entry/DisplayName`

`<x>/OnNetwork/ConversationManagement/ReadDisposition/<x>/Entry/DisplayName`

Status	Occurrence	Format	Min. Access Types
Optional	One	chr	Get, Replace

This leaf node contains a human readable name that corresponds to the MCDData ID.

10.2.89 `<x>/<x>/OnNetwork/OneToOneEmergencyAlert`

Table 10.2.89.1: `<x>/<x>/OnNetwork/OneToOneEmergencyAlert`

`<x>/OnNetwork/OneToOneEmergencyAlert`

Status	Occurrence	Format	Min. Access Types
Required	One	node	Get, Replace

This interior node is a placeholder for on-network one-to-one emergency alert configuration.

10.2.90 `<x>/<x>/OnNetwork/OneToOneEmergencyAlert/Entry`

Table 10.2.90.1: `<x>/<x>/OnNetwork/OneToOneEmergencyAlert/Entry`

`<x>/OnNetwork/OneToOneEmergencyAlert/Entry`

Status	Occurrence	Format	Min. Access Types
Required	One	node	Get, Replace

This interior node is a placeholder for the details of the MCDData ID of an MCDData emergency alert.

10.2.91 `<x>/<x>/OnNetwork/OneToOneEmergencyAlert/Entry/ID`

Table 10.2.91.1: `<x>/<x>/OnNetwork/OneToOneEmergencyAlert/Entry/ID`

`<x>/OnNetwork/OneToOneEmergencyAlert/Entry/ID`

Status	Occurrence	Format	Min. Access Types
Required	One	chr	Get, Replace

This leaf node indicates the MCDData user ID used upon certain criteria on initiation of a one-to-one MCDData emergency alert.

10.2.92 `<x>/<x>/OnNetwork/OneToOneEmergencyAlert/Entry/DisplayName`

Table 10.2.92.1: `<x>/<x>/OnNetwork/OneToOneEmergencyAlert/Entry/DisplayName`

`<x>/OnNetwork/OneToOneEmergencyAlert/Entry/DisplayName`

Status	Occurrence	Format	Min. Access Types
Optional	One	chr	Get, Replace

This leaf node contains a human readable name that corresponds to the ID.

10.2.93 /<x>/<x>/OnNetwork/OneToOneEmergencyAlert/Entry/Usage

Table 10.2.93.1: /<x>/<x>/OnNetwork/OneToOneEmergencyAlert/Entry/Usage

<x>/OnNetwork/OneToOneEmergencyAlert/Entry/Usage

Status	Occurrence	Format	Min. Access Types
Required	One	chr	Get, Replace

This leaf node indicates the criteria to determine when initiation of an MCDATA emergency alert uses the ID.

The valid values are 'LocallyDetermined' and 'UsePreConfigured'.

When set to 'LocallyDetermined' then if the MCDATA user selects an MCDATA ID then use that MCDATA ID for an on-network MCDATA emergency alert, if the MCDATA user does not select a MCDATA ID then use the MCDATA ID identified by the ID in subclause 10.2.91 for an on-network MCDATA emergency alert.

When set to 'UsePreConfigured' then use the ID identified by the ID in subclause 10.2.91 for an on-network MCDATA emergency alert.

10.2.94 /<x>/<x>/OnNetwork/AllowedRegroup

Table 10.2.94.1: /<x>/<x>/OnNetwork/AllowedRegroup

<x>/OnNetwork/AllowedRegroup

Status	Occurrence	Format	Min. Access Types
Required	One	bool	Get, Replace

This leaf node indicates whether the MCDATA user is authorised to perform dynamic regrouping operations.

When set to "true" the MCDATA user is authorised to perform dynamic regrouping operations.

When set to "false" the MCDATA user is not authorised to perform dynamic regrouping operations.

10.2.95 /<x>/<x>/OnNetwork/AllowedPresenceStatus

Table 10.2.95.1: /<x>/<x>/OnNetwork/AllowedPresenceStatus

<x>/OnNetwork/AllowedPresenceStatus

Status	Occurrence	Format	Min. Access Types
Optional	One	bool	Get, Replace

This leaf node indicates the presence status on the network of this MCDATA user is available.

When set to "true" the presence status on the network of this MCDATA user is available.

When set to "false" the presence status on the network of this MCDATA user is not available. This is the default if this leaf node is not present.

10.2.96 /<x>/<x>/OnNetwork/AllowedPresence

Table 10.2.96.1: /<x>/<x>/OnNetwork/AllowedPresence

<x>/OnNetwork/AllowedPresence

Status	Occurrence	Format	Min. Access Types
Optional	One	bool	Get, Replace

This leaf node indicates whether the MCDATA user is authorised to obtain whether a particular MCDATA User is present on the network.

When set to "true" the MCDATA user is authorised to obtain whether a particular MCDATA User is present on the network.

When set to "false" the MCDData user is not authorised to obtain whether a particular MCDData User is present on the network.

10.2.97 /<x>/<x>/OnNetwork/AllowedManualSwitch

Table 10.2.97.1: /<x>/<x>/OnNetwork/AllowedManualSwitch

<x>/OnNetwork/AllowedManualSwitch

Status	Occurrence	Format	Min. Access Types
Required	One	bool	Get, Replace

This leaf node indicates whether the MCDData user is authorised to manually switch to off-network operation while in on-network operation.

When set to "true" the MCDData user is authorised to manually switch to off-network operation while in on-network operation.

When set to "false" the MCDData user is not authorised to manually switch to off-network operation while in on-network operation.

10.2.97A /<x>/<x>/OnNetwork/MCDDataContentServerURI

Table 10.2.97A.1: /<x>/<x>/OnNetwork/MCDDataContentServerURI

<x>/OnNetwork/MCDDataContentServerURI

Status	Occurrence	Format	Min. Access Types
Required	One	chr	Get, Replace

This leaf node indicates the absolute URI associated with the media storage function of the MCDData content server.

The value is a URI as specified in 3GPP TS 23.003 [5].

10.2.97B /<x>/<x>/OnNetwork/FunctionalAliasList

Table 10.2.97B.1: /<x>/<x>/OnNetwork/FunctionalAliasList

<x>/OnNetwork/FunctionalAliasList

Status	Occurrence	Format	Min. Access Types
Required	One	node	Get, Replace

This interior node is a placeholder for the functional alias configuration.

10.2.97B1 /<x>/<x>/OnNetwork/FunctionalAliasList/<x>

Table 10.2.97B1.1: /<x>/<x>/OnNetwork/FunctionalAliasList/<x>

<x>/OnNetwork/FunctionalAliasList/<x>

Status	Occurrence	Format	Min. Access Types
Required	OneOrMore	node	Get, Replace

This interior node is a placeholder for one or more functional alias configuration elements.

10.2.97B2 /<x>/<x>/OnNetwork/FunctionalAliasList/<x>/Entry

Table 10.2.97B2.1: /<x>/<x>/OnNetwork/FunctionalAliasList/<x>/Entry

<x>/OnNetwork/FunctionalAliasList/<x>/Entry

Status	Occurrence	Format	Min. Access Types
Optional	One	node	Get, Replace

This interior node is a placeholder for the details of the functional alias.

10.2.97B3

`<x>/<x>/OnNetwork/FunctionalAliasList/<x>/Entry/FunctionalAlias`

Table 10.2.97B3.1: `<x>/<x>/OnNetwork/FunctionalAliasList/<x>/Entry/ FunctionalAlias`

`<x>/OnNetwork/FunctionalAliasList/<x>/ Entry/FunctionalAlias`

Status	Occurrence	Format	Min. Access Types
Required	One	chr	Get, Replace

This leaf node indicates a functional alias that can be activated by the MCDData user.

The value is a "uri" attribute specified in OMA OMA-TS-XDM_Group-V1_1 [4].

10.2.97B3A

`<x>/<x>/OnNetwork/FunctionalAliasList/<x>/Entry/DisplayName`

Table 10.2.97B3A.1: `<x>/<x>/OnNetwork/FunctionalAliasList/<x>/Entry/DisplayName`

`<x>/OnNetwork/FunctionalAliasList/<x>/Entry/DisplayName`

Status	Occurrence	Format	Min. Access Types
Optional	One	chr	Get, Replace

This leaf node contains a human readable name that corresponds to a functional alias that can be activated by the MCDData user.

10.2.97B3B

`<x>/<x>/OnNetwork/FunctionalAliasList/<x>/Entry/
LocationCriteriaForActivation`

Table 10.2.97B3B.1: `<x>/<x>/OnNetwork/FunctionalAliasList/<x>/Entry/LocationCriteriaForActivation`

`<x>/OnNetwork/FunctionalAliasList/<x>/Entry/LocationCriteriaForActivation`

Status	Occurrence	Format	Min. Access Types
Optional	ZeroOrOne	node	Get, Replace

This interior node contains the location criteria for activation of a functional alias.

10.2.97B3B1

`<x>/<x>/OnNetwork/FunctionalAliasList/<x>/Entry/
LocationCriteriaForActivation/EnterSpecificArea`

Table 10.2.97B3B1.1:

`<x>/<x>/OnNetwork/FunctionalAliasList/<x>/Entry/LocationCriteriaForActivation/EnterSpecificArea`

`<x>/OnNetwork/FunctionalAliasList/<x>/Entry/LocationCriteriaForActivation/EnterSpecificArea`

Status	Occurrence	Format	Min. Access Types
Optional	ZeroOrMore	node	Get, Replace

This interior node contains a geographical area which when entered by the MC service UE triggers the functional alias activation.

10.2.97B3B2

/<x>/<x>/OnNetwork/FunctionalAliasList/<x>/Entry/
LocationCriteriaForActivation/EnterSpecificArea/PolygonArea

Table 10.2.97B3B2.1:

/<x>/<x>/OnNetwork/FunctionalAliasList/<x>/Entry/LocationCriteriaForActivation/EnterSpecificArea/
PolygonArea

<x>/OnNetwork/FunctionalAliasList/<x>/Entry/LocationCriteriaForActivation/EnterSpecificArea/PolygonArea

Status	Occurrence	Format	Min. Access Types
Optional	ZeroOrOne	node	Get, Replace

This interior node contains a geographical area described by a polygon.

10.2.97B3B3

/<x>/<x>/OnNetwork/FunctionalAliasList/<x>/Entry/
LocationCriteriaForActivation/EnterSpecificArea/PolygonArea/
Corner

Table 10.2.97B3B3.1:

/<x>/<x>/OnNetwork/FunctionalAliasList/<x>/Entry/LocationCriteriaForActivation/EnterSpecificArea/
PolygonArea/Corner

<x>/OnNetwork/FunctionalAliasList/<x>/Entry/LocationCriteriaForActivation/EnterSpecificArea/PolygonArea/
Corner

Status	Occurrence	Format	Min. Access Types
Required	ThreeToFifteen	node	Get, Replace

This interior node contains the coordinates of the corners which define a polygon.

10.2.97B3B4

/<x>/<x>/OnNetwork/FunctionalAliasList/<x>/Entry/
LocationCriteriaForActivation/EnterSpecificArea/PolygonArea/
Corner/PointCoordinateType

Table 10.2.97B3B4.1:

/<x>/<x>/OnNetwork/FunctionalAliasList/<x>/Entry/LocationCriteriaForActivation/EnterSpecificArea/P
olygonArea/Corner/PointCoordinateType

<x>/OnNetwork/FunctionalAliasList/<x>/Entry/LocationCriteriaForActivation/EnterSpecificArea/PolygonArea/Cor
ner/PointCoordinateType

Status	Occurrence	Format	Min. Access Types
Required	One	node	Get, Replace

This interior node contains the coordinates of the center point of the ellipsoid arc.

10.2.97B3B5

`<x>/<x>/OnNetwork/FunctionalAliasList/<x>/Entry/
LocationCriteriaForActivation/EnterSpecificArea/PolygonArea/
Corner/PointCoordinateType/Longitude`

Table 10.2.97B3B5.1:

`<x>/<x>/OnNetwork/FunctionalAliasList/<x>/Entry/LocationCriteriaForActivation/EnterSpecificArea/
PolygonArea/Corner/PointCoordinateType/Longitude`

`<x>/OnNetwork/FunctionalAliasList/<x>/Entry/LocationCriteriaForActivation/EnterSpecificArea/PolygonArea/
Corner/PointCoordinateType/Longitude`

Status	Occurrence	Format	Min. Access Types
Required	One	int	Get, Replace

This leaf node contains the longitudinal coordinate of a corner.

- Values: 0-16777215

10.2.97B3B6

`<x>/<x>/OnNetwork/FunctionalAliasList/<x>/Entry/
LocationCriteriaForActivation/EnterSpecificArea/PolygonArea/
Corner/PointCoordinateType/Latitude`

Table 10.2.97B3B6.1:

`<x>/<x>/OnNetwork/FunctionalAliasList/<x>/Entry/LocationCriteriaForActivation/EnterSpecificArea/
PolygonArea/Corner/PointCoordinateType/Latitude`

`<x>/OnNetwork/FunctionalAliasList/<x>/Entry/LocationCriteriaForActivation/EnterSpecificArea/
PolygonArea/Corner/PointCoordinateType/Latitude`

Status	Occurrence	Format	Min. Access Types
Required	One	int	Get, Replace

This leaf node contains the latitudinal coordinate of a corner.

- Values: 0-16777215

10.2.97B3B7

`<x>/<x>/OnNetwork/FunctionalAliasList/<x>/Entry/
LocationCriteriaForActivation/EnterSpecificArea/EllipsoidArcArea`

Table 10.2.97B3B7.1:

`<x>/<x>/OnNetwork/FunctionalAliasList/<x>/Entry/LocationCriteriaForActivation/EnterSpecificArea/
EllipsoidArcArea`

`<x>/OnNetwork/FunctionalAliasList/<x>/Entry/LocationCriteriaForActivation/EnterSpecificArea/EllipsoidArcArea`

Status	Occurrence	Format	Min. Access Types
Optional	ZeroOrOne	node	Get, Replace

This interior node contains a geographical area described by an ellipsoid arc.

10.2.97B3B8

`<x>/<x>/OnNetwork/FunctionalAliasList/<x>/Entry/LocationCriteriaForActivation/EnterSpecificArea/EllipsoidArcArea/Center`

Table 10.2.97B3B8.1:

`<x>/<x>/OnNetwork/FunctionalAliasList/<x>/Entry/LocationCriteriaForActivation/EnterSpecificArea/EllipsoidArcArea/Center`

`<x>/OnNetwork/FunctionalAliasList/<x>/Entry/LocationCriteriaForActivation/EnterSpecificArea/EllipsoidArcArea/Center`

Status	Occurrence	Format	Min. Access Types
Required	One	node	Get, Replace

This interior node contains the coordinates of the center point of the ellipsoid arc.

10.2.97B3B9

`<x>/<x>/OnNetwork/FunctionalAliasList/<x>/Entry/LocationCriteriaForActivation/EnterSpecificArea/EllipsoidArcArea/Center/PointCoordinateType`

Table 10.2.97B3B9.1:

`<x>/<x>/OnNetwork/FunctionalAliasList/<x>/Entry/LocationCriteriaForActivation/EnterSpecificArea/EllipsoidArcArea/Center/PointCoordinateType`

`<x>/<x>/OnNetwork/FunctionalAliasList/<x>/Entry/LocationCriteriaForActivation/EnterSpecificArea/EllipsoidArcArea/Center/PointCoordinateType`

Status	Occurrence	Format	Min. Access Types
Required	One	node	Get, Replace

This interior node contains the coordinates of the center point of the ellipsoid arc.

10.2.97B3B10

`<x>/<x>/OnNetwork/FunctionalAliasList/<x>/Entry/LocationCriteriaForActivation/EnterSpecificArea/EllipsoidArcArea/Center/PointCoordinateType/Longitude`

Table 10.2.97B3B10.1:

`<x>/<x>/OnNetwork/FunctionalAliasList/<x>/Entry/LocationCriteriaForActivation/EnterSpecificArea/EllipsoidArcArea/Center/PointCoordinateType/Longitude`

`<x>/OnNetwork/FunctionalAliasList/<x>/Entry/LocationCriteriaForActivation/EnterSpecificArea/EllipsoidArcArea/Center/PointCoordinateType/Longitude`

Status	Occurrence	Format	Min. Access Types
Required	One	int	Get, Replace

This leaf node contains the longitudinal coordinate of the center.

- Values: 0-16777215

10.2.97B3B11

/<x>/<x>/OnNetwork/FunctionalAliasList/<x>/Entry/
LocationCriteriaForActivation/EnterSpecificArea/EllipsoidArcArea/
Center/PointCoordinateType/Latitude

Table 10.2.97B3B11.1:

/<x>/<x>/OnNetwork/FunctionalAliasList/<x>/Entry/LocationCriteriaForActivation/EnterSpecificArea/E
llipsoidArcArea/Center/PointCoordinateType/Latitude

<x>/OnNetwork/FunctionalAliasList/<x>/Entry/LocationCriteriaForActivation/EnterSpecificArea/EllipsoidArcArea/
Center/PointCoordinateType/Latitude

Status	Occurrence	Format	Min. Access Types
Required	One	int	Get, Replace

This leaf node contains the latitudinal coordinate of the center.

- Values: 0-16777215

10.2.97B3B12

/<x>/<x>/OnNetwork/FunctionalAliasList/<x>/Entry/
LocationCriteriaForActivation/EnterSpecificArea/EllipsoidArcArea/
Radius

Table 10.2.97B3B12.1:

/<x>/<x>/OnNetwork/FunctionalAliasList/<x>/Entry/LocationCriteriaForActivation/EnterSpecificArea/
EllipsoidArcArea/Radius

<x>/OnNetwork/FunctionalAliasList/<x>/Entry/LocationCriteriaForActivation/EnterSpecificArea/EllipsoidArcArea/
Radius

Status	Occurrence	Format	Min. Access Types
Required	One	int	Get, Replace

This leaf node contains the radius of the ellipsoid arc.

- Values: non-negative integer

10.2.97B3B13

/<x>/<x>/OnNetwork/FunctionalAliasList/<x>/Entry/
LocationCriteriaForActivation/EnterSpecificArea/EllipsoidArcArea/
OffsetAngle

Table 10.2.97B3B13.1:

/<x>/<x>/OnNetwork/FunctionalAliasList/<x>/Entry/LocationCriteriaForActivation/EnterSpecificArea/
EllipsoidArcArea/OffsetAngle

<x>/OnNetwork/FunctionalAliasList/<x>/Entry/LocationCriteriaForActivation/EnterSpecificArea/EllipsoidArcArea/
OffsetAngle

Status	Occurrence	Format	Min. Access Types
Required	One	int	Get, Replace

This leaf node contains the offset angle of the ellipsoid arc.

- Values: 0-255

10.2.97B3B14

/<x>/<x>/OnNetwork/FunctionalAliasList/<x>/Entry/
LocationCriteriaForActivation/EnterSpecificArea/EllipsoidArcArea/
IncludedAngle

Table 10.2.97B3B14.1:

/<x>/<x>/OnNetwork/FunctionalAliasList/<x>/Entry/LocationCriteriaForActivation/EnterSpecificArea/
EllipsoidArcArea/IncludedAngle

<x>/OnNetwork/FunctionalAliasList/<x>/Entry/LocationCriteriaForActivation/EnterSpecificArea/EllipsoidArcArea/
IncludedAngle

Status	Occurrence	Format	Min. Access Types
Required	One	int	Get, Replace

This leaf node contains the included angle of the ellipsoid arc.

- Values: 0-255

10.2.97B3B15

/<x>/<x>/OnNetwork/FunctionalAliasList/<x>/Entry/
LocationCriteriaForActivation/EnterSpecificArea/Speed

Table 10.2.97B3B15.1:

/<x>/<x>/OnNetwork/FunctionalAliasList/<x>/Entry/LocationCriteriaForActivation/EnterSpecificArea/S
peed

/<x>/OnNetwork/FunctionalAliasList/<x>/Entry/LocationCriteriaForActivation/EnterSpecificArea/Speed

Status	Occurrence	Format	Min. Access Types
Optional	One	node	Get, Replace

This interior node contains the speed.

10.2.97B3B16

/<x>/<x>/OnNetwork/FunctionalAliasList/<x>/Entry/
LocationCriteriaForActivation/EnterSpecificArea/Speed/
MinimumSpeed

Table 10.2.97B3B16.1:

/<x>/<x>/OnNetwork/FunctionalAliasList/<x>/Entry/LocationCriteriaForActivation/EnterSpecificAre
a/Speed/MinimumSpeed

<x>/OnNetwork/FunctionalAliasList/<x>/Entry/LocationCriteriaForActivation/EnterSpecificArea/Speed/MinimumS
peed

Status	Occurrence	Format	Min. Access Types
Required	One	int	Get, Replace

This leaf node contains the minimum speed.

- Values: non-negative integer in units of kilometers/hour.

10.2.97B3B17

`/<x>/<x>/OnNetwork/FunctionalAliasList/<x>/Entry/
LocationCriteriaForActivation/EnterSpecificArea/Speed/
MaximumSpeed`

Table 10.2.97B3B17.1:

`/<x>/<x>/OnNetwork/FunctionalAliasList/<x>/Entry/LocationCriteriaForActivation/EnterSpecificArea/Speed/MaximumSpeed`

`<x>/OnNetwork/FunctionalAliasList/<x>/Entry/LocationCriteriaForActivation/EnterSpecificArea/Speed/MaximumSpeed`

Status	Occurrence	Format	Min. Access Types
Required	One	int	Get, Replace

This leaf node contains the maximum speed.

- Values: non-negative integer in units of kilometers/hour.

10.2.97B3B18

`/<x>/<x>/OnNetwork/FunctionalAliasList/<x>/Entry/
LocationCriteriaForActivation/EnterSpecificArea/Heading`

Table 10.2.97B3B18.1:

`/<x>/<x>/OnNetwork/FunctionalAliasList/<x>/Entry/LocationCriteriaForActivation/EnterSpecificArea/Heading`

`<x>/OnNetwork/FunctionalAliasList/<x>/Entry/LocationCriteriaForActivation/EnterSpecificArea/Heading`

Status	Occurrence	Format	Min. Access Types
Optional	One	node	Get, Replace

This interior node contains the heading.

10.2.97B3B19

`/<x>/<x>/OnNetwork/FunctionalAliasList/<x>/Entry/
LocationCriteriaForActivation/EnterSpecificArea/Heading/
MinimumHeading`

Table 10.2.97B3B19.1:

`/<x>/<x>/OnNetwork/FunctionalAliasList/<x>/Entry/LocationCriteriaForActivation/EnterSpecificArea/Heading/MinimumHeading`

`<x>/OnNetwork/FunctionalAliasList/<x>/Entry/LocationCriteriaForActivation/EnterSpecificArea/Heading/MinimumHeading`

Status	Occurrence	Format	Min. Access Types
Required	One	int	Get, Replace

This leaf node contains the minimum heading.

- Values: 0-359

10.2.97B3B20

`<x>/<x>/OnNetwork/FunctionalAliasList/<x>/Entry/
LocationCriteriaForActivation/EnterSpecificArea/Heading/
MaximumHeading`

Table 10.2.97B3B20.1:

`<x>/<x>/OnNetwork/FunctionalAliasList/<x>/Entry/LocationCriteriaForActivation/EnterSpecificArea/
Heading/MaximumHeading`

`<x>/OnNetwork/FunctionalAliasList/<x>/Entry/LocationCriteriaForActivation/EnterSpecificArea/Heading/MaximumHeading`

Status	Occurrence	Format	Min. Access Types
Required	One	int	Get, Replace

This leaf node contains the maximum heading.

- Values: 0-359

10.2.97B3B21

`<x>/<x>/OnNetwork/FunctionalAliasList/<x>/Entry/
LocationCriteriaForActivation/ExitSpecificArea`

Table 10.2.97B3B21.1:

`<x>/<x>/OnNetwork/FunctionalAliasList/<x>/Entry/LocationCriteriaForActivation/EnterSpecificArea`

`<x>/OnNetwork/FunctionalAliasList/<x>/Entry/LocationCriteriaForActivation/EnterSpecificArea`

Status	Occurrence	Format	Min. Access Types
Optional	ZeroOrMore	node	Get, Replace

This interior node contains a geographical area which when exited by the MC service UE triggers the functional alias activation.

10.2.97B3B22

`<x>/<x>/OnNetwork/FunctionalAliasList/<x>/
Entry/LocationCriteriaForActivation/ExitSpecificArea/PolygonArea`

Table 10.2.97B3B22.1:

`<x>/<x>/OnNetwork/FunctionalAliasList/<x>/Entry/LocationCriteriaForActivation/ExitSpecificArea/
PolygonArea`

`<x>/OnNetwork/FunctionalAliasList/<x>/Entry/LocationCriteriaForActivation/ExitSpecificArea/PolygonArea`

Status	Occurrence	Format	Min. Access Types
Optional	ZeroOrOne	node	Get, Replace

This interior node contains a geographical area described by a polygon.

10.2.97B3B23

`<x>/<x>/OnNetwork/FunctionalAliasList/<x>/Entry/
LocationCriteriaForActivation/ExitSpecificArea/PolygonArea/
Corner`

Table 10.2.97B3B23.1:

`<x>/<x>/OnNetwork/FunctionalAliasList/<x>/Entry/LocationCriteriaForActivation/ExitSpecificArea/
PolygonArea/Corner`

`<x>/OnNetwork/FunctionalAliasList/<x>/Entry/LocationCriteriaForActivation/ExitSpecificArea/PolygonArea/
Corner`

Status	Occurrence	Format	Min. Access Types
Required	ThreeToFifteen	node	Get, Replace

This interior node contains the coordinates of the corners which define a polygon.

10.2.97B3B24

`<x>/<x>/OnNetwork/FunctionalAliasList/<x>/Entry/LocationCriteriaForActivation/ExitSpecificArea/PolygonArea/Corner/PointCoordinateType`

Table 10.2.97B3B24.1:

`<x>/<x>/OnNetwork/FunctionalAliasList/<x>/Entry/LocationCriteriaForActivation/ExitSpecificArea/PolygonArea/Corner/PointCoordinateType`

`<x>/OnNetwork/FunctionalAliasList/<x>/Entry/LocationCriteriaForActivation/ExitSpecificArea/PolygonArea/Corner/PointCoordinateType`

Status	Occurrence	Format	Min. Access Types
Required	One	node	Get, Replace

This interior node contains the type of the coordinates.

10.2.97B3B25

`<x>/<x>/OnNetwork/FunctionalAliasList/<x>/Entry/LocationCriteriaForActivation/ExitSpecificArea/PolygonArea/Corner/PointCoordinateType/Longitude`

Table 10.2.97B3B25.1:

`<x>/<x>/OnNetwork/FunctionalAliasList/<x>/Entry/LocationCriteriaForActivation/ExitSpecificArea/PolygonArea/Corner/PointCoordinateType/Longitude`

`<x>/OnNetwork/FunctionalAliasList/<x>/Entry/LocationCriteriaForActivation/ExitSpecificArea/PolygonArea/Corner/PointCoordinateType/Longitude`

Status	Occurrence	Format	Min. Access Types
Required	One	int	Get, Replace

This leaf node contains the longitudinal coordinate of a corner.

- Values: 0-16777215

10.2.97B3B26

`<x>/<x>/OnNetwork/FunctionalAliasList/<x>/Entry/LocationCriteriaForActivation/ExitSpecificArea/PolygonArea/Corner/PointCoordinateType/Latitude`

Table 10.2.97B3B26.1:

`<x>/<x>/OnNetwork/FunctionalAliasList/<x>/Entry/LocationCriteriaForActivation/ExitSpecificArea/PolygonArea/Corner/PointCoordinateType/Latitude`

`<x>/OnNetwork/FunctionalAliasList/<x>/Entry/LocationCriteriaForActivation/ExitSpecificArea/PolygonArea/Corner/PointCoordinateType/Latitude`

Status	Occurrence	Format	Min. Access Types
Required	One	int	Get, Replace

This leaf node contains the latitudinal coordinate of a corner.

- Values: 0-16777215

10.2.97B3B27

`/<x>/<x>/OnNetwork/FunctionalAliasList/<x>/Entry/
LocationCriteriaForActivation/ExitSpecificArea/EllipsoidArcArea`

Table 10.2.97B3B27.1:

`/<x>/<x>/OnNetwork/FunctionalAliasList/<x>/Entry/LocationCriteriaForActivation/ExitSpecificArea/
EllipsoidArcArea`

`<x>/OnNetwork/FunctionalAliasList/<x>/Entry/LocationCriteriaForActivation/ExitSpecificArea/EllipsoidArcArea`

Status	Occurrence	Format	Min. Access Types
Optional	ZeroOrOne	node	Get, Replace

This interior node contains a geographical area described by an ellipsoid arc.

10.2.97B3B28

`/<x>/<x>/OnNetwork/FunctionalAliasList/<x>/Entry/
LocationCriteriaForActivation/ExitSpecificArea/EllipsoidArcArea/
Center`

Table 10.2.97B3B28.1:

`/<x>/<x>/OnNetwork/FunctionalAliasList/<x>/Entry/LocationCriteriaForActivation/ExitSpecificArea/
EllipsoidArcArea/Center`

`<x>/OnNetwork/FunctionalAliasList/<x>/Entry/LocationCriteriaForActivation/ExitSpecificArea/EllipsoidArcArea/
Center`

Status	Occurrence	Format	Min. Access Types
Required	One	node	Get, Replace

This interior node contains the coordinates of the center point of the ellipsoid arc.

10.2.97B3B29

`/<x>/<x>/OnNetwork/FunctionalAliasList/<x>/Entry/
LocationCriteriaForActivation/ExitSpecificArea/EllipsoidArcArea/
Center/PointCoordinateType`

Table 10.2.97B3B29.1:

`/<x>/<x>/OnNetwork/FunctionalAliasList/<x>/Entry/LocationCriteriaForActivation/ExitSpecificArea/EllipsoidArcArea/Center/PointCoordinateType`

`<x>/OnNetwork/FunctionalAliasList/<x>/Entry/LocationCriteriaForActivation/ExitSpecificArea/EllipsoidArcArea/
Center/PointCoordinateType`

Status	Occurrence	Format	Min. Access Types
Required	One	node	Get, Replace

This interior node contains the coordinates of the center point of the ellipsoid arc.

10.2.97B3B30

`/<x>/<x>/OnNetwork/FunctionalAliasList/<x>/Entry/
LocationCriteriaForActivation/ExitSpecificArea/EllipsoidArcArea/
Center/PointCoordinateType/Longitude`

Table 10.2.97B3B30.1:

`/<x>/<x>/OnNetwork/FunctionalAliasList/<x>/Entry/LocationCriteriaForActivation/ExitSpecificArea/EllipsoidArcArea/Center/PointCoordinateType/Longitude`

`<x>/OnNetwork/FunctionalAliasList/<x>/Entry/LocationCriteriaForActivation/ExitSpecificArea/EllipsoidArcArea/Center/PointCoordinateType/Longitude`

Status	Occurrence	Format	Min. Access Types
Required	One	int	Get, Replace

This leaf node contains the longitudinal coordinate of the center.

- Values: 0-16777215

10.2.97B3B31

`/<x>/<x>/OnNetwork/FunctionalAliasList/<x>/Entry/
LocationCriteriaForActivation/ExitSpecificArea/EllipsoidArcArea/
Center/PointCoordinateType/Latitude`

Table 10.2.97B3B31.1:

`/<x>/<x>/OnNetwork/FunctionalAliasList/<x>/Entry/LocationCriteriaForActivation/ExitSpecificArea/EllipsoidArcArea/Center/PointCoordinateType/Latitude`

`<x>/OnNetwork/FunctionalAliasList/<x>/Entry/LocationCriteriaForActivation/ExitSpecificArea/EllipsoidArcArea/Center/PointCoordinateType/Latitude`

Status	Occurrence	Format	Min. Access Types
Required	One	int	Get, Replace

This leaf node contains the latitudinal coordinate of the center.

- Values: 0-16777215

10.2.97B3B32

`/<x>/<x>/OnNetwork/FunctionalAliasList/<x>/Entry/
LocationCriteriaForActivation/ExitSpecificArea/EllipsoidArcArea/
Radius`

Table 10.2.97B3B32.1:

`/<x>/<x>/OnNetwork/FunctionalAliasList/<x>/Entry/LocationCriteriaForActivation/ExitSpecificArea/EllipsoidArcArea/Radius`

`<x>/OnNetwork/FunctionalAliasList/<x>/Entry/LocationCriteriaForActivation/ExitSpecificArea/EllipsoidArcArea/Radius`

Status	Occurrence	Format	Min. Access Types
Required	One	int	Get, Replace

This leaf node contains the radius of the ellipsoid arc.

- Values: non-negative integer

10.2.97B3B33

/<x>/<x>/OnNetwork/FunctionalAliasList/<x>/Entry/
LocationCriteriaForActivation/ExitSpecificArea/EllipsoidArcArea/
OffsetAngle

Table 10.2.97B3B33.1:

**/<x>/<x>/OnNetwork/FunctionalAliasList/<x>/Entry/LocationCriteriaForActivation/ExitSpecificArea/
EllipsoidArcArea/OffsetAngle**

<x>/OnNetwork/FunctionalAliasList/<x>/Entry/LocationCriteriaForActivation/ExitSpecificArea/EllipsoidArcArea/
OffsetAngle

Status	Occurrence	Format	Min. Access Types
Required	One	int	Get, Replace

This leaf node contains the offset angle of the ellipsoid arc.

- Values: 0-255

10.2.97B3B34

/<x>/<x>/OnNetwork/FunctionalAliasList/<x>/Entry/
LocationCriteriaForActivation/ExitSpecificArea/EllipsoidArcArea/
IncludedAngle

Table 10.2.97B3B34.1:

**/<x>/<x>/OnNetwork/FunctionalAliasList/<x>/Entry/LocationCriteriaForActivation/ExitSpecificArea/
EllipsoidArcArea/IncludedAngle**

<x>/OnNetwork/FunctionalAliasList/<x>/Entry/LocationCriteriaForActivation/ExitSpecificArea/EllipsoidArcArea/
IncludedAngle

Status	Occurrence	Format	Min. Access Types
Required	One	int	Get, Replace

This leaf node contains the included angle of the ellipsoid arc.

- Values: 0-255

10.2.97B3B35

/<x>/<x>/OnNetwork/FunctionalAliasList/<x>/Entry/
LocationCriteriaForActivation/ExitSpecificArea/Speed

Table 10.2.97B3B35.1:

**/<x>/<x>/OnNetwork/FunctionalAliasList/<x>/Entry/LocationCriteriaForActivation/ExitSpecificArea/Sp
eed**

<x>/OnNetwork/FunctionalAliasList/<x>/Entry/LocationCriteriaForActivation/ExitSpecificArea/Speed

Status	Occurrence	Format	Min. Access Types
Optional	One	node	Get, Replace

This interior node contains the speed.

10.2.97B3B36

`/<x>/<x>/OnNetwork/FunctionalAliasList/<x>/Entry/LocationCriteriaForActivation/ExitSpecificArea/Speed/MinimumSpeed`

Table 10.2.97B3B36.1:

`/<x>/<x>/OnNetwork/FunctionalAliasList/<x>/Entry/LocationCriteriaForActivation/ExitSpecificArea/Speed/MinimumSpeed`

`<x>/OnNetwork/FunctionalAliasList/<x>/Entry/LocationCriteriaForActivation/ExitSpecificArea/Speed/MinimumSpeed`

Status	Occurrence	Format	Min. Access Types
Required	One	int	Get, Replace

This leaf node contains the minimum speed.

- Values: non-negative integer in units of kilometers/hour.

10.2.97B3B37

`/<x>/<x>/OnNetwork/FunctionalAliasList/<x>/Entry/LocationCriteriaForActivation/ExitSpecificArea/Speed/MaximumSpeed`

Table 10.2.97B3B37.1:

`/<x>/<x>/OnNetwork/FunctionalAliasList/<x>/Entry/LocationCriteriaForActivation/ExitSpecificArea/Speed/MaximumSpeed`

`<x>/OnNetwork/FunctionalAliasList/<x>/Entry/LocationCriteriaForActivation/ExitSpecificArea/Speed/MaximumSpeed`

Status	Occurrence	Format	Min. Access Types
Required	One	int	Get, Replace

This leaf node contains the maximum speed.

- Values: non-negative integer in units of kilometers/hour.

10.2.97B3B38

`/<x>/<x>/OnNetwork/FunctionalAliasList/<x>/Entry/LocationCriteriaForActivation/ExitSpecificArea/Heading`

Table 10.2.97B3B38.1:

`/<x>/<x>/OnNetwork/FunctionalAliasList/<x>/Entry/LocationCriteriaForActivation/ExitSpecificArea/Heading`

`<x>/OnNetwork/FunctionalAliasList/<x>/Entry/LocationCriteriaForActivation/ExitSpecificArea/Heading`

Status	Occurrence	Format	Min. Access Types
Optional	One	node	Get, Replace

This interior node contains the heading.

10.2.97B3B39

`<x>/<x>/OnNetwork/FunctionalAliasList/<x>/Entry/
LocationCriteriaForActivation/ExitSpecificArea/Heading/
MinimumHeading`

Table 10.2.97B3B39.1:

`<x>/<x>/OnNetwork/FunctionalAliasList/<x>/Entry/LocationCriteriaForActivation/ExitSpecificArea/Heading/MinimumHeading`

`<x>/OnNetwork/FunctionalAliasList/<x>/Entry/LocationCriteriaForActivation/ExitSpecificArea/Heading/MinimumHeading`

Status	Occurrence	Format	Min. Access Types
Required	One	int	Get, Replace

This leaf node contains the minimum heading.

- Values: 0-359

10.2.97B3B40

`<x>/<x>/OnNetwork/FunctionalAliasList/<x>/Entry/
LocationCriteriaForActivation/ExitSpecificArea/Heading/
MaximumHeading`

Table 10.2.97B3B40.1:

`<x>/<x>/OnNetwork/FunctionalAliasList/<x>/Entry/LocationCriteriaForActivation/ExitSpecificArea/Heading/MaximumHeading`

`<x>/OnNetwork/FunctionalAliasList/<x>/Entry/LocationCriteriaForActivation/ExitSpecificArea/Heading/MaximumHeading`

Status	Occurrence	Format	Min. Access Types
Required	One	int	Get, Replace

This leaf node contains the maximum heading.

- Values: 0-359

10.2.97B3C

`<x>/<x>/OnNetwork/FunctionalAliasList/<x>/Entry/
LocationCriteriaForDeactivation`

Table 10.2.97B3C.1:

`<x>/<x>/OnNetwork/FunctionalAliasList/<x>/Entry/LocationCriteriaForDeactivation`

`<x>/OnNetwork/FunctionalAliasList/<x>/Entry/LocationCriteriaForDeactivation`

Status	Occurrence	Format	Min. Access Types
Optional	ZeroOrOne	node	Get, Replace

This interior node contains the location criteria for de-activation of a functional alias.

10.2.97B3C1

/<x>/<x>/OnNetwork/FunctionalAliasList/<x>/Entry/
LocationCriteriaForDeactivation/EnterSpecificArea

Table 10.2.97B3C1.1:

/<x>/<x>/OnNetwork/FunctionalAliasList/<x>/Entry/LocationCriteriaForDeactivation/EnterSpecificArea

<x>/OnNetwork/FunctionalAliasList/<x>/Entry/LocationCriteriaForDeactivation/EnterSpecificArea

Status	Occurrence	Format	Min. Access Types
Optional	ZeroOrMore	node	Get, Replace

This interior node contains a geographical area which when entered by the MC service UE triggers the functional alias de-activation.

10.2.97B3C2

/<x>/<x>/OnNetwork/FunctionalAliasList/<x>/Entry/
LocationCriteriaForDeactivation/EnterSpecificArea/PolygonArea

Table 10.2.97B3C2.1:

/<x>/<x>/OnNetwork/FunctionalAliasList/<x>/Entry/LocationCriteriaForDeactivation/EnterSpecificArea/
a/ PolygonArea

<x>/OnNetwork/FunctionalAliasList/<x>/Entry/LocationCriteriaForDeactivation/EnterSpecificArea/PolygonArea

Status	Occurrence	Format	Min. Access Types
Optional	ZeroOrOne	node	Get, Replace

This interior node contains a geographical area described by a polygon.

10.2.97B3C3

/<x>/<x>/OnNetwork/FunctionalAliasList/<x>/Entry/
LocationCriteriaForDeactivation/EnterSpecificArea/PolygonArea/
Corner

Table 10.2.97B3C3.1:

/<x>/<x>/OnNetwork/FunctionalAliasList/<x>/Entry/LocationCriteriaForDeactivation/EnterSpecificArea/
a/ PolygonArea/Corner

<x>/OnNetwork/FunctionalAliasList/<x>/Entry/LocationCriteriaForDeactivation/EnterSpecificArea/PolygonArea/
Corner

Status	Occurrence	Format	Min. Access Types
Required	ThreeToFifteen	node	Get, Replace

This interior node contains the coordinates of the corners which define a polygon.

10.2.97B3C4

/<x>/<x>/OnNetwork/FunctionalAliasList/<x>/Entry/
LocationCriteriaForDeactivation/EnterSpecificArea/PolygonArea/
Corner/PointCoordinateType

Table 10.2.97B3C4.1:

/<x>/<x>/OnNetwork/FunctionalAliasList/<x>/Entry/LocationCriteriaForDeactivation/EnterSpecificArea/
a/PolygonArea/Corner/PointCoordinateType

<x>/OnNetwork/FunctionalAliasList/<x>/Entry/LocationCriteriaForDeactivation/EnterSpecificArea/PolygonArea/
Corner/PointCoordinateType

Status	Occurrence	Format	Min. Access Types
Required	One	node	Get, Replace

This interior node contains the coordinates of the center point of the ellipsoid arc.

10.2.97B3C5

`/<x>/<x>/OnNetwork/FunctionalAliasList/<x>/Entry/
LocationCriteriaForDeactivation/EnterSpecificArea/PolygonArea/
Corner/PointCoordinateType/Longitude`

Table 10.2.97B3C5.1:

`/<x>/<x>/OnNetwork/FunctionalAliasList/<x>/Entry/LocationCriteriaForDeactivation/EnterSpecificArea/PolygonArea/Corner/PointCoordinateType/Longitude`

`<x>/OnNetwork/FunctionalAliasList/<x>/Entry/LocationCriteriaForDeactivation/EnterSpecificArea/PolygonArea/Corner/PointCoordinateType/Longitude`

Status	Occurrence	Format	Min. Access Types
Required	One	int	Get, Replace

This leaf node contains the longitudinal coordinate of a corner.

- Values: 0-16777215

10.2.97B3C6

`/<x>/<x>/OnNetwork/FunctionalAliasList/<x>/Entry/
LocationCriteriaForDeactivation/EnterSpecificArea/PolygonArea/
Corner/PointCoordinateType/Latitude`

Table 10.2.97B3C6.1:

`/<x>/<x>/OnNetwork/FunctionalAliasList/<x>/Entry/LocationCriteriaForDeactivation/EnterSpecificArea/PolygonArea/Corner/PointCoordinateType/Latitude`

`<x>/OnNetwork/FunctionalAliasList/<x>/Entry/LocationCriteriaForDeactivation/EnterSpecificArea/PolygonArea/Corner/PointCoordinateType/Latitude`

Status	Occurrence	Format	Min. Access Types
Required	One	int	Get, Replace

This leaf node contains the latitudinal coordinate of a corner.

- Values: 0-16777215

10.2.97B3C7

`/<x>/<x>/OnNetwork/FunctionalAliasList/<x>/Entry/
LocationCriteriaForDeactivation/EnterSpecificArea/EllipsoidArcArea`

Table 10.2.97B3C7.1:

`/<x>/<x>/OnNetwork/FunctionalAliasList/<x>/Entry/LocationCriteriaForDeactivation/EnterSpecificArea/EllipsoidArcArea`

`<x>/OnNetwork/FunctionalAliasList/<x>/Entry/LocationCriteriaForDeactivation/EnterSpecificArea/EllipsoidArcArea`

Status	Occurrence	Format	Min. Access Types
Optional	ZeroOrOne	node	Get, Replace

This interior node contains a geographical area described by an ellipsoid arc.

10.2.97B3C8

`/<x>/<x>/OnNetwork/FunctionalAliasList/<x>/Entry/
LocationCriteriaForDeactivation/EnterSpecificArea/EllipsoidArcArea/
Center`

Table 10.2.97B3C8.1:

`/<x>/<x>/OnNetwork/FunctionalAliasList/<x>/Entry/LocationCriteriaForDeactivation/EnterSpecificArea/
a/ EllipsoidArcArea/Center`

`<x>/OnNetwork/FunctionalAliasList/<x>/Entry/LocationCriteriaForDeactivation/EnterSpecificArea/EllipsoidArcAr
ea/ Center`

Status	Occurrence	Format	Min. Access Types
Required	One	node	Get, Replace

This interior node contains the coordinates of the center point of the ellipsoid arc.

10.2.97B3C9

`/<x>/<x>/OnNetwork/FunctionalAliasList/<x>/Entry/
LocationCriteriaForDeactivation/EnterSpecificArea/EllipsoidArcArea/
Center/PointCoordinateType`

Table 10.2.97B3C9.1:

`/<x>/<x>/OnNetwork/FunctionalAliasList/<x>/Entry/LocationCriteriaForDeactivation/EnterSpecificArea/
a/EllipsoidArcArea/Center/PointCoordinateType`

`<x>/OnNetwork/FunctionalAliasList/<x>/Entry/LocationCriteriaForDeactivation/EnterSpecificArea/EllipsoidArcAr
ea/Center/PointCoordinateType`

Status	Occurrence	Format	Min. Access Types
Required	One	node	Get, Replace

This interior node contains the coordinates of the center point of the ellipsoid arc.

10.2.97B3C10

`/<x>/<x>/OnNetwork/FunctionalAliasList/<x>/Entry/
LocationCriteriaForDeactivation/EnterSpecificArea/EllipsoidArcArea/
Center/PointCoordinateType/Longitude`

Table 10.2.97B3C10.1:

`/<x>/<x>/OnNetwork/FunctionalAliasList/<x>/Entry/LocationCriteriaForDeactivation/EnterSpecificArea/
a/EllipsoidArcArea/Center/PointCoordinateType/Longitude`

`<x>/OnNetwork/FunctionalAliasList/<x>/Entry/LocationCriteriaForDeactivation/EnterSpecificArea/EllipsoidArcAr
ea/Center/PointCoordinateType/Longitude`

Status	Occurrence	Format	Min. Access Types
Required	One	int	Get, Replace

This leaf node contains the longitudinal coordinate of the center.

- Values: 0-16777215

10.2.97B3C11

/<x>/<x>/OnNetwork/FunctionalAliasList/<x>/Entry/
LocationCriteriaForDeactivation/EnterSpecificArea/EllipsoidArcArea/
Center/PointCoordinateType/Latitude

Table 10.2.97B3C11.1:

/<x>/<x>/OnNetwork/FunctionalAliasList/<x>/Entry/LocationCriteriaForDeactivation/EnterSpecificArea/
a/EllipsoidArcArea/Center/PointCoordinateType/Latitude

<x>/OnNetwork/FunctionalAliasList/<x>/Entry/LocationCriteriaForDeactivation/EnterSpecificArea/EllipsoidArcAr
ea/Center/PointCoordinateType/Latitude

Status	Occurrence	Format	Min. Access Types
Required	One	int	Get, Replace

This leaf node contains the latitudinal coordinate of the center.

- Values: 0-16777215

10.2.97B3C12

/<x>/<x>/OnNetwork/FunctionalAliasList/<x>/Entry/
LocationCriteriaForDeactivation/EnterSpecificArea/EllipsoidArcArea/
Radius

Table 10.2.97B3C12.1:

/<x>/<x>/OnNetwork/FunctionalAliasList/<x>/Entry/LocationCriteriaForDeactivation/EnterSpecificArea/
a/EllipsoidArcArea/Radius

<x>/OnNetwork/FunctionalAliasList/<x>/Entry/LocationCriteriaForDeactivation/EnterSpecificArea/EllipsoidArcAr
ea/ Radius

Status	Occurrence	Format	Min. Access Types
Required	One	int	Get, Replace

This leaf node contains the radius of the ellipsoid arc.

- Values: non-negative integer

10.2.97B3C13

/<x>/<x>/OnNetwork/FunctionalAliasList/<x>/Entry/
LocationCriteriaForDeactivation/EnterSpecificArea/EllipsoidArcArea/
OffsetAngle

Table 10.2.97B3C13.1:

/<x>/<x>/OnNetwork/FunctionalAliasList/<x>/Entry/LocationCriteriaForDeactivation/EnterSpecificArea/
a/EllipsoidArcArea/OffsetAngle

<x>/OnNetwork/FunctionalAliasList/<x>/Entry/LocationCriteriaForDeactivation/EnterSpecificArea/EllipsoidArcAr
ea/ OffsetAngle

Status	Occurrence	Format	Min. Access Types
Required	One	int	Get, Replace

This leaf node contains the offset angle of the ellipsoid arc.

- Values: 0-255

10.2.97B3C14

/<x>/<x>/OnNetwork/FunctionalAliasList/<x>/Entry/
LocationCriteriaForDeactivation/EnterSpecificArea/EllipsoidArcArea/
IncludedAngle

Table 10.2.97B3C14.1:

/<x>/<x>/OnNetwork/FunctionalAliasList/<x>/Entry/LocationCriteriaForDeactivation/EnterSpecificArea/
a/ EllipsoidArcArea/IncludedAngle

<x>/OnNetwork/FunctionalAliasList/<x>/Entry/LocationCriteriaForDeactivation/EnterSpecificArea/EllipsoidArcAr
ea/ IncludedAngle

Status	Occurrence	Format	Min. Access Types
Required	One	int	Get, Replace

This leaf node contains the included angle of the ellipsoid arc.

- Values: 0-255

10.2.97B3C15

/<x>/<x>/OnNetwork/FunctionalAliasList/<x>/Entry/
LocationCriteriaForDeactivation/EnterSpecificArea/Speed

Table 10.2.97B3C15.1:

/<x>/<x>/OnNetwork/FunctionalAliasList/<x>/Entry/LocationCriteriaForDeactivation/EnterSpecificArea/
a/Speed

<x>/OnNetwork/FunctionalAliasList/<x>/Entry/LocationCriteriaForDeactivation/EnterSpecificArea/Speed

Status	Occurrence	Format	Min. Access Types
Optional	One	node	Get, Replace

This interior node contains the speed.

10.2.97B3C16

/<x>/<x>/OnNetwork/FunctionalAliasList/<x>/Entry/
LocationCriteriaForDeactivation/EnterSpecificArea/Speed/
MinimumSpeed

Table 10.2.97B3C16.1:

/<x>/<x>/OnNetwork/FunctionalAliasList/<x>/Entry/LocationCriteriaForDeactivation/EnterSpecificArea/
a/Speed/MinimumSpeed

<x>/OnNetwork/FunctionalAliasList/<x>/Entry/LocationCriteriaForDeactivation/EnterSpecificArea/Speed/Minimu
mSpeed

Status	Occurrence	Format	Min. Access Types
Required	One	int	Get, Replace

This leaf node contains the minimum speed.

- Values: non-negative integer in units of kilometers/hour.

10.2.97B3C17

/<x>/<x>/OnNetwork/FunctionalAliasList/<x>/Entry/
LocationCriteriaForDeactivation/EnterSpecificArea/Speed/
MaximumSpeed

Table 10.2.97B3C17.1:

/<x>/<x>/OnNetwork/FunctionalAliasList/<x>/Entry/LocationCriteriaForDeactivation/EnterSpecificArea/Speed/MaximumSpeed

<x>/OnNetwork/FunctionalAliasList/<x>/Entry/LocationCriteriaForDeactivation/EnterSpecificArea/Speed/MaximumSpeed

Status	Occurrence	Format	Min. Access Types
Required	One	int	Get, Replace

This leaf node contains the maximum speed.

- Values: non-negative integer in units of kilometers/hour.

10.2.97B3C18

/<x>/<x>/OnNetwork/FunctionalAliasList/<x>/Entry/
LocationCriteriaForDeactivation/EnterSpecificArea/Heading

Table 10.2.97B3C18.1:

/<x>/<x>/OnNetwork/FunctionalAliasList/<x>/Entry/LocationCriteriaForDeactivation/EnterSpecificArea/Heading

<x>/OnNetwork/FunctionalAliasList/<x>/Entry/LocationCriteriaForDeactivation/EnterSpecificArea/Heading

Status	Occurrence	Format	Min. Access Types
Optional	One	node	Get, Replace

This interior node contains the heading.

10.2.97B3C19

/<x>/<x>/OnNetwork/FunctionalAliasList/<x>/Entry/
LocationCriteriaForDeactivation/EnterSpecificArea/Heading/
MinimumHeading

Table 10.2.97B3C19.1:

/<x>/<x>/OnNetwork/FunctionalAliasList/<x>/Entry/LocationCriteriaForDeactivation/EnterSpecificArea/Heading/MinimumHeading

<x>/OnNetwork/FunctionalAliasList/<x>/Entry/LocationCriteriaForDeactivation/EnterSpecificArea/Heading/MinimumHeading

Status	Occurrence	Format	Min. Access Types
Required	One	int	Get, Replace

This leaf node contains the minimum heading.

- Values: 0-359

10.2.97B3C20

/<x>/<x>/OnNetwork/FunctionalAliasList/<x>/Entry/
LocationCriteriaForDeactivation/EnterSpecificArea/Heading/
MaximumHeading

Table 10.2.97B3C20.1:

/<x>/<x>/OnNetwork/FunctionalAliasList/<x>/Entry/LocationCriteriaForDeactivation/EnterSpecificArea/Heading/MaximumHeading

<x>/OnNetwork/FunctionalAliasList/<x>/Entry/LocationCriteriaForDeactivation/EnterSpecificArea/Heading/MaximumHeading

Status	Occurrence	Format	Min. Access Types
Required	One	int	Get, Replace

This leaf node contains the maximum heading.

- Values: 0-359

10.2.97B3C21

/<x>/<x>/OnNetwork/FunctionalAliasList/<x>/Entry/
LocationCriteriaForDeactivation/ExitSpecificArea

Table 10.2.97B3C21.1:

/<x>/<x>/OnNetwork/FunctionalAliasList/<x>/Entry/LocationCriteriaForDeactivation/EnterSpecificArea

<x>/OnNetwork/FunctionalAliasList/<x>/Entry/LocationCriteriaForDeactivation/EnterSpecificArea

Status	Occurrence	Format	Min. Access Types
Optional	ZeroOrMore	node	Get, Replace

This interior node contains a geographical area which when exited by the MC service UE triggers the functional alias de-activation.

10.2.97B3C22

/<x>/<x>/OnNetwork/FunctionalAliasList/<x>/Entry/
LocationCriteriaForDeactivation/ExitSpecificArea/PolygonArea

Table 10.2.97B3C22.1:

/<x>/<x>/OnNetwork/FunctionalAliasList/<x>/Entry/LocationCriteriaForDeactivation/ExitSpecificArea/PolygonArea

<x>/OnNetwork/FunctionalAliasList/<x>/Entry/LocationCriteriaForDeactivation/ExitSpecificArea/PolygonArea

Status	Occurrence	Format	Min. Access Types
Optional	ZeroOrOne	node	Get, Replace

This interior node contains a geographical area described by a polygon.

10.2.97B3C23

/<x>/<x>/OnNetwork/FunctionalAliasList/<x>/Entry/
LocationCriteriaForDeactivation/ExitSpecificArea/PolygonArea/
Corner

Table 10.2.97B3C23.1:

/<x>/<x>/OnNetwork/FunctionalAliasList/<x>/Entry/LocationCriteriaForDeactivation/ExitSpecificArea/
PolygonArea/Corner

<x>/OnNetwork/FunctionalAliasList/<x>/Entry/LocationCriteriaForDeactivation/ExitSpecificArea/PolygonArea/
Corner

Status	Occurrence	Format	Min. Access Types
Required	ThreeToFifteen	node	Get, Replace

This interior node contains the coordinates of the corners which define a polygon.

10.2.97B3C24

/<x>/<x>/OnNetwork/FunctionalAliasList/<x>/Entry/
LocationCriteriaForDeactivation/ExitSpecificArea/PolygonArea/
Corner/PointCoordinateType

Table 10.2.97B3C24.1:

/<x>/<x>/OnNetwork/FunctionalAliasList/<x>/Entry/LocationCriteriaForDeactivation/ExitSpecificArea/
PolygonArea/Corner/PointCoordinateType

<x>/OnNetwork/FunctionalAliasList/<x>/Entry/LocationCriteriaForDeactivation/ExitSpecificArea/PolygonArea/Co
rner/PointCoordinateType

Status	Occurrence	Format	Min. Access Types
Required	One	node	Get, Replace

This interior node contains the coordinates of the center point of the ellipsoid arc.

10.2.97B3C25

/<x>/<x>/OnNetwork/FunctionalAliasList/<x>/Entry/
LocationCriteriaForDeactivation/ExitSpecificArea/PolygonArea/
Corner/PointCoordinateType/Longitude

Table 10.2.97B3C25.1:

/<x>/<x>/OnNetwork/FunctionalAliasList/<x>/Entry/LocationCriteriaForDeactivation/ExitSpecificArea/
PolygonArea/Corner/PointCoordinateType/Longitude

<x>/OnNetwork/FunctionalAliasList/<x>/Entry/LocationCriteriaForDeactivation/ExitSpecificArea/PolygonArea/Co
rner/PointCoordinateType/Longitude

Status	Occurrence	Format	Min. Access Types
Required	One	int	Get, Replace

This leaf node contains the longitudinal coordinate of a corner.

- Values: 0-16777215

10.2.97B3C26

/<x>/<x>/OnNetwork/FunctionalAliasList/<x>/Entry/
LocationCriteriaForDeactivation/ExitSpecificArea/PolygonArea/
Corner/PointCoordinateType/Latitude

Table 10.2.97B3C26.1:

/<x>/<x>/OnNetwork/FunctionalAliasList/<x>/Entry/LocationCriteriaForDeactivation/ExitSpecificArea/PolygonArea/Corner/PointCoordinateType/Latitude

<x>/OnNetwork/FunctionalAliasList/<x>/Entry/LocationCriteriaForDeactivation/ExitSpecificArea/PolygonArea/Corner/PointCoordinateType/Latitude

Status	Occurrence	Format	Min. Access Types
Required	One	int	Get, Replace

This leaf node contains the latitudinal coordinate of a corner.

- Values: 0-16777215

10.2.97B3C27

/<x>/<x>/OnNetwork/FunctionalAliasList/<x>/Entry/
LocationCriteriaForDeactivation/ExitSpecificArea/EllipsoidArcArea

Table 10.2.97B3C27.1:

/<x>/<x>/OnNetwork/FunctionalAliasList/<x>/Entry/LocationCriteriaForDeactivation/ExitSpecificArea/EllipsoidArcArea

<x>/OnNetwork/FunctionalAliasList/<x>/Entry/LocationCriteriaForDeactivation/ExitSpecificArea/EllipsoidArcArea

Status	Occurrence	Format	Min. Access Types
Optional	ZeroOrOne	node	Get, Replace

This interior node contains a geographical area described by an ellipsoid arc.

10.2.97B3C28

/<x>/<x>/OnNetwork/FunctionalAliasList/<x>/Entry/
LocationCriteriaForDeactivation/ExitSpecificArea/EllipsoidArcArea/
Center

Table 10.2.97B3C28.1:

/<x>/<x>/OnNetwork/FunctionalAliasList/<x>/Entry/LocationCriteriaForDeactivation/ExitSpecificArea/EllipsoidArcArea/Center

<x>/OnNetwork/FunctionalAliasList/<x>/Entry/LocationCriteriaForDeactivation/ExitSpecificArea/EllipsoidArcArea/Center

Status	Occurrence	Format	Min. Access Types
Required	One	node	Get, Replace

This interior node contains the coordinates of the center point of the ellipsoid arc.

10.2.97B3C29

/<x>/<x>/OnNetwork/FunctionalAliasList/<x>/Entry/
LocationCriteriaForDeactivation/ExitSpecificArea/EllipsoidArcArea/
Center/PointCoordinateType

Table 10.2.97B3C29.1:

/<x>/<x>/OnNetwork/FunctionalAliasList/<x>/Entry/LocationCriteriaForDeactivation/ExitSpecificArea/
EllipsoidArcArea/Center/PointCoordinateType

<x>/OnNetwork/FunctionalAliasList/<x>/Entry/LocationCriteriaForDeactivation/ExitSpecificArea/EllipsoidArcArea/Center/PointCoordinateType

Status	Occurrence	Format	Min. Access Types
Required	One	node	Get, Replace

This interior node contains the coordinates of the center point of the ellipsoid arc.

10.2.97B3C30

/<x>/<x>/OnNetwork/FunctionalAliasList/<x>/Entry/
LocationCriteriaForDeactivation/ExitSpecificArea/EllipsoidArcArea/
Center/PointCoordinateType/Longitude

Table 10.2.97B3C30.1:

/<x>/<x>/OnNetwork/FunctionalAliasList/<x>/Entry/LocationCriteriaForDeactivation/ExitSpecificArea/
EllipsoidArcArea/Center/PointCoordinateType/Longitude

<x>/OnNetwork/FunctionalAliasList/<x>/Entry/LocationCriteriaForDeactivation/ExitSpecificArea/EllipsoidArcArea/Center/PointCoordinateType/Longitude

Status	Occurrence	Format	Min. Access Types
Required	One	int	Get, Replace

This leaf node contains the longitudinal coordinate of the center.

- Values: 0-16777215

10.2.97B3C31

/<x>/<x>/OnNetwork/FunctionalAliasList/<x>/Entry/
LocationCriteriaForDeactivation/ExitSpecificArea/EllipsoidArcArea/
Center/PointCoordinateType/Latitude

Table 10.2.97B3C31.1:

/<x>/<x>/OnNetwork/FunctionalAliasList/<x>/Entry/LocationCriteriaForDeactivation/ExitSpecificArea/
EllipsoidArcArea/Center/PointCoordinateType/Latitude

<x>/OnNetwork/FunctionalAliasList/<x>/Entry/LocationCriteriaForDeactivation/ExitSpecificArea/EllipsoidArcArea/Center/PointCoordinateType/Latitude

Status	Occurrence	Format	Min. Access Types
Required	One	int	Get, Replace

This leaf node contains the latitudinal coordinate of the center.

- Values: 0-16777215

10.2.97B3C32

/<x>/<x>/OnNetwork/FunctionalAliasList/<x>/Entry/
LocationCriteriaForDeactivation/ExitSpecificArea/EllipsoidArcArea/
Radius

Table 10.2.97B3C32.1:

/<x>/<x>/OnNetwork/FunctionalAliasList/<x>/Entry/LocationCriteriaForDeactivation/ExitSpecificArea/
EllipsoidArcArea/Radius

<x>/OnNetwork/FunctionalAliasList/<x>/Entry/LocationCriteriaForDeactivation/ExitSpecificArea/EllipsoidArcArea/
Radius

Status	Occurrence	Format	Min. Access Types
Required	One	int	Get, Replace

This leaf node contains the radius of the ellipsoid arc.

- Values: non-negative integer

10.2.97B3C33

/<x>/<x>/OnNetwork/FunctionalAliasList/<x>/Entry/
LocationCriteriaForDeactivation/ExitSpecificArea/EllipsoidArcArea/
OffsetAngle

Table 10.2.97B3C33.1:

/<x>/<x>/OnNetwork/FunctionalAliasList/<x>/Entry/LocationCriteriaForDeactivation/ExitSpecificArea/
EllipsoidArcArea/OffsetAngle

<x>/OnNetwork/FunctionalAliasList/<x>/Entry/LocationCriteriaForDeactivation/ExitSpecificArea/EllipsoidArcArea/
OffsetAngle

Status	Occurrence	Format	Min. Access Types
Required	One	int	Get, Replace

This leaf node contains the offset angle of the ellipsoid arc.

- Values: 0-255

10.2.97B3C34

/<x>/<x>/OnNetwork/FunctionalAliasList/<x>/Entry/
LocationCriteriaForDeactivation/ExitSpecificArea/EllipsoidArcArea/
IncludedAngle

Table 10.2.97B3C34.1:

/<x>/<x>/OnNetwork/FunctionalAliasList/<x>/Entry/LocationCriteriaForDeactivation/ExitSpecificArea/
EllipsoidArcArea/IncludedAngle

<x>/OnNetwork/FunctionalAliasList/<x>/Entry/LocationCriteriaForDeactivation/ExitSpecificArea/EllipsoidArcArea/
IncludedAngle

Status	Occurrence	Format	Min. Access Types
Required	One	int	Get, Replace

This leaf node contains the included angle of the ellipsoid arc.

- Values: 0-255

10.2.97B3C35

/<x>/<x>/OnNetwork/FunctionalAliasList/<x>/Entry/
LocationCriteriaForDeactivation/ExitSpecificArea/Speed

Table 10.2.97B3C35.1:

/<x>/<x>/OnNetwork/FunctionalAliasList/<x>/Entry/LocationCriteriaForDeactivation/ExitSpecificArea/
Speed

<x>/OnNetwork/FunctionalAliasList/<x>/Entry/LocationCriteriaForDeactivation/ExitSpecificArea/Speed

Status	Occurrence	Format	Min. Access Types
Optional	One	node	Get, Replace

This interior node contains the speed.

10.2.97B3C36

/<x>/<x>/OnNetwork/FunctionalAliasList/<x>/Entry/
LocationCriteriaForDeactivation/ExitSpecificArea/Speed/
MinimumSpeed

Table 10.2.97B3C36.1:

/<x>/<x>/OnNetwork/FunctionalAliasList/<x>/Entry/LocationCriteriaForDeactivation/ExitSpecificArea/
Speed/MinimumSpeed

<x>/OnNetwork/FunctionalAliasList/<x>/Entry/LocationCriteriaForDeactivation/ExitSpecificArea/Speed/Minimum
Speed

Status	Occurrence	Format	Min. Access Types
Required	One	int	Get, Replace

This leaf node contains the minimum speed.

- Values: non-negative integer in units of kilometers/hour.

10.2.97B3C37

/<x>/<x>/OnNetwork/FunctionalAliasList/<x>/Entry/
LocationCriteriaForDeactivation/ExitSpecificArea/Speed/
MaximumSpeed

Table 10.2.97B3C37.1:

/<x>/<x>/OnNetwork/FunctionalAliasList/<x>/Entry/LocationCriteriaForDeactivation/ExitSpecificArea/
Speed/MaximumSpeed

<x>/OnNetwork/FunctionalAliasList/<x>/Entry/LocationCriteriaForDeactivation/ExitSpecificArea/Speed/Maximum
Speed

Status	Occurrence	Format	Min. Access Types
Required	One	int	Get, Replace

This leaf node contains the maximum speed.

- Values: non-negative integer in units of kilometers/hour.

10.2.97B3C38

/<x>/<x>/OnNetwork/FunctionalAliasList/<x>/Entry/
LocationCriteriaForDeactivation/ExitSpecificArea/Heading

Table 10.2.97B3C38.1:

/<x>/<x>/OnNetwork/FunctionalAliasList/<x>/Entry/LocationCriteriaForDeactivation/ExitSpecificArea/
Heading

<x>/OnNetwork/FunctionalAliasList/<x>/Entry/LocationCriteriaForDeactivation/ExitSpecificArea/Heading

Status	Occurrence	Format	Min. Access Types
Optional	One	node	Get, Replace

This interior node contains the heading.

10.2.97B3C39

/<x>/<x>/OnNetwork/FunctionalAliasList/<x>/Entry/
LocationCriteriaForDeactivation/ExitSpecificArea/Heading/
MinimumHeading

Table 10.2.97B3C39.1:

/<x>/<x>/OnNetwork/FunctionalAliasList/<x>/Entry/LocationCriteriaForDeactivation/ExitSpecificArea/
Heading/MinimumHeading

<x>/OnNetwork/FunctionalAliasList/<x>/Entry/LocationCriteriaForDeactivation/ExitSpecificArea/Heading/Minimu
mHeading

Status	Occurrence	Format	Min. Access Types
Required	One	int	Get, Replace

This leaf node contains the minimum heading.

- Values: 0-359

10.2.97B3C40

/<x>/<x>/OnNetwork/FunctionalAliasList/<x>/Entry/
LocationCriteriaForDeactivation/ExitSpecificArea/Heading/
MaximumHeading

Table 10.2.97B3C40.1:

/<x>/<x>/OnNetwork/FunctionalAliasList/<x>/Entry/LocationCriteriaForDeactivation/ExitSpecificArea/
Heading/MaximumHeading

<x>/OnNetwork/FunctionalAliasList/<x>/Entry/LocationCriteriaForDeactivation/ExitSpecificArea/Heading/Maxim
umHeading

Status	Occurrence	Format	Min. Access Types
Required	One	int	Get, Replace

This leaf node contains the maximum heading.

- Values: 0-359

10.2.97B3D

`<x>/<x>/OnNetwork/FunctionalAliasList/<x>/Entry/
ManualDeactivationNotAllowedIfLocationCriteriaMet`

Table 10.2.97B3D.1:

`<x>/<x>/OnNetwork/FunctionalAliasList/<x>/Entry/ManualDeactivationNotAllowedIfLocationCriteriaMet`

`<x>/OnNetwork/FunctionalAliasList/<x>/Entry/ManualDeactivationNotAllowedIfLocationCriteriaMet`

Status	Occurrence	Format	Min. Access Types
Optional	ZeroOrOne	bool	Get, Replace

This leaf node indicates whether the MCDData user is authorised to de-activate a functional alias if the location criteria are met.

10.2.97C `<x>/<x>/OnNetwork/AllowedQueryFunctionalAliasOtherUser`Table 10.2.97C.1: `<x>/<x>/OnNetwork/AllowedQueryFunctionalAliasOtherUser`

`<x>/OnNetwork/AllowedQueryFunctionalAliasOtherUser`

Status	Occurrence	Format	Min. Access Types
Required	One	bool	Get, Replace

This leaf node indicates whether the MCDData user is authorised query the functional alias(es) activated by another MCDData user.

When set to "true" the MCDData user is authorised to query the functional alias(es) activated by another MCDData user.

When set to "false" the MCDData user is not authorised to query the functional alias(es) activated by another MCDData user.

10.2.97D `<x>/<x>/OnNetwork/AllowedTakeoverFunctionalAliasOtherUser`Table 10.2.97D.1: `<x>/<x>/OnNetwork/AllowedTakeoverFunctionalAliasOtherUser`

`<x>/OnNetwork/AllowedTakeoverFunctionalAliasOtherUser`

Status	Occurrence	Format	Min. Access Types
Required	One	bool	Get, Replace

This leaf node indicates whether the MCDData user is authorised to take over the functional alias(es) previously activated by another MCDData user.

When set to "true" the MCDData user is authorised to take over the functional alias(es) previously activated by another MCDData user.

When set to "false" the MCDData user is not authorised to take over the functional alias(es) previously activated by another MCDData user.

10.2.97E `<x>/<x>/OnNetwork/MessageStoreHostname`Table 10.2.97E.1: `<x>/<x>/OnNetwork/MessageStoreHostname`

`<x>/OnNetwork/MessageStoreHostname`

Status	Occurrence	Format	Min. Access Types
Required	One	chr	Get, Replace

This leaf node indicates value of the hostname identifying the message store function.

The value is a string.

10.2.97F /<x>/<x>/OnNetwork/AuthorisedIncomingAny

Table 10.2.97F.1: /<x>/<x>/OnNetwork/AuthorisedIncomingAny

<x>/OnNetwork/AuthorisedIncomingAny

Status	Occurrence	Format	Min. Access Types
Required	One	Bool	Get, Replace

This leaf node indicates the authorisation to receive MCDData communication from any MCDData user.

When set to "true" the MCDData user is authorised to receive MCDData communication from any MCDData user.

When set to "false" the MCDData user is not authorised to receive an MCDData communication from any MCDData user, but only from the MCDData users contained in the IncomingUserList.

10.2.97G /<x>/<x>/OnNetwork/IncomingUserList

Table 10.2.97G.1: /<x>/<x>/OnNetwork/IncomingUserList

<x>/ OnNetwork/IncomingUserList

Status	Occurrence	Format	Min. Access Types
Required	One	node	Get, Replace

This interior node is a placeholder for a list of MCDData user(s) who are authorised to initiate one-to-one MCDData communication to the configured MCDData user.

10.2.97G1 /<x>/<x>/OnNetwork/IncomingUserList/<x>

Table 10.2.97G1.1: /<x>/<x>/OnNetwork/IncomingUserList/<x>

<x>/OnNetwork/IncomingUserList/<x>

Status	Occurrence	Format	Min. Access Types
Optional	OneOrMore	node	Get, Replace

This interior node is a placeholder for one or more list of MCDData users who are authorised to initiate one-to-one MCDData communication to the configured MCDData user.

10.2.97G2 /<x>/<x>/OnNetwork/IncomingUserList/<x>/Entry

Table 10.2.97G2.1: /<x>/<x>/OnNetwork/IncomingUserList/<x>/Entry

<x>/OnNetwork/IncomingUserList/<x>/Entry

Status	Occurrence	Format	Min. Access Types
Required	One	node	Get, Replace

This interior node is a placeholder for one or more MCDData users who are authorised to initiate one-to-one MCDData communication to the configured MCDData user.

10.2.97G3 /<x>/<x>/OnNetwork/IncomingUserList/<x>/Entry/MCDDataID

Table 10.2.97G3.1: /<x>/<x>/OnNetwork/IncomingUserList/<x>/Entry/MCDDataID

<x>/OnNetwork/IncomingUserList/<x>/Entry/MCDDataID

Status	Occurrence	Format	Min. Access Types
Optional	One	chr	Get, Replace

This leaf node indicates an MCDData user identity (MCDData ID) which is a globally unique identifier within the MCDData service that represents the MCDData user.

The value is a "uri" attribute specified in OMA OMA-TS-XDM_Group-V1_1 [4].

10.2.97G4

`<x>/<x>/OnNetwork/IncomingUserList/<x>/Entry/MCDataIDKMSUR`
`I`

Table 10.2.97G4.1: `<x>/<x>/OnNetwork/IncomingUserList/<x>/Entry/MCDataIDKMSURI`

`<x>/OnNetwork/IncomingUserList/<x>/Entry/PrivateCallKMSURI`

Status	Occurrence	Format	Min. Access Types
Optional	One	chr	Get, Replace

This leaf node indicates the identity (URI) of the KMS associated with the MCDataID of an MCData user who is authorised to initiate a one-to-one communication to the configured MCData user.

The value is a URI as specified in 3GPP TS 23.003 [5].

10.2.98 `<x>/<x>/OffNetwork`

Table 10.2.98.1: `<x>/<x>/OffNetwork`

`<x>/OffNetwork`

Status	Occurrence	Format	Min. Access Types
Required	ZeroOrOne	node	Get, Replace

This interior node represents a container for off-network operation.

10.2.99 `<x>/<x>/OffNetwork/Authorised`

Table 10.2.99.1: `<x>/<x>/OffNetwork/Authorised`

`<x>/OffNetwork/Authorised`

Status	Occurrence	Format	Min. Access Types
Required	One	bool	Get, Replace

This leaf node indicates the authorisation for off-network services.

When set to "true" the MCData user is authorised for off-network.

When set to "false" the MCData user is not authorised for off-network operation.

10.2.100 `<x>/<x>/OffNetwork/MCDataGroupList`

Table 10.2.100.1: `<x>/<x>/OffNetwork/MCDataGroupList`

`<x>/OffNetwork/MCDataGroupList`

Status	Occurrence	Format	Min. Access Types
Required	One	node	Get, Replace

This interior node is a placeholder for the list of off-network MCData groups that the MCData user is allowed to use.

10.2.101 `<x>/<x>/OffNetwork/MCDataGroupList/<x>`

Table 10.2.101.1: `<x>/<x>/OffNetwork/MCDataGroupList/<x>`

`<x>/OffNetwork/MCDataGroupList/<x>`

Status	Occurrence	Format	Min. Access Types
Required	OneOrMore	node	Get, Replace

This interior node is a placeholder for one or more list of off-network MCDData groups that the MCDData user is allowed to use.

10.2.102 /<x>/<x>/OffNetwork/MCDDataGroupList/<x>/Entry

Table 10.2.102.1: /<x>/<x>/OffNetwork/MCDDataGroupList/<x>/Entry

<x>/OffNetwork/MCDDataGroupList/<x>/Entry

Status	Occurrence	Format	Min. Access Types
Optional	One	node	Get, Replace

This interior node is a placeholder for the details of the off-network MCDData groups that the MCDData user is allowed to use.

10.2.103 /<x>/<x>/OffNetwork/MCDDataGroupList/<x>/Entry/MCDDataGroupID

Table 10.2.103.1: /<x>/<x>/OffNetwork/MCDDataGroupList/<x>/Entry/MCDDataGroupID

<x>/OffNetwork/MCDDataGroupList/<x>/Entry/MCDDataGroupID

Status	Occurrence	Format	Min. Access Types
Required	One	chr	Get, Replace

This leaf node indicates the MCDData group ID for the off-network MCDData group that the MCDData user is allowed to use.

The value is a "uri" attribute specified in OMA OMA-TS-XDM_Group-V1_1 [4].

10.2.104 /<x>/<x>/OffNetwork/MCDDataGroupList/<x>/Entry/DisplayName

Table 10.2.104.1: /<x>/<x>/OffNetwork/MCDDataGroupList/<x>/Entry/DisplayName

<x>/OffNetwork/MCDDataGroupList/<x>/Entry/DisplayName

Status	Occurrence	Format	Min. Access Types
Optional	One	chr	Get, Replace

This leaf node contains a human readable name that corresponds to the MCDData Group ID.

10.2.105 /<x>/<x>/OffNetwork/MCDDataGroupList/<x>/Entry/GMSAppServList

Table 10.2.105.1: /<x>/<x>/OffNetwork/MCDDataGroupList/<x>/Entry/GMSAppServList

<x>/OffNetwork/MCDDataGroupList/<x>/Entry/GMSAppServList

Status	Occurrence	Format	Min. Access Types
Required	One	node	Get, Replace

This interior node is a placeholder for the Group Management Server application plane server identity configuration.

10.2.106

/<x>/<x>/OffNetwork/MCDDataGroupList/<x>/>/Entry/GMSAppServList/<x>

Table 10.2.106.1: /<x>/<x>/OffNetwork/MCDDataGroupList/<x>/Entry/GMSAppServList/<x>

<x>/OffNetwork/MCDDataGroupList/<x>/Entry/GMSAppServList/<x>

Status	Occurrence	Format	Min. Access Types
Required	OneOrMore	node	Get, Replace

This interior node is a placeholder for one or more Group Management Server configuration.

10.2.107

`/<x>/<x>/OffNetwork/MCDataGroupList/<x>/Entry/GMSAppServList/
<x>/GMSAppServId`

Table 10.2.107.1:

`/<x>/<x>/OffNetwork/MCDataGroupList/<x>/Entry/GMSAppServList/<x>/GMSAppServId`

`<x>/OffNetwork/MCDataGroupList/<x>/Entry/GMSAppServList/<x>/GMSAppServId`

Status	Occurrence	Format	Min. Access Types
Optional	One	chr	Get, Replace

This leaf node indicates the identity (URI) of the the group management server hosting the MCData Group ID.

10.2.108

`/<x>/<x>/OffNetwork/MCDataGroupList/<x>/Entry/IdMSTokenEndPointList`

Table 10.2.108.1: `/<x>/<x>/OffNetwork/MCDataGroupList/<x>/Entry/IdMSTokenEndPointList`

`<x>/OffNetwork/MCDataGroupList/<x>/Entry/IdMSTokenEndPointList`

Status	Occurrence	Format	Min. Access Types
Required	One	node	Get, Replace

This interior node is a placeholder for the Identity Management Server token endpoints configuration..

10.2.109

`/<x>/<x>/OffNetwork/MCDataGroupList/<x>/Entry/IdMSTokenEndPointList/<x>`

Table 10.2.109.1: `/<x>/<x>/OffNetwork/MCDataGroupList/<x>/Entry/IdMSTokenEndPointList/<x>`

`<x>/OffNetwork/MCDataGroupList/<x>/Entry/IdMSTokenEndPointList/<x>`

Status	Occurrence	Format	Min. Access Types
Required	OneOrMore	node	Get, Replace

This interior node is a placeholder for one or more IDMS token endpoints configuration.

10.2.110 `/<x>/<x>/OffNetwork/MCDataGroupList/<x>/Entry/IdMSTokenEndPointList/<x>/IdMSTokenEndPoint`**Table 10.2.110.1:**

`/<x>/<x>/OffNetwork/MCDataGroupList/<x>/Entry/IdMSTokenEndPointList/<x>/IdMSTokenEndPoint`

`<x>/OffNetwork/MCDataGroupList/<x>/Entry/IdMSTokenEndPointList/<x>/IdMSTokenEndPoint`

Status	Occurrence	Format	Min. Access Types
Optional	One	chr	Get, Replace

This leaf node indicates the identity (URI) of the the IDMS token endpoint for the MCData Group ID in the MCDataGroupList. If the value is empty, the IDMS identities (IDMSAuthEndpoint and IDMSTokenEndpoint) present in the MCS UE initial configuration MO are used.

10.2.110A

`/<x>/<x>/OffNetwork/MCDataGroupList/<x>/Entry/MCDataGroupIDKMSURI`

Table 10.2.110A.1: `/<x>/<x>/OffNetwork/MCDataGroupList/<x>/Entry/MCDataGroupIDKMSURI`

`<x>/OffNetwork/MCDataGroupList/<x>/Entry/MCDataGroupIDKMSURI`

Status	Occurrence	Format	Min. Access Types
Required	One	chr	Get, Replace

This leaf node indicates key management server URI for the security domain of the MCData group identity (MCData Group ID) of the off-network MCData group

The value is a URI as specified in 3GPP TS 23.003 [5].

10.2.111

`/<x>/<x>/OffNetwork/MCDataGroupList/<x>/Entry/PresentationPriority`

Table 10.2.111.1: `/<x>/<x>/OffNetwork/MCDataGroupList/<x>/Entry/PresentationPriority`

`<x>/OffNetwork/MCDataGroupList/<x>/Entry/PresentationPriority`

Status	Occurrence	Format	Min. Access Types
Optional	One	int	Get, Replace

This leaf node indicates indicating the presentation priority of the off-network group for the MCData user relative to other off-network groups and off-network users.

- Values: 0-255

The lowest PresentationPriority value shall be considered as the MCData group transaction having the lowest priority for presentation among other group MCData and one-to-one user transactions.

10.2.112 `/<x>/<x>/OffNetwork/UserInfoID`

Table 10.2.112.1: `/<x>/<x>/OffNetwork/UserInfoID`

`<x>/OffNetwork/UserInfoID`

Status	Occurrence	Format	Min. Access Types
Required	One	chr	Get, Replace

This leaf node indicates the ProSe user info ID as specified in 3GPP TS 23.303 [6].

10.2.113 Void

10.2.114 Void

10.2.115 Void

10.2.116 Void

10.2.117 Void

10.2.118 Void

10.2.119 Void

10.2.120 Void

10.2.121 /<x>/Status

Table 10.2.121.1: /<x>/Status

Status

Status	Occurrence	Format	Min. Access Types
Optional	One	bool	Get, Replace

This leaf node indicates whether this MCDData user profile is enabled or disabled.

When set to "true" this MCDData user profile is enabled.

When set to "false" this MCDData user profile is disabled.

11 MCDData service configuration MO

11.1 General

The MCDData service configuration Management Object (MO) is used to configure MCDData Client behaviour for the on-network or off-network MCDData Service. The MCDData service configuration parameters may be stored in the ME, or in the USIM as specified in 3GPP TS 31.102 [10], or in both the ME and the USIM. If both the ME and the USIM contain the same parameters, the values stored in the USIM shall take precedence.

The Management Object Identifier is: urn:oma:mo:ext-3gpp-MCDData-service-configuration:1.0.

Protocol compatibility: This MO is compatible with OMA OMA DM 1.2 [3].

The OMA DM ACL property mechanism (see OMA OMA-ERELED-DM-V1_2 [2]) may be used to grant or deny access rights to OMA DM servers in order to modify nodes and leaf objects of the MCDData service configuration MO.

The following nodes and leaf objects are possible under the MCDData service configuration node as described in figure 11.1.1:

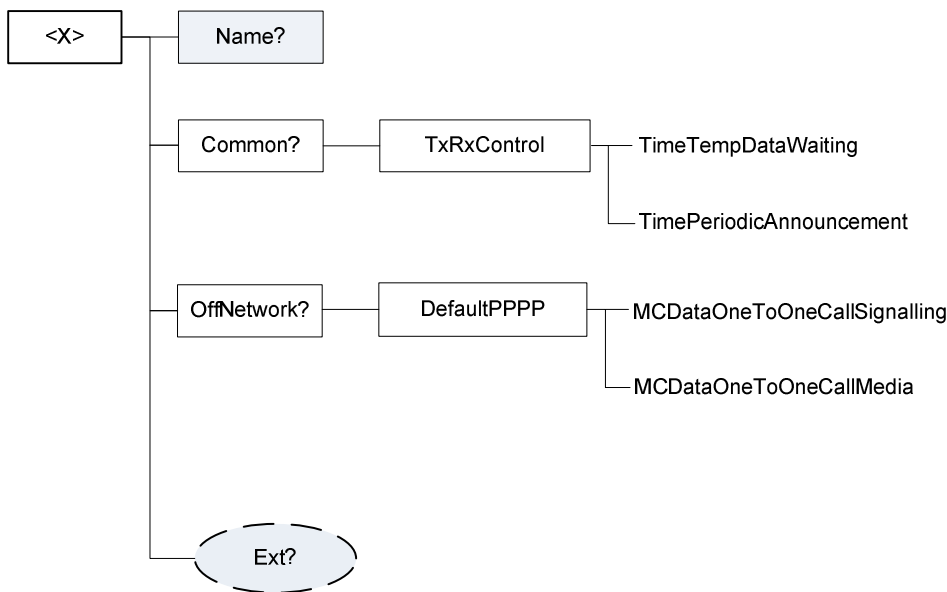

Figure 11.1.1: The MCDATA service configuration MO

11.2 MCDATA service configuration MO parameters

11.2.1 General

This clause describes the parameters for the MCDATA service configuration Management Object (MO).

11.2.2 Node: <x>

Table 11.2.2.1: Node: <x>

<x>

Status	Occurrence	Format	Min. Access Types
Required	OneOrMore	node	Get

This interior node acts as a placeholder for the MCDATA service configuration Management Object (MO).

For the MCDATA service configuration MO, the namespace specific string is: "urn:oma:mo:oma-dm-mcdata-service configuration:1.0"

- Values: N/A

11.2.3 /<x>/Name

Table 11.2.3.1: /<x>/Name

Name

Status	Occurrence	Format	Min. Access Types
Required	ZeroOrOne	chr	Get

The Name leaf is a name for the MCDATA service configuration settings.

- Values: <User displayable name>

11.2.4 /<x>/Ext/

Table 11.2.4.1: /<x>/Ext/

Ext

Status	Occurrence	Format	Min. Access Types
Optional	ZeroOrOne	node	Get, Replace

The Ext is an interior node for where the vendor specific information about the MCDData service configuration MO is being placed.

Usually the vendor extension is identified by vendor specific name under the ext node and contains the vendor meaning application vendor, device vendor etc. The tree structure under the vendor identified is not defined and can therefore include one or more un-standardized sub-trees.

- Values: N/A

11.2.5 /<x>/Common

Table 11.2.5.1: /<x>/Common

Common

Status	Occurrence	Format	Min. Access Types
Required	ZeroOrOne	node	Get, Replace

This interior node represents a container for the common network operation which means both on-network operation and off-network operation.

11.2.6 /<x>/Common/TxRxControl

Table 11.2.6.1: /<x>/Common/TxRxControl

Common/TxRxControl

Status	Occurrence	Format	Min. Access Types
Required	One	node	Get, Replace

This interior node is a placeholder for transmission and reception control configuration.

11.2.7 /<x>/Common/TxRxControl/TimeTempDataWaiting

Table 11.2.7.1: /<x>/Common/TxRxControl/TimeTempDataWaiting

Common/TxRxControl/TimeTempDataWaiting

Status	Occurrence	Format	Min. Access Types
Required	One	int	Get, Replace

This leaf node indicates the time limit for the temporarily stored data that is waiting to be delivered to a receiving user.

- Values: 0-65535

The TimeTempDataWaiting is in minutes.

11.2.8 /<x>/Common/TxRxControl/TimePeriodicAnnouncement

Table 11.2.8.1: /<x>/Common/TxRxControl/TimePeriodicAnnouncement

Common/TxRxControl/TimePeriodicAnnouncement

Status	Occurrence	Format	Min. Access Types
Required	One	int	Get, Replace

This leaf node indicates the timer for the periodic announcement which contains a list of available recently invited data group communications.

- Values: 0-65535

The TimePeriodicAnnouncement is in minutes.

11.2.9 /<x>/OffNetwork

Table 11.2.9.1: /<x>/OffNetwork

OffNetwork

Status	Occurrence	Format	Min. Access Types
Required	ZeroOrOne	node	Get, Replace

This interior node represents a container for off-network operation.

11.2.10 /<x>/OffNetwork/DefaultPPPP

Table 11.2.10.1: /<x>/OffNetwork/DefaultPPPP

OffNetwork/DefaultPPPP

Status	Occurrence	Format	Min. Access Types
Required	One	node	Get, Replace

This interior node is a placeholder for the default ProSe Per-Packet Priority (PPPP) configuration.

11.2.11 /<x>/OffNetwork/DefaultPPPP/MCDataOneToOneCallSignalling

Table 11.2.11.1: /<x>/OffNetwork/DefaultPPPP/MCDataOneToOneCallSignalling

OffNetwork/DefaultPPPP/MCDataOneToOneCallSignalling

Status	Occurrence	Format	Min. Access Types
Required	One	int	Get, Replace

This leaf node indicates the default ProSe Per-Packet Priority (PPPP) value (as specified in 3GPP TS 23.303 [6]) for the MCData one-to-one call signalling.

- Values: 1-8

The MCData user data with the lowest ProSe Per-Packet Priority value shall be considered as the MCData user data having the highest priority among the MCData user data.

11.2.12 /<x>/OffNetwork/DefaultPPPP/MCDataOneToOneCallMedia

Table 11.2.12.1: /<x>/OffNetwork/DefaultPPPP/MCDataOneToOneCallMedia

OffNetwork/DefaultPPPP/MCDataOneToOneCallMedia

Status	Occurrence	Format	Min. Access Types
Required	One	int	Get, Replace

This leaf node indicates the default ProSe Per-Packet Priority (PPPP) value (as specified in 3GPP TS 23.303 [6]) for the MCData private call media.

- Values: 1-8

The MCData user data with the lowest ProSe Per-Packet Priority value shall be considered as the MCData user data having the highest priority among the MCData user data.

12 MCVideo UE configuration MO

12.1 General

The MCVideo UE configuration Management Object (MO) is used to configure MCVideo Client behaviour for the on-network or off-network MCVideo Service. The MCVideo UE configuration parameters may be stored in the ME, or in the USIM as specified in 3GPP TS 31.102 [10], or in both the ME and the USIM. If both the ME and the USIM contain the same parameters, the values stored in the USIM shall take precedence.

The Management Object Identifier is: urn:oma:mo:ext-3gpp-MCVideo-UE-configuration:1.0.

Protocol compatibility: This MO is compatible with OMA OMA DM 1.2 [3].

The OMA DM ACL property mechanism (see OMA OMA-ERELD-DM-V1_2 [2]) may be used to grant or deny access rights to OMA DM servers in order to modify nodes and leaf objects of the MCVideo UE configuration MO.

The following nodes and leaf objects are possible under the MCVideo UE configuration node as described in figure 12.1.1:

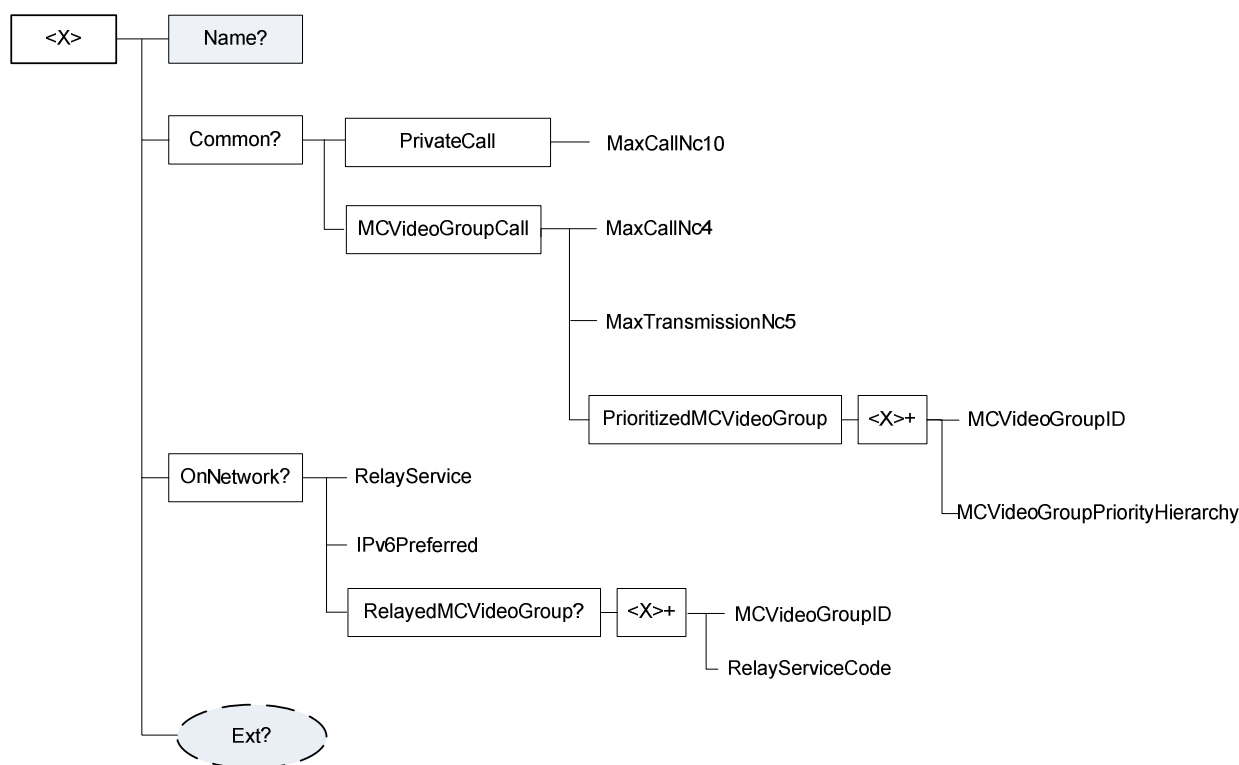

Figure 12.1.1: The MCVideo UE configuration MO

12.2 MCVideo UE configuration MO parameters

12.2.1 General

This clause describes the parameters for the MCVideo UE configuration Management Object (MO).

12.2.2 Node: <x>

Table 12.2.2.1: Node: <x>

<x>

Status	Occurrence	Format	Min. Access Types
Required	OneOrMore	node	Get

This interior node acts as a placeholder for the MCVideo UE configuration Management Object (MO).

For the MCVideo UE configuration MO, the namespace specific string is: "urn:oma:mo:oma-dm-mcvideo-ue-configuration:1.0"

- Values: N/A

12.2.3 /<x>/Name

Table 12.2.3.1: /<x>/Name

Name

Status	Occurrence	Format	Min. Access Types
Required	ZeroOrOne	chr	Get

The Name leaf is a name for the MCVideo UE configuration settings.

- Values: <User displayable name>

12.2.4 /<x>/Ext/

Table 12.2.4.1: /<x>/Ext/

Ext

Status	Occurrence	Format	Min. Access Types
Optional	ZeroOrOne	node	Get, Replace

The Ext is an interior node for where the vendor specific information about the MCVideo UE configuration MO is being placed.

Usually the vendor extension is identified by vendor specific name under the ext node and contains the vendor meaning application vendor, device vendor etc. The tree structure under the vendor identified is not defined and can therefore include one or more un-standardized sub-trees.

- Values: N/A

12.2.5 /<x>/Common

Table 12.2.5.1: /<x>/Common

Common

Status	Occurrence	Format	Min. Access Types
Required	ZeroOrOne	node	Get, Replace

This interior node represents a container for the common network operation which means both on-network operation and off-network operation.

12.2.5A /<x>/Common/PrivateCall

Table 12.2.5A.1: /<x>/Common/PrivateCall

Common/PrivateCall

Status	Occurrence	Format	Min. Access Types

Required	One	node	Get, Replace
----------	-----	------	--------------

This interior node is a placeholder for the private call configuration.

12.2.5B /<x>/Common/PrivateCall/MaxCallNc10

Table 12.2.5B.1: /<x>/Common/PrivateCall/MaxCallNc10

Common/PrivateCall/MaxCallNc10

Status	Occurrence	Format	Min. Access Types
Required	One	int	Get, Replace

This leaf node indicates the maximum number of private calls.

- Values: 0-255

12.2.6 /<x>/Common/MCVideoGroupCall

Table 12.2.6.1: /<x>/Common/MCVideoGroupCall

Common/MCVideoGroupCall

Status	Occurrence	Format	Min. Access Types
Required	One	node	Get, Replace

This interior node is a placeholder for the MCVideo group call configuration.

12.2.7 /<x>/Common/MCVideoGroupCall/MaxCallNc4

Table 12.2.7.1: /<x>/Common/MCVideoGroupCall/MaxCallNc4

Common/MCVideoGroupCall/MaxCallNc4

Status	Occurrence	Format	Min. Access Types
Required	One	int	Get, Replace

This leaf node indicates the maximum number of simultaneous MCVideo group calls.

- Values: 0-255

12.2.8 /<x>/Common/MCVideoGroupCall/MaxTransmissionNc5

Table 12.2.8.1: /<x>/Common/MCVideoGroupCall/MaxTransmissionNc5

Common/MCVideoGroupCall/MaxTransmissionNc5

Status	Occurrence	Format	Min. Access Types
Required	One	int	Get, Replace

This leaf node indicates the maximum number of video transmissions in a group.

- Values: 0-255

12.2.9 /<x>/Common/MCVideoGroupCall/PrioritizedMCVideoGroup

Table 12.2.9.1: /<x>/Common/MCVideoGroupCall/PrioritizedMCVideoGroup

Common/MCVideoGroupCall/PrioritizedMCVideoGroup

Status	Occurrence	Format	Min. Access Types
Required	One	node	Get, Replace

This interior node is a placeholder for the prioritized MCVideo group call configuration.

12.2.10 /<x>/Common/MCVideoGroupCall/PrioritizedMCVideoGroup/<x>

Table 12.2.10.1: /<x>/Common/MCVideoGroupCall/PrioritizedMCVideoGroup/<x>

Common/MCVideoGroupCall/PrioritizedMCVideoGroup /<x>

Status	Occurrence	Format	Min. Access Types
Required	OneOrMore	node	Get, Replace

This interior node is a placeholder for one or more prioritized MCVideo group call configuration.

12.2.11

/<x>/Common/MCVideoGroupCall/PrioritizedMCVideoGroup/<x>/MCVideoGroupID

Table 12.2.11.1: /<x>/Common/MCVideoGroupCall/PrioritizedMCVideoGroup/<x>/MCVideoGroupID

Common/MCVideoGroupCall/PrioritizedMCVideoGroup/<x>/MCVideoGroupID

Status	Occurrence	Format	Min. Access Types
Required	One	chr	Get, Replace

This leaf node indicates the associated MCVideo group ID.

The value is a "uri" attribute specified in OMA OMA-TS-XDM_Group-V1_1 [4].

12.2.12 /<x>/Common/MCVideoGroupCall/PrioritizedMCVideoGroup/<x>/MCVideoGroupPriorityHierarchy

Table 12.2.12.1:

/<x>/Common/MCVideoGroupCall/PrioritizedMCVideoGroup/<x>/MCVideoGroupPriorityHierarchy

Common/MCVideoGroupCall/PrioritizedMCVideoGroup/<x>/MCVideoGroupPriorityHierarchy

Status	Occurrence	Format	Min. Access Types
Required	One	int	Get, Replace

This leaf node indicates the requested presentation priority of MCVideo group call.

- Values: 0-255

The group with the lowest MCVideoGroupPriorityHierarchy value shall be considered as the group having the lowest priority among the groups.

12.2.13 /<x>/OnNetwork

Table 12.2.13.1: /<x>/OnNetwork

OnNetwork

Status	Occurrence	Format	Min. Access Types
Required	ZeroOrOne	node	Get, Replace

This interior node represents a container for on-network operation.

12.2.14 /<x>/OnNetwork/RelayService

Table 12.2.14.1: /<x>/OnNetwork/RelayService

OnNetwork/RelayService

Status	Occurrence	Format	Min. Access Types

Required	One	bool	Get, Replace
----------	-----	------	--------------

This leaf node indicates the authorisation to use a relay service.

When set to "true" the MCVideo group is allowed to use a relay service.

When set to "false" the MCVideo group is not allowed to use a relay service.

12.2.15 /<x>/OnNetwork/IPv6Preferred

Table 12.2.15.1: /<x>/OnNetwork/IPv6Preferred

OnNetwork/IPv6Preferred

Status	Occurrence	Format	Min. Access Types
Required	One	bool	Get, Replace

This leaf node indicates whether IPv6 is preferred over IPv4 for on-network operation when the MCVideo UE has both IPv4 and IPv6 host configuration.

If the MCVideo UE has both IPv4 and IPv6 host configuration and:

- if IPv6Preferred is set to "true" then the UE uses IPv6 for all on-network signalling and media; otherwise
- if IPv6Preferred is set to "false" then the UE uses IPv4 for all on-network signalling and media.

12.2.16 /<x>/OnNetwork/RelayedMCVideoGroup

Table 12.2.16.1: /<x>/OnNetwork/RelayedMCVideoGroup

OnNetwork/RelayedMCVideoGroup

Status	Occurrence	Format	Min. Access Types
Optional	ZeroOrOne	node	Get, Replace

This interior node is a placeholder for the allowed relayed MCVideo groups.

12.2.17 /<x>/OnNetwork/RelayedMCVideoGroup/<x>

Table 12.2.17.1: /<x>/OnNetwork/RelayedMCVideoGroup/<x>

OnNetwork/RelayedMCVideoGroup/<x>

Status	Occurrence	Format	Min. Access Types
Required	OneOrMore	node	Get, Replace

This interior node is a placeholder for one or more allowed relayed MCVideo groups.

12.2.18 /<x>/OnNetwork/RelayedMCVideoGroup/<x>/MCVideoGroupID

Table 12.2.18.1: /<x>/OnNetwork/RelayedMCVideoGroup/<x>/MCVideoGroupID

OnNetwork/RelayedMCVideoGroup/<x>/MCVideoGroupID

Status	Occurrence	Format	Min. Access Types
Required	One	chr	Get, Replace

This leaf node indicates the associated MCVideo group ID.

The value is a "uri" attribute specified in OMA OMA-TS-XDM_Group-V1_1 [4].

12.2.19 /<x>/OnNetwork/RelayedMCVideoGroup/<x>/RelayServiceCode

Table 12.2.19.1: /<x>/OnNetwork/RelayedMCVideoGroup/<x>/RelayServiceCode

OnNetwork/RelayedMCVideoGroup/<x>/RelayServiceCode

Status	Occurrence	Format	Min. Access Types
Required	One	chr	Get, Replace

This leaf node indicates the connectivity service that the ProSe UE-to-network relay provides to public safety applications as specified in 3GPP TS 23.303 [6].

13 MCVideo user profile MO

13.1 General

The MCVideo user profile configuration Management Object (MO) is used to configure the MCVideo Client behaviour for the on-network or off-network MCVideo Service. The MCVideo user profile configuration parameters may be stored in the ME, or in the USIM as specified in 3GPP TS 31.102 [10], or in both the ME and the USIM. If both the ME and the USIM contain the same parameters, the values stored in the USIM shall take precedence.

The Management Object Identifier is: urn:oma:mo:ext-3gpp-MCVideo-user-profile:1.0.

Protocol compatibility: This MO is compatible with OMA OMA DM 1.2 [3].

The OMA DM ACL property mechanism (see OMA OMA-ERELED-DM-V1_2 [2]) may be used to grant or deny access rights to OMA DM servers in order to modify nodes and leaf objects of the MCVideo user profile MO.

The following nodes and leaf objects are possible under the MCVideo user profile node as described in figure 13.1.1, figure 13.1.2 and figure 13.1.3:

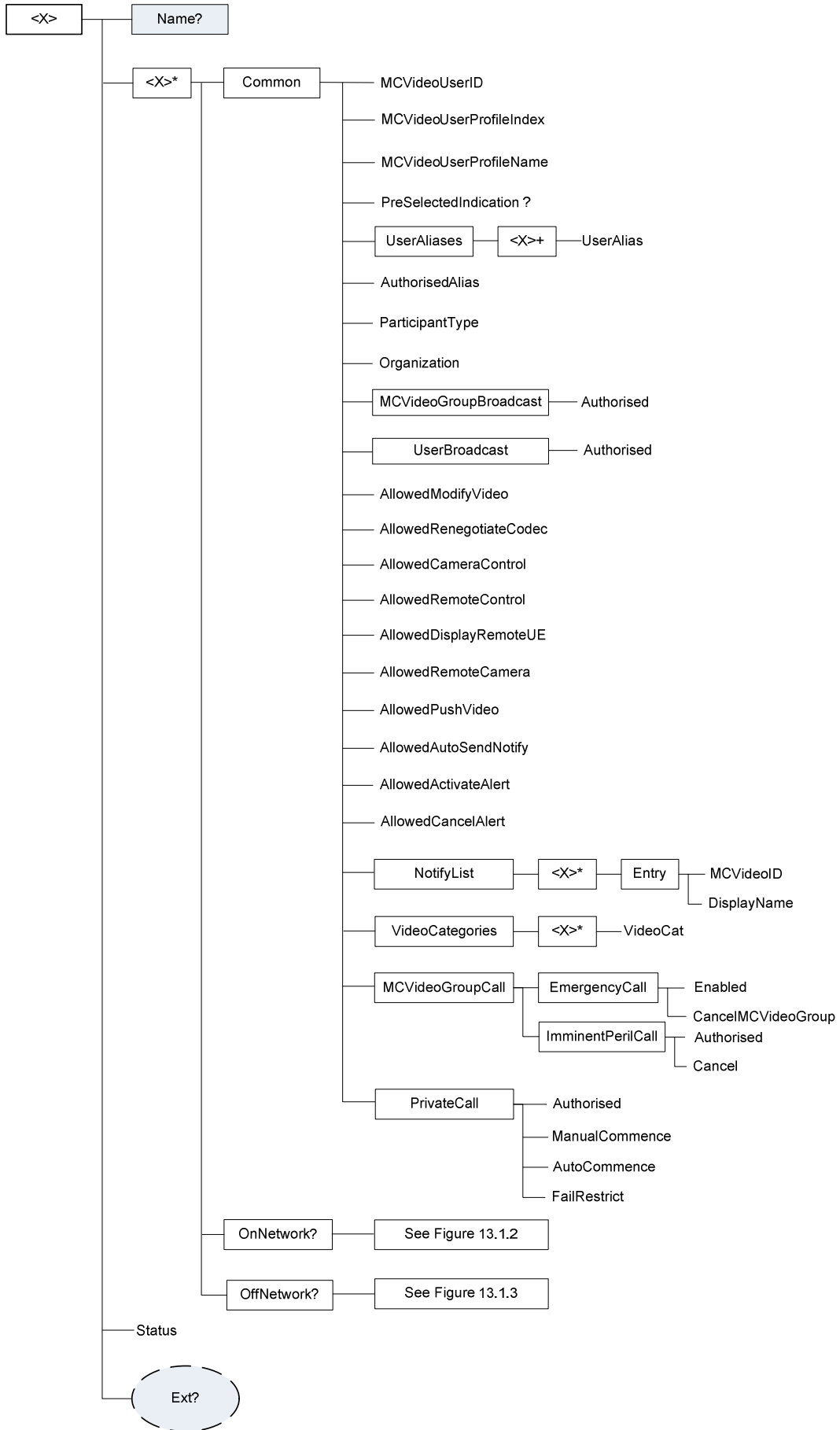

Figure 13.1.1: The MCVideo user profile MO (1 of 3)

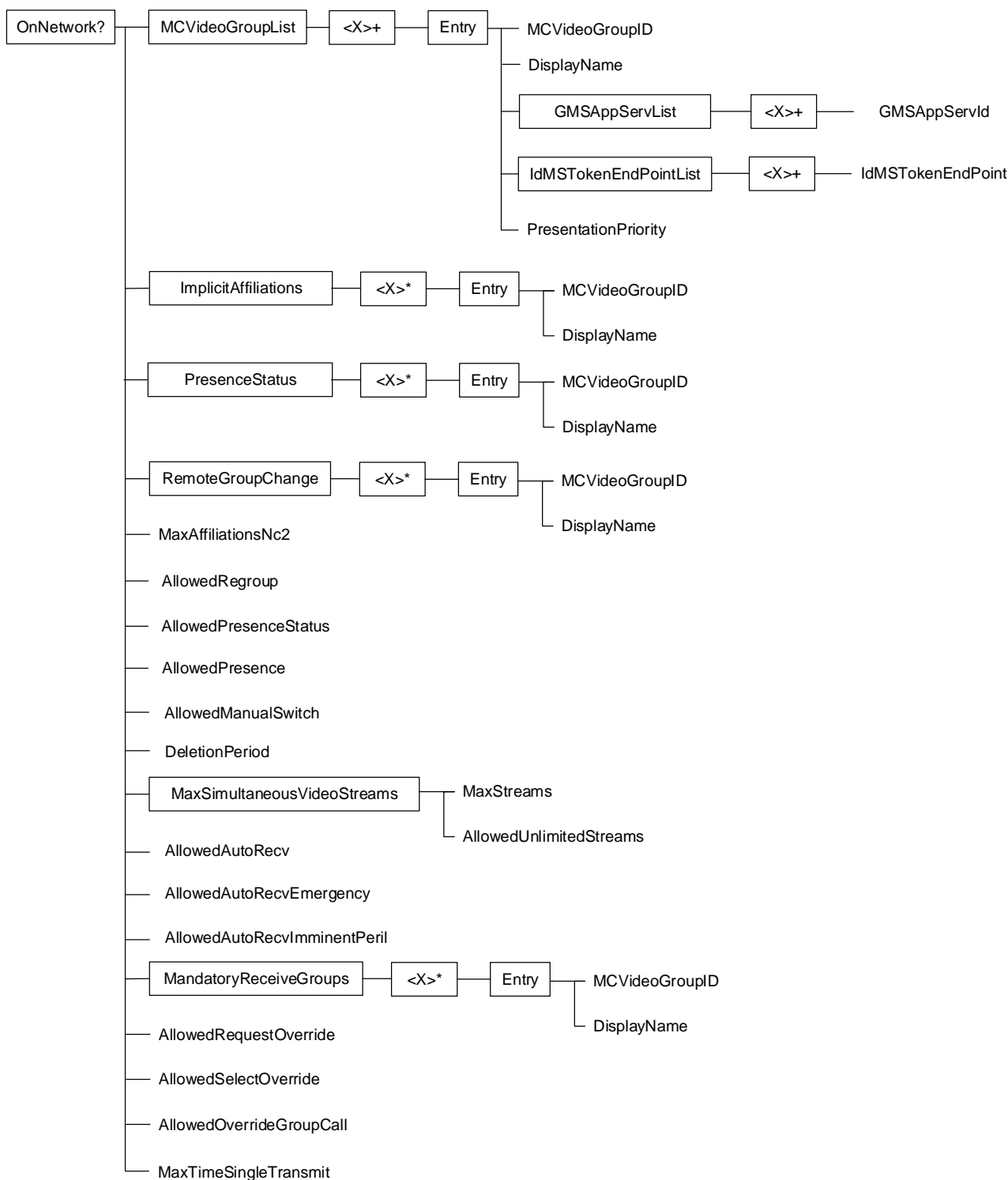

Figure 13.1.2: The MCVideo user profile MO (2 of 3)

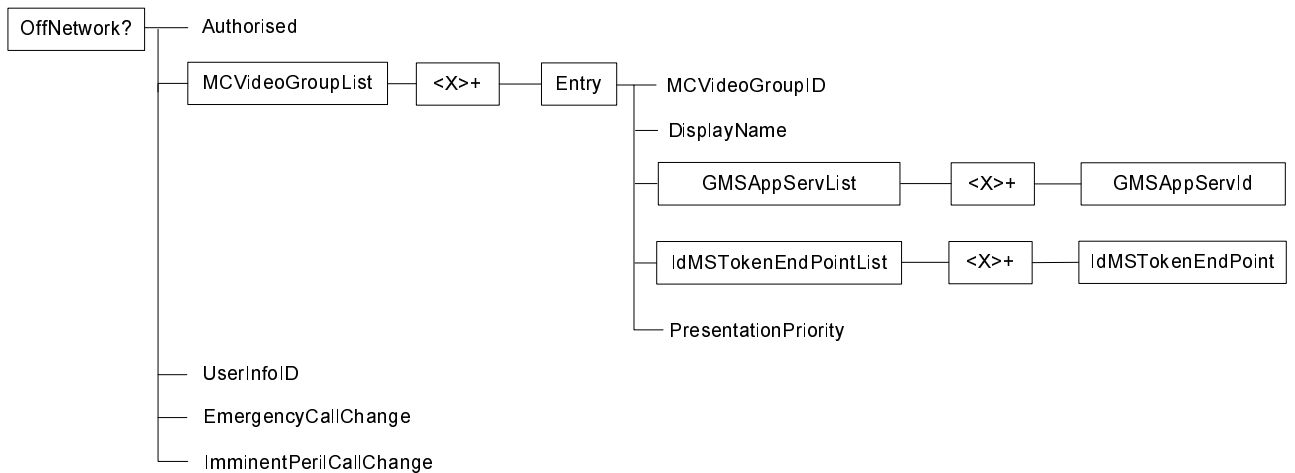

Figure 13.1.3: The MCVideo user profile MO (3 of 3)

13.2 MCVideo user profile MO parameters

13.2.1 General

This clause describes the parameters for the MCVideo user profile Management Object (MO).

13.2.2 Node: <x>

Table 13.2.2.1: Node: <x>

<x>

Status	Occurrence	Format	Min. Access Types
Required	OneOrMore	node	Get

This interior node acts as a placeholder for the MCVideo user profile Management Object (MO).

For the MCVideo user profile MO, the namespace specific string is: "urn:oma:mo:oma-dm-mcvideo-user-profile:1.0"

- Values: N/A

13.2.3 /<x>/Name

Table 13.2.3.1: /<x>/Name

Name

Status	Occurrence	Format	Min. Access Types
Required	ZeroOrOne	chr	Get

The Name leaf is a name for the MCVideo user profile settings.

- Values: <User displayable name>

13.2.4 /<x>/Ext/

Table 13.2.4.1: /<x>/Ext/

Ext

Status	Occurrence	Format	Min. Access Types
Optional	ZeroOrOne	node	Get, Replace

The Ext is an interior node for where the vendor specific information about the MCVideo user profile MO is being placed.

Usually the vendor extension is identified by vendor specific name under the ext node and contains the vendor meaning application vendor, device vendor etc. The tree structure under the vendor identified is not defined and can therefore include one or more un-standardized sub-trees.

- Values: N/A

13.2.5 /<x>/<x>

Table 13.2.5.1: /<x>/<x>

<x>

Status	Occurrence	Format	Min. Access Types
Required	ZeroOrMore	node	Get, Replace

This interior node represents a container for on-network operation and off-network operation.

13.2.6 /<x>/<x>/Common

Table 13.2.6.1: /<x>/<x>/Common

<x>/Common

Status	Occurrence	Format	Min. Access Types
Required	OneOrMore	node	Get, Replace

This interior node represents a container for the common network operation which means both on-network operation and off-network operation.

13.2.7 /<x>/<x>/Common/MCVideoUserID

Table 13.2.7.1: /<x>/<x>/Common/MCVideoUserID

<x>/Common/MCVideoUserID

Status	Occurrence	Format	Min. Access Types
Required	One	chr	Get, Replace

This leaf node indicates an MCVideo user identity (MCVideo ID) which is a globally unique identifier within the MCVideo service that represents the MCVideo user.

13.2.8 /<x>/<x>/Common/MCVideoUserProfileIndex

Table 13.2.8.1: /<x>/<x>/Common/MCVideoUserProfileIndex

<x>/Common/MCVideoUserProfileIndex

Status	Occurrence	Format	Min. Access Types
Required	One	int	Get, Replace

This leaf node indicates an index for the particular MCVideo user profile.

- Values: 0-255

13.2.9 /<x>/<x>/Common/MCVideoUserProfileName

Table 13.2.9.1: /<x>/<x>/Common/MCVideoUserProfileName

<x>/Common/MCVideoUserProfileName

Status	Occurrence	Format	Min. Access Types
Optional	One	chr	Get, Replace

This leaf node indicates a profile name for the particular MCVideo user profile.

13.2.10 /<x>/<x>/Common/PreSelectedIndication

Table 13.2.10.1: /<x>/<x>/Common/PreSelectedIndication

<x>/Common/PreSelectedIndication

Status	Occurrence	Format	Min. Access Types
Optional	ZeroOrOne	null	Get, Replace

This leaf node indicates that this MCVideo user profile MO is designated to be the pre-selected MCVideo user profile as defined by 3GPP TS 23.179 [15]

- Values: null

When this leaf node is present, this MCVideo user profile MO is designated as the pre-selected MCVideo user profile.

When this leaf node is absent, this MCVideo user profile MO is not designated as the pre-selected MCVideo user profile.

If more than one MCVideo user profile MO is specified for the MCVideo user, then only one MCVideo user profile MO for the MCVideo user shall contain the <x>/Common/PreSelectedIndication leaf node.

If there is only one MCVideo user profile MO specified for the MCVideo user, then it is optional to include the <x>/Common/PreSelectedIndication leaf node.

13.2.11 /<x>/<x>/Common/UserAliases

Table 13.2.11.1: /<x>/<x>/Common/UserAliases

<x>/Common/UserAliases

Status	Occurrence	Format	Min. Access Types
Required	One	node	Get, Replace

This interior node is a placeholder for a list of aliases of an MCVideo user.

13.2.12 /<x>/<x>/Common/UserAliases/<x>

Table 13.2.12.1: /<x>/<x>/Common/UserAliases/<x>

<x>/Common/UserAliases/<x>

Status	Occurrence	Format	Min. Access Types
Required	OneOrMore	node	Get, Replace

This interior node is a placeholder for one or more aliases of an MCVideo user.

13.2.13 /<x>/<x>/Common/UserAliases/<x>/UserAlias

Table 13.2.13.1: /<x>/<x>/Common/UserAliases/<x>/UserAlias

<x>/Common/UserAliases/<x>/UserAlias

Status	Occurrence	Format	Min. Access Types
Required	One	chr	Get, Replace

This leaf node indicates an alphanumeric alias of the MCVideo user.

13.2.14 /<x>/<x>/Common/AuthorisedAlias

Table 13.2.14.1: /<x>/<x>/Common/AuthorisedAlias

<x>/Common/AuthorisedAlias

Status	Occurrence	Format	Min. Access Types
Optional	One	bool	Get, Replace

This leaf node indicates authorisation to create and delete aliases of other MCVideo users and their associated MCVideo user profiles.

When set to "true" the MCVideo user is authorised to create and delete aliases of other MCVideo users and their associated MCVideo user profiles.

When set to "false" the MCVideo user is not authorised to create and delete aliases of other MCVideo user and their associated MCVideo user profiles. This is the default if this leaf node is not present.

13.2.15 /<x>/<x>/Common/ParticipantType

Table 13.2.15.1: /<x>/<x>/Common/ParticipantType

<x>/Common/ParticipantType

Status	Occurrence	Format	Min. Access Types
Required	One	chr	Get, Replace

This leaf node indicates the participant type of the MCVideo user.

The ParticipantType means the functional category of the participant (e.g., first responder, second responder, dispatch, dispatch supervisor), typically defined by the MCVideo administrators.

13.2.16 /<x>/<x>/Common/Organization

Table 13.2.16.1: /<x>/<x>/Common/Organization

<x>/Common/Organization

Status	Occurrence	Format	Min. Access Types
Required	One	chr	Get, Replace

This leaf node indicates the organization an MCVideo user belongs to.

13.2.17 /<x>/<x>/Common/MCVideoGroupBroadcast

Table 13.2.17.1: /<x>/<x>/Common/MCVideoGroupBroadcast

<x>/Common/MCVideoGroupBroadcast

Status	Occurrence	Format	Min. Access Types
Required	One	node	Get, Replace

This interior node is a placeholder for the group-broadcast group policy.

13.2.18 /<x>/<x>/Common/MCVideoGroupBroadcast/Authorised

Table 13.2.18.1: /<x>/<x>/Common/MCVideoGroupBroadcast/Authorised

<x>/Common/MCVideoGroupBroadcast/Authorised

Status	Occurrence	Format	Min. Access Types
Required	One	bool	Get, Replace

This leaf node indicates the authorisation to create a group-broadcast group.

When set to "true" the MCVidéo user is authorised to create a group-broadcast group.

When set to "false" the MCVidéo user is not authorised to create a group-broadcast group.

13.2.19 /<x>/<x>/Common/UserBroadcast

Table 13.2.19.1: /<x>/<x>/Common/UserBroadcast

<x>/Common/UserBroadcast

Status	Occurrence	Format	Min. Access Types
Required	One	node	Get, Replace

This interior node is a placeholder for the user-broadcast group policy.

13.2.20 /<x>/<x>/Common/UserBroadcast/Authorised

Table 13.2.20.1: /<x>/<x>/Common/UserBroadcast/Authorised

<x>/Common/UserBroadcast/Authorised

Status	Occurrence	Format	Min. Access Types
Required	One	bool	Get, Replace

This leaf node indicates the authorisation to create a user-broadcast group.

When set to "true" the MCVidéo user is authorised to create a user-broadcast group.

When set to "false" the MCVidéo user is not authorised to create a user-broadcast group.

13.2.21 /<x>/<x>/Common/AllowedModifyVideo

Table 13.2.21.1: /<x>/<x>/Common/AllowedModifyVideo

<x>/Common/AllowedModifyVideo

Status	Occurrence	Format	Min. Access Types
Required	One	bool	Get, Replace

This leaf node indicates whether the MCVidéo user is authorised to modify the video settings of the transmitted video stream of another MCVidéo user.

When set to "true" the MCVidéo user is authorised to modify the video settings of the transmitted video stream of another MCVidéo user.

When set to "false" the MCVidéo user is not authorised to modify the video settings of the transmitted video stream of another MCVidéo user.

13.2.22 /<x>/<x>/Common/AllowedRenegotiateCodec

Table 13.2.22.1: /<x>/<x>/Common/AllowedRenegotiateCodec

<x>/Common/AllowedRenegotiateCodec

Status	Occurrence	Format	Min. Access Types
Required	One	bool	Get, Replace

This leaf node indicates whether the MCVidéo user is authorised to renegotiate a codec during a video transmission.

When set to "true" the MCVidéo user is authorised to renegotiate a codec during a video transmission.

When set to "false" the MCVidéo user is not authorised to renegotiate a codec during a video transmission.

13.2.23 /<x>/<x>/Common/AllowedCameraControl

Table 13.2.23.1: /<x>/<x>/Common/AllowedCameraControl

<x>/Common/AllowedCameraControl

Status	Occurrence	Format	Min. Access Types
Required	One	bool	Get, Replace

This leaf node indicates whether the MCVideo user is authorised to remotely control the video capabilities or parameters for a camera on an MCVideo UE.

When set to "true" the MCVideo user is authorised to remotely control the video capabilities or parameters for a camera on an MCVideo UE.

When set to "false" the MCVideo user is not authorised to remotely control the video capabilities or parameters for a camera on an MCVideo UE.

13.2.24 /<x>/<x>/Common/AllowedRemoteControl

Table 13.2.24.1: /<x>/<x>/Common/AllowedRemoteControl

<x>/Common/AllowedRemoteControl

Status	Occurrence	Format	Min. Access Types
Required	One	bool	Get, Replace

This leaf node indicates whether the MCVideo user is authorised to remotely control the video capabilities or parameters of a remote MCVideo UE.

When set to "true" the MCVideo user is authorised to remotely control the video capabilities or parameters of a remote MCVideo UE.

When set to "false" the MCVideo user is not authorised to remotely control the video capabilities or parameters of a remote MCVideo UE.

13.2.25 /<x>/<x>/Common/AllowedDisplayRemoteUE

Table 13.2.25.1: /<x>/<x>/Common/AllowedDisplayRemoteUE

<x>/Common/AllowedDisplayRemoteUE

Status	Occurrence	Format	Min. Access Types
Required	One	bool	Get, Replace

This leaf node indicates whether the MCVideo user is authorised to receive and display the capabilities of a remote MCVideo UE.

When set to "true" the MCVideo user is authorised to receive and display the capabilities of a remote MCVideo UE.

When set to "false" the MCVideo user is not authorised to receive and display the capabilities of a remote MCVideo UE.

13.2.26 /<x>/<x>/Common/AllowedRemoteCamera

Table 13.2.26.1: /<x>/<x>/Common/AllowedRemoteCamera

<x>/Common/AllowedRemoteCamera

Status	Occurrence	Format	Min. Access Types
Required	One	bool	Get, Replace

This leaf node indicates whether the MCVideo user is authorised to remotely activate another MCVideo user's camera.

When set to "true" the MCVideo user is authorised to remotely activate another MCVideo user's camera.

When set to "false" the MCVideo user is not authorised to remotely activate another MCVideo user's camera.

13.2.27 /<x>/<x>/Common/AllowedPushVideo

Table 13.2.27.1: /<x>/<x>/Common/AllowedPushVideo

<x>/Common/AllowedPushVideo

Status	Occurrence	Format	Min. Access Types
Required	One	bool	Get, Replace

This leaf node indicates whether the MCVideo user is authorised to push a video to another MCVideo user.

When set to "true" the MCVideo user is authorised to push a video to another MCVideo user.

When set to "false" the MCVideo user is not authorised to push a video to another MCVideo user.

13.2.28 /<x>/<x>/Common/AllowedAutoSendNotify

Table 13.2.28.1: /<x>/<x>/Common/AllowedAutoSendNotify

<x>/Common/AllowedAutoSendNotify

Status	Occurrence	Format	Min. Access Types
Required	One	bool	Get, Replace

This leaf node indicates whether the MCVideo user is authorised to enable and disable the automatic sending of a notification to a second MCVideo user that a video is being pushed to a third MCVideo user.

When set to "true" the MCVideo user is authorised to enable and disable the automatic sending of a notification to a second MCVideo user that a video is being pushed to a third MCVideo user.

When set to "false" the MCVideo user is not authorised to enable and disable the automatic sending of a notification to a second MCVideo user that a video is being pushed to a third MCVideo user.

13.2.29 /<x>/<x>/Common/AllowedActivateAlert

Table 13.2.29.1: /<x>/<x>/Common/AllowedActivateAlert

<x>/Common/AllowedActivateAlert

Status	Occurrence	Format	Min. Access Types
Required	One	bool	Get, Replace

This leaf node indicates whether the MCVideo user is authorised to activate an emergency alert.

When set to "true" the MCVideo user is authorised to activate an emergency alert.

When set to "false" the MCVideo user is not authorised to activate an emergency alert.

13.2.30 /<x>/<x>/Common/AllowedCancelAlert

Table 13.2.30.1: /<x>/<x>/Common/AllowedCancelAlert

<x>/Common/AllowedCancelAlert

Status	Occurrence	Format	Min. Access Types
Required	One	bool	Get, Replace

This leaf node indicates whether the MCVideo user is allowed to cancel an emergency alert.

When set to "true" the MCVideo user is authorised to cancel an emergency alert.

When set to "false" the MCVideo user is not authorised to cancel an emergency alert.

13.2.31 /<x>/<x>/Common/NotifyList

Table 13.2.31.1: /<x>/<x>/Common/NotifyList

<x>/Common/NotifyList

Status	Occurrence	Format	Min. Access Types
Required	One	node	Get, Replace

This interior node is a placeholder for a list of MCVideo users for whom to receive notifications about video being pushed to them.

13.2.32 /<x>/<x>/Common/NotifyList/<x>

Table 13.2.32.1: /<x>/<x>/Common/NotifyList/<x>

<x>/Common/NotifyList/<x>

Status	Occurrence	Format	Min. Access Types
Optional	ZeroOrMore	node	Get, Replace

This interior node is a placeholder for zero or more list of MCVideo users for whom to receive notifications about video being pushed to them.

13.2.33 /<x>/<x>/Common/NotifyList/<x>/Entry

Table 13.2.33.1: /<x>/<x>/Common/NotifyList/<x>/Entry

<x>/Common/NotifyList/<x>/Entry

Status	Occurrence	Format	Min. Access Types
Required	One	node	Get, Replace

This interior node is a placeholder for one or more MCVideo users for whom to receive notifications about video being pushed to them.

13.2.34 /<x>/<x>/Common/NotifyList/<x>/Entry/MCVideoID

Table 13.2.34.1: /<x>/<x>/Common/NotifyList/<x>/Entry/MCVideoID

<x>/Common/NotifyList/<x>/Entry/MCVideoID

Status	Occurrence	Format	Min. Access Types
Optional	One	chr	Get, Replace

This leaf node indicates an MCVideo user identity (MCVideo ID) which is a globally unique identifier within the MCVideo service that represents the MCVideo user.

The value is a "uri" attribute specified in OMA OMA-TS-XDM_Group-V1_1 [4].

13.2.35 /<x>/<x>/Common/NotifyList/<x>/Entry/DisplayName

Table 13.2.35.1: /<x>/<x>/Common/NotifyList/<x>/Entry/DisplayName

<x>/Common/NotifyList/<x>/Entry/DisplayName

Status	Occurrence	Format	Min. Access Types
Optional	One	chr	Get, Replace

This leaf node contains a human readable name.

13.2.36 /<x>/<x>/Common/VideoCategories

Table 13.2.36.1: /<x>/<x>/Common/VideoCategories

<x>/Common/VideoCategories

Status	Occurrence	Format	Min. Access Types
Required	One	node	Get, Replace

This interior node is a placeholder for a list of specific video categories to receive

13.2.37 /<x>/<x>/Common/VideoCategories/<x>

Table 13.2.37.1: /<x>/<x>/Common/VideoCategories/<x>

<x>/Common/VideoCategories/<x>

Status	Occurrence	Format	Min. Access Types
Required	ZeroOrMore	node	Get, Replace

This interior node is a placeholder for one or more specific video categories to receive.

If the list is empty, then all video categories are acceptable to the MCVideo user.

13.2.38 /<x>/<x>/Common/VideoCategories/<x>/VideoCat

Table 13.2.38.1: /<x>/<x>/Common/VideoCategories/<x>/VideoCat

<x>/Common/VideoCategories/<x>/VideoCat

Status	Occurrence	Format	Min. Access Types
Required	One	chr	Get, Replace

This leaf node indicates an alphanumeric video category

13.2.38A/<x>/<x>/Common/MCVideoGroupCall

Table 13.2.38A.1: /<x>/<x>/Common/MCVideoGroupCall

<x>/Common/MCVideoGroupCall

Status	Occurrence	Format	Min. Access Types
Required	One	node	Get, Replace

This interior node is a placeholder for the MCVideo group call configuration.

13.2.38B/<x>/<x>/Common/MCVideoGroupCall/EmergencyCall

Table 13.2. 38B.1: /<x>/<x>/Common/MCVideoGroupCall/EmergencyCall

<x>/Common/MCVideoGroupCall/EmergencyCall

Status	Occurrence	Format	Min. Access Types
Required	One	node	Get, Replace

This interior node is a placeholder for the MCVideo emergency call policy.

13.2.38C /<x>/<x>/Common/MCVideoGroupCall/EmergencyCall/Enabled

Table 13.2.38C.1: /<x>/<x>/Common/MCVideoGroupCall/EmergencyCall/Enabled

<x>/Common/MCVideoGroupCall/EmergencyCall/Enabled

Status	Occurrence	Format	Min. Access Types

Optional	One	bool	Get, Replace
----------	-----	------	--------------

This leaf node indicates the authorisation to make an MCVideo emergency group call functionality enabled for MCVideo user.

When set to "true" the MCVideo user is authorised to make an MCVideo emergency group call functionality enabled.

When set to "false" the MCVideo user is not authorised to make an MCVideo emergency group call functionality enabled.

13.2.38D

`<x>/<x>/Common/MCVideoGroupCall/EmergencyCall/CancelMCVideoGroup`

Table 13.2.38D.1: `<x>/<x>/Common/MCVideoGroupCall/EmergencyCall/CancelMCVideoGroup`

`<x>/Common/MCVideoGroupCall/EmergencyCall/CancelMCVideoGroup`

Status	Occurrence	Format	Min. Access Types
Required	One	bool	Get, Replace

This leaf node indicates the authorisation to cancel an in progress MCVideo emergency group call associated with a group.

When set to "true" the MCVideo user is authorised to cancel a MCVideo emergency group call.

When set to "false" the MCVideo user is not authorised to cancel a MCTT emergency group call.

13.2.38E `<x>/<x>/Common/MCVideoGroupCall/ImminentPerilCall`

Table 13.2.38E.1: `<x>/<x>/Common/MCVideoGroupCall/ImminentPerilCall`

`<x>/Common/MCVideoGroupCall/ImminentPerilCall`

Status	Occurrence	Format	Min. Access Types
Required	One	node	Get, Replace

This interior node is a placeholder for the MCVideo imminent peril call policy.

13.2.38F `<x>/<x>/Common/MCVideoGroupCall/ImminentPerilCall/Authorised`

Table 13.2.38F.1: `<x>/<x>/Common/MCVideoGroupCall/ImminentPerilCall/Authorised`

`<x>/Common/MCVideoGroupCall/ImminentPerilCall/Authorised`

Status	Occurrence	Format	Min. Access Types
Required	One	bool	Get, Replace

This leaf node indicates the authorisation to make an Imminent Peril group call.

When set to "true" the MCVideo user is authorised to create an MCVideo imminent peril group call.

When set to "false" the MCVideo user is not authorised to create an MCVideo imminent peril group call.

13.2.38G `<x>/<x>/Common/MCVideoGroupCall/ImminentPerilCall/Cancel`

Table 13.2.38G.1: `<x>/<x>/Common/MCVideoGroupCall/ImminentPerilCall/Cancel`

`<x>/Common/MCVideoGroupCall/ImminentPerilCall/Cancel`

Status	Occurrence	Format	Min. Access Types
Required	One	bool	Get, Replace

This leaf node indicates the authorisation for in-progress MCVideo imminent peril cancellation.

When set to "true" the MCVideo user is authorised to cancel an MCVideo imminent peril call.

When set to "false" the MCVideo user is not authorised to cancel an MCVideo imminent peril call.

13.2.38H /<x>/<x>/Common/PrivateCall

Table 13.2.38H.1: /<x>/<x>/Common/PrivateCall

<x>/Common/PrivateCall

Status	Occurrence	Format	Min. Access Types
Required	One	node	Get, Replace

This interior node is a placeholder for the MCVideo private call configuration.

13.2.38I /<x>/<x>/Common/PrivateCall/Authorised

Table 13.2.38I.1: /<x>/<x>/Common/PrivateCall/Authorised

<x>/Common/PrivateCall/Authorised

Status	Occurrence	Format	Min. Access Types
Required	One	bool	Get, Replace

This leaf node indicates the authorisation to make a MCVideo private call.

13.2.38J /<x>/<x>/Common/PrivateCall/ManualCommence

Table 13.2.38J.1: /<x>/<x>/Common/PrivateCall/ManualCommence

<x>/Common/PrivateCall/ManualCommence

Status	Occurrence	Format	Min. Access Types
Required	One	bool	Get, Replace

This leaf node indicates the authorisation to make a MCVideo private call with manual commencement.

When set to "true" the MCVideo user is authorised to make a MCVideo private call in manual commencement mode.

When set to "false" the MCVideo user is not authorised to make a MCVideo private call in manual commencement mode.

13.2.38K /<x>/<x>/Common/PrivateCall/AutoCommence

Table 13.2.38K.1: /<x>/<x>/Common/PrivateCall/AutoCommence

<x>/Common/PrivateCall/AutoCommence

Status	Occurrence	Format	Min. Access Types
Required	One	bool	Get, Replace

This leaf node indicates the authorisation to make a MCVideo private call with automatic commencement.

When set to "true" the MCVideo user is authorised to make a MCVideo private call in automatic commencement mode.

When set to "false" the MCVideo user is not authorised to make a MCVideo private call in automatic commencement mode.

13.2.38L /<x>/<x>/Common/PrivateCall/FailRestrict

Table 13.2.38L.1: /<x>/<x>/Common/PrivateCall/FailRestrict

<x>/Common/PrivateCall/FailRestrict

Status	Occurrence	Format	Min. Access Types

Required	One	bool	Get, Replace
----------	-----	------	--------------

This leaf node indicates the authorisation to restrict the provision of a notification of call failure reason for a MCVideo private call.

When set to "true" the MCVideo user is authorised to restrict notification of call failure reason for MCVideo private call.

When set to "false" the MCVideo user is not authorised to restrict notification of call failure reason for MCVideo private call.

13.2.38M /<x>/<x>/Common/ReceptionPriority

Table 13.2.38M.1: /<x>/<x>/Common/ReceptionPriority

<x>/Common/ReceptionPriority

Status	Occurrence	Format	Min. Access Types
Optional	One	int	Get, Replace

This leaf node indicates the reception priority of the MCVideo user.

- Values: 0-255

The lowest ReceptionPriority value shall be considered as the MCVideo user having the lowest priority.

13.2.39 /<x>/<x>/OnNetwork

Table 13.2.39.1: /<x>/<x>/OnNetwork

<x>/OnNetwork

Status	Occurrence	Format	Min. Access Types
Required	ZeroOrOne	node	Get, Replace

This interior node represents a container for on-network operation.

13.2.40 /<x>/<x>/OnNetwork/MCVideoGroupList

Table 13.2.40.1: /<x>/<x>/OnNetwork/MCVideoGroupList

<x>/OnNetwork/MCVideoGroupList

Status	Occurrence	Format	Min. Access Types
Required	One	node	Get, Replace

This interior node is a placeholder for the list of on-network MCVideo groups that the MCVideo user is allowed to use.

13.2.41 /<x>/<x>/OnNetwork/MCVideoGroupList/<x>

Table 13.2.41.1: /<x>/<x>/OnNetwork/MCVideoGroupList/<x>

<x>/OnNetwork/MCVideoGroupList/<x>

Status	Occurrence	Format	Min. Access Types
Required	OneOrMore	node	Get, Replace

This interior node is a placeholder for one or more list of on-network MCVideo groups that the MCVideo user is allowed to use.

13.2.42 /<x>/<x>/OnNetwork/MCVideoGroupList/<x>/Entry

Table 13.2.42.1: /<x>/<x>/OnNetwork/MCVideoGroupList/<x>/Entry

<x>/OnNetwork/MCVideoGroupList/<x>/Entry

Status	Occurrence	Format	Min. Access Types
Optional	One	node	Get, Replace

This interior node is a placeholder for the details of the on-network MCVideo groups that the MCVideo user is allowed to use.

13.2.43

/<x>/<x>/OnNetwork/MCVideoGroupList/<x>/Entry/MCVideoGroupID

Table 13.2.43.1: /<x>/<x>/OnNetwork/MCVideoGroupList/<x>/Entry/MCVideoGroupID

<x>/OnNetwork/MCVideoGroupList/<x>/Entry/MCVideoGroupID

Status	Occurrence	Format	Min. Access Types
Required	One	chr	Get, Replace

This leaf node indicates the MCVideo group ID for the on-network MCVideo group that the MCVideo user is allowed to use.

The value is a "uri" attribute specified in OMA OMA-TS-XDM_Group-V1_1 [4].

13.2.44 /<x>/<x>/OnNetwork/MCVideoGroupList/<x>/Entry/DisplayName

Table 13.2.44.1: /<x>/<x>/OnNetwork/MCVideoGroupList/<x>/Entry/DisplayName

<x>/OnNetwork/MCVideoGroupList/<x>/Entry/DisplayName

Status	Occurrence	Format	Min. Access Types
Optional	One	chr	Get, Replace

This leaf node contains a human readable name that corresponds to the MCVideo Group ID.

13.2.45

/<x>/<x>/OnNetwork/MCVideoGroupList/<x>/Entry/GMSAppServList

Table 13.2.45.1: /<x>/<x>/OnNetwork/MCVideoGroupList/<x>/Entry/GMSAppServList

<x>/OnNetwork/MCVideoGroupList/<x>/Entry/GMSAppServList

Status	Occurrence	Format	Min. Access Types
Required	One	node	Get, Replace

This interior node is a placeholder for the Group Management Server application plane server identity configuration.

13.2.46

/<x>/<x>/OnNetwork/MCVideoGroupList/<x>/Entry/GMSAppServList/<x>

Table 13.2.46.1: /<x>/<x>/OnNetwork/MCVideoGroupList/<x>/Entry/GMSAppServList/<x>

<x>/OnNetwork/MCVideoGroupList/<x>/Entry/GMSAppServList/<x>

Status	Occurrence	Format	Min. Access Types

Required	OneOrMore	node	Get, Replace
----------	-----------	------	--------------

This interior node is a placeholder for one or more Group Management Server configuration.

13.2.47

`/<x>/<x>/OnNetwork/MCVideoGroupList/<x>/Entry/GMSAppServList/<x>/GMSAppServId`

Table 13.2.47.1:

`/<x>/<x>/OnNetwork/MCVideoGroupList/<x>/Entry/GMSAppServList/<x>/GMSAppServId`

`<x>/OnNetwork/MCVideoGroupList/<x>/Entry/GMSAppServList/<x>/GMSAppServId`

Status	Occurrence	Format	Min. Access Types
Optional	One	chr	Get, Replace

This leaf node indicates the identity (URI) of the the group management server hosting the MCVideo Group ID.

13.2.48

`/<x>/<x>/OnNetwork/MCVideoGroupList/<x>/Entry/IdMSTokenEndPointList`

Table 13.2.48.1: /<x>/<x>/OnNetwork/MCVideoGroupList/<x>/Entry/IdMSTokenEndPointList

`<x>/OnNetwork/MCVideoGroupList/<x>/Entry/IdMSTokenEndPointList`

Status	Occurrence	Format	Min. Access Types
Required	One	node	Get, Replace

This interior node is a placeholder for the Identity Management Server application plane server identity configuration.

13.2.49

`/<x>/<x>/OnNetwork/MCVideoGroupList/<x>/Entry/IdMSTokenEndPointList/<x>`

Table 13.2.49.1: /<x>/<x>/OnNetwork/MCVideoGroupList/<x>/Entry/IdMSTokenEndPointList/<x>

`<x>/OnNetwork/MCVideoGroupList/<x>/Entry/IdMSTokenEndPointList/<x>`

Status	Occurrence	Format	Min. Access Types
Required	OneOrMore	node	Get, Replace

This interior node is a placeholder for one or more Identity Management Server configuration.

13.2.50 `/<x>/<x>/OnNetwork/MCVideoGroupList/<x>/Entry/IdMSTokenEndPointList/<x>/IdMSTokenEndPoint`

Table 13.2.50.1:

`/<x>/<x>/OnNetwork/MCVideoGroupList/<x>/Entry/IdMSTokenEndPointList/<x>/IdMSTokenEndPoint`

`<x>/OnNetwork/MCVideoGroupList/<x>/Entry/IdMSTokenEndPointList/<x>/IdMSTokenEndPoint`

Status	Occurrence	Format	Min. Access Types
Optional	One	chr	Get, Replace

This leaf node indicates the identity (URI) of the the identity management server hosting the MCVideo Group ID.

13.2.51

/<x>/<x>/OnNetwork/MCVideoGroupList/<x>/Entry/PresentationPriority

Table 13.2.51.1: /<x>/<x>/OnNetwork/MCVideoGroupList/<x>/Entry/PresentationPriority

<x>/OnNetwork/MCVideoGroupList/<x>/Entry/PresentationPriority

Status	Occurrence	Format	Min. Access Types
Optional	One	int	Get, Replace

This leaf node indicates indicating the presentation priority of the on-network group for the MCVideo user relative to other on-network groups and on-network users.

- Values: 0-255

The lowest PresentationPriority value shall be considered as the MCVideo group transaction having the lowest priority for presentation among other group MCVideo and one-to-one user transactions.

13.2.52 /<x>/<x>/OnNetwork/ImplicitAffiliations

Table 13.2.52.1: /<x>/<x>/OnNetwork/ImplicitAffiliations

<x>/OnNetwork/ImplicitAffiliations

Status	Occurrence	Format	Min. Access Types
Required	One	node	Get, Replace

This interior node is a placeholder for the implicit affiliation configuration.

13.2.53 /<x>/<x>/OnNetwork/ImplicitAffiliations/<x>

Table 13.2.53.1: /<x>/<x>/OnNetwork/ImplicitAffiliations/<x>

<x>/OnNetwork/ImplicitAffiliations/<x>

Status	Occurrence	Format	Min. Access Types
Required	ZeroOrMore	node	Get, Replace

This interior node is a placeholder for zero or more implicit affiliation configuration.

13.2.54 /<x>/<x>/OnNetwork/ImplicitAffiliations/<x>/Entry

Table 13.2.54.1: /<x>/<x>/OnNetwork/ImplicitAffiliations/<x>/Entry

<x>/OnNetwork/ImplicitAffiliations/<x>/Entry

Status	Occurrence	Format	Min. Access Types
Optional	One	node	Get, Replace

This interior node is a placeholder for the details of the on-network MCVideo groups that the MCVideo user is implicitly affiliated to.

13.2.55 /<x>/<x>/OnNetwork/ImplicitAffiliations/<x>/Entry/MCVideoGroupID

Table 13.2.55.1: /<x>/<x>/OnNetwork/ImplicitAffiliations/<x>/Entry/MCVideoGroupID

<x>/OnNetwork/ImplicitAffiliations/<x>/Entry/MCVideoGroupID

Status	Occurrence	Format	Min. Access Types
Required	One	chr	Get, Replace

This leaf node indicates a MCVideo group ID to which the MCVideo user is implicitly affiliated to.

The value is a "uri" attribute specified in OMA OMA-TS-XDM_Group-V1_1 [4].

13.2.56 /<x>/<x>/OnNetwork/ImplicitAffiliations/<x>/Entry/DisplayName

Table 13.2.56.1: /<x>/<x>/OnNetwork/ImplicitAffiliations/<x>/Entry/DisplayName

<x>/OnNetwork/ImplicitAffiliations/<x>/Entry/DisplayName

Status	Occurrence	Format	Min. Access Types
Optional	One	chr	Get, Replace

This leaf node contains a human readable name that corresponds to the MCVideo Group ID.

13.2.57 /<x>/<x>/OnNetwork/PresenceStatus

Table 13.2.57.1: /<x>/<x>/OnNetwork/PresenceStatus

<x>/OnNetwork/PresenceStatus

Status	Occurrence	Format	Min. Access Types
Required	One	node	Get, Replace

This interior node is a placeholder for the presence status configuration.

13.2.58 /<x>/<x>/OnNetwork/PresenceStatus/<x>

Table 13.2.58.1: /<x>/<x>/OnNetwork/PresenceStatus/<x>

<x>/OnNetwork/PresenceStatus/<x>

Status	Occurrence	Format	Min. Access Types
Required	ZeroOrMore	node	Get, Replace

This interior node is a placeholder for zero or more presence status configuration.

13.2.59 /<x>/<x>/OnNetwork/PresenceStatus/<x>/Entry

Table 13.2.59.1: /<x>/<x>/OnNetwork/PresenceStatus/<x>/Entry

<x>/OnNetwork/PresenceStatus/<x>/Entry

Status	Occurrence	Format	Min. Access Types
Optional	One	node	Get, Replace

This interior node is a placeholder for the details of the MCVideo IDs of MCVideo users that the configured MCVideo user is authorised to obtain presence status;

13.2.60 /<x>/<x>/OnNetwork/PresenceStatus/<x>/Entry/MCVideoGroupID

Table 13.2.60.1: /<x>/<x>/OnNetwork/PresenceStatus/<x>/Entry/MCVideoGroupID

<x>/OnNetwork/PresenceStatus/<x>/Entry/MCVideoGroupID

Status	Occurrence	Format	Min. Access Types
Required	One	chr	Get, Replace

This leaf node indicates an MCVideo ID of an MCVideo user that the configured MCVideo user is authorised to obtain presence status;

The value is a "uri" attribute specified in OMA OMA-TS-XDM_Group-V1_1 [4].

13.2.61 /<x>/<x>/OnNetwork/PresenceStatus/<x>/Entry/DisplayName

Table 13.2.61.1: /<x>/<x>/OnNetwork/PresenceStatus/<x>/Entry/DisplayName

<x>/OnNetwork/PresenceStatus/<x>/Entry/DisplayName

Status	Occurrence	Format	Min. Access Types
Optional	One	chr	Get, Replace

This leaf node contains a human readable name that corresponds to the MCVideo ID.

13.2.62 /<x>/<x>/OnNetwork/RemoteGroupChange

Table 13.2.62.1: /<x>/<x>/OnNetwork/RemoteGroupChange

<x>/OnNetwork/RemoteGroupChange

Status	Occurrence	Format	Min. Access Types
Required	One	node	Get, Replace

This interior node is a placeholder for the remote group change configuration.

13.2.63 /<x>/<x>/OnNetwork/RemoteGroupChange/<x>

Table 13.2.63.1: /<x>/<x>/OnNetwork/RemoteGroupChange/<x>

<x>/OnNetwork/RemoteGroupChange/<x>

Status	Occurrence	Format	Min. Access Types
Required	ZeroOrMore	node	Get, Replace

This interior node is a placeholder for zero or more remote group change configuration.

13.2.64 /<x>/<x>/OnNetwork/RemoteGroupChange/<x>/Entry

Table 13.2.64.1: /<x>/<x>/OnNetwork/RemoteGroupChange/<x>/Entry

<x>/OnNetwork/RemoteGroupChange/<x>/Entry

Status	Occurrence	Format	Min. Access Types
Optional	One	node	Get, Replace

This interior node is a placeholder for the details of the MCVideo IDs of MCVideo users whose selected groups are authorised to be remotely changed by the configured MCVideo user;

13.2.65

/<x>/<x>/OnNetwork/RemoteGroupChange/<x>/Entry/MCVideoGroupID

Table 13.2.65.1: /<x>/<x>/OnNetwork/RemoteGroupChange/<x>/Entry/MCVideoGroupID

<x>/OnNetwork/RemoteGroupChange/<x>/Entry/MCVideoGroupID

Status	Occurrence	Format	Min. Access Types
Required	One	chr	Get, Replace

This leaf node indicates an MCVideo ID of an MCVideo user whose selected groups are authorised to be remotely changed by the configured MCVideo user;

The value is a "uri" attribute specified in OMA OMA-TS-XDM_Group-V1_1 [4].

13.2.66 /<x>/<x>/OnNetwork/RemoteGroupChange/<x>/Entry/DisplayName

Table 13.2.66.1: /<x>/<x>/OnNetwork/RemoteGroupChange/<x>/Entry/DisplayName

<x>/OnNetwork/RemoteGroupChange/<x>/Entry/DisplayName

Status	Occurrence	Format	Min. Access Types
Optional	One	chr	Get, Replace

This leaf node contains a human readable name that corresponds to the MCVideo ID.

13.2.67 /<x>/<x>/OnNetwork/MaxAffiliationsNc2

Table 13.2.67.1: /<x>/<x>/OnNetwork/MaxAffiliationsNc2

<x>/OnNetwork/MaxAffiliationsNc2

Status	Occurrence	Format	Min. Access Types
Optional	One	int	Get, Replace

This leaf node indicates the maximum number of MCVideo groups that the MCVideo user is authorised to affiliate with.

- Values: 0-65535

13.2.68 /<x>/<x>/OnNetwork/AllowedRegroup

Table 13.2.68.1: /<x>/<x>/OnNetwork/AllowedRegroup

<x>/OnNetwork/AllowedRegroup

Status	Occurrence	Format	Min. Access Types
Required	One	bool	Get, Replace

This leaf node indicates whether the MCVideo user is authorised to perform dynamic regrouping operations.

When set to "true" the MCVideo user is authorised to perform dynamic regrouping operations.

When set to "false" the MCVideo user is not authorised to perform dynamic regrouping operations.

13.2.69 /<x>/<x>/OnNetwork/AllowedPresenceStatus

Table 13.2.69.1: /<x>/<x>/OnNetwork/AllowedPresenceStatus

<x>/OnNetwork/AllowedPresenceStatus

Status	Occurrence	Format	Min. Access Types
Optional	One	bool	Get, Replace

This leaf node indicates the presence status on the network of this MCVideo user is available.

When set to "true" the presence status on the network of this MCVideo user is available.

When set to "false" the presence status on the network of this MCVideo user is not available. This is the default if this leaf node is not present.

13.2.70 /<x>/<x>/OnNetwork/AllowedPresence

Table 13.2.70.1: /<x>/<x>/OnNetwork/AllowedPresence

<x>/OnNetwork/AllowedPresence

Status	Occurrence	Format	Min. Access Types
Optional	One	bool	Get, Replace

This leaf node indicates whether the MCVideo user is authorised to obtain whether a particular MCVideo User is present on the network.

When set to "true" the MCVideo user is authorised to obtain whether a particular MCVideo User is present on the network.

When set to "false" the MCVideo user is not authorised to obtain whether a particular MCVideo User is present on the network. This is the default if this leaf node is not present.

13.2.71 /<x>/<x>/OnNetwork/AllowedManualSwitch

Table 13.2.71.1: /<x>/<x>/OnNetwork/AllowedManualSwitch

<x>/OnNetwork/AllowedManualSwitch

Status	Occurrence	Format	Min. Access Types
Required	One	bool	Get, Replace

This leaf node indicates whether the MCVideo user is authorised to manually switch to off-network operation while in on-network operation.

When set to "true" the MCVideo user is authorised to manually switch to off-network operation while in on-network operation.

When set to "false" the MCVideo user is not authorised to manually switch to off-network operation while in on-network operation.

13.2.72 /<x>/<x>/OnNetwork/DeletionPeriod

Table 13.2.72.1: /<x>/<x>/OnNetwork/DeletionPeriod

<x>/OnNetwork/DeletionPeriod

Status	Occurrence	Format	Min. Access Types
Required	One	int	Get, Replace

This leaf node indicates the period (in hours) after which MCVideo data on an MCVideo UE is to be deleted if no action is taken by an authorized MCVideo user.

- Values: 0-65535

13.2.73 /<x>/<x>/OnNetwork/MaxSimultaneousVideoStreams

Table 13.2.73.1: /<x>/<x>/OnNetwork/MaxSimultaneousVideoStreams

<x>/OnNetwork/MaxSimultaneousVideoStreams

Status	Occurrence	Format	Min. Access Types
Required	One	node	Get, Replace

This interior node is a placeholder for maximum number of simultaneous video streams that can be received.

13.2.74 /<x>/<x>/OnNetwork/MaxSimultaneousVideoStreams/MaxStreams

Table 13.2.74.1: /<x>/<x>/OnNetwork/MaxSimultaneousVideoStreams/MaxStreams

<x>/OnNetwork/MaxSimultaneousVideoStreams/MaxStreams

Status	Occurrence	Format	Min. Access Types
Optional	One	int	Get, Replace

This leaf node indicates the maximum number of simultaneous video streams that can be received.

- Values: 0-65535

13.2.75

`<x>/OnNetwork/MaxSimultaneousVideoStreams/AllowedUnlimited`

Table 13.2.75.1: `<x>/OnNetwork/MaxSimultaneousVideoStreams/AllowedUnlimited`

`<x>/OnNetwork/MaxSimultaneousVideoStreams/AllowedUnlimited`

Status	Occurrence	Format	Min. Access Types
Required	One	bool	Get, Replace

This leaf node indicates whether the MCVideo user can receive an unlimited number of simultaneous video streams.

When set to "true" the MCVideo user is allowed to receive an unlimited number of simultaneous video streams .

When set to "false" the MCVideo user is not allowed to receive an unlimited number of simultaneous video streams.

When set to "true", the value in the MaxStreams element (if present) is ignored.

13.2.76 `<x>/OnNetwork/AllowedAutoRecv`

Table 13.2.76.1: `<x>/OnNetwork/AllowedAutoRecv`

`<x>/OnNetwork/AllowedAutoRecv`

Status	Occurrence	Format	Min. Access Types
Required	One	bool	Get, Replace

This leaf node indicates whether the MCVideo user is authorised to automatically receive video communications.

When set to "true" the MCVideo user is authorised to automatically receive video communications.

When set to "false" the MCVideo user is not authorised to automatically receive video communications.

13.2.77 `<x>/OnNetwork/AllowedAutoRecvEmergency`

Table 13.2.77.1: `<x>/OnNetwork/AllowedAutoRecvEmergency`

`<x>/OnNetwork/AllowedAutoRecvEmergency`

Status	Occurrence	Format	Min. Access Types
Required	One	bool	Get, Replace

This leaf node indicates whether the MCVideo user is authorised to automatically receive emergency video streams.

When set to "true" the MCVideo user is authorised to automatically receive emergency video streams.

When set to "false" the MCVideo user is not authorised to automatically receive emergency video streams.

13.2.78 `<x>/OnNetwork/AllowedAutoRecvImminentPeril`

Table 13.2.78.1: `<x>/OnNetwork/AllowedAutoRecvImminentPeril`

`<x>/OnNetwork/AllowedAutoRecvImminentPeril`

Status	Occurrence	Format	Min. Access Types
Required	One	bool	Get, Replace

This leaf node indicates whether the MCVideo user is authorised to automatically receive imminent peril video streams.

When set to "true" the MCVideo user is authorised to automatically receive imminent peril video streams.

When set to "false" the MCVideo user is not authorised to automatically receive imminent peril video streams.

13.2.79 /<x>/<x>/OnNetwork/MandatoryReceiveGroups

Table 13.2.79.1: /<x>/<x>/OnNetwork/MandatoryReceiveGroups

<x>/OnNetwork/MandatoryReceiveGroups

Status	Occurrence	Format	Min. Access Types
Required	One	node	Get, Replace

This interior node is a placeholder for the list of on-network MCVideo groups for which video can be automatically/mandatorily received.

13.2.80 /<x>/<x>/OnNetwork/MandatoryReceiveGroups/<x>

Table 13.2.80.1: /<x>/<x>/OnNetwork/MCVideoGroupList/<x>

<x>/OnNetwork/MandatoryReceiveGroups/<x>

Status	Occurrence	Format	Min. Access Types
Required	ZeroOrMore	node	Get, Replace

This interior node is a placeholder for zero or more list of on-network MCVideo groups for which video can be automatically/mandatorily received.

13.2.81 /<x>/<x>/OnNetwork/MandatoryReceiveGroups/<x>/Entry

Table 13.2.81.1: /<x>/<x>/OnNetwork/MCVideoGroupList/<x>/Entry

<x>/OnNetwork/MandatoryReceiveGroups/<x>/Entry

Status	Occurrence	Format	Min. Access Types
Optional	One	node	Get, Replace

This interior node is a placeholder for the details of an on-network MCVideo group for which video can be automatically/mandatorily received.

13.2.82

/<x>/<x>/OnNetwork/MandatoryReceiveGroups/<x>/Entry/MCVideoGroupID

Table 13.2.82.1: /<x>/<x>/OnNetwork/MandatoryReceiveGroups/<x>/Entry/MCVideoGroupID

<x>/OnNetwork/MandatoryReceiveGroups/<x>/Entry/MCVideoGroupID

Status	Occurrence	Format	Min. Access Types
Required	One	chr	Get, Replace

This leaf node indicates the MCVideo group ID for the on-network MCVideo group for which video can be automatically/mandatorily received.

The value is a "uri" attribute specified in OMA OMA-TS-XDM_Group-V1_1 [4].

13.2.83

/<x>/<x>/OnNetwork/MandatoryReceiveGroups/<x>/Entry/DisplayName

Table 13.2.83.1: /<x>/<x>/OnNetwork/MCVideoGroupList/<x>/Entry/DisplayName

<x>/OnNetwork/MandatoryReceiveGroups/<x>/Entry/DisplayName

Status	Occurrence	Format	Min. Access Types

Optional	One	chr	Get, Replace
----------	-----	-----	--------------

This leaf node contains a human readable name that corresponds to the MCVideo Group ID.

13.2.84 /<x>/<x>/OnNetwork/AllowedRequestOverride

Table 13.2.84.1: /<x>/<x>/OnNetwork/AllowedRequestOverride

<x>/OnNetwork/AllowedRequestOverride

Status	Occurrence	Format	Min. Access Types
Required	One	bool	Get, Replace

This leaf node indicates whether the MCVideo user is authorised to request to override an active MCVideo transmission.

When set to "true" the MCVideo user is authorised to request to override an active MCVideo transmission.

When set to "false" the MCVideo user is not authorised to request to override an active MCVideo transmission.

13.2.85 /<x>/<x>/OnNetwork/AllowedSelectOverride

Table 13.2.85.1: /<x>/<x>/OnNetwork/AllowedSelectOverride

<x>/OnNetwork/AllowedSelectOverride

Status	Occurrence	Format	Min. Access Types
Required	One	bool	Get, Replace

This leaf node indicates whether the MCVideo user is authorised to select MCVideo transmissions that can be overridden.

When set to "true" the MCVideo user is authorised to select MCVideo transmissions that can be overridden.

When set to "false" the MCVideo user is not authorised to select MCVideo transmissions that can be overridden.

13.2.86 /<x>/<x>/OnNetwork/AllowedOverrideGroupCall

Table 13.2.86.1: /<x>/<x>/OnNetwork/AllowedOverrideGroupCall

<x>/OnNetwork/AllowedOverrideGroupCall

Status	Occurrence	Format	Min. Access Types
Required	One	bool	Get, Replace

This leaf node indicates whether the MCVideo user is authorised to allow MCVideo private communications to override active MCVideo group communications

When set to "true" the MCVideo user is authorised to allow MCVideo private communications to override active MCVideo group communications.

When set to "false" the MCVideo user is not authorised to allow MCVideo private communications to override active MCVideo group communications.

13.2.87 /<x>/<x>/OnNetwork/MaxTimeSingleTransmit

Table 13.2.87.1: /<x>/<x>/OnNetwork/MaxTimeSingleTransmit

<x>/OnNetwork/MaxTimeSingleTransmit

Status	Occurrence	Format	Min. Access Types
Required	One	int	Get, Replace

This leaf node indicates the maximum length of time that an MCVideo user can transmit for a single video transmission.

- Values: 0-65535

The MaxTimeSingleTransmit time is in seconds.

13.2.88 /<x>/<x>/OffNetwork

Table 13.2.88.1: /<x>/<x>/OffNetwork

<x>/OffNetwork

Status	Occurrence	Format	Min. Access Types
Required	ZeroOrOne	node	Get, Replace

This interior node represents a container for off-network operation.

13.2.89 /<x>/<x>/OffNetwork/Authorised

Table 13.2.89.1: /<x>/<x>/OffNetwork/Authorised

<x>/OffNetwork/Authorised

Status	Occurrence	Format	Min. Access Types
Required	One	bool	Get, Replace

This leaf node indicates the authorisation for off-network services.

When set to "true" the MCVideo user is authorised for off-network operation.

When set to "false" the MCVideo user is not authorised for off-network operation.

13.2.90 /<x>/<x>/OffNetwork/MCVideoGroupList

Table 13.2.90.1: /<x>/<x>/OffNetwork/MCVideoGroupList

<x>/OffNetwork/MCVideoGroupList

Status	Occurrence	Format	Min. Access Types
Required	One	node	Get, Replace

This interior node is a placeholder for the list of off-network MCVideo groups that the MCVideo user is allowed to use.

13.2.91 /<x>/<x>/OffNetwork/MCVideoGroupList/<x>

Table 13.2.91.1: /<x>/<x>/OffNetwork/MCVideoGroupList/<x>

<x>/OffNetwork/MCVideoGroupList/<x>

Status	Occurrence	Format	Min. Access Types
Required	OneOrMore	node	Get, Replace

This interior node is a placeholder for one or more list of off-network MCVideo groups that the MCVideo user is allowed to use.

13.2.92 /<x>/<x>/OffNetwork/MCVideoGroupList/<x>/Entry

Table 13.2.92.1: /<x>/<x>/OffNetwork/MCVideoGroupList/<x>/Entry

<x>/OffNetwork/MCVideoGroupList/<x>/Entry

Status	Occurrence	Format	Min. Access Types
Optional	One	node	Get, Replace

This interior node is a placeholder for the details of the off-network MCVideo groups that the MCVideo user is allowed to use.

13.2.93

`<x>/<x>/OffNetwork/MCVideoGroupList/<x>/Entry/MCVideoGroupID`

Table 13.2.93.1: `<x>/<x>/OffNetwork/MCVideoGroupList/<x>/Entry/MCVideoGroupID`

`<x>/OffNetwork/MCVideoGroupList/<x>/Entry/MCVideoGroupID`

Status	Occurrence	Format	Min. Access Types
Required	One	chr	Get, Replace

This leaf node indicates the MCVideo group ID for the off-network MCVideo group that the MCVideo user is allowed to use.

The value is a "uri" attribute specified in OMA OMA-TS-XDM_Group-V1_1 [4].

13.2.94 `<x>/<x>/OffNetwork/MCVideoGroupList/<x>/Entry/DisplayName`

Table 13.2.94.1: `<x>/<x>/OffNetwork/MCVideoGroupList/<x>/Entry/DisplayName`

`<x>/OffNetwork/MCVideoGroupList/<x>/Entry/DisplayName`

Status	Occurrence	Format	Min. Access Types
Optional	One	chr	Get, Replace

This leaf node contains a human readable name that corresponds to the MCVideo Group ID.

13.2.95

`<x>/<x>/OffNetwork/MCVideoGroupList/<x>/Entry/GMSAppServList`

Table 13.2.95.1: `<x>/<x>/OffNetwork/MCVideoGroupList/<x>/Entry/GMSAppServList`

`<x>/OffNetwork/MCVideoGroupList/<x>/Entry/GMSAppServList`

Status	Occurrence	Format	Min. Access Types
Required	One	node	Get, Replace

This interior node is a placeholder for the Group Management Server application plane server identity configuration.

13.2.96

`<x>/<x>/OffNetwork/MCVideoGroupList/<x>/Entry/GMSAppServList/<x>`

Table 13.2.96.1: `<x>/<x>/OffNetwork/MCVideoGroupList/<x>/Entry/GMSAppServList/<x>`

`<x>/OffNetwork/MCVideoGroupList/<x>/Entry/GMSAppServList/<x>`

Status	Occurrence	Format	Min. Access Types
Required	OneOrMore	node	Get, Replace

This interior node is a placeholder for one or more Group Management Server configuration.

13.2.97

`/<x>/<x>/OffNetwork/MCVideoGroupList/<x>/Entry/GMSAppServList/<x>/GMSAppServId`

Table 13.2.97.1:

`/<x>/<x>/OffNetwork/MCVideoGroupList/<x>/Entry/GMSAppServList/<x>/GMSAppServId`

`<x>/OffNetwork/MCVideoGroupList/<x>/Entry/GMSAppServList/<x>/GMSAppServId`

Status	Occurrence	Format	Min. Access Types
Optional	One	chr	Get, Replace

This leaf node indicates the identity (URI) of the the group management server hosting the MCVideo Group ID.

13.2.98

`/<x>/<x>/OffNetwork/MCVideoGroupList/<x>/Entry/IdMSTokenEndPointList`

Table 13.2.98.1: `/<x>/<x>/OffNetwork/MCVideoGroupList/<x>/Entry/IdMSTokenEndPointList`

`<x>/OffNetwork/MCVideoGroupList/<x>/Entry/IdMSTokenEndPointList`

Status	Occurrence	Format	Min. Access Types
Required	One	node	Get, Replace

This interior node is a placeholder for the Identity Management Server application plane server identity configuration.

13.2.99

`/<x>/<x>/OffNetwork/MCVideoGroupList/<x>/Entry/IdMSTokenEndPointList/<x>`

Table 13.2.99.1: `/<x>/<x>/OffNetwork/MCVideoGroupList/<x>/Entry/IdMSTokenEndPointList/<x>`

`<x>/OffNetwork/MCVideoGroupList/<x>/Entry/IdMSTokenEndPointList/<x>`

Status	Occurrence	Format	Min. Access Types
Required	OneOrMore	node	Get, Replace

This interior node is a placeholder for one or more Identity Management Server configuration.

13.2.100 `/<x>/<x>/OffNetwork/MCVideoGroupList/<x>/Entry/IdMSTokenEndPointList/<x>/IdMSTokenEndPoint`

Table 13.2.100.1:

`/<x>/<x>/OffNetwork/MCVideoGroupList/<x>/Entry/IdMSTokenEndPointList/<x>/IdMSTokenEndPoint`

`<x>/OffNetwork/MCVideoGroupList/<x>/Entry/IdMSTokenEndPointList/<x>/IdMSTokenEndPoint`

Status	Occurrence	Format	Min. Access Types
Optional	One	chr	Get, Replace

This leaf node indicates the identity (URI) of the the identity management server hosting the MCVideo Group ID.

13.2.101

`<x>/<x>/OffNetwork/MCVideoGroupList/<x>/>/Entry/PresentationPriority`

Table 13.2.101.1: `<x>/<x>/OffNetwork/MCVideoGroupList/<x>/>/Entry/PresentationPriority`

`<x>/OffNetwork/MCVideoGroupList/<x>/Entry/PresentationPriority`

Status	Occurrence	Format	Min. Access Types
Optional	One	int	Get, Replace

This leaf node indicates indicating the presentation priority of the off-network group for the MCVideo user relative to other off-network groups and off-network users.

- Values: 0-255

The lowest PresentationPriority value shall be considered as the MCVideo group transaction having the lowest priority for presentation among other group MCVideo and one-to-one user transactions.

13.2.102 `<x>/<x>/OffNetwork/UserInfoID`

Table 13.2.102.1: `<x>/<x>/OffNetwork/UserInfoID`

`<x>/OffNetwork/UserInfoID`

Status	Occurrence	Format	Min. Access Types
Required	One	chr	Get, Replace

This leaf node indicates the ProSe user info ID as specified in 3GPP TS 23.303 [6].

13.2.102A `<x>/<x>/OffNetwork/EmergencyCallChange`

Table 13.2.102A.1: `<x>/<x>/OffNetwork/EmergencyCallChange`

`<x>/OffNetwork/EmergencyCallChange`

Status	Occurrence	Format	Min. Access Types
Required	One	bool	Get, Replace

This leaf node indicates the authorization for a participant to change an off-network group call in-progress to an off-network MCVideo emergency group call.

When set to "true" the MCVideo user is authorised to change an MCVideo emergency group call.

When set to "false" the MCVideo user is not authorised to change an MCVideo emergency group call.

13.2.102B `<x>/<x>/OffNetwork/ImminentPerilCallChange`

Table 13.2.102B.1: `<x>/<x>/OffNetwork/ImminentPerilCallChange`

`<x>/OffNetwork/ImminentPerilCallChange`

Status	Occurrence	Format	Min. Access Types
Required	One	bool	Get, Replace

This leaf node indicates the authorization for a participant to change an off-network group call in-progress to an off-network MCVideo imminent peril group call.

When set to "true" the MCVideo user is authorised to change an MCVideo imminent peril group call.

When set to "false" the MCVideo user is not authorised to change an MCVideo imminent peril group call.

13.2.103 /<x>/Status

Table 13.2.103.1: /<x>/Status

Status

Status	Occurrence	Format	Min. Access Types
Optional	One	bool	Get, Replace

This leaf node indicates whether this MCVideo user profile is enabled or disabled.

When set to "true" this MCVideo user profile is enabled.

When set to "false" this MCVideo user profile is disabled.

14 MCVideo service configuration MO

14.1 General

The MCVideo service configuration Management Object (MO) is used to configure MCVideo Client behaviour for the on-network or off-network MCVideo Service. The MCVideo service configuration parameters may be stored in the ME, or in the USIM as specified in 3GPP TS 31.102 [10], or in both the ME and the USIM. If both the ME and the USIM contain the same parameters, the values stored in the USIM shall take precedence.

The Management Object Identifier is: urn:oma:mo:ext-3gpp-MCVideo-service-configuration:1.0.

Protocol compatibility: This MO is compatible with OMA OMA DM 1.2 [3].

The OMA DM ACL property mechanism (see OMA OMA-ERELD-DM-V1_2 [2]) may be used to grant or deny access rights to OMA DM servers in order to modify nodes and leaf objects of the MCVideo service configuration MO.

The following nodes and leaf objects are possible under the MCVideo service configuration node as described in figure 14.1.1:

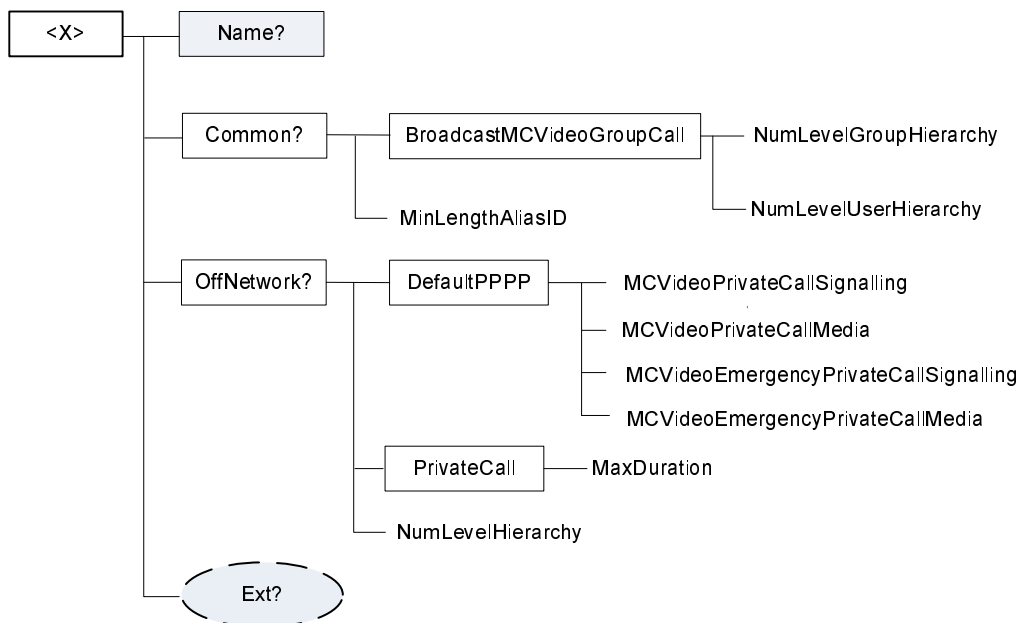

Figure 14.1.1: The MCVideo service configuration MO

14.2 MCVideo service configuration MO parameters

14.2.1 General

This clause describes the parameters for the MCVideo service configuration Management Object (MO).

14.2.2 Node: <x>

Table 14.2.2.1: Node: <x>

<x>

Status	Occurrence	Format	Min. Access Types
Required	OneOrMore	node	Get

This interior node acts as a placeholder for the MCVideo service configuration Management Object (MO).

For the MCVideo service configuration MO, the namespace specific string is: "urn:oma:mo:oma-dm-mcvideo-service configuration:1.0"

- Values: N/A

14.2.3 /<x>/Name

Table 14.2.3.1: /<x>/Name

Name

Status	Occurrence	Format	Min. Access Types
Required	ZeroOrOne	chr	Get

The Name leaf is a name for the MCVideo service configuration settings.

- Values: <User displayable name>

14.2.4 /<x>/Ext/

Table 14.2.4.1: /<x>/Ext/

Ext

Status	Occurrence	Format	Min. Access Types
Optional	ZeroOrOne	node	Get, Replace

The Ext is an interior node for where the vendor specific information about the MCVideo service configuration MO is being placed.

Usually the vendor extension is identified by vendor specific name under the ext node and contains the vendor meaning application vendor, device vendor etc. The tree structure under the vendor identified is not defined and can therefore include one or more un-standardized sub-trees.

- Values: N/A

14.2.5 /<x>/Common

Table 14.2.5.1: /<x>/Common

Common

Status	Occurrence	Format	Min. Access Types
Required	ZeroOrOne	node	Get, Replace

This interior node represents a container for the common network operation which means both on-network operation and off-network operation.

14.2.6 /<x>/Common/BroadcastMCVideoGroupCall

Table 14.2.6.1: /<x>/Common/BroadcastMCVideoGroupCall

Common/BroadcastMCVideoGroupCall

Status	Occurrence	Format	Min. Access Types
Required	One	node	Get, Replace

This interior node is a placeholder for Broadcast MCVideo Group Call configuration.

14.2.7

/<x>/Common/BroadcastMCVideoGroupCall/NumLevelGroupHierarchy

Table 14.2.7.1: /<x>/Common/BroadcastMCVideoGroupCall/NumLevelGroupHierarchy

Common/BroadcastMCVideoGroupCall/NumLevelGroupHierarchy

Status	Occurrence	Format	Min. Access Types
Required	One	int	Get, Replace

This leaf node indicates the number of levels of group hierarchy for group-broadcast groups.

- Values: 0-255

The group-broadcast group with the lowest NumLevelGroupHierarchy value shall be considered as the group-broadcast group having the lowest level among the groups.

14.2.8

/<x>/Common/BroadcastMCVideoGroupCall/NumLevelUserHierarchy

Table 14.2.8.1: /<x>/Common/BroadcastMCVideoGroupCall/NumLevelUserHierarchy

Common/BroadcastMCVideoGroupCall/NumLevelUserHierarchy

Status	Occurrence	Format	Min. Access Types
Required	One	int	Get, Replace

This leaf node indicates the number of levels of user hierarchy for user-broadcast groups.

- Values: 0-255

The user-broadcast group with the lowest NumLevelUserHierarchy value shall be considered as the user-broadcast group the lowest level among the groups.

14.2.9 /<x>/Common/MinLengthAliasID

Table 14.2.9.1: /<x>/Common/MinLengthAliasID

Common/MinLengthAliasID

Status	Occurrence	Format	Min. Access Types
Required	One	int	Get, Replace

This leaf node indicates minimum length of an alphanumeric identifier (i.e., alias) assigned by an MCVideo administrator.

- Values: 0-255

14.2.10 /<x>/OffNetwork

Table 14.2.10.1: /<x>/OffNetwork

OffNetwork

Status	Occurrence	Format	Min. Access Types
Required	ZeroOrOne	node	Get, Replace

This interior node represents a container for off-network operation.

14.2.11 /<x>/OffNetwork/DefaultPPPP

Table 14.2.11.1: /<x>/OffNetwork/DefaultPPPP

OffNetwork/DefaultPPPP

Status	Occurrence	Format	Min. Access Types
Required	One	node	Get, Replace

This interior node is a placeholder for the default ProSe Per-Packet Priority (PPPP) configuration.

14.2.12 /<x>/OffNetwork/DefaultPPPP/MCVideoPrivateCallSignalling

Table 14.2.12.1: /<x>/OffNetwork/DefaultPPPP/MCVideoPrivateCallSignalling

OffNetwork/DefaultPPPP/MCVideoPrivateCallSignalling

Status	Occurrence	Format	Min. Access Types
Required	One	int	Get, Replace

This leaf node indicates the default ProSe Per-Packet Priority (PPPP) value (as specified in 3GPP TS 23.303 [6]) for the MCVideo private call signalling.

- Values: 1-8

The MCVideo user data with the lowest ProSe Per-Packet Priority value shall be considered as the MCVideo user data having the highest priority among the MCVideo user data.

14.2.13 /<x>/OffNetwork/DefaultPPPP/MCVideoPrivateCallMedia

Table 14.2.13.1: /<x>/OffNetwork/DefaultPPPP/MCVideoPrivateCallMedia

OffNetwork/DefaultPPPP/MCVideoPrivateCallMedia

Status	Occurrence	Format	Min. Access Types
Required	One	int	Get, Replace

This leaf node indicates the default ProSe Per-Packet Priority (PPPP) value (as specified in 3GPP TS 23.303 [6]) for the MCVideo private call media.

- Values: 1-8

The MCVideo user data with the lowest ProSe Per-Packet Priority value shall be considered as the MCVideo user data having the highest priority among the MCVideo user data.

14.2.14

/<x>/OffNetwork/DefaultPPPP/MCVideoEmergencyPrivateCallSignalling

Table 14.2.14.1: /<x>/OffNetwork/DefaultPPPP/MCVideoEmergencyPrivateCallSignalling

OffNetwork/DefaultPPPP/MCVideoEmergencyPrivateCallSignalling

Status	Occurrence	Format	Min. Access Types

Required	One	int	Get, Replace
----------	-----	-----	--------------

This leaf node indicates the default ProSe Per-Packet Priority (PPPP) value (as specified in 3GPP TS 23.303 [6]) for the MCVideo emergency private call signalling.

- Values: 1-8

The MCVideo user data with the lowest ProSe Per-Packet Priority value shall be considered as the MCVideo user data having the highest priority among the MCVideo user data.

14.2.15 /<x>/OffNetwork/DefaultPPPP/MCVideoEmergencyPrivateCallMedia

Table 14.2.15.1: /<x>/OffNetwork/DefaultPPPP/MCVideoEmergencyPrivateCallMedia

OffNetwork/DefaultPPPP/MCVideoEmergencyPrivateCallMedia

Status	Occurrence	Format	Min. Access Types
Required	One	int	Get, Replace

This leaf node indicates the default ProSe Per-Packet Priority (PPPP) value (as specified in 3GPP TS 23.303 [6]) for the MCVideo emergency private call media.

- Values: 1-8

The MCVideo user data with the lowest ProSe Per-Packet Priority value shall be considered as the MCVideo user data having the highest priority among the MCVideo user data.

14.2.16 /<x>/OffNetwork/PrivateCall

Table 14.2.16.1: /<x>/OffNetwork/PrivateCall

OffNetwork/PrivateCall

Status	Occurrence	Format	Min. Access Types
Required	One	node	Get, Replace

This interior node is a placeholder for private call configuration.

14.2.17 /<x>/OffNetwork/PrivateCall/MaxDuration

Table 14.2.17.1: /<x>/OffNetwork/PrivateCall/MaxDuration

OffNetwork/PrivateCall/MaxDuration

Status	Occurrence	Format	Min. Access Types
Required	One	int	Get, Replace

This leaf node indicates max private call duration.

- Values: 0-65535

The MaxDuration time is in seconds.

14.2.18 /<x>/OffNetwork/NumLevelHierarchy

Table 14.2.18.1: /<x>/OffNetwork/NumLevelHierarchy

OffNetwork/NumLevelHierarchy

Status	Occurrence	Format	Min. Access Types
Required	One	int	Get, Replace

This leaf node indicates the number of levels of hierarchy for transmission control override in off-network.

- Values: 4-256

The request with the lowest NumLevelHierarchy value shall be considered as the request having the lowest priority level given to override an active transmission among the requests.

Annex A (informative): MCPTT UE configuration MO DDF

This DDF is the standardized minimal set. A vendor can define its own DDF for the complete device. This DDF can include more features than this minimal standardized version. The DDF is included as an XML file.

Annex B (informative): MCPTT user profile MO DDF

This DDF is the standardized minimal set. A vendor can define its own DDF for the complete device. This DDF can include more features than this minimal standardized version. The DDF is included as an XML file.

Annex C (informative): MCS group configuration MO DDF

This DDF is the standardized minimal set. A vendor can define its own DDF for the complete device. This DDF can include more features than this minimal standardized version. The DDF is included as an XML file.

Annex D (informative): MCPTT service configuration MO DDF

This DDF is the standardized minimal set. A vendor can define its own DDF for the complete device. This DDF can include more features than this minimal standardized version. The DDF is included as an XML file.

Annex E (informative): MCS UE initial configuration MO DDF

This DDF is the standardized minimal set. A vendor can define its own DDF for the complete device. This DDF can include more features than this minimal standardized version. The DDF is included as an XML file.

Annex F (informative): MCVideo UE configuration MO DDF

This DDF is the standardized minimal set. A vendor can define its own DDF for the complete device. This DDF can include more features than this minimal standardized version. The DDF is included as an XML file.

Annex G (informative): MCVideo user profile configuration MO DDF

This DDF is the standardized minimal set. A vendor can define its own DDF for the complete device. This DDF can include more features than this minimal standardized version. The DDF is included as an XML file.

Annex H (informative): MCVideo service configuration MO DDF

This DDF is the standardized minimal set. A vendor can define its own DDF for the complete device. This DDF can include more features than this minimal standardized version. The DDF is included as an XML file.

Annex I (informative): MCData UE configuration MO DDF

This DDF is the standardized minimal set. A vendor can define its own DDF for the complete device. This DDF can include more features than this minimal standardized version. The DDF is included as an XML file.

Annex J (informative): MCData user profile configuration MO DDF

This DDF is the standardized minimal set. A vendor can define its own DDF for the complete device. This DDF can include more features than this minimal standardized version. The DDF is included as an XML file.

Annex K (informative): MCData service configuration MO DDF

This DDF is the standardized minimal set. A vendor can define its own DDF for the complete device. This DDF can include more features than this minimal standardized version. The DDF is included as an XML file.

Annex L (informative): Change history

Change history							
Date	TSG #	TSG Doc.	CR	Rev	Subject/Comment	Old	New
2015-07					Initial proposal to CT1	-	0.0.0
2015-08					Included skeleton from C1ah-150016 and scope from C1ah-150038 agreed at CT1#92bis	0.0.0	0.10
2015-08					Included CRs C1-152964 and C1-152965 agreed at CT1#93	0.1.0	0.2.0
2015-08					Revision number changed due to cover sheet modifications	0.2.0	0.2.1
2015-09					Modifying the cover sheet to add the TS number. Changes by the rapporteur.	0.2.1	0.2.2
2015-10					Included CRs C1-153754, and C1-153755 agreed at CT1#94	0.2.2	0.3.0
2016-01					Included CRs C1-160352, C1-160474, C1-160475, C1-160476, C1-160477 and C1-160478 agreed at CT1#95bis	0.3.0	0.4.0
2016-01					Editorial and formatting fixes	0.4.0	0.4.1
2016-02					Included CRs C1-161077, C1-161078, C1-161231, C1-161324, C1-161326, C1-161327, C1-161509 and C1-161510 agreed at CT1#96 Editorial and formatting fixes by the rapporteur.	0.4.1	0.5.0
2016-03	CT-71	CP-160056			Version 1.0.0 created for presentation for information and approval	0.5.0	1.0.0
2016-03	CT-71				Version 13.0.0 created after approval	1.0.0	13.0.0
2016-03					An editorial change from TS rapporteur	13.0.0	13.0.10
2016-06	CT-72	CP-160322	0002	1	Corrections to the scope of MCPTT Management Object (MO)	13.0.1	13.1.0
2016-06	CT-72	CP-160322	0003	3	Correction for MCPTT UE configuration management object (MO)	13.0.1	13.1.0
2016-06	CT-72	CP-160322	0004	3	Correction for MCPTT user profile management object (MO)	13.0.1	13.1.0
2016-06	CT-72	CP-160322	0005	2	Correction for MCPTT group configuration management object (MO)	13.0.1	13.1.0
2016-06	CT-72	CP-160322	0006	1	Correction for MCPTT service configuration management object (MO)	13.0.1	13.1.0
2016-06	CT-72	CP-160322	0007	3	Correction for MCPTT UE initial configuration management object (MO)	13.0.1	13.1.0
2016-06	CT-72	CP-160322	0011		Correction for security configuration parameters in MCPTT management object (MO)	13.0.1	13.1.0

Change history							
Date	Meeting	TDoc	CR	Rev	Cat	Subject/Comment	New version
2016-09	CT#73	CP-160565	0013	3	F	Correction for configuration parameters in MCPTT user profile management object (MO)	13.2.0
2016-09	CT#73	CP-160503	0014	1	F	Correction for group related parameters in MCPTT UE initial configuration management object (MO)	13.2.0
2016-09	CT#73	CP-160503	0015	1	F	Correction for security material parameter in MCPTT group configuration management object (MO)	13.2.0
2016-09	CT#73	CP-160503	0016		F	Correction for "MCPTTGroupPriorityHierarchy" value in MCPTT UE configuration management object (MO)	24.383 13.2.0
2016-12	CT#74					Change of spec number from 24.383 to 24.483 with wider scope and changed title	24.483 13.2.1
2016-12	CT#74	CP-160733	0018	1	F	Identity management endpoint UE initial configuration MO correction (24.383 CR)	13.3.0
2016-12	CT#74	CP-160733	0019	1	F	Correction for ProSe related configuration parameters (24.383 CR)	13.3.0
2016-12	CT#74	CP-160733	0020	3	F	Correction for MCPTT Private Call and Group Call in MCPTT user profile management (MO) (24.383 CR)	13.3.0
2016-12	CT#74	CP-160733	0021		F	Modify number of levels for priority hierarchy (24.383 CR)	13.3.0
2016-12	CT#74	CP-160733	0022	1	F	Identification of pre-selected MCPTT user profile in MCPTT user profile managed object. (24.383 CR)	13.3.0
2016-12	CT#74	CP-160734	0023	2	F	Off-network configuration parameter for queue (24.383 CR)	13.3.0
2017-03	CT#75	CP-170117	0001	2	F	Scope alignment with TS 24.483 title	13.4.0
2017-03	CT#75	CP-170117	0004		F	Corrections to upper limits	13.4.0
2017-03	CT#75	CP-170127	0002	1	F	Modifying references in TS 24.483 to cater for rel-14 Stage 2 and Stage 3 mission critical restructure	14.0.0
2017-03	CT#75	CP-170127	0003	1	F	Corrections and clean-up for 24.483	14.0.0
2017-03	CT#75	CP-170125	0005	1	B	MCPTT user profile MO modifications in support of private call call-back	14.0.0
2017-06	CT#76	CP-171080	0006		B	Updating general parts of TS 24.483 for MCDData, MCVideo and the initial configuration MO	14.1.0
2017-06	CT#76	CP-171080	0007	2	B	Modifications to the Group Configuration MO for MCDData and MCVideo	14.1.0
2017-06	CT#76	CP-171081	0008	1	B	MCVideo UE configuration MO	14.1.0
2017-06	CT#76	CP-171081	0009	2	B	MCVideo user profile configuration MO	14.1.0
2017-06	CT#76	CP-171081	0010		B	MCVideo service configuration MO	14.1.0
2017-06	CT#76	CP-171080	0011	2	B	MCDData UE configuration MO	14.1.0
2017-06	CT#76	CP-171080	0012	2	B	MCDData user profile configuration MO	14.1.0
2017-06	CT#76	CP-171080	0013	1	B	MCDData service configuration MO	14.1.0
2017-06	CT#76	CP-171114	0014	1	B	eMCPTT user profile MO updates	14.1.0
2017-06	CT#76	CP-171113	0016	1	A	AllowedFloorControlProtection configuration parameter	14.1.0
2017-06	CT#76	CP-171113	0018		A	QueueUsage configuration parameter	14.1.0
2017-06	CT#76	CP-171082	0019	1	F	Correction of User Aliases configuration parameter in the MCPTT user profile MO	14.1.0
2017-09	CT#77	CP-172101	0020	1	B	User profile MO additions for eMCPTT	14.2.0
2017-09	CT#77	CP-172096	0022	1	A	Clause 4 - Correction of occurrences of parameters	14.2.0
2017-09	CT#77	CP-172104	0025		F	Clause 6 - Correction of occurrences of parameters	14.2.0
2017-09	CT#77	CP-172102	0026	1	F	Clause 9 - Correction of occurrences of parameters	14.2.0
2017-09	CT#77	CP-172143	0028	2	F	Specify KMS-URI configuration for MCDATA in the MCDData User Profile Management Object.	14.2.0
2017-09	CT#77	CP-172144	0029	2	F	Clause 10 - Correction of names and formats of some parameters	14.2.0
2017-09	CT#77	CP-172104	0030		F	Clause 12 - Correction of occurrences of parameters	14.2.0
2017-09	CT#77	CP-172104	0031		F	Clause 13 - Correction of occurrences of parameters and their graphical representation	14.2.0
2017-09	CT#77	CP-172096	0032	2	A	Clause 8 – Inclusion of missing timer TFG14	14.2.0
2017-09	CT#77	CP-172096	0034	1	A	Include missing elements in MCPTT UE initial configuration MO	14.2.0
2017-09	CT#77	CP-172134	0037		F	DDF files for TS 24.483	14.2.0
2017-12	CT#78	CP-173066	0039	1	F	Off-network MCVideo configurations	14.3.0
2017-12	CT#78	CP-173073	0038	1	B	Authorisation parameters for remotely initiated calls - user profile MO	15.0.0
2018-03	CT#79	CP-180087	0040	1	B	User profile MO updates for functional alias	15.1.0
2018-03	CT#79	CP-180072	0042	1	A	User profile presentation priority	15.1.0
2018-06	CT#80	CP-181064	0043		F	Unique ID leaf node for enhanced status operational value	15.2.0
2018-09	CT#81	CP-182149	0045	2	B	Location of Talker	15.3.0
2018-09	CT#81	CP-182148	0046		B	Reception Priority	15.3.0
2019-03	CT#83	CP-190078	0051	1	A	Correction of MO counter names CFx11 and CFx12	15.4.0
2019-03	CT#83	CP-190078	0055	1	A	Remove T230 from TS 24.483	15.4.0
2019-03	CT#83	CP-190103	0048	2	F	24.483 Server URI and IP version additions	16.0.0
2019-03	CT#83	CP-190103	0052	1	F	Correction of Annex C and Annex E	16.0.0
2019-09	CT#85	CP-192066	0057	1	B	Restricting incoming private communications MO	16.1.0
2019-12	CT#86	CP-193110	0058	1	B	MO for limiting the number of emergency group calls for a specific functional alias	16.2.0

2019-12	CT#86	CP-193110	0059	1	B	Automatic activation and deactivation of functional aliases based on location	16.2.0
2019-12	CT#86	CP-193082	0063		A	Correction of single timer TFP2 mistakenly use for two different purposes	16.2.0
2019-12	CT#86	CP-193110	0065		B	List of MCPTT group members who did not acknowledge the group call request	16.2.0
2020-03	CT#87e	CP-200122	0064	3	B	Automatic group affiliation and deaffiliation based on location or functional alias	16.3.0
2020-03	CT#87e	CP-200115	0066	1	C	Included absolute URI associated with the media storage function of MCDData content server	16.3.0
2020-06	CT#88e	CP-201124	0067	1	B	IPConnectivity extension to include IP Information	16.4.0
2020-06	CT#88e	CP-201086	0071	1	A	Correction of unit values for T204 and T205	16.4.0
2020-06	CT#88e	CP-201124	0072	1	B	Add PointCoordinate, Speed, Heading nodes in 5.2.48W	16.4.0
2020-06	CT#88e	CP-201124	0073	1	D	Correct capitalisation in ListOfFunctionalaliases	16.4.0
2020-06	CT#88e	CP-201124	0074	1	B	MCDData FA (de)affiliation by location criteria MOs	16.4.0
2020-06	CT#88e	CP-201124	0075	1	B	MCDData Functional Alias by location criteria	16.4.0
2020-06	CT#88e	CP-201121	0076		F	Correction of node formats	16.4.0
2020-06	CT#88e	CP-201112	0077	1	B	Included the MessageStoreHostname element	16.4.0
2020-06	CT#88e	CP-201124	0078	1	F	Restricting incoming MCDData communications MO	16.4.0

History

Document history		
V16.4.0	August 2020	Publication