

ETSI TS 124 501 V15.4.0 (2019-07)



**5G;  
Non-Access-Stratum (NAS) protocol for 5G System (5GS);  
Stage 3  
(3GPP TS 24.501 version 15.4.0 Release 15)**



---

Reference

RTS/TSGC-0124501vF40

---

Keywords

5G

**ETSI**

650 Route des Lucioles  
F-06921 Sophia Antipolis Cedex - FRANCE

Tel.: +33 4 92 94 42 00 Fax: +33 4 93 65 47 16

Siret N° 348 623 562 00017 - NAF 742 C  
Association à but non lucratif enregistrée à la  
Sous-Préfecture de Grasse (06) N° 7803/88

---

**Important notice**

The present document can be downloaded from:

<http://www.etsi.org/standards-search>

The present document may be made available in electronic versions and/or in print. The content of any electronic and/or print versions of the present document shall not be modified without the prior written authorization of ETSI. In case of any existing or perceived difference in contents between such versions and/or in print, the prevailing version of an ETSI deliverable is the one made publicly available in PDF format at [www.etsi.org/deliver](http://www.etsi.org/deliver).

Users of the present document should be aware that the document may be subject to revision or change of status.

Information on the current status of this and other ETSI documents is available at

<https://portal.etsi.org/TB/ETSIDeliverableStatus.aspx>

If you find errors in the present document, please send your comment to one of the following services:

<https://portal.etsi.org/People/CommitteeSupportStaff.aspx>

---

**Copyright Notification**

No part may be reproduced or utilized in any form or by any means, electronic or mechanical, including photocopying and microfilm except as authorized by written permission of ETSI.

The content of the PDF version shall not be modified without the written authorization of ETSI.

The copyright and the foregoing restriction extend to reproduction in all media.

© ETSI 2019.

All rights reserved.

**DECT™**, **PLUGTESTS™**, **UMTS™** and the ETSI logo are trademarks of ETSI registered for the benefit of its Members.

**3GPP™** and **LTE™** are trademarks of ETSI registered for the benefit of its Members and of the 3GPP Organizational Partners.

**oneM2M™** logo is a trademark of ETSI registered for the benefit of its Members and of the oneM2M Partners.

**GSM®** and the GSM logo are trademarks registered and owned by the GSM Association.

---

## Intellectual Property Rights

### Essential patents

IPRs essential or potentially essential to normative deliverables may have been declared to ETSI. The information pertaining to these essential IPRs, if any, is publicly available for **ETSI members and non-members**, and can be found in ETSI SR 000 314: "*Intellectual Property Rights (IPRs); Essential, or potentially Essential, IPRs notified to ETSI in respect of ETSI standards*", which is available from the ETSI Secretariat. Latest updates are available on the ETSI Web server (<https://ipr.etsi.org/>).

Pursuant to the ETSI IPR Policy, no investigation, including IPR searches, has been carried out by ETSI. No guarantee can be given as to the existence of other IPRs not referenced in ETSI SR 000 314 (or the updates on the ETSI Web server) which are, or may be, or may become, essential to the present document.

### Trademarks

The present document may include trademarks and/or tradenames which are asserted and/or registered by their owners. ETSI claims no ownership of these except for any which are indicated as being the property of ETSI, and conveys no right to use or reproduce any trademark and/or tradename. Mention of those trademarks in the present document does not constitute an endorsement by ETSI of products, services or organizations associated with those trademarks.

---

## Legal Notice

This Technical Specification (TS) has been produced by ETSI 3rd Generation Partnership Project (3GPP).

The present document may refer to technical specifications or reports using their 3GPP identities. These shall be interpreted as being references to the corresponding ETSI deliverables.

The cross reference between 3GPP and ETSI identities can be found under <http://webapp.etsi.org/key/queryform.asp>.

---

## Modal verbs terminology

In the present document "**shall**", "**shall not**", "**should**", "**should not**", "**may**", "**need not**", "**will**", "**will not**", "**can**" and "**cannot**" are to be interpreted as described in clause 3.2 of the [ETSI Drafting Rules](#) (Verbal forms for the expression of provisions).

"**must**" and "**must not**" are **NOT** allowed in ETSI deliverables except when used in direct citation.

# Contents

Intellectual Property Rights .....	2
Legal Notice .....	2
Modal verbs terminology.....	2
Foreword.....	18
1 Scope .....	19
2 References .....	19
3 Definitions and abbreviations.....	21
3.1 Definitions .....	21
3.2 Abbreviations .....	25
4 General .....	27
4.1 Overview .....	27
4.2 Coordination between the protocols for 5GS mobility management and 5GS session management .....	27
4.3 UE domain selection .....	28
4.3.1 UE's usage setting .....	28
4.3.2 Domain selection for UE originating sessions / calls.....	28
4.3.3 Change of UE's usage setting.....	30
4.3.4 Change or determination of IMS voice availability .....	30
4.4 NAS security .....	31
4.4.1 General.....	31
4.4.2 Handling of 5G NAS security contexts.....	31
4.4.2.1 General .....	31
4.4.2.2 Establishment of a mapped 5G NAS security context during inter-system change from S1 mode to N1 mode in 5GMM-CONNECTED mode.....	33
4.4.2.3 Establishment of a 5G NAS security context during N1 mode to N1 mode handover .....	34
4.4.2.4 Establishment of an EPS security context during inter-system change from N1 mode to S1 mode in 5GMM-CONNECTED mode .....	35
4.4.2.5 Establishment of secure exchange of NAS messages .....	35
4.4.2.6 Change of security keys .....	37
4.4.3 Handling of NAS COUNT and NAS sequence number .....	37
4.4.3.1 General .....	37
4.4.3.2 Replay protection .....	38
4.4.3.3 Integrity protection and verification.....	38
4.4.3.4 Cipherring and deciphering .....	38
4.4.3.5 NAS COUNT wrap around.....	38
4.4.4 Integrity protection of NAS signalling messages.....	39
4.4.4.1 General .....	39
4.4.4.2 Integrity checking of NAS signalling messages in the UE .....	39
4.4.4.3 Integrity checking of NAS signalling messages in the AMF .....	40
4.4.5 Cipherring of NAS signalling messages .....	42
4.4.6 Protection of initial NAS signalling messages.....	42
4.5 Unified access control .....	43
4.5.1 General.....	43
4.5.2 Determination of the access identities and access category associated with a request for access.....	45
4.5.3 Operator-defined access categories.....	49
4.5.4 Access control and checking.....	50
4.5.4.1 Access control and checking in 5GMM-IDLE mode.....	50
4.5.4.2 Access control and checking in 5GMM-CONNECTED mode and in 5GMM-CONNECTED mode with RRC inactive indication .....	51
4.5.5 Exception handling and avoiding double barring .....	53
4.5.6 Mapping between access categories/access identities and RRC establishment cause .....	56
4.6 Network slicing .....	57
4.6.1 General.....	57
4.6.2 Mobility management aspects.....	57
4.6.2.1 General .....	57

4.6.2.2	NSSAI storage.....	58
4.6.2.3	Provision of NSSAI to lower layers in 5GMM-IDLE mode.....	59
4.6.3	Session management aspects .....	61
4.7	NAS over non-3GPP access .....	61
4.7.1	General.....	61
4.7.2	5GS mobility management aspects.....	61
4.7.2.1	General .....	61
4.7.2.2	Establishment cause for non-3GPP access.....	62
4.7.3	5GS session management aspects.....	62
4.7.4	Limited service state over non-3GPP access .....	62
4.8	Interworking with E-UTRAN connected to EPC .....	63
4.8.1	General.....	63
4.8.2	Single-registration mode.....	63
4.8.2.1	General .....	63
4.8.2.2	Single-registration mode with N26 interface .....	63
4.8.2.3	Single-registration mode without N26 interface .....	63
4.8.2.3.1	Interworking between NG-RAN and E-UTRAN .....	63
4.8.2.3.2	Interworking between N3IWF connected to 5GCN and E-UTRAN .....	64
4.8.3	Dual-registration mode .....	65
4.8.4	Core Network selection .....	66
4.9	Disabling and re-enabling of UE's N1 mode capability .....	66
4.9.1	General.....	66
4.9.2	Disabling and re-enabling of UE's N1 mode capability for 3GPP access.....	67
4.9.3	Disabling and re-enabling of UE's N1 mode capability for non-3GPP access.....	67
4.10	Interworking with ePDG connected to EPC.....	68
4.11	UE configuration parameter updates .....	68
5	Elementary procedures for 5GS mobility management .....	68
5.1	Overview .....	68
5.1.1	General.....	68
5.1.2	Types of 5GMM procedures.....	68
5.1.3	5GMM sublayer states .....	70
5.1.3.1	General .....	70
5.1.3.2	5GMM sublayer states .....	70
5.1.3.2.1	5GMM sublayer states in the UE.....	70
5.1.3.2.1.1	General.....	70
5.1.3.2.1.2	Main states .....	70
5.1.3.2.1.2.1	5GMM-NUL.....	70
5.1.3.2.1.2.2	5GMM-DEREGISTERED.....	70
5.1.3.2.1.2.3	5GMM-REGISTERED-INITIATED .....	71
5.1.3.2.1.2.4	5GMM-REGISTERED .....	71
5.1.3.2.1.2.5	5GMM-DEREGISTERED-INITIATED.....	71
5.1.3.2.1.2.6	5GMM-SERVICE-REQUEST-INITIATED.....	71
5.1.3.2.1.3	Substates of state 5GMM-DEREGISTERED .....	71
5.1.3.2.1.3.1	General .....	71
5.1.3.2.1.3.2	5GMM-DEREGISTERED.NORMAL-SERVICE.....	71
5.1.3.2.1.3.3	5GMM-DEREGISTERED.LIMITED-SERVICE.....	71
5.1.3.2.1.3.4	5GMM-DEREGISTERED.ATTEMPTING-REGISTRATION .....	71
5.1.3.2.1.3.5	5GMM-DEREGISTERED.PLMN-SEARCH.....	71
5.1.3.2.1.3.6	5GMM-DEREGISTERED.NO-SUPI .....	72
5.1.3.2.1.3.7	5GMM-DEREGISTERED.NO-CELL-AVAILABLE.....	72
5.1.3.2.1.3.8	5GMM-DEREGISTERED.eCALL-INACTIVE.....	72
5.1.3.2.1.3.9	5GMM-DEREGISTERED.INITIAL-REGISTRATION-NEEDED .....	72
5.1.3.2.1.4	Substates of state 5GMM-REGISTERED .....	72
5.1.3.2.1.4.1	General .....	72
5.1.3.2.1.4.2	5GMM-REGISTERED.NORMAL-SERVICE .....	72
5.1.3.2.1.4.3	5GMM-REGISTERED.NON-ALLOWED-SERVICE.....	72
5.1.3.2.1.4.4	5GMM-REGISTERED.ATTEMPTING-REGISTRATION-UPDATE.....	73
5.1.3.2.1.4.5	5GMM-REGISTERED.LIMITED-SERVICE .....	73
5.1.3.2.1.4.6	5GMM-REGISTERED.PLMN-SEARCH .....	73
5.1.3.2.1.4.7	5GMM-REGISTERED.NO-CELL-AVAILABLE .....	73
5.1.3.2.1.4.8	5GMM-REGISTERED.UPDATE-NEEDED .....	73

5.1.3.2.2	5GS update status in the UE .....	73
5.1.3.2.3	5GMM sublayer states in the network side .....	74
5.1.3.2.3.1	General .....	74
5.1.3.2.3.2	5GMM-DEREGISTERED .....	74
5.1.3.2.3.3	5GMM-COMMON-PROCEDURE-INITIATED .....	74
5.1.3.2.3.4	5GMM-REGISTERED .....	74
5.1.3.2.3.5	5GMM-DEREGISTERED-INITIATED .....	74
5.1.4	Coordination between 5GMM and EMM .....	75
5.1.4.1	General .....	75
5.1.4.2	Coordination between 5GMM and EMM with N26 interface .....	75
5.1.4.3	Coordination between 5GMM and EMM without N26 interface .....	75
5.2	Behaviour of the UE in state 5GMM-DEREGISTERED and state 5GMM-REGISTERED .....	76
5.2.1	General .....	76
5.2.2	UE behaviour in state 5GMM-DEREGISTERED .....	76
5.2.2.1	General .....	76
5.2.2.2	Primary substate selection .....	76
5.2.2.2.1	Selection of the substate after power on .....	76
5.2.2.3	Detailed description of UE behaviour in state 5GMM-DEREGISTERED .....	76
5.2.2.3.1	NORMAL-SERVICE .....	76
5.2.2.3.2	LIMITED-SERVICE .....	77
5.2.2.3.3	ATTEMPTING-REGISTRATION .....	77
5.2.2.3.4	PLMN-SEARCH .....	77
5.2.2.3.5	NO-SUPI .....	77
5.2.2.3.6	NO-CELL-AVAILABLE .....	77
5.2.2.3.7	eCALL-INACTIVE .....	77
5.2.2.4	Substate when back to state 5GMM-DEREGISTERED from another 5GMM state .....	78
5.2.3	UE behaviour in state 5GMM-REGISTERED .....	78
5.2.3.1	General .....	78
5.2.3.2	Detailed description of UE behaviour in state 5GMM-REGISTERED .....	78
5.2.3.2.1	NORMAL-SERVICE .....	78
5.2.3.2.2	NON-ALLOWED-SERVICE .....	79
5.2.3.2.3	ATTEMPTING-REGISTRATION-UPDATE .....	79
5.2.3.2.4	LIMITED-SERVICE .....	80
5.2.3.2.5	PLMN-SEARCH .....	80
5.2.3.2.6	NO-CELL-AVAILABLE .....	80
5.3	General on elementary 5GMM procedures .....	80
5.3.1	5GMM modes and N1 NAS signalling connection .....	80
5.3.1.1	Establishment of the N1 NAS signalling connection .....	80
5.3.1.2	Re-establishment of the N1 NAS signalling connection .....	81
5.3.1.3	Release of the N1 NAS signalling connection .....	82
5.3.1.4	5GMM-CONNECTED mode with RRC inactive indication .....	85
5.3.2	Permanent identifiers .....	87
5.3.3	Temporary identities .....	87
5.3.4	Registration areas .....	88
5.3.5	Service area restrictions .....	89
5.3.6	Mobile initiated connection only mode .....	90
5.3.7	Handling of the periodic registration update timer and mobile reachable timer .....	91
5.3.8	Handling of timer T3502 .....	93
5.3.9	Handling of NAS level mobility management congestion control .....	93
5.3.10	Handling of DNN based congestion control .....	94
5.3.11	Handling of S-NSSAI based congestion control .....	94
5.3.12	Handling of local emergency numbers .....	94
5.3.12A	Handling of local emergency numbers received via 3GPP access and non-3GPP access .....	95
5.3.12A.1	General .....	95
5.3.12A.2	Receiving a REGISTRATION ACCEPT message via non-3GPP access .....	96
5.3.13	Lists of 5GS forbidden tracking areas .....	96
5.3.14	List of equivalent PLMNs .....	97
5.3.15	Transmission failure abnormal case in the UE .....	97
5.4	5GMM common procedures .....	97
5.4.1	Primary authentication and key agreement procedure .....	97
5.4.1.1	General .....	97
5.4.1.2	EAP based primary authentication and key agreement procedure .....	97

5.4.1.2.1	General .....	97
5.4.1.2.2	EAP-AKA' related procedures.....	100
5.4.1.2.2.1	General.....	100
5.4.1.2.2.2	Initiation.....	100
5.4.1.2.2.3	UE successfully authenticates network .....	100
5.4.1.2.2.4	Errors when handling EAP-request/AKA'-challenge message .....	101
5.4.1.2.2.5	Network successfully authenticates UE .....	101
5.4.1.2.2.6	UE handling EAP-AKA' notification message .....	101
5.4.1.2.2.6A	EAP based Identification initiation by the network .....	101
5.4.1.2.2.6B	EAP based Identification response by the UE .....	101
5.4.1.2.2.7	Network sending EAP-success message .....	102
5.4.1.2.2.8	UE handling EAP-success message .....	102
5.4.1.2.2.9	Network not successfully authenticates UE .....	102
5.4.1.2.2.10	Network sending EAP-failure message .....	102
5.4.1.2.2.11	UE handling EAP-failure message .....	103
5.4.1.2.2.12	Abnormal cases in the UE.....	103
5.4.1.2.3	EAP-TLS related procedures.....	103
5.4.1.2.3.1	General.....	103
5.4.1.2.4	EAP message reliable transport procedure .....	105
5.4.1.2.4.1	General.....	105
5.4.1.2.4.2	EAP message reliable transport procedure initiation by the network .....	105
5.4.1.2.4.3	EAP message reliable transport procedure accepted by the UE.....	105
5.4.1.2.4.4	Abnormal cases on the network side.....	106
5.4.1.2.4.5	Abnormal cases in the UE.....	106
5.4.1.2.5	EAP result message transport procedure .....	108
5.4.1.2.5.1	General.....	108
5.4.1.2.5.2	EAP result message transport procedure initiation by the network .....	108
5.4.1.3	5G AKA based primary authentication and key agreement procedure .....	109
5.4.1.3.1	General .....	109
5.4.1.3.2	Authentication initiation by the network .....	109
5.4.1.3.3	Authentication response by the UE .....	110
5.4.1.3.4	Authentication completion by the network.....	110
5.4.1.3.5	Authentication not accepted by the network.....	111
5.4.1.3.6	Authentication not accepted by the UE .....	111
5.4.1.3.7	Abnormal cases .....	112
5.4.2	Security mode control procedure .....	116
5.4.2.1	General .....	116
5.4.2.2	NAS security mode control initiation by the network.....	116
5.4.2.3	NAS security mode command accepted by the UE.....	118
5.4.2.4	NAS security mode control completion by the network .....	120
5.4.2.5	NAS security mode command not accepted by the UE.....	120
5.4.2.6	Abnormal cases in the UE.....	121
5.4.2.7	Abnormal cases on the network side.....	121
5.4.3	Identification procedure .....	121
5.4.3.1	General .....	121
5.4.3.2	Identification initiation by the network .....	122
5.4.3.3	Identification response by the UE .....	122
5.4.3.4	Identification completion by the network .....	122
5.4.3.5	Abnormal cases in the UE.....	122
5.4.3.6	Abnormal cases on the network side.....	122
5.4.4	Generic UE configuration update procedure.....	123
5.4.4.1	General .....	123
5.4.4.2	Generic UE configuration update procedure initiated by the network .....	125
5.4.4.3	Generic UE configuration update accepted by the UE.....	126
5.4.4.4	Generic UE configuration update completion by the network .....	127
5.4.4.5	Abnormal cases in the UE.....	128
5.4.4.6	Abnormal cases on the network side.....	128
5.4.5	NAS transport procedure(s).....	129
5.4.5.1	General .....	129
5.4.5.2	UE-initiated NAS transport procedure .....	130
5.4.5.2.1	General .....	130
5.4.5.2.2	UE-initiated NAS transport procedure initiation.....	130

5.4.5.2.3	UE-initiated NAS transport of messages accepted by the network .....	132
5.4.5.2.4	UE-initiated NAS transport of messages not accepted by the network .....	135
5.4.5.2.5	Abnormal cases on the network side .....	135
5.4.5.2.6	Abnormal cases in the UE .....	138
5.4.5.3	Network-initiated NAS transport procedure .....	139
5.4.5.3.1	General .....	139
5.4.5.3.2	Network-initiated NAS transport procedure initiation .....	139
5.4.5.3.3	Network-initiated NAS transport of messages .....	142
5.4.6	5GMM status procedure .....	144
5.4.6.1	General .....	144
5.4.6.2	5GMM status received in the UE .....	144
5.4.6.3	5GMM status received in the network .....	145
5.5	5GMM specific procedures .....	145
5.5.1	Registration procedure .....	145
5.5.1.1	General .....	145
5.5.1.2	Registration procedure for initial registration .....	146
5.5.1.2.1	General .....	146
5.5.1.2.2	Initial registration initiation .....	146
5.5.1.2.3	5GMM common procedure initiation .....	149
5.5.1.2.4	Initial registration accepted by the network .....	149
5.5.1.2.5	Initial registration not accepted by the network .....	155
5.5.1.2.6	Initial registration for emergency services not accepted by the network .....	158
5.5.1.2.6A	Initial registration for initiating a PDU session for emergency services not accepted by the network .....	158
5.5.1.2.7	Abnormal cases in the UE .....	159
5.5.1.2.8	Abnormal cases on the network side .....	161
5.5.1.3	Registration procedure for mobility and periodic registration update .....	162
5.5.1.3.1	General .....	162
5.5.1.3.2	Mobility and periodic registration update initiation .....	162
5.5.1.3.3	5GMM common procedure initiation .....	167
5.5.1.3.4	Mobility and periodic registration update accepted by the network .....	168
5.5.1.3.5	Mobility and periodic registration update not accepted by the network .....	177
5.5.1.3.6	Mobility and periodic registration update for initiating an emergency PDU session not accepted by the network .....	180
5.5.1.3.7	Abnormal cases in the UE .....	180
5.5.1.3.8	Abnormal cases on the network side .....	183
5.5.2	De-registration procedure .....	184
5.5.2.1	General .....	184
5.5.2.2	UE-initiated de-registration procedure .....	185
5.5.2.2.1	UE-initiated de-registration procedure initiation .....	185
5.5.2.2.2	UE-initiated de-registration procedure completion .....	186
5.5.2.2.3	UE-initiated de-registration procedure completion for 5GS services over 3GPP access .....	186
5.5.2.2.4	UE-initiated de-registration procedure completion for 5GS services non-3GPP access .....	187
5.5.2.2.5	UE-initiated de-registration procedure completion for 5GS services over both 3GPP access and non-3GPP access .....	187
5.5.2.2.6	Abnormal cases in the UE .....	187
5.5.2.2.7	Abnormal cases in the network side .....	189
5.5.2.3	Network-initiated de-registration procedure .....	189
5.5.2.3.1	Network-initiated de-registration procedure initiation .....	189
5.5.2.3.2	Network-initiated de-registration procedure completion by the UE .....	189
5.5.2.3.3	Network-initiated de-registration procedure completion by the network .....	192
5.5.2.3.4	Abnormal cases in the UE .....	192
5.5.2.3.5	Abnormal cases in the network side .....	193
5.5.3	eCall inactivity procedure .....	193
5.6	5GMM connection management procedures .....	194
5.6.1	Service request procedure .....	194
5.6.1.1	General .....	194
5.6.1.2	Service request procedure initiation .....	196
5.6.1.3	Common procedure initiation .....	198
5.6.1.4	Service request procedure accepted by the network .....	198
5.6.1.5	Service request procedure not accepted by the network .....	200
5.6.1.6	Service request procedure for initiating an emergency PDU session not accepted by the network .....	203



5.6.1.7	Abnormal cases in the UE.....	204
5.6.1.8	Abnormal cases on the network side.....	206
5.6.2	Paging procedure .....	207
5.6.2.1	General .....	207
5.6.2.2	Paging for 5GS services .....	207
5.6.2.2.1	General .....	207
5.6.2.2.2	Abnormal cases on the network side .....	208
5.6.2.2.3	Abnormal cases in the UE .....	208
5.6.3	Notification procedure .....	208
5.6.3.1	General .....	208
5.6.3.2	Notification procedure initiation .....	208
5.6.3.3	Notification procedure completion.....	209
5.6.3.4	Abnormal cases on the network side.....	210
5.6.3.5	Abnormal cases on the UE side.....	210
6	Elementary procedures for 5GS session management .....	210
6.1	Overview .....	210
6.1.1	General.....	210
6.1.2	Types of 5GSM procedures .....	211
6.1.3	5GSM sublayer states .....	211
6.1.3.1	General .....	211
6.1.3.2	5GSM sublayer states in the UE .....	211
6.1.3.2.1	Overview .....	211
6.1.3.2.2	PDU SESSION INACTIVE .....	212
6.1.3.2.3	PDU SESSION ACTIVE PENDING.....	212
6.1.3.2.4	PDU SESSION ACTIVE .....	212
6.1.3.2.5	PDU SESSION INACTIVE PENDING.....	212
6.1.3.2.6	PDU SESSION MODIFICATION PENDING .....	212
6.1.3.2.7	PROCEDURE TRANSACTION INACTIVE.....	212
6.1.3.2.8	PROCEDURE TRANSACTION PENDING.....	212
6.1.3.3	5GSM sublayer states in the network side .....	213
6.1.3.3.1	Overview .....	213
6.1.3.3.2	PDU SESSION INACTIVE .....	213
6.1.3.3.3	PDU SESSION ACTIVE .....	213
6.1.3.3.4	PDU SESSION INACTIVE PENDING.....	213
6.1.3.3.5	PDU SESSION MODIFICATION PENDING .....	214
6.1.3.3.6	PROCEDURE TRANSACTION INACTIVE.....	214
6.1.3.3.7	PROCEDURE TRANSACTION PENDING.....	214
6.1.4	Coordination between 5GSM and ESM.....	214
6.1.4.1	Coordination between 5GSM and ESM with N26 interface .....	214
6.1.4.2	Coordination between 5GSM and ESM without N26 interface .....	221
6.2	General on elementary 5GSM procedures.....	223
6.2.1	Principles of PTI handling for 5GSM procedures.....	223
6.2.2	PDU session types .....	225
6.2.3	PDU session management .....	225
6.2.4	IP address allocation .....	225
6.2.4.1	General .....	225
6.2.4.2	IP address allocation via NAS signalling .....	226
6.2.5	Quality of service.....	227
6.2.5.1	General .....	227
6.2.5.1.1	QoS rules .....	227
6.2.5.1.1.1	General.....	227
6.2.5.1.1.2	Signalled QoS rules .....	227
6.2.5.1.1.3	Derived QoS rules.....	228
6.2.5.1.1.4	QoS flow descriptions.....	228
6.2.5.1.2	Session-AMBR.....	229
6.2.5.1.3	UL user data packet matching .....	229
6.2.5.1.4	Reflective QoS.....	229
6.2.5.1.4.1	General.....	229
6.2.5.1.4.2	Derivation of packet filter for UL direction from DL user data packet .....	229
6.2.5.1.4.3	Creating a derived QoS rule by reflective QoS in the UE.....	231
6.2.5.1.4.4	Updating a derived QoS rule by reflective QoS in the UE .....	232

6.2.5.1.4.5	Deleting a derived QoS rule in the UE .....	232
6.2.5.1.4.6	Ignoring RQI in the UE.....	232
6.2.6	Local area data network (LADN) .....	232
6.2.7	Handling of DNN based congestion control .....	233
6.2.8	Handling of S-NSSAI based congestion control.....	233
6.2.9	Interaction with upper layers .....	234
6.2.9.1	General .....	234
6.2.9.2	URSP.....	234
6.2.10	Handling of 3GPP PS data off .....	235
6.2.11	Multi-homed IPv6 PDU session .....	236
6.3	Network-requested 5GSM procedures .....	236
6.3.1	PDU session authentication and authorization procedure.....	236
6.3.1.1	General .....	236
6.3.1.2	PDU EAP message reliable transport procedure.....	238
6.3.1.2.1	PDU EAP message reliable transport procedure initiation.....	238
6.3.1.2.2	PDU EAP message reliable transport procedure accepted by the UE .....	239
6.3.1.2.3	Abnormal cases on the network side .....	239
6.3.1.2.4	Abnormal cases in the UE .....	239
6.3.1.3	PDU EAP result message transport procedure.....	239
6.3.1.3.1	PDU EAP result message transport procedure initiation .....	239
6.3.2	Network-requested PDU session modification procedure .....	240
6.3.2.1	General .....	240
6.3.2.2	Network-requested PDU session modification procedure initiation .....	240
6.3.2.3	Network-requested PDU session modification procedure accepted by the UE.....	242
6.3.2.4	Network-requested PDU session modification procedure not accepted by the UE.....	247
6.3.2.5	Abnormal cases on the network side.....	250
6.3.2.6	Abnormal cases in the UE.....	250
6.3.3	Network-requested PDU session release procedure .....	251
6.3.3.1	General .....	251
6.3.3.2	Network-requested PDU session release procedure initiation .....	251
6.3.3.3	Network-requested PDU session release procedure accepted by the UE.....	252
6.3.3.4	N1 SM delivery skipped.....	258
6.3.3.5	Abnormal cases on the network side.....	258
6.3.3.6	Abnormal cases in the UE.....	258
6.4	UE-requested 5GSM procedures.....	258
6.4.1	UE-requested PDU session establishment procedure .....	258
6.4.1.1	General .....	258
6.4.1.2	UE-requested PDU session establishment procedure initiation .....	259
6.4.1.3	UE-requested PDU session establishment procedure accepted by the network .....	262
6.4.1.4	UE requested PDU session establishment procedure not accepted by the network .....	269
6.4.1.5	Handling the maximum number of established PDU sessions.....	277
6.4.1.6	Abnormal cases in the UE.....	278
6.4.1.7	Abnormal cases on the network side.....	278
6.4.2	UE-requested PDU session modification procedure.....	279
6.4.2.1	General .....	279
6.4.2.2	UE-requested PDU session modification procedure initiation.....	280
6.4.2.3	UE-requested PDU session modification procedure accepted by the network .....	282
6.4.2.4	UE-requested PDU session modification procedure not accepted by the network .....	282
6.4.2.5	Abnormal cases in the UE.....	289
6.4.2.6	Abnormal cases on the network side.....	289
6.4.3	UE-requested PDU session release procedure .....	290
6.4.3.1	General .....	290
6.4.3.2	UE-requested PDU session release procedure initiation .....	290
6.4.3.3	UE-requested PDU session release procedure accepted by the network.....	291
6.4.3.4	UE-requested PDU session release procedure not accepted by the network.....	291
6.4.3.5	Abnormal cases in the UE.....	291
6.4.3.6	Abnormal cases on the network side.....	292
6.5	5GSM status procedure .....	292
6.5.1	General.....	292
6.5.2	5GSM status received in the UE.....	293
6.5.3	5GSM status received in the SMF .....	293
6.6	Miscellaneous procedures .....	293

6.6.1	Exchange of extended protocol configuration options.....	293
7	Handling of unknown, unforeseen, and erroneous protocol data.....	294
7.1	General.....	294
7.2	Message too short or too long.....	294
7.2.1	Message too short.....	294
7.2.2	Message too long.....	294
7.3	Unknown or unforeseen procedure transaction identity or PDU Session identity.....	294
7.3.1	Procedure transaction identity.....	294
7.3.2	PDU Session identity.....	295
7.4	Unknown or unforeseen message type.....	295
7.5	Non-semantic mandatory information element errors.....	296
7.5.1	Common procedures.....	296
7.5.2	5GS mobility management.....	296
7.5.3	5GS session management.....	296
7.6	Unknown and unforeseen IEs in the non-imperative message part.....	297
7.6.1	IEs unknown in the message.....	297
7.6.2	Out of sequence IEs.....	297
7.6.3	Repeated IEs.....	297
7.7	Non-imperative message part errors.....	297
7.7.1	Syntactically incorrect optional IEs.....	298
7.7.2	Conditional IE errors.....	298
7.8	Messages with semantically incorrect contents.....	298
8	Message functional definitions and contents.....	298
8.1	Overview.....	298
8.2	5GS mobility management messages.....	298
8.2.1	Authentication request.....	298
8.2.1.1	Message definition.....	298
8.2.1.2	Authentication parameter RAND.....	299
8.2.1.3	Authentication parameter AUTN.....	299
8.2.1.4	Void.....	299
8.2.1.5	EAP message.....	299
8.2.2	Authentication response.....	299
8.2.2.1	Message definition.....	299
8.2.2.2	Authentication response parameter.....	300
8.2.2.3	EAP message.....	300
8.2.3	Authentication result.....	300
8.2.3.1	Message definition.....	300
8.2.3.2	ABBA.....	300
8.2.4	Authentication failure.....	301
8.2.4.1	Message definition.....	301
8.2.4.2	Authentication failure parameter.....	301
8.2.5	Authentication reject.....	301
8.2.5.1	Message definition.....	301
8.2.5.2	EAP message.....	302
8.2.6	Registration request.....	302
8.2.6.1	Message definition.....	302
8.2.6.2	Non-current native NAS key set identifier.....	304
8.2.6.3	5GMM capability.....	304
8.2.6.4	UE security capability.....	304
8.2.6.5	Requested NSSAI.....	304
8.2.6.6	Last visited registered TAI.....	304
8.2.6.7	S1 UE network capability.....	304
8.2.6.8	Uplink data status.....	304
8.2.6.9	PDU session status.....	304
8.2.6.10	MICO indication.....	304
8.2.6.11	UE status.....	304
8.2.6.12	Additional GUTI.....	304
8.2.6.13	Allowed PDU session status.....	305
8.2.6.14	UE's usage setting.....	305
8.2.6.15	Requested DRX parameters.....	305

8.2.6.16	EPS NAS message container.....	305
8.2.6.17	LADN indication.....	305
8.2.6.17A	Payload container type .....	305
8.2.6.18	Payload container.....	305
8.2.6.19	Network slicing indication .....	305
8.2.6.20	5GS update type .....	305
8.2.6.21	NAS message container .....	305
8.2.6.22	EPS bearer context status .....	306
8.2.7	Registration accept.....	306
8.2.7.1	Message definition .....	306
8.2.7.2	5G-GUTI.....	309
8.2.7.3	Equivalent PLMNs.....	309
8.2.7.4	TAI list .....	309
8.2.7.5	Allowed NSSAI .....	309
8.2.7.6	Rejected NSSAI .....	309
8.2.7.7	Configured NSSAI.....	309
8.2.7.8	5GS network feature support.....	309
8.2.7.9	PDU session status .....	309
8.2.7.10	PDU session reactivation result.....	309
8.2.7.11	PDU session reactivation result error cause.....	309
8.2.7.12	LADN information.....	310
8.2.7.13	MICO indication .....	310
8.2.7.14	Network slicing indication .....	310
8.2.7.15	Service area list .....	310
8.2.7.16	T3512 value.....	310
8.2.7.17	Non-3GPP de-registration timer value .....	310
8.2.7.18	T3502 value.....	310
8.2.7.19	Emergency number list .....	310
8.2.7.20	Extended emergency number list .....	310
8.2.7.21	SOR transparent container .....	310
8.2.7.22	EAP message.....	310
8.2.7.23	NSSAI inclusion mode.....	311
8.2.7.24	Operator-defined access category definitions .....	311
8.2.7.25	Negotiated DRX parameters .....	311
8.2.7.26	Non-3GPP NW provided policies .....	311
8.2.7.27	EPS bearer context status .....	311
8.2.8	Registration complete .....	311
8.2.8.1	Message definition .....	311
8.2.8.2	SOR transparent container .....	311
8.2.9	Registration reject.....	312
8.2.9.1	Message definition .....	312
8.2.9.2	T3346 value.....	312
8.2.9.3	T3502 value.....	312
8.2.9.4	EAP message.....	312
8.2.10	UL NAS transport.....	312
8.2.10.1	Message definition .....	312
8.2.10.2	PDU session ID .....	313
8.2.10.3	Old PDU session ID .....	313
8.2.10.4	Request type .....	313
8.2.10.5	S-NSSAI .....	313
8.2.10.6	DNN.....	313
8.2.10.7	Additional information.....	313
8.2.11	DL NAS transport.....	314
8.2.11.1	Message definition .....	314
8.2.11.2	PDU session ID .....	314
8.2.11.3	Additional information.....	314
8.2.11.4	5GMM cause.....	314
8.2.11.5	Back-off timer value .....	314
8.2.12	De-registration request (UE originating de-registration) .....	315
8.2.12.1	Message definition .....	315
8.2.13	De-registration accept (UE originating de-registration).....	315
8.2.13.1	Message definition .....	315

8.2.14	De-registration request (UE terminated de-registration).....	315
8.2.14.1	Message definition .....	315
8.2.14.2	5GMM cause.....	316
8.2.14.3	T3346 value.....	316
8.2.15	De-registration accept (UE terminated de-registration).....	316
8.2.15.1	Message definition .....	316
8.2.16	Service request.....	317
8.2.16.1	Message definition .....	317
8.2.16.2	Uplink data status.....	317
8.2.16.3	PDU session status .....	317
8.2.16.4	Allowed PDU session status .....	317
8.2.16.5	NAS message container .....	317
8.2.17	Service accept.....	318
8.2.17.1	Message definition .....	318
8.2.17.2	PDU session status .....	318
8.2.17.3	PDU session reactivation result.....	318
8.2.17.4	PDU session reactivation result error cause .....	318
8.2.17.5	EAP message.....	318
8.2.18	Service reject .....	319
8.2.18.1	Message definition .....	319
8.2.18.2	PDU session status .....	319
8.2.18.3	T3346 value.....	319
8.2.18.4	EAP message.....	319
8.2.19	Configuration update command.....	319
8.2.19.1	Message definition .....	319
8.2.19.2	Configuration update indication.....	320
8.2.19.3	5G-GUTI.....	320
8.2.19.4	TAI list .....	320
8.2.19.5	Allowed NSSAI .....	320
8.2.19.6	Service area list .....	321
8.2.19.7	Full name for network.....	321
8.2.19.8	Short name for network.....	321
8.2.19.9	Local time zone .....	321
8.2.19.10	Universal time and local time zone .....	321
8.2.19.11	Network daylight saving time .....	321
8.2.19.12	LADN information.....	321
8.2.19.13	MICO indication .....	321
8.2.19.14	Network slicing indication .....	321
8.2.19.15	Configured NSSAI.....	321
8.2.19.16	Rejected NSSAI .....	321
8.2.19.17	Operator-defined access category definitions .....	321
8.2.19.18	SMS indication.....	321
8.2.20	Configuration update complete.....	322
8.2.20.1	Message definition .....	322
8.2.21	Identity request .....	322
8.2.21.1	Message definition .....	322
8.2.22	Identity response .....	322
8.2.22.1	Message definition .....	322
8.2.23	Notification .....	323
8.2.23.1	Message definition .....	323
8.2.24	Notification response .....	323
8.2.24.1	Message definition .....	323
8.2.24.2	PDU session status .....	324
8.2.25	Security mode command .....	324
8.2.25.1	Message definition .....	324
8.2.25.2	IMEISV request .....	325
8.2.25.3	Void.....	325
8.2.25.4	Selected EPS NAS security algorithms.....	325
8.2.25.5	Additional 5G security information .....	325
8.2.25.6	EAP message.....	325
8.2.25.7	ABBA .....	325
8.2.25.8	Replayed S1 UE security capabilities .....	326

8.2.26	Security mode complete.....	326
8.2.26.1	Message definition .....	326
8.2.26.2	IMEISV .....	326
8.2.26.3	NAS message container .....	326
8.2.27	Security mode reject .....	326
8.6.27.1	Message definition .....	326
8.2.28	Security protected 5GS NAS message.....	327
8.2.28.1	Message definition .....	327
8.2.29	5GMM status .....	327
8.2.29.1	Message definition .....	327
8.3	5GS session management messages.....	328
8.3.1	PDU session establishment request .....	328
8.3.1.1	Message definition .....	328
8.3.1.2	PDU session type .....	329
8.3.1.3	SSC mode.....	329
8.3.1.4	Maximum number of supported packet filters .....	329
8.3.1.5	5GSM capability .....	329
8.3.1.6	Void.....	329
8.3.1.7	Always-on PDU session requested .....	329
8.3.1.8	SM PDU DN request container.....	329
8.3.1.9	Extended protocol configuration options .....	329
8.3.2	PDU session establishment accept.....	329
8.3.2.1	Message definition .....	329
8.3.2.2	5GSM cause .....	330
8.3.2.3	PDU address.....	330
8.3.2.4	RQ timer value .....	330
8.3.2.5	S-NSSAI .....	330
8.3.2.6	Always-on PDU session indication.....	331
8.3.2.7	Mapped EPS bearer contexts.....	331
8.3.2.8	EAP message.....	331
8.3.2.9	Authorized QoS flow descriptions .....	331
8.3.2.10	Extended protocol configuration options .....	331
8.3.2.11	DNN.....	331
8.3.3	PDU session establishment reject .....	331
8.3.3.1	Message definition .....	331
8.3.3.2	Back-off timer value .....	332
8.3.3.3	Allowed SSC mode .....	332
8.3.3.4	EAP message.....	332
8.3.3.5	Extended protocol configuration options .....	332
8.3.3.6	5GSM congestion re-attempt indicator .....	332
8.3.4	PDU session authentication command.....	332
8.3.4.1	Message definition .....	332
8.3.4.2	Extended protocol configuration options .....	333
8.3.5	PDU session authentication complete.....	333
8.3.5.1	Message definition .....	333
8.3.5.2	Extended protocol configuration options .....	334
8.3.6	PDU session authentication result .....	334
8.3.6.1	Message definition .....	334
8.3.6.2	EAP message.....	334
8.3.6.3	Extended protocol configuration options .....	334
8.3.7	PDU session modification request .....	334
8.3.7.1	Message definition .....	334
8.3.7.2	5GSM capability .....	335
8.3.7.3	5GSM cause .....	335
8.3.7.4	Maximum number of supported packet filters .....	335
8.3.7.5	Always-on PDU session requested .....	336
8.3.7.6	Integrity protection maximum data rate .....	336
8.3.7.7	Requested QoS rules .....	336
8.3.7.8	Requested QoS flow descriptions .....	336
8.3.7.9	Extended protocol configuration options .....	336
8.3.7.10	Mapped EPS bearer contexts.....	336
8.3.8	PDU session modification reject.....	336

8.3.8.1	Message definition .....	336
8.3.8.2	Back-off timer value .....	337
8.3.8.3	Extended protocol configuration options .....	337
8.3.8.4	5GSM congestion re-attempt indicator .....	337
8.3.9	PDU session modification command .....	337
8.3.9.1	Message definition .....	337
8.3.9.2	5GSM cause .....	337
8.3.9.3	Session-AMBR .....	338
8.3.9.4	RQ timer value .....	338
8.3.9.5	Always-on PDU session indication .....	338
8.3.9.6	Authorized QoS rules .....	338
8.3.9.7	Mapped EPS bearer contexts .....	338
8.3.9.8	Authorized QoS flow descriptions .....	338
8.3.9.9	Extended protocol configuration options .....	338
8.3.10	PDU session modification complete .....	338
8.3.10.1	Message definition .....	338
8.3.10.2	Extended protocol configuration options .....	339
8.3.11	PDU session modification command reject .....	339
8.3.11.1	Message definition .....	339
8.3.11.2	Extended protocol configuration options .....	339
8.3.12	PDU session release request .....	340
8.3.12.1	Message definition .....	340
8.3.12.2	5GSM cause .....	340
8.3.12.3	Extended protocol configuration options .....	340
8.3.13	PDU session release reject .....	340
8.3.13.1	Message definition .....	340
8.3.13.2	Extended protocol configuration options .....	341
8.3.14	PDU session release command .....	341
8.3.14.1	Message definition .....	341
8.3.14.2	Back-off timer value .....	341
8.3.14.3	EAP message .....	342
8.3.14.4	Extended protocol configuration options .....	342
8.3.14.5	5GSM congestion re-attempt indicator .....	342
8.3.15	PDU session release complete .....	342
8.3.15.1	Message definition .....	342
8.3.15.2	5GSM cause .....	342
8.3.15.3	Extended protocol configuration options .....	342
8.3.16	5GSM status .....	343
8.3.16.1	Message definition .....	343
9	General message format and information elements coding .....	343
9.1	Overview .....	343
9.1.1	NAS message format .....	343
9.1.2	Field format and mapping .....	344
9.2	Extended protocol discriminator .....	344
9.3	Security header type .....	345
9.4	PDU session identity .....	345
9.5	Spare half octet .....	345
9.6	Procedure transaction identity .....	345
9.7	Message type .....	345
9.8	Message authentication code .....	347
9.9	Plain 5GS NAS message .....	347
9.10	Sequence number .....	347
9.11	Other information elements .....	347
9.11.1	General .....	347
9.11.2	Common information elements .....	348
9.11.2.1	Additional information .....	348
9.11.2.1A	DNN .....	348
9.11.2.2	EAP message .....	349
9.11.2.3	GPRS timer .....	349
9.11.2.4	GPRS timer 2 .....	349
9.11.2.5	GPRS timer 3 .....	349

9.11.2.6	Intra N1 mode NAS transparent container .....	349
9.11.2.7	N1 mode to S1 mode NAS transparent container .....	350
9.11.2.8	S-NSSAI .....	351
9.11.2.9	S1 mode to N1 mode NAS transparent container .....	352
9.11.3	5GS mobility management (5GMM) information elements .....	353
9.11.3.1	5GMM capability .....	353
9.11.3.2	5GMM cause .....	354
9.11.3.2A	5GS DRX parameters .....	355
9.11.3.3	5GS identity type .....	356
9.11.3.4	5GS mobile identity .....	356
9.11.3.5	5GS network feature support .....	363
9.11.3.6	5GS registration result .....	366
9.11.3.7	5GS registration type .....	366
9.11.3.8	5GS tracking area identity .....	367
9.11.3.9	5GS tracking area identity list .....	368
9.11.3.9A	5GS update type .....	373
9.11.3.10	ABBA .....	373
9.11.3.11	Access type .....	374
9.11.3.12	Additional 5G security information .....	374
9.11.3.13	Allowed PDU session status .....	375
9.11.3.14	Authentication failure parameter .....	375
9.11.3.15	Authentication parameter AUTN .....	375
9.11.3.16	Authentication parameter RAND .....	376
9.11.3.17	Authentication response parameter .....	376
9.11.3.18	Configuration update indication .....	376
9.11.3.19	Daylight saving time .....	376
9.11.3.20	De-registration type .....	376
9.11.3.21	Void .....	377
9.11.3.22	Void .....	377
9.11.3.23	Emergency number list .....	377
9.11.3.23A	EPS bearer context status .....	377
9.11.3.24	EPS NAS message container .....	377
9.11.3.25	EPS NAS security algorithms .....	378
9.11.3.26	Extended emergency number list .....	378
9.11.3.27	Void .....	378
9.11.3.28	IMEISV request .....	378
9.11.3.29	LADN indication .....	378
9.11.3.30	LADN information .....	379
9.11.3.31	MICO indication .....	380
9.11.3.32	NAS key set identifier .....	380
9.11.3.33	NAS message container .....	381
9.11.3.34	NAS security algorithms .....	381
9.11.3.35	Network name .....	382
9.11.3.36	Network slicing indication .....	382
9.11.3.36A	Non-3GPP NW provided policies .....	383
9.11.3.37	NSSAI .....	383
9.11.3.37A	NSSAI inclusion mode .....	384
9.11.3.38	Operator-defined access category definitions .....	384
9.11.3.39	Payload container .....	388
9.11.3.40	Payload container type .....	392
9.11.3.41	PDU session identity 2 .....	392
9.11.3.42	PDU session reactivation result .....	392
9.11.3.43	PDU session reactivation result error cause .....	393
9.11.3.44	PDU session status .....	394
9.11.3.45	PLMN list .....	394
9.11.3.46	Rejected NSSAI .....	394
9.11.3.47	Request type .....	395
9.11.3.48	S1 UE network capability .....	396
9.11.3.48A	S1 UE security capability .....	396
9.11.3.49	Service area list .....	396
9.11.3.50	Service type .....	401
9.11.3.50A	SMS indication .....	401



9.11.3.51	SOR transparent container .....	402
9.11.3.52	Time zone.....	404
9.11.3.53	Time zone and time .....	404
9.11.3.53A	UE parameters update transparent container.....	404
9.11.3.54	UE security capability .....	405
9.11.3.55	UE's usage setting .....	410
9.11.3.56	UE status .....	410
9.11.3.57	Uplink data status.....	411
9.11.4	5GS session management (5GSM) information elements .....	411
9.11.4.1	5GSM capability .....	411
9.11.4.2	5GSM cause .....	412
9.11.4.2A	5GSM congestion re-attempt indicator .....	413
9.11.4.3	Always-on PDU session indication.....	414
9.11.4.4	Always-on PDU session requested .....	414
9.11.4.5	Allowed SSC mode.....	415
9.11.4.6	Extended protocol configuration options .....	415
9.11.4.7	Integrity protection maximum data rate .....	415
9.11.4.8	Mapped EPS bearer contexts.....	416
9.11.4.9	Maximum number of supported packet filters .....	420
9.11.4.10	PDU address.....	420
9.11.4.11	PDU session type .....	421
9.11.4.12	QoS flow descriptions .....	422
9.11.4.13	QoS rules.....	428
9.11.4.14	Session-AMBR .....	434
9.11.4.15	SM PDU DN request container.....	435
9.11.4.16	SSC mode.....	436
9.12	3GPP specific coding information defined within present document .....	436
9.12.1	Serving network name (SNN).....	436
10	List of system parameters.....	437
10.1	General .....	437
10.2	Timers of 5GS mobility management .....	437
10.3	Timers of 5GS session management .....	445
<b>Annex A (informative):</b>	<b>Cause values for 5GS mobility management.....</b>	<b>450</b>
A.1	Causes related to UE identification .....	450
A.2	Cause related to subscription options .....	450
A.3	Causes related to PLMN specific network failures and congestion/authentication failures .....	451
A.4	Causes related to invalid messages.....	452
<b>Annex B (informative):</b>	<b>Cause values for 5GS session management .....</b>	<b>454</b>
B.1	Causes related to nature of request.....	454
B.2	Protocol errors (e.g., unknown message) .....	456
<b>Annex C (normative):</b>	<b>Storage of 5GMM information.....</b>	<b>457</b>
<b>Annex D (normative):</b>	<b>UE policy delivery service .....</b>	<b>458</b>
D.1	General .....	458
D.1.1	Overview .....	458
D.1.2	Principles of PTI handling for UE policy delivery service procedures.....	458
D.2	Procedures .....	459
D.2.1	Network-requested UE policy management procedure .....	459
D.2.1.1	General .....	459
D.2.1.2	Network-requested UE policy management procedure initiation .....	459
D.2.1.3	Network-requested UE policy management procedure accepted by the UE.....	460
D.2.1.4	Network-requested UE policy management procedure not accepted by the UE.....	460
D.2.1.5	Abnormal cases on the network side .....	460
D.2.1.6	Abnormal cases in the UE.....	461
D.2.2	UE-initiated UE state indication procedure .....	461
D.2.2.1	General .....	461
D.2.2.2	UE-initiated UE state indication procedure initiation .....	462
D.2.2.3	UE-initiated UE state indication procedure accepted by the network.....	462

D.2.2.4	Abnormal cases on the network side .....	462
D.3	UE policy re-assembly at the UE .....	462
D.4	Void .....	462
D.5	Message functional definition and contents .....	462
D.5.1	Manage UE policy command .....	462
D.5.1.1	Message definition .....	462
D.5.2	Manage UE policy complete .....	463
D.5.2.1	Message definition .....	463
D.5.3	Manage UE policy command reject .....	463
D.5.3.1	Message definition .....	463
D.5.4	UE state indication .....	464
D.5.4.1	Message definition .....	464
D.6	Information elements coding .....	465
D.6.1	UE policy delivery service message type .....	465
D.6.2	UE policy section management list .....	465
D.6.3	UE policy section management result .....	469
D.6.4	UPSI list .....	471
D.6.5	UE policy classmark .....	472
D.6.6	UE OS Id .....	473
D.7	Timers of UE policy delivery service .....	473
<b>Annex E (informative):</b>	<b>Change history .....</b>	<b>475</b>
History .....		497

---

# Foreword

This Technical Specification has been produced by the 3rd Generation Partnership Project (3GPP).

The contents of the present document are subject to continuing work within the TSG and may change following formal TSG approval. Should the TSG modify the contents of the present document, it will be re-released by the TSG with an identifying change of release date and an increase in version number as follows:

Version x.y.z

where:

- x the first digit:
  - 1 presented to TSG for information;
  - 2 presented to TSG for approval;
  - 3 or greater indicates TSG approved document under change control.
- y the second digit is incremented for all changes of substance, i.e. technical enhancements, corrections, updates, etc.
- z the third digit is incremented when editorial only changes have been incorporated in the document.

---

# 1 Scope

The present document specifies the non-access stratum (NAS) procedures in the 5G system (5GS) used by the protocols for:

- mobility management between the user equipment (UE) and the access and mobility management function (AMF) for both 3GPP access and non-3GPP access; and
- session management between the user equipment (UE) and the session management function (SMF) for both 3GPP access and non-3GPP access.

The 5GS mobility management (5GMM) protocol defined in the present document provides procedures for the control of mobility when the user equipment (UE) is using the NG radio access network (NG-RAN) and/or non-3GPP access network. The 5GMM protocol also provides control of security for the NAS protocols.

The 5GS session management (5GSM) protocol defined in the present document provides procedures for the handling of 5GS PDU sessions. Together with the bearer control provided by the access stratum, this protocol is used for the control of user-plane resources.

For both NAS protocols the present document specifies procedures for the support of inter-system mobility between the NG-RAN and the evolved universal terrestrial radio access (E-UTRAN), between the NG-RAN and the non-3GPP access network connected to the EPC, and between the non-3GPP access network connected to the 5G core network (5GCN) and the E-UTRAN.

For both NAS protocols the present document specifies procedures for the support of mobility between the NG-RAN and the non-3GPP access network connected to the 5GCN.

In addition, the present document specifies the procedures in the 5GS for UE policy delivery service between the UE and the policy control function (PCF) for both 3GPP access and non-3GPP access.

The present document is applicable to the UE, the access and mobility management function (AMF), the session management function (SMF), and the PCF in the 5GS.

The clauses and subclauses in the present document are common for both 3GPP access and non-3GPP access unless it is explicitly stated that they apply to 3GPP access only or non-3GPP access only.

---

# 2 References

The following documents contain provisions which, through reference in this text, constitute provisions of the present document.

- References are either specific (identified by date of publication, edition number, version number, etc.) or non-specific.
- For a specific reference, subsequent revisions do not apply.
- For a non-specific reference, the latest version applies. In the case of a reference to a 3GPP document (including a GSM document), a non-specific reference implicitly refers to the latest version of that document in the same Release as the present document.

- [1] 3GPP TR 21.905: "Vocabulary for 3GPP Specifications".
- [1A] 3GPP TS 22.011: "Service accessibility".
- [2] 3GPP TS 22.101: "Service aspects; Service principles".
- [3] 3GPP TS 22.261: "Service requirements for the 5G system; Stage 1".
- [4] 3GPP TS 23.003: "Numbering, addressing and identification".
- [4A] 3GPP TS 23.040: "Technical realization of Short Message Service (SMS)".
- [5] 3GPP TS 23.122: "Non-Access-Stratum functions related to Mobile Station (MS) in idle mode".

- [6] 3GPP TS 23.167: "IP Multimedia Subsystem (IMS) emergency sessions".
- [7] 3GPP TS 23.401: "GPRS enhancements for E-UTRAN access".
- [8] 3GPP TS 23.501: "System Architecture for the 5G System; Stage 2".
- [9] 3GPP TS 23.502: "Procedures for the 5G System; Stage 2".
- [10] 3GPP TS 23.503: "Policy and Charging Control Framework for the 5G System; Stage 2".
- [11] 3GPP TS 24.007: "Mobile radio interface signalling layer 3; General aspects".
- [12] 3GPP TS 24.008: "Mobile Radio Interface Layer 3 specification; Core Network Protocols; Stage 3".
- [13] 3GPP TS 24.011: "Point-to-Point Short Message Service (SMS) support on mobile radio interface".
- [14] 3GPP TS 24.229: "IP multimedia call control protocol based on Session Initiation Protocol (SIP) and Session Description Protocol (SDP); Stage 3".
- [15] 3GPP TS 24.301: "Non-Access-Stratum (NAS) protocol for Evolved Packet System (EPS); Stage 3".
- [16] 3GPP TS 24.302: "Access to the 3GPP Evolved Packet Core (EPC) via non-3GPP access networks; Stage 3".
- [17] 3GPP TS 24.368: "Non-Access Stratum (NAS) configuration Management Object (MO)".
- [18] 3GPP TS 24.502: "Access to the 3GPP 5G System (5GS) via non-3GPP access networks; Stage 3".
- [19] 3GPP TS 24.526: "UE policies for 5G System (5GS); Stage 3".
- [20] 3GPP TS 24.623: "Extensive Markup Language (XML) Configuration Access Protocol (XCAP) over the Ut interface for Manipulating Supplementary Services".
- [20A] 3GPP TS 29.502: "5G System; Session Management Services; Stage 3".
- [21] 3GPP TS 29.525: "5G System; UE Policy Control Service; Stage 3".
- [22] 3GPP TS 31.102: "Characteristics of the Universal Subscriber Identity Module (USIM) application".
- [22A] 3GPP TS 31.111: "USIM Application Toolkit (USAT)".
- [22B] 3GPP TS 31.115: "Secured packet structure for (Universal) Subscriber Identity Module (U)SIM Toolkit applications".
- [23] 3GPP TS 33.102: "3G security; Security architecture".
- [23A] 3GPP TS 33.401: "3GPP System Architecture Evolution; Security architecture".
- [24] 3GPP TS 33.501: "Security architecture and procedures for 5G System".
- [25] 3GPP TS 36.323: "NR; Packet Data Convergence Protocol (PDCP) specification".
- [25A] 3GPP TS 36.331: "Evolved Universal Terrestrial Radio Access (E-UTRA); Radio Resource Control (RRC) protocol specification".
- [26] 3GPP TS 36.355: "Evolved Universal Terrestrial Radio Access (E-UTRA); LTE Positioning Protocol (LPP)".
- [27] 3GPP TS 38.300: "NR; NR and NG-RAN Overall Description; Stage 2".
- [28] 3GPP TS 38.304: "New Generation Radio Access Network; User Equipment (UE) procedures in Idle mode".

- [29] 3GPP TS 38.323: "Evolved Universal Terrestrial Radio Access (E-UTRA); Packet Data Convergence Protocol (PDCP) specification".
- [30] 3GPP TS 38.331: "NR; Radio Resource Control (RRC); Protocol Specification".
- [31] 3GPP TS 38.413: "NG Radio Access Network (NG-RAN); NG Application Protocol (NGAP)".
- [32] IETF RFC 768: "User Datagram Protocol".
- [33] IETF RFC 793: "Transmission Control Protocol."
- [34] IETF RFC 3748: "Extensible Authentication Protocol (EAP)".
- [35] IETF RFC 3736: "Stateless Dynamic Host Configuration Protocol (DHCP) Service for IPv6"
- [35A] IETF RFC 4122: "A Universally Unique Identifier (UUID) URN Namespace".
- [36] IETF RFC 4191: "Default Router Preferences and More-Specific Routes".
- [37] IETF RFC 7542: "The Network Access Identifier".
- [38] IETF RFC 4303: "IP Encapsulating Security Payload (ESP)".
- [39] IETF RFC 4862: "IPv6 Stateless Address Autoconfiguration".
- [40] IETF RFC 5448: "Improved Extensible Authentication Protocol Method for 3rd Generation Authentication and Key Agreement (EAP-AKA)".
- [41] IETF RFC 7296: "Internet Key Exchange Protocol Version 2 (IKEv2)".
- [42] ITU-T Recommendation E.212: "The international identification plan for public networks and subscriptions", 2016-09-23.

---

## 3 Definitions and abbreviations

### 3.1 Definitions

For the purposes of the present document, the terms and definitions given in 3GPP TR 21.905 [1] and the following apply. A term defined in the present document takes precedence over the definition of the same term, if any, in 3GPP TR 21.905 [1].

**5GMM-IDLE mode:** In this specification, if the term is used standalone, a UE in 5GMM-IDLE mode means the UE can be either in 5GMM-IDLE mode over 3GPP access or in 5GMM-IDLE mode over non-3GPP access.

**5GMM-CONNECTED mode:** In this specification, if the term is used standalone, a UE in 5GMM-CONNECTED mode means the UE can be either in 5GMM-CONNECTED mode over 3GPP access or in 5GMM-CONNECTED mode over non-3GPP access.

**5GMM-IDLE mode over 3GPP access:** A UE is in 5GMM-IDLE mode over 3GPP access when no N1 NAS signalling connection between the UE and network over 3GPP access exists. The term 5GMM-IDLE mode over 3GPP access used in the present document corresponds to the term CM-IDLE state for 3GPP access used in 3GPP TS 23.501 [8].

**5GMM-CONNECTED mode over 3GPP access:** A UE is in 5GMM-CONNECTED mode over 3GPP access when an N1 NAS signalling connection between the UE and network over 3GPP access exists. The term 5GMM-CONNECTED mode over 3GPP access used in the present document corresponds to the term CM-CONNECTED state for 3GPP access used in 3GPP TS 23.501 [8].

**5GMM-IDLE mode over non-3GPP access:** A UE is in 5GMM-IDLE mode over non-3GPP access no N1 NAS signalling connection between the UE and network over non-3GPP access exists. The term 5GMM-IDLE mode over non-3GPP access used in the present document corresponds to the term CM-IDLE state for non-3GPP access used in 3GPP TS 23.501 [8].

**5GMM-CONNECTED mode over non-3GPP access:** A UE is in 5GMM-CONNECTED mode over non-3GPP access when it has N1 NAS signalling connection between the UE and network over non-3GPP access exists. The term 5GMM-CONNECTED mode over non-3GPP access used in the present document corresponds to the term CM-CONNECTED state for non-3GPP access used in 3GPP TS 23.501 [8].

**5GS services:** Services provided by PS domain. Within the context of this specification, 5GS services is used as a synonym for EPS services.

**5G-EA:** 5GS encryption algorithms. The term 5G-EA, 5G-EA0, 128-5G-EA1-3 and 5G-EA4-7 used in the present document corresponds to the term NEA, NEA0, NEA1-3 and NEA4-7 defined in 3GPP TS 33.501 [24].

**5G-IA:** 5GS integrity algorithms. The term 5G-IA, 5G-IA0, 128-5G-IA1-3 and 5G-IA4-7 used in the present document corresponds to the term NIA, NIA0, NIA1-3 and NIA4-7 defined in 3GPP TS 33.501 [24].

**Access stratum connection:** A peer to peer access stratum connection between either the UE and the NG-RAN for 3GPP access or the UE and the N3IWF for non-3GPP access. The access stratum connection for 3GPP access corresponds to an RRC connection via the Uu reference point. The creation of the access stratum connection for non-3GPP access corresponds to the completion of the IKE\_SA\_INIT exchange (see IETF RFC 7296 [41]) via the NWu reference point.

**Aggregate maximum bit rate:** The maximum bit rate that limits the aggregate bit rate of a set of non-GBR bearers of a UE. Definition derived from 3GPP TS 23.501 [8].

**Always-on PDU session:** A PDU session for which user-plane resources have to be established during every transition from 5GMM-IDLE mode to 5GMM-CONNECTED mode. A UE requests a PDU session to be established as an always-on PDU session based on indication from upper layers and the network decides whether a PDU session is established as an always-on PDU session.

NOTE 1: How the upper layers in the UE are configured to provide an indication is out of scope of the specification.

**Cleartext IEs:** Information elements that can be sent without confidentiality protection in initial NAS messages as specified in subclause 4.4.6.

**DNN based congestion control:** Type of congestion control at session management level that is applied to reject session management requests from UEs or release PDU sessions when the associated DNN is congested. DNN based congestion control can be activated at the SMF over session management level and also activated at the AMF over mobility management level.

**Emergency PDU session:** A PDU session which was established with the request type "initial emergency request" or "existing emergency PDU session".

**General NAS level congestion control:** Type of congestion control at mobility management level that is applied at a general overload or congestion situation in the network, e.g. lack of processing resources.

**Initial NAS message:** A NAS message is considered as an initial NAS message, if this NAS message can trigger the establishment of an N1 NAS signalling connection. For instance, the REGISTRATION REQUEST message is an initial NAS message.

**Initial registration for emergency services:** A registration performed with 5GS registration type "emergency registration" in the REGISTRATION REQUEST message.

**Last visited registered TAI:** A TAI which is contained in the registration area that the UE registered to the network and which identifies the tracking area last visited by the UE.

**Mapped S-NSSAI:** An S-NSSAI in the subscribed S-NSSAIs for the HPLMN, which is mapped to an S-NSSAI of the registered PLMN in case of a roaming scenario.

**N1 mode:** A mode of a UE allowing access to the 5G core network via the 5G access network.

**N1 NAS signalling connection:** A peer to peer N1 mode connection between UE and AMF. An N1 NAS signalling connection is either the concatenation of an RRC connection via the Uu reference point and an NG connection via the N2 reference point for 3GPP access, or the concatenation of an IPsec tunnel via the NWu reference point and an NG connection via the N2 reference point for non-3GPP access.

**Network slicing information:** information stored at the UE consisting of one or more of the following:

- a) default configured NSSAI;
- b) configured NSSAI for a PLMN;
- c) mapped S-NSSAI(s) for the configured NSSAI for a PLMN;
- d) for each access type:
  - 1) allowed NSSAI for a PLMN;
  - 2) mapped S-NSSAI(s) for the allowed NSSAI for a PLMN.

**Non-cleartext IEs:** Information elements that are not cleartext IEs.

**Non-emergency PDU session:** Any PDU session which is not an emergency PDU session.

**PDU address:** An IP address assigned to the UE by the packet data network.

**PDU session for LADN:** A PDU session with a DNN associated with a LADN.

**PDU session with suspended user-plane resources:** A PDU session for which user-plane resources were established or re-established, and for which data radio bearers were suspended when transiting to 5GMM-CONNECTED mode with RRC inactive indication.

**Persistent PDU session:** either a non-emergency PDU session contains a GBR QoS flow with QoS equivalent to QoS of teleservice 11 and where there is a radio bearer associated with that PDU session, or an emergency PDU session where there is a radio bearer associated with that PDU session.

NOTE 2: An example of a persistent PDU session is a non-emergency PDU session with 5QI = 1 where there is a radio bearer associated with that context.

**Procedure transaction identity:** An identity which is dynamically allocated by the UE for the UE-requested 5GSM procedures, or allocated by the UE or the PCF for the UE policy delivery procedures. The procedure transaction identity is released when the procedure is completed but it should not be released immediately.

**RAT frequency selection priority index:** A parameter provided by the AMF to the NG-RAN via the N2 reference point. The AMF selects an RFSP index for a particular UE based on the subscribed RFSP index, the locally configured operator's policies, the allowed NSSAI and the UE context information, including the UE's usage setting, if received during the registration procedure. Definition derived from 3GPP TS 23.501 [8].

**Registered for emergency services:** A UE is considered as "registered for emergency services" when it has successfully completed initial registration for emergency services .

**Registered PLMN:** The PLMN on which the UE is registered. The identity of the registered PLMN (MCC and MNC) is provided to the UE within the GUAMI field of the 5G-GUTI.

**Rejected NSSAI:** Rejected NSSAI for the current PLMN or rejected NSSAI for the current registration area.

**Rejected NSSAI for the current PLMN:** A set of S-NSSAIs which was included in the requested NSSAI by the UE and is sent by the AMF with the rejection cause "S-NSSAI not available in the current PLMN".

**Rejected NSSAI for the current registration area:** A set of S-NSSAIs which was included in the requested NSSAI by the UE and is sent by the AMF with the rejection cause "S-NSSAI not available in the current registration area".

**Local release:** Release of a PDU session without peer-to-peer signalling between the network and the UE,

NOTE 3: Local release can include communication among network entities.

**Removal of eCall only mode restriction:** All the limitations as described in 3GPP TS 22.101 [2] for the eCall only mode do not apply any more.

**Routing indicator:** Routing Indicator is an identifier assigned by the UE's home network operator to be used together with the Home Network Identifier for routing network signalling. Routing Indicator is provisioned in the USIM. The term Routing indicator used in the present document corresponds to the term Routing ID used in 3GPP TS 23.501 [8].

**S-NSSAI-based congestion control:** Type of congestion control at session management level that is applied to reject session management requests from UEs or release PDU sessions when the associated S-NSSAI and optionally the



associated DNN are congested. . S-NSSAI based congestion control can be activated at the SMF over session management level and also activated at the AMF over mobility management level.

**Selected core network type information:** A type of core network (EPC or 5GCN) selected by the UE NAS layer in case of an E-UTRA cell connected to both EPC and 5GCN.

**UE configured for high priority access in selected PLMN:** A UE configured with one or more access identities equal to 1, 2, or 11-15 applicable in the selected PLMN as specified in subclause 4.5.2. Definition derived from 3GPP TS 22.261 [3].

**User-plane resources:** Resources established between the UE and the UPF. The user-plane resources consist of either user plane radio bearers via the Uu reference point, a tunnel via the N3 reference point and a tunnel via the N9 reference point (if any) for 3GPP access, or IPsec tunnels via the NWu reference point, a tunnel via the N3 reference point and a tunnel via the N9 reference point (if any) for non-3GPP access.

For the purposes of the present document, the following terms and definitions given in 3GPP TS 23.003 [4] apply:

**5G-GUTI**  
**5G-S-TMSI**  
**PEI**  
**SUPI**  
**SUCI**

For the purposes of the present document, the following terms and definitions given in 3GPP TS 23.122 [5] apply:

**Country**  
**EHPLMN**  
**HPLMN**  
**Selected PLMN**  
**Shared network**  
**Steering of Roaming (SOR)**  
**Steering of Roaming information**  
**Suitable cell**  
**VPLMN**

For the purposes of the present document, the following terms and definitions given in 3GPP TS 23.167 [6] apply:

**eCall over IMS**

For the purposes of the present document, the following terms and definitions given in 3GPP TS 23.401 [7] apply:

**eCall only mode**

For the purposes of the present document, the following terms and definitions given in 3GPP TS 23.501 [8] apply:

**5G access network**  
**5G core network**  
**5G QoS flow**  
**5G QoS identifier**  
**5G System**  
**Allowed area**  
**Allowed NSSAI**  
**AMF region**  
**AMF set**  
**Configured NSSAI**  
**Local area data network**  
**Network slice**  
**NG-RAN**  
**Non-allowed area**  
**PDU session**  
**PDU session type**  
**Requested NSSAI**  
**Routing ID**  
**Service data flow**

**UE presence in LADN service area**

For the purposes of the present document, the following terms and definitions given in 3GPP TS 23.503 [10] apply:

**UE local configuration**

For the purposes of the present document, the following terms and definitions given in 3GPP TS 24.008 [12] apply:

**GMM**  
**MM**

For the purposes of the present document, the following terms and definitions given in 3GPP TS 24.301 [15] apply:

**EENLV**  
**EMM**  
**EPS**  
**EPS security context**  
**EPS services**  
**Lower layer failure**  
**Megabit**  
**Message header**  
**NAS signalling connection recovery**  
**S1 mode**  
**Non-EPS services**

For the purposes of the present document, the following terms and definitions given in 3GPP TS 33.501 [24] apply:

**5G security context**  
**5G NAS security context**  
**ABBA**  
**Current 5G security context**  
**Full native 5G security context**  
**K'<sub>AME</sub>**  
**K<sub>AMF</sub>**  
**K<sub>ASME</sub>**  
**Mapped security context**  
**Native 5G security context**  
**NCC**  
**Non-current 5G security context**  
**Partial native 5G security context**  
**RES\***

For the purposes of the present document, the following terms and definitions given in 3GPP TS 38.413 [31] apply:

**NG connection**

## 3.2 Abbreviations

For the purposes of the present document, the abbreviations given in 3GPP TR 21.905 [1] and the following apply. An abbreviation defined in the present document takes precedence over the definition of the same abbreviation, if any, in 3GPP TR 21.905 [1].

4G-GUTI	4G-Globally Unique Temporary Identifier
5GCN	5G Core Network
5G-GUTI	5G-Globally Unique Temporary Identifier
5GMM	5GS Mobility Management
5GS	5G System
5GSM	5GS Session Management
5G-S-TMSI	5G S-Temporary Mobile Subscription Identifier
5G-TMSI	5G Temporary Mobile Subscription Identifier
5QI	5G QoS Identifier
AKA	Authentication and Key Agreement
AMBR	Aggregate Maximum Bit Rate

AMF	Access and Mobility Management Function
APN	Access Point Name
DL	Downlink
DN	Data Network
DNN	Data Network Name
E-UTRAN	Evolved Universal Terrestrial Radio Access Network
EAP-AKA'	Improved Extensible Authentication Protocol method for 3rd generation Authentication and Key Agreement
ECIES	Elliptic Curve Integrated Encryption Scheme
EPD	Extended Protocol Discriminator
EMM	EPS Mobility Management
EPC	Evolved Packet Core Network
EPS	Evolved Packet System
ESM	EPS Session Management
Gbps	Gigabits per second
GFBR	Guaranteed Flow Bit Rate
GUAMI	Globally Unique AMF Identifier
IP-CAN	IP-Connectivity Access Network
KSI	Key Set Identifier
LADN	Local Area Data Network
LMF	Location Management Function
LPP	LTE Positioning Protocol
MAC	Message Authentication Code
Mbps	Megabits per second
MFBR	Maximum Flow Bit Rate
MICO	Mobile Initiated Connection Only
N3IWF	Non-3GPP Inter-Working Function
NAI	Network Access Identifier
NITZ	Network Identity and Time Zone
NR	New Radio
ngKSI	Key Set Identifier for Next Generation Radio Access Network
NSSAI	Network Slice Selection Assistance Information
OS	Operating System
OS Id	OS Identity
PTI	Procedure Transaction Identity
QFI	QoS Flow Identifier
QoS	Quality of Service
QRI	QoS Rule Identifier
(R)AN	(Radio) Access Network
RPLMN	Registered PLMN
RQA	Reflective QoS Attribute
RQI	Reflective QoS Indication
RFSP	RAT Frequency Selection Priority
S-NSSAI	Single NSSAI
SA	Security Association
SDF	Service Data Flow
SNN	Serving Network Name
SMF	Session Management Function
SOR	Steering of Roaming
TA	Tracking Area
TAC	Tracking Area Code
TAI	Tracking Area Identity
Tbps	Terabits per second
UL	Uplink
UPF	User Plane Function
UPSC	UE Policy Section Code
UPSI	UE Policy Section Identifier
URN	Uniform Resource Name
URSP	UE Route Selection Policy

---

## 4 General

### 4.1 Overview

The non-access stratum (NAS) described in the present document forms the highest stratum of the control plane between UE and AMF (reference point "N1" see 3GPP TS 23.501 [8]) for both 3GPP and non-3GPP access.

Main functions of the protocols that are part of the NAS are:

- support of mobility of the user equipment (UE) including also common common procedures such as authentication, identification, generic UE configuration update and security control mode procedures;
- support of session management procedures to establish and maintain data connectivity between the UE and the data network; and
- NAS transport procedure to provide a transport of SMS, LPP, UE policy container, SOR transparent container and UE parameters update information payload.

Principles for the handling of 5GS security contexts and for the activation of ciphering and integrity protection, when a NAS signalling connection is established, are provided in subclause 4.4.

For the support of the above functions, the following procedures are supplied within this specification:

- elementary procedures for 5GS mobility management in clause 5; and
- elementary procedures for 5GS session management in clause 6.

Signalling procedures for the control of NAS security are described as part of the 5GMM common procedures in subclause 5.4.

Complete NAS transactions consist of specific sequences of elementary procedures. Examples of such specific sequences can be found in 3GPP TS 23.502 [9].

The NAS for 5GS follows the protocol architecture model for layer 3 as described in 3GPP TS 24.007 [11].

### 4.2 Coordination between the protocols for 5GS mobility management and 5GS session management

A 5GS session management (5GSM) message is piggybacked in specific 5GS mobility management (5GMM) transport messages. To this purpose, the 5GSM messages can be transmitted in an information element in the 5GMM transport messages. In this case, the UE, the AMF and the SMF execute the 5GMM procedure and the 5GSM procedure in parallel. The success of the 5GMM procedure is not dependent on the success of the piggybacked 5GSM procedure.

The UE can only initiate the 5GSM procedure when there is a 5GMM context established at the UE.

During 5GMM procedures, the UE and the AMF shall suspend the transmission of 5GSM messages, except when:

- a) the 5GMM procedure is piggybacking 5GSM messages; or
- b) the UE is in 5GMM-CONNECTED mode and a service request procedure for re-establishing user-plane resources of PDU session(s) is initiated without including PDU session status IE or Allowed PDU session status IE.

In these cases, the UE and the AMF need not suspend the transmission of 5GSM messages related to other PDU session(s) than the one(s) for which the user- plane resources re-establishment is requested.

A 5GMM message piggybacking a 5GSM message for a PDU session shall be delivered via the access associated with the PDU session, if any, with the following exceptions:

- a) the AMF shall send, via 3GPP access, a DL NAS TRANSPORT message piggybacking a downlink 5GSM message of a network-requested 5GSM procedure for a PDU session associated with non-3GPP access if the conditions specified in subclause 5.5.1.3.4 or subclause 5.6.1.4 are met;

b) the UE shall send an UL NAS TRANSPORT message piggybacking a response message to the 5GSM message described in a) via either:

- 1) 3GPP access; or
- 2) non-3GPP access if the UE is in 5GMM-CONNECTED mode over non-3GPP access.

NOTE: The interaction between the 5GMM sublayer and the 5GSM sublayer to enable the UE to send the UL NAS TRANSPORT message containing the response message via 3GPP access is required. This is achieved via UE implementation.

c) the UE shall send, via the target access, an UL NAS TRANSPORT message piggybacking a 5GSM message associated with a request type set to "existing PDU session" or "existing emergency PDU session" for handover of an existing PDU session between 3GPP access and non-3GPP access.

## 4.3 UE domain selection

### 4.3.1 UE's usage setting

The UE's usage setting defined in 3GPP TS 24.301 [15] applies to voice capable UEs in 5GS and indicates whether the UE has preference for voice services over data services or vice-versa, where:

- a) voice services include IMS voice; and
- b) data services include any kind of user data transfer without a voice media component.

The UE's usage setting can be set to:

- a) "voice centric"; or
- b) "data centric".

If the UE is capable of S1 mode, there is a single UE's usage setting at the UE which applies to both 5GS and EPS.

### 4.3.2 Domain selection for UE originating sessions / calls

The behaviour of the UE for domain selection is determined by:

- a) the UE usage setting;
- b) the availability of IMS voice; and
- c) whether the UE operates in single-registration mode or dual-registration mode (see 3GPP TS 23.501 [8]).

In the present document the condition "the UE supports IMS voice over 3GPP access" evaluates to "true" if at least one of the following is fulfilled:

- 1) the UE supports IMS voice over NR connected to 5GCN;
- 2) the UE supports IMS voice over E-UTRA connected to 5GCN; or
- 3) the UE supports IMS voice in EPS.

In the present document the condition "the UE does not support IMS voice over 3GPP access" evaluates to "true" if the condition "the UE supports IMS voice over 3GPP access" evaluates to "false".

In the present document the condition "the UE supports IMS voice over non-3GPP access" evaluates to "true" if the UE supports IMS voice over non-3GPP access connected to 5GCN.

In the present document the condition "the UE does not support IMS voice over non-3GPP access" evaluates to "true" if the condition "the UE supports IMS voice over non-3GPP access" evaluates to "false".

In the present document, "IMS voice not available" is determined per access type independently, i.e. 3GPP access or non-3GPP access.

In the present document, "IMS voice not available" refers to one of the following conditions:

- a) the UE does not support IMS voice;
- b) the UE supports IMS voice, but the network indicates in the REGISTRATION ACCEPT message that IMS voice over PS sessions are not supported; or
- c) the UE supports IMS voice, the network indicates in the REGISTRATION ACCEPT message that IMS voice over PS sessions are supported, but the upper layers:
  - 1) provide no indication that the UE is available for voice call in the IMS within a manufacturer determined period of time; or
  - 2) indicate that the UE is not available for voice calls in the IMS.

NOTE: If conditions a and b evaluate to false, the upper layers need time to attempt IMS registration. In the event an indication from the upper layers that the UE is available for voice calls in the IMS takes longer than the manufacturer determined period of time (e.g. due to delay when attempting IMS registration or due to delay in obtaining a QoS flow for SIP signalling), the NAS layer assumes the UE is not available for voice calls in the IMS.

Other conditions may exist but these are implementation specific.

In the present document, "IMS voice available" applies when "IMS voice not available" does not apply.

When IMS voice is not available over 3GPP access, if the UE's usage setting is "voice centric", the UE operates in single-registration mode, and the UE:

- a) does not have a persistent PDU session, and:
  - 1) if the UE is only registered over 3GPP access, or if the UE is registered over both 3GPP access and non-3GPP access and IMS voice is not available over non-3GPP access, the UE shall disable the N1 mode capability for 3GPP access and proceed as specified in subclause 4.9.2 with modifications described below; or
  - 2) if the UE is registered over both 3GPP access and non-3GPP access and IMS voice is available over non-3GPP access, the UE may disable the N1 mode capability for 3GPP access and proceed as specified in subclause 4.9.2 with modifications described below; or
- b) has a persistent PDU session, then the UE waits until the radio bearer associated with the persistent PDU session has been released. When the radio bearer associated with the persistent PDU session has been released, then:
  - 1) if the UE is only registered over 3GPP access, or if the UE is registered over both 3GPP access and non-3GPP access and IMS voice is not available over non-3GPP access, the UE shall disable the N1 mode capability for 3GPP access and proceed as specified in subclause 4.9.2 with modifications described below; or
  - 2) If the UE is registered over both 3GPP access and non-3GPP access and IMS voice is available over non-3GPP access, the UE may disable the N1 mode capability for 3GPP access and proceed as specified in subclause 4.9.2 with modifications described below.

The following modifications are applied to the procedure in subclause 4.9.2 for disabling the N1 mode capability for 3GPP access, if the UE's usage setting is "voice centric" and the UE operates in single-registration mode:

- a) in item a) of subclause 4.9.2, the UE shall attempt to select an E-UTRA cell connected to EPC. If such a cell is found, the UE shall then perform voice domain selection procedures as defined in 3GPP TS 24.301 [15]; and
- b) in item b) of subclause 4.9.2, if an E-UTRA cell connected to EPC cannot be found, the UE shall attempt to select another supported radio access technology which supports voice services.

When IMS voice is not available over non-3GPP access, if the UE's usage setting is "voice centric" and the UE operates in single-registration mode, then:

- a) if the UE is only registered over non-3GPP access, the UE shall disable the N1 mode capability for non-3GPP access (see subclause 4.9.3); or

- b) if the UE is registered over both 3GPP access and non-3GPP access and IMS voice is not available also over 3GPP access, the UE shall disable the N1 mode capability for non-3GPP access (see subclause 4.9.3).

### 4.3.3 Change of UE's usage setting

If the UE operates in single-registration mode, whenever the UE's usage setting changes, the UE shall execute procedures according to table 4.3.3.1:

**Table 4.3.3.1: Change of UE's usage setting for a UE in single-registration mode**

UE's usage setting change	Procedure to execute
From "data centric" to "voice centric" and "IMS voice not available" over 3GPP access only	Disable the N1 mode capability for 3GPP access (see subclause 4.9.2), if the UE is only registered over 3GPP access
From "data centric" to "voice centric", and "IMS voice not available" over both 3GPP access and non-3GPP access	Disable the N1 mode capability for 3GPP access (see subclause 4.9.2) and non-3GPP access (see subclause 4.9.3), if the UE is registered over both 3GPP access and non-3GPP access Disable the N1 mode capability for 3GPP access (see subclause 4.9.2), if the UE is registered over 3GPP access only. Disable the N1 mode capability for non-3GPP access (see subclause 4.9.3), if the UE is registered over non-3GPP access only.
From "voice centric" to "data centric" and the N1 mode capability for 3GPP access is disabled at the UE due to "IMS voice not available"	Re-enable the N1 mode capability for 3GPP access (see subclause 4.9.2)
From "data centric" to "voice centric" and "IMS voice not available" over non-3GPP access only	Disable the N1 mode capability for non-3GPP access (see subclause 4.9.3), if the UE is only registered over non-3GPP access
From "voice centric" to "data centric", and the N1 mode capability for non-3GPP access is disabled at the UE due to "IMS voice not available"	Re-enable the N1 mode capability for non-3GPP access (see subclause 4.9.3)

### 4.3.4 Change or determination of IMS voice availability

If the UE operates in single-registration mode, whenever the IMS voice availability is determined or changes, the UE shall execute procedures according to table 4.3.4.1:

**Table 4.3.4.1: Change of IMS voice availability for a UE in single-registration mode**

Change of IMS voice available condition	Procedure to execute
"IMS voice not available" over 3GPP access only and the UE's usage setting is "voice centric"	Disable the N1 mode capability for 3GPP access, if the UE is only registered over 3GPP access (see subclause 4.9.2)
"IMS voice not available" over non-3GPP access only and the UE's usage setting is "voice centric"	Disable the N1 mode capability for non-3GPP access (see subclause 4.9.3), if the UE is only registered over non-3GPP access
"IMS voice not available" over both 3GPP access and non-3GPP access, and the UE's usage setting is "voice centric"	Disable the N1 mode capability for 3GPP access (see subclause 4.9.2) and non-3GPP access (see subclause 4.9.3), if the UE is registered over both 3GPP access and non-3GPP access. Disable the N1 mode capability for 3GPP access (see subclause 4.9.2), if the UE is registered over 3GPP access only Disable the N1 mode capability for non-3GPP access (see subclause 4.9.3), if the UE is registered over non-3GPP access only.

## 4.4 NAS security

### 4.4.1 General

This clause describes the principles for the handling of 5G NAS security contexts in the UE and in the AMF and the procedures used for the security protection of NAS messages between the UE and the AMF. Security protection involves integrity protection and ciphering of the 5GMM messages. 5GSM messages are security protected indirectly by being piggybacked by the security protected 5GMM messages (i.e. UL NAS TRANSPORT message and the DL NAS TRANSPORT message).

The signalling procedures for the control of NAS security are part of the 5GMM protocol and are described in detail in clause 5.

**NOTE:** The use of ciphering in a network is an operator option. In this subclause, for the ease of description, it is assumed that ciphering is used, unless explicitly indicated otherwise. Operation of a network without ciphering is achieved by configuring the AMF so that it always selects the "null ciphering algorithm", 5G-EA0.

### 4.4.2 Handling of 5G NAS security contexts

#### 4.4.2.1 General

The security parameters for authentication, integrity protection and ciphering are tied together in a 5G NAS security context and identified by a key set identifier (ngKSI). The relationship between the security parameters is defined in 3GPP TS 33.501 [24].

Before security can be activated, the AMF and the UE need to establish a 5G NAS security context. Usually, the 5G NAS security context is created as the result of a primary authentication and key agreement procedure between the AMF and the UE. A new 5G NAS security context may also be created during an N1 mode to N1 mode handover. Alternatively, during inter-system change from S1 mode to N1 mode, the AMF not supporting interworking without N26 and the UE operating in single-registration mode may derive a mapped 5G NAS security context from an EPS security context that has been established while the UE was in S1 mode.

The 5G NAS security context is taken into use by the UE and the AMF, when the AMF initiates a security mode control procedure, during an N1 mode to N1 mode handover, or during the inter-system change procedure from S1 mode to N1 mode. The 5G NAS security context which has been taken into use by the network most recently is called current 5G NAS security context. This current 5G NAS security context can be of type native or mapped, i.e. originating from a native 5G NAS security context or mapped 5G NAS security context.

The key set identifier ngKSI is assigned by the AMF either during the primary authentication and key agreement procedure or, for the mapped 5G NAS security context, during the inter-system change. The ngKSI consists of a value



and a type of security context parameter indicating whether a 5G NAS security context is a native 5G NAS security context or a mapped 5G NAS security context. When the 5G NAS security context is a native 5G NAS security context, the ngKSI has the value of  $KSI_{AMF}$ , and when the current 5G NAS security context is of type mapped, the ngKSI has the value of  $KSI_{ASME}$ .

The 5G NAS security context which is indicated by an ngKSI can be taken into use to establish the secure exchange of NAS messages when a new N1 NAS signalling connection is established without executing a new primary authentication and key agreement procedure (see subclause 5.4.1) or when the AMF initiates a security mode control procedure. For this purpose, the initial NAS messages (i.e. REGISTRATION REQUEST, DEREGISTRATION REQUEST and SERVICE REQUEST) and the SECURITY MODE COMMAND message contain an ngKSI in the NAS key set identifier IE indicating the current 5G NAS security context used to integrity protect the NAS message.

In the present document, when the UE is required to delete an ngKSI, the UE shall set the ngKSI to the value "no key is available" and consider also the associated keys  $K_{AMF}$  or  $K'_{AMF}$ , 5G NAS ciphering key and 5G NAS integrity key invalid (i.e. the 5G NAS security context associated with the ngKSI as no longer valid).

NOTE: In some specifications the term ciphering key sequence number might be used instead of the term key set identifier (KSI).

As described in subclause 4.8 in order to interwork with E-UTRAN connected to EPC, the UE supporting both S1 mode and N1 mode can operate in either single-registration mode or dual-registration mode. A UE operating in dual-registration mode shall independently maintain and use both EPS security context (see 3GPP TS 24.301 [15]) and 5G NAS security context. When the UE operating in dual-registration mode performs an EPS attach procedure, it shall take into use an EPS security context and follow the handling of this security context as specified in 3GPP TS 24.301 [15]. However, when the UE operating in dual-registration mode performs an initial registration procedure, it shall take into use a 5G NAS security context and follow the handling of this security context as described in the present specification.

The UE and the AMF need to be able to maintain two 5G NAS security contexts simultaneously, i.e. a current 5G NAS security context and a non-current 5G NAS security context, since:

- a) after a 5G re-authentication, the UE and the AMF can have both a current 5G NAS security context and a non-current 5G NAS security context which has not yet been taken into use (i.e. a partial native 5G NAS security context); and
- b) after an inter-system change from S1 mode to N1 mode, the UE and the AMF can have both a mapped 5G NAS security context, which is the current 5G NAS security context, and a non-current native 5G NAS security context that was created during a previous access in N1 mode.

The number of 5G NAS security contexts that need to be maintained simultaneously by the UE and the AMF is limited by the following requirements:

- a) after a successful 5G (re-)authentication, which creates a new partial native 5G NAS security context, the AMF and the UE shall delete the non-current 5G NAS security context, if any;
- b) when a partial native 5G NAS security context is taken into use through a security mode control procedure, the AMF and the UE shall delete the previously current 5G NAS security context;
- c) when the AMF and the UE create a 5G NAS security context using "null integrity protection algorithm" and "null ciphering algorithm" during an initial registration procedure for emergency services, or a registration procedure for mobility and periodic registration update for a UE that has an emergency PDU session (see subclause 5.4.2.2), the AMF and the UE shall delete the previous current 5G NAS security context;
- d) when a new mapped 5G NAS security context or 5G NAS security context created using "null integrity protection algorithm" and "null ciphering algorithm" is taken into use during the inter-system change from S1 mode to N1 mode, the AMF and the UE shall not delete the previously current native 5G NAS security context, if any. Instead, the previously current native 5G NAS security context shall become a non-current native 5G NAS security context, and the AMF and the UE shall delete any partial native 5G NAS security context;

If no previously current native 5G NAS security context exists, the AMF and the UE shall not delete the partial native 5G NAS security context, if any;

- e) when the AMF and the UE derive a new mapped 5G NAS security context during inter-system change from S1 mode to N1 mode, the AMF and the UE shall delete any existing current mapped 5G NAS security context;

- f) when a non-current full native 5G NAS security context is taken into use by a security mode control procedure, then the AMF and the UE shall delete the previously current mapped 5G NAS security context; and
- g) when the UE or the AMF moves from 5GMM-REGISTERED to 5GMM-DEREGISTERED state, if the current 5G NAS security context is a mapped 5G NAS security context and a non-current full native 5G NAS security context exists, then the non-current 5G NAS security context shall become the current 5G NAS security context. Furthermore, the UE and the AMF shall delete any mapped 5G NAS security context or partial native 5G NAS security context.

The UE shall mark the 5G NAS security context on the USIM or in the non-volatile memory as invalid when the UE initiates an initial registration procedure as described in subclause 5.5.1.2 or when the UE leaves state 5GMM-DEREGISTERED for any other state except 5GMM-NULL.

The UE shall store the current native 5G NAS security context as specified in annex C and mark it as valid only when the UE enters state 5GMM-DEREGISTERED from any other state except 5GMM-NULL or when the UE aborts the initial registration procedure without having left 5GMM-DEREGISTERED.

#### 4.4.2.2 Establishment of a mapped 5G NAS security context during inter-system change from S1 mode to N1 mode in 5GMM-CONNECTED mode

In order for the UE operating in single-registration mode to derive a mapped 5G NAS security context for an inter-system change from S1 mode to N1 mode in 5GMM-CONNECTED mode, the AMF shall construct a mapped 5G NAS security context from the EPS security context received from the source MME as indicated in 3GPP TS 33.501 [24]. The AMF shall select the 5G NAS security algorithms and derive the 5G NAS keys (i.e.  $K_{NASenc}$  and  $K_{NASint}$ ). The AMF shall define an ngKSI for the newly derived  $K'_{AMF}$  key such that the value field is taken from the eKSI of the  $K_{ASME}$  key and the type field is set to indicate a mapped security context and associate this ngKSI with the newly created mapped 5G NAS security context. The AMF shall then include the message authentication code, selected NAS algorithms, NCC, NAS sequence number, replayed UE security capabilities and generated ngKSI in the S1 mode to N1 mode NAS transparent container IE (see subclause 9.11.2.9).

When the UE operating in single-registration mode receives the command to perform inter-system change to N1 mode in 5GMM-CONNECTED mode, the UE shall derive a mapped  $K'_{AMF}$ , as indicated in 3GPP TS 33.501 [24], using the  $K'_{ASME}$  from the EPS security context. Furthermore, the UE shall also derive the 5G NAS keys from the mapped  $K'_{AMF}$  using the selected NAS algorithm identifiers included in the S1 mode to N1 mode NAS transparent container IE and associate this mapped 5G NAS security context with the ngKSI value received. The UE shall then verify the received NAS MAC.

When the UE operating in single-registration mode has a PDN connection for emergency bearer services and has no current EPS security context, the AMF shall set 5G-IA0 and 5G-EA0 as the selected 5G NAS security algorithms in the S1 mode to N1 mode NAS transparent container IE. The AMF shall create a locally generated  $K'_{AMF}$ . The AMF shall set the ngKSI value of the associated security context to "000" and the type of security context flag to "mapped security context" in the S1 mode to N1 mode NAS transparent container IE.

When the UE operating in single-registration mode receives the command to perform inter-system change to N1 mode in 5GMM-CONNECTED mode (see 3GPP TS 38.331 [30]) and has a PDN connection for emergency bearer services, if 5G-IA0 and 5G-EA0 as the selected 5G NAS security algorithms are included in the S1 mode to N1 mode NAS transparent container IE, the UE shall create a locally generated  $K'_{AMF}$ . Furthermore, the UE shall set the ngKSI value of the associated security context to the KSI value received.

After the new mapped 5G NAS security context is taken into use for the 3GPP access following a successful inter system change from S1 mode to N1 mode in 5GMM-CONNECTED mode and the UE is registered with the same PLMN over the 3GPP access and non-3GPP access:

- a) if a native 5G NAS security context is used on the non-3GPP access and:
  - 1) the UE is in 5GMM-IDLE mode over the non-3GPP access, then the AMF and the UE shall activate and take into use the 5G NAS security context over the non-3GPP access that is used on the 3GPP access as described in 3GPP TS 33.501 [24] after the AMF sends or the UE receives the REGISTRATION ACCEPT message respectively. If the 5G NAS security context in use on both accesses is a mapped context, the UE and AMF shall keep the native 5G NAS security context over the non-3GPP access and make it a non-current native 5G NAS security context. The non-current native 5G NAS security context may be re-activated later using the security mode control procedure; or

- 2) the UE is in 5GMM-CONNECTED mode over the non-3GPP access, in order to activate the native 5G NAS security context over the 3GPP access that is active on the non-3GPP access the AMF shall send the SECURITY MODE COMMAND message over the 3GPP access as described in 3GPP TS 33.501 [24]. The SECURITY MODE COMMAND message shall include the same ngKSI to identify the native 5G NAS security context that is used on the non-3GPP access; or
- b) if a mapped 5G NAS security context is used on the non-3GPP access and:
- 1) the UE is in 5GMM-IDLE mode over the non-3GPP access, then the AMF and the UE shall activate and take into use the new mapped 5G NAS security context active on the 3GPP access over the non-3GPP access as described in 3GPP TS 33.501 [24] after the AMF sends or the UE receives the REGISTRATION ACCEPT message respectively; or
  - 2) the UE is in 5GMM-CONNECTED mode over the non-3GPP access, in order to activate the same mapped 5G NAS security context over a target access that is used on the other access the AMF shall send the SECURITY MODE COMMAND message over one-access as described in 3GPP TS 33.501 [24]. The SECURITY MODE COMMAND message shall include the same ngKSI to identify the mapped 5G NAS security context that is used over the other access.

If the inter-system change from S1 mode to N1 mode in 5GMM-CONNECTED mode is not completed successfully, the AMF and the UE operating in single-registration mode shall delete the new mapped 5G NAS security context.

#### 4.4.2.3 Establishment of a 5G NAS security context during N1 mode to N1 mode handover

During an N1 mode to N1 mode handover, the target AMF may derive a new 5G NAS security context for which the target AMF creates a new 5G NAS security context as indicated in 3GPP TS 33.501 [24].

When a new 5G NAS security context is derived using the same  $K_{AMF}$ , the target AMF includes the 8 least significant bits of the downlink NAS COUNT in the Intra N1 mode NAS transparent container, and indicates that a new  $K_{AMF}$  shall not be derived (see subclause 9.11.2.6). The AMF shall increment the downlink NAS COUNT by one after creating the NAS security transparent container.

When a new 5G NAS security context is created from a new  $K_{AMF}$ , the target AMF includes the 8 least significant bits of the downlink NAS COUNT in the Intra N1 mode NAS transparent container and indicates that a new  $K_{AMF}$  shall be derived (see subclause 9.11.2.6). The AMF shall then set both the uplink and downlink NAS COUNT counters of this 5G NAS security context to zero. The AMF shall increment the downlink NAS COUNT by one after creating the NAS security transparent container.

The target AMF also includes the ngKSI with the same value as the ngKSI currently being used with the UE, the message authentication code, and the selected NAS algorithms in the Intra N1 mode NAS transparent container.

When the UE receives a command to perform handover to NG-RAN including an Intra N1 mode NAS transparent container (see subclause 9.11.2.6), the UE derives a new 5G NAS security context as described in 3GPP TS 33.501 [24]. When the Intra N1 mode NAS transparent container indicates that a new  $K_{AMF}$  needs to be derived, the UE shall set both the downlink NAS COUNT and uplink NAS COUNT to zero after creating the new 5G NAS security context.

NOTE 1: During N1 mode to N1 mode handover, the Intra N1 mode NAS transparent container (see subclause 9.11.2.6) is equivalent to sending a SECURITY MODE COMMAND message to the UE in order to derive and use a new 5G NAS security context, optionally created with a new  $K_{AMF}$ .

After the new 5G NAS security context is taken into use for 3GPP access following a successful N1 mode to N1 mode handover and the UE is registered with the same PLMN over the 3GPP access and non-3GPP access:

- a) the UE is in 5GMM-IDLE mode over the non-3GPP access, the AMF and the UE shall activate and take into use the new 5G NAS security context over the non-3GPP access as described in 3GPP TS 33.501 [24] after the AMF sends or the UE receives the REGISTRATION ACCEPT message respectively. If the new 5G NAS security context is created from a new  $K_{AMF}$ , the AMF and the UE shall set the downlink NAS COUNT and uplink NAS COUNT to zero also for the non-3GPP access, otherwise the downlink NAS COUNT and uplink NAS COUNT for the non-3GPP access are not changed; or
- b) the UE is in 5GMM-CONNECTED mode over the non-3GPP access, in order to activate the new 5G NAS security context over the non-3GPP access that has been activated for the 3GPP access the AMF shall send the

SECURITY MODE COMMAND message over the non-3GPP access as described in 3GPP TS 33.501 [24]. The SECURITY MODE COMMAND message shall include the same ngKSI to identify the new 5G NAS security context that was activated over the 3GPP access and shall include the horizontal derivation parameter indicating "K<sub>AMF</sub> derivation is not required". Otherwise, if the new 5G NAS security context is created from a new K<sub>AMF</sub>, the AMF and the UE shall set the downlink NAS COUNT and uplink NAS COUNT to zero for the non-3GPP access.

NOTE 2: Explicit indication "K<sub>AMF</sub> derivation is not required" for the non-3GPP access is to align security contexts within the UE without a subsequent derivation of a new K<sub>AMF</sub> in the non-3GPP access.

#### 4.4.2.4 Establishment of an EPS security context during inter-system change from N1 mode to S1 mode in 5GMM-CONNECTED mode

In order for the UE operating in single-registration mode to derive a mapped EPS security context for an inter-system change from N1 mode to S1 mode in 5GMM-CONNECTED mode, the AMF shall prepare a mapped EPS security context for the target MME as indicated in 3GPP TS 33.501 [24].

The AMF shall derive a K'<sub>ASME</sub> using the K<sub>AMF</sub> key and the downlink NAS COUNT of the current 5G security context, include the corresponding NAS sequence number in the N1 mode to S1 mode NAS transparent container (see subclause 9.11.2.7) and then increments its stored downlink NAS COUNT value by one. The AMF shall select the NAS algorithms identifiers to be used in the target MME after the inter-system change from N1 mode to S1 mode in 5GMM-CONNECTED mode, for encryption and integrity protection. The uplink and downlink NAS COUNT associated with the newly derived K'<sub>ASME</sub> key are set to 0. The eKSI for the newly derived K'<sub>ASME</sub> key shall be defined such as the value field is taken from the ngKSI and the type field is set to indicate a mapped security context.

When the UE operating in single-registration mode receives a command to perform inter-system change from N1 mode to S1 mode in 5GMM-CONNECTED mode including the NAS security transparent container for handover to E-UTRAN (see 3GPP TS 24.301 [15]), the UE shall derive the mapped EPS security context, i.e. derive K'<sub>ASME</sub> from K<sub>AMF</sub> using a downlink NAS COUNT based on the NAS sequence number received in the N1 mode to S1 mode NAS transparent container (see subclause 9.11.2.7) as described in 3GPP TS 33.501 [24]. The eKSI for the newly derived K'<sub>ASME</sub> key is defined such that the value field is taken from the ngKSI and the type field is set to indicate a mapped security context. The UE shall also derive the NAS keys as specified in 3GPP TS 33.401 [23A] using the EPS NAS security algorithms identifiers that are stored in the UE's 5G NAS security context.

If the inter-system change from N1 mode to S1 mode in 5GMM-CONNECTED mode is not completed successfully, the AMF and the UE shall delete the new mapped EPS security context.

#### 4.4.2.5 Establishment of secure exchange of NAS messages

Secure exchange of NAS messages via a NAS signalling connection is usually established by the AMF during the registration procedure by initiating a security mode control procedure. After successful completion of the security mode control procedure, all NAS messages exchanged between the UE and the AMF are sent integrity protected using the current 5G security algorithms, and except for the messages specified in subclause 4.4.5, all NAS messages exchanged between the UE and the AMF are sent ciphered using the current 5G security algorithms.

During inter-system change from S1 mode to N1 mode in 5GMM-CONNECTED mode, secure exchange of NAS messages is established between the AMF and the UE by:

- a) the transmission of NAS security related parameters encapsulated in the AS signalling from the AMF to the UE triggering the inter-system change in 5GMM-CONNECTED mode (see 3GPP TS 33.501 [24]). The UE uses these parameters to generate the mapped 5G NAS security context (see subclause 8.6.2 of 3GPP TS 33.501 [24]); and
- b) after the inter-system change in 5GMM-CONNECTED mode, the transmission of a REGISTRATION REQUEST message from the UE to the AMF. The UE shall send this message integrity protected using the mapped 5G NAS security context and further protect this message as specified in subclause 4.4.6 and subclause 5.5.1.3.2. From this time onward, all NAS messages exchanged between the UE and the AMF are sent integrity protected using the mapped 5G NAS security context, and except for the messages specified in subclause 4.4.5, all NAS messages exchanged between the UE and the AMF are sent ciphered using the mapped 5G NAS security context.

During inter-system change from S1 mode to N1 mode in 5GMM-IDLE mode, if the UE is operating in single-registration mode and:

- a) if the UE has a valid native 5G NAS security context, the UE shall transmit a REGISTRATION REQUEST message integrity protected with the native 5G NAS security context. The UE shall include the ngKSI indicating the native 5G NAS security context value in the REGISTRATION REQUEST message.

After receiving the REGISTRATION REQUEST message including the ngKSI indicating a native 5G NAS security context value, the AMF shall check whether the ngKSI included in the REGISTRATION REQUEST message belongs to a 5G NAS security context available in the AMF, and shall verify the MAC of the REGISTRATION REQUEST message. If the verification is successful, the AMF deletes the EPS security context received from the source MME if any, and the AMF re-establishes the secure exchange of NAS messages by either:

- 1) replying with a REGISTRATION ACCEPT message that is integrity protected and ciphered using the native 5G NAS security context. From this time onward, all NAS messages exchanged between the UE and the AMF are sent integrity protected and except for the messages specified in subclause 4.4.5, all NAS messages exchanged between the UE and the AMF are sent ciphered; or
  - 2) initiating a security mode control procedure. This can be used by the AMF to take a non-current 5G NAS security context into use or to modify the current 5G NAS security context by selecting new NAS security algorithms.
- b) if the UE has no valid native 5G NAS security context, the UE shall send the REGISTRATION REQUEST message without integrity protection and encryption.

After receiving the REGISTRATION REQUEST message without integrity protection and encryption:

- 1) if N26 interface is supported:
  - i) if an EPS security context received from the source MME does not include the NAS security algorithms set to EIA0 and EEA0, the AMF shall either create a fresh mapped 5G NAS security context (see subclause 8.6.2 of 3GPP TS 33.501 [24]) or trigger a primary authentication and key agreement procedure to create a fresh native 5G NAS security context; or
  - ii) if an EPS security context received from the source MME includes the NAS security algorithms set to EIA0 and EEA0, the AMF shall trigger a primary authentication and key agreement procedure to create a fresh native 5G NAS security context; or
- 2) if N26 interface is not supported, the AMF shall trigger a primary authentication and key agreement procedure.

The newly created 5G NAS security context is taken into use by initiating a security mode control procedure and this context becomes the current 5G NAS security context in both the UE and the AMF. This re-establishes the secure exchange of NAS messages.

During an N1 mode to N1 mode handover, secure exchange of NAS messages is established between the AMF and the UE by:

- the transmission of NAS security related parameters encapsulated in the AS signalling from the target AMF to the UE triggering the N1 mode to N1 mode handover (see 3GPP TS 33.501 [24]). The UE uses these parameters to create a new 5G NAS security context.

The secure exchange of NAS messages shall be continued after N1 mode to N1 mode handover. It is terminated after inter-system change from N1 mode to S1 mode in 5GMM-CONNECTED mode or when the NAS signalling connection is released.

When a UE in 5GMM-IDLE mode establishes a new NAS signalling connection and has a valid current 5G NAS security context, the UE shall transmit the initial NAS message integrity protected with the current 5G NAS security context and further protect this message as specified in subclause 4.4.6. The UE shall include the ngKSI indicating the current 5G NAS security context value in the initial NAS message. The AMF shall check whether the ngKSI included in the initial NAS message belongs to a 5G NAS security context available in the AMF, and shall verify the MAC of the NAS message. If the verification is successful, the AMF may re-establish the secure exchange of NAS messages:

- a) by replying with a NAS message that is integrity protected and ciphered using the current 5G NAS security context. From this time onward, all NAS messages exchanged between the UE and the AMF are sent integrity protected and except for the messages specified in subclause 4.4.5, all NAS messages exchanged between the UE and the AMF are sent ciphered; or

- b) by initiating a security mode control procedure. This can be used by the AMF to take a non-current 5G NAS security context into use or to modify the current 5G NAS security context by selecting new NAS security algorithms.

#### 4.4.2.6 Change of security keys

When the AMF initiates a re-authentication to create a new 5G NAS security context, the messages exchanged during the authentication procedure are integrity protected and ciphered using the current 5G NAS security context, if any.

Both UE and AMF shall continue to use the current 5G NAS security context, until the AMF initiates a security mode control procedure. The SECURITY MODE COMMAND message sent by the AMF includes the ngKSI of the new 5G NAS security context to be used. The AMF shall send the SECURITY MODE COMMAND message integrity protected with the new 5G NAS security context, but unciphered. When the UE responds with a SECURITY MODE COMPLETE message, it shall send the message integrity protected and ciphered with the new 5G NAS security context.

The AMF can also modify the current 5G NAS security context or take the non-current native 5G NAS security context, if any, into use, by sending a SECURITY MODE COMMAND message including the ngKSI of the 5G NAS security context to be modified and including a new set of selected NAS security algorithms. In this case the AMF shall send the SECURITY MODE COMMAND message integrity protected with the modified 5G NAS security context, but unciphered. When the UE replies with a SECURITY MODE COMPLETE message, it shall send the message integrity protected and ciphered with the modified 5G NAS security context.

#### 4.4.3 Handling of NAS COUNT and NAS sequence number

##### 4.4.3.1 General

Each 5G NAS security context shall be associated with two separate counters NAS COUNT per access type in the same PLMN: one related to uplink NAS messages and one related to downlink NAS messages. If the 5G NAS security context is used for access via both 3GPP and non-3GPP access in the same PLMN, there are two NAS COUNT counter pairs associated with the 5G NAS security context. The NAS COUNT counters use 24 bit internal representation and are independently maintained by UE and AMF. The NAS COUNT shall be constructed as a NAS sequence number (8 least significant bits) concatenated with a NAS overflow counter (16 most significant bits).

When NAS COUNT is input to NAS ciphering or NAS integrity algorithms it shall be considered to be a 32-bit entity which shall be constructed by padding the 24-bit internal representation with 8 zeros in the most significant bits.

The value of the uplink NAS COUNT that is stored or read out of the USIM or non-volatile memory as described in annex C, is the value that shall be used in the next NAS message.

The value of the downlink NAS COUNT that is stored or read out of the USIM or non-volatile memory as described in annex C, is the largest downlink NAS COUNT used in a successfully integrity checked NAS message.

The NAS sequence number part of the NAS COUNT shall be exchanged between the UE and the AMF as part of the NAS signalling. After each new or retransmitted outbound SECURITY PROTECTED 5GS NAS MESSAGE message, the sender shall increase the NAS COUNT number by one, except for the initial NAS messages if the lower layers indicated the failure to establish the RRC connection (see 3GPP TS 38.331 [30]). Specifically, on the sender side, the NAS sequence number shall be increased by one, and if the result is zero (due to wrap around), the NAS overflow counter shall also be incremented by one (see subclause 4.4.3.5). The receiving side shall estimate the NAS COUNT used by the sending side. Specifically, if the estimated NAS sequence number wraps around, the NAS overflow counter shall be incremented by one.

During the inter-system change from S1 mode to N1 mode in 5GMM-CONNECTED mode, when a mapped 5G NAS security context is derived and taken into use, the AMF shall set both the uplink and downlink NAS COUNT counters of this 5G NAS security context to zero. The UE shall set both the uplink and downlink NAS COUNT counters to zero.

During inter-system change to N1 mode in 5GMM-CONNECTED mode, the AMF shall increment downlink NAS COUNT by one after it has created a NAS transparent container (see subclause 9.11.2.7).

During handover from NG-RAN to E-UTRAN, the AMF shall increment downlink NAS COUNT by one after it has created an N1 mode to S1 mode NAS transparent container (see subclause 9.11.2.7).

During N1 mode to N1 mode handover, if a new 5G NAS security context is created, the AMF signals the 8 least significant bits of the current downlink NAS COUNT value in an Intra N1 mode NAS transparent container (see subclause 9.11.2.6). The AMF increments downlink NAS COUNT by one after it has created the NAS security transparent container.

If the 5G NAS security context is created with a new  $K_{AMF}$ , the AMF signals the 8 least significant bits of the current downlink NAS COUNT value in an Intra N1 mode NAS transparent container (see subclause 9.11.2.6) and shall then set both the uplink and downlink NAS COUNT counters of this 5G NAS security context to zero. The AMF shall then increment the downlink NAS COUNT by one. The UE shall also set both the uplink and downlink NAS COUNT counters to zero.

**NOTE:** During the inter-system change from S1 mode to N1 mode in 5GMM-CONNECTED mode, the NAS transparent container (see subclause 9.11.2.7) is treated as an implicit SECURITY MODE COMMAND message for the UE and the AMF, and therefore the AMF regards the sending of the NAS transparent container as the sending of an initial SECURITY MODE COMMAND message in order to derive and take into use a mapped 5G NAS security context for the purpose of the NAS COUNT handling.

#### 4.4.3.2 Replay protection

Replay protection shall be supported for received NAS messages both in the AMF and the UE. However, since the realization of replay protection does not affect the interoperability between nodes, no specific mechanism is required for implementation.

Replay protection assures that one and the same NAS message is not accepted twice by the receiver. Specifically, for a given 5G NAS security context, a given NAS COUNT value shall be accepted at most one time and only if message integrity verifies correctly.

Replay protection is not applicable when 5G-IA0 is used.

#### 4.4.3.3 Integrity protection and verification

The sender shall use its locally stored NAS COUNT as input to the integrity protection algorithm.

The receiver shall use the NAS sequence number included in the received message and an estimate for the NAS overflow counter as defined in subclause 4.4.3.1 to form the NAS COUNT input to the integrity verification algorithm.

The algorithm to calculate the integrity protection information is specified in 3GPP TS 33.501 [24], and the integrity protection shall include octet 7 to n of the SECURITY PROTECTED 5GS NAS MESSAGE message, i.e. the Sequence number IE and the NAS message IE. In addition to the data that is to be integrity protected, the BEARER ID, DIRECTION bit, NAS COUNT and 5G NAS are input to the integrity protection algorithm. These parameters are described in 3GPP TS 33.501 [24].

After successful integrity protection validation, the receiver shall update its corresponding locally stored NAS COUNT with the value of the estimated NAS COUNT for this NAS message.

Integrity verification is not applicable when 5G-IA0 is used.

#### 4.4.3.4 Ciphering and deciphering

The sender shall use its locally stored NAS COUNT as input to the ciphering algorithm.

The receiver shall use the NAS sequence number included in the received message and an estimate for the NAS overflow counter as defined in subclause 4.4.3.1 to form the NAS COUNT input to the deciphering algorithm.

The input parameters to the NAS ciphering algorithm are the BEARER ID, DIRECTION bit, NAS COUNT, NAS encryption key and the length of the key stream to be generated by the encryption algorithm.

#### 4.4.3.5 NAS COUNT wrap around

If, when increasing the NAS COUNT as specified above, the AMF detects that either its downlink NAS COUNT or the UE's uplink NAS COUNT is "close" to wrap around, (close to  $2^{24}$ ), the AMF shall take the following actions:

- If there is no non-current native 5G NAS security context with sufficiently low NAS COUNT values, the AMF shall initiate a new primary authentication and key agreement procedure with the UE, leading to a new established 5G NAS security context and the NAS COUNT being reset to 0 in both the UE and the AMF when the new 5G NAS security context is activated;
- Otherwise, the AMF can activate a non-current native 5G NAS security context with sufficiently low NAS COUNT values or initiate a new primary authentication and key agreement procedure as specified above.

If for some reason a new  $K_{AMF}$  has not been established using primary authentication and key agreement procedure before the NAS COUNT wraps around, the node (AMF or UE) in need of sending a NAS message shall instead release the NAS signalling connection. Prior to sending the next uplink NAS message, the UE shall delete the ngKSI indicating the current 5G NAS security context.

When the 5G-IA0 is used as the NAS integrity algorithm, the UE and the AMF shall allow NAS COUNT wrap around. If NAS COUNT wrap around occurs, the following requirements apply:

- a) the UE and the AMF shall continue to use the current 5G NAS security context;
- b) the AMF shall not initiate the primary authentication and key agreement procedure;
- c) the AMF shall not release the NAS signalling connection; and
- d) the UE shall not perform a local release of the NAS signalling connection.

## 4.4.4 Integrity protection of NAS signalling messages

### 4.4.4.1 General

For the UE, integrity protected signalling is mandatory for the 5GMM NAS messages once a valid 5G NAS security context exists and has been taken into use. For the network, integrity protected signalling is mandatory for the 5GMM NAS messages once a secure exchange of 5GS NAS messages has been established for the NAS signalling connection. Integrity protection of all NAS signalling messages is the responsibility of the NAS. It is the network which activates integrity protection.

The use of "null integrity protection algorithm" 5G-IA0 (see subclause 9.11.3.32) in the current 5G NAS security context is only allowed for an unauthenticated UE for which establishment of emergency services is allowed. For setting the security header type in outbound NAS messages, the UE and the AMF shall apply the same rules irrespective of whether the "null integrity protection algorithm" or any other integrity protection algorithm is indicated in the 5G NAS security context.

If the "null integrity protection algorithm" 5G-IA0 has been selected as an integrity protection algorithm, the receiver shall regard the NAS messages with the security header indicating integrity protection as integrity protected.

Details of the integrity protection and verification of NAS signalling messages are specified in 3GPP TS 33.501 [24].

When a NAS message needs to be sent both ciphered and integrity protected, the NAS message is first ciphered and then the ciphered NAS message and the NAS sequence number are integrity protected by calculating the MAC.

NOTE: NAS messages that are ciphered with the "null ciphering algorithm" 5G-EA0 are regarded as ciphered (see subclause 4.4.5).

When a NAS message needs to be sent only integrity protected and unciphered, the unciphered NAS message and the NAS sequence number are integrity protected by calculating the MAC.

When a 5GSM message is piggybacked in a 5GMM message, there is only one Sequence number IE and one Message authentication code IE for the 5GMM message piggybacking the 5GSM message.

### 4.4.4.2 Integrity checking of NAS signalling messages in the UE

Except the messages listed below, no NAS signalling messages shall be processed by the receiving 5GMM entity in the UE or forwarded to the 5GSM entity, unless the network has established secure exchange of 5GS NAS messages for the NAS signalling connection:

- a) IDENTITY REQUEST (if requested identification parameter is SUCI);



- b) AUTHENTICATION REQUEST;
- c) AUTHENTICATION RESULT;
- d) AUTHENTICATION REJECT;
- e) REGISTRATION REJECT;
- f) DEREGISTRATION ACCEPT (for non switch off); and
- g) SERVICE REJECT.

NOTE: These messages are accepted by the UE without integrity protection, as in certain situations they are sent by the network before security can be activated.

Integrity protection is never applied directly to 5GSM messages, but to the 5GMM message in which the 5GSM message is included.

The network can provide the SOR transparent container IE during the registration procedure to the UE in the REGISTRATION ACCEPT message. The SOR transparent container IE is integrity protected by the HPLMN as specified in 3GPP TS 33.501 [24].

Once the secure exchange of NAS messages has been established, the receiving 5GMM entity in the UE shall not process any NAS signalling messages unless they have been successfully integrity checked by the NAS. If NAS signalling messages, having not successfully passed the integrity check, are received, then the NAS in the UE shall discard that message. The processing of the SECURITY MODE COMMAND message that has not successfully passed the integrity check is specified in subclause 5.4.2.5. If any NAS signalling message is received as not integrity protected even though the secure exchange of NAS messages has been established by the network, then the NAS shall discard this message.

#### 4.4.4.3 Integrity checking of NAS signalling messages in the AMF

Except the messages listed below, no NAS signalling messages shall be processed by the receiving 5GMM entity in the AMF or forwarded to the 5GSM entity, unless the secure exchange of NAS messages has been established for the NAS signalling connection:

- a) REGISTRATION REQUEST;
- b) IDENTITY RESPONSE (if requested identification parameter is SUCI);
- c) AUTHENTICATION RESPONSE;
- d) AUTHENTICATION FAILURE;
- e) SECURITY MODE REJECT;
- f) DEREGISTRATION REQUEST; and
- g) DEREGISTRATION ACCEPT;

NOTE 1: The REGISTRATION REQUEST message is sent by the UE without integrity protection, if the registration procedure is initiated due to an inter-system change in 5GMM-IDLE mode and no current 5G NAS security context is available in the UE. The other messages are accepted by the AMF without integrity protection, as in certain situations they are sent by the UE before security can be activated.

NOTE 2: The DEREGISTRATION REQUEST message can be sent by the UE without integrity protection, e.g. if the UE is registered for emergency services and there is no shared 5G NAS security context available, or if due to user interaction a registration procedure is cancelled before the secure exchange of NAS messages has been established. For these cases the network can attempt to use additional criteria (e.g. whether the UE is subsequently still performing periodic registration update or still responding to paging) before marking the UE as 5GMM-DEREGISTERED.

Integrity protection is never applied directly to 5GSM messages, but to the 5GMM message in which the 5GSM message is included.

Once a current 5G NAS security context exists, until the secure exchange of NAS messages has been established for the NAS signalling connection, the receiving 5GMM entity in the AMF shall process the following NAS signalling messages, even if the MAC included in the message fails the integrity check or cannot be verified, as the 5G NAS security context is not available in the network:

- a) REGISTRATION REQUEST;
- b) IDENTITY RESPONSE (if requested identification parameter is SUCI);
- c) AUTHENTICATION RESPONSE;
- d) AUTHENTICATION FAILURE;
- e) SECURITY MODE REJECT;
- f) DEREGISTRATION REQUEST;
- g) DEREGISTRATION ACCEPT; and
- h) SERVICE REQUEST;

NOTE 3: These messages are processed by the AMF even when the MAC that fails the integrity check or cannot be verified, as in certain situations they can be sent by the UE protected with a 5G NAS security context that is no longer available in the network.

If a REGISTRATION REQUEST message fails the integrity check and it is not a registration request for emergency services, the AMF shall authenticate the subscriber before processing the registration request any further. Additionally, the AMF shall initiate a security mode control procedure, and include the Additional 5G security information IE with the RINMR bit set to "Retransmission of the initial NAS message requested" in the SECURITY MODE COMMAND message as specified in subclause 5.4.2.2. For the case when the registration procedure is for emergency services see subclause 5.5.1.2.3 and subclause 5.4.1.3.5.

If a DEREGISTRATION REQUEST message fails the integrity check, the AMF shall proceed as follows:

- If it is not a deregistration request due to switch off, and the AMF can initiate an authentication procedure, the AMF should authenticate the subscriber before processing the deregistration request any further.
- If it is a deregistration request due to switch off, or the AMF does not initiate an authentication procedure for any other reason, the AMF may ignore the deregistration request and remain in state 5GMM-REGISTERED.

NOTE 4: The network can attempt to use additional criteria (e.g. whether the UE is subsequently still performing periodic registration update or still responding to paging) before marking the UE as 5GMM-DEREGISTERED.

If a REGISTRATION REQUEST message fails the integrity check and the UE provided EPS NAS message container IE which was successfully verified by the source MME, the AMF may create a mapped 5G NAS security context and initiate a security mode control procedure to take the new mapped 5G NAS security context into use; otherwise if the UE has only a non-emergency PDU session established, the AMF shall initiate a primary authentication and key agreement procedure to create a new native 5G NAS security context. Additionally, the AMF shall initiate a security mode control procedure, and include the Additional 5G security information IE with the RINMR bit set to "Retransmission of the initial NAS message requested" in the SECURITY MODE COMMAND message as specified in subclause 5.4.2.2. For the case when the UE has an emergency PDU session see subclause 5.5.1.3.3 and subclause 5.4.1.3.5.

If a SERVICE REQUEST message fails the integrity check and the UE has only non-emergency PDU sessions established, the AMF shall send the SERVICE REJECT message with 5GMM cause #9 "UE identity cannot be derived by the network" and keep the 5GMM-context and 5G NAS security context unchanged. For the case when the UE has an emergency PDU session and integrity check fails, the AMF may skip the authentication procedure even if no 5G NAS security context is available and proceed directly to the execution of the security mode control procedure as specified in subclause 5.4.2. Additionally, the AMF shall include the Additional 5G security information IE with the RINMR bit set to "Retransmission of the initial NAS message requested" in the SECURITY MODE COMMAND message as specified in subclause 5.4.2.2. After successful completion of the service request procedure, the network shall perform a local release of all non-emergency PDU sessions. The emergency PDU sessions shall not be released.

Once the secure exchange of NAS messages has been established for the NAS signalling connection, the receiving 5GMM entity in the AMF shall not process any NAS signalling messages unless they have been successfully integrity checked by the NAS. If any NAS signalling message, having not successfully passed the integrity check, is received, then the NAS in the AMF shall discard that message. If any NAS signalling message is received, as not integrity protected even though the secure exchange of NAS messages has been established, then the NAS shall discard this message.

#### 4.4.5 Cipherring of NAS signalling messages

The use of cipherring in a network is an operator option subject to AMF configuration. When operation of the network without cipherring is configured, the AMF shall indicate the use of "null cipherring algorithm" 5G-EA0 (see subclause 9.11.3.32) in the current 5G NAS security context for all UEs. For setting the security header type in outbound NAS messages, the UE and the AMF shall apply the same rules irrespective of whether the "null cipherring algorithm" or any other cipherring algorithm is indicated in the 5G NAS security context.

When the UE establishes a new N1 NAS signalling connection, it shall apply security protection to the initial NAS message as described in subclause 4.4.6.

The UE shall start the cipherring and deciphering of NAS messages when the secure exchange of NAS messages has been established for an N1 NAS signalling connection. From this time onward, unless explicitly defined, the UE shall send all NAS messages ciphered until the N1 NAS signalling connection is released, or the UE performs inter-system change to S1 mode.

The AMF shall start cipherring and deciphering of NAS messages as described in subclause 4.4.2.5. From this time onward, except for the SECURITY MODE COMMAND message, the AMF shall send all NAS messages ciphered until the N1 NAS signalling connection is released, or the UE performs inter-system change to S1 mode.

Cipherring is never applied directly to 5GSM messages, but to the 5GMM message in which the 5GSM message is included.

Once the encryption of NAS messages has been started between the AMF and the UE, the receiver shall discard the unciphered NAS messages which shall have been ciphered according to the rules described in this specification.

If the "null cipherring algorithm" 5G-EA0 has been selected as a cipherring algorithm, the NAS messages with the security header indicating cipherring are regarded as ciphered.

Details of cipherring and deciphering of NAS signalling messages are specified in 3GPP TS 33.501 [24].

#### 4.4.6 Protection of initial NAS signalling messages

The 5GS supports protection of initial NAS messages as specified in 3GPP TS 33.501 [24]. The protection of initial NAS messages applies to the REGISTRATION REQUEST and SERVICE REQUEST message, and is achieved as follows:

- a) If the UE does not have a valid 5G NAS security context, the UE sends a REGISTRATION REQUEST message including cleartext IEs only. After activating a 5G NAS security context resulting from a security mode control procedure:
  - 1) if the UE needs to send non-cleartext IEs, the UE shall include the entire REGISTRATION REQUEST message (i.e. containing both cleartext IEs and non-cleartext IEs) in the NAS message container IE and shall include the NAS message container IE in the SECURITY MODE COMPLETE message; or
  - 2) if the UE does not need to send non-cleartext IEs, the UE shall include the entire REGISTRATION REQUEST message (i.e. containing cleartext IEs only) in the NAS message container IE and shall include the NAS message container IE in the SECURITY MODE COMPLETE message.
- b) If the UE has a valid 5G NAS security context and:
  - 1) the UE needs to send non-cleartext IEs in a REGISTRATION REQUEST or SERVICE REQUEST message, the UE includes the entire REGISTRATION REQUEST or SERVICE REQUEST message (i.e. containing both cleartext IEs and non-cleartext IEs) in the NAS message container IE and shall cipher the value part of the NAS message container IE. The UE shall then send a REGISTRATION REQUEST or SERVICE REQUEST message containing the cleartext IEs and the NAS message container IE; or

- 2) the UE does not need to send non-clear-text IEs in a REGISTRATION REQUEST or SERVICE REQUEST message, the UE sends the REGISTRATION REQUEST or SERVICE REQUEST message without including the NAS message container IE.

When the initial NAS message is a REGISTRATION REQUEST message, the clear-text IEs are:

- Extended protocol discriminator;
- Security header type;
- Spare half octet;
- Registration request message identity;
- 5GS registration type;
- ngKSI;
- 5GS mobile identity;
- UE security capability;
- Additional GUTI;
- UE status; and
- EPS NAS message container.

When the initial NAS message is a SERVICE REQUEST message, the clear-text IEs are:

- Extended protocol discriminator;
- Security header type;
- Spare half octet;
- ngKSI;
- Service request message identity;
- Service type; and
- 5G-S-TMSI.

When the UE sends a REGISTRATION REQUEST or SERVICE REQUEST message that includes a NAS message container IE, the UE shall set the security header type of the initial NAS message to "integrity protected".

If the UE does not need to send non-clear-text IEs in the initial NAS message, the UE shall send the initial NAS message i.e. REGISTRATION REQUEST or SERVICE REQUEST message with clear-text IEs only i.e. without including the NAS message container IE in the initial NAS message.

When the AMF receives an integrity protected initial NAS message which includes a NAS message container IE, the AMF shall decipher the value part of the NAS message container IE. The AMF shall consider the NAS message that is obtained from the NAS message container IE as the initial NAS message that triggered the procedure.

When the initial NAS message is a DEREGISTRATION REQUEST message, the UE always sends the NAS message unciphered.

## 4.5 Unified access control

### 4.5.1 General

When the UE needs to access the 5GS, the UE first performs access control checks to determine if the access is allowed. Access control checks shall be performed for the access attempts defined by the following list of events:

- a) the UE is in 5GMM-IDLE mode over 3GPP access and an event that requires a transition to 5GMM-CONNECTED mode occurs; and
- b) the UE is in 5GMM-CONNECTED mode over 3GPP access or 5GMM-CONNECTED mode with RRC inactive indication and one of the following events occurs:
  - 1) 5GMM receives an MO-MMTEL-voice-call-started indication, an MO-MMTEL-video-call-started indication or an MO-SMSoIP-attempt-started indication from upper layers;
  - 2) 5GMM receives a request from upper layers to send a mobile originated SMS over NAS unless the request triggered a service request procedure to transition the UE from 5GMM-IDLE mode to 5GMM-CONNECTED mode;
  - 3) 5GMM receives a request from upper layers to send an UL NAS TRANSPORT message for the purpose of PDU session establishment unless the request triggered a service request procedure to transition the UE from 5GMM-IDLE mode to 5GMM-CONNECTED mode;
  - 4) 5GMM receives a request from upper layers to send an UL NAS TRANSPORT message for the purpose of PDU session modification unless the request triggered a service request procedure to transition the UE from 5GMM-IDLE mode to 5GMM-CONNECTED mode;
  - 5) 5GMM receives a request to re-establish the user-plane resources for an existing PDU session; and
  - 6) 5GMM is notified that an uplink user data packet is to be sent for a PDU session with suspended user-plane resources.

NOTE 1: 5GMM specific procedures initiated by NAS in 5GMM-CONNECTED mode are not subject to access control, e.g. a registration procedure after PS handover will not be prevented by access control (see subclause 5.5).

NOTE 2: In this version of the protocol, initiating a mobile originating location request by sending an UL NAS TRANSPORT message (see subclause 5.4.5.2.1) is not supported, and therefore access control for this case has not been specified. All LPP messages transported in the UL NAS TRANSPORT message are sent in response to a mobile terminating or network induced location request, and the corresponding access attempts are handled as MT access.

NOTE 3: Initiating a mobile originated signalling transaction towards the PCF by sending an UL NAS TRANSPORT message including a UE policy container (see subclause 5.4.5.2.1) is not supported (see subclause D.2.2). Furthermore, initiating a mobile originated signalling transaction towards the UDM by sending an UL NAS TRANSPORT message including an SOR transparent container is not supported. Therefore, access control for these cases has not been specified.

When the NAS detects one of the above events, the NAS needs to perform the mapping of the kind of request to one or more access identities and one access category and lower layers will perform access barring checks for that request based on the determined access identities and access category.

NOTE 4: The NAS is aware of the above events through indications provided by upper layers or when determining the need to start 5GMM procedures through normal NAS behaviour, or both.

To determine the access identities and the access category for a request, the NAS checks the reason for access, types of service requested and profile of the UE including UE configurations, against a set of access identities and access categories defined in 3GPP TS 22.261 [3], namely:

- a) a set of standardized access identities;
- b) a set of standardized access categories; and
- c) a set of operator-defined access categories, if available.

For the purpose of determining the applicable access identities from the set of standardized access identities defined in 3GPP TS 22.261 [3], the NAS shall follow the requirements set out in subclause 4.5.2 and the rules and actions defined in table 4.5.2.1.

In order to enable access barring checks for access attempts identified by lower layers in 5GMM-CONNECTED mode with RRC inactive indication, the UE provides the applicable access identities to lower layers.

NOTE 5: When and how the NAS provides the applicable access identities to lower layers is UE implementation specific.

For the purpose of determining the applicable access category from the set of standardized access categories and operator-defined access categories defined in 3GPP TS 22.261 [3], the NAS shall follow the requirements set out in subclause 4.5.2 and the rules and actions defined in table 4.5.2.2.

## 4.5.2 Determination of the access identities and access category associated with a request for access

When the UE needs to initiate an access attempt in one of the events listed in subclause 4.5.1, the UE shall determine one or more access identities from the set of standardized access identities, and one access category from the set of standardized access categories and operator-defined access categories, to be associated with that access attempt.

The set of the access identities applicable for the request is determined by the UE in the following way:

- a) for each of the access identities 1, 2, 11, 12, 13, 14 and 15 in table 4.5.2.1, the UE shall check whether the access identity is applicable in the selected PLMN, if a new PLMN is selected, or otherwise if it is applicable in the RPLMN or equivalent PLMN; and
- b) if none of the above access identities is applicable, then access identity 0 is applicable.

**Table 4.5.2.1: Access identities**

Access Identity number	UE configuration
0	UE is not configured with any parameters from this table
1 (NOTE 1)	UE is configured for multimedia priority service (MPS).
2 (NOTE 2)	UE is configured for mission critical service (MCS).
3-10	Reserved for future use
11 (NOTE 3)	Access Class 11 is configured in the UE.
12 (NOTE 3)	Access Class 12 is configured in the UE.
13 (NOTE 3)	Access Class 13 is configured in the UE.
14 (NOTE 3)	Access Class 14 is configured in the UE.
15 (NOTE 3)	Access Class 15 is configured in the UE.
<p>NOTE 1: Access identity 1 is valid when:</p> <ul style="list-style-type: none"> <li>- the USIM file EFUAC_AIC indicates the UE is configured for access identity 1 and the RPLMN is the HPLMN (if the EHPLMN list is not present or is empty) or EHPLMN (if the EHPLMN list is present), or a visited PLMN of the home country (see the definition of home country in 3GPP TS 24.301 [15]); or</li> <li>- the UE receives the 5GS network feature support IE with the MPS indicator bit set to "Access identity 1 valid in RPLMN or equivalent PLMN" from the RPLMN as described in subclause 5.5.1.2.4 and subclause 5.5.1.3.4.</li> </ul> <p>NOTE 2: Access identity 2 is used by UEs configured for MCS and is valid when:</p> <ul style="list-style-type: none"> <li>- the USIM file EFUAC_AIC indicates the UE is configured for access identity 2 and the RPLMN is the HPLMN (if the EHPLMN list is not present or is empty) or EHPLMN (if the EHPLMN list is present), or a visited PLMN of the home country (see 3GPP TS 23.122 [5]); or</li> <li>- the UE receives the 5GS network feature support IE with the MCS indicator bit set to "Access identity 2 valid in RPLMN or equivalent PLMN" from the RPLMN as described in subclause 5.5.1.2.4 and subclause 5.5.1.3.4.</li> </ul> <p>NOTE 3: Access identities 11 and 15 are valid in HPLMN (if the EHPLMN list is not present or is empty) or EHPLMN (if the EHPLMN list is present). Access Identities 12, 13 and 14 are valid in HPLMN and visited PLMNs of home country only (see the definition of home country in 3GPP TS 24.301 [15]).</p>	

The UE uses the MPS indicator bit of the 5GS network feature support IE to determine if access identity 1 is valid. Processing of the MPS indicator bit of the 5GS network feature support IE in the REGISTRATION ACCEPT message is described in subclause 5.5.1.2.4 and subclause 5.5.1.3.4. The UE shall not consider access identity 1 to be valid when the UE is not in the country of its HPLMN prior to receiving the MPS indicator bit of the 5GS network feature support IE in the REGISTRATION ACCEPT message being set to "Access identity 1 valid in RPLMN or equivalent PLMN".

When the UE is in the country of its HPLMN, the contents of the USIM files EF<sub>UAC\_AIC</sub> and EF<sub>ACC</sub> as specified in 3GPP TS 31.102 [22] and the rules specified in table 4.5.2.1 are used to determine the applicability of access identity 1 and access classes 11 - 15. When the UE is in the country of its HPLMN, and the USIM file EF<sub>UAC\_AIC</sub> does not indicate

the UE is configured for access identity 1, the UE uses the MPS indicator bit of the 5GS network feature support IE in the REGISTRATION ACCEPT message to determine if access identity 1 is valid. When the UE is in the country of its HPLMN, and the USIM file EF<sub>UAC\_AIC</sub> indicates the UE is configured for access identity 1, the MPS indicator bit of the 5GS network feature support IE is not applicable. When the UE is not in the country of its HPLMN, the contents of the USIM files EF<sub>UAC\_AIC</sub> and EF<sub>ACC</sub> are not applicable.

The UE uses the MCS indicator bit of the 5GS network feature support IE to determine if access identity 2 is valid. Processing of the MCS indicator bit of the 5GS network feature support IE in the REGISTRATION ACCEPT message is described in subclause 5.5.1.2.4 and subclause 5.5.1.3.4. The UE shall not consider access identity 2 to be valid when the UE is not in the country of its HPLMN prior to receiving the MCS indicator bit of the 5GS network feature support IE in the REGISTRATION ACCEPT message being set to "Access identity 2 valid in RPLMN or equivalent PLMN".

When the UE is in the country of its HPLMN, the contents of the USIM files EF<sub>UAC\_AIC</sub> and EF<sub>ACC</sub> as specified in 3GPP TS 31.102 [22] and the rules specified in table 4.5.2.1 are used to determine the applicability of access identity 2 and access classes 11 - 15. When the UE is in the country of its HPLMN, and the USIM file EF<sub>UAC\_AIC</sub> does not indicate the UE is configured for access identity 2, the UE uses the MCS indicator bit of the 5GS network feature support IE in the REGISTRATION ACCEPT message to determine if access identity 2 is valid. When the UE is in the country of its HPLMN, and the USIM file EF<sub>UAC\_AIC</sub> indicates the UE is configured for access identity 2, the MCS indicator bit of the 5GS network feature support IE is not applicable. When the UE is not in the country of its HPLMN, the contents of the USIM files EF<sub>UAC\_AIC</sub> and EF<sub>ACC</sub> are not applicable.

In order to determine the access category applicable for the access attempt, the NAS shall check the rules in table 4.5.2.2, and use the access category for which there is a match for barring check. If the access attempt matches more than one rule, the access category of the lowest rule number shall be selected. If the access attempt matches more than one operator-defined access category definition, the UE shall select the access category from the operator-defined access category definition with the lowest precedence value (see subclause 4.5.3).

**NOTE:** The case when an access attempt matches more than one rule includes the case when multiple events trigger an access attempt at the same time.

**Table 4.5.2.2: Mapping table for access categories**



Rule #	Type of access attempt	Requirements to be met	Access Category
1	Response to paging or NOTIFICATION over non-3GPP access; 5GMM connection management procedure initiated for the purpose of transporting an LPP message	Access attempt is for MT access	0 (= MT_acc)
2	Emergency	UE is attempting access for an emergency session (NOTE 1, NOTE 2)	2 (= emergency)
3	Access attempt for operator-defined access category	UE stores operator-defined access category definitions valid in the current PLMN as specified in subclause 4.5.3, and access attempt is matching criteria of an operator-defined access category definition	32-63 (= based on operator classification)
4	Access attempt for delay tolerant service	(a) UE is configured for NAS signalling low priority or UE supporting S1 mode is configured for EAB (see the "ExtendedAccessBarring" leaf of NAS configuration MO in 3GPP TS 24.368 [17] or 3GPP TS 31.102 [22]) where "EAB override" does not apply, and (b).the UE received one of the categories a, b or c as part of the parameters for unified access control in the broadcast system information, and the UE is a member of the broadcasted category in the selected PLMN or RPLMN/equivalent PLMN (NOTE 3, NOTE 5, NOTE 6, NOTE 7, NOTE 8)	1 (= delay tolerant)
5	MO MMTel voice call	Access attempt is for MO MMTel voice call or for NAS signalling connection recovery during ongoing MO MMTel voice call (NOTE 2)	4 (= MO MMTel voice)
6	MO MMTel video call	Access attempt is for MO MMTel video call or for NAS signalling connection recovery during ongoing MO MMTel video call (NOTE 2)	5 (= MO MMTel video)
7	MO SMS over NAS or MO SMSoIP	Access attempt is for MO SMS over NAS (NOTE 4) or MO SMS over SMSoIP transfer or for NAS signalling connection recovery during ongoing MO SMS or SMSoIP transfer (NOTE 2)	6 (= MO SMS and SMSoIP)
8	UE NAS initiated 5GMM specific procedures	Access attempt is for MO signalling	3 (= MO_sig)
9	UE NAS initiated 5GMM connection management procedure or 5GMM NAS transport procedure	Access attempt is for MO data	7 (= MO_data)
10	An uplink user data packet is to be sent for a PDU session with suspended user-plane resources	No further requirement is to be met	7 (= MO_data)

NOTE 1:	This includes 5GMM specific procedures while the service is ongoing and 5GMM connection management procedures required to establish a PDU session with request type = "initial emergency request" or "existing emergency PDU session", or to re-establish user-plane resources for such a PDU session. This further includes the service request procedure initiated with a SERVICE REQUEST message with the Service type IE set to "emergency services fallback".<
NOTE 2:	Access for the purpose of NAS signalling connection recovery during an ongoing service, or for the purpose of NAS signalling connection establishment following fallback indication from lower layers during an ongoing service, is mapped to the access category of the ongoing service in order to derive an RRC establishment cause, but barring checks will be skipped for this access attempt.
NOTE 3:	If the UE selects a new PLMN, then the selected PLMN is used to check the membership; otherwise the UE uses the RPLMN or a PLMN equivalent to the RPLMN.
NOTE 4:	This includes the 5GMM connection management procedures triggered by the UE-initiated NAS transport procedure for transporting the MO SMS.
NOTE 5:	The UE configured for NAS signalling low priority is not supported in this release of specification. If a UE supporting both S1 mode and N1 mode is configured for NAS signalling low priority in S1 mode as specified in 3GPP TS 24.368 [17] or 3GPP TS 31.102 [22], the UE shall ignore the configuration for NAS signalling low priority when in N1 mode.
NOTE 6:	If the access category applicable for the access attempt is 1, then the UE shall additionally determine a second access category from the range 3 to 7. If more than one access category matches, the access category of the lowest rule number shall be chosen. The UE shall use the second access category only to derive an RRC establishment cause for the access attempt.
NOTE 7:	"EAB override" does not apply, if the UE is not configured to allow overriding EAB (see the "Override_ExtendedAccessBarring" leaf of NAS configuration MO in 3GPP TS 24.368 [17] or 3GPP TS 31.102 [22]), or if NAS has not received an indication from the upper layers to override EAB and the UE does not have a PDU session that was established with EAB override.
NOTE 8:	For the definition of categories a, b and c associated with access category 1, see 3GPP TS 22.261 [3]. The categories associated with access category 1 are distinct from the categories a, b and c associated with EAB (see 3GPP TS 22.011 [1A]).

### 4.5.3 Operator-defined access categories

Operator-defined access category definitions can be signalled to the UE using NAS signalling. Each operator-defined access category definition consists of the following parameters:

- a) a precedence value which indicates in which order the UE shall evaluate the operator-defined category definition for a match;
- b) an operator-defined access category number, i.e. access category number in the 32-63 range that uniquely identifies the access category in the PLMN in which the access categories are being sent to the UE;
- c) criteria consisting of one or more access category criteria type and associated access category criteria type values. The access category criteria type can be set to one of the following:
  - 1) DNN;
  - 2) OS Id + OS App Id of application triggering the access attempt; or
  - 3) S-NSSAI; and

NOTE 1: An access category criteria type can be associated with more than one access category criteria values.

- d) optionally, a standardized access category. This standardized access category is used in combination with the access identities of the UE to determine the RRC establishment cause as specified in subclause 4.5.6.

An access attempt matches the criteria of an operator-defined access category definition, if the access attempt matches all access category criteria types included in the criteria with any of the associated access criteria type values.

Each operator-defined access category definition has a different precedence value.

Several operator-defined access category definitions can have the same operator-defined access category number.

If:

- an access category in bullet d) is not provided;

- an access category in bullet d) is provided and is not a standardized access category; or
- an access category in bullet d) is provided, is a standardized access category and is not recognized by the UE;

the UE shall use instead:

- access category 3 (MO\_sig) if the access attempt is triggered by uplink signalling; or
- access category 7 (MO\_data) if the access attempt is triggered by uplink data

in combination with the access identities of the UE to determine the RRC establishment cause as specified in subclause 4.5.6.

The operator-defined access category definitions are valid in the PLMN which provided them and in a PLMN equivalent to the PLMN which provided them, as specified in annex C.

If the UE stores operator-defined access category definitions valid in the selected PLMN or the RPLMN, then access control in 5GMM-IDLE mode will only be performed for the event a) defined in subclause 4.5.1. If the transition from 5GMM-IDLE mode over 3GPP access to 5GMM-CONNECTED mode is due to a UE NAS initiated 5GMM specific procedure, then this access attempt shall be mapped to one of the standardized access categories in the range < 32, see subclause 4.5.2. I.e. for this case the UE shall skip the checking of operator-defined access category definitions.

If the UE stores operator-defined access category definitions valid in the selected PLMN or the RPLMN, then access control in 5GMM-CONNECTED mode and in 5GMM-CONNECTED mode with RRC inactive indication will only be performed for the events 1) to 6) defined in subclause 4.5.1.

The UE shall handle the operator-defined access category definitions stored for the RPLMN as specified in subclause 5.4.4.3, subclause 5.5.1.2.4, and subclause 5.5.1.3.4.

When the UE is switched off, the UE shall keep the operator-defined access category definitions so that the operator-defined access category definitions can be used after switch on.

When the UE selects a new PLMN which is not equivalent to the previously selected PLMN, the UE shall stop using the operator-defined access category definitions stored for the previously selected PLMN and should keep the operator-defined access category definitions stored for the previously selected PLMN.

NOTE 2: When the UE selects a new PLMN which is not equivalent to the previously selected PLMN, the UE can delete the operator-defined access category definitions stored for the previously selected PLMN e.g. if there is no storage space in the UE.

## 4.5.4 Access control and checking

### 4.5.4.1 Access control and checking in 5GMM-IDLE mode

When the UE is in 5GMM-IDLE mode, upon receiving a request from the upper layers for an access attempt, the NAS shall categorize the access attempt into access identities and an access category following subclause 4.5.2, table 4.5.2.1 and table 4.5.2.2, and subclause 4.5.3, and provide the applicable access identities and the access category to the lower layers for the purpose of access control checking. In this request to the lower layer the NAS can also provide to the lower layer the RRC establishment cause determined as specified in subclause 4.5.6 of this specification.

NOTE 1: The access barring check is performed by the lower layers.

NOTE 2: As an implementation option, the NAS can provide the RRC establishment cause to the lower layers after being informed by the lower layers that the access attempt is allowed.

If the UE has uplink user data pending for one or more PDU sessions when it builds a REGISTRATION REQUEST or SERVICE REQUEST message as initial NAS message, the UE shall indicate the respective PDU sessions in the Uplink data status IE as specified in subclause 5.5.1.3.2 and 5.6.1.2, regardless of the access category for which the access barring check is performed.

NOTE 3: The UE indicates pending user data for all the respective PDU sessions, even if barring timers are running for some of the corresponding access categories.

If the lower layers indicate that the access attempt is allowed, the NAS shall initiate the procedure to send the initial NAS message for the access attempt.

If the lower layers indicate that the access attempt is barred, the NAS shall not initiate the procedure to send the initial NAS message for the access attempt. Additionally:

- a) if the event which triggered the access attempt was an MO-MMTEL-voice-call-started indication or an MO-MMTEL-video-call-started indication:
  - 1) if the UE is operating in the single-registration mode and the UE's usage setting is "voice centric", the UE may attempt to select an E-UTRA cell connected to EPC. If the UE finds a suitable E-UTRA cell connected to EPC, it then proceeds with the appropriate EMM specific procedures and, if necessary, ESM procedures to make a PDN connection providing access to IMS available; see subclause 4.8.2 and 3GPP TS 24.301 [15];
  - 2) if the UE is operating in the dual-registration mode, the UE may proceed in S1 mode with the appropriate EMM specific procedures and ESM procedures to make a PDN connection providing access to IMS available; see subclause 4.8.3 and 3GPP TS 24.301 [15];
  - 3) otherwise, the NAS shall notify the upper layers that the access attempt is barred. In this case, upon receiving an indication from the lower layers that the barring is alleviated for the access category with which the access attempt was associated, the NAS shall notify the upper layers that the barring is alleviated for the access category and may initiate the procedure to send the initial NAS message, if still needed; and
- b) if the event which triggered the access attempt was an MO-SMSoIP-attempt-started indication:
  - 1) if the UE is operating in the single-registration mode, the UE may attempt to select an E-UTRA cell connected to EPC. If the UE finds a suitable E-UTRA cell connected to EPC, it then proceeds with the appropriate EMM specific procedures and, if necessary, ESM procedures to make a PDN connection providing access to IMS available; see subclause 4.8.2 and 3GPP TS 24.301 [15];
  - 2) if the UE is operating in the dual-registration mode, the UE may proceed in S1 mode with the appropriate EMM specific procedures and ESM procedures to make a PDN connection providing access to IMS available; see subclause 4.8.3 and 3GPP TS 24.301 [15];
  - 3) otherwise, the NAS layer shall notify the upper layers that the access attempt is barred. In this case, upon receiving an indication from the lower layers that the barring is alleviated for the access category with which the access attempt was associated, the NAS shall notify the upper layers that the barring is alleviated for the access category and may initiate the procedure to send the initial NAS message, if still needed.

NOTE 4: Barring timers, on a per access category basis, are run by the lower layers. At expiry of barring timers, the indication of alleviation of access barring is indicated to the NAS on a per access category basis.

#### 4.5.4.2 Access control and checking in 5GMM-CONNECTED mode and in 5GMM-CONNECTED mode with RRC inactive indication

When the UE is in 5GMM-CONNECTED mode or 5GMM-CONNECTED mode with RRC inactive indication, upon detecting one of events 1) through 6) listed in subclause 4.5.1, the NAS shall categorize the corresponding access attempt into access identities and an access category following subclause 4.5.2, table 4.5.2.1 and table 4.5.2.2, and subclause 4.5.2.3, and provide the access identities and the access category to the lower layers for the purpose of access control checking. In this request to the lower layer the NAS can also provide to the lower layer the RRC establishment cause determined as specified in subclause 4.5.6 of this specification.

NOTE 1: As an implementation option, the NAS can provide the RRC establishment cause to the lower layers after being informed by the lower layers that the access attempt is allowed.

If the UE has uplink user data pending for one or more PDU sessions when it builds a REGISTRATION REQUEST or SERVICE REQUEST message for the access attempt, the UE shall indicate the respective PDU sessions in the Uplink data status IE as specified in subclause 5.5.1.3.2 and 5.6.1.2, regardless of the access category for which the access barring check is performed.

NOTE 2: The UE indicates pending user data for all the respective PDU sessions, even if barring timers are running for some of the corresponding access categories.

If the lower layers indicate that the access attempt is allowed, the NAS shall take the following action depending on the event which triggered the access attempt:

- a) if the event which triggered the access attempt was an MO-MMTEL-voice-call-started indication, an MO-MMTEL-video-call-started indication or an MO-SMSoIP-attempt-started indication, the NAS shall notify the upper layers that the access attempt is allowed;
- b) if the event which triggered the access attempt was a request from upper layers to send a mobile originated SMS over NAS, 5GMM shall initiate the NAS transport procedure as specified in subclause 5.4.5 to send the SMS in an UL NAS TRANSPORT message;
- c) if the event which triggered the access attempt was a request from upper layers to establish a new PDU session, 5GMM shall initiate the NAS transport procedure as specified in subclause 5.4.5 to send the PDU SESSION ESTABLISHMENT REQUEST message;
- d) if the event which triggered the access attempt was a request from upper layers to modify an existing PDU session, 5GMM shall initiate the NAS transport procedure as specified in subclause 5.4.5 to send the PDU SESSION MODIFICATION REQUEST message;
- e) if the event which triggered the access attempt was a request to re-establish the user-plane resources for an existing PDU session, 5GMM shall initiate the service request procedure as specified in subclause 5.6.1; and
- f) if the event which triggered the access attempt was an uplink user data packet to be sent for a PDU session with suspended user-plane resources, 5GMM shall consider that the uplink user data packet is allowed to be sent.

If the lower layers indicate that the access attempt is barred, the NAS shall take the following action depending on the event which triggered the access attempt:

- a) if the event which triggered the access attempt was an MO-MMTEL-voice-call-started indication, an MO-MMTEL-video-call-started indication or an MO-SMSoIP-attempt-started indication:
  - 1) if the UE is operating in the dual-registration mode, the UE may proceed in S1 mode with the appropriate EMM specific procedures and ESM procedures to make a PDN connection providing access to IMS available; see subclause 4.8.3 and 3GPP TS 24.301 [15];
  - 2) otherwise, the NAS shall notify the upper layers that the access attempt is barred. In this case, upon receiving an indication from the lower layers that the barring is alleviated for the access category with which the access attempt was associated, the NAS shall notify the upper layers that the barring is alleviated for the access category;

NOTE 3: In this case prohibiting the initiation of the MMTEL voice session, MMTEL video session or prohibiting sending of the SMS over IP is performed by the upper layers.

- b) if the event which triggered the access attempt was a request from upper layers to send a mobile originated SMS over NAS, 5GMM shall not initiate the NAS transport procedure as specified in subclause 5.4.5 to send the SMS in an UL NAS TRANSPORT message. Upon receiving an indication from the lower layers that the barring is alleviated for the access category with which the access attempt was associated, 5GMM may initiate the NAS transport procedure as specified in subclause 5.4.5 to send the SMS in an UL NAS TRANSPORT message, if still needed;
- c) if the event which triggered the access attempt was a request from upper layers to establish a new PDU session, 5GMM shall not initiate the NAS transport procedure to send the PDU SESSION ESTABLISHMENT REQUEST message. Upon receiving an indication from the lower layers that the barring is alleviated for the access category with which the access attempt was associated, the NAS may initiate the NAS transport procedure as specified in subclause 5.4.5, if still needed;
- d) if the event which triggered the access attempt was a request from upper layers to modify an existing PDU session modification, 5GMM shall not initiate the NAS transport procedure to send the PDU SESSION MODIFICATION REQUEST message. Upon receiving an indication from the lower layers that the barring is alleviated for the access category with which the access attempt was associated, the NAS may initiate the NAS transport procedure as specified in subclause 5.4.5, if still needed;
- e) if the event which triggered the access attempt was a request to re-establish the user-plane resources for an existing PDU session, the NAS shall not initiate the service request procedure as specified in subclause 5.6.1. Upon receiving an indication from the lower layers that the barring is alleviated for the access category with

which the access attempt was associated, the NAS may initiate the service request procedure as specified in subclause 5.6.1, if still needed; and

- f) if the event which triggered the access attempt was an uplink user data packet to be sent for a PDU session with suspended user-plane resources, 5GMM shall consider that the uplink user data packet is not allowed to be sent. Upon receiving an indication from the lower layers that the barring is alleviated for the access category with which the access attempt was associated, the NAS shall consider that the barring is alleviated for the access category.

#### 4.5.5 Exception handling and avoiding double barring

Access attempts are allowed to proceed without further access control checking in order to avoid double barring for any service request or registration procedure initiated for the purpose of NAS signalling connection recovery or following a fallback indication from the lower layers (see subclauses 5.3.1.2 and 5.3.1.4). For any service request or registration procedure of this kind the UE determines an access category as specified in subclause 4.5.1 and 4.5.2, unless a different access category is specified in the rest of the present subclause.

NOTE 1: Although the access control checking is skipped, the access category is determined for the specific access attempt in order to derive an RRC establishment cause.

There are several services for which the NAS needs to be informed when the service starts and stops,

- because, while the service is ongoing, the mapping of other access attempts to a specific access category can be affected; and
- in order to avoid double barring at the start of these services.

These services are:

- a) emergency service;
- b) MMTEL voice;
- c) MMTEL video;
- d) SMS over IP; and
- e) SMS over NAS.

The UE considers an emergency service a) as started when 5GMM receives a request from upper layers to register for emergency services or to establish a PDU session with request type = "initial emergency request" or "existing emergency PDU session". It considers the emergency service as stopped when this PDU session is released.

In addition, the UE considers an emergency service a) as started when the 5GMM receives a request for emergency services fallback from the upper layer and performs emergency services fallback as specified in subclause 4.13.4.2 of 3GPP TS 23.502 [9]. In this case, the UE considers the emergency service as stopped when:

- the emergency PDU session established during the emergency services fallback is released if the UE has moved to an E-UTRA cell connected to 5GCN; or
- the service request procedure involved in the emergency services fallback is completed otherwise.

While an emergency service a) is ongoing, any access attempt triggered by the initiation of a registration, de-registration or service request procedure or by an uplink user data packet to be sent for a PDU session with suspended user-plane resources is mapped to access category 2 = emergency.

Once the emergency service has successfully passed access control, then as long as the service is ongoing, the following access attempts are allowed to proceed without further access control checking in order to avoid double barring:

- any service request procedure related to the PDU session associated with request type = "initial emergency request" or "existing emergency PDU session"; and
- any uplink user data packet to be sent for a PDU session with suspended user-plane resources associated with request type = "initial emergency request" or "existing emergency PDU session".

NOTE 2: Although the access control checking is skipped, the mapping is performed in order to derive an RRC establishment cause.

For services b) to e) the 5GMM receives explicit start and stop indications from the upper layers.

Once the service has successfully passed access control, then as long as the service is ongoing, the following access attempts are allowed to proceed without further access control checking in order to avoid double barring:

- for services b), c) and d):
  - 1) any service request procedure related to the PDU session established for DNN = "IMS" except between receiving from the lower layers an indication that access barring is applicable for all access categories except categories 0 and 2 and receiving from the lower layers an indication that the barring is alleviated for the access category determined for the access attempt; and
  - 2) any uplink user data packet to be sent for a PDU session with suspended user-plane resources established for DNN = "IMS" except between receiving from the lower layers an indication that access barring is applicable for all access categories except categories 0 and 2 and receiving from the lower layers an indication that the barring is alleviated for the access category determined for the access attempt;
- for service d), if the upper layers have indicated a DNN used for SMSoIP and the indicated DNN used for SMSoIP is different from "IMS":
  - 1) any service request procedure related to the PDU session established for the DNN used for SMSoIP except between receiving from the lower layers an indication that access barring is applicable for all access categories except categories 0 and 2 and receiving from the lower layers an indication that the barring is alleviated for access category 6; and
  - 2) any uplink user data packet to be sent for a PDU session with suspended user-plane resources established for the DNN used for SMSoIP except between receiving from the lower layers an indication that access barring is applicable for all access categories except categories 0 and 2 and receiving from the lower layers an indication that the barring is alleviated for access category 6.

While an MMTEL voice call is ongoing:

- any service request procedure related to the PDU session established for DNN = "IMS" is mapped to access category 4;
- any uplink user data packet to be sent for a PDU session with suspended user-plane resources established for DNN = "IMS" is mapped to access category 4; and
- any:
  - 1) service request procedure; or
  - 2) registration procedure;

initiated in 5GMM-IDLE mode for the purpose of NAS signalling connection recovery or following a fallback indication from the lower layers (see subclause 5.3.1.2 and 5.3.1.4) is mapped to access category 4.

While an MMTEL video call is ongoing and no MMTEL voice call is ongoing:

- any service request procedure related to the PDU session established for DNN = "IMS" is mapped to access category 5;
- any uplink user data packet to be sent for a PDU session with suspended user-plane resources established for DNN = "IMS" is mapped to access category 5; and
- any:
  - 1) service request procedure; or
  - 2) registration procedure;

initiated in 5GMM-IDLE mode for the purpose of NAS signalling connection recovery or following a fallback indication from the lower layers (see subclause 5.3.1.2 and 5.3.1.4) is mapped to access category 5.

While an SMSoIP is ongoing, no MMTEL video call is ongoing and no MMTEL voice call is ongoing:

- any service request procedure related to the PDU session established:
  - 1) for DNN = "IMS"; or
  - 2) for the DNN used for SMSoIP, if the upper layers have indicated a DNN used for SMSoIP and the indicated DNN used for SMSoIP is different from "IMS";
 is mapped to access category 6; and
- any uplink user data packet to be sent for a PDU session with suspended user-plane resources established:
  - 1) for DNN = "IMS"; or
  - 2) for the DNN used for SMSoIP, if the upper layers have indicated a DNN used for SMSoIP and the indicated DNN used for SMSoIP is different from "IMS";
 is mapped to access category 6; and
- any:
  - 1) service request procedure; or
  - 2) registration procedure;
 initiated in 5GMM-IDLE mode for the purpose of NAS signalling connection recovery or following a fallback indication from the lower layers (see subclause 5.3.1.2 and 5.3.1.4) is mapped to access category 6.

While an SMS over NAS is ongoing, no SMSoIP is ongoing, no MMTEL video call is ongoing and no MMTEL voice call is ongoing:

- any:
  - 1) service request procedure; or
  - 2) registration procedure;
 initiated in 5GMM-IDLE mode for the purpose of NAS signalling connection recovery or following a fallback indication from the lower layers (see subclause 5.3.1.2 and 5.3.1.4) is mapped to access category 6.

NOTE 3: Although the access control checking is skipped, the mapping is performed in order to derive an RRC establishment cause.

If an access category is determined and the access control checking is skipped, the NAS shall determine the RRC establishment cause from one or more determined access identities and the access category as specified in subclause 4.5.6, the NAS shall initiate the procedure to send the initial NAS message for the access attempt and shall provide the RRC establishment cause to lower layers.

If the UE receives from the lower layers an indication that access barring is applicable for all access categories except categories 0 and 2:

- a) if an MMTEL voice call or MMTEL video call is ongoing:
  - 1) if the UE is operating in the single-registration mode and the UE's usage setting is "voice centric", the UE may attempt to select an E-UTRA cell connected to EPC. If the UE finds a suitable E-UTRA cell connected to EPC, it then proceeds with the appropriate EMM specific procedures and, if necessary, ESM procedures to make a PDN connection providing access to IMS available; see subclause 4.8.2 and 3GPP TS 24.301 [15]; and
  - 2) if the UE is operating in the dual-registration mode, the UE may proceed in S1 mode with the appropriate EMM specific procedures and ESM procedures to make a PDN connection providing access to IMS available; see subclause 4.8.3 and 3GPP TS 24.301 [15]; and
- b) if SMSoIP is ongoing:



- 1) if the UE is operating in the single-registration mode, the UE may attempt to select an E-UTRA cell connected to EPC. If the UE finds a suitable E-UTRA cell connected to EPC, it then proceeds with the appropriate EMM specific procedures and, if necessary, ESM procedures to make a PDN connection providing access to IMS available; see subclause 4.8.2 and 3GPP TS 24.301 [15]; and
- 2) if the UE is operating in the dual-registration mode, the UE may proceed in S1 mode with the appropriate EMM specific procedures and ESM procedures to make a PDN connection providing access to IMS available; see subclause 4.8.3 and 3GPP TS 24.301 [15].

#### 4.5.6 Mapping between access categories/access identities and RRC establishment cause

When 5GMM requests the establishment of a NAS-signalling connection, the RRC establishment cause used by the UE shall be selected according to one or more access identities (see subclause 4.5.2) and the determined access category by checking the rules specified in table 4.5.6.1 and table 4.5.6.2. If the access attempt matches more than one rule, the RRC establishment cause of the lowest rule number shall be used. If the determined access category is an operator-defined access category, then the RRC establishment cause used by the UE shall be selected according to table 4.5.6.1 and table 4.5.6.2 based on one or more access identities (see subclause 4.5.2) and the standardized access category determined for the operator-defined access category as described in subclause 4.5.3.

**Table 4.5.6.1: Mapping table for access identities/access categories and RRC establishment cause when establishing N1 NAS signalling connection via NR connected to 5GCN**

Rule #	Access identities	Access categories	RRC establishment cause is set to
1	1	Any category	mps-PriorityAccess
2	2	Any category	mcs-PriorityAccess
3	11, 15	Any category	highPriorityAccess
4	12,13,14,	Any category	highPriorityAccess
5	0	0 (= MT_acc)	mt-Access
		1 (= delay tolerant)	Not applicable (NOTE 1)
		2 (= emergency)	emergency
		3 (= MO_sig)	mo-Signalling
		4 (= MO MMTel voice)	mo-VoiceCall
		5 (= MO MMTel video)	mo-VideoCall
		6 (= MO SMS and SMSoIP)	mo-SMS
		7 (= MO_data)	mo-Data
NOTE 1: A UE using access category 1 for the access barring check will determine a second access category in the range 3 to 7 that is to be used for determination of the RRC establishment cause. See subclause 4.5.2, table 4.5.2.2, NOTE 6.			
NOTE 2: See subclause 4.5.2, table 4.5.2.1 for use of the access identities of 0, 1, 2, and 11-15.			

**Table 4.5.6.2: Mapping table for access identities/access categories and RRC establishment cause when establishing N1 NAS signalling connection via E-UTRA connected to 5GCN**

Rule #	Access identities	Access categories	RRC establishment cause is set to
1	1	Any category	highPriorityAccess
2	2	Any category	highPriorityAccess
3	11, 15	Any category	highPriorityAccess
4	12,13,14,	Any category	highPriorityAccess
5	0	0 (= MT_acc)	mt-Access
		1 (= delay tolerant)	Not applicable (NOTE 1)
		2 (= emergency)	emergency
		3 (= MO_sig)	mo-Signalling
		4 (= MO MMTel voice)	mo-VoiceCall
		5 (= MO MMTel video)	mo-VoiceCall
		6 (= MO SMS and SMSoIP)	mo-Data
		7 (= MO_data)	mo-Data

<p>NOTE 1: A UE using access category 1 for the access barring check will determine a second access category in the range 3 to 7 that is to be used for determination of the RRC establishment cause. See subclause 4.5.2, table 4.5.2.2, NOTE 6.</p> <p>NOTE 2: See subclause 4.5.2, table 4.5.2.1 for use of the access identities of 0, 1, 2, and 11-15.</p>
---

## 4.6 Network slicing

### 4.6.1 General

The 5GS supports network slicing as described in 3GPP TS 23.501 [8]. Within a PLMN, a network slice is identified by an S-NSSAI, which is comprised of a slice/service type (SST) and a slice differentiator (SD). Inclusion of an SD in an S-NSSAI is optional. A set of one or more S-NSSAIs is called the NSSAI. The following NSSAIs are defined in 3GPP TS 23.501 [8]:

- a) configured NSSAI;
- b) requested NSSAI;
- c) allowed NSSAI; and
- d) subscribed S-NSSAIs;

The following NSSAIs are defined in the present document:

- a) rejected NSSAI for the current PLMN; and
- b) rejected NSSAI for the current registration area.

A serving PLMN may configure a UE with the configured NSSAI per PLMN. In addition, the HPLMN may configure a UE with a single default configured NSSAI, and consider the default configured NSSAI as valid in a PLMN for which the UE has neither a configured NSSAI nor an allowed NSSAI.

The allowed NSSAI and rejected NSSAI for the current registration area are managed per access type independently, i.e. 3GPP access or non-3GPP access, and is applicable for the registration area. If the registration area contains TAIs belonging to different PLMNs, which are equivalent PLMNs, the allowed NSSAI and the rejected NSSAI for the current registration area are applicable to these PLMNs in this registration area.

The rejected NSSAI for the current PLMN is applicable for the whole registered PLMN, where the registration area shall only contain TAIs belonging to the registered PLMN.

### 4.6.2 Mobility management aspects

#### 4.6.2.1 General

Upon registration to a PLMN, the UE shall send to the AMF the requested NSSAI which includes one or more S-NSSAIs of the allowed NSSAI for the PLMN or the configured NSSAI and corresponds to the network slice(s) to which the UE intends to register with, if:

- a) the UE has a configured NSSAI for the current PLMN;
- b) the UE has an allowed NSSAI for the current PLMN; or
- c) the UE has neither allowed NSSAI for the current PLMN nor configured NSSAI for the current PLMN and has a default configured NSSAI. In this case the UE indicates to the AMF that the requested NSSAI is created from the default configured NSSAI;

If the UE has neither a configured NSSAI nor an allowed NSSAI valid for a PLMN and does not have any default configured NSSAI, the UE does not send a requested NSSAI when requesting registration towards the PLMN. In roaming scenarios, the UE shall also provide the mapped S-NSSAI(s) for the requested NSSAI, if available. The AMF verifies if the requested NSSAI is permitted based on the subscribed S-NSSAIs in the UE subscription and optionally the mapped S-NSSAI(s) provided by the UE, and if so then the AMF shall provide the UE with the allowed NSSAI for

the PLMN, and shall also provide the UE with the mapped S-NSSAI(s) for the allowed NSSAI for the PLMN if available. The AMF shall ensure that there are no two or more S-NSSAIs of the allowed NSSAI which are mapped to the same S-NSSAI of the HPLMN. The AMF may also query the NSSF to determine the allowed NSSAI for a given registration area as defined in 3GPP TS 23.501 [8].

The set of network slice(s) for a UE can be changed at any time while the UE is registered to a PLMN, and the change may be initiated by the network, or the UE. In this case, the allowed NSSAI and associated registration area may be changed during the registration procedure. The network may notify the UE of the change of the supported network slice(s) in order to trigger the registration procedure. Change in the allowed NSSAI may lead to AMF relocation subject to operator policy. See subclause 5.4.4 describing the generic UE configuration update procedure for further details.

#### 4.6.2.2 NSSAI storage

If available, the configured NSSAI(s) shall be stored in a non-volatile memory in the ME as specified in annex C.

Each of the configured NSSAI stored in the UE is a set composed of at most 16 S-NSSAIs. Each of the allowed NSSAI stored in the UE is a set composed of at most 8 S-NSSAIs and is associated with a PLMN identity and an access type. Each of the configured NSSAI except the default configured NSSAI, and the rejected NSSAI is associated with a PLMN identity. The S-NSSAI(s) in the rejected NSSAI for the current registration area are further associated with a registration area where the rejected S-NSSAI(s) is not available. The S-NSSAI(s) in the rejected NSSAI for the current PLMN shall be considered rejected for the current PLMN regardless of the access type. There shall be no duplicated PLMN identities in each of the list of configured NSSAI(s), allowed NSSAI(s), rejected NSSAI(s) for the current PLMN, and rejected NSSAI(s) for the current registration area.

The UE stores NSSAIs as follows:

- a) The configured NSSAI shall be stored until a new configured NSSAI is received for a given PLMN. The network may provide to the UE the mapped S-NSSAI(s) for the new configured NSSAI which shall also be stored in the UE. When the UE is provisioned with a new configured NSSAI for a PLMN, the UE shall:
  - 1) replace any stored configured NSSAI for this PLMN with the new configured NSSAI for this PLMN;
  - 2) delete any stored mapped S-NSSAI(s) for the configured NSSAI and, if available, store the mapped S-NSSAI(s) for the new configured NSSAI;
  - 3) delete any stored allowed NSSAI for this PLMN and, if available, the stored mapped S-NSSAI(s) for the allowed NSSAI, if the UE received the new configured NSSAI for this PLMN and the "registration requested" indication in the same CONFIGURATION UPDATE COMMAND message but without any new allowed NSSAI for this PLMN included; and
  - 4) delete any rejected NSSAI for the current PLMN, and rejected NSSAI for the current registration area.

If the UE receives an S-NSSAI associated with a PLMN ID from the network during the PDN connection establishment procedure in EPS as specified in 3GPP TS 24.301 [15], the UE may store the received S-NSSAI in the configured NSSAI for the PLMN identified by the PLMN ID associated with the S-NSSAI, if not already in the configured NSSAI;

The UE may continue storing a received configured NSSAI for a PLMN and associated mapped S-NSSAI(s), if available, when the UE registers in another PLMN.

NOTE 1: The maximum number of configured NSSAIs and associated mapped S-NSSAIs for PLMNs other than the HPLMN that need to be stored in the UE, and how to handle the stored entries, are up to UE implementation.

- b) The allowed NSSAI shall be stored until a new allowed NSSAI is received for a given PLMN. The network may provide to the UE the mapped S-NSSAI(s) for the new allowed NSSAI (see subclauses 5.5.1.2 and 5.5.1.3) which shall also be stored in the UE. When a new allowed NSSAI for a PLMN is received, the UE shall:
  - 1) replace any stored allowed NSSAI for this PLMN with the new allowed NSSAI for this PLMN;
  - 2) delete any stored mapped S-NSSAI(s) for the allowed NSSAI and, if available, store the mapped S-NSSAI(s) for the new allowed NSSAI; and
  - 3) remove from the stored rejected NSSAI, the rejected S-NSSAI(s), if any, included in the new allowed NSSAI for the current PLMN;

If the UE receives the CONFIGURATION UPDATE COMMAND message indicating "registration requested" and contains no other parameters (see subclauses 5.4.4.2 and 5.4.4.3), the UE shall delete any stored allowed NSSAI for this PLMN, and delete any stored mapped S-NSSAI(s) for the allowed NSSAI, if available;

NOTE 2: Whether the UE stores the allowed NSSAI and the mapped S-NSSAI(s) for the allowed NSSAI also when the UE is switched off is implementation specific.

- c) When the UE receives the S-NSSAI(s) included in rejected NSSAI in the REGISTRATION ACCEPT message or in the CONFIGURATION UPDATE COMMAND message, the UE shall:
- 1) store the S-NSSAI(s) into the rejected NSSAI based on the associated rejection cause(s);
  - 2) remove from the stored allowed NSSAI for the current PLMN, the rejected S-NSSAI(s), if any, included in the:
    - i) rejected NSSAI for the current PLMN, for each and every access type; and
    - ii) rejected NSSAI for the current registration area, associated with the same access type;

Once the UE is deregistered over all access types, the rejected NSSAI for the current PLMN shall be deleted. Once the UE is deregistered over an access type, the rejected NSSAI for the current registration area corresponding to the access type shall be deleted. The UE shall delete, if any, the stored rejected NSSAI for the current registration area if the UE moves out of the registration area; and

- d) When the UE receives the Network slicing indication IE with the Network slicing subscription change indication set to "Network slicing subscription changed" in the REGISTRATION ACCEPT message or in the CONFIGURATION UPDATE COMMAND message, the UE shall delete the network slicing information for each of the PLMNs that the UE has slicing information stored for (excluding the current PLMN). The UE shall not delete the default configured NSSAI. Additionally, the UE shall update the network slicing information for the current PLMN (if received) as specified above in bullets a), b) and c):

#### 4.6.2.3 Provision of NSSAI to lower layers in 5GMM-IDLE mode

The UE NAS layer may provide the lower layers with an NSSAI (either requested NSSAI or allowed NSSAI) when the UE in 5GMM-IDLE mode sends an initial NAS message.

The AMF may indicate, via the NSSAI inclusion mode IE of a REGISTRATION ACCEPT message, an NSSAI inclusion mode in which the UE shall operate over the current access within the current PLMN, if any (see subclauses 5.5.1.2.4 and 5.5.1.3.4), where the NSSAI inclusion mode is chosen among the following NSSAI inclusion modes described in table 4.6.2.3.1.

**Table 4.6.2.3.1: NSSAI inclusion modes and NSSAI which shall be provided to the lower layers**

Initial NAS message	NSSAI inclusion mode A	NSSAI inclusion mode B	NSSAI inclusion mode C	NSSAI inclusion mode D
REGISTRATION REQUEST message: i) including the 5GS registration type IE set to "initial registration"	Requested NSSAI	Requested NSSAI	Requested NSSAI	No NSSAI
REGISTRATION REQUEST message: i) including the 5GS registration type IE set to "mobility registration updating"; and ii) initiated by case other than case g) or n) in subclause 5.5.1.3.2	Requested NSSAI	Requested NSSAI	Requested NSSAI	No NSSAI
REGISTRATION REQUEST message: i) including the 5GS registration type IE set to "mobility registration updating"; and ii) initiated by case g) or n) in subclause 5.5.1.3.2	Allowed NSSAI	Allowed NSSAI	No NSSAI	No NSSAI
REGISTRATION REQUEST message: i) including the 5GS registration type IE set to "periodic registration updating"	Allowed NSSAI	Allowed NSSAI	No NSSAI	No NSSAI
SERVICE REQUEST message	Allowed NSSAI	See NOTE 1	No NSSAI	No NSSAI
<p>NOTE 1: All the S-NSSAIs of the PDU sessions that have the user-plane resources requested to be re-established by the service request procedure or the S-NSSAIs of a control plane interaction triggering the service request is related to (see 3GPP TS 23.501 [8])</p> <p>NOTE 2: For a REGISTRATION REQUEST message including the 5GS registration type IE set to "emergency registration" and a DEREGISTRATION REQUEST message, no NSSAI is provided to the lower layers.</p> <p>NOTE 3: The mapped configured S-NSSAI(s) from the S-NSSAI(s) of the HPLMN are not included as part of the S-NSSAIs in the requested NSSAI or the allowed NSSAI when it is provided to the lower layers.</p>				

The UE shall store the NSSAI inclusion mode:

- a) indicated by the AMF, if the AMF included the NSSAI inclusion mode IE in the REGISTRATION ACCEPT message; or
- b) decided by the UE, if the AMF did not include the NSSAI inclusion mode IE in the REGISTRATION ACCEPT message;

together with the identity of the current PLMN and access type in a non-volatile memory in the ME as specified in annex C.

The UE shall apply the NSSAI inclusion mode received in the REGISTRATION ACCEPT message over the current access within the current PLMN and its equivalent PLMN(s), if any, in the current registration area.

When a UE performs a registration procedure to a PLMN which is not a PLMN in the current registration area, if the UE has no NSSAI inclusion mode for the PLMN stored in a non-volatile memory in the ME, the UE shall provide the lower layers with:

- a) no NSSAI if the UE is performing the registration procedure over 3GPP access; or
- b) requested NSSAI if the UE is performing the registration procedure over non-3GPP access.

When a UE performs a registration procedure after an inter-system change from S1 mode to N1 mode, if the UE has no NSSAI inclusion mode for the PLMN stored in a non-volatile memory in the ME and the registration procedure is performed over 3GPP access, the UE shall not provide the lower layers with any NSSAI over the 3GPP access.

### 4.6.3 Session management aspects

In order to enable PDU transmission in a network slice, the UE may request establishment of a PDU session in a network slice towards a data network (DN) which is associated with an S-NSSAI and a data network name (DNN) if there is no established PDU session adequate for the PDU transmission. The S-NSSAI included is part of allowed NSSAI of the serving PLMN, which is an S-NSSAI value valid in the serving PLMN, and in roaming scenarios the mapped S-NSSAI is also included for the PDU session if available. See subclause 6.4.1 for further details. The UE determines whether to establish a new PDU session or use one of the established PDU session(s) based on the URSP rules which include S-NSSAIs, if any (see subclause 6.2.9), or based on UE local configuration, as described in subclause 4.2.2 of 3GPP TS 24.526 [19].

## 4.7 NAS over non-3GPP access

### 4.7.1 General

From the UE's NAS perspective, in general the procedures and messages defined for 5GMM and 5GSM are used over non-3GPP access as over 3GPP access. However, a number of aspects are different as described in the following subclauses.

### 4.7.2 5GS mobility management aspects

#### 4.7.2.1 General

The mobility management procedures defined over 3GPP access are re-used over non-3GPP access with the following exceptions:

- a) the registration status, and the 5GMM parameters of the UE's 3GPP access and non-3GPP access 5GMM state machine instances are independent in each of these accesses and can be different;
- b) single-registration mode and dual-registration mode do not apply for 5GMM over non-3GPP access;
- c) the RPLMN over non-3GPP access can be different from the RPLMN over 3GPP access. The MCC of the RPLMN over 3GPP access and the MCC of the RPLMN over the non-3GPP access can also be different;
- d) the registration for 3GPP access and for non-3GPP access are performed separately. Like for 3GPP access, an access stratum connection exists before the UE can perform the registration procedure for non-3GPP access. As over non-3GPP access the 5GS operates one single common registration area for an entire PLMN, which is associated with the operator-specific N3GPP TAI for the PLMN, list management of registration areas is not required, and registration updating due to registration area change with the registered PLMN is not performed. Furthermore, the periodic registration update procedure is also not performed. New registration at change of PLMN is required;
- e) the 5GMM over non-3GPP access in the UE considers that the N1 NAS signalling connection is established when the lower layers indicate that the access stratum connection is established successfully;
- f) the UE-initiated service request procedure via non-3GPP access is supported. Upon indication from the lower layers of non-3GPP access, that the access stratum connection is established between the UE and the network, the UE in 5GMM-REGISTERED state and in 5GMM-IDLE mode over non-3GPP access shall initiate the service request procedure via non-3GPP access. The UE may indicate with the service request message the PDU session(s) associated with non-3GPP access to re-establish user-plane resources for which the UE has pending user data to be sent;
- g) paging procedure is not performed via non-3GPP access;
- h) service area restrictions do not apply for non-3GPP access;
- i) the establishment cause for non-3GPP access is determined according to subclause 4.7.2.2;
- j) eCall inactivity procedure is not performed via non-3GPP access;
- k) local area data network (LADN) do not apply for non-3GPP access;

- l) Allowed PDU session IE shall not be included in REGISTRATION REQUEST message or SERVICE REQUEST message sent over non-3GPP access;
- m) DRX parameters does not apply for non-3GPP access; and
- n) Mobile initiated connection only mode (MICO) does not apply for non-3GPP access.

#### 4.7.2.2 Establishment cause for non-3GPP access

When establishment of an N1 NAS signalling connection over non-3GPP access is initiated, the UE shall determine one or more access identities to be associated with the establishment of the N1 NAS signalling connection as specified in subclause 4.5.2 and table 4.5.2.1, shall select the establishment cause for non-3GPP access from the determined one or more access identities and the event which triggered initiation of the N1 NAS signalling connection over non-3GPP access by checking the rules specified in table 4.7.2.2.1 and shall provide the selected establishment cause for non-3GPP access to the lower layers. If the access attempt matches more than one rule, the establishment cause for non-3GPP access of the lowest rule number shall be used.

**Table 4.7.2.2.1: Mapping table for determination of establishment cause for non-3GPP access**

Rule #	Access identities	Type of access attempt	Requirements to be met	Establishment cause for non-3GPP access
1	1	Any	Any	mps-PriorityAccess
2	2	Any	Any	mcs-PriorityAccess
3	11, 15	Any	Any	highPriorityAccess
4	12,13,14,	Any	Any	highPriorityAccess
5	0	Emergency	UE is attempting access for an emergency session (NOTE 1)	emergency
		UE NAS initiated 5GMM specific procedures	Access attempt is for MO signalling	mo-Signalling
		UE NAS initiated 5GMM connection management procedures or 5GMM NAS transport procedure	Access attempt is for MO data	mo-Data
NOTE 1: This includes 5GMM specific procedures while the service is ongoing and 5GMM connection management procedures required to establish a PDU session with request type = "initial emergency request" or "existing emergency PDU session", or to re-establish user-plane resources for such a PDU session.				
NOTE 2: See subclause 4.5.2, table 4.5.2.1 for use of the access identities of 0, 1, 2, and 11-15.				

#### 4.7.3 5GS session management aspects

The session management procedures defined over 3GPP access are re-used over non-3GPP access.

#### 4.7.4 Limited service state over non-3GPP access

There are a number of situations in which the UE is unable to obtain normal service from a PLMN over non-3GPP access and the UE enters the limited service state over non-3GPP access. These include:

- a) no USIM in the ME;
- b) an "illegal UE" or "illegal ME" response is received when registration or service request is performed (any USIM in the ME is then considered "invalid");
- c) a "5GS services not allowed" response is received when a registration or service request is performed;
- d) a "PLMN not allowed" response is received when registration or service request is performed;
- e) a "Tracking area not allowed" response is received when a registration or service request is performed;

- f) a "Roaming not allowed in this tracking area" response is received when a registration or service request is performed; or
- g) a "No suitable cells in tracking area" response is received when a registration or service request is performed.

In limited service state with a valid USIM in the UE, the network selection is performed as defined in 3GPP TS 24.502 [18].

With the exception of performing initial registration for emergency services, no registration requests are made until a valid USIM is present. For registration for emergency services, the PLMN of the current N3IWF is considered as the selected PLMN for the duration the UE is registered for emergency services.

## 4.8 Interworking with E-UTRAN connected to EPC

### 4.8.1 General

In order to interwork with E-UTRAN connected to EPC, the UE supporting both S1 mode and N1 mode can operate in single-registration mode or dual-registration mode (see 3GPP TS 23.501 [8]). Support of single-registration mode is mandatory for UEs supporting both S1 mode and N1 mode.

During the EPS attach procedure (see 3GPP TS 24.301 [15]) or initial registration procedure (see subclause 5.5.1.2), the mode for interworking is selected if the UE supports both S1 mode and N1 mode, and the network supports interworking. The mode for interworking may also be selected during the EPS tracking area updating procedure (see 3GPP TS 24.301 [15]) or registration procedure for mobility and periodic registration update (see subclause 5.5.1.3).

For interworking between E-UTRAN connected to EPC and N3IWF connected to 5GCN, the UE shall operate as specified in either subclause 4.8.2.3 or subclause 4.8.3. Which subclause the UE follows is chosen by the UE irrespective of the interworking without N26 interface indicator.

### 4.8.2 Single-registration mode

#### 4.8.2.1 General

If the UE receives the indication that "interworking without N26 interface not supported" (see 3GPP TS 24.301 [15]), the UE operates as described in subclause 4.8.2.2.

If the UE receives the indication that "interworking without N26 interface supported" and

- a) the UE does not support dual-registration mode; or
- b) the UE supporting dual-registration mode determines to operate in single-registration mode,

the UE operates as described in subclause 4.8.2.3.

#### 4.8.2.2 Single-registration mode with N26 interface

See subclause 5.1.4.2 for coordination between 5GMM and EMM and subclause 6.1.4.1 for coordination between 5GSM and ESM.

#### 4.8.2.3 Single-registration mode without N26 interface

##### 4.8.2.3.1 Interworking between NG-RAN and E-UTRAN

At inter-system change from N1 mode to S1 mode in EMM-IDLE mode when:

- a) the UE supports non-IP PDN type and at least one PDU session is active; or
- b) the UE does not support non-IP PDN type and at least one PDU session of IPv4, IPv6 or IPv4v6 PDU session type is active,

the UE shall proceed as follows:



- a) if the UE supports sending an ATTACH REQUEST message containing a PDN CONNECTIVITY REQUEST message with request type set to "handover" to transfer a PDU session from N1 mode to S1 mode and the UE has received an "interworking without N26 interface supported" indication from the network, the UE shall:
  - 1) enter substates EMM-DEREGISTERED.NORMAL-SERVICE and 5GMM-REGISTERED.NO-CELL-AVAILABLE;
  - 2) map the PDU session(s) which the UE intends to transfer to EPS to the default EPS bearer context of the corresponding PDN connection(s) as specified in subclause 6.1.4.2; and
  - 3) initiate an EPS attach procedure and include a PDN CONNECTIVITY REQUEST message with request type set to "handover" in the ATTACH REQUEST message to activate a default EPS bearer context for one of the active PDU sessions which the UE intends to transfer to EPS.

After successful completion of the EPS attach procedure, the UE shall reset the registration attempt counter and the attach attempt counter (see 3GPP TS 24.301 [15]) and attempt to activate each of the other default EPS bearer contexts, if any, by initiating a stand-alone PDN connectivity procedure with request type set to "handover" in the PDN CONNECTIVITY REQUEST message; and

- b) otherwise, enter substates EMM-REGISTERED.NORMAL-SERVICE and 5GMM-REGISTERED.NO-CELL-AVAILABLE and initiate a tracking area update procedure (see 3GPP TS 24.301 [15]).

At inter-system change from N1 mode to S1 mode in EMM-IDLE mode when:

- a) the UE supports non-IP PDN type and no PDU session is active; or
- b) the UE does not support non-IP PDN type and no PDU session of IPv4, IPv6 or IPv4v6 PDU session type is active,

the UE shall enter substates EMM-DEREGISTERED.NORMAL-SERVICE and 5GMM-DEREGISTERED.NO-CELL-AVAILABLE, and initiate an attach procedure.

At inter-system change from S1 mode to N1 mode in 5GMM-IDLE mode, the UE shall:

- a) enter substate 5GMM-REGISTERED.NORMAL-SERVICE and substate EMM-REGISTERED.NO-CELL-AVAILABLE;
- b) map the default EPS bearer context(s) of the PDN connection(s) which the UE intends to transfer to 5GS, if any, to the corresponding PDU session(s) as specified in subclause 6.1.4.2; and
- c) initiate the registration procedure for mobility and periodic registration update indicating "mobility registration updating" in the 5GS registration type IE of the REGISTRATION REQUEST message (see subclause 5.5.1.3).

After having successfully registered in N1 mode the UE shall reset the registration attempt counter and the attach attempt counter (see 3GPP TS 24.301 [15]) and:

- a) if the UE supports the PDU session establishment procedure with request type set to "existing PDU session" to transfer a PDN connection from S1 mode to N1 mode and the UE has received an "interworking without N26 interface supported" indication from the network, attempt to transfer the PDN connection(s) which the UE intends to transfer to 5GS, if any, from S1 mode to N1 mode by initiating the PDU session establishment procedure with request type set to "existing PDU session"; and
- b) otherwise, establish PDU session(s) corresponding to the PDN connection(s) which the UE intends to transfer to 5GS, if any, by initiating the PDU session establishment procedure with request type set to "initial request".

See subclause 5.1.4.3 for coordination between 5GMM and EMM and subclause 6.1.4.2 for coordination between 5GSM and ESM.

#### 4.8.2.3.2 Interworking between N3IWF connected to 5GCN and E-UTRAN

If:

- a) the UE has registered in neither N1 mode over 3GPP access nor S1 mode yet; and
- b) the UE has at least one active PDU session associated with non-3GPP access which the UE intends to transfer to EPS,

the UE shall initiate an EPS attach procedure and include a PDN CONNECTIVITY REQUEST message with request type set to "handover" in the ATTACH REQUEST message to activate a default EPS bearer context for one of the active PDU sessions which the UE intends to transfer to EPS (see 3GPP TS 24.301 [15]).

NOTE 1: It is necessary for the UE to support sending an ATTACH REQUEST message containing a PDN CONNECTIVITY REQUEST message with request type set to "handover" to transfer a PDU session from N1 mode to S1 mode for interworking between N3IWF connected to 5GCN and E-UTRAN.

After successful completion of the EPS attach procedure, the UE shall initiate a UE requested PDN connectivity procedure with request type set to "handover" in the PDN CONNECTIVITY REQUEST message to transfer each of the other PDU sessions which the UE intends to transfer to EPS, if any.

If:

- a) the UE has not registered in N1 mode over non-3GPP access yet; and
- b) the UE has at least one active PDN connection which the UE intends to transfer to N3IWF connected to 5GCN,

the UE shall initiate an initial registration procedure over non-3GPP access (see subclause 5.5.1.2).

After successful completion of the 5GS initial registration in N1 mode over non-3GPP access, the UE shall initiate a UE-requested PDU session establishment procedure with request type set to "existing PDU session" to transfer each of the PDN connections which the UE intends to transfer to N3IWF connected to 5GCN, if any.

NOTE 2: If the UE has no active PDU session associated with non-3GPP access which the UE in N1 mode intends to transfer to EPS or no active PDN connection associated with 3GPP access which the UE in S1 mode intends to transfer to N3IWF connected to 5GCN, the interworking between N3IWF connected to 5GCN and E-UTRAN is not supported.

See subclause 6.1.4.2 for coordination between 5GSM and ESM.

### 4.8.3 Dual-registration mode

If both 5GMM and EMM are enabled, a UE, operating in the dual-registration mode shall maintain independent contexts for 5GMM and EMM and this includes independent lists of equivalent PLMNs. Coordination between 5GMM and EMM is not needed, except as specified in the present subclause.

- a) A UE operating in the dual-registration mode may register to N1 mode only, S1 mode only, or to both N1 mode and S1 mode.
- b) When the UE decides to operate in dual-registration mode (see subclause 5.5.1.2.4), NAS informs the lower layers about this.
- c) If a UE is registered in N1 mode only, then for registration in S1 mode it shall use the same PLMN to which it is registered in N1 mode or an equivalent PLMN.
- d) If a UE is registered in S1 mode only, then for registration in N1 mode it shall use the same PLMN to which it is registered in S1 mode or an equivalent PLMN.

NOTE 1: It is up to UE implementation how to handle the case when the UE is registered in both N1 mode and S1 mode and the PLMNs to which the UE is registered, are not equivalent, e.g. search for a PLMN which is the same or equivalent to any of the registered ones.

When no PDU session is active and the UE has not registered to S1 mode yet, the UE may initiate the EPS attach procedure with PDN connection establishment if EMM-REGISTERED without PDN connection is not supported by the MME. If EMM-REGISTERED without PDN connection is supported by the MME, the UE may initiate either the EPS attach procedure without PDN connection establishment or the attach procedure with PDN connection establishment.

When at least one PDU session is active and the UE has not registered to S1 mode yet, the UE may initiate the EPS attach procedure. If necessary, the UE may transfer an active PDU session from N1 mode to S1 mode by initiating the EPS attach procedure with request type set to "handover" in the PDN CONNECTIVITY REQUEST message. After successfully attached in S1 mode, if necessary, the UE may transfer other active PDU sessions from N1 mode to S1 mode by initiating the PDN connectivity procedure with request type set to "handover" in the PDN CONNECTIVITY REQUEST message.

NOTE 2: It is up to UE implementation to determine which active PDU session is transferred from N1 mode to S1 mode.

When the UE has not registered to N1 mode, the UE may initiate the initial registration procedure. After successfully registered in N1 mode, if necessary, the UE may transfer one or more active PDN connections from S1 mode to N1 mode by initiating the PDU session establishment procedure with request type set to "existing PDU session".

NOTE 3: It is up to UE implementation to determine which active PDN connection is transferred from S1 mode to N1 mode.

If the MME supports EMM-REGISTERED without PDN connection, the UE that transferred all PDN connections to the 5GS, may stay in state EMM-REGISTERED. Otherwise, the UE shall enter state EMM-DEREGISTERED upon transferring all PDN connection to the 5GS.

NOTE 4: When the UE has registered in both N1 mode and S1 mode, it is up to UE implementation to maintain the registration update to date in both N1 mode and S1 mode.

See subclause 6.1.4 for coordination between 5GSM and ESM.

See subclause 4.8.2.3.2 for interworking between N3IWF connected to 5GCN and E-UTRAN.

## 4.8.4 Core Network selection

If the UE is capable of both N1 mode and S1 mode, when the UE needs to use one or more functionalities not supported in 5GS but supported in EPS and the UE is in 5GMM-IDLE mode, the UE may disable the N1 mode capability for 3GPP access (see subclause 4.9.2).

If the UE is capable of both N1 mode and S1 mode and lower layers provide an indication that the current E-UTRA cell is connected to both EPC and 5GCN without also providing an indication that a target core network type was received from the NG-RAN, the UE shall select a core network type (EPC or 5GCN) based on the PLMN selection procedures as specified in 3GPP TS 23.122 [5] and provide the selected core network type information to the lower layer during the initial registration procedure.

If the UE is capable of both N1 mode and S1 mode and the lower layers have provided an indication that the current E-UTRA cell is connected to both EPC and 5GCN and an indication of whether the network supports IMS emergency services via either EPC or 5GCN or both (see 3GPP TS 36.331 [25A]), the UE selects a core network type (EPC or 5GCN) as specified in 3GPP TS 23.167 [6] annex H.2 for initiating emergency calls when in the state 5GMM-DEREGISTERED.LIMITED-SERVICE or EMM-DEREGISTERED.LIMITED-SERVICE.

NOTE 1: If the PLMN selection information provisioned in the USIM does not contain any prioritization between E-UTRAN and NG-RAN for a PLMN, which core network type to select for that PLMN is up to UE implementation.

If the UE is capable of both N1 mode and S1 mode and lower layers provide an indication that the current E-UTRA cell is connected to both EPC and 5GCN with:

- 1) an indication that target core network type EPC was received from the NG-RAN, the UE shall select the EPC and proceed with the appropriate EMM procedure as specified in 3GPP TS 24.301 [15]; or
- 2) an indication that target core network type 5GCN was received from the NG-RAN, the UE shall select the 5GCN and proceed with the appropriate 5GMM procedure.

NOTE 2: The NG-RAN can provide a target core network type to the UE during RRC connection release with redirection (see 3GPP TS 36.331 [25A] and 3GPP TS 38.331 [30]).

## 4.9 Disabling and re-enabling of UE's N1 mode capability

### 4.9.1 General

The UE shall re-enable the N1 mode capability when the UE powers off and powers on again or the USIM is removed.

As an implementation option, the UE may start a timer for re-enabling N1 mode capability, after the N1 mode capability was disabled. On the expiry of this timer, the UE should re-enable the N1 mode capability.

## 4.9.2 Disabling and re-enabling of UE's N1 mode capability for 3GPP access

When the UE is disabling the N1 mode capability for 3GPP access, it should proceed as follows:

- a) select an E-UTRA cell connected to EPC of the registered PLMN or a PLMN from the list of equivalent PLMNs, if the UE supports S1 mode;
- b) if an E-UTRA cell connected to EPC of the registered PLMN or a PLMN from the list of equivalent PLMNs cannot be found or the UE does not support S1 mode, the UE may select another RAT of the registered PLMN or a PLMN from the list of equivalent PLMNs that the UE supports;
- c) if another RAT of the registered PLMN or a PLMN from the list of equivalent PLMNs cannot be found, or the UE does not have a registered PLMN, then enter the state 5GMM-DEREGISTERED.PLMN-SEARCH and perform PLMN selection as specified in 3GPP TS 23.122 [5]. As an implementation option, if the UE does not have a registered PLMN, instead of performing PLMN selection, the UE may select another RAT of the selected PLMN if the UE has chosen a PLMN and the RAT is supported by the UE; or
- d) if no other allowed PLMN and RAT combinations are available, then the UE may re-enable the N1 mode capability for 3GPP access and remain camped in NG-RAN of the registered PLMN, and may periodically scan for another PLMN and RAT combination which can provide EPS services or non-EPS services (if the UE supports EPS services or non-EPS services). The UE enters the state 5GMM-DEREGISTERED.

When the UE supporting both N1 mode and S1 mode needs to stay in E-UTRA connected to EPC (e.g. due to the domain selection for UE originating sessions as specified in subclause 4.3.2), in order to prevent unintentional handover or cell reselection from E-UTRA connected to EPC to NG-RAN connected to 5GCN, the UE operating in single-registration mode shall disable the N1 mode capability for 3GPP access and:

- a) shall set the N1mode bit to "N1 mode not supported" in the UE network capability IE (see 3GPP TS 24.301 [15]) of the ATTACH REQUEST message and the TRACKING AREA UPDATE REQUEST message in EPC; and
- b) the UE NAS layer shall indicate the access stratum layer(s) of disabling of the N1 mode capability for 3GPP access.

NOTE 1: The UE can only disable the N1 mode capability for 3GPP access when in 5GMM-IDLE mode.

The UE shall re-enable the N1 mode capability for 3GPP access when the UE performs PLMN selection over 3GPP access.

If the disabling of N1 mode capability for 3GPP access was due to IMS voice is not available over 3GPP access and the UE's usage setting is "voice centric", the UE shall re-enable the N1 mode capability for 3GPP access when the UE's usage setting is changed from "voice centric" to "data centric", as specified in subclauses 4.3.3.

The UE should memorize the identity of the PLMN where N1 mode capability for 3GPP access was disabled and should use that stored information in subsequent PLMN selections as specified in 3GPP TS 23.122 [5].

If the UE attempts to establish an emergency PDU session in a PLMN where N1 mode capability was disabled due to the UE's registration attempt counter have reached 5, the UE may enable N1 mode capability for that PLMN memorized by the UE.

NOTE 2: If N1 mode capability is disabled due to the UE's registration attempt counter reaches 5, the value of the timer for re-enabling N1 mode capability is recommended to be the same as the value of T3502 which follows the handling specified in subclause 5.3.8.

## 4.9.3 Disabling and re-enabling of UE's N1 mode capability for non-3GPP access

When the UE disables the N1 mode capability for non-3GPP access, the UE NAS layer shall not initiate any 5GS NAS procedures towards the network over non-3GPP access.

When the UE supporting both N1 mode and S1 mode needs to stay in non-3GPP access connected to EPC (e.g. due to the domain selection for UE originating sessions as specified in subclause 4.3.2), in order to prevent unintentional

selection of a non-3GPP access network connected to 5GCN, the UE operating in single-registration mode shall not transfer any PDN connection to a non-3GPP access network connected to the 5GCN.

If the disabling of N1 mode capability for non-3GPP access was due to IMS voice is not available over non-3GPP access in 5GS and the UE's usage setting is "voice centric", the UE shall re-enable the N1 mode capability for non-3GPP access when the UE's usage setting is changed from "voice centric" to "data centric" as specified in subclauses 4.3.3.

The UE shall re-enable the N1 mode capability for non-3GPP access when a new PLMN is selected over non-3GPP access.

## 4.10 Interworking with ePDG connected to EPC

In order to interwork with ePDG connected to EPC, the UE shall operate as specified in either subclause 4.8.2.3 or subclause 4.8.3. Which subclause the UE follows is chosen by the UE irrespective of the interworking without N26 interface indicator.

The UE shall not attempt to transfer PDU sessions with PDU session type "Ethernet" or "Unstructured" to an ePDG connected to EPC.

NOTE: PDU sessions with PDU session type "Ethernet" or "Unstructured" cannot be transferred to an ePDG connected to EPC because PDN connections with PDN type "non-IP" are not supported over ePDG connected to EPC.

## 4.11 UE configuration parameter updates

The 5GS supports updating UE parameters via NAS signalling. The feature enables the HPLMN to securely and dynamically re-configure the UE configuration parameters stored on the USIM and the ME.

In this release of the specification, updates of the following USIM configuration parameters are supported:

- routing indicator.

In this release of specification, updates of the following ME configuration parameters are supported:

- default configured NSSAI.

The update of UE configuration parameters is initiated by the network using the network-initiated downlink NAS transport procedure as described in subclause 5.4.5.3. The ME acknowledgement of successful reception of the updated UE configuration parameter information is sent back to the network using the UE-initiated uplink NAS transport procedure as described in subclause 5.4.5.2.

---

# 5 Elementary procedures for 5GS mobility management

## 5.1 Overview

### 5.1.1 General

The main function of the 5GS mobility management (5GMM) sublayer is to support the identification, security, mobility of a UE as well as generic message transport.

A further function of the 5GMM sublayer is to provide connection management services to the other sublayer(s).

### 5.1.2 Types of 5GMM procedures

Depending on how they can be initiated, three types of 5GMM procedures can be distinguished:

## a) 5GMM common procedures

5GMM common procedure can always be initiated when the UE is in 5GMM-CONNECTED mode. The procedures belonging to this type are:

## 1) Initiated by the network:

- i) network-initiated NAS transport.
- ii) primary authentication and key agreement procedure
- iii) security mode control;
- iv) generic UE configuration update
- v) identification

## 2) Initiated by the UE:

UE-initiated NAS transport.

## 3) Initiated by the UE or the network and used to report certain error conditions detected upon receipt of 5GMM protocol data:

5GMM status.

## b) 5GMM specific procedures:

At any time only one UE initiated 5GMM specific procedure can be running for each of the access network(s) that the UE is camping in. The procedures belonging to this type are:

## 1) Initiated by the UE and used e.g. to register to the network for 5GS services and establish a 5GMM context, to update the location/parameter(s) of the UE:

registration.

## 2) Initiated by the UE or the network and used to deregister from the network for 5GS services and to release a 5GMM context:

de-registration.

## 3) Initiated by the UE and used to deregister from the network for 5GS services and to release a 5GMM context:

eCall inactivity procedure.

## c) 5GMM connection management procedures:

## 1) Initiated by the UE and used to establish a secure connection to the network or to request the resource reservation for sending data, or both:

service request.

The service request procedure can only be initiated if no UE initiated 5GMM specific procedure is ongoing for each of the access network(s) that the UE is camping in.

## 2) Initiated by the network and used to request the establishment of an N1 NAS signalling connection or to request re-establishment of user-plane resources for the PDU session(s) associated with 3GPP access or to request re-establishment of user-plane resources of the PDU session(s) associated with non-3GPP access over 3GPP access; not applicable for the non-3GPP access network:

paging.

## 3) Initiated by the network and used to request re-establishment of user-plane resources of the PDU session(s) associated with non-3GPP access over 3GPP access when the UE is in 5GMM-CONNECTED mode over 3GPP access and in 5GMM-IDLE mode over non-3GPP access; or

Initiated by the network and used to request re-establishment of user-plane resources of the PDU session(s) associated with 3GPP access over 3GPP access when the UE is in 5GMM-CONNECTED mode over non-3GPP access and in 5GMM-IDLE mode over 3GPP access:

notification.

### 5.1.3 5GMM sublayer states

#### 5.1.3.1 General

In the following subclauses, the 5GS mobility management (5GMM) sublayer of the UE and the network is described by means of different state machines. The 5GMM sublayer states is managed per access type independently, i.e. 3GPP access or non-3GPP access. In subclause 5.1.3.2, the states of the 5GMM sublayer are introduced.

#### 5.1.3.2 5GMM sublayer states

##### 5.1.3.2.1 5GMM sublayer states in the UE

###### 5.1.3.2.1.1 General

In the following subclauses, the possible 5GMM sublayer states of the UE are described and shown in Figure 5.1.3.2.1.1.1.

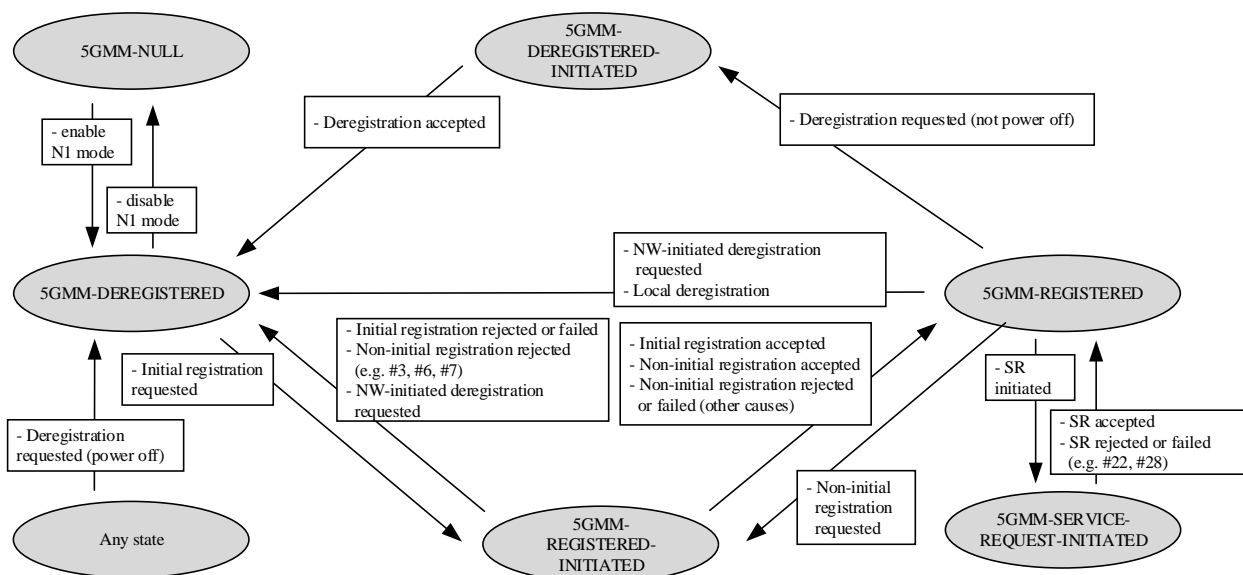

NOTE: Not all possible transitions are shown in this figure.

Figure 5.1.3.2.1.1.1: 5GMM main states in the UE

###### 5.1.3.2.1.2 Main states

###### 5.1.3.2.1.2.1 5GMM-NUL

5GS services are disabled in the UE. No 5GS mobility management function shall be performed in this state.

###### 5.1.3.2.1.2.2 5GMM-DEREGISTERED

In the state 5GMM-DEREGISTERED, no 5GMM context has been established and the UE location is unknown to the network and hence it is unreachable by a network. In order to establish a 5GMM context, the UE shall start the initial registration procedure.

#### 5.1.3.2.1.2.3 5GMM-REGISTERED-INITIATED

A UE enters the state 5GMM-REGISTERED-INITIATED after it has started the initial registration procedure or the non-initial registration procedure, and is waiting for a response from the network.

#### 5.1.3.2.1.2.4 5GMM-REGISTERED

In the state 5GMM-REGISTERED, a 5GMM context has been established. Additionally, one or more PDU session(s) may be established at the UE. The UE may initiate the non-initial registration procedure (including the normal registration update and periodic registration update) and the service request procedure. The UE in the state 5GMM-REGISTERED over non-3GPP access shall not initiate the periodic registration update procedure.

#### 5.1.3.2.1.2.5 5GMM-DEREGISTERED-INITIATED

A UE enters the state 5GMM-DEREGISTERED-INITIATED after it has requested release of the 5GMM context by starting the de-registration procedure and is waiting for a response from the network.

#### 5.1.3.2.1.2.6 5GMM-SERVICE-REQUEST-INITIATED

A UE enters the state 5GMM-SERVICE-REQUEST-INITIATED after it has started the service request procedure and is waiting for a response from the network.

#### 5.1.3.2.1.3 Substates of state 5GMM-DEREGISTERED

##### 5.1.3.2.1.3.1 General

The state 5GMM-DEREGISTERED is subdivided into a number of substates as described in this subclause. The following substates are not applicable to non-3GPP access:

- a) 5GMM-DEREGISTERED.PLMN-SEARCH;
- b) 5GMM-DEREGISTERED.NO-CELL-AVAILABLE; and
- c) 5GMM-DEREGISTERED.eCALL-INACTIVE.

Valid subscriber data are available for the UE before it enters the substates, except for the substate 5GMM-DEREGISTERED.NO-SUPI.

##### 5.1.3.2.1.3.2 5GMM-DEREGISTERED.NORMAL-SERVICE

The substate 5GMM-DEREGISTERED.NORMAL-SERVICE is chosen in the UE when a suitable cell has been found and the PLMN or tracking area is not in the forbidden list.

##### 5.1.3.2.1.3.3 5GMM-DEREGISTERED.LIMITED-SERVICE

The substate 5GMM-DEREGISTERED.LIMITED-SERVICE is chosen in the UE, when it is known that a selected cell for 3GPP access or TA for non-3GPP access is unable to provide normal service (e.g. the selected cell over 3GPP access is in a forbidden PLMN or is in a forbidden tracking area or TA for non-3GPP access is forbidden).

##### 5.1.3.2.1.3.4 5GMM-DEREGISTERED.ATTEMPTING-REGISTRATION

The substate 5GMM-DEREGISTERED.ATTEMPTING-REGISTRATION is chosen in the UE if the initial registration procedure failed due to a missing response from the network or due to the circumstances described in subclauses 5.5.1.1, 5.5.1.2.4, 5.5.1.2.5 and 5.5.1.3.4.

##### 5.1.3.2.1.3.5 5GMM-DEREGISTERED.PLMN-SEARCH

The substate 5GMM-DEREGISTERED.PLMN-SEARCH is chosen in the UE, if the UE is searching for PLMNs. This substate is left either when a cell has been selected (the new substate is NORMAL-SERVICE or LIMITED-SERVICE) or when it has been concluded that no cell is available at the moment (the new substate is NO-CELL-AVAILABLE).

This substate is not applicable to non-3GPP access.



#### 5.1.3.2.1.3.6 5GMM-DEREGISTERED.NO-SUPI

The substate 5GMM-DEREGISTERED.NO-SUPI is chosen in the UE, if the N1 mode is enabled and the UE has no valid subscriber data available (SIM/USIM not available, the SIM/USIM is considered invalid by the UE).

#### 5.1.3.2.1.3.7 5GMM-DEREGISTERED.NO-CELL-AVAILABLE

No 5G cell can be selected. This substate is entered after a first intensive search failed when in substate 5GMM-DEREGISTERED.PLMN-SEARCH. Cells are searched for at a low rhythm. No 5GS services are offered.

This substate is not applicable to non-3GPP access.

#### 5.1.3.2.1.3.8 5GMM-DEREGISTERED.eCALL-INACTIVE

The substate 5GMM-DEREGISTERED.eCALL-INACTIVE is chosen in the UE when:

- a) the UE is configured for eCall only mode as specified in 3GPP TS 31.102 [22];
- b) timer T3444 and timer T3445 have expired or are not running;
- c) a PLMN has been selected as specified in 3GPP TS 23.122 [5];
- d) the UE does not need to perform an eCall over IMS; and
- e) the UE does not need to perform a call to a non-emergency MSISDN or URI for test or terminal reconfiguration service.

In this substate, the UE shall not initiate any signalling towards the network, except to originate an eCall over IMS, or a call to a non-emergency MSISDN or URI for test or terminal reconfiguration service.

This substate is not applicable to non-3GPP access.

#### 5.1.3.2.1.3.9 5GMM-DEREGISTERED.INITIAL-REGISTRATION-NEEDED

Valid subscriber data are available for the UE and for some reason a registration procedure for initial registration has to be performed as soon as possible. This substate can be entered if the access is barred due to unified access control, (see subclause 4.5.4) or if the network rejects the N1 NAS signalling connection establishment.

#### 5.1.3.2.1.4 Substates of state 5GMM-REGISTERED

##### 5.1.3.2.1.4.1 General

The state 5GMM-REGISTERED is subdivided into a number of substates as described in this subclause. The following substates are not applicable to non-3GPP access:

- a) 5GMM-REGISTERED.PLMN-SEARCH;
- b) 5GMM-REGISTERED.NON-ALLOWED-SERVICE; and
- c) 5GMM-REGISTERED.NO-CELL-AVAILABLE.

##### 5.1.3.2.1.4.2 5GMM-REGISTERED.NORMAL-SERVICE

The substate 5GMM-REGISTERED.NORMAL-SERVICE is chosen by the UE as the primary substate when the UE enters the state 5GMM-REGISTERED, and for 3GPP access, the cell the UE selected is known to be in an allowed area.

##### 5.1.3.2.1.4.3 5GMM-REGISTERED.NON-ALLOWED-SERVICE

The substate 5GMM-REGISTERED.NON-ALLOWED-SERVICE is chosen in the UE, if the cell the UE selected is known to be in a non-allowed area.

This substate is not applicable to non-3GPP access.

#### 5.1.3.2.1.4.4 5GMM-REGISTERED.ATTEMPTING-REGISTRATION-UPDATE

The substate 5GMM-REGISTERED.ATTEMPTING-REGISTRATION-UPDATE is chosen by the UE if the registration procedure for mobility and periodic registration update failed due to a missing response from the network, or due to the circumstances described in subclauses 5.3.9 and 5.5.1.3.5. No 5GMM procedure except registration procedure for mobility and periodic registration update (i.e. the 5GS registration type IE set to "mobility registration updating" in the REGISTRATION REQUEST message) shall be initiated by the UE in this substate. No data shall be sent or received.

NOTE: The registration procedure for mobility and periodic registration update over non-3GPP access can be triggered by, e.g. the change of S1 UE network capability or renegotiating some parameters.

#### 5.1.3.2.1.4.5 5GMM-REGISTERED.LIMITED-SERVICE

The substate 5GMM-REGISTERED.LIMITED-SERVICE is chosen in the UE, if the cell the UE selected is known not to be able to provide normal service.

#### 5.1.3.2.1.4.6 5GMM-REGISTERED.PLMN-SEARCH

The substate 5GMM-REGISTERED.PLMN-SEARCH is chosen in the UE, while the UE is searching for PLMNs.

This substate is not applicable to non-3GPP access.

#### 5.1.3.2.1.4.7 5GMM-REGISTERED.NO-CELL-AVAILABLE

5G coverage has been lost or MICO mode is active in the UE. If MICO mode is active, the UE can deactivate MICO mode at any time by activating the AS layer when the UE needs to send mobile originated signalling or user data. Otherwise, the UE shall not initiate any 5GMM procedure except for cell and PLMN reselection.

This substate is not applicable to non-3GPP access.

#### 5.1.3.2.1.4.8 5GMM-REGISTERED.UPDATE-NEEDED

This state can be entered if the access is barred due to unified access control when in 3GPP access, if the network rejects the N1 NAS signalling connection establishment when in 3GPP access or in non-3GPP access or if the UE in 5GMM-CONNECTED mode with RRC inactive indication receives an indication from the lower layers that the resumption of the RRC connection has failed (see subclause 5.3.1.4). For 3GPP access, the UE has to perform a registration procedure for mobility and periodic registration update, but access to the current cell is barred.

No 5GMM procedure except:

- registration procedure for mobility and periodic registration update;
- service request procedure as a response to paging or notification

shall be initiated by the UE in this substate.

#### 5.1.3.2.2 5GS update status in the UE

In order to describe the detailed UE behaviour, the 5GS update (5U) status pertaining to a specific subscriber is defined.

The 5GS update status is stored in a non-volatile memory in the USIM if the corresponding file is present in the USIM, else in the non-volatile memory in the ME, as described in annex C.

The 5GS update status value is changed only after the execution of a registration, network-initiated de-registration, 5GS based primary authentication and key agreement, service request or paging procedure.

##### 5U1: UPDATED

The last registration attempt was successful.

##### 5U2: NOT UPDATED

The last registration attempt failed procedurally, e.g. no response or reject message was received from the AMF.

5U3: ROAMING NOT ALLOWED

The last registration, service request, or registration for mobility or periodic registration update attempt was correctly performed, but the answer from the AMF was negative (because of roaming or subscription restrictions).

5.1.3.2.3 5GMM sublayer states in the network side

5.1.3.2.3.1 General

In the following subclauses, the possible 5GMM sublayer states of the network are described and shown in Figure 5.1.3.2.3.1.1.

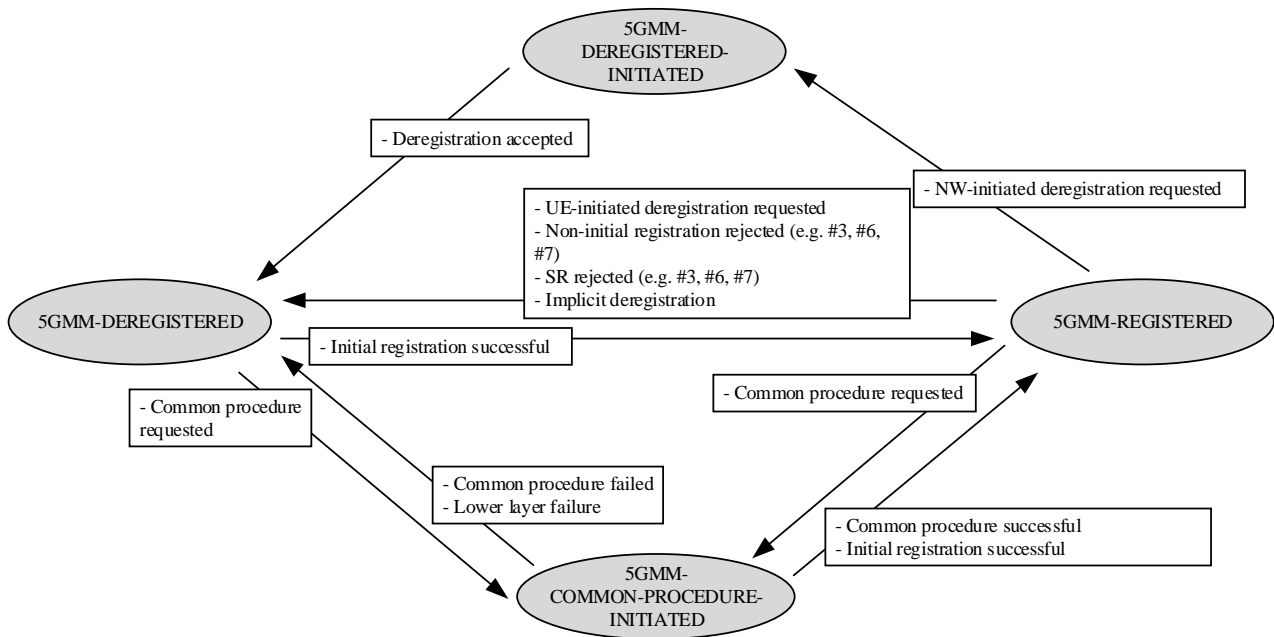

NOTE: Not all possible transitions are shown in this figure.

Figure 5.1.3.2.3.1.1: 5GMM main states in the network

5.1.3.2.3.2 5GMM-DEREGISTERED

In the state 5GMM-DEREGISTERED, no 5GMM context has been established or the 5GMM context is marked as deregistered. The UE is deregistered. The network may answer to an initial registration procedure initiated by the UE. The network may also answer to a de-registration procedure initiated by the UE.

5.1.3.2.3.3 5GMM-COMMON-PROCEDURE-INITIATED

The network enters the state 5GMM-COMMON-PROCEDURE-INITIATED, after it has started a common 5GMM procedure and is waiting for a response from the UE.

5.1.3.2.3.4 5GMM-REGISTERED

In the state 5GMM-REGISTERED, a 5GMM context has been established. Additionally, one or more PDU session(s) may be established at the network.

5.1.3.2.3.5 5GMM-DEREGISTERED-INITIATED

The network enters the state 5GMM-DEREGISTERED-INITIATED after it has started a de-registration procedure and is waiting for a response from the UE.

## 5.1.4 Coordination between 5GMM and EMM

### 5.1.4.1 General

If both 5GMM and EMM are enabled, a UE, operating in single-registration mode, shall maintain one common registration for 5GMM and EMM.

Coordination between 5GMM and EMM for a UE, which is capable of N1 mode and S1 mode and operates in dual-registration mode, is not needed, except as specified in subclause 4.8.3.

The coordination between 5GMM and EMM in subclauses 5.1.4.2 and 5.1.4.3 only applies to the UEs operating in single-registration mode.

### 5.1.4.2 Coordination between 5GMM and EMM with N26 interface

A UE that is not registered shall be in state EMM-DEREGISTERED and state 5GMM-DEREGISTERED.

In N1 mode, upon successful completion of a registration procedure, the UE operating in single-registration mode shall enter substates 5GMM-REGISTERED.NORMAL-SERVICE and EMM-REGISTERED.NO-CELL-AVAILABLE. The UE shall reset the registration attempt counter and the attach attempt counter (see 3GPP TS 24.301 [15]).

At inter-system change from S1 mode to N1 mode, the UE shall enter substates 5GMM-REGISTERED.NORMAL-SERVICE and EMM-REGISTERED.NO-CELL-AVAILABLE and initiate a registration procedure for mobility and periodic registration update indicating "mobility registration updating" in the 5GS registration type IE of the REGISTRATION REQUEST message (see subclause 5.5.1.3).

In S1 mode, upon successful completion of an attach or tracking area updating procedure, the UE operating in single-registration mode shall enter substates 5GMM-REGISTERED.NO-CELL-AVAILABLE and EMM-REGISTERED.NORMAL-SERVICE. The UE shall reset the registration attempt counter and the attach attempt counter (see 3GPP TS 24.301 [15]).

At inter-system change from N1 mode to S1 mode when there is no active PDU session for which interworking with EPS is supported as specified in subclause 6.1.4.1, and EMM-REGISTERED without PDN connection is not supported by the UE or the MME, the UE shall enter state 5GMM-DEREGISTERED and state EMM-DEREGISTERED and then initiate the EPS attach procedure. If EMM-REGISTERED without PDN connection is supported by the UE and the MME, the UE shall enter substates EMM-REGISTERED.NORMAL-SERVICE and 5GMM-REGISTERED.NO-CELL-AVAILABLE and initiate a tracking area updating procedure.

At inter-system change from N1 mode to S1 mode when there is at least one active PDU session for which interworking with EPS is supported as specified in subclause 6.1.4.1, the UE shall enter substates EMM-REGISTERED.NORMAL-SERVICE and 5GMM-REGISTERED.NO-CELL-AVAILABLE and initiate a tracking area updating procedure (see 3GPP TS 24.301 [15]).

### 5.1.4.3 Coordination between 5GMM and EMM without N26 interface

A UE operating in the single-registration mode that is not registered shall be in state EMM-DEREGISTERED and in state 5GMM-DEREGISTERED.

In N1 mode, upon successful completion of a registration procedure, the UE operating in the single-registration mode shall enter substates 5GMM-REGISTERED.NORMAL-SERVICE and EMM-REGISTERED.NO-CELL-AVAILABLE.

At inter-system change from N1 mode to S1 mode in 5GMM-IDLE mode, the UE shall behave as specified in subclause 4.8.2.3.

In S1 mode, upon successful completion of an attach or tracking area updating procedure, the UE operating in the single-registration mode shall enter substates 5GMM-REGISTERED.NO-CELL-AVAILABLE and EMM-REGISTERED.NORMAL-SERVICE.

At inter-system change from S1 mode to N1 mode in 5GMM-IDLE mode, the UE operating in the single-registration mode shall enter substates EMM-REGISTERED.NO-CELL-AVAILABLE and 5GMM-REGISTERED.NORMAL-SERVICE and then initiate the registration procedure for mobility and periodic registration update indicating "mobility

registration updating" in the 5GS registration type IE of the REGISTRATION REQUEST message (see subclause 5.5.1.3).

## 5.2 Behaviour of the UE in state 5GMM-DEREGISTERED and state 5GMM-REGISTERED

### 5.2.1 General

In this subclause, the detailed behaviour of the UE in the states 5GMM-DEREGISTERED and 5GMM-REGISTERED is described.

### 5.2.2 UE behaviour in state 5GMM-DEREGISTERED

#### 5.2.2.1 General

The state 5GMM-DEREGISTERED is entered in the UE, when:

- a) the de-registration is performed either by the UE or by the network (see subclause 5.5.2);
- b) the registration request is rejected by the AMF (see subclause 5.5.1.2.5 and 5.5.1.3.5);
- c) the service request is rejected by the AMF (see subclause 5.6.1); or
- d) the UE is switched on.

In state 5GMM-DEREGISTERED, the UE shall behave according to the substate as explained in subclause 5.2.2.3.

#### 5.2.2.2 Primary substate selection

##### 5.2.2.2.1 Selection of the substate after power on

For a UE configured for eCall only mode as specified in 3GPP TS 31.102 [22], timers T3444 and T3445 are considered to have expired at power on. When the UE is switched on, the substate shall be PLMN-SEARCH if the USIM is available and valid. See 3GPP TS 23.122 [5] for further details.

The substate chosen after PLMN-SEARCH, following power on is:

- a) if no cell can be selected, the substate shall be NO-CELL-AVAILABLE;
- b) if no USIM is present, the substate shall be NO-SUPI;
- c) if a suitable cell has been found, the PLMN identity of the cell is not in one of the forbidden PLMN lists, and the tracking area is not in one of the lists of 5GS forbidden tracking areas, then the substate shall be NORMAL-SERVICE;
- d) if the selected cell is known not to be able to provide normal service, then the UE shall enter the substate LIMITED-SERVICE;
- e) if the UE is in manual network selection mode and no cell of the selected PLMN has been found, the UE shall enter the substate NO-CELL-AVAILABLE; and
- f) if the UE is configured for eCall only mode as specified in 3GPP TS 31.102 [22], the substate shall be eCALL-INACTIVE.

#### 5.2.2.3 Detailed description of UE behaviour in state 5GMM-DEREGISTERED

##### 5.2.2.3.1 NORMAL-SERVICE

The UE shall initiate an initial registration procedure if the timer T3346 is not running. If timer T3346 is running, the UE shall initiate an initial registration procedure on the expiry of timer T3346.

#### 5.2.2.3.2 LIMITED-SERVICE

The UE shall initiate an initial registration procedure when entering a cell which provides normal service.

The UE may initiate initial registration for emergency services.

#### 5.2.2.3.3 ATTEMPTING-REGISTRATION

The UE in 3GPP access:

- a) shall initiate an initial registration procedure on the expiry of timers T3502, T3511 or T3346;
- b) may initiate an initial registration procedure for emergency services even if timer T3346 is running;
- c) shall initiate an initial registration procedure when entering a new PLMN, if timer T3346 is running and the new PLMN is not equivalent to the PLMN where the UE started timer T3346, the PLMN identity of the new cell is not in the forbidden PLMN lists and the tracking area is not in one of the lists of 5GS forbidden tracking areas;
- d) shall initiate an initial registration procedure when the tracking area of the serving cell has changed, if timer T3346 is not running, the PLMN identity of the new cell is not in one of the forbidden PLMN lists and the tracking area of the new cell is not in one of the lists of 5GS forbidden tracking areas; and
- e) shall initiate an initial registration procedure if the 5GS update status is set to 5U2 NOT UPDATED, and timers T3511, T3502 and T3346 are not running.

The UE in non-3GPP access:

- a) shall initiate an initial registration procedure on the expiry of timers T3502, T3511 or T3346;
- b) may initiate an initial registration procedure for emergency services even if timer T3346 is running;
- c) shall initiate an initial registration procedure when entering a new PLMN, if timer T3346 is running and the new PLMN is not equivalent to the PLMN where the UE started timer T3346; and
- d) shall initiate an initial registration procedure if the 5GS update status is set to 5U2 NOT UPDATED, and timers T3511, T3502 and T3346 are not running.

#### 5.2.2.3.4 PLMN-SEARCH

The UE shall perform PLMN selection. If a new PLMN is selected, the UE shall reset the registration attempt counter and initiate the registration procedure for initial registration (see subclause 5.5.1.2.2).

If the selected cell is known not to be able to provide normal service, the UE may initiate the registration procedure for initial registration for emergency services.

#### 5.2.2.3.5 NO-SUPI

The UE may initiate the registration procedure for initial registration for emergency services.

#### 5.2.2.3.6 NO-CELL-AVAILABLE

The UE shall perform cell selection and choose an appropriate substate when a cell is found.

#### 5.2.2.3.7 eCALL-INACTIVE

The UE camps on a suitable cell or an acceptable cell in a PLMN selected as specified in 3GPP TS 23.122 [5] but initiates no 5GMM signalling with the network and ignores any paging requests.

The UE shall leave substate EMM-DEREGISTERED.eCALL-INACTIVE state only when one of the following events occur:

- a) if the USIM is removed, the UE enters substate 5GMM-DEREGISTERED.NO-SUPI;
- b) if coverage is lost, the UE enters substate 5GMM-DEREGISTERED.PLMN-SEARCH;

- c) if the UE is deactivated (e.g. powered off) by the user, the UE enters state 5GMM-NULL;
- d) if the UE receives a request from upper layers to establish an eCall over IMS, the UE enters state 5GMM-DEREGISTERED.ATTEMPTING-REGISTRATION. The UE then uses the relevant 5GMM and 5GSM procedures to establish the eCall over IMS at the earliest opportunity; or
- e) if the UE receives a request from upper layers to establish a call to an HPLMN designated non-emergency MSISDN or URI for test or terminal reconfiguration service, the UE enters state 5GMM-DEREGISTERED.ATTEMPTING-REGISTRATION. Once the registration procedure is completed, the UE uses the relevant 5GMM and 5GSM procedures to establish the non-emergency call.

#### 5.2.2.4 Substate when back to state 5GMM-DEREGISTERED from another 5GMM state

When returning to state 5GMM-DEREGISTERED, the UE shall select a cell as specified in 3GPP TS 38.304 [28].

The substate depends on the result of the cell selection procedure, the outcome of the previously performed 5GMM specific procedures, on the 5GS update status of the UE, on the tracking area data stored in the UE, on the presence of the USIM, on the UE configuration and on the reason for moving to 5GMM-DEREGISTERED:

- a) If no cell has been found, the substate is NO-CELL-AVAILABLE, until a cell is found;
- b) If no USIM is present or if the inserted USIM is considered invalid by the UE, the substate shall be NO-SUPI;
- c) If a suitable cell has been found and the PLMN or tracking area is not in one of the lists of 5GS forbidden tracking areas, the substate shall be NORMAL-SERVICE;
- d) If a registration shall be performed (e.g. network-requested re-registration), the substate shall be ATTEMPTING-REGISTRATION;
- e) If a PLMN reselection (according to 3GPP TS 23.122 [5]) is needed, the substate shall be PLMN-SEARCH;
- f) If the selected cell is known not to be able to provide normal service, the substate shall be LIMITED-SERVICE; and
- g) If the UE is configured for eCall only mode as specified in 3GPP TS 31.102 [22], T3444 and T3445 have expired or are not running, and substate PLMN-SEARCH is not required, the substate shall be eCALL-INACTIVE.

### 5.2.3 UE behaviour in state 5GMM-REGISTERED

#### 5.2.3.1 General

The state 5GMM-REGISTERED is entered at the UE, when:

the initial registration procedure is performed by the UE (see subclause 5.5.1.2.2).

In state 5GMM-REGISTERED, the UE shall behave according to the substate as explained in subclause 5.2.3.2.

#### 5.2.3.2 Detailed description of UE behaviour in state 5GMM-REGISTERED

##### 5.2.3.2.1 NORMAL-SERVICE

The UE:

- a) shall initiate the mobility or the periodic registration update procedure (according to conditions given in subclause 5.5.1.3.2), except that the periodic registration update procedure shall not be initiated over non-3GPP access;
- b) shall initiate the service request procedure (according to conditions given in subclause 5.6.1);
- c) shall respond to paging; and

- d) if configured for eCall only mode as specified in 3GPP TS 31.102 [22], shall perform the eCall inactivity procedure at expiry of timer T3444 or timer T3445 (see subclause 5.5.3).

NOTE: Paging is not supported over non-3GPP access.

#### 5.2.3.2.2 NON-ALLOWED-SERVICE

The UE shall behave as specified in subclause 5.3.5.

#### 5.2.3.2.3 ATTEMPTING-REGISTRATION-UPDATE

The UE in 3GPP access:

- a) shall not send any user data;
- b) shall initiate a registration procedure for mobility and periodic registration update on the expiry of timers T3502, T3511 or T3346;
- c) shall initiate a registration procedure for mobility and periodic registration update when entering a new PLMN, if timer T3346 is running and the new PLMN is not equivalent to the PLMN where the UE started timer T3346, the PLMN identity of the new cell is not in the forbidden PLMN lists, and the tracking area is not in one of the lists of 5GS forbidden tracking areas;
- d) shall initiate a registration procedure for mobility and periodic registration update when the tracking area of the serving cell has changed, if timer T3346 is not running, the PLMN identity of the new cell is not in one of the forbidden PLMN lists and the tracking area is not in one of the lists of 5GS forbidden tracking areas;
- e) may initiate a registration procedure for mobility and periodic registration update upon request of the upper layers to establish an emergency PDU session;
- f) may perform de-registration locally and initiate a registration procedure for initial registration for emergency services even if timer T3346 is running;
- g) shall initiate registration procedure for mobility and periodic registration update upon reception of paging, or upon reception of NOTIFICATION message with access type indicating 3GPP access;
- h) may initiate a registration procedure for mobility and periodic registration update upon request for an MMTEL voice call or MMTEL video call from the upper layers, if timer T3346 is not running;
- i) shall initiate a registration procedure for mobility and periodic registration update if the 5GS update status is set to 5U2 NOT UPDATED, and timers T3511, T3502 and T3346 are not running;
- j) if configured for eCall only mode as specified in 3GPP TS 31.102 [22], shall perform the eCall inactivity procedure at expiry of timer T3444 or timer T3445 (see subclause 5.5.3); and
- k) shall not initiate de-registration procedure unless timer T3346 is running and the current TAI is part of the TAI list.

The UE in non-3GPP access:

- a) shall not send any user data;
- b) shall initiate the registration procedure for mobility and periodic registration update on the expiry of timers T3502, T3511 or T3346;
- c) may initiate a registration procedure for mobility registration update upon request of the upper layers to establish an emergency PDU session;
- d) may perform de-registration locally and initiate a registration procedure for initial registration for emergency services even if timer T3346 is running;
- e) may initiate a registration procedure for mobility and periodic registration update upon request for an MMTEL voice call or MMTEL video call from the upper layers, if timer T3346 is not running;



- f) shall initiate a registration procedure for mobility and periodic registration update if the 5GS update status is set to 5U2 NOT UPDATED, and timers T3511, T3502 and T3346 are not running; and
- g) shall not initiate de-registration procedure unless timer T3346 is running.

#### 5.2.3.2.4 LIMITED-SERVICE

The UE:

- a) shall perform cell selection/reselection;
- b) may initiate an initial registration for emergency services; and
- c) if configured for eCall only mode as specified in 3GPP TS 31.102 [22], shall perform the eCall inactivity procedure at expiry of timer T3444 or timer T3445 (see subclause 5.5.3).

#### 5.2.3.2.5 PLMN-SEARCH

The UE shall perform PLMN selection. If a new PLMN is selected, the UE shall reset the registration attempt counter and initiate the initial registration procedure (see subclause 5.5.1.2).

If the selected cell is known not to be able to provide normal service, the UE may initiate an initial registration for emergency services.

#### 5.2.3.2.6 NO-CELL-AVAILABLE

The UE shall perform cell selection and choose an appropriate substate when a cell is found.

## 5.3 General on elementary 5GMM procedures

### 5.3.1 5GMM modes and N1 NAS signalling connection

#### 5.3.1.1 Establishment of the N1 NAS signalling connection

When the UE is in 5GMM-IDLE mode over 3GPP access and needs to transmit an initial NAS message, the UE shall request the lower layer to establish an RRC connection. Upon indication from the lower layers that the RRC connection has been established, the UE shall consider that the N1 NAS signalling connection over 3GPP access is established and enter 5GMM-CONNECTED mode over 3GPP access.

When the UE is in 5GMM-IDLE mode over non-3GPP access, and the UE receives an indication from the lower layers of access stratum connection establishment, the UE shall consider the N1 NAS signalling connection established enter 5GMM-CONNECTED mode over non-3GPP access and send an initial NAS message.

Initial NAS messages are:

- a) REGISTRATION REQUEST message;
- b) DEREGISTRATION REQUEST message; and
- c) SERVICE REQUEST message.

If the UE is capable of both N1 mode and S1 mode and lower layers provide an indication that the current E-UTRA cell is connected to both EPC and 5GCN, for the routing of the REGISTRATION REQUEST message during the initial registration procedure to the appropriate core network (EPC or 5GCN), the UE NAS provides the lower layers with the selected core network type information.

For the routing of the initial NAS message to the appropriate AMF, if the UE holds a 5G-GUTI or 4G-GUTI, the UE NAS provides the lower layers with either the 5G-S-TMSI or the registered GUAMI, or neither the 5G-S-TMSI nor registered GUAMI according to the following rules:

- a) if the registration procedure for mobility and periodic update was triggered due to the last CONFIGURATION UPDATE COMMAND message that indicates "registration requested" including:

- 1) no other parameters;
- 2) one or both of the Allowed NSSAI IE and the Configured NSSAI IE; or
- 3) the Network slicing indication IE with the Network slicing subscription change indication set to "Network slicing subscription changed"

the UE NAS shall not provide the lower layers with the 5G-S-TMSI or the registered GUAMI;

- b) if the service request procedure was initiated over non-3GPP access, the UE NAS shall provide the lower layers with the registered GUAMI, but shall not provide the lower layers with the 5G-S-TMSI;
- c) if the initial NAS message other than the SERVICE REQUEST message was initiated over non-3GPP access, the UE NAS shall provide the lower layers with the GUAMI of the 5G-GUTI that the UE NAS has selected as specified in the subclause 5.5.1.2.2 and 5.5.1.3.2, but shall not provide the lower layers with the 5G-S-TMSI;
- d) if the UE does not hold a 5G-GUTI that was previously assigned by the same PLMN with which the UE is performing the registration procedure and if :
  - 1) the UE operating in the single-registration mode performs a registration procedure for mobility and periodic update indicating "mobility registration updating" following an inter-system change from S1 mode to N1 mode; or
  - 2) the UE which was previously registered in S1 mode before entering state EMM-DEREGISTERED, performs an initial registration procedure, the UE has received the interworking without N26 interface indicator set to "interworking without N26 interface not supported" from the network, and the UE holds a 4G-GUTI;

then the UE NAS provides the lower layers with a GUAMI part of the 5G-GUTI mapped from 4G-GUTI as specified in 3GPP TS 23.003 [4] with an indication that the GUAMI is mapped from EPS; or

- e) otherwise:
  - 1) if the tracking area of the current cell is in the registration area, the UE NAS shall provide the lower layers with the 5G-S-TMSI, but shall not provide the registered GUAMI to the lower layers; or
  - 2) if the tracking area of the current cell is not in the registration area, the UE NAS shall provide the lower layers with the GUAMI of the 5G-GUTI that the UE NAS has selected as specified in the subclause 5.5.1.2.2 and 5.5.1.3.2, but shall not provide the lower layers with the 5G-S-TMSI.

If the UE does not hold a 5G-GUTI and the UE does not hold a 4G-GUTI, the UE NAS does not provide the lower layers with the 5G-S-TMSI or the registered GUAMI.

The UE NAS also provides the lower layers with the identity of the selected PLMN (see 3GPP TS 38.331 [30]). In a shared network, the UE shall choose one of the PLMN identities as specified in 3GPP TS 23.122 [5].

### 5.3.1.2 Re-establishment of the N1 NAS signalling connection

When the UE in 5GMM-CONNECTED mode over 3GPP access receives a fallback indication from lower layers, and the UE has no pending NAS procedure and no pending uplink user data for PDU session(s) with user-plane resources already established, the UE shall:

- a) enter 5GMM-IDLE mode; and
- b) initiate the registration procedure for mobility and periodic registration update and include the Uplink data status IE in the REGISTRATION REQUEST message indicating the PDU session(s) for which user-plane resources were active prior to receiving the fallback indication, if any (see subclause 5.5.1.3 for further details).

When the UE in 5GMM-CONNECTED mode over 3GPP access receives a fallback indication from lower layers, and the UE has pending uplink user data for PDU session(s) with user-plane resources already established but no pending NAS procedure, the UE shall:

- a) enter 5GMM-IDLE mode; and

- b) initiate the service request procedure and include the Uplink data status IE in the SERVICE REQUEST message indicating the PDU session(s) for which user-plane resources were active prior to receiving the fallback indication (see subclause 5.6.1 for further details).

When the UE in 5GMM-CONNECTED mode over 3GPP access receives a fallback indication from lower layers, and the UE has a pending registration procedure, a service request procedure, or a de-registration procedure, the UE shall:

- a) enter 5GMM-IDLE mode;
- b) proceed with the pending procedure; and
- c) if the pending procedure is a service request or registration procedure, the UE shall include the Uplink data status IE in the SERVICE REQUEST message, or in the REGISTRATION REQUEST message, indicating the PDU session(s) for which user-plane resources were not active prior to receiving a fallback indication from the lower layers and the UE has pending user data to be sent over 3GPP access, if any, and the PDU session(s) for which user-plane resources were active prior to receiving the fallback indication, if any (see subclauses 5.5.1.3 and 5.6.1 for further details).

When the UE in 5GMM-CONNECTED mode over 3GPP access receives a fallback indication from lower layers, and the UE has a pending NAS procedure other than a registration procedure, a service request procedure, or a de-registration procedure, the UE shall:

- a) enter 5GMM-IDLE mode;
- b) initiate the service request procedure and include the Uplink data status IE in the SERVICE REQUEST message indicating the PDU session(s) for which user-plane resources were active prior to receiving the fallback indication, if any (see subclause 5.6.1 for further details); and
- c) upon successful service request procedure completion, proceed with any pending procedure.

The cases above apply when the UE is in an allowed area or when the UE is not in a non-allowed area.

When the UE:

- a) is in a non-allowed area or is not in an allowed area;
- b) is in 5GMM-CONNECTED mode over 3GPP access;
- c) receives a fallback indication from lower layers; and
- d) does not have signalling pending,

the UE shall:

- a) enter 5GMM-IDLE mode; and
- b) initiate the registration procedure for mobility and periodic registration update. The UE shall not include the Uplink data status IE in the REGISTRATION REQUEST message except if the PDU session for which user-plane resources were active is an emergency PDU session, or if the UE is configured for high priority access in the selected PLMN.

In the above cases when the UE receives a fallback indication from lower layers, if the UE is in non-allowed area or not in allowed area, the UE shall behave as specified in subclause 5.3.5.

### 5.3.1.3 Release of the N1 NAS signalling connection

The signalling procedure for the release of the N1 NAS signalling connection is initiated by the network.

In N1 mode, upon indication from lower layers that the access stratum connection has been released, the UE shall enter 5GMM-IDLE mode and consider the N1 NAS signalling connection released.

If the UE in 3GPP access is configured for eCall only mode as specified in 3GPP TS 31.102 [22] then:

- if the N1 NAS signalling connection that was released had been established for eCall over IMS, the UE shall start timer T3444; and

- if the N1 NAS signalling connection that was released had been established for a call to an HPLMN designated non-emergency MSISDN or URI for test or terminal reconfiguration service, the UE shall start timer T3445.

To allow the network to release the N1 NAS signalling connection, the UE:

- a) shall start the timer T3540 if the UE receives any of the 5GMM cause values #7, #11, #12, #13, #15, #27, or #72;
- b) shall start the timer T3540 for a UE in 3GPP access if:
  - 1) the UE receives a REGISTRATION ACCEPT message;
  - 2) the UE has set the Follow-on request indicator to 0 in the REGISTRATION REQUEST message;
  - 3) the UE has not included the Uplink data status IE in the REGISTRATION REQUEST message, or the UE has included the Uplink data status IE in the REGISTRATION REQUEST message but the REGISTRATION ACCEPT message indicates that no user-plane resources of any PDU sessions are to be re-established;
  - 4) the UE has not included the Allowed PDU session status IE or has included the Allowed PDU session status IE indicating there is no PDU session(s) for which the UE allowed the user-plane resource to be re-established over 3GPP access in the REGISTRATION REQUEST message, or the UE has included the Allowed PDU session status IE in the REGISTRATION REQUEST message but the REGISTRATION ACCEPT message does not indicate that any user-plane resources of any PDU sessions are to be re-established;
  - 5) the registration procedure has been initiated in 5GMM-IDLE mode; and
  - 6) the user-plane resources for PDU sessions have not been set up;

NOTE 1: The lower layers indicate when the user-plane resources for PDU sessions are successfully established or released.

- c) shall start the timer T3540 if the UE receives a REGISTRATION REJECT message indicating:
  - the 5GMM cause value #9 or #10;
- d) shall start the timer T3540 if the UE receives a SERVICE REJECT message indicating:
  - the 5GMM cause value #9 or #10;
- e) shall start the timer T3540 if:
  - 1) the UE receives a CONFIGURATION UPDATE COMMAND message indicating registration requested with:
    - i) either new allowed NSSAI information or new configured NSSAI information or both included;
    - ii) the network slicing indication; or
    - iii) no other parameters;
  - 2) the user-plane resources for PDU sessions have not been set up; and
  - 3) no emergency PDU session has been established; or
- f) shall start the timer T3540 if:
  - 1) the UE receives a SERVICE ACCEPT message;
  - 2) the UE has not included the Uplink data status IE in the SERVICE REQUEST message, or the UE has included the Uplink data status IE in the SERVICE REQUEST message but the SERVICE ACCEPT message indicates that no user-plane resources of any PDU sessions are to be re-established;
  - 3) the UE has not included the Allowed PDU session status IE or has included the Allowed PDU session status IE indicating there is no PDU session(s) for which the UE allowed the user-plane resource to be re-established over 3GPP access in the SERVICE ACCEPT message, or the UE has included the Uplink data

status IE in the SERVICE REQUEST message but the SERVICE ACCEPT message does not indicate that any user-plane resources of any PDU sessions are to be re-established;

- 4) the service request procedure has been initiated in 5GMM-IDLE mode; and
- 5) the user-plane resources for PDU sessions have not been set up.

NOTE 2: The lower layers indicate when the user-plane resources for PDU sessions are successfully established or released.

Upon expiry of T3540,

- in cases a), b) and f), the UE shall locally release the established N1 NAS signalling connection;
- in cases c) and d) the UE shall locally release the established N1 NAS signalling connection and the UE shall initiate the registration procedure as described in subclause 5.5.1.3.5 or 5.6.1.5; or
- in case e), the UE shall locally release the established N1 NAS signalling connection and perform a new registration procedure as specified in subclause 5.5.1.3.2.

In case a),

- upon receiving a request from upper layers to send NAS signalling associated with emergency services fallback only for a UE in 3GPP access or establishing an emergency PDU session, the UE shall stop timer T3540 and shall locally release the N1 NAS signalling connection, before proceeding as specified in subclause 5.5.1.

In case b) and f),

- upon an indication from the lower layers that the user-plane resources for PDU sessions are set up, the UE shall stop timer T3540 and may send uplink signalling via the existing N1 NAS signalling connection or user data via user plane. If the uplink signalling is associated with emergency services fallback only for a UE in 3GPP access or establishing an emergency PDU session, the UE shall stop timer T3540 and send the uplink signalling via the existing N1 NAS signalling connection;
- upon receipt of a DEREGISTRATION REQUEST message, the UE shall stop timer T3540 and respond to the network-initiated de-registration request as specified in subclause 5.5.2.3;
- upon receiving a request from upper layers to send NAS signalling associated with emergency services fallback only for a UE in 3GPP access or establishing an emergency PDU session, the UE shall stop timer T3540 and shall locally release the N1 NAS signalling connection, before proceeding as specified in subclause 5.6.1; or
- upon receiving a request from upper layers to send NAS signalling not associated with emergency services fallback only for a UE in 3GPP access or establishing an emergency PDU session, the UE shall wait for the local release of the established N1 NAS signalling connection upon expiry of timer T3540 or wait for timer T3540 being stopped, before initiating NAS signalling.

In case c) and d),

- upon an indication from the lower layers that the access stratum connection has been released, the UE shall stop timer T3540 and perform a new registration procedure as specified in subclause 5.5.1.3.5 or 5.6.1.5.
- upon receiving a request from upper layers to send NAS signalling associated with emergency services fallback only for a UE in 3GPP access or establishing an emergency PDU session, the UE shall stop timer T3540 and shall locally release the N1 NAS signalling connection, before proceeding as specified in subclause 5.5.1.

In case e),

- upon an indication from the lower layers that the access stratum connection has been released, the UE shall stop timer T3540 and perform a new registration procedure as specified in subclause 5.5.1.3.2.
- upon an indication from the lower layers that the user-plane resources for PDU sessions are set up, the UE shall stop timer T3540 and may send user data via user plane.
- upon receiving a request from upper layers to send NAS signalling associated with emergency services fallback only for a UE in 3GPP access or establishing an emergency PDU session, the UE shall stop timer T3540 and shall locally release the N1 NAS signalling connection, before proceeding as specified in subclause 5.6.1.

#### 5.3.1.4 5GMM-CONNECTED mode with RRC inactive indication

This subclause is only applicable for UE's 5GMM mode over 3GPP access.

The UE is in 5GMM-CONNECTED mode with RRC inactive indication when the UE is in:

- a) 5GMM-CONNECTED mode over 3GPP access at the NAS layer; and
- b) RRC\_INACTIVE state at the AS layer (see 3GPP TS 38.300 [27]).

Unless stated otherwise, the UE behaviour in 5GMM-CONNECTED mode with RRC inactive indication follows the UE behaviour in 5GMM-CONNECTED over 3GPP access, except that:

- a) the UE shall apply the mobility restrictions; and
- b) the UE shall perform the PLMN selection procedures

as in 5GMM-IDLE mode over 3GPP access.

The UE shall transition from 5GMM-CONNECTED mode over 3GPP access to 5GMM-CONNECTED mode with RRC inactive indication upon receiving an indication from the lower layers that the RRC connection has been suspended.

If the UE in 5GMM-CONNECTED mode with RRC inactive indication receives an indication from the lower layers that the RRC connection has been suspended, the UE shall stay in 5GMM-CONNECTED mode with RRC inactive indication.

Upon:

- a trigger of a procedure which requires sending of a NAS message different from a REGISTRATION REQUEST message with the NG-RAN-RCU bit of the 5GS update type IE set to "NG-RAN radio capability update needed"; or
- an uplink user data packet to be sent for a PDU session with suspended user-plane resources;

the UE in 5GMM-CONNECTED mode with RRC inactive indication over 3GPP access shall request the lower layers to transition to RRC\_CONNECTED state (see 3GPP TS 38.300 [27]).

Upon a trigger to send a REGISTRATION REQUEST message with the NG-RAN-RCU bit of the 5GS update type IE set to "NG-RAN radio capability update needed", the UE in 5GMM-CONNECTED mode with RRC inactive indication shall move to 5GMM-IDLE mode over 3GPP access and proceed with the registration procedure for mobility and periodic registration as specified in subclause 5.5.1.3.2.

The UE shall transition from 5GMM-CONNECTED mode with RRC inactive indication to 5GMM-CONNECTED mode over 3GPP access upon receiving an indication from the lower layers that the UE has transitioned to RRC\_CONNECTED state (see 3GPP TS 38.300 [27]).

NOTE 1: The AMF can be aware of the transition between 5GMM-CONNECTED mode and 5GMM-CONNECTED mode with RRC inactive indication for a UE (see 3GPP TS 23.502 [9]).

The UE shall trigger a transition from 5GMM-CONNECTED mode with RRC inactive indication to 5GMM-IDLE mode upon selection of a PLMN that is not an equivalent PLMN to the registered PLMN. The UE shall not trigger a transition from 5GMM-CONNECTED mode with RRC inactive indication to 5GMM-IDLE mode upon entering a new PLMN which is in the list of equivalent PLMNs.

When the UE in 5GMM-CONNECTED mode with RRC indication receives a fallback indication from lower layers, and the UE has no pending NAS procedure and no pending uplink user data for PDU session(s) with user-plane resources already established, the UE shall:

- a) enter 5GMM-IDLE mode; and
- b) initiate the registration procedure for mobility and periodic registration update and include the Uplink data status IE in the REGISTRATION REQUEST message indicating the PDU session(s) for which user-plane resources were active prior to receiving the fallback indication, if any (see subclause 5.5.1.3 for further details).

If the UE requests the lower layers to transition to RRC\_CONNECTED state at initiation of a registration procedure, a service request procedure or a de-registration procedure, upon fallback indication from lower layers, the UE shall:

- enter 5GMM-IDLE mode;
- proceed with the pending procedure; and
- if the pending procedure is a service request or registration request procedure, the UE shall include the Uplink data status IE in the SERVICE REQUEST message, or in the REGISTRATION REQUEST message, indicating the PDU session(s) without active user-plane resources for which the UE has pending user data to be sent, if any, and the PDU session(s) for which user-plane resources were active prior to receiving the fallback indication, if any (see subclauses 5.5.1.3 and 5.6.1 for further details).

If the UE requests the lower layers to transition to RRC\_CONNECTED state for other reason than initiation of a registration procedure, or for other reason than a service request procedure, or for other reason than a de-registration procedure, upon fallback indication from lower layers, the UE shall:

- enter 5GMM-IDLE mode;
- initiate service request procedure and include the Uplink data status IE in the SERVICE REQUEST message indicating the PDU session(s) for which user-plane resources were active prior to receiving the fallback indication, if any (see subclause 5.6.1 for further details); and
- upon successful service request procedure completion, proceed with any pending procedure.

If the UE in 5GMM-CONNECTED mode with RRC inactive indication receives a fallback indication from lower layers, and the UE has pending uplink user data for PDU session(s) with user-plane resources already established but no pending NAS procedure, the UE shall:

- enter 5GMM-IDLE mode; and
- initiate the service request procedure and include the Uplink data status IE in the SERVICE REQUEST message indicating the PDU session(s) for which user-plane resources were active prior to receiving the fallback indication (see subclause 5.6.1 for further details).

In the above cases when the UE receives a fallback indication from lower layers, if the UE is in non-allowed area or not in allowed area, the UE shall behave as specified in subclause 5.3.5.

If the UE in 5GMM-CONNECTED mode with RRC inactive indication receives an indication from the lower layers that the resumption of the RRC connection has failed, and:

- a) if the lower layers indicate that access barring is applicable for all access categories except categories 0 and 2, the UE shall:
  - 1) stay in 5GMM-CONNECTED mode with RRC inactive indication;
- b) else, the UE shall:
  - 1) enter 5GMM-IDLE mode; and
  - 2) initiate the registration procedure for mobility and periodic registration update used for mobility (i.e. the 5GS registration type IE set to "mobility registration updating" in the REGISTRATION REQUEST message) for N1 NAS signalling connection recovery as specified in subclause 5.5.1.3.2.

NOTE 2: An indication from the lower layer that the RRC connection has been released with cause "RRC resume failure" can be considered as an indication that the resumption of the RRC connection has failed.

The UE shall transition from 5GMM-CONNECTED mode with RRC inactive indication to 5GMM-IDLE mode over 3GPP access upon receiving from the lower layers:

- a) indication of transition from RRC\_INACTIVE state to RRC\_IDLE state; or
- b) indication of cell selection to E-UTRAN or another RAT that the UE supports.

Upon receiving AMF paging indication from the lower layers, the UE shall transition from 5GMM-CONNECTED mode with RRC inactive indication to 5GMM-IDLE mode over 3GPP access and handle the AMF paging same as the paging request received in the 5GMM-IDLE mode over 3GPP access as specified in subclause 5.6.1.

### 5.3.2 Permanent identifiers

A globally unique permanent identity, the 5G subscription permanent identifier (SUPI), is allocated to each subscriber for 5GS-based services. The IMSI and network specific identifier are valid SUPI types. When the SUPI contains a network specific identifier, it shall take the form of a network access identifier (NAI). The structure of the SUPI and its derivatives are specified in 3GPP TS 23.003 [4].

The UE provides the SUPI to the network in concealed form. The SUCI is a privacy preserving identifier containing the concealed SUPI. When the SUPI contains a network specific identifier, the SUCI shall take the form of an NAI as specified in 3GPP TS 23.003 [4].

A UE supporting N1 mode includes a SUCI:

- a) in the REGISTRATION REQUEST message when the UE is attempting initial registration procedure and a valid 5G-GUTI is not available; or
- b) in the IDENTITY RESPONSE message, if the SUCI is requested by the network during the identification procedure.

NOTE: If the home network has not provisioned the public key needed to generate a SUCI, the UE uses "null-scheme" as specified in 3GPP TS 33.501 [24] to generate a SUCI which equals to the SUPI.

The UE shall use the "null-scheme" as specified in 3GPP TS 33.501 [24] to generate the SUCI, if the following applies:

- a) the UE performs a registration procedure for emergency services or initiates a de-registration procedure before the registration procedure for emergency services was completed successfully; and
- b) the UE does not have a valid 5G-GUTI for the selected PLMN or it receives an identity request for SUCI during any of the procedures of item a).

Each UE supporting NG-RAN contains a permanent equipment identifier (PEI) for accessing 5GS-based services. In this release of the specification, the IMEI and the IMEISV are the only PEI formats supported by 5GS. The structure of the PEI and its formats are specified in 3GPP TS 23.003 [4].

A UE supporting NG-RAN includes a PEI:

- a) when neither SUPI nor valid 5G-GUTI is available to use for emergency services in the REGISTRATION REQUEST message with 5GS registration type IE set to "emergency registration"; and
- b) when the network requests the PEI by using the identification procedure, in the IDENTITY RESPONSE message.

The AMF can request the PEI at any time by using the identification procedure.

### 5.3.3 Temporary identities

A globally unique temporary user identity for 5GS-based services, the 5G globally unique temporary identity (5G-GUTI), is used for identification within the signalling procedures. When the UE is registered to the same PLMN over 3GPP and non-3GPP access, the UE and the AMF maintain one 5G-GUTI that is common to both 3GPP and non-3GPP access. When the UE is registered to different PLMNs over 3GPP access and non-3GPP access, the UE maintains two 5G-GUTIs, a 5G-GUTI for the registration with a PLMN over the 3GPP access and another 5G-GUTI for the registration with another PLMN over the non-3GPP access. In the paging and service request procedures, a shortened form of the 5G-GUTI, the 5G S-temporary mobile subscriber identity (5G-S-TMSI), is used to enable more efficient radio signalling. The purpose of the 5G-GUTI and 5G-S-TMSI is to provide identity confidentiality, i.e., to protect a user from being identified and located by an intruder. The structure of the 5G-GUTI and its derivatives are specified in 3GPP TS 23.003 [4]. The 5G-GUTI has two main components (see 3GPP TS 23.501 [8]):

- a) the GUAMI; and
- b) the 5G-TMSI that provides an unambiguous identity of the UE within the AMF(s) identified by the GUAMI.



The 5G-S-TMSI has three main components:

- a) the AMF set ID that uniquely identifies the AMF set within the AMF region;
- b) the AMF pointer that identifies one or more AMFs within the AMF set; and
- c) the 5G-TMSI.

A UE supporting N1 mode includes a valid 5G-GUTI, if any is available, in the REGISTRATION REQUEST and DEREGISTRATION REQUEST messages. In the SERVICE REQUEST message, the UE includes a valid 5G-S-TMSI as user identity. The AMF shall assign a new 5G-GUTI for a particular UE:

- a) during a successful initial registration procedure;
- b) during a successful registration procedure for mobility registration update; and
- c) after a successful service request procedure invoked as a response to a paging request from the network and before the release of the N1 NAS signalling connection as specified in subclause 5.4.4.1.

The AMF should assign a new 5G-GUTI for a particular UE during a successful registration procedure for periodic registration update. The AMF may assign a new 5G-GUTI at any time for a particular UE by performing the generic UE configuration update procedure.

If a new 5G-GUTI is assigned by the AMF, the UE and the AMF handle the 5G-GUTI as follows:

- a) Upon receipt of a 5GMM message containing a new 5G-GUTI, the UE considers the new 5G-GUTI as valid and the old 5G-GUTI as invalid, stops timer T3519 if running, and deletes any stored SUCI. The new 5G-GUTI is stored in a non-volatile memory in the USIM if the corresponding file is present in the USIM, else in the non-volatile memory in the ME, as described in annex C.
- b) The AMF considers the old 5G-GUTI as invalid as soon as an acknowledgement for a registration or generic UE configuration update procedure is received.

### 5.3.4 Registration areas

Within the 5GS, the registration area is managed independently per access type, i.e., 3GPP access or non-3GPP access. The AMF assigns a registration area to the UE during the registration procedure. A registration area is defined as a set of tracking areas and each of these tracking areas consists of one or more cells that cover a geographical area. Tracking areas cannot overlap each other. Within the 5GS, the concept of "registration to multiple tracking areas" applies:

- a) A tracking area is identified by a TAI which is broadcast in the cells of the tracking area. The TAI is constructed from a TAC and a PLMN identifier. In case of a shared network, one or more TAC and multiple PLMN identifiers are broadcast.
- b) In order to reduce the tracking area update signalling within the 5GS, the AMF can assign several tracking areas to the UE. These tracking areas construct a list of tracking areas which is identified by a TAI list. When generating the TAI list, the AMF shall include only TAIs that are applicable on the access where the TAI list is sent. The AMF shall be able to allocate a TAI List over different NG-RAN access technologies.
- c) The UE considers itself registered to a list of tracking areas and does not need to trigger the registration procedure for mobility and periodic registration update used for mobility (i.e. the 5GS registration type IE set to "mobility registration updating" in the REGISTRATION REQUEST message) as long as the UE stays in one of the tracking areas of the list of tracking areas received from the AMF.
- d) The UE will consider the TAI list as valid, until it receives a new TAI list in the next registration procedure for mobility and periodic registration update or generic UE configuration update procedure, or the UE is commanded by the network to delete the TAI list by a reject message or it is deregistered from the 5GS. If the registration request is accepted or the TAI list is reallocated by the AMF, the AMF shall provide at least one entry in the TAI list. If the new and the old TAI list are identical, the AMF does not need to provide the new TAI list to the UE during mobility registration update or periodic registration update.
- e) The TAI list can be reallocated by the AMF.
- f) When the UE is deregistered from the 5GS, the TAI list in the UE is invalid.

- g) The AMF allocates one 5G-GUTI, which is common between 3GPP access and non-3GPP access, to the UE when the UE is registered to the same PLMN over both accesses.
- h) The UE includes the last visited registered TAI, if available, to the AMF. The last visited registered TAI is stored in a non-volatile memory in the USIM if the corresponding file is present in the USIM, else in the non-volatile memory in the ME, as described in annex C.

### 5.3.5 Service area restrictions

Service area restrictions are applicable only to 3GPP access.

The service area restrictions consist of tracking areas forming either an allowed area, or a non-allowed area. The tracking areas belong to either the registered PLMN or its equivalent PLMNs in the registration area. The allowed area can contain up to 16 tracking areas or include all tracking areas in the registered PLMN and its equivalent PLMN(s) in the registration area. The non-allowed area can contain up to 16 tracking areas. The network conveys the service area restrictions to the UE by including either an allowed area, or a non-allowed area, but not both, in the Service area list IE of a REGISTRATION ACCEPT message or a CONFIGURATION UPDATE COMMAND message.

If the network does not convey the service area restrictions to the UE in the Service area list IE of a REGISTRATION ACCEPT message, the UE shall treat all tracking areas in the registered PLMN and its equivalent PLMN(s) in the registration area as allowed area and delete the stored list of "allowed tracking areas" or the stored list of "non-allowed tracking areas"

When the UE receives a Service area list IE with an allowed area indication during a registration procedure or a generic UE configuration update procedure:

- a) if the "Type of list" included in the Service area list IE does not indicate "all TAIs belonging to all PLMNs in the registration area are allowed area", the UE shall delete the old list of "allowed tracking areas" and store the tracking areas in the allowed area as the list of "allowed tracking areas". If the UE has a stored list of "non-allowed tracking areas", the UE shall delete that list; or
- b) if the "Type of list" included in the Service area list IE indicates "all TAIs belonging to all PLMNs in the registration area are allowed area", the UE shall treat all tracking areas in the registered PLMN and its equivalent PLMN(s) as allowed area and delete the stored list of "allowed tracking areas" or the stored list of "non-allowed tracking areas".

When the UE receives a Service area list IE with a non-allowed area indication during a registration procedure or a generic UE configuration update procedure, the UE shall delete the old list of "non-allowed tracking areas" and store the tracking areas in the non-allowed area as the list of "non-allowed tracking areas". If the UE has a stored list of "allowed tracking areas", the UE shall delete that list.

If the UE is successfully registered to a PLMN and has a stored list of "allowed tracking areas":

- a) while camped on a cell whose TAI is in the list of "allowed tracking areas", the UE shall stay or enter the state 5GMM-REGISTERED.NORMAL-SERVICE and is allowed to initiate any 5GMM and 5GSM procedures; and
- b) while camped on a cell which is in the registered PLMN or a PLMN from the list of equivalent PLMNs and whose TAI is in the registration area and is not in the list of "allowed tracking areas", the UE shall enter the state 5GMM-REGISTERED.NON-ALLOWED-SERVICE, and:
  - 1) if the UE is in 5GMM-IDLE mode over 3GPP access, the UE:
    - i) shall not perform the registration procedure for mobility and periodic registration update with Uplink data status IE except for emergency services or for high priority access; and
    - ii) shall not initiate a service request procedure except for emergency services, high priority access, responding to paging or notification or indicating a change of 3GPP PS data off UE status; and
  - 2) if the UE is in 5GMM-CONNECTED mode or 5GMM-CONNECTED mode with RRC inactive indication over 3GPP access, the UE:
    - i) shall not perform the registration procedure for mobility and periodic registration update with Uplink data status IE except for emergency services or for high priority access; and

- ii) shall not initiate a service request procedure except for emergency services, high priority access or for responding to paging or notification over non-3GPP access; and
- iii) shall not initiate a 5GSM procedure except for emergency services, high priority access or indicating a change of 3GPP PS data off UE status.

If the UE is successfully registered to a PLMN and has a stored list of "non-allowed tracking areas":

- a) while camped on a cell which is in the registered PLMN or a PLMN from the list of equivalent PLMNs and whose TAI is not in the list of "non-allowed tracking areas", the UE shall stay or enter the state 5GMM-REGISTERED.NORMAL-SERVICE and is allowed to initiate any 5GMM and 5GSM procedures; and
- b) while camped on a cell whose TAI is in the list of "non-allowed tracking areas", the UE shall enter the state 5GMM-REGISTERED.NON-ALLOWED-SERVICE, and:
  - 1) if the UE is in 5GMM-IDLE mode over 3GPP access, the UE:
    - i) shall not perform the registration procedure for mobility and periodic registration update with Uplink data status IE except for emergency services or for high priority access; and
    - ii) shall not initiate a service request procedure except for emergency services, high priority access, responding to paging or notification or indicating a change of 3GPP PS data off UE status; and
  - 2) if the UE is in 5GMM-CONNECTED mode or 5GMM-CONNECTED mode with RRC inactive indication over 3GPP access, the UE:
    - i) shall not perform the registration procedure for mobility and registration update with the Uplink data status IE except for emergency services or for high priority access; and
    - ii) shall not initiate a service request procedure except for emergency services, high priority access or for responding to paging or notification over non-3GPP access; and
    - iii) shall not initiate a 5GSM procedure except for emergency services, high priority access or indicating a change of 3GPP PS data off UE status.

The list of "allowed tracking areas", as well as the list of "non-allowed tracking areas" shall be erased when:

- a) the UE is switched off; and
- b) the UICC containing the USIM is removed.

When a tracking area is added to the list of "5GS forbidden tracking areas for roaming" or to the list of "5GS forbidden tracking areas for regional provision of service" as specified in the subclauses 5.5.1.2.5 or 5.5.1.3.5, the tracking area shall be removed from the list of "allowed tracking areas" if the tracking area is already present in the list of "allowed tracking areas" and from the list of "non-allowed tracking areas" if the tracking area is already present in the list of "non-allowed tracking areas".

### 5.3.6 Mobile initiated connection only mode

The UE can request the use of mobile initiated connection only (MICO) mode during the registration procedure (see 3GPP TS 23.501 [8] and 3GPP TS 23.502 [9]). The UE shall not request use of MICO mode over non-3GPP access. Furthermore, the UE in 3GPP access shall not request the use of MICO mode during:

- a) a registration procedure for initial registration for emergency services (see subclause 5.5.1.2);
- b) a registration procedure for initial registration for initiating an emergency PDU session (see subclause 5.5.1.2);
- c) a registration procedure for mobility and periodic registration update (see subclause 5.5.1.3) for initiating an emergency PDU session if the UE is in the state 5GMM-REGISTERED.ATTEMPTING-REGISTRATION-UPDATE; or
- d) a registration procedure for mobility and periodic registration update (see subclause 5.5.1.3) when the UE has an emergency PDU session established.

If the UE requests the use of MICO mode, the network can accept the use of MICO mode by providing a MICO indication when accepting the registration procedure. The UE may use MICO mode only if the network has provided the MICO indication IE during the last registration procedure.

If the network accepts the use of MICO mode, the AMF may include an "all PLMN registration area allocated" indication in the MICO indication IE to the UE.

If the network accepts the use of MICO mode, the UE may deactivate the AS layer and activate MICO mode by entering the state 5GMM-REGISTERED.NO-CELL-AVAILABLE if:

- a) the UE is in 5GMM-IDLE mode for 3GPP access; and
- b) in the 5GMM-REGISTERED.NORMAL-SERVICE state for 3GPP access.

When MICO mode is activated all NAS timers are stopped and associated procedures aborted except for timers T3512, T3346, T3396, T3584, T3585, any back-off timers, and the timer T controlling the periodic search for HPLMN or EHPLMN or higher prioritized PLMNs (see 3GPP TS 23.122 [5]).

**NOTE:** When MICO mode is activated and if the UE is also registered over the non-3GPP access, the AMF will not send a NOTIFICATION message with access type indicating 3GPP access over the non-3GPP access for PDU sessions associated with 3GPP access.

The UE may deactivate MICO mode and activate the AS layer at any time. Upon deactivating MICO mode, the UE may initiate 5GMM procedures (e.g. for the transfer of mobile originated signalling or user data).

When an emergency PDU session is successfully established after the MICO mode was enabled, the UE and the AMF shall locally disable MICO mode. The UE and the AMF shall not enable MICO mode until the AMF accepts the use of MICO mode in the next registration procedure. To enable an emergency call back, the UE should wait for a UE implementation-specific duration of time before requesting the use of MICO mode after the release of the emergency PDU session

If the AMF accepts the use of MICO mode, the AMF starts the implicit de-registration timer for 3GPP access when entering 5GMM-IDLE mode for 3GPP access.

Upon successful completion of an attach procedure or tracking area updating procedure after inter-system change from N1 mode to S1 mode (see 3GPP TS 24.301 [15]), the UE operating in single-registration mode shall locally disable MICO mode. After inter-system change from S1 mode to N1 mode, the UE operating in single-registration mode may re-negotiate MICO mode with the network during the registration procedure for mobility and periodic registration update.

### 5.3.7 Handling of the periodic registration update timer and mobile reachable timer

The periodic registration update procedure is used over 3GPP access to periodically notify the availability of the UE to the network. The procedure is controlled in the UE by the periodic registration update timer, T3512.

If the UE is registered over the 3GPP access, the AMF maintains an implicit de-registration timer to control when the UE is considered implicitly de-registered over the 3GPP access. If the UE is registered over the non-3GPP access, the AMF also maintains a non-3GPP implicit de-registration timer to control when the UE is considered implicitly de-registered over the non-3GPP access. The UE registered over the non-3GPP access maintains a non-3GPP de-registration timer to control when the UE is considered implicitly de-registered for the non-3GPP access.

The AMF shall start a non-3GPP implicit de-registration timer for the UE registered over non-3GPP access when the N1 NAS signalling connection over non-3GPP access is released.

The UE registered over non-3GPP access shall reset and start a non-3GPP de-registration timer when the N1 NAS signalling connection over non-3GPP access is released. The non-3GPP de-registration timer is stopped when the UE enters 5GMM-CONNECTED mode over non-3GPP access or the 5GMM-DEREGISTERED state over non-3GPP access.

The non-3GPP implicit de-registration timer shall be longer than the non-3GPP de-registration timer.

The value of timer T3512 is sent by the network to the UE in the REGISTRATION ACCEPT message. The UE shall apply this value in all tracking areas of the list of tracking areas assigned to the UE until a new value is received. The periodic registration update timer only applies to the UE registered to the 5GS services over 3GPP access.

If timer T3512 received by the UE in a REGISTRATION ACCEPT message contains an indication that the timer is deactivated or the timer value is zero, then timer T3512 is deactivated and the UE shall not perform the periodic registration update procedure.

NOTE: The UE does not perform the periodic registration update procedure for non-3GPP access.

Timer T3512 is reset and started with its initial value, when the UE changes from 5GMM-CONNECTED over 3GPP access to 5GMM-IDLE mode over 3GPP access. Timer T3512 is stopped when the UE enters 5GMM-CONNECTED mode over 3GPP access or the 5GMM-DEREGISTERED state over 3GPP access.

If the UE is registered for emergency services, and timer T3512 expires, the UE shall not initiate a periodic registration update procedure, but shall locally de-register from the network. When the UE is camping on a suitable cell, it may re-register to regain normal service.

When a UE is not registered for emergency services, and timer T3512 expires, the periodic registration update procedure shall be started.

If the UE is not registered for emergency services, and is in a state other than 5GMM-REGISTERED.NORMAL-SERVICE over 3GPP access when timer T3512 expires, the periodic registration update procedure is delayed until the UE returns to 5GMM-REGISTERED.NORMAL-SERVICE over 3GPP access.

The network supervises the periodic registration update procedure of the UE by means of the mobile reachable timer.

If the UE is not registered for emergency services, the mobile reachable timer shall be longer than the value of timer T3512. In this case, by default, the mobile reachable timer is 4 minutes greater than the value of timer T3512.

The network behaviour upon expiry of the mobile reachable timer is network dependent, but typically the network stops sending paging messages to the UE on the first expiry, and may take other appropriate actions.

If the UE is registered for emergency services, the AMF shall set the mobile reachable timer with a value equal to timer T3512. When the mobile reachable timer expires, the AMF shall locally de-register the UE.

The mobile reachable timer shall be reset and started with the value as indicated above, when the AMF releases the NAS signalling connection for the UE. The mobile reachable timer shall be stopped when a NAS signalling connection is established for the UE.

Upon expiry of the mobile reachable timer the network shall start the implicit de-registration timer over 3GPP access. The value of the implicit de-registration timer over 3GPP access is network dependent. If MICO is activated, the default value of the implicit de-registration timer over 3GPP access is 4 minutes greater than the value of timer T3512.

If the implicit de-registration timer expires before the UE contacts the network, the network shall implicitly de-register the UE. The implicit de-registration timer shall be stopped when a NAS signalling connection is established for the UE.

If the non-3GPP implicit de-registration timer expires before the UE contacts the network over the non-3GPP access, the network shall implicitly de-register the UE and enter the state 5GMM-DEREGISTERED over non-3GPP access for the UE. The non-3GPP implicit de-registration timer shall be stopped when a NAS signalling connection over non-3GPP access is established for the UE.

If the non-3GPP de-registration timer expires before the UE contacts the network over the non-3GPP access, the UE shall enter the state 5GMM-DEREGISTERED over non-3GPP access. The non-3GPP de-registration timer shall be stopped when a NAS signalling connection over non-3GPP access is established for the UE.

If the AMF provides T3346 value IE in the DEREGISTRATION REQUEST message with Access type set to "Non-3GPP access" in Deregistration type IE, REGISTRATION REJECT message during a registration procedure for mobility and periodic registration update or SERVICE REJECT message and the value of timer T3346 is greater than the value of timer T3512, the AMF sets the mobile reachable timer and the implicit de-registration timer such that the sum of the timer values is greater than the value of timer T3346.

If the AMF provides T3346 value IE in the DEREGISTRATION REQUEST message with Access type set to "3GPP access" in Deregistration type IE, REGISTRATION REJECT message during a registration procedure for mobility and periodic registration update or SERVICE REJECT message and the value of timer T3346 is greater than the value of the

non-3GPP de-registration timer, the AMF sets the non-3GPP implicit de-registration timer value to be 8 minutes greater than the value of timer T3346.

If the UE receives T3346 value IE in the DEREGISTRATION REQUEST message with Access type set to "3GPP access" in Deregistration type IE, REGISTRATION REJECT message during a registration procedure for mobility and periodic registration update or SERVICE REJECT message and the value of timer T3346 is greater than the value of the non-3GPP de-registration timer, the UE sets the non-3GPP de-registration timer value to be 4 minutes greater than the value of timer T3346.

### 5.3.8 Handling of timer T3502

The value of timer T3502 can be sent by the network to the UE in the REGISTRATION ACCEPT message. The UE shall apply this value in all tracking areas of the registration area assigned to the UE, until a new value is received.

The value of timer T3502 can be sent by the network to the UE in the REGISTRATION REJECT message during the initial registration. If a REGISTRATION REJECT message including timer T3502 value was received integrity protected, the UE shall apply this value until a new value is received with integrity protection or a new PLMN is selected. Otherwise, the default value of this timer is used.

The default value of this timer is also used by the UE in the following cases:

- a) REGISTRATION ACCEPT message is received without a value specified;
- b) the UE does not have a stored value for this timer; or
- c) a new PLMN which is not in the list of equivalent PLMNs has been entered, the registration procedure fails, the registration attempt counter is equal to 5 and no REGISTRATION REJECT message was received from the new PLMN.

### 5.3.9 Handling of NAS level mobility management congestion control

The AMF may detect 5GMM signalling congestion and perform general NAS level congestion control. Under the 5GMM signalling congestion conditions the AMF may reject 5GMM signalling requests from UEs as specified in 3GPP TS 23.501 [8]. The AMF should not reject the following request:

- a) requests for emergency services;
- b) requests for emergency services fallback;
- c) requests from UEs configured for high priority access in selected PLMN; and
- d) DEREGISTRATION REQUEST message.

When general NAS level congestion control is active, the AMF may include a value for the mobility management back-off timer T3346 in the reject messages. The UE starts the timer T3346 with the value received in the 5GMM reject messages. To avoid that large numbers of UEs simultaneously initiate deferred requests, the AMF should select the value for the timer T3346 for the rejected UEs so that timeouts are not synchronised.

If the UE is registered in the same PLMN over the 3GPP access and non-3GPP access, and the UE receives the timer T3346 from the AMF, the timer T3346 shall apply to both 3GPP access and non-3GPP access.

If the timer T3346 is running when the UE enters state 5GMM-DEREGISTERED, the UE remains switched on, and the USIM in the UE remains the same, then the timer T3346 is kept running until it expires or it is stopped.

If the UE is switched off when the timer T3346 is running, the UE shall behave as follows when the UE is switched on and the USIM in the UE remains the same:

let  $t_1$  be the time remaining for T3346 timeout at switch off and let  $t$  be the time elapsed between switch off and switch on. If  $t_1$  is greater than  $t$ , then the timer shall be restarted with the value  $t_1 - t$ . If  $t_1$  is equal to or less than  $t$ , then the timer need not be restarted. If the UE is not capable of determining  $t$ , then the UE shall restart the timer with the value  $t_1$ .

If the UE enters a new PLMN while timer T3346 is running, and the new PLMN is not equivalent to the PLMN where the UE started timer T3346, the UE shall stop timer T3346 when initiating 5GMM procedures in the new PLMN.

After a change in registration area, if the timer T3346 is running and 5GS update status is 5U1 UPDATED then the UE shall set the 5GS update status to 5U2 NOT UPDATED and enter state 5GMM-REGISTERED.ATTEMPTING-REGISTRATION-UPDATE.

If timer T3346 is running or is deactivated, and the UE is a UE configured for high priority access in selected PLMN, or the UE needs to initiate signalling for emergency services or emergency services fallback, then the UE is allowed to initiate 5GMM procedures.

### 5.3.10 Handling of DNN based congestion control

The AMF may detect and start performing DNN based congestion control when one or more DNN congestion criteria as specified in 3GPP TS 23.501 [8] are met. The AMF may store a DNN congestion back-off timer on a per UE and congested DNN basis. If the UE does not provide a DNN for a non-emergency PDU session, then the AMF uses the selected DNN or the DNN associated with the PDU session corresponding to the 5GSM procedure.

When DNN based congestion control is activated at the AMF, the AMF performs the congestion control as specified in subclause 5.4.5 and the UE performs the congestion control as specified in subclause 5.4.5 and subclause 6.2.7.

### 5.3.11 Handling of S-NSSAI based congestion control

The AMF may detect and start performing S-NSSAI based congestion control when one or more S-NSSAI congestion criteria as specified in 3GPP TS 23.501 [8] are met. The AMF may store an S-NSSAI congestion back-off timer on a per UE, congested S-NSSAI, and optionally DNN basis. If the UE does not provide a DNN for a non-emergency PDU session, then the AMF uses the selected DNN or the DNN associated with the PDU session corresponding to the 5GSM procedure. If the UE does not provide an S-NSSAI for a non-emergency PDU session, then the AMF uses the selected S-NSSAI or the S-NSSAI associated with the PDU session corresponding to the 5GSM procedure.

When S-NSSAI based congestion control is activated at the AMF, the AMF performs the congestion control as specified in subclause 5.4.5 and the UE performs the congestion control as specified in subclause 5.4.5 and subclause 6.2.8.

### 5.3.12 Handling of local emergency numbers

The additional requirements in subclause 5.3.12A apply to a UE supporting registration or attach procedures via 3GPP access and registration procedures via non-3GPP access.

The network may send a local emergency numbers list or an extended local emergency numbers list or both, in the REGISTRATION ACCEPT message, by including the Emergency number list IE and the Extended emergency number list IE, respectively. The Local emergency numbers list can be updated as described in 3GPP TS 24.301 [15], subclause 5.3.7.

The user equipment shall store the local emergency numbers list and the extended local emergency numbers list, as provided by the network. The local emergency numbers list stored in the user equipment shall be replaced on each receipt of the Emergency number list IE. The extended local emergency numbers list stored in the user equipment shall be replaced on each receipt of the Extended emergency number list IE. The received local emergency numbers list or the received extended local emergency numbers list or both shall be provided to the upper layers.

If a REGISTRATION ACCEPT message is received via non-3GPP access from a PLMN in a country different from the current country of the UE, the UE shall keep the stored local emergency numbers list and the extended local emergency numbers list, if available.

The emergency number(s) received in the Emergency number list IE are valid only in networks in the same country as the PLMN from which this IE is received. If no Emergency number list IE is contained in the REGISTRATION ACCEPT message, then the stored local emergency numbers list in the user equipment shall be kept, except if the user equipment has successfully registered to a PLMN in a country different from that of the PLMN that sent the list.

The emergency number(s) received in the Extended emergency number list IE are valid only in:

- networks in the same country as the PLMN from which this IE is received, if the Extended Emergency Number List Validity (EENLV) field within the Extended emergency number list IE indicates "Extended Local Emergency Numbers List is valid in the country of the PLMN from which this IE is received"; and

- the PLMN from which this IE is received, if the EENLV field within the Extended emergency number list IE indicates "Extended Local Emergency Numbers List is valid only in the PLMN from which this IE is received".

If no Extended Local Emergency Numbers List is contained in the REGISTRATION ACCEPT message, and the registered PLMN has not changed, then the stored Extended Local Emergency Numbers List in the user equipment shall be kept. If no Extended Local Emergency Numbers List is contained in the REGISTRATION ACCEPT message, but the registered PLMN has changed, then:

- if the last received indication in the EENLV field within the Extended emergency number list IE indicates "Extended Local Emergency Numbers List is valid only in the PLMN from which this IE is received", the stored Extended Local Emergency Numbers List in the user equipment shall be deleted; and
- if the last received indication in the EENLV field within the Extended emergency number list IE indicates "Extended Local Emergency Numbers List is valid in the country of the PLMN from which this IE is received" the list shall be kept except if the user equipment has successfully registered to a PLMN in a country different from that of the PLMN that sent the stored list.

NOTE: To prevent the misrouting of emergency calls, all operators within a country need to follow the regulation or agree on the setting of the Extended emergency number list IE in accordance to national agreement – either to indicate validity within a country or to indicate validity only within the PLMN.

The local emergency numbers list and the extended local emergency numbers list shall be deleted at switch off or removal of the USIM. The user equipment shall be able to store up to ten entries in the local emergency numbers list and up to twenty entries in the Extended local emergency numbers list, received from the network.

For the use of the local emergency numbers list and the extended local emergency numbers list by the UE see 3GPP TS 24.301 [15], subclause 5.3.7.

## 5.3.12A Handling of local emergency numbers received via 3GPP access and non-3GPP access

### 5.3.12A.1 General

The requirements in subclause 5.3.12 with the clarifications and additional conditions in subclause 5.3.12A apply to a UE supporting:

- attach procedures (see 3GPP TS 24.301 [15]) or registration procedures via 3GPP access; and
- registration procedures via non-3GPP access.

The UE shall ignore the presence or absence of local emergency numbers list, extended local emergency numbers list or both, in a REGISTRATION ACCEPT message received via non-3GPP access, unless conditions in subclause 5.3.12A.2 are met.

For the purposes of subclause 5.3.12A, the UE is considered neither registered nor attached over 3GPP access if:

- 1) the UE supports 3GPP access to EPC, the UE does not support 3GPP access to 5GC, and:
  - a) the EMM sublayer is in the EMM-NULL state, EMM-DEREGISTERED state or EMM-DEREGISTERED-INITIATED state; or
- 2) the UE supports 3GPP access to 5GC, the UE does not support 3GPP access to EPC, and:
  - a) the 5GMM sublayer is in the 5GMM-NULL state, 5GMM-DEREGISTERED state or 5GMM-DEREGISTERED-INITIATED state; or
- 3) supports both 3GPP access to EPC and 3GPP access to 5GC, and:
  - a) the EMM sublayer is in the EMM-NULL state, EMM-DEREGISTERED state or EMM-DEREGISTERED-INITIATED state; and
  - a) the 5GMM sublayer is in the 5GMM-NULL state, 5GMM-DEREGISTERED state or 5GMM-DEREGISTERED-INITIATED state.



### 5.3.12A.2 Receiving a REGISTRATION ACCEPT message via non-3GPP access

If the UE can determine the current country and after switch on or after removal of the USIM, has not been registered or has not been attached via 3GPP access in the current country, then the UE shall store the local emergency numbers list or the extended local emergency numbers list or both, as provided by the network with an MCC matching the current country via non-3GPP access.

NOTE: The UE determines, as the current country, the country in which it is located in accordance with 3GPP TS 24.502 [18].

The UE shall replace a previously stored local emergency numbers list or a previously stored extended local emergency numbers list or both with a local emergency numbers list or an extended local emergency numbers list or both received in a REGISTRATION ACCEPT message via non-3GPP access, if the previously stored local emergency numbers list was also received via non-3GPP access or the previously stored extended local emergency numbers list was also received via non-3GPP access.

The UE shall replace a previously stored extended local emergency numbers list with an extended local emergency numbers list received in a REGISTRATION ACCEPT message via non-3GPP access, if:

- the UE is neither registered nor attached over 3GPP access;
- the REGISTRATION ACCEPT message is received from a PLMN different from which the stored list was received; and
- the stored indication in the EENLV field within the Extended emergency number list IE indicates "Extended Local Emergency Numbers List is valid only in the PLMN from which this IE is received".

If no extended local emergency numbers list is contained in a REGISTRATION ACCEPT message received via non-3GPP access and the UE is neither registered nor attached over 3GPP access, the stored extended local emergency numbers list in the UE shall be discarded if:

- the UE can determine the current country and the UE has successfully registered to a PLMN in the country and that country is different from that of the PLMN that sent the stored list via 3GPP access; or
- the REGISTRATION ACCEPT message is received from a PLMN different from which the stored list was received, and the stored indication in the EENLV field within the Extended emergency number list IE indicates "Extended Local Emergency Numbers List is valid only in the PLMN from which this IE is received".

### 5.3.13 Lists of 5GS forbidden tracking areas

The UE shall store a list of "5GS forbidden tracking areas for roaming", as well as a list of "5GS forbidden tracking areas for regional provision of service". Within the 5GS, these lists are managed independently per access type, i.e., 3GPP access or non-3GPP access. These lists shall be erased when

- a) the UE is switched off or the UICC containing the USIM is removed; and
- b) periodically (with a period in the range 12 to 24 hours).

Over 3GPP access, when the lists are erased, the UE performs cell selection according to 3GPP TS 38.304 [28]. A tracking area shall be removed from the list of "5GS forbidden tracking areas for roaming", as well as the list of "5GS forbidden tracking areas for regional provision of service", if the UE receives the tracking area in the TAI list or the Service area list of "allowed tracking areas" in REGISTRATION ACCEPT message or a CONFIGURATION UPDATE COMMAND message. The UE shall not remove the tracking area from "5GS forbidden tracking areas for roaming" or "5GS forbidden tracking areas for regional provision of service" if the UE is registered for emergency services.

In N1 mode, the UE shall update the suitable list whenever a REGISTRATION REJECT, SERVICE REJECT or DEREGISTRATION REQUEST message is received with the 5GMM cause #12 "tracking area not allowed", #13 "roaming not allowed in this tracking area", or #15 "no suitable cells in tracking area".

Each list shall accommodate 40 or more TAIs. When the list is full and a new entry has to be inserted, the oldest entry shall be deleted.

### 5.3.14 List of equivalent PLMNs

The UE shall store a list of equivalent PLMNs. These PLMNs shall be regarded by the UE as equivalent to each other for PLMN selection and cell selection/re-selection. The same list is used by 5GMM, EMM, GMM and MM (see 3GPP TS 24.301 [15] and 3GPP TS 24.008 [12]) except for the case when the UE operates in dual-registration mode (see subclause 4.8.3).

The UE shall update or delete this list at the end of each registration procedure. The stored list consists of a list of equivalent PLMNs as downloaded by the network plus the PLMN code of the registered PLMN that downloaded the list. When the UE is switched off, the UE shall keep the stored list so that it can be used for PLMN selection after switch on. The UE shall delete the stored list if the USIM is removed or when the UE registered for emergency services enters the state 5GMM-DEREGISTERED. The maximum number of possible entries in the stored list is 16.

### 5.3.15 Transmission failure abnormal case in the UE

The abnormal case 5GMM uplink message transmission failure indication by lower layers can be identified for 5GMM procedures:

When it is specified in the relevant procedure that it is up to the UE implementation to re-run the ongoing procedure that triggered that procedure, the procedure can typically be re-initiated using a retransmission mechanism of the uplink message (i.e. the one that has previously failed to be transmitted) with new sequence number and message authentication code information thus avoiding to re-start the whole procedure.

## 5.4 5GMM common procedures

### 5.4.1 Primary authentication and key agreement procedure

#### 5.4.1.1 General

The purpose of the primary authentication and key agreement procedure is to enable mutual authentication between the UE and the network and to provide keying material that can be used between the UE and network in subsequent security procedures, as specified in 3GPP TS 33.501 [24].

Two methods are defined:

- a) EAP based primary authentication and key agreement procedure.
- b) 5G AKA based primary authentication and key agreement procedure.

The UE and the AMF shall support the EAP based primary authentication and key agreement procedure and the 5G AKA based primary authentication and key agreement procedure.

#### 5.4.1.2 EAP based primary authentication and key agreement procedure

##### 5.4.1.2.1 General

The purpose of the EAP based primary authentication and key agreement procedure is to provide mutual authentication between the UE and the network and to agree on the keys  $K_{\text{AUSF}}$ ,  $K_{\text{SEAF}}$  and  $K_{\text{AMF}}$  (see 3GPP TS 33.501 [24]).

Extensible authentication protocol (EAP) as specified in IETF RFC 3748 [34] enables authentication using various EAP methods.

EAP defines four types of EAP messages:

- a) an EAP-request message;
- b) an EAP-response message;
- c) an EAP-success message; and
- d) an EAP-failure message.

Several rounds of exchanges of an EAP-request message and a related EAP-response message can be required to achieve the authentication (see example in figure 5.4.1.2.1.1).

The EAP based primary authentication and key agreement procedure is always initiated and controlled by the network.

The EAP-request message, the ngKSI and the ABBA are transported from the network to the UE using the AUTHENTICATION REQUEST message of the EAP message reliable transport procedure.

The EAP-response message is transported from the UE to the network using the AUTHENTICATION RESPONSE message of the EAP message reliable transport procedure.

If the authentication of the UE completes successfully, the serving AMF intends to initiate a security mode control procedure after the EAP based primary authentication and key agreement procedure and the security mode control procedure intends to bring into use the partial native 5G NAS security context created by the EAP based primary authentication and key agreement procedure, then the EAP-success message and the ngKSI are transported from the network to the UE using the SECURITY MODE COMMAND message of the security mode control procedure (see subclause 5.4.2).

If the authentication of the UE completes successfully and the serving AMF does not intend to initiate a security mode control procedure bringing into use the partial native 5G NAS security context created by the EAP based primary authentication and key agreement procedure, then the EAP-success message, and the ngKSI are transported from the network to the UE using the AUTHENTICATION RESULT message of the EAP result message transport procedure.

NOTE 1: The serving AMF will not initiate a security mode control procedure after the EAP based primary authentication and key agreement procedure e.g. in case of AMF relocation during registration procedure.

If the authentication of the UE completes unsuccessfully, the EAP-failure message is transported from the network to the UE using the AUTHENTICATION RESULT message or the AUTHENTICATION REJECT message of the EAP result message transport procedure or in a response of the initial 5GMM procedure as part of which the EAP based primary authentication and key agreement procedure is performed.

The AMF shall set the authenticator retransmission timer specified in IETF RFC 3748 [34] subclause 4.3 to infinite value.

NOTE 2: The EAP message reliable transport procedure provides a reliable transport of EAP messages and therefore retransmissions at the EAP layer do not occur.

The AUSF and the AMF support exchange of EAP messages using N12.

The UE shall detect and handle any duplication of EAP message as specified in IETF RFC 3748 [34].

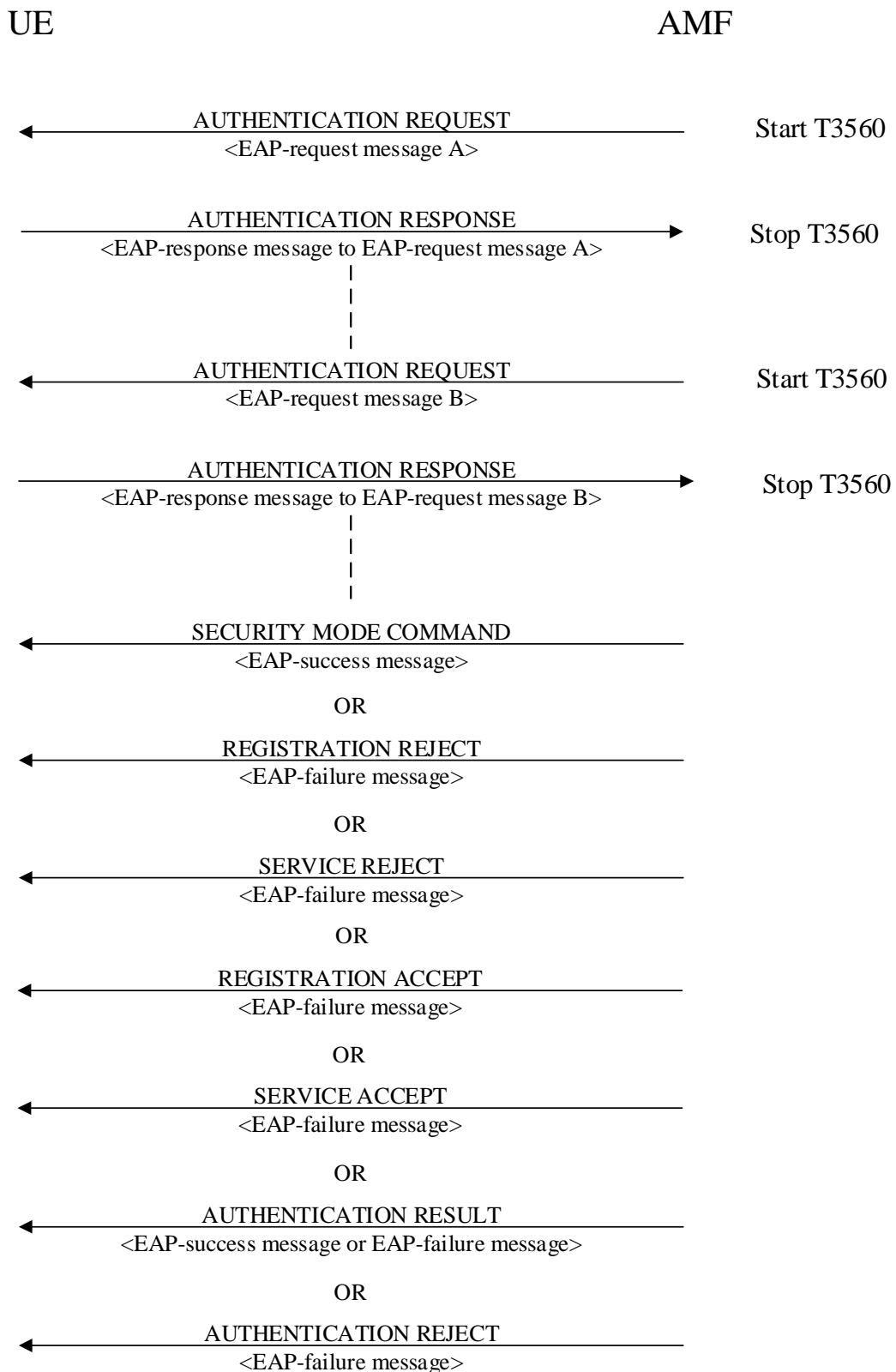

Figure 5.4.1.2.1.1: EAP based primary authentication and key agreement procedure

### 5.4.1.2.2 EAP-AKA' related procedures

#### 5.4.1.2.2.1 General

The UE shall support acting as EAP-AKA' peer as specified in IETF RFC 5448 [40]. The AUSF may support acting as EAP-AKA' server as specified in IETF RFC 5448 [40].

The EAP-AKA' enables mutual authentication of the UE and the network.

The UE can reject the EAP-request/AKA'-challenge message sent by the network. The UE shall proceed with an EAP-request/AKA'-challenge message only if a USIM is present.

During a successful EAP based primary authentication and key agreement procedure, the CK and IK are computed by the USIM. CK and IK are then used by the ME as key material to generate an EMSK.

#### 5.4.1.2.2.2 Initiation

In order to initiate the EAP based primary authentication and key agreement procedure using EAP-AKA', the AUSF shall send an EAP-request/AKA'-challenge message as specified in IETF RFC 5448 [40]. The AUSF shall set the AT\_KDF\_INPUT attribute of the EAP-request/AKA'-challenge message to the SNN. The SNN is in format described in subclause 9.12.1. The AUSF may include AT\_RESULT\_IND attribute in the EAP-request/AKA'-challenge message.

The network shall select an ngKSI value. If an ngKSI is contained in an initial NAS message during a 5GMM procedure, the network shall select a different ngKSI value. The network shall send the selected ngKSI value to the UE along with each EAP message. The network shall send the ABBA value as described in subclause 9.11.3.10 to the UE along with the EAP request message and EAP-success message.

Upon receiving an EAP-request/AKA'-challenge message, the UE shall check whether the UE has a USIM, shall check the key derivation function indicated in AT\_KDF attributes as specified in IETF RFC 5448 [40], and if the value of the Key derivation function field within the received AT\_KDF attribute, is of value 1, shall check:

- a) whether the network name field of the AT\_KDF\_INPUT attribute is the SNN constructed according to subclause 9.12.1; and
- b) whether the network name field of the AT\_KDF\_INPUT attribute matches the PLMN identity saved in the UE.

The PLMN identity the UE uses for the above network name check is as follows:

- a) when the UE moves from 5GMM-IDLE mode to 5GMM-CONNECTED mode, until the first handover, the UE shall use the PLMN identity of the selected PLMN; and
- b) after handover or inter-system change to N1 mode in 5GMM-CONNECTED mode:
  - 1) if the target cell is not a shared network cell, the UE shall use the PLMN identity received as part of the broadcast system information;
  - 2) if the target cell is a shared network cell and the UE has a valid 5G-GUTI, the UE shall use the PLMN identity that is part of the 5G-GUTI; and
  - 3) if the target cell is a shared network cell and the UE has a valid 4G-GUTI and TAI, but not a valid 5G-GUTI, the UE shall use the PLMN identity that is part of the TAI.

#### 5.4.1.2.2.3 UE successfully authenticates network

If a USIM is present and the SNN check is successful, the UE shall handle the EAP-request/AKA'-challenge message as specified in IETF RFC 5448 [40]. The USIM shall derive CK and IK and compute the authentication response (RES) using the 5G authentication challenge data received from the ME, and pass RES to the ME. The ME shall derive CK' and IK' from CK and IK, and EMSK from CK' and IK'. Furthermore, the ME may generate  $K_{AUSF}$  from the EMSK, the  $K_{SEAF}$  from the  $K_{AUSF}$ , and the  $K_{AMF}$  from the ABBA received together with the EAP-request/AKA'-challenge message, and the  $K_{SEAF}$  as described in 3GPP TS 33.501 [24], and create a partial native 5G NAS security context identified by the ngKSI value received together with the EAP-request/AKA'-challenge message in subclause 5.4.1.2.4.2 in the volatile memory of the ME. If the  $K_{AMF}$  and the partial native 5G NAS security context are created, the ME shall store the  $K_{AMF}$  in the created partial native 5G NAS security context, and shall send an EAP-response/AKA'-challenge message as specified in IETF RFC 5448 [40].

If the EAP-request/AKA'-challenge message contains AT\_RESULT\_IND attribute, the UE may include AT\_RESULT\_IND attribute in the EAP-response/AKA'-challenge message as specified in IETF RFC 5448 [40].

#### 5.4.1.2.2.4 Errors when handling EAP-request/AKA'-challenge message

If a USIM is present, the SNN check fails or the UE does not accept AUTN during handling of the EAP-request/AKA'-challenge message as specified in IETF RFC 5448 [40], the UE shall send an EAP-response/AKA'-authentication-reject message as specified in IETF RFC 5448 [40].

If a USIM is present, the SNN check is successful but the UE detects that the sequence number in AUTN is not correct during handling of the EAP-request/AKA'-challenge message as specified in IETF RFC 5448 [40], the UE shall send an EAP-response/AKA'-synchronization-failure message as specified in IETF RFC 5448 [40].

If a USIM is present, the SNN check is successful, the sequence number in AUTN is correct and the UE detects another error during handling of the EAP-request/AKA'-challenge message as specified in IETF RFC 5448 [40], the UE shall send an EAP-response/AKA'-client-error message as specified in IETF RFC 5448 [40].

If a USIM is not present, the UE shall send an EAP-response/AKA'-client-error message as specified in IETF RFC 5448 [40].

For any of the above, the UE shall start timer T3520 when the AUTHENTICATION RESPONSE message containing the EAP-response message is sent. Furthermore, the UE shall stop any of the retransmission timers that are running (e.g. T3510, T3517 or T3521). Upon receiving an AUTHENTICATION REQUEST message with the EAP message IE containing an EAP-request/AKA'-challenge from the network, the UE shall stop timer T3520, if running, and then process the EAP-request/AKA'-challenge information as normal.

#### 5.4.1.2.2.5 Network successfully authenticates UE

Upon reception of the EAP-response/AKA'-challenge message, if procedures for handling an EAP-response/AKA'-challenge message as specified in IETF RFC 5448 [40] are successful, the AUSF shall generate EMSK, the  $K_{AUSF}$  from the EMSK, and the  $K_{SEAF}$  from the  $K_{AUSF}$  as described in 3GPP TS 33.501 [24], and the AUSF shall check whether the AT\_RESULT\_IND attribute is included in the EAP-response/AKA'-challenge message and:

- a) if the AT\_RESULT\_IND attribute is included in the EAP-response/AKA'-challenge message, the AUSF shall send an EAP-request/AKA'-notification message as specified in IETF RFC 5448 [40]; and
- b) if the AT\_RESULT\_IND attribute is not included in the EAP-response/AKA'-challenge message, the AUSF shall send an EAP-success message as specified in IETF RFC 5448 [40] and shall consider the procedure complete.

**NOTE:** The AUSF provides the  $K_{SEAF}$  to the SEAF. Upon reception of the  $K_{SEAF}$ , the SEAF generates the  $K_{AMF}$  based on the ABBA and the  $K_{SEAF}$  as described in 3GPP TS 33.501 [24], and provides ngKSI and the  $K_{AMF}$  to the AMF. Upon reception of the ngKSI and the  $K_{AMF}$ , the AMF creates a partial native 5G NAS security context identified by the ngKSI, and stores the  $K_{AMF}$  in the created partial native 5G NAS security context.

#### 5.4.1.2.2.6 UE handling EAP-AKA' notification message

Upon receiving an EAP-request/AKA'-notification message, the UE shall send an EAP-response/AKA'-notification message as specified in IETF RFC 5448 [40].

#### 5.4.1.2.2.6A EAP based Identification initiation by the network

If AUSF decides to initiate the EAP based identification procedure, the AUSF shall send an EAP-Request/Identity or EAP-Request/AKA'-Identity message as specified in IETF RFC 5448 [40].

The AMF shall encapsulate the EAP-Request/Identity or EAP-Request/AKA'-Identity message in the AUTHENTICATION REQUEST message and send it to the UE.

#### 5.4.1.2.2.6B EAP based Identification response by the UE

Upon receipt of the AUTHENTICATION REQUEST message with EAP-Request/Identity message the UE shall send an AUTHENTICATION RESPONSE message with EAP-Response/Identity to the network. In the EAP-

Response/Identity message, the UE shall provide the requested identity according to 3GPP TS 33.501 [24] annex F.2, in the UE identity in the EAP-Response/Identity message as specified in IETF RFC 5448 [40].

Upon receipt of the AUTHENTICATION REQUEST message with EAP-Request/AKA'-Identity message the UE shall send an AUTHENTICATION RESPONSE message with EAP-Response/AKA'-Identity to the network. Based on the attribute received in the EAP-Request/AKA'-Identity, the UE shall provide the requested identity according to 3GPP TS 33.501 [24] annex F.2, in the EAP-Response/AKA'-Identity message, as specified in IETF RFC 5448 [40].

If the EAP-Request/AKA'-Identity carries the AT\_PERMANENT\_REQ, the UE shall respond with EAP-Response/AKA'-Client-Error with the error code "unable to process packet".

#### 5.4.1.2.2.7 Network sending EAP-success message

Upon reception of the EAP-response/AKA'-notification message, if earlier procedures for handling an EAP-request/AKA'-challenge message as specified in IETF RFC 5448 [40] were successful, the AUSF shall send an EAP-success message as specified in IETF RFC 5448 [40] and shall consider the procedure complete.

NOTE: The AUSF provides the  $K_{SEAF}$  to the SEAF. Upon reception of the  $K_{SEAF}$ , the SEAF generates the  $K_{AMF}$  based on the ABBA and the  $K_{SEAF}$  as described in 3GPP TS 33.501 [24], and provides ngKSI and the  $K_{AMF}$  to the AMF. Upon reception of the ngKSI and the  $K_{AMF}$ , the AMF creates a partial native 5G NAS security context identified by the ngKSI, and stores the  $K_{AMF}$  in the created partial native 5G NAS security context.

#### 5.4.1.2.2.8 UE handling EAP-success message

Upon receiving an EAP-success message, if the ME has not generated a partial native 5G NAS security context as described in subclause 5.4.1.2.2.3, the ME shall:

- a) generate the  $K_{AUSF}$  from the EMSK, the  $K_{SEAF}$  from the  $K_{AUSF}$ , and the  $K_{AMF}$  from the ABBA that was received with the EAP-success message, and the  $K_{SEAF}$  as described in 3GPP TS 33.501 [24];
- b) create a partial native 5G NAS security context identified by the ngKSI value in the volatile memory of the ME; and
- c) store the  $K_{AMF}$  in the created partial native 5G NAS security context.

The UE shall consider the procedure complete.

#### 5.4.1.2.2.9 Network not successfully authenticates UE

Upon reception of the EAP-response/AKA'-challenge message, if procedures for handling an EAP-response/AKA'-challenge message as specified in IETF RFC 5448 [40] are not successful, the AUSF shall send an EAP-request/AKA'-notification message that implies failure as specified in IETF RFC 5448 [40].

#### 5.4.1.2.2.10 Network sending EAP-failure message

Upon reception of the EAP-response/AKA'-notification message, if earlier procedures for handling an EAP-request/AKA'-challenge message as specified in IETF RFC 5448 [40] were not successful, the AUSF shall send an EAP-failure message as specified in IETF RFC 5448 [40] and shall consider the procedure complete.

If the authentication response (RES) returned by the UE in the AT\_RES attribute of the EAP-response/AKA'-challenge message is not valid, the network handling depends upon the type of identity used by the UE in the initial NAS message, that is:

- if the 5G-GUTI was used; or
- if the SUCI was used.

If the 5G-GUTI was used, the network should transport the EAP-failure message in the AUTHENTICATION RESULT message of the EAP result message transport procedure, initiate an identification procedure to retrieve SUCI from the UE and restart the EAP based primary authentication and key agreement procedure with the received SUCI.

If the SUCI was used for identification in the initial NAS message or in a restarted EAP based primary authentication and key agreement procedure, or the network decides not to initiate the identification procedure to retrieve SUCI from

the UE after an unsuccessful EAP based primary authentication and key agreement procedure, the network should transport the EAP-failure message in an AUTHENTICATION REJECT message of the EAP result message transport procedure.

Depending on local requirements or operator preference for emergency services, if the UE initiates a registration procedure with 5GS registration type IE set to "emergency registration" and the AMF is configured to allow emergency registration without user identity, the AMF needs not follow the procedures specified for transporting the EAP-failure message in the AUTHENTICATION REJECT message of the EAP result message transport procedure in the present subclause. The AMF may include the EAP-failure message in a response of the current 5GMM specific procedure or in the AUTHENTICATION RESULT of the EAP result message transport procedure.

#### 5.4.1.2.2.11 UE handling EAP-failure message

Upon receiving an EAP-failure message, the UE shall delete the partial native 5G NAS security context if any was created as described in subclause 5.4.1.2.2.3.

The UE shall consider the procedure complete.

If the EAP-failure message is received in an AUTHENTICATION REJECT message:

- the UE shall set the update status to 5U3 ROAMING NOT ALLOWED, delete the stored 5G-GUTI, TAI list, last visited registered TAI and ngKSI. The USIM shall be considered invalid until switching off the UE or the UICC containing the USIM is removed; and
- if the UE is operating in single-registration mode, the UE shall handle 4G-GUTI, TAI list and eKSI as specified in 3GPP TS 24.301 [15] for the case when the authentication procedure is not accepted by the network. The USIM shall be considered as invalid also for non-EPS services until switching off or the UICC containing the USIM is removed.

If the AUTHENTICATION REJECT message is received by the UE, the UE shall abort any 5GMM signalling procedure, stop any of the timers T3510, T3517 or T3521 (if they were running) and enter state 5GMM-DEREGISTERED.

#### 5.4.1.2.2.12 Abnormal cases in the UE

The following abnormal cases can be identified:

- a) EAP-request/AKA'-challenge message with the key derivation function indicated in AT\_KDF attributes set to a value other than 1.

The UE shall act as specified in IETF RFC 5448 [40] subclause 3.2 for the case when the AUTN had been incorrect.

#### 5.4.1.2.3 EAP-TLS related procedures

##### 5.4.1.2.3.1 General

The UE may support acting as EAP-TLS peer as specified in 3GPP TS 33.501 [24]. The AUSF may support acting as EAP-TLS server as specified in 3GPP TS 33.501 [24].

The EAP-TLS enables mutual authentication of the UE and the network.

When initiating an EAP based primary authentication and key agreement procedure using EAP-TLS, the network shall select an ngKSI value. If an ngKSI is contained in an initial NAS message during a 5GMM procedure, the network shall select a different ngKSI value. The network shall send the selected ngKSI value to the UE along with each EAP message. The network shall send the ABBA value as described in subclause 9.11.3.10 to the UE along with the EAP-request message and EAP-success message.

When the EAP based primary authentication and key agreement procedure uses EAP-TLS, the ME and the AUSF shall generate EMSK as described in 3GPP TS 33.501 [24].

When handling of an EAP-request message results into generation of EMSK, the ME may generate the  $K_{AUSF}$  from the EMSK, the  $K_{SEAF}$  from the  $K_{AUSF}$ , and the  $K_{AMF}$  from the ABBA received together with the EAP-request message, and the  $K_{SEAF}$  as described in 3GPP TS 33.501 [24], and create a partial native 5G NAS security context identified by the



ngKSI value received together with the EAP-request message in subclause 5.4.1.2.4.2, in the volatile memory of the ME. If the  $K_{AMF}$  and the partial native 5G NAS security context are created, the ME shall store the  $K_{AMF}$  in the created partial native 5G NAS security context.

When handling of an EAP response message results into generation of EMSK, the AUSF shall generate the  $K_{AUSF}$  from the EMSK, and the  $K_{SEAF}$  from the  $K_{AUSF}$  as described in 3GPP TS 33.501 [24].

NOTE: The AUSF provides the  $K_{SEAF}$  to the SEAF. Upon reception of the  $K_{SEAF}$ , the SEAF generates the  $K_{AMF}$  based on the ABBA and the  $K_{SEAF}$  as described in 3GPP TS 33.501 [24], and provides ngKSI and the  $K_{AMF}$  to the AMF. Upon reception of the ngKSI and the  $K_{AMF}$ , the AMF creates a partial native 5G NAS security context identified by the ngKSI, and stores the  $K_{AMF}$  in the created partial native 5G NAS security context.

If the UE does not accept the server certificate of the network, the UE shall start timer T3520 when the AUTHENTICATION RESPONSE message containing the EAP-response message is sent. Furthermore, the UE shall stop any of the retransmission timers that are running (e.g. T3510, T3517 or T3521). Upon receiving an AUTHENTICATION REQUEST message with the EAP message IE containing an EAP-request message from the network, the UE shall stop timer T3520, if running, and then process the EAP-request message as normally.

If the network does not accept the client certificate of the UE, the network handling depends upon the type of identity used by the UE in the initial NAS message, that is:

- if the 5G-GUTI was used; or
- if the SUCI was used.

If the 5G-GUTI was used, the network should transport the EAP-failure message in the AUTHENTICATION RESULT message of the EAP result message transport procedure, initiate an identification procedure to retrieve SUCI from the UE and restart the EAP based primary authentication and key agreement procedure with the received SUCI.

If the SUCI was used for identification in the initial NAS message or in a restarted EAP based primary authentication and key agreement procedure, or the network decides not to initiate the identification procedure to retrieve SUCI from the UE after an unsuccessful the EAP based primary authentication and key agreement procedure, the network should transport the EAP-failure message in an AUTHENTICATION REJECT message of the EAP result message transport procedure.

Depending on local requirements or operator preference for emergency services, if the UE initiates a registration procedure with 5GS registration type IE set to "emergency registration" and the AMF is configured to allow emergency registration without user identity, the AMF needs not follow the procedures specified for transporting the EAP-failure message in the AUTHENTICATION REJECT message of the EAP result message transport procedure in the present subclause. The AMF may include the EAP-failure message in a response of the current 5GMM specific procedure or in the AUTHENTICATION RESULT of the EAP result message transport procedure.

If the EAP-failure message is received in an AUTHENTICATION REJECT message:

- the UE shall set the update status to 5U3 ROAMING NOT ALLOWED, delete the stored 5G-GUTI, TAI list, last visited registered TAI and ngKSI. The USIM shall be considered invalid until switching off the UE or the UICC containing the USIM is removed; and
- if the UE is operating in single-registration mode, the UE shall handle 4G-GUTI, TAI list and eKSI as specified in 3GPP TS 24.301 [15] for the case when the authentication procedure is not accepted by the network. The USIM shall be considered as invalid also for non-EPS services until switching off or the UICC containing the USIM is removed.

If the AUTHENTICATION REJECT message is received by the UE, the UE shall abort any 5GMM signalling procedure, stop any of the timers T3510, T3517 or T3521 (if they were running) and enter state 5GMM-DEREGISTERED.

Upon receiving an EAP-success message, if the ME has not generated a partial native 5G NAS security context when handling the EAP-request message which resulted into generation of EMSK as described above, the ME shall generate the  $K_{AUSF}$  from the EMSK, the  $K_{SEAF}$  from the  $K_{AUSF}$ , and the  $K_{AMF}$  from the ABBA that was received with the EAP-success message, and the  $K_{SEAF}$  as described in 3GPP TS 33.501 [24], shall create a partial native 5G NAS security context identified by the ngKSI value in the volatile memory of the ME, and shall store the  $K_{AMF}$  in the created partial native 5G NAS security context.

The UE shall consider the procedure complete.

Upon receiving an EAP-failure message, the UE shall delete the partial native 5G NAS security context if any was created when handling the EAP-request message which resulted into generation of EMSK as described above .

The UE shall consider the procedure complete.

#### 5.4.1.2.4 EAP message reliable transport procedure

##### 5.4.1.2.4.1 General

The purpose of the EAP message reliable transport procedure is to provide a reliable transport of an EAP-request message, the ngKSI and the ABBA from the network to the UE and of an EAP-response message from the UE to the network.

The EAP message reliable transport procedure is initiated by an AUTHENTICATION REQUEST message with the EAP message IE.

##### 5.4.1.2.4.2 EAP message reliable transport procedure initiation by the network

In order to initiate the EAP message reliable transport procedure, the AMF shall create an AUTHENTICATION REQUEST message.

The AMF shall set the EAP message IE of the AUTHENTICATION REQUEST message to the EAP-request message to be sent to the UE. The AMF shall set the ngKSI IE of the AUTHENTICATION REQUEST message to the ngKSI value selected in subclause 5.4.1.2.2.2 or subclause 5.4.1.2.3.1. In this release of specification, the AMF shall set the ABBA IE of the AUTHENTICATION REQUEST message with the length of ABBA IE to 2 and the ABBA contents to be 2 octets in length with value 0000H as described in subclause 9.11.3.10.

The AMF shall send the AUTHENTICATION REQUEST message to the UE, and the AMF shall start timer T3560 (see example in figure 5.4.1.2.4.2.1).

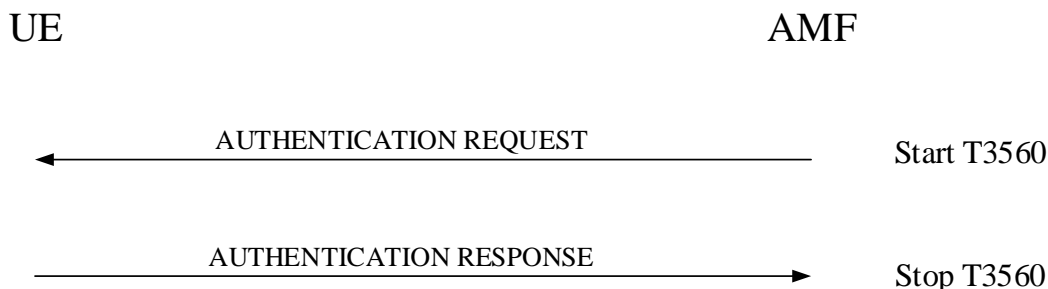

**Figure 5.4.1.2.4.2.1: EAP message reliable transport procedure**

Upon receipt of an AUTHENTICATION REQUEST message with the EAP message IE, the UE handles the EAP message received in the EAP message IE and the ABBA of the AUTHENTICATION REQUEST message.

##### 5.4.1.2.4.3 EAP message reliable transport procedure accepted by the UE

The UE shall create an AUTHENTICATION RESPONSE message.

If the received EAP message is an EAP-request message, the UE shall set the EAP message IE of the AUTHENTICATION RESPONSE message to the EAP-response message responding to the received EAP-request message.

The UE shall send the AUTHENTICATION RESPONSE message to the AMF.

Upon receipt of an AUTHENTICATION RESPONSE message, the AMF shall stop timer T3560. If the EAP message IE is included in the AUTHENTICATION RESPONSE message, the AMF handles the EAP message received in the EAP message IE of the AUTHENTICATION RESPONSE message.

#### 5.4.1.2.4.4 Abnormal cases on the network side

The following abnormal cases can be identified:

- a) Expiry of timer T3560.

The AMF shall, on the first expiry of the timer T3560, retransmit the AUTHENTICATION REQUEST message and shall reset and start timer T3560. This retransmission is repeated four times, i.e. on the fifth expiry of timer T3560, the AMF shall abort the EAP based primary authentication and key agreement procedure and any ongoing 5GMM specific procedure, and release the N1 NAS signalling connection.

- b) Lower layers indication of non-delivered NAS PDU due to handover.

If the AUTHENTICATION REQUEST message could not be delivered due to an intra AMF handover and the target TA is included in the TAI list, then upon successful completion of the intra AMF handover the AMF shall retransmit the AUTHENTICATION REQUEST message. If a failure of handover procedure is reported by the lower layer and the N1 NAS signalling connection exists, the AMF shall retransmit the AUTHENTICATION REQUEST message.

#### 5.4.1.2.4.5 Abnormal cases in the UE

The following abnormal cases can be identified:

- a) Authentication failure (5GMM cause #71 "ngKSI already in use").

The UE shall send an AUTHENTICATION FAILURE message, with 5GMM cause #71 "ngKSI already in use", to the network and start the timer T3520 (see example in figure 5.4.1.3.7.1). Furthermore, the UE shall stop any of the retransmission timers that are running (e.g. T3510, T3517 or T3521). Upon the first receipt of an AUTHENTICATION FAILURE message from the UE with 5GMM cause #71 "ngKSI already in use", the network performs necessary actions to select a new ngKSI and send the same EAP-request message to the UE.

NOTE 1: Upon receipt of an AUTHENTICATION FAILURE message from the UE with 5GMM cause #71 "ngKSI already in use", the network can also re-initiate the EAP based primary authentication and key agreement procedure (see subclause 5.4.1.2.2.2).

Upon receiving a new AUTHENTICATION REQUEST message with the EAP message IE containing an EAP-request message from the network, the UE shall stop timer T3520, if running, process the EAP-request message as normal.

If the network is validated successfully (an AUTHENTICATION REQUEST message that contains a valid ngKSI and EAP-request message is received), the UE shall send the AUTHENTICATION RESPONSE message to the network and shall start any retransmission timers (e.g. T3510, T3517 or T3521) if they were running and stopped when the UE received the first failed AUTHENTICATION REQUEST message.

- b) Transmission failure of AUTHENTICATION RESPONSE message or AUTHENTICATION FAILURE message indication from lower layers (if the EAP based primary authentication and key agreement procedure is triggered by a registration procedure for mobility and periodic registration update).

The UE shall stop the timer T3520, if running, and re-initiate the registration procedure for mobility and periodic registration update.

- c) Transmission failure of AUTHENTICATION RESPONSE message or AUTHENTICATION FAILURE message indication with TAI change from lower layers (if the EAP based primary authentication and key agreement procedure is triggered by a service request procedure).

The UE shall stop the timer T3520, if running.

If the current TAI is not in the TAI list, the EAP based primary authentication and key agreement procedure shall be aborted and a registration procedure for mobility and periodic registration update shall be initiated.

If the current TAI is still part of the TAI list, it is up to the UE implementation how to re-run the ongoing procedure that triggered the EAP based primary authentication and key agreement procedure.

- d) Transmission failure of AUTHENTICATION RESPONSE message or AUTHENTICATION FAILURE message indication without TAI change from lower layers (if the authentication procedure is triggered by a service request procedure).

The UE shall stop the timer T3520, if running. It is up to the UE implementation how to re-run the ongoing procedure that triggered the EAP based primary authentication and key agreement procedure.

- e) Network failing the authentication check.

If the UE deems that the network has failed the authentication check, then it shall request RRC to locally release the RRC connection and treat the active cell as barred (see 3GPP TS 38.304 [28]). The UE shall start any retransmission timers (e.g. T3510, T3517 or T3521), if they were running and stopped when the UE received the first AUTHENTICATION REQUEST message containing an ngKSI that was already in use.

For item e, whether or not the UE is registered for emergency services:

The UE shall stop timer T3520, if the timer is running and the UE enters 5GMM-IDLE mode, e.g. upon detection of a lower layer failure, release of the N1 NAS signalling connection, or as the result of an inter-system change in 5GMM-CONNECTED mode from N1 mode to S1 mode.

The UE shall deem that the network has failed the authentication check or assume that the authentication is not genuine and proceed as described in item e above if any of the following occurs:

- the timer T3520 expires;
- the UE detects any combination of the EAP-based authentication failures: transmission of AUTHENTICATION FAILURE message with 5GMM cause #71 "ngKSI already in use", transmission of AUTHENTICATION RESPONSE message with an EAP-response message after detecting an error as described in subclause 5.4.1.2.2.4 or with an EAP-response message after not accepting of the server certificate as described in subclause 5.4.1.2.3.1, during three consecutive authentication challenges. The EAP-request/AKA'-challenge challenges shall be considered as consecutive only, if the EAP-request/AKA'-challenge challenges causing the second and third EAP-based authentication failure are received by the UE, while the timer T3520 started after the previous EAP-based authentication failure is running. Not accepting of the server certificate shall be considered as consecutive only, if the EAP-request messages causing the second and third not accepting of the server certificate are received by the UE, while the timer T3520 started after the previous EAP request message causing the previous not accepting of the server certificate is running.

NOTE 2: Reception of an EAP-failure message is not considered when determining the three consecutive authentication challenges or three consecutive not accepting of the server certificate.

For item e:

If a UE has an emergency PDU session established or is establishing an emergency PDU session, and sends an AUTHENTICATION FAILURE message to the AMF with the 5GMM cause appropriate for this cases (i.e. #71) or an AUTHENTICATION RESPONSE message containing an EAP-response message as described in subclause 5.4.1.2.2.4 or containing an EAP-response message after not accepting of the server certificate as described in subclause 5.4.1.2.3.1, and receives the SECURITY MODE COMMAND message before the timeout of timer T3520, the UE shall deem that the network has passed the authentication check successfully, stop timer T3520, respectively, and execute the security mode control procedure.

If a UE has an emergency PDU session established or is establishing an emergency PDU session when timer T3520 expires, the UE shall not deem that the network has failed the authentication check and not behave as described in item e. Instead the UE shall continue using the current security context, if any, release all non-emergency PDU sessions, if any, by initiating UE-requested PDU session release procedure. If there is an ongoing PDU session establishment procedure, the UE shall release all non-emergency PDU sessions upon

completion of the PDU session establishment procedure. The UE shall start any retransmission timers (e.g. T3510, T3517 or T3521) if:

- they were running and stopped when the UE received the AUTHENTICATION REQUEST message and detected an authentication failure;
- the procedures associated with these timers have not yet been completed.

The UE shall consider itself to be registered for emergency services.

#### 5.4.1.2.5 EAP result message transport procedure

##### 5.4.1.2.5.1 General

The purpose of the EAP result message transport procedure is to provide an EAP-success message or an EAP-failure message, and ngKSI from the network to the UE, when the EAP message cannot be piggybacked by another NAS message.

The EAP result message transport procedure is initiated:

- by an AUTHENTICATION RESULT message with the EAP message IE carrying the EAP-success message or the EAP-failure message; or
- by an AUTHENTICATION REJECT message with the EAP message IE carrying the EAP-failure message.

##### 5.4.1.2.5.2 EAP result message transport procedure initiation by the network

In order to initiate the EAP result message transport procedure, the AMF shall create an AUTHENTICATION RESULT message or an AUTHENTICATION REJECT message.

The AMF shall set the EAP message IE of the AUTHENTICATION RESULT message to an EAP-success message or an EAP-failure message to be sent to the UE. The AMF shall set the EAP message IE of the AUTHENTICATION REJECT message to an EAP-failure message to be sent to the UE. The AMF shall set the ngKSI IE of the AUTHENTICATION RESULT message or the AUTHENTICATION REJECT message to the ngKSI value selected in subclause 5.4.1.2.2.2 or subclause 5.4.1.2.3.1.

The AMF shall send the AUTHENTICATION RESULT message or the AUTHENTICATION REJECT message to the UE (see example in figure 5.4.1.2.5.2.1).

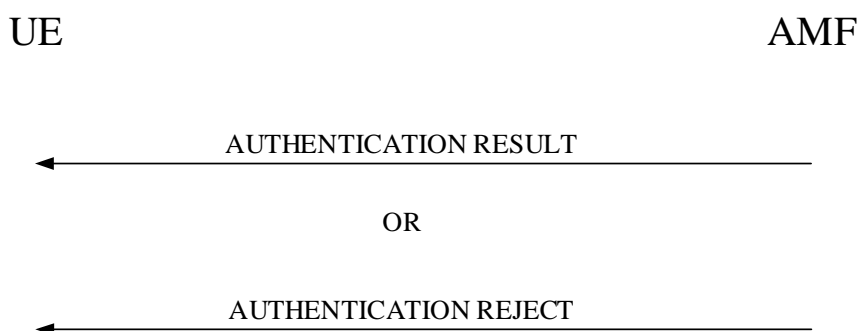

**Figure 5.4.1.2.5.2.1: EAP result message transport procedure**

Upon receipt of an AUTHENTICATION RESULT message or an AUTHENTICATION REJECT message with the EAP message IE, the UE handles the EAP message received in the EAP message IE and the ABBA if received of the AUTHENTICATION RESULT message or in the AUTHENTICATION REJECT message.

### 5.4.1.3 5G AKA based primary authentication and key agreement procedure

#### 5.4.1.3.1 General

The purpose of the 5G AKA based primary authentication and key agreement procedure is to provide mutual authentication between the UE and the network and to agree on the keys  $K_{\text{AUSF}}$ ,  $K_{\text{SEAF}}$  and  $K_{\text{AMF}}$  (see 3GPP TS 33.501 [24]). The cases when the 5G AKA based primary authentication and key agreement procedure is used are defined in 3GPP TS 33.501 [24].

The network initiates the 5G AKA based primary authentication and key agreement procedure by sending an AUTHENTICATION REQUEST message to the UE without the EAP message IE. The network shall include the ngKSI and the ABBA in AUTHENTICATION REQUEST message.

The 5G AKA based primary authentication and key agreement procedure is always initiated and controlled by the network. However, the UE can reject the 5G authentication challenge sent by the network.

The UE shall proceed with a 5G authentication challenge only if a USIM is present.

A partial native 5G NAS security context is established in the UE and the network when a 5G authentication is successfully performed. During a successful 5G AKA based primary authentication and key agreement procedure, the CK and IK are computed by the USIM. CK and IK are then used by the ME as key material to compute a new key,  $K_{\text{AMF}}$ .  $K_{\text{AMF}}$  is stored in the 5G NAS security contexts (see 3GPP TS 33.501 [24]) of both the network and in the volatile memory of the ME while registered to the network, and is the root for the 5GS integrity protection and ciphering key hierarchy.

The 5G AKA based primary authentication and key agreement procedure is initiated by an AUTHENTICATION REQUEST message without the EAP message IE.

#### 5.4.1.3.2 Authentication initiation by the network

The network may initiate a 5G AKA based primary authentication and key agreement procedure for a UE in 5GMM-CONNECTED mode at any time. For restrictions applicable after handover or inter-system change to N1 mode in 5GMM-CONNECTED mode, see subclause 5.4.1.2.3.

The network initiates the 5G AKA based primary authentication and key agreement procedure by sending an AUTHENTICATION REQUEST message to the UE and starting the timer T3560 (see example in figure 5.4.1.3.2.1). The AUTHENTICATION REQUEST message shall contain the parameters necessary to calculate the authentication response (see 3GPP TS 33.501 [24]). This message shall include the ngKSI that will be used by the UE and AMF to identify the  $K_{\text{AMF}}$  and the partial native security context that is created if the authentication is successful. This message shall also include the ABBA parameter. In this release of specification, the network shall set the length of ABBA IE to 2 and the ABBA contents to be 2 octets in length with value 0000H as described in subclause 9.11.3.10.

If an ngKSI is contained in an initial NAS message during a 5GMM procedure, the network shall include a different ngKSI value in the AUTHENTICATION REQUEST message when it initiates a 5G AKA based primary authentication and key agreement procedure.

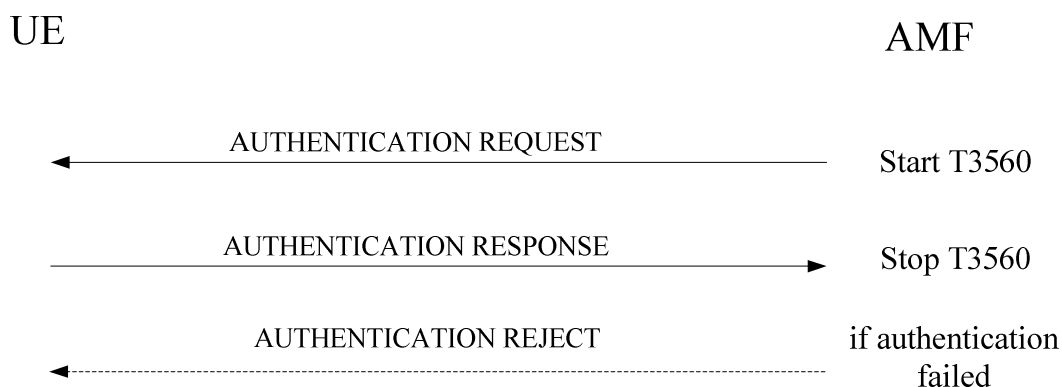

Figure 5.4.1.3.2.1: 5G AKA based primary authentication and key agreement procedure

#### 5.4.1.3.3 Authentication response by the UE

The UE shall respond to an AUTHENTICATION REQUEST message. With the exception of the cases described in subclause 5.4.1.3.5, the UE shall process the 5G authentication challenge data and respond with an AUTHENTICATION RESPONSE message to the network.

Upon a successful 5G authentication challenge, the UE shall determine the PLMN identity to be used for the calculation of the new  $K_{AMF}$  from the 5G authentication challenge data according to the following rules:

- a) When the UE moves from 5GMM-IDLE mode to 5GMM-CONNECTED mode, until the first handover, the UE shall use the PLMN identity of the selected PLMN; and
- b) After handover or inter-system change to N1 mode in 5GMM-CONNECTED mode,
  - 1) if the target cell is not a shared network cell, the UE shall use the PLMN identity received as part of the broadcast system information;
  - 2) if the target cell is a shared network cell and the UE has a valid 5G-GUTI, the UE shall use the PLMN identity that is part of the 5G-GUTI; and
  - 3) if the target cell is a shared network cell and the UE has a valid 4G-GUTI and TAI, but not a valid 5G-GUTI, the UE shall use the PLMN identity that is part of the TAI.

Upon a successful 5G authentication challenge, the new  $K_{AMF}$  calculated from the 5G authentication challenge data shall be stored in a new 5G NAS security context in the volatile memory of the ME.

The USIM will compute the authentication response (RES) using the 5G authentication challenge data received from the ME, and pass RES to the ME. From the RES, RES\* is then generated according to Annex A of 3GPP TS 33.501 [24].

In order to avoid a synchronisation failure, when the UE receives an AUTHENTICATION REQUEST message, the UE shall store the received RAND together with the RES\*, in the volatile memory of the ME. When the UE receives a subsequent AUTHENTICATION REQUEST message, if the stored RAND value is equal to the new received value in the AUTHENTICATION REQUEST message, then the ME shall not pass the RAND to the USIM, but shall send the AUTHENTICATION RESPONSE message with the stored RES\*. If there is no valid stored RAND in the ME or the stored RAND is different from the new received value in the AUTHENTICATION REQUEST message, the ME shall pass the RAND to the USIM, shall override any previously stored RAND and RES\* with the new ones and start, or reset and restart timer T3516.

The RAND and RES\* values stored in the ME shall be deleted and timer T3516, if running, shall be stopped:

- a) upon receipt of a
  - 1) SECURITY MODE COMMAND message,
  - 2) SERVICE REJECT message,
  - 3) REGISTRATION REJECT message,
  - 4) REGISTRATION ACCEPT message, or
  - 5) AUTHENTICATION REJECT message;
- b) upon expiry of timer T3516;
- c) if the UE enters the 5GMM state 5GMM-DEREGISTERED or 5GMM-NULL; or
- d) if the UE enters 5GMM-IDLE mode.

#### 5.4.1.3.4 Authentication completion by the network

Upon receipt of an AUTHENTICATION RESPONSE message, the network stops the timer T3560 and checks the correctness of RES\* (see 3GPP TS 33.501 [24]).

If the 5G AKA based primary authentication and key agreement procedure has been completed successfully and the related ngKSI is stored in the 5G NAS security context of the network, the network shall include a different ngKSI

value in the AUTHENTICATION REQUEST message when it initiates a new 5G AKA based primary authentication and key agreement procedure.

Upon receipt of an AUTHENTICATION FAILURE message, the network stops the timer T3560. In the case where the 5GMM cause #21 "synch failure" is received, the core network may renegotiate with the UDM/AUSF and provide the UE with new authentication parameters.

#### 5.4.1.3.5 Authentication not accepted by the network

If the authentication response (RES) returned by the UE is not valid, the network response depends upon the type of identity used by the UE in the initial NAS message, that is:

- if the 5G-GUTI was used; or
- if the SUCI was used.

If the 5G-GUTI was used, the network should initiate an identification procedure to retrieve SUCI from the UE and restart the 5G AKA based primary authentication and key agreement procedure with the received SUCI.

If the SUCI was used for identification in the initial NAS message or in a restarted 5G AKA based primary authentication and key agreement procedure, or the network decides not to initiate the identification procedure to retrieve SUCI from the UE after an unsuccessful 5G AKA based primary authentication and key agreement procedure, the network should send an AUTHENTICATION REJECT message to the UE.

Upon receipt of an AUTHENTICATION REJECT message,

- the UE shall set the update status to 5U3 ROAMING NOT ALLOWED, delete the stored 5G-GUTI, TAI list, last visited registered TAI and ngKSI. The USIM shall be considered invalid until switching off the UE or the UICC containing the USIM is removed; and
- if the UE is operating in single-registration mode, the UE shall handle 4G-GUTI, TAI list and eKSI as specified in 3GPP TS 24.301 [15] for the case when the authentication procedure is not accepted by the network. The USIM shall be considered as invalid also for non-EPS services until switching off or the UICC containing the USIM is removed.

If the AUTHENTICATION REJECT message is received by the UE, the UE shall abort any 5GMM signalling procedure, stop any of the timers T3510, T3516, T3517, T3519 or T3521 (if they were running) and enter state 5GMM-DEREGISTERED.

Depending on local requirements or operator preference for emergency services, if the UE initiates a registration procedure with 5GS registration type IE set to "emergency registration" and the AMF is configured to allow emergency registration without user identity, the AMF needs not follow the procedures specified for the authentication failure in the present subclause. The AMF may continue a current 5GMM specific procedure.

#### 5.4.1.3.6 Authentication not accepted by the UE

In the 5G authentication challenge, the UE shall check the 5G authentication challenge data (RAND, AUTN and ngKSI) received in the AUTHENTICATION REQUEST message to verify authenticity of the 5G core network.

The ME shall check that ngKSI received in the AUTHENTICATION REQUEST message is not already in use. The ME shall forward the RAND and AUTN to the USIM to check.

The UE may reject the core network due to an incorrect AUTN or ngKSI parameter. If the UE has to reject the 5G authentication challenge, the UE shall return AUTHENTICATION FAILURE message to the network with a cause value indicating the reason for the failure (see 3GPP TS 33.501 [24]).

Incorrect 5G authentication challenge data contains four possible causes for authentication failure:

a) MAC code failure:

If the UE finds the MAC code (supplied by the core network in the AUTN parameter) to be invalid, the UE shall send an AUTHENTICATION FAILURE message to the network, with the 5GMM cause #20 "MAC failure". The UE shall then follow the procedure described in subclause 5.4.1.3.7, item c.

b) Non-5G authentication unacceptable:



If the UE finds that the "separation bit" in the AMF field of AUTN supplied by the core network is set to 0, the UE shall send an AUTHENTICATION FAILURE message to the network, with the 5GMM cause #26 "non-5G authentication unacceptable" (see subclause 6.1.3 in 3GPP TS 33.501 [24]). The UE shall then follow the procedure described in subclause 5.4.1.3.7, item d.

c) ngKSI already in use:

If the UE detects that ngKSI received in the AUTHENTICATION REQUEST message is already in use in the UE shall send an AUTHENTICATION FAILURE message to the network, with the 5GMM cause #71 "ngKSI already in use". The UE shall then follow the procedure described in subclause 5.4.1.3.7, item e.

d) SQN failure:

If the UE finds the sequence number SQN (supplied by the core network in the AUTN parameter) to be out of range, the UE shall send an AUTHENTICATION FAILURE message to the network, with the 5GMM cause #21 "synch failure" and a re-synchronization token AUTS provided by the USIM (see 3GPP TS 33.102 [23]). The UE shall then follow the procedure described in subclause 5.4.1.3.7, item f.

If the UE returns an AUTHENTICATION FAILURE message to the network, the UE shall delete any previously stored RAND and RES\* and shall stop timer T3516, if running.

If the UE has an emergency PDU session established or is establishing such a PDU session, additional UE requirements are specified in subclause 5.4.1.3.7, under "for items c, d, e and f".

#### 5.4.1.3.7 Abnormal cases

a) Lower layer failure.

Upon detection of lower layer failure before the AUTHENTICATION RESPONSE message is received, the network shall abort the procedure.

b) Expiry of timer T3560.

The network shall, on the first expiry of the timer T3560, retransmit the AUTHENTICATION REQUEST message and shall reset and start timer T3560. This retransmission is repeated four times, i.e. on the fifth expiry of timer T3560, the network shall abort the 5G AKA based primary authentication and key agreement procedure and any ongoing 5GMM specific procedure and release the N1 NAS signalling connection.

c) Authentication failure (5GMM cause #20 "MAC failure").

The UE shall send an AUTHENTICATION FAILURE message, with 5GMM cause #20 "MAC failure" according to subclause 5.4.1.3.6, to the network and start timer T3520 (see example in figure 5.4.1.3.7.1). Furthermore, the UE shall stop any of the retransmission timers that are running (e.g. T3510, T3517 or T3521). Upon the first receipt of an AUTHENTICATION FAILURE message from the UE with 5GMM cause #20 "MAC failure", the network may initiate the identification procedure described in subclause 5.4.3. This is to allow the network to obtain the SUCI from the UE. The network may then check that the 5G-GUTI originally used in the 5G authentication challenge corresponded to the correct SUPI. Upon receipt of the IDENTITY REQUEST message from the network, the UE shall proceed as specified in subclause 5.4.3.3.

NOTE 1: Upon receipt of an AUTHENTICATION FAILURE message from the UE with 5GMM cause #20 "MAC failure", the network may also terminate the 5G AKA based primary authentication and key agreement procedure (see subclause 5.4.1.3.5).

If the mapping of 5G-GUTI to SUPI in the network was incorrect, the network should respond by sending a new AUTHENTICATION REQUEST message to the UE. Upon receiving the new AUTHENTICATION REQUEST message from the network, the UE shall stop the timer T3520, if running, and then process the 5G challenge information as normal. If the mapping of 5G-GUTI to SUPI in the network was correct, the network should terminate the 5G AKA based primary authentication and key agreement procedure by sending an AUTHENTICATION REJECT message (see subclause 5.4.1.3.5).

If the network is validated successfully (an AUTHENTICATION REQUEST message that contains a valid SQN and MAC is received), the UE shall send the AUTHENTICATION RESPONSE message to the network and shall start any retransmission timers (e.g. T3510, T3517 or T3521) if they were running and stopped when the UE received the first failed AUTHENTICATION REQUEST message.

If the UE receives the second AUTHENTICATION REQUEST message, and the MAC value cannot be resolved, the UE shall follow the procedure specified in this subclause, item c, starting again from the beginning, or if the message contains a UMTS authentication challenge, the UE shall follow the procedure specified in item d. If the SQN is invalid, the UE shall proceed as specified in item f.

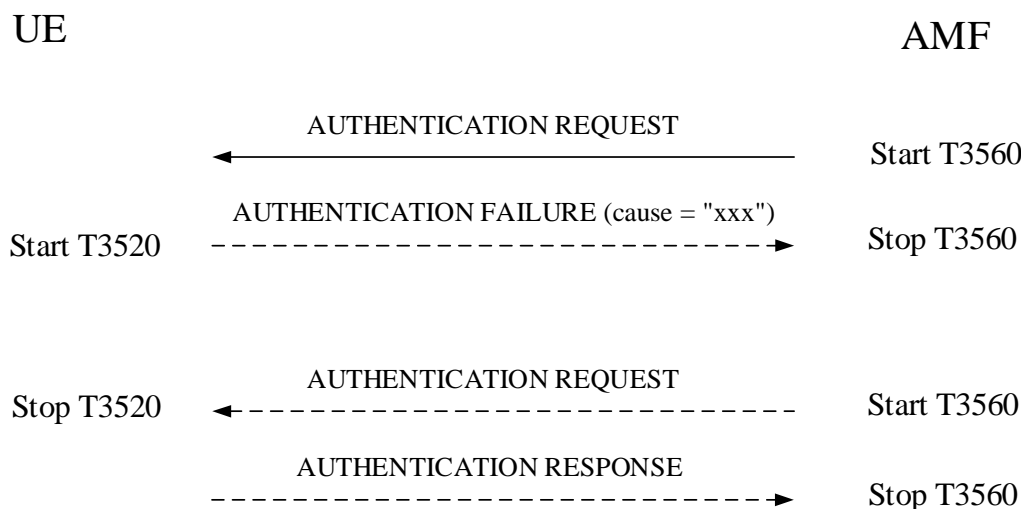

**Figure 5.4.1.3.7.1: Authentication failure during 5G AKA based primary authentication and key agreement procedure**

- d) Authentication failure (5GMM cause #26 "non-5G authentication unacceptable").

The UE shall send an AUTHENTICATION FAILURE message, with 5GMM cause #26 "non-5G authentication unacceptable", to the network and start the timer T3520 (see example in figure 5.4.1.3.7.1). Furthermore, the UE shall stop any of the retransmission timers that are running (e.g. T3510, T3517 or T3521). Upon the first receipt of an AUTHENTICATION FAILURE message from the UE with 5GMM cause #26 "non-5G authentication unacceptable", the network may initiate the identification procedure described in subclause 5.4.3. This is to allow the network to obtain the SUCI from the UE. The network may then check that the 5G-GUTI originally used in the 5G authentication challenge corresponded to the correct SUPI. Upon receipt of the IDENTITY REQUEST message from the network, the UE shall proceed as specified in subclause 5.4.3.3.

NOTE 2: Upon receipt of an AUTHENTICATION FAILURE message from the UE with 5GMM cause #26 "non-5G authentication unacceptable", the network may also terminate the 5G AKA based primary authentication and key agreement procedure (see subclause 5.4.1.3.5).

If the mapping of 5G-GUTI to SUPI in the network was incorrect, the network should respond by sending a new AUTHENTICATION REQUEST message to the UE. Upon receiving the new AUTHENTICATION REQUEST message from the network, the UE shall stop the timer T3520, if running, and then process the 5G challenge information as normal. If the mapping of 5G-GUTI to SUPI in the network was correct, the network should terminate the 5G AKA based primary authentication and key agreement authentication procedure by sending an AUTHENTICATION REJECT message (see subclause 5.4.1.3.5).

If the network is validated successfully (an AUTHENTICATION REQUEST message that contains a valid 5G authentication challenge is received), the UE shall send the AUTHENTICATION RESPONSE message to the network and shall start any retransmission timers (e.g. T3510, T3517 or T3521) if they were running and stopped when the UE received the first failed AUTHENTICATION REQUEST message.

- e) Authentication failure (5GMM cause #71 "ngKSI already in use").

The UE shall send an AUTHENTICATION FAILURE message, with 5GMM cause #71 "ngKSI already in use", to the network and start the timer T3520 (see example in figure 5.4.1.3.7.1). Furthermore, the UE shall stop any of the retransmission timers that are running (e.g. T3510, T3517 or T3521). Upon the first receipt of an AUTHENTICATION FAILURE message from the UE with 5GMM cause #71 "ngKSI already in use", the network performs necessary actions to select a new ngKSI and send the same 5G authentication challenge to the UE.

NOTE 3: Upon receipt of an AUTHENTICATION FAILURE message from the UE with 5GMM cause #71 "ngKSI already in use", the network may also re-initiate the 5G AKA based primary authentication and key agreement procedure (see subclause 5.4.1.3.2).

Upon receiving the new AUTHENTICATION REQUEST message from the network, the UE shall stop the timer T3520, if running, and then process the 5G challenge information as normal.

If the network is validated successfully (an AUTHENTICATION REQUEST message that contains a valid ngKSI, SQN and MAC is received), the UE shall send the AUTHENTICATION RESPONSE message to the network and shall start any retransmission timers (e.g. T3510, T3517 or T3521) if they were running and stopped when the UE received the first failed AUTHENTICATION REQUEST message.

- f) Authentication failure (5GMM cause #21 "synch failure").

The UE shall send an AUTHENTICATION FAILURE message, with 5GMM cause #21 "synch failure", to the network and start the timer T3520 (see example in figure 5.4.1.3.7.1). Furthermore, the UE shall stop any of the retransmission timers that are running (e.g. T3510, T3517 or T3521). Upon the first receipt of an AUTHENTICATION FAILURE message from the UE with the 5GMM cause #21 "synch failure", the network shall use the returned AUTS parameter from the authentication failure parameter IE in the AUTHENTICATION FAILURE message, to re-synchronise. The re-synchronisation procedure requires the AMF to delete all unused authentication vectors for that SUPI and obtain new vectors from the UDM/AUSF. When re-synchronisation is complete, the network shall initiate the 5G AKA based primary authentication and key agreement procedure. Upon receipt of the AUTHENTICATION REQUEST message, the UE shall stop the timer T3520, if running.

NOTE 4: Upon receipt of two consecutive AUTHENTICATION FAILURE messages from the UE with 5GMM cause #21 "synch failure", the network may terminate the 5G AKA based primary authentication and key agreement procedure by sending an AUTHENTICATION REJECT message.

If the network is validated successfully (a new AUTHENTICATION REQUEST message is received which contains a valid SQN and MAC) while T3520 is running, the UE shall send the AUTHENTICATION RESPONSE message to the network and shall start any retransmission timers (e.g. T3510, T3517 or T3521), if they were running and stopped when the UE received the first failed AUTHENTICATION REQUEST message.

Upon receipt of an AUTHENTICATION REJECT message, the UE shall perform the actions as specified in subclause 5.4.1.3.5.

- g) Network failing the authentication check.

If the UE deems that the network has failed the authentication check, then it shall request RRC to locally release the RRC connection and treat the active cell as barred (see 3GPP TS 38.304 [28]). The UE shall start any retransmission timers (e.g. T3510, T3517 or T3521), if they were running and stopped when the UE received the first AUTHENTICATION REQUEST message containing an incorrect authentication challenge data causing authentication failure.

- h) Transmission failure of AUTHENTICATION RESPONSE message or AUTHENTICATION FAILURE message indication from lower layers (if the 5G AKA based primary authentication and key agreement procedure is triggered by a registration procedure for mobility and periodic registration update).

The UE shall stop the timer T3520, if running, and re-initiate the registration procedure for mobility and periodic registration update.

- i) Transmission failure of AUTHENTICATION RESPONSE message or AUTHENTICATION FAILURE message indication with TAI change from lower layers (if the 5G AKA based primary authentication and key agreement procedure is triggered by a service request procedure).

The UE shall stop the timer T3520, if running.

If the current TAI is not in the TAI list, the 5G AKA based primary authentication and key agreement procedure shall be aborted and a registration procedure for mobility and periodic registration update shall be initiated.

If the current TAI is still part of the TAI list, it is up to the UE implementation how to re-run the ongoing procedure that triggered the 5G AKA based primary authentication and key agreement procedure.

- j) Transmission failure of AUTHENTICATION RESPONSE message or AUTHENTICATION FAILURE message indication without TAI change from lower layers (if the authentication procedure is triggered by a service request procedure).

The UE shall stop the timer T3520, if running. It is up to the UE implementation how to re-run the ongoing procedure that triggered the 5G AKA based primary authentication and key agreement procedure.

- k) Lower layers indication of non-delivered NAS PDU due to handover.

If the AUTHENTICATION REQUEST message could not be delivered due to an intra AMF handover and the target TA is included in the TAI list, then upon successful completion of the intra AMF handover the AMF shall retransmit the AUTHENTICATION REQUEST message. If a failure of handover procedure is reported by the lower layer and the N1 NAS signalling connection exists, the AMF shall retransmit the AUTHENTICATION REQUEST message.

For items c, d, e, and f whether or not the UE is registered for emergency services:

The UE shall stop timer T3520, if the timer is running and the UE enters 5GMM-IDLE mode, e.g. upon detection of a lower layer failure, release of the N1 NAS signalling connection, or as the result of an inter-system change in 5GMM-CONNECTED mode from N1 mode to S1 mode.

The UE shall deem that the network has failed the authentication check or assume that the authentication is not genuine and proceed as described in item g above if any of the following occurs:

- the timer T3520 expires;
- the UE detects any combination of the 5G authentication failures: 5GMM causes #20 "MAC failure", #21 "synch failure", #26 "non-5G authentication unacceptable" or #71 "ngKSI already in use", during three consecutive authentication challenges. The 5G authentication challenges shall be considered as consecutive only, if the 5G authentication challenges causing the second and third 5G authentication failure are received by the UE, while the timer T3520 started after the previous 5G authentication failure is running.

For items c, d, e, and f:

Depending on local requirements or operator preference for emergency services, if the UE has an emergency PDU session established or is establishing an emergency PDU session, the AMF need not follow the procedures specified for the authentication failure specified in the present subclause. The AMF may respond to the AUTHENTICATION FAILURE message by initiating the security mode control procedure selecting the "null integrity protection algorithm" 5G-IA0, "null ciphering algorithm" 5G-EA0 or may abort the 5G AKA based primary authentication and key agreement procedure and continue using the current security context, if any. The AMF shall release all non-emergency PDU sessions, if any, by initiating a PDU session release procedure. If there is an ongoing PDU session establishment procedure, the AMF shall release all non-emergency PDU sessions upon completion of the PDU session establishment procedure. The network shall behave as if the UE is registered for emergency services.

If a UE has an emergency PDU session established or is establishing an emergency PDU session and sends an AUTHENTICATION FAILURE message to the AMF with the 5GMM cause appropriate for these cases (#20, #21, #26, or #71 respectively) and receives the SECURITY MODE COMMAND message before the timeout of timer T3520, the UE shall deem that the network has passed the authentication check successfully, stop timer T3520, respectively, and execute the security mode control procedure.

If a UE has an emergency PDU session established or is establishing an emergency PDU session when timer T3520 expires, the UE shall not deem that the network has failed the authentication check and not behave as described in item g. Instead the UE shall continue using the current security context, if any, release all non-emergency PDU sessions, if any, by initiating UE-requested PDU session release procedure. If there is an ongoing PDU session establishment procedure, the UE shall release all non-emergency PDU sessions upon completion of the PDU session establishment procedure. The UE shall start any retransmission timers (e.g. T3510, T3517 or T3521) if:

- they were running and stopped when the UE received the AUTHENTICATION REQUEST message and detected an authentication failure;
- the procedures associated with these timers have not yet been completed.

The UE shall behave as if the UE is registered for emergency services.

## 5.4.2 Security mode control procedure

### 5.4.2.1 General

The purpose of the NAS security mode control procedure is to take a 5G NAS security context into use, and initialise and start NAS signalling security between the UE and the AMF with the corresponding 5G NAS keys and 5G NAS security algorithms.

Furthermore, the network may also initiate the security mode control procedure in the following cases:

- a)- in order to change the 5G NAS security algorithms for a current 5G NAS security context already in use;
- b) in order to change the value of uplink NAS COUNT used in the latest SECURITY MODE COMPLETE message as described in 3GPP TS 33.501 [24], subclause 6.9.4.4; and
- c) in order to provide the Selected EPS NAS security algorithms to the UE.

For restrictions concerning the concurrent running of a security mode control procedure with other security related procedures in the AS or inside the core network see 3GPP TS 33.501 [24], subclause 6.9.5.

### 5.4.2.2 NAS security mode control initiation by the network

The AMF initiates the NAS security mode control procedure by sending a SECURITY MODE COMMAND message to the UE and starting timer T3560 (see example in figure 5.4.2.2).

The AMF shall reset the downlink NAS COUNT counter and use it to integrity protect the initial SECURITY MODE COMMAND message if the security mode control procedure is initiated:

- a) to take into use the security context created after a successful execution of the 5G AKA based primary authentication and key agreement procedure or the EAP based primary authentication and key agreement procedure; or
- b) upon receipt of REGISTRATION REQUEST message, if the AMF needs to create a mapped 5G NAS security context (i.e. the type of security context flag is set to "mapped security context" in the NAS key set identifier IE included in the SECURITY MODE COMMAND message).

The AMF shall send the SECURITY MODE COMMAND message unciphered, but shall integrity protect the message with the 5G NAS integrity key based on  $K_{AMF}$  or mapped  $K'_{AMF}$  indicated by the ngKSI included in the message. The AMF shall set the security header type of the message to "integrity protected with new 5G NAS security context".

The AMF shall create a locally generated  $K_{AMF}$  and send the SECURITY MODE COMMAND message including an ngKSI value in the NAS key set identifier IE set to "000" and 5G-IA0 and 5G-EA0 as the selected NAS security algorithms only when the security mode control procedure is initiated:

- a) during an initial registration procedure for emergency services if no shared 5G NAS security context is available;
- b) during a registration procedure for mobility and periodic registration update for a UE that has an emergency PDU session if no shared 5G NAS security context is available;
- c) during a service request procedure for a UE that has an emergency PDU session if no shared 5G NAS security context is available; or
- d) after a failed primary authentication and key agreement procedure for a UE that has an emergency PDU session or is establishing an emergency PDU session, if continued usage of a shared 5G NAS security context is not possible.

The UE shall process a SECURITY MODE COMMAND message including an ngKSI value in the NAS key set identifier IE set to "000" and 5G-IA0 and 5G-EA0 as the selected NAS security algorithms and, if accepted, create a locally generated  $K_{AMF}$  when the security mode control procedure is initiated:

- a) during an initial registration procedure for emergency services;
- b) during a registration procedure for mobility and periodic registration update for a UE that has an emergency PDU session;

- c) during a service request procedure for a UE that has an emergency PDU session; or
- d) after a primary authentication and key agreement procedure for a UE that has an emergency PDU session or is establishing an emergency PDU session.

NOTE 1: The process for creation of the locally generated  $K_{AMF}$  by the AMF and the UE is implementation dependent. The  $K_{AMF}$  is specified in 3GPP TS 33.501 [24].

Upon receipt of a REGISTRATION REQUEST message, if the AMF does not have the valid current 5G NAS security context indicated by the UE, the AMF shall either:

- a) indicate the use of the new mapped 5G NAS security context to the UE by setting the type of security context flag in the NAS key set identifier IE to "mapped security context" and the KSI value related to the security context of the source system; or
- b) set the ngKSI value "000" in the NAS key set identifier IE if the AMF sets 5G-IA0 and 5G-EA0 as the selected NAS security algorithms for a UE that has an emergency PDU session.

While having a current mapped 5G NAS security context with the UE, if the AMF needs to take the native 5G NAS security context into use, the AMF shall include the ngKSI that indicates the native 5G NAS security context in the SECURITY MODE COMMAND message.

The AMF shall include the replayed security capabilities of the UE (including the security capabilities with regard to NAS, RRC and UP (user plane) ciphering as well as NAS and RRC integrity, and other possible target network security capabilities, i.e. E-UTRAN if the UE included them in the message to network), the selected 5GS ciphering and integrity algorithms and the ngKSI.

If a UE is already registered over one access to a PLMN and the AMF decides to skip primary authentication and key agreement procedure when the UE attempts to register over the other access to the same PLMN, the AMF shall take into use the UE's current 5G NAS security context over the other access that the UE is registering. In this case, SECURITY MODE COMMAND message is not sent to the UE.

If the UE is registered to the same AMF and the same PLMN over both 3GPP access and non-3GPP access, and the UE is in 5GMM-CONNECTED mode over both the 3GPP and non-3GPP accesses, then at any time the primary authentication and key agreement procedure has successfully completed over:

- a) the 3GPP access, the AMF includes the ngKSI in the SECURITY MODE COMMAND message over the 3GPP access. When the AMF sends the SECURITY MODE COMMAND message to UE over the non-3GPP access to take into use the new 5G NAS security context, the AMF shall include the same ngKSI in the SECURITY MODE COMMAND message to identify the new 5G NAS security context; or
- b) the non 3GPP access, the AMF includes the ngKSI in the SECURITY MODE COMMAND message over the non-3GPP access. When the AMF sends the SECURITY MODE COMMAND message to UE over the 3GPP access to take into use the new 5G NAS security context, the AMF shall include the same ngKSI in the SECURITY MODE COMMAND message to identify the new 5G NAS security context.

The AMF may initiate a SECURITY MODE COMMAND in order to change the 5G security algorithms for a current 5G NAS security context already in use. The AMF re-derives the 5G NAS keys from  $K_{AMF}$  with the new 5G algorithm identities as input and provides the new 5GS algorithm identities within the SECURITY MODE COMMAND message. The AMF shall set the security header type of the message to "integrity protected with new 5G NAS security context".

If, during an ongoing registration procedure, the AMF is initiating a SECURITY MODE COMMAND (i.e. after receiving the REGISTRATION REQUEST message, but before sending a response to that message) and the REGISTRATION REQUEST message does not successfully pass the integrity check at the AMF, the AMF shall include the Additional 5G security information IE with the RINMR bit set to "Retransmission of the initial NAS message requested" in the SECURITY MODE COMMAND message requesting the UE to send the entire REGISTRATION REQUEST message in the SECURITY MODE COMPLETE message as described in 3GPP TS 33.501 [24].

If, during an ongoing service request procedure for a UE with an emergency PDU session, the AMF is initiating a SECURITY MODE COMMAND (i.e. after receiving the SERVICE REQUEST message, but before sending a response to that message) and the SERVICE REQUEST message does not successfully pass the integrity check at the AMF, the AMF shall include the Additional 5G security information IE with the RINMR bit set to "Retransmission of the initial NAS message requested" in the SECURITY MODE COMMAND message requesting the UE to send the entire SERVICE REQUEST message in the SECURITY MODE COMPLETE message as described in 3GPP TS 33.501 [24].

Additionally, the AMF may request the UE to include its IMEISV in the SECURITY MODE COMPLETE message.

If the AMF supports N26 interface and the UE set the S1 mode bit to "S1 mode supported" in the 5GMM capability IE of the REGISTRATION REQUEST message, the AMF shall select ciphering and integrity algorithms to be used in the EPS and indicate them to the UE via the Selected EPS NAS security algorithms IE in the SECURITY MODE COMMAND message.

NOTE 2: The AS and NAS security capabilities are the same, i.e. if the UE supports one algorithm for NAS, the same algorithm is also supported for AS.

If the AMF performs horizontal key derivation e.g. during the mobility and periodic registration update or when the UE is already registered in the PLMN with another access type as described in 3GPP TS 33.501 [24], the AMF shall include horizontal derivation parameter in the SECURITY MODE COMMAND message.

If the security mode control procedure is initiated after successful EAP based primary authentication and key agreement procedure and the security mode control procedure intends to bring into use the partial native 5G NAS security context created by the EAP based primary authentication and key agreement procedure, the AMF shall set the EAP message IE of the SECURITY MODE COMMAND message to an EAP-success message to be sent to the UE.

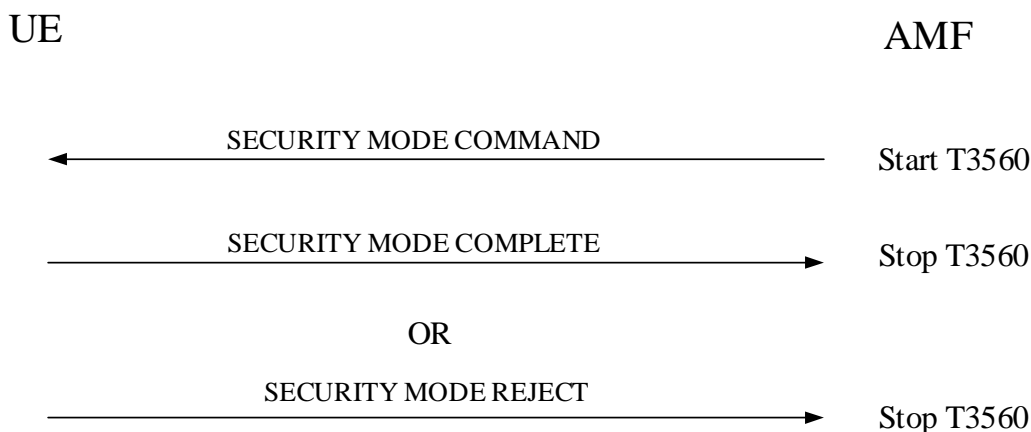

**Figure 5.4.2.2: Security mode control procedure**

### 5.4.2.3 NAS security mode command accepted by the UE

Upon receipt of the SECURITY MODE COMMAND message, the UE shall check whether the security mode command can be accepted or not. This is done by performing the integrity check of the message, and by checking that the received Replayed UE security capabilities IE has not been altered compared to the latest values that the UE sent to the network.

When the SECURITY MODE COMMAND message includes an EAP-success message the UE handles the EAP-success message and the ABBA as described in subclause 5.4.1.2.2.8.

If the UE is registered for emergency services, performing initial registration for emergency services or establishing an emergency PDU session and the SECURITY MODE COMMAND message is received with ngKSI value "000" and 5G-IA0 and 5G-EA0 as selected 5G NAS security algorithms, the UE shall locally derive and take in use 5G NAS security context. The UE shall delete existing current 5G NAS security context.

The UE shall accept a SECURITY MODE COMMAND message indicating the "null integrity protection algorithm" 5G-EA0 as the selected 5G NAS integrity algorithm only if the message is received when the UE is registered for emergency services, performing initial registration for emergency services or establishing an emergency PDU session.

If the type of security context flag included in the SECURITY MODE COMMAND message is set to "native security context" and if the ngKSI matches a valid non-current native 5G NAS security context held in the UE while the UE has a mapped 5G NAS security context as the current 5G NAS security context, the UE shall take the non-current native 5G NAS security context into use which then becomes the current native 5G NAS security context and delete the mapped 5G NAS security context.

The UE shall ignore the Replayed S1 UE security capabilities IE if this IE is included in the SECURITY MODE COMMAND message.

If the SECURITY MODE COMMAND message can be accepted, the UE shall take the 5G NAS security context indicated in the message into use. The UE shall in addition reset the uplink NAS COUNT counter if:

- a) the SECURITY MODE COMMAND message is received in order to take a 5G NAS security context into use created after a successful execution of the 5G AKA based primary authentication and key agreement procedure or the EAP based primary authentication and key agreement procedure; or
- b) the SECURITY MODE COMMAND message received includes the type of security context flag set to "mapped security context" in the NAS key set identifier IE the ngKSI does not match the current 5G NAS security context, if it is a mapped 5G NAS security context.

If the SECURITY MODE COMMAND message can be accepted and a new 5G NAS security context is taken into use and SECURITY MODE COMMAND message does not indicate the "null integrity protection algorithm" 5G-IA0 as the selected NAS integrity algorithm, the UE shall:

- if the SECURITY MODE COMMAND message has been successfully integrity checked using an estimated downlink NAS COUNT equal to 0, then the UE shall set the downlink NAS COUNT of this new 5G NAS security context to 0;
- otherwise the UE shall set the downlink NAS COUNT of this new 5G NAS security context to the downlink NAS COUNT that has been used for the successful integrity checking of the SECURITY MODE COMMAND message.

If the SECURITY MODE COMMAND message includes the horizontal derivation parameter indicating " $K_{AMF}$  derivation is required", the UE shall derive a new  $K'_{AMF}$ , as specified in 3GPP TS 33.501 [24] for  $K_{AMF}$  to  $K'_{AMF}$  derivation in mobility, and set both uplink and downlink NAS COUNTs to zero. When the new 5G NAS security context is taken into use for current access and the UE is registered with the same PLMN over the 3GPP access and the non-3GPP access:

- a) the UE is in 5GMM-IDLE mode over the non-current access, the AMF and the UE shall activate the new 5G NAS security context over the non-current access as described in 3GPP TS 33.501 [24]. The AMF and the UE shall set the downlink NAS COUNT and uplink NAS COUNT to zero for the non-current access; or
- b) the UE is in 5GMM-CONNECTED mode over the non-current access, the AMF shall send the SECURITY MODE COMMAND message over the non-current access to activate the new 5G NAS security context that was activated over the current access as described in 3GPP TS 33.501 [24]. The AMF shall include the same ngKSI in the SECURITY MODE COMMAND message to identify the new 5G NAS security context.

If the SECURITY MODE COMMAND message includes the horizontal derivation parameter indicating " $K_{AMF}$  derivation is not required" or the Additional 5G security parameters IE is not included in the message, the UE is registered with the same PLMN over the 3GPP access and non-3GPP access, then after the completion of a security mode control procedure over the current access:

- a) the UE is in 5GMM-IDLE mode over the non-current access, the AMF and the UE shall activate the new 5G NAS security context for the non-current access. If a primary authentication and key agreement procedure was completed before the security mode control procedure, the AMF and the UE shall set the downlink NAS COUNT and uplink NAS COUNT to zero for the non-current access, otherwise the downlink NAS COUNT and uplink NAS COUNT for the non-3GPP access are not changed; or
- b) the UE is in 5GMM-CONNECTED mode over the non-current access, the AMF shall send the SECURITY MODE COMMAND message over the non-current access to activate the new 5G NAS security context that was activated over the current access as described in 3GPP TS 33.501 [24]. The AMF shall include the same ngKSI in the SECURITY MODE COMMAND message to identify the new 5G NAS security context.

If the SECURITY MODE COMMAND message can be accepted, the UE shall send a SECURITY MODE COMPLETE message integrity protected with the selected 5GS integrity algorithm and the 5G NAS integrity key based on the  $K_{AMF}$  or mapped  $K'_{AMF}$  if the type of security context flag is set to "mapped security context" indicated by the ngKSI. When the SECURITY MODE COMMAND message includes the type of security context flag set to "mapped security context" in the NAS key set identifier IE, then the UE shall check whether the SECURITY MODE COMMAND message indicates the ngKSI of the current 5GS security context, if it is a mapped 5G NAS security context, in order not to re-generate the  $K'_{AMF}$ .



Furthermore, if the SECURITY MODE COMMAND message can be accepted, the UE shall cipher the SECURITY MODE COMPLETE message with the selected 5GS ciphering algorithm and the 5GS NAS ciphering key based on the  $K_{AMF}$  or mapped  $K'_{AMF}$  indicated by the ngKSI. The UE shall set the security header type of the message to "integrity protected and ciphered with new 5G NAS security context".

From this time onward the UE shall cipher and integrity protect all NAS signalling messages with the selected 5GS integrity and ciphering algorithms.

If the AMF indicated in the SECURITY MODE COMMAND message that the IMEISV is requested, the UE shall include its IMEISV in the SECURITY MODE COMPLETE message.

If, during an ongoing registration procedure or service request procedure, the SECURITY MODE COMMAND message includes the Additional 5G security information IE with the RINMR bit set to "Retransmission of the initial NAS message requested", the UE shall include the entire unciphered REGISTRATION REQUEST message or SERVICE REQUEST message, which the UE had previously included in the NAS message container IE of the initial NAS message (i.e. REGISTRATION REQUEST message or SERVICE REQUEST message, respectively), in the NAS message container IE of the SECURITY MODE COMPLETE message.

If, prior to receiving the SECURITY MODE COMMAND message, the UE without a valid 5GS NAS security context had sent a REGISTRATION REQUEST message the UE shall include the entire REGISTRATION REQUEST message in the NAS message container IE of the SECURITY MODE COMPLETE message as described in subclause 4.4.6.

If the UE operating in the single-registration mode receives the Selected EPS NAS security algorithms IE, the UE shall use the IE according to 3GPP TS 33.501 [24].

For a UE operating in single-registration mode with N26 interface supported in the network, after an inter-system change from S1 mode to N1 mode in 5GMM-CONNECTED mode, the UE shall set the value of the Selected EPS NAS security algorithms IE in the 5G NAS security context to the NAS security algorithms that were received from the source MME when the UE was in S1 mode.

#### 5.4.2.4 NAS security mode control completion by the network

The AMF shall, upon receipt of the SECURITY MODE COMPLETE message, stop timer T3560. From this time onward the AMF shall integrity protect and encipher all signalling messages with the selected 5GS integrity and ciphering algorithms.

If the SECURITY MODE COMPLETE message contains a NAS message container IE with a REGISTRATION REQUEST message, the AMF shall complete the ongoing registration procedure by considering the REGISTRATION REQUEST message contained in the NAS message container IE as the message that triggered the procedure.

If the SECURITY MODE COMPLETE message contains a NAS message container IE with a SERVICE REQUEST message, the AMF shall complete the ongoing service request procedure by considering the SERVICE REQUEST message contained in the NAS message container IE as the message that triggered the procedure.

#### 5.4.2.5 NAS security mode command not accepted by the UE

If the security mode command cannot be accepted, the UE shall send a SECURITY MODE REJECT message. The SECURITY MODE REJECT message contains a 5GMM cause that typically indicates one of the following cause values:

#23 UE security capabilities mismatch.

#24 security mode rejected, unspecified.

If the UE detects that the received Replayed UE security capabilities IE has been altered compared to the latest values that the UE sent to the network, the UE shall set the cause value to #23 "UE security capabilities mismatch".

Upon receipt of the SECURITY MODE REJECT message, the AMF shall stop timer T3560. The AMF shall also abort the ongoing procedure that triggered the initiation of the NAS security mode control procedure.

Both the UE and the AMF shall apply the 5G NAS security context in use before the initiation of the security mode control procedure, if any, to protect the SECURITY MODE REJECT message and any other subsequent messages according to the rules in subclause 4.4.4 and 4.4.5.

### 5.4.2.6 Abnormal cases in the UE

The following abnormal cases can be identified:

- a) Transmission failure of SECURITY MODE COMPLETE message or SECURITY MODE REJECT message indication from lower layers (if the security mode control procedure is triggered by a registration procedure).

The UE shall abort the security mode control procedure and re-initiate the registration procedure.

- b) Transmission failure of SECURITY MODE COMPLETE message or SECURITY MODE REJECT message indication with TAI change from lower layers (if the security mode control procedure is triggered by a service request procedure).

If the current TAI is not in the TAI list, the security mode control procedure shall be aborted and a registration procedure shall be initiated.

If the current TAI is still part of the TAI list, the security mode control procedure shall be aborted and it is up to the UE implementation how to re-run the ongoing procedure that triggered the security mode control procedure.

- c) Transmission failure of SECURITY MODE COMPLETE message or SECURITY MODE REJECT message indication without TAI change from lower layers (if the security mode control procedure is triggered by a service request procedure).

The security mode control procedure shall be aborted and it is up to the UE implementation how to re-run the ongoing procedure that triggered the security mode control procedure.

### 5.4.2.7 Abnormal cases on the network side

The following abnormal cases can be identified:

- a) Lower layer failure before the SECURITY MODE COMPLETE or SECURITY MODE REJECT message is received.

The network shall abort the security mode control procedure.

- b) Expiry of timer T3560.

The network shall, on the first expiry of the timer T3560, retransmit the SECURITY MODE COMMAND message and shall reset and start timer T3560. This retransmission is repeated four times, i.e. on the fifth expiry of timer T3560, the procedure shall be aborted.

- c) Collision between security mode control procedure and registration, service request or de-registration procedure not indicating switch off.

The network shall abort the security mode control procedure and proceed with the UE initiated procedure.

- d) Collision between security mode control procedure and other 5GMM procedures than in item c.

The network shall progress both procedures.

- e) Lower layers indication of non-delivered NAS PDU due to handover:

If the SECURITY MODE COMMAND message could not be delivered due to an intra AMF handover and the target TA is included in the TAI list, then upon successful completion of the intra AMF handover the AMF shall retransmit the SECURITY MODE COMMAND message. If a failure of the handover procedure is reported by the lower layer and the N1 signalling connection exists, the AMF shall retransmit the SECURITY MODE COMMAND message.

## 5.4.3 Identification procedure

### 5.4.3.1 General

The purpose of this procedure is to request a particular UE to provide specific identification parameters, e.g. the SUCI or the IMEI. The SUCI is a privacy preserving identifier containing the concealed SUPI and IMEI is a format of PEI.

### 5.4.3.2 Identification initiation by the network

The AMF initiates the identification procedure by sending an IDENTITY REQUEST message to the UE and starting timer T3570 (see example in figure 5.4.3.2.1). The IDENTITY REQUEST message specifies the requested identification parameters in the Identity type information element.

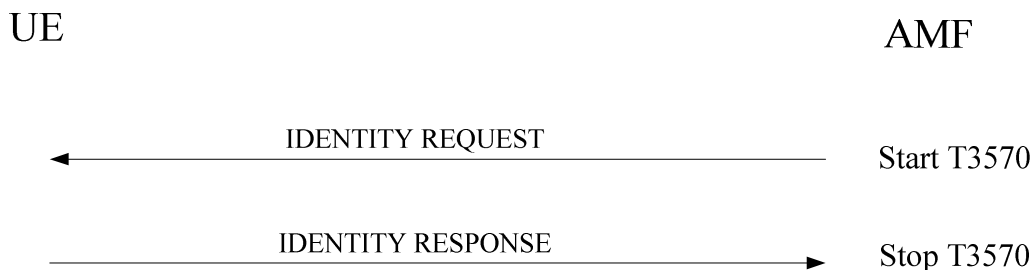

**Figure 5.4.3.2.1: Identification procedure**

### 5.4.3.3 Identification response by the UE

A UE shall be ready to respond to an IDENTITY REQUEST message at any time whilst in 5GMM-CONNECTED mode.

Upon receipt of the IDENTITY REQUEST message:

- a) if the Identity type IE in the IDENTITY REQUEST message is not set to "SUCI", the UE shall send an IDENTITY RESPONSE message to the network. The IDENTITY RESPONSE message shall contain the identification parameters as requested by the network; and
- b) if the Identity type IE in the IDENTITY REQUEST message is set to "SUCI", the UE shall:
  - 1) if timer T3519 is not running, generate a fresh SUCI as specified in 3GPP TS 33.501 [24], send an IDENTITY RESPONSE message with the SUCI, start timer T3519 and store the value of the SUCI sent in the IDENTITY RESPONSE message; and
  - 2) if timer T3519 is running, send an IDENTITY RESPONSE message with the stored SUCI.

### 5.4.3.4 Identification completion by the network

Upon receipt of the IDENTITY RESPONSE the network shall stop the timer T3570.

### 5.4.3.5 Abnormal cases in the UE

The following abnormal cases can be identified:

- a) Transmission failure of the IDENTITY RESPONSE message (if the identification procedure is triggered by a registration procedure).

The UE shall re-initiate the registration procedure.

- b) Requested identity is not available

If the UE cannot encode the requested identity in the IDENTITY RESPONSE message, e.g. because no valid USIM is available, then it shall encode the identity type as "No identity".

### 5.4.3.6 Abnormal cases on the network side

The following abnormal cases can be identified:

- a) Lower layer failure.

Upon detection of a lower layer failure before the IDENTITY RESPONSE is received, the network shall abort any ongoing 5GMM procedure.

b) Expiry of timer T3570.

The network shall, on the first expiry of the timer T3570, retransmit the IDENTITY REQUEST message and reset and restart the timer T3570. This retransmission is repeated four times, i.e. on the fifth expiry of timer T3570, the network shall abort the identification procedure and any ongoing 5GMM procedure.

c) Collision of an identification procedure with a registration procedure for initial registration.

If the network receives a REGISTRATION REQUEST message indicating either "initial registration" or "emergency registration" in the 5GS registration type IE before the ongoing identification procedure has been completed and no registration procedure is pending on the network (i.e. no REGISTRATION ACCEPT/REJECT message has still to be sent as an answer to a REGISTRATION REQUEST message), the network shall proceed with the registration procedure for initial registration.

d) Collision of an identification procedure with a registration procedure for initial registration when the identification procedure has been caused by a registration procedure for initial registration.

If the network receives a REGISTRATION REQUEST message indicating either "initial registration" or "emergency registration" in the 5GS registration type IE before the ongoing identification procedure has been completed and a registration procedure for initial registration is pending (i.e. a REGISTRATION ACCEPT/REJECT message has to be sent as an answer to an earlier REGISTRATION REQUEST message), then:

- If one or more of the information elements in the REGISTRATION REQUEST message differ from the ones received within the previous REGISTRATION REQUEST message, the network shall proceed with the new registration procedure for initial registration; or
- If the information elements do not differ, then the network shall not treat any further this new REGISTRATION REQUEST message.

e) Collision of an identification procedure with a registration procedure for mobility and periodic registration update.

If the network receives a REGISTRATION REQUEST message indicating either "mobility registration updating" or "periodic registration updating" in the 5GS registration type IE before the ongoing identification procedure has been completed, the network shall progress both procedures.

f) Collision of an identification procedure with a UE initiated de-registration procedure.

If the network receives a DEREGISTRATION REQUEST message with "switch off" indication in the De-registration type IE before the ongoing identification procedure has been completed, the network shall abort the identification procedure and shall progress the UE-initiated de-registration procedure;

Else the network shall complete the identification procedure and shall respond to the UE-initiated de-registration procedure as described in subclause 5.5.2.2.

## 5.4.4 Generic UE configuration update procedure

### 5.4.4.1 General

The purpose of this procedure is to:

- a) allow the AMF to update the UE configuration for access and mobility management-related parameters decided and provided by the AMF by providing new parameter information within the command; or
- b) request the UE to perform a registration procedure for mobility and periodic registration update towards the network to update access and mobility management-related parameters decided and provided by the AMF (see subclause 5.5.1.3).

This procedure is initiated by the network and can only be used when the UE has an established 5GMM context, and the UE is in 5GMM-CONNECTED mode. When the UE is in 5GMM-IDLE mode, the AMF may use the paging or

notification procedure to initiate the generic UE configuration update procedure. The AMF can request a confirmation response in order to ensure that the parameter has been updated by the UE.

This procedure shall be initiated by the network to assign a new 5G-GUTI to the UE after a successful service request procedure invoked as a response to a paging request from the network and before the release of the N1 NAS signalling connection. If the service request procedure was triggered due to 5GSM downlink signalling pending, the procedure for assigning a new 5G-GUTI can be initiated by the network after the transport of the 5GSM downlink signalling.

The following parameters are supported by the generic UE configuration update procedure without the need to request the UE to perform the registration procedure for mobility and periodic registration update:

- a) 5G-GUTI;
- b) TAI list;
- c) Service area list;
- d) Network identity and time zone information (Full name for network, short name for network, local time zone, universal time and local time zone, network daylight saving time);
- e) LADN information;
- f) Rejected NSSAI;
- g) Network slicing indication;
- h) Operator-defined access category definitions; and
- i) SMS indication.

The following parameters can be sent to the UE with or without a request to perform the registration procedure for mobility and periodic registration update:

- a) Allowed NSSAI; or
- b) Configured NSSAI.

The following parameter is sent to the UE with a request to perform the registration procedure for mobility and periodic registration update:

- a) MICO indication.

The following parameters are sent over 3GPP access only:

- a) LADN information;
- b) MICO indication;
- c) TAI list; and
- d) Service area list.

The following parameters are managed and sent per access type i.e., independently over 3GPP access or non 3GPP access:

- a) Allowed NSSAI; and
- b) Rejected NSSAI (when the NSSAI is rejected for the current registration area).

The following parameters are managed commonly and sent over 3GPP access or non 3GPP access:

- a) 5G-GUTI;
- b) Network identity and time zone information;
- c) Rejected NSSAI (when the NSSAI is rejected for the current PLMN);
- d) Configured NSSAI; and

e) SMS indication.

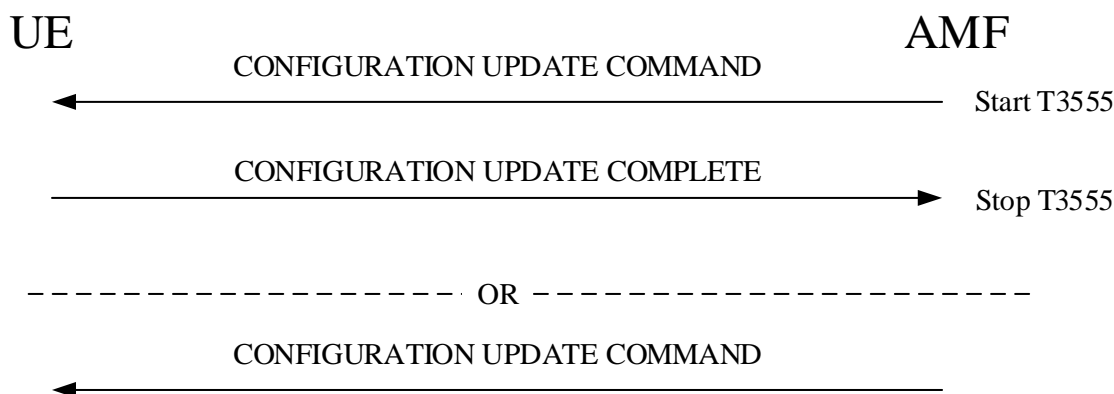

**Figure 5.4.4.1.1: Generic UE configuration update procedure**

#### 5.4.4.2 Generic UE configuration update procedure initiated by the network

The AMF shall initiate the generic UE configuration update procedure by sending the CONFIGURATION UPDATE COMMAND message to the UE.

The AMF shall in the CONFIGURATION UPDATE COMMAND message either:

- include one or more of the following parameters: 5G-GUTI, TAI list, allowed NSSAI that may include the mapped S-NSSAI(s), LADN information, service area list, MICO indication NITZ information, configured NSSAI that may include the mapped S-NSSAI(s), rejected NSSAI, network slicing indication, operator-defined access category definitions or SMS indication;
- include the registration requested parameter; or
- include a combination of both a) and b).

If an acknowledgement from the UE is requested, the AMF shall indicate acknowledgement requested in the Configuration update indication IE in the CONFIGURATION UPDATE COMMAND message and shall start timer T3555. Acknowledgement shall be requested for all parameters except when only NITZ is included.

To initiate parameter re-negotiation between the UE and network, the AMF shall indicate "registration requested" in the Configuration update indication IE in the CONFIGURATION UPDATE COMMAND message.

If a new allowed NSSAI information or AMF re-configuration of supported S-NSSAIs requires an AMF relocation, the AMF shall indicate "registration requested" in the Configuration update indication IE and include the Allowed NSSAI IE in the CONFIGURATION UPDATE COMMAND message.

If the AMF includes a new configured NSSAI in the CONFIGURATION UPDATE COMMAND message and the new configured NSSAI requires an AMF relocation as specified in 3GPP TS 23.501 [8], the AMF shall indicate "registration requested" in the Configuration update indication IE in the message.

If the AMF indicates "registration requested" in the Configuration update indication IE, acknowledgement shall be requested.

If changes to the allowed NSSAI require the UE to initiate a registration procedure, but the AMF is unable to determine an allowed NSSAI for the UE as specified in 3GPP TS 23.501 [8], the CONFIGURATION UPDATE COMMAND message shall indicate "registration requested" and shall not contain any other parameters.

If the AMF needs to update the LADN information, the AMF shall include the LADN information in the LADN information IE of the CONFIGURATION UPDATE COMMAND message.

During an established 5GMM context, the network may send none, one, or more CONFIGURATION UPDATE COMMAND messages to the UE. If more than one CONFIGURATION UPDATE COMMAND message is sent, the messages need not have the same content.

### 5.4.4.3 Generic UE configuration update accepted by the UE

Upon receiving the CONFIGURATION UPDATE COMMAND message, the UE shall stop timer T3346 if running and use the contents to update appropriate information stored within the UE.

If acknowledgement requested is indicated in the Configuration update indication IE in the CONFIGURATION UPDATE COMMAND message, the UE shall send a CONFIGURATION UPDATE COMPLETE message.

If the UE receives a new 5G-GUTI in the CONFIGURATION UPDATE COMMAND message, the UE shall consider the new 5G-GUTI as valid, the old 5G-GUTI as invalid, stop timer T3519 if running, and delete any stored SUCI; otherwise, the UE shall consider the old 5G-GUTI as valid. The UE shall provide the 5G-GUTI to the lower layer of 3GPP access if the CONFIGURATION UPDATE COMMAND message is sent over the non-3GPP access, and the UE is in 5GMM-REGISTERED in both 3GPP access and non-3GPP access in the same PLMN.

If the UE receives a new TAI list in the CONFIGURATION UPDATE COMMAND message, the UE shall consider the new TAI list as valid and the old TAI list as invalid; otherwise, the UE shall consider the old TAI list as valid.

If the UE receives a new service area list in the CONFIGURATION UPDATE COMMAND message, the UE shall consider the new service area list as valid and the old service area list as invalid; otherwise, the UE shall consider the old service area list, if any, as valid.

If the UE receives new NITZ information in the CONFIGURATION UPDATE COMMAND message, the UE considers the new NITZ information as valid and the old NITZ information as invalid; otherwise, the UE shall consider the old NITZ information as valid.

If the UE receives a LADN information IE in the CONFIGURATION UPDATE COMMAND message, the UE shall consider the old LADN information as invalid and the new LADN information as valid, if any; otherwise, the UE shall consider the old LADN information as valid.

If the UE receives a new allowed NSSAI for the associated access type in the CONFIGURATION UPDATE COMMAND message, the UE shall consider the new allowed NSSAI as valid for the associated access type, store the allowed NSSAI for the associated access type as specified in subclause 4.6.2.2 and consider the old allowed NSSAI for the associated access type as invalid; otherwise, the UE shall consider the old Allowed NSSAI as valid for the associated access type.

If the UE receives a new configured NSSAI in the CONFIGURATION UPDATE COMMAND message, the UE shall consider the new configured NSSAI for the registered PLMN as valid and the old configured NSSAI for the registered PLMN as invalid; otherwise, the UE shall consider the old configured NSSAI for the registered PLMN as valid. The UE shall store the new configured NSSAI as specified in subclause 4.6.2.2.

If the UE receives the Network slicing indication IE in the CONFIGURATION UPDATE COMMAND message with the Network slicing subscription change indication set to "Network slicing subscription changed", the UE shall delete the network slicing information for each and every PLMN except for the current PLMN as specified in subclause 4.6.2.2.

If the UE receives Operator-defined access category definitions IE in the CONFIGURATION UPDATE COMMAND message and the Operator-defined access category definitions IE contains one or more operator-defined access category definitions, the UE shall delete any operator-defined access category definitions stored for the RPLMN and shall store the received operator-defined access category definitions for the RPLMN. If the UE receives the Operator-defined access category definitions IE in the CONFIGURATION UPDATE COMMAND message and the Operator-defined access category definitions IE contains no operator-defined access category definitions, the UE shall delete any operator-defined access category definitions stored for the RPLMN. If the CONFIGURATION UPDATE COMMAND message does not contain the Operator-defined access category definitions IE, the UE shall not delete the operator-defined access category definitions stored for the RPLMN.

If the UE receives the SMS indication IE in the CONFIGURATION UPDATE COMMAND message with the SMS availability indication set to:

- a) "SMS over NAS not available", the UE shall consider that SMS over NAS transport is not allowed by the network; and
- b) "SMS over NAS available", the UE may request the use of SMS over NAS transport by performing a registration procedure for mobility and periodic registration update as specified in subclause 5.5.1.3, after the completion of the generic UE configuration update procedure.

If the CONFIGURATION UPDATE COMMAND message indicates "registration requested" in the Configuration update indication IE and:

- a) contains no other parameters or contains at least one of the following parameters: a new allowed NSSAI, a new configured NSSAI or the Network slicing subscription change indication, and:
  - 1) an emergency PDU session exists, the UE shall, after the completion of the generic UE configuration update procedure and after the emergency PDU session is released, release the existing N1 NAS signalling connection, and start a registration procedure for mobility and periodic registration update as specified in subclause 5.5.1.3; or
  - 2) no emergency PDU Session exists, the UE shall, after the completion of the generic UE configuration update procedure, and the release of the existing N1 NAS signalling connection, start a registration procedure for mobility and periodic registration update as specified in subclause 5.5.1.3; or
- b) an MICO indication is included without a new allowed NSSAI or a new configured NSSAI, the UE shall, after the completion of the generic UE configuration update procedure, start a registration procedure for mobility and registration update as specified in subclause 5.5.1.3 to re-negotiate MICO mode with the network.

The UE receiving the rejected NSSAI in the CONFIGURATION UPDATE COMMAND message takes the following actions based on the rejection cause in the rejected NSSAI:

"S-NSSAI not available in the current PLMN"

The UE shall add the rejected S-NSSAI(s) in the rejected NSSAI for the current PLMN as specified in subclause 4.6.2.2 and not attempt to use this S-NSSAI in the current PLMN until switching off the UE or the UICC containing the USIM is removed.

"S-NSSAI not available in the current registration area"

The UE shall add the rejected S-NSSAI(s) in the rejected NSSAI for the current registration area as specified in subclause 4.6.2.2 and not attempt to use this S-NSSAI in the current registration area until switching off the UE, the UE moving out of the current registration area or the UICC containing the USIM is removed.

#### 5.4.4.4 Generic UE configuration update completion by the network

Upon receipt of the CONFIGURATION UPDATE COMPLETE message, the AMF shall stop the timer T3555.

If a new 5G-GUTI was included in the CONFIGURATION UPDATE COMMAND message, the AMF shall consider the new 5G-GUTI as valid and the old 5G-GUTI as invalid.

If a new TAI list was included in the CONFIGURATION UPDATE COMMAND message, the AMF shall consider the new TAI list as valid and the old TAI list as invalid.

If a new service area list was included in the CONFIGURATION UPDATE COMMAND message, the AMF shall consider the new service area list as valid and the old service area list as invalid.

If new allowed NSSAI information was included in the CONFIGURATION UPDATE COMMAND message, the AMF shall consider the new allowed NSSAI information as valid and the old allowed NSSAI information as invalid. If new configured NSSAI information was included in the CONFIGURATION UPDATE COMMAND message, the AMF shall consider the new configured NSSAI information as valid and the old configured information as invalid. If there are active PDU sessions associated with S-NSSAI(s) not included in the new allowed NSSAI, the AMF shall notify the SMF(s) associated with these PDU sessions to initiate the network-requested PDU session release procedure according to subclause 6.3.3 in the present specification and subclause 5.15.5.2.2 in 3GPP TS 23.501 [8].

If registration requested was indicated in the CONFIGURATION UPDATE COMMAND message and:

- a) the CONFIGURATION UPDATE COMMAND message contained:
  - 1) an allowed NSSAI, a configured NSSAI or both;
  - 2) the Network slicing indication IE with the Network slicing subscription change indication set to "Network slicing subscription changed"; or
  - 3) no other parameters; and



- b) no emergency PDU session has been established for the UE;

then the AMF shall initiate the release of the N1 NAS signalling connection.

If a LADN information IE was included in the CONFIGURATION UPDATE COMMAND message, the AMF shall consider the old LADN information as invalid and the new LADN information as valid, if any. In this case, if the tracking area identity list received in the new LADN information does not include the current TA, the AMF shall indicate the SMF to release the PDU session for LADN or release the user-plane resources for the PDU session for LADN (see 3GPP TS 23.501 [8] and 3GPP TS 23.502 [9]).

#### 5.4.4.5 Abnormal cases in the UE

The following abnormal cases can be identified:

- a) Transmission failure of the CONFIGURATION UPDATE COMPLETE message with TAI change from lower layers

If the current TAI is not in the TAI list, the generic UE configuration update procedure shall be aborted and a registration procedure for mobility and periodic registration update shall be initiated.

If the current TAI is still part of the TAI list, it is up to the UE implementation how to re-run the ongoing procedure that triggered the generic UE configuration update procedure.

- b) Transmission failure of CONFIGURATION UPDATE COMPLETE message indication without TAI change from lower layers

It is up to the UE implementation how to re-run the ongoing procedure that triggered the generic UE configuration update procedure.

- c) Generic UE configuration update and de-registration procedure collision

If the UE receives CONFIGURATION UPDATE COMMAND message after sending a DEREGISTRATION REQUEST message and the access type included in the DEREGISTRATION REQUEST message is same as the access in which the CONFIGURATION UPDATE COMMAND message is received, then the UE shall ignore the CONFIGURATION UPDATE COMMAND message and proceed with the de-registration procedure. Otherwise, the UE shall proceed with both the procedures.

- d) Void

- e) Generic UE configuration update and service request procedure collision

If the UE receives a CONFIGURATION UPDATE COMMAND message before the ongoing service request procedure has been completed, the UE shall proceed with both the procedures.

#### 5.4.4.6 Abnormal cases on the network side

The following abnormal cases can be identified:

- a) Expiry of timer T3555.

The network shall, on the first expiry of the timer T3555, retransmit the CONFIGURATION UPDATE COMMAND message and shall reset and start timer T3555. This retransmission is repeated four times, i.e. on the fifth expiry of timer T3555, the procedure shall be aborted. In addition, if the CONFIGURATION UPDATE COMMAND message includes the 5G-GUTI IE, the network shall behave as described in case b)-1) below.

- b) Lower layer failure.

If a lower layer failure is detected before the CONFIGURATION UPDATE COMPLETE message is received and:

- 1) if the CONFIGURATION UPDATE COMMAND message includes the 5G-GUTI IE, the old and the new 5G-GUTI shall be considered as valid until the old 5G-GUTI can be considered as invalid by the AMF. If a new TAI list was provided in the CONFIGURATION UPDATE COMMAND message, the old and new TAI list shall also be considered as valid until the old TAI list can be considered as invalid by the AMF.

During this period the AMF:

- i) may first use the old 5G-S-TMSI from the old 5G-GUTI for paging within the area defined by the old TAI list for an implementation dependent number of paging attempts for network originated transactions. If a new TAI list was provided with old 5G-GUTI in the CONFIGURATION UPDATE COMMAND message, the new TAI list should also be used for paging. Upon response from the UE, the AMF may re-initiate the CONFIGURATION UPDATE COMMAND. If the response is received from a tracking area within the old and new TAI list, the network shall re-initiate the CONFIGURATION UPDATE COMMAND message. If no response is received to the paging attempts, the network may use the new 5G-S-TMSI from the new 5G-GUTI for paging for an implementation dependent number of paging attempts. In this case, if a new TAI list was provided with new 5G-GUTI in the CONFIGURATION UPDATE COMMAND message, the new TAI list shall be used instead of the old TAI list. Upon response from the UE the AMF shall consider the new 5G-GUTI as valid and the old 5G-GUTI as invalid.
  - ii) shall consider the new 5G-GUTI as valid if it is used by the UE and, additionally, the new TAI list as valid if it was provided with this 5G-GUTI in the CONFIGURATION UPDATE COMMAND message; and
  - iii) may use the identification procedure followed by a new generic UE configuration update procedure if the UE uses the old 5G-GUTI; or
- 2) if the CONFIGURATION UPDATE COMMAND message does not include the 5G-GUTI IE, the network shall abort the procedure.
- c) Generic UE configuration update and UE initiated de-registration procedure collision.

If the network receives a DEREGISTRATION REQUEST message before the ongoing generic UE configuration update procedure has been completed, the network shall abort the generic UE configuration update procedure and shall progress the de-registration procedure.

- d) Generic UE configuration update and registration procedure for mobility and periodic registration update collision

If the network receives a REGISTRATION REQUEST message before the ongoing generic UE configuration update procedure has been completed, the network shall abort the generic UE configuration update procedure and shall progress the registration procedure for mobility and periodic registration update procedure.

- e) Generic UE configuration update and service request procedure collision

If the network receives a SERVICE REQUEST message before the ongoing generic UE configuration update procedure has been completed, both the procedures shall be progressed.

## 5.4.5 NAS transport procedure(s)

### 5.4.5.1 General

The purpose of the NAS transport procedures is to provide a transport of payload between the UE and the AMF. The type of the payload is identified by the Payload container type IE and includes one of the following:

- a) a single 5GSM message;
- b) SMS;
- c) an LPP message (see 3GPP TS 36.355 [26]);
- d) an SOR transparent container;
- e) a UE policy container;
- f) a UE parameters update transparent container; or
- g) Multiple payloads.

For payload type a) to e), along with the payload, the NAS transport procedure may transport the associated information (e.g. PDU session information for 5GSM message payload).

For payload type g), the Payload container IE consists a list of payload container entries, where each of payload container entry contains the payload and optional associated information (e.g. PDU session information for 5GSM message payload).

NOTE: Payload type can be set to "Multiple payloads" if there are more than one payloads to be transported using the NAS transport procedures.

## 5.4.5.2 UE-initiated NAS transport procedure

### 5.4.5.2.1 General

The purpose of the UE-initiated NAS transport procedure is to provide a transport of:

- a) a single 5GSM message as defined in subclause 8.3;
- b) SMS (see 3GPP TS 24.011 [13]);
- c) an LPP message;
- d) an SOR transparent container;
- e) a UE policy container; or
- f) a UE parameters update transparent container; or
- g) multiple of the above types.

and:

- for a) to e), optional associated payload routing information from the UE to the AMF in a 5GMM message; and
- for g), the Payload container IE consists a list of payload container entries, where each of the payload container entry contains the payload and optional associated payload routing information (e.g. PDU session information for 5GSM message payload).

### 5.4.5.2.2 UE-initiated NAS transport procedure initiation

In the connected mode, the UE initiates the NAS transport procedure by sending the UL NAS TRANSPORT message, as shown in figure 5.4.5.2.2.1.

In case a) in subclause 5.4.5.2.1, the UE shall:

- a) include the PDU session information (PDU session ID, old PDU session ID, S-NSSAI, mapped S-NSSAI (if available in roaming scenarios), DNN, request type), if available;
- b) set the Payload container type IE to "N1 SM information"; and
- c) set the Payload container IE to the 5GSM message.

The UE shall set the PDU session ID IE to the PDU session ID. If an old PDU session ID is to be included, the UE shall set the Old PDU session ID IE to the old PDU session ID.

If an S-NSSAI is to be included, the UE shall set the S-NSSAI IE to the S-NSSAI selected for the PDU session from the allowed NSSAI for the serving PLMN, associated with the mapped S-NSSAI (if available in roaming scenarios).

If a DNN is to be included, the UE shall set the DNN IE to the DNN. 5GSM procedures specified in clause 9 describe conditions for inclusion of the S-NSSAI, mapped S-NSSAI (if available in roaming scenarios), and the DNN.

If a request type is to be included, the UE shall set the Request type IE to the request type. The request type is not provided along 5GSM messages other than the PDU SESSION ESTABLISHMENT REQUEST message and the PDU SESSION MODIFICATION REQUEST message.

The UE shall send the UL NAS TRANSPORT message to the AMF (see example in figure 5.4.5.2.2.1).

In case b) in subclause 5.4.5.2.1, the UE shall:

- set the Payload container type IE to "SMS"; and
- set the Payload container IE to the SMS payload.

Based on the UE preferences regarding access selection for mobile originated (MO) transmission of SMS over NAS as described in 3GPP TS 23.501 [8]:

- a) when SMS over NAS is preferred to be sent over 3GPP access: the UE attempts to deliver MO SMS over NAS via the 3GPP access if the UE is registered over both 3GPP access and non-3GPP access. If the delivery of SMS over NAS via the 3GPP access is not available, the UE attempts to deliver MO SMS over NAS via the non-3GPP access; and
- b) when SMS over NAS is preferred to be sent over non-3GPP access: the UE attempts to deliver MO SMS over NAS via the non-3GPP access if the UE is registered over both 3GPP access and non-3GPP access. If the delivery of SMS over NAS via the non-3GPP access is not available, the UE attempts to deliver MO SMS over NAS via the 3GPP access.

In case c) in subclause 5.4.5.2.1, the UE shall:

- set the Payload container type IE to "LTE Positioning Protocol (LPP) message container";
- set the Payload container IE to the LPP message payload; and
- set the Additional information IE to the routing information provided by the upper layer location services application.

In case d) in subclause 5.4.5.2.1, the UE shall:

- set the Payload container type IE to "SOR transparent container"; and
- set the Payload container IE to the UE acknowledgement due to successful reception of steering of roaming information (see 3GPP TS 23.122 [5]).

In case e) in subclause 5.4.5.2.1, the UE shall:

- set the Payload container type IE to "UE policy container"; and
- set the contents of the Payload container IE as specified in Annex D.

In case f) in subclause 5.4.5.2.1, the UE shall:

- set the Payload container type IE to "UE parameters update transparent container"; and
- set the contents of the Payload container IE to the UE acknowledgement due to successful reception of UE parameters update data (see 3GPP TS 23.502 [9]).

In case g) in subclause 5.4.5.2.1, the UE shall:

- set the Payload container type IE to "Multiple payloads"; and
- set the contents of each payload container entry of the Payload container IE (see subclause 9.11.3.39), as follows:
  - i) set the payload container type field to a payload container type value set in the Payload container type IE as specified in cases a) to f) above;
  - ii) set the payload container contents field of the payload container entry to the payload contents set in the Payload container IE as specified in cases a) to f) above, and
  - iii) set the optional IE fields, if any, to the optional associated payload routing information as specified in cases a) to f) above.



**Figure 5.4.5.2.2.1: UE-initiated NAS transport procedure**

### 5.4.5.2.3 UE-initiated NAS transport of messages accepted by the network

Upon reception of a UL NAS TRANSPORT message, if the Payload container type IE is set to:

- a) "N1 SM information", the AMF looks up a PDU session routing context for:
  - 1) the UE and the PDU session ID IE in case the Old PDU session ID IE is not included, and:

NOTE 1: If the Old PDU session ID IE is not included in the UL NAS TRANSPORT message and the AMF has received a reallocation requested indication from the SMF, the AMF needs to ignore the reallocation requested indication.

- i) if the AMF has a PDU session routing context for the PDU session ID and the UE, and the Request type IE is either not included or is included but set to other value than "initial request", "existing PDU session", "initial emergency request" and "existing emergency PDU session", the AMF shall forward the 5GSM message, and the PDU session ID IE towards the SMF identified by the SMF ID of the PDU session routing context;
- ii) if the AMF has a PDU session routing context for the PDU session ID and the UE, the PDU session routing context indicates that the PDU session is not an emergency PDU session, the Request type IE is included and is set to "existing PDU session", and the S-NSSAI associated with the PDU session identified by the PDU session ID is allowed for the target access type, the AMF shall forward the 5GSM message, the PDU session ID, the S-NSSAI, the mapped S-NSSAI (if available in roaming scenarios), the DNN (if received) and the request type towards the SMF identified by the SMF ID of the PDU session routing context;
- iii) if the AMF does not have a PDU session routing context for the PDU session ID and the UE, and the Request type IE is included and is set to "initial request":

A) the AMF shall select an SMF with following handlings:

If the S-NSSAI IE is not included and the user's subscription context obtained from UDM:

- contains one default S-NSSAI, the AMF shall use the default S-NSSAI as the S-NSSAI;
- contains two or more default S-NSSAIs, the AMF shall use one of the default S-NSSAIs selected by operator policy as the S-NSSAI; and
- does not contain a default S-NSSAI, the AMF shall use an S-NSSAI selected based on operator policy as the S-NSSAI.

If the DNN IE is not included, and the user's subscription context obtained from UDM:

- contains the default DNN for the S-NSSAI, the AMF shall use the default DNN as the DNN; and
- does not contain the default DNN for the S-NSSAI, the AMF shall use a locally configured DNN as the DNN; and

If the DNN is a LADN DNN, the AMF shall determine the UE presence in LADN service area; and

NOTE 2: SMF selection is out of scope of CT1.

B) if the SMF selection is successful:

- the AMF shall store a PDU session routing context for the PDU session ID and the UE, shall set the SMF ID in the stored PDU session routing context to the SMF ID corresponding to the DNN in the user's subscription context obtained from the UDM; and
  - the AMF shall forward the 5GSM message, the PDU session ID, the S-NSSAI, the mapped S-NSSAI (if available in roaming scenarios), the DNN, the request type and UE presence in LADN service area (if DNN received corresponds to an LADN DNN) towards the SMF identified by the SMF ID of the PDU session routing context;
- iv) if the AMF does not have a PDU session routing context for the PDU session ID and the UE, the Request type IE is included and is set to "existing PDU session", and the user's subscription context obtained from the UDM contains an SMF ID associated with:
- A) the PDU session ID matching the PDU session ID received from the UE, if any; or
  - B) the DNN matching the DNN received from the UE, otherwise;
- such that the SMF ID includes a PLMN identity corresponding to the UE's HPLMN or the current PLMN, then:
- A) the AMF shall store a PDU session routing context for the PDU session ID and the UE, shall set the SMF ID in the stored PDU session routing context to the SMF ID contained in the user's subscription context obtained from the UDM; and
  - B) the AMF shall forward the 5GSM message, the PDU session ID, the S-NSSAI, the mapped S-NSSAI (if available in roaming scenarios), the DNN (if received) and the request type towards the SMF identified by the SMF ID of the PDU session routing context;
- v) if the AMF does not have a PDU session routing context for the PDU session ID and the UE, the Request type IE is included and is set to "initial emergency request", and the AMF does not have a PDU session routing context for another PDU session ID of the UE indicating that the PDU session is an emergency PDU session:
- A) the AMF shall select an SMF. The AMF shall use the emergency DNN from the AMF emergency configuration data as the DNN, if configured. The AMF shall derive the SMF from the emergency DNN or use the statically configured SMF from the AMF emergency configuration data, if configured; and
  - B) if the SMF selection is successful:
    - the AMF shall store a PDU session routing context for the PDU session ID and the UE, shall set the SMF ID in the stored PDU session routing context to the SMF ID of the selected SMF, and shall store an indication that the PDU session is an emergency PDU session in the stored PDU session routing context; and
    - the AMF shall forward the 5GSM message, the PDU session ID, the S-NSSAI (if configured in the AMF emergency configuration data), the DNN (if configured in the AMF emergency configuration data), and the request type towards the SMF identified by the SMF ID of the PDU session routing context; and
- vi) if the AMF does not have a PDU session routing context for the PDU session ID and the UE, the Request type IE is included and is set to "initial emergency request", and the AMF has a PDU session routing context indicating that the PDU session is an emergency PDU session for another PDU session ID of the UE:
- A) the AMF shall store a PDU session routing context for the PDU session ID and the UE and shall set the SMF ID in the stored PDU session routing context to the SMF ID of the PDU session routing context for the other PDU session ID of the UE; and
  - B) the AMF shall forward the 5GSM message, the PDU session ID, the S-NSSAI (if configured in the AMF emergency configuration data), the DNN (if configured in the AMF emergency configuration data) and the request type towards the SMF identified by the SMF ID of the PDU session routing context; or

- vii) if the AMF has a PDU session routing context for the PDU session ID and the UE, the PDU session routing context indicates that the PDU session is an emergency PDU session, and the Request type IE is included and is set to "existing emergency PDU session", the AMF shall forward the 5GSM message, the PDU session ID, the S-NSSAI (if configured in the AMF emergency configuration data), the DNN (if configured in the AMF emergency configuration data), and the request type towards the SMF identified by the SMF ID of the PDU session routing context; and
- viii) if the AMF does not have a PDU session routing context for the PDU session ID and the UE, the Request type IE is included and is set to "existing emergency PDU session", and the user's subscription context obtained from the UDM contains an SMF ID for the DNN matching the DNN received from the UE such that the SMF ID includes a PLMN identity corresponding to the current PLMN, then:
- A) the AMF shall store a PDU session routing context for the PDU session ID and the UE, shall set the SMF ID in the stored PDU session routing context to the SMF ID contained in the user's subscription context obtained from the UDM; and
- B) the AMF shall forward the 5GSM message, the PDU session ID, the S-NSSAI (if configured in the AMF emergency configuration data), the DNN (if configured in the AMF emergency configuration data), and the request type towards the SMF identified by the SMF ID of the PDU session routing context; or
- 2) the UE and the Old PDU session ID IE in case the Old PDU session ID IE is included, and:
- i) the AMF has a PDU session routing context for the old PDU session ID and the UE and does not have a PDU session routing context for the PDU session ID and the UE, the Request type IE is included and is set to "initial request", and the AMF received a reallocation requested indication from the SMF indicating that the SMF is to be reused, the AMF shall store a PDU session routing context for the PDU session ID and the UE, set the SMF ID in the stored PDU session routing context to the SMF ID of the PDU session routing context for the old PDU session ID and the UE. If the DNN is a LADN DNN, the AMF shall determine the UE presence in LADN service area. The AMF shall forward the 5GSM message, the PDU session ID, the old PDU session ID, the S-NSSAI (if received), the mapped S-NSSAI (if available in roaming scenarios), the DNN, the request type and UE presence in LADN service area (if DNN received corresponds to an LADN DNN) towards the SMF identified by the SMF ID of the PDU session routing context;
- ii) the AMF has a PDU session routing context for the old PDU session ID and the UE and does not have a PDU session routing context for the PDU session ID and the UE, the Request type IE is included and is set to "initial request", and the AMF received a reallocation requested indication from the SMF indicating that the SMF is to be reallocated:
- A) the AMF shall select an SMF with the following handling:
- If the S-NSSAI IE is not included and the user's subscription context obtained from UDM:
- contains one default S-NSSAI, the AMF shall use the default S-NSSAI as the S-NSSAI;
  - contains two or more default S-NSSAIs, the AMF shall use one of the default S-NSSAIs selected by operator policy as the S-NSSAI; and
  - does not contain a default S-NSSAI, the AMF shall use an S-NSSAI selected based on operator policy as the S-NSSAI.
- If the DNN is a LADN DNN, the AMF shall determine the UE presence in LADN service area.
- B) if the SMF selection is successful:
- the AMF shall store a PDU session routing context for the PDU session ID and the UE and set the SMF ID of the PDU session routing context to the SMF ID of the selected SMF; and
  - the AMF shall forward the 5GSM message, the PDU session ID, the old PDU session ID, the S-NSSAI, the mapped S-NSSAI (if available in roaming scenarios), the DNN, the request type and UE presence in LADN service area (if DNN received corresponds to an LADN DNN) towards the SMF identified by the SMF ID of the PDU session routing context for the PDU session ID and the UE;

- b) "SMS", the AMF shall forward the content of the Payload container IE to the SMSF associated with the UE;
- c) "LTE Positioning Protocol (LPP) message container", the AMF shall forward the content of the Payload container IE to the LMF associated with the routing information included in the Additional information IE of the UL NAS TRANSPORT message;
- d) "SOR transparent container", the AMF shall forward the content of the Payload container IE to the UDM;
- e) "UE policy container", the AMF shall forward the content of the Payload container IE to the PCF.
- f) "UE parameters update transparent container", the AMF shall forward the content of the Payload container IE to the UDM.
- g) "Multiple payloads", the AMF shall first decode the content of the Payload container IE (see subclause 9.11.3.39) to obtain the number of payload container entries and for each payload container entry, the AMF shall:
  - i) decode the payload container type field;
  - ii) decode the optional IE fields and the payload container contents field in the payload container entry; and
  - iii) handle the content of each payload container entry the same as the content of the Payload container IE and the associated optional IEs as specified in bullets a) to f) above according to the payload container type field.

#### 5.4.5.2.4 UE-initiated NAS transport of messages not accepted by the network

Upon reception of an UL NAS TRANSPORT message, if the Payload container type IE is set to "N1 SM information", the Request type IE is set to "initial request", "existing PDU session" or "modification request", the UE is not configured for high priority access in selected PLMN and:

- a) DNN based congestion control is activated for the DNN included in the UL NAS TRANSPORT message, or DNN based congestion control is activated for the selected DNN in case of no DNN included in the UL NAS TRANSPORT message, e.g. configured by operation and maintenance, the AMF shall send back to the UE the 5GSM message which was not forwarded, a back-off timer value and 5GMM cause #22 "congestion" as specified in subclause 5.4.5.3.1 case f);
- b) S-NSSAI and DNN based congestion control is activated for the S-NSSAI and DNN included in the UL NAS TRANSPORT message, or S-NSSAI and DNN based congestion control is activated for the S-NSSAI included in the UL NAS TRANSPORT message and the selected DNN in case of no DNN included in the UL NAS TRANSPORT message, or S-NSSAI and DNN based congestion control is activated for the selected S-NSSAI in case of no S-NSSAI included in the UL NAS TRANSPORT message and the DNN included in the UL NAS TRANSPORT message, or S-NSSAI and DNN based congestion control is activated for the selected S-NSSAI and the selected DNN in case of no S-NSSAI and no DNN included in the UL NAS TRANSPORT message, e.g. configured by operation and maintenance, the AMF shall send back to the UE the 5GSM message which was not forwarded, a back-off timer value and 5GMM cause #67 "insufficient resources for specific slice and DNN" as specified in subclause 5.4.5.3.1 case f); or
- c) S-NSSAI only based congestion control is activated for the S-NSSAI included in the UL NAS TRANSPORT message, or S-NSSAI based congestion control is activated for the selected S-NSSAI in case of no S-NSSAI included in the UL NAS TRANSPORT message, e.g. configured by operation and maintenance, the AMF shall send back to the UE the 5GSM message which was not forwarded, a back-off timer value and 5GMM cause #69 "insufficient resources for specific slice" as specified in subclause 5.4.5.3.1 case f).

Upon reception of a UL NAS TRANSPORT message, if the Payload container type IE is set to "N1 SM information", the Request type IE is set to "initial request" or "existing PDU session", and the AMF determines that the PLMN's maximum number of PDU sessions has already been reached for the UE, the AMF shall send back to the UE the 5GSM message which was not forwarded and 5GMM cause #65 "maximum number of PDU sessions reached" as specified in subclause 5.4.5.3.1 case h).

#### 5.4.5.2.5 Abnormal cases on the network side

The following abnormal cases in AMF are identified:

- a) if the Payload container type IE is set to "N1 SM information" and:



- 1) if the Old PDU session ID IE is not included in the UL NAS TRANSPORT message, the AMF does not have a PDU session routing context for the PDU session ID and the UE, the Request type IE is set to "initial request", and the SMF selection fails, then the AMF shall send back to the UE the 5GSM message which was not forwarded as specified in subclause 5.4.5.3.1 case e);
- 2) if the Old PDU session ID IE is included in the UL NAS TRANSPORT message, the AMF has a PDU session routing context for the old PDU session ID and the UE and does not have a PDU session routing context for the PDU session ID and the UE, the Request type IE is set to "initial request", the AMF received a reallocation requested indication from the SMF indicating that the SMF is to be reallocated, and the SMF selection fails, then the AMF shall send back to the UE the 5GSM message which was not forwarded as specified in subclause 5.4.5.3.1 case e);
- 3) if the AMF does not have a PDU session routing context for the PDU session ID and the UE, the Request type IE is set to "existing PDU session", and the user's subscription context obtained from the UDM does not contain an SMF ID for the PDU session ID matching the PDU session ID received from the UE or for the DNN matching the DNN received from the UE such that the SMF ID includes a PLMN identity corresponding to the UE's HPLMN or the current PLMN, then the AMF may send back to the UE the 5GSM message which was not forwarded as specified in subclause 5.4.5.3.1 case e).
- 4) if the Old PDU session ID IE is included in the UL NAS TRANSPORT message, and the AMF has a PDU session routing context for the old PDU session ID and the UE and does not have a PDU session routing context for the PDU session ID and the UE, the Request type IE is set to "initial request" and the AMF has not received a reallocation requested indication, the AMF should select an SMF with following handlings:

If the S-NSSAI IE is not included and the user's subscription context obtained from UDM:

- i) contains one default S-NSSAI, the AMF shall use the default S-NSSAI as the S-NSSAI;
- ii) contains two or more default S-NSSAIs, the AMF shall use one of the default S-NSSAIs selected by operator policy as the S-NSSAI; and
- iii) does not contain a default S-NSSAI, the AMF shall use an S-NSSAI selected based on operator policy as the S-NSSAI.

If the DNN IE is not included, and the user's subscription context obtained from UDM:

- i) contains the default DNN for the S-NSSAI, the AMF shall use the default DNN as the DNN; and
- ii) does not contain the default DNN for the S-NSSAI, the AMF shall use a locally configured DNN as the DNN; and

If the DNN is a LADN DNN, the AMF shall determine the UE presence in LADN service area.

If the SMF selection is successful, the AMF should store a PDU session routing context for the PDU session ID and the UE, set the SMF ID in the stored PDU session routing context to the selected SMF ID, and forward the 5GSM message, the PDU session ID, the old PDU session ID, the S-NSSAI, the mapped S-NSSAI (if available in roaming scenarios), the DNN, the request type and UE presence in LADN service area (if DNN received corresponds to an LADN DNN) towards the SMF ID of the PDU session routing context.

If the SMF selection fails then the AMF shall send back to the UE the 5GSM message which was not forwarded as specified in subclause 5.4.5.3.1 case e).

- 5) if the AMF has a PDU session routing context for the PDU session ID and the UE, the PDU session routing context indicates that the PDU session is an emergency PDU session, the Request type IE is set to "initial emergency request", the AMF should forward the 5GSM message, the PDU session ID, the S-NSSAI (if configured in the AMF emergency configuration data), the DNN (if configured in the AMF emergency configuration data) and the request type towards the SMF ID of the PDU session routing context.
- 6) if the Request type IE is set to "initial emergency request" and the S-NSSAI or the DNN is received, the AMF ignores the received S-NSSAI or the DNN and uses the emergency DNN from the AMF emergency configuration data, if any.
- 7) if the AMF does not have a PDU session routing context for the PDU session ID and the UE, and the Request type IE of the UL NAS TRANSPORT message is either not provided or is provided but set to other value than "initial request", "existing PDU session", "initial emergency request" and "existing emergency PDU

session", then the AMF may send back to the UE the 5GSM message which was not forwarded as specified in subclause 5.4.5.3.1 case e).

- 8) if the AMF unsuccessfully attempted to forward the 5GSM message, the PDU session ID, the S-NSSAI, the mapped S-NSSAI (if available in roaming scenarios), the DNN and the request type (if received) towards a SMF ID, then the AMF may send back to the UE the 5GSM message which was not forwarded as specified in subclause 5.4.5.3.1 case e).
- 9) the Old PDU session ID IE is included in the UL NAS TRANSPORT message, the AMF does not have a PDU session routing context for the old PDU session ID and the UE, the AMF does not have a PDU session routing context for the PDU session ID and the UE, the Request type IE is set to "initial request", the AMF should select an SMF with following handlings

If the S-NSSAI IE is not included and the user's subscription context obtained from UDM:

- i) contains one default S-NSSAI, the AMF shall use the default S-NSSAI as the S-NSSAI;
- ii) contains two or more default S-NSSAIs, the AMF shall use one of the default S-NSSAIs selected by operator policy as the S-NSSAI; and
- iii) does not contain a default S-NSSAI, the AMF shall use an S-NSSAI selected based on operator policy as the S-NSSAI.

If the DNN IE is not included, and the user's subscription context obtained from UDM:

- i) contains the default DNN for the S-NSSAI, the AMF shall use the default DNN as the DNN; and
- ii) does not contain the default DNN for the S-NSSAI, the AMF shall use a locally configured DNN as the DNN; and

If the DNN is a LADN DNN, the AMF shall determine the UE presence in LADN service area.

If the SMF selection is successful, the AMF should store a PDU session routing context for the PDU session ID and the UE, set the SMF ID in the stored PDU session routing context to the selected SMF ID, and forward the 5GSM message, the PDU session ID, the old PDU session ID, the S-NSSAI, the mapped S-NSSAI (if available in roaming scenarios), the DNN, the request type and UE presence in LADN service area (if DNN received corresponds to an LADN DNN) towards the SMF ID of the PDU session routing context.

If the SMF selection fails then the AMF shall send back to the UE the 5GSM message which was not forwarded as specified in subclause 5.4.5.3.1 case e).

- 10) if the AMF has a PDU session routing context for the PDU session ID and the UE, the PDU session routing context indicates that the PDU session is not an emergency PDU session, and the Request type IE is included and is set to "existing emergency PDU session", the AMF may send back to the UE the 5GSM message which was not forwarded as specified in subclause 5.4.5.3.1 case e).
- 11) if the AMF has a PDU session routing context for the PDU session ID and the UE, the PDU session routing context indicates that the PDU session is an emergency PDU session, and the Request type IE is included and is set to "existing PDU session", the AMF may forward the 5GSM message, the PDU session ID, the S-NSSAI (if configured in the AMF emergency configuration data), the DNN (if configured in the AMF emergency configuration data), and the request type towards the SMF identified by the SMF ID of the PDU session routing context.
- 12) if the AMF has a PDU session routing context for the PDU session ID and the UE, the Request type IE is set to "initial request", then the AMF shall perform a local release of the PDU session identified by the PDU session ID and shall request the SMF to perform a local release of the PDU session, and proceed as specified in subclause 5.4.5.2.3.
- 13) if the Payload container type IE is set to "N1 SM information", the Request type IE is set to "initial request" and the S-NSSAI IE contains an S-NSSAI that is not allowed by the network, then the AMF shall send back to the UE the 5GSM message which was not forwarded as specified in subclause 5.4.5.3.1 case e).
- 14) if the Payload container type IE is set to "N1 SM information", the Request type IE is set to "existing PDU session", the AMF has a PDU session routing context for the PDU session ID and the UE, the PDU session routing context indicates that the PDU session is not an emergency PDU session, and the S-NSSAI

associated with the PDU session identified by the PDU session ID is not allowed for the target access type, the AMF shall send back to the UE the 5GSM message which was not forwarded as specified in subclause 5.4.5.3.1 case e).

- 15) if the AMF receives an UL NAS TRANSPORT message with the Payload container type IE set to "N1 SM information" and the Request type IE set to "initial request", "existing PDU session" or "modification request", the UE is not configured for high priority access in selected PLMN and the UE is in non-allowed area or is not in allowed area, the AMF shall send back to the UE the 5GSM message which was not forwarded, and 5GMM cause #28 "Restricted service area" as specified in subclause 5.4.5.3.1 case i).
- 16) if the Request type IE is set to "initial request", the AMF is pending the receipt of a REGISTRATION REQUEST message indicating "mobility registration updating" in the 5GS registration type IE, and an emergency PDU session exists for the UE (see subclause 5.4.4.3), the AMF shall send back to the UE the 5GSM message which was not forwarded as specified in subclause 5.4.5.3.1 case e).
- b) If the Payload container type IE is set to "SMS" and the AMF does not have an SMSF address associated with the UE or the AMF cannot forward the content of the Payload container IE to the SMSF associated with the SMSF address available in the AMF, the AMF shall abort the procedure.
- c) If the Payload container type IE is set to "LTE Positioning Protocol (LPP) message container" and if the Additional information IE is not included in the UL NAS TRANSPORT message or the AMF cannot forward the content of the Payload container IE to the LMF associated with the routing information included in the Additional information IE, the AMF shall abort the procedure.
- d) If the Payload container type IE is set to "UE policy container" and the AMF does not have a PCF address associated with the UE or the AMF cannot forward the content of the Payload container IE to the PCF associated with the PCF address available in the AMF, the AMF shall abort the procedure.

#### 5.4.5.2.6 Abnormal cases in the UE

The following abnormal cases can be identified:

- a) The lower layers indicate that the access attempt is barred.

The UE shall not start the UE-initiated NAS transport procedure. The UE stays in the current serving cell and applies the normal cell reselection process.

If the access category for the access attempt is 6 due to a request from upper layers to send a mobile originated SMS over NAS and the UE is registered to the network via both 3GPP access and non-3GPP access, the UE may transmit the UL NAS TRANSPORT message via non-3GPP access, if the AMF set the SMS allowed bit of the 5GS registration result IE to "SMS over NAS allowed" in the REGISTRATION ACCEPT message.

Otherwise, the UE-initiated NAS transport procedure is started, if still needed, when the lower layers indicate that the barring is alleviated for the access category with which the access attempt was associated.

- aa) The lower layers indicate that access barring is applicable for all access categories except categories 0 and 2 and the access category with which the access attempt was associated is other than 0 and 2.

The UE shall proceed as specified for case a. For additional UE requirements see subclause 4.5.5.

- b) If the Payload container type IE is set to "N1 SM information", the Request type IE is set to "initial request" and registration procedure for mobility and periodic registration update is pending due to receipt by the UE of new network slicing information via the generic UE configuration update procedure with re-registration request; and an emergency PDU session exists then:
- 1) The UE shall not send the UL NAS TRANSPORT message; and
  - 2) The UL NAS TRANSPORT message can be sent, if still necessary, after a successful procedure for mobility and periodic registration update.
- c) Transmission failure of the UL NAS TRANSPORT message with TAI change from lower layers.

If the current TAI is not in the TAI list, the UE-initiated NAS transport procedure shall be aborted and a registration procedure for mobility and periodic registration update shall be initiated. The UL NAS

TRANSPORT message can be sent, if still necessary, after a successful procedure for mobility and periodic registration update.

If the current TAI is still part of the TAI list, it is up to the UE implementation how to re-run the ongoing procedure that triggered the UE-initiated NAS transport procedure.

- d) Transmission failure of the UL NAS TRANSPORT message indication without TAI change from lower layers.

It is up to the UE implementation how to re-run the ongoing procedure that triggered the UE-initiated NAS transport procedure.

- e) The UE shall not send the UL NAS TRANSPORT message when the UE is in non-allowed area or is not in allowed area and:
- 1) the Payload container type IE is set to "N1 SM information", the Request type IE is set to "initial request", "existing PDU session" or "modification request" and the UE is not configured for high priority access in selected PLMN; or
  - 2) the Payload container type IE is set to "SMS" and the UE is not configured for high priority access in selected PLMN.

The UL NAS TRANSPORT message can be sent, if still necessary, when the UE moves out of the non-allowed area or enters the allowed area.

### 5.4.5.3 Network-initiated NAS transport procedure

#### 5.4.5.3.1 General

The purpose of the network-initiated NAS transport procedure is to provide a transport of:

- a) a single 5GSM message;
- b) SMS;
- c) an LPP message;
- d) an SOR transparent container;
- e) a single uplink 5GSM message which was not forwarded due to routing failure;
- f) a single uplink 5GSM message which was not forwarded due to congestion control;
- g) a UE policy container;
- h) a single uplink 5GSM message which was not forwarded, because the PLMN's maximum number of PDU sessions has been reached;
- i) a single uplink 5GSM message which was not forwarded due to service area restrictions;
- j) a UE parameters update transparent container; or
- k) multiple of the above types.

from the AMF to the UE in a 5GMM message.

#### 5.4.5.3.2 Network-initiated NAS transport procedure initiation

In 5GMM-CONNECTED mode, the AMF initiates the NAS transport procedure by sending the DL NAS TRANSPORT message, as shown in figure 5.4.5.3.2.1.

In case a) in subclause 5.4.5.3.1, i.e. upon reception from an SMF of a 5GSM message without an N1 SM delivery skip allowed indication for a UE or a 5GSM message with an N1 SM delivery skip allowed indication for a UE in the 5GMM-CONNECTED mode, the AMF shall:

- a) include the PDU session information (PDU session ID) in the PDU session ID IE;

- b) set the Payload container type IE to "N1 SM information"; and
- c) set the Payload container IE to the 5GSM message.

In case b) in subclause 5.4.5.3.1, i.e. upon reception from an SMSF of an SMS payload, the AMF shall:

- a) set the Payload container type IE to "SMS";
- b) set the Payload container IE to the SMS payload; and
- c) select the access type to deliver the DL NAS TRANSPORT message as follows in case the access type selection is required:
  - 1) if the UE to receive the DL NAS TRANSPORT message is registered to the network via both 3GPP access and non-3GPP access, the 5GMM context of the UE indicates that SMS over NAS is allowed, the UE is in MICO mode, and the UE is in 5GMM-IDLE mode for 3GPP access and in 5GMM-CONNECTED mode for non-3GPP access, then the AMF selects non-3GPP access. Otherwise, the AMF selects either 3GPP access or non-3GPP access.

If the delivery of the DL NAS TRANSPORT message over 3GPP access has failed, the AMF may re-send the DL NAS TRANSPORT message over the non-3GPP access.

If the delivery of the DL NAS TRANSPORT message over non-3GPP access has failed, the AMF may re-send the DL NAS TRANSPORT message over the 3GPP access; and

- 2) otherwise, the AMF selects 3GPP access.

NOTE: The AMF selects an access type between 3GPP access and non-3GPP access based on operator policy.

In case c) in subclause 5.4.5.3.1 i.e. upon reception from an LMF of an LPP message payload, the AMF shall:

- a) set the Payload container type IE to "LTE Positioning Protocol (LPP) message container";
- b) set the Payload container IE to the LPP message payload received from the LMF; and
- c) set the Additional information IE to the routing information associated with the LMF from which the LPP message was received.

In case d) in subclause 5.4.5.3.1 i.e. upon reception of a steering of roaming information (see 3GPP TS 23.122 [5]) from the UDM to be forwarded to the UE, the AMF shall:

- a) set the Payload container type IE to "SOR transparent container"; and
- b) set the Payload container IE to the steering of roaming information (see 3GPP TS 23.122 [5]) received from the UDM.

In case e) in subclause 5.4.5.3.1, i.e. upon sending a single uplink 5GSM message which was not forwarded due to routing failure, the AMF shall:

- a) include the PDU session ID in the PDU session ID IE;
- b) set the Payload container type IE to "N1 SM information";
- c) set the Payload container IE to the 5GSM message which was not forwarded; and
- d) set the 5GMM cause IE to the 5GMM cause #90 "payload was not forwarded" or 5GMM cause #91 "DNN not supported or not subscribed in the slice". The AMF sets the 5GMM cause IE to the 5GMM cause #91 "DNN not supported or not subscribed in the slice", if the 5GSM message could not be forwarded since SMF selection fails due to:
  - 1) the DNN is not supported in the slice identified by the S-NSSAI used by the AMF; or
  - 2) neither the DNN provided by the UE nor the wildcard DNN are in the subscribed DNN list of the UE for the S-NSSAI used by the AMF.

Otherwise, the AMF sets the 5GMM cause IE to the 5GMM cause #90 "payload was not forwarded".

In case f) in subclause 5.4.5.3.1, i.e. upon sending a single uplink 5GSM message which was not forwarded due to congestion control, the AMF shall:

- a) include the PDU session ID in the PDU session ID IE;
- b) set the Payload container type IE to "N1 SM information";
- c) set the Payload container IE to the 5GSM message which was not forwarded;
- d) set the 5GMM cause IE to the 5GMM cause #22 "Congestion", the 5GMM cause #67 "insufficient resources for specific slice and DNN" or the 5GMM cause #69 "insufficient resources for specific slice"; and
- e) include the Back-off timer value IE.

In case g) in subclause 5.4.5.3.1, i.e. upon reception of a UE policy container from the PCF to be forwarded to the UE, the AMF shall:

- a) set the Payload container type IE to "UE policy container"; and
- b) set the Payload container IE to the UE policy container received from the PCF.

In case h) in subclause 5.4.5.3.1, i.e. upon sending a single uplink 5GSM message which was not forwarded, because the PLMN's maximum number of PDU sessions has been reached, the AMF shall:

- a) include the PDU session ID in the PDU session ID IE;
- b) set the Payload container type IE to "N1 SM information";
- c) set the Payload container IE to the 5GSM message which was not forwarded; and
- d) set the 5GMM cause IE to the 5GMM cause #65 "maximum number of PDU sessions reached".

In case i) in subclause 5.4.5.3.1, i.e. upon sending a single uplink 5GSM message which was not forwarded due to service area restrictions, the AMF shall:

- a) include the PDU session ID in the PDU session ID IE;
- b) set the Payload container type IE to "N1 SM information";
- c) set the Payload container IE to the 5GSM message which was not forwarded; and
- d) set the 5GMM cause IE to the 5GMM cause #28 "Restricted service area".

In case j) in subclause 5.4.5.3.1 i.e. upon reception of UE parameters update data (see 3GPP TS 23.502 [9]) from the UDM to be forwarded to the UE, the AMF shall:

- a) set the Payload container type IE to "UE parameters update transparent container"; and
- b) set the contents of the Payload container IE to the UE parameters update data (see 3GPP TS 23.502 [9]) received from the UDM.

In case k) in subclause 5.4.5.3.1, the AMF shall:

- a) set the Payload container type IE to "Multiple payloads";
- b) set each payload container entry of the Payload container IE (see subclause 9.11.3.39) as follows:
  - i) set the payload container type field of the payload container entry to a payload container type value set in the Payload container type IE as specified for cases a) to j) above;
  - ii) set the payload container contents field of the payload container entry to the payload contents set in the Payload container type IE as specified for cases a) to j) above;
  - iii) set the optional IE fields, if any, to the optional associated information as specified for cases a) to j) above.



**Figure 5.4.5.3.2.1: Network-initiated NAS transport procedure**

### 5.4.5.3.3 Network-initiated NAS transport of messages

Upon reception of a DL NAS TRANSPORT message, the UE shall stop the timer T3346 if running.

Upon reception of a DL NAS TRANSPORT message, if the Payload container type IE is set to:

- a) "N1 SM information" and the 5GMM cause IE is not included in the DL NAS TRANSPORT message, the 5GSM message in the Payload container IE and the PDU session ID are handled in the 5GSM procedures specified in clause 6;
- b) "SMS", the UE shall forward the content of the Payload container IE to the SMS stack entity;
- c) "LTE Positioning Protocol (LPP) message container", the UE shall forward the content of the Payload container IE and the routing information included in the Additional information IE to the upper layer location services application;
- d) "SOR transparent container" and if the Payload container IE:
  - 1) successfully passes the integrity check (see 3GPP TS 33.501 [24]), indicates a list of preferred PLMN/access technology combinations is provided and the list type indicates:
    - i) "PLMN ID and access technology list", then the ME shall replace the highest priority entries in the "Operator Controlled PLMN Selector with Access Technology" list stored in the ME and shall proceed with the behaviour as specified in 3GPP TS 23.122 [5] annex C; or
    - ii) "secured packet", then the ME shall behave as if a SMS is received with protocol identifier set to SIM data download, data coding scheme set to class 2 message and SMS payload as secured packet contents of SOR transparent container IE. The SMS payload is forwarded to UICC as specified in 3GPP TS 23.040 [4A] and the ME shall proceed with the behaviour as specified in 3GPP TS 23.122 [5] annex C; or
  - 2) does not successfully pass the integrity check (see 3GPP TS 33.501 [24]) then the UE shall proceed with the behaviour as specified in 3GPP TS 23.122 [5] annex C.
- e) "N1 SM information" and the 5GMM cause IE is set to the 5GMM cause #90 "payload was not forwarded" in the DL NAS TRANSPORT message, the UE passes to the 5GSM sublayer an indication that the 5GSM message was not forwarded due to routing failure along with the 5GSM message from the Payload container IE of the DL NAS TRANSPORT message;
- f) "N1 SM information" and the 5GMM cause IE is set to the 5GMM cause #91 "DNN not supported or not subscribed in the slice" in the DL NAS TRANSPORT message, the UE passes to the 5GSM sublayer an indication that the 5GSM message was not forwarded due to the DNN is not supported or not subscribed in a slice along with the 5GSM message from the Payload container IE of the DL NAS TRANSPORT message;
- g) "N1 SM information" and:
  - the 5GMM cause IE is set to the 5GMM cause #22 "Congestion", the UE passes to the 5GSM sublayer an indication that the 5GSM message was not forwarded due to DNN based congestion control along with the 5GSM message from the Payload container IE of the DL NAS TRANSPORT message, and the time value from the Back-off timer value IE;
  - the 5GMM cause IE is set to the 5GMM cause #28 "Restricted service area", the UE passes to the 5GSM sublayer an indication that the 5GSM message was not forwarded due to service area restrictions along with

- the 5GSM message from the Payload container IE of the DL NAS TRANSPORT message, enters the state 5GMM-REGISTERED.NON-ALLOWED-SERVICE, and performs the registration procedure for mobility and periodic registration update (see subclause 5.3.5 and 5.5.1.3);
- the 5GMM cause IE is set to the 5GMM cause #65 "maximum number of PDU sessions reached", the UE passes to the 5GSM sublayer an indication that the 5GSM message was not forwarded because the PLMN's maximum number of PDU sessions has been reached, along with the 5GSM message from the Payload container IE of the DL NAS TRANSPORT message;
  - the 5GMM cause IE is set to the 5GMM cause #67 "insufficient resources for specific slice and DNN", the UE passes to the 5GSM sublayer an indication that the 5GSM message was not forwarded due to S-NSSAI and DNN based congestion control along with the 5GSM message from the Payload container IE of the DL NAS TRANSPORT message, and the time value from the Back-off timer value IE; or
  - the 5GMM cause IE is set to the 5GMM cause #69 "insufficient resources for specific slice", the UE passes to the 5GSM sublayer an indication that the 5GSM message was not forwarded due to S-NSSAI only based congestion control along with the 5GSM message from the Payload container IE of the DL NAS TRANSPORT message, and the time value from the Back-off timer value IE;
- h) "UE policy container", the UE policy container in the Payload container IE is handled in the UE policy delivery procedures specified in Annex D;
- i) "UE parameters update transparent container" and if the Payload container IE
- 1) successfully passes the integrity check (see 3GPP TS 33.501 [24]):
    - i) if the UE parameters update list includes a UE parameters update data set with UE parameters update data set type indicating "Routing indicator update data",
      - A) the ME shall behave as if an SMS is received with protocol identifier set to SIM data download, data coding scheme set to class 2 message and SMS payload as secured packet contents of UE parameters update transparent container IE. The SMS payload is forwarded to UICC as specified in 3GPP TS 23.040 [4A]; and
      - B) if the ACK bit of the UE parameters update header in the UE parameters update transparent container is set to "acknowledgment requested" and if the ME receives status bytes from the UICC indicating that the UICC has received the secured packet successfully, the ME shall send an acknowledgement in the Payload container IE of an UL NAS TRANSPORT message with Payload type IE set to "UE parameters update transparent container" as specified in subclause 5.4.5.2.2; and
      - C) if the ME receives a REFRESH command from the UICC as specified in 3GPP TS 31.111 [22A] and if the REG bit of the UE parameters update header in the UE parameters update transparent container IE is set to "re-registration requested", and:
        - C1) the UE is registered over 3GPP access, then the UE shall wait until it enters 5GMM-IDLE mode over 3GPP access, and then perform a de-registration procedure, delete its 5G-GUTI and initiate a registration procedure for initial registration as specified in subclause 5.5.1.2;
        - C2) the UE is registered over non-3GPP access and does not have emergency services ongoing over non-3GPP access, then the UE shall locally release the N1 NAS signalling connection and enter 5GMM-IDLE mode over non-3GPP access, perform a de-registration procedure, delete its 5G-GUTI if the UE is registered to different PLMN on 3GPP access or the UE is not registered over 3GPP access, and then initiate a registration procedure for initial registration as specified in subclause 5.5.1.2; and
        - C3) the UE is registered over non-3GPP access and has an emergency services ongoing over non-3GPP access, then the UE shall wait until the emergency services are completed before locally releasing the N1 NAS signalling connection and enter 5GMM-IDLE mode over non-3GPP access, perform a de-registration procedure, delete its 5G-GUTI if the UE is registered to different PLMN on 3GPP access or if the UE is not registered over 3GPP access, and then initiate a registration procedure for initial registration as specified in subclause 5.5.1.2.
    - ii) if the UE parameters update list includes a UE parameters update data set with UE parameters update data set type indicating "Default configured NSSAI update data",



- A) if the ACK bit of the UE parameters update header in the UE parameters update transparent container is set to "acknowledgment requested" and if the UE parameters update list does not include a UE parameters update data set with UE parameters update data set type indicating "Routing indicator update data", the ME shall send an acknowledgement in the Payload container IE of an UL NAS TRANSPORT message with Payload type IE set to "UE parameters update transparent container" as specified in subclause 5.4.5.2.2
  - B) the ME shall replace the stored default configured NSSAI with the default configured NSSAI included in the default configured NSSAI update data; and
  - C) if the UE parameters update list does not include a UE parameters update data set with UE parameters update data set type indicating "Routing indicator update data", the UE used the old default configured NSSAI to create the requested NSSAI in a REGISTRATION REQUEST message, the UE does not have a configured NSSAI for the current PLMN and the UE has an allowed NSSAI for the current PLMN which contains one or more S-NSSAIs that are not included in the new default configured NSSAI, the UE shall wait until it enters 5GMM-IDLE mode and then the UE shall initiate a registration procedure for mobility and periodic registration update as specified in subclause 5.5.1.3; and
- 2) does not successfully pass the integrity check (see 3GPP TS 33.501 [24]) then the UE shall discard the content of the payload container IE; and
- j) "Multiple payloads", the UE shall first decode the content of the Payload container IE (see subclause 9.11.3.39) to obtain the number of payload container entries and for each payload container entry, the UE shall:
    - i) decode the payload container type field;
    - ii) decode the optional IE fields and the payload container contents field in the payload container entry; and
    - iii) handle the content of each payload container entry the same as the content of the Payload container IE and the associated optional IEs as specified in bullets a) to i) above according to the payload container type field.

## 5.4.6 5GMM status procedure

### 5.4.6.1 General

The purpose of the 5GMM status procedure is to report at any time in the 5GMM STATUS message certain error conditions detected upon receipt of 5GMM protocol data in the AMF or in the UE. The 5GMM STATUS message can be sent by both the AMF and the UE (see example in figure 5.4.6.1).

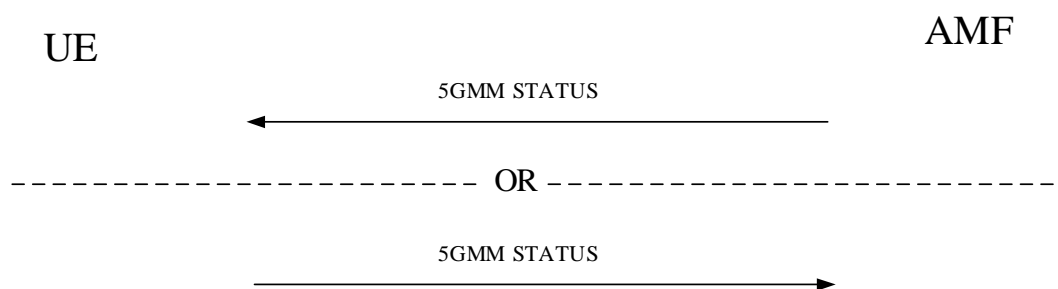

**Figure 5.4.6.1: 5GMM status procedure**

### 5.4.6.2 5GMM status received in the UE

On receipt of a 5GMM STATUS message, no state transition and no specific action shall be taken as seen from the radio interface, i.e. local actions are possible. The local actions to be taken by UE on receipt of a 5GMM STATUS message are implementation dependent.

### 5.4.6.3 5GMM status received in the network

On receipt of a 5GMM STATUS message in the AMF, no state transition and no specific action shall be taken as seen from the radio interface, i.e. local actions are possible. The local actions to be taken by the AMF on receipt of a 5GMM STATUS message are implementation dependent.

## 5.5 5GMM specific procedures

### 5.5.1 Registration procedure

#### 5.5.1.1 General

The registration procedure is always initiated by the UE and used for initial registration as specified in subclause 5.5.1.2.2 or mobility and periodic registration update as specified in subclause 5.5.1.3.2.

When the UE needs to initiate registration over both 3GPP access and non-3GPP access in the same PLMN (e.g. the 3GPP access and the selected N3IWF are located in the same PLMN), the UE:

- a) in 5GMM-REGISTERED-INITIATED over 3GPP access shall not initiate registration over non-3GPP access; or
- b) in 5GMM-REGISTERED-INITIATED over non-3GPP access shall not initiate registration over 3GPP access.

NOTE: To which access (i.e. 3GPP access or non-3GPP access) the UE initiates registration first is up to UE implementation.

When the UE is registered with a PLMN over a non-3GPP access, the AMF and the UE maintain:

- a) registration state and state machine over non-3GPP access;
- b) 5G NAS security context;
- c) 5G-GUTI;
- d) registration area for non-3GPP access, which is associated with a fixed well-known N3GPP TAI; and
- e) non-3GPP de-registration timer in the UE and non-3GPP implicit de-registration timer in the AMF.

A registration attempt counter is used to limit the number of subsequently rejected registration attempts. The registration attempt counter shall be incremented as specified in subclause 5.5.1.2.7 or subclause 5.5.1.3.7. Depending on the value of the registration attempt counter, specific actions shall be performed. The registration attempt counter shall be reset when:

- the UE is powered on;
- a USIM is inserted;
- a registration procedure is successfully completed;
- an EPS attach or combined EPS attach procedure is successfully completed in S1 mode and the UE is operating in single-registration mode;
- a registration procedure is rejected with cause #11, #12, #13, #27 and #73;
- a network initiated deregistration procedure is completed with cause #11, #12, #13 and #27; or
- a new PLMN is selected.

Additionally, the registration attempt counter shall be reset when the UE is in substate 5GMM-DEREGISTERED.ATTEMPTING-REGISTRATION or 5GMM-REGISTERED.ATTEMPTING-REGISTRATION-UPDATE, and:

- a new tracking area is entered;
- timer T3502 expires; or

- timer T3346 is started.

When the registration attempt counter is reset, the UE shall stop timer T3519 if running, and delete any stored SUCI.

The lower layers indicate to NAS whether the network supports emergency services for the UE in limited service state (see 3GPP TS 38.331 [30]). This information is taken into account when deciding whether to initiate an initial registration for emergency services.

## 5.5.1.2 Registration procedure for initial registration

### 5.5.1.2.1 General

This procedure can be used by a UE for initial registration for 5GS services.

When the UE initiates the registration procedure for initial registration, the UE shall indicate "initial registration" in the 5GS registration type IE. When the UE initiates the registration procedure for emergency services, the UE shall indicate "emergency registration" in the 5GS registration type IE.

### 5.5.1.2.2 Initial registration initiation

The UE in state 5GMM-DEREGISTERED shall initiate the registration procedure for initial registration by sending a REGISTRATION REQUEST message to the AMF,

- a) when the UE performs initial registration for 5GS services;
- b) when the UE performs initial registration for emergency services;
- c) when the UE performs initial registration for SMS over NAS; and
- d) when the UE moves from GERAN to NG-RAN coverage or the UE moves from a UTRAN to NG-RAN coverage.

with the following clarifications to initial registration for emergency services:

- a) the UE shall not initiate an initial registration for emergency services over the current access, if the UE is already registered for emergency services over the non-current access, unless the initial registration has to be initiated to perform handover of an existing emergency PDU session from the non-current access to the current access; and

NOTE 1: Transfer of an existing emergency PDU session between 3GPP access and non-3GPP access is needed e.g. if the UE determines that the current access is no longer available.

- b) the UE can only initiate an initial registration for emergency services over non-3GPP access if it can not register for emergency services over 3GPP access.

The UE initiates the registration procedure for initial registration by sending a REGISTRATION REQUEST message to the AMF, starting timer T3510. If timer T3502 is currently running, the UE shall stop timer T3502. If timer T3511 is currently running, the UE shall stop timer T3511.

During initial registration the UE handles the 5GS mobile identity IE in the following order:

- a) Voidb)if the UE holds a valid 5G-GUTI that was previously assigned, over 3GPP access or non-3GPP access, by the same PLMN with which the UE is performing the registration, the UE shall indicate the 5G-GUTI in the 5GS mobile identity IE;
- c) if the UE holds a valid 5G-GUTI that was previously assigned, over 3GPP access or non-3GPP access, by an equivalent PLMN, the UE shall indicate the 5G-GUTI in the 5GS mobile identity IE;
- d) if the UE holds a valid 5G-GUTI that was previously assigned, over 3GPP access or non-3GPP, by any other PLMN, the UE shall indicate the 5G-GUTI in the 5GS mobile identity IE;
- e) if a SUCI is available the UE shall include the SUCI in the 5GS mobile identity IE; and
- f) if the UE does not hold a valid 5G-GUTI or SUCI, and is initiating the registration procedure for emergency services, the PEI shall be included in the 5GS mobile identity IE.

If the SUCI is included in the 5GS mobile identity IE and the timer T3519 is not running, the UE shall start timer T3519 and store the value of the SUCI sent in the REGISTRATION REQUEST message. The UE shall include the stored SUCI in the REGISTRATION REQUEST message while timer T3519 is running.

If the UE is operating in the dual-registration mode and it is in EMM state EMM-REGISTERED, the UE shall include the UE status IE with the EMM registration status set to "UE is in EMM-REGISTERED state".

NOTE 2: Inclusion of the UE status IE with this setting corresponds to the indication that the UE is "moving from EPC" as specified in 3GPP TS 23.502 [9].

If the last visited registered TAI is available, the UE shall include the last visited registered TAI in the REGISTRATION REQUEST message.

If the UE requests the use of SMS over NAS, the UE shall include the 5GS update type IE in the REGISTRATION REQUEST message with the SMS requested bit set to "SMS over NAS supported". When the 5GS update type IE is included in the REGISTRATION REQUEST for reasons other than requesting the use of SMS over NAS, and the UE does not need to register for SMS over NAS, the UE shall set the SMS requested bit of the 5GS update type IE to "SMS over NAS not supported" in the REGISTRATION REQUEST message.

If the UE supports MICO mode and requests the use of MICO mode, then the UE shall include the MICO indication IE in the REGISTRATION REQUEST message.

If the UE needs to use the UE specific DRX parameters, the UE shall include the Requested DRX parameters IE in the REGISTRATION REQUEST message.

If the UE needs to request LADN information for specific LADN DNN(s) or indicates a request for LADN information as specified in 3GPP TS 23.501 [8], the UE shall include the LADN indication IE in the REGISTRATION REQUEST message and:

- request specific LADN DNNs by including a LADN DNN value in the LADN indication IE for each LADN DNN for which the UE requests LADN information; or
- to indicate a request for LADN information by not including any LADN DNN value in the LADN indication IE.

The UE shall include the requested NSSAI containing the S-NSSAI(s) corresponding to the slice(s) to which the UE intends to register with and shall include the mapped S-NSSAI(s) for the requested NSSAI, if available, in the REGISTRATION REQUEST message. If the UE has allowed NSSAI or configured NSSAI for the current PLMN, the requested NSSAI shall be either:

- a) the configured NSSAI for the current PLMN, or a subset thereof as described below, if the UE has no allowed NSSAI for the current PLMN;
- b) the allowed NSSAI for the current PLMN, or a subset thereof as described below, if the UE has an allowed NSSAI for the current PLMN; or
- c) the allowed NSSAI for the current PLMN, or a subset thereof as described below, plus one or more S-NSSAIs from the configured NSSAI for which no corresponding S-NSSAI is present in the allowed NSSAI and those are neither in the rejected NSSAI for the current PLMN nor in the rejected NSSAI for the current registration area.

If the UE has neither allowed NSSAI for the current PLMN nor configured NSSAI for the current PLMN and has a default configured NSSAI, the UE shall:

- a) include the S-NSSAI(s) in the Requested NSSAI IE of the REGISTRATION REQUEST message using the default configured NSSAI; and
- b) include the Network slicing indication IE with the Default configured NSSAI indication bit set to "Requested NSSAI created from default configured NSSAI" in the REGISTRATION REQUEST message.

If the UE has no allowed NSSAI for the current PLMN, no configured NSSAI for the current PLMN, and no default configured NSSAI, the UE shall not include a requested NSSAI in the REGISTRATION message.

The subset of configured NSSAI provided in the requested NSSAI consists of one or more S-NSSAIs in the configured NSSAI applicable to the current PLMN, if the S-NSSAI is neither in the rejected NSSAI for the current PLMN nor in the rejected NSSAI for the current registration area.

The subset of allowed NSSAI provided in the requested NSSAI consists of one or more S-NSSAIs in the allowed NSSAI for the current PLMN.

NOTE 3: How the UE selects the subset of configured NSSAI or allowed NSSAI to be provided in the requested NSSAI is implementation specific. The UE can take preferences indicated by the upper layers (e.g. policies, applications) into account.

NOTE 4: The number of S-NSSAI(s) included in the requested NSSAI cannot exceed eight.

If the UE initiates an initial registration for emergency services or needs to prolong the established NAS signalling connection after the completion of the initial registration procedure (e.g. due to uplink signalling pending), the UE shall set the Follow-on request indicator to 1.

If the UE supports S1 mode, the UE shall:

- set the S1 mode bit to "S1 mode supported" in the 5GMM capability IE of the REGISTRATION REQUEST message;
- include the S1 UE network capability IE in the REGISTRATION REQUEST message; and
- if the UE supports sending an ATTACH REQUEST message containing a PDN CONNECTIVITY REQUEST message with request type set to "handover" to transfer a PDU session from N1 mode to S1 mode, set the HO attach bit to "attach request message containing PDN connectivity request with request type set to handover to transfer PDU session from N1 mode to S1 mode supported" in the 5GMM capability IE of the REGISTRATION REQUEST message.

If the UE supports the LTE positioning protocol (LPP) in N1 mode as specified in 3GPP TS 36.355 [26], the UE shall set the LPP bit to "LPP in N1 mode supported" in the 5GMM capability IE of the REGISTRATION REQUEST message.

If the UE has one or more stored UE policy sections identified by a UPSI with the PLMN ID part indicating the HPLMN or the selected PLMN, the UE shall include the UE STATE INDICATION message (see annex D) in the Payload container IE of the REGISTRATION REQUEST message.

If the UE does not have a valid 5G NAS security context, the UE shall send the REGISTRATION REQUEST message without including the NAS message container IE. The UE shall set the Payload container type IE to "UE policy container" and include the entire REGISTRATION REQUEST message (i.e. containing cleartext IEs and non-cleartext IEs, if any) in the NAS message container IE that is sent as part of the SECURITY MODE COMPLETE message as described in subclauses 4.4.6 and 5.4.2.3.

NOTE 1: In this version of the protocol, the UE can only include the Payload container IE in the REGISTRATION REQUEST message to carry a payload of type "UE policy container".

If the UE has a valid 5G NAS security context and the UE needs to send non-cleartext IEs, the UE shall send a REGISTRATION REQUEST message including the NAS message container IE as described in subclause 4.4.6. If the UE does not need to send non-cleartext IEs, the UE shall send a REGISTRATION REQUEST message without including the NAS message container IE.

If the REGISTRATION REQUEST message includes a NAS message container IE, the AMF shall process the REGISTRATION REQUEST message that is obtained from the NAS message container IE as described in subclause 4.4.6.

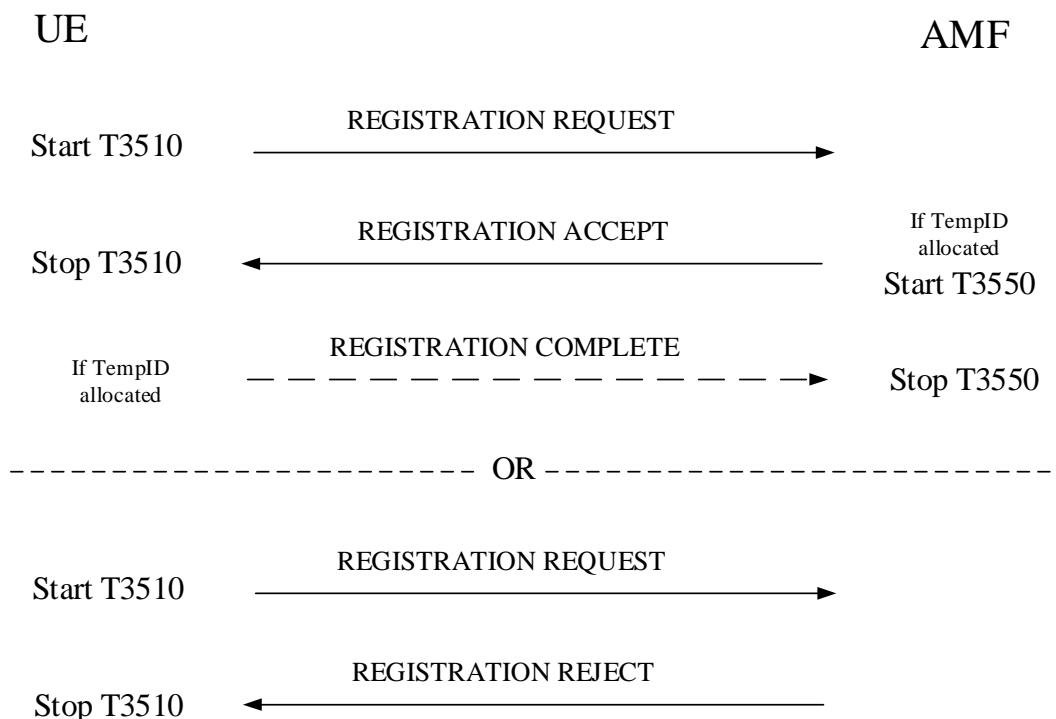

**Figure 5.5.1.2.2.1: Registration procedure for initial registration**

#### 5.5.1.2.3 5GMM common procedure initiation

The network may initiate 5GMM common procedures, e.g. the identification, authentication and security procedures during the registration procedure, depending on the information received in the REGISTRATION REQUEST message.

During a registration procedure with 5GS registration type IE set to "emergency registration", if the AMF is configured to support emergency registration for unauthenticated SUCIs, the AMF may choose to skip the authentication procedure even if no 5G NAS security context is available and proceed directly to the execution of the security mode control procedure.

#### 5.5.1.2.4 Initial registration accepted by the network

During a registration procedure with 5GS registration type IE set to "emergency registration", the AMF shall not check for mobility and access restrictions, regional restrictions or subscription restrictions, when processing the REGISTRATION REQUEST message.

If the initial registration request is accepted by the network, the AMF shall send a REGISTRATION ACCEPT message to the UE.

For each of the information elements: 5GMM capability, S1 UE network capability, and UE security capability, the AMF shall store all octets received from the UE in the REGISTRATION REQUEST message, up to the maximum length defined for the respective information element.

**NOTE 1:** This information is forwarded to the new AMF during inter-AMF handover or to the new MME during inter-system handover to S1 mode.

The AMF shall assign and include a TAI list as a registration area the UE is registered to in the REGISTRATION ACCEPT message. The UE, upon receiving a REGISTRATION ACCEPT message, shall delete its old TAI list and store the received TAI list. If the REGISTRATION REQUEST message was received over non-3GPP access, the AMF shall include only the N3GPP TAI in the TAI list.

**NOTE 2:** The N3GPP TAI is operator-specific.

The AMF may include service area restrictions in the Service area list IE in the REGISTRATION ACCEPT message. The UE, upon receiving a REGISTRATION ACCEPT message with the service area restrictions shall act as described in subclause 5.3.5.

The AMF may also include a list of equivalent PLMNs in the REGISTRATION ACCEPT message. Each entry in the list contains a PLMN code (MCC+MNC). The UE shall store the list as provided by the network, and if the initial registration procedure is not for emergency services, the UE shall remove from the list any PLMN code that is already in the list of "forbidden PLMNs". In addition, the UE shall add to the stored list the PLMN code of the registered PLMN that sent the list. The UE shall replace the stored list on each receipt of the REGISTRATION ACCEPT message. If the REGISTRATION ACCEPT message does not contain a list, then the UE shall delete the stored list.

If the initial registration procedure is not for emergency services, and if the PLMN identity of the registered PLMN is a member of the list of "forbidden PLMNs", any such PLMN identity shall be deleted from the corresponding list(s).

If the Service area list IE is not included in the REGISTRATION ACCEPT message, any tracking area in the registered PLMN and its equivalent PLMN(s) in the registration area is considered as an allowed tracking area as described in subclause 5.3.5.

If the REGISTRATION REQUEST message contains the LADN indication IE, based on the LADN indication IE, UE subscription information, UE location and local configuration about LADN and:

- if the LADN indication IE includes requested LADN DNNs, the UE subscribed DNN list includes the requested LADN DNNs or the wildcard DNN, and the LADN service area of the requested LADN DNN has an intersection with the current registration area, the AMF shall determine the requested LADN DNNs included in the LADN indication IE as LADN DNNs for the UE;
- if no requested LADN DNNs included in the LADN indication IE and the wildcard DNN is included in the UE subscribed DNN list, the AMF shall determine the LADN DNN(s) configured in the AMF whose LADN service area has an intersection with the current registration area as LADN DNNs for the UE; or
- if no requested LADN DNNs included in the LADN indication IE and the wildcard DNN is not included in the UE subscribed DNN list, the AMF shall determine the LADN DNN(s) included in the UE subscribed DNN list whose LADN service area has an intersection with the current registration area as LADN DNNs for the UE.

If the LADN indication IE is not included in the REGISTRATION REQUEST message, the AMF shall determine the LADN DNN(s) included in the UE subscribed DNN list whose service area has an intersection with the current registration area as LADN DNNs for the UE, except for the wildcard DNN included in the UE subscribed DNN list.

The AMF shall include the LADN information which consists of the determined LADN DNNs for the UE and LADN service area(s) available in the current registration area in the LADN information IE of the REGISTRATION ACCEPT message.

The UE, upon receiving the REGISTRATION ACCEPT message with the LADN information, shall store the received LADN information. If there exists one or more LADN DNNs which are included in the LADN indication IE of the REGISTRATION REQUEST message and are not included in the LADN information IE of the REGISTRATION ACCEPT message, the UE considers such LADN DNNs as not available in the current registration area.

The 5G-GUTI reallocation shall be part of the initial registration procedure. During the initial registration procedure, if the AMF has not allocated a new 5G-GUTI by the generic UE configuration update procedure, the AMF shall include in the REGISTRATION ACCEPT message the new assigned 5G-GUTI together with the assigned TAI list.

If a 5G-GUTI or the SOR transparent container IE is included in the REGISTRATION ACCEPT message, the AMF shall start timer T3550 and enter state 5GMM-COMMON-PROCEDURE-INITIATED as described in subclause 5.1.3.2.3.3.

If the Operator-defined access category definitions IE or the Extended emergency number list IE is included in the REGISTRATION ACCEPT message, the AMF shall start timer T3550 and enter state 5GMM-COMMON-PROCEDURE-INITIATED as described in subclause 5.1.3.2.3.3.

The AMF shall include the MICO indication IE in the REGISTRATION ACCEPT message only if the MICO indication IE was included in the REGISTRATION REQUEST message, the AMF supports and accepts the use of MICO mode. If the AMF supports and accepts the use of MICO mode, the AMF may indicate "all PLMN registration area allocated" in the MICO indication IE in the REGISTRATION ACCEPT message. If "all PLMN registration area allocated" is indicated in the MICO indication IE, the AMF shall not assign and include the TAI list in the REGISTRATION ACCEPT message. If the REGISTRATION ACCEPT message included an MICO indication IE

indicating "all PLMN registration area allocated", the UE shall treat all TAIs in the current PLMN as a registration area and delete its old TAI list.

The AMF shall include the T3512 value IE in the REGISTRATION ACCEPT message only if the REGISTRATION REQUEST message was sent over the 3GPP access.

The AMF shall include the non-3GPP de-registration timer value IE in the REGISTRATION ACCEPT message only if the REGISTRATION REQUEST message was sent for the non-3GPP access.

Upon receipt of the REGISTRATION ACCEPT message, the UE shall reset the registration attempt counter, enter state 5GMM-REGISTERED and set the 5GS update status to 5U1 UPDATED.

If the REGISTRATION ACCEPT message included a T3512 value IE, the UE shall use the value in the T3512 value IE as periodic registration update timer (T3512).

If the REGISTRATION ACCEPT message included a non-3GPP de-registration timer value IE, the UE shall use the value in non-3GPP de-registration timer value IE as non-3GPP de-registration timer.

If the REGISTRATION ACCEPT message contained a 5G-GUTI, the UE shall return a REGISTRATION COMPLETE message to the AMF to acknowledge the received 5G-GUTI, stop timer T3519 if running, and delete any stored SUCI. The UE shall provide the 5G-GUTI to the lower layer of 3GPP access if the REGISTRATION ACCEPT message is sent over the non-3GPP access, and the UE is in 5GMM-REGISTERED in both 3GPP access and non-3GPP access in the same PLMN.

If the REGISTRATION ACCEPT message contains the Network slicing indication IE with the Network slicing subscription change indication set to "Network slicing subscription changed", or contains a configured NSSAI IE with a new configured NSSAI for the current PLMN and optionally the mapped S-NSSAI(s) for the configured NSSAI for the current PLMN, the UE shall return a REGISTRATION COMPLETE message to the AMF to acknowledge the successful update of the network slicing information.

If the REGISTRATION ACCEPT message contains the Operator-defined access category definitions IE or the Extended emergency number list IE or both, the UE shall return a REGISTRATION COMPLETE message to the AMF to acknowledge reception of the operator-defined access category definitions or the extended local emergency numbers list or both.

Upon receiving a REGISTRATION COMPLETE message, the AMF shall stop timer T3550 and change to state 5GMM-REGISTERED. The 5G-GUTI, if sent in the REGISTRATION ACCEPT message, shall be considered as valid.

If the 5GS update type IE was included in the REGISTRATION REQUEST message with the SMS requested bit set to "SMS over NAS supported", and SMSF selection is successful, then the AMF shall send the REGISTRATION ACCEPT message after the SMSF has confirmed that the activation of the SMS service was successful. When sending the REGISTRATION ACCEPT message, the AMF shall:

- a) set the SMS allowed bit of the 5GS registration result IE to "SMS over NAS allowed" in the REGISTRATION ACCEPT message, if the UE has set the SMS requested bit of the 5GS registration type IE to "SMS over NAS supported" in the REGISTRATION REQUEST message and the network allows the use of SMS over NAS for the UE; and
- b) store the SMSF address and the value of the SMS allowed bit of the 5GS registration result IE in the UE 5GMM context, and consider the UE available for SMS over NAS.

If:

- a) the SMSF selection in the AMF is not successful;
- b) the SMS activation via the SMSF is not successful;
- c) the AMF does not allow the use of SMS over NAS;
- d) the SMS requested bit of the 5GS update type IE was set to "SMS over NAS not supported" in the REGISTRATION REQUEST message; or
- e) the 5GS update type IE was not included in the REGISTRATION REQUEST message;

then the AMF shall set the SMS allowed bit of the 5GS registration result IE to "SMS over NAS not allowed" in the REGISTRATION ACCEPT message.



When the UE receives the REGISTRATION ACCEPT message, if the UE is also registered over another access to the same PLMN, the UE considers the value indicated by the SMS allowed bit of the 5GS registration result IE as applicable for both accesses over which the UE is registered.

The AMF shall include the 5GS registration result IE in the REGISTRATION ACCEPT message. If the 5GS registration result IE value indicates:

- a) "3GPP access", the UE:
  - shall consider itself as being registered to 3GPP access only; and
  - if in 5GMM-REGISTERED state over non-3GPP access and on the same PLMN as 3GPP access, shall enter state 5GMM-DEREGISTERED.ATTEMPTING-REGISTRATION over non-3GPP access and set the 5GS update status to 5U2 NOT UPDATED over non-3GPP access;
- b) "Non-3GPP access", the UE:
  - shall consider itself as being registered to non-3GPP access only; and
  - if in the 5GMM-REGISTERED state over 3GPP access and is on the same PLMN as non-3GPP access, shall enter the state 5GMM-DEREGISTERED.ATTEMPTING-REGISTRATION over 3GPP access and set the 5GS update status to 5U2 NOT UPDATED over 3GPP access; or
- c) "3GPP access and Non-3GPP access", the UE shall consider itself as being registered to both 3GPP access and non-3GPP access.

The AMF shall include the allowed NSSAI for the current PLMN and shall include the mapped S-NSSAI(s) for the allowed NSSAI contained in the requested NSSAI from the UE if available, in the REGISTRATION ACCEPT message if the UE included the requested NSSAI in the REGISTRATION REQUEST message and the AMF allows one or more S-NSSAIs in the requested NSSAI. The AMF may also include rejected NSSAI in the REGISTRATION ACCEPT message. Rejected NSSAI contains S-NSSAI(s) which was included in the requested NSSAI but rejected by the network associated with rejection cause(s).

The AMF may include a new configured NSSAI for the current PLMN in the REGISTRATION ACCEPT message if:

- a) the REGISTRATION REQUEST message did not include the requested NSSAI;
- b) the REGISTRATION REQUEST message included the requested NSSAI containing an S-NSSAI that is not valid in the serving PLMN;
- c) the REGISTRATION REQUEST message included the requested NSSAI containing S-NSSAI(s) with incorrect mapped S-NSSAI(s); or
- d) the REGISTRATION REQUEST message included the Network slicing indication IE with the Default configured NSSAI indication bit set to "Requested NSSAI created from default configured NSSAI".

If a new configured NSSAI for the current PLMN is included in the REGISTRATION ACCEPT message, the AMF shall also include the mapped S-NSSAI(s) for the configured NSSAI for the current PLMN if available in the REGISTRATION ACCEPT message. In this case the AMF shall start timer T3550 and enter state 5GMM-COMMON-PROCEDURE-INITIATED as described in subclause 5.1.3.2.3.3.

The AMF shall include the Network slicing indication IE with the Network slicing subscription change indication set to "Network slicing subscription changed" in the REGISTRATION ACCEPT message if the UDM has indicated that the subscription data for network slicing has changed. In this case the AMF shall start timer T3550 and enter state 5GMM-COMMON-PROCEDURE-INITIATED as described in subclause 5.1.3.2.3.3.

The UE receiving the rejected NSSAI in the REGISTRATION ACCEPT message takes the following actions based on the rejection cause in the rejected NSSAI:

"S-NSSAI not available in the current PLMN"

The UE shall add the rejected S-NSSAI(s) in the rejected NSSAI for the current PLMN as specified in subclause 4.6.2.2 and not attempt to use this S-NSSAI in the current PLMN until switching off the UE or the UICC containing the USIM is removed.

"S-NSSAI not available in the current registration area"

The UE shall add the rejected S-NSSAI(s) in the rejected NSSAI for the current registration area as specified in subclause 4.6.2.2 and not attempt to use this S-NSSAI in the current registration area until switching off the UE, the UE moving out of the current registration area or the UICC containing the USIM is removed.

If the UE did not include the requested NSSAI in the REGISTRATION REQUEST message or none of the requested NSSAI are present in the subscribed S-NSSAIs, and one or more subscribed S-NSSAIs (containing one or more S-NSSAIs each of which may be associated with a new S-NSSAI) marked as default are available, the AMF shall put the subscribed S-NSSAIs marked as default in the allowed NSSAI of the REGISTRATION ACCEPT message. The AMF shall determine a registration area such that all S-NSSAIs of the allowed NSSAI are available in the registration area.

If the REGISTRATION ACCEPT message contains the Network slicing indication IE with the Network slicing subscription change indication set to "Network slicing subscription changed", the UE shall delete the network slicing information for each and every PLMN except for the current PLMN as specified in subclause 4.6.2.2.

If the REGISTRATION ACCEPT message contains the allowed NSSAI, then the UE shall store the included allowed NSSAI together with the PLMN identity of the registered PLMN and the registration area as specified in subclause 4.6.2.2.

If the REGISTRATION ACCEPT message contains a configured NSSAI IE with a new configured NSSAI for the current PLMN and optionally the mapped S-NSSAI(s) for the configured NSSAI for the current PLMN, the UE shall store the contents of the configured NSSAI IE as specified in subclause 4.6.2.2.

If the UE included S1 mode supported indication in the REGISTRATION REQUEST message, the AMF supporting interworking with EPS shall set the IWK N26 bit to either:

- a) "interworking without N26 interface not supported" if the AMF supports N26 interface ; or
- b) "interworking without N26 interface supported" if the AMF does not support N26 interface

in the 5GS network feature support IE in the REGISTRATION ACCEPT message.

The UE supporting S1 mode shall operate in the mode for interworking with EPS as follows:

- a) if the IWK N26 bit in the 5GS network feature support IE is set to "interworking without N26 interface not supported", the UE shall operate in single-registration mode;
- b) if the IWK N26 bit in the 5GS network feature support IE is set to "interworking without N26 interface supported" and the UE supports dual-registration mode, the UE may operate in dual-registration mode; or

NOTE 3: The registration mode used by the UE is implementation dependent.

- c) if the IWK N26 bit in the 5GS network feature support IE is set to "interworking without N26 interface supported" and the UE only supports single-registration mode, the UE shall operate in single-registration mode.

The UE shall treat the received interworking without N26 interface indicator for interworking with EPS as valid in the entire PLMN and its equivalent PLMN(s).

The network informs the UE about the support of specific features, such as IMS voice over PS session, emergency services or emergency services fallback, in the 5GS network feature support information element. In a UE with IMS voice over PS session capability, the IMS voice over PS session indicator, the Emergency services support indicator, and the Emergency services fallback indicator shall be provided to the upper layers. The upper layers take the IMS voice over PS session indicator into account when selecting the access domain for voice sessions or calls. When initiating an emergency call, the upper layers also take the IMS voice over PS session indicator, the Emergency services support indicator, and the Emergency services fallback indicator into account for the access domain selection.

The AMF shall set the EMF bit in the 5GS network feature support IE to:

- a) "Emergency services fallback supported in NR connected to 5GCN and E-UTRA connected to 5GCN" if the network supports the emergency services fallback procedure when the UE is in an NR cell connected to 5GCN or an E-UTRA cell connected to 5GCN;
- b) "Emergency services fallback supported in NR connected to 5GCN only" if the network supports the emergency services fallback procedure when the UE is in an NR cell connected to 5GCN and does not support the emergency services fallback procedure when the UE is in an E-UTRA cell connected to 5GCN;

- c) "Emergency services fallback supported in E-UTRA connected to 5GCN only" if the network supports the emergency services fallback procedure when the UE is in an E-UTRA cell connected to 5GCN and does not support the emergency services fallback procedure when the UE is in an NR cell connected to 5GCN; or
- d) "Emergency services fallback not supported" if network does not support the emergency services fallback procedure when the UE is in any cell connected to 5GCN.

NOTE 4: If the emergency services are supported in neither the EPS nor the 5GS homogeneously, based on operator policy, the AMF will set the EMF bit in the 5GS network feature support IE to "Emergency services fallback not supported".

NOTE 5: Even though the AMF's support of emergency services fallback is indicated per RAT, the UE's support of emergency services fallback is not per RAT, i.e. the UE's support of emergency services fallback is the same for both NR connected to 5GCN and E-UTRA connected to 5GCN.

The network informs the UE that the use of access identity 1 is valid in the RPLMN or equivalent PLMN by setting the MPS indicator bit of the 5GS network feature support IE to "Access identity 1 valid in RPLMN or equivalent PLMN", in the REGISTRATION ACCEPT message. Based on operator policy, the AMF sets the MPS indicator bit in the REGISTRATION ACCEPT message based on the MPS priority information in the user's subscription context obtained from the UDM.

Upon receiving a REGISTRATION ACCEPT message with the MPS indicator bit set to "Access identity 1 valid in RPLMN or equivalent PLMN", the UE shall act as a UE with access identity 1 configured for MPS as described in subclause 4.5.2, in all NG-RAN of the registered PLMN and its equivalent PLMNs. The MPS indicator bit in the 5GS network feature support IE provided in the REGISTRATION ACCEPT message is valid until the UE receives a REGISTRATION ACCEPT message with the MPS indicator bit set to "Access identity 1 not valid in RPLMN or equivalent PLMN" or until the UE selects a non-equivalent PLMN. Access identity 1 is only applicable while the UE is in N1 mode.

The network informs the UE that the use of access identity 2 is valid in the RPLMN or equivalent PLMN by setting the MCS indicator bit of the 5GS network feature support IE to "Access identity 2 valid in RPLMN or equivalent PLMN", in the REGISTRATION ACCEPT message. Based on operator policy, the AMF sets the MCS indicator bit in the REGISTRATION ACCEPT message based on the MCS priority information in the user's subscription context obtained from the UDM.

Upon receiving a REGISTRATION ACCEPT message with the MCS indicator bit set to "Access identity 2 valid in RPLMN or equivalent PLMN", the UE shall act as a UE with access identity 2 configured for MCS as described in subclause 4.5.2, in all NG-RAN of the registered PLMN and its equivalent PLMNs. The MCS indicator bit in the 5GS network feature support IE provided in the REGISTRATION ACCEPT message is valid until the UE receives a REGISTRATION ACCEPT message with the MCS indicator bit set to "Access identity 2 not valid in RPLMN or equivalent PLMN" or until the UE selects a non-equivalent PLMN. Access identity 2 is only applicable while the UE is in N1 mode.

If the UE has set the Follow-on request indication to 1 in the REGISTRATION REQUEST message, or the network has downlink signalling pending, the AMF shall not immediately release the NAS signalling connection after the completion of the registration procedure.

If the Requested DRX parameters IE was included in the REGISTRATION REQUEST message, the AMF shall include the Negotiated DRX parameters IE in the REGISTRATION ACCEPT message. The AMF may set the Negotiated DRX parameters IE based on the received Requested DRX parameters IE and operator policy if available.

If:

- a) the UE's USIM is configured with indication that the UE is to receive the SOR transparent container IE, the SOR transparent container IE is not included in the REGISTRATION ACCEPT message or the SOR transparent container IE does not successfully pass the integrity check (see 3GPP TS 33.501 [24]); and
- b) if the UE attempts obtaining service on another PLMNs as specified in 3GPP TS 23.122 [5] annex C;

then the UE shall locally release the established N1 NAS signalling connection after sending a REGISTRATION COMPLETE message.

If the REGISTRATION ACCEPT message includes the SOR transparent container IE and the SOR transparent container IE successfully passes the integrity check (see 3GPP TS 33.501 [24]):

- a) the UE shall proceed with the behaviour as specified in 3GPP TS 23.122 [5] annex C; and
- b) if the registration procedure is performed over 3GPP access and the UE attempts obtaining service on another PLMNs as specified in 3GPP TS 23.122 [5] annex C, then the UE may locally release the established N1 NAS signalling connection after sending a REGISTRATION COMPLETE message. Otherwise the UE shall send a REGISTRATION COMPLETE message and not release the current N1 NAS signalling connection locally. If an acknowledgement is requested in the SOR transparent container IE of the REGISTRATION ACCEPT message, the UE acknowledgement is included in the SOR transparent container IE of the REGISTRATION COMPLETE message.

If the SOR transparent container IE successfully passes the integrity check (see 3GPP TS 33.501 [24]), indicates list of preferred PLMN/access technology combinations is provided and the list type indicates:

- a) "PLMN ID and access technology list", then the ME shall replace the highest priority entries in the "Operator Controlled PLMN Selector with Access Technology" list stored in the ME and shall proceed with the behaviour as specified in 3GPP TS 23.122 [5] annex C; or
- b) "secured packet", then the ME shall behave as if a SMS is received with protocol identifier set to SIM data download, data coding scheme set to class 2 message and SMS payload as secured packet contents of SOR transparent container IE. The SMS payload is forwarded to UICC as specified in 3GPP TS 23.040 [4A] and the ME shall proceed with the behaviour as specified in 3GPP TS 23.122 [5] annex C.

If required by operator policy, the AMF shall include the NSSAI inclusion mode IE in the REGISTRATION ACCEPT message (see table 4.6.2.3.1 of subclause 4.6.2.3). Upon receipt of the REGISTRATION ACCEPT message:

- a) if the message includes the NSSAI inclusion mode IE, the UE shall operate in the NSSAI inclusion mode indicated in the NSSAI inclusion mode IE over the current access within the current PLMN and its equivalent PLMN(s), if any, in the current registration area; or
- b) otherwise if:
  - 1) the UE has NSSAI inclusion mode for the current PLMN and access type stored in the UE, the UE shall operate in the stored NSSAI inclusion mode; or
  - 2) the UE does not have NSSAI inclusion mode for the current PLMN and the access type stored in the UE and if the UE is performing the registration procedure over:
    - i) 3GPP access, the UE shall operate in NSSAI inclusion mode D over in the current PLMN and the current access type; or
    - ii) non-3GPP access, the UE shall operate in NSSAI inclusion mode C over non-3GPP access in the current PLMN and the current access type.

The AMF may include operator-defined access category definitions in the REGISTRATION ACCEPT message.

If the UE receives Operator-defined access category definitions IE in the REGISTRATION ACCEPT message and the Operator-defined access category definitions IE contains one or more operator-defined access category definitions, the UE shall delete any operator-defined access category definitions stored for the RPLMN and shall store the received operator-defined access category definitions for the RPLMN. If the UE receives the Operator-defined access category definitions IE in the REGISTRATION ACCEPT message and the Operator-defined access category definitions IE contains no operator-defined access category definitions, the UE shall delete any operator-defined access category definitions stored for the RPLMN. If the REGISTRATION ACCEPT message does not contain the Operator-defined access category definitions IE, the UE shall not delete the operator-defined access category definitions stored for the RPLMN.

#### 5.5.1.2.5 Initial registration not accepted by the network

If the initial registration request cannot be accepted by the network, the AMF shall send a REGISTRATION REJECT message to the UE including an appropriate 5GMM cause value.

If the initial registration request is rejected due to general NAS level mobility management congestion control, the network shall set the 5GMM cause value to #22 "congestion" and assign a back-off timer T3346.

The UE shall take the following actions depending on the 5GMM cause value received in the REGISTRATION REJECT message.

#3 (Illegal UE); or

#6 (Illegal ME).

The UE shall set the 5GS update status to 5U3 ROAMING NOT ALLOWED (and shall store it according to subclause 5.1.3.2.2) and shall delete any 5G-GUTI, last visited registered TAI, TAI list and ngKSI. The UE shall consider the USIM as invalid for 5GS services until switching off or the UICC containing the USIM is removed. The UE shall delete the list of equivalent PLMNs and enter the state 5GMM-DEREGISTERED.

If the UE is operating in single-registration mode, the UE shall handle the EMM parameters EMM state, EPS update status, 4G-GUTI, TAI list and eKSI as specified in 3GPP TS 24.301 [15] for the case when the EPS attach request procedure is rejected with the EMM cause with the same value. The USIM shall be considered as invalid also for non-EPS services until switching off or the UICC containing the USIM is removed.

If the UE also supports the registration procedure over the other access, the UE shall in addition handle 5GMM parameters and 5GMM state for this access, as described for this 5GMM cause value.

#7 (5GS services not allowed).

The UE shall set the 5GS update status to 5U3 ROAMING NOT ALLOWED (and shall store it according to subclause 5.1.3.2.2) and shall delete any 5G-GUTI, last visited registered TAI, TAI list and ngKSI. The UE shall consider the USIM as invalid for 5GS services until switching off or the UICC containing the USIM is removed. The UE shall enter the state 5GMM-DEREGISTERED.

If the UE is operating in single-registration mode, the UE shall handle the EMM parameters EMM state, EPS update status, 4G-GUTI, TAI list and eKSI as specified in 3GPP TS 24.301 [15] for the case when the EPS attach request procedure is rejected with the EMM cause with the same value.

If the UE also supports the registration procedure over the other access, the UE shall in addition handle 5GMM parameters and 5GMM state for this access, as described for this 5GMM cause value.

#11 (PLMN not allowed).

The UE shall set the 5GS update status to 5U3 ROAMING NOT ALLOWED (and shall store it according to subclause 5.1.3.2.2) and shall delete any 5G-GUTI, last visited registered TAI, TAI list and ngKSI. The UE shall delete the list of equivalent PLMNs and reset the registration attempt counter and store the PLMN identity in the "forbidden PLMN list". The UE shall enter state 5GMM-DEREGISTERED.PLMN-SEARCH and perform a PLMN selection according to 3GPP TS 23.122 [5].

If the UE is operating in single-registration mode, the UE shall in addition handle the EMM parameters EMM state, EPS update status, 4G-GUTI, TAI list, eKSI and attach attempt counter as specified in 3GPP TS 24.301 [15] for the case when the EPS attach request procedure is rejected with the EMM cause with the same value.

If the REGISTRATION REJECT message is integrity protected and the UE also supports the registration procedure over the other access to the same PLMN, the UE shall in addition handle 5GMM parameters and 5GMM state for this access, as described for this 5GMM cause value.

#12 (Tracking area not allowed).

The UE shall set the 5GS update status to 5U3 ROAMING NOT ALLOWED (and shall store it according to subclause 5.1.3.2.2) and shall delete 5G-GUTI, last visited registered TAI, TAI list and ngKSI. Additionally, the UE shall reset the registration attempt counter.

The UE shall store the current TAI in the list of "5GS forbidden tracking areas for regional provision of service" and enter the state 5GMM-DEREGISTERED.LIMITED-SERVICE.

If the UE is operating in single-registration mode, the UE shall handle the EMM parameters EMM state, EPS update status, 4G-GUTI, TAI list, eKSI and attach attempt counter as specified in 3GPP TS 24.301 [15] for the case when the EPS attach request procedure is rejected with the EMM cause with the same value.

#13 (Roaming not allowed in this tracking area).

The UE shall set the 5GS update status to 5U3 ROAMING NOT ALLOWED (and shall store it according to subclause 5.1.3.2.2) and shall delete 5G-GUTI, last visited registered TAI, TAI list and ngKSI. Additionally, the UE shall delete the list of equivalent PLMNs and reset the registration attempt counter.

The UE shall store the current TAI in the list of "5GS forbidden tracking areas for roaming" and enter the state 5GMM-DEREGISTERED.LIMITED-SERVICE or optionally 5GMM-DEREGISTERED.PLMN-SEARCH. The UE shall perform a PLMN selection according to 3GPP TS 23.122 [5].

If the UE is operating in single-registration mode, the UE shall handle the EMM parameters EMM state, EPS update status, 4G-GUTI, TAI list, eKSI and attach attempt counter as specified in 3GPP TS 24.301 [15] for the case when the EPS attach request procedure is rejected with the EMM cause with the same value.

#15 (No suitable cells in tracking area);

The UE shall set the 5GS update status to 5U3 ROAMING NOT ALLOWED (and shall store it according to subclause 5.1.3.2.2) and shall delete any 5G-GUTI, last visited registered TAI, TAI list and ngKSI. Additionally, the UE shall reset the registration attempt counter.

The UE shall store the current TAI in the list of "5GS forbidden tracking areas for roaming" and enter the state 5GMM-DEREGISTERED.LIMITED-SERVICE. The UE shall search for a suitable cell in another tracking area according to 3GPP TS 38.304 [28].

If the UE is operating in single-registration mode, the UE shall handle the EMM parameters EMM state, EPS update status, 4G-GUTI, TAI list, eKSI and attach attempt counter as specified in 3GPP TS 24.301 [15] for the case when the EPS attach request procedure is rejected with the EMM cause with the same value.

#22 (Congestion).

If the T3346 value IE is present in the REGISTRATION REJECT message and the value indicates that this timer is neither zero nor deactivated, the UE shall proceed as described below; otherwise it shall be considered as an abnormal case and the behaviour of the UE for this case is specified in subclause 5.5.1.2.7.

The UE shall abort the initial registration procedure, set the 5GS update status to 5U2 NOT UPDATED and enter state 5GMM-DEREGISTERED.ATTEMPTING-REGISTRATION.

The UE shall stop timer T3346 if it is running.

If the REGISTRATION REJECT message is integrity protected, the UE shall start timer T3346 with the value provided in the T3346 value IE.

If the REGISTRATION REJECT message is not integrity protected, the UE shall start timer T3346 with a random value from the default range specified in 3GPP TS 24.008 [12].

The UE stays in the current serving cell and applies the normal cell reselection process. The initial registration procedure is started if still needed when timer T3346 expires or is stopped.

If the UE is operating in single-registration mode, the UE shall handle the EMM parameters EMM state, EPS update status, and attach attempt counter as specified in 3GPP TS 24.301 [15] for the case when the EPS attach request procedure is rejected with the EMM cause with the same value.

#27 (N1 mode not allowed).

The UE shall set the 5GS update status to 5U3 ROAMING NOT ALLOWED (and shall store it according to subclause 5.1.3.2.2) and shall delete any 5G-GUTI, last visited registered TAI, TAI list and ngKSI. Additionally, the UE shall reset the registration attempt counter and shall enter the state 5GMM-NULL.

The UE shall disable the N1 mode capability for both 3GPP access and non-3GPP access (see subclause 4.9).

#72 (Non-3GPP access to 5GCN not allowed).

When received over non-3GPP access the UE shall set the 5GS update status to 5U3 ROAMING NOT ALLOWED (and shall store it according to subclause 5.1.3.2.2) and shall delete 5G-GUTI, last visited registered TAI, TAI list and ngKSI. Additionally, the UE shall reset the registration attempt counter and enter the state 5GMM-DEREGISTERED.

NOTE: The 5GMM sublayer states, the 5GMM parameters and the registration status are managed per access type independently, i.e. 3GPP access or non-3GPP access (see subclauses 4.7.2 and 5.1.3).

The UE shall disable the N1 mode capability for non-3GPP access (see subclause 4.9.3).

As an implementation option, the UE may enter the state 5GMM-DEREGISTERED.PLMN-SEARCH in order to perform a PLMN selection according to 3GPP TS 23.122 [5].

If received over 3GPP access the cause shall be considered as an abnormal case and the behaviour of the UE for this case is specified in subclause 5.5.1.2.7.

#73 (Serving network not authorized).

The UE shall set the 5GS update status to 5U2 NOT UPDATED, reset the registration attempt counter, store the PLMN identity in the "forbidden PLMN list" and enter state 5GMM-DEREGISTERED.PLMN-SEARCH in order to perform a PLMN selection according to 3GPP TS 23.122 [5].

Other values are considered as abnormal cases. The behaviour of the UE in those cases is specified in subclause 5.5.1.2.7.

#### 5.5.1.2.6 Initial registration for emergency services not accepted by the network

Upon receiving the REGISTRATION REJECT message including 5GMM cause #5 "PEI not accepted", the UE shall enter the state 5GMM-DEREGISTERED.NO-SUPI.

Upon receiving the REGISTRATION REJECT message including 5GMM cause value which is not #5 "PEI not accepted", the UE shall perform the actions as described in subclause 5.5.1.2.5 with the following addition: the UE shall inform the upper layers of the failure of the procedure.

NOTE 1: This can result in the upper layers requesting implementation specific mechanisms, e.g. procedures specified in 3GPP TS 24.229 [14] can result in the emergency call being attempted to another IP-CAN.

If the initial registration request for emergency services fails due to abnormal cases, the UE shall perform the actions as described in subclause 5.5.1.2.7 and inform the upper layers of the failure to access the network or the failure of the procedure.

NOTE 2: This can result in the upper layers requesting other implementation specific mechanisms, e.g. procedures specified in 3GPP TS 24.229 [14] can result in the emergency call being attempted to another IP-CAN.

In a shared network, upon receiving the REGISTRATION REJECT message, the UE shall perform the actions as described in subclause 5.5.1.2.5, and shall:

a) inform the upper layers of the failure of the procedure; or

NOTE 3: The upper layers may request implementation specific mechanisms, e.g. procedures specified in 3GPP TS 24.229 [14] that can result in the emergency call being attempted to another IP-CAN.

b) attempt to perform a PLMN selection in the shared network and initiate an initial registration for emergency services to the selected PLMN.

In a shared network, if the initial registration request for emergency services fails due to abnormal cases, the UE shall perform the actions as described in subclause 5.5.1.2.7 and shall:

a) inform the upper layers of the failure of the procedure; or

NOTE 4: The upper layers may request implementation specific mechanisms, e.g. procedures specified in 3GPP TS 24.229 [14] that can result in the emergency call being attempted to another IP-CAN.

b) attempt the initial registration for emergency services to another PLMN in the shared network.

#### 5.5.1.2.6A Initial registration for initiating a PDU session for emergency services not accepted by the network

If the network cannot accept initial registration request for initiating a PDU session for emergency services with 5GS registration type IE set to "initial registration", the UE shall perform the procedures as described in subclause 5.5.1.2.5. Then if the UE is in the same selected PLMN where the last initial registration request was attempted, the UE shall:

a) inform the upper layers of the failure of the procedure; or

NOTE 1: This can result in the upper layers requesting implementation specific mechanisms, e.g. procedures specified in 3GPP TS 24.229 [14] can result in the emergency call being attempted to another IP-CAN.

- b) attempt initial registration for emergency services.

If the initial registration request for initiating a PDU session for emergency services with 5GS registration type IE set to "initial registration" fails due to abnormal case b) in subclause 5.5.1.2.7, the UE shall perform the actions as described in subclause 5.5.1.2.7 and inform the upper layers of the failure to access the network.

NOTE 2: This can result in the upper layers requesting implementation specific mechanisms, e.g. procedures specified in 3GPP TS 24.229 [14] can result in the emergency call being attempted to another IP-CAN.

If the initial registration request for initiating a PDU session for emergency services with 5GS registration type IE set to "initial registration" fails due to abnormal cases c), d) or e) in subclause 5.5.1.2.7, the UE shall perform the actions as described in subclause 5.5.1.2.7. Then if the UE is in the same selected PLMN where the last initial registration request was attempted, the UE shall:

- a) inform the upper layers of the failure of the procedure; or

NOTE 3: This can result in the upper layers requesting implementation specific mechanisms, e.g. procedures specified in 3GPP TS 24.229 [14] can result in the emergency call being attempted to another IP-CAN.

- b) attempt initial registration for emergency services.

#### 5.5.1.2.7 Abnormal cases in the UE

The following abnormal cases can be identified:

- a) Timer T3346 is running.

The UE shall not start the registration procedure for initial registration unless:

- 1) the UE is a UE configured for high priority access in selected PLMN;
- 2) the UE needs to perform the registration procedure for initial registration for emergency services; or
- 3) the UE receives a DEREGISTRATION REQUEST message with the "re-registration required" indication.

The UE stays in the current serving cell and applies the normal cell reselection process.

NOTE 1: It is considered an abnormal case if the UE needs to initiate a registration procedure for initial registration while timer T3346 is running independent on whether timer T3346 was started due to an abnormal case or a non-successful case.

- b) The lower layers indicate that the access attempt is barred.

The UE shall not start the initial registration procedure. The UE stays in the current serving cell and applies the normal cell reselection process.

The initial registration procedure is started, if still needed, when the lower layers indicate that the barring is alleviated for the access category with which the access attempt was associated.

- ba) The lower layers indicate that access barring is applicable for all access categories except categories 0 and 2 and the access category with which the access attempt was associated is other than 0 and 2.

If the REGISTRATION REQUEST message has not been sent, the UE shall proceed as specified for case b. If the REGISTRATION REQUEST message has been sent, the UE shall proceed as specified for case e and, additionally, the registration procedure for initial registration is started, if still needed, when the lower layers indicate that the barring is alleviated for the access category with which the access attempt was associated.

- c) T3510 timeout.

The UE shall abort the registration procedure for initial registration and the NAS signalling connection, if any, shall be released locally if the initial registration request is not for emergency services. The UE shall proceed as described below.



- d) REGISTRATION REJECT message, other 5GMM cause values than those treated in subclause 5.5.1.2.5, and cases of 5GMM cause value #22 and #72, if considered as abnormal cases according to subclause 5.5.1.2.5.

If the registration request is not an initial registration request for emergency services, upon reception of the 5GMM causes #95, #96, #97, #99 and #111 the UE should set the registration attempt counter to 5.

The UE shall proceed as described below.

- e) Lower layer failure or release of the NAS signalling connection received from lower layers before the REGISTRATION ACCEPT or REGISTRATION REJECT message is received.

The UE shall abort the registration procedure for initial registration and proceed as described below.

- f) UE initiated de-registration required.

The registration procedure for initial registration shall be aborted, and the UE initiated de-registration procedure shall be performed.

- g) De-registration procedure collision.

If the UE receives a DEREGISTRATION REQUEST message from the network in state 5GMM-REGISTERED-INITIATED and the de-registration type indicates "re-registration not required", the de-registration procedure shall be progressed and the registration procedure shall be aborted. If the UE receives a DEREGISTRATION REQUEST message from the network in state 5GMM-REGISTERED-INITIATED and the de-registration type indicates "re-registration required", the de-registration procedure shall be progressed and the UE shall locally release the NAS signalling connection, before re-initiating the registration procedure.

- h) Change of cell into a new tracking area.

If a cell change into a new tracking area occurs before the registration procedure for initial registration is completed, the registration procedure for initial registration shall be aborted and re-initiated immediately. If a tracking area border is crossed when the REGISTRATION ACCEPT message has been received but before a REGISTRATION COMPLETE message is sent, the registration procedure for initial registration shall be re-initiated. If a 5G-GUTI was allocated during the registration procedure, this 5G-GUTI shall be used in the registration procedure.

- i) Transmission failure of REGISTRATION COMPLETE message indication with TAI change from lower layers.

If the current TAI is not in the TAI list, the registration procedure for initial registration shall be aborted and re-initiated immediately.

If the current TAI is still part of the TAI list, it is up to the UE implementation how to re-run the ongoing procedure.

- j) Transmission failure of REGISTRATION COMPLETE message indication without TAI change from lower layers.

It is up to the UE implementation how to re-run the ongoing procedure.

For the cases c, d and e, the UE shall proceed as follows:

Timer T3510 shall be stopped if still running.

If the registration procedure is neither an initial registration for emergency services nor for establishing an emergency PDU session with registration type not set to "emergency registration", the registration attempt counter shall be incremented, unless it was already set to 5.

If the registration attempt counter is less than 5:

- if the initial registration request is not for emergency services, timer T3511 is started and the state is changed to 5GMM-DEREGISTERED.ATTEMPTING-REGISTRATION. When timer T3511 expires the registration procedure for initial registration shall be restarted, if still required.

If the registration attempt counter is equal to 5

- the UE shall delete 5G-GUTI, TAI list, last visited TAI, list of equivalent PLMNs and ngKSI, start timer T3502 and shall set the 5GS update status to 5U2 NOT UPDATED. The state is changed to 5GMM-DEREGISTERED.ATTEMPTING-REGISTRATION or optionally to 5GMM-DEREGISTERED.PLMN-SEARCH in order to perform a PLMN selection according to 3GPP TS 23.122 [5].
- if the UE is operating in single registration mode:
  - the UE shall in addition handle the EPS update status, EMM parameters, EMM state as specified in 3GPP TS 24.301 [15] for the abnormal cases when an EPS attach procedure fails and the tracking area attempt counter is equal to 5; and
  - the UE shall attempt to select E-UTRAN radio access technology and proceed with appropriate EMM specific procedures. Additionally, The UE may disable N1 mode capability as specified in subclause 4.9.

#### 5.5.1.2.8 Abnormal cases on the network side

The following abnormal cases can be identified:

a) Lower layer failure

If a lower layer failure occurs before the REGISTRATION COMPLETE message has been received from the UE, the AMF shall locally abort the registration procedure for initial registration, enter 5GMM-IDLE mode and shall not resend the REGISTRATION ACCEPT message. If a new 5G-GUTI was assigned to the UE in the registration procedure for initial registration, the AMF shall consider both the old and the new 5G-GUTI as valid until the old 5G-GUTI can be considered as invalid by the AMF or the 5GMM context which has been marked as deregistered in the AMF is released. During this period the network may use the identification procedure followed by a generic UE configuration update procedure if the old 5G-GUTI is used by the UE in a subsequent message.

b) Protocol error

If the REGISTRATION REQUEST message is received with a protocol error, the AMF shall return a REGISTRATION REJECT message with one of the following 5GMM cause values:

- #96 invalid mandatory information;
- #99 information element non-existent or not implemented;
- #100 conditional IE error; or
- #111 protocol error, unspecified.

c) T3550 time-out

On the first expiry of the timer, the AMF shall retransmit the REGISTRATION ACCEPT message and shall reset and restart timer T3550.

This retransmission is repeated four times, i.e. on the fifth expiry of timer T3550, the registration procedure for initial registration shall be aborted and the AMF enters state 5GMM-REGISTERED. If a new 5G-GUTI was allocated in the REGISTRATION ACCEPT message, the AMF shall consider both the old and the new 5G-GUTIs as valid until the old 5G-GUTI can be considered as invalid by the AMF or the 5GMM context which has been marked as de-registered in the AMF is released. During this period, if the old 5G-GUTI is used by the UE in a subsequent message, the AMF acts as specified for case a) above.

d) REGISTRATION REQUEST message received after the REGISTRATION ACCEPT message has been sent and before the REGISTRATION COMPLETE message is received.

- 1) If one or more of the information elements in the REGISTRATION REQUEST message differ from the ones received within the previous REGISTRATION REQUEST message, the previously initiated the registration procedure for initial registration shall be aborted if the REGISTRATION COMPLETE message has not been received and the new registration procedure for initial registration shall be progressed; or
- 2) if the information elements do not differ, then the REGISTRATION ACCEPT message shall be resent and the timer T3550 shall be restarted if a REGISTRATION COMPLETE message is expected. In that case, the retransmission counter related to T3550 is not incremented.

- e) More than one REGISTRATION REQUEST message with 5GS registration type IE set to "initial registration" received and no REGISTRATION ACCEPT or REGISTRATION REJECT message has been sent.
  - 1) If one or more of the information elements in the REGISTRATION REQUEST message with 5GS registration type IE set to "initial registration" differs from the ones received within the previous REGISTRATION REQUEST message with 5GS registration type IE set to "initial registration", the previously initiated the registration procedure for initial registration shall be aborted and the new the registration procedure for initial registration shall be executed;
  - 2) if the information elements do not differ, then the network shall continue with the previous the registration procedure for initial registration and shall ignore the second REGISTRATION REQUEST message.
- f) REGISTRATION REQUEST message with 5GS registration type IE set to "initial registration" received in state 5GMM-REGISTERED.

If a REGISTRATION REQUEST message with 5GS registration type IE set to "initial registration" is received in state 5GMM-REGISTERED the network may initiate the 5GMM common procedures; if it turned out that the REGISTRATION REQUEST message was sent by a UE that has already been registered, the 5GMM context, if any, are deleted and the new REGISTRATION REQUEST is progressed.

- g) REGISTRATION REQUEST message with 5GS registration type IE set to "mobility registration updating" or "periodic registration updating" received before REGISTRATION COMPLETE message.

Timer T3550 shall be stopped. The allocated 5G-GUTI in the registration procedure for initial registration shall be considered as valid and the registration procedure for mobility and periodic update shall be rejected with the 5GMM cause #10 "implicitly de-registered" as described in subclause 5.5.1.3.5.

- h) DEREGISTRATION REQUEST message received before REGISTRATION COMPLETE message.

The AMF shall abort the registration procedure for initial registration and shall progress the de-registration procedure as described in subclause 5.5.2.2.

- i) UE security capabilities invalid or unacceptable

If the REGISTRATION REQUEST message is received with invalid or unacceptable UE security capabilities (e.g. no 5GS encryption algorithms (all bits zero), no 5GS integrity algorithms (all bits zero), mandatory 5GS encryption algorithms not supported or mandatory 5GS integrity algorithms not supported, etc.), the AMF shall return a REGISTRATION REJECT message.

NOTE: 5GMM cause value to be used in REGISTRATION REJECT message is up to the network implementation.

### 5.5.1.3 Registration procedure for mobility and periodic registration update

#### 5.5.1.3.1 General

This procedure is used by a UE for both mobility and periodic registration update of 5GS services. This procedure, when used for periodic registration update of 5GS services, is performed only in 3GPP access.

This procedure used for periodic registration update of 5GS services is controlled in the UE by timer T3512. When timer T3512 expires, the registration procedure for mobility and periodic registration area updating is started. Start and reset of timer T3512 is described in subclause 10.2.

#### 5.5.1.3.2 Mobility and periodic registration update initiation

The UE in state 5GMM-REGISTERED shall initiate the registration procedure for mobility and periodic registration update by sending a REGISTRATION REQUEST message to the AMF,

- a) when the UE detects entering a tracking area that is not in the list of tracking areas that the UE previously registered in the AMF;
- b) when the periodic registration updating timer T3512 expires;

- c) when the UE receives a CONFIGURATION UPDATE COMMAND message indicating "registration requested" in the Configuration update indication IE as specified in subclauses 5.4.4.3;
- d) when the UE in state 5GMM-REGISTERED.ATTEMPTING-REGISTRATION-UPDATE either receives a paging or the UE receives a NOTIFICATION message with access type indicating 3GPP access over the non-3GPP access for PDU sessions associated with 3GPP access;
- e) upon inter-system change from S1 mode to N1 mode;
- f) when the UE receives an indication of "RRC Connection failure" from the lower layers and does not have signalling pending (i.e. when the lower layer requests NAS signalling connection recovery) except for the case specified in subclause 5.3.1.4;
- g) when the UE changes the 5GMM capability or the S1 UE network capability or both;
- h) when the UE's usage setting changes;
- i) when the UE needs to change the slice(s) it is currently registered to;
- j) when the UE changes the UE specific DRX parameters;
- k) when the UE in state 5GMM-REGISTERED.ATTEMPTING-REGISTRATION-UPDATE receives a request from the upper layers to establish an emergency PDU session or perform emergency services fallback;
- l) when the UE needs to register for SMS over NAS, indicate a change in the requirements to use SMS over NAS, or de-register from SMS over NAS;
- m) when the UE needs to indicate PDU session status to the network after performing a local release of PDU session(s) as specified in subclauses 6.4.1.5 and 6.4.3.5;
- n) when the UE in 5GMM-IDLE mode changes the radio capability for NG-RAN;
- o) when the UE receives a fallback indication from the lower layers and does not have signalling pending (i.e. when the lower layer requests NAS signalling connection recovery, see subclauses 5.3.1.4 and 5.3.1.2);
- p) void;
- q) when the UE needs to request new LADN information;
- r) when the UE needs to request the use of MICO mode or needs to stop the use of MICO mode;
- s) when the UE in 5GMM-CONNECTED mode with RRC inactive indication enters a cell in the current registration area belonging to an equivalent PLMN of the registered PLMN and not belonging to the registered PLMN; or
- t) when the UE receives a SERVICE REJECT message with the 5GMM cause value set to #28 "Restricted service area".

If case b) is the only reason for initiating the registration procedure for mobility and periodic registration update, the UE shall indicate "periodic registration updating" in the 5GS registration type IE; otherwise the UE shall indicate "mobility registration updating".

If the UE indicates "mobility registration updating" in the 5GS registration type IE and the UE supports S1 mode, the UE shall:

- set the S1 mode bit to "S1 mode supported" in the 5GMM capability IE of the REGISTRATION REQUEST message;
- include the S1 UE network capability IE in the REGISTRATION REQUEST message; and
- if the UE supports sending an ATTACH REQUEST message containing a PDN CONNECTIVITY REQUEST message with request type set to "handover" to transfer a PDU session from N1 mode to S1 mode, set the HO attach bit to "attach request message containing PDN connectivity request with request type set to handover to transfer PDU session from N1 mode to S1 mode supported" in the 5GMM capability IE of the REGISTRATION REQUEST message.

If the UE supports the LTE positioning protocol (LPP) in N1 mode as specified in 3GPP TS 36.355 [26], the UE shall set the LPP bit to "LPP in N1 mode supported" in the 5GMM capability IE of the REGISTRATION REQUEST message.

If the UE operating in the single-registration mode performs inter-system change from S1 mode to N1 mode and has one or more stored UE policy sections identified by a UPSI with the PLMN ID part indicating the HPLMN or the selected PLMN, the UE shall set the Payload container type IE to "UE policy container" and include the UE STATE INDICATION message (see annex D) in the Payload container IE of the REGISTRATION REQUEST message.

NOTE 1: In this version of the protocol, the UE can only include the Payload container IE in the REGISTRATION REQUEST message to carry a payload of type "UE policy container".

The UE in state 5GMM-REGISTERED shall initiate the registration procedure for mobility and periodic update by sending a REGISTRATION REQUEST message to the AMF when the UE needs to request the use of SMS over NAS transport or the current requirements to use SMS over NAS transport change in the UE. The UE shall set the SMS requested bit of the 5GS update type IE in the REGISTRATION REQUEST message as specified in subclause 5.5.1.2.2.

When initiating a registration procedure for mobility and periodic registration update and the UE needs to send the 5GS update type IE for a reason different than indicating a change in requirement to use SMS over NAS, the UE shall set the SMS requested bit of the 5GS update type IE in the REGISTRATION REQUEST message to the same value as indicated by the UE in the last REGISTRATION REQUEST message.

If the UE no longer requires the use of SMS over NAS, then the UE shall include the 5GS update type IE in the REGISTRATION REQUEST message with the SMS requested bit set to "SMS over NAS not supported".

After sending the REGISTRATION REQUEST message to the AMF the UE shall start timer T3510. If timer T3502 is currently running, the UE shall stop timer T3502. If timer T3511 is currently running, the UE shall stop timer T3511.

If the last visited registered TAI is available, the UE shall include the last visited registered TAI in the REGISTRATION REQUEST message.

The UE shall handle the 5GS mobile identity IE in the REGISTRATION REQUEST message as follows:

- a) if the UE is operating in the single-registration mode, performs inter-system change from S1 mode to N1 mode, and the UE holds a valid 4G-GUTI, the UE shall include the 5G-GUTI mapped from the 4G-GUTI as specified in 3GPP TS 23.003 [4] in the 5GS mobile identity IE. Additionally, if the UE holds a valid 5G-GUTI, the UE shall include the 5G-GUTI in the Additional GUTI IE in the REGISTRATION REQUEST message in the following order:
  - 1) a valid 5G-GUTI that was previously assigned by the same PLMN with which the UE is performing the registration, if available;
  - 2) a valid 5G-GUTI that was previously assigned by an equivalent PLMN, if available; and
  - 3) a valid 5G-GUTI that was previously assigned by any other PLMN, if available; and
- b) for all other cases, if the UE holds a valid 5G-GUTI, the UE shall indicate the 5G-GUTI in the 5GS mobile identity IE.

If the UE supports MICO mode and requests the use of MICO mode, then the UE shall include the MICO indication IE in the REGISTRATION REQUEST message.

If the UE needs to change the UE specific DRX parameters, the UE shall include the Requested DRX parameters IE in the REGISTRATION REQUEST message.

If the UE needs to request LADN information for specific LADN DNN(s) or indicates a request for LADN information as specified in 3GPP TS 23.501 [8], the UE shall include the LADN indication IE in the REGISTRATION REQUEST message and:

- request specific LADN DNNs by including a LADN DNN value in the LADN indication IE for each LADN DNN for which the UE requests LADN information; or
- to indicate a request for LADN information by not including any LADN DNN value in the LADN indication IE.

If the UE is initiating the registration procedure for mobility and periodic registration update, the UE may include the Uplink data status IE to indicate which PDU session(s) associated with the access type the REGISTRATION REQUEST message is sent over have pending user data to be sent. If the UE has one or more active always-on PDU sessions associated with the access type over which the REGISTRATION REQUEST message is sent and the user-plane resources for these PDU sessions are not established, the UE shall include the Uplink data status IE and indicate that the UE has pending user data to be sent for those PDU sessions. If the UE is located outside the LADN service area, the UE shall not include the PDU session for LADN in the Uplink data status IE. If the UE is in a non-allowed area or is not in an allowed area as specified in subclause 5.3.5, the UE shall not include the Uplink data status IE except for emergency services or for high priority access.

If the UE has one or more active PDU sessions which are not accepted by the network as always-on PDU sessions and no uplink user data pending to be sent for those PDU sessions, the UE shall not include those PDU sessions in the Uplink data status IE in the REGISTRATION REQUEST message.

When the registration procedure for mobility and periodic registration update is initiated in 5GMM-IDLE mode, the UE may include a PDU session status IE in the REGISTRATION REQUEST message, indicating which PDU sessions associated with the access type the REGISTRATION REQUEST message is sent over are active in the UE.

If the UE received a paging message with the access type indicating non-3GPP access, the UE shall include the Allowed PDU session status IE in the REGISTRATION REQUEST message indicating the PDU session(s) for which the UE allows to re-establish the user-plane resources over 3GPP access.

When the Allowed PDU session status IE is included in the REGISTRATION REQUEST message, the UE shall indicate that a PDU session is not allowed to be transferred to the 3GPP access if the 3GPP PS data off UE status is "activated" for the corresponding PDU session and the UE is not using the PDU session to send uplink IP packets for any of the 3GPP PS data off exempt services (see subclause 6.2.10).

If the UE operating in the single-registration mode performs inter-system change from S1 mode to N1 mode, the UE:

- a) shall include the UE status IE with the EMM registration status set to "UE is in EMM-REGISTERED state" in the REGISTRATION REQUEST message;

NOTE 2: Inclusion of the UE status IE with this setting corresponds to the indication that the UE is "moving from EPC" as specified in 3GPP TS 23.502 [9], subclause 4.11.1.3.3 and 4.11.2.3.

- b) may include the PDU session status IE in the REGISTRATION REQUEST message indicating the status of the PDU session(s) mapped during the inter-system change from S1 mode to N1 mode from the PDN connection(s) for which the EPS indicated that interworking to 5GS is supported, if any (see subclause 6.1.4.1);
- c) shall include a TRACKING AREA UPDATE REQUEST message as specified in 3GPP TS 24.301 [15] in the EPS NAS message container IE in the REGISTRATION REQUEST message; and
- d) shall include an EPS bearer context status IE in the REGISTRATION REQUEST message indicating which EPS bearer contexts are active in the UE, if the UE has locally deactivated EPS bearer context(s) for which interworking to 5GS is supported while the UE was in S1 mode without notifying the network.

If the UE operating in the single-registration mode performs inter-system change from S1 mode to N1 mode and the UE has at least one PDN connection with active EPS bearer context(s), the UE shall include in the Requested NSSAI IE of the REGISTRATION REQUEST message:

- a) the S-NSSAI(s) which:
  - 1) are associated with the established PDN connection(s); and
  - 2) are applicable in the serving PLMN; and
- b) the mapped S-NSSAI(s) for these S-NSSAI(s) if available at the UE.

For a REGISTRATION REQUEST message with a 5GS registration type IE indicating "mobility registration updating", UE shall include the requested NSSAI containing the S-NSSAI(s) corresponding to the slices to which the UE intends to register with and shall include the mapped S-NSSAI(s) for the requested NSSAI, if available, in the REGISTRATION REQUEST message. If the UE has allowed NSSAI or configured NSSAI for the current PLMN, the requested NSSAI shall be either:

- a) the configured NSSAI for the current PLMN, or a subset thereof as described below, if the UE has no allowed NSSAI for the current PLMN;
- b) the allowed NSSAI for the current PLMN, or a subset thereof as described below, if the UE has an allowed NSSAI for the current PLMN; or
- c) the allowed NSSAI for the current PLMN, or a subset thereof as described below, plus one or more S-NSSAIs from the configured NSSAI for which no corresponding S-NSSAI is present in the allowed NSSAI and those are neither in the rejected NSSAI for the current PLMN nor in the rejected NSSAI for the current registration area.

If the UE has neither allowed NSSAI for the current PLMN nor configured NSSAI for the current PLMN and has a default configured NSSAI, the UE shall:

- a) include the S-NSSAI(s) in the Requested NSSAI IE of the REGISTRATION REQUEST message using the default configured NSSAI; and
- b) include the Network slicing indication IE with the Default configured NSSAI indication bit set to "Requested NSSAI created from default configured NSSAI" in the REGISTRATION REQUEST message.

If the UE has no allowed NSSAI for the current PLMN, no configured NSSAI for the current PLMN, and no default configured NSSAI, the UE shall not include a requested NSSAI in the REGISTRATION REQUEST message.

The subset of configured NSSAI provided in the requested NSSAI consists of one or more S-NSSAIs in the configured NSSAI applicable to this PLMN, if the S-NSSAI is neither in the rejected NSSAIs for the current PLMN nor in the rejected NSSAI for the current registration area.

The subset of allowed NSSAI provided in the requested NSSAI consists of one or more S-NSSAIs in the allowed NSSAI for this PLMN.

NOTE 3: How the UE selects the subset of configured NSSAI or allowed NSSAI to be provided in the requested NSSAI is implementation specific. The UE can take preferences indicated by the upper layers (e.g. policies, applications) into account.

NOTE 4: The number of S-NSSAI(s) included in the requested NSSAI cannot exceed eight.

The UE shall set the Follow-on request indicator to 1, if the UE:

- a) initiates the mobility and periodic registration updating procedure upon request of the upper layers to establish an emergency PDU session;
- b) initiates the mobility and periodic registration updating procedure upon receiving a request from the upper layers to send NAS signalling associated with emergency services fallback; or
- c) needs to prolong the established NAS signalling connection after the completion of the registration procedure for mobility and periodic registration update (e.g. due to uplink signalling pending but no user data pending).

For case n), the UE shall include the 5GS update type IE in the REGISTRATION REQUEST message with the NG-RAN-RCU bit set to "NG-RAN radio capability update needed".

For case o), the UE shall include the Uplink data status IE in the REGISTRATION REQUEST message indicating the PDU session(s) without active user-plane resources for which the UE has pending user data to be sent, if any, and the PDU session(s) for which user-plane resources were active prior to receiving the fallback indication, if any. If the UE is in a non-allowed area or if the UE is not in allowed area, the UE shall not include the Uplink data status IE in REGISTRATION REQUEST message, except if the PDU session for which user-plane resources were active prior to receiving the fallback indication is an emergency PDU session, or if the UE is configured for high priority access in the selected PLMN as specified in subclause 5.3.5.

For case f), the UE shall include the Uplink data status IE in the REGISTRATION REQUEST message indicating the PDU session(s) for which user-plane resources were active prior to receiving "RRC Connection failure" indication from the lower layers, if any. If the UE is in non-allowed area or not in allowed area, the UE shall not include the Uplink data status IE in REGISTRATION REQUEST message, except that the PDU session(s) for which user-plane resources were active prior to receiving the fallback indication is emergency PDU session(s), or that the UE is configured for high priority access in selected PLMN, as specified in subclause 5.3.5.

If the UE does not have a valid 5G NAS security context and the UE is sending the REGISTRATION REQUEST message after an inter-system change from S1 mode to N1 mode in 5GMM-IDLE mode, the UE shall send the

REGISTRATION REQUEST message without including the NAS message container IE. The UE shall include the entire REGISTRATION REQUEST message (i.e. containing cleartext IEs and non-cleartext IEs, if any) in the NAS message container IE that is sent as part of the SECURITY MODE COMPLETE message as described in subclauses 4.4.6 and 5.4.2.3.

The UE shall send the REGISTRATION REQUEST message including the NAS message container IE as described in subclause 4.4.6:

- a) when the UE is sending the message from 5GMM-IDLE mode, the UE has a valid 5G NAS security context, and needs to send non-cleartext IEs; and
- b) when the UE is sending the message after an inter-system change from S1 mode to N1 mode in 5GMM-IDLE mode and the UE has a valid 5G NAS security context and needs to send non-cleartext IEs.

The UE with a valid 5G NAS security context shall send the REGISTRATION REQUEST message without including the NAS message container IE when the UE does not need to send non-cleartext IEs and the UE is sending the message:

- a) from 5GMM-IDLE mode; and
- b) after an inter-system change from S1 mode to N1 mode in 5GMM-IDLE mode.

If the UE is sending the REGISTRATION REQUEST message after an inter-system change from S1 mode to N1 mode in 5GMM-CONNECTED mode and the UE needs to send non-cleartext IEs, the UE shall cipher the NAS message container IE using the mapped 5G NAS security context and send the REGISTRATION REQUEST message including the NAS message container IE as described in subclause 4.4.6. If the UE does not need to send non-cleartext IEs, the UE shall send the REGISTRATION REQUEST message without including the NAS message container IE.

If the REGISTRATION REQUEST message includes a NAS message container IE, the AMF shall process the REGISTRATION REQUEST message that is obtained from the NAS message container IE as described in subclause 4.4.6.

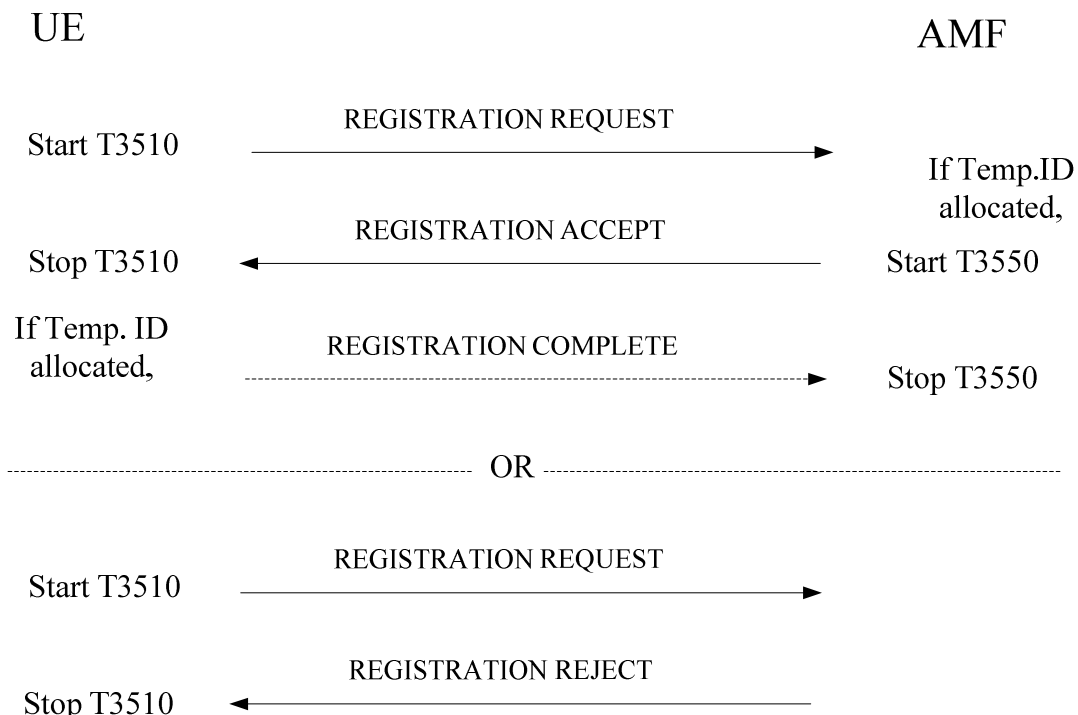

**Figure 5.5.1.3.2.1: Registration procedure for mobility and periodic registration update**

**5.5.1.3.3 5GMM common procedure initiation**

The AMF may initiate 5GMM common procedures, e.g. the identification, authentication and security procedures during the registration procedure, depending on the information received in the REGISTRATION REQUEST message.



The AMF may be configured to skip the authentication procedure even if no 5GS security context is available and proceed directly to the execution of the security mode control procedure as specified in subclause 5.4.2, during the registration procedure for mobility and periodic registration update for a UE that has only an emergency PDU session.

The AMF shall not initiate a 5GMM authentication procedure before completion of the registration procedure for mobility and periodic registration update, if the following conditions apply:

- a) the UE initiated the registration procedure for mobility and periodic registration update after handover or inter-system change to N1 mode in 5GMM-CONNECTED mode;
- b) the target cell is a shared network cell; and
- c.1) the UE has provided its 5G-GUTI in the 5GS mobile identity IE or the Additional GUTI IE in the REGISTRATION REQUEST message, and the PLMN identity included in the 5G-GUTI is different from the selected PLMN identity of the target cell; or
- c.2) the UE has included the 5G-GUTI mapped from the 4G-GUTI in the 5GS mobile identity IE and not included an Additional GUTI IE in the REGISTRATION REQUEST message, and the PLMN identity included in the 5G-GUTI is different from the selected PLMN identity of the target cell.

#### 5.5.1.3.4 Mobility and periodic registration update accepted by the network

If the registration update request has been accepted by the network, the AMF shall send a REGISTRATION ACCEPT message to the UE.

If timer T3513 is running in the AMF, the AMF shall stop timer T3513 if a paging request was sent with the access type indicating non-3GPP and the REGISTRATION REQUEST message includes the Allowed PDU session status IE.

If timer T3565 is running in the AMF, the AMF shall stop timer T3565 when a REGISTRATION REQUEST message is received.

For each of the information elements: 5GMM capability, S1 UE network capability, and UE security capability, the AMF shall store all octets received from the UE in the REGISTRATION REQUEST message, up to the maximum length defined for the respective information element.

NOTE 1: This information is forwarded to the new AMF during inter-AMF handover or to the new MME during inter-system handover to S1 mode.

The 5G-GUTI reallocation shall be part of the registration procedure for mobility registration update. The 5G-GUTI reallocation should be part of the registration procedure for periodic registration update. During the registration procedure for mobility registration update, if the AMF has not allocated a new 5G-GUTI by the generic UE configuration update procedure, the AMF shall include in the REGISTRATION ACCEPT message the new assigned 5G-GUTI.

If a 5G-GUTI or the SOR transparent container IE is included in the REGISTRATION ACCEPT message, the AMF shall start timer T3550 and enter state 5GMM-COMMON-PROCEDURE-INITIATED as described in subclause 5.1.3.2.3.3.

If the Operator-defined access category definitions IE or the Extended emergency number list IE is included in the REGISTRATION ACCEPT message, the AMF shall start timer T3550 and enter state 5GMM-COMMON-PROCEDURE-INITIATED as described in subclause 5.1.3.2.3.3.

The AMF may include a new TAI list for the UE in the REGISTRATION ACCEPT message. The UE, upon receiving a REGISTRATION ACCEPT message, shall delete its old TAI list and store the received TAI list. If there is no TAI list received, the UE shall consider the old TAI list as valid.

The AMF may also include a list of equivalent PLMNs in the REGISTRATION ACCEPT message. Each entry in the list contains a PLMN code (MCC+MNC). The UE shall store the list as provided by the network, and if there is no emergency PDU session established, the UE shall remove from the list any PLMN code that is already in the list of "forbidden PLMNs". If the UE is not registered for emergency services and there is an emergency PDU session established, the UE shall remove from the list of equivalent PLMNs any PLMN code present in the "forbidden PLMNs list" when the emergency PDU session is released. In addition, the UE shall add to the stored list the PLMN code of the registered PLMN that sent the list. The UE shall replace the stored list on each receipt of the REGISTRATION

ACCEPT message. If the REGISTRATION ACCEPT message does not contain a list, then the UE shall delete the stored list.

If the UE is not registered for emergency services, and if the PLMN identity of the registered PLMN is a member of the list of "forbidden PLMNs", any such PLMN identity shall be deleted from the corresponding list(s).

The AMF may include new service area restrictions in the Service area list IE in the REGISTRATION ACCEPT message. The UE, upon receiving a REGISTRATION ACCEPT message with new service area restrictions shall act as described in subclause 5.3.5.

If the Service area list IE is not included in the REGISTRATION ACCEPT message, any tracking area in the registered PLMN and its equivalent PLMN(s) in the registration area is considered as an allowed tracking area as described in subclause 5.3.5.

The AMF shall include the MICO indication IE in the REGISTRATION ACCEPT only if the MICO indication IE was included in the REGISTRATION REQUEST message, the AMF supports and accepts the use of MICO mode. If the AMF supports and accepts the use of MICO mode, the AMF may indicate "all PLMN registration area allocated" in the MICO indication IE in the REGISTRATION ACCEPT message. If "all PLMN registration area allocated" is indicated in the MICO indication IE, the AMF shall not assign and include the TAI list in the REGISTRATION ACCEPT message. If the REGISTRATION ACCEPT message includes an MICO indication IE indicating "all PLMN registration area allocated", the UE shall treat all TAIs in the current PLMN as a registration area and delete its old TAI list.

The AMF may include the T3512 value IE in the REGISTRATION ACCEPT message only if the REGISTRATION REQUEST message was sent over the 3GPP access.

The AMF may include the non-3GPP de-registration timer value IE in the REGISTRATION ACCEPT message only if the REGISTRATION REQUEST message was sent for the non-3GPP access.

Upon receipt of the REGISTRATION ACCEPT message, the UE shall reset the registration attempt counter and service request attempt counter, enter state 5GMM-REGISTERED and set the 5GS update status to 5U1 UPDATED.

If the REGISTRATION ACCEPT message included a T3512 value IE, the UE shall use the value in T3512 value IE as periodic registration update timer (T3512). If the T3512 value IE is not included, the UE shall use the value currently stored, e.g. from a prior REGISTRATION ACCEPT message.

If the REGISTRATION ACCEPT message included a non-3GPP de-registration timer value IE, the UE shall use the value in non-3GPP de-registration timer value IE as non-3GPP de-registration timer. If non-3GPP de-registration timer value IE is not included, the UE shall use the value currently stored, e.g. from a prior REGISTRATION ACCEPT message. If non-3GPP de-registration timer value IE is not included and there is no stored non-3GPP de-registration timer value in the UE, the UE shall use the default value of the non-3GPP de-registration timer.

If the REGISTRATION ACCEPT message contains a 5G-GUTI, the UE shall return a REGISTRATION COMPLETE message to the AMF to acknowledge the received 5G-GUTI, stop timer T3519 if running, and delete any stored SUCI. The UE shall provide the 5G-GUTI to the lower layer of 3GPP access if the REGISTRATION ACCEPT message is sent over the non-3GPP access, and the UE is in 5GMM-REGISTERED in both 3GPP access and non-3GPP access in the same PLMN.

If the REGISTRATION ACCEPT message contains the Network slicing indication IE with the Network slicing subscription change indication set to "Network slicing subscription changed", or contains a configured NSSAI IE with a new configured NSSAI for the current PLMN and optionally the mapped S-NSSAI(s) for the configured NSSAI for the current PLMN, the UE shall return a REGISTRATION COMPLETE message to the AMF to acknowledge the successful update of the network slicing information.

If the REGISTRATION ACCEPT message contains the Operator-defined access category definitions IE or the Extended emergency number list IE or both, the UE shall return a REGISTRATION COMPLETE message to the AMF to acknowledge reception of the operator-defined access category definitions or the extended local emergency numbers list or both.

Upon receiving a REGISTRATION COMPLETE message, the AMF shall stop timer T3550 and change to state 5GMM-REGISTERED. The 5G-GUTI, if sent in the REGISTRATION ACCEPT message, shall be considered as valid.

If the 5GS update type IE was included in the REGISTRATION REQUEST message with the SMS requested bit set to "SMS over NAS supported" and:

- a) the SMSF address is stored in the UE 5GMM context and:

- 1) the UE is considered available for SMS over NAS; or
  - 2) the UE is considered not available for SMS over NAS and the SMSF has confirmed that the activation of the SMS service is successful; or
- b) the SMSF address is not stored in the UE 5GMM context, the SMSF selection is successful and the SMSF has confirmed that the activation of the SMS service is successful;

then the AMF shall set the SMS allowed bit of the 5GS registration result IE in the REGISTRATION ACCEPT message as specified in subclause 5.5.1.2.4. If the UE 5GMM context does not contain an SMSF address or the UE is not considered available for SMS over NAS, then the AMF shall:

- a) store the SMSF address in the UE 5GMM context if not stored already; and
- b) store the value of the SMS allowed bit of the 5GS registration result IE in the UE 5GMM context and consider the UE available for SMS over NAS.

If SMSF selection in the AMF or SMS activation via the SMSF is not successful, or the AMF does not allow the use of SMS over NAS, then the AMF shall set the SMS allowed bit of the 5GS registration result IE to "SMS over NAS not allowed" in the REGISTRATION ACCEPT message.

If the 5GS update type IE was included in the REGISTRATION REQUEST message with the SMS requested bit set to "SMS over NAS not supported" or the 5GS update type IE was not included in the REGISTRATION REQUEST message, then the AMF shall:

- a) mark the 5GMM context to indicate that the UE is not available for SMS over NAS; and

NOTE 2: The AMF can notify the SMSF that the UE is deregistered from SMS over NAS based on local configuration.

- b) set the SMS allowed bit of the 5GS registration result IE to "SMS over NAS not allowed" in the REGISTRATION ACCEPT message.

When the UE receives the REGISTRATION ACCEPT message, if the UE is also registered over another access to the same PLMN, the UE considers the value indicated by the SMS allowed bit of the 5GS registration result IE as applicable for both accesses over which the UE is registered.

If the 5GS update type IE was included in the REGISTRATION REQUEST message with the NG-RAN-RCU bit set to "NG-RAN radio capability update needed", the AMF shall delete any stored UE radio capability information for NG-RAN.

The AMF shall include the 5GS registration result IE in the REGISTRATION ACCEPT message. If the 5GS registration result IE value indicates:

- a) "3GPP access", the UE:
  - shall consider itself as being registered to 3GPP access only; and
  - if in 5GMM-REGISTERED state over non-3GPP access and on the same PLMN as 3GPP access, shall enter state 5GMM-DEREGISTERED.ATTEMPTING-REGISTRATION over non-3GPP access and set the 5GS update status to 5U2 NOT UPDATED over non-3GPP access;
- b) "Non-3GPP access", the UE:
  - shall consider itself as being registered to non-3GPP access only; and
  - if in the 5GMM-REGISTERED state over 3GPP access and is on the same PLMN as non-3GPP access, shall enter the state 5GMM-DEREGISTERED.ATTEMPTING-REGISTRATION over 3GPP access and set the 5GS update status to 5U2 NOT UPDATED over 3GPP access; or
- c) "3GPP access and Non-3GPP access", the UE shall consider itself as being registered to both 3GPP access and non-3GPP access.

The AMF shall include the allowed NSSAI for the current PLMN and shall include the mapped S-NSSAI(s) for the allowed NSSAI contained in the requested NSSAI from the UE if available, in the REGISTRATION ACCEPT message if the UE included the requested NSSAI in the REGISTRATION REQUEST message and the AMF allows one or more

S-NSSAIs in the requested NSSAI. The S-NSSAI associated with each of the active PDN connections for which interworking to 5GS is supported, shall be included in the allowed NSSAI if the UE included the UE status IE with the EMM registration status set to "UE is in EMM-REGISTERED state" in the REGISTRATION REQUEST message and the AMF supports N26 interface.

The AMF may also include rejected NSSAI in the REGISTRATION ACCEPT message. Rejected NSSAI contains S-NSSAI(s) which was included in the requested NSSAI but rejected by the network associated with rejection cause(s).

The AMF may include a new configured NSSAI for the current PLMN in the REGISTRATION ACCEPT message if:

- a) the REGISTRATION REQUEST message did not include the requested NSSAI;
- b) the REGISTRATION REQUEST message included the requested NSSAI containing an S-NSSAI that is not valid in the serving PLMN;
- c) the REGISTRATION REQUEST message included the requested NSSAI containing an S-NSSAI with incorrect mapping information to an S-NSSAI of the HPLMN; or
- d) the REGISTRATION REQUEST message included the Network slicing indication IE with the Default configured NSSAI indication bit set to "Requested NSSAI created from default configured NSSAI".

If a new configured NSSAI for the current PLMN is included, the AMF shall also include the mapped S-NSSAI(s) for the configured NSSAI for the current PLMN if available in the REGISTRATION ACCEPT message. In this case the AMF shall start timer T3550 and enter state 5GMM-COMMON-PROCEDURE-INITIATED as described in subclause 5.1.3.2.3.3.

The AMF shall include the Network slicing indication IE with the Network slicing subscription change indication set to "Network slicing subscription changed" in the REGISTRATION ACCEPT message if the UDM has indicated that the subscription data for network slicing has changed. In this case the AMF shall start timer T3550 and enter state 5GMM-COMMON-PROCEDURE-INITIATED as described in subclause 5.1.3.2.3.3.

If the S-NSSAI(s) associated with the existing PDU session(s) of the UE is not included in the requested NSSAI of the REGISTRATION REQUEST message, the AMF shall perform a local release of the PDU session(s) associated with the S-NSSAI(s) and shall request the SMF to perform a local release of those PDU session(s).

The UE receiving the rejected NSSAI in the REGISTRATION ACCEPT message takes the following actions based on the rejection cause in the rejected NSSAI:

"S-NSSAI not available in the current PLMN"

The UE shall add the rejected S-NSSAI(s) in the rejected NSSAI for the current PLMN as specified in subclause 4.6.2.2 and not attempt to use this S-NSSAI in the current PLMN until switching off the UE or the UICC containing the USIM is removed.

"S-NSSAI not available in the current registration area"

The UE shall add the rejected S-NSSAI(s) in the rejected NSSAI for the current registration area as specified in subclause 4.6.2.2 and not attempt to use this S-NSSAI in the current registration area until switching off the UE, the UE moving out of the current registration area or the UICC containing the USIM is removed.

For a REGISTRATION REQUEST message with a 5GS registration type IE indicating "mobility registration updating", if the UE did not include the requested NSSAI in the REGISTRATION REQUEST message or none of the requested NSSAI are present in the subscribed S-NSSAIs, and one or more subscribed S-NSSAIs marked as default are available, the AMF shall put the subscribed S-NSSAIs marked as default in the allowed NSSAI of the REGISTRATION ACCEPT message. The AMF shall determine a registration area such that all S-NSSAIs of the allowed NSSAI are available in the registration area.

During a periodic registration update procedure, the AMF may provide a new allowed NSSAI to the UE in the REGISTRATION ACCEPT message.

If the REGISTRATION ACCEPT message contains the Network slicing indication IE with the Network slicing subscription change indication set to "Network slicing subscription changed", the UE shall delete the network slicing information for each and every PLMN except for the current PLMN as specified in subclause 4.6.2.2.

If the REGISTRATION ACCEPT message contains the allowed NSSAI, then the UE shall store the included allowed NSSAI together with the PLMN identity of the registered PLMN and the registration area as specified in

subclause 4.6.2.2. If the UE has one or more PDU sessions associated with S-NSSAI(s) not included in the received allowed NSSAI, the UE shall perform a local release of all such PDU sessions except for the persistent PDU session(s).

If the REGISTRATION ACCEPT message contains a configured NSSAI IE with a new configured NSSAI for the current PLMN and optionally the mapped S-NSSAI(s) for the configured NSSAI for the current PLMN, the UE shall store the contents of the configured NSSAI IE as specified in subclause 4.6.2.2.

During a periodic registration update procedure, if the REGISTRATION ACCEPT message does not contain an allowed NSSAI, the UE considers the previously received allowed NSSAI as valid.

If the Uplink data status IE is included in the REGISTRATION REQUEST message:

- a) if the AMF determines that the UE is in non-allowed area or is not in allowed area, and the PDU session(s) indicated by the Uplink data status IE is non-emergency PDU session(s) or the UE is not configured for high priority access in selected PLMN, the AMF shall include the PDU session reactivation result IE in the REGISTRATION ACCEPT message indicating that user-plane resources for the corresponding PDU session(s) cannot be re-established, and shall include the PDU session reactivation result error cause IE with the 5GMM cause set to #28 "Restricted service area";
- b) otherwise, the AMF shall:
  - 1) indicate the SMF to re-establish the user-plane resources for the corresponding PDU session;
  - 2) include PDU session reactivation result IE in the REGISTRATION ACCEPT message to indicate the user-plane resources re-establishment result of the PDU sessions for which the UE requested to re-establish the user-plane resources; and
  - 3) determine the UE presence in LADN service area and forward the UE presence in LADN service area towards the SMF, if the corresponding PDU session is a PDU session for LADN.

If the Uplink data status IE is not included in the REGISTRATION REQUEST message and the REGISTRATION REQUEST message is sent for the trigger d) in subclause 5.5.1.3.2, the AMF may indicate the SMF to re-establish the user-plane resources for the PDU sessions.

If a PDU session status IE is included in the REGISTRATION REQUEST message, the AMF shall:

- a) perform a local release of all those PDU session which are in 5GSM state PDU SESSION ACTIVE on the AMF side associated with the access type the REGISTRATION REQUEST message is sent over, but are indicated by the UE as being in 5GSM state PDU SESSION INACTIVE; and
- b) include a PDU session status IE in the REGISTRATION ACCEPT message to indicate which PDU sessions associated with the access type the REGISTRATION REQUEST message is sent over are active in the AMF.

If the Allowed PDU session status IE is included in the REGISTRATION REQUEST message, the AMF shall:

- a) for a 5GSM message from each SMF that has indicated pending downlink signalling only, forward the received 5GSM message via 3GPP access to the UE after the REGISTRATION ACCEPT message is sent;
- b) for each SMF that has indicated pending downlink data only:
  - 1) notify the SMF that reactivation of the user-plane resources for the corresponding PDU session(s) associated with non-3GPP access cannot be performed if the corresponding PDU session ID(s) are not indicated in the Allowed PDU session status IE; and
  - 2) notify the SMF that reactivation of the user-plane resources for the corresponding PDU session(s) associated with non-3GPP access can be performed if the corresponding PDU session ID(s) are indicated in the Allowed PDU session status IE.
- c) for each SMF that have indicated pending downlink signalling and data:
  - 1) notify the SMF that reactivation of the user-plane resources for the corresponding PDU session(s) associated with non-3GPP access cannot be performed if the corresponding PDU session ID(s) are not indicated in the Allowed PDU session status IE;

- 2) notify the SMF that reactivation of the user-plane resources for the corresponding PDU session(s) associated with non-3GPP access can be performed if the corresponding PDU session ID(s) are indicated in the Allowed PDU session status IE; and
- 3) discard the received 5GSM message for PDU session(s) associated with non-3GPP access; and
- d) include the PDU session reactivation result IE in the REGISTRATION ACCEPT message to indicate the successfully re-established user-plane resources for the corresponding PDU sessions, if any.

If the PDU session reactivation result IE is included in the REGISTRATION ACCEPT message indicating that the user-plane resources have been successfully reactivated for a PDU session that was requested by the UE in the Allowed PDU session status IE, the UE considers the corresponding PDU session to be associated with the 3GPP access. If the user-plane resources of a PDU session have been successfully reactivated over the 3GPP access, the AMF and SMF update the associated access type of the corresponding PDU session.

If the AMF has included the PDU session reactivation result IE in the REGISTRATION ACCEPT message and there exist one or more PDU sessions for which the user-plane resources cannot be re-established, then the AMF may include the PDU session reactivation result error cause IE to indicate the cause of failure to re-establish the user-plane resources.

If an EPS bearer context status IE is included in the REGISTRATION REQUEST message, the AMF handles the received EPS bearer context status IE as specified in 3GPP TS 23.502 [9].

If the user-plane resources cannot be established for a PDU session, the AMF shall include the PDU session reactivation result IE in the REGISTRATION ACCEPT message indicating that user-plane resources for the corresponding PDU session cannot be re-established, and shall include the PDU session reactivation result error cause IE with the 5GMM cause set to:

- a) #43 "LADN not available" if the user-plane resources cannot be established because the SMF indicated to the AMF that the UE is located out of the LADN service area (see 3GPP TS 29.502 [20A]);
- b) #28 "restricted service area" if the user-plane resources cannot be established because the SMF indicated to the AMF that only prioritized services are allowed (see 3GPP TS 29.502 [20A]); or
- c) #92 "insufficient user-plane resources for the PDU session" if the user-plane resources cannot be established because the SMF indicated to the AMF that the resource is not available in the UPF (see 3GPP TS 29.502 [20A]).

NOTE 3: It is up to UE implementation when to re-send a request for user-plane re-establishment for the associated PDU session after receiving a PDU session reactivation result error cause IE with a 5GMM cause set to #92 "insufficient user-plane resources for the PDU session".

If the AMF needs to initiate PDU session status synchronization the AMF shall include a PDU session status IE in the REGISTRATION ACCEPT message to indicate the UE which PDU sessions are active in the AMF.

If the EPS bearer context status information is generated for the UE during the inter-system change from S1 mode to N1 mode as specified in 3GPP TS 23.502 [9] and the AMF supports N26 interface, the AMF shall include an EPS bearer context status IE in the REGISTRATION ACCEPT message to indicate the UE which mapped EPS bearer contexts are active in the network.

The AMF may include the LADN information IE in the REGISTRATION ACCEPT message as described in subclause 5.5.1.2.4. The UE, upon receiving the REGISTRATION ACCEPT message with the LADN information IE, shall delete its old LADN information (if any) and store the received new LADN information.

If the AMF does not include the LADN information IE in the REGISTRATION ACCEPT message during registration procedure for mobility and registration update, the UE shall delete its old LADN information.

If the PDU session status IE is included in the REGISTRATION ACCEPT message, the UE shall perform a local release of all those PDU sessions associated with the access type the REGISTRATION ACCEPT message is sent over which are in 5GSM state PDU SESSION ACTIVE on the UE side, but are indicated by the AMF as being in 5GSM state PDU SESSION INACTIVE.

If:

- a) the UE included a PDU session status IE in the REGISTRATION REQUEST message;

- b) the UE is operating in the single-registration mode;
- c) the UE is performing inter-system change from S1 mode to N1 mode in 5GMM-IDLE mode; and
- d) the UE has received the IWK N26 bit set to "interworking without N26 interface supported";

the UE shall ignore the PDU session status IE if received in the REGISTRATION ACCEPT message.

If the EPS bearer context status IE is included in the REGISTRATION ACCEPT message, the UE shall locally delete all those QoS flow descriptions and all associated QoS rules, if any, which are associated with inactive EPS bearer contexts as indicated by the AMF in the EPS bearer context status IE.

If the UE included S1 mode supported indication in the REGISTRATION REQUEST message, the AMF supporting inter-system change with EPS shall set the IWK N26 bit to either:

- a) "interworking without N26 not supported" if the AMF supports N26 interface; or
- b) "interworking without N26 supported" if the AMF does not support N26 interface

in the 5GS network feature support IE in the REGISTRATION ACCEPT message.

The UE supporting S1 mode shall operate in the mode for inter-system interworking with EPS as follows:

- a) if the IWK N26 bit in the 5GS network feature support IE is set to "interworking without N26 interface not supported", the UE shall operate in single-registration mode;
- b) if the IWK N26 bit in the 5GS network feature support IE is set to "interworking without N26 interface supported" and the UE supports dual-registration mode, the UE may operate in dual-registration mode; or

NOTE 4: The registration mode used by the UE is implementation dependent.

- c) if the IWK N26 bit in the 5GS network feature support IE is set to "interworking without N26 interface supported" and the UE only supports single-registration mode, the UE shall operate in single-registration mode.

The UE shall treat the received interworking without N26 interface indicator for inter-system change with EPS as valid in the entire PLMN and its equivalent PLMN(s).

The network informs the UE about the support of specific features, such as IMS voice over PS session, emergency services or emergency services fallback, in the 5GS network feature support information element. In a UE with IMS voice over PS session capability, the IMS voice over PS session indicator, Emergency services support indicator and Emergency services fallback indicator shall be provided to the upper layers. The upper layers take the IMS voice over PS session indicator into account when selecting the access domain for voice sessions or calls. When initiating an emergency call, the upper layers take the IMS voice over PS session indicator, Emergency services support indicator and Emergency services fallback indicator into account for the access domain selection. When the UE determines via the IMS voice over PS session indicator that the network does not support IMS voice over PS sessions in N1 mode, then the UE shall not perform a local release of any persistent PDU session if the AMF does not indicate that the PDU session is in 5GSM state PDU SESSION INACTIVE via the PDU session status IE. When the UE determines via the Emergency services support indicator that the network does not support emergency services in N1 mode, then the UE shall not perform a local release of any emergency PDU session if user-plane resources associated with that emergency PDU session are established if the AMF does not indicate that the PDU session is in 5GSM state PDU SESSION INACTIVE via the PDU session status IE.

The AMF shall set the EMF bit in the 5GS network feature support IE to:

- a) "Emergency services fallback supported in NR connected to 5GCN and E-UTRA connected to 5GCN" if the network supports the emergency services fallback procedure when the UE is in an NR cell connected to 5GCN or an E-UTRA cell connected to 5GCN;
- b) "Emergency services fallback supported in NR connected to 5GCN only" if the network supports the emergency services fallback procedure when the UE is in an NR cell connected to 5GCN and does not support the emergency services fallback procedure when the UE is in an E-UTRA cell connected to 5GCN;
- c) "Emergency services fallback supported in E-UTRA connected to 5GCN only" if the network supports the emergency services fallback procedure when the UE is in an E-UTRA cell connected to 5GCN and does not support the emergency services fallback procedure when the UE is in an NR cell connected to 5GCN; or

- d) "Emergency services fallback not supported" if network does not support the emergency services fallback procedure when the UE is in any cell connected to 5GCN.

NOTE 5: If the emergency services are supported in neither the EPS nor the 5GS homogeneously, based on operator policy, the AMF will set the EMF bit in the 5GS network feature support IE to "Emergency services fallback not supported".

NOTE 6: Even though the AMF's support of emergency services fallback is indicated per RAT, the UE's support of emergency services fallback is not per RAT, i.e. the UE's support of emergency services fallback is the same for both NR connected to 5GCN and E-UTRA connected to 5GCN.

The network informs the UE that the use of access identity 1 is valid in the RPLMN or equivalent PLMN by setting the MPS indicator bit of the 5GS network feature support IE to "Access identity 1 valid in RPLMN or equivalent PLMN", in the REGISTRATION ACCEPT message. Based on operator policy, the AMF sets the MPS indicator bit in the REGISTRATION ACCEPT message based on the MPS priority information in the user's subscription context obtained from the UDM.

Upon receiving a REGISTRATION ACCEPT message with the MPS indicator bit set to "Access identity 1 valid in RPLMN or equivalent PLMN", the UE shall act as a UE with access identity 1 configured for MPS as described in subclause 4.5.2, in all NG-RAN of the registered PLMN and its equivalent PLMNs. The MPS indicator bit in the 5GS network feature support IE provided in the REGISTRATION ACCEPT message is valid until the UE receives a REGISTRATION ACCEPT message with the MPS indicator bit set to "Access identity 1 not valid in RPLMN or equivalent PLMN" or until the UE selects a non-equivalent PLMN. Access identity 1 is only applicable while the UE is in N1 mode.

During ongoing active PDU sessions that were set up relying on the MPS indicator bit being set to "Access identity 1 valid in RPLMN or equivalent PLMN", if the network indicates in a registration update that the MPS indicator bit is reset to "Access identity 1 not valid in RPLMN or equivalent PLMN", then the UE shall no longer act as a UE with access identity 1 configured for MPS as described in subclause 4.5.2 unless the USIM contains a valid configuration for access identity 1 in RPLMN or equivalent PLMN. In the UE, the ongoing active PDU sessions are not affected by the change of the MPS indicator bit.

The network informs the UE that the use of access identity 2 is valid in the RPLMN or equivalent PLMN by setting the MCS indicator bit of the 5GS network feature support IE to "Access identity 2 valid in RPLMN or equivalent PLMN", in the REGISTRATION ACCEPT message. Based on operator policy, the AMF sets the MCS indicator bit in the REGISTRATION ACCEPT message based on the MCS priority information in the user's subscription context obtained from the UDM.

Upon receiving a REGISTRATION ACCEPT message with the MCS indicator bit set to "Access identity 2 valid in RPLMN or equivalent PLMN", the UE shall act as a UE with access identity 2 configured for MCS as described in subclause 4.5.2, in all NG-RAN of the registered PLMN and its equivalent PLMNs. The MCS indicator bit in the 5GS network feature support IE provided in the REGISTRATION ACCEPT message is valid until the UE receives a REGISTRATION ACCEPT message with the MCS indicator bit set to "Access identity 2 not valid in RPLMN or equivalent PLMN" or until the UE selects a non-equivalent PLMN. Access identity 2 is only applicable while the UE is in N1 mode.

During ongoing active PDU sessions that were set up relying on the MCS indicator bit being set to "Access identity 2 valid in RPLMN or equivalent PLMN", if the network indicates in a registration update that the MCS indicator bit is reset to "Access identity 2 not valid in RPLMN or equivalent PLMN", then the UE shall no longer act as a UE with access identity 2 configured for MCS as described in subclause 4.5.2 unless the USIM contains a valid configuration for access identity 2 in RPLMN or equivalent PLMN. In the UE, the ongoing active PDU sessions are not affected by the change of the MCS indicator bit.

If the UE has set the Follow-on request indication to 1 in the REGISTRATION REQUEST message, or the network has downlink signalling pending, the AMF shall not immediately release the NAS signalling connection after the completion of the registration procedure.

If the Requested DRX parameters IE was included in the REGISTRATION REQUEST message, the AMF shall include the Negotiated DRX parameters IE in the REGISTRATION ACCEPT message. The AMF may set the Negotiated DRX parameters IE based on the received Requested DRX parameters IE and operator policy if available.

If the UE included in the REGISTRATION REQUEST message the UE status information IE with the EMM registration status set to "UE is in EMM-REGISTERED state" and the AMF does not support N26 interface, the AMF shall operate as described in subclause 5.5.1.2.4.



If due to regional subscription restrictions or access restrictions the UE is not allowed to access the TA, but the UE has an emergency PDU session established, the AMF may accept the REGISTRATION REQUEST message and indicate to the SMF to release all non-emergency PDU sessions when the registration procedure is initiated in 5GMM-CONNECTED mode. When the registration procedure is initiated in 5GMM-IDLE mode, the AMF indicates to the SMF to release all non-emergency PDU sessions and informs the UE via the PDU session status IE in the REGISTRATION ACCEPT message. The AMF shall not indicate to the SMF to release the emergency PDU session. The network shall behave as if the UE is registered for emergency services.

If the REGISTRATION ACCEPT message includes the PDU session reactivation result error cause IE with the 5GMM cause set to #28 "Restricted service area", the UE shall enter the state 5GMM-REGISTERED.NON-ALLOWED-SERVICE, and behave as specified in subclause 5.3.5.

If the REGISTRATION ACCEPT message includes the SOR transparent container IE and:

- a) the SOR transparent container IE does not successfully pass the integrity check (see 3GPP TS 33.501 [24]); and
- b) if the UE attempts obtaining service on another PLMNs as specified in 3GPP TS 23.122 [5] annex C;

then the UE shall release locally the established NAS signalling connection after sending a REGISTRATION COMPLETE message.

If the REGISTRATION ACCEPT message includes the SOR transparent container IE and the SOR transparent container IE successfully passes the integrity check (see 3GPP TS 33.501 [24]):

- a) the UE shall proceed with the behaviour as specified in 3GPP TS 23.122 [5] annex C; and
- b) if the registration procedure is performed over 3GPP access and the UE attempts obtaining service on another PLMNs as specified in 3GPP TS 23.122 [5] annex C then the UE may release locally the established NAS signalling connection after sending a REGISTRATION COMPLETE message. Otherwise the UE shall send a REGISTRATION COMPLETE message and not release the current N1 NAS signalling connection locally. If an acknowledgement is requested in the SOR transparent container IE of the REGISTRATION ACCEPT message, the UE acknowledgement is included in the SOR transparent container IE of the REGISTRATION COMPLETE message.

If the SOR transparent container IE successfully passes the integrity check (see 3GPP TS 33.501 [24]), indicates list of preferred PLMN/access technology combinations is provided and the list type indicates:

- a) "PLMN ID and access technology list", then the ME shall replace the highest priority entries in the "Operator Controlled PLMN Selector with Access Technology" list stored in the ME and shall proceed with the behaviour as specified in 3GPP TS 23.122 [5] annex C; or
- b) "secured packet", then the ME shall behave as if a SMS is received with protocol identifier set to SIM data download, data coding scheme set to class 2 message and SMS payload as secured packet contents of SOR transparent container IE. The SMS payload is forwarded to UICC as specified in 3GPP TS 23.040 [4A] and the ME shall proceed with the behaviour as specified in 3GPP TS 23.122 [5] annex C.

If required by operator policy, the AMF shall include the NSSAI inclusion mode IE in the REGISTRATION ACCEPT message (see table 4.6.2.3.1 of subclause 4.6.2.3). Upon receipt of the REGISTRATION ACCEPT message:

- a) if the message includes the NSSAI inclusion mode IE, the UE shall operate in the NSSAI inclusion mode indicated in the NSSAI inclusion mode IE over the current access within the current PLMN and its equivalent PLMN(s), if any, in the current registration area; or
- b) otherwise if:
  - 1) the UE has NSSAI inclusion mode for the current PLMN and access type stored in the UE, the UE shall operate in the stored NSSAI inclusion mode; or
  - 2) the UE does not have NSSAI inclusion mode for the current PLMN and the access type stored in the UE and if the UE is performing the registration procedure over:
    - i) 3GPP access, the UE shall operate in NSSAI inclusion mode D in the current PLMN and the current access type; or
    - ii) non-3GPP access, the UE shall operate in NSSAI inclusion mode C in the current PLMN and the current access type.

The AMF may include operator-defined access category definitions in the REGISTRATION ACCEPT message.

If the UE receives Operator-defined access category definitions IE in the REGISTRATION ACCEPT message and the Operator-defined access category definitions IE contains one or more operator-defined access category definitions, the UE shall delete any operator-defined access category definitions stored for the RPLMN and shall store the received operator-defined access category definitions for the RPLMN. If the UE receives the Operator-defined access category definitions IE in the REGISTRATION ACCEPT message and the Operator-defined access category definitions IE contains no operator-defined access category definitions, the UE shall delete any operator-defined access category definitions stored for the RPLMN. If the REGISTRATION ACCEPT message does not contain the Operator-defined access category definitions IE, the UE shall not delete the operator-defined access category definitions stored for the RPLMN.

#### 5.5.1.3.5 Mobility and periodic registration update not accepted by the network

If the mobility and periodic registration update request cannot be accepted by the network, the AMF shall send a REGISTRATION REJECT message to the UE including an appropriate 5GMM cause value.

When the UE performs inter-system change from S1 mode to N1 mode, if the AMF is informed that verification of the integrity protection of the TRACKING AREA UPDATE REQUEST message included by the UE in the EPS NAS message container IE of the REGISTRATION REQUEST message has failed in the MME, the AMF should send REGISTRATION REJECT message including 5GMM cause #9 "UE identity cannot be derived by the network".

The UE shall take the following actions depending on the 5GMM cause value received in the REGISTRATION REJECT message.

#3 (Illegal UE); or

#6 (Illegal ME).

The UE shall set the 5GS update status to 5U3 ROAMING NOT ALLOWED (and shall store it according to subclause 5.1.3.2.2) and shall delete any 5G-GUTI, last visited registered TAI, TAI list and ngKSI. The UE shall consider the USIM as invalid for 5GS services until switching off or the UICC containing the USIM is removed. The UE shall delete the list of equivalent PLMNs and shall move to 5GMM-DEREGISTERED state.

If the UE is operating in single-registration mode, the UE shall handle the EMM parameters EMM state, EPS update status, 4G-GUTI, TAI list and eKSI as specified in 3GPP TS 24.301 [15] for the case when the normal tracking area updating procedure is rejected with the EMM cause with the same value. The USIM shall be considered as invalid also for non-EPS services until switching off or the UICC containing the USIM is removed. If the UE is in EMM-REGISTERED state, the UE shall move to EMM-DEREGISTERED state.

If the UE also supports the registration procedure over the other access, the UE shall in addition handle 5GMM parameters and 5GMM state for this access, as described for this 5GMM cause value.

#7 (5GS services not allowed).

The UE shall set the 5GS update status to 5U3 ROAMING NOT ALLOWED (and shall store it according to subclause 5.1.3.2.2) and shall delete any 5G-GUTI, last visited registered TAI, TAI list and ngKSI. The UE shall consider the USIM as invalid for 5GS services until switching off or the UICC containing the USIM is removed. The UE shall move to 5GMM-DEREGISTERED state.

If the UE is operating in single-registration mode, the UE shall handle the EMM parameters EMM state, EPS update status, 4G-GUTI, TAI list and eKSI as specified in 3GPP TS 24.301 [15] for the case when the normal tracking area updating procedure is rejected with the EMM cause with the same value.

If the UE also supports the registration procedure over the other access, the UE shall in addition handle 5GMM parameters and 5GMM state for this access, as described for this 5GMM cause value.

#9 (UE identity cannot be derived by the network).

The UE shall set the 5GS update status to 5U2 NOT UPDATED (and shall store it according to subclause 5.1.3.2.2) and shall delete any 5G-GUTI, last visited registered TAI, TAI list and ngKSI. The UE shall enter the state 5GMM-DEREGISTERED.

If the rejected request was not for initiating an emergency PDU session, the UE shall subsequently, automatically initiate the initial registration procedure.

NOTE 1: User interaction is necessary in some cases when the UE cannot re-establish the PDU session(s) automatically.

If the UE is operating in single-registration mode, the UE shall handle the EMM parameters EMM state, EPS update status, 4G-GUTI, last visited registered TAI, TAI list and eKSI as specified in 3GPP TS 24.301 [15] for the case when the normal tracking area updating procedure is rejected with the EMM cause with the same value.

If the UE also supports the registration procedure over the other access to the same PLMN, the UE shall in addition handle 5GMM parameters and 5GMM state for this access, as described for this 5GMM cause value.

#10 (implicitly de-registered).

The UE shall enter the state 5GMM-DEREGISTERED.NORMAL-SERVICE. The UE shall delete any mapped 5G security context or partial native 5G security context.

If the registration rejected request was not for initiating an emergency PDU session, the UE shall perform a new registration procedure for initial registration.

NOTE 2: User interaction is necessary in some cases when the UE cannot re-establish the PDU session(s) automatically.

If the UE is operating in single-registration mode, the UE shall handle the EMM state as specified in 3GPP TS 24.301 [15] for the case when the normal tracking area updating procedure is rejected with the EMM cause with the same value.

#11 (PLMN not allowed).

The UE shall set the 5GS update status to 5U3 ROAMING NOT ALLOWED (and shall store it according to subclause 5.1.3.2.2) and shall delete any 5G-GUTI, last visited registered TAI, TAI list and ngKSI. The UE shall store the PLMN identity in the "forbidden PLMN list", delete the list of equivalent PLMNs, reset the registration attempt counter and enter the state 5GMM-DEREGISTERED.PLMN-SEARCH. The UE shall perform a PLMN selection according to 3GPP TS 23.122 [5].

If the UE is operating in single-registration mode, the UE shall in addition handle the EMM parameters EMM state, EPS update status, 4G-GUTI, TAI list, eKSI and tracking area updating attempt counter as specified in 3GPP TS 24.301 [15] for the case when the normal tracking area updating procedure is rejected with the EMM cause with the same value.

If the UE also supports the registration procedure over the other access to the same PLMN, the UE shall in addition handle 5GMM parameters and 5GMM state for this access, as described for this 5GMM cause value.

#12 (Tracking area not allowed).

The UE shall set the 5GS update status to 5U3 ROAMING NOT ALLOWED (and shall store it according to subclause 5.1.3.2.2) and shall delete 5G-GUTI, last visited registered TAI, TAI list and ngKSI. Additionally, the UE shall reset the registration attempt counter.

The UE shall store the current TAI in the list of "5GS forbidden tracking areas for regional provision of service" and enter the state 5GMM-DEREGISTERED.LIMITED-SERVICE.

If the UE is operating in single-registration mode, the UE shall handle the EMM parameters EMM state, EPS update status, 4G-GUTI, TAI list, eKSI and tracking area updating attempt counter as specified in 3GPP TS 24.301 [15] for the case when the normal tracking area updating procedure is rejected with the EMM cause with the same value.

#13 (Roaming not allowed in this tracking area).

The UE shall set the 5GS update status to 5U3 ROAMING NOT ALLOWED (and shall store it according to subclause 5.1.3.2.2) and shall delete the list of equivalent PLMNs. The UE shall reset the registration attempt counter and shall change to state 5GMM-REGISTERED.PLMN-SEARCH.

The UE shall store the current TAI in the list of "5GS forbidden tracking areas for roaming" and shall remove the current TAI from the stored TAI list if present.

The UE shall perform a PLMN selection according to 3GPP TS 23.122 [5].

If the UE is operating in single-registration mode, the UE shall handle the EMM parameters EMM state, EPS update status and tracking area updating attempt counter as specified in 3GPP TS 24.301 [15] for the case when the normal tracking area updating procedure is rejected with the EMM cause with the same value.

#15 (No suitable cells in tracking area).

The UE shall set the 5GS update status to 5U3 ROAMING NOT ALLOWED (and shall store it according to subclause 5.1.3.2.2). The UE shall reset the registration attempt counter and shall enter the state 5GMM-REGISTERED.LIMITED-SERVICE. The UE shall search for a suitable cell in another tracking area according to 3GPP TS 38.304 [28].

The UE shall store the current TAI in the list of "5GS forbidden tracking areas for roaming" and shall remove the current TAI from the stored TAI list, if present.

If the UE is operating in single-registration mode, the UE shall handle the EMM parameters EMM state, EPS update status and tracking area updating attempt counter as specified in 3GPP TS 24.301 [15] for the case when the normal tracking area updating procedure is rejected with the EMM cause with the same value.

#22 (Congestion).

If the T3346 value IE is present in the REGISTRATION REJECT message and the value indicates that this timer is neither zero nor deactivated, the UE shall proceed as described below, otherwise it shall be considered as an abnormal case and the behaviour of the UE for this case is specified in subclause 5.5.1.3.7.

The UE shall abort the registration procedure for mobility and periodic registration update. If the rejected request was not for initiating an emergency PDU session, the UE shall set the 5GS update status to 5U2 NOT UPDATED and change to state 5GMM-REGISTERED.ATTEMPTING-REGISTRATION-UPDATE.

The UE shall stop timer T3346 if it is running.

If the REGISTRATION REJECT message is integrity protected, the UE shall start timer T3346 with the value provided in the T3346 value IE.

If the REGISTRATION REJECT message is not integrity protected, the UE shall start timer T3346 with a random value from the default range specified in 3GPP TS 24.008 [12].

The UE stays in the current serving cell and applies the normal cell reselection process. The registration procedure for mobility and periodic registration update is started, if still necessary, when timer T3346 expires or is stopped.

If the UE is operating in single-registration mode, the UE shall handle the EMM parameters EMM state, EPS update status and tracking area updating attempt counter as specified in 3GPP TS 24.301 [15] for the case when the normal tracking area updating procedure is rejected with the EMM cause with the same value.

#27 (N1 mode not allowed).

The UE shall set the 5GS update status to 5U3 ROAMING NOT ALLOWED (and shall store it according to subclause 5.1.3.2.2) and shall delete any 5G-GUTI, last visited registered TAI, TAI list and ngKSI. Additionally, the UE shall reset the registration attempt counter and shall enter the state 5GMM-NULL.

The UE shall disable the N1 mode capability for both 3GPP access and non-3GPP access (see subclause 4.9).

#72 (Non-3GPP access to 5GCN not allowed).

When received over non-3GPP access the UE shall set the 5GS update status to 5U3 ROAMING NOT ALLOWED (and shall store it according to subclause 5.1.3.2.2) and shall delete 5G-GUTI, last visited registered TAI, TAI list and ngKSI. Additionally, the UE shall reset the registration attempt counter and enter the state 5GMM-DEREGISTERED.

NOTE: The 5GMM sublayer states, the 5GMM parameters and the registration status are managed per access type independently, i.e. 3GPP access or non-3GPP access (see subclauses 4.7.2 and 5.1.3).

The UE shall disable the N1 mode capability for non-3GPP access (see subclause 4.9.3).

As an implementation option, the UE may enter the state 5GMM-DEREGISTERED.PLMN-SEARCH in order to perform a PLMN selection according to 3GPP TS 23.122 [5].

If received over 3GPP access the cause shall be considered as an abnormal case and the behaviour of the UE for this case is specified in subclause 5.5.1.3.7.

#73 (Serving network not authorized).

The UE shall set the 5GS update status to 5U2 NOT UPDATED, reset the registration attempt counter, store the PLMN identity in the "forbidden PLMN list" and enter state 5GMM-DEREGISTERED.PLMN-SEARCH in order to perform a PLMN selection according to 3GPP TS 23.122 [5].

Other values are considered as abnormal cases. The behaviour of the UE in those cases is specified in subclause 5.5.1.3.7.

#### 5.5.1.3.6 Mobility and periodic registration update for initiating an emergency PDU session not accepted by the network

If the mobility and periodic registration update request for initiating an emergency PDU session cannot be accepted by the network, the UE shall perform the procedures as described in subclause 5.5.1.3.5. Then if the UE is in the same selected PLMN where the last mobility and periodic registration update request was attempted, the UE shall:

a) inform the upper layers of the failure of the procedure; or

NOTE 1: This can result in the upper layers requesting implementation specific mechanisms, e.g. procedures specified in 3GPP TS 24.229 [14] can result in the emergency call being attempted to another IP-CAN.

b) perform de-registration locally, if not de-registered already, and attempt initial registration for emergency services.

If the mobility and periodic registration update request for initiating an emergency PDU session fails due to abnormal case b) in subclause 5.5.1.3.7, the UE shall perform the actions as described in subclause 5.5.1.3.7 and inform the upper layers of the failure to access the network.

NOTE 2: This can result in the upper layers requesting implementation specific mechanisms, e.g. procedures specified in 3GPP TS 24.229 [14] can result in the emergency call being attempted to another IP-CAN.

If the mobility and periodic registration update request for initiating an emergency PDU session fails due to abnormal cases c) or d) in subclause 5.5.1.3.7, the UE shall perform the procedures as described in subclause 5.5.1.3.7. Then if the UE is in the same selected PLMN where the last mobility and periodic registration update request was attempted, the UE shall:

a) inform the upper layers of the failure of the procedure; or

NOTE 3: This can result in the upper layers requesting implementation specific mechanisms, e.g. procedures specified in 3GPP TS 24.229 [14] can result in the emergency call being attempted to another IP-CAN.

b) perform de-registration locally, if not de-registered already, and attempt initial registration for emergency services.

#### 5.5.1.3.7 Abnormal cases in the UE

The following abnormal cases can be identified:

a) Timer T3346 is running.

The UE shall not start the registration procedure for mobility and periodic registration update unless:

- 1) the UE is in 5GMM-CONNECTED mode;
- 2) the UE received a paging;
- 3) the UE receives a NOTIFICATION message over non-3GPP access when the UE is in 5GMM-CONNECTED mode over non-3GPP access and in 5GMM-IDLE mode over 3GPP access;
- 4) the UE is a UE configured for high priority access in selected PLMN;
- 5) the UE has an emergency PDU session established or is establishing an emergency PDU session;

- 6) the UE receives a request from the upper layers to send NAS signalling associated with emergency services fallback; or
- 7) the UE receives the CONFIGURATION UPDATE COMMAND message as specified in subclause 5.4.4.3.

The UE stays in the current serving cell and applies the normal cell reselection process.

NOTE 1: It is considered an abnormal case if the UE needs to initiate a registration procedure for mobility and periodic registration update while timer T3346 is running independent on whether timer T3346 was started due to an abnormal case or a non-successful case.

- b) The lower layers indicate that the access attempt is barred.

The UE shall not start the registration procedure for mobility and periodic registration update. The UE stays in the current serving cell and applies the normal cell reselection process.

The registration procedure for mobility and periodic registration update is started, if still needed, when the lower layers indicate that the barring is alleviated for the access category with which the access attempt was associated.

- ba) The lower layers indicate that access barring is applicable for all access categories except categories 0 and 2 and the access category with which the access attempt was associated is other than 0 and 2.

If the REGISTRATION REQUEST message has not been sent, the UE shall proceed as specified for case b. If the REGISTRATION REQUEST message has been sent, the UE shall proceed as specified for case e and, additionally, the registration procedure for mobility and periodic registration update is started, if still needed, when the lower layers indicate that the barring is alleviated for the access category with which the access attempt was associated. For additional UE requirements for both cases see subclause 4.5.5.

- c) T3510 timeout.

The UE shall abort the registration update procedure and the NAS signalling connection, if any, shall be released locally. The UE shall proceed as described below.

- d) REGISTRATION REJECT message, other 5GMM cause values than those treated in subclause 5.5.1.3.5, and cases of 5GMM cause value #22 and #72, if considered as abnormal cases according to subclause 5.5.1.3.5.

Upon reception of the 5GMM causes #95, #96, #97, #99 and #111 the UE should set the registration attempt counter to 5.

The UE shall proceed as described below.

- e) Lower layer failure or release of the NAS signalling connection received from lower layers before the REGISTRATION ACCEPT or REGISTRATION REJECT message is received.

The UE shall abort the registration procedure and proceed as described below.

- f) Change of cell into a new tracking area.

If a cell change into a new tracking area occurs before the registration procedure for mobility and periodic registration update is completed, the registration procedure for mobility and periodic registration update shall be aborted and re-initiated immediately. The UE shall set the 5GS update status to 5U2 NOT UPDATED.

- g) Registration procedure for mobility and periodic registration update and de-registration procedure collision.

If the UE receives a DEREGISTRATION REQUEST message before the registration procedure for mobility and periodic registration update has been completed, the registration procedure for mobility and periodic registration update shall be aborted and the de-registration procedure shall be progressed.

NOTE 2: The registration procedure for mobility and periodic registration update shall be aborted only if the DEREGISTRATION REQUEST message indicates in the access type that the access in which the registration procedure for mobility and periodic registration update was attempted shall be de-registered. Otherwise both the procedures shall be progressed.

- h) Void

- i) Transmission failure of REGISTRATION REQUEST message indication from the lower layers.

The registration procedure for mobility and periodic registration update shall be aborted and re-initiated immediately. The UE shall set the 5GS update status to 5U2 NOT UPDATED.

- j) Transmission failure of REGISTRATION COMPLETE message indication with TAI change from lower layers.

If the current TAI is not in the TAI list, the registration procedure for mobility and periodic registration update shall be aborted and re-initiated immediately. The UE shall set the 5GS update status to 5U2 NOT UPDATED.

If the current TAI is still part of the TAI list, it is up to the UE implementation how to re-run the ongoing procedure.

- k) Transmission failure of REGISTRATION COMPLETE message indication without TAI change from lower layers.

It is up to the UE implementation how to re-run the ongoing procedure.

- l) UE-initiated de-registration required.

De-registration due to removal of USIM or due to switch off:

The registration procedure for mobility and periodic registration update shall be aborted, and the UE initiated de-registration procedure shall be performed.

De-registration not due to removal of USIM and not due to switch off:

the UE initiated de-registration procedure shall be initiated after successful completion of the registration procedure for mobility and periodic registration update.

For the cases c, d and e the UE shall proceed as follows:

Timer T3510 shall be stopped if still running.

The registration attempt counter shall be incremented, unless it was already set to 5.

If the registration attempt counter is less than 5:

- if the TAI of the current serving cell is not included in the TAI list or the 5GS update status is different to 5U1 UPDATED, the UE shall start timer T3511, shall set the 5GS update status to 5U2 NOT UPDATED and change to state 5GMM-REGISTERED.ATTEMPTING-REGISTRATION-UPDATE. When timer T3511 expires and the registration update procedure is triggered again.
- if the TAI of the current serving cell is included in the TAI list, the 5GS update status is equal to 5U1 UPDATED, and the UE is not performing the registration procedure after an inter-system change from S1 mode to N1 mode, the UE shall keep the 5GS update status to 5U1 UPDATED and enter state 5GMM-REGISTERED.NORMAL-SERVICE. The UE shall start timer T3511. If in addition the REGISTRATION REQUEST message indicated "periodic registration updating" or if the registration procedure was initiated to recover the NAS signalling connection due to "RRC Connection failure" from the lower layers, none of the other reasons for initiating the registration updating procedure listed in subclause 5.5.1.3.2 was applicable, and the REGISTRATION REQUEST message did not include the MICO indication IE, the timer T3511 may be stopped when the UE enters 5GMM-CONNECTED mode.
- if the TAI of the current serving cell is included in the TAI list, the 5GS update status is equal to 5U1 UPDATED and the UE is performing the registration procedure after an inter-system change from S1 mode to N1 mode, the UE shall change the 5GS update status to 5U2 NOT UPDATED and enter state 5GMM-REGISTERED.ATTEMPTING-REGISTRATION-UPDATE. The UE shall start timer T3511.
- If the UE is operating in single registration mode, the UE shall in addition handle the EPS update status as specified in 3GPP TS 24.301 [15] for the abnormal cases when a normal or periodic tracking area updating procedure fails and the tracking area attempt counter is less than 5 and the EPS update status is different from EU1 UPDATED.

If the registration attempt counter is equal to 5

- the UE shall start timer T3502, shall set the 5GS update status to 5U2 NOT UPDATED.

- the UE shall delete the list of equivalent PLMNs and shall change to state 5GMM-REGISTERED.ATTEMPTING-REGISTRATION-UPDATE UPDATE or optionally to 5GMM-REGISTERED.PLMN-SEARCH in order to perform a PLMN selection according to 3GPP TS 23.122 [5].
- if the UE is operating in single registration mode:
  - the UE shall in addition handle the EPS update status as specified in 3GPP TS 24.301 [15] for the abnormal cases when a normal or periodic tracking area updating procedure fails and the tracking area attempt counter is equal to 5; and
  - if the UE does not change to state 5GMM-REGISTERED.PLMN-SEARCH, the UE shall attempt to select E-UTRAN radio access technology. The UE may disable N1 mode capability as specified in subclause 4.9.

#### 5.5.1.3.8 Abnormal cases on the network side

The following abnormal cases can be identified:

- a) If a lower layer failure occurs before the message REGISTRATION COMPLETE has been received from the UE and a 5G-GUTI has been assigned, the AMF shall abort the procedure, enter 5GMM-IDLE mode and shall consider both, the old and new 5G-GUTI as valid until the old 5G-GUTI can be considered as invalid by the AMF (see subclause 5.4.4.3). During this period the AMF may use the identification procedure followed by a generic UE configuration update procedure if the old 5G-GUTI is used by the UE in a subsequent message.

- b) Protocol error.

If the REGISTRATION REQUEST message has been received with a protocol error, the AMF shall return a REGISTRATION REJECT message with one of the following 5GMM cause values:

- #96 invalid mandatory information;
- #99 information element non-existent or not implemented;
- #100 conditional IE error; or
- #111 protocol error, unspecified.

- c) T3550 time out.

On the first expiry of the timer, the AMF shall retransmit the REGISTRATION ACCEPT message and shall reset and restart timer T3550. The retransmission is performed four times, i.e. on the fifth expiry of timer T3550, the registration procedure for mobility and periodic update procedure is aborted. Both, the old and new 5G-GUTI shall be considered as valid until the old 5G-GUTI can be considered as invalid by the AMF (see subclause 5.4.4.3). During this period the AMF acts as described for case a) above.

- d) REGISTRATION REQUEST with 5GS registration type IE set to "mobility registration updating" or "periodic registration updating" received after the REGISTRATION ACCEPT message has been sent and before the REGISTRATION COMPLETE message is received.
- 1) If one or more of the information elements in the REGISTRATION REQUEST message differ from the ones received within the previous REGISTRATION REQUEST message, the previously initiated registration procedure for mobility and periodic registration update shall be aborted if the REGISTRATION COMPLETE message has not been received and the new registration procedure for mobility and periodic registration update shall be progressed; or
  - 2) if the information elements do not differ, then the REGISTRATION ACCEPT message shall be resent and timer T3550 shall be restarted if an REGISTRATION COMPLETE message is expected. In that case, the retransmission counter related to timer T3550 is not incremented.
- e) More than one REGISTRATION REQUEST with 5GS registration type IE set to "mobility registration updating" or "periodic registration updating" received and no REGISTRATION ACCEPT or REGISTRATION REJECT message has been sent.
- 1) If one or more of the information elements in the REGISTRATION REQUEST message differs from the ones received within the previous REGISTRATION REQUEST message, the previously initiated registration



procedure for mobility and periodic registration update shall be aborted and the new registration procedure for mobility and periodic registration update shall be progressed; or

- 2) if the information elements do not differ, then the network shall continue with the previous registration procedure for mobility and periodic registration update and shall not treat any further this REGISTRATION REQUEST message.
- f) Lower layers indication of non-delivered NAS PDU due to handover.

If the REGISTRATION ACCEPT message or REGISTRATION REJECT message could not be delivered due to an intra AMF handover and the target TA is included in the TAI list, then upon successful completion of the intra AMF handover the AMF shall retransmit the REGISTRATION ACCEPT message or REGISTRATION REJECT message. If a failure of the handover procedure is reported by the lower layer and the N1 NAS signalling connection exists, the AMF shall retransmit the REGISTRATION ACCEPT message or REGISTRATION REJECT message.

- g) DEREGISTRATION REQUEST message received before REGISTRATION COMPLETE message is received.

If the De-registration type IE is set to "switch off":

The AMF shall abort the signalling for the registration procedure for mobility and periodic update towards the UE and shall progress the de-registration procedure as described in subclause 5.5.2.2.

NOTE: Internally in the AMF, before processing the de-registration request, the AMF can perform the necessary signalling procedures for the registration procedure for mobility and periodic update before progressing the de-registration procedure.

If the De-registration type IE is set to other type than "switch off":

The AMF shall proceed with registration procedure for mobility and periodic update and shall progress the de-registration procedure after successful completion of the registration procedure for mobility and periodic update.

- h) If the REGISTRATION REQUEST message with 5GS registration type IE indicating "periodic registration updating" is received by the new AMF which does not have the 5GMM context data related to the subscription, the new AMF may send the REGISTRATION REJECT message with 5GMM cause #10 "implicitly de-registered".

## 5.5.2 De-registration procedure

### 5.5.2.1 General

The de-registration procedure is used:

- a) by the UE to de-register for 5GS services over 3GPP access when the UE is registered over 3GPP access;
- b) by the UE to de-register for 5GS services over non-3GPP access when the UE is registered over non-3GPP access;
- c) by the UE to de-register for 5GS services over both 3GPP access and non-3GPP access when the UE is registered in the same PLMN over both accesses;
- d) by the network to inform the UE that it is deregistered for 5GS services over 3GPP access when the UE is registered over 3GPP access;
- e) by the network to inform the UE that it is deregistered for 5GS services over non-3GPP access when the UE is registered over non-3GPP access;
- f) by the network to inform the UE that it is deregistered for 5GS services over both 3GPP access and non-3GPP access when the UE is registered in the same PLMN over both accesses; and
- g) by the network to inform the UE to re-register to the network.

The de-registration procedure with appropriate de-registration type shall be invoked by the UE:

- a) if the UE is switched off; and
- b) as part of the eCall inactivity procedure defined in subclause 5.5.3.

The de-registration procedure with appropriate de-registration type shall be invoked by the network:

- a) if the network informs whether the UE should re-register to the network.

The de-registration procedure with appropriate access type shall be invoked by the UE:

- a) if the UE needs to de-register for 5GS services over 3GPP access when the UE is registered over 3GPP access;
- b) if the UE needs to de-register for 5GS services over non-3GPP access when the UE is registered over non-3GPP access; or
- c) the UE needs to de-register for 5GS services over both 3GPP access and non-3GPP access when the UE is registered in the same PLMN over both accesses.

The de-registration procedure with appropriate access type shall be invoked by the network:

- a) if the network needs to inform the UE that it is deregistered over 3GPP access when the UE is registered over 3GPP access;
- b) if the network needs to inform the UE that it is deregistered over non-3GPP access when the UE is registered over non-3GPP access; or
- c) if the network needs to inform the UE that it is deregistered over both 3GPP access and non-3GPP access when the UE is registered in the same PLMN over both accesses.

If the de-registration procedure is triggered due to USIM removal, the UE shall indicate "switch off" in the de-registration type IE.

If the de-registration procedure is requested by the network for a UE that has an emergency PDU session, the AMF shall not send a DEREGISTRATION REQUEST message to the UE and indicate to the SMF to release all non-emergency PDU sessions as specified in 3GPP TS 23.502 [9].

If the de-registration procedure for 5GS services is performed, a local release of the PDU sessions, if any, for this particular UE is performed.

The UE is allowed to initiate the de-registration procedure even if the timer T3346 is running.

**NOTE:** When the UE has no PDU sessions over non-3GPP access, or the UE moves all the PDU sessions over a non-3GPP access to a 3GPP access, the UE and the AMF need not initiate de-registration over the non-3GPP access.

The AMF shall provide the UE with a non-3GPP de-registration timer.

## 5.5.2.2 UE-initiated de-registration procedure

### 5.5.2.2.1 UE-initiated de-registration procedure initiation

The de-registration procedure is initiated by the UE by sending a DEREGISTRATION REQUEST message (see example in figure 5.5.2.2.1). The De-registration type IE included in the message indicates whether the de-registration procedure is due to a "switch off" or not. The access type included in the message indicates whether the de-registration procedure is:

- a) for 5GS services over 3GPP access when the UE is registered over 3GPP access;
- b) for 5GS services over non-3GPP access when the UE is registered over non-3GPP access; or
- c) for both 3GPP access and non-3GPP access when the UE is registered in the same PLMN over both accesses.

If the UE has a valid 5G-GUTI, the UE shall populate the 5GS mobile identity IE with the valid 5G-GUTI. If the UE does not have a valid 5G-GUTI, the UE shall populate the 5GS mobile identity IE with its SUCI as follows:

- a) if timer T3519 is not running, generate a fresh SUCI as specified in 3GPP TS 33.501 [24], send a DEREGISTRATION REQUEST message with the SUCI, start timer T3519 and store the value of the SUCI sent in the DEREGISTRATION REQUEST message; and
- b) if timer T3519 is running, send a DEREGISTRATION REQUEST message with the stored SUCI.

If the UE does not have a valid 5G-GUTI and it does not have a valid SUCI, then the UE shall populate the 5GS mobile identity IE with its PEI.

If the de-registration request is not due to switch off and the UE is in the state 5GMM-REGISTERED or 5GMM-REGISTERED-INITIATED, timer T3521 shall be started in the UE after the DEREGISTRATION REQUEST message has been sent. The UE shall enter the state 5GMM-DEREGISTERED-INITIATED.

If the UE is to be switched off, the UE shall try for a period of 5 seconds to send the DEREGISTRATION REQUEST message. During this period, the UE may be switched off as soon as the DEREGISTRATION REQUEST message has been sent.

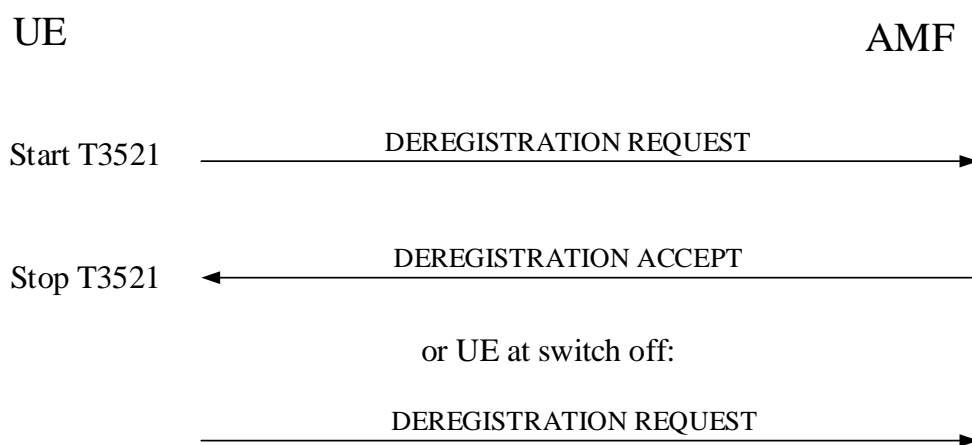

**Figure 5.5.2.2.1.1: UE-initiated de-registration procedure**

#### 5.5.2.2.2 UE-initiated de-registration procedure completion

When the DEREGISTRATION REQUEST message is received by the AMF, the AMF shall send a DEREGISTRATION ACCEPT message to the UE, if the De-registration type IE does not indicate "switch off". Otherwise, the procedure is completed when the AMF receives the DEREGISTRATION REQUEST message.

The UE, when receiving the DEREGISTRATION ACCEPT message, shall stop timer T3521, stop timer T3519 if running, and delete any stored SUCI.

#### 5.5.2.2.3 UE-initiated de-registration procedure completion for 5GS services over 3GPP access

If the access type in the DEREGISTRATION REQUEST message indicates that the de-registration procedure is for 3GPP access, the AMF shall trigger the SMF to perform a local release of the PDU session(s) established over 3GPP access, if any, for this UE. The UE shall perform a local release of the PDU session(s) established over 3GPP access, if any. The UE is marked as inactive in the AMF for 5GS services for 3GPP access. The AMF shall enter the state 5GMM-DEREGISTERED for 3GPP access.

If the UE supports N1 mode only and the de-registration request is not due to switch off, then:

- a) if the de-registration procedure was performed due to disabling of 5GS services, then the UE shall enter the 5GMM-NUL state for 3GPP access;
- b) otherwise, the UE shall enter the 5GMM-DEREGISTERED state for 3GPP access.

NOTE: Case b) is applicable when the UE is also registered over non-3GPP access.

If the UE is operating in single-registration mode, it shall additionally proceed as specified in 3GPP TS 24.301 [15], subclause 5.5.2.2.2, for the case when the UE receives an EMM message DETACH ACCEPT.

#### 5.5.2.2.4 UE-initiated de-registration procedure completion for 5GS services non-3GPP access

If the access type in the DEREGISTRATION REQUEST indicates that the de-registration procedure is for non-3GPP access, the AMF shall trigger SMF to perform a local release of the PDU session(s) established over non-3GPP access, if any, for this UE. The UE shall perform a local release of the PDU session(s) established over non-3GPP access, if any. The UE is marked as inactive in the AMF for 5GS services for non-3GPP access. The AMF shall enter the state 5GMM-DEREGISTERED over non-3GPP access.

If the de-registration request is not due to switch off, the UE shall:

- a) if the de-registration procedure was performed due to disabling of 5GS services, enter the 5GMM-NULL state for non-3GPP access;
- b) otherwise, enter the 5GMM-DEREGISTERED state for non-3GPP access.

NOTE: Case b) is applicable when the UE is also registered over 3GPP access.

#### 5.5.2.2.5 UE-initiated de-registration procedure completion for 5GS services over both 3GPP access and non-3GPP access

If the access type in the DEREGISTRATION REQUEST indicates that the de-registration procedure is for both 3GPP access and non-3GPP access when the UE is registered in the same PLMN over both accesses, the descriptions for UE-initiated de-registration procedure completion for 5GS services over 3GPP access and over non-3GPP access, as specified in subclauses 5.5.2.2.3 and 5.5.2.2.4, shall be followed.

#### 5.5.2.2.6 Abnormal cases in the UE

The following abnormal cases can be identified:

- a) Lower layer failure or release of the N1 NAS signalling connection before reception of DEREGISTRATION ACCEPT message.

The de-registration procedure shall be aborted and the UE proceeds as follows:

- 1) if the de-registration procedure was performed due to disabling of 5GS services, the UE shall enter the 5GMM-NULL state; or
  - 2) if the de-registration type "normal de-registration" was requested for reasons other than disabling of 5GS services, the UE shall enter the 5GMM-DEREGISTERED state.
- b) The lower layers indicate that the access attempt is barred.

The UE shall not start the de-registration procedure. The UE stays in the current serving cell and applies the normal cell reselection process.

The UE may perform a local de-registration either immediately or after an implementation-dependent time.

The de-registration procedure is started, if still needed, when the lower layers indicate that the barring is alleviated for the access category with which the access attempt was associated.

- ba) The lower layers indicate that access barring is applicable for all access categories except categories 0 and 2 and the access category with which the access attempt was associated is other than '0' and '2'.

If the DEREGISTRATION REQUEST message has not been sent, the UE shall proceed as specified for case b. If the DEREGISTRATION REQUEST message has been sent, the UE shall proceed as specified for case a.

- c) T3521 timeout.

On the first four expiries of the timer, the UE shall retransmit the DEREGISTRATION REQUEST message and shall reset and restart timer T3521. On the fifth expiry of timer T3521, the de-registration procedure shall be aborted and the UE proceeds as follows:

- 1) if the de-registration procedure was performed due to disabling of 5GS services, the UE shall enter the 5GMM-NULL state; or
  - 2) if the de-registration type "normal de-registration" was requested for reasons other than disabling of 5GS services, the UE shall enter the 5GMM-DEREGISTERED state.
- d) De-registration procedure collision.

De-registration containing de-registration type "switch off":

- If the UE receives a DEREGISTRATION REQUEST message before the UE-initiated de-registration procedure has been completed, this message shall be ignored and the UE-initiated de-registration procedure shall continue.

Otherwise:

- If the UE receives a DEREGISTRATION REQUEST message before the UE-initiated de-registration procedure has been completed, it shall treat the message as specified in subclause 5.5.2.3.2 with the following modification:
  - If the DEREGISTRATION REQUEST message received by the UE contains de-registration type "re-registration required", and the UE-initiated de-registration procedure is with de-registration type "normal de-registration", the UE need not initiate the registration procedure for initial registration.

- e) De-registration and 5GMM common procedure collision.

De-registration containing de-registration type "switch off":

- If the UE receives a message used in a 5GMM common procedure before the de-registration procedure has been completed, this message shall be ignored and the de-registration procedure shall continue.

Otherwise:

- If the UE receives a message used in a 5GMM common procedure before the de-registration procedure has been completed, both the 5GMM common procedure and the de-registration procedure shall continue.

- f) Change of cell into a new tracking area.

If a cell change into a new tracking area that is not in the stored TAI list occurs before the UE-initiated de-registration procedure is completed, the de-registration procedure shall be aborted and re-initiated after successfully performing a registration procedure for mobility or periodic update used for mobility (i.e. the 5GS registration type IE set to "mobility registration updating" in the REGISTRATION REQUEST message). If the de-registration procedure was initiated due to removal of the USIM or the UE is to be switched off, the UE shall abort the de-registration procedure and enter the state 5GMM-DEREGISTERED.

- g) Transmission failure of DEREGISTRATION REQUEST message indication with TAI change from lower layers.

If the current TAI is not in the TAI list, the de-registration procedure shall be aborted and re-initiated after successfully performing a registration procedure for mobility or periodic update. If the de-registration procedure was initiated due to removal of the USIM or the UE is to be switched off, the UE shall abort the de-registration procedure and enter the state 5GMM-DEREGISTERED.

If the current TAI is still part of the TAI list, the UE shall restart the de-registration procedure.

- h) Transmission failure of DEREGISTRATION REQUEST message indication without TAI change from lower layers.

The UE shall restart the de-registration procedure.

### 5.5.2.2.7 Abnormal cases in the network side

Apart from the case described in subclauses 5.5.2.2.2 and 5.5.2.2.3, no abnormal cases have been identified.

## 5.5.2.3 Network-initiated de-registration procedure

### 5.5.2.3.1 Network-initiated de-registration procedure initiation

The network initiates the de-registration procedure by sending a DEREGISTRATION REQUEST message to the UE (see example in figure 5.5.2.3.1.1).

**NOTE:** If the AMF performs a local de-registration, it will inform the UE with a 5GMM messages (e.g. SERVICE REJECT message or REGISTRATION REJECT message) with 5GMM cause #10 "implicitly de-registered" only when the UE initiates a 5GMM procedure.

The network may include a 5GMM cause IE to specify the reason for the DEREGISTRATION REQUEST message. The network shall start timer T3522. The network shall indicate whether re-registration is needed or not in the De-registration type IE. The network shall also indicate via the access type whether the de-registration procedure is:

- for 3GPP access only;
- for non-3GPP access only; or
- for both 3GPP access and non-3GPP access when the UE is registered in the same PLMN for both accesses.

The AMF shall trigger the SMF to release locally the PDU session(s) over the indicated access(es), if any, for the UE and enter state 5GMM-DEREGISTERED-INITIATED.

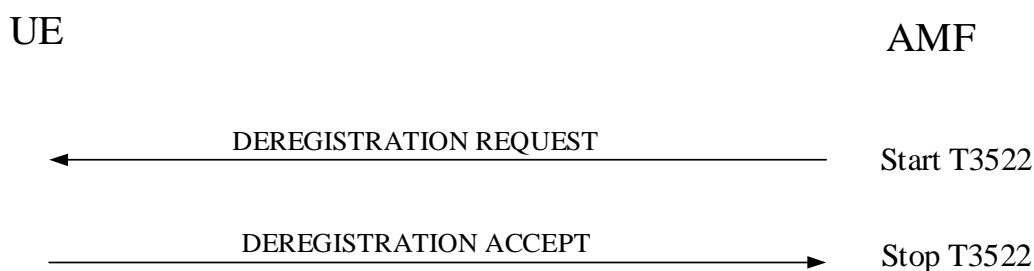

**Figure 5.5.2.3.1.1: Network-initiated de-registration procedure**

### 5.5.2.3.2 Network-initiated de-registration procedure completion by the UE

Upon receiving the DEREGISTRATION REQUEST message, if the DEREGISTRATION REQUEST message indicates "re-registration required" and the de-registration request is for 3GPP access, the UE shall perform a local release of the PDU sessions over 3GPP access, if any. The UE shall stop the timer(s) T3346, T3396, T3584 and T3585, if it is running for the current PLMN. The UE shall send a DEREGISTRATION ACCEPT message to the network and enter the state 5GMM-DEREGISTERED for 3GPP access. Furthermore, the UE shall, after the completion of the de-registration procedure, and the release of the existing NAS signalling connection, initiate an initial registration. The UE should also re-establish any previously established PDU sessions over 3GPP access.

Upon receiving the DEREGISTRATION REQUEST message, if the DEREGISTRATION REQUEST message indicates "re-registration required" and the de-registration request is for non-3GPP access, the UE shall perform a local release of the PDU sessions over non-3GPP access, if any. The UE shall stop the timer(s) T3346, T3396, T3584 and T3585, if it is running for the current PLMN. The UE shall send a DEREGISTRATION ACCEPT message to the network and enter the state 5GMM-DEREGISTERED for non-3GPP access. Furthermore, the UE shall, after the completion of the de-registration procedure, and the release of the existing NAS signalling connection, initiate an initial registration over non-3GPP. The UE should also re-establish any previously established PDU sessions over non-3GPP access.

Upon receiving the DEREGISTRATION REQUEST message, if the DEREGISTRATION REQUEST message indicates "re-registration required" and the de-registration request is for both 3GPP access and non-3GPP access when

the UE is registered in the same PLMN for both accesses, the UE shall perform a local release of the PDU sessions over both 3GPP access and non-3GPP access, if any. The UE shall stop the timer(s) T3346, T3396, T3584 and T3585, if it is running for the current PLMN. The UE shall send a DEREGISTRATION ACCEPT message to the network and enter the state 5GMM-DEREGISTERED for both 3GPP access and non-3GPP access. Furthermore, the UE shall, after the completion of the de-registration procedure, and the release of the existing NAS signalling connection, initiate an initial registration over both 3GPP access and non-3GPP access. The UE should also re-establish any previously established PDU sessions over both 3GPP access and non-3GPP access.

NOTE 1: When the de-registration type indicates "re-registration required", user interaction is necessary in some cases when the UE cannot re-establish the PDU session (s), if any, automatically.

Upon receiving the DEREGISTRATION REQUEST message, if the DEREGISTRATION REQUEST message indicates "re-registration not required" and the de-registration request is for 3GPP access, the UE shall perform a local release of the PDU sessions over 3GPP access, if any. The UE shall send a DEREGISTRATION ACCEPT message to the network and enter the state 5GMM-DEREGISTERED for 3GPP access.

Upon receiving the DEREGISTRATION REQUEST message, if the DEREGISTRATION REQUEST message indicates "re-registration not required" and the de-registration request is for non-3GPP access, the UE shall perform a local release of the PDU sessions over non-3GPP access, if any. The UE shall send a DEREGISTRATION ACCEPT message to the network and enter the state 5GMM-DEREGISTERED for non-3GPP access.

Upon receiving the DEREGISTRATION REQUEST message, if the DEREGISTRATION REQUEST message indicates "re-registration not required" and the de-registration request is for both 3GPP access and non-3GPP access when the UE is registered in the same PLMN for both accesses, the UE shall perform a local release of the PDU sessions over both 3GPP access and non-3GPP access, if any. The UE shall send a DEREGISTRATION ACCEPT message to the network and enter the state 5GMM-DEREGISTERED for both 3GPP access and non-3GPP access.

Upon sending a DEREGISTRATION ACCEPT message, the UE shall delete the rejected NSSAI as specified in subclause 4.6.2.2.

If the de-registration type indicates "re-registration required", then the UE shall ignore the 5GMM cause IE if received.

If the de-registration type indicates "re-registration not required", the UE shall take the actions depending on the received 5GMM cause value:

#3 (Illegal UE); or

#6 (Illegal ME).

The UE shall set the 5GS update status to 5U3 ROAMING NOT ALLOWED (and shall store it according to subclause 5.1.3.2.2) and shall delete any 5G-GUTI, last visited registered TAI, TAI list and ngKSI. The UE shall consider the USIM as invalid for 5GS services until switching off or the UICC containing the USIM is removed. The UE shall delete the list of equivalent PLMNs and shall enter the state 5GMM-DEREGISTERED.

If the UE is operating in single-registration mode, the UE shall handle the EMM parameters EMM state, EPS update status, 4G-GUTI, TAI list and eKSI as specified in 3GPP TS 24.301 [15] for the case when a DETACH REQUEST is received with the EMM cause with the same value and with detach type set to "re-attach not required". The USIM shall be considered as invalid also for non-EPS services until switching off or the UICC containing the USIM is removed.

If the UE also supports the registration procedure over the other access, the UE shall in addition handle 5GMM parameters and 5GMM state for this access, as described for this 5GMM cause value.

#7 (5GS services not allowed).

The UE shall set the 5GS update status to 5U3 ROAMING NOT ALLOWED (and shall store it according to subclause 5.1.3.2.2) and shall delete any 5G-GUTI, last visited registered TAI, TAI list and ngKSI. The UE shall consider the USIM as invalid for 5GS services until switching off or the UICC containing the USIM is removed. The UE shall delete the list of equivalent PLMNs and shall enter the state 5GMM-DEREGISTERED.

If the UE is operating in single-registration mode, the UE shall handle the EMM parameters EMM state, EPS update status, 4G-GUTI, last visited registered TAI, TAI list and eKSI as specified in 3GPP TS 24.301 [15] for the case when a DETACH REQUEST is received with the EMM cause with the same value and with detach type set to "re-attach not required".

If the UE also supports the registration procedure over the other access, the UE shall in addition handle 5GMM parameters and 5GMM state for this access, as described for this 5GMM cause value.

#11 (PLMN not allowed).

The UE shall set the 5GS update status to 5U3 ROAMING NOT ALLOWED (and shall store it according to subclause 5.1.3.2.2) and shall delete any 5G-GUTI, last visited registered TAI, TAI list and ngKSI. The UE shall delete the list of equivalent PLMNs, shall reset the registration attempt counter and enter the state 5GMM-DEREGISTERED.PLMN-SEARCH.

The UE shall store the PLMN identity in the "forbidden PLMN list".

The UE shall perform a PLMN selection according to 3GPP TS 23.122 [5].

If the UE is operating in single-registration mode, the UE shall handle the EMM parameters EMM state, EPS update status, 4G-GUTI, TAI list, eKSI and attach attempt counter as specified in 3GPP TS 24.301 [15] for the case when a DETACH REQUEST is received with the EMM cause with the same value and with detach type set to "re-attach not required".

If the UE also supports the registration procedure over the other access to the same PLMN, the UE shall in addition handle 5GMM parameters and 5GMM state for this access, as described for this 5GMM cause value.

#12 (Tracking area not allowed).

The UE shall set the 5GS update status to 5U3 ROAMING NOT ALLOWED (and shall store it according to subclause 5.1.3.2.2) and shall delete 5G-GUTI, last visited registered TAI, TAI list and ngKSI. The UE shall reset the registration attempt counter and shall enter the state 5GMM-DEREGISTERED.LIMITED-SERVICE.

The UE shall store the current TAI in the list of "5GS forbidden tracking areas for regional provision of service".

If the UE is operating in single-registration mode, the UE shall handle the EMM parameters, EMM state, EPS update status, 4G-GUTI, TAI list, eKSI and attach attempt counter as specified in 3GPP TS 24.301 [15] for the case when a DETACH REQUEST is received with the EMM cause with the same value and with detach type set to "re-attach not required".

#13 (Roaming not allowed in this tracking area).

The UE shall set the 5GS update status to 5U3 ROAMING NOT ALLOWED (and shall store it according to subclause 5.1.3.2.2) and shall delete 5G-GUTI, last visited registered TAI, TAI list and ngKSI. The UE shall delete the list of equivalent PLMNs, reset the registration attempt counter and shall change to state 5GMM-DEREGISTERED.PLMN-SEARCH.

The UE shall store the current TAI in the list of "5GS forbidden tracking areas for roaming".

The UE shall perform a PLMN selection according to 3GPP TS 23.122 [5].

If the UE is operating in single-registration mode, the UE shall handle the EMM parameters EMM state, EPS update status, 4G-GUTI, TAI list, eKSI and attach attempt counter as specified in 3GPP TS 24.301 [15] for the case when a DETACH REQUEST is received with the EMM cause with the same value and with detach type set to "re-attach not required".

#15 (No suitable cells in tracking area).

The UE shall set the 5GS update status to 5U3 ROAMING NOT ALLOWED (and shall store it according to subclause 5.1.3.2.2) and shall delete any 5G-GUTI, last visited registered TAI, TAI list and ngKSI. The UE shall reset the registration attempt counter and shall enter the state 5GMM-DEREGISTERED.LIMITED-SERVICE.

The UE shall store the current TAI in the list of "5GS forbidden tracking areas for roaming".

The UE shall search for a suitable cell in another tracking area according to 3GPP TS 38.304 [28].

If the UE is operating in single-registration mode, the UE shall handle the EMM parameters EMM state, EPS update status, 4G-GUTI, TAI list, eKSI and attach attempt counter as specified in 3GPP TS 24.301 [15] for the case when a DETACH REQUEST is received with the EMM cause with the same value and with detach type set to "re-attach not required".



#22 (Congestion).

The UE shall stop timer T3346 if it is running and shall set the 5GS update status to 5U2 NOT UPDATED and shall enter the state 5GMM-DEREGISTERED.ATTEMPTING-REGISTRATION.

If the T3346 value IE is present in the DEREGISTRATION REQUEST message and the value indicates that this timer is neither zero nor deactivated, the UE shall start timer T3346 with the value provided in the T3346 value IE.

#27 (N1 mode not allowed).

The UE shall set the 5GS update status to 5U3 ROAMING NOT ALLOWED (and shall store it according to subclause 5.1.3.2.2) and shall delete any 5G-GUTI, last visited registered TAI, TAI list and ngKSI. Additionally, the UE shall reset the registration attempt counter and shall enter the state 5GMM-NULL.

The UE shall disable the N1 mode capability for both 3GPP access and non-3GPP access (see subclause 4.9).

#72 (Non-3GPP access to 5GCN not allowed).

If received over non-3GPP access when the UE is registered over non-3GPP access, the UE shall set the 5GS update status to 5U3 ROAMING NOT ALLOWED (and shall store it according to subclause 5.1.3.2.2) and shall delete 5G-GUTI, last visited registered TAI, TAI list and ngKSI for non-3GPP access. Additionally, the UE shall reset the registration attempt counter and enter the state 5GMM-DEREGISTERED for non-3GPP access.

NOTE 2: The 5GMM sublayer states, the 5GMM parameters and the registration status are managed per access type independently, i.e. 3GPP access or non-3GPP access (see subclauses 4.7.2 and 5.1.3).

The UE shall disable the N1 mode capability for non-3GPP access (see subclause 4.9.3).

As an implementation option, if the UE is not currently registered over 3GPP access, the UE may enter the state 5GMM-DEREGISTERED.PLMN-SEARCH in order to perform a PLMN selection according to 3GPP TS 23.122 [5].

If received over 3GPP access the cause shall be considered as an abnormal case and the behaviour of the UE for this case is specified in subclause 5.5.2.3.4.

### 5.5.2.3.3 Network-initiated de-registration procedure completion by the network

The network shall stop timer T3522 upon receipt of the DEREGISTRATION ACCEPT message. The network shall enter state 5GMM-DEREGISTERED for 3GPP access if the de-registration request is for 3GPP access. The network shall enter state 5GMM-DEREGISTERED for non-3GPP access if the de-registration request is for non-3GPP access. The network shall enter state 5GMM-DEREGISTERED for both 3GPP access and non-3GPP access if the de-registration request is for both 3GPP access and non-3GPP access.

### 5.5.2.3.4 Abnormal cases in the UE

The following abnormal cases can be identified:

- a) Transmission failure of DEREGISTRATION ACCEPT message indication from lower layers.

The de-registration procedure shall be progressed and the UE shall send the DEREGISTRATION ACCEPT message.

- b) DEREGISTRATION REQUEST, other 5GMM cause values than those treated in subclause 5.5.2.3.2, cases of 5GMM cause value #72 that are considered as abnormal cases according to subclause 5.5.2.3.2 or no 5GMM cause IE is included, and the De-registration type IE indicates "re-registration not required".

The UE shall delete 5G-GUTI, TAI list, last visited registered TAI, list of equivalent PLMNs, ngKSI, shall set the 5GS update status to 5U2 NOT UPDATED and shall start timer T3502.

A UE not supporting S1 mode may enter the state 5GMM-DEREGISTERED.PLMN-SEARCH in order to perform a PLMN selection according to 3GPP TS 23.122 [5]; otherwise the UE shall enter the state 5GMM-DEREGISTERED.ATTEMPTING-REGISTRATION.

A UE operating in single-registration mode shall:

- enter the state 5GMM-DEREGISTERED and attempt to select E-UTRAN radio access technology and proceed with the appropriate EMM specific procedures. In this case, the UE may disable N1 mode capability (see subclause 4.9); or
- enter the state 5GMM-DEREGISTERED.PLMN-SEARCH in order to perform a PLMN selection according to 3GPP TS 23.122 [5].

A UE operating in single-registration mode shall set the EPS update status to EU2 NOT UPDATED and shall delete the EMM parameters 4G-GUTI, TAI list and eKSI and shall enter the state EMM-DEREGISTERED.

### 5.5.2.3.5 Abnormal cases in the network side

The following abnormal cases can be identified:

a) T3522 time-out

On the first expiry of the timer, the network shall retransmit the DEREGISTRATION REQUEST message and shall start timer T3522. This retransmission is repeated four times, i.e. on the fifth expiry of timer T3522, the de-registration procedure shall be aborted. The network shall change to the state 5GMM-DEREGISTERED for the access type which the de-registration procedure is intended for.

b) Lower layer failure

The de-registration procedure is aborted. The network shall change to the state 5GMM-DEREGISTERED for the access type which the de-registration procedure is intended for.

c) De-registration procedure collision

If the network receives a DEREGISTRATION REQUEST message with "switch off" indication, before the network-initiated de-registration procedure has been completed, both procedures shall be considered completed.

If the network receives a DEREGISTRATION REQUEST message without "switch off" indication, before the network-initiated de-registration procedure has been completed, the network shall send a DEREGISTRATION ACCEPT message to the UE.

d) De-registration and registration procedure for initial registration collision

If the network receives a REGISTRATION REQUEST message indicating either "initial registration" or "emergency registration" in the 5GS registration type IE before the network-initiated de-registration procedure has been completed, the network shall abort the de-registration procedure and the registration procedure shall be progressed after the PDU sessions associated with the access type the REGISTRATION REQUEST message is sent over have been deleted.

e) De-registration and registration procedure for mobility and periodic registration update collision

If the network sent a DEREGISTRATION REQUEST message and the network receives a REGISTRATION REQUEST message indicating either "mobility registration updating" or "periodic registration updating" in the 5GS registration type IE before the network-initiated de-registration procedure has been completed, the de-registration procedure shall be progressed, i.e. the REGISTRATION REQUEST message shall be ignored.

f) De-registration and service request procedure collision

If the network receives a SERVICE REQUEST message before the network-initiated de-registration procedure has been completed (e.g. the DEREGISTRATION REQUEST message is pending to be sent to the UE), the network shall progress the de-registration procedure.

## 5.5.3 eCall inactivity procedure

The eCall inactivity procedure is performed only in 3GPP access and applicable only to a UE configured for eCall only mode as specified in 3GPP TS 31.102 [22]. The procedure shall be started when:

- a) the UE is in any 5GMM-REGISTERED substate except substates 5GMM-REGISTERED.PLMN-SEARCH or 5GMM-REGISTERED.NO-CELL-AVAILABLE;
- b) the UE is in 5GMM-IDLE mode; and

c) one of the following conditions applies:

- 1) timer T3444 expires or is found to have already expired and timer T3445 is not running;
- 2) timer T3445 expires or is found to have already expired and timer T3444 is not running; or
- 3) timers T3444 and T3445 expire or are found to have already expired.

The UE shall then perform the following actions:

- a) stop other running timers (e.g. T3511, T3512);
- b) if the UE is currently registered to the network for 5GS services, perform a de-registration procedure;
- c) delete any 5G-GUTI, TAI list, last visited registered TAI, list of equivalent PLMNs, and ngKSI; and
- d) enter 5GMM-DEREGISTERED.eCALL-INACTIVE state.

## 5.6 5GMM connection management procedures

### 5.6.1 Service request procedure

#### 5.6.1.1 General

The purpose of the service request procedure is to change the 5GMM mode from 5GMM-IDLE to 5GMM-CONNECTED mode, and/or to request the establishment of user-plane resources for PDU sessions which are established without user-plane resources. In latter case, the 5GMM mode can be the 5GMM-IDLE mode or the 5GMM-CONNECTED mode if the UE requires to establish user-plane resources for PDU sessions.

NOTE 1: The lower layer indicates when the user-plane resources for PDU sessions are successfully established or released.

This procedure is used when:

- the network has downlink signalling pending over 3GPP access and the UE is in 5GMM-IDLE mode over 3GPP access;
- the network has downlink signalling pending over non-3GPP access, the UE is in 5GMM-IDLE mode over non-3GPP access and in 5GMM-IDLE or 5GMM-CONNECTED mode over 3GPP access;
- the UE has uplink signalling pending over 3GPP access and the UE is in 5GMM-IDLE mode over 3GPP access;
- the network has downlink user data pending over 3GPP access and the UE is in 5GMM-IDLE mode over 3GPP access;
- the network has downlink user data pending over non-3GPP access, the UE is in 5GMM-IDLE mode over non-3GPP access and in 5GMM-IDLE or 5GMM-CONNECTED mode over 3GPP access;
- the UE has user data pending over 3GPP access and the UE is in 5GMM-IDLE or 5GMM-CONNECTED mode over 3GPP access;
- the UE has user data pending over non-3GPP access and the UE is in 5GMM-CONNECTED mode over non-3GPP access;
- the UE in 5GMM-IDLE mode over non-3GPP access, receives an indication from the lower layers of non-3GPP access, that the access stratum connection is established between UE and network; or
- the UE in 5GMM-IDLE or 5GMM-CONNECTED mode over 3GPP access receives a request for emergency services fallback from the upper layer and performs emergency services fallback as specified in subclause 4.13.4.2 of 3GPP TS 23.502 [9].

This procedure shall not be used for initiating user data transfer or PDU session management related signalling other than for performing UE-requested PDU session release procedure related to a PDU session for LADN when the UE is located outside the LADN service area.

The service request procedure is initiated by the UE, however, it can be triggered by the network by means of:

- the paging procedure (see subclause 5.6.2) for the transfer of downlink signalling or user data pending over 3GPP access to a UE in 5GMM-IDLE mode over 3GPP access;
- the paging procedure (see subclause 5.6.2) for the transfer of downlink signalling or user data pending over non-3GPP access to a UE in 5GMM-IDLE mode over 3GPP access and in 5GMM-IDLE mode over non-3GPP access;
- the notification procedure (see subclause 5.6.3) for the transfer of downlink signalling or user data pending over non-3GPP access to a UE in 5GMM-CONNECTED mode over 3GPP access and in 5GMM-IDLE mode over non-3GPP access; or
- the notification procedure (see subclause 5.6.3) for the transfer of downlink signalling or user data pending over 3GPP access to a UE in 5GMM-IDLE mode over 3GPP access and in 5GMM-CONNECTED mode over non-3GPP access.

NOTE 2: In case the UE is in 5GMM-IDLE mode over 3GPP access and in 5GMM-CONNECTED mode over non-3GPP access and downlink signalling or user data pending over 3GPP access needs to be transferred, the AMF can trigger either the notification procedure or the paging procedure based on implementation.

The UE shall invoke the service request procedure when:

- a) the UE, in 5GMM-IDLE mode over 3GPP access, receives a paging request from the network;
- b) the UE, in 5GMM-CONNECTED mode over 3GPP access, receives a notification from the network with access type indicating non-3GPP access;
- c) the UE, in 5GMM-IDLE mode over 3GPP access, has uplink signalling pending;
- d) the UE, in 5GMM-IDLE mode over 3GPP access, has uplink user data pending;
- e) the UE, in 5GMM-CONNECTED mode or in 5GMM-CONNECTED mode with RRC inactive indication, has user data pending due to no user-plane resources established for PDU session(s) used for user data transport;
- f) the UE in 5GMM-IDLE mode over non-3GPP access, receives an indication from the lower layers of non-3GPP access, that the access stratum connection is established between UE and network;
- g) the UE, in 5GMM-IDLE mode over 3GPP access, receives a notification from the network with access type indicating 3GPP access when the UE is in 5GMM-CONNECTED mode over non-3GPP access;
- h) the UE, in 5GMM-IDLE, 5GMM-CONNECTED mode over 3GPP access, or 5GMM-CONNECTED mode with RRC inactive indication, receives a request for emergency services fallback from the upper layer and performs emergency services fallback as specified in subclause 4.13.4.2 of 3GPP TS 23.502 [9]; or
- i) the UE, in 5GMM-CONNECTED mode over 3GPP access or in 5GMM-CONNECTED mode with RRC inactive indication, receives a fallback indication from the lower layers (see subclauses 5.3.1.2 and 5.3.1.4) and or the UE has a pending NAS procedure other than a registration, service request, or de-registration procedure.

If one of the above criteria to invoke the service request procedure is fulfilled, then the service request procedure shall only be initiated by the UE when the following conditions are fulfilled:

- its 5GS update status is 5U1 UPDATED, and the TAI of the current serving cell is included in the TAI list; and
- no 5GMM specific procedure is ongoing.

The UE shall not invoke the service request procedure when the UE is in the state 5GMM-SERVICE-REQUEST-INITIATED.

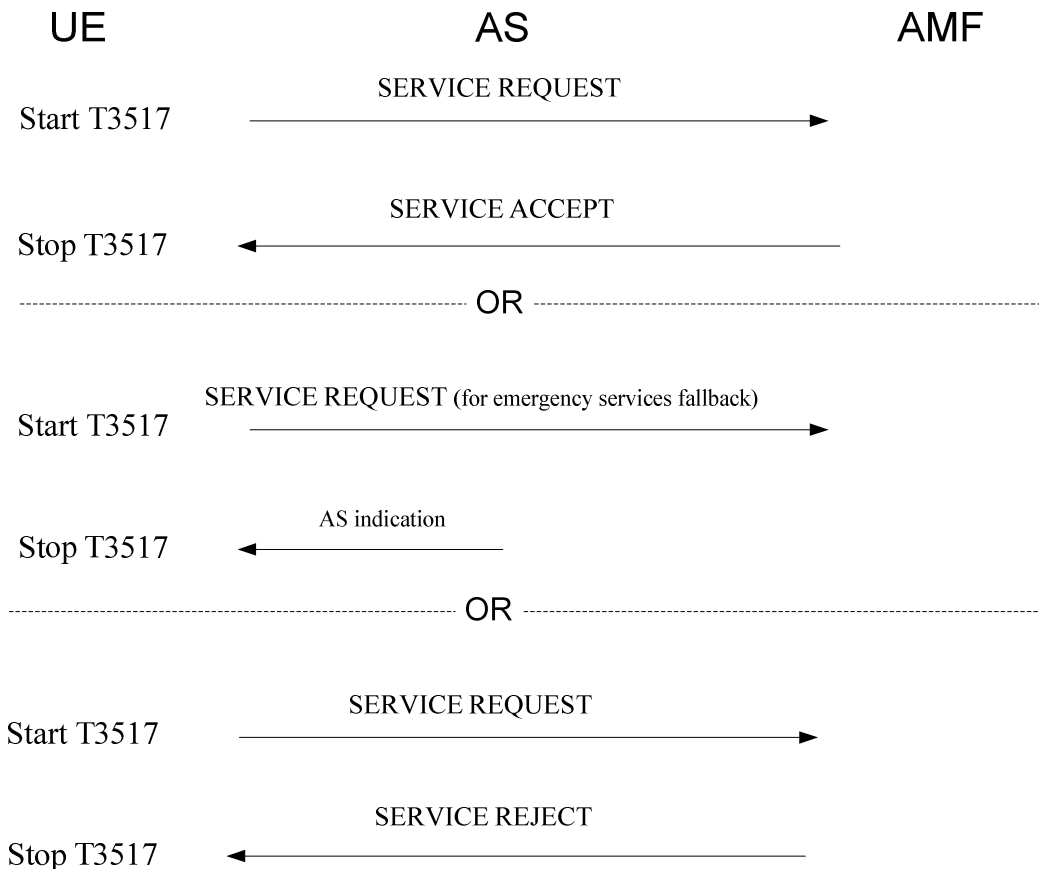

**Figure 5.6.1.1.1: Service Request procedure**

A service request attempt counter is used to limit the number of service request attempts and no response from the network. The service request attempt counter shall be incremented as specified in subclause 5.6.1.7.

The service request attempt counter shall be reset when:

- a registration procedure for mobility and periodic registration update is successfully completed;
- a service request procedure is successfully completed; or
- a service request procedure is rejected as specified in subclause 5.6.1.5.

### 5.6.1.2 Service request procedure initiation

The UE initiates the service request procedure by sending a SERVICE REQUEST message to the AMF and starts timer T3517.

If the UE is sending the SERVICE REQUEST message from 5GMM-IDLE mode and the UE needs to send non-clear text IEs, the UE shall send the SERVICE REQUEST message including the NAS message container IE as described in subclause 4.4.6.

For cases a), b), and g) in subclause 5.6.1.1, the service type IE in the SERVICE REQUEST message shall be set to "mobile terminated services".

For cases c), d), e), f), and i) in subclause 5.6.1.1, if the UE is a UE configured for high priority access in selected PLMN, the service type IE in the SERVICE REQUEST message shall be set to "high priority access".

For case a) in subclause 5.6.1.1:

- a) if the paging request includes an indication for non-3GPP access type, the Allowed PDU session status IE shall be included in the SERVICE REQUEST message. If the UE has established the PDU session(s) associated with the S-NSSAI(s) which are included in the allowed NSSAI for 3GPP access, the UE shall indicate the PDU

session(s) for which the UE allows the user-plane resources to be re-established over 3GPP access in the Allowed PDU session status IE. Otherwise, the UE shall not indicate any PDU session(s) in the Allowed PDU session status IE;

- b) if the UE has uplink user data pending to be sent over 3GPP access, the Uplink data status IE shall be included in the SERVICE REQUEST message to indicate the PDU session(s) for which the UE has pending user data to be sent; or
- c) otherwise, the Uplink data status IE shall not be included in the SERVICE REQUEST message.

For case b) in subclause 5.6.1.1:

- a) the Allowed PDU session status IE shall be included in the SERVICE REQUEST message. If the UE has the PDU session(s) associated with the S-NSSAI(s) which are included in the allowed NSSAI for 3GPP access, the UE shall indicate the PDU session(s) for which the UE allows the user-plane resources to be re-established over 3GPP access in the Allowed PDU session status IE. Otherwise, the UE shall not indicate any PDU session(s) in the Allowed PDU session status IE;
- b) if the UE has uplink user data pending to be sent over 3GPP access, the Uplink data status IE shall be included in the SERVICE REQUEST message to indicate the PDU session(s) for which the UE has pending user data to be sent;
- c) otherwise, the Uplink data status IE shall not be included in the SERVICE REQUEST message.

When the Allowed PDU session status IE is included in the SERVICE REQUEST message, the UE shall indicate that a PDU session is not allowed to be transferred to the 3GPP access if the 3GPP PS data off UE status is "activated" for the corresponding PDU session and the UE is not using the PDU session to send uplink IP packets for any of the 3GPP PS data off exempt services (see subclause 6.2.10).

For case c) in subclause 5.6.1.1, the Uplink data status IE shall not be included in the SERVICE REQUEST message except if the UE has one or more active always-on PDU sessions associated with the access type over which the SERVICE REQUEST message is sent. If the UE is not a UE configured for high priority access in selected PLMN and:

- a) if the SERVICE REQUEST message is triggered by a request for emergency services from the upper layer, the UE shall set the service type IE in the SERVICE REQUEST message to "emergency services"; or
- b) otherwise, the UE shall set the service type IE to "signalling".

When the UE is in a non-allowed area or is not in an allowed area as specified in subclause 5.3.5 and:

- a) if the uplink signalling pending is to indicate a change of 3GPP PS data off UE status for a PDU session, the UE shall set the service type IE in the SERVICE REQUEST message to "elevated signalling", and shall not include the Uplink data status IE in the SERVICE REQUEST message even if the UE has one or more active always-on PDU sessions associated with the access type over which the SERVICE REQUEST message is sent; or
- b) otherwise, the UE shall not initiate service request procedure except for emergency services, high priority access or responding to paging or notification.

For cases d) and e) in subclause 5.6.1.1, the Uplink data status IE shall be included in the SERVICE REQUEST message to indicate the PDU session(s) the UE has pending user data to be sent. If the UE is not a UE configured for high priority access in selected PLMN:

- a) if there exists an emergency PDU session which is indicated in the Uplink data status IE the service type IE in the SERVICE REQUEST message shall be set to "emergency services"; or
- b) otherwise, the service type IE in the SERVICE REQUEST message shall be set to "data".

For case f) in subclause 5.6.1.1:

- a) if the UE has uplink user data pending to be sent, the Uplink data status IE shall be included in the SERVICE REQUEST message to indicate the PDU session(s) the UE has pending user data to be sent. If the UE is not a UE configured for high priority access in selected PLMN, the service type IE in the SERVICE REQUEST message shall be set to "data";
- b) otherwise, if the UE is not a UE configured for high priority access in selected PLMN, the service type IE in the SERVICE REQUEST message shall be set to "signalling".

For case g) in subclause 5.6.1.1, if the UE has uplink user data pending to be sent, the Uplink data status IE shall be included in the SERVICE REQUEST message to indicate the PDU session(s) the UE has pending user data to be sent.

For case h) in subclause 5.6.1.1, the UE shall send a SERVICE REQUEST message with service type set to "emergency services fallback".

For case i) in subclause 5.6.1.1, if the UE is not configured for high priority access in selected PLMN, the UE shall set the Service type IE in the SERVICE REQUEST message as follows:

- a) if the pending message is an UL NAS TRANSPORT message with the Request type IE set to "initial emergency request" or "existing emergency PDU session", the UE shall set the Service type IE in the SERVICE REQUEST message to "emergency services"; or
- b) otherwise, the UE shall set the Service type IE in the SERVICE REQUEST message to "signalling".

The UE shall include a valid 5G-S-TMSI in the 5G-S-TMSI IE of the SERVICE REQUEST message.

If the UE has one or more active always-on PDU sessions associated with the access type over which the SERVICE REQUEST message is sent and the user-plane resources for these PDU sessions are not established, the UE shall include the Uplink data status IE in the SERVICE REQUEST message and indicate that the UE has pending user data to be sent for those PDU sessions.

If the UE has one or more active PDU sessions which are not accepted by the network as always-on PDU sessions and no uplink user data pending to be sent for those PDU sessions, the UE shall not include those PDU sessions in the Uplink data status IE in the SERVICE REQUEST message.

The Uplink data status IE may be included in the SERVICE REQUEST message to indicate which PDU session(s) associated with the access type the SERVICE REQUEST message is sent over have pending user data to be sent.

The PDU session status information element may be included in the SERVICE REQUEST message to indicate the PDU session(s) available in the UE associated with the access type the SERVICE REQUEST message is sent over.

If the SERVICE REQUEST message includes a NAS message container IE, the AMF shall process the SERVICE REQUEST message that is obtained from the NAS message container IE as described in subclause 4.4.6.

If the PDU session status information element is included in the SERVICE REQUEST message, then the AMF shall perform a local release of all those PDU sessions which are in active on the AMF side associated with the access type the SERVICE REQUEST message is sent over, but are indicated by the UE as being inactive, and shall request the SMF to perform a local release of all those PDU sessions.

If the UE has an emergency PDU session over the non-current access, it shall not initiate the SERVICE REQUEST message with the service type IE set to "emergency services" over the current access, unless the SERVICE REQUEST message has to be initiated to perform handover of an existing emergency PDU session from the non-current access to the current access.

NOTE: Transfer of an existing emergency PDU session between 3GPP access and non-3GPP access is needed e.g. if the UE determines that the current access is no longer available.

### 5.6.1.3 Common procedure initiation

Upon receipt of the SERVICE REQUEST message, the AMF may initiate the common procedures e.g. the 5G AKA based primary authentication and key agreement procedure or the EAP based primary authentication and key agreement procedure.

### 5.6.1.4 Service request procedure accepted by the network

For cases other than h) in subclause 5.6.1.1, the UE shall treat the reception of the SERVICE ACCEPT message as successful completion of the procedure. The UE shall reset the service request attempt counter, stop timer T3517 and enter the state 5GMM-REGISTERED.

For case h) in subclause 5.6.1.1, the UE shall treat the indication from the lower layers when the UE has changed to S1 mode or E-UTRA connected to 5GCN (see 3GPP TS 23.502 [9]) as successful completion of the procedure and stop timer T3517.

If the AMF needs to initiate PDU session status synchronization or a PDU session status IE was included in the SERVICE REQUEST message, the AMF shall include a PDU session status IE in the SERVICE ACCEPT message to indicate which PDU sessions associated with the access type the SERVICE ACCEPT message is sent over are active in the AMF. If the PDU session status information element is included in the SERVICE ACCEPT message, then the UE shall perform a local release of all those PDU sessions which are in active on the UE side associated with the access type the SERVICE ACCEPT message is sent over, but are indicated by the AMF as being inactive.

If the Uplink data status IE is included in the SERVICE REQUEST message, the AMF shall:

- a) indicate the SMF to re-establish the user-plane resources for the corresponding PDU sessions;
- b) include the PDU session reactivation result IE in the SERVICE ACCEPT message to indicate the user-plane resources re-establishment result of the PDU sessions for which the UE requested to re-establish the user-plane resources; and
- c) determine the UE presence in LADN service area and forward the UE presence in LADN service area towards the SMF, if the corresponding PDU session is a PDU session for LADN.

If the Allowed PDU session status IE is included in the SERVICE REQUEST message, the AMF shall:

- a) for a 5GSM message from each SMF that has indicated pending downlink signalling only, forward the received 5GSM message via 3GPP access to the UE after the SERVICE ACCEPT message is sent;
- b) for each SMF that has indicated pending downlink data only:
  - 1) notify the SMF that reactivation of the user-plane resources for the corresponding PDU session(s) associated with non-3GPP access cannot be performed if the corresponding PDU session ID(s) are not indicated in the Allowed PDU session status IE; and
  - 2) notify the SMF that reactivation of the user-plane resources for the corresponding PDU session(s) associated with non-3GPP access can be performed if the corresponding PDU session ID(s) are indicated in the Allowed PDU session status IE.
- c) for each SMF that have indicated pending downlink signalling and data:
  - 1) notify the SMF that reactivation of the user-plane resources for the corresponding PDU session(s) associated with non-3GPP access cannot be performed if the corresponding PDU session ID(s) are not indicated in the Allowed PDU session status IE;
  - 2) notify the SMF that reactivation of the user-plane resources for the corresponding PDU session(s) associated with non-3GPP access can be performed if the corresponding PDU session ID(s) are indicated in the Allowed PDU session status IE; and
  - 3) discard the received 5GSM message for PDU session(s) associated with non-3GPP access; and
- d) include the PDU session reactivation result IE in the SERVICE ACCEPT message to indicate the successfully re-established user-plane resources for the corresponding PDU sessions, if any.

If the PDU session reactivation result IE is included in the SERVICE ACCEPT message indicating that the user-plane resources have been successfully reactivated for a PDU session that was requested by the UE in the Allowed PDU session status IE, the UE considers the corresponding PDU session to be associated with the 3GPP access. If the user-plane resources of a PDU session have been successfully reactivated over the 3GPP access, the AMF and SMF update the associated access type of the corresponding PDU session.

If the AMF has included the PDU session reactivation result IE in the SERVICE ACCEPT message and there exist one or more PDU sessions for which the user-plane resources cannot be re-established, then the AMF may include the PDU session reactivation result error cause IE to indicate the cause of failure to re-establish the user-plane resources.

If the user-plane resources cannot be established for a PDU session, the AMF shall include the PDU session reactivation result IE in the SERVICE ACCEPT message indicating that user-plane resources for the corresponding PDU session cannot be re-established, and shall include the PDU session reactivation result error cause IE with the 5GMM cause set to:

- a) #43 "LADN not available" if the user-plane resources cannot be established because the SMF indicated to the AMF that the UE is located out of the LADN service area (see 3GPP TS 29.502 [20A]);



- b) #28 "restricted service area" if the user-plane resources cannot be established because the SMF indicated to the AMF that only prioritized services are allowed (see 3GPP TS 29.502 [20A]); or
- c) #92 "insufficient user-plane resources for the PDU session" if the user-plane resources cannot be established because the SMF indicated to the AMF that the resource is not available in the UPF (see 3GPP TS 29.502 [20A]).

NOTE: It is up to UE implementation when to re-send a request for user-plane re-establishment for the associated PDU session after receiving a PDU session reactivation result error cause IE with a 5GMM cause set to #92 "insufficient user-plane resources for the PDU session".

If the SERVICE REQUEST message is for emergency services fallback, the AMF triggers the emergency services fallback procedure as specified in subclause 4.13.4.2 of 3GPP TS 23.502 [9].

### 5.6.1.5 Service request procedure not accepted by the network

If the service request cannot be accepted, the network shall return a SERVICE REJECT message to the UE including an appropriate 5GMM cause value and stop timer T3517.

If the AMF needs to initiate PDU session status synchronisation or a PDU session status IE was included in the SERVICE REQUEST message, the AMF shall include a PDU session status IE in the SERVICE REJECT message to indicate which PDU sessions associated with the access type the SERVICE REJECT message is sent over are active in the AMF. If the PDU session status IE is included in the SERVICE REJECT message and if the message is integrity protected, then the UE shall perform a local release of all those PDU sessions which are active on the UE side associated with the access type the SERVICE REJECT message is sent over, but are indicated by the AMF as being inactive.

If the service request for mobile originated services is rejected due to general NAS level mobility management congestion control, the network shall set the 5GMM cause value to #22 "congestion" and assign a value for back-off timer T3346.

If the AMF determines that the UE is in a non-allowed area or is not in an allowed area as specified in subclause 5.3.5, then:

- a) if the service type IE in the SERVICE REQUEST message is set to "signalling" or "data", the AMF shall send a SERVICE REJECT message with the 5GMM cause value set to #28 "Restricted service area";
- b) otherwise, if the service type IE in the SERVICE REQUEST message is set to "mobile terminated services", "emergency services", "emergency services fallback", "high priority access" or "elevated signalling", the AMF shall continue the process as specified in subclause 5.6.1.4 unless for other reasons the service request cannot be accepted.

On receipt of the SERVICE REJECT message, if the UE is in state 5GMM-SERVICE-REQUEST-INITIATED and the message is integrity protected, the UE shall reset the service request attempt counter and stop timer T3517 if running.

The UE shall take the following actions depending on the 5GMM cause value received in the SERVICE REJECT message.

#3 (Illegal UE);

#6 (Illegal ME);

The UE shall set the 5GS update status to 5U3 ROAMING NOT ALLOWED (and shall store it according to subclause 5.1.3.2.2) and shall delete any 5G-GUTI, last visited registered TAI, TAI list and ngKSI. The UE shall consider the USIM as invalid for 5GS services until switching off or the UICC containing the USIM is removed. The UE shall enter the state 5GMM-DEREGISTERED.

If the UE is operating in the single-registration mode, the UE shall handle the EMM parameters EMM state, EPS update status, 4G-GUTI, TAI list and eKSI as specified in 3GPP TS 24.301 [15] for the case when the service request procedure is rejected with the EMM cause with the same value. The USIM shall be considered as invalid also for non-EPS services until switching off or the UICC containing the USIM is removed.

If the UE also supports the registration procedure over the other access, the UE shall in addition handle 5GMM parameters and 5GMM state for this access, as described for this 5GMM cause value.

#7 (5GS services not allowed).

The UE shall set the 5GS update status to 5U3 ROAMING NOT ALLOWED (and shall store it according to subclause 5.1.3.2.2) and shall delete any 5G-GUTI, last visited registered TAI, TAI list and ngKSI. The UE shall consider the USIM as invalid for 5GS services until switching off or the UICC containing the USIM is removed. The UE shall enter the state 5GMM-DEREGISTERED.

If the UE is operating in single-registration mode, the UE shall handle the EMM parameters EMM state, EPS update status, 4G-GUTI, TAI list and eKSI as specified in 3GPP TS 24.301 [15] for the case when the service request procedure is rejected with the EMM cause with the same value.

If the UE also supports the registration procedure over the other access, the UE shall in addition handle 5GMM parameters and 5GMM state for this access, as described for this 5GMM cause value.

NOTE 1: The possibility to configure a UE so that the radio transceiver for a specific radio access technology is not active, although it is implemented in the UE, is out of scope of the present specification.

#9 (UE identity cannot be derived by the network).

The UE shall set the 5GS update status to 5U2 NOT UPDATED (and shall store it according to subclause 5.1.3.2.2) and shall delete any 5G-GUTI, last visited registered TAI, TAI list and ngKSI. The UE shall enter the state 5GMM-DEREGISTERED.

If the service request was initiated for emergency services fallback, the UE shall attempt to select an E-UTRA cell connected to EPC or 5GCN according to the domain priority and selection rules specified in 3GPP TS 23.167 [6]. If the UE finds a suitable E-UTRA cell, it then proceeds with the appropriate EMM or 5GMM procedures.

If the service request was initiated for any reason other than emergency services fallback or initiating an emergency PDU session, the UE shall perform a new initial registration procedure.

NOTE 2: User interaction is necessary in some cases when the UE cannot re-establish the PDU session(s) automatically.

If the UE is operating in the single-registration mode, the UE shall handle the EMM parameters EMM state, EPS update status, 4G-GUTI, last visited registered TAI, TAI list and eKSI as specified in 3GPP TS 24.301 [15] for the case when the service request procedure is rejected with the EMM cause with the same value.

If the UE also supports the registration procedure over the other access to the same PLMN, the UE shall in addition handle 5GMM parameters and 5GMM state for this access, as described for this 5GMM cause value.

#10 (Implicitly de-registered).

The UE shall enter the state 5GMM-DEREGISTERED.NORMAL-SERVICE. The UE shall delete any mapped 5G NAS security context or partial native 5G NAS security context.

If the rejected request was not for initiating an emergency PDU session, the UE shall perform a new initial registration procedure.

NOTE 3: User interaction is necessary in some cases when the UE cannot re-establish the PDU session(s) automatically.

If the UE is operating in the single-registration mode, the UE shall handle the EMM state as specified in 3GPP TS 24.301 [15] for the case when the service request procedure is rejected with the EMM cause with the same value.

#11 (PLMN not allowed).

The UE shall set the 5GS update status to 5U3 ROAMING NOT ALLOWED (and shall store it according to subclause 5.1.3.2.2) and shall delete any 5G-GUTI, last visited registered TAI, TAI list and ngKSI. The UE shall delete the list of equivalent PLMNs and store the PLMN identity in the "forbidden PLMN list". The UE shall enter the state 5GMM-DEREGISTERED and perform a PLMN selection according to 3GPP TS 23.122 [5].

If the UE is operating in single-registration mode, the UE shall in addition handle the EMM parameters EMM state, EPS update status, 4G-GUTI, TAI list and eKSI as specified in 3GPP TS 24.301 [15] for the case when the service request procedure is rejected with the EMM cause with the same value.

If the UE also supports the registration procedure over the other access to the same PLMN, the UE shall in addition handle 5GMM parameters and 5GMM state for this access, as described for this 5GMM cause value.

#12 (Tracking area not allowed).

The UE shall set the 5GS update status to 5U3 ROAMING NOT ALLOWED (and shall store it according to subclause 5.1.3.2.2) and shall delete 5G-GUTI, last visited registered TAI, TAI list and ngKSI.

The UE shall store the current TAI in the list of "5GS forbidden tracking areas for regional provision of service" and enter the state 5GMM-DEREGISTERED.LIMITED-SERVICE.

If the UE is operating in single-registration mode, the UE shall handle the EMM parameters EMM state, EPS update status, 4G-GUTI, TAI list and eKSI as specified in 3GPP TS 24.301 [15] for the case when the service request procedure is rejected with the EMM cause with the same value.

#13 (Roaming not allowed in this tracking area).

The UE shall set the 5GS update status to 5U3 ROAMING NOT ALLOWED (and shall store it according to subclause 5.1.3.2.2). The UE shall enter the state 5GMM-REGISTERED.PLMN-SEARCH.

The UE shall store the current TAI in the list of "5GS forbidden tracking areas for roaming" and remove the current TAI from the stored TAI list if present.

The UE shall perform a PLMN selection according to 3GPP TS 23.122 [5].

If the UE is operating in single-registration mode, the UE shall handle the EMM parameters EMM state and EPS update status as specified in 3GPP TS 24.301 [15] for the case when the service request procedure is rejected with the EMM cause with the same value.

#15 (No suitable cells in tracking area).

The UE shall set the 5GS update status to 5U3 ROAMING NOT ALLOWED (and shall store it according to subclause 5.1.3.2.2). The UE shall enter the state 5GMM-REGISTERED.LIMITED-SERVICE.

The UE shall store the current TAI in the list of "5GS forbidden tracking areas for roaming" and remove the current TAI from the stored TAI list if present.

If the UE initiated service request for emergency services fallback, the UE shall attempt to select an E-UTRA cell connected to EPC or 5GC according to the emergency services support indicator. If the UE finds a suitable E-UTRA cell, it then proceeds with the appropriate EMM or 5GMM procedures.

If the service request was not initiated for emergency services fallback, the UE shall search for a suitable cell in another tracking area according to 3GPP TS 38.304 [28].

If the UE is operating in the single-registration mode, the UE shall handle the EMM parameters EMM state and EPS update status as specified in 3GPP TS 24.301 [15] for the case when the service request procedure is rejected with the EMM cause with the same value.

#22 (Congestion).

If the T3346 value IE is present in the SERVICE REJECT message and the value indicates that this timer is neither zero nor deactivated, the UE shall proceed as described below, otherwise it shall be considered as an abnormal case and the behaviour of the UE for this case is specified in subclause 5.6.1.7.

If the rejected request was not for initiating an emergency PDU session, the UE shall abort the service request procedure and enter state 5GMM-REGISTERED, and stop timer T3517 if still running.

The UE shall stop timer T3346 if it is running.

If the SERVICE REJECT message is integrity protected, the UE shall start timer T3346 with the value provided in the T3346 value IE.

If the SERVICE REJECT message is not integrity protected, the UE shall start timer T3346 with a random value from the default range specified in 3GPP TS 24.008 [12].

For all other cases the UE stays in the current serving cell and applies normal cell reselection process. The service request procedure is started, if still necessary, when timer T3346 expires or is stopped.

If the UE is operating in the single-registration mode, the UE shall handle the EMM parameters EMM state and EPS update status as specified in 3GPP TS 24.301 [15] for the case when the service request procedure is rejected with the EMM cause with the same value.

#27 (N1 mode not allowed).

The UE shall set the 5GS update status to 5U3 ROAMING NOT ALLOWED (and shall store it according to subclause 5.1.3.2.2) and shall delete any 5G-GUTI, last visited registered TAI, TAI list and ngKSI and shall enter the state 5GMM-NULL.

The UE shall disable the N1 mode capability for both 3GPP access and non-3GPP access (see subclause 4.9).

#28 (Restricted service area).

The UE shall enter the state 5GMM-REGISTERED.NON-ALLOWED-SERVICE, and perform the registration procedure for mobility and periodic registration update unless the service type IE in the SERVICE REQUEST message was set to "elevated signalling" (see subclause 5.3.5 and 5.5.1.3).

If the service type IE in the SERVICE REQUEST message was set to "elevated signalling", the UE shall not re-initiate service request procedure until the UE enters an allowed area or leaves a non-allowed area, except for emergency services, high priority access or responding to paging or notification.

#72 (Non-3GPP access to 5GCN not allowed).

If the UE initiated the service request procedure over non-3GPP access, the UE shall set the 5GS update status to 5U3 ROAMING NOT ALLOWED (and shall store it according to subclause 5.1.3.2.2) and shall delete 5G-GUTI, last visited registered TAI, TAI list and ngKSI for non-3GPP access. Additionally, the UE shall reset the registration attempt counter and enter the state 5GMM-DEREGISTERED for non-3GPP access.

NOTE 4: The 5GMM sublayer states, the 5GMM parameters and the registration status are managed per access type independently, i.e. 3GPP access or non-3GPP access (see subclauses 4.7.2 and 5.1.3).

The UE shall disable the N1 mode capability for non-3GPP access (see subclause 4.9.3).

As an implementation option, if the UE is not currently registered over 3GPP access, the UE may enter the state 5GMM-DEREGISTERED.PLMN-SEARCH in order to perform a PLMN selection according to 3GPP TS 23.122 [5].

If received over 3GPP access the cause shall be considered as an abnormal case and the behaviour of the UE for this case is specified in subclause 5.6.1.7.

#73 (Serving network not authorized).

The UE shall set the 5GS update status to 5U2 NOT UPDATED, store the PLMN identity in the "forbidden PLMN list" and enter state 5GMM-DEREGISTERED.PLMN-SEARCH in order to perform a PLMN selection according to 3GPP TS 23.122 [5].

### 5.6.1.6 Service request procedure for initiating an emergency PDU session not accepted by the network

If the service request for initiating an emergency PDU session cannot be accepted by the network, the UE shall perform the procedures as described in subclause 5.6.1.5. Then if the UE is in the same selected PLMN where the last service request was attempted, the UE shall:

- a) inform the upper layers of the failure of the procedure; or

NOTE 1: This can result in the upper layers requesting another emergency call attempt using domain selection as specified in 3GPP TS 23.167 [6].

- b) de-register locally, if not de-registered already, attempt initial registration for emergency services.

If the service request for initiating an emergency PDU session fails due to abnormal cases a) in subclause 5.6.1.7, the UE shall perform the procedures as described in subclause 5.6.1.5. Then if the UE is in the same selected PLMN where the last SERVICE REQUEST message was attempted, the UE shall:

- a) inform the upper layers of the failure of the procedure; or

NOTE 2: This can result in the upper layers requesting another emergency call attempt using domain selection as specified in 3GPP TS 23.167 [6] and 3GPP TS 24.229 [14].

- b) de-register locally, if not de-registered already, attempt initial registration for emergency services.

### 5.6.1.7 Abnormal cases in the UE

The following abnormal cases can be identified:

- a) T3517 expired.

The UE shall enter the state 5GMM-REGISTERED.

If the UE triggered the service request procedure in 5GMM-IDLE mode and the service type of the SERVICE REQUEST message was not set to "emergency services fallback", then the 5GMM sublayer shall increment the service request attempt counter, abort the procedure and release locally any resources allocated for the service request procedure. The service request attempt counter shall not be incremented, if:

- 1) the service request procedure is initiated to establish an emergency PDU session;
- 2) the UE has an emergency PDU session established;
- 3) the UE is a UE configured for high priority access in selected PLMN; or
- 4) the service request is initiated in response to paging or notification from the network.

If the service request attempt counter is greater than or equal to 5, the UE shall start timer T3525. Additionally, if the service request was initiated for an MO MMTEL voice call, a notification that the service request was not accepted due to the UE having started timer T3525 shall be provided to the upper layers.

NOTE 1: This can result in the upper layers requesting implementation specific mechanisms, e.g. the MMTEL voice call being attempted to another IP-CAN, or establishment of a CS voice call (if supported and not already attempted in the CS domain).

The UE shall not attempt service request until expiry of timer T3525 unless:

- 1) the service request is initiated in response to paging or notification from the network;
- 2) the UE is a UE configured for high priority access in selected PLMN;
- 3) the service request is initiated to establish an emergency PDU session;
- 4) the UE has an emergency PDU session established; or
- 5) the UE is registered in a new PLMN.

NOTE 2: The NAS signalling connection can also be released if the UE deems that the network has failed the authentication check as specified in subclause 5.4.1.3.7.

If the UE triggered the service request procedure in 5GMM-CONNECTED mode and the service type of the SERVICE REQUEST message was not set to "emergency services fallback", the 5GMM sublayer shall abort the procedure, and stay in 5GMM-CONNECTED mode.

If the service type of the SERVICE REQUEST message was set to "emergency services fallback" and:

- 1) the service request procedure was triggered in 5GMM-IDLE mode, the 5GMM sublayer shall abort the procedure, release locally any resources allocated for the service request procedure, and inform the upper layers of the failure of the service request procedure (see 3GPP TS 24.229 [14]); or

- 2) the service request procedure was triggered in 5GMM-CONNECTED mode, the 5GMM sublayer shall abort the procedure, stay in 5GMM-CONNECTED mode, and inform the upper layers of the failure of the service request procedure (see 3GPP TS 24.229 [14]).

- b) The lower layers indicate that the access attempt is barred.

The UE shall not start the service request procedure. The UE stays in the current serving cell and applies the normal cell reselection process.

The service request procedure is started, if still needed, when the lower layers indicate that the barring is alleviated for the access category with which the access attempt was associated.

- ba) The lower layers indicate that access barring is applicable for all access categories except categories 0 and 2 and the access category with which the access attempt was associated is other than 0 and 2.

If the SERVICE REQUEST message has not been sent, the UE shall proceed as specified for case b.

If the SERVICE REQUEST message has been sent:

- 1) the UE shall abort the service request procedure and stop timer T3517. The UE stays in the current serving cell and applies the normal cell reselection process; and
- 2) the service request procedure is started, if still needed, when the lower layers indicate that the barring is alleviated for the access category with which the access attempt was associated.

For additional UE requirements for both cases see subclause 4.5.5.

- c) Timer T3346 is running.

The UE shall not start the service request procedure unless:

- 1) the UE receives a paging;
- 2) the UE receives a NOTIFICATION message over non-3GPP access when the UE is in 5GMM-CONNECTED mode over non-3GPP access and in 5GMM-IDLE mode over 3GPP access;
- 3) the UE receives a NOTIFICATION message over 3GPP access when the UE is in 5GMM-CONNECTED mode over 3GPP access and in 5GMM-IDLE mode over non-3GPP access;
- 4) the UE is a UE configured for high priority access in selected PLMN;
- 5) the UE has an emergency PDU session established or is establishing an emergency PDU session; or
- 6) the service request is initiated for emergency services fallback.

If the UE is in 5GMM-IDLE mode, the UE stays in the current serving cell and applies normal cell reselection process. The service request procedure is started, if still necessary, when timer T3346 expires or is stopped.

- d) Registration procedure for mobility and periodic registration update is triggered.

The UE shall abort the service request procedure, stop timer T3517, if running and perform the registration procedure for mobility and periodic registration update. The Follow-on request indicator shall be set to 1 in the REGISTRATION REQUEST message.

- e) Switch off.

If the UE is in state 5GMM-SERVICE-REQUEST-INITIATED at switch off, the de-registration procedure shall be performed.

- f) De-registration procedure collision.

If the UE receives a DEREGISTRATION REQUEST message from the network in state 5GMM-SERVICE-REQUEST-INITIATED, the UE shall progress the DEREGISTRATION REQUEST message and the service request procedure shall be aborted.

- g) Transmission failure of SERVICE REQUEST message indication with TAI change from lower layers.

If the current TAI is not in the TAI list, UE shall abort the service request procedure to perform the registration procedure for mobility and periodic registration update and shall include Uplink data status IE in the REGISTRATION REQUEST message. If the current TAI is part of the TAI list, the UE shall restart the service request procedure.

- h) Transmission failure of SERVICE REQUEST message indication without TAI change from lower layers.

The UE shall restart the service request procedure.

- i) SERVICE REJECT message received with other 5GMM cause values than those treated in subclause 5.6.1.5, and cases of 5GMM cause value #22 and #72 that are considered as abnormal cases according to subclause 5.6.1.5.

The UE shall enter state 5GMM-REGISTERED.

The UE shall abort the service request procedure, stop timer T3517 and locally release any resources allocated for the service request procedure.

### 5.6.1.8 Abnormal cases on the network side

The following abnormal cases can be identified:

- a) Lower layer failure.

If a lower layer failure occurs before a SERVICE REJECT message has been sent to the UE or the service request procedure has been completed by the AMF, the AMF enters/stays in 5GMM-IDLE.

- b) Protocol error.

If the SERVICE REQUEST message is received with a protocol error, the AMF shall return a SERVICE REJECT message with one of the following 5GMM cause values:

- #96 invalid mandatory information;
- #99 information element non-existent or not implemented;
- #100 conditional IE error; or
- #111 protocol error, unspecified.

The AMF stays in the current 5GMM mode.

- c) More than one SERVICE REQUEST message received before the procedure has been completed (i.e., before SERVICE REJECT message has been sent or service request procedure has been completed).
- If one or more of the information elements in the SERVICE REQUEST message differs from the ones received within the previous SERVICE REQUEST message, the previously initiated service request procedure shall be aborted and the new service request procedure shall be progressed;
  - If the information elements do not differ, then the AMF shall continue with the previous service request procedure and shall not treat any further this SERVICE REQUEST message.
- d) REGISTRATION REQUEST message received with "initial registration" or "emergency registration" in the 5GS registration type IE before a SERVICE REJECT message has been sent or the service request procedure has been completed.

If a REGISTRATION REQUEST message with "initial registration" or "emergency registration" in the 5GS registration type IE is received and the service request procedure has not been completed or a SERVICE REJECT message has not been sent, the AMF may initiate the 5GMM common procedures, e.g. the primary authentication and key agreement procedure. The AMF may e.g. after a successful primary authentication and key agreement procedure execution, abort the service request procedure, delete the 5GMM context, indicate towards the SMF that the 5GMM context has been deleted and progress the new REGISTRATION REQUEST message.

- e) REGISTRATION REQUEST message received with "mobility registration updating" or "periodic registration updating" in the 5GS registration type IE received before the service request procedure has been completed or a SERVICE REJECT message has been sent.

If a REGISTRATION REQUEST message with "mobility registration updating" or "periodic registration updating" in the 5GS registration type IE is received and the service request procedure has not been completed or a SERVICE REJECT message has not been sent, the AMF may initiate the 5GMM common procedures, e.g. the primary authentication and key agreement procedure. The AMF may e.g. after a successful primary authentication and key agreement procedure execution, abort the service request procedure and progress the new REGISTRATION REQUEST message.

## 5.6.2 Paging procedure

### 5.6.2.1 General

The paging procedure is performed only in 3GPP access and used by the network to request the establishment of a NAS signalling connection to the UE. The paging procedure is also used by the network to request the UE to re-establish the user-plane resources of PDU sessions for downlink user data transport. Another purpose of the paging procedure is to request the UE to re-establish the user-plane resources of PDU session(s) associated with non-3GPP access over 3GPP access.

Additionally, the network can use the paging procedure to initiate the mobile terminating SMS.

### 5.6.2.2 Paging for 5GS services

#### 5.6.2.2.1 General

The network shall initiate the paging procedure for 5GS services when NAS signalling messages or user data is pending to be sent to the UE in 5GMM-IDLE mode over 3GPP access (see example in figure 5.6.2.2.1.1).

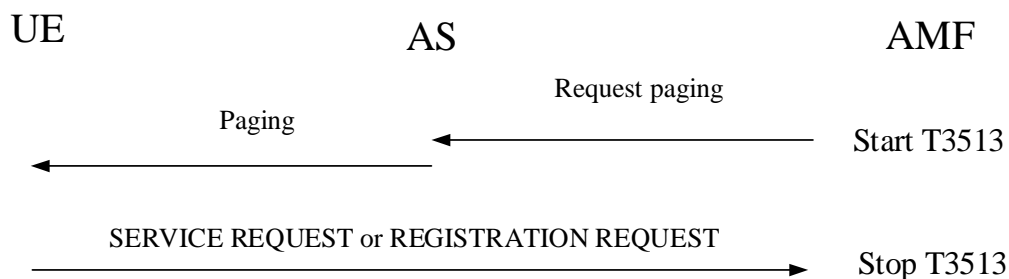

**Figure 5.6.2.2.1.1: Paging procedure**

To initiate the procedure the 5GMM entity in the AMF requests the lower layer to start paging and shall start timer T3513.

If downlink signalling or user data is pending to be sent over non-3GPP access, the 5GMM entity in the AMF shall indicate to the lower layer that the paging is associated to non-3GPP access.

Upon reception of a paging indication, the UE shall stop the timer T3346, if running, and shall initiate:

- a service request procedure over 3GPP access to respond to the paging as specified in subclauses 5.6.1; or
- a registration procedure for mobility and periodic registration update over 3GPP access to respond to the paging as specified in subclauses 5.5.1.3.

The network shall stop timer T3513 for the paging procedure when an integrity-protected response is received from the UE and successfully integrity checked by the network. If the response received is not integrity protected, or the integrity check is unsuccessful, timer T3513 for the paging procedure shall be kept running.



Upon expiry of timer T3513, the network may reinitiate paging.

If the network, while waiting for a response to the paging sent without paging priority, receives downlink signalling or downlink data associated with priority user-plane resources for PDU sessions, the network shall stop timer T3513, and then initiate the paging procedure with paging priority.

#### 5.6.2.2.2 Abnormal cases on the network side

The following abnormal case can be identified:

- a) Void.

#### 5.6.2.2.3 Abnormal cases in the UE

The following abnormal cases can be identified:

- a) Paging message received with access type set to non-3GPP access while the UE is in 5GMM-CONNECTED mode over non-3GPP access.

The UE shall not respond to paging message.

- b) Paging message received with access type set to 3GPP access when UE-initiated 5GMM specific procedure or service request procedure is ongoing.

The UE shall ignore the paging.

### 5.6.3 Notification procedure

#### 5.6.3.1 General

The notification procedure is used by the network:

- a) to request the UE, by sending the NOTIFICATION message over 3GPP access, to re-establish the user-plane resources of PDU session(s) associated with non-3GPP access over 3GPP access or to deliver 5GSM downlink signalling messages associated with non-3GPP access over 3GPP access when the UE is in 5GMM-IDLE mode over non-3GPP access and in 5GMM-CONNECTED mode over 3GPP access; or
- b) to request the UE, by sending the NOTIFICATION message over non-3GPP access, to re-establish user-plane resources of the PDU session(s) or to deliver downlink signalling associated with 3GPP access over 3GPP access when the UE is in 5GMM-CONNECTED mode over non-3GPP access and in 5GMM-IDLE mode over 3GPP access when the UE is not in MICO mode.

#### 5.6.3.2 Notification procedure initiation

The network shall initiate the notification procedure by sending the NOTIFICATION message to the UE and start timer T3565 (see example in figure 5.6.3.2.1).

For case a) in subclause 5.6.3.1, the NOTIFICATION message is sent from the network to the UE via 3GPP access with access type indicating non-3GPP access.

For case b) in subclause 5.6.3.1, the NOTIFICATION message is sent from the network to the UE via non-3GPP access with access type indicating 3GPP access when the UE is not in MICO mode.

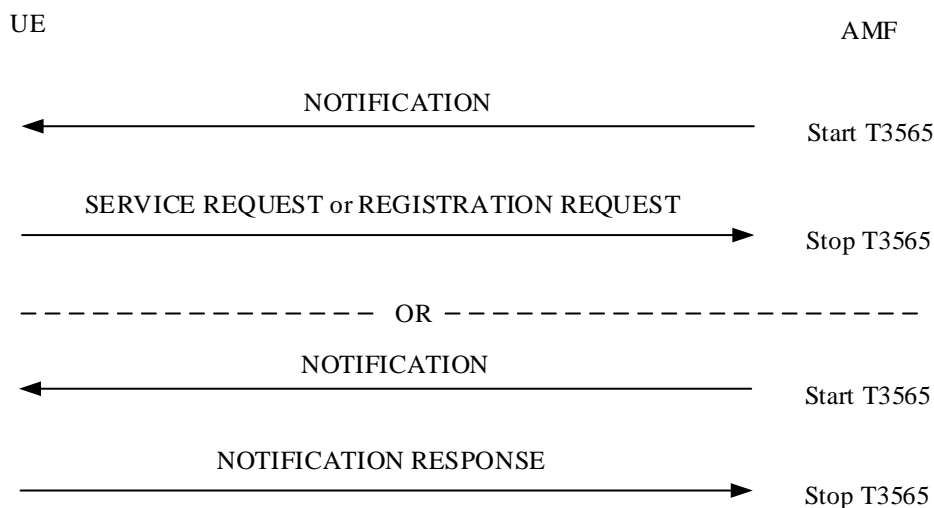

**Figure 5.6.3.2.1: Notification procedure**

For case a) in subclause 5.6.3.1, upon reception of NOTIFICATION message, the UE shall initiate a service request procedure over 3GPP access as specified in subclauses 5.6.1.

For case b) in subclause 5.6.3.1, upon reception of NOTIFICATION message:

- a) if the UE is in 5GMM-REGISTERED.NORMAL-SERVICE state, the UE shall initiate a service request procedure over 3GPP access as specified in subclauses 5.6.1;
- b) if the UE is in 5GMM-REGISTERED.ATTEMPTING-REGISTRATION-UPDATE state, the UE shall initiate a registration procedure for mobility and periodic registration update over 3GPP access as specified in subclauses 5.5.1.3; or
- c) if the UE is in 5GMM-REGISTERED.NO-CELL-AVAILABLE state or 5GMM-REGISTERED.PLMN-SEARCH state, the UE shall respond with NOTIFICATION RESPONSE message indicating failure to re-establish the user-plane resources of PDU sessions and may include the PDU session status information element to indicate the PDU session(s) available in the UE associated with the 3GPP access type.

Upon reception of NOTIFICATION message:

For case b) in subclause 5.6.3.1, if the UE is in 5GMM-REGISTERED.NO-CELL-AVAILABLE state or 5GMM-REGISTERED.PLMN-SEARCH state and a local release was performed in the UE for the PDU sessions associated with the 3GPP access;

then the UE shall respond with NOTIFICATION RESPONSE message indicating with the PDU session status information element that the local release of its PDU sessions was performed.

Upon reception of a NOTIFICATION message, the UE shall stop the timer T3346, if running.

### 5.6.3.3 Notification procedure completion

Upon reception of SERVICE REQUEST message or REGISTRATION REQUEST message, the AMF shall stop T3565 and proceed service request procedure as specified in subclauses 5.6.3.1 or registration procedure for mobility and periodic registration update as specified in subclauses 5.5.1.3. If no user-plane resources of PDU session(s) need to be re-established, the AMF should notify the SMF that the UE was reachable but did not accept to re-establish the user-plane resources of PDU session(s).

Upon reception of NOTIFICATION RESPONSE message, the AMF shall stop timer T3565 and should notify the SMF that the UE is unreachable.

If the NOTIFICATION RESPONSE message includes the PDU session status information element, then the AMF shall perform a local release of all those PDU sessions which are active on the AMF side associated with 3GPP access, but

are indicated by the UE in the PDU session status information element in the NOTIFICATION RESPONSE message as being inactive, and shall request the SMF to perform a local release of all those PDU sessions.

#### 5.6.3.4 Abnormal cases on the network side

The following abnormal cases can be identified:

- a) Expiry of timer T3565.

The network shall, on the first expiry of the timer T3565, retransmit the NOTIFICATION message and shall reset and start timer T3565. This retransmission is repeated four times, i.e. on the fifth expiry of timer T3565, the procedure shall be aborted. In addition, upon the fifth expiry of timer T3565:

For case a) in subclause 5.6.3.1, the AMF should notify the SMF that the UE is unreachable. The AMF may enter 5GMM-IDLE mode over 3GPP access.

For case b) in subclause 5.6.3.1, the AMF may either:

- 1) perform the paging procedure over the 3GPP access; or
- 2) notify the SMF that the UE is unreachable.

NOTE: Whether the AMF performs the paging procedure or notifies the SMF is up to operator's policies.

#### 5.6.3.5 Abnormal cases on the UE side

The following abnormal cases can be identified:

- a) NOTIFICATION message received via non-3GPP access with access type indicating 3GPP access when UE-initiated 5GMM specific procedure or service request procedure over 3GPP access is ongoing.

The UE shall ignore the NOTIFICATION message.

---

## 6 Elementary procedures for 5GS session management

### 6.1 Overview

#### 6.1.1 General

This clause describes the procedures used for 5GS session management (5GSM) performed over an N1 NAS signalling connection.

The main function of the 5GSM sublayer is to support the PDU session handling in the UE and in the SMF (transferred via the AMF).

The 5GSM comprises procedures for:

- the authentication and authorization, establishment, modification and release of PDU sessions; and
- request for performing handover of an existing PDU session between 3GPP access and non-3GPP access, or to transfer an existing PDN connection in the EPS to the 5GS.

Each PDU session represents a PDU session established between the UE and an SMF. PDU sessions can remain established even if the radio and network resources constituting the corresponding PDU session between the UE and the SMF are temporarily released.

5GSM procedures can be performed only if a 5GMM context has been established between the UE and the AMF, and the secure exchange of NAS messages has been initiated by the AMF by use of the 5GMM procedures described in clause 5. Once the UE is successfully registered to a PLMN, a PDU session can be established. If no 5GMM context

has been established, the 5GMM sublayer has to initiate the establishment of a 5GMM context by use of the 5GMM procedures as described in clause 5.

The UE can request the network to modify or release PDU sessions. The network can fulfil such a request from the UE by modifying a PDU session or releasing a PDU session using network-requested procedures (see subclause 6.3).

## 6.1.2 Types of 5GSM procedures

Three types of 5GSM procedures can be distinguished:

a) Procedures related to PDU sessions:

These procedures are initiated by the network and are used for authentication and authorization or manipulation of PDU sessions:

- 1) PDU authentication and authorization;
- 2) network-initiated PDU session modification; and
- 3) network-initiated PDU session release.

This procedure is initiated by the UE and to request for establishment of PDU sessions or to perform handover of an existing PDU session between 3GPP access and non-3GPP access, or to transfer an existing PDN connection in the EPS to the 5GS:

UE-requested PDU session establishment.

b) Transaction related procedures:

These procedures are initiated by the UE to request for handling of PDU sessions, i.e. to modify a PDU session, or to release a PDU session:

- 1) UE-requested PDU session modification; and
- 2) UE-requested PDU session release.

A successful transaction related procedure initiated by the UE triggers the network to execute one of the following procedures related to PDU session; network-initiated PDU session modification procedure or network-initiated PDU session release procedure. The UE treats the start of the procedure related to the PDU session as completion of the transaction related procedure.

c) Common procedure:

The following 5GSM procedure can be related to a PDU session or to a procedure transaction:

5GSM status procedure.

## 6.1.3 5GSM sublayer states

### 6.1.3.1 General

In the following subclauses, the possible states of a PDU session in the UE and the network side are described.

### 6.1.3.2 5GSM sublayer states in the UE

#### 6.1.3.2.1 Overview

In the following subclauses, the possible 5GSM sublayer states of the UE are described and shown in figure 6.1.3.2.1.1.

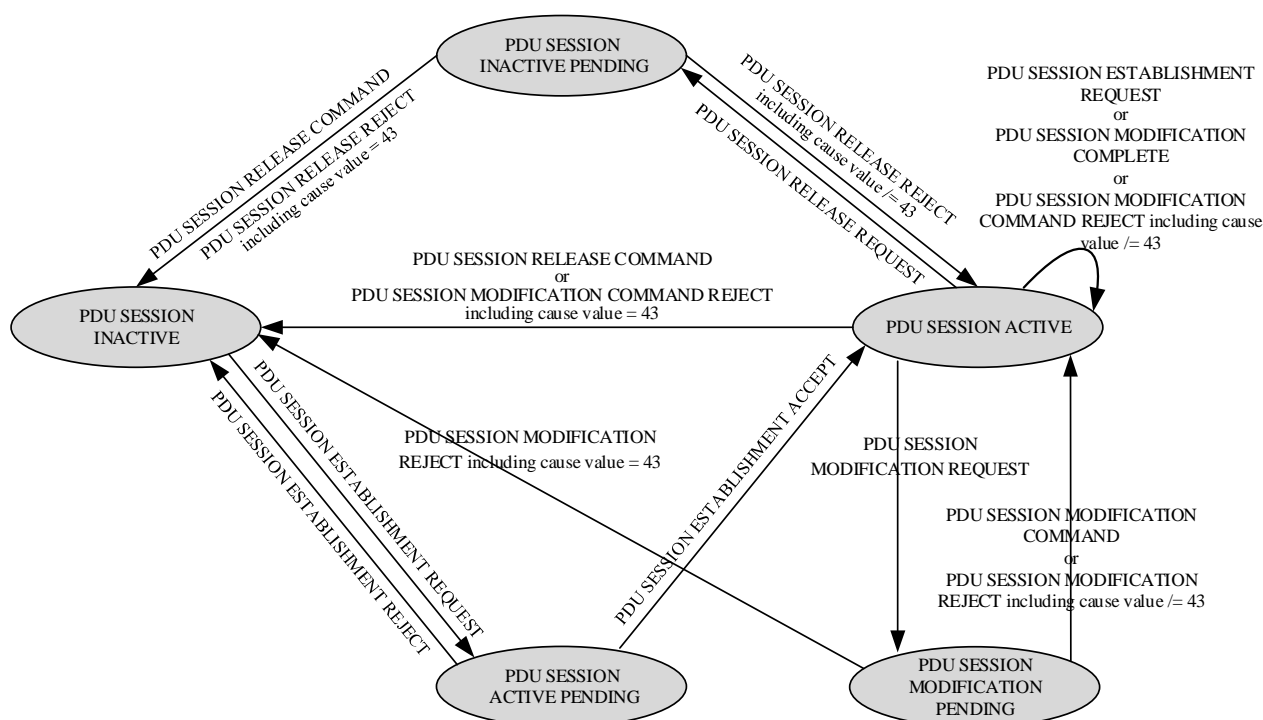

NOTE: Not all possible transitions are shown in this figure.

**Figure 6.1.3.2.1.1: The 5GSM sublayer states for PDU session handling in the UE (overview)**

#### 6.1.3.2.2 PDU SESSION INACTIVE

No PDU session exists.

#### 6.1.3.2.3 PDU SESSION ACTIVE PENDING

The UE has initiated a PDU session establishment procedure towards the network and is waiting for a response from the network.

#### 6.1.3.2.4 PDU SESSION ACTIVE

The PDU session is active in the UE.

#### 6.1.3.2.5 PDU SESSION INACTIVE PENDING

The UE has initiated a PDU session release procedure towards the network and is waiting for a response from the network.

#### 6.1.3.2.6 PDU SESSION MODIFICATION PENDING

The UE has initiated a PDU session modification procedure towards the network and is waiting for a response from the network.

#### 6.1.3.2.7 PROCEDURE TRANSACTION INACTIVE

No procedure transaction exists.

#### 6.1.3.2.8 PROCEDURE TRANSACTION PENDING

The UE has initiated a procedure transaction towards the network.

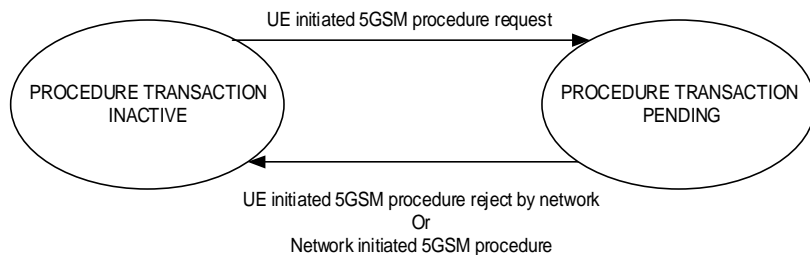
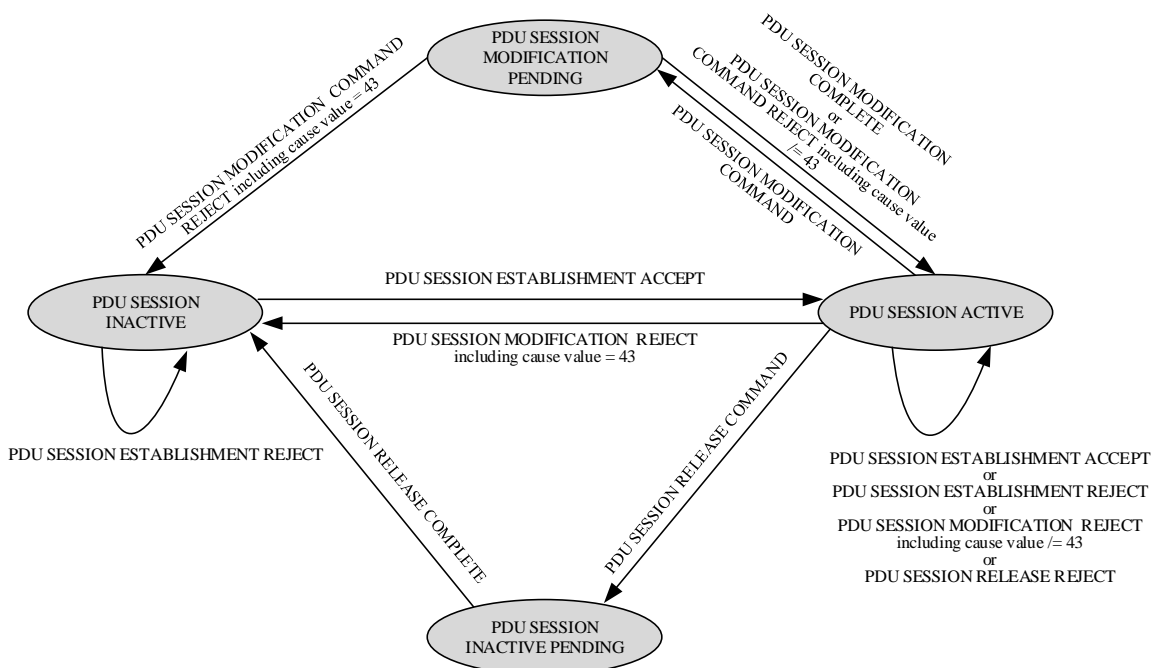

**Figure 6.1.3.2.8.1: The procedure transaction states in the UE (overview)**

6.1.3.3 5GSM sublayer states in the network side

6.1.3.3.1 Overview

In the following subclauses, the possible 5GSM sublayer states of the network are described and shown in Figure 6.1.3.3.1.1.



NOTE: Not all possible transitions are shown in this figure.

**Figure 6.1.3.3.1.1: The 5GSM sublayer states for PDU session handling in the network (overview)**

6.1.3.3.2 PDU SESSION INACTIVE

No PDU session exists.

6.1.3.3.3 PDU SESSION ACTIVE

The PDU session is active in the network.

6.1.3.3.4 PDU SESSION INACTIVE PENDING

The network has initiated a PDU session release procedure towards the UE and is waiting for a response from the UE.

### 6.1.3.3.5 PDU SESSION MODIFICATION PENDING

The network has initiated a PDU session modification procedure towards the UE and is waiting for a response from the UE.

### 6.1.3.3.6 PROCEDURE TRANSACTION INACTIVE

No procedure transaction exists.

### 6.1.3.3.7 PROCEDURE TRANSACTION PENDING

The network has initiated a procedure transaction towards the UE.

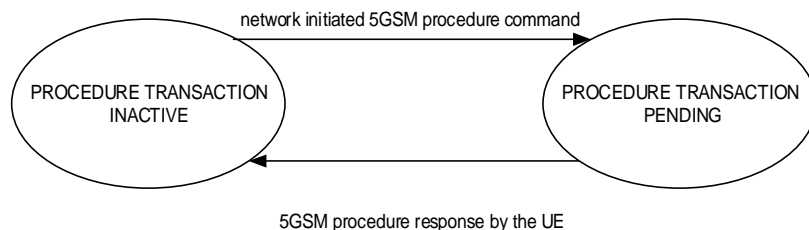

**Figure 6.1.3.3.7.1: The procedure transaction states in the network (overview)**

## 6.1.4 Coordination between 5GSM and ESM

### 6.1.4.1 Coordination between 5GSM and ESM with N26 interface

Interworking with EPS is supported for a PDU session, if the PDU session includes the mapped EPS bearer(s) or has association(s) between QoS flow and mapped EPS bearer after inter-system change from S1 mode to N1 mode. The SMF shall not include any mapped EPS bearer contexts associated with a PDU session for LADN and with a PDU session which is a multi-homed IPv6 PDU session. See coding of the Mapped EPS bearer contexts IE in subclause 9.11.4.8.

Upon inter-system change from N1 mode to S1 mode, the UE shall create the default EPS bearer context and the dedicated EPS bearer context(s) based on the parameters of the mapped EPS bearer contexts or the associations between QoS flow and mapped EPS bearer in the PDU session, if available. The EPS bearer identity assigned for the QoS flow of the default QoS rule becomes the EPS bearer identity of the default bearer in the corresponding PDN connection. If there is no EPS bearer identity assigned to the QoS flow of the default QoS rule, the UE shall perform a local release of the PDU session. If there is no EPS bearer identity assigned to the QoS flow(s) which is not associated with the default QoS rule, the UE shall locally delete the QoS rules and the QoS flow description(s). The UE uses the parameters from each PDU session for which interworking with EPS is supported to create corresponding default EPS bearer context and optionally dedicated EPS bearer context(s) as follows:

- a) the PDU session type of the PDU session shall be mapped to the PDN type of the default EPS bearer context as follows:
  - 1) the PDN type shall be set to "non-IP" if the PDU session type is "Ethernet" or "Unstructured";
  - 2) the PDN type shall be set to "IPv4" if the PDU session type is "IPv4";
  - 3) the PDN type shall be set to "IPv6" if the PDU session type is "IPv6"; and
  - 4) the PDN type shall be set to "IPv4v6" if the PDU session type is "IPv4v6";
- b) the PDU address of the PDU session shall be mapped to the PDN address of the default EPS bearer context as follows:
  - 1) the PDN address of the default EPS bearer context is set to the PDU address of the PDU session, if the PDU session type is "IPv4", "IPv6" or "IPv4v6"; and

- 2) the PDN address of the default EPS bearer context is set to zero, if the PDU session type is "Ethernet" or "Unstructured";
- c) the DNN of the PDU session shall be mapped to the APN of the default EPS bearer context;
- d) the APN-AMBR and extended APN-AMBR received in the parameters of the default EPS bearer context of the mapped EPS bearer contexts shall be mapped to the APN-AMBR and extended APN-AMBR of the default EPS bearer context;
- e) for each PDU session in state PDU SESSION ACTIVE, PDU SESSION MODIFICATION PENDING or PDU SESSION INACTIVE PENDING the UE shall set the state of the mapped EPS bearer context(s) to BEARER CONTEXT ACTIVE; and
- f) for any other PDU session the UE shall set the state of the mapped EPS bearer context(s) to BEARER CONTEXT INACTIVE.

Additionally, for each mapped EPS bearer context or the association between QoS flow and mapped EPS bearer in the PDU session:

- a) the EPS bearer identity shall be set to the EPS bearer identity received in the mapped EPS bearer context, or the EPS bearer identity associated with the QoS flow;
- b) the EPS QoS parameters shall be set to the mapped EPS QoS parameters of the EPS bearer received in the mapped EPS bearer context, or the EPS QoS parameters associated with the QoS flow;
- c) the extended EPS QoS parameters shall be set to the mapped extended EPS QoS parameters of the EPS bearer received in the mapped EPS bearer context, or the extended EPS QoS parameters associated with the QoS flow; and
- d) the traffic flow template shall be set to the mapped traffic flow template of the EPS bearer received in the mapped EPS bearer context, or the stored traffic flow template associated with the QoS flow, if available.

After inter-system change from N1 mode to S1 mode, the UE shall associate the PDU session identity, the S-NSSAI, and the session-AMBR with the default EPS bearer context, and for each EPS bearer context mapped from one or more QoS flows, associate the QoS rule(s) for the QoS flow(s) and the QoS flow description(s) for the QoS flow(s) with the EPS bearer context.

After inter-system change from N1 mode to S1 mode, the UE and the SMF shall maintain the PDU session type of the PDU session until the PDN connection corresponding to the PDU session is released if the UE supports non-IP PDN type and the PDU session type is "Ethernet" or "Unstructured".

After inter-system change from N1 mode to S1 mode, the UE and the SMF shall maintain the following 5GSM attributions and capabilities associated with the PDU session until the PDN connection corresponding to the PDU session is released:

- the always-on PDU session indication;
- the maximum number of supported packet filters;
- the support of reflective QoS;
- the maximum data rate per UE for user-plane integrity protection supported by the UE for uplink and the maximum data rate per UE for user-plane integrity protection supported by the UE for downlink; and
- the support of multi-homed IPv6 PDU session.

If there is a QoS flow used for IMS signalling, after inter-system change from N1 mode to S1 mode, the EPS bearer associated with the QoS flow for IMS signalling becomes the EPS bearer for IMS signalling.

When the UE is provided with a new session-AMBR in the Protocol configuration options IE or Extended protocol configuration options IE in the MODIFY EPS BEARER CONTEXT REQUEST message, the UE shall discard the corresponding association(s) and associate the new value(s) with the EPS bearer context.

When the UE is provided with one or more QoS flow descriptions or the EPS bearer identity of an existing QoS flow description is modified in the Protocol configuration options IE or Extended protocol configuration options IE in the MODIFY EPS BEARER CONTEXT REQUEST message, the UE shall check whether the EPS bearer identity included



in the QoS flow description corresponds to an active EPS bearer context of the PDN connection associated with the EPS bearer context being modified. If the EPS bearer identity included in the QoS flow description does not correspond to any active EPS bearer context of the PDN connection associated with the EPS bearer context being modified, the UE shall locally delete the QoS flow description and all the associated QoS rules, if any, and include a Protocol configuration options IE or Extended protocol configuration options IE with a 5GSM cause parameter set to 5GSM cause #84 "syntactical error in the QoS operation" in the MODIFY EPS BEARER CONTEXT ACCEPT message.

When the UE is provided with one or more QoS rules, or one or more QoS flow descriptions in the Protocol configuration options IE or Extended protocol configuration options IE in the MODIFY EPS BEARER CONTEXT REQUEST message, the UE shall process the QoS rules sequentially starting with the first QoS rule. The UE shall check the QoS rules and QoS flow descriptions for different types of errors as follows:

a) Semantic errors in QoS operations:

- 1) When the rule operation is "Modify existing QoS rule and add packet filters", "Modify existing QoS rule and replace all packet filters", "Modify existing QoS rule and delete packet filters" or "Modify existing QoS rule without modifying packet filters" on the default QoS rule and the DQR bit is set to "the QoS rule is not the default QoS rule".
- 2) When the rule operation is "Modify existing QoS rule and add packet filters", "Modify existing QoS rule and replace all packet filters", "Modify existing QoS rule and delete packet filters" or "Modify existing QoS rule without modifying packet filters" on a QoS rule which is not the default QoS rule and the DQR bit is set to "the QoS rule is the default QoS rule".
- 3) When the rule operation is "Create new QoS rule" and the DQR bit is set to "the QoS rule is the default QoS rule" when there's already a default QoS rule.
- 4) When the rule operation is "Delete existing QoS rule" on the default QoS rule.
- 5) When the rule operation is "Create new QoS rule", "Modify existing QoS rule and add packet filters", "Modify existing QoS rule and replace all packet filters", "Modify existing QoS rule and delete packet filters", or "Modify existing QoS rule without modifying packet filters" and two or more QoS rules associated with this PDU session would have identical precedence values.
- 6) When the rule operation is "Modify existing QoS rule and delete packet filters", the QoS rule is a QoS rule of a PDU session of IPv4, IPv6, IPv4v6 or Ethernet PDU session type, and the packet filter list in the resultant QoS rule is empty.
- 7) When the rule operation is "Create new QoS rule" and there is already an existing QoS rule with the same QoS rule identifier.
- 8) When the rule operation is "Modify existing QoS rule and add packet filters", "Modify existing QoS rule and replace all packet filters", "Modify existing QoS rule and delete packet filters", "Modify existing QoS rule without modifying packet filters" or "Delete existing QoS rule" and there is no existing QoS rule with the same QoS rule identifier.
- 9) When the rule operation is "Delete existing QoS rule" and there is no existing QoS rule with the same QoS rule identifier.
- 10) When the flow description operation is "Create new QoS flow description" and there is already an existing QoS flow description with the same QoS flow identifier.
- 11) When the flow description operation is "Modify existing QoS flow description" and there is no existing QoS flow description with the same QoS flow identifier.
- 12) When the flow description operation is "Delete existing QoS flow description" and there is no existing QoS flow description with the same QoS flow identifier.
- 13) When the UE determines that:
  - i) the default EPS bearer context is associated with one or more QoS rules and all of them are non-default QoS rules.
  - ii) a dedicated EPS bearer context is associated with the default QoS rule.

- iii) at least one dedicated EPS bearer is associated with at least one QoS flow, but the default EPS bearer is not associated with the default QoS rule.

In case 4, the UE shall include a Protocol configuration options IE or Extended protocol configuration options IE with a 5GSM cause parameter set to 5GSM cause #83 "semantic error in the QoS operation" in the MODIFY EPS BEARER CONTEXT ACCEPT message.

In case 5, if the old QoS rule is not the default QoS rule, the UE shall not diagnose an error, shall further process the new request and, if it was processed successfully, shall delete the old QoS rule which has identical precedence value. If the QoS rule is the default QoS rule, the UE shall include a Protocol configuration options IE or Extended protocol configuration options IE with a 5GSM cause parameter set to 5GSM cause #83 "semantic error in the QoS operation" in the MODIFY EPS BEARER CONTEXT ACCEPT message.

In case 6, if the QoS rule is not the default QoS rule, the UE shall delete the QoS rule. If the QoS rule is the default QoS rule, the UE shall include a Protocol configuration options IE or Extended protocol configuration options IE with a 5GSM cause parameter set to 5GSM cause #83 "semantic error in the QoS operation" in the MODIFY EPS BEARER CONTEXT ACCEPT message.

In case 7, if the QoS rule is not the default QoS rule, the UE shall not diagnose an error, further process the create request and, if it was processed successfully, delete the old QoS rule. If the QoS rule is the default QoS rule, the UE shall include a Protocol configuration options IE or Extended protocol configuration options IE with a 5GSM cause parameter set to 5GSM cause #83 "semantic error in the QoS operation" in the MODIFY EPS BEARER CONTEXT ACCEPT message.

In case 9, the UE shall not diagnose an error, further process the delete request and, if it was processed successfully, consider the respective QoS rule as successfully deleted.

In case 10, the UE shall not diagnose an error, further process the create request and, if it was processed successfully, delete the old QoS flow description.

In case 12, the UE shall not diagnose an error, further process the delete request and, if it was processed successfully, consider the respective QoS flow description as successfully deleted.

Otherwise, the UE shall include a Protocol configuration options IE or Extended protocol configuration options IE with a 5GSM cause parameter set to 5GSM cause #83 "semantic error in the QoS operation" in the MODIFY EPS BEARER CONTEXT ACCEPT message.

b) Syntactical errors in QoS operations:

- 1) When the rule operation is "Create new QoS rule", "Modify existing QoS rule and add packet filters", "Modify existing QoS rule and replace packet filters" or "Modify existing QoS rule and delete packet filters" and the packet filter list in the QoS rule is empty.
- 2) When the rule operation is "Delete existing QoS rule" or "Modify existing QoS rule without modifying packet filters" with a non-empty packet filter list in the QoS rule.
- 3) When the rule operation is "Modify existing QoS rule and delete packet filters" and the packet filter to be deleted does not exist in the original QoS rule.
- 4) When the rule operation is "Modify existing QoS rule and delete packet filters" with a packet filter list also including packet filters in addition to the packet filter identifiers.
- 5) When there are other types of syntactical errors in the coding of the QoS rules IE or the QoS flow descriptions IE, such as a mismatch between the number of packet filters subfield, and the number of packet filters in the packet filter list.

In case 3 the UE shall not diagnose an error, further process the deletion request and, if no error according to items c and d was detected, consider the respective packet filter as successfully deleted.

Otherwise the UE shall include a Protocol configuration options IE or Extended protocol configuration options IE with a 5GSM cause parameter set to 5GSM cause #84 "syntactical error in the QoS operation" in the MODIFY EPS BEARER CONTEXT ACCEPT message.

c) Semantic errors in packet filters:

- 1) When a packet filter consists of conflicting packet filter components which would render the packet filter ineffective, i.e. no IP packet will ever fit this packet filter. How the UE determines a semantic error in a packet filter is outside the scope of the present document.

The UE shall include a Protocol configuration options IE or Extended protocol configuration options IE with a 5GSM cause parameter set to 5GSM cause #44 "semantic errors in packet filter(s)" in the MODIFY EPS BEARER CONTEXT ACCEPT message.

- d) Syntactical errors in packet filters:

- 1) When the rule operation is "Create new QoS rule", "Modify existing QoS rule and add packet filters" or "Modify existing QoS rule and replace all packet filters", and two or more packet filters in the resultant QoS rule would have identical packet filter identifiers.
- 2) When there are other types of syntactical errors in the coding of packet filters, such as the use of a reserved value for a packet filter component identifier.

In case 1, if two or more packet filters with identical packet filter identifiers are contained in the MODIFY EPS BEARER CONTEXT REQUEST message, the UE shall include a Protocol configuration options IE or Extended protocol configuration options IE with a 5GSM cause parameter set to 5GSM cause #45 "syntactical error in packet filter(s)" in the MODIFY EPS BEARER CONTEXT ACCEPT message. Otherwise, the UE shall not diagnose an error, further process the MODIFY EPS BEARER CONTEXT REQUEST message and, if it was processed successfully, delete the old packet filters which have the identical packet filter identifiers.

Otherwise the UE shall include a Protocol configuration options IE or Extended protocol configuration options IE with a 5GSM cause parameter set to 5GSM cause #45 "syntactical error in packet filter(s)" in the MODIFY EPS BEARER CONTEXT ACCEPT message.

Upon successful completion of an EPS attach procedure or tracking area updating procedure after inter-system change from N1 mode to S1 mode (see 3GPP TS 24.301 [15]), the UE shall delete any UE derived QoS rules. The UE and the SMF shall perform a local release of the PDU session(s) and QoS flow(s) which have not been transferred to EPS.

For PDU session(s) associated with non-3GPP access in 5GS, if present, the UE may:

- a) keep some or all of these PDU sessions still associated with non-3GPP access in 5GS, if supported;
- b) release some or all of these PDU sessions explicitly by initiating the UE requested PDU session release procedure(s); or
- c) attempt to transfer some or all of these PDU sessions from N1 mode to S1 mode by initiating the UE requested PDN connectivity procedure(s) with the PDN CONNECTIVITY REQUEST message created as specified in subclause 6.1.4.2.

Interworking to 5GS is supported for a PDN connection, if the corresponding default EPS bearer context includes a PDU session identity, session AMBR and one or more QoS flow descriptions received in the Protocol configuration options IE or Extended protocol configuration options IE (see 3GPP TS 24.301 [15]), or the default EPS bearer context has association with the PDU session identity, the S-NSSAI, the session-AMBR and one or more QoS flow descriptions after inter-system change from N1 mode to S1 mode.

For a PDN connection established in S1 mode, the SMF assigning the QoS rules shall consider that the UE supports 16 packet filters for the corresponding PDU session until the UE indicates a higher number (as specified in subclause 6.4.2.2).

When the UE is provided with one or more QoS flow descriptions or the EPS bearer identity of an existing QoS flow description is modified in the Protocol configuration options IE or Extended protocol configuration options IE of the ACTIVATE DEFAULT EPS BEARER CONTEXT REQUEST or ACTIVATE DEDICATED EPS BEARER CONTEXT REQUEST message, the UE shall check whether the EPS bearer identity included in the QoS flow description corresponds to an active EPS bearer context of the PDN connection associated with the EPS bearer context being activated. If the EPS bearer identity included in the QoS flow description does not correspond to any active EPS bearer context of the PDN connection associated with the EPS bearer context being activated, the UE shall locally delete the QoS flow description and all the associated QoS rules, if any, and include a Protocol configuration options IE or Extended protocol configuration options IE with a 5GSM cause parameter set to 5GSM cause #84 "syntactical error in the QoS operation" in the ACTIVATE DEFAULT EPS BEARER CONTEXT ACCEPT or ACTIVATE DEDICATED EPS BEARER CONTEXT ACCEPT message.

When the UE is provided with one or more QoS rules, or one or more QoS flow descriptions in the Protocol configuration options IE or Extended protocol configuration options IE of the ACTIVATE DEFAULT EPS BEARER CONTEXT REQUEST or ACTIVATE DEDICATED EPS BEARER CONTEXT REQUEST message, the UE shall check QoS rules and QoS flow descriptions for different types of errors as follows:

a) Semantic errors in QoS operations:

- 1) When the rule operation is "Create new QoS rule" and the DQR bit is set to "the QoS rule is the default QoS rule" when there's already a default QoS rule.
- 2) When the rule operation is "Create new QoS rule", and there is no rule with the DQR bit set to "the QoS rule is the default QoS rule".
- 3) When the rule operation is "Create new QoS rule" and two or more QoS rules associated with this PDU session would have identical precedence values.
- 4) When the rule operation is an operation other than "Create a new QoS rule".
- 5) When the flow description operation is an operation other than "Create new QoS flow description".
- 6) When the UE determines that:
  - i) the default EPS bearer context is associated with one or more QoS rules and all of them are non-default QoS rules.
  - ii) a dedicated EPS bearer context is associated with the default QoS rule.
  - iii) at least one dedicated EPS bearer is associated with at least one QoS flow, but the default EPS bearer is not associated with the default QoS rule.

In case 4, if the rule operation is for a non-default QoS rule, the UE shall delete the QoS rule. If the QoS rule is the default QoS rule, the UE shall include a Protocol configuration options IE or Extended protocol configuration options IE with a 5GSM cause parameter set to 5GSM cause #83 "semantic error in the QoS operation" in the ACTIVATE DEFAULT EPS BEARER CONTEXT ACCEPT or ACTIVATE DEDICATED EPS BEARER CONTEXT ACCEPT message.

Otherwise for all the cases above, the UE shall include a Protocol configuration options IE or Extended protocol configuration options IE with a 5GSM cause parameter set to 5GSM cause #83 "semantic error in the QoS operation" in the ACTIVATE DEFAULT EPS BEARER CONTEXT ACCEPT or ACTIVATE DEDICATED EPS BEARER CONTEXT ACCEPT message.

b) Syntactical errors in QoS operations:

- 1) When the rule operation is "Create new QoS rule" and the packet filter list in the QoS rule is empty.
- 2) When the rule operation is "Modify existing QoS rule and delete packet filters ", and the packet filter list in the resultant QoS rule is empty.
- 3) When there are other types of syntactical errors in the coding of the QoS rules IE, such as a mismatch between the number of packet filters subfield, and the number of packet filters in the packet filter list.

In case 1, case 2 or case 3, if the QoS rule is not the default QoS rule, the UE shall delete the QoS rule. If the QoS rule is the default QoS rule, the UE shall include a Protocol configuration options IE or Extended protocol configuration options IE with a 5GSM cause parameter set to 5GSM cause #84 "syntactical error in the QoS operation" in the ACTIVATE DEFAULT EPS BEARER CONTEXT ACCEPT or ACTIVATE DEDICATED EPS BEARER CONTEXT ACCEPT message.

c) Semantic errors in packet filters:

- 1) When a packet filter consists of conflicting packet filter components which would render the packet filter ineffective, i.e. no IP packet will ever fit this packet filter. How the UE determines a semantic error in a packet filter is outside the scope of the present document.

The UE shall include a Protocol configuration options IE or Extended protocol configuration options IE with a 5GSM cause parameter set to 5GSM cause #44 "semantic errors in packet filter(s)" in the ACTIVATE

DEFAULT EPS BEARER CONTEXT ACCEPT or ACTIVATE DEDICATED EPS BEARER CONTEXT ACCEPT message.

d) Syntactical errors in packet filters:

- 1) When the rule operation is "Create new QoS rule" and two or more packet filters in the resultant QoS rule would have identical packet filter identifiers.
- 2) When there are other types of syntactical errors in the coding of packet filters, such as the use of a reserved value for a packet filter component identifier.

If the QoS rule is not the default QoS rule, the UE shall delete the QoS rule. If the QoS rule is the default QoS rule, the UE shall include a Protocol configuration options IE or Extended protocol configuration options IE with a 5GSM cause parameter set to 5GSM cause #45 "syntactical error in packet filter(s)" in the ACTIVATE DEFAULT EPS BEARER CONTEXT ACCEPT or ACTIVATE DEDICATED EPS BEARER CONTEXT ACCEPT message.

Upon inter-system change from S1 mode to N1 mode, the UE uses the parameters from the default EPS bearer context of each PDN connection for which interworking to 5GS is supported to create a corresponding PDU session as follows:

- a) the PDN type of the default EPS bearer context shall be mapped to the PDU session type of the PDU session as follows:
  - 1) if the PDN type is "non-IP":
    - the PDU session type is set to the locally available information associated with the PDN connection (either "Ethernet" or "Unstructured"), if available; or
    - otherwise, the PDU session type is set to "Unstructured";
  - 2) if the PDN type is "IPv4" the PDU session type is set to "IPv4";
  - 3) if the PDN type is "IPv6", the PDU session type is set to "IPv6"; and
  - 4) the PDN type shall be set to "IPv4v6" if the PDU session type is "IPv4v6";
- b) the PDN address of the default EPS bearer context shall be mapped to PDU address of the PDU session, if the PDN type is "IPv4", "IPv6" or "IPv4v6";
- c) the APN of the default EPS bearer context shall be mapped to the DNN of the PDU session;
- d) for each default EPS bearer context in state BEARER CONTEXT ACTIVE the UE shall set the state of the mapped PDU session to PDU SESSION ACTIVE; and
- e) for any other default EPS bearer context the UE shall set the state of the mapped PDU session to PDU SESSION INACTIVE.

Additionally, the UE shall set:

- a) the PDU session identity of the PDU session to the PDU session identity included by the UE in the Protocol configuration options IE or Extended protocol configuration options IE in the PDN CONNECTIVITY REQUEST message, or the PDU session identity associated with the default EPS bearer context;
- b) the S-NSSAI of the PDU session to the S-NSSAI included by the network in the Protocol configuration options IE or Extended protocol configuration options IE in the ACTIVATE DEFAULT EPS BEARER REQUEST message, the S-NSSAI included by the network in the N1\_MODE\_INFORMATION Notify payload of the IKE\_AUTH response message, or the S-NSSAI associated with the default EPS bearer context;
- c) the session-AMBR of the PDU session to the session-AMBR included by the network in the Protocol configuration options IE or Extended protocol configuration options IE in the ACTIVATE DEFAULT EPS BEARER REQUEST message or the MODIFY EPS BEARER CONTEXT REQUEST message, or the session-AMBR associated with the default EPS bearer context;
- d) the SSC mode of the PDU session to "SSC mode 1"; and
- e) the always-on PDU session indication to the always-on PDU session indication maintained in the UE, if any.

Additionally, for each EPS bearer context of the PDN connection, the UE shall create QoS flow(s) each of which is associated with the QoS flow description received in the Protocol configuration options IE or Extended protocol configuration options IE in the ACTIVATE DEFAULT EPS BEARER REQUEST message, ACTIVATE DEDICATED EPS BEARER REQUEST message, and/or MODIFY EPS BEARER REQUEST message (see 3GPP TS 24.301 [15]), or the QoS flow description associated with EPS bearer context.

Additionally, for each EPS bearer context of the PDN connection, the UE shall create QoS rules(s), if any, each of which is associated with the QoS rule received in the Protocol configuration options IE or Extended protocol configuration options IE in the ACTIVATE DEFAULT EPS BEARER REQUEST message, ACTIVATE DEDICATED EPS BEARER REQUEST message, or MODIFY EPS BEARER CONTEXT REQUEST message (see 3GPP TS 24.301 [15]), or the QoS rules associated with EPS bearer context.

The UE and the network shall locally release the PDN connection(s) and EPS bearer(s) associated with the 3GPP access which have not been transferred to 5GS.

After inter-system change from S1 mode to N1 mode, for each QoS flow mapped from a EPS bearer context the UE shall associate the EPS bearer identity, the EPS QoS parameters, the extended EPS QoS parameters, and the traffic flow template, if available, of the EPS bearer context with the QoS flow.

If there is an EPS bearer used for IMS signalling, after inter-system change from S1 mode to N1 mode, the QoS flow of the default QoS rule in the corresponding PDU session is used for IMS signalling.

For a PDN connection established when in S1 mode, upon the first inter-system change from S1 mode to N1 mode, the SMF shall determine the PDU session indication as specified in subclause 6.3.2.2.

When the UE is provided with a new EPS bearer identity, a new EPS QoS parameters, or a new extended EPS QoS parameters in the Mapped EPS bearer context IE of the PDU SESSION MODIFICATION COMMAND message for a QoS flow, the UE shall discard the corresponding association(s) and associate the new value(s) with the QoS flow.

When the UE is provided with a new traffic flow template in the Mapped EPS bearer contexts IE of the PDU SESSION MODIFICATION COMMAND message for a QoS flow, the UE shall check the traffic flow template for different types of TFT IE errors as specified in subclause 6.3.2.3.

When a QoS flow is deleted, the associated EPS bearer context information that are mapped from the deleted QoS flow shall be deleted from the UE and the network if there is no other existing QoS flow associated with this EPS bearer context. When the EPS bearer identity of a QoS flow is deleted, the associated EPS bearer context information that are mapped from the deleted EPS bearer identity shall be deleted from the UE and the network if there is no other existing QoS flow associated with this EPS bearer context. When an EPS bearer is released, all the associated QoS flow descriptions and QoS rules that are mapped from the released EPS bearer shall be deleted from the UE and the network.

NOTE: If T3584 is running or deactivated for the S-NSSAI and optionally the DNN combination, the UE is allowed to initiate ESM procedures in EPS with or without APN corresponding to that DNN, and if the APN is congested in EPS, the MME can send a back-off timer for the APN to the UE as specified in 3GPP TS 24.301 [15].

For PDN connection(s) associated with non-3GPP access in EPS, if present, the UE may:

- a) keep some or all of these PDN connections still associated with non-3GPP access in EPS, if supported;
- b) release some or all of these PDN connections explicitly by initiating the UE requested PDN disconnect procedure(s) as specified in 3GPP TS 24.301; or
- c) attempt to transfer some or all of these PDN connections from S1 mode to N1 mode by initiating the PDU session establishment procedure(s) with the PDU SESSION ESTABLISHMENT REQUEST message created as specified in subclause 6.1.4.2.

After handover of an existing PDU session from 3GPP access to non-3GPP access, the network and the UE shall locally delete EPS bearer identities for the PDU session, if any.

#### 6.1.4.2 Coordination between 5GSM and ESM without N26 interface

When the network does not support N26 interface, the SMF does not provide the UE with the mapped EPS bearer context for a PDU session.

NOTE 1: Since the SMF does not provide the UE with the mapped EPS bearer context for a PDU session, the UE does not know whether interworking with EPS is supported for a PDU session before attempting to transfer the PDU session from N1 mode to S1 mode.

NOTE 2: It is up to UE implementation to decide which PDU session(s) to be attempted to transfer from N1 mode to S1 mode, e.g. based on UE policy or user preference.

Upon inter-system change from N1 mode to S1 mode in EMM-IDLE mode, the UE shall use the parameters from each PDU session which the UE intends to transfer to EPS to create the contents of a PDN CONNECTIVITY REQUEST message as follows:

- a) if the PDU session is an emergency PDU session, the request type shall be set to "handover of emergency bearer services". Otherwise the request type shall be set to "handover";
- b) the PDU session type of the PDU session shall be mapped to the PDN type of the default EPS bearer context as follows:
  - 1) the PDN type shall be set to "non-IP" if the PDU session type is "Ethernet" or "Unstructured";
  - 2) the PDN type shall be set to "IPv4" if the PDU session type is "IPv4";
  - 3) the PDN type shall be set to "IPv6" if the PDU session type is "IPv6"; and
  - 4) the PDN type shall be set to "IPv4v6" if the PDU session type is "IPv4v6";
- c) the DNN of the PDU session shall be mapped to the APN of the default EPS bearer context; and
- d) the PDU session ID parameter in the PCO IE shall be set to the PDU session identity of the PDU session.

After inter-system change from N1 mode to S1 mode, the UE shall associate the PDU session identity with the default EPS bearer context.

Upon successful completion of an EPS attach procedure after inter-system change from N1 mode to S1 mode (see 3GPP TS 24.301 [15]), the UE shall delete any UE derived QoS rules.

The UE shall perform a local release of the PDU session(s) and QoS flow(s) associated with the 3GPP access which have not been transferred to EPS.

For PDU session(s) associated with non-3GPP access in 5GS, if present, the UE may:

- a) keep some or all of these PDU sessions still associated with non-3GPP access in 5GS, if supported;
- b) release some or all of these PDU sessions explicitly by initiating the UE requested PDU session release procedure(s); or
- c) attempt to transfer some or all of these PDU sessions from N1 mode to S1 mode by initiating the UE requested PDN connectivity procedure(s) with the PDN CONNECTIVITY REQUEST message created as above.

When the network does not support N26 interface, the MME does not provide the UE with the mapped PDU session for a PDN connection but provides the UE with an S-NSSAI. When establishing a new PDN connection in S1 mode, to enable the UE to attempt to transfer the PDN connection from S1 mode to N1 mode in case of inter-system change, the UE shall allocate a PDU session identity, indicate the allocated PDU session identity in the PDU session ID parameter in the Protocol configuration options IE of the PDN CONNECTIVITY REQUEST message and associate the allocated PDU session identity with the default EPS bearer context of the PDN connection. The network provides the UE with an S-NSSAI in the Protocol configuration options IE or Extended protocol configuration options IE of the ACTIVATE DEFAULT EPS BEARER REQUEST message, or in the N1\_MODE\_INFORMATION Notify payload of the IKE\_AUTH response message.

NOTE 3: Since the MME does not provide the UE with the mapped PDU session for a PDN connection, the UE does not know whether interworking to 5GS is supported for a PDN connection for which the UE assigned a PDU Session identity before attempting to transfer the PDN connection from S1 mode to N1 mode.

NOTE 4: It is up to UE implementation to decide which PDN connection(s) to be attempted to transfer from S1 mode to N1 mode, e.g. based on UE policy or user preference.

Upon inter-system change from S1 mode to N1 mode in 5GMM-IDLE mode, the UE uses the parameters from the default EPS bearer context of each PDN connection which the UE intends to transfer to 5GS and for which the UE has allocated a PDU session identity to create a PDU SESSION ESTABLISHMENT REQUEST message as follows:

- a) if the PDN connection is for emergency bearer services, the request type shall be set to "existing emergency PDU session". Otherwise the request type shall be set to "existing PDU session";
- b) the PDN type of the default EPS bearer context shall be mapped to the PDU session type of the PDU session as follows:
  - 1) if the PDN type is "non-IP":
    - the PDU session type is set to the locally available information associated with the PDN connection (either "Ethernet" or "Unstructured"), if available; or
    - otherwise, the PDU session type is set to "Unstructured";
  - 2) if the PDN type is "IPv4" the PDU session type is set to "IPv4";
  - 3) if the PDN type is "IPv6", the PDU session type is set to "IPv6"; and
  - 4) the PDN type shall be set to "IPv4v6" if the PDU session type is "IPv4v6";
- c) the APN of the default EPS bearer context shall be mapped to the DNN of the PDU session;
- d) the PDU session ID shall be set to the PDU session identity included by the UE in the Protocol configuration options IE or Extended protocol configuration options IE in the PDN CONNECTIVITY REQUEST message, or to the PDU session ID associated with the default EPS bearer context; and
- e) the S-NSSAI of the PDU session shall be set to the S-NSSAI included by the network in the Protocol configuration options IE or Extended protocol configuration options IE in the ACTIVATE DEFAULT EPS BEARER REQUEST message, if provided by the network, or the S-NSSAI associated with the default EPS bearer context, if available.

NOTE 5: If T3584 is running or deactivated for the S-NSSAI and optionally the DNN combination, the UE is allowed to initiate ESM procedures in EPS with or without APN corresponding to that DNN, and if the APN is congested in EPS, the MME can send a back-off timer for the APN to the UE as specified in 3GPP TS 24.301 [15].

The UE shall locally release the PDN connection(s) and EPS bearer(s) associated with the 3GPP access which have not been transferred to 5GS.

For PDN connection(s) associated with non-3GPP access in EPS, if present, the UE may:

- a) keep some or all of these PDN connections still associated with non-3GPP access in EPS, if supported;
- b) release some or all of these PDN connections explicitly by initiating the UE requested PDN disconnect procedure(s) as specified in 3GPP TS 24.301; or
- c) attempt to transfer some or all of these PDN connections from S1 mode to N1 mode by initiating the PDU session establishment procedure(s) with the PDU SESSION ESTABLISHMENT REQUEST message created as above.

## 6.2 General on elementary 5GSM procedures

### 6.2.1 Principles of PTI handling for 5GSM procedures

When the UE or the network initiates a transaction related procedure (i.e. a procedure consisting of more than one message and the messages are related), it shall include a valid PTI value in the message header of the request message or of the command message.

If a response message is sent as result of a received request message or a received command message, the sending entity shall include in the response message the PTI value received within the request message or within the command message (see examples in figure 6.2.1.1, figure 6.2.1.2, and figure 6.2.1.3).



If a command message is sent as result of a received request message, the sending entity shall include in the command message the PTI value received with the request message (see examples in figure 6.2.1.3).

If a command message is not sent as result of a received request message, the sending entity shall include in the command message the PTI value set to "no procedure transaction identity assigned" (see examples in figure 6.2.1.4).

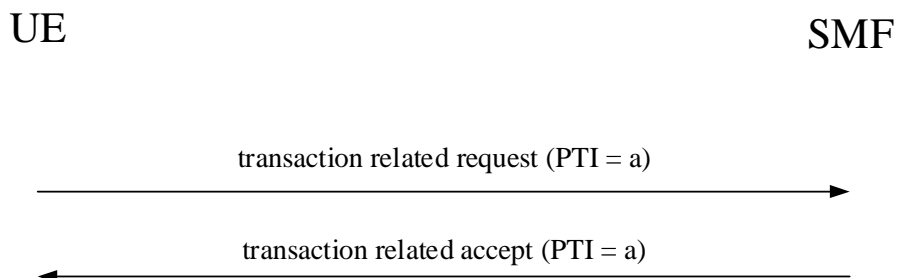

**Figure 6.2.1.1: UE-requested transaction related procedure accepted by the network**

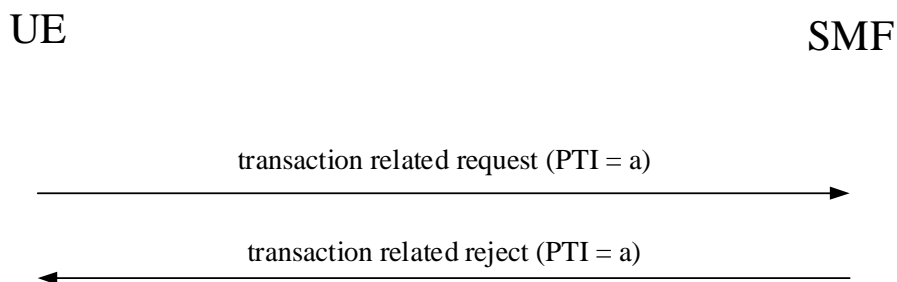

**Figure 6.2.1.2: UE-requested transaction related procedure rejected by the network**

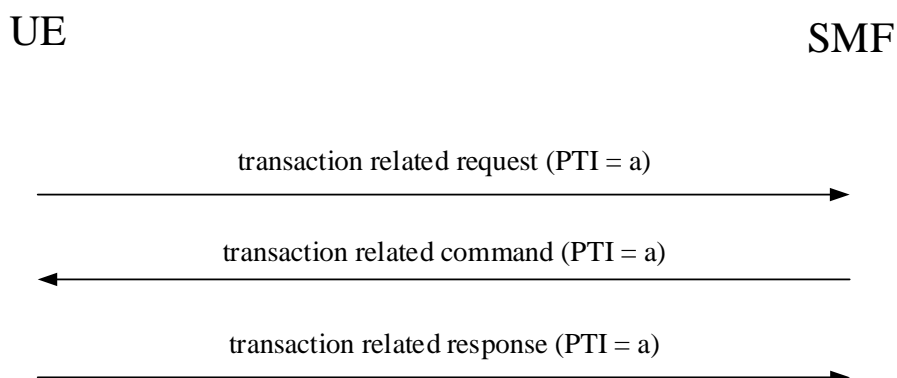

**Figure 6.2.1.3: UE-requested transaction related procedure triggering a network-requested transaction related procedure**

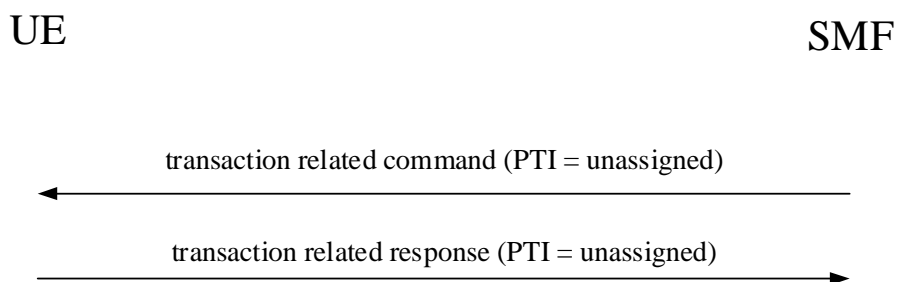

**Figure 6.2.1.4: network-requested transaction related procedure not triggered by a UE-requested transaction related procedure**

## 6.2.2 PDU session types

The following PDU Session types are supported:

- a) IPv4;
- b) IPv6;
- c) IPv4v6;
- d) Ethernet (EtherType as defined in IEEE 802.3); and
- e) Unstructured.

IP address allocation for IPv4, IPv6 and IPv4v6 PDU session types is described in subclause 6.2.4.

Neither a MAC nor an IP address is allocated by the 5GCN to the UE for Ethernet PDU session type.

## 6.2.3 PDU session management

The SMF is responsible for the session management functions to provide the PDU connectivity service to the UE via the SM signalling between UE and SMF. The session management procedures includes:

- a) the UE-requested PDU session establishment procedure;
- b) the PDU session authentication and authorization procedure;
- c) the UE-requested PDU session modification procedure;
- d) the network-requested PDU session modification procedure;
- e) the UE-requested PDU session release procedure; and
- f) the network-requested PDU session release procedure.

A UE may establish multiple PDU sessions, to the same data network or to different data networks, via 3GPP and via and Non-3GPP access networks at the same time.

The session management messages between UE and SMF are transferred via AMF as specified in subclause 8.3.

## 6.2.4 IP address allocation

### 6.2.4.1 General

This clause specifies IP address allocation for the PDU session.

In this release of specification, PDU session can be initiated with one IP version, i.e. IPv4 PDU session type or IPv6 PDU session type, or with both IP versions, i.e. IPv4v6 PDU session type.

IP address allocation to the UE shall be performed by SMF based on one or both the selected IP versions and operator policies. If IPv4 PDU session type is selected, an IPv4 address is allocated to the UE. If IPv6 PDU session type is selected, an IPv6 prefix and an interface identifier for the IPv6 link local address are allocated to the UE. If IPv4v6 PDU session type is selected, an IPv4 address, an IPv6 prefix and an interface identifier for the IPv6 link local address are allocated to the UE.

For IPv4 PDU session type and for IPv4v6 PDU session type, the UE:

- a) shall obtain an IPv4 address via:
  - 1) NAS signalling as specified in subclause 6.2.4.2; or
  - 2) DHCPv4; and
- b) may obtain IPv4 configuration parameters (e.g. DNS server address) via DHCPv4.

For IPv6 PDU session type and for IPv4v6 PDU session type, the UE:

- a) shall build an IPv6 link local address based on the allocated interface identifier for the IPv6 link local address;
- b) shall obtain /64 IPv6 prefix via IPv6 stateless address autoconfiguration as specified in 3GPP TS 23.501 [8] and IETF RFC 4862 [39]; and
- c) may obtain IPv6 configuration parameters via stateless DHCPv6 as specified in IETF RFC 3736 [35].

#### 6.2.4.2 IP address allocation via NAS signalling

The UE shall set the PDU session type IE in the PDU SESSION ESTABLISHMENT REQUEST message, based on its IP stack capabilities if the UE requests IP connectivity as follows:

- a) A UE:
  - 1) which is IPv6 and IPv4 capable, shall set the PDU session type IE to IPv4, IPv6 or IPv4v6 according to UE configuration or received policy.
  - 2) which is only IPv6 capable, shall set the PDU session type IE to IPv6.
  - 3) which is only IPv4 capable, shall set the PDN type IE to IPv4.
- b) When the IP version capability of the UE is unknown in the UE (as in the case when the MT and TE are separated and the capability of the TE is not known in the MT), the UE shall set the PDU session type IE to IPv4v6.

If the UE wants to use DHCPv4 for IPv4 address assignment, it shall indicate that to the network within the Extended protocol configuration options IE in the PDU SESSION ESTABLISHMENT REQUEST.

On receipt of the PDU SESSION ESTABLISHMENT REQUEST message sent by the UE, the network when allocating an IP address shall take into account the PDU session type IE, the operator's policies of the network, and the user's subscription data and:

- a) if the network sets the PDU session type IE to IPv4, the network shall include an IPv4 address in the PDU address IE;
- b) if the network sets the PDU session type IE to IPv6, the network shall include an interface identifier for the IPv6 link local address in the PDU address IE; and
- c) if the network sets the PDU session type IE to IPv4v6, the network shall include an IPv4 address and an interface identifier for the IPv6 link local address in the PDU address IE.

## 6.2.5 Quality of service

### 6.2.5.1 General

#### 6.2.5.1.1 QoS rules

##### 6.2.5.1.1.1 General

In a PDU session of IPv4, IPv6, IPv4v6 and Ethernet PDU session type, the NAS protocol enables different forwarding treatments of UL user data packets in one or more QoS flows based on signalled QoS rules, derived QoS rules or any combination of them.

In a PDU session of Unstructured PDU session type, all UL user data packets are associated with the same QoS flow.

##### 6.2.5.1.1.2 Signalled QoS rules

The NAS protocol enables the network to provide the UE with signalled QoS rules associated with a PDU session.

The network can provide the UE with one or more signalled QoS rules associated with a PDU session at the PDU session establishment or at the PDU session modification.

Each signalled QoS rule contains:

- a) an indication of whether the QoS rule is the default QoS rule;
- b) a QoS rule identifier (QRI);
- c) a QoS flow identifier (QFI);
- d) optionally, a set of packet filters; and
- e) a precedence value.

NOTE: The default QoS rule indication (DQR) of a signalled QoS rule cannot be changed.

For case d) above:

- 1) If the QoS rule is the default rule of a PDU session of IPv4, IPv6, IPv4v6 or Ethernet PDU session type, the set of packet filters contains zero or more packet filters for DL direction, and may additionally contain one of the following:
  - A) a match-all packet filter for UL direction;
  - B) a match-all packet filter for UL and DL directions;
  - C) zero or more packet filters for UL direction (other than the match-all packet filter for UL direction);
  - D) zero or more packet filters for UL and DL directions (other than the match-all packet filter for UL and DL directions); or
  - E) one or more packet filters for UL direction (other than the match-all packet filter for UL direction) and one or more packet filters for UL and DL directions (other than the match-all packet filter for UL and DL directions).

The set of packet filters for the default rule shall not be empty. If the default QoS rule contains a match-all packet filter, then the highest precedence value shall be used for the default QoS rule.
- 2) If the QoS rule is a QoS rule of a PDU session of IPv4, IPv6, IPv4v6 or Ethernet PDU session type and is not the default QoS rule, the set of packet filters contains zero or more packet filters for the DL direction, and may additionally contain one of the following:
  - A) zero or more packet filters for UL direction (other than the match-all packet filter for UL direction); and

B) zero or more packet filters for both UL and DL directions (other than the match-all packet filter for UL and DL directions).

The set of packet filters for a QoS rule which is not the default QoS rule shall not be empty.

- 3) For PDU session of unstructured PDU session type, there is only one QoS rule associated with it and the set of packet filters of that QoS rule is empty.

If the UE requests a new QoS rule, it shall assign a precedence value for the signalled QoS rule which is not in the range from 70 to 99 (decimal).

Within a PDU session:

- a) each signalled QoS rule has a unique QRI;
- b) there is at least one signalled QoS rule;
- c) one signalled QoS rule is the default QoS rule; and
- d) there can be zero, one or more signalled QoS rules associated with a given QFI.

#### 6.2.5.1.1.3 Derived QoS rules

Derived QoS rules are applicable only for PDU session of IPv4, IPv6, IPv4v6 or Ethernet PDU session type.

The reflective QoS in the UE creates derived QoS rules associated with a PDU session based on DL user data packets received via the PDU session.

Each derived QoS rule contains:

- a) a QoS flow identifier (QFI);
- b) a packet filter for UL direction; and
- c) a precedence value of 80 (decimal).

NOTE: On the network side, the corresponding QoS rule can be associated with a different precedence value in the range from 70 to 99 (decimal).

Within a PDU session:

- a) there can be zero, one or more derived QoS rules associated with a given QFI; and
- b) there can be up to one derived QoS rule associated with a given packet filter for UL direction.

In the UE, a timer T3583 runs for each derived QoS rule.

#### 6.2.5.1.1.4 QoS flow descriptions

The network can also provide the UE with one or more QoS flow descriptions associated with a PDU session at the PDU session establishment or at the PDU session modification.

Each QoS flow description contains:

- a) a QoS flow identifier (QFI);
- b) if the flow is a GBR QoS flow:
  - 1) Guaranteed flow bit rate (GFBR) for UL;
  - 2) Guaranteed flow bit rate (GFBR) for DL;
  - 3) Maximum flow bit rate (MFBR) for UL;
  - 4) Maximum flow bit rate (MFBR) for DL; and
  - 5) optionally averaging window, applicable for both UL and DL;

- c) 5QI, if the QFI is not the same as the 5QI of the QoS flow identified by the QFI; and
- d) optionally, an EPS bearer identity (EBI) if the QoS flow can be mapped to an EPS bearer as specified in subclause 4.11.2 of 3GPP TS 23.502 [9].

If the averaging window is not included in a QoS flow description for a GBR QoS flow with a 5QI indicated in 3GPP TS 23.501 [8] table 5.7.4-1, the averaging window associated with the 5QI in 3GPP TS 23.501 [8] table 5.7.4-1 applies for the averaging window.

If the averaging window is not included in a QoS flow description for a GBR QoS flow with a 5QI not indicated in 3GPP TS 23.501 [8] table 5.7.4-1, the standardized value of two seconds is used as the averaging window.

#### 6.2.5.1.2 Session-AMBR

The NAS protocol enables the network to provide the UE with the session-AMBR associated with a PDU session.

The standardized value of two seconds is used as the averaging window for the UE's enforcement of the UL rate limitation indicated by the session-AMBR.

#### 6.2.5.1.3 UL user data packet matching

For PDU session of IPv4, IPv6, IPv4v6 or Ethernet PDU session type, upon receiving an UL user data packet from the upper layers for transmission via a PDU session, the UE shall attempt to associate the UL user data packet with:

- a) the QFI of a signalled QoS rule associated with the PDU session which has a set of packet filters containing a packet filter for UL direction matching the UL user data packet or containing a packet filter for both UL and DL directions matching the UL user data packet; or
- b) the QFI of a derived QoS rule associated with the PDU session which has the packet filter for UL direction matching the UL user data packet;

by evaluating the QoS rules in increasing order of their precedence values until the UL user data packet is associated with a QFI or all QoS rules are evaluated.

For PDU session of unstructured PDU session type, upon receiving an UL user data packet from the upper layers for transmission via a PDU session, the UE shall associate the UL user data packet with the QFI of the default QoS rule associated with the PDU session.

If the UL user data packet is associated with a QFI, the UE shall pass the QFI along the UL user data packet to the lower layers for transmission.

NOTE: Marking of the UL user data packet with the QFI is performed by the lower layers.

If all QoS rules are evaluated and the UL user data packet is not associated with a QFI, the UE shall discard the UL user data packet.

#### 6.2.5.1.4 Reflective QoS

##### 6.2.5.1.4.1 General

The UE may support reflective QoS.

If the UE supports the reflective QoS, the UE shall support the procedures in the following subclauses.

The reflective QoS is applicable in a PDU session of IPv4, IPv6, IPv4v6 and Ethernet PDU session type. The reflective QoS is not applicable in a PDU session of Unstructured PDU session type.

The UE may request to revoke the usage of reflective QoS for an existing PDU session for which the UE had previously indicated support for reflective QoS.

##### 6.2.5.1.4.2 Derivation of packet filter for UL direction from DL user data packet

If the UE needs to derive a packet filter for UL direction from the DL user data packet (see subclause 6.2.5.1.4.3 and 6.2.5.1.4.4), the UE shall proceed as follows:

- a) if the received DL user data packet belongs to a PDU session of IPv4 or IPv4v6 PDU session type and is an IPv4 packet and:
- 1) the protocol field of the received DL user data packet indicates TCP as specified in IETF RFC 793 [33];
  - 2) the protocol field of the received DL user data packet indicates UDP as specified in IETF RFC 768 [32]; or
  - 3) the protocol field of the received DL user data packet indicates ESP as specified in IETF RFC 4303 [38] and an uplink IPsec SA corresponding to a downlink IPsec SA indicated in the security parameters index field of the received DL user data packet exists;

then the packet filter for UL direction contains the following packet filter components:

- 1) an IPv4 remote address component set to the value of the source address field of the received DL user data packet;
- 2) an IPv4 local address component set to the value of the destination address field of the received DL user data packet;
- 3) a protocol identifier/next header type component set to the value of the protocol field of the received DL user data packet;
- 4) if the protocol field of the received DL user data packet indicates TCP as specified in IETF RFC 793 [33] or UDP as specified in IETF RFC 768 [32]:
  - i) a single local port type component set to the value of the destination port field of the received DL user data packet; and
  - ii) a single remote port type component set to the value of the source port field of the received DL user data packet; and
- 5) if the protocol field of the received DL user data packet indicates ESP as specified in IETF RFC 4303 [38]:
  - i) a security parameter index type component set to the security parameters index of the uplink IPsec SA corresponding to the downlink IPsec SA indicated in the security parameters index field of the received DL user data packet;

otherwise it is not possible to derive a packet filter for UL direction from the DL user data packet;

- b) if the received DL user data packet belongs to a PDU session of IPv6 or IPv4v6 PDU session type and is an IPv6 packet and:
- 1) the last next header field of the received DL user data packet indicates TCP as specified in IETF RFC 793 [33];
  - 2) the last next header field of the received DL user data packet indicates UDP as specified in IETF RFC 768 [32]; or
  - 3) the last next header field of the received DL user data packet indicates ESP as specified in IETF RFC 4303 [38] and an uplink IPsec SA corresponding to a downlink IPsec SA indicated in the security parameters index field of the received DL user data packet exists;

then the packet filter for UL direction contains the following packet filter components:

- 1) an IPv6 remote address/prefix length component set to the value of the source address field of the received DL user data packet;
- 2) an IPv6 local address/prefix length component set to the value of the destination address field of the received DL user data packet;
- 3) a protocol identifier/next header type component set to the value of the last next header field of the received DL user data packet;
- 4) if the last next header field of the received DL user data packet indicates TCP as specified in IETF RFC 793 [33] or UDP as specified in IETF RFC 768 [32]:

- i) a single local port type component set to the value of the destination port field of the received DL user data packet; and
  - ii) a single remote port type component set to the value of the source port field of the received DL user data packet; and
- 5) if the last next header field of the received DL user data packet indicates ESP as specified in IETF RFC 4303 [38]:
- i) a security parameter index type component set to the security parameters index of the uplink IPsec SA corresponding to the downlink IPsec SA indicated in the security parameters index field of the received DL user data packet;

otherwise it is not possible to derive a packet filter for UL direction from the DL user data packet;

- c) if the received DL user data packet belongs to a PDU session of Ethernet PDU session type, the packet filter for UL direction contains the following packet filter components:
- 1) a destination MAC address component set to the source MAC address of the received DL user data packet;
  - 2) a source MAC address component set to the destination MAC address of the received DL user data packet;
  - 3) if an 802.1Q C-TAG is included in the received DL user data packet, an 802.1Q C-TAG VID component set to the 802.1Q C-TAG VID of the received DL user data packet and an 802.1Q C-TAG PCP/DEI component set to the 802.1Q C-TAG PCP/DEI of the received DL user data packet;
  - 4) if an 802.1Q S-TAG is included in the received DL user data packet, an 802.1Q S-TAG VID component set to the 802.1Q S-TAG VID of the received DL user data packet and an 802.1Q S-TAG PCP/DEI component set to the 802.1Q S-TAG PCP/DEI of the received DL user data packet;
  - 5) If the Ethertype field of the received DL user data packet is set to a value of 1536 or above, an Ethertype component set to the Ethertype of the received DL user data packet;
  - 6) if the Ethertype field of the Ethernet frame header indicates that the data carried in the Ethernet frame is IPv4 data, the UE shall also add to the packet filter for UL direction the IP-specific components based on the contents of the IP header of the received DL user data packet as described in bullet a) above; and
  - 7) if the Ethertype field of the Ethernet frame header indicates that the data carried in the Ethernet frame is IPv6 data, the UE shall also add to the packet filter for UL direction the IP-specific components based on the contents of the IP header of the received DL user data packet as described in bullet b) above; and
- d) if the received DL user data packet belongs to a PDU session of PDU session type other than Ethernet, IPv4, IPv6 and IPv4v6, it is not possible to derive a packet filter for UL direction from the DL user data packet.

#### 6.2.5.1.4.3 Creating a derived QoS rule by reflective QoS in the UE

If the UE receives a DL user data packet marked with a QFI and an RQI, the DL user data packet belongs to a PDU session of IPv4, IPv6, IPv4v6 or Ethernet PDU session type, and the UE does not have a derived QoS rule with the same packet filter for UL direction as the packet filter for UL direction derived from the DL user data packet as specified in subclause 6.2.5.1.4.2, then the UE shall create a new derived QoS rule as follows:

- a) the QFI of the derived QoS rule is set to the received QFI;
- b) the precedence value of the derived QoS rule is set to 80 (decimal); and
- c) the packet filter for UL direction of the derived QoS rule is set to the derived packet filter for UL direction;

and the UE shall start the timer T3583 associated with the derived QoS rule with the RQ timer value last received during the UE-requested PDU session establishment procedure of the PDU session (see subclause 6.4.1) or the network-requested PDU session modification procedure of the PDU session (see subclause 6.4.2). If the RQ timer value was received neither in the UE-requested PDU session establishment procedure of the PDU session nor in any network-requested PDU session modification procedure of the PDU session, the default standardized RQ timer value is used.



#### 6.2.5.1.4.4 Updating a derived QoS rule by reflective QoS in the UE

If the UE receives a DL user data packet associated with a QFI and an RQI, the DL user data packet belongs to a PDU session of IPv4, IPv6, IPv4v6 or Ethernet PDU session type, and the UE has a derived QoS rule with the same packet filter for UL direction as the packet filter for UL direction derived from the DL user data packet as specified in subclause 6.2.5.1.4.2:

- a) the UE shall re-start the timer T3583 associated with the derived QoS rule with the RQ timer value last received during the UE-requested PDU session establishment procedure of the PDU session (see subclause 6.4.1) or the network-requested PDU session modification procedure of the PDU session (see subclause 6.4.2). If the RQ timer value was received neither in the UE-requested PDU session establishment procedure of the PDU session nor in any network-requested PDU session modification procedure of the PDU session, the default standardized RQ timer value is used; and
- b) if the QFI value associated with the DL user data packet is different from the QFI value stored for the derived QoS rule, the UE shall replace the QFI value stored for the derived QoS rule with the new QFI value for the derived QoS rule.

#### 6.2.5.1.4.5 Deleting a derived QoS rule in the UE

Upon expiration of timer T3583 associated with a derived QoS rule, the UE shall remove the derived QoS rule.

Upon release of the PDU session, the UE shall remove the derived QoS rule(s) associated with the PDU session.

If the network accepts the request from the UE to revoke the usage of reflective QoS and sets the value of the RQ timer to "deactivated" or zero, the UE shall remove the derived QoS rule(s) associated with the PDU session.

When a derived QoS rule is deleted, the timer T3583 associated with the derived QoS rule shall be stopped.

#### 6.2.5.1.4.6 Ignoring RQI in the UE

If the UE receives a DL user data packet marked with a QFI and an RQI and it is not possible to derive a packet filter for UL direction from the DL user data packet as specified in subclause 6.2.5.1.4.2, the UE shall ignore the RQI and shall handle the received DL user data packet.

## 6.2.6 Local area data network (LADN)

The UE can receive the local area data network (LADN) information consisting of LADN DNNs and LADN service area information (a set of tracking areas that belong to the current registration area) during the registration procedure or the generic UE configuration update procedure (see subclause 5.5.1 and subclause 5.4.4).

The UE shall consider itself to be located inside the LADN service area based on the LADN service area information. If the UE does not have a LADN service area information for the LADN DNN, the UE shall consider itself to be located outside the LADN service area.

When the UE is located in the LADN service area, the UE may initiate:

- the UE-requested PDU session establishment procedure with a LADN DNN to establish a PDU session for LADN;
- the UE-requested PDU session modification procedure to modify the PDU session for LADN; and
- the service request procedure to re-establish the user-plane resources for the PDU session for LADN.

When the UE is located outside the LADN service area, the UE is allowed:

- to initiate the UE-requested PDU session release procedure to release a PDU session for LADN; or
- to initiate the UE-requested PDU session modification procedure to indicate a change of 3GPP PS data off UE status.

If the UE has moved out of the LADN service area, the SMF shall:

- a) release the PDU session for LADN; or

b) release the user-plane resources for the PDU session for LADN and maintain the PDU session for LADN; according to operator's policy.

In case b):

- if the UE has returned to the LADN service area, and the network has downlink user data pending, the network re-establishes the user-plane resources for the PDU session for LADN; and.
- if the UE has not returned to the LADN service area after a period of time according to operator's policy, the SMF may release the PDU session for LADN.

When the UE moves to 5GMM-DEREGISTERED state, the UE shall delete the stored LADN information, if any.

NOTE: In this release, LADNs apply only to 3GPP access.

## 6.2.7 Handling of DNN based congestion control

The network may detect and start performing DNN based congestion control when one or more DNN congestion criteria as specified in 3GPP TS 23.501 [8] are met. The network may store a DNN congestion back-off timer on a per UE and congested DNN basis. If the UE does not provide a DNN for a non-emergency PDU session, then the network uses the selected DNN.

In the UE, 5GS session management timers T3396 for DNN based congestion control are started and stopped on a per DNN basis except for an LADN DNN. For an LADN DNN, 5GS session management timers T3396 for DNN based congestion control is applied to the registered PLMN and its equivalent PLMNs.

The DNN associated with T3396 is the DNN provided by the UE during the PDU session establishment. If no DNN is provided by the UE along the PDU SESSION ESTABLISHMENT REQUEST, then T3396 is associated with no DNN. For this purpose the UE shall memorize the DNN provided to the network during the PDU session establishment. The timer T3396 associated with no DNN will never be started due to any 5GSM procedure related to an emergency PDU session. If the timer T3396 associated with no DNN is running, it does not affect the ability of the UE to request an emergency PDU session.

If T3396 is running or is deactivated, then the UE is neither allowed to initiate the PDU session establishment procedure nor the PDU session modification procedure for the respective DNN or without a DNN unless the UE is a UE configured for high priority access in selected PLMN or to report a change of 3GPP PS data off UE status.

## 6.2.8 Handling of S-NSSAI based congestion control

The network may detect and start performing S-NSSAI based congestion control when one or more S-NSSAI congestion criteria as specified in 3GPP TS 23.501 [8] are met. The network may store an S-NSSAI congestion back-off timer on a per UE, S-NSSAI, and optionally DNN basis. If the UE does not provide a DNN for a non-emergency PDU session, then the network uses the selected DNN. If the UE does not provide an S-NSSAI for a non-emergency PDU session, then the network uses the selected S-NSSAI.

In the UE, 5GS session management timers T3584 for the S-NSSAI based congestion control are started and stopped on a per S-NSSAI, DNN and PLMN basis. If the 5GSM congestion re-attempt indicator IE set to "The back-off timer is applied in all PLMNs" is included in the 5GSM message with the 5GSM cause value #67 "insufficient resources for specific slice and DNN", then the UE applies the timer T3584 for all the PLMNs.

In the UE, 5GS session management timers T3585 for the S-NSSAI based congestion control are started and stopped on a per S-NSSAI and PLMN basis. If the 5GSM congestion re-attempt indicator IE set to "The back-off timer is applied in all PLMNs" is included in the 5GSM message with the 5GSM cause value #69 "insufficient resources for specific slice", then the UE applies the timer T3585 for all the PLMNs.

The S-NSSAI associated with T3584 is the S-NSSAI provided by the UE during the PDU session establishment. The DNN associated with T3584 is the DNN provided by the UE during the PDU session establishment. If no S-NSSAI but DNN is provided by the UE along the PDU SESSION ESTABLISHMENT REQUEST message, then T3584 is associated with no S-NSSAI and a DNN provided to the network during the PDU session establishment. If no DNN but S-NSSAI is provided by the UE along the PDU SESSION ESTABLISHMENT REQUEST message, then T3584 is associated with no DNN and an S-NSSAI provided to the network during the PDU session establishment. If no DNN and no S-NSSAI is provided by the UE along the PDU SESSION ESTABLISHMENT REQUEST message, then T3584

is associated with no DNN and no S-NSSAI. For this purpose, the UE shall memorize the DNN and S-NSSAI provided to the network during the PDU session establishment. The timer T3584 associated with no DNN and an S-NSSAI will never be started due to any 5GSM procedure related to an emergency PDU session. If the timer T3584 associated with no DNN and an S-NSSAI is running, it does not affect the ability of the UE to request an emergency PDU session.

The S-NSSAI associated with T3585 is the S-NSSAI provided by the UE during the PDU session establishment. If no S-NSSAI is provided by the UE along the PDU SESSION ESTABLISHMENT REQUEST message, then T3585 is associated with no S-NSSAI.

If T3584 is running or is deactivated, then the UE is neither allowed to initiate the PDU session establishment procedure nor the PDU session modification procedure for the respective [S-NSSAI, no DNN] or [S-NSSAI, DNN] combination unless the UE is a UE configured for high priority access in selected PLMN or to report a change of 3GPP PS data off UE status.

If the timer T3584 is running or is deactivated for all the PLMNs, then

- a) the UE is neither allowed to initiate the PDU session establishment procedure nor the PDU session modification procedure for the respective [S-NSSAI, no DNN] or [S-NSSAI, DNN] combination in all the PLMNs unless the UE is a UE configured for high priority access in selected PLMN or to report a change of 3GPP PS data off UE status; and
- b) the UE is neither allowed to initiate the PDU session establishment procedure nor the PDU session modification procedure for the mapped S-NSSAI of the respective [S-NSSAI, no DNN] or [S-NSSAI, DNN] combination in all visited PLMNs unless the UE is a UE configured for high priority access in selected PLMN or to report a change of 3GPP PS data off UE status.

If the timer T3584 is running or is deactivated for all the PLMNs and is associated with [no S-NSSAI, no DNN] or [no S-NSSAI, DNN] combination, then the UE is neither allowed to initiate the PDU session establishment procedure nor the PDU session modification procedure for [no S-NSSAI, no DNN] or [no S-NSSAI, DNN] combination in any PLMN unless the UE is a UE configured for high priority access in selected PLMN or to report a change of 3GPP PS data off UE status.

If T3585 is running or is deactivated, then the UE is neither allowed to initiate the PDU session establishment procedure nor the PDU session modification procedure for the respective S-NSSAI unless the UE is a UE configured for high priority access in selected PLMN or to report a change of 3GPP PS data off UE status.

If the timer T3585 is running or is deactivated for all the PLMNs, then

- a) the UE is neither allowed to initiate the PDU session establishment procedure nor the PDU session modification procedure for the respective S-NSSAI in all the PLMNs unless the UE is a UE configured for high priority access in selected PLMNs or to report a change of 3GPP PS data off UE status; and
- b) the UE is neither allowed to initiate the PDU session establishment procedure nor the PDU session modification procedure for the mapped S-NSSAI of the respective S-NSSAI in all visited PLMNs unless the UE is a UE configured for high priority access in selected PLMN or to report a change of 3GPP PS data off UE status.

If the timer T3585 is running or is deactivated for all the PLMNs and is associated with no S-NSSAI, then the UE is neither allowed to initiate the PDU session establishment procedure nor the PDU session modification procedure for no S-NSSAI in any PLMN unless the UE is a UE configured for high priority access in selected PLMN or to report a change of 3GPP PS data off UE status.

## 6.2.9 Interaction with upper layers

### 6.2.9.1 General

A 5GSM entity may interact with upper layers. Subclause 6.2.9.2 describes how the 5GSM entity interacts with upper layers with respect to the URSP.

### 6.2.9.2 URSP

The URSP requires interaction between upper layers and the 5GSM entities in the UE (see 3GPP TS 24.526 [19] for further details). Each of the 5GSM entities in the UE shall indicate attributes (e.g. PDU session identity, SSC mode, S-NSSAI, DNN, PDU session type, access type, PDU address) of a newly established PDU session to the upper layers. If

a PDU session is released, the 5GSM entity handling the PDU session shall inform the PDU session identity of the released PDU session to the upper layers. The upper layers may request a 5GSM entity:

- a) to establish a PDU session indicating one or more PDU session attributes;
- b) to release an existing PDU session; or
- c) to establish a PDU session indicating one or more PDU session attributes, and to release an existing PDU session.

## 6.2.10 Handling of 3GPP PS data off

A UE, which supports 3GPP PS data off (see 3GPP TS 23.501 [8]), can be configured with up to two lists of 3GPP PS data off exempt services as specified in 3GPP TS 24.368 [17] or in the EF<sub>3GPPPSDATAOFF</sub> USIM file as specified in 3GPP TS 31.102 [22]:

- a) a list of 3GPP PS data off exempt services to be used in the HPLMN or EHPLMN; and
- b) a list of 3GPP PS data off exempt services to be used in the VPLMN.

If only the list of 3GPP PS data off exempt services to be used in the HPLMN or EHPLMN is configured at the UE, this list shall be also used in the VPLMN.

If the UE supports 3GPP PS data off, the UE shall provide the 3GPP PS data off UE status in the extended protocol configuration options IE during UE-requested PDU session establishment procedure, and UE-requested PDU session modification procedure (see subclause 6.4.1 and subclause 6.4.2).

The network shall support of 3GPP PS data off.

The UE shall indicate change of the 3GPP PS data off UE status for the PDU session by using the UE-requested PDU session modification procedure as specified in subclause 6.4.2.

When the 3GPP PS data off UE status is "activated":

- a) the UE does not send uplink IP packets via 3GPP access except:
  - 1) for those services indicated in the list of 3GPP PS data off exempt services to be used in the HPLMN or EHPLMN as specified in 3GPP TS 24.368 [17] when the UE is in its HPLMN or EHPLMN;
  - 2) for those services indicated in the list of 3GPP PS data off exempt services to be used in the HPLMN or EHPLMN when the UE is in the VPLMN, if only the list of 3GPP PS data off exempt services to be used in the HPLMN or EHPLMN is configured to the UE as specified in 3GPP TS 24.368 [17];
  - 3) for those services indicated in the list of 3GPP PS data off exempt services to be used in the VPLMN when the UE is in the VPLMN, if the list of 3GPP PS data off exempt services to be used in the VPLMN is configured to the UE as specified in 3GPP TS 24.368 [17];
  - 4) for those services indicated in the EF<sub>3GPPPSDATAOFF</sub> USIM file as specified in 3GPP TS 31.102 [22];
  - 5) any uplink traffic due to procedures specified in 3GPP TS 24.229 [14]; and
  - 6) any uplink traffic due to procedures specified in 3GPP TS 24.623 [20];
- b) the UE does not send uplink Ethernet user data packets via 3GPP access; and
- c) the UE does not send uplink Unstructured user data packets via 3GPP access.

Otherwise the UE sends uplink user data packets without restriction.

NOTE: If the UE supports 3GPP PS data off, uplink IP packets are filtered as specified in 3GPP TS 24.229 [14] in U.3.1.5.

3GPP PS data off does not restrict sending of uplink user data packets via non-3GPP access.

## 6.2.11 Multi-homed IPv6 PDU session

The UE supporting IPv6 may support multi-homed IPv6 PDU session.

If the UE supports the multi-homed IPv6 PDU session:

- a) the UE shall support acting as a type C host as specified in IETF RFC 4191 [36]; and
- b) the UE indicates support of the multi-homed IPv6 PDU session:
  - 1) during the UE-requested PDU session establishment of a PDU session of "IPv6" or "IPv4v6" PDU session type; and
  - 2) during the UE-requested PDU session modification performed after the first inter-system change from S1 mode to N1 mode, for a PDU session associated with a PDN connection established when in S1 mode, if the UE is operating in single-registration mode in the network supporting N26 interface, and the PDU session is of "IPv6" or "IPv4v6" PDU session type.

## 6.3 Network-requested 5GSM procedures

### 6.3.1 PDU session authentication and authorization procedure

#### 6.3.1.1 General

The purpose of the PDU session authentication and authorization procedure is to enable the DN:

- a) to authenticate the upper layers of the UE, when establishing the PDU session;
- b) to authorize the upper layers of the UE, when establishing the PDU session;
- c) both of the above; or
- d) to re-authenticate the upper layers of the UE after establishment of the PDU session.

The PDU session authentication and authorization procedure can be performed only during or after the UE-requested PDU session procedure establishing a non-emergency PDU session. The PDU session authentication and authorization procedure shall not be performed during or after the UE-requested PDU session establishment procedure establishing an emergency PDU session.

The network authenticates the UE using the Extensible Authentication Protocol (EAP) as specified in IETF RFC 3748 [32].

EAP has defined four types of EAP messages:

- a) an EAP-request message;
- b) an EAP-response message;
- c) an EAP-success message; and
- d) an EAP-failure message.

The EAP-request message is transported from the network to the UE using the PDU SESSION AUTHENTICATION COMMAND message of the PDU EAP message reliable transport procedure.

The EAP-response message to the EAP-request message is transported from the UE to the network using the PDU SESSION AUTHENTICATION COMPLETE message of the PDU EAP message reliable transport procedure.

If the PDU session authentication and authorization procedure is performed during the UE-requested PDU session establishment procedure:

- a) and the DN authentication of the UE completes successfully, the EAP-success message is transported from the network to the UE as part of the UE-requested PDU session establishment procedure in the PDU SESSION ESTABLISHMENT ACCEPT message.

- b) and the DN authentication of the UE completes unsuccessfully, the EAP-failure message is transported from the network to the UE as part of the UE-requested PDU session establishment procedure in the PDU SESSION ESTABLISHMENT REJECT message.

If the PDU session authentication and authorization procedure is performed after the UE-requested PDU session establishment procedure:

- a) and the DN authentication of the UE completes successfully, the EAP-success message is transported from the network to the UE using the PDU SESSION AUTHENTICATION RESULT message of the PDU EAP result message transport procedure.
- b) and the DN authentication of the UE completes unsuccessfully, the EAP-failure message is transported from the network to the UE using the PDU SESSION RELEASE COMMAND message of the network-requested PDU session release procedure.

There can be several rounds of exchange of an EAP-request message and a related EAP-response message for the DN to complete the authentication and authorization of the request for a PDU session (see example in figure 6.3.1.1).

The SMF shall set the authenticator retransmission timer specified in IETF RFC 3748 [34] subclause 4.3 to infinite value.

- NOTE: The PDU session authentication and authorization procedure provides a reliable transport of EAP messages and therefore retransmissions at the EAP layer of the SMF do not occur.

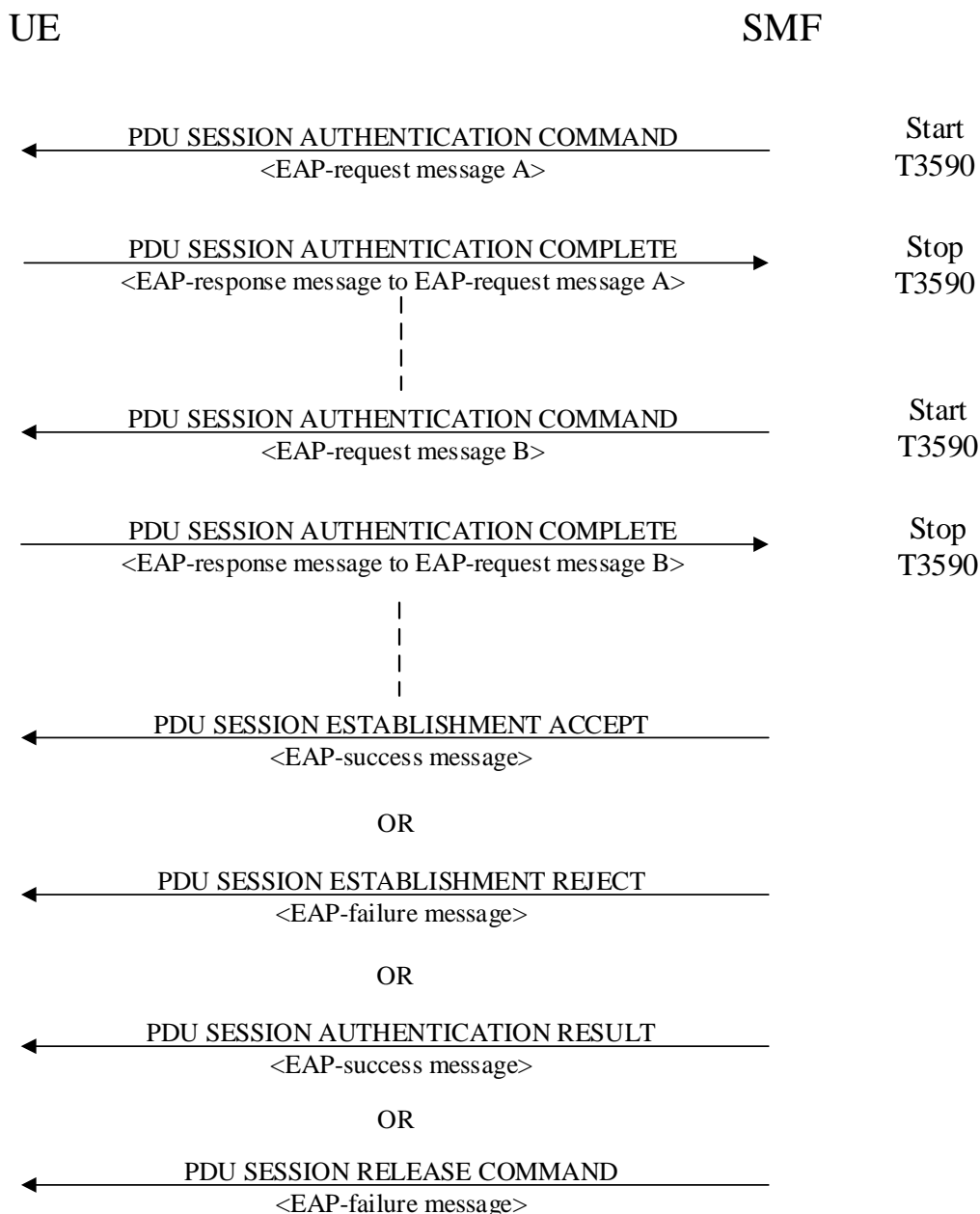

**Figure 6.3.1.1: PDU session authentication and authorization procedure**

### 6.3.1.2 PDU EAP message reliable transport procedure

#### 6.3.1.2.1 PDU EAP message reliable transport procedure initiation

In order to initiate the PDU EAP message reliable transport procedure, the SMF shall create a PDU SESSION AUTHENTICATION COMMAND message.

The SMF shall set the PTI IE of the PDU SESSION AUTHENTICATION COMMAND message to "No procedure transaction identity assigned".

The SMF shall set the EAP message IE of the PDU SESSION AUTHENTICATION COMMAND message to the EAP-request message provided by the DN or generated locally.

The SMF shall send the PDU SESSION AUTHENTICATION COMMAND message, and the SMF shall start timer T3590 (see example in figure 6.3.1.1).

Upon receipt of a PDU SESSION AUTHENTICATION COMMAND message and a PDU session ID, using the NAS transport procedure as specified in subclause 5.4.5, the UE passes to the upper layers the EAP message received in the EAP message IE of the PDU SESSION AUTHENTICATION COMMAND message. Apart from this action, the authentication and authorization procedure initiated by the DN is transparent to the 5GSM layer of the UE.

#### 6.3.1.2.2 PDU EAP message reliable transport procedure accepted by the UE

When the upper layers provide an EAP-response message responding to the received EAP-request message, the UE shall create a PDU SESSION AUTHENTICATION COMPLETE message.

The UE shall set the EAP message IE of the PDU SESSION AUTHENTICATION COMPLETE message to the EAP-response message.

The UE shall transport the PDU SESSION AUTHENTICATION COMPLETE message and the PDU session ID, using the NAS transport procedure as specified in subclause 5.4.5. Apart from this action, the authentication and authorization procedure initiated by the DN is transparent to the 5GSM layer of the UE.

Upon receipt of a PDU SESSION AUTHENTICATION COMPLETE message, the SMF shall stop timer T3590 and provides the EAP message received in the EAP message IE of the PDU SESSION AUTHENTICATION COMPLETE message to the DN or handles it locally.

#### 6.3.1.2.3 Abnormal cases on the network side

The following abnormal cases can be identified:

- a) T3590 expired.

The SMF shall, on the first expiry of the timer T3590, retransmit the PDU SESSION AUTHENTICATION COMMAND message and shall reset and start timer T3590. This retransmission is repeated four times, i.e. on the fifth expiry of timer T3590, the SMF shall abort the procedure.

#### 6.3.1.2.4 Abnormal cases in the UE

The following abnormal cases can be identified:

- a) PDU session inactive for the received PDU session ID.

If the PDU session ID in the PDU SESSION AUTHENTICATION COMMAND message belongs to any PDU session in state PDU SESSION INACTIVE in the UE, the UE shall send a 5GSM STATUS message with the 5GSM cause IE set to #43 "Invalid PDU session identity".

- b) Collision of UE-requested PDU session release procedure and a PDU session authentication and authorization procedure.

When the UE receives a PDU SESSION AUTHENTICATION COMMAND message during the UE-requested PDU session release procedure, and the PDU session indicated in PDU SESSION AUTHENTICATION COMMAND message is the PDU session that the UE had requested to release, the UE shall ignore the PDU SESSION AUTHENTICATION COMMAND message and proceed with the UE-requested PDU session release procedure.

### 6.3.1.3 PDU EAP result message transport procedure

#### 6.3.1.3.1 PDU EAP result message transport procedure initiation

In order to initiate the PDU EAP result message transport procedure, the SMF shall create a PDU SESSION AUTHENTICATION RESULT message.

The SMF shall set the PTI IE of the PDU SESSION AUTHENTICATION RESULT message to "No procedure transaction identity assigned".

The SMF shall set the EAP message IE of the PDU SESSION AUTHENTICATION RESULT message to the EAP-success message provided by the DN.



The SMF shall send the PDU SESSION AUTHENTICATION RESULT message.

Upon receipt of a PDU SESSION AUTHENTICATION RESULT message and a PDU session ID, using the NAS transport procedure as specified in subclause 5.4.5, the UE passes to the upper layers the EAP message received in the EAP message IE of the PDU SESSION AUTHENTICATION RESULT message. Apart from this action, the authentication and authorization procedure initiated by the DN is transparent to the 5GSM layer of the UE.

## 6.3.2 Network-requested PDU session modification procedure

### 6.3.2.1 General

The purpose of the network-requested PDU session modification procedure is to enable the network to modify a PDU session.

### 6.3.2.2 Network-requested PDU session modification procedure initiation

In order to initiate the network-requested PDU session modification procedure, the SMF shall create a PDU SESSION MODIFICATION COMMAND message.

If the authorized QoS rules of the PDU session is modified, the SMF shall set the authorized QoS rules IE of the PDU SESSION MODIFICATION COMMAND message to the authorized QoS rules of the PDU session. The SMF shall ensure that the number of the packet filters used in the authorized QoS rules of the PDU Session does not exceed the maximum number of packet filters supported by the UE for the PDU session. The SMF may bind service data flows for which the UE has requested traffic segregation to a dedicated QoS flow for the PDU session, if possible. Otherwise the SMF may bind the service data flows to an existing QoS flow. The SMF shall use only one dedicated QoS flow for traffic segregation. If the UE has requested traffic segregation for multiple service data flows with different QoS handling, the SMF shall bind all these service data flows to a single QoS flow. If the SMF allows traffic segregation for service data flows in a QoS rule, then the SMF shall create a new authorized QoS rule for these service data flows and shall delete packet filters corresponding to these service data flows from the other authorized QoS rules.

If the authorized QoS flow descriptions of the PDU session is modified, the SMF shall set the authorized QoS flow descriptions IE of the PDU SESSION MODIFICATION COMMAND message to the authorized QoS flow descriptions of the PDU session.

If SMF creates a new authorized QoS rule for a new QoS flow, then SMF shall include the authorized QoS flow description for that QoS flow in the authorized QoS flow descriptions IE of the PDU SESSION MODIFICATION COMMAND message, if:

- a) the newly created authorized QoS rules is for a new GBR QoS flow;
- b) the QFI of the new QoS flow is not the same as the 5QI of the QoS flow identified by the QFI; or
- c) the new QoS flow can be mapped to an EPS bearer as specified in subclause 4.11.2 of 3GPP TS 23.502 [9].

If the session-AMBR of the PDU session is modified, the SMF shall set the selected Session-AMBR IE of the PDU SESSION MODIFICATION COMMAND message to the session-AMBR of the PDU session.

If interworking with EPS is supported for the PDU session and if the mapped EPS bearer contexts of the PDU session is modified, the SMF shall set the mapped EPS bearer contexts IE of the PDU SESSION MODIFICATION COMMAND message to the mapped EPS bearer contexts of the PDU session. If the association between a QoS flow and the mapped EPS bearer context is changed, the SMF shall set the EPS bearer identity parameter in authorized QoS flow descriptions IE of the PDU SESSION MODIFICATION COMMAND message to the new EPS bearer identity associated with the QoS flow.

If the network-requested PDU session modification procedure is triggered by a UE-requested PDU session modification procedure and the PDU SESSION MODIFICATION REQUEST message includes a 5GSM capability IE, the SMF shall:

- a) if the RQoS bit is set to:
  - 1) "Reflective QoS supported", consider that the UE supports reflective QoS for this PDU session; or

- 2) "Reflective QoS not supported", consider that the UE does not support reflective QoS for this PDU session; and;
- b) if the MH6-PDU bit is set to:
- 1) "Multi-homed IPv6 PDU session supported", consider that this PDU session is supported to use multiple IPv6 prefixes; or
  - 2) "Multi-homed IPv6 PDU session not supported", consider that this PDU session is not supported to use multiple IPv6 prefixes.

If the SMF considers that reflective QoS is supported for QoS flows belonging to this PDU session, the SMF may include the RQ timer IE set to an RQ timer value in the PDU SESSION MODIFICATION COMMAND message.

If the network-requested PDU session modification procedure is triggered by a UE-requested PDU session modification procedure, the PDU session type is "IPv4", "IPv6", "IPv4v6" or "Ethernet" and the PDU SESSION MODIFICATION REQUEST message includes a Maximum number of supported packet filters IE, the SMF shall consider this number as the maximum number of packet filters that can be supported by the UE for this PDU session. Otherwise the SMF considers that the UE supports 16 packet filters for this PDU session.

For a PDN connection established when in S1 mode, upon the first inter-system change from S1 mode to N1 mode, if the network-requested PDU session modification procedure is triggered by a UE-requested PDU session modification procedure, the SMF shall consider that the maximum data rate per UE for user-plane integrity protection supported by the UE for uplink and the maximum data rate per UE for user-plane integrity protection supported by the UE for downlink are valid for the lifetime of the PDU session.

For a PDN connection established when in S1 mode, upon the first inter-system change from S1 mode to N1 mode, if the network-requested PDU session modification procedure is triggered by a UE-requested PDU session modification procedure and the SMF determines, based on local policies or configurations in the SMF and the Always-on PDU session requested IE in the PDU SESSION MODIFICATION REQUEST message (if available), that either:

- a) the requested PDU session needs to be an always-on PDU session, the SMF shall include the Always-on PDU session indication IE in the PDU SESSION MODIFICATION COMMAND message and shall set the value to "Always-on PDU session required"; or
- b) the requested PDU session shall not be an always-on PDU session and:
  - i) if the UE included the Always-on PDU session requested IE, the SMF shall include the Always-on PDU session indication IE in the PDU SESSION MODIFICATION COMMAND message and shall set the value to "Always-on PDU session not allowed"; or
  - ii) if the UE did not include the Always-on PDU session requested IE, the SMF shall not include the Always-on PDU session indication IE in the PDU SESSION MODIFICATION COMMAND message.

If the value of the RQ timer is set to "deactivated" or has a value of zero, the UE considers that RQoS is not applied for this PDU session and remove the derived QoS rule(s) associated with the PDU session, if any.

If the network-requested PDU session modification procedure is triggered by a UE-requested PDU session modification procedure, the SMF shall set the PTI IE of the PDU SESSION MODIFICATION COMMAND message to the PTI of the PDU SESSION MODIFICATION REQUEST message received as part of the UE-requested PDU session modification procedure.

If the network-requested PDU session modification procedure is not triggered by a UE-requested PDU session modification procedure, the SMF shall set the PTI IE of the PDU SESSION MODIFICATION COMMAND message to "No procedure transaction identity assigned".

If the selected SSC mode of the PDU session is "SSC mode 3" and the SMF requests the relocation of SSC mode 3 PDU session anchor with multiple PDU sessions as specified in 3GPP TS 23.502 [9], the SMF shall include 5GSM cause #39 "reactivation requested" , in the PDU SESSION MODIFICATION COMMAND message, and may include the PDU session address lifetime in a PDU session address lifetime PCO parameter in the Extended protocol configuration options IE of the PDU SESSION MODIFICATION COMMAND message.

The SMF shall send the PDU SESSION MODIFICATION COMMAND message, and the SMF shall start timer T3591 (see example in figure 6.3.2.2.1).

NOTE: If the SMF requests the relocation of SSC mode 3 PDU session anchor with multiple PDU sessions as specified in 3GPP TS 23.502 [9], the reallocation requested indication indicating whether the SMF is to be reallocated or the SMF is to be reused is provided to the AMF.

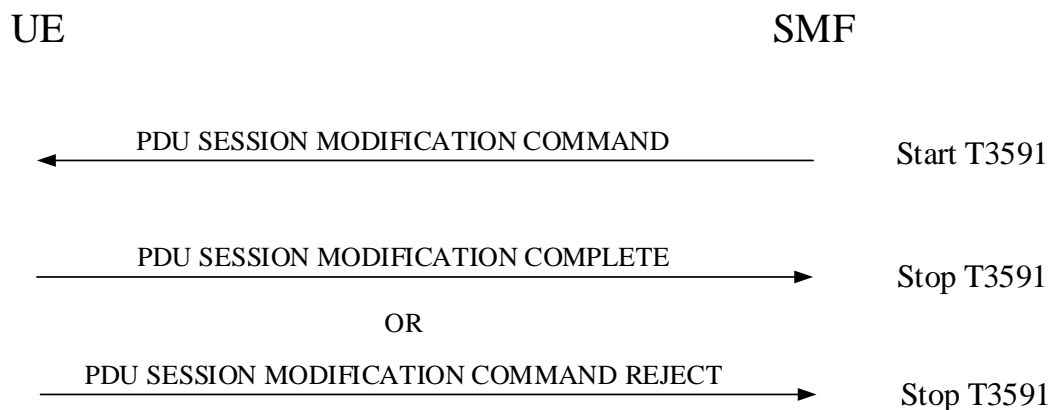

**Figure 6.3.2.2.1: Network-requested PDU session modification procedure**

### 6.3.2.3 Network-requested PDU session modification procedure accepted by the UE

Upon receipt of the PDU SESSION MODIFICATION COMMAND message, if the UE provided a DNN during the PDU session establishment, the UE shall stop timer T3396, if it is running for the DNN provided by the UE. If the UE did not provide a DNN during the PDU session establishment and the request type was different from "initial emergency request" and different from "existing emergency PDU session", the UE shall stop the timer T3396 associated with no DNN if it is running. If the PDU SESSION MODIFICATION COMMAND message was received for an emergency PDU session, the UE shall not stop the timer T3396 associated with no DNN if it is running.

Upon receipt of the PDU SESSION MODIFICATION COMMAND message, if the UE provided an S-NSSAI and a DNN during the PDU session establishment, the UE shall stop timer T3584, if it is running for the same [S-NSSAI, DNN] combination provided by the UE. If the UE did not provide an S-NSSAI during the PDU session establishment, the UE shall stop timer T3584, if it is running for the same [no S-NSSAI, DNN] combination provided by the UE. If the UE provided neither a DNN nor an S-NSSAI during the PDU session establishment, the UE shall stop timer T3584, if it is running for the same [no S-NSSAI, no DNN] combination provided by the UE.

Upon receipt of the PDU SESSION MODIFICATION COMMAND message, if the UE provided an S-NSSAI during the PDU session establishment, the UE shall stop timer T3585, if it is running for the S-NSSAI provided by the UE. If the UE did not provide an S-NSSAI during the PDU session establishment and the request type was different from "initial emergency request" and different from "existing emergency PDU session", the UE shall stop the timer T3585 associated with no S-NSSAI if it is running. If the PDU SESSION MODIFICATION COMMAND message was received for an emergency PDU session, the UE shall not stop the timer T3585 associated with no S-NSSAI if it is running.

NOTE 1: Upon receipt of the PDU SESSION MODIFICATION COMMAND message for a PDU session, if the UE provided a DNN (or no DNN) and an S-NSSAI (or no S-NSSAI) when the PDU session is established, timer T3396 associated with the DNN (or no DNN, if no DNN was provided by the UE) is running, and timer T3584 associated with the DNN (or no DNN, if no DNN was provided by the UE) and the S-NSSAI (or no S-NSSAI, if no S-NSSAI was provided by the UE) is running, then the UE stops both the timer T3396 and the timer T3584.

NOTE 2: Upon receipt of the PDU SESSION MODIFICATION COMMAND message for a PDU session, if the UE provided a DNN (or no DNN) and an S-NSSAI (or no S-NSSAI) when the PDU session is established, timer T3585 associated with the S-NSSAI (or no S-NSSAI, if no S-NSSAI was provided by the UE) is running, and timer T3584 associated with the DNN (or no DNN, if no DNN was provided by the UE) and the S-NSSAI (or no S-NSSAI, if no S-NSSAI was provided by the UE) is running, then the UE stops both the timer T3585 and the timer T3584.

If the PDU SESSION MODIFICATION COMMAND message includes the Authorized QoS rules IE, the UE shall process the QoS rules sequentially starting with the first QoS rule.

The UE shall replace the stored authorized QoS rules, authorized QoS flow descriptions and session-AMBR of the PDU session with the received value(s), if any, in the PDU SESSION MODIFICATION COMMAND message.

If the PDU SESSION MODIFICATION COMMAND message includes a Mapped EPS bearer contexts IE, the UE shall check each mapped EPS bearer context for different types of errors as follows:

NOTE 3: An error detected in a mapped EPS bearer context does not cause the UE to discard the Authorized QoS rules IE and Authorized QoS flow descriptions IE included in the PDU SESSION MODIFICATION COMMAND message, if any.

a) Semantic error in the mapped EPS bearer operation:

- 1) operation code = "Create new EPS bearer" and there is already an existing mapped EPS bearer context with the same EPS bearer identity associated with any PDU session.
- 2) operation code = "Delete existing EPS bearer" and there is no existing mapped EPS bearer context with the same EPS bearer identity associated with the PDU session that is being modified.
- 3) operation code = "Modify existing EPS bearer" and there is no existing mapped EPS bearer context with the same EPS bearer identity associated with the PDU session that is being modified.

In case 1, if the existing mapped EPS bearer context is associated with the PDU session that is being modified, the UE shall not diagnose an error, further process the create request and, if it was processed successfully, delete the old EPS bearer context.

In case 2, the UE shall not diagnose an error, further process the delete request and, if it was processed successfully, consider the mapped EPS bearer context as successfully deleted.

Otherwise, after sending the PDU SESSION MODIFICATION COMPLETE for the ongoing PDU session modification procedure, the UE shall initiate a PDU session modification procedure by sending a PDU SESSION MODIFICATION REQUEST message to delete the mapped EPS bearer context with 5GSM cause #85 "Invalid mapped EPS bearer identity".

b) if the mapped EPS bearer context includes a traffic flow template, the UE shall check the traffic flow template for different types of TFT IE errors as follows:

2) Semantic errors in TFT operations:

- i) TFT operation = "Create a new TFT" when there is already an existing TFT for the EPS bearer context.
- ii) When the TFT operation is an operation other than "Create a new TFT" and there is no TFT for the EPS bearer context.
- iii) TFT operation = "Delete packet filters from existing TFT" when it would render the TFT empty.
- iv) TFT operation = "Delete existing TFT" for a dedicated EPS bearer context.

In case iv, after sending the PDU SESSION MODIFICATION COMPLETE for the ongoing PDU session modification procedure, the UE shall initiate a PDU session modification procedure by sending a PDU SESSION MODIFICATION REQUEST message to delete the mapped EPS bearer context with 5GSM cause #41 "semantic error in the TFT operation".

In the other cases the UE shall not diagnose an error and perform the following actions to resolve the inconsistency:

In case i, the UE shall further process the new activation request and, if it was processed successfully, delete the old TFT.

In case ii, the UE shall:

- process the new request and if the TFT operation is "Delete existing TFT" or "Delete packet filters from existing TFT", and if no error according to items b, c, and d was detected, consider the TFT as successfully deleted;

- process the new request as an activation request, if the TFT operation is "Add packet filters in existing TFT" or "Replace packet filters in existing TFT".

In case iii, if the packet filters belong to a dedicated EPS bearer context, the UE shall process the new deletion request and, if no error according to items b, c, and d was detected, after sending the PDU SESSSION MODIFICATION COMPLETE for the ongoing PDU session modification procedure, the UE shall initiate a PDU session modification procedure by sending a PDU SESSION MODIFICATION REQUEST message to delete the mapped EPS bearer context with 5GSM cause #41 "semantic error in the TFT operation".

In case iii, if the packet filters belong to the default EPS bearer context, the UE shall process the new deletion request and if no error according to items b, c, and d was detected then delete the existing TFT, this corresponds to using match-all packet filter for the default EPS bearer context.

## 2) Syntactical errors in TFT operations:

- i) When the TFT operation = "Create a new TFT", "Add packet filters in existing TFT", "Replace packet filters in existing TFT" or "Delete packet filters from existing TFT" and the packet filter list in the TFT IE is empty.
- ii) TFT operation = "Delete existing TFT" or "No TFT operation" with a non-empty packet filter list in the TFT IE.
- iii) TFT operation = "Replace packet filters in existing TFT" when the packet filter to be replaced does not exist in the original TFT.
- iv) TFT operation = "Delete packet filters from existing TFT" when the packet filter to be deleted does not exist in the original TFT.
- v) TFT operation = "Delete packet filters from existing TFT" with a packet filter list also including packet filters in addition to the packet filter identifiers.
- vi) When there are other types of syntactical errors in the coding of the TFT IE, such as a mismatch between the number of packet filters subfield, and the number of packet filters in the packet filter list.

In case iii, the UE shall not diagnose an error, further process the replace request and, if no error according to items c and d was detected, include the packet filters received to the existing TFT.

In case iv, the UE shall not diagnose an error, further process the deletion request and, if no error according to items c and d was detected, consider the respective packet filter as successfully deleted.

Otherwise, after sending the PDU SESSSION MODIFICATION COMPLETE for the ongoing PDU session modification procedure, the UE shall initiate a PDU session modification procedure by sending a PDU SESSION MODIFICATION REQUEST message to delete the mapped EPS bearer context with 5GSM cause #42 "syntactical error in the TFT operation".

## 3) Semantic errors in packet filters:

- i) When a packet filter consists of conflicting packet filter components which would render the packet filter ineffective, i.e. no IP packet will ever fit this packet filter. How the UE determines a semantic error in a packet filter is outside the scope of the present document.
- ii) When the resulting TFT, which is assigned to a dedicated EPS bearer context, does not contain any packet filter applicable for the uplink direction among the packet filters created on request from the network.

After sending the PDU SESSSION MODIFICATION COMPLETE for the ongoing PDU session modification procedure, the UE shall initiate a PDU session modification procedure by sending a PDU SESSION MODIFICATION REQUEST message to delete the mapped EPS bearer context with 5GSM cause #44 "semantic errors in packet filter(s)".

## 4) Syntactical errors in packet filters:

- i) When the TFT operation = "Create a new TFT", "Add packet filters to existing TFT", and two or more packet filters in the resultant TFT would have identical packet filter identifiers.

- ii) When the TFT operation = "Create a new TFT", "Add packet filters to existing TFT" or "Replace packet filters in existing TFT", and two or more packet filters among all TFTs associated with this PDN connection would have identical packet filter precedence values.
- iii) When there are other types of syntactical errors in the coding of packet filters, such as the use of a reserved value for a packet filter component identifier.

In case i, if two or more packet filters with identical packet filter identifiers are contained in the new request, after sending the PDU SESSSION MODIFICATION COMPLETE for the ongoing PDU session modification procedure, the UE shall initiate a PDU session modification procedure by sending a PDU SESSION MODIFICATION REQUEST message to delete the mapped EPS bearer context with 5GSM cause #45 "syntactical error in packet filter(s)". Otherwise, the UE shall not diagnose an error, further process the new request and, if it was processed successfully, delete the old packet filters which have the identical packet filter identifiers.

In case ii, if the old packet filters do not belong to the default EPS bearer context, the UE shall not diagnose an error, shall further process the new request and, if it was processed successfully, shall delete the old packet filters which have identical filter precedence values.

In case ii, if one or more old packet filters belong to the default EPS bearer context, after sending the PDU SESSSION MODIFICATION COMPLETE for the ongoing PDU session modification procedure, the UE shall initiate a PDU session modification procedure by sending a PDU SESSION MODIFICATION REQUEST message to delete the mapped EPS bearer context with 5GSM cause #45 "syntactical errors in packet filter(s)".

Otherwise, after sending the PDU SESSSION MODIFICATION COMPLETE for the ongoing PDU session modification procedure, the UE shall initiate a PDU session modification procedure by sending a PDU SESSION MODIFICATION REQUEST message to delete the mapped EPS bearer context with 5GSM cause #45 "syntactical error in packet filter(s)".

And if a new EPS bearer identity parameter in authorized QoS flow descriptions IE is received for a QoS flow which can be transferred to EPS, the UE shall update the association between the QoS flow and the mapped EPS bearer context, based on the new EPS bearer identity and the mapped EPS bearer contexts. If the "Delete existing EPS bearer" operation code in the Mapped EPS bearer contexts IE was received, the UE shall discard the association between the QoS flow and the corresponding mapped EPS bearer context.

Upon receipt of a PDU SESSION MODIFICATION COMMAND message and a PDU session ID, using the NAS transport procedure as specified in subclause 5.4.5, if the UE accepts the PDU SESSION MODIFICATION COMMAND message, the UE considers the PDU session as modified and the UE shall create a PDU SESSION MODIFICATION COMPLETE message.

If the PDU SESSION MODIFICATION COMMAND message contains the PTI value allocated in the UE-requested PDU session modification procedure, the UE shall stop the timer T3581. The UE should ensure that the PTI value assigned to this procedure is not released immediately.

NOTE 4: The way to achieve this is implementation dependent. For example, the UE can ensure that the PTI value assigned to this procedure is not released during the time equal to or greater than the default value of timer T3591.

While the PTI value is not released, the UE regards any received PDU SESSION MODIFICATION COMMAND message with the same PTI value as a network retransmission (see subclause 7.3.1).

If the selected SSC mode of the PDU session is "SSC mode 3" and the PDU SESSION MODIFICATION COMMAND message includes 5GSM cause #39 "reactivation requested", the UE can provide to the upper layers the PDU session address lifetime if received in the PDU session address lifetime PCO parameter of the Extended protocol configuration options IE of the PDU SESSION MODIFICATION COMMAND message. After the completion of the network-requested PDU session modification procedure, the UE should re-initiate the UE-requested PDU session establishment procedure with a new PDU session ID as specified in subclause 6.4.1 for:

- a) the PDU session type associated with the present PDU session;
- b) the SSC mode associated with the present PDU session;
- c) the DNN associated with the present PDU session; and

- d) the S-NSSAI associated with (if available in roaming scenarios) a mapped S-NSSAI if provided in the UE-requested PDU session establishment procedure of the present PDU session.

The UE shall include the PDU session ID of the old PDU session which is about to get released in the old PDU session ID IE of the UL NAS TRANSPORT message that transports the PDU SESSION ESTABLISHMENT REQUEST message.

NOTE 5: The UE is expected to maintain the PDU session for which the PDU SESSION MODIFICATION COMMAND message including 5GSM cause #39 "reactivation requested" is received during the time indicated by the PDU session address lifetime value or until receiving an indication from upper layers (e.g. that the old PDU session is no more needed).

If the selected PDU session type of the PDU session is "Unstructured" or "Ethernet", the UE supports inter-system change from N1 mode to S1 mode, the UE does not support establishment of a PDN connection for the PDN type set to "non-IP" in S1 mode, and the parameters list field of one or more authorized QoS flow descriptions received in the authorized QoS flow descriptions IE of the PDU SESSION MODIFICATION COMMAND message contains an EPS bearer identity (EBI) then the UE shall locally remove the EPS bearer identity (EBI) from the parameters list field of such one or more authorized QoS flow descriptions.

If the Always-on PDU session indication IE is included in the PDU SESSION MODIFICATION COMMAND message and:

- a) the value of the IE is set to "Always-on PDU session required", the UE shall consider the established PDU session as an always-on PDU session; or
- b) the value of the IE is set to "Always-on PDU session not allowed", the UE shall not consider the established PDU session as an always-on PDU session.

If the UE does not receive the Always-on PDU session indication IE in the PDU SESSION MODIFICATION COMMAND message:

- a) if the network-requested PDU session modification procedure is triggered by a UE-requested PDU session modification procedure upon the first inter-system change from S1 mode to N1 mode for a PDN connection established when in S1 mode, the UE shall not consider the modified PDU session as an always-on PDU session; or
- b) otherwise:
  - 1) if the UE has received the Always-on PDU session indication IE with the value set to "Always-on PDU session required" for this PDU session, the UE shall consider the PDU session as an always-on PDU session; or
  - 2) otherwise the UE shall not consider the PDU session as an always-on PDU session.

The UE shall transport the PDU SESSION MODIFICATION COMPLETE message and the PDU session ID, using the NAS transport procedure as specified in subclause 5.4.5.

After sending the PDU SESSION MODIFICATION COMPLETE message, if the "Create new EPS bearer" operation code in the mapped EPS bearer contexts IE was received in the PDU SESSION MODIFICATION COMMAND message and there is neither a corresponding authorized QoS flow descriptions IE in the PDU SESSION MODIFICATION COMMAND message nor an existing QoS flow description corresponding to the EPS bearer identity included in the mapped EPS bearer context, the UE shall send a PDU SESSION MODIFICATION REQUEST message including a mapped EPS bearer contexts IE to delete the mapped EPS bearer context.

Upon receipt of a PDU SESSION MODIFICATION COMPLETE message, the SMF shall stop timer T3591 and shall consider the PDU session as modified. If the selected SSC mode of the PDU session is "SSC mode 3" and the PDU SESSION MODIFICATION COMMAND message included 5GSM cause #39 "reactivation requested", the SMF shall start timer T3593. If the PDU Session Address Lifetime value is sent to the UE in the PDU SESSION MODIFICATION COMMAND message then timer T3593 shall be started with the same value, otherwise it shall use a default value.

### 6.3.2.4 Network-requested PDU session modification procedure not accepted by the UE

Upon receipt of a PDU SESSION MODIFICATION COMMAND message and a PDU session ID, using the NAS transport procedure as specified in subclause 5.4.5, if the UE rejects the PDU SESSION MODIFICATION COMMAND message, the UE shall create a PDU SESSION MODIFICATION COMMAND REJECT message.

If the PDU SESSION MODIFICATION COMMAND message contains the PTI value allocated in the UE-requested PDU session modification procedure, the UE shall stop the timer T3581. The UE should ensure that the PTI value assigned to this procedure is not released immediately.

NOTE 1: The way to achieve this is implementation dependent. For example, the UE can ensure that the PTI value assigned to this procedure is not released during the time equal to or greater than the default value of timer T3591.

While the PTI value is not released, the UE regards any received PDU SESSION MODIFICATION COMMAND message with the same PTI value as a network retransmission (see subclause 7.3.1).

The UE shall set the 5GSM cause IE of the PDU SESSION MODIFICATION COMMAND REJECT message to indicate the reason for rejecting the PDU session modification.

The 5GSM cause IE typically indicates one of the following 5GSM cause values:

- #26 insufficient resources;
- #43 invalid PDU session identity;
- #44 semantic error in packet filter(s);
- #45 syntactical error in packet filter(s);
- #83 semantic error in the QoS operation; or
- #84 syntactical error in the QoS operation.

If the selected SSC mode of the PDU session is "SSC mode 3" and the PDU SESSION MODIFICATION COMMAND messages includes 5GSM cause #39 "reactivation requested", while the UE does not have sufficient resources for initiating the PDU session establishment procedure as specified in subclause 6.4.1 then the UE shall set cause IE to #26 "insufficient resources".

If the PDU SESSION MODIFICATION COMMAND message includes a request to add a new authorized QoS rule, or a request to modify the authorized QoS rules, or both, and the UE decides to reject the request due to e.g. the supported number of authorized QoS rules or number of packet filters associated with a PDU session having reached the maximum number, then the UE shall set the 5GSM cause IE to #26 "insufficient resources".

NOTE 2: The maximum number of supported authorized QoS rules or packet filters associated with a PDU session is implementation specific.

If the PDU SESSION MODIFICATION COMMAND message includes a request to add a new authorized QoS flow description, or a request to modify the authorized QoS flow descriptions, or both and the UE decides to reject the request due to e.g. the supported number of authorized QoS flow descriptions, then the UE shall set the 5GSM cause IE to #26 "insufficient resources".

NOTE 3: The maximum number of supported authorized QoS flow descriptions associated with a PDU session is implementation specific.

If the PDU SESSION MODIFICATION COMMAND message includes the Authorized QoS rules IE, the UE shall process the QoS rules sequentially starting with the first QoS rule. The UE shall check the QoS rule and the QoS flow description provided in the PDU SESSION MODIFICATION COMMAND message for different types of errors as follows:

- a) Semantic errors in QoS operations:
  - 1) When the rule operation is "Modify existing QoS rule and add packet filters", "Modify existing QoS rule and replace all packet filters", "Modify existing QoS rule and delete packet filters" or "Modify existing QoS rule



without modifying packet filters" on the default QoS rule and the DQR bit is set to "the QoS rule is not the default QoS rule".

- 2) When the rule operation is "Modify existing QoS rule and add packet filters", "Modify existing QoS rule and replace all packet filters", "Modify existing QoS rule and delete packet filters" or "Modify existing QoS rule without modifying packet filters" on a QoS rule which is not the default QoS rule and the DQR bit is set to "the QoS rule is the default QoS rule".
- 3) When the rule operation is "Create new QoS rule" and the DQR bit is set to "the QoS rule is the default QoS rule" when there's already a default QoS rule.
- 4) When the rule operation is "Delete existing QoS rule" on the default QoS rule.
- 5) When the rule operation is "Create new QoS rule", "Modify existing QoS rule and add packet filters", "Modify existing QoS rule and replace all packet filters", "Modify existing QoS rule and delete packet filters", or "Modify existing QoS rule without modifying packet filters" and two or more QoS rules associated with this PDU session would have identical precedence values.
- 6) When the rule operation is "Modify existing QoS rule and delete packet filters", the QoS rule is a QoS rule of a PDU session of IPv4, IPv6, IPv4v6 or Ethernet PDU session type, and the packet filter list in the resultant QoS rule is empty.
- 7) When the rule operation is "Create new QoS rule" and there is already an existing QoS rule with the same QoS rule identifier.
- 8) When the rule operation is "Modify existing QoS rule and add packet filters", "Modify existing QoS rule and replace all packet filters", "Modify existing QoS rule and delete packet filters" or "Modify existing QoS rule without modifying packet filters" and the associated QoS rule does not exist.
- 9) When the rule operation is "Delete existing QoS rule" and there is no existing QoS rule with the same QoS rule identifier.
- 10) When the flow description operation is "Create new QoS flow description" and there is already an existing QoS flow description with the same QoS flow identifier.
- 11) When the flow description operation is "Modify existing QoS flow description" and the associated QoS flow description does not exist.
- 12) When the flow description operation is "Delete existing QoS flow description" and there is no existing QoS flow description with the same QoS flow identifier. In case 4, the UE shall initiate a PDU session release procedure by sending a PDU SESSION RELEASE REQUEST message with 5GSM cause #83 "semantic error in the QoS operation".

In case 5, if the old QoS rule is not the default QoS rule, the UE shall not diagnose an error, shall further process the new request and, if it was processed successfully, shall delete the old QoS rule which has identical precedence value. Furthermore, the UE shall send a PDU SESSION MODIFICATION REQUEST message with 5GSM cause #83 "semantic error in the QoS operation" to delete the QoS rule.

In case 5, if the QoS rule is the default QoS rule, the UE shall initiate a PDU session release procedure by sending a PDU SESSION RELEASE REQUEST message with 5GSM cause #83 "semantic error in the QoS operation".

In case 6, if the QoS rule is not the default QoS rule, the UE shall send a PDU SESSION MODIFICATION REQUEST message with 5GSM cause #83 "semantic error in the QoS operation" to delete the QoS rule.

In case 6, if the QoS rule is the default QoS rule, the UE shall initiate a PDU session release procedure by sending a PDU SESSION RELEASE REQUEST message with 5GSM cause #83 "semantic error in the QoS operation".

In case 7, if the QoS rule is not the default QoS rule, the UE shall not diagnose an error, further process the create request and, if it was processed successfully, delete the old QoS rule.

In case 9, the UE shall not diagnose an error, further process the delete request and, if it was processed successfully, consider the respective QoS rule as successfully deleted.

In case 10, the UE shall not diagnose an error, further process the create request and, if it was processed successfully, delete the old QoS flow description.

In case 12, the UE shall not diagnose an error, further process the delete request and, if it was processed successfully, consider the respective QoS flow description as successfully deleted.

Otherwise, the UE shall reject the PDU SESSION MODIFICATION COMMAND message with 5GSM cause #83 "semantic error in the QoS operation".

b) Syntactical errors in QoS operations:

- 1) When the rule operation is "Create new QoS rule", "Modify existing QoS rule and add packet filters", "Modify existing QoS rule and replace packet filters" or "Modify existing QoS rule and delete packet filters" and the packet filter list in the QoS rule is empty.
- 2) When the rule operation is "Delete existing QoS rule" or "Modify existing QoS rule without modifying packet filters" with a non-empty packet filter list in the QoS rule.
- 3) When the rule operation is "Modify existing QoS rule and delete packet filters" and the packet filter to be deleted does not exist in the original QoS rule.
- 4) When the rule operation is "Modify existing QoS rule and delete packet filters" with a packet filter list also including packet filters in addition to the packet filter identifiers.
- 5) When there are other types of syntactical errors in the coding of the QoS rules IE, such as a mismatch between the number of packet filters subfield, and the number of packet filters in the packet filter list.
- 6) When, the
  - A) rule operation is "Create new QoS rule", the UE determines that there is a resulting QoS rule for a GBR QoS flow (as described in 3GPP TS 23.501 [8] table 5.7.4-1), and there is no QoS flow description with a QFI corresponding to the QFI of the resulting QoS rule.
  - B) flow description operation is "Delete existing QoS flow description", and the UE determines that there is a resulting QoS rule for a GBR QoS flow (as described in 3GPP TS 23.501 [8] table 5.7.4-1) with a QFI corresponding to the QFI of the QoS flow description that is deleted (i.e. there is no associated QoS flow description with the same QFI).

In case 3 the UE shall not diagnose an error, further process the deletion request and, if no error according to items c and d was detected, consider the respective packet filter as successfully deleted.

In case 6, if the QoS rules IE contains at least one other valid QoS rule, the UE shall not diagnose an error and shall further process the request, if no error according to items c and d was detected. After completion of the PDU session modification procedure, the UE shall delete the QoS rule for which no corresponding QoS flow description is available and initiate UE requested PDU session modification procedure to delete the QoS rule for which it has deleted.

Otherwise the UE shall reject the PDU SESSION MODIFICATION COMMAND message with 5GSM cause #84 "syntactical error in the QoS operation".

c) Semantic errors in packet filters:

- 1) When a packet filter consists of conflicting packet filter components which would render the packet filter ineffective, i.e. no IP packet will ever fit this packet filter. How the UE determines a semantic error in a packet filter is outside the scope of the present document.

The UE shall reject the PDU SESSION MODIFICATION COMMAND message with 5GSM cause #44 "semantic error in packet filter(s)".

d) Syntactical errors in packet filters:

- 1) When the rule operation is "Create new QoS rule", "Modify existing QoS rule and add packet filters" or "Modify existing QoS rule and replace all packet filters", and two or more packet filters in the resultant QoS rule would have identical packet filter identifiers.

- 2) When there are other types of syntactical errors in the coding of packet filters, such as the use of a reserved value for a packet filter component identifier.

In case 1, if two or more packet filters with identical packet filter identifiers are contained in the PDU SESSION MODIFICATION COMMAND message, the UE shall reject the PDU SESSION MODIFICATION COMMAND with 5GSM cause #45 "syntactical errors in packet filter(s)". Otherwise, the UE shall not diagnose an error, further process the PDU SESSION MODIFICATION COMMAND message and, if it was processed successfully, replace the old packet filter with the new packet filter which have the identical packet filter identifiers.

Otherwise the UE shall reject the PDU SESSION MODIFICATION COMMAND message with 5GSM cause #45 "syntactical errors in packet filter(s)".

The UE shall transport the PDU SESSION MODIFICATION COMMAND REJECT message and the PDU session ID, using the NAS transport procedure as specified in subclause 5.4.5.

Upon receipt of a PDU SESSION MODIFICATION COMMAND REJECT message with 5GSM cause value other than #43 "invalid PDU session identity" in state PDU SESSION MODIFICATION PENDING, the SMF shall stop timer T3591, enter the state PDU SESSION ACTIVE and abort the PDU session modification procedure.

### 6.3.2.5 Abnormal cases on the network side

The following abnormal cases can be identified:

- a) Expiry of timer T3591.

On the first expiry of the timer T3591, the SMF shall resend the PDU SESSION MODIFICATION COMMAND message and shall reset and restart timer T3591. This retransmission is repeated four times, i.e. on the fifth expiry of timer T3591, the SMF shall abort the procedure and enter the state PDU SESSION ACTIVE.

The SMF may continue to use the previous configuration of the PDU session or initiate the network-requested PDU session release procedure.

- b) Invalid PDU session identity.

Upon receipt of the PDU SESSION MODIFICATION COMMAND REJECT message including 5GSM cause #43 "invalid PDU session identity", the SMF shall release locally the existing PDU session.

- c) Collision of UE-requested PDU session release procedure and network-requested PDU session modification procedure.

If the SMF receives a PDU SESSION RELEASE REQUEST message during the network-requested PDU session modification procedure, and the PDU session indicated in the PDU SESSION RELEASE REQUEST message is the PDU session that the SMF had requested to modify, the SMF shall abort the PDU session modification procedure and proceed with the UE-requested PDU session release procedure.

- d) Collision of UE-requested PDU session modification procedure and network-requested PDU session modification procedure.

If the network receives a PDU SESSION MODIFICATION REQUEST message during the network-requested PDU session modification procedure, and the PDU session indicated in the PDU SESSION MODIFICATION REQUEST message is the PDU session that the network had requested to modify, the network shall ignore the PDU SESSION MODIFICATION REQUEST message received in the state PDU SESSION MODIFICATION PENDING. The network shall proceed with the network-requested PDU session modification procedure as if no PDU SESSION MODIFICATION REQUEST message was received from the UE.

### 6.3.2.6 Abnormal cases in the UE

The following abnormal cases can be identified:

- a) PDU session inactive for the received PDU session ID.

If the PDU session ID in the PDU SESSION MODIFICATION COMMAND message belongs to any PDU session in state PDU SESSION INACTIVE in the UE, the UE shall set the 5GSM cause IE to #43 "Invalid PDU

session identity" in the 5GSM STATUS message, and set the PDU session ID to the received PDU session ID in the UL NAS TRANSPORT message as specified in subclause 5.4.5.

- b) Collision of network-requested PDU session modification procedure and UE-requested PDU session modification procedure.

If the UE receives a PDU SESSION MODIFICATION COMMAND message during the UE-requested PDU session modification procedure, the PTI IE of the PDU SESSION MODIFICATION COMMAND message is set to "No procedure transaction identity assigned", and the PDU session indicated in the PDU SESSION MODIFICATION COMMAND message is the PDU session that the UE had requested to modify, the UE shall abort internally the UE-requested PDU session modification procedure, enter the state PDU SESSION ACTIVE and proceed with the network-requested PDU session modification procedure.

### 6.3.3 Network-requested PDU session release procedure

#### 6.3.3.1 General

The purpose of the network-requested PDU session release procedure is to enable the network to release a PDU session.

#### 6.3.3.2 Network-requested PDU session release procedure initiation

In order to initiate the network-requested PDU session release procedure, the SMF shall create a PDU SESSION RELEASE COMMAND message.

The SMF shall set the 5GSM cause IE of the PDU SESSION RELEASE COMMAND message to indicate the reason for releasing the PDU session.

The 5GSM cause IE typically indicates one of the following 5GSM cause values:

- #8 operator determined barring;
- #26 insufficient resources;
- #29 user authentication or authorization failed;
- #36 regular deactivation;
- #38 network failure;
- #39 reactivation requested;
- #46 out of LADN service area;
- #67 insufficient resources for specific slice and DNN;
- #69 insufficient resources for specific slice.

If the selected SSC mode of the PDU session is "SSC mode 2" and the SMF requests the relocation of SSC mode 2 PDU session anchor with different PDU sessions as specified in 3GPP TS 23.502 [9], the SMF shall include 5GSM cause #39 "reactivation requested".

If the network-requested PDU session release procedure is triggered by a UE-requested PDU session release procedure, the SMF shall set the PTI IE of the PDU SESSION RELEASE COMMAND message to the PTI of the PDU SESSION RELEASE REQUEST message received as part of the UE-requested PDU session release procedure.

If the network-requested PDU session release procedure is not triggered by a UE-requested PDU session release procedure, the SMF shall set the PTI IE of the PDU SESSION RELEASE COMMAND message to "No procedure transaction identity assigned".

If the SMF receives an event notification from the AMF that the UE is out of the LADN service area and the SMF decides to release the PDU session, the SMF shall include the 5GSM cause value #46 "out of LADN service area" in the 5GSM cause IE of the PDU SESSION RELEASE COMMAND message. Upon receipt of the 5GSM cause value #46 "out of LADN service area" in the 5GSM cause IE of the PDU SESSION RELEASE COMMAND message, the UE shall release the PDU session.

The SMF may include a Back-off timer value IE in the PDU SESSION RELEASE COMMAND message when the 5GSM cause value #26 "insufficient resources" is included in the PDU SESSION RELEASE COMMAND message. If the 5GSM cause value is #26 "insufficient resources" and the PDU SESSION RELEASE COMMAND message is sent to a UE configured for high priority access in selected PLMN or the request type was set to "initial emergency request" or "existing emergency PDU session" for the establishment of the PDU session, the network shall not include a Back-off timer value IE.

The SMF may include a Back-off timer value IE in the PDU SESSION RELEASE COMMAND message when the 5GSM cause value #67 "insufficient resources for specific slice and DNN" is included in the PDU SESSION RELEASE COMMAND message. If the 5GSM cause value is #67 "insufficient resources for specific slice and DNN" and the PDU SESSION RELEASE COMMAND message is sent to a UE configured for high priority access in selected PLMN or the request type was set to "initial emergency request" or "existing emergency PDU session" for the establishment of the PDU session, the network shall not include a Back-off timer value IE.

The SMF may include a Back-off timer value IE in the PDU SESSION RELEASE COMMAND message when the 5GSM cause #69 "insufficient resources for specific slice" is included in the PDU SESSION RELEASE COMMAND message. If the 5GSM cause value is #69 "insufficient resources for specific slice" and the PDU SESSION RELEASE COMMAND message is sent to a UE configured for high priority access in selected PLMN or the request type was set to "initial emergency request" or "existing emergency PDU session" for the establishment of the PDU session, the network shall not include a Back-off timer value IE.

The SMF shall send:

- a) the PDU SESSION RELEASE COMMAND message; and
- b) if the SMF allows the AMF to skip sending of the N1 SM container to the UE and the 5GSM cause IE is not set to #39 "reactivation requested", the N1 SM delivery skip allowed indication;

towards the AMF, and the SMF shall start timer T3592 (see example in figure 6.3.3.2.1).

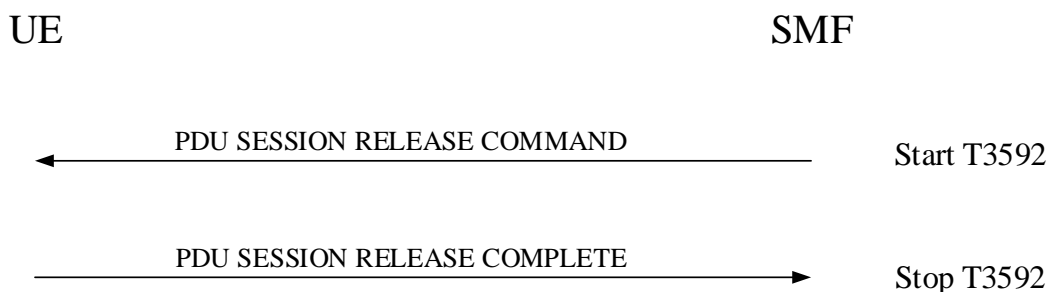

**Figure 6.3.3.2.1: Network-requested PDU session release procedure**

### 6.3.3.3 Network-requested PDU session release procedure accepted by the UE

Upon receipt of a PDU SESSION RELEASE COMMAND message and a PDU session ID, using the NAS transport procedure as specified in subclause 5.4.5, the UE considers the PDU session as released and the UE shall create a PDU SESSION RELEASE COMPLETE message.

If the PDU SESSION RELEASE COMMAND message contains the PTI value allocated in the UE-requested PDU session release procedure, the UE shall stop the timer T3582. The UE should ensure that the PTI value assigned to this procedure is not released immediately.

NOTE 1: The way to achieve this is implementation dependent. For example, the UE can ensure that the PTI value assigned to this procedure is not released during the time equal to or greater than the default value of timer T3592.

While the PTI value is not released, the UE regards any received PDU SESSION RELEASE COMMAND message with the same PTI value as a network retransmission (see subclause 7.3.1).

If the PDU SESSION RELEASE COMMAND message includes 5GSM cause #39 "reactivation requested", then after completion of the network-requested PDU session release procedure, the UE should re-initiate the UE-requested PDU session establishment procedure as specified in subclause 6.4.1 for:

- a) the PDU session type associated with the released PDU session;
- b) the SSC mode associated with the released PDU session;
- c) the DNN associated with the released PDU session; and
- d) the S-NSSAI associated with (if available in roaming scenarios) a mapped S-NSSAI if provided in the UE-requested PDU session establishment procedure of the released PDU session.

If the PDU SESSION RELEASE COMMAND message includes 5GSM cause #39 "reactivation requested" and the UE provided an S-NSSAI during the PDU session establishment, the UE shall stop timer T3585 if it is running for the S-NSSAI provided by the UE. The UE should then re-initiate the UE requested PDU session establishment procedure for the same S-NSSAI. If the UE did not provide an S-NSSAI during the PDU session establishment and the request type was different from "initial emergency request" and different from "existing emergency PDU session", the UE shall stop the timer T3585 associated with no S-NSSAI if it is running, and should re-initiate the UE requested PDU session establishment procedure without including an S-NSSAI. If the PDU SESSION RELEASE COMMAND message was received for an emergency PDU session, the UE shall not stop the timer T3585 associated with no S-NSSAI if it is running.

If the PDU SESSION RELEASE COMMAND message includes 5GSM cause #39 "reactivation requested" and the UE provided a DNN during the PDU session establishment, the UE shall stop timer T3396 if it is running for the DNN provided by the UE. The UE should then re-initiate the UE requested PDU session establishment procedure for the same DNN. If the UE did not provide a DNN during the PDU session establishment and the request type was different from "initial emergency request" and different from "existing emergency PDU session", the UE shall stop the timer T3396 associated with no DNN if it is running, and should re-initiate the UE requested PDU session establishment procedure without including a DNN. If the PDU SESSION RELEASE COMMAND message was received for an emergency PDU session, the UE shall not stop the timer T3396 associated with no DNN if it is running.

If the PDU SESSION RELEASE COMMAND message includes 5GSM cause #39 "reactivation requested" and the UE provided an S-NSSAI and a DNN during the PDU session establishment, the UE shall stop timer T3584 if it is running for the same [S-NSSAI, DNN] combination provided by the UE. The UE should then re-initiate the UE requested PDU session establishment procedure for the same [S-NSSAI, DNN] combination. If the UE did not provide an S-NSSAI during the PDU session establishment, the UE shall stop the timer T3584 associated with [no S-NSSAI, DNN] if it is running, and should re-initiate the UE requested PDU session establishment procedure with the same DNN but without an S-NSSAI. If the UE did not provide a DNN during the PDU session establishment and the request type was different from "initial emergency request" and different from "existing emergency PDU session", the UE shall stop the timer T3584 associated with [S-NSSAI, no DNN] if it is running, and should re-initiate the UE requested PDU session establishment procedure with the same S-NSSAI but without a DNN. If the PDU SESSION RELEASE COMMAND message was received for an emergency PDU session, the UE shall not stop the timer T3584 associated with [S-NSSAI, no DNN] if it is running. If the UE provided neither a DNN nor an S-NSSAI during the PDU session establishment and the request type was different from "initial emergency request" and different from "existing emergency PDU session", the UE shall stop the timer T3584 associated with [no S-NSSAI, no DNN] if it is running, and should re-initiate the UE requested PDU session establishment procedure without an S-NSSAI and a DNN. If the PDU SESSION RELEASE COMMAND message was received for an emergency PDU session, the UE shall not stop the timer T3584 associated with [no S-NSSAI, no DNN] if it is running.

NOTE 2: User interaction is necessary in some cases when the UE cannot re-initiate the UE-requested PDU session establishment procedure automatically.

NOTE 3: If the PDU SESSION RELEASE COMMAND message includes 5GSM cause #39 "reactivation requested" for a PDU session, the UE provided a DNN (or no DNN) and an S-NSSAI (or no S-NSSAI) when the PDU session is established, timer T3396 associated with the DNN (or no DNN, if no DNN was provided by the UE) is running, and timer T3584 associated with the DNN (or no DNN, if no DNN was provided by the UE) and the S-NSSAI (or no S-NSSAI, if no S-NSSAI was provided by the UE) is running, then the UE stops both the timer T3396 and the timer T3584.

NOTE 4: If the PDU SESSION RELEASE COMMAND message includes 5GSM cause #39 "reactivation requested" for a PDU session, the UE provided a DNN (or no DNN) and an S-NSSAI (or no S-NSSAI) when the PDU session is established, timer T3585 associated with the S-NSSAI (or no S-NSSAI, if no S-NSSAI was provided by the UE) is running, and timer T3584 associated with the DNN (or no DNN, if no DNN was provided by the UE) and the S-NSSAI (or no S-NSSAI, if no S-NSSAI was provided by the UE) is running, then the UE stops both the timer T3585 and the timer T3584.

If the PDU SESSION RELEASE COMMAND message includes 5GSM cause #26 "insufficient resources" and the Back-off timer value IE, the UE shall ignore the 5GSM congestion re-attempt indicator IE provided by the network, if any, and the UE shall take different actions depending on the timer value received for timer T3396 in the Back-off timer value:

- a) If the timer value indicates neither zero nor deactivated and a DNN was provided during the PDU session establishment, the UE shall stop timer T3396 associated with the corresponding DNN, if it is running. If the timer value indicates neither zero nor deactivated and no DNN was provided during the PDU session establishment and the request type was different from "initial emergency request" and different from "existing emergency PDU session", the UE shall stop timer T3396 associated with no DNN if it is running. The UE shall then start timer T3396 with the value provided in the Back-off timer value IE and:
  - 1) shall not send a PDU SESSION ESTABLISHMENT REQUEST message or PDU SESSION MODIFICATION REQUEST message with exception of those identified in subclause 6.4.2.1, for the same DNN that was sent by the UE, until timer T3396 expires or timer T3396 is stopped; and
  - 2) shall not send a PDU SESSION ESTABLISHMENT REQUEST message without an DNN and with request type different from "initial emergency request" and different from "existing emergency PDU session", or a PDU SESSION MODIFICATION REQUEST message with exception of those identified in subclause 6.4.2.1, for a non-emergency PDU session established without an DNN provided by the UE, if no DNN was provided during the PDU session establishment and the request type was different from "initial emergency request" and different from "existing emergency PDU session", until timer T3396 expires or timer T3396 is stopped.

The UE shall not stop timer T3396 upon a PLMN change or inter-system change;

- b) if the timer value indicates that this timer is deactivated and a DNN was provided during the PDU session establishment, the UE shall stop timer T3396 associated with the corresponding DNN, if it is running. If the timer value indicates that this timer is deactivated and no DNN was provided during the PDU session establishment and the request type was different from "initial emergency request" and different from "existing emergency PDU session", the UE shall stop timer T3396 associated with no DNN if it is running. The UE:
  - 1) shall not send a PDU SESSION ESTABLISHMENT REQUEST message or PDU SESSION MODIFICATION REQUEST message with exception of those identified in subclause 6.4.2.1, for the same DNN until the UE is switched off or the USIM is removed, or the UE receives a PDU SESSION MODIFICATION COMMAND message for the same DNN from the network or a PDU SESSION RELEASE COMMAND message including 5GSM cause #39 "reactivation requested" for the same DNN from the network; and
  - 2) shall not send a PDU SESSION ESTABLISHMENT REQUEST message without an DNN and with request type different from "initial emergency request" and different from "existing emergency PDU session", or a PDU SESSION MODIFICATION REQUEST message with exception of those identified in subclause 6.4.2.1, for a non-emergency PDU session established without an DNN provided by the UE, if no DNN was provided during the PDU session establishment and the request type was different from "initial emergency request" and different from "existing emergency PDU session", until the UE is switched off or the USIM is removed, or the UE receives a PDU SESSION MODIFICATION COMMAND message for a non-emergency PDU session established without an DNN provided by the UE, or a PDU SESSION RELEASE COMMAND message including 5GSM cause IE set to 5GSM cause #39 "reactivation requested" for a non-emergency PDU session established without an DNN provided by the UE.

The timer T3396 remains deactivated upon a PLMN change or inter-system change; and

- c) if the timer value indicates zero, the UE:
- 1) shall stop timer T3396 associated with the corresponding DNN, if running, and may send a PDU SESSION ESTABLISHMENT REQUEST message or PDU SESSION MODIFICATION REQUEST message for the same DNN; and
  - 2) if no DNN was provided during the PDU session establishment and the request type was different from "initial emergency request" and different from "existing emergency PDU session", the UE shall stop timer T3396 associated with no DNN, if running, and may send a PDU SESSION ESTABLISHMENT REQUEST message without a DNN, or a PDU SESSION MODIFICATION REQUEST message without an DNN provided by the UE.

If the PDU SESSION RELEASE COMMAND message includes 5GSM cause #26 "insufficient resources" and the Back-off timer value IE is not included, then the UE may send a PDU SESSION ESTABLISHMENT REQUEST message or PDU SESSION MODIFICATION REQUEST message for the same DNN or without a DNN.

When the timer T3396 is running or the timer is deactivated, the UE is allowed to initiate a PDU session establishment procedure for emergency services.

If the timer T3396 is running when the UE enters state 5GMM-DEREGISTERED, the UE remains switched on, and the USIM in the UE remains the same, then timer T3396 is kept running until it expires or it is stopped.

If the UE is switched off when the timer T3396 is running, and if the USIM in the UE remains the same when the UE is switched on, the UE shall behave as follows:

- let  $t_1$  be the time remaining for T3396 timeout at switch off and let  $t$  be the time elapsed between switch off and switch on. If  $t_1$  is greater than  $t$ , then the timer shall be restarted with the value  $t_1 - t$ . If  $t_1$  is equal to or less than  $t$ , then the timer need not be restarted. If the UE is not capable of determining  $t$ , then the UE shall restart the timer with the value  $t_1$ .

If the 5GSM cause value is #67 "insufficient resources for specific slice and DNN" and the Back-off timer value IE is included, the UE shall take different actions depending on the timer value received for timer T3584 in the Back-off timer value:

- a) If the timer value indicates neither zero nor deactivated, the UE shall stop timer T3584 associated with the same [S-NSSAI, DNN] combination as that the UE provided when the PDU session is established, if it is running. The UE shall then start timer T3584 with the value provided in the Back-off timer value IE.

The UE shall not send another PDU SESSION ESTABLISHMENT REQUEST message with request type different from "initial emergency request" and different from "existing emergency PDU session", or PDU SESSION MODIFICATION REQUEST message with exception of those identified in subclause 6.4.2.1, for the same [S-NSSAI, DNN] combination that was sent by the UE, until timer T3584 expires or timer T3584 is stopped;

The UE shall not stop timer T3584 upon a PLMN change or inter-system change;

- b) if the timer value indicates that this timer is deactivated, the UE shall stop timer T3584 associated with the same [S-NSSAI, DNN] combination as that the UE provided when the PDU session is established, if it is running.

The UE shall not send another PDU SESSION ESTABLISHMENT REQUEST message with request type different from "initial emergency request" and different from "existing emergency PDU session", or PDU SESSION MODIFICATION REQUEST message with exception of those identified in subclause 6.4.2.1, for the same [S-NSSAI, DNN] combination that was sent by the UE, until the UE is switched off or the USIM is removed, or the UE receives a PDU SESSION MODIFICATION REQUEST message for the same [S-NSSAI, DNN] combination from the network or a PDU SESSION RELEASE COMMAND message including 5GSM cause #39 "reactivation requested" for the same [S-NSSAI, DNN] combination from the network; and

The timer T3584 remains deactivated upon a PLMN change or inter-system change; and

- c) if the timer value indicates zero, the UE shall stop timer T3584 associated with the same [S-NSSAI, DNN] combination that was sent by the UE, if running, and may send another PDU SESSION ESTABLISHMENT REQUEST message or PDU SESSION MODIFICATION REQUEST message for the same [S-NSSAI, DNN] combination.



If the 5GSM congestion re-attempt indicator IE set to "The back-off timer is applied in all PLMNs" is included in the PDU SESSION RELEASE COMMAND message with the 5GSM cause value #67 "insufficient resources for specific slice and DNN", then the UE shall apply the timer T3584 for all the PLMNs. Otherwise, the UE shall apply the timer T3584 for the registered PLMN.

If the 5GSM cause value is #67 "insufficient resources for specific slice and DNN" and the Back-off timer value IE is not included, then the UE may send another PDU SESSION ESTABLISHMENT REQUEST message or PDU SESSION MODIFICATION REQUEST message for the same [S-NSSAI, DNN] combination.

When the timer T3584 is running or the timer is deactivated, the UE is allowed to initiate a PDU session establishment procedure for emergency services.

If the timer T3584 is running when the UE enters state 5GMM-DEREGISTERED, the UE remains switched on, and the USIM in the UE remains the same, then timer T3584 is kept running until it expires or it is stopped.

If the UE is switched off when the timer T3584 is running, and if the USIM in the UE remains the same when the UE is switched on, the UE shall behave as follows:

- let  $t_1$  be the time remaining for T3584 timeout at switch off and let  $t$  be the time elapsed between switch off and switch on. If  $t_1$  is greater than  $t$ , then the timer shall be restarted with the value  $t_1 - t$ . If  $t_1$  is equal to or less than  $t$ , then the timer need not be restarted. If the UE is not capable of determining  $t$ , then the UE shall restart the timer with the value  $t_1$ .

If the 5GSM cause value is #69 "insufficient resources for specific slice" and the Back-off timer value IE is included, the UE shall take different actions depending on the timer value received for timer T3585 in the Back-off timer value:

- a) If the timer value indicates neither zero nor deactivated and an S-NSSAI was provided during the PDU session establishment, the UE shall stop timer T3585 associated with the corresponding S-NSSAI, if it is running. If the timer value indicates neither zero nor deactivated and no S-NSSAI was provided during the PDU session establishment and the request type was different from "initial emergency request" and different from "existing emergency PDU session", the UE shall stop timer T3585 associated with no S-NSSAI if it is running. The UE shall then start timer T3585 with the value provided in the Back-off timer value IE and:
  - 1) shall not send another PDU SESSION ESTABLISHMENT REQUEST message, or PDU SESSION MODIFICATION REQUEST message with exception of those identified in subclause 6.4.2.1, for the same S-NSSAI that was sent by the UE, until timer T3585 expires or timer T3585 is stopped; and
  - 2) shall not send another PDU SESSION ESTABLISHMENT REQUEST message without an S-NSSAI and with request type different from "initial emergency request" and different from "existing emergency PDU session", or another PDU SESSION MODIFICATION REQUEST message with exception of those identified in subclause 6.4.2.1, for a non-emergency PDU session established without an S-NSSAI provided by the UE, if no S-NSSAI was provided during the PDU session establishment and the request type was different from "initial emergency request" and different from "existing emergency PDU session", until timer T3585 expires or timer T3585 is stopped.

The UE shall not stop timer T3585 upon a PLMN change or inter-system change;

- b) if the timer value indicates that this timer is deactivated and an S-NSSAI was provided during the PDU session establishment, the UE shall stop timer T3585 associated with the corresponding S-NSSAI, if it is running. If the timer value indicates that this timer is deactivated and no S-NSSAI was provided during the PDU session establishment and the request type was different from "initial emergency request" and different from "existing emergency PDU session", the UE shall stop timer T3585 associated with no S-NSSAI if it is running. The UE:
  - 1) shall not send another PDU SESSION ESTABLISHMENT REQUEST, or PDU SESSION MODIFICATION REQUEST with exception of those identified in subclause 6.4.2.1, for the same S-NSSAI until the UE is switched off or the USIM is removed, or a PDU SESSION RELEASE COMMAND message including 5GSM cause #39 "reactivation requested" for the same S-NSSAI from the network; and
  - 2) shall not send another PDU SESSION ESTABLISHMENT REQUEST message without an S-NSSAI and with request type different from "initial emergency request" and different from "existing emergency PDU session", or another PDU SESSION MODIFICATION REQUEST message with exception of those identified in subclause 6.4.2.1, for a non-emergency PDU session established without an S-NSSAI provided by the UE, if no S-NSSAI was provided during the PDU session establishment and the request type was different from "initial emergency request" and different from "existing emergency PDU session", until the

UE is switched off or the USIM is removed, or a PDU SESSION RELEASE COMMAND messages including 5GSM cause IE set to 5GSM cause #39 "reactivation requested" for a non-emergency PDU session established without an S-NSSAI provided by the UE.

The timer T3585 remains deactivated upon a PLMN change or inter-system change; and

- c) if the timer value indicates zero, the UE:
- 1) shall stop timer T3585 associated with the corresponding S-NSSAI, if running, and may send another PDU SESSION ESTABLISHMENT REQUEST, or PDU SESSION MODIFICATION REQUEST message for the same S-NSSAI; and
  - 2) if no S-NSSAI was provided during the PDU session establishment and the request type was different from "initial emergency request" and different from "existing emergency PDU session", the UE shall stop timer T3585 associated with no S-NSSAI, if running, and may send another PDU SESSION ESTABLISHMENT REQUEST message without an S-NSSAI, or another PDU SESSION MODIFICATION REQUEST message without an S-NSSAI provided by the UE.

If the 5GSM congestion re-attempt indicator IE set to "The back-off timer is applied in all PLMNs" is included in the PDU SESSION RELEASE COMMAND message with the 5GSM cause value #69 "insufficient resources for specific slice", then the UE shall apply the timer T3585 for all the PLMNs. Otherwise, the UE shall apply the timer T3585 for the registered PLMN.

If the 5GSM cause value is #69 "insufficient resources for specific slice" and the Back-off timer value IE is not included, then the UE may send another PDU SESSION ESTABLISHMENT REQUEST message or PDU SESSION MODIFICATION REQUEST message for the same S-NSSAI or without an S-NSSAI.

When the timer T3585 is running or the timer is deactivated, the UE is allowed to initiate a PDU session establishment procedure for emergency services.

If the timer T3585 is running when the UE enters state 5GMM-DEREGISTERED, the UE remains switched on, and the USIM in the UE remains the same, then timer T3585 is kept running until it expires or it is stopped.

If the UE is switched off when the timer T3585 is running, and if the USIM in the UE remains the same when the UE is switched on, the UE shall behave as follows:

- let  $t_1$  be the time remaining for T3585 timeout at switch off and let  $t$  be the time elapsed between switch off and switch on. If  $t_1$  is greater than  $t$ , then the timer shall be restarted with the value  $t_1 - t$ . If  $t_1$  is equal to or less than  $t$ , then the timer need not be restarted. If the UE is not capable of determining  $t$ , then the UE shall restart the timer with the value  $t_1$ .

NOTE 5: As described in this subclause, upon PLMN change or inter-system change, the UE does not stop the timer T3584 or T3585. This means the timer T3584 or T3585 can still be running or be deactivated for the given 5GSM procedure, the PLMN, the S-NSSAI and optionally the DNN combination when the UE returns to the PLMN or when it performs inter-system change back from S1 mode to N1 mode. Thus the UE can still be prevented from sending another PDU SESSION ESTABLISHMENT REQUEST or PDU SESSION MODIFICATION REQUEST message in the PLMN for the same S-NSSAI and optionally the same DNN.

Upon PLMN change, if T3584 is running or is deactivated for an S-NSSAI, a DNN, and old PLMN, but T3584 is not running and is not deactivated for the S-NSSAI, the DNN, and new PLMN, then the UE is allowed to send a PDU SESSION ESTABLISHMENT REQUEST message for the same S-NSSAI and the same DNN in the new PLMN.

Upon PLMN change, if T3585 is running or is deactivated for an S-NSSAI and old PLMN, but T3585 is not running and is not deactivated for the S-NSSAI and new PLMN, then the UE is allowed to send a PDU SESSION ESTABLISHMENT REQUEST message for the same S-NSSAI in the new PLMN.

The UE shall transport the PDU SESSION RELEASE COMPLETE message and the PDU session ID, using the NAS transport procedure as specified in subclause 5.4.5.

Upon receipt of a PDU SESSION RELEASE COMPLETE message, the SMF shall stop timer T3592 and shall consider the PDU session as released.

#### 6.3.3.4 N1 SM delivery skipped

If the PDU SESSION RELEASE COMMAND message was sent along the N1 SM delivery skip allowed indication towards AMF, then upon receipt of an indication that N1 SM delivery was skipped, the SMF shall stop timer T3592 and shall consider the PDU session as released.

#### 6.3.3.5 Abnormal cases on the network side

The following abnormal cases can be identified:

- a) Expiry of timer T3592.

The SMF shall, on the first expiry of the timer T3592, retransmit the PDU SESSION RELEASE COMMAND message and shall reset and start timer T3592. This retransmission is repeated four times, i.e. on the fifth expiry of timer T3592, the SMF shall abort the procedure.

- b) Collision of network-requested PDU session release procedure and UE-requested PDU session modification procedure.

When the SMF receives a PDU SESSION MODIFICATION REQUEST message during the network-requested PDU session release procedure, and the PDU session indicated in PDU SESSION MODIFICATION REQUEST message is the PDU session that the SMF had requested to release, the SMF shall ignore the PDU SESSION MODIFICATION REQUEST message and proceed with the PDU session release procedure.

- c) Collision of network-requested PDU session release procedure and UE-requested PDU session release procedure.

If the SMF receives a PDU SESSION RELEASE REQUEST message after sending a PDU SESSION RELEASE COMMAND message to the UE, and the PDU session ID in the PDU SESSION RELEASE REQUEST message is the same as the PDU session ID in the PDU SESSION RELEASE COMMAND message, the SMF shall ignore the PDU SESSION RELEASE REQUEST message and proceed with the network-requested PDU session release procedure.

#### 6.3.3.6 Abnormal cases in the UE

The following abnormal cases can be identified:

- a) PDU session inactive for the received PDU session ID.

If the PDU session ID in the PDU SESSION RELEASE COMMAND message belongs to any PDU session in state PDU SESSION INACTIVE in the UE, the UE shall include the 5GSM cause #43 "Invalid PDU session identity" in the 5GSM STATUS message, and set the PDU session ID to the received PDU session ID in the UL NAS TRANSPORT message as specified in subclause 5.4.5.

### 6.4 UE-requested 5GSM procedures

#### 6.4.1 UE-requested PDU session establishment procedure

##### 6.4.1.1 General

The purpose of the UE-requested PDU session establishment procedure is to establish a new PDU session with a DN, to perform handover of an existing PDU session between 3GPP access and non-3GPP access, to transfer an existing PDN connection in the EPS to the 5GS, or to transfer an existing PDN connection in an untrusted non-3GPP access connected to the EPC to the 5GS. If accepted by the network, the PDU session enables exchange of PDUs between the UE and the DN.

The UE shall not request a PDU session establishment:

- a) for an LADN when the UE is located outside the LADN service area; or

- b) to transfer a PDU session from non-3GPP access to 3GPP access when the 3GPP PS data off UE status is "activated" and the UE is not using the PDU session to send uplink IP packets for any of the 3GPP PS data off exempt services (see subclause 6.2.10).

#### 6.4.1.2 UE-requested PDU session establishment procedure initiation

In order to initiate the UE-requested PDU session establishment procedure, the UE shall create a PDU SESSION ESTABLISHMENT REQUEST message.

NOTE 0: When IMS voice is available over either 3GPP access or non-3GPP access, the "voice centric" UE in 5GMM-REGISTERED state will receive a request from upper layers to establish the PDU session for IMS signalling, if the conditions for performing an initial registration with IMS indicated in 3GPP TS 24.229 [14] subclause U.3.1.2 are satisfied.

If the UE requests to establish a new PDU session, the UE shall allocate a PDU session ID which is not currently being used by another PDU session over either 3GPP access or non-3GPP access.

The UE shall allocate a PTI value currently not used and shall set the PTI IE of the PDU SESSION ESTABLISHMENT REQUEST message to the allocated PTI value.

If the UE is registered for emergency services over the current access, the UE shall not request establishing a non-emergency PDU session over the current access. If the UE is registered for emergency services over the current access it shall not request establishing an emergency PDU session over the non-current access except if the request is for transferring the emergency PDU session to the non-current access.

NOTE 1: Transfer of an existing emergency PDU session between 3GPP access and non-3GPP access is needed e.g. if the UE determines that the current access is no longer available.

If the UE requests to establish a new non-emergency PDU session with a DN and requests a PDU session type, the UE shall set the PDU session type IE of the PDU SESSION ESTABLISHMENT REQUEST message to one of the following values: the IP version capability as specified in subclause 6.2.4.2, "Ethernet" or "Unstructured".

NOTE 2: When the UE initiates the UE-requested PDU session establishment procedure to transfer an existing non-IP PDN connection in the EPS to the 5GS, the UE can use locally available information associated with the PDN connection to select the PDU session type between "Ethernet" and "Unstructured".

If the UE requests to establish a new non-emergency PDU session with a DN and the UE requests an SSC mode, the UE shall set the SSC mode IE of the PDU SESSION ESTABLISHMENT REQUEST message to the SSC mode. If the UE requests to establish a PDU session of "IPv4", "IPv6" or "IPv4v6" PDU session type, the UE shall either omit the SSC mode IE or set the SSC mode IE to "SSC mode 1", "SSC mode 2", or "SSC mode 3". If the UE requests to establish a PDU session of "Ethernet" or "Unstructured" PDU session type, the UE shall either omit the SSC mode IE or set the SSC mode IE to "SSC mode 1" or "SSC mode 2". If the UE requests transfer of an existing PDN connection in the EPS to the 5GS or the UE requests transfer of an existing PDN connection in an untrusted non-3GPP access connected to the EPC to the 5GS, the UE shall set the SSC mode IE to "SSC mode 1".

If the UE requests to establish a new emergency PDU session, the UE shall set the SSC mode IE of the PDU SESSION ESTABLISHMENT REQUEST message to "SSC mode 1".

If the UE requests to establish a new PDU session with a DN, the UE may include the SM PDU DN request container IE with a DN-specific identity of the UE complying with network access identifier (NAI) format as specified in IETF RFC 7542 [37].

The UE should set the RQoS bit to "Reflective QoS supported" in the 5GSM capability IE of the PDU SESSION ESTABLISHMENT REQUEST message if the UE supports reflective QoS and:

- a) the UE requests to establish a new PDU session of "IPv4", "IPv6", "IPv4v6" or "Ethernet" PDU session type;
- b) the UE requests to transfer an existing PDN connection in the EPS of "IPv4", "IPv6", "IPv4v6" or "Non-IP" PDN type mapping to "Ethernet" PDU session type to the 5GS; or
- c) the UE requests to transfer an existing PDN connection in an untrusted non-3GPP access connected to the EPC of "IPv4", "IPv6" or "IPv4v6" PDN type to the 5GS.

NOTE 3: The determination to not request the usage of reflective QoS by the UE for a PDU session is implementation dependent.

The UE shall indicate the maximum number of packet filters that can be supported for the PDU session in the Maximum number of supported packet filters IE of the PDU SESSION ESTABLISHMENT REQUEST message if:

- a) the UE requests to establish a new PDU session of "IPv4", "IPv6", "IPv4v6", or "Ethernet" PDU session type, and the UE can support more than 16 packet filters for this PDU session;
- b) the UE requests to transfer an existing PDN connection in the EPS of "IPv4", "IPv6", "IPv4v6" or "Non-IP" PDN type mapping to "Ethernet" PDU session type to the 5GS and the UE can support more than 16 packet filters for this PDU session; or
- c) the UE requests to transfer an existing PDN connection in an untrusted non-3GPP access connected to the EPC of "IPv4", "IPv6" or "IPv4v6" PDN type to the 5GS and the UE can support more than 16 packet filters for this PDU session.

The UE shall include the Integrity protection maximum data rate IE in the PDU SESSION ESTABLISHMENT REQUEST message to indicate the maximum data rate per UE for user-plane integrity protection supported by the UE for uplink and the maximum data rate per UE for user-plane integrity protection supported by the UE for downlink.

The UE shall set the MH6-PDU bit to "Multi-homed IPv6 PDU session supported" in the 5GSM capability IE of the PDU SESSION ESTABLISHMENT REQUEST message if the UE supports multi-homed IPv6 PDU session and:

- a) the UE requests to establish a new PDU session of "IPv6" or "IPv4v6" PDU session type; or
- b) the UE requests to transfer an existing PDN connection of "IPv6" or "IPv4v6" PDN type in the EPS or in an untrusted non-3GPP access connected to the EPC to the 5GS.

If the UE requests to establish a new PDU session as an always-on PDU session, the UE shall include the Always-on PDU session requested IE and set the value of the IE to "Always-on PDU session requested" in the PDU SESSION ESTABLISHMENT REQUEST message.

If the UE has an emergency PDU session, the UE shall not perform the UE-requested PDU session establishment procedure to establish another emergency PDU session. The UE may perform the UE-requested PDU session establishment procedure to transfer an existing emergency PDU session or an existing PDN connection for emergency services.

If:

- a) the UE requests to perform handover of an existing PDU session between 3GPP access and non-3GPP access;
- b) the UE requests to perform transfer an existing PDN connection in the EPS to the 5GS; or
- c) the UE requests to perform transfer an existing PDN connection in an untrusted non-3GPP access connected to the EPC to the 5GS;

the UE shall:

- a) set the PDU session ID in the PDU SESSION ESTABLISHMENT REQUEST message and in the UL NAS TRANSPORT message to the stored PDU session ID corresponding to the PDN connection; and
- b) set the S-NSSAI in the UL NAS TRANSPORT message to the stored S-NSSAI associated with the PDU session ID only if the S-NSSAI is included in the allowed NSSAI.

If the UE supports 3GPP PS data off, the UE shall include the extended protocol configuration options IE in the PDU SESSION ESTABLISHMENT REQUEST message and include the 3GPP PS data off UE status. The UE behaves as described in subclause 6.2.10.

The UE shall transport:

- a) the PDU SESSION ESTABLISHMENT REQUEST message;
- b) the PDU session ID of the PDU session being established, or being handed over or being transferred;
- c) if the request type is set to:

- 1) "initial request" and the UE determined to establish a new PDU session based on either a URSP rule including one or more S-NSSAIs in the URSP (see subclause 6.2.9) or UE local configuration, according to subclause 4.2.2 of 3GPP TS 24.526 [19]:
    - i) in case of a non-roaming scenario, an S-NSSAI in the allowed NSSAI which corresponds to one of the S-NSSAI(s) in the matching URSP rule, if any, or the S-NSSAI(s) in the UE local configuration or in the default URSP rule, according to the conditions given in subclause 4.2.2 of 3GPP TS 24.526 [19]; or
    - ii) in case of a roaming scenario:
      - A) one of the mapped S-NSSAI(s) which corresponds to one of the S-NSSAI(s) in the matching URSP rule, if any, or else to the S-NSSAI(s) in the UE local configuration or in the default URSP rule, according to the conditions given in subclause 4.2.2 of 3GPP TS 24.526 [19]; and
      - B) the S-NSSAI in the allowed NSSAI associated with the S-NSSAI in A);
  - 2) "existing PDU session", an S-NSSAI, which is an S-NSSAI associated with the PDU session and (if available in roaming scenarios) a mapped S-NSSAI;
- d) the requested DNN, if the request type is set to "initial request" or "existing PDU session", and the UE requests a connectivity to a DNN other than the default DNN;
- e) the request type which is set to:
- 1) "initial request", if the UE is not registered for emergency services and the UE requests to establish a new non-emergency PDU session;
  - 2) "existing PDU session", if the UE is not registered for emergency services and the UE requests:
    - i) handover of an existing non-emergency PDU session between 3GPP access and non-3GPP access;
    - ii) transfer of an existing PDN connection for non-emergency bearer services in the EPS to the 5GS; or
    - iii) transfer of an existing PDN connection for non-emergency bearer services in an untrusted non-3GPP access connected to the EPC to the 5GS; or
  - 3) "initial emergency request", if the UE requests to establish a new emergency PDU session; and
  - 4) "existing emergency PDU session", if the UE requests:
    - i) handover of an existing emergency PDU session between 3GPP access and non-3GPP access;
    - ii) transfer of an existing PDN connection for emergency bearer services in the EPS to the 5GS; or
    - iii) transfer of an existing PDN connection for emergency bearer services in an untrusted non-3GPP access connected to the EPC to the 5GS; and
- f) the old PDU session ID which is the PDU session ID of the existing PDU session, if the UE initiates the UE-requested PDU session establishment procedure upon receiving the PDU SESSION MODIFICATION COMMAND messages with the 5GSM cause IE set to #39 "reactivation requested";

using the NAS transport procedure as specified in subclause 5.4.5, and the UE shall start timer T3580 (see example in figure 6.4.1.2.1).

For bullet c), if the matching URSP rule does not have an associated S-NSSAI, or if the UE does not have any matching URSP rule and there is no S-NSSAI in the UE local configuration or in the default URSP rule, the UE shall not provide any S-NSSAI in a PDU session establishment procedure.

If the request type is set to "initial emergency request" or "existing emergency PDU session", neither DNN nor S-NSSAI is transported by the UE using the NAS transport procedure as specified in subclause 5.4.5.

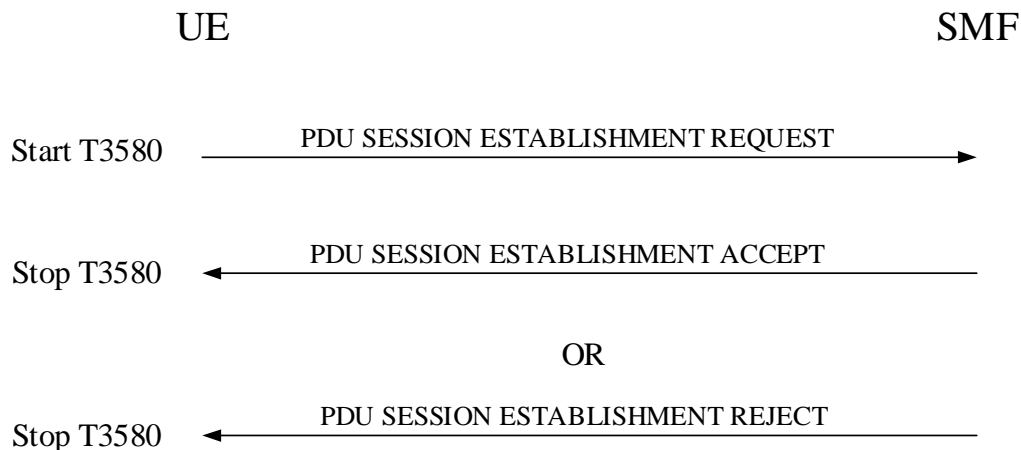

**Figure 6.4.1.2.1: UE-requested PDU session establishment procedure**

Upon receipt of a PDU SESSION ESTABLISHMENT REQUEST message, a PDU session ID, optionally an S-NSSAI associated with (if available in roaming scenarios) a mapped S-NSSAI, optionally a DNN, the request type, and optionally an old PDU session ID, the SMF checks whether connectivity with the requested DN can be established. If the requested DNN is not included, the SMF shall use the default DNN.

If the PDU session being established is a non-emergency PDU session, the request type is not set to "existing PDU session" and the PDU session authentication and authorization by the external DN is required due to local policy, the SMF shall check whether the PDU SESSION ESTABLISHMENT REQUEST message includes the SM PDU DN request container IE.

If the PDU session being established is a non-emergency PDU session, the request type is not set to "existing PDU session", the SM PDU DN request container IE is included in the PDU SESSION ESTABLISHMENT REQUEST message and the PDU session authentication and authorization by the external DN is required due to local policy and user's subscription data, the SMF shall:

- a) if the information for the PDU session authentication and authorization by the external DN in the SM PDU DN request container IE is compliant with the local policy and user's subscription data, proceed with the EAP Authentication procedure specified in 3GPP TS 33.501 [24] and refrain from accepting or rejecting the PDU SESSION ESTABLISHMENT REQUEST message until the EAP Authentication procedure finalizes; and
- b) if the information for the PDU session authentication and authorization by the external DN in the SM PDU DN request container IE is not compliant with the local policy, reject the PDU session establishment request including the 5GSM cause #29 "user authentication or authorization failed", in the PDU SESSION ESTABLISHMENT REJECT message.

If the PDU session being established is a non-emergency PDU session, the request type is not set to "existing PDU session", the SM PDU DN request container IE is not included in the PDU SESSION ESTABLISHMENT REQUEST message and the PDU session authentication and authorization by the external DN is required due to local policy and user's subscription data, the SMF shall proceed with the EAP Authentication procedure specified in 3GPP TS 33.501 [24] and refrain from accepting or rejecting the PDU SESSION ESTABLISHMENT REQUEST message until the EAP Authentication procedure finalizes.

If the SMF receives the old PDU session ID from the AMF and a PDU session exists for the old PDU session ID, the SMF shall consider that the request for the relocation of SSC mode 3 PDU session anchor with multiple PDU sessions as specified in 3GPP TS 23.502 [9] is accepted by the UE.

### 6.4.1.3 UE-requested PDU session establishment procedure accepted by the network

If the connectivity with the requested DN is accepted by the network, the SMF shall create a PDU SESSION ESTABLISHMENT ACCEPT message.

If the UE requests establishing an emergency PDU session, the network shall not check for service area restrictions or subscription restrictions when processing the PDU SESSION ESTABLISHMENT REQUEST message.

The SMF shall set the authorized QoS rules IE of the PDU SESSION ESTABLISHMENT ACCEPT message to the authorized QoS rules of the PDU session and may include the authorized QoS flow descriptions IE of the PDU SESSION ESTABLISHMENT ACCEPT message set to the authorized QoS flow descriptions of the PDU session. The SMF shall ensure that the number of the packet filters used in the authorized QoS rules of the PDU Session does not exceed the maximum number of packet filters supported by the UE for the PDU session. If the received request type is "initial emergency request", the SMF shall set the authorized QoS flow descriptions IE according to the initial QoS parameters used for establishing emergency services configured in the SMF emergency configuration data.

SMF shall set the authorized QoS flow descriptions IE to the authorized QoS flow descriptions of the PDU session, if:

- a) the authorized QoS rules IE contains at least one GBR QoS flow;
- b) the QFI is not the same as the 5QI of the QoS flow identified by the QFI; or
- c) the QoS flow can be mapped to an EPS bearer as specified in subclause 4.11.2 of 3GPP TS 23.502 [9].

If interworking with EPS is supported for the PDU session, the SMF shall set in the PDU SESSION ESTABLISHMENT ACCEPT message:

- a) the Mapped EPS bearer contexts IE to the EPS bearer contexts mapped from one or more QoS flows of the PDU session; and
- b) the EPS bearer identity parameter in the authorized QoS flow descriptions IE to the EPS bearer identity corresponding to the QoS flow, for each QoS flow which can be transferred to EPS.

If the "Create new EPS bearer" operation code in the mapped EPS bearer contexts IE was received, and there is no corresponding authorized QoS flow descriptions IE in the PDU SESSION ESTABLISHMENT ACCEPT message, the UE shall send a PDU SESSION MODIFICATION REQUEST message including a mapped EPS bearer contexts IE to delete the mapped EPS bearer context.

Furthermore, the SMF shall store the association between the QoS flow and the mapped EPS bearer context, for each QoS flow which can be transferred to EPS.

The SMF shall set the selected SSC mode IE of the PDU SESSION ESTABLISHMENT ACCEPT message to:

- a) the received SSC mode in the SSC mode IE included in the PDU SESSION ESTABLISHMENT REQUEST message based on one or more of the PDU session type, the subscription and the SMF configuration;
- b) either the default SSC mode for the data network listed in the subscription or the SSC mode associated with the SMF configuration, if the SSC mode IE is not included in the PDU SESSION ESTABLISHMENT REQUEST message.

If the PDU session is an emergency PDU session, the SMF shall set the Selected SSC mode IE of the PDU SESSION ESTABLISHMENT ACCEPT message to "SSC mode 1". If the PDU session is a non-emergency PDU session of "Ethernet" or "Unstructured" PDU session type, the SMF shall set the Selected SSC mode IE to "SSC mode 1" or "SSC mode 2". If the PDU session is a non-emergency PDU session of "IPv4", "IPv6" or "IPv4v6" PDU session type, the SMF shall set the selected SSC mode IE to "SSC mode 1", "SSC mode 2", or "SSC mode 3".

If the PDU session is a non-emergency PDU session, the SMF shall set the S-NSSAI IE of the PDU SESSION ESTABLISHMENT ACCEPT message to:

- a) the S-NSSAI of the PDU session; and
- b) the mapped S-NSSAI (if available in roaming scenarios).

The SMF shall set the selected PDU session type IE of the PDU SESSION ESTABLISHMENT ACCEPT message to the PDU session type of the PDU session.

If the PDU SESSION ESTABLISHMENT REQUEST message includes a PDU session type IE set to "IPv4v6", the SMF shall select "IPv4", "IPv6" or "IPv4v6" as the selected PDU session type IE of the PDU session. If the subscription, the SMF configuration, or both, are limited to IPv4 only or IPv6 only for the requested DNN, the SMF shall include the 5GSM cause value #50 "PDU session type IPv4 only allowed", or #51 "PDU session type IPv6 only allowed", respectively, in the 5GSM cause IE of the PDU SESSION ESTABLISHMENT ACCEPT message.



If the selected PDU session type is "IPv4", the SMF shall include the PDU address IE in the PDU SESSION ESTABLISHMENT ACCEPT message and shall set the PDU address IE to an IPv4 address is allocated to the UE in the PDU session.

If the selected PDU session type is "IPv6", the SMF shall include the PDU address IE in the PDU SESSION ESTABLISHMENT ACCEPT message and shall set the PDU address IE to an interface identifier for the IPv6 link local address allocated to the UE in the PDU session.

If the selected PDU session type is "IPv4v6", the SMF shall include the PDU address IE in the PDU SESSION ESTABLISHMENT ACCEPT message and shall set the PDU address IE to an IPv4 address and an interface identifier for the IPv6 link local address, allocated to the UE in the PDU session.

If the PDU session is a non-emergency PDU session, the SMF shall set the DNN IE of the PDU SESSION ESTABLISHMENT ACCEPT message to the DNN of the PDU session.

The SMF shall set the Session-AMBR IE of the PDU SESSION ESTABLISHMENT ACCEPT message to the Session-AMBR of the PDU session.

If the selected PDU session type is "IPv4", "IPv6", "IPv4v6" or "Ethernet" and if the PDU SESSION ESTABLISHMENT REQUEST message includes a 5GSM capability IE with the RQoS bit set to "Reflective QoS supported", the SMF shall consider that reflective QoS is supported for QoS flows belonging to this PDU session and may include the RQ timer IE set to an RQ timer value in the PDU SESSION ESTABLISHMENT ACCEPT message.

If the selected PDU session type is "IPv4", "IPv6", "IPv4v6" or "Ethernet" and if the PDU SESSION ESTABLISHMENT REQUEST message includes a Maximum number of supported packet filters IE, the SMF shall consider this number as the maximum number of packet filters that can be supported by the UE for this PDU session. Otherwise the SMF considers that the UE supports 16 packet filters for this PDU session.

The SMF shall consider that the maximum data rate per UE for user-plane integrity protection supported by the UE for uplink and the maximum data rate per UE for user-plane integrity protection supported by the UE for downlink are valid for the lifetime of the PDU session.

If the value of the RQ timer is set to "deactivated" or has a value of zero, the UE considers that RQoS is not applied for this PDU session.

NOTE 1: If the 5G core network determines that reflective QoS is to be used for a QoS flow, the SMF sends reflective QoS indication (RQI) to UPF to activate reflective QoS. If the QoS flow is established over 3GPP access, the SMF also includes reflective QoS Attribute (RQA) in QoS profile of the QoS flow during QoS flow establishment.

If the selected PDU session type is "IPv6" or "IPv4v6" and if the PDU SESSION ESTABLISHMENT REQUEST message includes a 5GSM capability IE with the MH6-PDU bit set to "Multi-homed IPv6 PDU session supported", the SMF shall consider that this PDU session is supported to use multiple IPv6 prefixes.

If the DN authentication of the UE was performed and completed successfully, the SMF shall set the EAP message IE of the PDU SESSION ESTABLISHMENT ACCEPT message to an EAP-success message as specified in IETF RFC 3748 [34], provided by the DN.

Based on local policies or configurations in the SMF and the Always-on PDU session requested IE in the PDU SESSION ESTABLISHMENT REQUEST message (if available), if the SMF determines that either:

- a) the requested PDU session needs to be established as an always-on PDU session, the SMF shall include the Always-on PDU session indication IE in the PDU SESSION ESTABLISHMENT ACCEPT message and shall set the value to "Always-on PDU session required"; or
- b) the requested PDU session shall not be established as an always-on PDU session and:
  - i) if the UE included the Always-on PDU session requested IE, the SMF shall include the Always-on PDU session indication IE in the PDU SESSION ESTABLISHMENT ACCEPT message and shall set the value to "Always-on PDU session not allowed"; or
  - ii) if the UE did not include the Always-on PDU session requested IE, the SMF shall not include the Always-on PDU session indication IE in the PDU SESSION ESTABLISHMENT ACCEPT message.

The SMF shall send the PDU SESSION ESTABLISHMENT ACCEPT message.

Upon receipt of a PDU SESSION ESTABLISHMENT ACCEPT message and a PDU session ID, using the NAS transport procedure as specified in subclause 5.4.5, the UE shall stop timer T3580, shall release the allocated PTI value and shall consider that the PDU session was established.

The UE shall store the authorized QoS rules, and the session-AMBR received in the PDU SESSION ESTABLISHMENT ACCEPT message for the PDU session. The UE shall also store the authorized QoS flow descriptions if it is included in the authorized QoS flow descriptions IE of the PDU SESSION ESTABLISHMENT ACCEPT message for the PDU session.

For a PDU session that is being established with the request type set to "initial request" or "initial emergency request", or a PDU session that is being transferred from EPS to 5GS and established with the request type set to "existing PDU session" or "existing emergency PDU session" or a PDU session that is being handed over between non-3GPP access and 3GPP access and established with the request type set to "existing PDU session" or "existing emergency PDU session", the UE shall verify the authorized QoS rules and the authorized QoS flow descriptions provided in the PDU SESSION ESTABLISHMENT ACCEPT message for different types of errors as follows:

a) Semantic errors in QoS operations:

- 1) When the rule operation is "Create new QoS rule", and the DQR bit is set to "the QoS rule is the default QoS rule" when there's already a default QoS rule.
- 2) When the rule operation is "Create new QoS rule", and there is no rule with the DQR bit set to "the QoS rule is the default QoS rule".
- 3) When the rule operation is "Create new QoS rule" and two or more QoS rules associated with this PDU session would have identical precedence values.
- 4) When the rule operation is an operation other than "Create new QoS rule", and the request type is "initial request" or "initial emergency request".
- 5) When the rule operation is "Create new QoS rule" and two or more QoS rules associated with this PDU session would have identical QoS rule identifier values.
- 6) When the flow description operation is an operation other than "Create new QoS flow description", and the request type is "initial request" or "initial emergency request".

In case 4, if the rule operation is for a non-default QoS rule, the UE shall send a PDU SESSION MODIFICATION REQUEST message to delete the QoS rule with 5GSM cause #83 "semantic error in the QoS operation".

In case 6, the UE shall send a PDU SESSION MODIFICATION REQUEST message to delete the QoS flow description with 5GSM cause #83 "semantic error in the QoS operation".

Otherwise for all the cases above, the UE shall initiate a PDU session release procedure by sending a PDU SESSION RELEASE REQUEST message with 5GSM cause #83 "semantic error in the QoS operation".

b) Syntactical errors in QoS operations:

- 1) When the rule operation is "Create new QoS rule" and the packet filter list in the QoS rule is empty.
- 2) When there are other types of syntactical errors in the coding of the QoS rules IE, such as a mismatch between the number of packet filters subfield, and the number of packet filters in the packet filter list.
- 3) When, the
  - A) rule operation is "Create new QoS rule", the UE determines that there is a resulting QoS rule for a GBR QoS flow (as described in 3GPP TS 23.501 [8] table 5.7.4-1), and there is no QoS flow description with a QFI corresponding to the QFI of the resulting QoS rule.
  - B) request type is "existing PDU session" or "existing emergency PDU session", the flow description operation is "Delete existing QoS flow description", and the UE determines that there is a resulting QoS rule for a GBR QoS flow (as described in 3GPP TS 23.501 [8] table 5.7.4-1) with a QFI corresponding to the QFI of the QoS flow description that is deleted (i.e. there is no associated QoS flow description with the same QFI).

In case 1, case 2 or case 3, if the QoS rule is not the default QoS rule, the UE shall send a PDU SESSION MODIFICATION REQUEST message including a requested QoS rule IE to delete the QoS rule with 5GSM cause #84 "syntactical error in the QoS operation". Otherwise, if the QoS rule is the default QoS rule, the UE shall initiate a PDU session release procedure by sending a PDU SESSION RELEASE REQUEST message with 5GSM cause #84 "syntactical error in the QoS operation".

In case 3, if the QoS rule is the default QoS rule, the UE initiate a PDU session release procedure by sending a PDU SESSION RELEASE REQUEST message with 5GSM cause #84 "syntactical error in the QoS operation". Otherwise, the UE shall send a PDU SESSION MODIFICATION REQUEST message including a requested QoS rule IE to delete the QoS rule with 5GSM cause #84 "syntactical error in the QoS operation".

c) Semantic errors in packet filters:

- 1) When a packet filter consists of conflicting packet filter components which would render the packet filter ineffective, i.e. no IP packet will ever fit this packet filter. How the UE determines a semantic error in a packet filter is outside the scope of the present document.

If the QoS rule is the default QoS rule, the UE shall initiate a PDU session release procedure by sending a PDU SESSION RELEASE REQUEST message with 5GSM cause #44 "semantic error in packet filter(s)". Otherwise, the UE shall send a PDU SESSION MODIFICATION REQUEST message to delete the QoS rule with 5GSM cause #44 "semantic error in packet filter(s)".

d) Syntactical errors in packet filters:

- 1) When the rule operation is "Create new QoS rule" and two or more packet filters in the resultant QoS rule would have identical packet filter identifiers.
- 2) When there are other types of syntactical errors in the coding of packet filters, such as the use of a reserved value for a packet filter component identifier.

If the QoS rule is the default QoS rule, the UE shall initiate a PDU session release procedure by sending a PDU SESSION RELEASE REQUEST message with 5GSM cause #45 "syntactical errors in packet filter(s)". Otherwise, the UE shall send a PDU SESSION MODIFICATION REQUEST message to delete the QoS rule with 5GSM cause #45 "syntactical errors in packet filter(s)".

If the Always-on PDU session indication IE is included in the PDU SESSION ESTABLISHMENT ACCEPT message and:

- a) the value of the IE is set to "Always-on PDU session required", the UE shall consider the established PDU session as an always-on PDU session; or
- b) the value of the IE is set to "Always-on PDU session not allowed", the UE shall not consider the established PDU session as an always-on PDU session.

The UE shall not consider the established PDU session as an always-on PDU session if the UE does not receive the Always-on PDU session indication IE in the PDU SESSION ESTABLISHMENT ACCEPT message.

The UE shall store the mapped EPS bearer contexts, if received in the PDU SESSION ESTABLISHMENT ACCEPT message. Furthermore, the UE shall also store the association between the QoS flow and the mapped EPS bearer context, for each QoS flow which can be transferred to EPS, based on the received EPS bearer identity parameter in authorized QoS flow descriptions IE and the mapped EPS bearer contexts. The UE shall check each mapped EPS bearer context for different types of errors as follows:

NOTE 2: An error detected in a mapped EPS bearer context does not cause the UE to discard the Authorized QoS rules IE and Authorized QoS flow descriptions IE included in the PDU SESSION ESTABLISHMENT ACCEPT, if any.

a) Semantic error in the mapped EPS bearer operation:

- 1) When the operation code is an operation code other than "Create new EPS bearer" and the PDU session is being established with the request type set to "initial request" or "initial emergency request".
- 2) When the operation code is "Create new EPS bearer" and there is already an existing mapped EPS bearer context with the same EPS bearer identity associated with any PDU session.

In case 2, if the existing mapped EPS bearer context is associated with the PDU session that is being established, the UE shall not diagnose an error, further process the create request and, if it was process successfully, delete the old EPS bearer context.

Otherwise, the UE shall initiate a PDU session modification procedure by sending a PDU SESSION MODIFICATION REQUEST message to delete the mapped EPS bearer context with 5GSM cause #85 "Invalid mapped EPS bearer identity".

b) if the mapped EPS bearer context includes a traffic flow template, the UE shall check the traffic flow template for different types of TFT IE errors as follows:

1) Semantic errors in TFT operations:

i) When the TFT operation is an operation other than "Create a new TFT"

The UE shall initiate a PDU session modification procedure by sending a PDU SESSION MODIFICATION REQUEST message to delete the mapped EPS bearer context with 5GSM cause #41 "semantic error in the TFT operation".

2) Syntactical errors in TFT operations:

i) When the TFT operation = "Create a new TFT" and the packet filter list in the TFT IE is empty.

ii) When there are other types of syntactical errors in the coding of the TFT IE, such as a mismatch between the number of packet filters subfield, and the number of packet filters in the packet filter list.

The UE shall initiate a PDU session modification procedure by sending a PDU SESSION MODIFICATION REQUEST message with to delete the mapped EPS bearer context 5GSM cause #42 "syntactical error in the TFT operation".

3) Semantic errors in packet filters:

i) When a packet filter consists of conflicting packet filter components which would render the packet filter ineffective, i.e. no IP packet will ever fit this packet filter. How the UE determines a semantic error in a packet filter is outside the scope of the present document.

ii) When the resulting TFT does not contain any packet filter which applicable for the uplink direction.

The UE shall initiate a PDU session modification procedure by sending a PDU SESSION MODIFICATION REQUEST message to delete the mapped EPS bearer context with 5GSM cause #44 "semantic errors in packet filter(s)".

4) Syntactical errors in packet filters:

i) When the TFT operation = "Create a new TFT" and two or more packet filters in the resultant TFT would have identical packet filter identifiers.

ii) When the TFT operation = "Create a new TFT" and two or more packet filters in all TFTs associated with this PDN connection would have identical packet filter precedence values.

iii) When there are other types of syntactical errors in the coding of packet filters, such as the use of a reserved value for a packet filter component identifier.

In case ii, if the old packet filters do not belong to the default EPS bearer context, the UE shall not diagnose an error and shall delete the old packet filters which have identical filter precedence values.

In case ii, if one or more old packet filters belong to the default EPS bearer context, the UE shall initiate a PDU session modification procedure by sending a PDU SESSION MODIFICATION REQUEST message to delete the mapped EPS bearer context with 5GSM cause #45 "syntactical errors in packet filter(s)".

In cases i and iii the UE shall initiate a PDU session modification procedure by sending a PDU SESSION MODIFICATION REQUEST message to delete the mapped EPS bearer context with 5GSM cause #45 "syntactical error in packet filter(s)".

If the UE requests the PDU session type "IPv4v6" and:

- a) the UE receives the selected PDU session type set to "IPv4" and does not receive the 5GSM cause value #50 "PDU session type IPv4 only allowed"; or
- b) the UE receives the selected PDU session type set to "IPv6" and does not receive the 5GSM cause value #51 "PDU session type IPv6 only allowed";

the UE may subsequently request another PDU session for the other IP version using the UE-requested PDU session establishment procedure to the same DNN (or no DNN, if no DNN was indicated by the UE) and the same S-NSSAI associated with (if available in roaming scenarios) a mapped S-NSSAI (or no S-NSSAI, if no S-NSSAI was indicated by the UE) with a single address PDN type (IPv4 or IPv6) other than the one already activated.

If the UE requests the PDU session type "IPv4v6", receives the selected PDU session type set to "IPv4" and the 5GSM cause value #50 "PDU session type IPv4 only allowed", the UE shall not subsequently request another PDU session for "IPv6" using the UE-requested PDU session establishment procedure to the same DNN (or no DNN, if no DNN was indicated by the UE) and the same S-NSSAI associated with (if available in roaming scenarios) a mapped S-NSSAI (or no S-NSSAI, if no S-NSSAI was indicated by the UE) and the PDU session type "IPv6" until:

- the UE is registered to a new PLMN which is not in the list of equivalent PLMNs;
- the PDU type which is used to access the DNN (or no DNN, if no DNN was indicated by the UE) and the S-NSSAI (or no S-NSSAI, if no S-NSSAI was indicated by the UE) is changed;
- the UE is switched off, or
- the USIM is removed.

If the UE requests the PDU session type "IPv4v6", receives the selected PDU session type set to "IPv6" and the 5GSM cause value #51 "PDU session type IPv6 only allowed", the UE shall not subsequently request another PDU session for "IPv4" using the UE-requested PDU session establishment procedure to the same DNN (or no DNN, if no DNN was indicated by the UE) and the same S-NSSAI associated with (if available in roaming scenarios) a mapped S-NSSAI (or no S-NSSAI, if no S-NSSAI was indicated by the UE) and the PDU session type "IPv4" until:

- the UE is registered to a new PLMN which is not in the list of equivalent PLMNs;
- the PDU type which is used to access the DNN (or no DNN, if no DNN was indicated by the UE) and the S-NSSAI (or no S-NSSAI, if no S-NSSAI was indicated by the UE) is changed;
- the UE is switched off, or
- the USIM is removed.

If the selected PDU session type of the PDU session is "Unstructured" or "Ethernet", the UE supports inter-system change from N1 mode to S1 mode, the UE does not support establishment of a PDN connection for the PDN type set to "non-IP" in S1 mode, and the parameters list field of one or more authorized QoS flow descriptions received in the authorized QoS flow descriptions IE of the PDU SESSION ESTABLISHMENT ACCEPT message contains an EPS bearer identity (EBI) then the UE shall locally remove the EPS bearer identity (EBI) from the parameters list field of such one or more authorized QoS flow descriptions.

If the UE receives an IPv4 Link MTU parameter, an Ethernet Frame Payload MTU parameter, or an Unstructured Link MTU parameter in the Extended protocol configuration options IE of the PDU SESSION ESTABLISHMENT ACCEPT message, the UE shall pass to the upper layer the received IPv4 link MTU size, the received Ethernet frame payload MTU size, or the unstructured link MTU size.

NOTE 3: The IPv4 link MTU size corresponds to the maximum length of user data packet that can be sent via N3 interface for a PDU session of the "IPv4" PDU session types.

NOTE 4: The Ethernet frame payload MTU size corresponds to the maximum length of a payload of an Ethernet frame that can be sent via N3 interface for a PDU session of the "Ethernet" PDU session type.

NOTE 5: The unstructured link MTU size correspond to the maximum length of user data packet that can be sent via N3 interface for a PDU session of the "Unstructured" PDU session types.

#### 6.4.1.4 UE requested PDU session establishment procedure not accepted by the network

If the connectivity with the requested DN is rejected by the network, the SMF shall create a SM PDU SESSION ESTABLISHMENT REJECT message.

The SMF shall set the 5GSM cause IE of the PDU SESSION ESTABLISHMENT REJECT message to indicate the reason for rejecting the PDU session establishment.

The 5GSM cause IE typically indicates one of the following SM cause values:

- #8 operator determined barring;
- #26 insufficient resources;
- #27 missing or unknown DNN;
- #28 unknown PDU session type;
- #29 user authentication or authorization failed;
- #31 request rejected, unspecified;
- #32 service option not supported;
- #33 requested service option not subscribed;
- #35 PTI already in use;
- #38 network failure;
- #46 out of LADN service area;
- #50 PDU session type IPv4 only allowed;
- #51 PDU session type IPv6 only allowed;
- #54 PDU session does not exist;
- #67 insufficient resources for specific slice and DNN;
- #68 not supported SSC mode;
- #69 insufficient resources for specific slice;
- #70 missing or unknown DNN in a slice;
- #82 maximum data rate per UE for user-plane integrity protection is too low; or
- #95 – 111 protocol errors.

If the PDU SESSION ESTABLISHMENT REQUEST message includes a PDU session type IE set to "IPv6", and the subscription, the SMF configuration, or both, are limited to IPv4 only for the requested DNN, the SMF shall include the 5GSM cause value #50 "PDU session type IPv4 only allowed" in the 5GSM cause IE of the PDU SESSION ESTABLISHMENT REJECT message.

If the PDU SESSION ESTABLISHMENT REQUEST message includes a PDU session type IE set to "IPv6", and the subscription, the SMF configuration, or both, support none of "IPv4" and "IPv6" PDU session types for the requested DNN, the SMF shall include the 5GSM cause value #28 "unknown PDU session type" in the 5GSM cause IE of the PDU SESSION ESTABLISHMENT REJECT message.

If the PDU SESSION ESTABLISHMENT REQUEST message includes a PDU session type IE set to "IPv4", and the subscription, the SMF configuration, or both, are limited to IPv6 only for the requested DNN, the SMF shall include the 5GSM cause value #51 "PDU session type IPv6 only allowed" in the 5GSM cause IE of the PDU SESSION ESTABLISHMENT REJECT message.

If the PDU SESSION ESTABLISHMENT REQUEST message includes a PDU session type IE set to "IPv4", and the subscription, the SMF configuration, or both, support none of "IPv4" and "IPv6" PDU session types for the requested DNN, the SMF shall include the 5GSM cause value #28 "unknown PDU session type" in the 5GSM cause IE of the PDU SESSION ESTABLISHMENT REJECT message.

If the PDU SESSION ESTABLISHMENT REQUEST message includes a PDU session type IE set to "IPv4v6", and the subscription, the SMF configuration, or both, support none of "IPv4v6", "IPv4" and "IPv6" PDU session types for the requested DNN, the SMF shall include the 5GSM cause value #28 "unknown PDU session type" in the 5GSM cause IE of the PDU SESSION ESTABLISHMENT REJECT message.

If the PDU SESSION ESTABLISHMENT REQUEST message includes a PDU session type IE set to "Unstructured" or "Ethernet", and the subscription, the SMF configuration, or both, do not support the PDU session type for the requested DNN, the SMF shall include the 5GSM cause value #28 "unknown PDU session type" in the 5GSM cause IE of the PDU SESSION ESTABLISHMENT REJECT message.

If the PDU SESSION ESTABLISHMENT REQUEST message contains the SSC mode IE indicating an SSC mode not supported by the subscription, the SMF configuration, or both of them, and the SMF decides to reject the PDU session establishment, the SMF shall include the 5GSM cause value #68 "not supported SSC mode" in the 5GSM cause IE and the SSC modes allowed by SMF in the Allowed SSC mode IE of the PDU SESSION ESTABLISHMENT REJECT message.

In 3GPP access, if the operator's configuration requires user-plane integrity protection for the PDU session and, the maximum data rate per UE for user-plane integrity protection supported by the UE for uplink or the maximum data rate per UE for user-plane integrity protection supported by the UE for downlink, or both, are lower than required by the operator's configuration, the SMF shall include the 5GSM cause value #82 "maximum data rate per UE for user-plane integrity protection is too low" in the 5GSM cause IE of the PDU SESSION ESTABLISHMENT REJECT message.

If the UE requests a PDU session establishment for an LADN when the UE is located outside of the LADN service area, the SMF shall include the 5GSM cause value #46 "out of LADN service area" in the 5GSM cause IE of the PDU SESSION ESTABLISHMENT REJECT message.

If the DN authentication of the UE was performed and completed unsuccessfully, the SMF shall include the 5GSM cause value #29 "user authentication or authorization failed" in the 5GSM cause IE of the PDU SESSION ESTABLISHMENT REJECT message and shall set the EAP message IE of the PDU SESSION ESTABLISHMENT REJECT message to an EAP-failure message as specified in IETF RFC 3748 [34], provided by the DN.

The SMF may include a Back-off timer value IE in the PDU SESSION ESTABLISHMENT REJECT message when the 5GSM cause value #26 "insufficient resources" is included in the PDU SESSION ESTABLISHMENT REJECT message. If the 5GSM cause value is #26 "insufficient resources" and the PDU SESSION ESTABLISHMENT REQUEST message was received from a UE configured for high priority access in selected PLMN or the request type is set to "initial emergency request" or "existing emergency PDU session", the network shall not include a Back-off timer value IE.

The SMF may include a Back-off timer value IE in the PDU SESSION ESTABLISHMENT REJECT message when the 5GSM cause value #67 "insufficient resources for specific slice and DNN" is included in the PDU SESSION ESTABLISHMENT REJECT message. If the 5GSM cause value is #67 "insufficient resources for specific slice and DNN" and the PDU SESSION ESTABLISHMENT REQUEST message was received from a UE configured for high priority access in selected PLMN or the request type is "initial emergency request" or "existing emergency PDU session", the network shall not include a Back-off timer value IE.

The SMF may include a Back-off timer value IE in the PDU SESSION ESTABLISHMENT REJECT message when the 5GSM cause #69 "insufficient resources for specific slice" is included in the PDU SESSION ESTABLISHMENT REJECT message. If the 5GSM cause value is #69 "insufficient resources for specific slice" and the PDU SESSION ESTABLISHMENT REQUEST message was received from a UE configured for high priority access in selected PLMN or the request type is "initial emergency request" or "existing emergency PDU session", the network shall not include a Back-off timer value IE.

If the PDU session cannot be established due to resource unavailability in the UPF, the SMF shall include the 5GSM cause value #26 "insufficient resources" in the 5GSM cause IE of the PDU SESSION ESTABLISHMENT REJECT message.

The SMF shall send the SM PDU SESSION ESTABLISHMENT REJECT message.

Upon receipt of a PDU SESSION ESTABLISHMENT REJECT message and a PDU session ID, using the NAS transport procedure as specified in subclause 5.4.5, the UE shall stop timer T3580 shall release the allocated PTI value and shall consider that the PDU session was not established.

If the PDU SESSION ESTABLISHMENT REQUEST message was sent with request type set to "initial emergency request" or "existing emergency PDU session" and the UE receives a PDU SESSION ESTABLISHMENT REJECT message, then the UE may:

- a) inform the upper layers of the failure of the procedure; or

NOTE 1: This can result in the upper layers requesting another emergency call attempt using domain selection as specified in 3GPP TS 23.167 [6].

- b) de-register locally, if not de-registered already, attempt initial registration for emergency services.

If:

- the 5GSM cause value #26 "insufficient resources" and the Back-off timer value IE are included in the PDU SESSION ESTABLISHMENT REJECT message; or
- an indication that the 5GSM message was not forwarded due to DNN based congestion control is received along a Back-off timer value and a PDU SESSION ESTABLISHMENT REQUEST message with the PDU session ID IE set to the PDU session ID of the PDU session;

the UE shall ignore the 5GSM congestion re-attempt indicator IE provided by the network, if any, and the UE shall take different actions depending on the timer value received for timer T3396 in the Back-off timer value IE (if the UE is a UE configured for high priority access in selected PLMN, exceptions are specified in subclause 6.2.7):

- a) If the timer value indicates neither zero nor deactivated and a DNN was provided during the PDU session establishment, the UE shall stop timer T3396 associated with the corresponding DNN, if it is running. If the timer value indicates neither zero nor deactivated and no DNN was provided during the PDU session establishment and the request type was different from "initial emergency request" and different from "existing emergency PDU session", the UE shall stop timer T3396 associated with no DNN if it is running. The UE shall then start timer T3396 with the value provided in the Back-off timer value IE and:
  - 1) shall not send another PDU SESSION ESTABLISHMENT REQUEST message or PDU SESSION MODIFICATION REQUEST message with exception of those identified in subclause 6.4.2.1, for the same DNN that was sent by the UE, until timer T3396 expires or timer T3396 is stopped; and
  - 2) shall not send another PDU SESSION ESTABLISHMENT REQUEST message without a DNN and with request type different from "initial emergency request" and different from "existing emergency PDU session", or another PDU SESSION MODIFICATION REQUEST message with exception of those identified in subclause 6.4.2.1, for a non-emergency PDU session established without a DNN provided by the UE, if no DNN was provided during the PDU session establishment and the request type was different from "initial emergency request" and different from "existing emergency PDU session", until timer T3396 expires or timer T3396 is stopped.

The UE shall not stop timer T3396 upon a PLMN change or inter-system change;

- b) if the timer value indicates that this timer is deactivated and a DNN was provided during the PDU session establishment, the UE shall stop timer T3396 associated with the corresponding DNN, if it is running. If the timer value indicates that this timer is deactivated and no DNN was provided during the PDU session establishment and the request type was different from "initial emergency request" and different from "existing emergency PDU session", the UE shall stop timer T3396 associated with no DNN if it is running. The UE:
  - 1) shall not send another PDU SESSION ESTABLISHMENT REQUEST message or PDU SESSION MODIFICATION REQUEST message with exception of those identified in subclause 6.4.2.1, for the same DNN until the UE is switched off or the USIM is removed, or the UE receives a PDU SESSION MODIFICATION COMMAND message for the same DNN from the network or a PDU SESSION RELEASE COMMAND message including 5GSM cause #39 "reactivation requested" for the same DNN from the network; and
  - 2) shall not send another PDU SESSION ESTABLISHMENT REQUEST message without a DNN and with request type different from "initial emergency request" and different from "existing emergency PDU session", or another PDU SESSION MODIFICATION REQUEST message with exception of those



identified in subclause 6.4.2.1, for a non-emergency PDU session established without a DNN provided by the UE, if no DNN was provided during the PDU session establishment and the request type was different from "initial emergency request" and different from "existing emergency PDU session", until the UE is switched off or the USIM is removed, or the UE receives a PDU SESSION MODIFICATION COMMAND message for a non-emergency PDU session established without a DNN provided by the UE, or a PDU SESSION RELEASE COMMAND messages including 5GSM cause IE set to 5GSM cause #39 "reactivation requested" for a non-emergency PDU session established without a DNN provided by the UE.

The timer T3396 remains deactivated upon a PLMN change or inter-system change; and

c) if the timer value indicates zero, the UE:

- 1) shall stop timer T3396 associated with the corresponding DNN, if running, and may send another PDU SESSION ESTABLISHMENT REQUEST message or PDU SESSION MODIFICATION REQUEST message for the same DNN; and
- 2) if no DNN was provided during the PDU session establishment and the request type was different from "initial emergency request" and different from "existing emergency PDU session", the UE shall stop timer T3396 associated with no DNN, if running, and may send another PDU SESSION ESTABLISHMENT REQUEST message without a DNN, or another PDU SESSION MODIFICATION REQUEST message without a DNN provided by the UE.

If the Back-off timer value IE is not included or no Back-off timer value is received from the 5GMM sublayer, then the UE may send another PDU SESSION ESTABLISHMENT REQUEST message or PDU SESSION MODIFICATION REQUEST message for the same DNN or without a DNN.

When the timer T3396 is running or the timer is deactivated, the UE is allowed to initiate a PDU session establishment procedure for emergency services.

If the timer T3396 is running when the UE enters state 5GMM-DEREGISTERED, the UE remains switched on, and the USIM in the UE remains the same, then timer T3396 is kept running until it expires or it is stopped.

If the UE is switched off when the timer T3396 is running, and if the USIM in the UE remains the same when the UE is switched on, the UE shall behave as follows:

- let  $t_1$  be the time remaining for T3396 timeout at switch off and let  $t$  be the time elapsed between switch off and switch on. If  $t_1$  is greater than  $t$ , then the timer shall be restarted with the value  $t_1 - t$ . If  $t_1$  is equal to or less than  $t$ , then the timer need not be restarted. If the UE is not capable of determining  $t$ , then the UE shall restart the timer with the value  $t_1$ .

If:

- the 5GSM cause value #67 "insufficient resources for specific slice and DNN" and the Back-off timer value IE are included in the PDU SESSION ESTABLISHMENT REJECT message; or
- an indication that the 5GSM message was not forwarded due to S-NSSAI and DNN based congestion control is received along a Back-off timer value and a PDU SESSION ESTABLISHMENT REQUEST message with the PDU session ID IE set to the PDU session ID of the PDU session;

the UE shall take different actions depending on the timer value received for timer T3584 in the Back-off timer value IE (if the UE is a UE configured for high priority access in selected PLMN, exceptions are specified in subclause 6.2.8):

- a) If the timer value indicates neither zero nor deactivated, the UE shall stop timer T3584 associated with the same [S-NSSAI, DNN] combination as that the UE provided during the PDU session establishment, if it is running. If the timer value indicates neither zero nor deactivated and no DNN was provided during the PDU session establishment and the request type was different from "initial emergency request" and different from "existing emergency PDU session", the UE shall stop timer T3584 associated with [S-NSSAI, no DNN] combination as that the UE provided during the PDU session establishment, if it is running. If the timer value indicates neither zero nor deactivated and no S-NSSAI was provided during the PDU session establishment, the UE shall stop timer T3584 associated with [no S-NSSAI, DNN] combination as that the UE provided during the PDU session establishment, if it is running. If the timer value indicates neither zero nor deactivated and neither S-NSSAI nor DNN was provided during the PDU session establishment and the request type was different from "initial emergency request" and different from "existing emergency PDU session", the UE shall stop timer T3584 associated with [no S-NSSAI, no DNN] combination as that the UE provided during the PDU session

establishment, if it is running. The UE shall then start timer T3584 with the value provided in the Back-off timer value IE and:

- 1) shall not send another PDU SESSION ESTABLISHMENT REQUEST message, or PDU SESSION MODIFICATION REQUEST message with exception of those identified in subclause 6.4.2.1, for the same [S-NSSAI, DNN] combination that was sent by the UE, until timer T3584 expires or timer T3584 is stopped;
- 2) shall not send another PDU SESSION ESTABLISHMENT REQUEST message with request type different from "initial emergency request" and different from "existing emergency PDU session", or another PDU SESSION MODIFICATION REQUEST message with exception of those identified in subclause 6.4.2.1, message for the same [S-NSSAI, no DNN] combination that was sent by the UE, if no DNN was provided during the PDU session establishment, until timer T3584 expires or timer T3584 is stopped;
- 3) shall not send another PDU SESSION ESTABLISHMENT REQUEST message, or another PDU SESSION MODIFICATION REQUEST message with exception of those identified in subclause 6.4.2.1, for the same [no S-NSSAI, DNN] combination that was sent by the UE, if no S-NSSAI was provided during the PDU session establishment, until timer T3584 expires or timer T3584 is stopped; and
- 4) shall not send another PDU SESSION ESTABLISHMENT REQUEST message with request type different from "initial emergency request" and different from "existing emergency PDU session", or another PDU SESSION MODIFICATION REQUEST message with exception of those identified in subclause 6.4.2.1, for the same [no S-NSSAI, no DNN] combination that was sent by the UE, if neither S-NSSAI nor DNN was provided during the PDU session establishment, until timer T3584 expires or timer T3584 is stopped.

The UE shall not stop timer T3584 upon a PLMN change or inter-system change;

b) if the timer value indicates that this timer is deactivated, the UE:

- 1) shall stop timer T3584 associated with the same [S-NSSAI, DNN] combination as that the UE provided during the PDU session establishment, if it is running. The UE shall not send another PDU SESSION ESTABLISHMENT REQUEST message, or PDU SESSION MODIFICATION REQUEST message with exception of those identified in subclause 6.4.2.1, for the same [S-NSSAI, DNN] combination that was sent by the UE, until the UE is switched off or the USIM is removed, or the UE receives a PDU SESSION MODIFICATION COMMAND message for the same [S-NSSAI, DNN] combination from the network or a PDU SESSION RELEASE COMMAND message including 5GSM cause #39 "reactivation requested" for the same [S-NSSAI, DNN] combination from the network;
- 2) shall stop timer T3584 associated with the same [S-NSSAI, no DNN] combination as that the UE provided during the PDU session establishment, if it is running. The UE shall not send a PDU SESSION ESTABLISHMENT REQUEST message with request type different from "initial emergency request" and different from "existing emergency PDU session", or a PDU SESSION MODIFICATION REQUEST message with exception of those identified in subclause 6.4.2.1, for the same [S-NSSAI, no DNN] combination that was sent by the UE, if no DNN was provided during the PDU session establishment, until the UE is switched off or the USIM is removed, or the UE receives an PDU SESSION MODIFICATION COMMAND message for a non-emergency PDU session established for the same [S-NSSAI, no DNN] combination from the network or a PDU SESSION RELEASE COMMAND message including 5GSM cause #39 "reactivation requested" for a non-emergency PDU session established for the same [S-NSSAI, no DNN] combination from the network;
- 3) shall stop timer T3584 associated with the same [no S-NSSAI, DNN] combination as that the UE provided during the PDU session establishment, if it is running. The UE shall not send a PDU SESSION ESTABLISHMENT REQUEST message, or a PDU SESSION MODIFICATION REQUEST message with exception of those identified in subclause 6.4.2.1, for the same [no S-NSSAI, DNN] combination that was sent by the UE, if no S-NSSAI was provided during the PDU session establishment, until the UE is switched off or the USIM is removed, or the UE receives an PDU SESSION MODIFICATION COMMAND message for the same [no S-NSSAI, DNN] combination from the network or a PDU SESSION RELEASE COMMAND message including 5GSM cause #39 "reactivation requested" for the same [no S-NSSAI, DNN] combination from the network; and
- 4) shall stop timer T3584 associated with the same [no S-NSSAI, no DNN] combination as that the UE provided during the PDU session establishment, if it is running. The UE shall not send a PDU SESSION ESTABLISHMENT REQUEST message with request type different from "initial emergency request" and different from "existing emergency PDU session", or a PDU SESSION MODIFICATION REQUEST message with exception of those identified in subclause 6.4.2.1, for the same [no S-NSSAI, no DNN]

combination that was sent by the UE, if neither S-NSSAI nor DNN was provided during the PDU session establishment, until the UE is switched off or the USIM is removed, or the UE receives an PDU SESSION MODIFICATION COMMAND message for a non-emergency PDU session established for the same [no S-NSSAI, no DNN] combination from the network or a PDU SESSION RELEASE COMMAND message including 5GSM cause #39 "reactivation requested" for a non-emergency PDU session established for the same [no S-NSSAI, no DNN] combination from the network.

The timer T3584 remains deactivated upon a PLMN change or inter-system change; and

- c) if the timer value indicates zero, the UE:
- 1) shall stop timer T3584 associated with the same [S-NSSAI, DNN] combination as that the UE provided during the PDU session establishment, if it is running. The UE may send another PDU SESSION ESTABLISHMENT REQUEST message or PDU SESSION MODIFICATION REQUEST message for the same [S-NSSAI, DNN] combination;
  - 2) shall stop timer T3584 associated with the same [S-NSSAI, no DNN] combination as that the UE provided during the PDU session establishment, if it is running. The UE may send another PDU SESSION ESTABLISHMENT REQUEST message or PDU SESSION MODIFICATION REQUEST message for the same [S-NSSAI, no DNN] combination if no DNN was provided during the PDU session establishment and the request type was different from "initial emergency request" and different from "existing emergency PDU session";
  - 3) shall stop timer T3584 associated with the same [no S-NSSAI, DNN] combination as that the UE provided during the PDU session establishment, if it is running. The UE may send another PDU SESSION ESTABLISHMENT REQUEST message, or PDU SESSION MODIFICATION REQUEST message for the same [no S-NSSAI, DNN] combination if no NSSAI was provided during the PDU session establishment; and
  - 4) shall stop timer T3584 associated with the same [no S-NSSAI, no DNN] combination as that the UE provided during the PDU session establishment, if it is running. The UE may send another PDU SESSION ESTABLISHMENT REQUEST message, or PDU SESSION MODIFICATION REQUEST message for the same [no S-NSSAI, no DNN] combination if neither S-NSSAI nor DNN was provided during the PDU session establishment and the request type was different from "initial emergency request" and different from "existing emergency PDU session".

If the 5GSM congestion re-attempt indicator IE set to "The back-off timer is applied in all PLMNs" is included in the PDU SESSION ESTABLISHMENT REJECT message with the 5GSM cause value #67 "insufficient resources for specific slice and DNN", then the UE shall apply the timer T3584 for all the PLMNs. Otherwise, the UE shall apply the timer T3584 for the registered PLMN.

If the Back-off timer value IE is not included or no Back-off timer value is received from the 5GMM sublayer, then the UE may send another PDU SESSION ESTABLISHMENT REQUEST message or PDU SESSION MODIFICATION REQUEST message for the same [S-NSSAI, DNN] combination, or for the same [S-NSSAI, no DNN] combination, or for the same [no S-NSSAI, DNN] combination, or for the same [no S-NSSAI, no DNN] combination.

When the timer T3584 is running or the timer is deactivated, the UE is allowed to initiate a PDU session establishment procedure for emergency services.

If the timer T3584 is running when the UE enters state 5GMM-DEREGISTERED, the UE remains switched on, and the USIM in the UE remains the same, then timer T3584 is kept running until it expires or it is stopped.

If the UE is switched off when the timer T3584 is running, and if the USIM in the UE remains the same when the UE is switched on, the UE shall behave as follows:

- let  $t_1$  be the time remaining for T3584 timeout at switch off and let  $t$  be the time elapsed between switch off and switch on. If  $t_1$  is greater than  $t$ , then the timer shall be restarted with the value  $t_1 - t$ . If  $t_1$  is equal to or less than  $t$ , then the timer need not be restarted. If the UE is not capable of determining  $t$ , then the UE shall restart the timer with the value  $t_1$ .

If:

- the 5GSM cause value #69 "insufficient resources for specific slice" and the Back-off timer value IE are included in the PDU SESSION ESTABLISHMENT REJECT message; or

- an indication that the 5GSM message was not forwarded due to S-NSSAI only based congestion control is received along a Back-off timer value and a PDU SESSION ESTABLISHMENT REQUEST message with the PDU session ID IE set to the PDU session ID of the PDU session;

the UE shall take different actions depending on the timer value received for timer T3585 in the Back-off timer value IE (if the UE is a UE configured for high priority access in selected PLMN, exceptions are specified in subclause 6.2.8):

- a) If the timer value indicates neither zero nor deactivated and an S-NSSAI was provided during the PDU session establishment and the request type was different from "initial emergency request" and different from "existing emergency PDU session", the UE shall stop timer T3585 associated with the corresponding S-NSSAI, if it is running. If the timer value indicates neither zero nor deactivated and no S-NSSAI was provided during the PDU session establishment and the request type was different from "initial emergency request" and different from "existing emergency PDU session", the UE shall stop timer T3585 associated with no S-NSSAI if it is running. The UE shall then start timer T3585 with the value provided in the Back-off timer value IE and:
  - 1) shall not send another PDU SESSION ESTABLISHMENT REQUEST message with request type different from "initial emergency request" and different from "existing emergency PDU session", or another PDU SESSION MODIFICATION REQUEST message with exception of those identified in subclause 6.4.2.1, for a non-emergency PDU session for the same S-NSSAI that was sent by the UE, until timer T3585 expires or timer T3585 is stopped; and
  - 2) shall not send another PDU SESSION ESTABLISHMENT REQUEST message without an S-NSSAI and with request type different from "initial emergency request" and different from "existing emergency PDU session", or another PDU SESSION MODIFICATION REQUEST message with exception of those identified in subclause 6.4.2.1, for a non-emergency PDU session established without an S-NSSAI provided by the UE, if no S-NSSAI was provided during the PDU session establishment and the request type was different from "initial emergency request" and different from "existing emergency PDU session", until timer T3585 expires or timer T3585 is stopped.

The UE shall not stop timer T3585 upon a PLMN change or inter-system change;

- b) if the timer value indicates that this timer is deactivated and an S-NSSAI was provided during the PDU session establishment and the request type was different from "initial emergency request" and different from "existing emergency PDU session", the UE shall stop timer T3585 associated with the corresponding S-NSSAI, if it is running. If the timer value indicates that this timer is deactivated and no S-NSSAI was provided during the PDU session establishment and the request type was different from "initial emergency request" and different from "existing emergency PDU session", the UE shall stop timer T3585 associated with no S-NSSAI if it is running. The UE:
  - 1) shall not send another PDU SESSION ESTABLISHMENT REQUEST message with request type different from "initial emergency request" and different from "existing emergency PDU session", or another PDU SESSION MODIFICATION REQUEST with exception of those identified in subclause 6.4.2.1, for a non-emergency PDU session for the same S-NSSAI until the UE is switched off or the USIM is removed, or the UE receives a PDU SESSION MODIFICATION COMMAND message for a non-emergency PDU session for the same S-NSSAI from the network or a PDU SESSION RELEASE COMMAND message including 5GSM cause #39 "reactivation requested" for the same S-NSSAI from the network; and
  - 2) shall not send another PDU SESSION ESTABLISHMENT REQUEST message without an S-NSSAI and with request type different from "initial emergency request" and different from "existing emergency PDU session", or another PDU SESSION MODIFICATION REQUEST message with exception of those identified in subclause 6.4.2.1, for a non-emergency PDU session established without an S-NSSAI provided by the UE, if no S-NSSAI was provided during the PDU session establishment and the request type was different from "initial emergency request" and different from "existing emergency PDU session", until the UE is switched off or the USIM is removed, or the UE receives a PDU SESSION MODIFICATION COMMAND message for a non-emergency PDU session established without an S-NSSAI provided by the UE, or a PDU SESSION RELEASE COMMAND messages including 5GSM cause IE set to 5GSM cause #39 "reactivation requested" for a non-emergency PDU session established without an S-NSSAI provided by the UE.

The timer T3585 remains deactivated upon a PLMN change or inter-system change; and

- c) if the timer value indicates zero, the UE:

- 1) shall stop timer T3585 associated with the corresponding S-NSSAI, if running, and may send another PDU SESSION ESTABLISHMENT REQUEST message or PDU SESSION MODIFICATION REQUEST message for the same S-NSSAI; and
- 2) if no S-NSSAI was provided during the PDU session establishment and the request type was different from "initial emergency request " and different from "existing emergency PDU session", the UE shall stop timer T3585 associated with no S-NSSAI, if running, and may send another PDU SESSION ESTABLISHMENT REQUEST message without an S-NSSAI, or another PDU SESSION MODIFICATION REQUEST message without an S-NSSAI provided by the UE.

If the 5GSM congestion re-attempt indicator IE set to "The back-off timer is applied in all PLMNs" is included in the PDU SESSION ESTABLISHMENT REJECT message with the 5GSM cause value #69 "insufficient resources for specific slice", then the UE shall apply the timer T3585 for all the PLMNs. Otherwise, the UE shall apply the timer T3585 for the registered PLMN.

If the Back-off timer value IE is not included or no Back-off timer value is received from the 5GMM sublayer, then the UE may send another PDU SESSION ESTABLISHMENT REQUEST message or PDU SESSION MODIFICATION REQUEST message for the same S-NSSAI or without an S-NSSAI.

When the timer T3585 is running or the timer is deactivated, the UE is allowed to initiate a PDU session establishment procedure for emergency services.

If the timer T3585 is running when the UE enters state 5GMM-DEREGISTERED, the UE remains switched on, and the USIM in the UE remains the same, then timer T3585 is kept running until it expires or it is stopped.

If the UE is switched off when the timer T3585 is running, and if the USIM in the UE remains the same when the UE is switched on, the UE shall behave as follows:

let  $t_1$  be the time remaining for T3585 timeout at switch off and let  $t$  be the time elapsed between switch off and switch on. If  $t_1$  is greater than  $t$ , then the timer shall be restarted with the value  $t_1 - t$ . If  $t_1$  is equal to or less than  $t$ , then the timer need not be restarted. If the UE is not capable of determining  $t$ , then the UE shall restart the timer with the value  $t_1$ .

NOTE 2: As described in this subclause, upon PLMN change or inter-system change, the UE does not stop the timer T3584 or T3585. This means the timer T3584 or T3585 can still be running or be deactivated for the given 5GSM procedure, the PLMN, the S-NSSAI and optionally the DNN combination when the UE returns to the PLMN or when it performs inter-system change back from S1 mode to N1 mode. Thus the UE can still be prevented from sending another PDU SESSION ESTABLISHMENT REQUEST or PDU SESSION MODIFICATION REQUEST message in the PLMN for the same S-NSSAI and optionally the same DNN.

Upon PLMN change, if T3584 is running or is deactivated for an S-NSSAI, a DNN, and old PLMN, but T3584 is not running and is not deactivated for the S-NSSAI, the DNN, and new PLMN, then the UE is allowed to send a PDU SESSION ESTABLISHMENT REQUEST message for the same S-NSSAI and the same DNN in the new PLMN.

Upon PLMN change, if T3585 is running or is deactivated for an S-NSSAI and old PLMN, but T3585 is not running and is not deactivated for the S-NSSAI and new PLMN, then the UE is allowed to send a PDU SESSION ESTABLISHMENT REQUEST message for the same S-NSSAI in the new PLMN.

If the 5GSM cause value is #27 "missing or unknown DNN", the UE shall not send another PDU SESSION ESTABLISHMENT REQUEST message in the PLMN for the same DNN that was sent by the UE, until the UE is switched off, the USIM is removed, or the DNN is included in the LADN information and the network updates the LADN information during the registration procedure or the generic UE configuration update procedure.

If the 5GSM cause value is #28 "unknown PDU session type" and the PDU SESSION ESTABLISHMENT REQUEST message contained a PDU session type IE indicating a PDU session type, the UE may send another PDU SESSION ESTABLISHMENT REQUEST with the PDU session type IE indicating another PDU session type or without the PDU session type IE.

If the 5GSM cause value is #50 "PDU session type IPv4 only allowed" or #51 "PDU session type IPv6 only allowed", the UE shall not subsequently initiate another UE requested PDU session establishment procedure to the same DNN (or no DNN, if no DNN was indicated by the UE) and the same S-NSSAI associated with (if available in roaming scenarios) a mapped S-NSSAI (or no S-NSSAI, if no S-NSSAI was indicated by the UE) using the same PDU session type until any of the following conditions is fulfilled:

- a) the UE is registered to a new PLMN which was not in the list of equivalent PLMNs at the time when the PDU SESSION ESTABLISHMENT REJECT message was received;
- b) the PDU session type which is used to access to the DNN (or no DNN, if no DNN was indicated by the UE) and the S-NSSAI (or no S-NSSAI, if no S-NSSAI was indicated by the UE) are changed by the UE which subsequently requests another PDU session type;
- c) the UE is switched off; or
- d) the USIM is removed.

In this case, the UE is not prohibited from initiating a UE requested PDN connectivity procedure to the same DNN (or no DNN, if no DNN was indicated by the UE) in S1 mode.

If the 5GSM cause value is #54 "PDU session does not exist", the UE may initiate another UE requested PDU session establishment procedure with the request type set to "initial request" in the subsequent PDU SESSION ESTABLISHMENT REQUEST message to establish a PDU session with the same DNN (or no DNN, if no DNN was indicated by the UE) and the same S-NSSAI associated with (if available in roaming scenarios) a mapped S-NSSAI (or no S-NSSAI, if no S-NSSAI was indicated by the UE).

NOTE 3: User interaction is necessary in some cases when the UE cannot re-establish the PDU session(s) automatically.

If the 5GSM cause value is #68 "not supported SSC mode", UE may send PDU SESSION ESTABLISHMENT REQUEST with the SSC mode included in the Allowed SSC mode IE of the PDU SESSION ESTABLISHMENT REJECT message or evaluate other URSP rules if available as specified in 3GPP TS 24.526 [19].

If the 5GSM cause value is #70 "missing or unknown DNN in a slice", the UE shall not send another PDU SESSION ESTABLISHMENT REQUEST message in the PLMN for the same DNN and the same S-NSSAI associated with (if available in roaming scenarios) a mapped S-NSSAI that were sent by the UE, or for the same DNN and no S-NSSAI if S-NSSAI was not sent by the UE, until the UE is switched off, the USIM is removed, or the DNN is included in the LADN information and the network updates the LADN information during the registration procedure or the generic UE configuration update procedure.

Upon receiving an indication that the 5GSM message was not forwarded due to the DNN is not supported in a slice along with a PDU SESSION ESTABLISHMENT REQUEST message with the PDU session ID IE set to the PDU session ID of the PDU session, the UE:

- a) shall stop timer T3580;
- b) shall abort the procedure; and
- c) shall not send another PDU SESSION ESTABLISHMENT REQUEST message in the PLMN for the same DNN and the same S-NSSAI that were sent by the UE, or for the same DNN and no S-NSSAI if S-NSSAI that was not sent by the UE, until:
  - 1) the UE is switched off,
  - 2) the USIM is removed, or
  - 3) the DNN is included in the LADN information and the network updates the LADN information during the registration procedure or the generic UE configuration update procedure.

If the 5GSM cause value is #46 "out of LADN service area", the UE shall not send another PDU SESSION ESTABLISHMENT REQUEST message for the LADN DNN provided by the UE during the PDU session establishment procedure until the LADN information for the specific LADN DNN is updated as described in subclause 5.4.4 and subclause 5.5.1.

#### 6.4.1.5 Handling the maximum number of established PDU sessions

The maximum number of PDU sessions which a UE can establish in a PLMN is limited by whichever is the lowest of: the maximum number of PDU session IDs allowed by the protocol (as specified in 3GPP TS 24.007 [11] subclause 11.2.3.1b), the PLMN's maximum number of PDU sessions and the UE's implementation-specific maximum number of PDU sessions.

If during a UE-requested PDU session establishment procedure the 5GSM sublayer in the UE receives an indication that the 5GSM message was not forwarded because the PLMN's maximum number of PDU sessions has been reached, then the UE determines the PLMN's maximum number of PDU sessions as the number of active PDU sessions it has.

NOTE 1: In some situations, when attempting to establish multiple PDU sessions, the number of active PDU sessions that the UE has when 5GMM cause #65 is received is not equal to the maximum number of PDU sessions reached in the network.

NOTE 2: When the network supports emergency services, it is not expected that 5GSM cause #65 is returned by the network when the UE requests an emergency PDU session.

NOTE 3: There is only one maximum number of PDU sessions for a PLMN regardless of which access the PDU session exists in.

The PLMN's maximum number of PDU sessions applies to the PLMN in which the 5GMM cause #65 "maximum number of PDU sessions reached" is received. When the UE is switched off or when the USIM is removed, the UE shall clear all previous determinations representing PLMN's maximum number of PDU sessions. Upon successful registration with a new PLMN, the UE may clear previous determinations representing any PLMN's maximum number(s) of PDU sessions.

If the maximum number of established PDU sessions is reached at the UE and the upper layers of the UE request connectivity to a DNN the UE shall not send a PDU SESSION ESTABLISHMENT message unless an established PDU session is released. If the UE needs to release an established PDU session, choosing which PDU session to release is implementation specific, however the UE shall not release the emergency PDU session.

If the UE needs to release a PDU session in order to request an emergency PDU session, it shall either perform a local release of a PDU session or release a PDU session via explicit signalling. If the UE performs a local release, the UE shall perform a registration procedure for mobility and periodic registration update to indicate PDU session status to the network.

#### 6.4.1.6 Abnormal cases in the UE

The following abnormal cases can be identified:

a) Expiry of timer T3580

The UE shall, on the first expiry of the timer T3580, retransmit the PDU SESSION ESTABLISHMENT REQUEST message and the PDU session information which was transported together with the initial transmission of the PDU SESSION ESTABLISHMENT REQUEST message and shall reset and start timer T3580, if still needed. This retransmission can be repeated up to four times, i.e. on the fifth expiry of timer T3580, the UE shall abort the procedure, release the allocated PTI and enter the state PROCEDURE TRANSACTION INACTIVE.

b) Upon receiving an indication that the 5GSM message was not forwarded due to routing failure along with a PDU SESSION ESTABLISHMENT REQUEST message with the PDU session ID IE set to the PDU session ID of the PDU session, the UE shall stop timer T3580 and shall abort the procedure. If the UE sent the PDU SESSION ESTABLISHMENT REQUEST message in order for the handover of an existing non-emergency PDU session between 3GPP access and non-3GPP access, the UE shall consider that the PDU session is associated with the source access type.

c) Collision of UE-requested PDU session establishment procedure and network-requested PDU session release procedure.

If the UE receives a PDU SESSION RELEASE COMMAND message after sending a PDU SESSION ESTABLISHMENT REQUEST message to the network, and the PDU session ID in the PDU SESSION RELEASE COMMAND message is the same as the PDU session ID in the PDU SESSION ESTABLISHMENT REQUEST message, the UE shall ignore the PDU SESSION RELEASE COMMAND message and proceed with the UE-requested PDU session establishment procedure.

#### 6.4.1.7 Abnormal cases on the network side

The following abnormal cases can be identified:

- a) If the received request type is "initial emergency request" and there is already another emergency PDU session for the UE, the SMF shall reject the PDU SESSION ESTABLISHMENT REQUEST message with 5GSM cause #31 "request rejected, unspecified" or release locally the existing emergency PDU session and proceed the new PDU SESSION ESTABLISHMENT REQUEST message
- b) The information for the PDU session authentication and authorization by the external DN in PDU DN request container is not compliant with local policy and user's subscription data

If the PDU session being established is a non-emergency PDU session, the PDU session authentication and authorization by the external DN is required due to local policy and user's subscription data and the information for the PDU session authentication and authorization by the external DN in PDU DN request container is not compliant with local policy and user's subscription data, the SMF shall reject the PDU session establishment request including the 5GSM cause #29 "user authentication or authorization failed", in the PDU SESSION ESTABLISHMENT REJECT message.

- c) UE-requested PDU session establishment with request type set to "initial request" or "initial emergency request" for an existing PDU session:

If the SMF receives a PDU SESSION ESTABLISHMENT REQUEST message with a PDU session ID identical to the PDU session ID of an existing PDU session and with request type set to "initial request" or "initial emergency request", the SMF shall release locally the existing PDU session and proceed with the PDU session establishment procedure.

- d) UE-requested PDU session establishment with request type "existing PDU session" or "existing emergency PDU session" for a PDU session that does not exist:

If the SMF receives a PDU SESSION ESTABLISHMENT REQUEST message with request type set to "existing PDU session" or "existing emergency PDU session", and the SMF does not have any information about that PDU session, then the SMF shall reject the PDU session establishment procedure with the 5GSM cause set to #54 "PDU session does not exist" in the PDU SESSION ESTABLISHMENT REJECT message.

- e) 5G access network cannot forward the message:

If the SMF determines based on content of the n2SmInfo attribute specified in 3GPP TS 29.502 [20A] that the DL NAS TRANSPORT message carrying the PDU SESSION ESTABLISHMENT ACCEPT was not forwarded to the UE by the 5G access network, then the SMF shall reject the PDU session establishment procedure with the 5GSM cause set to #26 "insufficient resources" in the PDU SESSION ESTABLISHMENT REJECT message.

## 6.4.2 UE-requested PDU session modification procedure

### 6.4.2.1 General

The purpose of the UE-requested PDU session modification procedure is:

- a) to enable the UE to request modification of a PDU session;
- b) to indicate a change of 3GPP PS data off UE status for a PDU session;
- c) to revoke the previously indicated support for reflective QoS;
- d) to request specific QoS handling and segregation of service data flows;
- e) to indicate to the network the relevant 5GSM parameters and capabilities (e.g. the UE's 5GSM capabilities, whether the UE supports more than 16 packet filters, the maximum data rate per UE for user-plane integrity protection supported by the UE for uplink, the maximum data rate per UE for user-plane integrity protection supported by the UE for downlink and whether the UE requests the PDU session to be an always-on PDU session in the 5GS) for a PDN connection established when in S1 mode, after the first inter-system change from S1 mode to N1 mode, if the UE is operating in single-registration mode in the network supporting N26 interface; or
- f) to delete one or more mapped EPS bearer contexts.

When the UE-requested PDU session modification procedure is used to indicate a change of 3GPP PS data off UE status for a PDU session (see subclause 6.2.10), the UE shall initiate the UE-requested PDU session modification



procedure even if the UE is outside the LADN service area or the timer T3396, T3584, or T3585 is running or is deactivated.

If the UE needs to revoke the previously indicated support for reflective QoS for a PDU session and timer T3396, T3584, or T3585 is running or is deactivated, the UE shall not initiate the UE-requested PDU session modification procedure and shall instead initiate the UE-requested PDU session release procedure.

If the UE needs to initiate the UE-requested PDU session modification procedure to indicate to the network the relevant 5GSM parameters and capabilities (e.g. the UE's 5GSM capabilities, whether the UE supports more than 16 packet filters, the maximum data rate per UE for user-plane integrity protection supported by the UE for uplink, the maximum data rate per UE for user-plane integrity protection supported by the UE for downlink and whether the UE requests the PDU session to be an always-on PDU session in the 5GS) for a PDN connection established when in S1 mode, after the first inter-system change from S1 mode to N1 mode, the UE is operating in single-registration mode in the network supporting N26 interface and timer T3396 is running, the UE shall initiate the UE-requested PDU session modification procedure after expiry of timer T3396.

#### 6.4.2.2 UE-requested PDU session modification procedure initiation

In order to initiate the UE-requested PDU session modification procedure, the UE shall create a PDU SESSION MODIFICATION REQUEST message.

The UE shall allocate a PTI value currently not used and shall set the PTI IE of the PDU SESSION MODIFICATION REQUEST message to the allocated PTI value.

The UE shall not perform the UE-requested PDU session modification procedure for an emergency PDU session except for the error cases described in subclause 6.4.1.3.

The UE shall not perform the UE-requested PDU session modification procedure for a PDU session for LADN when the UE is located outside the LADN service area except for indicating a change of 3GPP PS data off UE status.

If the UE requests a specific QoS handling, the UE shall include the requested QoS rules IE indicating requested QoS rules or the requested QoS flow descriptions IE indicating requested QoS flow descriptions or both for the specific QoS handling. The QoS rules IE includes the packet filters which describe the service data flows requested by the UE. The specific QoS parameters requested by the UE is specified in the QoS flow descriptions IE. If the UE requests the network to bind specific service data flows to a dedicated QoS flow, the UE shall create a new QoS rule by setting the rule operation code to "Create new QoS rule" and shall set the segregation bit to "Segregation requested" for the corresponding QoS rule in the QoS rules IE. The UE shall set the QRI values to "no QoS rule identifier assigned" in the requested QoS rules IE, if the QoS rules are newly created; otherwise, the UE shall set the QRI values to those of the existing QoS rules for which the specific QoS handling applies. The UE shall set the QFI values to "no QoS flow identifier assigned" in the requested QoS flow descriptions IE, if the QoS flow descriptions are newly created; otherwise, the UE shall set the QFI values to the QFIs of the existing QoS flow descriptions for which the specific QoS handling applies. The UE shall not request to create more than one QoS flow in a UE-requested PDU session modification procedure.

For a PDN connection established when in S1 mode, after the first inter-system change from S1 mode to N1 mode, if the UE is operating in single-registration mode in the network supporting N26 interface, the PDU session is of "IPv4", "IPv6", "IPv4v6", or "Ethernet" PDU session type, and:

- a) the UE is performing the PDU session modification procedure to indicate the support of reflective QoS, the UE shall set the RQoS bit to "Reflective QoS supported" in the 5GSM capability IE of the PDU SESSION MODIFICATION REQUEST message; or
- b) the UE is performing the PDU session modification procedure to indicate that reflective QoS is not supported, the UE shall set the RQoS bit to "Reflective QoS not supported" in the 5GSM capability IE of the PDU SESSION MODIFICATION REQUEST message.

If the UE is performing the PDU session modification procedure to revoke the previously indicated support of reflective QoS, the UE shall set the RQoS bit to "Reflective QoS not supported" in the 5GSM capability IE of the PDU SESSION MODIFICATION REQUEST message. The UE shall not indicate support for reflective QoS for this PDU Session for the remaining lifetime of the PDU Session.

NOTE: The determination to revoke the usage of reflective QoS by the UE for a PDU session is implementation dependent.

For a PDN connection established when in S1 mode, after the first inter-system change from S1 mode to N1 mode, if the UE is operating in single-registration mode in the network supporting N26 interface, the PDU session is of "IPv6" or "IPv4v6" PDU session type, and:

- a) the UE is performing the PDU session modification procedure to indicate the support of Multi-homed IPv6 PDU session, the UE shall set the MH6-PDU bit to "Multi-homed IPv6 PDU session supported" in the 5GSM capability IE of the PDU SESSION MODIFICATION REQUEST message; or
- b) the UE is performing the PDU session modification procedure to indicate that Multi-homed IPv6 PDU session is not supported, the UE shall set the MH6-PDU bit to "Multi-homed IPv6 PDU session not supported" in the 5GSM capability IE of the PDU SESSION MODIFICATION REQUEST message.

For a PDN connection established when in S1 mode, after the first inter-system change from S1 mode to N1 mode, if the UE is operating in single-registration mode in the network supporting N26 interface, the PDU session is of "IPv4", "IPv6", "IPv4v6", or "Ethernet" PDU session type, and the UE supports more than 16 packet filters for this PDU session, the UE shall indicate the maximum number of packet filters supported for the PDU session in the Maximum number of supported packet filters IE of the PDU SESSION MODIFICATION REQUEST message.

For a PDN connection established when in S1 mode, after the first inter-system change from S1 mode to N1 mode, if the UE is operating in single-registration mode in the network supporting N26 interface, the UE shall include the Integrity protection maximum data rate IE in the PDU SESSION MODIFICATION REQUEST message.

If the UE is performing the PDU session modification procedure to request the deletion of a non-default QoS rule due to errors in QoS operations or packet filters, the UE shall include the 5GSM cause IE in the PDU SESSION MODIFICATION REQUEST message as described in subclause 6.4.1.3.

When the UE-requested PDU session modification procedure is used to indicate a change of 3GPP PS data off UE status for a PDU session, the UE shall include the extended protocol configuration options IE in the PDU SESSION MODIFICATION REQUEST message and setting the 3GPP PS data off UE status.

For a PDN connection established when in S1 mode, after the first inter-system change from S1 mode to N1 mode, if the UE is operating in single-registration mode in the network supporting N26 interface and the UE requests the PDU session to be an always-on PDU session in the 5GS, the UE shall include the Always-on PDU session requested IE and set the value of the IE to "Always-on PDU session requested" in the PDU SESSION MODIFICATION REQUEST message.

The UE shall transport:

- a) the PDU SESSION MODIFICATION REQUEST message;
- b) the PDU session ID; and
- c) if the UE-requested PDU session modification:
  - 1) is not initiated to indicate a change of 3GPP PS data off UE status associated to a PDU session, then the request type set to "modification request"; and
  - 2) is initiated to indicate a change of 3GPP PS data off UE status associated to a PDU session, then without transporting the request type;

using the NAS transport procedure as specified in subclause 5.4.5, and the UE shall start timer T3581 (see example in figure 6.4.2.2.1).

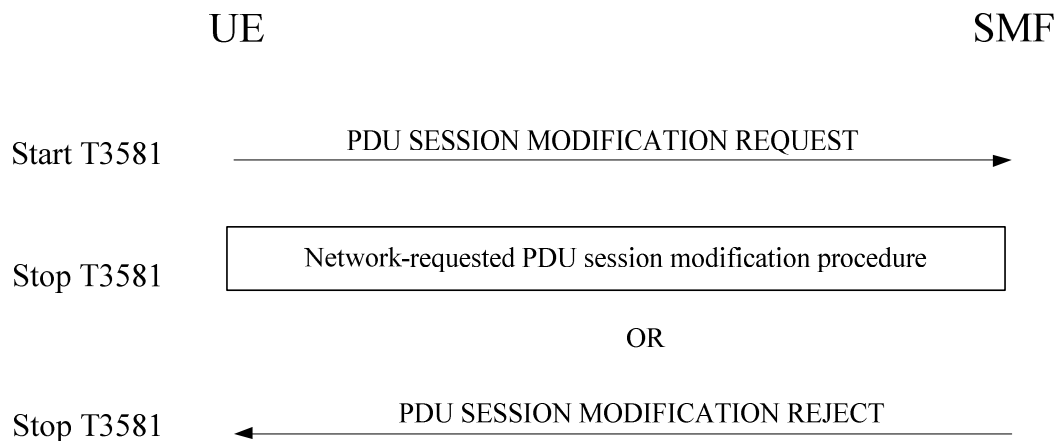

**Figure 6.4.2.2.1: UE-requested PDU session modification procedure**

#### 6.4.2.3 UE-requested PDU session modification procedure accepted by the network

Upon receipt of a PDU SESSION MODIFICATION REQUEST message, if the SMF accepts the request to modify the PDU session, the SMF shall perform the network-requested PDU session modification procedure as specified in subclause 6.3.2.

#### 6.4.2.4 UE-requested PDU session modification procedure not accepted by the network

Upon receipt of a PDU SESSION MODIFICATION REQUEST message, if the SMF does not accept the request to modify the PDU session, the SMF shall create a PDU SESSION MODIFICATION REJECT message.

The SMF shall set the 5GSM cause IE of the PDU SESSION MODIFICATION REJECT message to indicate the reason for rejecting the PDU session modification.

The 5GSM cause IE typically indicates one of the following SM cause values:

- #26 insufficient resources;
- #29 user authentication or authorization failed;
- #31 request rejected, unspecified;
- #32 service option not supported;
- #33 requested service option not subscribed;
- #35 PTI already in use;
- #43 Invalid PDU session identity;
- #46 out of LADN service area;
- #67 insufficient resources for specific slice and DNN;
- #69 insufficient resources for specific slice; or
- #95 – 111 protocol errors.

If the UE requests a PDU session modification for an LADN when the UE is located outside of the LADN service area, the SMF shall include the 5GSM cause value #46 "out of LADN service area" in the 5GSM cause IE of the PDU SESSION MODIFICATION REJECT message.

If the Extended protocol configuration options IE of the PDU SESSION MODIFICATION REQUEST message indicates 3GPP PS data off UE status and the SMF detects the change of the 3GPP PS data off UE status, the SMF shall not include the 5GSM cause value #26 "insufficient resources", the 5GSM cause value #67 "insufficient resources for specific slice and DNN", the 5GSM cause value #69 "insufficient resources for specific slice" and the 5GSM cause value #46 "out of LADN service area" in the 5GSM cause IE of the PDU SESSION MODIFICATION REJECT message.

The SMF may include a Back-off timer value IE in the PDU SESSION MODIFICATION REJECT message when the 5GSM cause value #26 "insufficient resources" is included in the PDU SESSION MODIFICATION REJECT message. If the 5GSM cause value is #26 "insufficient resources" and the PDU SESSION MODIFICATION REQUEST message was received from a UE configured for high priority access in selected PLMN or the request type was set to "initial emergency request" or "existing emergency PDU session" for the establishment of the PDU session, the network shall not include a Back-off timer value IE.

The SMF may include a Back-off timer value IE in the PDU SESSION MODIFICATION REJECT message when the 5GSM cause value #67 "insufficient resources for specific slice and DNN" is included in the PDU SESSION MODIFICATION REJECT message. If the 5GSM cause value is #67 "insufficient resources for specific slice and DNN" and the PDU SESSION MODIFICATION REQUEST message was received from a UE configured for high priority access in selected PLMN or the request type was set to "initial emergency request" or "existing emergency PDU session" for the establishment of the PDU session, the network shall not include a Back-off timer value IE.

The SMF may include a Back-off timer value IE in the PDU SESSION MODIFICATION REJECT message when the 5GSM cause #69 "insufficient resources for specific slice" is included in the PDU SESSION MODIFICATION REJECT message. If the 5GSM cause value is #69 "insufficient resources for specific slice" and the PDU SESSION MODIFICATION REQUEST message was received from a UE configured for high priority access in selected PLMN or the request type is set to "initial emergency request" for the establishment of the PDU session, the network shall not include a Back-off timer value IE.

The SMF shall send the PDU SESSION MODIFICATION REJECT message.

Upon receipt of a PDU SESSION MODIFICATION REJECT message and a PDU session ID, using the NAS transport procedure as specified in subclause 5.4.5, the UE shall stop timer T3581, release the allocated PTI value, and enter the state PROCEDURE TRANSACTION INACTIVE.

If:

- the 5GSM cause value #26 "insufficient resources" and the Back-off timer value IE are included in the PDU SESSION MODIFICATION REJECT message; or
- an indication that the 5GSM message was not forwarded due to DNN based congestion control is received along a Back-off timer value and a PDU SESSION MODIFICATION REQUEST message with the PDU session ID IE set to the PDU session ID of the PDU session;

the UE shall ignore the 5GSM congestion re-attempt indicator IE provided by the network, if any, and the UE shall take different actions depending on the timer value received for timer T3396 in the Back-off timer value IE (if the UE is a UE configured for high priority access in selected PLMN, exceptions are specified in subclause 6.2.7):

- a) If the timer value indicates neither zero nor deactivated and a DNN was provided during the PDU session establishment, the UE shall stop timer T3396 associated with the corresponding DNN, if it is running. If the timer value indicates neither zero nor deactivated and no DNN was provided during the PDU session establishment and the request type was different from "initial emergency request" and different from "existing emergency PDU session", the UE shall stop timer T3396 associated with no DNN if it is running. The UE shall then start timer T3396 with the value provided in the Back-off timer value IE and:
  - 1) shall not send another PDU SESSION ESTABLISHMENT REQUEST message, or PDU SESSION MODIFICATION REQUEST message with exception of those identified in subclause 6.4.2.1, for the same DNN that was sent by the UE, until timer T3396 expires or timer T3396 is stopped; and
  - 2) shall not send another PDU SESSION ESTABLISHMENT REQUEST message without a DNN and with request type different from "initial emergency request" and different from "existing emergency PDU session", or another PDU SESSION MODIFICATION REQUEST message with exception of those identified in subclause 6.4.2.1, for a non-emergency PDU session established without a DNN provided by the UE, if no DNN was provided during the PDU session establishment and the request type was different from

"initial emergency request" and different from "existing emergency PDU session", until timer T3396 expires or timer T3396 is stopped.

The UE shall not stop timer T3396 upon a PLMN change or inter-system change.

- b) if the timer value indicates that this timer is deactivated and a DNN was provided during the PDU session establishment, the UE shall stop timer T3396 associated with the corresponding DNN, if it is running. If the timer value indicates that this timer is deactivated and no DNN was provided during the PDU session establishment and the request type was different from "initial emergency request" and different from "existing emergency PDU session", the UE shall stop timer T3396 associated with no DNN if it is running. The UE:
- 1) shall not send another PDU SESSION ESTABLISHMENT REQUEST message or PDU SESSION MODIFICATION REQUEST with exception of those identified in subclause 6.4.2.1, for the same DNN until the UE is switched off or the USIM is removed, or the UE receives a PDU SESSION MODIFICATION COMMAND message for the same DNN from the network or a PDU SESSION RELEASE COMMAND message including 5GSM cause #39 "reactivation requested" for the same DNN from the network; and
  - 2) shall not send another PDU SESSION ESTABLISHMENT REQUEST message without a DNN and with request type different from "initial emergency request" and different from "existing emergency PDU session", or another PDU SESSION MODIFICATION REQUEST message with exception of those identified in subclause 6.4.2.1, for a non-emergency PDU session established without a DNN provided by the UE, if no DNN was provided during the PDU session establishment and the request type was different from "initial emergency request" and different from "existing emergency PDU session", until the UE is switched off or the USIM is removed, or the UE receives a PDU SESSION MODIFICATION COMMAND message for a non-emergency PDU session established without a DNN provided by the UE, or a PDU SESSION RELEASE COMMAND messages including 5GSM cause IE set to 5GSM cause #39 "reactivation requested" for a non-emergency PDU session established without a DNN provided by the UE.

The timer T3396 remains deactivated upon a PLMN change or inter-system change.

- c) if the timer value indicates zero, the UE:
- 1) shall stop timer T3396 associated with the corresponding DNN, if running, and may send another PDU SESSION ESTABLISHMENT REQUEST message or PDU SESSION MODIFICATION REQUEST message for the same DNN; and
  - 2) if no DNN was provided during the PDU session establishment and the request type was different from "initial emergency request" and different from "existing emergency PDU session", the UE shall stop timer T3396 associated with no DNN, if running, and may send another PDU SESSION ESTABLISHMENT REQUEST message without a DNN, or another PDU SESSION MODIFICATION REQUEST message without a DNN provided by the UE.

If the Back-off timer value IE is not included, then the UE may send another PDU SESSION ESTABLISHMENT REQUEST message or PDU SESSION MODIFICATION REQUEST message for the same DNN or without a DNN.

If the timer T3396 is running when the UE enters state 5GMM-DEREGISTERED, the UE remains switched on, and the USIM in the UE remains the same, then timer T3396 is kept running until it expires or it is stopped.

If the UE is switched off when the timer T3396 is running, and if the USIM in the UE remains the same when the UE is switched on, the UE shall behave as follows:

- let  $t_1$  be the time remaining for T3396 timeout at switch off and let  $t$  be the time elapsed between switch off and switch on. If  $t_1$  is greater than  $t$ , then the timer shall be restarted with the value  $t_1 - t$ . If  $t_1$  is equal to or less than  $t$ , then the timer need not be restarted. If the UE is not capable of determining  $t$ , then the UE shall restart the timer with the value  $t_1$ .

If the UE is operating in single-registration mode in the network supporting N26 interface and the PDU SESSION MODIFICATION REQUEST message was sent for a PDN connection established when in S1 mode after the first inter-system change from S1 mode to N1 mode, then the UE shall re-initiate the UE-requested PDU session modification procedure after expiry of timer T3396.

If:

- the 5GSM cause value #67 "insufficient resources for specific slice and DNN" and the Back-off timer value IE are included in the PDU SESSION MODIFICATION REJECT message; or

- an indication that the 5GSM message was not forwarded due to S-NSSAI and DNN based congestion control is received along a Back-off timer value and a PDU SESSION MODIFICATION REQUEST message with the PDU session ID IE set to the PDU session ID of the PDU session;

the UE shall take different actions depending on the timer value received for timer T3584 in the Back-off timer value IE (if the UE is a UE configured for high priority access in selected PLMN, exceptions are specified in subclause 6.2.8):

- a) If the timer value indicates neither zero nor deactivated, the UE shall stop timer T3584 associated with the same [S-NSSAI, DNN] combination as that the UE provided during the PDU session establishment, if it is running. If the timer value indicates neither zero nor deactivated and no DNN was provided during the PDU session establishment and the request type was different from "initial emergency request" and different from "existing emergency PDU session", the UE shall stop timer T3584 associated with [S-NSSAI, no DNN] combination as that the UE provided during the PDU session establishment, if it is running. If the timer value indicates neither zero nor deactivated and no S-NSSAI was provided during the PDU session establishment, the UE shall stop timer T3584 associated with [no S-NSSAI, DNN] combination as that the UE provided during the PDU session establishment, if it is running. If the timer value indicates neither zero nor deactivated and neither S-NSSAI nor DNN was provided during the PDU session establishment and the request type was different from "initial emergency request" and different from "existing emergency PDU session", the UE shall stop timer T3584 associated with [no S-NSSAI, no DNN] combination as that the UE provided during the PDU session establishment, if it is running. The UE shall then start timer T3584 with the value provided in the Back-off timer value IE and:
  - 1) shall not send another PDU SESSION ESTABLISHMENT REQUEST message or PDU SESSION MODIFICATION REQUEST message with exception of those identified in subclause 6.4.2.1, for the same [S-NSSAI, DNN] combination that was sent by the UE, until timer T3584 expires or timer T3584 is stopped;
  - 2) shall not send another PDU SESSION ESTABLISHMENT REQUEST message with request type different from "initial emergency request" and different from "existing emergency PDU session", or another PDU SESSION MODIFICATION REQUEST message with exception of those identified in subclause 6.4.2.1, for the same [S-NSSAI, no DNN] combination that was sent by the UE, if no DNN was provided during the PDU session establishment, until timer T3584 expires or timer T3584 is stopped;
  - 3) shall not send another PDU SESSION ESTABLISHMENT REQUEST message, or another PDU SESSION MODIFICATION REQUEST message with exception of those identified in subclause 6.4.2.1, for the same [no S-NSSAI, DNN] combination that was sent by the UE, if no S-NSSAI was provided during the PDU session establishment, until timer T3584 expires or timer T3584 is stopped; and
  - 4) shall not send another PDU SESSION ESTABLISHMENT REQUEST message with request type different from "initial emergency request" and different from "existing emergency PDU session", or another PDU SESSION MODIFICATION REQUEST message with exception of those identified in subclause 6.4.2.1, for the same [no S-NSSAI, no DNN] combination that was sent by the UE, if neither S-NSSAI nor DNN was provided during the PDU session establishment, until timer T3584 expires or timer T3584 is stopped.

The UE shall not stop timer T3584 upon a PLMN change or inter-system change.

- b) if the timer value indicates that this timer is deactivated, the UE:
  - 1) shall stop timer T3584 associated with the same [S-NSSAI, DNN] combination as that the UE provided during the PDU session establishment, if it is running. The UE shall not send another PDU SESSION ESTABLISHMENT REQUEST message or PDU SESSION MODIFICATION REQUEST message with exception of those identified in subclause 6.4.2.1, for the same [S-NSSAI, DNN] combination that was sent by the UE, until the UE is switched off or the USIM is removed, or the UE receives a PDU SESSION MODIFICATION COMMAND message for the same [S-NSSAI, DNN] combination from the network or a PDU SESSION RELEASE COMMAND message including 5GSM cause #39 "reactivation requested" for the same [S-NSSAI, DNN] combination from the network;
  - 2) shall stop timer T3584 associated with the same [S-NSSAI, no DNN] combination as that the UE provided during the PDU session establishment, if it is running. The UE shall not send a PDU SESSION ESTABLISHMENT REQUEST message with request type different from "initial emergency request" and different from "existing emergency PDU session", or a PDU SESSION MODIFICATION REQUEST message with exception of those identified in subclause 6.4.2.1, for the same [S-NSSAI, no DNN] combination that was sent by the UE, if no DNN was provided during the PDU session establishment, until the UE is switched off or the USIM is removed, or the UE receives an PDU SESSION MODIFICATION COMMAND message for a non-emergency PDU session established for the same [S-NSSAI, no DNN]

combination from the network or a PDU SESSION RELEASE COMMAND message including 5GSM cause #39 "reactivation requested" for a non-emergency PDU session established for the same [S-NSSAI, no DNN] combination from the network;

- 3) shall stop timer T3584 associated with the same [no S-NSSAI, DNN] combination as that the UE provided during the PDU session establishment, if it is running. The UE shall not send a PDU SESSION ESTABLISHMENT REQUEST message, or a PDU SESSION MODIFICATION REQUEST message with exception of those identified in subclause 6.4.2.1, for the same [no S-NSSAI, DNN] combination that was sent by the UE, if no S-NSSAI was provided during the PDU session establishment, until the UE is switched off or the USIM is removed, or the UE receives an PDU SESSION MODIFICATION COMMAND message for the same [no S-NSSAI, DNN] combination from the network or a PDU SESSION RELEASE COMMAND message including 5GSM cause #39 "reactivation requested" for the same [no S-NSSAI, DNN] combination from the network; and
- 4) shall stop timer T3584 associated with the same [no S-NSSAI, no DNN] combination as that the UE provided during the PDU session establishment, if it is running. The UE shall not send a PDU SESSION ESTABLISHMENT REQUEST message with request type different from "initial emergency request" and different from "existing emergency PDU session", or a PDU SESSION MODIFICATION REQUEST message with exception of those identified in subclause 6.4.2.1, for the same [no S-NSSAI, no DNN] combination that was sent by the UE, if neither S-NSSAI nor DNN was provided during the PDU session establishment, until the UE is switched off or the USIM is removed, or the UE receives an PDU SESSION MODIFICATION COMMAND message for a non-emergency PDU session established for the same [no S-NSSAI, no DNN] combination from the network or a PDU SESSION RELEASE COMMAND message including 5GSM cause #39 "reactivation requested" for a non-emergency PDU session established for the same [no S-NSSAI, no DNN] combination from the network.

The timer T3584 remains deactivated upon a PLMN change or inter-system change.

c) if the timer value indicates zero, the UE:

- 1) shall stop timer T3584 associated with the same [S-NSSAI, DNN] combination as that the UE provided during the PDU session establishment, if it is running. The UE may send another PDU SESSION ESTABLISHMENT REQUEST message or PDU SESSION MODIFICATION REQUEST message for the same [S-NSSAI, DNN] combination;
- 2) shall stop timer T3584 associated with the same [S-NSSAI, no DNN] combination as that the UE provided during the PDU session establishment, if it is running. The UE may send another PDU SESSION ESTABLISHMENT REQUEST message, or PDU SESSION MODIFICATION REQUEST message for the same [S-NSSAI, no DNN] combination if no DNN was provided during the PDU session establishment and the request type was different from "initial emergency request" and different from "existing emergency PDU session";
- 3) shall stop timer T3584 associated with the same [no S-NSSAI, DNN] combination as that the UE provided during the PDU session establishment, if it is running. The UE may send another PDU SESSION ESTABLISHMENT REQUEST message, or PDU SESSION MODIFICATION REQUEST message for the same [no S-NSSAI, DNN] combination if no NSSAI was provided during the PDU session establishment; and
- 4) shall stop timer T3584 associated with the same [no S-NSSAI, no DNN] combination as that the UE provided during the PDU session establishment, if it is running. The UE may send another PDU SESSION ESTABLISHMENT REQUEST message, or PDU SESSION MODIFICATION REQUEST message for the same [no S-NSSAI, no DNN] combination if neither S-NSSAI nor DNN was provided during the PDU session establishment and the request type was different from "initial emergency request" and different from "existing emergency PDU session".

If the 5GSM congestion re-attempt indicator IE set to "The back-off timer is applied in all PLMNs" is included in the PDU SESSION MODIFICATION REJECT message with the 5GSM cause value #67 "insufficient resources for specific slice and DNN", then the UE shall apply the timer T3584 for all the PLMNs. Otherwise, the UE shall apply the timer T3584 for the registered PLMN.

If the Back-off timer value IE is not included, then the UE may send another PDU SESSION ESTABLISHMENT REQUEST message or PDU SESSION MODIFICATION REQUEST message for the same [S-NSSAI, DNN] combination, or for the same [S-NSSAI, no DNN] combination, or for the same [no S-NSSAI, DNN] combination, or for the same [no S-NSSAI, no DNN] combination.

When the timer T3584 is running or the timer is deactivated, the UE is allowed to initiate a PDU session establishment procedure for emergency services.

If the timer T3584 is running when the UE enters state 5GMM-DEREGISTERED, the UE remains switched on, and the USIM in the UE remains the same, then timer T3584 is kept running until it expires or it is stopped.

If the UE is switched off when the timer T3584 is running, and if the USIM in the UE remains the same when the UE is switched on, the UE shall behave as follows:

- let  $t_1$  be the time remaining for T3584 timeout at switch off and let  $t$  be the time elapsed between switch off and switch on. If  $t_1$  is greater than  $t$ , then the timer shall be restarted with the value  $t_1 - t$ . If  $t_1$  is equal to or less than  $t$ , then the timer need not be restarted. If the UE is not capable of determining  $t$ , then the UE shall restart the timer with the value  $t_1$ .

If the UE is operating in single-registration mode in the network supporting N26 interface and the PDU SESSION MODIFICATION REQUEST message was sent for a PDN connection established when in S1 mode after the first inter-system change from S1 mode to N1 mode, then the UE shall re-initiate the UE-requested PDU session modification procedure after expiry of timer T3584.

If:

- the 5GSM cause value #69 "insufficient resources for specific slice" and the Back-off timer value IE are included in the PDU SESSION MODIFICATION REJECT message; or
- an indication that the 5GSM message was not forwarded due to S-NSSAI only based congestion control is received along a Back-off timer value and a PDU SESSION MODIFICATION REQUEST message with the PDU session ID IE set to the PDU session ID of the PDU session;

the UE shall take different actions depending on the timer value received for timer T3585 in the Back-off timer value IE (if the UE is a UE configured for high priority access in selected PLMN, exceptions are specified in subclause 6.2.8):

- a) If the timer value indicates neither zero nor deactivated and an S-NSSAI was provided during the PDU session establishment and the request type was different from "initial emergency request" and different from "existing emergency PDU session", the UE shall stop timer T3585 associated with the corresponding S-NSSAI, if it is running. If the timer value indicates neither zero nor deactivated and no S-NSSAI was provided during the PDU session establishment and the request type was different from "initial emergency request" and different from "existing emergency PDU session", the UE shall stop timer T3585 associated with no S-NSSAI if it is running. The UE shall then start timer T3585 with the value provided in the Back-off timer value IE and:
  - 1) shall not send another PDU SESSION ESTABLISHMENT REQUEST message with request type different from "initial emergency request" and different from "existing emergency PDU session", or another PDU SESSION MODIFICATION REQUEST message with exception of those identified in subclause 6.4.2.1, for a non-emergency PDU session for the same S-NSSAI that was sent by the UE, until timer T3585 expires or timer T3585 is stopped; and
  - 2) shall not send another PDU SESSION ESTABLISHMENT REQUEST message without an S-NSSAI and with request type different from "initial emergency request" and different from "existing emergency PDU session", or another PDU SESSION MODIFICATION REQUEST message with exception of those identified in subclause 6.4.2.1, for a non-emergency PDU session established without an S-NSSAI provided by the UE, if no S-NSSAI was provided during the PDU session establishment and the request type was different from "initial emergency request" and different from "existing emergency PDU session", until timer T3585 expires or timer T3585 is stopped.

The UE shall not stop timer T3585 upon a PLMN change or inter-system change.

- b) if the timer value indicates that this timer is deactivated and an S-NSSAI was provided during the PDU session establishment and the request type was different from "initial emergency request" and different from "existing emergency PDU session", the UE shall stop timer T3585 associated with the corresponding S-NSSAI, if it is running. If the timer value indicates that this timer is deactivated and no S-NSSAI was provided during the PDU session establishment and the request type was different from "initial emergency request" and different from "existing emergency PDU session", the UE shall stop timer T3585 associated with no S-NSSAI if it is running. The UE:
  - 1) shall not send another PDU SESSION ESTABLISHMENT REQUEST message with request type different from "initial emergency request" and different from "existing emergency PDU session", or another PDU



SESSION MODIFICATION REQUEST with exception of those identified in subclause 6.4.2.1, for a non-emergency PDU session for the same S-NSSAI until the UE is switched off or the USIM is removed, or the UE receives a PDU SESSION MODIFICATION COMMAND message for a non-emergency PDU session for the same S-NSSAI from the network or a PDU SESSION RELEASE COMMAND message including 5GSM cause #39 "reactivation requested" for the same S-NSSAI from the network; and

- 2) shall not send another PDU SESSION ESTABLISHMENT REQUEST message without an S-NSSAI and with request type different from "initial emergency request" and different from "existing emergency PDU session", or another PDU SESSION MODIFICATION REQUEST message with exception of those identified in subclause 6.4.2.1, for a non-emergency PDU session established without an S-NSSAI provided by the UE, if no S-NSSAI was provided during the PDU session establishment and the request type was different from "initial emergency request" and different from "existing emergency PDU session", until the UE is switched off or the USIM is removed, or the UE receives a PDU SESSION MODIFICATION COMMAND message for a non-emergency PDU session established without an S-NSSAI provided by the UE, or a PDU SESSION RELEASE COMMAND messages including 5GSM cause IE set to 5GSM cause #39 "reactivation requested" for a non-emergency PDU session established without an S-NSSAI provided by the UE.

The timer T3585 remains deactivated upon a PLMN change or inter-system change.

c) if the timer value indicates zero, the UE:

- 1) shall stop timer T3585 associated with the corresponding S-NSSAI, if running, and may send another PDU SESSION ESTABLISHMENT REQUEST message or PDU SESSION MODIFICATION REQUEST message for the same S-NSSAI; and
- 2) if no S-NSSAI was provided during the PDU session establishment and the request type was different from "initial emergency request" and different from "existing emergency PDU session", the UE shall stop timer T3585 associated with no S-NSSAI, if running, and may send another PDU SESSION ESTABLISHMENT REQUEST message without an S-NSSAI, or another PDU SESSION MODIFICATION REQUEST message without an S-NSSAI provided by the UE.

If the 5GSM congestion re-attempt indicator IE set to "The back-off timer is applied in all PLMNs" is included in the PDU SESSION MODIFICATION REJECT message with the 5GSM cause value #69 "insufficient resources for specific slice", then the UE shall apply the timer T3585 for all the PLMNs. Otherwise, the UE shall apply the timer T3585 for the registered PLMN.

If the Back-off timer value IE is not included, then the UE may send another PDU SESSION ESTABLISHMENT REQUEST message or PDU SESSION MODIFICATION REQUEST message for the same S-NSSAI or without an S-NSSAI.

If the timer T3585 is running when the UE enters state 5GMM-DEREGISTERED, the UE remains switched on, and the USIM in the UE remains the same, then timer T3585 is kept running until it expires or it is stopped.

If the UE is switched off when the timer T3585 is running, and if the USIM in the UE remains the same when the UE is switched on, the UE shall behave as follows:

- let  $t_1$  be the time remaining for T3585 timeout at switch off and let  $t$  be the time elapsed between switch off and switch on. If  $t_1$  is greater than  $t$ , then the timer shall be restarted with the value  $t_1 - t$ . If  $t_1$  is equal to or less than  $t$ , then the timer need not be restarted. If the UE is not capable of determining  $t$ , then the UE shall restart the timer with the value  $t_1$ .

If the UE is operating in single-registration mode in the network supporting N26 interface and the PDU SESSION MODIFICATION REQUEST message was sent for a PDN connection established when in S1 mode after the first inter-system change from S1 mode to N1 mode, then the UE shall re-initiate the UE-requested PDU session modification procedure after expiry of timer T3585.

**NOTE:** As described in this subclause, upon PLMN change or inter-system change, the UE does not stop the timer T3584 or T3585. This means the timer T3584 or T3585 can still be running or be deactivated for the given 5GSM procedure, the PLMN, the S-NSSAI and optionally the DNN combination when the UE returns to the PLMN or when it performs inter-system change back from S1 mode to N1 mode. Thus the UE can still be prevented from sending another PDU SESSION ESTABLISHMENT REQUEST or PDU SESSION MODIFICATION REQUEST message in the PLMN for the same S-NSSAI and optionally the same DNN.

Upon PLMN change, if T3584 is running or is deactivated for an S-NSSAI, a DNN, and old PLMN, but T3584 is not running and is not deactivated for the S-NSSAI, the DNN, and new PLMN, then the UE is allowed to send a PDU SESSION ESTABLISHMENT REQUEST message for the same S-NSSAI and the same DNN in the new PLMN.

Upon PLMN change, if T3585 is running or is deactivated for an S-NSSAI and old PLMN, but T3585 is not running and is not deactivated for the S-NSSAI and new PLMN, then the UE is allowed to send a PDU SESSION ESTABLISHMENT REQUEST message for the same S-NSSAI in the new PLMN.

If the 5GSM cause value is #46 "out of LADN service area", the UE shall not send another PDU SESSION MODIFICATION REQUEST message for the LADN DNN provided by the UE during the PDU session establishment procedure until the LADN information for the specific LADN DNN is updated as described in subclause 5.4.4 and subclause 5.5.1.

#### 6.4.2.5 Abnormal cases in the UE

The following abnormal cases can be identified:

- a) Expiry of timer T3581.

The UE shall, on the first expiry of the timer T3581, retransmit the PDU SESSION MODIFICATION REQUEST message and the PDU session information which was transported together with the initial transmission of the PDU SESSION MODIFICATION REQUEST message and shall reset and start timer T3581. This retransmission is repeated four times, i.e. on the fifth expiry of timer T3581, the UE shall abort the procedure and shall release the allocated PTI.

- b) Invalid PDU session identity.

Upon receipt of the PDU SESSION MODIFICATION REJECT message including 5GSM cause #43 "invalid PDU session identity", the UE shall perform a local release of the existing PDU session.

- c) Collision of network-requested PDU session release procedure and UE-requested PDU session modification procedure.

If the UE receives a PDU SESSION RELEASE COMMAND message during the UE-requested PDU session modification procedure, and the PDU session indicated in the PDU SESSION RELEASE COMMAND message is the PDU session that the UE had requested to modify, the UE shall abort the PDU session modification procedure and proceed with the network-requested PDU session release procedure.

- d) Handling DL user data packets marked with RQI when UE has already revoked the usage of reflective QoS

If the UE receives a DL user data packet marked with a RQI and the DL user data packet belongs to a PDU session of IPv4, IPv6, IPv4v6 or Ethernet PDU session type for which the UE has already revoked the usage of reflective QoS, then the UE shall ignore the RQI and shall handle the received DL user data packet.

- e) Collision of network-requested PDU session modification procedure and UE-requested PDU session modification procedure.

The handling of the same abnormal case as described in subclause 6.3.2.6 applies.

#### 6.4.2.6 Abnormal cases on the network side

The following abnormal cases can be identified:

- a) If the PDU session is an emergency PDU session, the SMF shall reject the PDU SESSION MODIFICATION REQUEST message with 5GSM cause #31 "request rejected, unspecified".

- b) PDU session inactive for the received PDU session identity.

If the PDU session ID in the PDU SESSION MODIFICATION REQUEST message belongs to any PDU session in state PDU SESSION INACTIVE in the SMF, the SMF shall set the 5GSM cause IE to #43 "Invalid PDU session identity" in the PDU SESSION MODIFICATION REJECT message.

- e) Collision of network-requested PDU session modification procedure and UE-requested PDU session modification procedure.

The handling of the same abnormal case as described in subclause 6.3.2.5 applies.

## 6.4.3 UE-requested PDU session release procedure

### 6.4.3.1 General

The purpose of the UE-requested PDU session release procedure is to enable by the UE to request a release of a PDU session.

The UE is allowed to initiate the PDU session release procedure even if the timer T3396 is running.

The UE is allowed to initiate the PDU session release procedure even if the timer T3584 is running.

The UE is allowed to initiate the PDU session release procedure even if the timer T3585 is running.

The UE is allowed to initiate the PDU session release procedure even if the UE is outside the LADN service area.

### 6.4.3.2 UE-requested PDU session release procedure initiation

In order to initiate the UE-requested PDU session release procedure, the UE shall create a PDU SESSION RELEASE REQUEST message.

The UE may set the 5GSM cause IE of the PDU SESSION RELEASE REQUEST message to indicate the reason for releasing the PDU session.

The 5GSM cause IE typically indicates one of the following 5GSM cause values:

- #36 regular deactivation;
- #41 Semantic error in the TFT operation;
- #42 Syntactical error in the TFT operation;
- #44 Semantic errors in packet filter(s);
- #45 Syntactical error in packet filter(s).

The UE shall allocate a PTI value currently not used and shall set the PTI IE of the PDU SESSION RELEASE REQUEST message to the allocated PTI value.

The UE shall transport the PDU SESSION RELEASE REQUEST message and the PDU session ID, using the NAS transport procedure as specified in subclause 5.4.5, and the UE shall start timer T3582 (see example in figure 6.4.3.2.1).

If the UE is releasing the PDU session due to errors in QoS operations or packet filters for the default QoS rule, the UE shall include the 5GSM cause IE in the PDU SESSION RELEASE REQUEST message as described in subclauses 6.4.1.3.

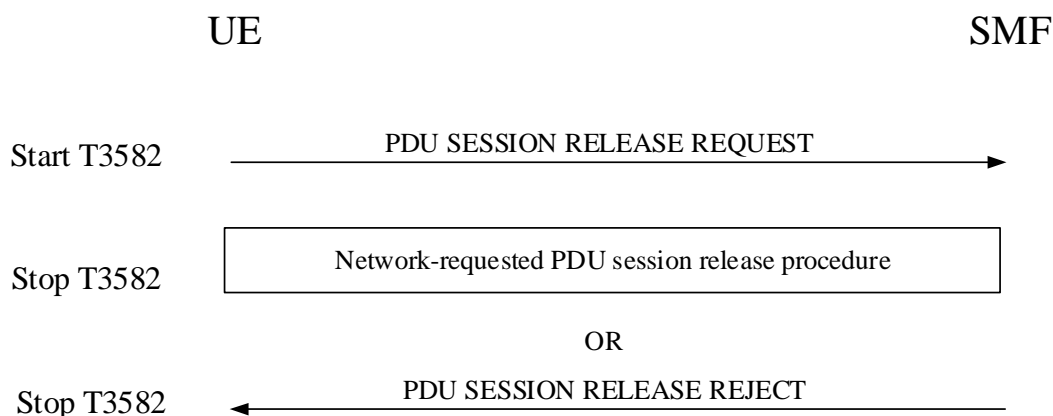

**Figure 6.4.3.2.1: UE-requested PDU session release procedure**

### 6.4.3.3 UE-requested PDU session release procedure accepted by the network

Upon receipt of a PDU SESSION RELEASE REQUEST message and a PDU session ID, if the SMF accepts the request to release the PDU session, and shall perform the network-requested PDU session release procedure as specified in subclause 6.3.3.

### 6.4.3.4 UE-requested PDU session release procedure not accepted by the network

Upon receipt of a PDU SESSION RELEASE REQUEST message, if the SMF does not accept the request to release the PDU session, the SMF shall create a PDU SESSION RELEASE REJECT message.

The SMF shall set the 5GSM cause IE of the PDU SESSION RELEASE REJECT message to indicate the reason for rejecting the PDU session release.

The 5GSM cause IE typically indicates one of the following SM cause values:

- #35 PTI already in use; or
- #43 Invalid PDU session identity; or
- #95 – 111: protocol errors.

The SMF shall send the PDU SESSION RELEASE REJECT message.

Upon receipt of a PDU SESSION RELEASE REJECT message and a PDU session ID, using the NAS transport procedure as specified in subclause 5.4.5, the UE shall stop timer T3582 and release the allocated PTI value.

If the PDU SESSION RELEASE REJECT message includes a 5GSM cause IE with a value different from #43 "invalid PDU session identity" or #35 "PTI already in use", the UE shall consider that the PDU session is not released.

### 6.4.3.5 Abnormal cases in the UE

The following abnormal cases can be identified:

- a) Expiry of timer T3582.

The UE shall, on the first expiry of the timer T3582, retransmit the PDU SESSION RELEASE REQUEST message and the PDU session information which was transported together with the initial transmission of the PDU SESSION RELEASE REQUEST message and shall reset and start timer T3582. This retransmission is repeated four times, i.e. on the fifth expiry of timer T3582, the UE shall abort the procedure, release the allocated PTI, perform a local release of the PDU session, and perform the registration procedure for mobility and periodic registration update with a REGISTRATION REQUEST message including the PDU session status IE.

- b) Collision of UE-requested PDU session release procedure and network-requested PDU session modification procedure.

When the UE receives a PDU SESSION MODIFICATION COMMAND message during the UE-requested PDU session release procedure, and the PDU session indicated in PDU SESSION MODIFICATION COMMAND message is the PDU session that the UE had requested to release, the UE shall ignore the PDU SESSION MODIFICATION COMMAND message and proceed with the PDU session release procedure.

- c) Collision of UE-requested PDU session release procedure and network-requested PDU session release procedure.

When the UE receives a PDU SESSION RELEASE COMMAND message with the PTI IE set to "No procedure transaction identity assigned" during the UE-requested PDU session release procedure, and the PDU session indicated in the PDU SESSION RELEASE COMMAND message is the same as the PDU session that the UE requests to release, the UE shall abort the UE-requested PDU session release procedure and proceed with the network-requested PDU session release procedure.

- d) Invalid PDU session identity.

Upon receipt of a PDU SESSION RELEASE REJECT message with a 5GSM cause IE set to #43 "invalid PDU session identity", the UE shall perform a local release of the PDU session.

- e) PTI already in use.

Upon receipt of a PDU SESSION RELEASE REJECT message with a 5GSM cause IE set to #35 "PTI already in use", the UE shall perform a local release of the PDU session.

#### 6.4.3.6 Abnormal cases on the network side

The following abnormal cases can be identified:

- a) PDU session inactive for the received PDU session identity.

If the PDU session ID in the PDU SESSION RELEASE REQUEST message belongs to any PDU session in state PDU SESSION INACTIVE in the SMF, the SMF shall send the PDU SESSION RELEASE REJECT message to the UE with the 5GSM cause #43 "Invalid PDU session identity".

## 6.5 5GSM status procedure

### 6.5.1 General

The purpose of the sending of the 5GSM STATUS message is to report at any time certain error conditions detected upon receipt of 5GSM protocol data. The 5GSM STATUS message can be sent by both the network and the UE (see example in figure 6.5.1.1).

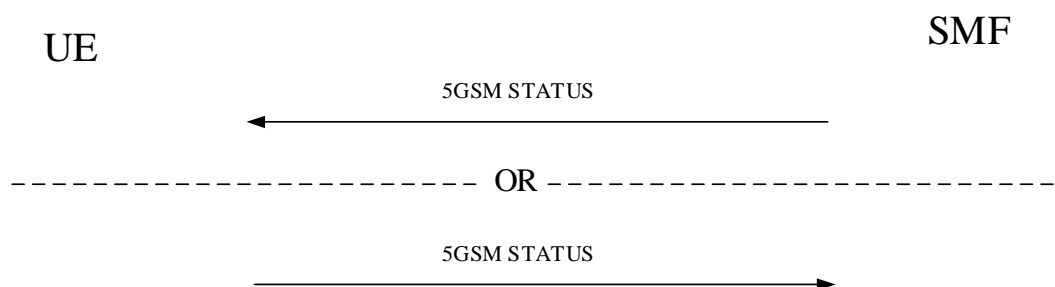

Figure 6.5.1.1: 5GSM status procedure

## 6.5.2 5GSM status received in the UE

If the 5GSM entity of the UE receives a 5GSM STATUS message the UE shall take different actions depending on the received 5GSM cause value:

#81 invalid PTI value.

The UE shall abort any ongoing 5GSM procedure related to the received PTI value and stop any related timer.

#97 Message type non-existent or not implemented.

The UE shall abort any ongoing 5GSM procedure related to the PTI or PDU session Id and stop any related timer.

On receipt of a 5GSM STATUS message with any other 5GSM cause value no state transition and no specific action shall be taken as seen from the radio interface, i.e. local actions are possible.

## 6.5.3 5GSM status received in the SMF

If the SMF receives a 5GSM STATUS message the SMF shall take different actions depending on the received 5GSM cause value:

#43 invalid PDU session identity.

The SMF shall abort any ongoing 5GSM procedure related to the PTI or PDU session ID, stop any related timer and locally release the PDU session indicated in the 5GSM STATUS message.

#47 PTI mismatch.

The SMF shall abort any ongoing 5GSM procedure related to the received PTI value and stop any related timer.

If the PTI indicated in the 5GSM STATUS message is related to a PDU SESSION ESTABLISHMENT ACCEPT message, the SMF shall perform a local release of the PDU session indicated in the PDU SESSION ESTABLISHMENT ACCEPT message.

#81 invalid PTI value.

The SMF shall abort any ongoing 5GSM procedure related to the received PTI value and stop any related timer.

#96 invalid mandatory information.

The SMF shall abort any ongoing 5GSM procedure related to the PTI or PDU session ID and stop any related timer.

#97 message type non-existent or not implemented.

The SMF shall abort any ongoing 5GSM procedure related to the PTI or PDU session ID and stop any related timer.

The local actions to be taken by the SMF on receipt of a 5GSM STATUS message with any other 5GSM cause value are implementation dependent.

## 6.6 Miscellaneous procedures

### 6.6.1 Exchange of extended protocol configuration options

The UE and the SMF can exchange protocol configuration options via 5GSM procedures.

The protocol configuration options shall be exchanged via the Extended protocol configuration options IE.

---

## 7 Handling of unknown, unforeseen, and erroneous protocol data

### 7.1 General

The procedures specified in the present document apply to those messages which pass the checks described in this subclause.

This subclause also specifies procedures for the handling of unknown, unforeseen, and erroneous protocol data by the receiving entity. These procedures are called "error handling procedures", but in addition to providing recovery mechanisms for error situations they define a compatibility mechanism for future extensions of the protocols.

Subclauses 7.1 to 7.8 shall be applied in order of precedence.

Detailed error handling procedures in the network are implementation dependent and may vary from PLMN to PLMN. However, when extensions of this protocol are developed, networks are assumed to have the error handling which is indicated in this subclause as mandatory ("shall") and that is indicated as strongly recommended ("should").

Also, the error handling of the network is only considered as mandatory or strongly recommended when certain thresholds for errors are not reached during a dedicated connection.

For definition of semantical and syntactical errors see 3GPP TS 24.007 [11], subclause 11.4.2.

### 7.2 Message too short or too long

#### 7.2.1 Message too short

When a message is received that is too short to contain a complete message type information element, that message shall be ignored, cf. 3GPP TS 24.007 [11].

#### 7.2.2 Message too long

The maximum size of a NAS message for NR connected to 5GCN is specified in 3GPP TS 38.323 [29].

The maximum size of a NAS message for E-UTRA connected to 5GCN is specified 3GPP TS 36.323 [25].

The maximum size of a NAS message for non-3GPP access connected to 5GCN is specified in 3GPP TS 24.502 [18]

### 7.3 Unknown or unforeseen procedure transaction identity or PDU Session identity

#### 7.3.1 Procedure transaction identity

The following UE-requested 5GSM procedures shall apply for handling an unknown, erroneous, or unforeseen PTI received in a 5GSM message:

- a) In case the UE receives a PDU SESSION MODIFICATION COMMAND message or a PDU SESSION MODIFICATION REJECT message in which the PTI value is an assigned value that does not match any PTI in use:
  - 1) if the UE detects that this PDU SESSION MODIFICATION COMMAND message is a network retransmission of an already accepted request (see subclause 6.3.2.3), the UE shall respond with a PDU SESSION MODIFICATION COMPLETE message;
  - 2) if the UE detects that this PDU SESSION MODIFICATION COMMAND message is a network retransmission of an already rejected request (see subclause 6.3.2.4), the UE shall respond with a PDU

SESSION MODIFICATION COMMAND REJECT message; or3) otherwise, the UE shall respond with a 5GSM STATUS message including 5GSM cause #47 "PTI mismatch".

- b) In case the UE receives a PDU SESSION RELEASE COMMAND message or a PDU SESSION RELEASE REJECT message in which the PTI value is an assigned value that does not match any PTI in use:
  - 1) if the UE detects that this PDU SESSION RELEASE COMMAND message is a network retransmission of an already accepted request (see subclause 6.3.3.3), the UE shall respond with a PDU SESSION RELEASE COMPLETE message; or
  - 2) otherwise, the UE shall respond with a 5GSM STATUS message including 5GSM cause #47 "PTI mismatch".
- c) In case the UE receives a PDU SESSION ESTABLISHMENT ACCEPT message or a PDU SESSION ESTABLISHMENT REJECT message in which the PTI value is an assigned value that does not match any PTI in use:
  - 1) the UE shall respond with a 5GSM STATUS message including 5GSM cause #47 "PTI mismatch".

### 7.3.2 PDU Session identity

The following network procedures shall apply for handling an unknown, erroneous, or unforeseen PDU session identity received in the header of a 5GSM message (specified as the header of a standard L3 message, see 3GPP TS 24.007 [11]):

- a) If the network receives a PDU SESSION MODIFICATION REQUEST message which includes an unassigned or reserved PDU session identity value, the network shall respond with a PDU SESSION MODIFICATION REJECT message including 5GSM cause #43 "invalid PDU session identity".
- b) If the network receives PDU SESSION RELEASE REQUEST message which includes an unassigned or reserved PDU session identity value, the network shall respond with a PDU SESSION RELEASE REJECT message including 5GSM cause #43 "invalid PDU session identity".
- c) Upon receipt of an UL NAS TRANSPORT message, the network takes the following actions:
  - 1) If the Request type IE is set to "initial request" or "initial emergency request" and the message includes a reserved PDU session identity value, the network shall respond with a DL NAS TRANSPORT message with 5GMM cause #90 "payload was not forwarded";
  - 2) otherwise, if the message includes an unassigned or reserved PDU session identity value, the network shall respond with a DL NAS TRANSPORT message with 5GMM cause #90 "payload was not forwarded".
- d) If the network receives a 5GSM message other than those listed in items a) through c) above in which the message includes a reserved PDU session identity value or an assigned value that does not match an existing PDU session, the network shall ignore the message.

The following UE procedures shall apply for handling an unknown, erroneous, or unforeseen PDU session identity received in the header of a 5GSM message:

- a) If the UE receives a 5GSM message which includes an unassigned or reserved PDU session identity value, the UE shall ignore the message.
- b) If the UE receives a 5GSM message which includes a PDU session identity belonging to any PDU session in state PDU SESSION INACTIVE in the UE, the UE shall respond with a 5GSM STATUS message including 5GSM cause #43 "invalid PDU session identity".

## 7.4 Unknown or unforeseen message type

If UE receives a 5GMM message or 5GSM message with message type not defined for the extended protocol discriminator (EPD) or not implemented by the receiver, it shall return a status message (5GMM STATUS or 5GSM STATUS depending on the EPD) with cause #97 "message type non-existent or not implemented".



If the network receives a 5GMM or 5GSM message with message type not defined for the EPD or not implemented by the receiver in a protocol state where reception of an unsolicited message with the given EPD from the UE is not foreseen in the protocol, the network actions are implementation dependent. Otherwise, if the network receives a message with message type not defined for the EPD or not implemented by the receiver, it shall ignore the message except that it should return a status message (5GMM STATUS or 5GSM STATUS depending on the EPD) with cause #97 "message type non-existent or not implemented".

NOTE: A message type not defined for the EPD in the given direction is regarded by the receiver as a message type not defined for the EPD, see 3GPP TS 24.007 [11].

If the UE receives a message not compatible with the protocol state, the UE shall return a status message (5GMM STATUS or 5GSM STATUS depending on the EPD) with cause #98 "message type not compatible with protocol state".

If the network receives a message not compatible with the protocol state, the network actions are implementation dependent.

## 7.5 Non-semantic mandatory information element errors

### 7.5.1 Common procedures

When on receipt of a message,

- a) an "imperative message part" error; or
- b) a "missing mandatory IE" error

is diagnosed or when a message containing:

- a) a syntactically incorrect mandatory IE;
- b) an IE unknown in the message, but encoded as "comprehension required" (see 3GPP TS 24.007 [11]); or
- c) an out of sequence IE encoded as "comprehension required" (see 3GPP TS 24.007 [11]) is received,

the UE shall proceed as follows:

If the message is not one of the messages listed in the UE procedures in subclause 7.5.3, item a), b) or c), the UE shall return a status message (5GMM STATUS or 5GSM STATUS depending on the EPD) with cause #96 "invalid mandatory information";

the network shall proceed as follows:

If the message is not one of the messages listed in the network procedures in subclause 7.5.3, item a), b) or c), the network shall either:

- 1) try to treat the message (the exact further actions are implementation dependent); or
- 2) ignore the message except that it should return a status message (5GMM STATUS or 5GSM STATUS depending on the EPD) with cause #96 "invalid mandatory information".

### 7.5.2 5GS mobility management

No exceptional cases are described for 5GS mobility management messages.

No semantic or syntactical diagnosis other than presence and length shall be performed on the EPS NAS message container information element in the REGISTRATION REQUEST message.

### 7.5.3 5GS session management

The following UE procedures shall apply for handling an error encountered with a mandatory information element in a 5GSM message:

- a) If the message is a PDU SESSION ESTABLISHMENT ACCEPT, the UE shall initiate PDU session release procedure by sending a PDU SESSION RELEASE REQUEST message with 5GSM cause #96 "invalid mandatory information".
- b) If the message is a PDU SESSION MODIFICATION COMMAND, a PDU SESSION MODIFICATION COMMAND REJECT message with 5GSM cause #96 "invalid mandatory information" shall be returned.
- c) If the message is a PDU SESSION RELEASE COMMAND, a PDU SESSION RELEASE COMPLETE message with 5GSM cause #96 "invalid mandatory information" shall be returned.

The following network procedures shall apply for handling an error encountered with a mandatory information element in a 5GSM message:

- a) If the message is a PDU SESSION ESTABLISHMENT REQUEST, a PDU SESSION ESTABLISHMENT REJECT message with 5GSM cause #96 "invalid mandatory information" shall be returned.
- b) If the message is a PDU SESSION MODIFICATION REQUEST, a PDU SESSION MODIFICATION REJECT message with 5GSM cause #96 "invalid mandatory information" shall be returned.
- c) If the message is a PDU SESSION RELEASE REQUEST, a PDU SESSION RELEASE REJECT message with 5GSM cause #96 "invalid mandatory information" shall be returned.

## 7.6 Unknown and unforeseen IEs in the non-imperative message part

### 7.6.1 IEs unknown in the message

The UE shall ignore all IEs unknown in a message which are not encoded as "comprehension required" (see 3GPP TS 24.007 [11]).

The network shall take the same approach.

### 7.6.2 Out of sequence IEs

The UE shall ignore all out of sequence IEs in a message which are not encoded as "comprehension required" (see 3GPP TS 24.007 [11]).

The network should take the same approach.

### 7.6.3 Repeated IEs

If an information element with format T, TV, TLV, or TLV-E is repeated in a message in which repetition of the information element is not specified in clause 8 and clause 9 of the present document, the UE shall handle only the contents of the information element appearing first and shall ignore all subsequent repetitions of the information element. When repetition of information elements is specified, the UE shall handle only the contents of specified repeated information elements. If the limit on repetition of information elements is exceeded, the UE shall handle the contents of information elements appearing first up to the limit of repetitions and shall ignore all subsequent repetitions of the information element.

The network should follow the same procedures.

## 7.7 Non-imperative message part errors

This category includes:

- a) syntactically incorrect optional IEs; and
- b) conditional IE errors.

### 7.7.1 Syntactically incorrect optional IEs

The UE shall treat all optional IEs that are syntactically incorrect in a message as not present in the message.

The network shall take the same approach.

### 7.7.2 Conditional IE errors

When upon receipt of a 5GMM or 5GSM message the UE diagnoses a "missing conditional IE" error or an "unexpected conditional IE" error, or when it receives a 5GMM or 5GSM message containing at least one syntactically incorrect conditional IE, the UE shall ignore the message and shall return a status message (5GMM STATUS or 5GSM STATUS depending on the EPD) with cause #100 "conditional IE error".

When the network receives a message and diagnoses a "missing conditional IE" error or an "unexpected conditional IE" error or when it receives a message containing at least one syntactically incorrect conditional IE, the network shall either:

- a) try to treat the message (the exact further actions are implementation dependent); or
- b) ignore the message except that it should return a status message (5GMM STATUS or 5GSM STATUS depending on the EPD) with cause #100 "conditional IE error".

## 7.8 Messages with semantically incorrect contents

When a message with semantically incorrect contents is received, the UE shall perform the foreseen reactions of the procedural part of the present document (i.e. of clauses 8, 9). If, however no such reactions are specified, the UE shall ignore the message except that it shall return a status message (5GMM STATUS or 5GSM STATUS depending on the EPD) with cause #95 "semantically incorrect message".

The network should follow the same procedure except that a status message is not normally transmitted.

---

## 8 Message functional definitions and contents

### 8.1 Overview

### 8.2 5GS mobility management messages

#### 8.2.1 Authentication request

##### 8.2.1.1 Message definition

The AUTHENTICATION REQUEST message is sent by the AMF to the UE to initiate authentication of the UE identity. See table 8.2.1.1.1.

Message type: AUTHENTICATION REQUEST

Significance: dual

Direction: network to UE

**Table 8.2.1.1.1: AUTHENTICATION REQUEST message content**

IEI	Information Element	Type/Reference	Presence	Format	Length
	Extended protocol discriminator	Extended protocol discriminator 9.2	M	V	1
	Security header type	Security header type 9.3	M	V	1/2
	Spare half octet	Spare half octet 9.5	M	V	1/2
	Authentication request message identity	Message type 9.7	M	V	1
	ngKSI	NAS key set identifier 9.11.3.32	M	V	1/2
	Spare half octet	Spare half octet 9.5	M	V	1/2
	ABBA	ABBA 9.11.3.10	M	LV	3-n
21	Authentication parameter RAND (5G authentication challenge)	Authentication parameter RAND 9.11.3.16	O	TV	17
20	Authentication parameter AUTN (5G authentication challenge)	Authentication parameter AUTN 9.11.3.15	O	TLV	18
78	EAP message	EAP message 9.11.2.2	O	TLV-E	7-1503

### 8.2.1.2 Authentication parameter RAND

Authentication parameter RAND IE is included if the AUTHENTICATION REQUEST message is used in a 5G AKA authentication procedure.

### 8.2.1.3 Authentication parameter AUTN

Authentication parameter AUTN IE is included if the AUTHENTICATION REQUEST message is used in a 5G AKA authentication procedure.

### 8.2.1.4 Void

### 8.2.1.5 EAP message

EAP message IE is included if the AUTHENTICATION REQUEST message is used in an EAP based primary authentication and key agreement procedure.

## 8.2.2 Authentication response

### 8.2.2.1 Message definition

The AUTHENTICATION RESPONSE message is sent by the UE to the AMF to deliver a calculated authentication response to the network. See table 8.2.2.1.1.

Message type: AUTHENTICATION RESPONSE

Significance: dual

Direction: UE to network

**Table 8.2.2.1.1: AUTHENTICATION RESPONSE message content**

IEI	Information Element	Type/Reference	Presence	Format	Length
	Extended protocol discriminator	Extended protocol discriminator 9.2	M	V	1
	Security header type	Security header type 9.3	M	V	1/2
	Spare half octet	Spare half octet 9.5	M	V	1/2
	Authentication response message identity	Message type 9.7	M	V	1
2D	Authentication response parameter	Authentication response parameter 9.11.3.17	O	TLV	18
78	EAP message	EAP message 9.11.2.2	O	TLV-E	7-1503

### 8.2.2.2 Authentication response parameter

This IE is included if the message is sent in a 5G AKA based primary authentication and key agreement procedure.

### 8.2.2.3 EAP message

EAP message IE is included if the EAP message received in a related AUTHENTICATION REQUEST message was an EAP-request.

## 8.2.3 Authentication result

### 8.2.3.1 Message definition

The AUTHENTICATION RESULT message is sent by the AMF to the UE to provide result of EAP authentication of the UE identity. See table 8.2.3.1.1.

Message type: AUTHENTICATION RESULT

Significance: dual

Direction: network to UE

**Table 8.2.3.1.1: AUTHENTICATION RESULT message content**

IEI	Information Element	Type/Reference	Presence	Format	Length
	Extended protocol discriminator	Extended protocol discriminator 9.2	M	V	1
	Security header type	Security header type 9.3	M	V	1/2
	Spare half octet	Spare half octet 9.5	M	V	1/2
	Authentication result message identity	Message type 9.7	M	V	1
	ngKSI	NAS key set identifier 9.11.3.32	M	V	1/2
	Spare half octet	Spare half octet 9.5	M	V	1/2
	EAP message	EAP message 9.11.2.2	M	LV-E	6-1502
38	ABBA	ABBA 9.11.3.10	O	TLV	4-n

### 8.2.3.2 ABBA

This IE shall be included if the message contains an EAP message IE with an EAP-success message.

## 8.2.4 Authentication failure

### 8.2.4.1 Message definition

The AUTHENTICATION FAILURE message is sent by the UE to the AMF to indicate that authentication of the network has failed. See table 8.2.4.1.1.

Message type: AUTHENTICATION FAILURE

Significance: dual

Direction: UE to network

**Table 8.2.4.1.1: AUTHENTICATION FAILURE message content**

IEI	Information Element	Type/Reference	Presence	Format	Length
	Extended protocol discriminator	Extended protocol discriminator 9.2	M	V	1
	Security header type	Security header type 9.3	M	V	1/2
	Spare half octet	Spare half octet 9.5	M	V	1/2
	Authentication failure message identity	Message type 9.7	M	V	1
	5GMM cause	5GMM cause 9.11.3.2	M	V	1
30	Authentication failure parameter	Authentication failure parameter 9.11.3.14	O	TLV	16

### 8.2.4.2 Authentication failure parameter

This IE shall be included in a 5G AKA based primary authentication and key agreement procedure if and only if the 5GMM cause was #21 "synch failure". It shall include the response to the authentication challenge from the USIM, which is made up of the AUTS parameter (see 3GPP TS 33.501 [24]).

## 8.2.5 Authentication reject

### 8.2.5.1 Message definition

The AUTHENTICATION REJECT message is sent by the AMF to the UE to indicate that the authentication procedure has failed and that the UE shall abort all activities. See table 8.2.5.1.1.

Message type: AUTHENTICATION REJECT

Significance: dual

Direction: network to UE

**Table 8.2.5.1.1: AUTHENTICATION REJECT message content**

IEI	Information Element	Type/Reference	Presence	Format	Length
	Extended protocol discriminator	Extended protocol discriminator 9.2	M	V	1
	Security header type	Security header type 9.3	M	V	1/2
	Spare half octet	Spare half octet 9.5	M	V	1/2
	Authentication reject message identity	Message type 9.7	M	V	1
78	EAP message	EAP message 9.11.2.2	O	TLV-E	7-1503

### 8.2.5.2 EAP message

EAP message IE is included if the AUTHENTICATION REJECT message is used to convey EAP-failure message.

## 8.2.6 Registration request

### 8.2.6.1 Message definition

The REGISTRATION REQUEST message is sent by the UE to the AMF. See table 8.2.6.1.1.

Message type: REGISTRATION REQUEST

Significance: dual

Direction: UE to network

Table 8.2.6.1.1: REGISTRATION REQUEST message content

IEI	Information Element	Type/Reference	Presence	Format	Length
	Extended protocol discriminator	Extended Protocol discriminator 9.2	M	V	1
	Security header type	Security header type 9.3	M	V	1/2
	Spare half octet	Spare half octet 9.5	M	V	1/2
	Registration request message identity	Message type 9.7	M	V	1
	5GS registration type	5GS registration type 9.11.3.7	M	V	1/2
	ngKSI	NAS key set identifier 9.11.3.32	M	V	1/2
	5GS mobile identity	5GS mobile identity 9.11.3.4	M	LV-E	6-n
C-	Non-current native NAS key set identifier	NAS key set identifier 9.11.3.32	O	TV	1
10	5GMM capability	5GMM capability 9.11.3.1	O	TLV	3-15
2E	UE security capability	UE security capability 9.11.3.54	O	TLV	4-10
2F	Requested NSSAI	NSSAI 9.11.3.37	O	TLV	4-74
52	Last visited registered TAI	5GS tracking area identity 9.11.3.8	O	TV	7
17	S1 UE network capability	S1 UE network capability 9.11.3.48	O	TLV	4-15
40	Uplink data status	Uplink data status 9.11.3.57	O	TLV	4-34
50	PDU session status	PDU session status 9.11.3.44	O	TLV	4-34
B-	MICO indication	MICO indication 9.11.3.31	O	TV	1
2B	UE status	UE status 9.11.3.56	O	TLV	3
77	Additional GUTI	5GS mobile identity 9.11.3.4	O	TLV-E	14
25	Allowed PDU session status	Allowed PDU session status 9.11.3.13	O	TLV	4-34
18	UE's usage setting	UE's usage setting 9.11.3.55	O	TLV	3
51	Requested DRX parameters	5GS DRX parameters 9.11.3.2A	O	TLV	3
70	EPS NAS message container	EPS NAS message container 9.11.3.24	O	TLV-E	4-n
74	LADN indication	LADN indication 9.11.3.29	O	TLV-E	3-811
8-	Payload container type	Payload container type 9.11.3.40	O	TV	1
7B	Payload container	Payload container 9.11.3.39	O	TLV-E	4-65538
9-	Network slicing indication	Network slicing indication 9.11.3.36	O	TV	1
53	5GS update type	5GS update type 9.11.3.9A	O	TLV	3
71	NAS message container	NAS message container 9.11.3.33	O	TLV-E	4-n
60	EPS bearer context status	EPS bearer context status 9.11.3.23A	O	TLV	4



### 8.2.6.2 Non-current native NAS key set identifier

The UE shall include this IE if the UE has a valid non-current native 5G NAS security context when the UE performs a inter-system change from S1 mode to N1 mode in 5GMM-CONNECTED mode and the UE uses a mapped 5G NAS security context to protect the REGISTRATION REQUEST message.

### 8.2.6.3 5GMM capability

The UE shall include this IE, unless the UE performs a periodic registration updating procedure.

### 8.2.6.4 UE security capability

The UE shall include this IE, unless the UE performs a periodic registration updating procedure.

### 8.2.6.5 Requested NSSAI

This IE shall be included by the UE when performing the registration procedure if the 5GS registration type IE:

- a) indicates "initial registration" or "mobility registration updating", and:
  - 1) the UE has a configured NSSAI for the current PLMN;
  - 2) the UE has an allowed NSSAI for the current PLMN; or
  - 3) the UE has neither allowed NSSAI for the current PLMN nor configured NSSAI for the current PLMN and has a default configured NSSAI.

### 8.2.6.6 Last visited registered TAI

This IE shall be included if the UE holds a valid last visited registered TAI.

### 8.2.6.7 S1 UE network capability

A UE supporting S1 mode shall include this IE, unless the UE performs a periodic registration updating procedure.

### 8.2.6.8 Uplink data status

This IE shall be included if the UE has uplink user data pending to be sent.

### 8.2.6.9 PDU session status

This IE shall be included when the UE needs to indicate the PDU sessions that are associated with the access type that the message is sent over, that are active within the UE.

### 8.2.6.10 MICO indication

The UE may include this IE to request the use of MICO mode.

### 8.2.6.11 UE status

This IE shall be included if the UE in single-registration mode performs the registration procedure due to inter-system change from S1 mode to N1 mode or if the UE in dual-registration mode and EMM state EMM-REGISTERED performs initial registration.

### 8.2.6.12 Additional GUTI

This IE shall be included if the UE performs the registration procedure due to inter-system change from S1 mode to N1 mode, the UE operates in single-registration mode and the UE has a 5G-GUTI.

### 8.2.6.13 Allowed PDU session status

This IE shall be included if the REGISTRATION REQUEST message is sent as a response to paging with the access type indicating non-3GPP access and the UE wants to indicate the user-plane resources of PDU session(s) associated with non-3GPP access allowed to be re-established over 3GPP access.

### 8.2.6.14 UE's usage setting

This IE shall be included if the UE supports IMS voice.

### 8.2.6.15 Requested DRX parameters

If the UE wants to use or change the UE specific DRX parameters, the UE shall include the Requested DRX parameters IE in the REGISTRATION REQUEST message.

### 8.2.6.16 EPS NAS message container

The UE operating in the single-registration mode shall include this information element if the UE performs mobility from S1 mode to N1 mode. The content of this message container is the complete integrity protected TRACKING AREA UPDATE REQUEST message, using EPS NAS security context.

### 8.2.6.17 LADN indication

The UE shall include this information element when the UE needs to request LADN information for specific LADN DNN(s) or to indicate a request for LADN information.

### 8.2.6.17A Payload container type

This IE shall be included if the UE includes the Payload container IE.

NOTE: In this version of the protocol, the Payload container type IE in the REGISTRATION REQUEST message is set to "UE policy container" as described in subclauses 5.5.1.2.2 and 5.5.1.3.2.

### 8.2.6.18 Payload container

This IE shall be included if the UE has one or more stored UE policy sections identified by a UPSI with the PLMN ID part indicating the HPLMN or the selected PLMN for the registration procedure for mobility and periodic registration update due to inter-system change from S1 mode to N1 mode of a UE operating in the single-registration mode or for the registration procedure for initial registration.

### 8.2.6.19 Network slicing indication

This IE shall be included when a requested NSSAI is included in the REGISTRATION REQUEST message and the requested NSSAI is created from the default configured NSSAI.

### 8.2.6.20 5GS update type

This IE shall be included when the UE is performing the registration procedure to indicate any of the following:

- a) the UE requests the use of SMS over NAS or there is a change in the UE's requirements to use SMS over NAS;  
or
- b) a change in the UE's radio capability for NG-RAN.

### 8.2.6.21 NAS message container

This IE shall be included if the UE is sending a REGISTRATION REQUEST message as an initial NAS message, the UE has a valid 5G NAS security context and the UE needs to send non-cleartext IEs.

### 8.2.6.22 EPS bearer context status

The UE shall include this IE if the UE operating in the single-registration mode performs inter-system change from S1 mode to N1 mode and the UE has locally deactivated EPS bearer context(s) for which interworking to 5GS is supported while the UE was in S1 mode without notifying the network.

## 8.2.7 Registration accept

### 8.2.7.1 Message definition

The REGISTRATION ACCEPT message is sent by the AMF to the UE. See table 8.2.7.1.1.

Message type: REGISTRATION ACCEPT

Significance: dual

Direction: network to UE

**Table 8.2.7.1.1: REGISTRATION ACCEPT message content**

IEI	Information Element	Type/Reference	Presence	Format	Length
	Extended protocol discriminator	Extended protocol discriminator 9.2	M	V	1
	Security header type	Security header type 9.3	M	V	1/2
	Spare half octet	Spare half octet 9.5	M	V	1/2
	Registration accept message identity	Message type 9.7	M	V	1
	5GS registration result	5GS registration result 9.11.3.6	M	LV	2
77	5G-GUTI	5GS mobile identity 9.11.3.4	O	TLV-E	14
4A	Equivalent PLMNs	PLMN list 9.11.3.45	O	TLV	5-47
54	TAI list	5GS tracking area identity list 9.11.3.9	O	TLV	9-114
15	Allowed NSSAI	NSSAI 9.11.3.37	O	TLV	4-74
11	Rejected NSSAI	Rejected NSSAI 9.11.3.46	O	TLV	4-42
31	Configured NSSAI	NSSAI 9.11.3.37	O	TLV	4-146
21	5GS network feature support	5GS network feature support 9.11.3.5	O	TLV	3-5
50	PDU session status	PDU session status 9.11.3.44	O	TLV	4-34
26	PDU session reactivation result	PDU session reactivation result 9.11.3.42	O	TLV	4-34
72	PDU session reactivation result error cause	PDU session reactivation result error cause 9.11.3.43	O	TLV-E	5-515
79	LADN information	LADN information 9.11.3.30	O	TLV-E	12-1715
B-	MICO indication	MICO indication 9.11.3.31	O	TV	1
9-	Network slicing indication	Network slicing indication 9.11.3.36	O	TV	1
27	Service area list	Service area list 9.11.3.49	O	TLV	6-114
5E	T3512 value	GPRS timer 3 9.11.2.5	O	TLV	3
5D	Non-3GPP de-registration timer value	GPRS timer 2 9.11.2.4	O	TLV	3
16	T3502 value	GPRS timer 2 9.11.2.4	O	TLV	3
34	Emergency number list	Emergency number list 9.11.3.23	O	TLV	5-50
7A	Extended emergency number list	Extended emergency number list 9.11.3.26	O	TLV-E	7-65538
73	SOR transparent container	SOR transparent container 9.11.3.51	O	TLV-E	20-2048
78	EAP message	EAP message 9.11.2.2	O	TLV-E	7-1503
A-	NSSAI inclusion mode	NSSAI inclusion mode 9.11.3.37A	O	TV	1
76	Operator-defined access category definitions	Operator-defined access category definitions 9.11.3.38	O	TLV-E	3-n
51	Negotiated DRX parameters	5GS DRX parameters 9.11.3.2A	O	TLV	3
D-	Non-3GPP NW policies	Non-3GPP NW provided policies 9.11.3.36A	O	TV	1
60	EPS bearer context status	EPS bearer context status 9.11.3.23A	O	TLV	4

### 8.2.7.2 5G-GUTI

This IE may be included to assign a 5G-GUTI to a UE.

### 8.2.7.3 Equivalent PLMNs

This IE may be included in order to assign a new equivalent PLMNs list to a UE.

### 8.2.7.4 TAI list

This IE may be included to assign a TAI list to a UE.

### 8.2.7.5 Allowed NSSAI

This IE shall be included:

- a) if the network allows one or more S-NSSAIs received in the requested NSSAI of the REGISTRATION REQUEST message; or
- b) if the requested NSSAI was not included in the REGISTRATION REQUEST message or none of the requested NSSAI are present in the subscribed S-NSSAIs and the network has one or more subscribed S-NSSAIs marked as default that are available.

### 8.2.7.6 Rejected NSSAI

The network may include this IE to inform the UE of the S-NSSAIs that were included in the requested NSSAI in the REGISTRATION REQUEST message but were rejected by the network.

### 8.2.7.7 Configured NSSAI

The network may include this IE if the network needs to provide the UE with a new configured NSSAI for the current PLMN.

### 8.2.7.8 5GS network feature support

The network may include this IE to inform the UE of the support of certain features. If this IE is not included then the UE shall interpret this as a receipt of an information element with all bits of the value part coded as zero.

### 8.2.7.9 PDU session status

This IE shall be included when the network needs to indicate the PDU sessions that are associated with the access type the message is sent over, that are active in the network.

### 8.2.7.10 PDU session reactivation result

This IE shall be included:

- if the Uplink data status IE is included in the REGISTRATION REQUEST message;
- if the Allowed PDU session status IE is included in the REGISTRATION REQUEST message and there is at least one PDU session indicated in the Allowed PDU session status IE for which the user-plane resources can be re-established over 3GPP access.

### 8.2.7.11 PDU session reactivation result error cause

This IE may be included, if the PDU session reactivation result IE is included and there exist one or more PDU sessions for which the user-plane resources cannot be re-established, to indicate the cause of failure to re-establish the user-plane resources

#### 8.2.7.12 LADN information

The network shall include this IE if there are valid LADN service area(s) for the subscribed DNN(s) of the UE in the current registration area.

#### 8.2.7.13 MICO indication

The network shall include the MICO indication IE if:

- a)- the UE included the MICO indication IE in the REGISTRATION REQUEST message; and
- b) the network supports and accepts the use of MICO mode.

#### 8.2.7.14 Network slicing indication

This IE shall be included if the user's network slicing subscription has changed in the UDM.

#### 8.2.7.15 Service area list

This IE may be included to assign new service area restrictions to the UE.

#### 8.2.7.16 T3512 value

The AMF shall include this IE during a registration procedure over 3GPP access when the 5GS registration type IE does not indicate "periodic registration updating". The AMF may include this IE during the mobility and periodic registration update procedure over 3GPP access when the 5GS registration type IE indicates "periodic registration updating".

#### 8.2.7.17 Non-3GPP de-registration timer value

This IE may be included if the network needs to indicate to the UE registered over non-3GPP access the value of a non-3GPP de-registration timer value.

#### 8.2.7.18 T3502 value

This IE may be included to indicate a value for timer T3502.

#### 8.2.7.19 Emergency number list

This IE may be sent by the network. If this IE is sent, the contents of this IE indicates a list of emergency numbers valid within the same country as in the PLMN from which this IE is received.

#### 8.2.7.20 Extended emergency number list

This IE may be sent by the network. If this IE is sent, the contents of this IE indicates a list of emergency numbers (with URN information) valid within the same country as in the PLMN from which this IE is received or valid only in the PLMN from which this IE is received.

#### 8.2.7.21 SOR transparent container

This IE may be sent by the network. If this IE is sent, the contents of this IE includes the list of preferred PLMN/access technology combinations (or HPLMN indication that 'no change of the "Operator Controlled PLMN Selector with Access Technology" list stored in the UE is needed and thus no list of preferred PLMN/access technology combinations is provided') (see 3GPP TS 23.122 [5] annex C) and optional acknowledgement request.

#### 8.2.7.22 EAP message

EAP message IE is included if the REGISTRATION ACCEPT message is sent as part of registration for emergency services and is used to convey EAP-failure message.

### 8.2.7.23 NSSAI inclusion mode

This IE shall be included if required by operatory policy.

### 8.2.7.24 Operator-defined access category definitions

This IE may be included to assign new operator-defined access category definitions to the UE or delete the operator-defined access category definitions at the UE side.

### 8.2.7.25 Negotiated DRX parameters

The network shall include this IE if the Requested DRX parameters IE was included in the REGISTRATION REQUEST message.

### 8.2.7.26 Non-3GPP NW provided policies

The AMF shall not include this IE during a registration procedure over non-3GPP access.

This IE is included if the network needs to indicate whether emergency numbers provided via non-3GPP access can be used to initiate UE detected emergency calls (see 3GPP TS 24.302 [16]). If this IE is not included then the UE shall interpret this as a receipt of an information element with all bits of the value part coded as zero.

NOTE: In this version of the specification, this IE is applicable in case the UE is connected to a PLMN using an ePDG as specified in 3GPP TS 24.302 [16].

### 8.2.7.27 EPS bearer context status

This IE shall be included when the network generated an EPS bearer context status information for the UE during the inter-system change from S1 mode to N1 mode and the network supports N26 interface.

## 8.2.8 Registration complete

### 8.2.8.1 Message definition

The REGISTRATION COMPLETE message is sent by the UE to the AMF. See table 8.2.8.1.1.

Message type: REGISTRATION COMPLETE

Significance: dual

Direction: UE to network

**Table 8.2.8.1.1: REGISTRATION COMPLETE message content**

IEI	Information Element	Type/Reference	Presence	Format	Length
	Extended protocol discriminator	Extended protocol discriminator 9.2	M	V	1
	Security header type	Security header type 9.3	M	V	1/2
	Spare half octet	Spare half octet 9.5	M	V	1/2
	Registration complete message identity	Message type 9.7	M	V	1
73	SOR transparent container	SOR transparent container 9.11.3.51	O	TLV-E	20-2048

### 8.2.8.2 SOR transparent container

This IE may be sent by the UE. If this IE is sent, the contents of this IE indicates the UE acknowledgement of successful reception of the SOR transparent container IE in the REGISTRATION ACCEPT message.



## 8.2.9 Registration reject

### 8.2.9.1 Message definition

The REGISTRATION REJECT message is sent by the AMF to the UE. See table 8.2.9.1.1.

Message type: REGISTRATION REJECT

Significance: dual

Direction: network to UE

**Table 8.2.9.1.1: REGISTRATION REJECT message content**

IEI	Information Element	Type/Reference	Presence	Format	Length
	Extended protocol discriminator	Extended protocol discriminator 9.2	M	V	1
	Security header type	Security header type 9.3	M	V	1/2
	Spare half octet	Spare half octet 9.5	M	V	1/2
	Registration reject message identity	Message type 9.7	M	V	1
	5GMM cause	5GMM cause 9.11.3.2	M	V	1
5F	T3346 value	GPRS timer 2 9.11.2.4	O	TLV	3
16	T3502 value	GPRS timer 2 9.11.2.4	O	TLV	3
78	EAP message	EAP message 9.11.2.2	O	TLV-E	7-1503

### 8.2.9.2 T3346 value

The AMF may include this IE when the general NAS level mobility management congestion control is active

### 8.2.9.3 T3502 value

This IE may be included to indicate a value for timer T3502 during the initial registration.

### 8.2.9.4 EAP message

EAP message IE is included if the REGISTRATION REJECT message is used to convey EAP-failure message.

## 8.2.10 UL NAS transport

### 8.2.10.1 Message definition

The UL NAS TRANSPORT message transports message payload and associated information to the AMF. See table 8.2.10.1.1.

Message type: UL NAS TRANSPORT

Significance: dual

Direction: UE to network

**Table 8.2.10.1.1: UL NAS TRANSPORT message content**

IEI	Information Element	Type/Reference	Presence	Format	Length
	Extended protocol discriminator	Extended protocol discriminator 9.2	M	V	1
	Security header type	Security header type 9.3	M	V	1/2
	Spare half octet	Spare half octet 9.5	M	V	1/2
	UL NAS TRANSPORT message identity	Message type 9.7	M	V	1
	Payload container type	Payload container type 9.11.3.40	M	V	1/2
	Spare half octet	Spare half octet 9.5	M	V	1/2
	Payload container	Payload container 9.11.3.39	M	LV-E	3-65537
12	PDU session ID	PDU session identity 2 9.11.3.41	C	TV	2
59	Old PDU session ID	PDU session identity 2 9.11.3.41	O	TV	2
8	Request type	Request type 9.11.3.47	O	TV	1
22	S-NSSAI	S-NSSAI 9.11.2.8	O	TLV	3-10
25	DNN	DNN 9.11.2.1A	O	TLV	3-102
24	Additional information	Additional information 9.11.2.1	O	TLV	3-n

### 8.2.10.2 PDU session ID

The UE shall include this IE when the Payload container type IE is set to "N1 SM information".

### 8.2.10.3 Old PDU session ID

The UE shall include this IE if the UL NAS TRANSPORT message transports a PDU SESSION ESTABLISHMENT REQUEST message upon receiving the PDU SESSION MODIFICATION COMMAND message with the 5GSM cause IE set to #39 "reactivation requested" and the Payload container type IE is set to "N1 SM information".

### 8.2.10.4 Request type

The UE shall include this IE when the PDU session ID IE is included and the Payload container IE contains the PDU SESSION ESTABLISHMENT REQUEST message or the PDU SESSION MODIFICATION REQUEST which is not initiated to indicate a change of 3GPP PS data off UE status associated to a PDU session.

### 8.2.10.5 S-NSSAI

The UE may include this IE when the Request type IE is set to "initial request" or "existing PDU session" and the Payload container type IE is set to "N1 SM information".

### 8.2.10.6 DNN

The UE may include this IE when the Request type IE is set to "initial request" or "existing PDU session" and the Payload container type IE is set to "N1 SM information".

### 8.2.10.7 Additional information

The UE may include this IE when the Payload container type IE is set to "LTE Positioning Protocol (LPP) message container".

## 8.2.11 DL NAS transport

### 8.2.11.1 Message definition

The DL NAS TRANSPORT message transports message payload and associated information to the UE. See table 8.2.11.1.1.

Message type: DL NAS TRANSPORT

Significance: dual

Direction: network to UE

**Table 8.2.11.1.1: DL NAS TRANSPORT message content**

IEI	Information Element	Type/Reference	Presence	Format	Length
	Extended protocol discriminator	Extended protocol discriminator 9.2	M	V	1
	Security header type	Security header type 9.3	M	V	1/2
	Spare half octet	Spare half octet 9.5	M	V	1/2
	DL NAS TRANSPORT message identity	Message type 9.7	M	V	1
	Payload container type	Payload container type 9.11.3.40	M	V	1/2
	Spare half octet	Spare half octet 9.5	M	V	1/2
	Payload container	Payload container 9.11.3.39	M	LV-E	3-65537
12	PDU session ID	PDU session identity 2 9.11.3.41	C	TV	2
24	Additional information	Additional information 9.11.2.1	O	TLV	3-n
58	5GMM cause	5GMM cause 9.11.3.2	O	TV	2
37	Back-off timer value	GPRS timer 3 9.11.2.5	O	TLV	3

#### 8.2.11.2 PDU session ID

The AMF shall include this IE when the Payload container type IE is set to "N1 SM information".

#### 8.2.11.3 Additional information

The AMF may include this IE when the Payload container type IE is set to "LTE Positioning Protocol (LPP) message container".

#### 8.2.11.4 5GMM cause

The AMF shall include this IE when the Payload container IE contains an uplink payload which was not forwarded and the Payload container type IE is not set to "Multiple payloads".

#### 8.2.11.5 Back-off timer value

The AMF shall include this IE when the Payload container IE contains an uplink 5GSM message which was not forwarded due to DNN based congestion control, S-NSSAI and DNN based congestion control or S-NSSAI only based congestion control and the Payload container type IE is not set to "Multiple payloads".

## 8.2.12 De-registration request (UE originating de-registration)

### 8.2.12.1 Message definition

The DEREGISTRATION REQUEST message is sent by the UE to the AMF. See table 8.2.12.1.1.

Message type: DEREGISTRATION REQUEST

Significance: dual

Direction: UE to network

**Table 8.2.12.1.1: DEREGISTRATION REQUEST message content**

IEI	Information Element	Type/Reference	Presence	Format	Length
	Extended protocol discriminator	Extended protocol discriminator 9.2	M	V	1
	Security header type	Security header type 9.3	M	V	1/2
	Spare half octet	Spare half octet 9.5	M	V	1/2
	De-registration request message identity	Message type 9.7	M	V	1
	De-registration type	De-registration type 9.11.3.20	M	V	1/2
	ngKSI	NAS key set identifier 9.11.3.32	M	V	1/2
	5GS mobile identity	5GS mobile identity 9.11.3.4	M	LV-E	6-n

## 8.2.13 De-registration accept (UE originating de-registration)

### 8.2.13.1 Message definition

The DEREGISTRATION ACCEPT message is sent by the AMF to the UE. See table 8.2.13.1.1.

Message type: DEREGISTRATION ACCEPT

Significance: dual

Direction: network to UE

**Table 8.2.13.1.1: DEREGISTRATION ACCEPT message content**

IEI	Information Element	Type/Reference	Presence	Format	Length
	Extended protocol discriminator	Extended protocol discriminator 9.2	M	V	1
	Security header type	Security header type 9.3	M	V	1/2
	Spare half octet	Spare half octet 9.5	M	V	1/2
	De-registration accept message identity	Message type 9.7	M	V	1

## 8.2.14 De-registration request (UE terminated de-registration)

### 8.2.14.1 Message definition

The DEREGISTRATION REQUEST message is sent by the AMF to the UE. See table 8.2.14.1.1.

Message type: DEREGISTRATION REQUEST

Significance: dual

Direction: network to UE

**Table 8.2.14.1.1: DEREGISTRATION REQUEST message content**

IEI	Information Element	Type/Reference	Presence	Format	Length
	Extended protocol discriminator	Extended protocol discriminator 9.2	M	V	1
	Security header type	Security header type 9.3	M	V	1/2
	Spare half octet	Spare half octet 9.5	M	V	1/2
	De-registration request message identity	Message type 9.7	M	V	1
	De-registration type	De-registration type 9.11.3.20	M	V	1/2
	Spare half octet	Spare half octet 9.5	M	V	1/2
58	5GMM cause	5GMM cause 9.11.3.2	O	TV	2
5F	T3346 value	GPRS timer 2 9.11.2.4	O	TLV	3

### 8.2.14.2 5GMM cause

This information element is included if a 5GMM cause is provided.

### 8.2.14.3 T3346 value

The AMF may include this IE when the general NAS level mobility management congestion control is active.

## 8.2.15 De-registration accept (UE terminated de-registration)

### 8.2.15.1 Message definition

The DEREGISTRATION ACCEPT message is sent by the UE to the AMF. See table 8.2.15.1.1.

Message type: DEREGISTRATION ACCEPT

Significance: dual

Direction: UE to network

**Table 8.2.15.1.1.1: DEREGISTRATION ACCEPT message content**

IEI	Information Element	Type/Reference	Presence	Format	Length
	Extended protocol discriminator	Extended protocol discriminator 9.2	M	V	1
	Security header type	Security header type 9.3	M	V	1/2
	Spare half octet	Spare half octet 9.5	M	V	1/2
	De-registration accept message identity	Message type 9.7	M	V	1

## 8.2.16 Service request

### 8.2.16.1 Message definition

The SERVICE REQUEST message is sent by the UE to the AMF in order to request the establishment of an N1 NAS signalling connection and/or to request the establishment of user-plane resources for PDU sessions which are established without user-plane resources. See table 8.2.16.1.1.

Message type: SERVICE REQUEST

Significance: dual

Direction: UE to network

**Table 8.2.16.1.1: SERVICE REQUEST message content**

IEI	Information Element	Type/Reference	Presence	Format	Length
	Extended protocol discriminator	Extended protocol discriminator 9.2	M	V	1
	Security header type	Security header type 9.3	M	V	1/2
	Spare half octet	Spare half octet 9.5	M	V	1/2
	Service request message identity	Message type 9.7	M	V	1
	ngKSI	NAS key set identifier 9.11.3.32	M	V	1/2
	Service type	Service type 9.11.3.50	M	V	1/2
	5G-S-TMSI	5GS mobile identity 9.11.3.4	M	LV-E	9
40	Uplink data status	Uplink data status 9.11.3.57	O	TLV	4-34
50	PDU session status	PDU session status 9.11.3.44	O	TLV	4-34
25	Allowed PDU session status	Allowed PDU session status 9.11.3.13	O	TLV	4-34
71	NAS message container	NAS message container 9.11.3.33	O	TLV-E	4-n

### 8.2.16.2 Uplink data status

This IE shall be included if the UE has uplink user data pending to be sent.

### 8.2.16.3 PDU session status

This IE shall be included when the UE needs to indicate the PDU sessions that are associated with the access type that the message is sent over, that are active within the UE.

### 8.2.16.4 Allowed PDU session status

This IE shall be included if the SERVICE REQUEST message is sent as a response to paging or notification via 3GPP access for PDU session(s) associated with non-3GPP access and the UE needs to indicate the user-plane resources of PDU session(s) associated with non-3GPP access allowed to be re-established over 3GPP access or if there is no PDU session(s) for which the UE allows the user-plane resources to be re-established over 3GPP access.

### 8.2.16.5 NAS message container

This IE shall be included if the UE is sending a SERVICE REQUEST message as an initial NAS message and the UE needs to send non-cleartext IEs.

## 8.2.17 Service accept

### 8.2.17.1 Message definition

The SERVICE ACCEPT message is sent by the AMF to the UE in order to accept the service request procedure. See table 8.2.17.1.1.

Message type: SERVICE ACCEPT

Significance: dual

Direction: network to UE

**Table 8.2.17.1.1: SERVICE ACCEPT message content**

IEI	Information Element	Type/Reference	Presence	Format	Length
	Extended protocol discriminator	Extended protocol discriminator 9.2	M	V	1
	Security header type	Security header type 9.3	M	V	1/2
	Spare half octet	Spare half octet 9.5	M	V	1/2
	Service accept message identity	Message type 9.7	M	V	1
50	PDU session status	PDU session status 9.11.3.44	O	TLV	4-34
26	PDU session reactivation result	PDU session reactivation result 9.11.3.42	O	TLV	4-34
72	PDU session reactivation result error cause	PDU session reactivation result error cause 9.11.3.43	O	TLV-E	5-515
78	EAP message	EAP message 9.11.2.2	O	TLV-E	7-1503

### 8.2.17.2 PDU session status

This IE shall be included when the network needs to indicate the PDU sessions that are associated with the access type that the message is sent over that are active within the network.

### 8.2.17.3 PDU session reactivation result

This IE shall be included:

- if the Uplink data status IE is included in the SERVICE REQUEST message;
- if the Allowed PDU session status IE is included in the SERVICE REQUEST message and there is at least one PDU session indicated in the Allowed PDU session status IE for which user-plane resources can be re-established over 3GPP access.

### 8.2.17.4 PDU session reactivation result error cause

This IE may be included if the PDU session reactivation result IE is included and there exist one or more PDU sessions for which the user-plane resources cannot be re-established, to indicate the cause of failure to re-establish the user-plane resources.

### 8.2.17.5 EAP message

EAP message IE is included if the SERVICE ACCEPT message is sent to a UE registered for emergency services and is used to convey EAP-failure message.

## 8.2.18 Service reject

### 8.2.18.1 Message definition

The SERVICE REJECT message is sent by the AMF to the UE in order to reject the service request procedure. See table 8.2.18.1.1.

Message type: SERVICE REJECT

Significance: dual

Direction: network to UE

**Table 8.2.18.1.1: SERVICE REJECT message content**

IEI	Information Element	Type/Reference	Presence	Format	Length
	Extended protocol discriminator	Extended protocol discriminator 9.2	M	V	1
	Security header type	Security header type 9.3	M	V	1/2
	Spare half octet	Spare half octet 9.5	M	V	1/2
	Service reject message identity	Message type 9.7	M	V	1
	5GMM cause	5GMM cause 9.11.3.2	M	V	1
50	PDU session status	PDU session status 9.11.3.44	O	TLV	4-34
5F	T3346 value	GPRS timer 2 9.11.2.4	O	TLV	3
78	EAP message	EAP message 9.11.2.2	O	TLV-E	7-1503

### 8.2.18.2 PDU session status

This IE shall be included when the network needs to indicate the PDU sessions that are associated with the access type that the message is sent over, that are active within the network.

### 8.2.18.3 T3346 value

The AMF may include this IE when the general NAS level mobility management congestion control is active.

### 8.2.18.4 EAP message

EAP message IE is included if the SERVICE REJECT message is used to convey EAP-failure message.

## 8.2.19 Configuration update command

### 8.2.19.1 Message definition

The CONFIGURATION UPDATE COMMAND message is sent by the AMF to the UE. See table 8.2.19.1.1.

Message type: CONFIGURATION UPDATE COMMAND

Significance: dual

Direction: network to UE



**Table 8.2.19.1.1: CONFIGURATION UPDATE COMMAND message content**

IEI	Information Element	Type/Reference	Presence	Format	Length
	Extended protocol discriminator	Extended protocol discriminator 9.2	M	V	1
	Security header type	Security header type 9.3	M	V	1/2
	Spare half octet	Spare half octet 9.5	M	V	1/2
	Configuration update command message identity	Message type 9.7	M	V	1
D-	Configuration update indication	Configuration update indication 9.11.3.18	O	TV	1
77	5G-GUTI	5GS mobile identity 9.11.3.4	O	TLV-E	14
54	TAI list	5GS tracking area identity list 9.11.3.9	O	TLV	9-114
15	Allowed NSSAI	NSSAI 9.11.3.37	O	TLV	4-74
27	Service area list	Service area list 9.11.3.49	O	TLV	6-114
43	Full name for network	Network name 9.11.3.35	O	TLV	3-n
45	Short name for network	Network name 9.11.3.35	O	TLV	3-n
46	Local time zone	Time zone 9.11.3.52	O	TV	2
47	Universal time and local time zone	Time zone and time 9.11.3.53	O	TV	8
49	Network daylight saving time	Daylight saving time 9.11.3.19	O	TLV	3
79	LADN information	LADN information 9.11.3.30	O	TLV-E	3-1715
B-	MICO indication	MICO indication 9.11.3.31	O	TV	1
9-	Network slicing indication	Network slicing indication 9.11.3.36	O	TV	1
31	Configured NSSAI	NSSAI 9.11.3.37	O	TLV	4-146
11	Rejected NSSAI	Rejected NSSAI 9.11.3.46	O	TLV	4-42
76	Operator-defined access category definitions	Operator-defined access category definitions 9.11.3.38	O	TLV-E	3-n
F-	SMS indication	SMS indication 9.11.3.50A	O	TV	1

### 8.2.19.2 Configuration update indication

The AMF shall include this IE if the AMF needs to request an acknowledgement or a registration procedure from the UE.

### 8.2.19.3 5G-GUTI

This IE may be included to assign a new 5G GUTI to the UE.

### 8.2.19.4 TAI list

This IE may be included to assign a new TAI list to the UE.

### 8.2.19.5 Allowed NSSAI

This IE may be included to assign a new allowed NSSAI to the UE.

#### 8.2.19.6 Service area list

This IE may be included to assign a new service area list to the UE.

#### 8.2.19.7 Full name for network

This IE may be included to assign a new full name for network to the UE.

#### 8.2.19.8 Short name for network

This IE may be included to assign a new short name for network to the UE.

#### 8.2.19.9 Local time zone

This IE may be included to assign a new local time zone to the UE.

#### 8.2.19.10 Universal time and local time zone

This IE may be included to assign new universal time and local time zone to the UE.

#### 8.2.19.11 Network daylight saving time

This IE may be included to assign new network daylight saving time to the UE.

#### 8.2.19.12 LADN information

This IE may be included to assign new LADN information to the UE or delete the LADN information at the UE side.

#### 8.2.19.13 MICO indication

This IE may be included to request the UE to re-negotiate MICO mode.

#### 8.2.19.14 Network slicing indication

This IE shall be included if the user's network slicing subscription has changed in the UDM.

#### 8.2.19.15 Configured NSSAI

The AMF shall include this IE when the AMF needs to provide the UE with a new configured NSSAI for the current PLMN.

#### 8.2.19.16 Rejected NSSAI

The network may include this IE to inform the UE of the S-NSSAIs that were previously sent to the UE in the allowed NSSAI, but are now considered to be rejected by the network.

#### 8.2.19.17 Operator-defined access category definitions

This IE may be included to assign new operator-defined access category definitions to the UE or delete the operator-defined access category definitions at the UE side.

#### 8.2.19.18 SMS indication

This IE may be included to indicate that the ability for the UE to use SMS over NAS has changed.

## 8.2.20 Configuration update complete

### 8.2.20.1 Message definition

The CONFIGURATION UPDATE COMPLETE message is sent by the UE to the AMF. See table 8.2.20.1.1.

Message type: CONFIGURATION UPDATE COMPLETE

Significance: dual

Direction: UE to network

**Table 8.2.20.1.1: CONFIGURATION UPDATE COMPLETE message content**

IEI	Information Element	Type/Reference	Presence	Format	Length
	Extended protocol discriminator	Extended protocol discriminator 9.2	M	V	1
	Security header type	Security header type 9.3	M	V	1/2
	Spare half octet	Spare half octet 9.5	M	V	1/2
	Configuration update complete message identity	Message type 9.7	M	V	1

## 8.2.21 Identity request

### 8.2.21.1 Message definition

The IDENTITY REQUEST message is sent by the AMF to the UE to request the UE to provide specified identity. See table 8.2.21.1.1

Message type: IDENTITY REQUEST

Significance: dual

Direction: AMF to UE

**Table 8.2.21.1.1: IDENTITY REQUEST message content**

IEI	Information Element	Type/Reference	Presence	Format	Length
	Extended protocol discriminator	Extended protocol discriminator 9.2	M	V	1
	Security header type	Security header type 9.3	M	V	1/2
	Spare half octet	Spare half octet 9.5	M	V	1/2
	Identity request message identity	Message type 9.7	M	V	1
	Identity type	5GS identity type 9.11.3.3	M	V	1/2
	Spare half octet	Spare half octet 9.5	M	V	1/2

## 8.2.22 Identity response

### 8.2.22.1 Message definition

The IDENTITY RESPONSE message is sent by the UE to the AMF to provide the requested identity. See table 8.2.22.1.

Message type: IDENTITY RESPONSE

Significance: dual

Direction: UE to AMF

**Table 8.2.22.1.1: IDENTITY RESPONSE message content**

IEI	Information Element	Type/Reference	Presence	Format	Length
	Extended protocol discriminator	Extended protocol discriminator 9.2	M	V	1
	Security header type	Security header type 9.3	M	V	1/2
	Spare half octet	Spare half octet 9.5	M	V	1/2
	Identity response message identity	Message type 9.7	M	V	1
	Mobile identity	5GS mobile identity 9.11.3.4	M	LV-E	3-n

## 8.2.23 Notification

### 8.2.23.1 Message definition

The NOTIFICATION message is sent by the AMF to the UE to notify the UE to initiate a service request procedure. See table 8.2.23.1.1.

Message type: NOTIFICATION

Significance: dual

Direction: network to UE

**Table 8.2.23.1.1: NOTIFICATION message content**

IEI	Information Element	Type/Reference	Presence	Format	Length
	Extended protocol discriminator	Extended protocol discriminator 9.2	M	V	1
	Security header type	Security header type 9.3	M	V	1/2
	Spare half octet	Spare half octet 9.5	M	V	1/2
	Notification message identity	Message type 9.7	M	V	1
	Access type	Access type 9.11.3.11	M	V	1/2
	Spare half octet	Spare half octet 9.5	M	V	1/2

## 8.2.24 Notification response

### 8.2.24.1 Message definition

The NOTIFICATION RESPONSE message is sent by the UE to the AMF to notify the failure to initiate the service request procedure as a response of notification. See table 8.2.24.1.1.

Message type: NOTIFICATION RESPONSE

Significance: dual

Direction: UE to network

**Table 8.2.2341.1: NOTIFICATION RESPONSE message content**

IEI	Information Element	Type/Reference	Presence	Format	Length
	Extended protocol discriminator	Extended protocol discriminator 9.2	M	V	1
	Security header type	Security header type 9.3	M	V	1/2
	Spare half octet	Spare half octet 9.5	M	V	1/2
	Notification response message identity	Message type 9.7	M	V	1
50	PDU session status	PDU session status 9.11.3.44	O	TLV	4-34

### 8.2.24.2 PDU session status

This information element shall be included when the UE needs to indicate over non-3GPP access the type of the PDU sessions that are associated with the 3GPP access type that are active within the UE.

## 8.2.25 Security mode command

### 8.2.25.1 Message definition

The SECURITY MODE COMMAND message is sent by the AMF to the UE to establish NAS signalling security. See table 8.2.25.1.1.

Message type: SECURITY MODE COMMAND

Significance: dual

Direction: network to UE

**Table 8.2.25.1.1: SECURITY MODE COMMAND message content**

IEI	Information Element	Type/Reference	Presence	Format	Length
	Extended protocol discriminator	Extended protocol discriminator 9.2	M	V	1
	Security header type	Security header type 9.3	M	V	1/2
	Spare half octet	Spare half octet 9.5	M	V	1/2
	Security mode command message identity	Message type 9.7	M	V	1
	Selected NAS security algorithms	NAS security algorithms 9.11.3.34	M	V	1
	ngKSI	NAS key set identifier 9.11.3.32	M	V	1/2
	Spare half octet	Spare half octet 9.5	M	V	1/2
	Replayed UE security capabilities	UE security capability 9.11.3.54	M	LV	3-9
E-	IMEISV request	IMEISV request 9.11.3.28	O	TV	1
57	Selected EPS NAS security algorithms	EPS NAS security algorithms 9.11.3.25	O	TV	2
36	Additional 5G security information	Additional 5G security information 9.11.3.12	O	TLV	3
78	EAP message	EAP message 9.11.2.2	O	TLV-E	7-1503
38	ABBA	ABBA 9.11.3.10	O	TLV	4-n
19	Replayed S1 UE security capabilities	S1 UE security capability 9.11.3.48A	O	TLV	4-7

### 8.2.25.2 IMEISV request

The AMF may include this information element to request the UE to send its IMEISV with the corresponding SECURITY MODE COMPLETE message.

### 8.2.25.3 Void

### 8.2.25.4 Selected EPS NAS security algorithms

This IE shall be included if the AMF supports N26 interface and the UE set the S1 mode bit to "S1 mode supported" in the 5GMM capability IE of the REGISTRATION REQUEST message.

### 8.2.25.5 Additional 5G security information

The network shall include this IE if:

- a) the network needs to provide the UE with horizontal derivation parameter; or
- b) the initial NAS message (i.e. REGISTRATION REQUEST or SERVICE REQUEST) does not successfully pass the integrity check at the AMF (see subclause 5.4.2.2).

### 8.2.25.6 EAP message

This IE is included when the EAP Success message is sent as part of the EAP based primary authentication and key agreement procedure, as specified in subclause 5.4.1.2.

### 8.2.25.7 ABBA

This IE shall be included if the message contains an EAP message IE with an EAP-success message.

### 8.2.25.8 Replayed S1 UE security capabilities

This IE shall be included if the Selected EPS NAS security algorithms information element is included.

## 8.2.26 Security mode complete

### 8.2.26.1 Message definition

The SECURITY MODE COMPLETE message is sent by the UE to the AMF in response to a SECURITY MODE COMMAND message. See table 8.2.26.1.1.

Message type: SECURITY MODE COMPLETE

Significance: dual

Direction: UE to network

**Table 8.2.26.1.1: SECURITY MODE COMPLETE message content**

IEI	Information Element	Type/Reference	Presence	Format	Length
	Extended protocol discriminator	Extended protocol discriminator 9.2	M	V	1
	Security header type	Security header type 9.3	M	V	1/2
	Spare half octet	Spare half octet 9.5	M	V	1/2
	Security mode complete message identity	Message type 9.6	M	V	1
77	IMEISV	5G mobile identity 9.11.3.4	O	TLV-E	12
71	NAS message container	NAS message container 9.11.3.33	O	TLV-E	4-n

### 8.2.26.2 IMEISV

The UE shall include this information element, if the IMEISV was requested within the corresponding SECURITY MODE COMMAND message.

### 8.2.26.3 NAS message container

The UE shall include this information element:

- a) if during an ongoing registration procedure or service request procedure, the AMF included the Additional 5G security information with the RINMR bit set to "Retransmission of the initial NAS message requested" in the SECURITY MODE COMMAND message as described in 3GPP TS 33.501 [24]; and
- b) if during an ongoing registration procedure, the UE does not have a valid 5G NAS security context.

## 8.2.27 Security mode reject

### 8.2.27.1 Message definition

The SECURITY MODE REJECT message is sent by the UE to the AMF to indicate that the corresponding security mode command has been rejected. See table 8.2.27.1.1.

Message type: SECURITY MODE REJECT

Significance: dual

Direction: UE to network

**Table 8.2.27.1.1: SECURITY MODE REJECT message content**

IEI	Information Element	Type/Reference	Presence	Format	Length
	Extended protocol discriminator	Extended protocol discriminator 9.2	M	V	1
	Security header type	Security header type 9.3	M	V	1/2
	Spare half octet	Spare half octet 9.5	M	V	1/2
	Security mode reject message identity	Message type 9.6	M	V	1
	5GMM cause	5GMM cause 9.11.3.2	M	V	1

## 8.2.28 Security protected 5GS NAS message

### 8.2.28.1 Message definition

This message is sent by the UE or the network to transfer a plain 5GS NAS message together with the sequence number and the message authentication code protecting the message. See table 8.2.28.1.1.

Message type: SECURITY PROTECTED 5GS NAS MESSAGE

Significance: dual

Direction: both

**Table 8.2.28.1.1: SECURITY PROTECTED 5GS NAS MESSAGE message content**

IEI	Information Element	Type/Reference	Presence	Format	Length
	Extended protocol discriminator	Extended protocol discriminator 9.2	M	V	1
	Security header type	Security header type 9.3	M	V	1/2
	Spare half octet	Spare half octet 9.5	M	V	1/2
	Message authentication code	Message authentication code 9.8	M	V	4
	Sequence number	Sequence number 9.10	M	V	1
	Plain 5GS NAS message	Plain 5GS NAS message 9.9	M	V	3-n

## 8.2.29 5GMM status

### 8.2.29.1 Message definition

The 5GMM STATUS message is sent by the UE or by the AMF at any time to report certain error conditions. See table 8.2.28.1.1.

Message type: 5GMM STATUS

Significance: local

Direction: both



**Table 8.2.29.1.1: 5GMM STATUS message content**

IEI	Information Element	Type/Reference	Presence	Format	Length
	Extended protocol discriminator	Extended protocol discriminator 9.2	M	V	1
	Security header type	Security header type 9.3	M	V	1/2
	Spare half octet	Spare half octet 9.5	M	V	1/2
	5GMM STATUS message identity	Message type 9.7	M	V	1
	5GMM cause	5GMM cause 9.11.3.2	M	V	1

## 8.3 5GS session management messages

### 8.3.1 PDU session establishment request

#### 8.3.1.1 Message definition

The PDU SESSION ESTABLISHMENT REQUEST message is sent by the UE to the SMF to initiate establishment of a PDU session. See table 8.3.1.1.1.

Message type: PDU SESSION ESTABLISHMENT REQUEST

Significance: dual

Direction: UE to network

**Table 8.3.1.1.1: PDU SESSION ESTABLISHMENT REQUEST message content**

IEI	Information Element	Type/Reference	Presence	Format	Length
	Extended protocol discriminator	Extended protocol discriminator 9.2	M	V	1
	PDU session ID	PDU session identity 9.4	M	V	1
	PTI	Procedure transaction identity 9.6	M	V	1
	PDU SESSION ESTABLISHMENT REQUEST message identity	Message type 9.7	M	V	1
	Integrity protection maximum data rate	Integrity protection maximum data rate 9.11.4.7	M	V	2
9-	PDU session type	PDU session type 9.11.4.11	O	TV	1
A-	SSC mode	SSC mode 9.11.4.16	O	TV	1
28	5GSM capability	5GSM capability 9.11.4.1	O	TLV	3-15
55	Maximum number of supported packet filters	Maximum number of supported packet filters 9.11.4.9	O	TV	3
B-	Always-on PDU session requested	Always-on PDU session requested 9.11.4.4	O	TV	1
39	SM PDU DN request container	SM PDU DN request container 9.11.4.15	O	TLV	3-255
7B	Extended protocol configuration options	Extended protocol configuration options 9.11.4.6	O	TLV-E	4-65538

### 8.3.1.2 PDU session type

This IE is included in the message when the UE requests to establish a new PDU session with a DN and requests a PDU session type.

### 8.3.1.3 SSC mode

This IE is included in the message when the UE requests to establish a new PDU session with a DN and requests an SSC mode.

### 8.3.1.4 Maximum number of supported packet filters

This IE shall be included in the message when the selected PDU session type is "IPv4", "IPv6", "IPv4v6" or "Ethernet" and the UE can support more than 16 packet filters for this PDU session.

### 8.3.1.5 5GSM capability

This IE is included in the message when:

- a) the UE requests to establish a new PDU session of "IPv4", "IPv6", "IPv4v6" or "Ethernet" PDU session type and the UE supports Reflective QoS;
- b) the UE requests to establish a new PDU session of "IPv6" or "IPv4v6" PDU session type and the UE supports multi-homed IPv6 PDU session;
- c) the UE requests to transfer an existing PDN connection of "IPv4", "IPv6", "IPv4v6" or "non-IP" PDN type mapping to "Ethernet" PDU session type in the EPS to the 5GS and the UE supports Reflective QoS;
- d) the UE requests to transfer an existing PDN connection of "IPv4", "IPv6" or "IPv4v6" PDN type in an untrusted non-3GPP access connected to the EPC to the 5GS and the UE supports Reflective QoS; or
- e) the UE requests to transfer an existing PDN connection of "IPv6" or "IPv4v6" PDN type in the EPS or in an untrusted non-3GPP access connected to the EPC to the 5GS and the UE supports multi-homed IPv6 PDU session.

### 8.3.1.6 Void

### 8.3.1.7 Always-on PDU session requested

The UE shall include this IE if the UE requests to establish a PDU session as an always-on PDU session.

### 8.3.1.8 SM PDU DN request container

This IE is included in the message when the UE requests to establish a new PDU session with a DN and needs to provide information for the PDU session authentication and authorization by the external DN.

### 8.3.1.9 Extended protocol configuration options

This IE is included in the message when the UE needs to transmit (protocol) data (e.g. configuration parameters, error codes or messages/events) to the network.

## 8.3.2 PDU session establishment accept

### 8.3.2.1 Message definition

The PDU SESSION ESTABLISHMENT ACCEPT message is sent by the SMF to the UE in response to PDU SESSION ESTABLISHMENT REQUEST message and indicates successful establishment of a PDU session. See table 8.3.2.1.1.

Message type: PDU SESSION ESTABLISHMENT ACCEPT

Significance: dual

Direction: network to UE

**Table 8.3.2.1.1: PDU SESSION ESTABLISHMENT ACCEPT message content**

IEI	Information Element	Type/Reference	Presence	Format	Length
	Extended protocol discriminator	Extended protocol discriminator 9.2	M	V	1
	PDU session ID	PDU session identity 9.4	M	V	1
	PTI	Procedure transaction identity 9.6	M	V	1
	PDU SESSION ESTABLISHMENT ACCEPT message identity	Message type 9.7	M	V	1
	Selected PDU session type	PDU session type 9.11.4.11	M	V	1/2
	Selected SSC mode	SSC mode 9.11.4.16	M	V	1/2
	Authorized QoS rules	QoS rules 9.11.4.13	M	LV-E	6-65538
	Session AMBR	Session-AMBR 9.11.4.14	M	LV	7
59	5GSM cause	5GSM cause 9.11.4.2	O	TV	2
29	PDU address	PDU address 9.11.4.10	O	TLV	7, 11 or 15
56	RQ timer value	GPRS timer 9.11.2.3	O	TV	2
22	S-NSSAI	S-NSSAI 9.11.2.8	O	TLV	3-10
8-	Always-on PDU session indication	Always-on PDU session indication 9.11.4.3	O	TV	1
75	Mapped EPS bearer contexts	Mapped EPS bearer contexts 9.11.4.8	O	TLV-E	7-65538
78	EAP message	EAP message 9.11.2.2	O	TLV-E	7-1503
79	Authorized QoS flow descriptions	QoS flow descriptions 9.11.4.12	O	TLV-E	6-65538
7B	Extended protocol configuration options	Extended protocol configuration options 9.11.4.6	O	TLV-E	4-65538
25	DNN	DNN 9.11.2.1A	O	TLV	3-102

### 8.3.2.2 5GSM cause

This IE is included when the selected PDU session type is different from the PDU session type requested by the UE.

### 8.3.2.3 PDU address

This IE is included when the selected PDU session type is "IPv4", "IPv6" or "IPv4v6".

### 8.3.2.4 RQ timer value

This IE is included when the network needs to provide the RQ timer value.

### 8.3.2.5 S-NSSAI

This IE shall be included in the message when the SMF received from the AMF an S-NSSAI together with the PDU SESSION ESTABLISHMENT REQUEST message, and the PDU session is a non-emergency PDU session.

### 8.3.2.6 Always-on PDU session indication

The network shall include this IE if the network decides to inform the UE whether the PDU session is established as an always-on PDU session.

### 8.3.2.7 Mapped EPS bearer contexts

This IE is included when interworking with EPS is supported for the PDU session.

### 8.3.2.8 EAP message

This IE is included when the external DN successfully performed authentication and authorization of the UE using EAP.

### 8.3.2.9 Authorized QoS flow descriptions

This IE is included when the network needs to provide authorized QoS flow descriptions.

### 8.3.2.10 Extended protocol configuration options

This IE is included in the message when the network needs to transmit (protocol) data (e.g. configuration parameters, error codes or messages/events) to the UE.

### 8.3.2.11 DNN

The IE shall be included in the message when the SMF received from the AMF a DNN together with the PDU SESSION ESTABLISHMENT REQUEST message, and the PDU session is a non-emergency PDU session.

## 8.3.3 PDU session establishment reject

### 8.3.3.1 Message definition

The PDU SESSION ESTABLISHMENT REJECT message is sent by the SMF to the UE in response to PDU SESSION ESTABLISHMENT REQUEST message and indicates unsuccessful establishment of a PDU session. See table 8.3.3.1.1.

Message type: PDU SESSION ESTABLISHMENT REJECT

Significance: dual

Direction: network to UE

**Table 8.3.3.1.1: PDU SESSION ESTABLISHMENT REJECT message content**

IEI	Information Element	Type/Reference	Presence	Format	Length
	Extended protocol discriminator	Extended protocol discriminator 9.2	M	V	1
	PDU session ID	PDU session identity 9.4	M	V	1
	PTI	Procedure transaction identity 9.6	M	V	1
	PDU SESSION ESTABLISHMENT REJECT message identity	Message type 9.7	M	V	1
	5GSM cause	5GSM cause 9.11.4.2	M	V	1
37	Back-off timer value	GPRS timer 3 9.11.2.5	O	TLV	3
F-	Allowed SSC mode	Allowed SSC mode 9.11.4.5	O	TV	1
78	EAP message	EAP message 9.11.2.2	O	TLV-E	7-1503
61	5GSM congestion re-attempt indicator	5GSM congestion re-attempt indicator 9.11.4.2A	O	TLV	3
7B	Extended protocol configuration options	Extended protocol configuration options 9.11.4.6	O	TLV-E	4-65538

### 8.3.3.2 Back-off timer value

The network may include this IE to request a minimum time interval before procedure retry is allowed.

### 8.3.3.3 Allowed SSC mode

This IE is included when the network rejects the PDU SESSION ESTABLISHMENT REQUEST with cause #68 "not supported SSC mode".

### 8.3.3.4 EAP message

This IE is included when the external DN unsuccessfully performed authentication and authorization of the UE using EAP.

### 8.3.3.5 Extended protocol configuration options

This IE is included in the message when the network needs to transmit (protocol) data (e.g. configuration parameters, error codes or messages/events) to the UE.

### 8.3.3.6 5GSM congestion re-attempt indicator

The network may include this IE only if it includes the Back-off timer value IE and the 5GSM cause value is either #67 "insufficient resources for specific slice and DNN" or #69 "insufficient resources for specific slice".

## 8.3.4 PDU session authentication command

### 8.3.4.1 Message definition

The PDU SESSION AUTHENTICATION COMMAND message is sent by the SMF to the UE for authentication of the UE establishing the PDU session or of the UE participating in the PDU session. See table 8.3.4.1.1.

Message type: PDU SESSION AUTHENTICATION COMMAND

Significance: dual

Direction: network to UE

**Table 8.3.4.1.1: PDU SESSION AUTHENTICATION COMMAND message content**

IEI	Information Element	Type/Reference	Presence	Format	Length
	Extended protocol discriminator	Extended protocol discriminator 9.2	M	V	1
	PDU session ID	PDU session identity 9.4	M	V	1
	PTI	Procedure transaction identity 9.6	M	V	1
	PDU SESSION AUTHENTICATION COMMAND message identity	Message type 9.7	M	V	1
	EAP message	EAP message 9.11.2.2	M	LV-E	6-1502
7B	Extended protocol configuration options	Extended protocol configuration options 9.11.4.6	O	TLV-E	4-65538

### 8.3.4.2 Extended protocol configuration options

This IE is included in the message when the network needs to transmit (protocol) data (e.g. configuration parameters, error codes or messages/events) to the UE.

NOTE: How the Extended protocol configuration options IE is used by the network and the UE during the PDU session authentication and authorization procedure is not specified in this release of the specification.

## 8.3.5 PDU session authentication complete

### 8.3.5.1 Message definition

The PDU SESSION AUTHENTICATION COMPLETE message is sent by the UE to the SMF in response to the PDU SESSION AUTHENTICATION COMMAND message and indicates acceptance of the PDU SESSION AUTHENTICATION COMMAND message. See table 8.3.5.1.1.

Message type: PDU SESSION AUTHENTICATION COMPLETE

Significance: dual

Direction: UE to network

**Table 8.3.5.1.1: PDU SESSION AUTHENTICATION COMPLETE message content**

IEI	Information Element	Type/Reference	Presence	Format	Length
	Extended protocol discriminator	Extended protocol discriminator 9.2	M	V	1
	PDU session ID	PDU session identity 9.4	M	V	1
	PTI	Procedure transaction identity 9.6	M	V	1
	PDU SESSION AUTHENTICATION COMPLETE message identity	Message type 9.7	M	V	1
	EAP message	EAP message 9.11.2.2	M	LV-E	6-1502
7B	Extended protocol configuration options	Extended protocol configuration options 9.11.4.6	O	TLV-E	4-65538

### 8.3.5.2 Extended protocol configuration options

This IE is included in the message when the UE needs to transmit (protocol) data (e.g. configuration parameters, error codes or messages/events) to the network.

NOTE: How the Extended protocol configuration options IE is used by the network and the UE during the PDU session authentication and authorization procedure is not specified in this release of the specification.

## 8.3.6 PDU session authentication result

### 8.3.6.1 Message definition

The PDU SESSION AUTHENTICATION RESULT message is sent by the SMF to the UE for indication of successful result of authentication of the UE participating in the PDU session. See table 8.3.6.1.1.

Message type: PDU SESSION AUTHENTICATION RESULT

Significance: dual

Direction: network to UE

**Table 8.3.6.1.1: PDU SESSION AUTHENTICATION RESULT message content**

IEI	Information Element	Type/Reference	Presence	Format	Length
	Extended protocol discriminator	Extended protocol discriminator 9.2	M	V	1
	PDU session ID	PDU session identity 9.4	M	V	1
	PTI	Procedure transaction identity 9.6	M	V	1
	PDU SESSION AUTHENTICATION RESULT message identity	Message type 9.7	M	V	1
78	EAP message	EAP message 9.11.2.2	O	TLV-E	7-1503
7B	Extended protocol configuration options	Extended protocol configuration options 9.11.4.6	O	TLV-E	4-65538

### 8.3.6.2 EAP message

This IE shall be included when the external DN performs authentication and authorization of the UE using EAP and it completes successfully.

### 8.3.6.3 Extended protocol configuration options

This IE is included in the message when the network needs to transmit (protocol) data (e.g. configuration parameters, error codes or messages/events) to the UE.

NOTE: How the Extended protocol configuration options IE is used by the network and the UE during the PDU session authentication and authorization procedure is not specified in this release of the specification.

## 8.3.7 PDU session modification request

### 8.3.7.1 Message definition

The PDU SESSION MODIFICATION REQUEST message is sent by the UE to the SMF to request a modification of a PDU session. See table 8.3.7.1.1.

Message type: PDU SESSION MODIFICATION REQUEST

Significance: dual

Direction: UE to network

**Table 8.3.7.1.1: PDU SESSION MODIFICATION REQUEST message content**

IEI	Information Element	Type/Reference	Presence	Format	Length
	Extended protocol discriminator	Extended protocol discriminator 9.2	M	V	1
	PDU session ID	PDU session identity 9.4	M	V	1
	PTI	Procedure transaction identity 9.6	M	V	1
	PDU SESSION MODIFICATION REQUEST message identity	Message type 9.7	M	V	1
28	5GSM capability	5GSM capability 9.11.4.1	O	TLV	3-15
59	5GSM cause	5GSM cause 9.11.4.2	O	TV	2
55	Maximum number of supported packet filters	Maximum number of supported packet filters 9.11.4.9	O	TV	3
B-	Always-on PDU session requested	Always-on PDU session requested 9.11.4.4	O	TV	1
13	Integrity protection maximum data rate	Integrity protection maximum data rate 9.11.4.7	O	TV	3
7A	Requested QoS rules	QoS rules 9.11.4.13	O	TLV-E	7-65538
79	Requested QoS flow descriptions	QoS flow descriptions 9.11.4.12	O	TLV-E	6-65538
75	Mapped EPS bearer contexts	Mapped EPS bearer contexts 9.11.4.8	O	TLV-E	7-65538
7B	Extended protocol configuration options	Extended protocol configuration options 9.11.4.6	O	TLV-E	4-65538

NOTE: It is possible for UEs compliant with earlier versions of this specification to send the Mapped EPS bearer contexts IE with IEI of value "7F" for this message.

### 8.3.7.2 5GSM capability

This IE is included in the message after inter-system change from S1 mode to N1 mode:

- a) if the PDU session is of "IPv4", "IPv6", "IPv4v6" or "Ethernet" PDU session type, and the UE supports reflective QoS or revokes the previously indicated support of reflective QoS; or
- b) if the PDU session is of "IPv6" or "IPv4v6" PDU session type, and the UE supports multi-homed IPv6 PDU session.

### 8.3.7.3 5GSM cause

This IE is included in the message when the UE releases the PDU session due to semantic or syntactical errors in QoS operations, or due to semantic or syntactical errors in packet filters.

### 8.3.7.4 Maximum number of supported packet filters

This IE shall be included in the message when the selected PDU session type is "IPv4", "IPv6", "IPv4v6" or "Ethernet", the UE can support more than 16 packet filters for this PDU session, and the UE is sending the message after an inter-system change from S1 mode to N1 mode.



### 8.3.7.5 Always-on PDU session requested

The UE shall include this IE if the UE requests to establish a PDU session as an always-on PDU session.

### 8.3.7.6 Integrity protection maximum data rate

This IE shall be included in the message for a PDN connection established when in S1 mode, after the first inter-system change from S1 mode to N1 mode, if the UE is operating in single-registration mode in the network supporting N26 interface.

### 8.3.7.7 Requested QoS rules

This IE is included in the message when the UE requests a specific QoS handling.

### 8.3.7.8 Requested QoS flow descriptions

This IE is included in the message when the UE requests a specific QoS flow descriptions.

### 8.3.7.9 Extended protocol configuration options

This IE is included in the message when the UE needs to transmit (protocol) data (e.g. configuration parameters, error codes or messages/events) to the network.

### 8.3.7.10 Mapped EPS bearer contexts

This IE is included when the UE requests to delete one or more mapped EPS bearer contexts.

## 8.3.8 PDU session modification reject

### 8.3.8.1 Message definition

The PDU SESSION MODIFICATION REJECT message is sent by the SMF to the UE to indicate rejection of the PDU SESSION MODIFICATION REQUEST. See table 8.3.8.1.1.

Message type: PDU SESSION MODIFICATION REJECT

Significance: dual

Direction: network to UE

**Table 8.3.8.1.1: PDU SESSION MODIFICATION REJECT message content**

IEI	Information Element	Type/Reference	Presence	Format	Length
	Extended protocol discriminator	Extended protocol discriminator 9.2	M	V	1
	PDU session ID	PDU session identity 9.4	M	V	1
	PTI	Procedure transaction identity 9.6	M	V	1
	PDU SESSION MODIFICATION REJECT message identity	Message type 9.7	M	V	1
	5GSM cause	5GSM cause 9.11.4.2	M	V	1
37	Back-off timer value	GPRS timer 3 9.11.2.5	O	TLV	3
61	5GSM congestion re-attempt indicator	5GSM congestion re-attempt indicator 9.11.4.2A	O	TLV	3
7B	Extended protocol configuration options	Extended protocol configuration options 9.11.4.6	O	TLV-E	4-65538

### 8.3.8.2 Back-off timer value

The network may include this IE to request a minimum time interval before procedure retry is allowed.

### 8.3.8.3 Extended protocol configuration options

This IE is included in the message when the network needs to transmit (protocol) data (e.g. configuration parameters, error codes or messages/events) to the UE.

### 8.3.8.4 5GSM congestion re-attempt indicator

The network may include this IE only if it includes the Back-off timer value IE and the 5GSM cause value is either #67 "insufficient resources for specific slice and DNN" or #69 "insufficient resources for specific slice".

## 8.3.9 PDU session modification command

### 8.3.9.1 Message definition

The PDU SESSION MODIFICATION COMMAND message is sent by the SMF to the UE to indicate a modification of a PDU session. See table 8.3.9.1.1

Message type: PDU SESSION MODIFICATION COMMAND

Significance: dual

Direction: network to UE

**Table 8.3.9.1.1: PDU SESSION MODIFICATION COMMAND message content**

IEI	Information Element	Type/Reference	Presence	Format	Length
	Extended protocol discriminator	Extended protocol discriminator 9.2	M	V	1
	PDU session ID	PDU session identity 9.4	M	V	1
	PTI	Procedure transaction identity 9.6	M	V	1
	PDU SESSION MODIFICATION COMMAND message identity	Message type 9.7	M	V	1
59	5GSM cause	5GSM cause 9.11.4.2	O	TV	2
2A	Session AMBR	Session-AMBR 9.11.4.14	O	TLV	8
56	RQ timer value	GPRS timer 9.11.2.3	O	TV	2
8-	Always-on PDU session indication	Always-on PDU session indication 9.11.4.3	O	TV	1
7A	Authorized QoS rules	QoS rules 9.11.4.13	O	TLV-E	7-65538
75	Mapped EPS bearer contexts	Mapped EPS bearer contexts 9.11.4.8	O	TLV-E	7-65538
79	Authorized QoS flow descriptions	QoS flow descriptions 9.11.4.12	O	TLV-E	6-65538
7B	Extended protocol configuration options	Extended protocol configuration options 9.11.4.6	O	TLV-E	4-65538

NOTE: It is possible for networks compliant with earlier versions of this specification to send the Mapped EPS bearer contexts IE with IEI of value "7F" for this message.

### 8.3.9.2 5GSM cause

This IE is included when the network performs the PDU session anchor relocation for SSC mode 3.

### 8.3.9.3 Session-AMBR

This IE is included when the session-AMBR of the PDU session is modified.

### 8.3.9.4 RQ timer value

This IE is included when the network needs to provide the RQ timer value.

### 8.3.9.5 Always-on PDU session indication

The network shall include this IE if the network decides to inform the UE whether the PDU session is an always-on PDU session.

### 8.3.9.6 Authorized QoS rules

This IE is included when the authorized QoS rules of the PDU session are modified.

### 8.3.9.7 Mapped EPS bearer contexts

This IE is included when interworking with EPS is supported for the PDU session and the mapped EPS bearer contexts is modified.

### 8.3.9.8 Authorized QoS flow descriptions

This IE is included when the authorized QoS flow descriptions of the PDU session are modified.

### 8.3.9.9 Extended protocol configuration options

This IE is included in the message when the network needs to transmit (protocol) data (e.g. configuration parameters, error codes or messages/events) to the UE.

## 8.3.10 PDU session modification complete

### 8.3.10.1 Message definition

The PDU SESSION MODIFICATION COMPLETE message is sent by the UE to the SMF in response to the PDU SESSION MODIFICATION COMMAND message and indicates an acceptance of the PDU SESSION MODIFICATION COMMAND message. See table 8.3.10.1.1.

Message type: PDU SESSION MODIFICATION COMPLETE

Significance: dual

Direction: UE to network

**Table 8.3.10.1.1: PDU SESSION MODIFICATION COMPLETE message content**

IEI	Information Element	Type/Reference	Presence	Format	Length
	Extended protocol discriminator	Extended protocol discriminator 9.2	M	V	1
	PDU session ID	PDU session identity 9.4	M	V	1
	PTI	Procedure transaction identity 9.6	M	V	1
	PDU SESSION MODIFICATION COMPLETE message identity	Message type 9.7	M	V	1
7B	Extended protocol configuration options	Extended protocol configuration options 9.11.4.6	O	TLV-E	4-65538

NOTE: It is possible for UEs compliant with earlier versions of this specification to include the 5GSM cause IE with IEI 59 in the PDU SESSION MODIFICATION COMPLETE message, and therefore the IEI 59 cannot be used for other optional IEs other than the 5GSM cause IE for future extensions of the PDU SESSION MODIFICATION COMPLETE message.

### 8.3.10.2 Extended protocol configuration options

This IE is included in the message when the UE needs to transmit (protocol) data (e.g. configuration parameters, error codes or messages/events) to the network.

## 8.3.11 PDU session modification command reject

### 8.3.11.1 Message definition

The PDU SESSION MODIFICATION COMMAND REJECT message is sent by the UE to the SMF to indicate rejection of the PDU SESSION MODIFICATION COMMAND message. See table 8.3.11.1.1.

Message type: PDU SESSION MODIFICATION COMMAND REJECT

Significance: dual

Direction: UE to network

**Table 8.3.11.1.1: PDU SESSION MODIFICATION COMMAND REJECT message content**

IEI	Information Element	Type/Reference	Presence	Format	Length
	Extended protocol discriminator	Extended protocol discriminator 9.2	M	V	1
	PDU session ID	PDU session identity 9.4	M	V	1
	PTI	Procedure transaction identity 9.6	M	V	1
	PDU SESSION MODIFICATION COMMAND REJECT message identity	Message type 9.7	M	V	1
	5GSM cause	5GSM cause 9.11.4.2	M	V	1
7B	Extended protocol configuration options	Extended protocol configuration options 9.11.4.6	O	TLV-E	4-65538

### 8.3.11.2 Extended protocol configuration options

This IE is included in the message when the UE needs to transmit (protocol) data (e.g. configuration parameters, error codes or messages/events) to the network.

## 8.3.12 PDU session release request

### 8.3.12.1 Message definition

The PDU SESSION RELEASE REQUEST message is sent by the UE to the SMF to request a release of a PDU session. See table 8.3.12.1.1.

Message type: PDU SESSION RELEASE REQUEST

Significance: dual

Direction: UE to network

**Table 8.3.12.1.1: PDU SESSION RELEASE REQUEST message content**

IEI	Information Element	Type/Reference	Presence	Format	Length
	Extended protocol discriminator	Extended protocol discriminator 9.2	M	V	1
	PDU session ID	PDU session identity 9.4	M	V	1
	PTI	Procedure transaction identity 9.6	M	V	1
	PDU SESSION RELEASE REQUEST message identity	Message type 9.7	M	V	1
59	5GSM cause	5GSM cause 9.11.4.2	O	TV	2
7B	Extended protocol configuration options	Extended protocol configuration options 9.11.4.6	O	TLV-E	4-65538

### 8.3.12.2 5GSM cause

This IE is included in the message when the UE releases the PDU session due to semantic or syntactical errors in QoS operations, or due to semantic or syntactical errors in packet filters.

### 8.3.12.3 Extended protocol configuration options

This IE is included in the message when the UE needs to transmit (protocol) data (e.g. configuration parameters, error codes or messages/events) to the network.

## 8.3.13 PDU session release reject

### 8.3.13.1 Message definition

The PDU SESSION RELEASE REJECT message is sent by the SMF to the UE to indicate rejection of request a release of a PDU session. See table 8.3.13.1.1.

Message type: PDU SESSION RELEASE REJECT

Significance: dual

Direction: network to UE

**Table 8.3.13.1.1: PDU SESSION RELEASE REJECT message content**

IEI	Information Element	Type/Reference	Presence	Format	Length
	Extended protocol discriminator	Extended protocol discriminator 9.2	M	V	1
	PDU session ID	PDU session identity 9.4	M	V	1
	PTI	Procedure transaction identity 9.6	M	V	1
	PDU SESSION RELEASE REJECT message identity	Message type 9.7	M	V	1
	5GSM cause	5GSM cause 9.11.4.2	M	V	1
7B	Extended protocol configuration options	Extended protocol configuration options 9.11.4.6	O	TLV-E	4-65538

### 8.3.13.2 Extended protocol configuration options

This IE is included in the message when the network needs to transmit (protocol) data (e.g. configuration parameters, error codes or messages/events) to the UE.

## 8.3.14 PDU session release command

### 8.3.14.1 Message definition

The PDU SESSION RELEASE COMMAND message is sent by the SMF to the UE to indicate a release of a PDU session. See table 8.3.14.1.1.

Message type: PDU SESSION RELEASE COMMAND

Significance: dual

Direction: network to UE

**Table 8.3.14.1.1: PDU SESSION RELEASE COMMAND message content**

IEI	Information Element	Type/Reference	Presence	Format	Length
	Extended protocol discriminator	Extended protocol discriminator 9.2	M	V	1
	PDU session ID	PDU session identity 9.4	M	V	1
	PTI	Procedure transaction identity 9.6	M	V	1
	PDU SESSION RELEASE COMMAND message identity	Message type 9.7	M	V	1
	5GSM cause	5GSM cause 9.11.4.2	M	V	1
37	Back-off timer value	GPRS timer 3 9.11.2.5	O	TLV	3
78	EAP message	EAP message 9.11.2.2	O	TLV-E	7-1503
61	5GSM congestion re-attempt indicator	5GSM congestion re-attempt indicator 9.11.4.2A	O	TLV	3
7B	Extended protocol configuration options	Extended protocol configuration options 9.11.4.6	O	TLV-E	4-65538

### 8.3.14.2 Back-off timer value

The network may include this IE to request a minimum time interval before procedure retry is allowed.

### 8.3.14.3 EAP message

This IE is included when the external DN performs re-authentication and re-authorization of the UE using EAP and it completes unsuccessfully.

### 8.3.14.4 Extended protocol configuration options

This IE is included in the message when the network wants to transmit (protocol) data (e.g. configuration parameters, error codes or messages/events) to the UE.

### 8.3.14.5 5GSM congestion re-attempt indicator

The network may include this IE only if it includes the Back-off timer value IE and the 5GSM cause value is either #67 "insufficient resources for specific slice and DNN" or #69 "insufficient resources for specific slice".

## 8.3.15 PDU session release complete

### 8.3.15.1 Message definition

The PDU SESSION RELEASE COMPLETE message is sent by the UE to the SMF in response to the PDU SESSION RELEASE COMMAND message and indicates an acceptance of a release of the PDU session. See table 8.3.15.1.1.

Message type: PDU SESSION RELEASE COMPLETE

Significance: dual

Direction: UE to network

**Table 8.3.15.1.1: PDU SESSION RELEASE COMPLETE message content**

IEI	Information Element	Type/Reference	Presence	Format	Length
	Extended protocol discriminator	Extended protocol discriminator 9.2	M	V	1
	PDU session ID	PDU session identity 9.4	M	V	1
	PTI	Procedure transaction identity 9.6	M	V	1
	PDU SESSION RELEASE COMPLETE message identity	Message type 9.7	M	V	1
59	5GSM cause	5GSM cause 9.11.4.2	O	TV	2
7B	Extended protocol configuration options	Extended protocol configuration options 9.11.4.6	O	TLV-E	4-65538

### 8.3.15.2 5GSM cause

This IE is included in the message when the UE needs to indicate to the network that an error encountered with a mandatory information element in the PDU SESSION RELEASE COMMAND message.

### 8.3.15.3 Extended protocol configuration options

This IE is included in the message when the UE needs to transmit (protocol) data (e.g. configuration parameters, error codes or messages/events) to the network.

## 8.3.16 5GSM status

### 8.3.16.1 Message definition

The 5GSM STATUS message is sent by the SMF or the UE to pass information on the status of the indicated PDU session and report certain error conditions. See table 8.3.16.1.1.

Message type: 5GSM STATUS

Significance: dual

Direction: both

**Table 8.3.16.1.1: 5GSM STATUS message content**

IEI	Information Element	Type/Reference	Presence	Format	Length
	Extended protocol discriminator	Extended protocol discriminator 9.2	M	V	1
	PDU session ID	PDU session identity 9.4	M	V	1
	PTI	Procedure transaction identity 9.6	M	V	1
	5GSM STATUS message identity	Message type 9.7	M	V	1
	5GSM cause	5GSM cause 9.11.4.2	M	V	1

---

## 9 General message format and information elements coding

### 9.1 Overview

#### 9.1.1 NAS message format

Within the protocols defined in the present document, every 5GS NAS message is a standard L3 message as defined in 3GPP TS 24.007 [11]. This means that the message consists of the following parts:

- 1) if the message is a plain 5GS NAS message:
  - a) extended protocol discriminator;
  - b) security header type associated with a half spare octet or PDU session identity;
  - c) procedure transaction identity;
  - d) message type;
  - e) other information elements, as required.
- 2) if the message is a security protected 5GS NAS message:
  - a) extended protocol discriminator;
  - b) security header type associated with a half spare octet;
  - c) message authentication code;
  - d) sequence number;
  - e) plain 5GS NAS message, as defined in item 1



The organization of a plain 5GS NAS message is illustrated in the example shown in figure 9.1.1.

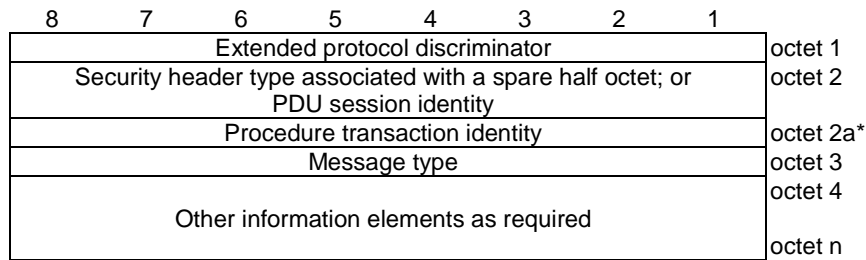

**Figure 9.1.1.1: General message organization example for a plain 5GS NAS message**

The PDU session identity and the procedure transaction identity are only used in messages with extended protocol discriminator 5GS session management. Octet 2a with the procedure transaction identity shall only be included in these messages.

The organization of a security protected 5GS NAS message is illustrated in the example shown in figure 9.1.2.

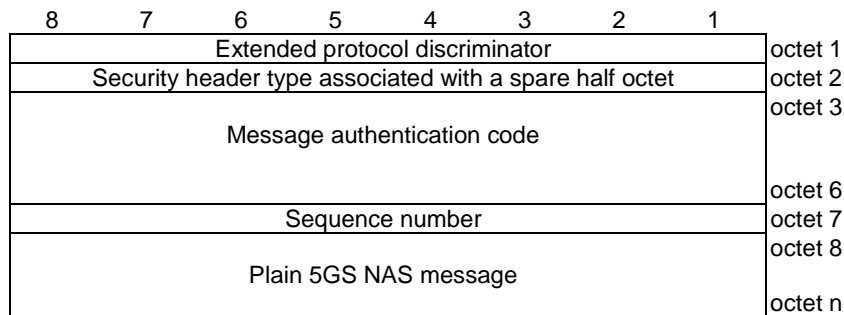

**Figure 9.1.1.2: General message organization example for a security protected 5GS NAS message**

Unless specified otherwise in the message descriptions of clause 8 and annex D, a particular information element shall not be present more than once in a given message.

### 9.1.2 Field format and mapping

When a field is contained within a single octet, the lowest numbered bit of the field represents the least significant bit.

When a field extends over more than one octet, the order of bit values progressively decreases as the octet number increases. In that part of the field contained in a given octet, the lowest numbered bit represents the least significant bit. The most significant bit of the field is represented by the highest numbered bit of the lowest numbered octet of the field. The least significant bit of the field is represented by the lowest numbered bit of the highest numbered octet of the field.

For example, a bit number can be identified as a couple (o, b) where o is the octet number and b is the relative bit number within the octet. Figure 9.1.2.1 illustrates a field that spans from bit (1, 3) to bit (2, 7). The most significant bit of the field is mapped on bit (1, 3) and the least significant bit is mapped on bit (2, 7).

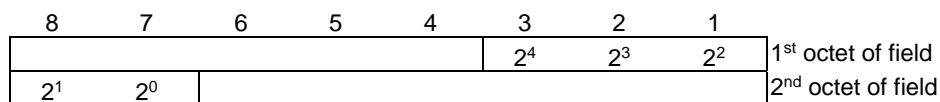

**Figure 9.1.2.1: Field mapping convention**

## 9.2 Extended protocol discriminator

Bits 1 to 8 of the first octet of every 5GS NAS message contain the Extended protocol discriminator (EPD) IE. The EPD and its use are defined in 3GPP TS 24.007 [11]. The extended protocol discriminator in the header (see 3GPP TS 24.007 [11]) of a security protected 5GS NAS message is encoded as "5GS mobility management messages".

## 9.3 Security header type

Bits 1 to 4 of the second octet of every 5GMM message contain the Security header type IE. This IE includes control information related to the security protection of a 5GMM message. The total size of the Security header type IE is 4 bits.

The Security header type IE can take the values shown in table 9.3.1.

**Table 9.3.1: Security header type**

Security header type (octet 1)				
Bits				
4	3	2	1	
0	0	0	0	Plain 5GS NAS message, not security protected
Security protected 5GS NAS message:				
0	0	0	1	Integrity protected
0	0	1	0	Integrity protected and ciphered
0	0	1	1	Integrity protected with new 5G NAS security context (NOTE 1)
0	1	0	0	Integrity protected and ciphered with new 5G NAS security context (NOTE 2)
All other values are reserved.				
NOTE 1: This codepoint may be used only for a SECURITY MODE COMMAND message.				
NOTE 2: This codepoint may be used only for a SECURITY MODE COMPLETE message.				

A 5GMM message received with the security header type encoded as 0000 shall be treated as not security protected, plain 5GS NAS message. A protocol entity sending a not security protected 5GMM message shall send the message as plain 5GS NAS message and encode the security header type as 0000.

## 9.4 PDU session identity

Bits 1 to 8 of the second octet of every 5GSM message contain the PDU session identity IE. The PDU session identity and its use to identify a message flow are defined in 3GPP TS 24.007 [11].

## 9.5 Spare half octet

This element is used in the description of 5GMM and 5GSM messages when an odd number of half octet type 1 information elements are used. This element is filled with spare bits set to zero and is placed in bits 5 to 8 of the octet unless otherwise specified.

## 9.6 Procedure transaction identity

Bits 1 to 8 of the third octet of every 5GSM message contain the procedure transaction identity. Bits 1 to 8 of the first octet of every UE policy delivery message contain the procedure transaction identity. The procedure transaction identity and its use are defined in 3GPP TS 24.007 [11].

## 9.7 Message type

The Message type IE and its use are defined in 3GPP TS 24.007 [11]. Tables 9.7.1 and 9.7.2 define the value part of the message type IE used in the 5GS mobility management protocol and 5GS session management protocol.

**Table 9.7.1: Message types for 5GS mobility management**

Bits								
8	7	6	5	4	3	2	1	
0	1	-	-	-	-	-	-	5GS mobility management messages
0	1	0	0	0	0	0	1	Registration request
0	1	0	0	0	0	1	0	Registration accept
0	1	0	0	0	0	1	1	Registration complete
0	1	0	0	0	1	0	0	Registration reject
0	1	0	0	0	1	0	1	Deregistration request (UE originating)
0	1	0	0	0	1	1	0	Deregistration accept (UE originating)
0	1	0	0	0	1	1	1	Deregistration request (UE terminated)
0	1	0	0	1	0	0	0	Deregistration accept (UE terminated)
0	1	0	0	1	1	0	0	Service request
0	1	0	0	1	1	0	1	Service reject
0	1	0	0	1	1	1	0	Service accept
0	1	0	1	0	1	0	0	Configuration update command
0	1	0	1	0	1	0	1	Configuration update complete
0	1	0	1	0	1	1	0	Authentication request
0	1	0	1	0	1	1	1	Authentication response
0	1	0	1	1	0	0	0	Authentication reject
0	1	0	1	1	0	0	1	Authentication failure
0	1	0	1	1	0	1	0	Authentication result
0	1	0	1	1	0	1	1	Identity request
0	1	0	1	1	1	0	0	Identity response
0	1	0	1	1	1	0	1	Security mode command
0	1	0	1	1	1	1	0	Security mode complete
0	1	0	1	1	1	1	1	Security mode reject
0	1	1	0	0	1	0	0	5GMM status
0	1	1	0	0	1	0	1	Notification
0	1	1	0	0	1	1	0	Notification response
0	1	1	0	0	1	1	1	UL NAS transport
0	1	1	0	1	0	0	0	DL NAS transport

**Table 9.7.2: Message types for 5GS session management**

Bits								
8	7	6	5	4	3	2	1	
1	1	-	-	-	-	-	-	5GS session management messages
1	1	0	0	0	0	0	1	PDU session establishment request
1	1	0	0	0	0	1	0	PDU session establishment accept
1	1	0	0	0	0	1	1	PDU session establishment reject
1	1	0	0	0	1	0	1	PDU session authentication command
1	1	0	0	0	1	1	0	PDU session authentication complete
1	1	0	0	0	1	1	1	PDU session authentication result
1	1	0	0	1	0	0	1	PDU session modification request
1	1	0	0	1	0	1	0	PDU session modification reject
1	1	0	0	1	0	1	1	PDU session modification command
1	1	0	0	1	1	0	0	PDU session modification complete
1	1	0	0	1	1	0	1	PDU session modification command reject
1	1	0	1	0	0	0	1	PDU session release request
1	1	0	1	0	0	1	0	PDU session release reject
1	1	0	1	0	0	1	1	PDU session release command
1	1	0	1	0	1	0	0	PDU session release complete
1	1	0	1	0	1	1	0	5GSM status

## 9.8 Message authentication code

The message authentication code (MAC) information element contains the integrity protection information for the message. The MAC IE shall be included in the SECURITY PROTECTED 5GS NAS MESSAGE message if a valid 5G NAS security context exists and security functions are started. The usage of MAC is specified in subclause 4.4.3.3.

## 9.9 Plain 5GS NAS message

This IE includes a complete plain 5GS NAS message as specified in subclauses 8.2 and 8.3. The SECURITY PROTECTED 5GS NAS MESSAGE message (see subclause 8.2.28) is not plain 5GS NAS messages and shall not be included in this IE.

## 9.10 Sequence number

This IE includes the NAS message sequence number (SN) which consists of the eight least significant bits of the NAS COUNT for a SECURITY PROTECTED 5GS NAS MESSAGE message. The usage of SN is specified in subclause 4.4.3.

## 9.11 Other information elements

### 9.11.1 General

The different formats (V, LV, T, TV, TLV, LV-E, TLV-E) and the five categories of information elements (type 1, 2, 3, 4 and 6) are defined in 3GPP TS 24.007 [11].

The first octet of an information element in the non-imperative part contains the IEI of the information element. If this octet does not correspond to an IEI known in the message, the receiver shall determine whether this IE is of type 1 or 2 (i.e. it is an information element of one octet length) or an IE of type 4 (i.e. that the next octet is the length indicator indicating the length of the remaining of the information element) (see 3GPP TS 24.007 [11]).

This allows the receiver to jump over unknown information elements and to analyse any following information elements of a particular message.

The definitions of information elements which are:

- a) common for the 5GMM and 5GSM protocols;
- b) used by access stratum protocols; or
- c) sent to upper layers

are described in subclause 9.11.2.

The information elements of the 5GMM or 5GSM protocols can be defined by reference to an appropriate specification which provides the definition of the information element, e.g., "see subclause 10.5.6.3A in 3GPP TS 24.008 [12]".

## 9.11.2 Common information elements

### 9.11.2.1 Additional information

The purpose of the Additional information information element is to provide additional information to upper layers in relation to the NAS transport mechanism.

The Additional information information element is coded as shown in figure 9.11.2.1.1 and table 9.11.2.1.1.

The Additional information is a type 4 information element with a minimum length of 3 octets.

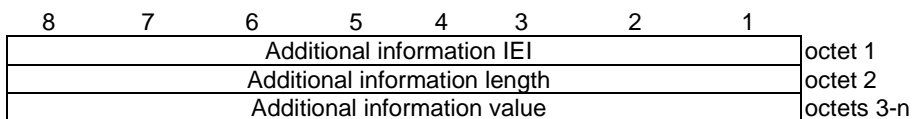

**Figure 9.11.2.1.1: Additional information information element**

**Table 9.11.2.1.1 : Additional information information element**

Additional information value (octet 3 to octet n)
The coding of the additional information value is dependent on the LCS application.

#### 9.11.2.1A DNN

The purpose of the DNN information element is to identify the data network.

The DNN information element is coded as shown in figure 9.11.2.1A.1.

The DNN is a type 4 information element with a minimum length of 3 octets and a maximum length of 102 octets.

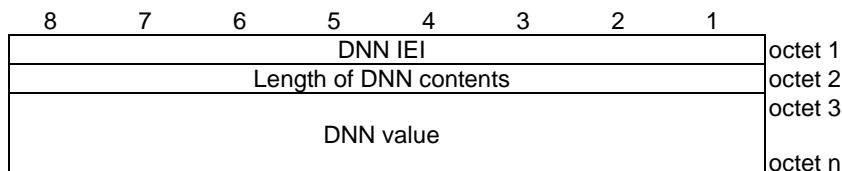

**Figure 9.11.2.1A.1: DNN information element**

A DNN value field contains an APN as defined in 3GPP TS 23.003 [4].

### 9.11.2.2 EAP message

The purpose of the EAP message information element is to transport an EAP message as specified in IETF RFC 3748 [34].

The EAP message information element is coded as shown in figure 9.11.2.2.1 and table 9.11.2.2.1.

The EAP message is a type 6 information element with minimum length of 7 octets and maximum length of 1503 octets.

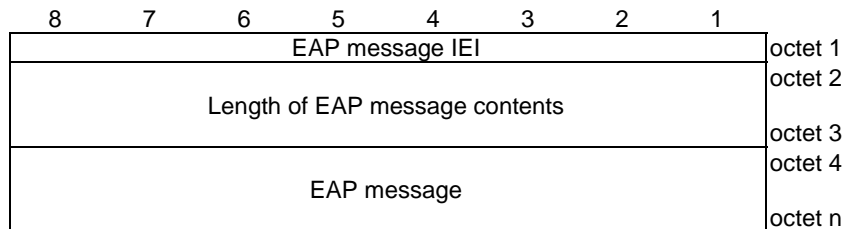

**Figure 9.11.2.2.1: EAP message information element**

**Table 9.11.2.2.1: EAP message information element**

EAP message (octet 4 to n) An EAP message as specified in IETF RFC 3748 [34].
--

### 9.11.2.3 GPRS timer

See subclause 10.5.7.3 in 3GPP TS 24.008 [12].

### 9.11.2.4 GPRS timer 2

See subclause 10.5.7.4 in 3GPP TS 24.008 [12].

### 9.11.2.5 GPRS timer 3

See subclause 10.5.7.4a in 3GPP TS 24.008 [12].

### 9.11.2.6 Intra N1 mode NAS transparent container

The purpose of the Intra N1 mode NAS transparent container information element is to provide the UE with parameters that enable the UE to handle the 5G NAS security context after N1 mode to N1 mode handover.

The Intra N1 mode NAS transparent container information element is coded as shown in figure 9.11.2.6.1 and table 9.11.2.6.1.

The Intra N1 mode NAS transparent container is a type 4 information element with a length of 9 octets.

The value part of the Intra N1 mode NAS transparent container information element is included in specific information elements within some RRC messages sent to the UE.

**NOTE:** For these cases the coding of the information element identifier and length information of RRC is defined in 3GPP TS 38.331 [30].

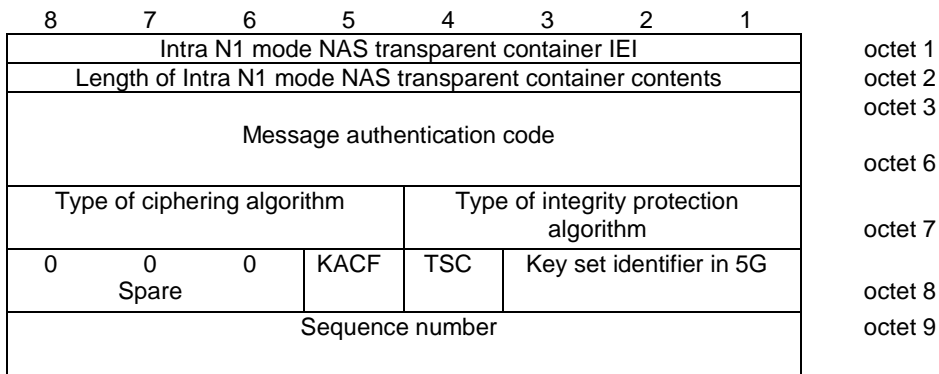

**Figure 9.11.2.6.1: Intra N1 mode NAS transparent container information element**

**Table 9.11.2.6.1: Intra N1 mode NAS transparent container information element**

<p>Message authentication code (octet 3 to 6)</p> <p>This field is coded as the Message authentication code information element (see subclause 9.8).</p> <p>Type of integrity protection algorithm (octet 7, bit 1 to 4) and type of ciphering algorithm (octet 7, bit 5 to 8)</p> <p>These fields are coded as the type of integrity protection algorithm and type of ciphering algorithm in the NAS security algorithms information element (see subclause 9.11.3.34).</p> <p>K_AMF_change_flag (KACF) (octet 8, bit 5)</p> <p>Bit</p> <p><b>5</b></p> <p>0 a new K<sub>AMF</sub> has not been calculated by the network</p> <p>1 a new K<sub>AMF</sub> has been calculated by the network</p> <p>Key set identifier in 5G (octet 8, bit 1 to 3) and Type of security context flag (TSC) (octet 8, bit 4)</p> <p>These fields are coded as the NAS key set identifier and type of security context flag in the NAS key set identifier information element (see subclause 9.11.3.32).</p> <p>Sequence number (octet 9)</p> <p>This field is coded as the Sequence number information element (see subclause 9.10)</p>
--

### 9.11.2.7 N1 mode to S1 mode NAS transparent container

The purpose of the N1 mode to S1 mode NAS transparent container information element is to provide the UE with information that enables the UE to create a mapped EPS security context.

The N1 mode to S1 mode NAS transparent container information element is coded as shown in figure 9.11.2.7.1 and table 9.11.2.7.1.

The N1 mode to S1 mode NAS transparent container is a type 3 information element with a length of 2 octets.

The value part of the N1 mode to S1 mode NAS transparent container information element is included in specific information elements within some RRC messages sent to the UE; see 3GPP TS 38.331 [30]. For these cases the coding of the information element identifier and length information is defined in 3GPP TS 38.331 [30].

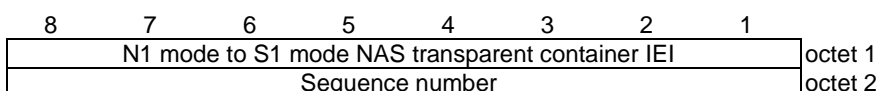

**Figure 9.11.2.7.1: N1 mode to S1 mode NAS transparent container information element**

**Table 9.11.2.7.1: N1 mode to S1 mode NAS transparent container information element**

Sequence number (octet 2)
This field is coded as the Sequence number information element (see subclause 9.10).

**9.11.2.8 S-NSSAI**

The purpose of the S-NSSAI information element is to identify a network slice.

The S-NSSAI information element is coded as shown in figure 9.11.2.8.1 and table 9.11.2.8.1.

The S-NSSAI is a type 4 information element with a minimum length of 3 octets and a maximum length of 10 octets.

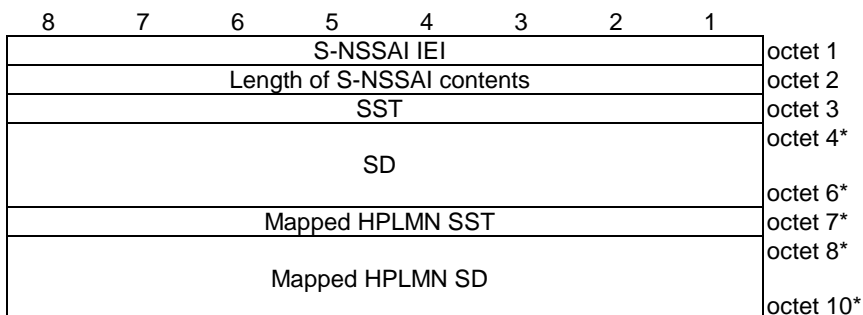

**Figure 9.11.2.8.1: S-NSSAI information element**



**Table 9.11.2.8.1: S-NSSAI information element**

Length of S-NSSAI contents (octet 2)	
This field indicates the length of the included S-NSSAI contents, and it can have the following values. Depending on the value of the length field the following S-NSSAI contents are included:	
Bits	
<b>8</b>	<b>7</b>
<b>6</b>	<b>5</b>
<b>4</b>	<b>3</b>
<b>2</b>	<b>1</b>
0 0 0 0 0 0 0 1	SST
0 0 0 0 0 0 1 0	SST and mapped HPLMN SST
0 0 0 0 0 1 0 0	SST and SD
0 0 0 0 0 1 0 1	SST, SD and mapped HPLMN SST
0 0 0 0 1 0 0 0	SST, SD, mapped HPLMN SST and mapped HPLMN SD
All other values are reserved.	
Slice/service type (SST) (octet 3)	
This field contains the 8 bit SST value. The coding of the SST value part is defined in 3GPP TS 23.003 [4].	
Slice differentiator (SD) (octet 4 to octet 6)	
This field contains the 24 bit SD value. The coding of the SD value part is defined in 3GPP TS 23.003 [4].	
If the SST encoded in octet 3 is not associated with a valid SD value, and the sender needs to include a mapped HPLMN SST (octet 7) and a mapped HPLMN SD (octets 8 to 10), then the sender shall set the SD value (octets 4 to 6) to "no SD value associated with the SST".	
mapped HPLMN Slice/service type (SST) (octet 7)	
This field contains the 8 bit SST value of an S-NSSAI in the S-NSSAI(s) of the HPLMN to which the SST value is mapped. The coding of the SST value part is defined in 3GPP TS 23.003 [4].	
mapped HPLMN Slice differentiator (SD) (octet 8 to octet 10)	
This field contains the 24 bit SD value of an S-NSSAI in the S-NSSAI(s) of the HPLMN to which the SD value is mapped. The coding of the SD value part is defined in 3GPP TS 23.003 [4].	
NOTE 1: Octet 3 shall always be included.	
NOTE 2: If the octet 4 is included, then octet 5 and octet 6 shall be included.	
NOTE 3: If the octet 7 is included, then octets 8, 9, and 10 may be included.	
NOTE 4: If the octet 8 is included, then octet 9 and octet 10 shall be included.	

### 9.11.2.9 S1 mode to N1 mode NAS transparent container

The purpose of the S1 mode to N1 mode NAS transparent container information element is to provide the UE with parameters that enable the UE to create a mapped 5G NAS security context and take this context into use after inter-system change to N1 mode in 5GMM-CONNECTED mode.

The S1 mode to N1 mode NAS transparent container information element is coded as shown in figure 9.11.2.9.1 and table 9.11.2.9.1.

The S1 mode to N1 mode NAS transparent container is a type 4 information element with a length of 10 octets.

The value part of the S1 mode to N1 mode NAS transparent container information element is included in specific information elements within some RRC messages sent to the UE.

NOTE: For these cases the coding of the information element identifier and length information of RRC is defined in 3GPP TS 38.331 [30].

8      7      6      5      4      3      2      1								
S1 mode to N1 mode NAS transparent container IEI								octet 1
Length of S1 mode to N1 mode NAS transparent container contents								octet 2
Message authentication code								octet 3
Message authentication code								octet 6
Type of ciphering algorithm				Type of integrity protection algorithm				octet 7
0 Spare	NCC			TSC	Key set identifier in 5G			octet 8
0 Spare	0 Spare	0 Spare	0 Spare	0 Spare	0 Spare	0 Spare	0 Spare	octet 9
0 Spare	0 Spare	0 Spare	0 Spare	0 Spare	0 Spare	0 Spare	0 Spare	octet 10

**Figure 9.11.2.9.1: S1 mode to N1 mode NAS transparent container information element**

**Table 9.11.2.9.1: S1 mode to N1 mode NAS transparent container information element**

<p>Message authentication code (octet 3 to 6)</p> <p>This field is coded as the Message authentication code information element (see subclause 9.8).</p> <p>Type of integrity protection algorithm (octet 7, bit 1 to 4) and type of ciphering algorithm (octet 7, bit 5 to 8)</p> <p>These fields are coded as the type of integrity protection algorithm and type of ciphering algorithm in the NAS security algorithms information element (see subclause 9.11.3.34).</p> <p>NCC (octet 8, bits 5 to 7)</p> <p>This field contains the 3 bit Next hop chaining counter (see 3GPP TS 33.501 [24])</p> <p>Key set identifier in 5G (octet 8, bit 1 to 3) and type of security context flag (TSC) (octet 8, bit 4)</p> <p>These fields are coded as the NAS key set identifier and type of security context flag in the NAS key set identifier information element (see subclause 9.11.3.32).</p> <p>Octets 9 and 10 are spare and shall be coded as zero.</p> <p>NOTE: In earlier versions of this protocol, octets 9 and 10 can have any value. In this version of the protocol, octets 9 and 10 can always be ignored by the UE.</p>
---

### 9.11.3 5GS mobility management (5GMM) information elements

#### 9.11.3.1 5GMM capability

The purpose of the 5GMM capability information element is to provide the network with information concerning aspects of the UE related to the 5GCN or interworking with the EPS. The contents might affect the manner in which the network handles the operation of the UE.

The 5GMM capability information element is coded as shown in figure 9.11.3.1.1 and table 9.11.3.1.1.

The 5GMM capability is a type 4 information element with a minimum length of 3 octets and a maximum length of 15 octets.

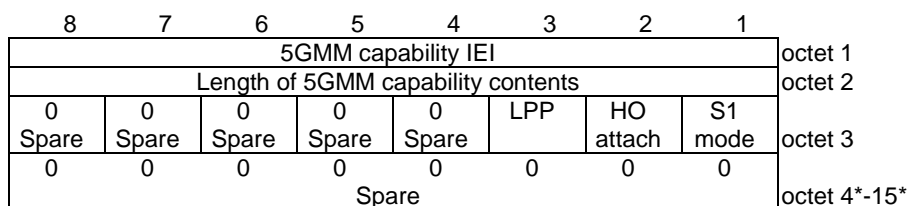

**Figure 9.11.3.1.1: 5GMM capability information element**

**Table 9.11.3.1.1: 5GMM capability information element**

EPC NAS supported (S1 mode) (octet 3, bit 1)	
0	S1 mode not supported
1	S1 mode supported
ATTACH REQUEST message containing PDN CONNECTIVITY REQUEST message for handover support (HO attach) (octet 3, bit 2)	
0	ATTACH REQUEST message containing PDN CONNECTIVITY REQUEST message with request type set to "handover" or "handover of emergency bearer services" to transfer PDU session from N1 mode to S1 mode not supported
1	ATTACH REQUEST message containing PDN CONNECTIVITY REQUEST message with request type set to "handover" or "handover of emergency bearer services" to transfer PDU session from N1 mode to S1 mode supported
LTE Positioning Protocol (LPP) capability (octet 3, bit 3)	
0	LPP in N1 mode not supported
1	LPP in N1 mode supported (see 3GPP TS 36.355 [26])
All other bits in octet 3 to 15 are spare and shall be coded as zero, if the respective octet is included in the information element.	

### 9.11.3.2 5GMM cause

The purpose of the 5GMM cause information element is to indicate the reason why a 5GMM request from the UE is rejected by the network.

The 5GMM cause information element is coded as shown in figure 9.11.3.2.1 and table 9.11.3.2.1.

The 5GMM cause is a type 3 information element with 2 octets length.

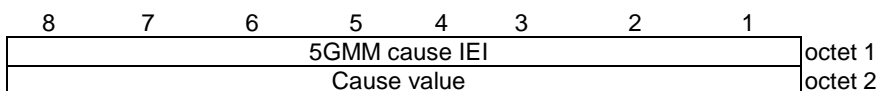

**Figure 9.11.3.2.1: 5GMM cause information element**

**Table 9.11.3.2.1 : 5GMM cause information element**

Cause value (octet 2)								
Bits								
8	7	6	5	4	3	2	1	
0	0	0	0	0	0	1	1	Illegal UE
0	0	0	0	0	1	0	1	PEI not accepted
0	0	0	0	0	1	1	0	Illegal ME
0	0	0	0	0	1	1	1	5GS services not allowed
0	0	0	0	1	0	0	1	UE identity cannot be derived by the network
0	0	0	0	1	0	1	0	Implicitly de-registered
0	0	0	0	1	0	1	1	PLMN not allowed
0	0	0	0	1	1	0	0	Tracking area not allowed
0	0	0	0	1	1	0	1	Roaming not allowed in this tracking area
0	0	0	0	1	1	1	1	No suitable cells in tracking area
0	0	0	1	0	1	0	0	MAC failure
0	0	0	1	0	1	0	1	Synch failure
0	0	0	1	0	1	1	0	Congestion
0	0	0	1	0	1	1	1	UE security capabilities mismatch
0	0	0	1	1	0	0	0	Security mode rejected, unspecified
0	0	0	1	1	0	1	0	Non-5G authentication unacceptable
0	0	0	1	1	0	1	1	N1 mode not allowed
0	0	0	1	1	1	0	0	Restricted service area
0	0	1	0	1	0	1	1	LADN not available
0	1	0	0	0	0	0	1	Maximum number of PDU sessions reached
0	1	0	0	0	0	1	1	Insufficient resources for specific slice and DNN
0	1	0	0	0	1	0	1	Insufficient resources for specific slice
0	1	0	0	0	1	1	1	ngKSI already in use
0	1	0	0	1	0	0	0	Non-3GPP access to 5GCN not allowed
0	1	0	0	1	0	0	1	Serving network not authorized
0	1	0	1	1	0	1	0	Payload was not forwarded
0	1	0	1	1	0	1	1	DNN not supported or not subscribed in the slice
0	1	0	1	1	1	0	0	Insufficient user-plane resources for the PDU session
0	1	0	1	1	1	1	1	Semantically incorrect message
0	1	1	0	0	0	0	0	Invalid mandatory information
0	1	1	0	0	0	0	1	Message type non-existent or not implemented
0	1	1	0	0	0	1	0	Message type not compatible with the protocol state
0	1	1	0	0	0	1	1	Information element non-existent or not implemented
0	1	1	0	0	1	0	0	Conditional IE error
0	1	1	0	0	1	0	1	Message not compatible with the protocol state
0	1	1	0	1	1	1	1	Protocol error, unspecified

Any other value received by the mobile station shall be treated as 0110 1111, "protocol error, unspecified". Any other value received by the network shall be treated as 0110 1111, "protocol error, unspecified".

### 9.11.3.2A 5GS DRX parameters

The purpose of the 5GS DRX parameters information element is to indicate that the UE wants to use DRX and for the network to indicate the DRX cycle value to be used at paging.

The 5GS DRX parameters is a type 4 information element with a length of 3 octets.

The 5GS DRX parameters information element is coded as shown in figure 9.11.3.2A.1 and table 9.11.3.2A.1.

The value part of a DRX parameter information element is coded as shown in table 9.11.3.2A.1.

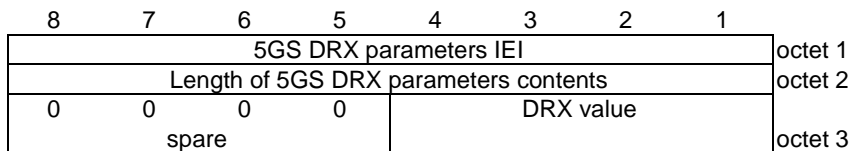

**Figure 9.11.3.2A.1: 5GS DRX parameters information element**

**Table 9.11.3.2A.1: 5GS DRX parameters information element**

<p>DRX value (bits 4 to 1 of octet 3)</p> <p>This field represents the DRX cycle parameter 'T' as defined in 3GPP TS 38.304 [28].</p> <p>Bits</p> <table style="width: 100%; border-collapse: collapse;"> <tr> <td style="width: 5%;"><b>4</b></td> <td style="width: 5%;"><b>3</b></td> <td style="width: 5%;"><b>2</b></td> <td style="width: 5%;"><b>1</b></td> <td style="width: 80%;"></td> </tr> <tr> <td>0</td> <td>0</td> <td>0</td> <td>0</td> <td>DRX value not specified</td> </tr> <tr> <td>0</td> <td>0</td> <td>0</td> <td>1</td> <td>DRX cycle parameter T = 32</td> </tr> <tr> <td>0</td> <td>0</td> <td>1</td> <td>0</td> <td>DRX cycle parameter T = 64</td> </tr> <tr> <td>0</td> <td>0</td> <td>1</td> <td>1</td> <td>DRX cycle parameter T = 128</td> </tr> <tr> <td>0</td> <td>1</td> <td>0</td> <td>0</td> <td>DRX cycle parameter T = 256</td> </tr> </table> <p>All other values shall be interpreted as "DRX value not specified" by this version of the protocol.</p> <p>Bits 5 to 8 of octet 3 are spare and shall be coded as zero.</p>	<b>4</b>	<b>3</b>	<b>2</b>	<b>1</b>		0	0	0	0	DRX value not specified	0	0	0	1	DRX cycle parameter T = 32	0	0	1	0	DRX cycle parameter T = 64	0	0	1	1	DRX cycle parameter T = 128	0	1	0	0	DRX cycle parameter T = 256
<b>4</b>	<b>3</b>	<b>2</b>	<b>1</b>																											
0	0	0	0	DRX value not specified																										
0	0	0	1	DRX cycle parameter T = 32																										
0	0	1	0	DRX cycle parameter T = 64																										
0	0	1	1	DRX cycle parameter T = 128																										
0	1	0	0	DRX cycle parameter T = 256																										

### 9.11.3.3 5GS identity type

The purpose of the 5GS identity type information element is to specify which identity is requested.

The 5GS identity type is a type 1 information element.

The 5GS identity type information element is coded as shown in figure 9.11.3.3.1 and table 9.11.3.3.1.

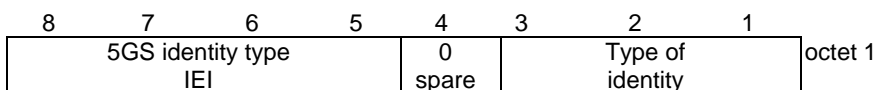

**Figure 9.11.3.3.1: 5GS identity type information element**

**Table 9.11.3.3.1: 5GS identity type information element**

<p>Type of identity (octet 1)</p> <p>Bits</p> <table style="width: 100%; border-collapse: collapse;"> <tr> <td style="width: 5%;"><b>3</b></td> <td style="width: 5%;"><b>2</b></td> <td style="width: 5%;"><b>1</b></td> <td style="width: 85%;"></td> </tr> <tr> <td>0</td> <td>0</td> <td>1</td> <td>SUCI</td> </tr> <tr> <td>0</td> <td>1</td> <td>0</td> <td>5G-GUTI</td> </tr> <tr> <td>0</td> <td>1</td> <td>1</td> <td>IMEI</td> </tr> <tr> <td>1</td> <td>0</td> <td>0</td> <td>5G-S-TMSI</td> </tr> <tr> <td>1</td> <td>0</td> <td>1</td> <td>IMEISV</td> </tr> </table> <p>All other values are unused and shall be interpreted as "SUCI", if received by the UE.</p>	<b>3</b>	<b>2</b>	<b>1</b>		0	0	1	SUCI	0	1	0	5G-GUTI	0	1	1	IMEI	1	0	0	5G-S-TMSI	1	0	1	IMEISV
<b>3</b>	<b>2</b>	<b>1</b>																						
0	0	1	SUCI																					
0	1	0	5G-GUTI																					
0	1	1	IMEI																					
1	0	0	5G-S-TMSI																					
1	0	1	IMEISV																					

### 9.11.3.4 5GS mobile identity

The purpose of the 5GS mobile identity information element is to provide either the SUCI, the 5G-GUTI, the IMEI, the IMEISV or the 5G-S-TMSI.

The 5GS mobile identity information element is coded as shown in figures 9.11.3.4.1, 9.11.3.4.2, 9.11.3.4.3, 9.11.3.4.4, 9.11.3.4.5 and 9.11.3.4.6, and table 9.11.3.4.1.

The 5GS mobile identity is a type 6 information element with a minimum length of 4.

8	7	6	5	4	3	2	1	
5GS mobile identity IEI								octet 1
Length of 5GS mobile identity contents								octet 2
Length of 5GS mobile identity contents								octet 3
1	1	1	1	0 spare	Type of identity			octet 4
MCC digit 2				MCC digit 1				octet 5
MNC digit 3				MCC digit 3				octet 6
MNC digit 2				MNC digit 1				octet 7
AMF Region ID								octet 8
AMF Set ID								octet 9
AMF Set ID (continued)		AMF Pointer						octet 10
5G-TMSI								octet 11
5G-TMSI (continued)								octet 12
5G-TMSI (continued)								octet 13
5G-TMSI (continued)								octet 14

Figure 9.11.3.4.1: 5GS mobile identity information element for type of identity "5G-GUTI"

8	7	6	5	4	3	2	1	
5GS mobile identity IEI								octet 1
Length of 5GS mobile identity contents								octet 2
Length of 5GS mobile identity contents								octet 3
Identity digit 1				odd/ even indic	Type of identity			octet 4
Identity digit p+1				Identity digit p				octet 5*

Figure 9.11.3.4.2: 5GS mobile identity information element for type of identity or "IMEI" or "IMEISV"

8	7	6	5	4	3	2	1	
5GS mobile identity IEI								octet 1
Length of 5GS mobile identity contents								octet 2
Length of 5GS mobile identity contents								octet 3
0					0			
Spare	SUPI format				Spare	Type of identity		octet 4
MCC digit 2				MCC digit 1				octet 5
MNC digit 3				MCC digit 3				octet 6
MNC digit 2				MNC digit 1				octet 7
Routing indicator digit 2				Routing indicator digit 1				octet 8
Routing indicator digit 4				Routing indicator digit 3				octet 9
0	0	0	0					
Spare	Spare	Spare	Spare	Protection scheme Id				octet 10
Home network public key identifier								octet 11
Scheme output								octet 12 - x

**Figure 9.11.3.4.3: 5GS mobile identity information element for type of identity "SUCI" and SUPI format "IMSI"**

8	7	6	5	4	3	2	1	
MSIN digit 2				MSIN digit 1				octet 12
...								
MSIN digit n+1				MSIN digit n				octet x

**Figure 9.11.3.4.3a: Scheme output for type of identity "SUCI", SUPI format "IMSI" and Protection scheme Id "Null scheme"**

8	7	6	5	4	3	2	1	
5GS mobile identity IEI								octet 1
Length of 5GS mobile identity contents								octet 2
Length of 5GS mobile identity contents								octet 3
0					0			
Spare	SUPI format				Spare	Type of identity		octet 4
SUCI NAI								octet 5 - y

**Figure 9.11.3.4.4: 5GS mobile identity information element for type of identity "SUCI" and SUPI format "Network specific identifier"**

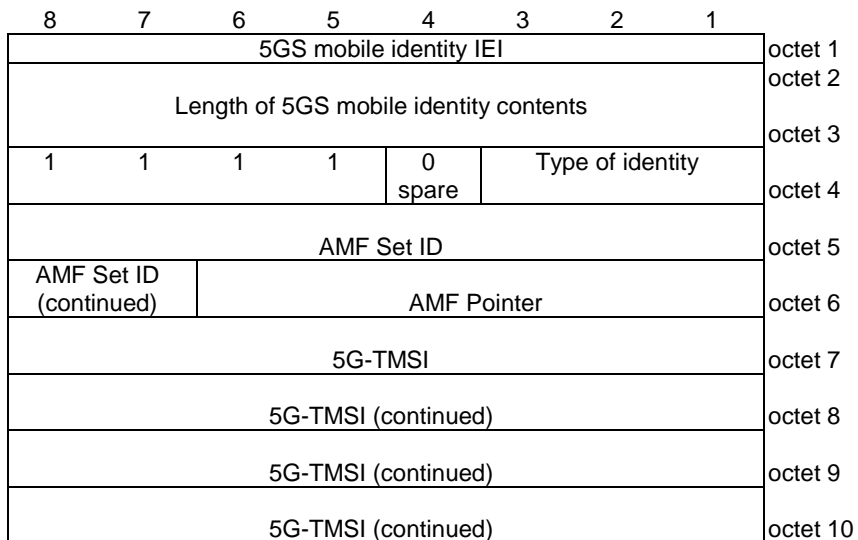

Figure 9.11.3.4.5: 5GS mobile identity information element for type of identity "5G-S-TMSI"

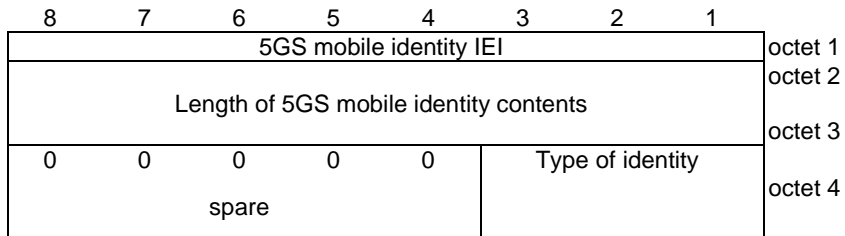

Figure 9.11.3.4.6: 5GS mobile identity information element for type of identity "No identity"



**Table 9.11.3.4.1: 5GS mobile identity information element**

Type of identity (octet 4)

Bits

**3 2 1**

0 0 0 No identity (NOTE)

0 0 1 SUCI

0 1 0 5G-GUTI

0 1 1 IMEI

1 0 0 5G-S-TMSI

1 0 1 IMEISV

All other values are reserved.

Odd/even indication (octet 4)

Bit

**4**

0 even number of identity digits

1 odd number of identity digits

For the 5G-GUTI, then bits 5 to 8 of octet 3 are coded as "1111", octet 4 through 6 contain the MCC and MNC values as specified below, octet 7 through 9 contain the AMF Region ID, the AMF Set ID and the AMF Pointer values and octet 10 through 13 contain the 5G-TMSI as defined in 3GPP TS 23.003 [4].

MCC, Mobile country code (octet 5, octet 6 bits 1 to 4)

The MCC field is coded as in ITU-T Recommendation E.212 [42], annex A.

MNC, Mobile network code (octet 6 bits 5 to 8, octet 7)

The coding of this field is the responsibility of each administration but BCD coding shall be used. The MNC shall consist of 2 or 3 digits. If a network operator decides to use only two digits in the MNC, bits 5 to 8 of octet 6 shall be coded as "1111".

The contents of the MCC and MNC digits are coded as octets 6 to 8 of the Temporary mobile group identity IE in figure 10.5.154 of 3GPP TS 24.008 [12].

AMF Region ID (octet 8)

This field contains the binary encoding of the AMF Region ID. Bit 8 of octet 7 is the most significant bit and bit 1 of octet 7 is the least significant bit.

AMF Set ID (octet 9, octet 9 bits 7 to 8)

This field contains the binary encoding of the AMF Set ID. Bit 8 of octet 8 is the most significant bit and bit 7 of octet 9 is the least significant bit.

AMF Pointer (octet 10 bits 1 to 6)

This field contains the binary encoding of the AMF Pointer. Bit 6 of octet 9 is the most significant bit and bit 1 of octet 9 is the least significant bit.

5G-TMSI (octet 11 to 14)

Bit 8 of octet 11 is the most significant bit and bit 1 of octet 14 is the least significant bit.

Identity digit (octet 4 bits 5 to 8, octet 5 etc.)

For the IMEI, Identity digit field is coded using BCD coding. If the number of identity digits is even then bits 5 to 8 of the last octet shall be filled with an end mark coded as "1111". The format of the IMEI is described in 3GPP TS 23.003 [4].

For the IMEISV, Identity digit field is coded using BCD coding. Bits 5 to 8 of the last octet shall be filled with an end mark coded as "1111". The format of the IMEISV is described in 3GPP TS 23.003 [4].

For the SUCI, bit 8 of octet 4 is spare and shall be coded as zero. Bits 5-7 of octet 4 contain the SUPI format and are coded as shown below.

SUPI format (octet 4, bits 5-7)

Bits

**7 6 5**

0 0 0 IMSI

0 0 1 Network Specific Identifier

All other values are interpreted as IMSI by this version of the protocol.

For the SUCI with SUPI format "IMSI", octets 5 through 7 contain the MCC and MNC values as specified below. For subsequent fields, bit 8 of octet 8 is the most significant bit and bit 1 of the last octet the least significant bit. The required fields for the SUCI are as defined in 3GPP TS 23.003 [4].

MCC, Mobile country code (octet 5, octet 6 bits 1 to 4)

The MCC field is coded as in ITU-T Recommendation E.212 [42], annex A.

MNC, Mobile network code (octet 6 bits 5 to 8, octet 7)

The coding of this field is the responsibility of each administration but BCD coding shall be used. The MNC shall consist of 2 or 3 digits. If a network operator decides to use only two digits in the MNC, bits 5 to 8 of octet 6 shall be coded as "1111".

The contents of the MCC and MNC digits are coded as octets 6 to 8 of the Temporary mobile group identity IE in figure 10.5.154 of 3GPP TS 24.008 [12].

Routing indicator (octets 8-9)

Routing Indicator shall consist of 1 to 4 digits. The coding of this field is the responsibility of home network operator but BCD coding shall be used. If a network operator decides to assign less than 4 digits to Routing Indicator, the remaining digits shall be coded as "1111" and inserted at the left side to fill the 4 digits coding of Routing Indicator. If no Routing Indicator is configured in the USIM, the UE shall code the first digit of the Routing Indicator as "0000" and the remaining digits as "1111".

Protection scheme identifier (octet 10 bits 1 to 4)

Bits

<b>4</b>	<b>3</b>	<b>2</b>	<b>1</b>	
0	0	0	0	Null scheme
0	0	0	1	ECIES scheme profile A
0	0	1	0	ECIES scheme profile B
0	0	1	1	Reserved
to				
1	0	1	1	Operator-specific protection scheme
1	1	0	0	
to				
1	1	1	1	

Bits 5-8 of octet 10 are spare and shall be coded as zero.

Home network public key identifier (octet 10)

The Home network public key identifier (PKI) field is coded as defined in 3GPP TS 23.003 [4]. Home network public key identifier shall be coded as "00000000" when Protection scheme identifier is set to "0000" (i.e. Null scheme).

Bits

<b>8</b>	<b>7</b>	<b>6</b>	<b>5</b>	<b>4</b>	<b>3</b>	<b>2</b>	<b>1</b>	
0	0	0	0	0	0	0	0	Home network PKI value 0
0	0	0	0	0	0	0	1	Home network PKI value (1-254)
to								
1	1	1	1	1	1	1	0	Reserved
1	1	1	1	1	1	1	1	

<p>Scheme output (octets 12 to x)</p> <p>The Scheme output field consists of a string of characters with a variable length or hexadecimal digits as specified in 3GPP TS 23.003 [4]. If Protection scheme identifier is set to "0000" (i.e. Null scheme), then the Scheme output consists of the MSIN and is coded using BCD coding with each digit of the MSIN coded over 4 bits. If the MSIN includes an odd number of digits, bits 5 to 8 of octet x shall be coded as "1111". If Protection scheme identifier is not "0000" (i.e. ECIES scheme profile A, ECIES scheme profile B or Operator-specific protection scheme), then Scheme output is coded as hexadecimal digits.</p> <p>For the SUCI with SUPI format set to "Network specific identifier", the SUCI NAI field contains an NAI constructed as specified in subclause 28.7.3 of 3GPP TS 23.003 [4] and encoded as UTF-8 string.</p> <p>For the 5G-S-TMSI, bits 5 to 8 of octet 4 are coded as "1111". The coding of the 5G-S-TMSI is left open for each administration.</p> <p>AMF Set ID (octet 5, octet 6 bits 7 to 8) This field contains the binary encoding of the AMF Set ID. Bit 8 of octet 5 is the most significant bit and bit 7 of octet 6 is the least significant bit.</p> <p>AMF Pointer (octet 6 bits 1 to 6) This field contains the binary encoding of the AMF Pointer. Bit 6 of octet 6 is the most significant bit and bit 1 of octet 6 is the least significant bit.</p> <p>5G-TMSI (octet 7 to 10) Bit 8 of octet 7 is the most significant bit and bit 1 of octet 10 is the least significant bit.</p> <p>For Type of identity "No identity", the length of mobile identity contents parameter shall be set to 1 and the bits 4-8 of octet 4 are spare and shall be coded as zero.</p> <p>NOTE: This can be used when the requested identity is not available at the UE during the identification procedure.</p>
---

### 9.11.3.5 5GS network feature support

The purpose of the 5GS network feature support information element is to indicate whether certain features are supported by the network.

The 5GS network feature support information element is coded as shown in figure 9.11.3.5.1 and table 9.11.3.5.1.

The 5GS network feature support is a type 4 information element with a minimum length of 3 octets and a maximum length of 5 octets.

8	7	6	5	4	3	2	1	
5GS network feature support IEI								octet 1
Length of 5GS network feature support contents								octet 2
MPSI	IWK N26	EMF		EMC		IMS- VoPS- N3GP P	IMS- VoPS- 3GPP	octet 3
0 Spare	0 Spare	0 Spare	0 Spare	0 Spare	0 Spare	MCSI	EMCN 3	octet 4
0	0	0	0	0	0	0	0	octet 5*
Spare								

Figure 9.11.3.5.1: 5GS network feature support information element

**Table 9.11.3.5.1: 5GS network feature support information element**

IMS voice over PS session over 3GPP access indicator (IMS-VoPS-3GPP) (octet 3, bit 1)	
This bit indicates the support of IMS voice over PS session over 3GPP access (see NOTE 1)	
Bit	
<b>1</b>	
0	IMS voice over PS session not supported over 3GPP access
1	IMS voice over PS session supported over 3GPP access
IMS voice over PS session over non-3GPP access indicator (IMS-VoPS-N3GPP) (octet 3, bit 2)	
This bit indicates the support of IMS voice over PS session over non-3GPP access	
Bit	
<b>2</b>	
0	IMS voice over PS session not supported over non-3GPP access
1	IMS voice over PS session supported over non-3GPP access
Emergency service support indicator for 3GPP access (EMC) (octet 3, bit 3 and bit 4)	
This bit indicates the support of emergency services in 5GS for 3GPP access (see NOTE 2)	
Bits	
<b>4 3</b>	
0 0	Emergency services not supported
0 1	Emergency services supported in NR connected to 5GCN only
1 0	Emergency services supported in E-UTRA connected to 5GCN only
1 1	Emergency services supported in NR connected to 5GCN and E-UTRA connected to 5GCN
Emergency service fallback indicator for 3GPP access (EMF) (octet 3, bit 5 and bit 6)	
This bit indicates the support of emergency services fallback for 3GPP access (see NOTE 2)	
Bits	
<b>6 5</b>	
0 0	Emergency services fallback not supported
0 1	Emergency services fallback supported in NR connected to 5GCN only
1 0	Emergency services fallback supported in E-UTRA connected to 5GCN only
1 1	Emergency services fallback supported in NR connected to 5GCN and E-UTRA connected to 5GCN
Interworking without N26 interface indicator (IWK N26) (octet 3, bit 7)	
This bit indicates whether interworking without N26 interface is supported	
Bit	
<b>7</b>	
0	Interworking without N26 interface not supported
1	Interworking without N26 interface supported
MPS indicator (MPSI) (octet 3, bit 8)	
This bit indicates the support of MPS in the RPLMN or equivalent PLMN.	
Bit	
<b>8</b>	
0	Access identity 1 not valid in RPLMN or equivalent PLMN
1	Access identity 1 valid in RPLMN or equivalent PLMN
Emergency service support for non-3GPP access indicator (EMCN3) (octet 4, bit 1)	
This bit indicates the support of emergency services in 5GS for non-3GPP access	
Bit (see NOTE 3)	
<b>1</b>	
0	Emergency services not supported over non-3GPP access
1	Emergency services supported over non-3GPP access
MCS indicator (MCSI) (octet 4, bit 2)	
This bit indicates the support of MCS in the RPLMN or equivalent PLMN.	
Bit	
<b>2</b>	
0	Access identity 2 not valid in RPLMN or equivalent PLMN
1	Access identity 2 valid in RPLMN or equivalent PLMN

Bits 3 to 8 in octets 4 and all bits in octet 5 are spare and shall be coded as zero, if the respective octet is included in the information element.

NOTE 1: For a registration procedure over non-3GPP access, bit 1 of octet 3 is ignored.

NOTE 2: For a registration procedure over 3GPP access, bit 1 of octet 4 is ignored.

NOTE 3: For a registration procedure over non-3GPP access, bits 3 to 6 of octet 3 are ignored.

### 9.11.3.6 5GS registration result

The purpose of the 5GS registration result information element is to specify the result of a registration procedure.

The 5GS registration result information element is coded as shown in figure 9.11.3.6.1 and table 9.11.3.6.1.

The 5GS registration result is a type 4 information element with a length of 3 octets.

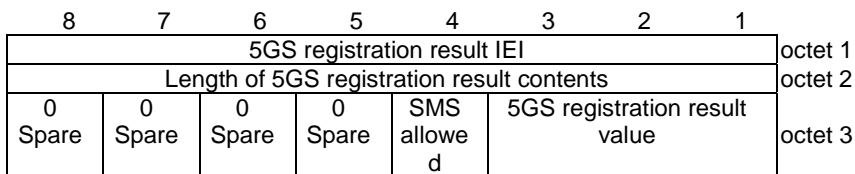

**Figure 9.11.3.6.1: 5GS registration result information element**

**Table 9.11.3.6.1: 5GS registration result information element**

5GS registration result value (octet 3, bits 1 to 3)			
Bits			
<b>3</b>	<b>2</b>	<b>1</b>	
0	0	1	3GPP access
0	1	0	Non-3GPP access
0	1	1	3GPP access and non-3GPP access
1	1	1	reserved
All other values are unused and shall be treated as "3GPP access", if received by the UE.			
SMS over NAS transport allowed (SMS allowed) (octet 3, bit 4)			
Bit			
<b>4</b>			
0	SMS over NAS not allowed		
1	SMS over NAS allowed		
Bits 5 to 8 of octet 3 are spare and shall be coded as zero.			

### 9.11.3.7 5GS registration type

The purpose of the 5GS registration type information element is to indicate the type of the requested registration.

The 5GS registration type information element is coded as shown in figure 9.11.3.7.1 and table 9.11.3.7.1.

The 5GS registration type is a type 1 information element with a length of 1 octet.

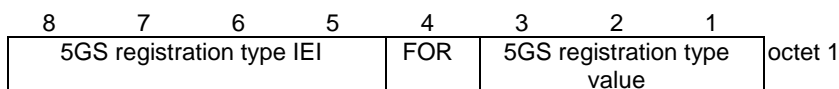

**Figure 9.11.3.7.1: 5GS registration type information element**

**Table 9.11.3.7.1: 5GS registration type information element**

5GS registration type value (octet 1, bits 1 to 3)			
Bits			
<b>3</b>	<b>2</b>	<b>1</b>	
0	0	1	initial registration
0	1	0	mobility registration updating
0	1	1	periodic registration updating
1	0	0	emergency registration
1	1	1	reserved
All other values are unused and shall be interpreted as "initial registration", if received by the network.			
Follow-on request bit (FOR) (octet 1, bit 4)			
Bit			
<b>4</b>			
0	No follow-on request pending		
1	Follow-on request pending		

**9.11.3.8 5GS tracking area identity**

The purpose of the 5GS tracking area identity information element is to provide an unambiguous identification of tracking areas within the area covered by the 5GS.

The 5GS tracking area identity information element is coded as shown in figure 9.11.3.8.1 and table 9.11.3.8.1.

The 5GS tracking area identity is a type 3 information element with a length of 7 octets.

8	7	6	5	4	3	2	1	
5GS tracking area identity IEI								octet 1
MCC digit 2				MCC digit 1				octet 2
MNC digit 3				MCC digit 3				octet 3
MNC digit 2				MNC digit 1				octet 4
TAC								octet 5
TAC (continued)								octet 6
TAC (continued)								octet 7

**Figure 9.11.3.8.1: 5GS tracking area identity information element**



**Table 9.11.3.8.1: 5GS tracking area identity information element**

<p>MCC, Mobile country code (octets 2 and 3) The MCC field is coded as in ITU-T Rec. E212 [39], annex A.</p> <p>If the TAI is deleted the MCC and MNC shall take the value from the deleted TAI.</p> <p>In abnormal cases, the MCC stored in the UE can contain elements not in the set {0, 1 ... 9}. In such cases the UE should transmit the stored values using full hexadecimal encoding. When receiving such an MCC, the network shall treat the TAI as deleted.</p> <p>MNC, Mobile network code (octet 3 bits 5 to 8, octet 4) The coding of this field is the responsibility of each administration, but BCD coding shall be used. The MNC shall consist of 2 or 3 digits. For PCS 1900 for NA, Federal regulation mandates that a 3-digit MNC shall be used. However, a network operator may decide to use only two digits in the MNC in the TAI over the radio interface. In this case, bits 5 to 8 of octet 3 shall be coded as "1111". Mobile equipment shall accept a TAI coded in such a way.</p> <p>In abnormal cases, the MNC stored in the UE can have:</p> <ul style="list-style-type: none"> <li>- digit 1 or 2 not in the set {0, 1 ... 9}, or</li> <li>- digit 3 not in the set {0, 1 ... 9, F} hex.</li> </ul> <p>In such cases the UE shall transmit the stored values using full hexadecimal encoding. When receiving such an MNC, the network shall treat the TAI as deleted.</p> <p>The same handling shall apply for the network, if a 3-digit MNC is sent by the UE to a network using only a 2-digit MNC.</p> <p>TAC, Tracking area code (octets 5 to 7) In the TAC field bit 8 of octet 5 is the most significant bit and bit 1 of octet 7 the least significant bit.</p> <p>The coding of the tracking area code is the responsibility of each administration except that two values are used to mark the TAC, and hence the TAI, as deleted. Coding using full hexadecimal representation may be used. The tracking area code consists of 3 octets.</p> <p>If a TAI has to be deleted, then all bits of the tracking area code shall be set to one with the exception of the least significant bit which shall be set to zero. If a USIM is inserted in a mobile equipment with the tracking area code containing all zeros, then the mobile equipment shall recognise this TAC as part of a deleted TAI.</p>
--

### 9.11.3.9 5GS tracking area identity list

The purpose of the 5GS tracking area identity list information element is to transfer a list of tracking areas from the network to the UE.

The coding of the information element allows combining different types of lists. The lists of type "00" and "01" allow a more compact encoding, when the different TAIs are sharing the PLMN identity.

The 5GS tracking area identity list information element is coded as shown in figure 9.11.3.8.1, figure 9.11.3.8.2, figure 9.11.3.9.3, figure 9.11.3.9.4 and table 9.11.3.9.1.

The 5GS tracking area identity list is a type 4 information element, with a minimum length of 9 octets and a maximum length of 114 octets. The list can contain a maximum of 16 different tracking area identities.

8	7	6	5	4	3	2	1	
5GS tracking area identity list IEI								octet 1
Length of 5GS tracking area identity list contents								octet 2
Partial tracking area identity list 1								octet 3
Partial tracking area identity list 2								octet i octet i+1*
...								octet l* octet l+1*
Partial tracking area identity list p								octet m* octet m+1* octet n*

Figure 9.11.3.9.1: 5GS tracking area identity list information element

8	7	6	5	4	3	2	1	
0 Spare	Type of list		Number of elements					octet 1
MCC digit 2			MCC digit 1					octet 2
MNC digit 3			MCC digit 3					octet 3
MNC digit 2			MNC digit 1					octet 4
TAC 1								octet 5
TAC 1 (continued)								octet 6
TAC 1 (continued)								octet 7
...								...
...								...
TAC k								octet 3k+2*
TAC k (continued)								octet 3k+3*
TAC k (continued)								octet 3k+4*

Figure 9.11.3.9.2: Partial tracking area identity list – type of list = "00"

8 0 Spare	7 Type of list	6 5 4 3 2 1 Number of elements	octet 1
	MCC digit 2	MCC digit 1	octet 2
	MNC digit 3	MCC digit 3	octet 3
	MNC digit 2	MNC digit 1	octet 4
TAC 1			octet 5
TAC 1 (continued)			octet 6
TAC 1 (continued)			octet 7

**Figure 9.11.3.9.3: Partial tracking area identity list – type of list = "01"**

8 0 Spare	7 Type of list	6 5 4 3 2 1 Number of elements	octet 1
	MCC digit 2	MCC digit 1	octet 2
	MNC digit 3	MCC digit 3	octet 3
	MNC digit 2	MNC digit 1	octet 4
TAC 1			octet 5
TAC 1 (continued)			octet 6
TAC 1 (continued)			octet 7
	MCC digit 2	MCC digit 1	octet 8*
	MNC digit 3	MCC digit 3	octet 9*
	MNC digit 2	MNC digit 1	octet 10*
TAC 2			octet 11*
TAC 2 (continued)			octet 12*
TAC 2 (continued)			octet 13*
...			
...			
	MCC digit 2	MCC digit 1	octet 6k-4*
	MNC digit 3	MCC digit 3	octet 6k-3*
	MNC digit 2	MNC digit 1	octet 6k-2*
TAC k			octet 6k-1*
TAC k (continued)			octet 6k*
TAC k (continued)			octet 6k+1*

**Figure 9.11.3.9.4: Partial tracking area identity list – type of list = "10"**

**Table 9.11.3.9.1: Tracking area identity list information element**

Value part of the Tracking area identity list information element (octets 3 to n)

The value part of the Tracking area identity list information element consists of one or several partial tracking area identity lists. The length of each partial tracking area identity list can be determined from the 'type of list' field and the 'number of elements' field in the first octet of the partial tracking area identity list.

The UE shall store the complete list received. If more than 16 TAIs are included in this information element, the UE shall store the first 16 TAIs and ignore the remaining octets of the information element.

Partial tracking area identity list:

Type of list (octet 1)

Bits

**7 6**

0 0 list of TACs belonging to one PLMN, with non-consecutive TAC values  
 0 1 list of TACs belonging to one PLMN, with consecutive TAC values  
 1 0 list of TAIs belonging to different PLMNs (see NOTE)

All other values are reserved.

Number of elements (octet 1)

Bits

**5 4 3 2 1**

0 0 0 0 0 1 element  
 0 0 0 0 1 2 elements  
 0 0 0 1 0 3 elements  
 ...  
 0 1 1 0 1 14 elements  
 0 1 1 1 0 15 elements  
 0 1 1 1 1 16 elements

All other values are unused and shall be interpreted as 16, if received by the UE.

Bit 8 of octet 1 is spare and shall be coded as zero.

For type of list = "00" and number of elements = k:

octet 2 to 4 contain the MCC+MNC, and

for  $j = 1, \dots, k$ :

octets  $3j+2$  to  $3j+4$  contain the TAC of the  $j$ -th TAI belonging to the partial list,

For type of list = "01" and number of elements = k:

octet 2 to 4 contain the MCC+MNC, and

octets 5 to 7 contain the TAC of the first TAI belonging to the partial list.

The TAC values of the other  $k-1$  TAIs are TAC+1, TAC+2, ..., TAC+k-1.

For type of list = "10" and number of elements = k:

for  $j = 1, \dots, k$ .

octets  $6j-4$  to  $6j-2$  contain the MCC+MNC, and

octets  $6j-1$  to  $6j+1$  contain the TAC of the  $j$ -th TAI belonging to the partial list.

MCC, Mobile country code

The MCC field is coded as in ITU-T Recommendation E.212 [42], annex A.

MNC, Mobile network code

The coding of this field is the responsibility of each administration but BCD coding shall be used. The MNC shall consist of 2 or 3 digits. If a network operator decides to use only two digits in the MNC, MNC digit 3 shall be coded as "1111".

TAC, Tracking area code

In the TAC field bit 8 of the first octet is the most significant bit and bit 1 of third octet the least significant bit.  
 The coding of the tracking area code is the responsibility of each administration.  
 Coding using full hexadecimal representation may be used. The tracking area code consists of 3 octets.

NOTE: If the "list of TAs belonging to different PLMNs" is used, the PLMNs included in the list need to be present in the list of "equivalent PLMNs".

### 9.11.3.9A 5GS update type

The purpose of the 5GS update type IE is to allow the UE to provide additional information to the network when performing a registration procedure.

The 5GS update type information element is coded as shown in figure 9.11.3.9A.1 and table 9.11.3.9A.1.

The 5GS update type is a type 4 information element.

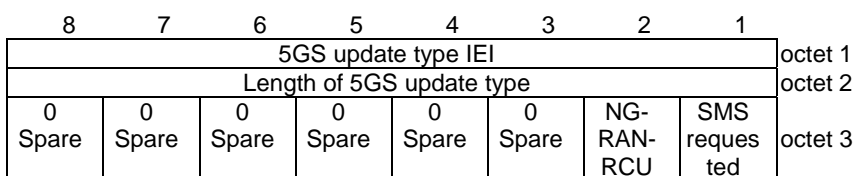

**Figure 9.11.3.9A.1: 5GS update type information element**

**Table 9.11.3.9A.1: 5GS update type information element**

SMS over NAS transport requested (SMS requested) (octet 3, bit 1)	
Bit	
1	
0	SMS over NAS not supported
1	SMS over NAS supported
NG-RAN Radio Capability Update (NG-RAN-RCU) (octet 3, bit 2)	
Bits	
2	
0	NG-RAN radio capability update not needed
1	NG-RAN radio capability update needed
Bits 3 to 8 of octet 3 are spare and shall be coded as zero.	

### 9.11.3.10 ABBA

The purpose of the ABBA information element is to enable the bidding down protection of security features.

The ABBA information element is coded as shown in figure 9.11.3.10.1 and table 9.11.3.10.1.

The ABBA is a type 4 information element with a minimum length of 4 octets.

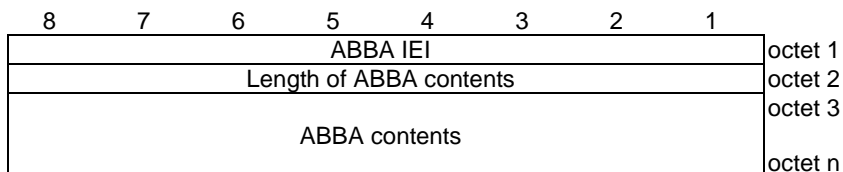

**Figure 9.11.3.10.1: ABBA information element**

**Table 9.11.3.10.1: ABBA information element**

ABBA contents (octet 3-n): indicate set of security features defined for 5GS as described in 3GPP TS 33.501 [24].
NOTE 1: If the UE receives the ABBA IE with a length that is set to a value of 2 and with a value of 0000H, the UE shall use the length and the contents of the ABBA IE as received from the network.
NOTE 2: If the UE receives the ABBA IE with a length that is set to a value larger than 2 or with a value that is different from 0000H, the UE shall use the length and the contents of the ABBA IE as received from the network.

**9.11.3.11 Access type**

The purpose of the access type information element is to indicate the access type over which the downlink signalling or user data is pending to be sent to the UE.

The access type is a type 1 information element.

The access type information element is coded as shown in figure 9.11.3.11.1 and table 9.11.3.11.1.

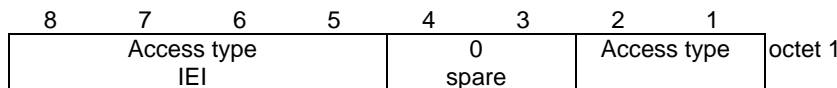

**Figure 9.11.3.11.1: Access type information element**

**Table 9.11.3.11.1: Access type information element**

Access type value (octet 1, bit 1 to bit 2)		
Bits		
<b>2</b>	<b>1</b>	
0	1	3GPP access
1	0	Non-3GPP access
All other values are reserved.		

**9.11.3.12 Additional 5G security information**

The purpose of the Additional 5G security information information element is to provide the UE with additional security parameters (e.g. horizontal derivation parameter) or to request the UE to retransmit an initial NAS message during a security mode control procedure as defined in 3GPP TS 33.501 [24]. The UE uses these parameters for completion of security mode control procedure.

The Additional 5G security parameters information element is coded as shown in figure 9.11.3.12.1 and table 9.11.3.12.1.

The Additional 5G security parameters is a type 4 information element with a length of 3 octets.

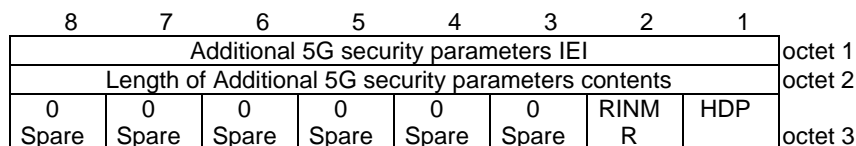

**Figure 9.11.3.12.1: Additional 5G security parameters information element**

**Table 9.11.3.12.1: Additional 5G security parameters information element**

Horizontal derivation parameter (HDP) (octet 3, bit 1)	
0	$K_{AMF}$ derivation is not required
1	$K_{AMF}$ derivation is required
Retransmission of initial NAS message request (octet 3, bit 2)	
0	Retransmission of the initial NAS message not requested
1	Retransmission of the initial NAS message requested
Bits 3 to 8 of octet 3 are spare and shall be coded as zero.	

### 9.11.3.13 Allowed PDU session status

The purpose of the Allowed PDU session status information element is to indicate to the network user-plane resources of PDU sessions associated with non-3GPP access that are allowed to be re-established over 3GPP access or if there is no PDU session(s) for which the UE allows the user-plane resources to be re-established over 3GPP access.

The Allowed PDU session status information element is coded as shown in figure 9.11.3.13.1 and table 9.11.3.13.1.

The Allowed PDU session status is a type 4 information element with minimum length of 4 octets and maximum length of 34 octets.

8	7	6	5	4	3	2	1	
Allowed PDU session status IEI								octet 1
Length of Allowed PDU session status contents								octet 2
PSI (7)	PSI (6)	PSI (5)	PSI (4)	PSI (3)	PSI (2)	PSI (1)	PSI (0)	octet 3
PSI (15)	PSI (14)	PSI (13)	PSI (12)	PSI (11)	PSI (10)	PSI (9)	PSI (8)	octet 4
0	0	0	0	0	0	0	0	octet 5* -34*
Spare								

**Figure 9.11.3.13.1: Allowed PDU session status information element****Table 9.11.3.13.1: Allowed PDU session status information element**

PSI(x) shall be coded as follows:
PSI(0): Bit 1 octet 3 is spare and shall be coded as zero.
PSI(1) – PSI(15): 0 indicates that the user-plane resources of corresponding PDU session is not allowed to be re-established over 3GPP access. 1 indicates that the user-plane resources of corresponding PDU session can be re-established over 3GPP access.
If there is no PDU session for which the user-plane resources can be re-established over 3GPP access, all bits in PSI(1) – PSI(15) shall be coded as zero.
All bits in octet 5 to 34 are spare and shall be coded as zero, if the respective octet is included in the information element.

### 9.11.3.14 Authentication failure parameter

See subclause 10.5.3.2.2 in 3GPP TS 24.008 [12].

### 9.11.3.15 Authentication parameter AUTN

See subclause 10.5.3.1.1 in 3GPP TS 24.008 [12].



### 9.11.3.16 Authentication parameter RAND

See subclause 10.5.3.1 in 3GPP TS 24.008 [12].

### 9.11.3.17 Authentication response parameter

See subclause 9.9.3.4 in 3GPP TS 24.301 [15].

### 9.11.3.18 Configuration update indication

The purpose of the Configuration update indication information element is to indicate the additional information associated with the generic UE configuration update procedure.

The Configuration update indication information element is coded as shown in figure 9.11.3.18.1 and table 9.11.3.18.1.

The Configuration update indication is a type 1 information element.

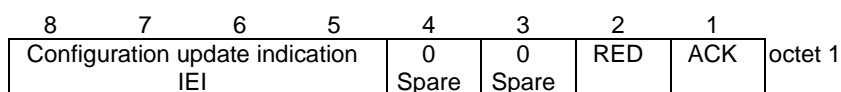

**Figure 9.11.3.18.1: Configuration update indication**

**Table 9.11.3.18.1: Configuration update indication**

Acknowledgement (ACK) value (octet 1, bit 1)	
Bit	
<b>1</b>	
0	acknowledgement not requested
1	acknowledgement requested
Registration requested (RED) value (octet 1, bit 2)	
Bit	
<b>2</b>	
0	registration not requested
1	registration requested
Bits 3 and 4 are spare and shall be coded as zero,	

### 9.11.3.19 Daylight saving time

See subclause 10.5.3.12 in 3GPP TS 24.008 [12].

### 9.11.3.20 De-registration type

The purpose of the De-registration type information element is to indicate the type of de-registration.

The De-registration type information element is coded as shown in figure 9.11.3.20.1 and table 9.11.3.20.1.

The De-registration type is a type 1 information element.

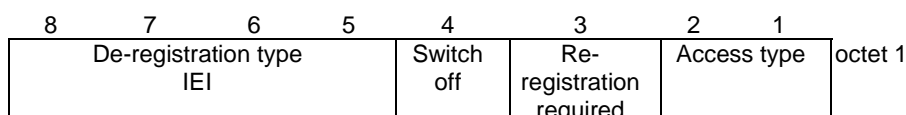

**Figure 9.11.3.20.1: Deregistration type information element**

**Table 9.11.3.20.1: Deregistration type information element**

Switch off (octet 1, bit 4)	
In the UE to network direction:	
Bit	
<b>4</b>	
0	Normal de-registration
1	Switch off
In the network to UE direction bit 4 is spare. The network shall set this bit to zero.	
Re-registration required (octet 1, bit 3)	
In the network to UE direction:	
Bit	
<b>3</b>	
0	re-registration not required
1	re-registration required
In the UE to network direction bit 3 is spare. The UE shall set this bit to zero.	
Access type (octet 1, bit 2, bit 1)	
Bit	
<b>2 1</b>	
0 1	3GPP access
1 0	Non-3GPP access
1 1	3GPP access and non-3GPP access
All other values are reserved.	

9.11.3.21 Void

9.11.3.22 Void

9.11.3.23 Emergency number list

See subclause 10.5.3.13 in 3GPP TS 24.008 [12].

9.11.3.23A EPS bearer context status

See subclause 9.9.2.1 in 3GPP TS 24.301 [15].

9.11.3.24 EPS NAS message container

The purpose of the EPS NAS message container information element is to transport an EPS NAS message as specified in 3GPP TS 24.301 [15].

The EPS NAS message container information element is coded as shown in figure 9.11.3.24.1 and table 9.11.3.24.1.

The EPS NAS message container is a type 6 information element.

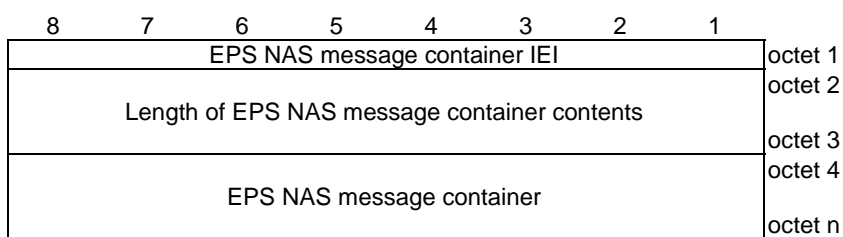

**Figure 9.11.3.24.1: EPS NAS message container information element**

**Table 9.11.3.24.1: EPS NAS message container information element**

EPS NAS message container (octet 4 to n) An EPS NAS message as specified in 3GPP TS 24.301 [15].
---

**9.11.3.25 EPS NAS security algorithms**

See subclause 9.9.3.23 in 3GPP TS 24.301 [15].

**9.11.3.26 Extended emergency number list**

See subclause 9.9.3.37A in 3GPP TS 24.301 [15].

**9.11.3.27 Void**

**9.11.3.28 IMEISV request**

See subclause 10.5.5.10 in 3GPP TS 24.008 [12].

**9.11.3.29 LADN indication**

The purpose of the LADN indication information element is to request the network for LADN information for specific LADN DNN(s) or to indicate a request for LADN information.

The LADN indication information element is coded as shown in figure 9.11.3.29.1 and table 9.11.3.29.1.

The LADN indication is a type 6 information element with a minimum length of 3 octets and a maximum length of 811 octets.

The LADN indication information element can contain a minimum of 0 and a maximum of 8 different LADN DNN values.

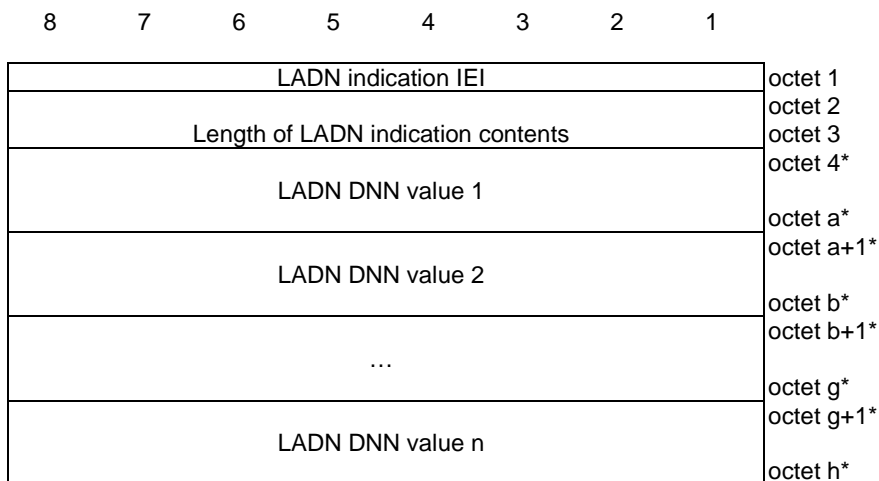

**Figure 9.11.3.29.1: LADN indication information element**

**Table 9.11.3.29.1: LADN indication information element**

Value part of the LADN indication information element (octet 4 to h):
The value part of the LADN indication information element consists of zero or more LADN DNN values. If the LADN indication information element conveys more than 8 LADN DNN values in this information element, the network shall consider the first 8 LADN DNN values and ignore the remaining octets of the information element.
LADN DNN value:
LADN DNN value is coded as the length and value part of DNN information element as specified in subclause 9.11.2.1A starting with the second octet.

**9.11.3.30 LADN information**

The purpose of the LADN information information element is to provide the UE with the LADN service area for each available LADN in the current registration area or to delete the LADN information at the UE.

The LADN information information element is coded as shown in figure 9.11.3.30.1, figure 9.11.3.30.2 and table 9.11.3.30.1.

The LADN information is a type 6 information element with a minimum length of 3 octets and a maximum length of 1715 octets.

The LADN information information element can contain a minimum of 0 and a maximum of 8 different LADNs each including a DNN and a 5GS tracking area identity list.

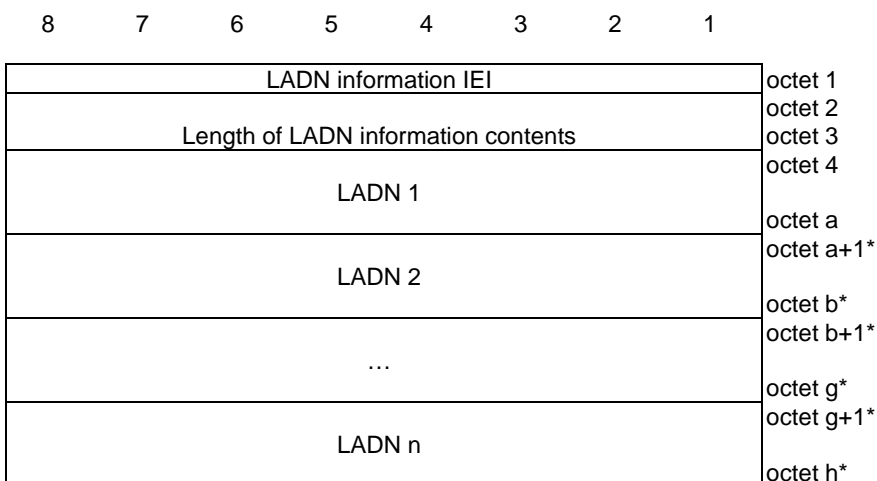

**Figure 9.11.3.30.1: LADN information information element**

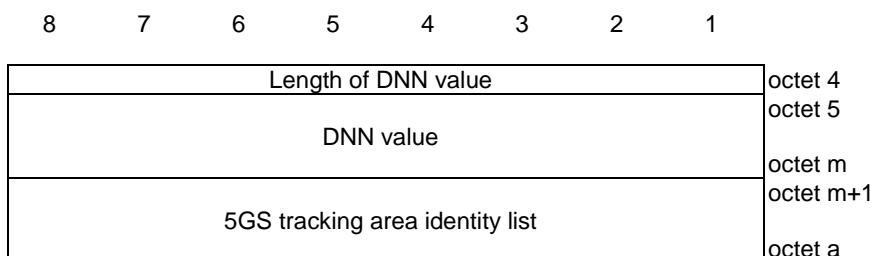

**Figure 9.11.3.30.2: LADN**

**Table 9.11.3.30.1: LADN information information element**

<p>Value part of the LADN information information element (octet 4 to octet h)                  The value part of the LADN information information element consists of one or several LADNs. Each LADN (e.g. octet 4 to octet a) consists one DNN value and one 5GS tracking area identity list. The length of each LADN is determined by the length of DNN value field and the length of 5GS tracking area identity list field. The UE shall store the complete list as received. If more than 8 LADNs are included in this information element, the UE shall store the first 8 LADNs and ignore the remaining octets of the information element.</p> <p>DNN value (octet 5 to octet m):</p> <p>DNN value field is coded as DNN value part of DNN information element as specified in subclause 9.11.2.1A starting with the third octet.</p> <p>5GS tracking area identity list (octet m+1 to octet a):</p> <p>5GS tracking area identity list field is coded as the length and the value part of the 5GS Tracking area identity list information element as specified in subclause 9.11.3.9 starting with the second octet.</p>
---

**9.11.3.31 MICO indication**

The purpose of the MICO indication information element is to indicate the use of MICO mode or the re-negotiation of MICO mode.

The MICO indication information element is coded as shown in figure 9.11.3.31.1 and table 9.11.3.31.1.

The MICO indication is a type 1 information element.

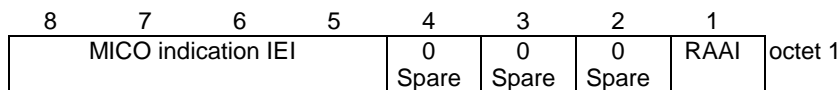

**Figure 9.11.3.31.1: MICO indication**

**Table 9.11.3.31.1: MICO indication**

<p>Registration Area Allocation Indication (RAAI) (octet 1)</p> <p>In the network to UE direction:</p> <p>Bit</p> <p><b>1</b></p> <p>0 all PLMN registration area not allocated</p> <p>1 all PLMN registration area allocated</p> <p>In the UE to network direction bit 1 is spare. The UE shall set this bit to zero.</p> <p>Bits 2, 3 and 4 are spare and shall be coded as zero.</p> <p>NOTE: In the network to UE direction in the CONFIGURATION UPDATE COMMAND message, bit 1 shall be coded as zero.</p>
--

**9.11.3.32 NAS key set identifier**

The NAS key set identifier is allocated by the network.

The NAS key set identifier information element is coded as shown in figure 9.11.3.32.1 and table 9.11.3.32.1.

The NAS key set identifier is a type 1 information element.

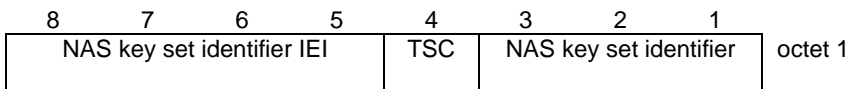

**Figure 9.11.3.32.1: NAS key set identifier information element**

**Table 9.11.3.32.1: NAS key set identifier information element**

Type of security context flag (TSC) (octet 1)	
Bit	
4	
0	native security context (for KSI <sub>AMF</sub> )
1	mapped security context (for KSI <sub>ASME</sub> )
TSC does not apply for NAS key set identifier value "111".	
NAS key set identifier (octet 1)	
Bits	
3 2 1	
0 0 0	through possible values for the NAS key set identifier
1 1 0	
1 1 1	no key is available (UE to network); reserved (network to UE)

### 9.11.3.33 NAS message container

The purpose of the NAS message container IE is to encapsulate a plain 5GS NAS message.

The NAS message container information element is coded as shown in figure 9.11.3.33.1 and table 9.11.3.33.1.

The NAS message container is a type 6 information element.

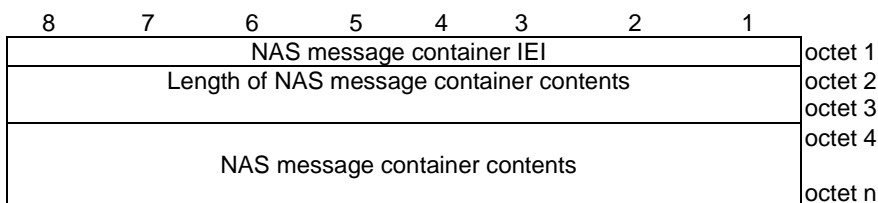

**Figure 9.11.3.33.1: NAS message container information element**

**Table 9.11.3.33.1: NAS message container information element**

NAS message container contents (octet 4 to octet n); Max value of 65535 octets
This IE can contain a REGISTRATION REQUEST message as defined in subclause 5.5.1, or a SERVICE REQUEST message as defined in subclause 5.6.1.

### 9.11.3.34 NAS security algorithms

The purpose of the NAS security algorithms information element is to indicate the 5G algorithms to be used for ciphering and integrity protection.

The NAS security algorithms information element is coded as shown in figure 9.11.3.34.1 and table 9.11.3.34.1.

The NAS security algorithms is a type 3 information element with a length of 2 octets.

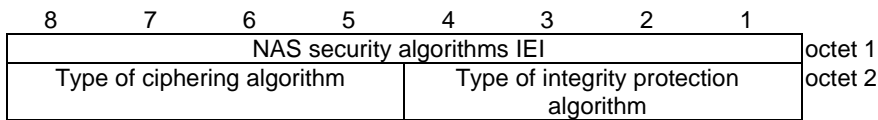

**Figure 9.11.3.34.1: NAS security algorithms information element**

**Table 9.11.3.34.1: NAS security algorithms information element**

Type of integrity protection algorithm (octet 2, bit 1 to 3)	
Bits	
<b>4 3 2 1</b>	
0 0 0 0	5G integrity algorithm 5G-IA0 (null integrity protection algorithm)
0 0 0 1	5G integrity algorithm 128-5G-IA1
0 0 1 0	5G integrity algorithm 128-5G-IA2
0 0 1 1	5G integrity algorithm 128-5G-IA3
0 1 0 0	5G integrity algorithm 5G-IA4
0 1 0 1	5G integrity algorithm 5G-IA5
0 1 1 0	5G integrity algorithm 5G-IA6
0 1 1 1	5G integrity algorithm 5G-IA7
All other values are reserved.	
Type of ciphering algorithm (octet 2, bit 5 to 7)	
Bits	
<b>8 7 6 5</b>	
0 0 0 0	5G encryption algorithm 5G-EA0 (null ciphering algorithm)
0 0 0 1	5G encryption algorithm 128-5G-EA1
0 0 1 0	5G encryption algorithm 128-5G-EA2
0 0 1 1	5G encryption algorithm 128-5G-EA3
0 1 0 0	5G encryption algorithm 5G-EA4
0 1 0 1	5G encryption algorithm 5G-EA5
0 1 1 0	5G encryption algorithm 5G-EA6
0 1 1 1	5G encryption algorithm 5G-EA7
All other values are reserved.	

### 9.11.3.35 Network name

See subclause 10.5.3.5a in 3GPP TS 24.008 [12].

### 9.11.3.36 Network slicing indication

The purpose of the Network slicing indication information element is to indicate additional information associated with network slicing in the generic UE configuration update procedure and the registration procedure, other than the user's configured NSSAI, allowed NSSAI and rejected NSSAI information.

The Network slicing indication information element is coded as shown in figure 9.11.3.36.1 and table 9.11.3.36.1.

The Network slicing indication is a type 1 information element.

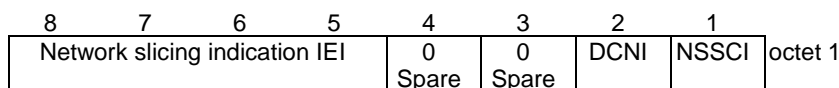

**Figure 9.11.3.36.1: Network slicing indication**

**Table 9.11.3.36.1: Network slicing indication**

Network slicing subscription change indication (NSSCI) (octet 1, bit 1)	
Bit	
1	
0	Network slicing subscription not changed
1	Network slicing subscription changed
Default configured NSSAI indication (DCNI) (octet 1, bit 2)	
Bit	
2	
0	Requested NSSAI not created from default configured NSSAI
1	Requested NSSAI created from default configured NSSAI
In the UE to network direction bit 1 is spare. The UE shall set this bit to zero.	
In the network to UE direction bit 2 is spare. The network shall set this bit to zero.	
Bits 3 and 4 are spare and shall be coded as zero.	

**9.11.3.36A Non-3GPP NW provided policies**

See subclause 10.5.5.37 in 3GPP TS 24.008 [12].

**9.11.3.37 NSSAI**

The purpose of the NSSAI information element is to identify a collection of S-NSSAIs

The NSSAI information element is coded as shown in figure 9.11.3.37.1 and table 9.11.3.37.1.

The NSSAI is a type 4 information element with a minimum length of 4 octets and a maximum length of 146 octets.

NOTE 1: The number of S-NSSAI values in a requested NSSAI or allowed NSSAI cannot exceed eight.

NOTE 2: The number of S-NSSAI values in a configured NSSAI cannot exceed sixteen.

NOTE 3: More than one S-NSSAIs in an NSSAI can have the same SST values, and optionally same SD values, which are associated with different mapped HPLMN SST values and optionally mapped HPLMN SD values.

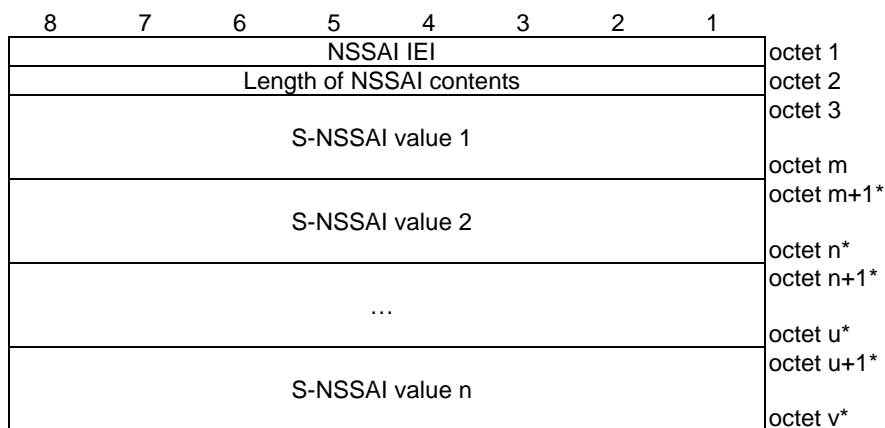

**Figure 9.11.3.37.1: NSSAI information element**



**Table 9.11.3.37.1: NSSAI information element**

<p>Value part of the NSSAI information element (octet 3 to v)</p> <p>The value part of the NSSAI information element consists of one or more S-NSSAI values. Each S-NSSAI value consists of one S-NSSAI and optionally one mapped S-NSSAI.</p> <p>If the recipient of this information element is the UE, the UE shall store the complete list received. If the NSSAI information element conveys an allowed NSSAI and more than 8 S-NSSAI values are included in this information element, the UE shall store the first 8 S-NSSAI values and ignore the remaining octets of the information element.</p> <p>If the NSSAI information element conveys a configured NSSAI and more than 16 S-NSSAI values are included in this information element, the UE shall store the first 16 S-NSSAI values and ignore the remaining octets of the information element.</p> <p>S-NSSAI value:</p> <p>S-NSSAI value is coded as the length and value part of S-NSSAI information element as specified in subclause 9.11.2.8 starting with the second octet.</p>
--

**9.11.3.37A NSSAI inclusion mode**

The purpose of the NSSAI inclusion mode information element is to indicate the NSSAI inclusion mode in which the UE shall operate.

The NSSAI inclusion mode is a type 1 information element.

The NSSAI inclusion mode information element is coded as shown in figure 9.11.3.37A.1 and table 9.11.3.37A.1.

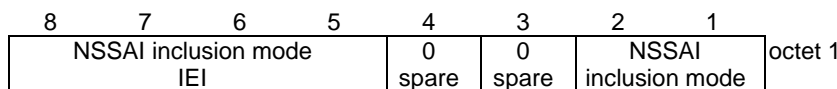

**Figure 9.11.3.37A.1: NSSAI inclusion mode information element**

**Table 9.11.3.37A.1: NSSAI inclusion mode information element**

NSSAI inclusion mode (octet 1, bit 1 to bit 2)		
Bits		
<b>2</b>	<b>1</b>	
0	0	NSSAI inclusion mode A
0	1	NSSAI inclusion mode B
1	0	NSSAI inclusion mode C
1	1	NSSAI inclusion mode D

**9.11.3.38 Operator-defined access category definitions**

The purpose of the Operator-defined access category definitions information element is to provide the UE with the operator-defined access category definitions or to delete the operator-defined access category definitions at the UE.

The Operator-defined access category definitions information element is coded as shown in figure 9.11.3.38.1, figure 9.11.3.38.2 and table 9.11.3.38.1.

The Operator-defined access category definitions is a type 6 information element with a minimum length of 3 octets.

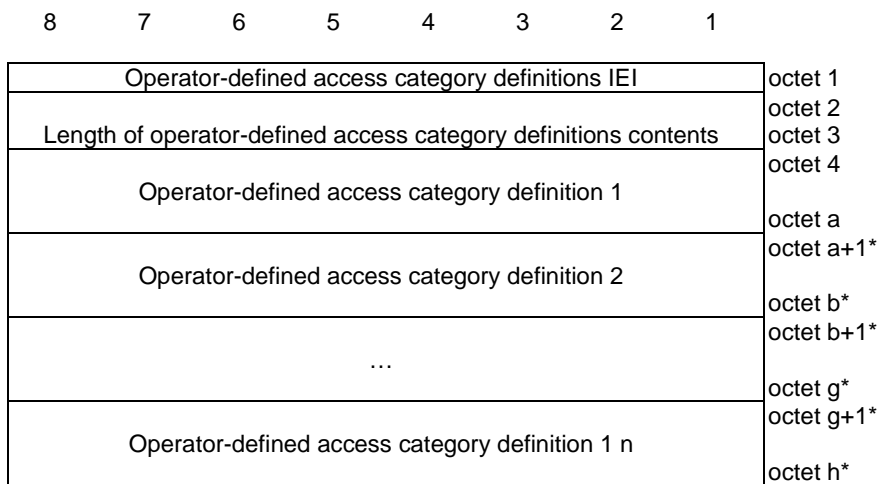

**Figure 9.11.3.38.1: Operator-defined access category definitions information element**

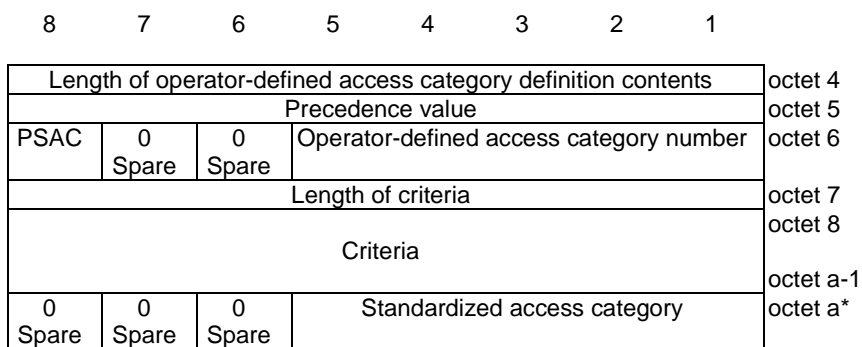

**Figure 9.11.3.38.2: Operator-defined access category definition**

**Table 9.11.3.38.1: Operator-defined access category definitions information element**

Value part of the Operator-defined access category definitions information element (octet 3 to h)

The value part of the Operator-defined access category definitions information element consists of zero or several operator-defined access category definition fields. Each operator-defined access category definition field is coded as described in figure 9.11.3.38.2. The length of each operator-defined access category definition field is determined by the length of operator-defined access category definition contents field.

Operator-defined access category definition (octet 4 to octet a):

Precedence value (octet 5)

Bits

<b>8</b>	<b>7</b>	<b>6</b>	<b>5</b>	<b>4</b>	<b>3</b>	<b>2</b>	<b>1</b>	
0	0	0	0	0	0	0	0	Precedence value 0
								to
1	1	1	1	1	1	1	1	Precedence value 255

Operator-defined access category number (bits 5 to 1 of octet 6)

Bits

<b>5</b>	<b>4</b>	<b>3</b>	<b>2</b>	<b>1</b>	
0	0	0	0	0	Access category number 32
					to
1	1	1	1	1	Access category number 63

Presence of standardized access category (PSAC) (bit 8 of octet 6)

PSAC field indicates whether the standardized access category field is present or absent.

Bit

<b>8</b>	
0	Standardized access category field is not included
1	Standardized access category field is included

Length of criteria (octet 7)

Length of criteria field indicates binary coded length of the criteria field.

Criteria (octets 8 to octet a-1)

The criteria field contains one or more criteria components fields. Each criteria component field shall be encoded as a sequence of a one octet criteria type field and zero or more octets criteria value field. The criteria type field shall be transmitted first.

Criteria type

Bits

<b>8</b>	<b>7</b>	<b>6</b>	<b>5</b>	<b>4</b>	<b>3</b>	<b>2</b>	<b>1</b>	
0	0	0	0	0	0	0	0	DNN type
0	0	0	0	0	0	0	1	OS id + OS App Id type
0	0	0	0	0	0	1	0	S-NSSAI type

All other values are reserved.

For "DNN type", the criteria value field shall be encoded as a sequence of one octet DNN length-value pair count field and one or more DNN length-value pair fields.

The DNN length-value pair count field indicates the number of included DNN length-value pair fields. Each DNN length-value pair field is coded as a sequence of one octet DNN value length field and a DNN value field. The DNN value length field indicates the length in octets of the DNN value field. The DNN value field contains an APN as specified in 3GPP TS 23.003 [4].

For "OS Id + OS App Id type", the criteria value field shall be encoded as a sequence of one octet app id value count field and one or more app id value fields. The app id value count field indicates the number of included app id value fields. Each app id value field is coded as a sequence of a sixteen octet OS id value field, one octet OS app id value length field and an OS app id value field. The OS app id value length field indicates the length in octets of the OS app id value field. The OS id value field contains a Universally Unique Identifier (UUID) as specified in IETF RFC 4122 [35A]. The OS app id value field contains an OS specific application identifier. Coding of the OS app id value field is out of scope of the present document.

For "S-NSSAI type", the criteria value field shall be encoded as a sequence of one octet S-NSSAI length-value pair count field and one or more S-NSSAI length-value value fields. The S-NSSAI length-value pair count field indicates the number of included S-NSSAI length-value pair fields. Each S-NSSAI length-value pair field is coded as a sequence of one octet S-NSSAI value length field and an S-NSSAI value field. The S-NSSAI value length field indicates the length in octets of the S-NSSAI value field. The S-NSSAI value field contains one octet SST field optionally followed by three octets SD field. The SST field contains a SST. The SD field contains an SD. SST and SD are specified in 3GPP TS 23.003 [4].

Standardized access category (bits 5 to 1 of octet a)  
 Standardized access category field indicates the access category number of the standardized access category that is used in combination with the access identities to determine the establishment cause.

Bits

<b>5</b>	<b>4</b>	<b>3</b>	<b>2</b>	<b>1</b>	
0	0	0	0	0	Access category number 0
					to
0	0	1	1	1	Access category number 7

All other values are reserved.

### 9.11.3.39 Payload container

The purpose of the Payload container information element is to transport one or multiple payloads. If multiple payloads are transported, the associated information of each payload are also transported together with the payload.

The Payload container information element is coded as shown in figure 9.11.3.39.1, figure 9.11.3.39.2, figure 9.11.3.39.3, figure 9.11.3.39.4 and table 9.11.3.39.1.

The Payload container is a type 6 information element with a minimum length of 4 octets and a maximum length of 65538 octets.

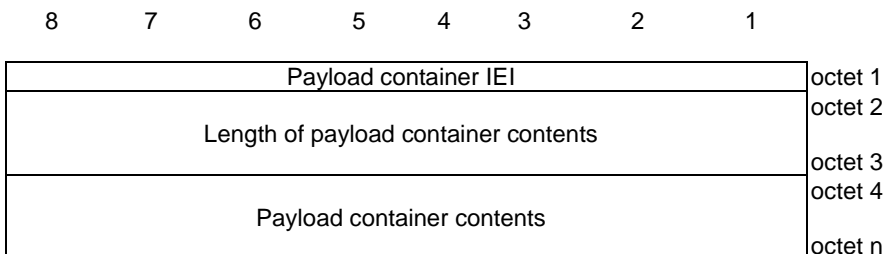

**Figure 9.11.3.39.1: Payload container information element**

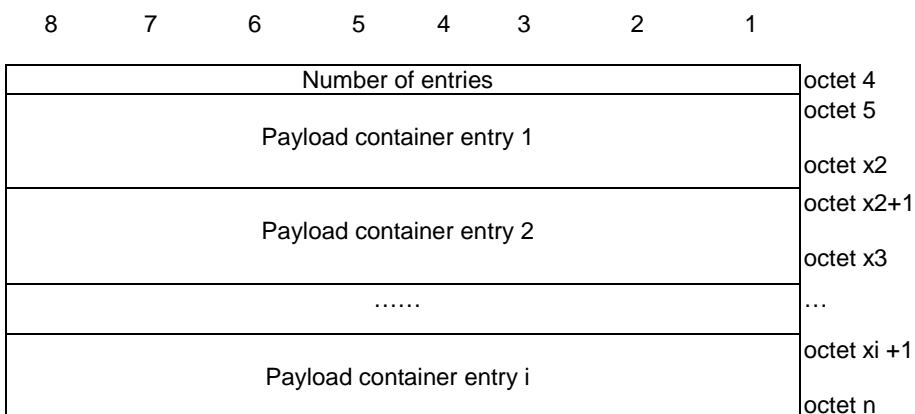

**Figure 9.11.3.39.2: Payload container contents with Payload container type "Multiple payloads"**

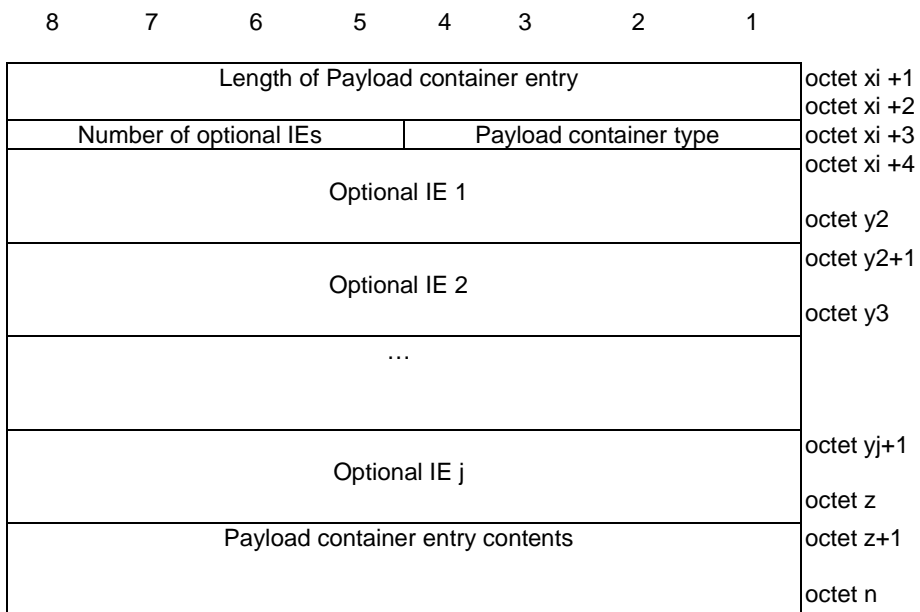

**Figure 9.11.3.39.3: Payload container entry**

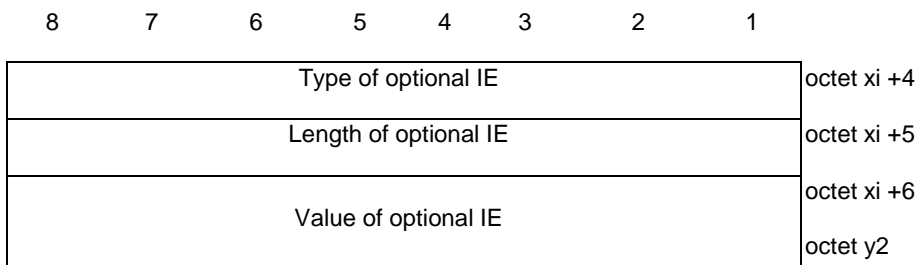

**Figure 9.11.3.39.4: Optional IE**

**Table 9.11.3.39.1: Payload container information element**

<p>Payload container contents (octet 4 to octet n); max value of 65535 octets</p> <p>If the payload container type is set to "SOR transparent container" and is included in the DL NAS TRANSPORT message, the payload container contents are coded the same way as the contents of the SOR transparent container IE (see subclause 9.11.3.51) for SOR data type is set to value "0" except that the first three octets are not included.</p> <p>If the payload container type is set to "SOR transparent container" and is included in the UL NAS TRANSPORT message, the payload container contents are coded the same way as the contents of the SOR transparent container IE (see subclause 9.11.3.51) for SOR data type is set to value "1" except that the first three octets are not included.</p> <p>If the payload container type is set to "UE parameters update transparent container" and is included in the DL NAS TRANSPORT message, the payload container contents are coded the same way as the contents of the UE parameters update transparent container IE (see subclause 9.11.3.53A) for UE parameters update data type is set to value "1" except that the first three octets are not included.</p> <p>If the payload container type is set to "UE parameters update transparent container" and is included in the UL NAS TRANSPORT message, the payload container contents are coded the same way as the contents of the UE parameters update transparent container IE (see subclause 9.11.3.53A) for UE parameters update data type is set to value "0" except that the first three octets are not included.</p> <p>The coding of Payload container contents is dependent on the particular application.</p> <p>If the payload container type is set to "Multiple payloads", the number of entries field represents the total number of payload container entries, and the payload container contents field is coded as a list of payload container entry according to figure 9.11.3.39.2, with each payload container entry is coded according to figure 9.11.3.39.3 and figure 9.11.3.39.4.</p>		
<p>Payload container entry</p> <p>For each payload container entry, the payload container type field represents the payload container type value as described in subclause 9.11.3.40, the coding of payload container entry contents field is dependent on the particular application, and the number of optional IEs field represents the total number of optional IEs associated with the payload container entry contents field in the payload container entry.</p>		
<p>Optional IEs</p> <p>Type of optional IE (octet xi +4) This field contains the IEI of the optional IE.</p> <p>Length of optional IE (octet xi+5) This field indicates binary coded length of the value of the optional IE entry.</p> <p>Value of optional IE (octet xi+6 to octet y2) This field contains the value of the optional IE entry with the value part of the referred information element based on following optional IE reference. If the Request type is included, the value part of the Request type shall be encoded in the bits 1 to 4 and bits 5 to 8 shall be coded as zero.</p>		
IEI	Optional IE name	Optional IE reference
12	PDU session ID	PDU session identity 2 (see subclause 9.11.3.41)
24	Additional information	Additional information (see subclause 9.11.2.1)
58	5GMM cause	5GMM cause (see subclause 9.11.3.2)
37	Back-off timer value	GPRS timer 3 (see subclause 9.11.2.5)
59	Old PDU session ID	PDU session identity (see subclause 2 9.11.3.41)
80	Request type	Request type (see subclause 9.11.3.47)
22	S-NSSAI	S-NSSAI (see subclause 9.11.2.8)
25	DNN	DNN (see subclause 9.11.2.1A)
<p>The coding of payload container entry contents is dependent on the particular application.</p>		



### 9.11.3.40 Payload container type

The purpose of the Payload container type information element indicates type of payload included in the payload container information element.

The Payload container information element is coded as shown in figure 9.11.3.40.1 and table 9.11.3.40.1.

The Payload container is a type 1 information element.

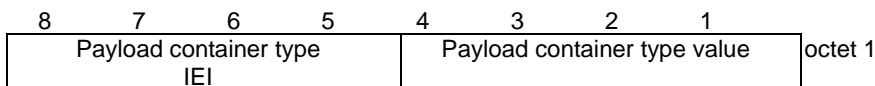

**Figure 9.11.3.40.1: Payload container information element**

**Table 9.11.3.40.1: Payload container information element**

Payload container type value (octet 1)				
Bits				
<b>4</b>	<b>3</b>	<b>2</b>	<b>1</b>	
0	0	0	1	N1 SM information
0	0	1	0	SMS
0	0	1	1	LTE Positioning Protocol (LPP) message container
0	1	0	0	SOR transparent container
0	1	0	1	UE policy container
0	1	1	0	UE parameters update transparent container
1	1	1	1	Multiple payloads
All other values are reserved.				
NOTE: The value "Multiple payloads" is only used when the Payload container contents in figure 9.11.3.39.1 contains multiple payloads as shown in figure 9.11.3.39.2.				

### 9.11.3.41 PDU session identity 2

The purpose of the PDU session identity 2 information element is to indicate the identity of a PDU session in a 5GMM message.

The PDU session identity 2 information element is coded as shown in figure 9.11.3.41.1 and table 9.11.3.41.1.

The PDU session identity 2 is a type 3 information element with a length of 2 octets .

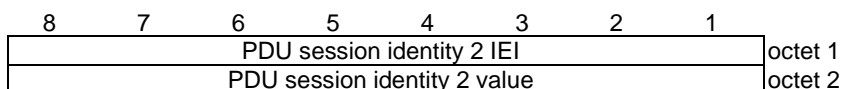

**Figure 9.11.3.41.1: PDU session identity 2 information element**

**Table 9.11.3.41.1: PDU session identity 2 information element**

PDU session identity 2 value (octet 2)
The coding of the DU session identity 2 value is identical to the coding of the PDU session identity value as defined in 3GPP TS 24.007 [11] .

### 9.11.3.42 PDU session reactivation result

The purpose of the PDU session reactivation result information element is to indicate the result of establishments of user-plane resources of PDU sessions.

The PDU session reactivation result information element is coded as shown in figure 9.11.3.42.1 and table 9.11.3.42.1.

The PDU session reactivation result is a type 4 information element with minimum length of 4 octets and maximum length of 34 octets.

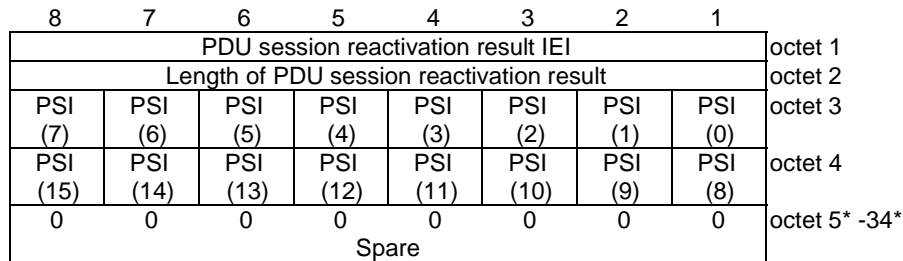

**Figure 9.11.3.42.1: PDU session reactivation result information element**

**Table 9.11.3.42.1: PDU session reactivation result information element**

<p>PSI(x) shall be coded as follows:</p> <p>PSI(0): Bit 0 of octet 3 is spare and shall be coded as zero.</p> <p>PSI(1) – PSI(15): 0 indicates establishment of user-plane resources of the PDU session was not requested in the Uplink data status IE or establishment of user-plane resources of the PDU session was not allowed in the Allowed PDU session status IE or establishment of user-plane resource of the PDU session is successful. 1 indicates either establishment of user-plane resources of the PDU session was requested in the Uplink data status IE but establishment of user-plane resource of the PDU session is not successful or indicates establishment of user-plane resources of the PDU session was allowed in the Allowed PDU session status IE but establishment of user-plane resource of the PDU session is either not performed or not successful.</p> <p>All bits in octet 5 to 34 are spare and shall be coded as zero, if the respective octet is included in the information element.</p>
---

### 9.11.3.43 PDU session reactivation result error cause

The purpose of the PDU session reactivation result error cause information element is to indicate error causes for PDU session ID(s) where there was a failure to establish the user-plane resources.

The PDU session reactivation result error cause information element is coded as shown in figure 9.11.3.43.1 and table 9.11.3.43.1.

The PDU session reactivation result error cause is a type 6 information element with a minimum length of 5 octets and a maximum length of 515 octets.

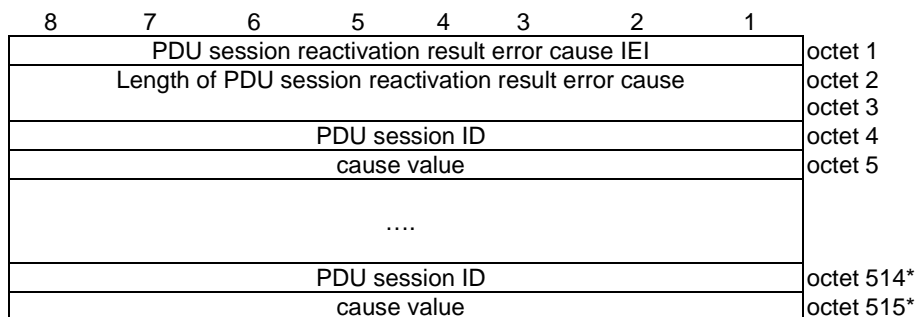

**Figure 9.11.3.43.1: PDU session reactivation result error cause information element**

**Table 9.11.3.43.1: PDU session reactivation result error cause information element**

PDU session ID is coded same as PDU session ID IE (see subclause 9.4).
The cause value is coded same as second octet of 5GMM cause information element (see subclause 9.11.3.2).

**9.11.3.44 PDU session status**

The purpose of the PDU session status information element is to indicate the state of each PDU session that can be identified by a PDU session identity.

The PDU session status information element is coded as shown in figure 9.11.3.44.1 and table 9.11.3.44.1.

The PDU session status information element is a type 4 information element with minimum length of 4 octets and a maximum length of 34 octets.

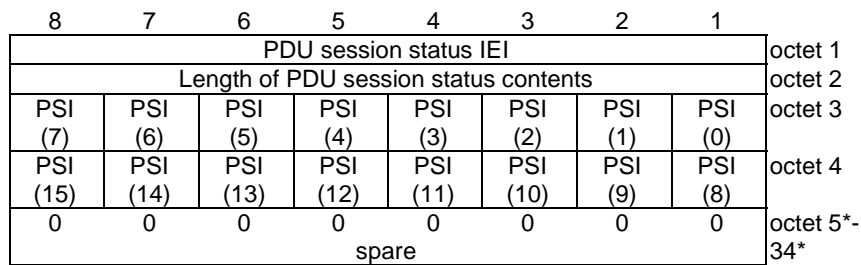

**Figure 9.11.3.44.1: PDU session status information element**

**Table 9.11.3.44.1: PDU session status information element**

PSI(x) shall be coded as follows:
PSI(0): Bit 1 of octet 3 is spare and shall be coded as zero.
PSI(1) – PSI(15): 0 indicates that the 5GSM state of the corresponding PDU session is PDU SESSION INACTIVE. 1 indicates that the 5GSM state of the corresponding PDU session is not PDU SESSION INACTIVE
All bits in octet 5 to 34 are spare and shall be coded as zero, if the respective octet is included in the information element.

**9.11.3.45 PLMN list**

See subclause 10.5.1.13 in 3GPP TS 24.008 [12].

**9.11.3.46 Rejected NSSAI**

The purpose of the Rejected NSSAI information element is to identify a collection of rejected S-NSSAIs.

The Rejected NSSAI information element is coded as shown in figure 9.11.3.46.1, figure 9.11.3.46.2 and table 9.11.3.46.1.

The Rejected NSSAI is a type 4 information element with a minimum length of 4 octets and a maximum length of 42 octets.

NOTE: The number of rejected S-NSSAI(s) cannot exceed eight.

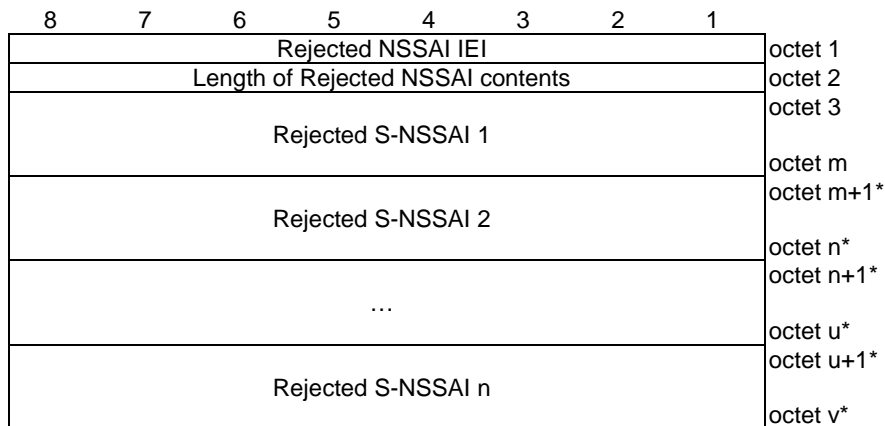

**Figure 9.11.3.46.1: Rejected NSSAI information element**

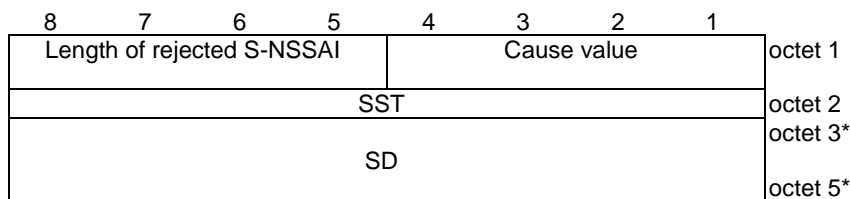

**Figure 9.11.3.46.2: Rejected S-NSSAI**

**Table 9.11.3.46.1: Rejected NSSAI information element**

<p>Value part of the Rejected NSSAI information element (octet 3 to v)</p> <p>The value part of the Rejected NSSAI information element consists of one or more rejected S-NSSAIs. Each rejected S-NSSAI consists of one S-NSSAI and an associated cause value. The length of each rejected S-NSSAI can be determined by the 'length of rejected S-NSSAI' field in the first octet of the rejected S-NSSAI. The UE shall store the complete list received. If more than 8 rejected S-NSSAIs are included in this information element, the UE shall store the first 8 rejected S-NSSAIs and ignore the remaining octets of the information element.</p> <p>Rejected S-NSSAI:</p> <p>Cause value (octet 1)</p> <p>Bits</p> <table style="border: none;"> <tr> <td style="text-align: right;"><b>4 3 2 1</b></td> <td></td> </tr> <tr> <td style="text-align: right;">0 0 0 0</td> <td>S-NSSAI not available in the current PLMN</td> </tr> <tr> <td style="text-align: right;">0 0 0 1</td> <td>S-NSSAI not available in the current registration area</td> </tr> </table> <p>All other values are reserved.</p> <p>Slice/service type (SST) (octet 2)</p> <p>This field contains the 8 bit SST value. The coding of the SST value part is defined in 3GPP TS 23.003 [4].</p> <p>Slice differentiator (SD) (octet 3 to octet 5)</p> <p>This field contains the 24 bit SD value. The coding of the SD value part is defined in 3GPP TS 23.003 [4].</p> <p>NOTE: If octet 3 is included, then octet 4 and octet 5 shall be included.</p>	<b>4 3 2 1</b>		0 0 0 0	S-NSSAI not available in the current PLMN	0 0 0 1	S-NSSAI not available in the current registration area
<b>4 3 2 1</b>						
0 0 0 0	S-NSSAI not available in the current PLMN					
0 0 0 1	S-NSSAI not available in the current registration area					

### 9.11.3.47 Request type

The purpose of the Request type information element is to indicate the type of the 5GSM message.

The Request type information element is coded as shown in figure 9.11.3.47.1 and table 9.11.3.47.1.

The Request type is a type 1 information element.

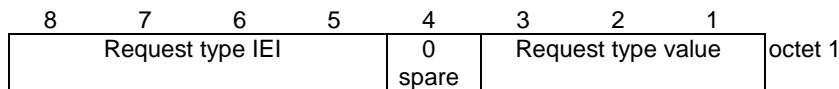

**Figure 9.11.3.47.1: Request type information element**

**Table 9.11.3.47.1: Request type information element**

Request type value (octet 1, bit 1 to bit 4)			
Bits			
3	2	1	
0	0	1	initial request
0	1	0	existing PDU session
0	1	1	initial emergency request
1	0	0	existing emergency PDU session
1	0	1	modification request
1	1	1	reserved
All other values are unused and shall be interpreted as "initial request", if received by the network.			

### 9.11.3.48 S1 UE network capability

See subclause 9.9.3.34 in 3GPP TS 24.301 [15].

### 9.11.3.48A S1 UE security capability

See subclause 9.9.3.36 in 3GPP TS 24.301 [15].

### 9.11.3.49 Service area list

The purpose of the Service area list information element is to transfer a list of allowed tracking areas for an allowed area or a list of non-allowed tracking areas for a non-allowed area from the network to the UE.

The coding of the information element allows combining different types of lists. The lists of type "00" and "01" allow a more compact encoding, when the different TAIs are sharing the PLMN identity. The lists of type "11" indicate all TAIs of the PLMNs in the registration area are allowed area.

The Service area list information element is coded as shown in figure 9.11.3.49.1, figure 9.11.3.49.2, figure 9.11.3.49.3, figure 9.11.3.49.4, figure 9.11.3.49.5 and table 9.11.3.49.1.

The Service area list is a type 4 information element with a minimum length of 6 octets and a maximum length of 114 octets. The list can contain a maximum of 16 different tracking area identities.

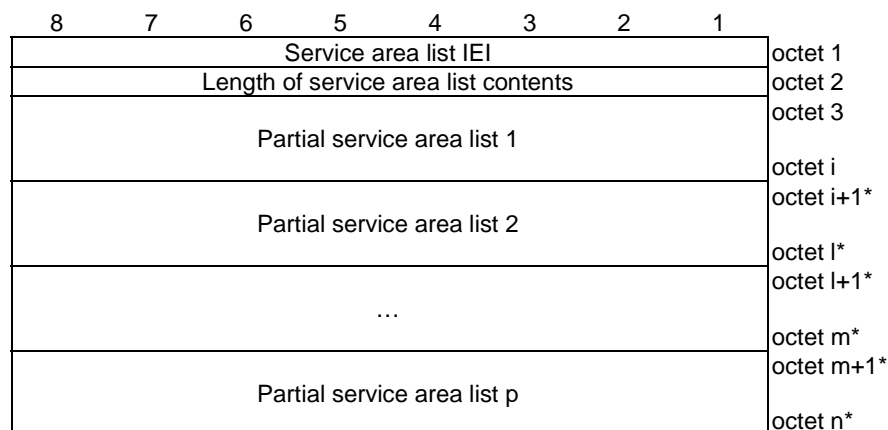

**Figure 9.11.3.49.1: Service area list information element**

8	7	6	5	4	3	2	1	
Allowed type	Type of list	Number of elements						octet 1
	MCC digit 2	MCC digit 1						octet 2
	MNC digit 3	MCC digit 3						octet 3
	MNC digit 2	MNC digit 1						octet 4
TAC 1								octet 5
TAC 1 (continued)								octet 6
TAC 1 (continued)								octet 7
...								...
TAC k								octet 3k+2*
TAC k (continued)								octet 3k+3*
TAC k (continued)								octet 3k+4*

**Figure 9.11.3.49.2: Partial service area list – type of list = "00"**

8	7	6	5	4	3	2	1	
Allowed type	Type of list	Number of elements						octet 1
	MCC digit 2	MCC digit 1						octet 2
	MNC digit 3	MCC digit 3						octet 3
	MNC digit 2	MNC digit 1						octet 4
TAC 1								octet 5
TAC 1 (continued)								octet 6
TAC 1 (continued)								octet 7

**Figure 9.11.3.49.3: Partial service area list – type of list = "01"**

8	7	6	5	4	3	2	1	
Allowed type	Type of list	Number of elements						octet 1
	MCC digit 2	MCC digit 1						octet 2
	MNC digit 3	MCC digit 3						octet 3
	MNC digit 2	MNC digit 1						octet 4
TAC 1								octet 5
TAC 1 (continued)								octet 6
TAC 1 (continued)								octet 7
	MCC digit 2	MCC digit 1						octet 8*
	MNC digit 3	MCC digit 3						octet 9*
	MNC digit 2	MNC digit 1						octet 10*
TAC 2								octet 11*
TAC 2 (continued)								octet 12*
TAC 2 (continued)								octet 13*
...								
	MCC digit 2	MCC digit 1						octet 6k-4*
	MNC digit 3	MCC digit 3						octet 6k-3*
	MNC digit 2	MNC digit 1						octet 6k-2*
TAC k								octet 6k*-1
TAC k (continued)								octet 6k*
TAC k (continued)								octet 6k+1*

**Figure 9.11.3.49.4: Partial service area list – type of list = "10"**

8	7	6	5	4	3	2	1	
Allowed type	Type of list	Number of elements						octet 1
	MCC digit 2	MCC digit 1						octet 2
	MNC digit 3	MCC digit 3						octet 3
	MNC digit 2	MNC digit 1						octet 4

**Figure 9.11.3.49.5: Partial service area list – type of list = "11"**

**Table 9.11.3.49.1: Service area list information element**



Value part of the Service area list information element (octets 3 to n)

The value part of the Service area list information element consists of one or several partial service area lists. The length of each partial service area list can be determined from the 'type of list' field and the 'number of elements' field in the first octet of the partial service area list.

The "Allowed type" fields in all the partial service area lists shall have the same value. For allowed type "0", TAIs contained in all partial service area lists are in the allowed area. For allowed type "1", TAIs contained in all partial service area lists are in the non-allowed area.

The UE shall store the complete list received. If more than 16 TAIs are included in this information element, the UE shall store the first 16 TAIs and ignore the remaining octets of the information element.

Partial service area list:

Allowed type (octet 1)

Bit

**8**

0 TAIs in the list are in the allowed area  
1 TAIs in the list are in the non-allowed area

Type of list (octet 1)

Bits

**7 6**

0 0 list of TACs belonging to one PLMN, with non-consecutive TAC values  
0 1 list of TACs belonging to one PLMN, with consecutive TAC values  
1 0 list of TAIs belonging to different PLMNs (see NOTE)  
1 1 All TAIs belonging to the PLMNs in the registration area are in the allowed area

Number of elements (octet 1)

Bits

**5 4 3 2 1**

0 0 0 0 0 1 element  
0 0 0 0 1 2 elements  
0 0 0 1 0 3 elements  
to  
0 1 1 0 1 14 elements  
0 1 1 1 0 15 elements  
0 1 1 1 1 16 elements

All other values are unused and shall be interpreted as 16, if received by the UE.

For type of list = "00" and number of elements = k:

octets 2 to 4 contain the MCC+MNC, and

for  $j = 1, \dots, k$ :

octets  $3j+2$  to  $3j+4$  contain the TAC of the  $j$ -th TAI belonging to the partial list,

For type of list = "01" and number of elements = k:

octets 2 to 4 contain the MCC+MNC, and

octets 5 to 7 contain the TAC of the first TAI belonging to the partial list.

The TAC values of the other  $k-1$  TAIs are TAC+1, TAC+2, ..., TAC+k-1.

For type of list = "10" and number of elements = k:

for  $j = 1, \dots, k$ .

octets  $6j-4$  to  $6j-1$  contain the MCC+MNC, and

octets  $6j-1$  to  $6j+1$  contain the TAC of the  $j$ -th TAI belonging to the partial list.

For type of list = "11":

Allowed type shall be coded as "0" and number of elements shall be ignored, and octets 2 to 4

containing the MCC+MNC can be ignored.

If allowed type is coded as "1", it shall be interpreted as "0".

<p>MNC, Mobile network code</p> <p>The coding of this field is the responsibility of each administration but BCD coding shall be used. The MNC shall consist of 2 or 3 digits. If a network operator decides to use only two digits in the MNC, MNC digit 3 shall be coded as "1111".</p>
<p>TAC, Tracking area code</p> <p>In the TAC field bit 8 of the first octet is the most significant bit and bit 1 of the third octet the least significant bit.</p> <p>The coding of the tracking area code is the responsibility of each administration. Coding using full hexadecimal representation may be used. The tracking area code consists of 3 octets.</p>
<p>NOTE: If the "list of TAs belonging to different PLMNs" is used, the PLMNs included in the list need to be present in the list of equivalent PLMNs.</p>

### 9.11.3.50 Service type

The purpose of the service type information element is to specify the purpose of the service request procedure.

The service type is a type 1 information element.

The service type information element is coded as shown in figure 9.11.3.50.1 and table 9.11.3.50.1.

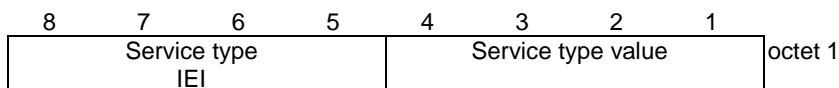

**Figure 9.11.3.50.1: Service type information element**

**Table 9.11.3.50.1: Service type information element**

Service type value (octet 1)				
Service type value				
Bits				
<b>4</b>	<b>3</b>	<b>2</b>	<b>1</b>	
0	0	0	0	signalling
0	0	0	1	data
0	0	1	0	mobile terminated services
0	0	1	1	emergency services
0	1	0	0	emergency services fallback
0	1	0	1	high priority access
0	1	1	0	elevated signalling
0	1	1	1	unused; shall be interpreted as "signalling", if received by the network
1	0	0	0	unused; shall be interpreted as "signalling", if received by the network
1	0	0	1	unused; shall be interpreted as "data", if received by the network
1	0	1	0	unused; shall be interpreted as "data", if received by the network
1	0	1	1	unused; shall be interpreted as "data", if received by the network
All other values are reserved.				

### 9.11.3.50A SMS indication

The purpose of the SMS indication information element is to indicate that the ability for the UE to use SMS over NAS has changed.

The SMS indication information element is coded as shown in figure 9.11.3.50A.1 and table 9.11.3.50A.1.

The SMS indication is a type 1 information element.

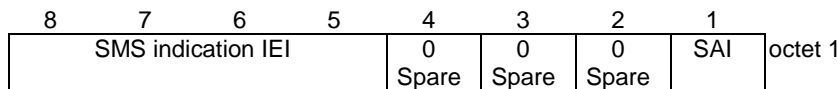

**Figure 9.11.3.50A.1: SMS indication**

**Table 9.11.3.50A.1: SMS indication**

SMS availability indication (SAI) (octet 1)	
Bit	
1	
0	SMS over NAS not available
1	SMS over NAS available
Bits 2, 3 and 4 are spare and shall be coded as zero,	

### 9.11.3.51 SOR transparent container

The purpose of the SOR transparent container information element in the REGISTRATION ACCEPT message is to provide the list of preferred PLMN/access technology combinations (or HPLMN indication that 'no change of the "Operator Controlled PLMN Selector with Access Technology" list stored in the UE is needed and thus no list of preferred PLMN/access technology combinations is provided') (see 3GPP TS 23.122 [5] annex C) and optional acknowledgement request. The purpose of the SOR transparent container information element in the REGISTRATION COMPLETE message is to indicate the UE acknowledgement of successful reception of the SOR transparent container IE in the REGISTRATION ACCEPT message.

**NOTE:** When used in NAS transport procedure, the contents of the SOR transparent container information element in the Payload container IE of the DL NAS TRANSPORT message are used to provide the list of preferred PLMN/access technology combinations and optional acknowledgement request, and the contents of the SOR transparent container information element in the Payload container IE of the UL NAS TRANSPORT message are used to indicate the UE acknowledgement of successful reception of the SOR transparent container IE in the DL NAS TRANSPORT message.

The SOR transparent container information element is coded as shown in figure 9.11.3.51.1, figure 9.11.3.51.2, figure 9.11.3.51.3, figure 9.11.3.51.4, figure 9.11.3.51.5, figure 9.11.3.51.6 and table 9.11.3.51.1.

The SOR transparent container is a type 6 information element with a minimum length of 20 octets and a maximum length of 2048 octets.

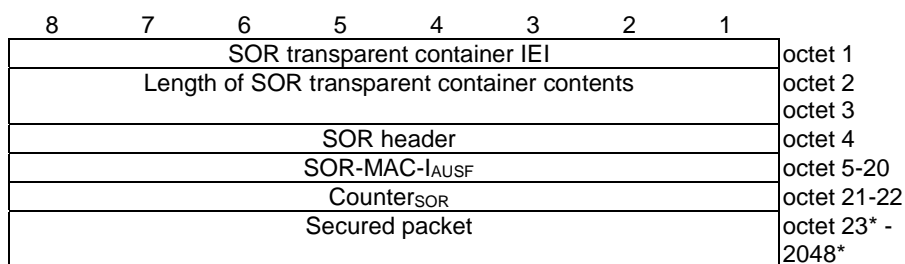

**Figure 9.11.3.51.1: SOR transparent container information element for list type with value "0" and SOR data type with value "0"**

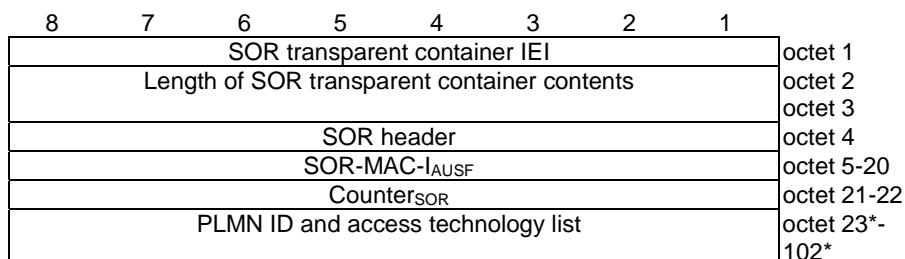

**Figure 9.11.3.51.2: SOR transparent container information element for list type with value "1" and SOR data type with value "0"**

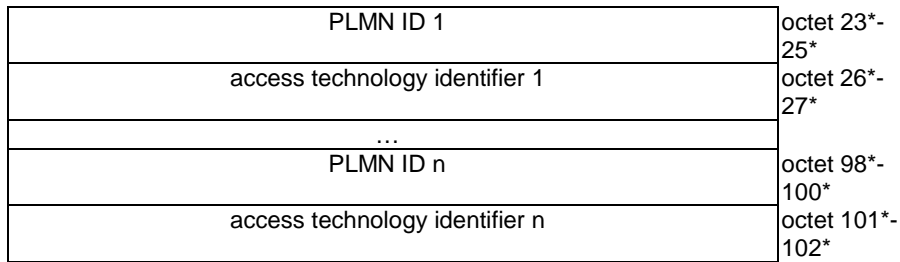

**Figure 9.11.3.51.3: PLMN ID and access technology list**

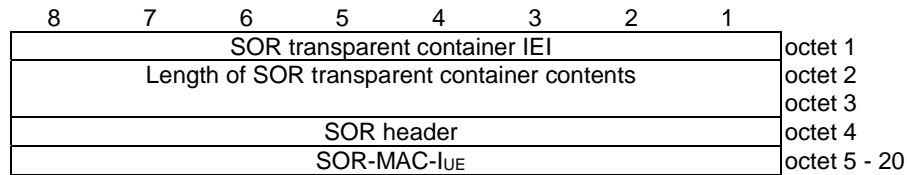

**Figure 9.11.3.51.4: SOR transparent container information element for SOR data type with value "1"**

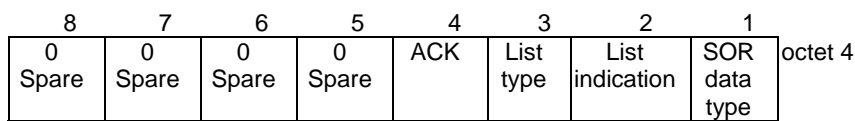

**Figure 9.11.3.51.5: SOR header for SOR data type with value "0"**

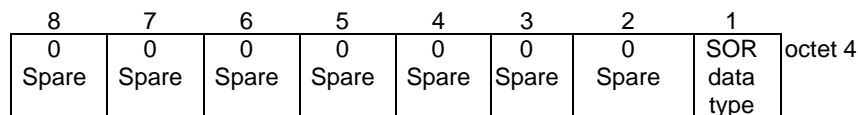

**Figure 9.11.3.51.6: SOR header for SOR data type with value "1"**

**Table 9.11.3.51.1: SOR transparent container information element**

<p>SOR-MAC-I<sub>AUSF</sub>, SOR-MAC-I<sub>UE</sub> and Counter<sub>SOR</sub> are coded as specified in 3GPP TS 33.501 [24]</p> <p>SOR data type (octet 4, bit 1)</p> <p>0 The SOR transparent container carries steering of roaming information.</p> <p>1 The SOR transparent container carries acknowledgement of successful reception of the steering of roaming information.</p> <p>List indication value (octet 4, bit 2)</p> <p>0 HPLMN indication that 'no change of the "Operator Controlled PLMN Selector with Access Technology" list stored in the UE is needed and thus no list of preferred PLMN/access technology combinations is provided'</p> <p>1 list of preferred PLMN/access technology combinations is provided</p> <p>List type (octet 4, bit 3)</p> <p>0 The list type is a secured packet.</p> <p>1 The list type is a "PLMN ID and access technology list".</p> <p>Acknowledgement (ACK) value (octet 4, bit 4)</p> <p>0 acknowledgement not requested</p> <p>1 acknowledgement requested</p> <p>The secure packet is coded as specified in 3GPP TS 31.115 [22B].</p> <p>The PLMN ID and access technology list consists of PLMN ID and access technology identifier and are coded as specified in 3GPP TS 31.102 [22] subclause 4.2.5. The PLMN ID and access technology identifier are provided in decreasing order of priority, i.e. PLMN ID 1 indicates highest priority and PLMN ID n indicates lowest priority.</p>
--

9.11.3.52 Time zone

See subclause 10.5.3.8 in 3GPP TS 24.008 [12].

9.11.3.53 Time zone and time

See subclause 10.5.3.9 in 3GPP TS 24.008 [12].

9.11.3.53A UE parameters update transparent container

The purpose of the UE parameters update transparent container when sent from the network to the UE is to provide UE parameters update data, optional acknowledgement request and optional re-registration request. The purpose of the UE parameters update transparent container when sent from the UE to the network is to indicate the UE acknowledgement of successful reception of the UE parameters update transparent container.

The UE parameters update transparent container information element is coded as shown in figure 9.11.3.53A.1, figure 9.11.3.53A.2, figure 9.11.3.53A.3, figure 9.11.3.53A.4, figure 9.11.3.53A.5, figure 9.11.3.53A.6, figure 9.11.3.53A.7 and table 9.11.3.53A.1.

The UE parameters update transparent container is a type 6 information element with a minimum length of 20 octets.

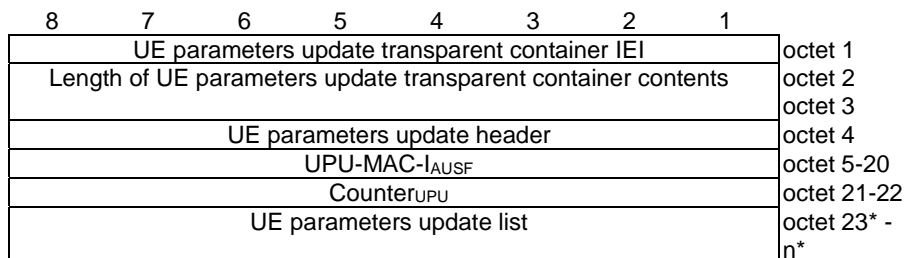

Figure 9.11.3.53A.1: UE parameters update transparent container information element for UE parameters update data type with value "0"

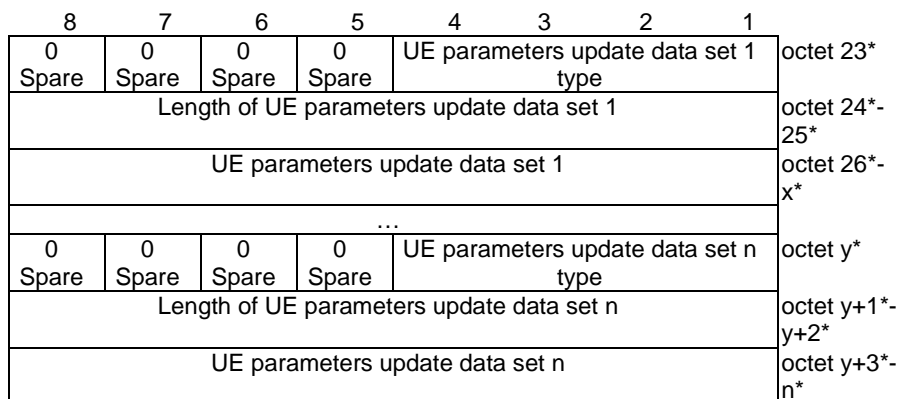

Figure 9.11.3.53A.2: UE parameters update list

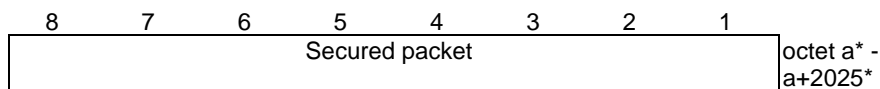

Figure 9.11.3.53A.3: UE parameters update data set for UE parameters update data set type with value "00000001"

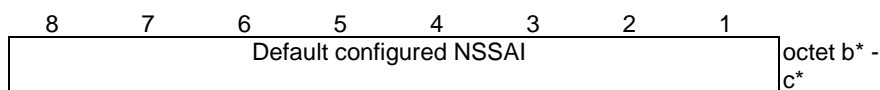

Figure 9.11.3.53A.4: UE parameters update data set for UE parameters update data set type with value "00000010"

UE parameters update transparent container IEI	octet 1
Length of UE parameters update transparent container contents	octet 2
	octet 3
UE parameters update header	octet 4
UPU-MAC-I <sub>UE</sub>	octet 5 - 20

**Figure 9.11.3.53A.5: UE parameters update transparent container information element for UE parameters update data type with value "1"**

8	7	6	5	4	3	2	1	
0	0	0	0	0	REG	ACK	UPU data type	octet 4
Spare	Spare	Spare	Spare	Spare				

**Figure 9.11.3.53A.6: UE parameters update header for UE parameters update data type with value "0"**

8	7	6	5	4	3	2	1	
0	0	0	0	0	0	0	UPU data type	octet 4
Spare	Spare	Spare	Spare	Spare	Spare	Spare		

**Figure 9.11.3.53A.7: UE parameters update header for UE parameters update data type with value "1"**

**Table 9.11.3.53A.1: UE parameters update transparent container information element**

<p>UPU-MAC-I<sub>AUSF</sub>, UPU-MAC-I<sub>UE</sub> and Counter<sub>UPU</sub> are coded as specified in 3GPP TS 33.501 [24]</p> <p>UPU data type (octet 4, bit 1)</p> <p>0 The UE parameters update transparent container carries a UE parameters update list</p> <p>1 The UE parameters update transparent container carries an acknowledgement of successful reception of a UE parameters update list</p> <p>Acknowledgement (ACK) value (octet 4, bit 2)</p> <p>0 acknowledgement not requested</p> <p>1 acknowledgement requested</p> <p>Re-registration (REG) value (octet 4, bit 3)</p> <p>0 re-registration not requested</p> <p>1 re-registration requested</p> <p>UE parameters update data set type</p> <p>Bits</p> <p>4 3 2 1</p> <p>0 0 0 1 Routing indicator update data</p> <p>0 0 1 0 Default configured NSSAI update data</p> <p>All other values are reserved</p> <p>The secured packet is coded as specified in 3GPP TS 31.115 [22B].</p> <p>The default configured NSSAI is encoded as the value part of the NSSAI IE (see subclause 9.11.3.37).</p>
---

### 9.11.3.54 UE security capability

The UE security capability information element is used by the UE and by the network to indicate which security algorithms are supported by the UE in N1 mode for NAS security as well as which security algorithms are supported over NR and E-UTRA connected to 5GCN for AS security.

The UE security capability information element is coded as shown in figure 9.11.3.54.1 and table 9.11.3.54.1.

The UE security capability is a type 4 information element with a minimum length of 4 octets and a maximum length of 10 octets.

Octets 5 to 10 are optional. If octet 5 is included, then also octet 6 shall be included.

If the UE does not support any security algorithm for AS security over E-UTRA connected to 5GCN, it shall not include octets 5 and 6. The UE shall not include octets 7 to 10.

If the network includes octet 7, then it shall include also octet 8. If the network includes octet 9, then it shall include also octet 10.

8      7      6      5      4      3      2      1								
UE security capability IEI								octet 1
Length of UE security capability contents								octet 2
5G- EA0	128- 5G- EA1	128- 5G- EA2	128- 5G- EA3	5G- EA4	5G- EA5	5G- EA6	5G- EA7	octet 3
5G-IA0	128- 5G-IA1	128- 5G-IA2	128- 5G-IA3	5G-IA4	5G-IA5	5G-IA6	5G-IA7	octet 4
EEA0	128- EEA1	128- EEA2	128- EEA3	EEA4	EEA5	EEA6	EEA7	octet 5*
EIA0	128- EIA1	128- EIA2	128- EIA3	EIA4	EIA5	EIA6	EIA7	octet 6*
0	0	0	0	0	0	0	0	octet 7* -10*
Spare								

**Figure 9.11.3.54.1: UE security capability information element**

**Table 9.11.3.54.1: UE security capability information element**



5GS encryption algorithms supported (see NOTE 1) (octet 3)	
5GS encryption algorithm 5G-EA0 supported (octet 3, bit 8)	
0	5GS encryption algorithm 5G-EA0 not supported
1	5GS encryption algorithm 5G-EA0 supported
5GS encryption algorithm 128-5G-EA1 supported (octet 3, bit 7)	
0	5GS encryption algorithm 128-5G-EA1 not supported
1	5GS encryption algorithm 128-5G-EA1 supported
5GS encryption algorithm 128-5G-EA2 supported (octet 3, bit 6)	
0	5GS encryption algorithm 128-5G-EA2 not supported
1	5GS encryption algorithm 128-5G-EA2 supported
5GS encryption algorithm 128-5G-EA3 supported (octet 3, bit 5)	
0	5GS encryption algorithm 128-5G-EA3 not supported
1	5GS encryption algorithm 128-5G-EA3 supported
5GS encryption algorithm 5G-EA4 supported (octet 3, bit 4)	
0	5GS encryption algorithm 5G-EA4 not supported
1	5GS encryption algorithm 5G-EA4 supported
5GS encryption algorithm 5G-EA5 supported (octet 3, bit 3)	
0	5GS encryption algorithm 5G-EA5 not supported
1	5GS encryption algorithm 5G-EA5 supported
5GS encryption algorithm 5G-EA6 supported (octet 3, bit 2)	
0	5GS encryption algorithm 5G-EA6 not supported
1	5GS encryption algorithm 5G-EA6 supported
5GS encryption algorithm 5G-EA7 supported (octet 3, bit 1)	
0	5GS encryption algorithm 5G-EA7 not supported
1	5GS encryption algorithm 5G-EA7 supported
5GS integrity algorithms supported (see NOTE 2) (octet 4)	
5GS integrity algorithm 5G-IA0 supported (octet 4, bit 8)	
0	5GS integrity algorithm 5G-IA0 not supported
1	5GS integrity algorithm 5G-IA0 supported
5GS integrity algorithm 128-5G-IA1 supported (octet 4, bit 7)	
0	5GS integrity algorithm 128-5G-IA1 not supported
1	5GS integrity algorithm 128-5G-IA1 supported
5GS integrity algorithm 128-5G-IA2 supported (octet 4, bit 6)	
0	5GS integrity algorithm 128-5G-IA2 not supported
1	5GS integrity algorithm 128-5G-IA2 supported
5GS integrity algorithm 128-5G-IA3 supported (octet 4, bit 5)	
0	5GS integrity algorithm 128-5G-IA3 not supported
1	5GS integrity algorithm 128-5G-IA3 supported
5GS integrity algorithm 5G-IA4 supported (octet 4, bit 4)	
0	5GS integrity algorithm 5G-IA4 not supported
1	5GS integrity algorithm 5G-IA4 supported
5GS integrity algorithm 5G-IA5 supported (octet 4, bit 3)	
0	5GS integrity algorithm 5G-IA5 not supported
1	5GS integrity algorithm 5G-IA5 supported
5GS integrity algorithm 5G-IA6 supported (octet 4, bit 2)	
0	5GS integrity algorithm 5G-IA6 not supported
1	5GS integrity algorithm 5G-IA6 supported
5GS integrity algorithm 5G-IA7 supported (octet 4, bit 1)	
0	5GS integrity algorithm 5G-IA7 not supported
1	5GS integrity algorithm 5G-IA7 supported

EPS encryption algorithms supported (see NOTE 3) (octet 5)	
EPS encryption algorithm EEA0 supported (octet 5, bit 8)	
0	EPS encryption algorithm EEA0 not supported
1	EPS encryption algorithm EEA0 supported
EPS encryption algorithm 128-EEA1 supported (octet 5, bit 7)	
0	EPS encryption algorithm 128-EEA1 not supported
1	EPS encryption algorithm 128-EEA1 supported
EPS encryption algorithm 128-EEA2 supported (octet 5, bit 6)	
0	EPS encryption algorithm 128-EEA2 not supported
1	EPS encryption algorithm 128-EEA2 supported
EPS encryption algorithm 128-EEA3 supported (octet 5, bit 5)	
0	EPS encryption algorithm 128-EEA3 not supported
1	EPS encryption algorithm 128-EEA3 supported
EPS encryption algorithm EEA4 supported (octet 5, bit 4)	
0	EPS encryption algorithm EEA4 not supported
1	EPS encryption algorithm EEA4 supported
EPS encryption algorithm EEA5 supported (octet 5, bit 3)	
0	EPS encryption algorithm EEA5 not supported
1	EPS encryption algorithm EEA5 supported
EPS encryption algorithm EEA6 supported (octet 5, bit 2)	
0	EPS encryption algorithm EEA6 not supported
1	EPS encryption algorithm EEA6 supported
EPS encryption algorithm EEA7 supported (octet 5, bit 1)	
0	EPS encryption algorithm EEA7 not supported
1	EPS encryption algorithm EEA7 supported
EPS integrity algorithms supported (see NOTE 4) (octet 6)	
EPS integrity algorithm EIA0 supported (octet 6, bit 8)	
0	EPS integrity algorithm EIA0 not supported
1	EPS integrity algorithm EIA0 supported
EPS integrity algorithm 128-EIA1 supported (octet 6, bit 7)	
0	EPS integrity algorithm 128-EIA1 not supported
1	EPS integrity algorithm 128-EIA1 supported
EPS integrity algorithm 128-EIA2 supported (octet 6, bit 6)	
0	EPS integrity algorithm 128-EIA2 not supported
1	EPS integrity algorithm 128-EIA2 supported
EPS integrity algorithm 128-EIA3 supported (octet 6, bit 5)	
0	EPS integrity algorithm 128-EIA3 not supported
1	EPS integrity algorithm 128-EIA3 supported
EPS integrity algorithm EIA4 supported (octet 6, bit 4)	
0	EPS integrity algorithm EIA4 not supported
1	EPS integrity algorithm EIA4 supported
EPS integrity algorithm EIA5 supported (octet 6, bit 3)	
0	EPS integrity algorithm EIA5 not supported
1	EPS integrity algorithm EIA5 supported
EPS integrity algorithm EIA6 supported (octet 6, bit 2)	
0	EPS integrity algorithm EIA6 not supported
1	EPS integrity algorithm EIA6 supported
EPS integrity algorithm EIA7 supported (octet 6, bit 1)	
0	EPS integrity algorithm EIA7 not supported
1	EPS integrity algorithm EIA7 supported

For the UE all bits in octets 7 to 10 are spare and shall be ignored, if the respective octet is received with the information element.  
 If the AMF receives any of the octets 7 to 10 (NOTE 5), it shall store the octets as received and include them when sending the UE security capability information element to the UE.

- NOTE 1: The code points in octet 3 are used to indicate support for 5GS encryption algorithms for NAS security in N1 mode and support for 5GS encryption algorithms for AS security over NR.
- NOTE 2: The code points in octet 4 are used to indicate support for 5GS integrity algorithms for NAS security in N1 mode and support for 5GS integrity algorithms for AS security over NR.
- NOTE 3: The code points in octet 5 are used to indicate support for EPS encryption algorithms for AS security over E-UTRA connected to 5GCN.
- NOTE 4: The code points in octet 6 are used to indicate support for EPS integrity algorithms for AS security over E-UTRA connected to 5GCN.
- NOTE 5: The AMF can receive this information element also from another AMF or MME during N1 mode to N1 mode or S1 mode to N1 mode handover preparation.

### 9.11.3.55 UE's usage setting

The purpose of the UE's usage setting information element is to provide the network with the UE's usage setting as defined in 3GPP TS 24.301 [15]. The network uses the UE's usage setting to select the RFSP index.

The UE's usage setting information element is coded as shown in figure 9.11.3.55.1 and table 9.11.3.55.1.

The UE's usage setting is a type 4 information element with a length of 3 octets.

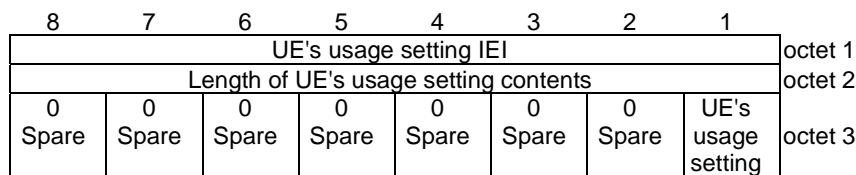

**Figure 9.11.3.55.1: UE's usage setting information element**

**Table 9.11.3.55.1: UE's usage setting information element**

UE's usage setting (octet 3, bit 1)	
0	voice centric
1	data centric
All other bits in the octet 3 are spare and shall be coded as zero,	

### 9.11.3.56 UE status

The purpose of the UE status information element is to provide the network with information concerning aspects of the current UE registration status which is used for interworking with EPS.

The UE status information element is coded as shown in figure 9.11.3.56.1 and table 9.11.3.56.1.

The UE status is a type 4 information element with a length of 3 octets.

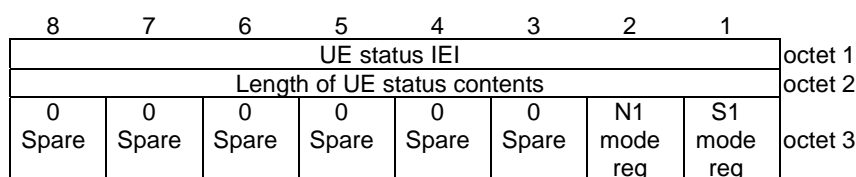

**Figure 9.11.3.56.1: UE status information element**

**Table 9.11.3.56.1: UE status information element**

EMM registration status (S1 mode reg) (octet 3, bit 1)	
0	UE is not in EMM-REGISTERED state
1	UE is in EMM-REGISTERED state
5GMM registration status (N1 mode reg) (octet 3, bit 2)	
0	UE is not in 5GMM-REGISTERED state
1	UE is in 5GMM-REGISTERED state
All other bits in the octet 3 are spare and shall be coded as zero.	

### 9.11.3.57 Uplink data status

The purpose of the Uplink data status information element is to indicate to the network which preserved PDU sessions have uplink data pending.

The Uplink data status information element is coded as shown in figure 9.11.3.57.1 and table 9.11.3.57.1.

The Uplink data status information element is a type 4 information element with minimum length of 4 octets a maximum length of 34 octets.

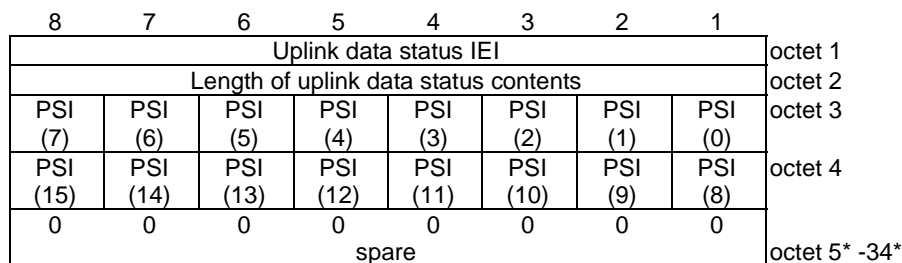

**Figure 9.11.3.57.1: Uplink data status information element**

**Table 9.11.3.57.1: Uplink data status information element**

PSI(x) shall be coded as follows:
PSI(0): Bit 1 of octet 3 is spare and shall be coded as zero.
PSI(1) – PSI(15): 0 indicates that no uplink data are pending for the corresponding PDU session identity. 1 indicates that uplink data are pending for the corresponding PDU session identity.
All bits in octet 5 to 34 are spare and shall be coded as zero, if the respective octet is included in the information element.

## 9.11.4 5GS session management (5GSM) information elements

### 9.11.4.1 5GSM capability

The purpose of the 5GSM capability information element is to indicate UE capability related to the PDU session management.

The 5GSM capability information element is coded as shown in figure 9.11.4.1.1 and table 9.11.4.1.1.

The 5GSM capability is a type 4 information element with a minimum length of 3 octets and a maximum length of 15 octets.

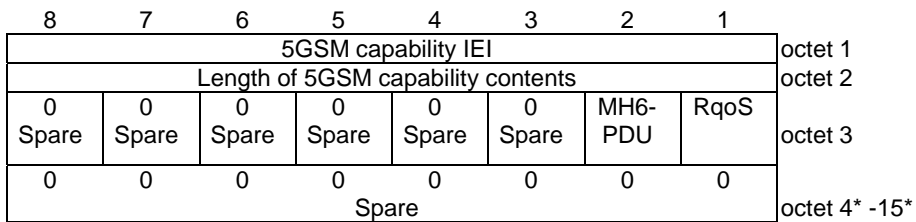

**Figure 9.11.4.1.1: 5GSM capability information element**

**Table 9.11.4.1.1: 5GSM capability information element**

<p>5GSM capability value</p> <p>RqoS(octet 3, bit 1)</p> <p>This bit indicates the 5GSM capability to support reflective QoS.</p> <p>0            Reflective QoS not supported</p> <p>1            Reflective QoS supported</p> <p>Multi-homed IPv6 PDU session (MH6-PDU) (octet 3, bit 2)</p> <p>This bit indicates the 5GSM capability for Multi-homed IPv6 PDU session.</p> <p>0            Multi-homed IPv6 PDU session not supported</p> <p>1            Multi-homed IPv6 PDU session supported</p> <p>All other bits in octet 3 to 15 are spare and shall be coded as zero, if the respective octet is included in the information element.</p>
---

**9.11.4.2      5GSM cause**

The purpose of the 5GSM cause information element is to indicate the reason why a 5GSM request is rejected.

The 5GSM cause information element is coded as shown in figure 9.11.4.2.1 and table 9.11.4.2.1.

The 5GSM cause is a type 3 information element with 2 octets length.

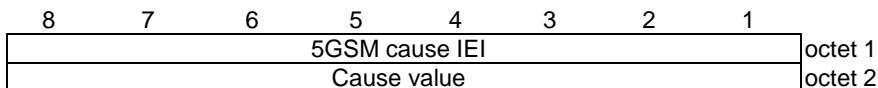

**Figure 9.11.4.2.1: 5GSM cause information element**

Table 9.11.4.2.1: 5GSM cause information element

Cause value (octet 2)								
Bits								
8	7	6	5	4	3	2	1	
0	0	0	0	1	0	0	0	Operator determined barring
0	0	0	1	1	0	1	0	Insufficient resources
0	0	0	1	1	0	1	1	Missing or unknown DNN
0	0	0	1	1	1	0	0	Unknown PDU session type
0	0	0	1	1	1	0	1	User authentication or authorization failed
0	0	0	1	1	1	1	1	Request rejected, unspecified
0	0	1	0	0	0	0	0	Service option not supported
0	0	1	0	0	0	0	1	Requested service option not subscribed
0	0	1	0	0	0	1	0	Service option temporarily out of order
0	0	1	0	0	0	1	1	PTI already in use
0	0	1	0	0	1	0	0	Regular deactivation
0	0	1	0	0	1	1	0	Network failure
0	0	1	0	0	1	1	1	Reactivation requested
0	0	1	0	1	0	1	1	Invalid PDU session identity
0	0	1	0	1	1	0	0	Semantic errors in packet filter(s)
0	0	1	0	1	1	0	1	Syntactical error in packet filter(s)
0	0	1	0	1	1	1	0	Out of LADN service area
0	0	1	0	1	1	1	1	PTI mismatch
0	0	1	1	0	0	1	0	PDU session type IPv4 only allowed
0	0	1	1	0	0	1	1	PDU session type IPv6 only allowed
0	0	1	1	0	1	1	0	PDU session does not exist
0	1	0	0	0	0	1	1	Insufficient resources for specific slice and DNN
0	1	0	0	0	1	0	0	Not supported SSC mode
0	1	0	0	0	1	0	1	Insufficient resources for specific slice
0	1	0	0	0	1	1	0	Missing or unknown DNN in a slice
0	1	0	1	0	0	0	1	Invalid PTI value
0	1	0	1	0	0	1	0	Maximum data rate per UE for user-plane integrity protection is too low
0	1	0	1	0	0	1	1	Semantic error in the QoS operation
0	1	0	1	0	1	0	0	Syntactical error in the QoS operation
0	1	0	1	0	1	0	1	Invalid mapped EPS bearer identity
0	1	0	1	1	1	1	1	Semantically incorrect message
0	1	1	0	0	0	0	0	Invalid mandatory information
0	1	1	0	0	0	0	1	Message type non-existent or not implemented
0	1	1	0	0	0	1	0	Message type not compatible with the protocol state
0	1	1	0	0	0	1	1	Information element non-existent or not implemented
0	1	1	0	0	1	0	0	Conditional IE error
0	1	1	0	0	1	0	1	Message not compatible with the protocol state
0	1	1	0	1	1	1	1	Protocol error, unspecified

Any other value received by the UE shall be treated as 0010 0010, "service option temporarily out of order". Any other value received by the network shall be treated as 0110 1111, "protocol error, unspecified".

### 9.11.4.2A 5GSM congestion re-attempt indicator

The purpose of the 5GSM congestion re-attempt indicator information element is to indicate whether the back-off timer is applied in the registered PLMN or all PLMNs.

The 5GSM congestion re-attempt indicator information element is coded as shown in figure 9.11.4.2A.1 and table 9.11.4.2A.1.

The 5GSM congestion re-attempt indicator is a type 4 information element with a length of 3 octets.

8	7	6	5	4	3	2	1	
5GSM congestion re-attempt indicator IEI								octet 1
Length of 5GSM congestion re-attempt indicator contents								octet 2
0	0	0	0	0	0	0	0	octet 3
Spare	Spare	Spare	Spare	Spare	Spare	Spare	Spare	ABO

**Figure 9.11.4.2A.1: 5GSM congestion re-attempt indicator**

**Table 9.11.4.2A.1: 5GSM congestion re-attempt indicator**

ABO (All PLMNs Back-off timer) (octet 3, bit 3)
Bit
<b>1</b>
0 The back-off timer is applied in the registered PLMN.
1 The back-off timer is applied in all PLMNs.
Bits 2 to 8 of octet 3 are spare and shall be encoded as zero.

### 9.11.4.3 Always-on PDU session indication

The purpose of the Always-on PDU session indication information element is to indicate whether a PDU session is established as an always-on PDU session.

The Always-on PDU session indication information element is coded as shown in figure 9.11.4.3.1 and table 9.11.4.3.1.

The Always-on PDU session indication is a type 1 information element.

8	7	6	5	4	3	2	1	
Always-on PDU session indication IEI				0	0	0	APSI	octet 1
				Spare	Spare	Spare		

**Figure 9.11.4.3.1: Always-on PDU session indication**

**Table 9.11.4.3.1: Always-on PDU session indication**

Always-on PDU session indication (APSI) (octet 1)
Bit
<b>1</b>
0 Always-on PDU session not allowed
1 Always-on PDU session required
Bits 2, 3 and 4 are spare and shall be coded as zero,

### 9.11.4.4 Always-on PDU session requested

The purpose of the Always-on PDU session requested information element is to indicate whether a PDU session is requested to be established as an always-on PDU session.

The Always-on PDU session requested information element is coded as shown in figure 9.11.4.4.1 and table 9.11.4.4.1.

The Always-on PDU session requested is a type 1 information element.

8	7	6	5	4	3	2	1	
Always-on PDU session requested IEI				0	0	0	APSR	octet 1
				Spare	Spare	Spare		

**Figure 9.11.4.4.1: Always-on PDU session requested**

**Table 9.11.4.4.1: Always-on PDU session requested**

Always-on PDU session requested (APSR) (octet 1)	
Bit	
<b>1</b>	
0	Always-on PDU session not requested
1	Always-on PDU session requested
Bits 2, 3 and 4 are spare and shall be coded as zero,	

**9.11.4.5 Allowed SSC mode**

The purpose of the Allowed SSC mode information element is to indicate the SSC modes allowed to be used by the UE for the PDU session.

The Allowed SSC mode information element is coded as shown in figure 9.11.4.5.1 and table 9.11.4.5.1.

The Allowed SSC mode is a type 1 information element.

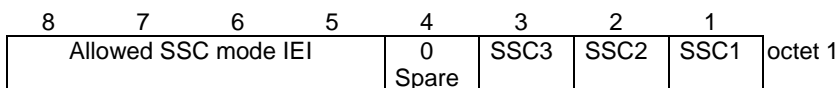

**Figure 9.11.4.5.1: Allowed SSC mode information element**

**Table 9.11.4.5.1: Allowed SSC mode information element**

SSC1 (octet 1, bit 1)	
Bit	
1	
0	SSC mode 1 not allowed
1	SSC mode 1 allowed
SSC2 (octet 1, bit 2)	
Bit	
2	
0	SSC mode 2 not allowed
1	SSC mode 2 allowed
SSC3 (octet 1, bit 3)	
Bit	
3	
0	SSC mode 3 not allowed
1	SSC mode 3 allowed
Bit 4 is spare and shall be encoded as zero.	

**9.11.4.6 Extended protocol configuration options**

See subclause 10.5.6.3A in 3GPP TS 24.008 [12].

**9.11.4.7 Integrity protection maximum data rate**

The purpose of the integrity protection maximum data rate information element is for the UE to indicate to the network the maximum data rate per UE for user-plane integrity protection for uplink and the maximum data rate per UE for user-plane integrity protection for downlink that are supported by the UE.

The integrity protection maximum data rate is coded as shown in figure 9.11.4.7.1 and table 9.11.4.7.2.

The integrity protection maximum data rate is a type 3 information element with a length of 3 octets.



8	7	6	5	4	3	2	1	
Integrity protection maximum data rate IEI								octet 1
Maximum data rate per UE for user-plane integrity protection for uplink								octet 2
Maximum data rate per UE for user-plane integrity protection for downlink								octet 3

**Figure 9.11.4.7.1: Integrity protection maximum data rate information element**

**Table 9.11.4.7.2: Integrity protection maximum data rate information element**

Maximum data rate per UE for user-plane integrity protection for uplink (octet 2)								
Bits								
8	7	6	5	4	3	2	1	
0	0	0	0	0	0	0	0	64 kbps
1	1	1	1	1	1	1	1	Full data rate
All other values are spare								
Maximum data rate per UE for user-plane integrity protection for downlink (octet 3)								
Bits								
8	7	6	5	4	3	2	1	
0	0	0	0	0	0	0	0	64 kbps
1	1	1	1	1	1	1	1	Full data rate
The receiving entity shall treat a spare value as "64 kbps".								

### 9.11.4.8 Mapped EPS bearer contexts

The purpose of the mapped EPS bearer contexts information element is to indicate a set of EPS contexts for a PDU session, as described in subclause 6.1.4.1.

The mapped EPS bearer contexts information element is a type 6 information element with a minimum length of 7 octet and a maximum length of 65538 octets.

The mapped EPS bearer contexts information element is coded as shown in figure 9.11.4.8.1, figure 9.11.4.8.2, figure 9.11.4.8.3 and table 9.11.4.8.1.

8	7	6	5	4	3	2	1	
Mapped EPS bearer contexts IEI								octet 1
Length of Mapped EPS bearer contexts contents								octet 2
Mapped EPS bearer context 1								octet 3
Mapped EPS bearer context 2								octet 4
...								octet u
Mapped EPS bearer context n								octet u+1
...								octet v
...								octet v+1
...								octet w
...								octet w+1
...								octet x

**Figure 9.11.4.8.1: Mapped EPS bearer contexts**

8	7	6	5	4	3	2	1	
EPS bearer identity								octet 4
Length of Mapped EPS bearer context								octet 5
Operation code								octet 6
0 Spare		E bit	Number of EPS parameters					octet 7
EPS parameters list								octet 8
...								octet u

**Figure 9.11.4.8.2: Mapped EPS bearer context**

8	7	6	5	4	3	2	1	
EPS parameter identifier 1								octet 8
Length of EPS parameter contents 1								octet 9
EPS parameter contents 1								octet 10 octet h
EPS parameter identifier 2								octet h+1
Length of EPS parameter contents 2								octet h+2
EPS parameter contents 2								octet h+3 octet i
...								octet i+1 octet j
EPS parameter identifier N								octet j+1
Length of EPS parameter contents N								octet j+2
EPS parameter contents N								octet j+3 octet u

**Figure 9.11.4.8.3: EPS parameters list**

**Table 9.11.4.8.1: Mapped EPS bearer contexts information element**

#### EPS bearer identity (octet 4)

The EPS bearer identity is used to identify the EPS bearer, and is coded as specified in subclause 9.3.2 of 3GPP TS 24.301 [15].

#### Operation code (bits 8 to 7 of octet 7)

Bits

8 7

0 0 Reserved

0 1 Create new EPS bearer

1 0 Delete existing EPS bearer

1 1 Modify existing EPS bearer

Bit 6 of octet 7 is spare and shall be coded as zero.

#### E bit (bit 5 of octet 7)

For the "create new EPS bearer" operation, the E bit is encoded as follows:

Bit

5

0 parameters list is not included

1 parameters list is included

For the "modify existing EPS bearer" operation, the E bit is encoded as follows:

Bit

5

0 previously provided parameters list extension

1 previously provided parameters list replacement

If the E bit is set to "parameters list is not included", the number of EPS parameters field has zero value. If the E bit is set to "parameters list is included", the number of EPS parameters field has non-zero value. If the E bit is set to "previously provided parameters list extension" or "previously provided parameters list replacement", the number of parameters field can have zero or non-zero value.

For the "create new EPS bearer" operation and "delete existing EPS bearer" operation, bit 5 of octet 7 is ignored.

#### Number of EPS parameters (bits 4 to 1 of octet 7)

The number of EPS parameters contains the binary coding for the number of EPS parameters in the EPS parameters list field. The number of EPS parameters field is encoded in bits 4 through 1 of octet x+1 where bit 4 is the most significant and bit 1 is the least significant bit.

#### EPS parameters list (octets 8 to u)

The EPS parameters list contains a variable number of EPS parameters.

Each EPS parameter included in the EPS parameters list is of variable length and consists of:

- an EPS parameter identifier (1 octet);
- the length of the EPS parameter contents (1 octet); and
- the EPS parameter contents itself (variable amount of octets).

The EPS parameter identifier field is used to identify each EPS parameter included in the EPS parameters list and it contains the hexadecimal coding of the EPS parameter identifier. Bit 8 of the EPS parameter identifier field contains the most significant bit and bit 1 contains the least significant bit. In this version of the protocol, the following EPS parameter identifiers are specified:

- 01H (Mapped EPS QoS parameters);
- 02H (Mapped extended EPS QoS parameters); and
- 03H (Traffic flow template).
- 04H (APN-AMBR).
- 05H (extended APN-AMBR).

If the EPS parameters list contains an EPS parameter identifier that is not supported by the receiving entity the corresponding EPS parameter shall be discarded.

The length of EPS parameter contents field contains the binary coded representation of the length of the EPS parameter contents field. The first bit in transmission order is the most significant bit.

When the parameter identifier indicates mapped EPS QoS parameters, the length and parameter contents field are coded as specified in subclause 9.9.4.3 of 3GPP TS 24.301 [15].

When the parameter identifier indicates mapped extended EPS QoS parameters, the length and parameter contents field are coded as specified in subclause 9.9.4.30 of 3GPP TS 24.301 [15].

When the parameter identifier indicates traffic flow template, the length and parameter contents field are coded from octet 2 as shown figure 10.5.144 and table 10.5.162 of 3GPP TS 24.008 [12].

When the parameter identifier indicates APN-AMBR, the length and parameter contents field are coded as specified in subclause 9.9.4.2 of 3GPP TS 24.301 [15].

When the parameter identifier indicates Extended APN-AMBR, the length and parameter contents field are coded as specified in subclause 9.9.4.29 of 3GPP TS 24.301 [15].

### 9.11.4.9 Maximum number of supported packet filters

The purpose of the Maximum number of supported packet filters information element is for the UE to indicate to the network the maximum number of packet filters, associated with signaled QoS rules, that can be supported by the UE for the PDU session that is being established, when the PDU session type "IPv4", "IPv6", "IPv4v6" or "Ethernet".

The Maximum number of supported packet filters is coded as shown in figure 9.11.4.9.1 and table 9.11.4.9.1.

The Maximum number of supported packet filters is a type 3 information element with a length of 3 octets.

	8	7	6	5	4	3	2	1	
Maximum number of supported packet filters IEI									octet 1
Maximum number of supported packet filters									octet 2
	Maximum number of supported packet filters (continued)	0 Spare	0 Spare	0 Spare	0 Spare	0 Spare	0 Spare	0 Spare	octet 3

**Figure 9.11.4.9.1: Maximum number of supported packet filters information element**

**Table 9.11.4.9.1: Maximum number of supported packet filters information element**

Maximum number of supported packet filters (octet 2 to 3)

In the Maximum number of supported packet filters field bit 8 of the first octet is the most significant bit and bit 6 of second octet is the least significant bit. Bit 5 to bit 1 of the second octet are spare bits and shall be coded as zero.

The number of supported packet filters shall be in the range of 17 to 1024.

### 9.11.4.10 PDU address

The purpose of the PDU address information element is to assign to the UE:

- an IPv4 address associated with a PDU session;
- an interface identifier for the IPv6 link local address associated with the PDU session; or
- an IPv4 address and an interface identifier for the IPv6 link local address, associated with the PDU session.

The PDU address information element is coded as shown in figure 9.11.4.10.1 and table 9.11.4.10.1.

The PDU address is a type 4 information element with minimum length of 7 octets and a maximum length of 15 octets.

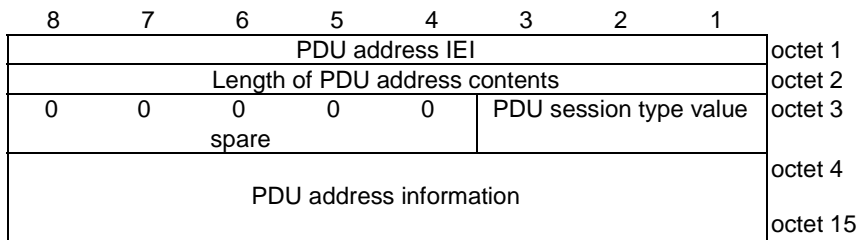

**Figure 9.11.4.10.1: PDU address information element**

**Table 9.11.4.10.1: PDU address information element**

PDU session type value (octet 3)	
Bits	
<b>3</b>	<b>2</b> <b>1</b>
0	0 1 IPv4
0	1 0 IPv6
0	1 1 IPv4v6
All other values are reserved.	
Bit 4 to 8 of octet 3 are spare and shall be coded as zero.	
PDU address information (octet 4 to 15)	
If the PDU session type value indicates IPv4, the PDU address information in octet 4 to octet 7 contains an IPv4 address.	
If the PDU session type value indicates IPv6, the PDU address information in octet 4 to octet 11 contains an interface identifier for the IPv6 link local address.	
If the PDU session type value indicates IPv4v6, the PDU address information in octet 4 to octet 11 contains an interface identifier for the IPv6 link local address and in octet 12 to octet 15 contains an IPv4 address.	

### 9.11.4.11 PDU session type

The purpose of the PDU session type information element is to indicate type of the PDU session.

The PDU session type information element is coded as shown in figure 9.11.4.11.1 and table 9.11.4.11.1.

The PDU session type is a type 1 information element.

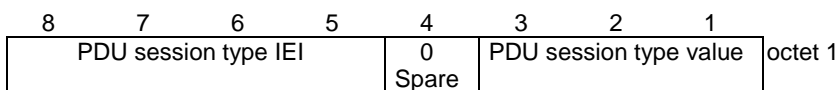

**Figure 9.11.4.11.1: PDU session type information element**

**Table 9.11.4.11.1: PDU session type information element**

PDU session type value (octet 1, bit 1 to bit 3)	
Bits	
<b>3</b>	<b>2</b> <b>1</b>
0	0 1 IPv4
0	1 0 IPv6
0	1 1 IPv4v6
1	0 0 Unstructured
1	0 1 Ethernet
1	1 1 reserved
All other values are unused and shall be interpreted as "IPv4v6", if received by the UE or the network.	

### 9.11.4.12 QoS flow descriptions

The purpose of the QoS flow descriptions information element is to indicate a set of QoS flow descriptions to be used by the UE, where each QoS flow description is a set of parameters as described in subclause 6.2.5.1.1.4.

The QoS flow descriptions information element is a type 6 information element with a minimum length of 6 octets. The maximum length for the information element is 65538 octets.

The QoS flow descriptions information element is coded as shown in figure 9.11.4.12.1, figure 9.11.4.12.2, figure 9.11.4.12.3, figure 9.11.4.12.4, and table 9.11.4.12.1.

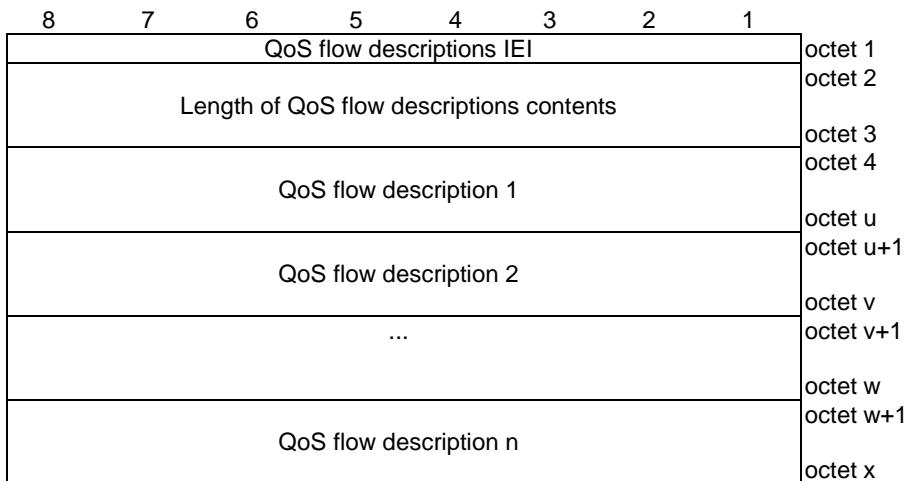

**Figure 9.11.4.12.1: QoS flow descriptions information element**

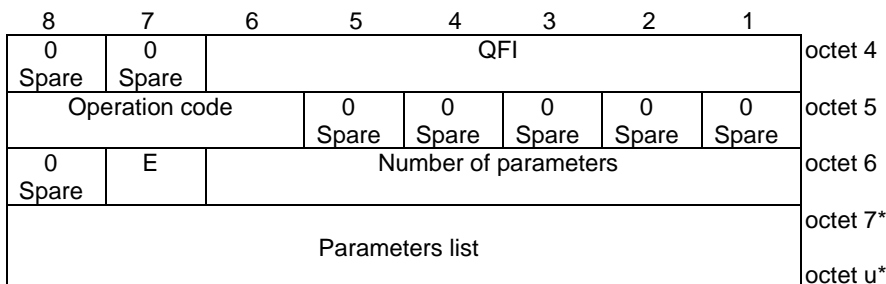

**Figure 9.11.4.12.2: QoS flow description**

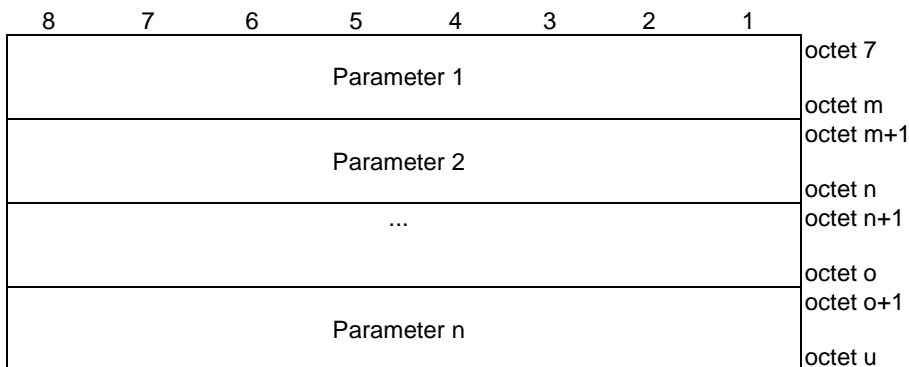

**Figure 9.11.4.12.3: Parameters list**

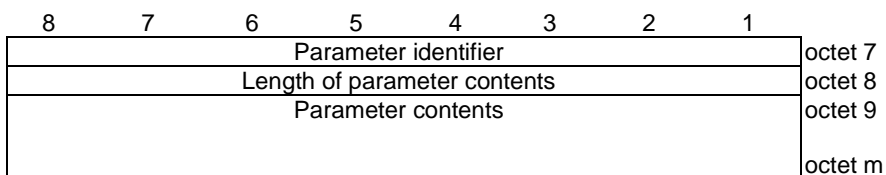

**Figure 9.11.4.12.4: Parameter**

**Table 9.11.4.12.1: QoS flow descriptions information element**



QoS flow identifier (QFI) (bits 6 to 1 of octet 4)

QFI field contains the QoS flow identifier.

Bits

6 5 4 3 2 1

0 0 0 0 0 0 no QoS flow identifier assigned

0 0 0 0 0 1 QFI 1

to

1 1 1 1 1 1 QFI 63

The network shall not set the QFI value to 0.

Operation code (bits 8 to 6 of octet 5)

Bits

8 7 6

0 0 1 Create new QoS flow description

0 1 0 Delete existing QoS flow description

0 1 1 Modify existing QoS flow description

All other values are reserved.

E bit (bit 7 of octet 6)

For the "create new QoS flow description" operation, the E bit is encoded as follows:

Bit

7

0 reserved

1 parameters list is included

For the "Delete existing QoS flow description" operation, the E bit is encoded as follows:

Bit

7

0 parameters list is not included

1 reserved

For the "modify existing QoS flow description" operation, the E bit is encoded as follows:

Bit

7

0 extension of previously provided parameters

1 replacement of all previously provided parameters

If the E bit is set to "parameters list is not included", the number of parameters field has zero value. If the E bit is set to "parameters list is included", the number of parameters field has non-zero value. If the E bit is set to "extension of previously provided parameters" or "replacement of all previously provided parameters", the number of parameters field has non-zero value. If the E bit is set to "extension of previously provided parameters" and one of the parameters in the new parameters list already exists in the previously provided parameters, the parameter shall be set to the new value.

Number of parameters (bits 6 to 1 of octet 6)

The number of parameters field contains the binary coding for the number of parameters in the parameters list field. The number of parameters field is encoded in bits 6 through 1 of octet 6 where bit 6 is the most significant and bit 1 is the least significant bit.

Parameters list (octets 7 to u)

The parameters list contains a variable number of parameters.

Each parameter included in the parameters list is of variable length and consists of:

- a parameter identifier (1 octet);
- the length of the parameter contents (1 octet); and
- the parameter contents itself (variable amount of octets).

The parameter identifier field is used to identify each parameter included in the parameters list and it contains the hexadecimal coding of the parameter identifier. Bit 8 of the parameter identifier field contains the most significant bit and bit 1 contains the least significant bit. In this version of the protocol, the following parameter identifiers are specified:

- 01H (5QI);
- 02H (GFBR uplink);
- 03H (GFBR downlink);
- 04H (MFBR uplink);
- 05H (MFBR downlink);
- 06H (Averaging window); and
- 07H (EPS bearer identity).

If the parameters list contains a parameter identifier that is not supported by the receiving entity the corresponding parameter shall be discarded.

The length of parameter contents field contains the binary coded representation of the length of the parameter contents field. The first bit in transmission order is the most significant bit.

When the parameter identifier indicates 5QI, the parameter contents field contains the binary representation of 5G QoS identifier (5QI) that is one octet in length.

5QI:

Bits

8 7 6 5 4 3 2 1

0 0 0 0 0 0 0 0 Reserved

0 0 0 0 0 0 0 1 5QI 1

```

0 0 0 0 0 0 1 0 5QI 2
0 0 0 0 0 0 1 1 5QI 3
0 0 0 0 0 1 0 0 5QI 4
0 0 0 0 0 1 0 1 5QI 5
0 0 0 0 0 1 1 0 5QI 6
0 0 0 0 0 1 1 1 5QI 7
0 0 0 0 1 0 0 0 5QI 8
0 0 0 0 1 0 0 1 5QI 9
0 0 0 0 1 0 1 0
to Spare
0 1 0 0 0 0 0 0
0 1 0 0 0 0 0 1 5QI 65
0 1 0 0 0 0 1 0 5QI 66
0 1 0 0 0 0 1 1 5QI 67
0 1 0 0 0 1 0 0 Spare
0 1 0 0 0 1 0 1 5QI 69
0 1 0 0 0 1 1 0 5QI 70
0 1 0 0 0 1 1 1
to Spare
0 1 0 0 1 0 1 0
0 1 0 0 1 0 1 1 5QI 75
0 1 0 0 1 1 0 0
to Spare
0 1 0 0 1 1 1 0
0 1 0 0 1 1 1 1 5QI 79
0 1 0 1 0 0 0 0 5QI 80
0 1 0 1 0 0 0 1 Spare
0 1 0 1 0 0 1 0 5QI 82
0 1 0 1 0 0 1 1 5QI 83
0 1 0 1 0 1 0 0 5QI 84
0 1 0 1 0 1 0 1 5QI 85
0 1 0 1 0 1 1 0
to Spare
0 1 1 1 1 1 1 1
1 0 0 0 0 0 0 0
to Operator-specific 5QIs
1 1 1 1 1 1 1 0
1 1 1 1 1 1 1 1 Reserved

```

The network shall consider all other values not explicitly defined in this version of the protocol as unsupported.

If the UE receives a 5QI value (excluding the reserved 5QI values) that it does not understand, the UE shall choose a 5QI value from the set of 5QI values defined in this version of the protocol (see 3GPP TS 23.501 [8]) and associated with:

- GBR QoS flows, if the QoS flow includes a GFBR uplink parameter and a GFBR downlink parameter; and
- non-GBR QoS flows, if the QoS flow does not include a GFBR uplink parameter or does not include a GFBR downlink parameter.

The UE shall use this chosen 5QI value for internal operations only. The UE shall use the received 5QI value in subsequent NAS signalling procedures.

When the parameter identifier indicates "GFBR uplink", the parameter contents field contains one octet indicating the unit of the guaranteed flow bit rate for uplink followed by two octets containing the value of the guaranteed flow bit rate for uplink.

Unit of the guaranteed flow bit rate for uplink (octet 1)

Bits

```

8 7 6 5 4 3 2 1
0 0 0 0 0 0 0 0 value is not used
0 0 0 0 0 0 0 1 value is incremented in multiples of 1 Kbps
0 0 0 0 0 0 1 0 value is incremented in multiples of 4 Kbps
0 0 0 0 0 0 1 1 value is incremented in multiples of 16 Kbps
0 0 0 0 0 1 0 0 value is incremented in multiples of 64 Kbps
0 0 0 0 0 1 0 1 value is incremented in multiples of 256 Kbps
0 0 0 0 0 1 1 0 value is incremented in multiples of 1 Mbps
0 0 0 0 0 1 1 1 value is incremented in multiples of 4 Mbps
0 0 0 0 1 0 0 0 value is incremented in multiples of 16 Mbps
0 0 0 0 1 0 0 1 value is incremented in multiples of 64 Mbps

```

0 0 0 0 1 0 1 0 value is incremented in multiples of 256 Mbps  
 0 0 0 0 1 0 1 1 value is incremented in multiples of 1 Gbps  
 0 0 0 0 1 1 0 0 value is incremented in multiples of 4 Gbps  
 0 0 0 0 1 1 0 1 value is incremented in multiples of 16 Gbps  
 0 0 0 0 1 1 1 0 value is incremented in multiples of 64 Gbps  
 0 0 0 0 1 1 1 1 value is incremented in multiples of 256 Gbps  
 0 0 0 1 0 0 0 0 value is incremented in multiples of 1 Tbps  
 0 0 0 1 0 0 0 1 value is incremented in multiples of 4 Tbps  
 0 0 0 1 0 0 1 0 value is incremented in multiples of 16 Tbps  
 0 0 0 1 0 0 1 1 value is incremented in multiples of 64 Tbps  
 0 0 0 1 0 1 0 0 value is incremented in multiples of 256 Tbps  
 0 0 0 1 0 1 0 1 value is incremented in multiples of 1 Pbps  
 0 0 0 1 0 1 1 0 value is incremented in multiples of 4 Pbps  
 0 0 0 1 0 1 1 1 value is incremented in multiples of 16 Pbps  
 0 0 0 1 1 0 0 0 value is incremented in multiples of 64 Pbps  
 0 0 0 1 1 0 0 1 value is incremented in multiples of 256 Pbps  
 Other values shall be interpreted as multiples of 256 Pbps in this version of the protocol.

Value of the guaranteed flow bit rate for uplink (octets 2 and 3)  
 Octets 2 and 3 represent the binary coded value of the guaranteed flow bit rate for uplink in units defined by the unit of the guaranteed flow bit rate for uplink.

When the parameter identifier indicates "GFBR downlink", the parameter contents field contains one octet indicating the unit of the guaranteed flow bit rate for downlink followed by two octets containing the value of the guaranteed flow bit rate for downlink.

Unit of the guaranteed flow bit rate for downlink (octet 1)  
 The coding is identical to that of the unit of the guaranteed flow bit rate for uplink.

Value of the guaranteed flow bit rate for downlink (octets 2 and 3)  
 Octets 2 and 3 represent the binary coded value of the guaranteed flow bit rate for downlink in units defined by the unit of the guaranteed flow bit rate for downlink.

When the parameter identifier indicates "MFBR uplink", the parameter contents field contains the one octet indicating the unit of the maximum flow bit rate for uplink followed by two octets containing the value of maximum flow bit rate for uplink.

Unit of the maximum flow bit rate for uplink (octet 1)  
 The coding is identical to that of the unit of the guaranteed flow bit rate for uplink.

Value of the maximum flow bit rate for uplink (octets 2 and 3)  
 Octets 2 and 3 represent the binary coded value of the maximum flow bit rate for uplink in units defined by the unit of the maximum flow bit rate for uplink.

When the parameter identifier indicates "MFBR downlink", the parameter contents field contains one octet indicating the unit of the maximum flow bit rate for downlink followed by two octets containing the value of the maximum flow bit rate for downlink.

Unit of the maximum flow bit rate for downlink (octet 1)  
 The coding is identical to that of the unit of the guaranteed flow bit rate for uplink.

Value of the maximum flow bit rate for downlink (octets 2 and 3)  
 Octets 2 and 3 represent the binary coded value of the maximum flow bit rate for downlink in units defined by the unit of the maximum flow bit rate for downlink.

When the parameter identifier indicates "averaging window", the parameter contents field contains the binary representation of the averaging window for both uplink and downlink in milliseconds and the parameter contents field is two octets in length.

When the parameter identifier indicates EPS bearer identity, the length of EPS bearer identity is one octet and parameter contents field is coded as specified in subclause 9.3.2 of 3GPP TS 24.301 [15] (see NOTE). The UE shall not include the EPS bearer identity parameter in any mobile originated 5GSM messages.

NOTE: The total number of EPS bearer identities included in all QoS flow descriptions of a UE cannot exceed fifteen.

9.11.4.13 QoS rules

The purpose of the QoS rules information element is to indicate a set of QoS rules to be used by the UE, where each QoS rule is a set of parameters as described in subclause 6.2.5.1.1.2:

- a) for classification and marking of uplink user traffic; and
- b) for identification of a QoS flow which the network is to use for a particular downlink user traffic.

NOTE: The UE needs to be aware of a QoS flow which the network is to use for a particular downlink user traffic e.g. to determine whether a resource is available for downlink media of a media stream of an SDP media description provided by the UE in an IMS session.

The QoS rules may contain a set of packet filters consisting of zero or more packet filters for UL direction, zero or more packet filters for DL direction, zero or more packet filters for both UL and DL directions or any combinations of these. The set of packet filters determine the traffic mapping to QoS flows.

The QoS rules information element is a type 6 information element with a minimum length of 7 octets. The maximum length for the information element is 65538 octets.

The QoS rules information element is coded as shown in figure 9.11.4.13.1, figure 9.11.4.13.2, figure 9.11.4.13.3, figure 9.11.4.13.4 and table 9.11.4.13.1.

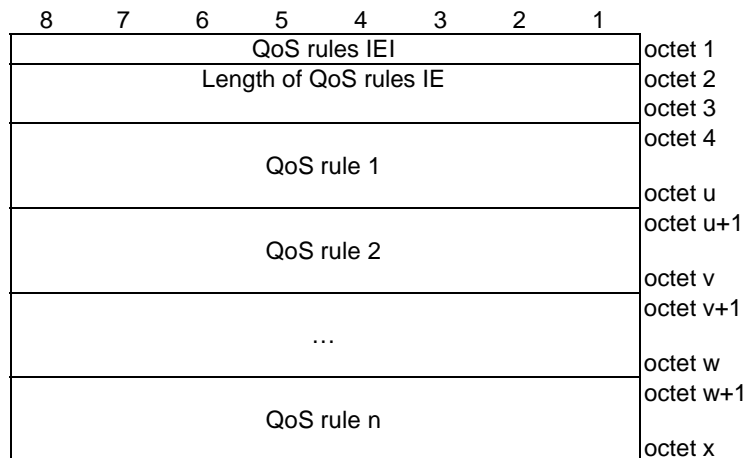

Figure 9.11.4.13.1: QoS rules information element

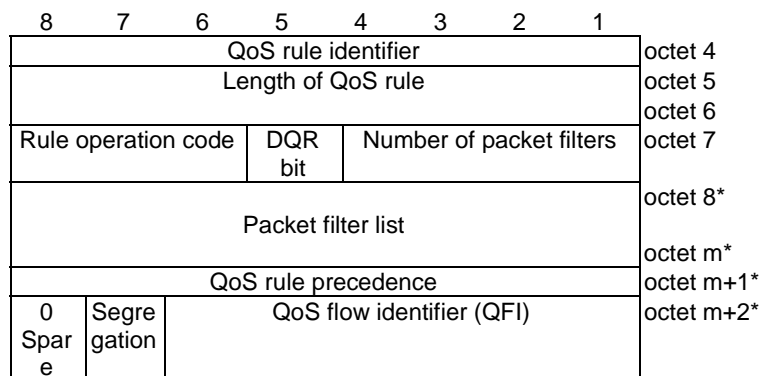
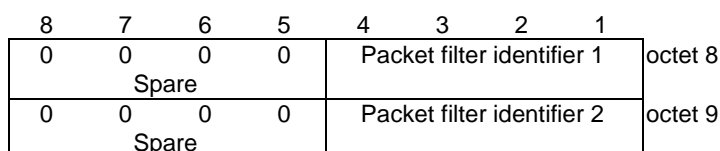

Figure 9.11.4.13.2: QoS rule (u=m+2)



0	0	0	0	...	Packet filter identifier N	octet N+7
Spare						

**Figure 9.11.4.13.3: Packet filter list when the rule operation is "modify existing QoS rule and delete packet filters" (z=N+7)**

8	7	6	5	4	3	2	1	
0	0	Packet filter direction 1		Packet filter identifier 1				octet 8
Spare								
Length of packet filter contents 1								octet 9
Packet filter contents 1								octet 10
...								octet m
0	0	Packet filter direction 2		Packet filter identifier 2				octet m+1
Spare								
Length of packet filter contents 2								octet m+2
Packet filter contents 2								octet m+3
...								octet n
...								octet n+1
...								octet y
0	0	Packet filter direction N		Packet filter identifier N				octet y+1
Spare								
Length of packet filter contents N								octet y+2
Packet filter contents N								octet y+3
...								octet z

**Figure 9.11.4.13.4: Packet filter list when the rule operation is "create new QoS rule", or "modify existing QoS rule and add packet filters" or "modify existing QoS rule and replace all packet filters"**

**Table 9.11.4.13.1: QoS rules information element**

<p>QoS rule identifier (octet 4) The QoS rule identifier field is used to identify the QoS rule.</p> <p>Bits</p> <p>8 7 6 5 4 3 2 1</p> <p>0 0 0 0 0 0 0 0 no QoS rule identifier assigned</p> <p>0 0 0 0 0 0 0 1 QRI 1</p> <p>to</p> <p>1 1 1 1 1 1 1 1 QRI 255</p> <p>The network shall not set the QRI value to 0.</p> <p>QoS rule precedence (octet m+1) The QoS rule precedence field is used to specify the precedence of the QoS rule among all QoS rules (both the signalled QoS rules as described in subclause 6.2.5.1.1.2 and the derived QoS rules as described in subclause 6.2.5.1.1.3) associated with the PDU session of the QoS flow. This field includes the binary coded value of the QoS rule precedence in the range from 0 to 255 (decimal). The higher the value of the QoS rule precedence field, the lower the precedence of that QoS rule is. For the "delete existing QoS rule" operation, the QoS rule precedence value field shall not be included. For the "create new QoS rule" operation, the QoS rule precedence value field shall be included. The value 80 (decimal) is reserved.</p> <p>Segregation bit (bit 7 of octet m+2) (see NOTE 1) In the UE to network direction the segregation bit indicates whether the UE is requesting the network to bind service data flows described by the QoS rule to a dedicated QoS Flow and it is encoded as follows. In the network to UE direction this bit is spare.</p> <p>Bit</p> <p>7</p> <p>0 Segregation not requested</p> <p>1 Segregation requested</p> <p>QoS flow identifier (QFI) (bits 6 to 1 of octet m+2) (see NOTE 1) The QoS flow identifier (QFI) field contains the QoS flow identifier.</p> <p>Bits</p> <p>6 5 4 3 2 1</p> <p>0 0 0 0 0 0 no QoS flow identifier assigned</p> <p>0 0 0 0 0 1 QFI 1</p> <p>to</p> <p>1 1 1 1 1 1 QFI 63</p> <p>The network shall not set the QFI value to 0. For the "delete existing QoS rule" operation, the QoS flow identifier value field shall not be included. For the "create new QoS rule" operation, the QoS flow identifier value field shall be included.</p> <p>DQR bit (bit 5 of octet 7) The DQR bit indicates whether the QoS rule is the default QoS rule and it is encoded as follows:</p> <p>Bit</p> <p>5</p> <p>0 the QoS rule is not the default QoS rule.</p> <p>1 the QoS rule is the default QoS rule.</p> <p>Rule operation code (bits 8 to 6 of octet 7)</p> <p>Bits</p> <p>8 7 6</p> <p>0 0 0 Reserved</p> <p>0 0 1 Create new QoS rule</p> <p>0 1 0 Delete existing QoS rule</p> <p>0 1 1 Modify existing QoS rule and add packet filters</p> <p>1 0 0 Modify existing QoS rule and replace all packet filters</p> <p>1 0 1 Modify existing QoS rule and delete packet filters</p> <p>1 1 0 Modify existing QoS rule without modifying packet filters</p> <p>1 1 1 Reserved</p> <p>Number of packet filters (bits 4 to 1 of octet 7)</p>
---



The number of packet filters contains the binary coding for the number of packet filters in the packet filter list. The number of packet filters field is encoded in bits 4 through 1 of octet 7 where bit 4 is the most significant and bit 1 is the least significant bit. For the "delete existing QoS rule" operation and for the "modify existing QoS rule without modifying packet filters" operation, the number of packet filters shall be coded as 0. For the "create new QoS rule" operation and the "modify existing QoS rule and replace all packet filters" operation, the number of packet filters shall be greater than or equal to 0 and less than or equal to 15. For all other operations, the number of packet filters shall be greater than 0 and less than or equal to 15.

Packet filter list (octets 8 to m)

The packet filter list contains a variable number of packet filters.

For the "delete existing QoS rule" operation, the length of QoS rule field is set to one.

For the "delete existing QoS rule" operation and the "modify existing QoS rule without modifying packet filters" operation, the packet filter list shall be empty.

For the "modify existing QoS rule and delete packet filters" operation, the packet filter list shall contain a variable number of packet filter identifiers. This number shall be derived from the coding of the number of packet filters field in octet 7.

For the "create new QoS rule" operation and for the "modify existing QoS rule and replace all packet filters" operation, the packet filter list shall contain 0 or a variable number of packet filters. This number shall be derived from the coding of the number of packet filters field in octet 7.

For the "modify existing QoS rule and add packet filters" operation, the packet filter list shall contain a variable number of packet filters. This number shall be derived from the coding of the number of packet filters field in octet 7.

Each packet filter is of variable length and consists of

- a packet filter direction (2 bits);
- a packet filter identifier (4 bits);
- the length of the packet filter contents (1 octet); and
- the packet filter contents itself (variable amount of octets).

The packet filter direction field is used to indicate for what traffic direction the filter applies.

Bits

6 5

0 0 reserved

0 1 downlink only

1 0 uplink only

1 1 bidirectional (see NOTE)

The packet filter identifier field is used to identify each packet filter in a QoS rule. The least significant 4 bits are used.

The length of the packet filter contents field contains the binary coded representation of the length of the packet filter contents field of a packet filter. The first bit in transmission order is the most significant bit.

The packet filter contents field is of variable size and contains a variable number (at least one) of packet filter components. Each packet filter component shall be encoded as a sequence of a one octet packet filter component type identifier and a fixed length packet filter component value field. The packet filter component type identifier shall be transmitted first.

In each packet filter, there shall not be more than one occurrence of each packet filter component type. Among the "IPv4 remote address type" and "IPv6 remote address/prefix length type" packet filter components, only one shall be present in one packet filter. Among the "IPv4 local address type" and "IPv6 local address/prefix length type" packet filter components, only one shall be present in one packet filter. Among the "single local port type" and "local port range type" packet filter components, only one shall be present in one packet filter. Among the "single

remote port type" and "remote port range type" packet filter components, only one shall be present in one packet filter. If the "match-all type" packet filter component is present in the packet filter, no other packet filter component shall be present in the packet filter and the length of the packet filter contents field shall be set to one.

The term local refers to the UE and the term remote refers to an external network entity.

Packet filter component type identifier

Bits

8	7	6	5	4	3	2	1	
0	0	0	0	0	0	0	1	Match-all type
0	0	0	1	0	0	0	0	IPv4 remote address type
0	0	0	1	0	0	0	1	IPv4 local address type
0	0	1	0	0	0	0	1	IPv6 remote address/prefix length type
0	0	1	0	0	0	1	1	IPv6 local address/prefix length type
0	0	1	1	0	0	0	0	Protocol identifier/Next header type
0	1	0	0	0	0	0	0	Single local port type
0	1	0	0	0	0	0	1	Local port range type
0	1	0	1	0	0	0	0	Single remote port type
0	1	0	1	0	0	0	1	Remote port range type
0	1	1	0	0	0	0	0	Security parameter index type
0	1	1	1	0	0	0	0	Type of service/Traffic class type
1	0	0	0	0	0	0	0	Flow label type
1	0	0	0	0	0	0	1	Destination MAC address type
1	0	0	0	0	0	1	0	Source MAC address type
1	0	0	0	0	0	1	1	802.1Q C-TAG VID type
1	0	0	0	0	1	0	0	802.1Q S-TAG VID type
1	0	0	0	0	1	0	1	802.1Q C-TAG PCP/DEI type
1	0	0	0	0	1	1	0	802.1Q S-TAG PCP/DEI type
1	0	0	0	0	1	1	1	Ethertype type

All other values are reserved.

The description and valid combinations of packet filter component type identifiers in a packet filter are defined in 3GPP TS 23.501 [8].

For "match-all type", the packet filter component shall not include the packet filter component value field.

For "IPv4 remote address type", the packet filter component value field shall be encoded as a sequence of a four octet IPv4 address field and a four octet IPv4 address mask field. The IPv4 address field shall be transmitted first.

For "IPv4 local address type", the packet filter component value field shall be encoded as defined for "IPv4 remote address type".

For "IPv6 remote address/prefix length type", the packet filter component value field shall be encoded as a sequence of a sixteen octet IPv6 address field and one octet prefix length field. The IPv6 address field shall be transmitted first.

For "IPv6 local address/prefix length type", the packet filter component value field shall be encoded as defined for "IPv6 remote address /prefix length".

For "protocol identifier/Next header type", the packet filter component value field shall be encoded as one octet which specifies the IPv4 protocol identifier or IPv6 next header.

For "single local port type" and "single remote port type", the packet filter component value field shall be encoded as two octets which specify a port number.

For "local port range type" and "remote port range type", the packet filter component value field shall be encoded as a sequence of a two octet port range low limit field and a two octet port range high limit field. The port range low limit field shall be transmitted first.

For "security parameter index", the packet filter component value field shall be encoded as four octets which specify the IPsec security parameter index.

For "type of service/traffic class type", the packet filter component value field shall be encoded as a sequence of a one octet type-of-service/traffic class field and a one octet type-of-service/traffic class mask field. The type-of-service/traffic class field shall be transmitted first.

For "flow label type", the packet filter component value field shall be encoded as three octets which specify the IPv6 flow label. The bits 8 through 5 of the first octet shall be spare whereas the remaining 20 bits shall contain the IPv6 flow label.

For "destination MAC address type" and "source MAC address type", the packet filter component value field shall be encoded as 6 octets which specify a MAC address.

For "802.1Q C-TAG VID type", the packet filter component value field shall be encoded as two octets which specify the VID of the customer-VLAN tag (C-TAG). The bits 8 through 5 of the first octet shall be spare whereas the remaining 12 bits shall contain the VID.

For "802.1Q S-TAG VID type", the packet filter component value field shall be encoded as two octets which specify the VID of the service-VLAN tag (S-TAG). The bits 8 through 5 of the first octet shall be spare whereas the remaining 12 bits shall contain the VID.

For "802.1Q C-TAG PCP/DEI type", the packet filter component value field shall be encoded as one octet which specifies the 802.1Q C-TAG PCP and DEI. The bits 8 through 5 of the octet shall be spare, the bits 4 through 2 contain the PCP and bit 1 contains the DEI.

For "802.1Q S-TAG PCP/DEI type", the packet filter component value field shall be encoded as one octet which specifies the 802.1Q S-TAG PCP. The bits 8 through 5 of the octet shall be spare, the bits 4 through 2 contain the PCP and bit 1 contains the DEI.

For "ethertype type", the packet filter component value field shall be encoded as two octets which specify an ethertype.

NOTE 1: Octet m+2 shall not be included without octet m+1.

### 9.11.4.14 Session-AMBR

The purpose of the Session-AMBR information element is to indicate the initial subscribed PDU session aggregate maximum bit rate when the UE establishes a PDU session or to indicate the new subscribed PDU session aggregate maximum bit rate if it is changed by the network.

The Session-AMBR information element is coded as shown in figure 9.11.4.14.1 and table 9.11.4.14.1.

The Session-AMBR is a type 4 information element with a length of 8 octets.

8	7	6	5	4	3	2	1	
Session-AMBR IEI								octet 1
Length of Session-AMBR contents								octet 2
Unit for Session-AMBR for downlink								octet 3
Session-AMBR for downlink								octet 4-5
Unit for Session-AMBR for uplink								octet 6
Session-AMBR for uplink								octet 7-8

**Figure 9.11.4.14.1: Session-AMBR information element**

**Table 9.11.4.14.1: Session-AMBR information element**

Unit for Session-AMBR for downlink (octet 3)	
0 0 0 0 0 0 0 0	value is not used
0 0 0 0 0 0 0 1	value is incremented in multiples of 1 Kbps
0 0 0 0 0 0 1 0	value is incremented in multiples of 4 Kbps
0 0 0 0 0 0 1 1	value is incremented in multiples of 16 Kbps
0 0 0 0 0 1 0 0	value is incremented in multiples of 64 Kbps
0 0 0 0 0 1 0 1	value is incremented in multiples of 256 kbps
0 0 0 0 0 1 1 0	value is incremented in multiples of 1 Mbps
0 0 0 0 0 1 1 1	value is incremented in multiples of 4 Mbps
0 0 0 0 1 0 0 0	value is incremented in multiples of 16 Mbps
0 0 0 0 1 0 0 1	value is incremented in multiples of 64 Mbps
0 0 0 0 1 0 1 0	value is incremented in multiples of 256 Mbps
0 0 0 0 1 0 1 1	value is incremented in multiples of 1 Gbps
0 0 0 0 1 1 0 0	value is incremented in multiples of 4 Gbps
0 0 0 0 1 1 0 1	value is incremented in multiples of 16 Gbps
0 0 0 0 1 1 1 0	value is incremented in multiples of 64 Gbps
0 0 0 0 1 1 1 1	value is incremented in multiples of 256 Gbps
0 0 0 1 0 0 0 0	value is incremented in multiples of 1 Tbps
0 0 0 1 0 0 0 1	value is incremented in multiples of 4 Tbps
0 0 0 1 0 0 1 0	value is incremented in multiples of 16 Tbps
0 0 0 1 0 0 1 1	value is incremented in multiples of 64 Tbps
0 0 0 1 0 1 0 0	value is incremented in multiples of 256 Tbps
0 0 0 1 0 1 0 1	value is incremented in multiples of 1 Pbps
0 0 0 1 0 1 1 0	value is incremented in multiples of 4 Pbps
0 0 0 1 0 1 1 1	value is incremented in multiples of 16 Pbps
0 0 0 1 1 0 0 0	value is incremented in multiples of 64 Pbps
0 0 0 1 1 0 0 1	value is incremented in multiples of 256 Pbps
Other values shall be interpreted as multiples of 256 Pbps in this version of the protocol.	
Session-AMBR for downlink (octets 4 and 5)	
Octets 4 and 5 represent the binary coded value of PDU session aggregated maximum bit rate for downlink in units defined by octet 3.	
Unit for Session-AMBR for uplink (octet 6)	
The coding is identical to the unit coding defined for Session-AMBR for downlink (octet 3)	
Session-AMBR for uplink (octets 7 and 8)	
Octets 7 and 8 represent the binary coded value of PDU session aggregated maximum bit rate for uplink in units defined by octet 6.	

**9.11.4.15 SM PDU DN request container**

The purpose of the SM PDU DN request container information element is to carry a DN-specific identity of the UE in the network access identifier (NAI) format.

The SM PDU DN request container information element is coded as shown in figure 9.11.4.15.1 and table 9.11.4.15.1.

The SM PDU DN request container is a type 4 information element with minimal length of 3 octets and maximum length of 255 octets.

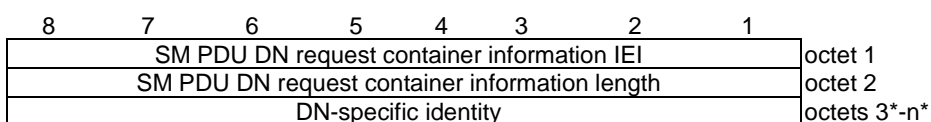

**Figure 9.11.4.15.1: SM PDU DN request container information element**

**Table 9.11.4.15.1: SM PDU DN request container information element**

DN-specific identity (octet 3 to octet n)  
 A DN-specific identity of the UE in the network access identifier (NAI) format according to IETF RFC 7542 [37], encoded as UTF-8 string.

### 9.11.4.16 SSC mode

The purpose of the SSC mode information element is to indicate SSC mode.

The SSC mode information element is coded as shown in figure 9.11.4.16.1 and table 9.11.4.16.1.

The SSC mode is a type 1 information element.

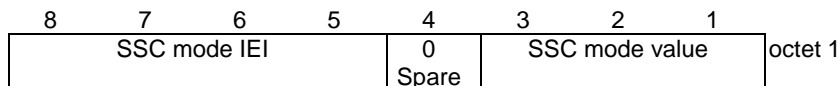
**Figure 9.11.4.16.1: SSC mode information element****Table 9.11.4.16.1: SSC mode information element**

SSC mode value (octet 1, bit 1 to bit 4)			
Bits			
<b>3</b>	<b>2</b>	<b>1</b>	
0	0	1	SSC mode 1
0	1	0	SSC mode 2
0	1	1	SSC mode 3
1	0	0	unused; shall be interpreted as "SSC mode 1", if received by the network
1	0	1	unused; shall be interpreted as "SSC mode 2", if received by the network
1	1	0	unused; shall be interpreted as "SSC mode 3", if received by the network
All other values are reserved.			

## 9.12 3GPP specific coding information defined within present document

### 9.12.1 Serving network name (SNN)

The serving network name (SNN) is used:

- in the Network name field of the AT\_KDF\_INPUT attribute defined in IETF RFC 5448 [40];
- in  $K_{AUSF}$  derivation function as specified in 3GPP TS 33.501 [24] annex A; and
- in RES\* and XRES\* derivation function as specified in 3GPP TS 33.501 [24] annex A.

SNN shall contain a UTF-8 string without terminating null characters.

SNN is of maximum length of 1020 octets.

SNN consists of SNN-service-code and SNN-network-identifier, delimited by a colon.

SNN-network-identifier identifies the serving PLMN.

MCC and MNC in the SNN-PLMN-ID are MCC and MNC of the serving PLMN. If the MNC of the serving PLMN has two digits, then a zero is added at the beginning.

ABNF syntax of SNN is specified in table 9.12.1.1

**Table 9.12.1.1: ABNF syntax of SNN**

```
SNN = SNN-service-code ":" SNN-network-identifier
SNN-service-code = %x35.47 ; "5G"
```

```
SNN-network-identifier = SNN-PLMN-ID
SNN-PLMN-ID = SNN-mnc-string SNN-mnc-digits "." SNN-mcc-string SNN-mcc-digits "." SNN-3gppnetwork-
string "." SNN-org-string

SNN-mnc-digits = DIGIT DIGIT DIGIT ; MNC of the PLMN ID
SNN-mcc-digits = DIGIT DIGIT DIGIT ; MCC of the PLMN ID
SNN-mnc-string = %x6d.6e.63 ; "mnc" in lower case
SNN-mcc-string = %x6d.63.63 ; "mcc" in lower case
SNN-3gppnetwork-string = %x33.67.70.70.6e.65.74.77.6f.72.6b ; "3gppnetwork" in lower case
SNN-org-string = %x6f.72.67 ; "org" in lower case
```

NOTE: SNN-service-code allows for distinguishing of ANID specified in 3GPP TS 24.302 [16] and SNN as either of SNN or ANID can be carried in the AT\_KDF\_INPUT attribute.

EXAMPLE: If PLMN ID contains MCC = 234 and MNC = 15, SNN is 5G:mnc015.mcc234.3gppnetwork.org.

---

## 10 List of system parameters

### 10.1 General

The description of timers in the following tables should be considered a brief summary. The precise details are found in clauses 4 to 6, which should be considered the definitive descriptions.

### 10.2 Timers of 5GS mobility management

Timers of 5GS mobility management are shown in table 10.2.1 and table 10.2.2

NOTE: Timer T3346 is defined in 3GPP TS 24.008 [12]. Timers T3444 and T3445 are defined in 3GPP TS 24.301 [15].

**Table 10.2.1: Timers of 5GS mobility management – UE side**

TIMER NUM.	TIMER VALUE	STATE	CAUSE OF START	NORMAL STOP	ON EXPIRY
T3510	15s	5GMM-REGISTERED-INITIATED	Transmission of REGISTRATION REQUEST message	REGISTRATION ACCEPT message received or REGISTRATION REJECT message received	Start T3511 or T3502 as specified in subclause 5.5.1.2.7 if T3510 expired during registration procedure for initial registration.  Start T3511 or T3502 as specified in subclause 5.5.1.3.7 if T3510 expired during the registration procedure for mobility and periodic registration update
T3502	Default 12 min. NOTE 1	5GMM-DEREGISTERED 5GMM-REGISTERED	At registration failure and the attempt counter is equal to 5	Transmission of REGISTRATION REQUEST message	Initiation of the registration procedure, if still required
T3511	10s	5GMM-DEREGISTERED.ATTEMPTING-REGISTRATION  5GMM-REGISTERED.ATTEMPTING-REGISTRATION-UPDATE  5GMM-REGISTERED.NORMAL-SERVICE	At registration failure due to lower layer failure, T3510 timeout or registration rejected with other 5GMM cause values than those treated in subclause 5.5.1.2.5 for initial registration or subclause 5.5.1.3.5 for mobility and periodic registration	Transmission of REGISTRATION REQUEST message  5GMM-CONNECTED mode entered (NOTE 5)	Retransmission of the REGISTRATION REQUEST, if still required
T3512	Default 54 min NOTE 1 NOTE 2	5GMM-REGISTERED	In 5GMM-REGISTERED, when 5GMM-CONNECTED mode is left	When entering state 5GMM-DEREGISTERED or when entering 5GMM-CONNECTED mode	Initiation of the periodic registration procedure if the UE is not registered for emergency services.  Locally deregister if the UE is registered for emergency services
T3516	30s	5GMM-REGISTERED-INITIATED 5GMM-REGISTERED 5GMM-DEREGISTERED-INITIATED 5GMM-SERVICE-REQUEST-INITIATED	RAND and RES* stored as a result of an 5G authentication challenge	SECURITY MODE COMMAND received SERVICE REJECT received REGISTRATION ACCEPT received AUTHENTICATION REJECT received AUTHENTICATION FAILURE sent 5GMM-DEREGISTERED, 5GMM-NULL or 5GMM-IDLE mode entered	Delete the stored RAND and RES*



TIMER NUM.	TIMER VALUE	STATE	CAUSE OF START	NORMAL STOP	ON EXPIRY
T3517	15s	5GMM-SERVICE-REQUEST-INITIATED	Transmission of SERVICE REQUEST message	(a) Indication from the lower layers that the UE has changed to S1 mode or E-UTRA connected to 5GCN for case h) in subclause 5.6.1.1; or (b) SERVICE ACCEPT message received, or SERVICE REJECT message received for cases other than h) in subclause 5.6.1.1	Abort the procedure
T3519	60s	5GMM-REGISTERED-INITIATED	Transmission of IDENTITY RESPONSE message, REGISTRATION REQUEST message, or DEREGISTRATION REQUEST message with freshly generated SUCI	REGISTRATION ACCEPT message with new 5G-GUTI received CONFIGURATION UPDATE COMMAND message with new 5G-GUTI received DEREGISTRATION ACCEPT message	Delete stored SUCI

TIMER NUM.	TIMER VALUE	STATE	CAUSE OF START	NORMAL STOP	ON EXPIRY
T3520	15s	5GMM-REGISTERED-INITIATED 5GMM-REGISTERED 5GMM-DEREGISTERED-INITIATED 5GMM-SERVICE-REQUEST-INITIATED	Transmission of AUTHENTICATION FAILURE message with any of the 5GMM cause #20, #21, #26 or #71  Transmission of AUTHENTICATION RESPONSE message with an EAP-response message after detection of an error as described in subclause 5.4.1.2.2.4	AUTHENTICATION REQUEST message received or AUTHENTICATION REJECT message received or SECURITY MODE COMMAND message received  when entering 5GMM-IDLE mode  indication of transmission failure of AUTHENTICATION FAILURE message from lower layers	On first expiry during a 5G AKA based primary authentication and key agreement procedure, the UE should consider the network as false and follow item g of subclause 5.4.1.3.7, if the UE is not registered for emergency services.  On first expiry during a 5G AKA based primary authentication and key agreement procedure, the UE will follow subclause 5.4.1.3.7 under "For items c, d, e and f:", if the UE is registered for emergency services.  On first expiry during an EAP based primary authentication and key agreement procedure, the UE should consider the network as false and follow item e of subclause 5.4.1.2.4.5, if the UE is not registered for emergency services.  On first expiry during an EAP based primary authentication and key agreement procedure, the UE will follow subclause 5.4.1.2.4.5 under "For item e:", if the UE is registered for emergency services
T3521	15s	5GMM-DEREGISTERED-INITIATED	Transmission of DEREGISTRATION REQUEST message when de-registration procedure is not due to a "switch off"	DEREGISTRATION ACCEPT message received	Retransmission of DEREGISTRATION REQUEST message

TIMER NUM.	TIMER VALUE	STATE	CAUSE OF START	NORMAL STOP	ON EXPIRY
T3525	Default 60s NOTE 3	5GMM-REGISTERED.NORMAL-SERVICE	T3517 expires and service request attempt counter is greater than or equal to 5	When entering state other than 5GMM-REGISTERED.NORMAL-SERVICE state, or UE camped on a new PLMN other than the PLMN on which timer started, or User-plane resources established with the network	The UE may initiate service request procedure
T3540	10s	5GMM-REGISTERED-INITIATED	REGISTRATION REJECT message or DEREGISTRATION REQUEST message received with any of the 5GMM cause #7, #11, #12, #13, #15, #27 or #72 SERVICE REJECT message received with any of the 5GMM cause #7, #11, #12, #13, #15, #27 or #72. REGISTRATION ACCEPT message received as described in subclause 5.3.1.3 case b) SERVICE ACCEPT message received as described in subclause 5.3.1.3 case f)	N1 NAS signalling connection released PDU sessions have been set up	Release the NAS signalling connection for the cases a), b) and f) as described in subclause 5.3.1.3
		5GMM-DEREGISTERED-INITIATED			
		5GMM-SERVICE-REQUEST-INITIATED			
		5GMM-REGISTERED	CONFIGURATION UPDATE COMMAND message received as described in subclause 5.3.1.3 case e)	N1 NAS signalling connection released	Release the NAS signalling connection for the case e) and perform a new registration procedure as described in subclause 5.5.1.3.2
		5GMM-DEREGISTERED	REGISTRATION REJECT message or SERVICE REJECT message received with the 5GMM cause #9 or #10		Release the NAS signalling connection for the cases c) and d) as described in subclause 5.3.1.3 and initiation of the registration procedure as specified in subclause 5.5.1.2.2 or 5.5.1.3.2
		5GMM-DEREGISTERED.NORMAL-SERVICE			

TIMER NUM.	TIMER VALUE	STATE	CAUSE OF START	NORMAL STOP	ON EXPIRY
Non-3GPP de-registration timer	Default 54 min. NOTE 1 NOTE 2 NOTE 4	All 5GMM state over non-3GPP access except 5GMM-DEREGISTERED over non-3GPP access	Entering 5GMM-IDLE mode over non-3GPP access	N1 NAS signalling connection over non-3GPP access established or when entering state 5GMM-DEREGISTERED over non-3GPP access	Implicitly de-register the UE for non-3GPP access on 1st expiry
<p>NOTE 1: The value of this timer is provided by the network operator during the registration procedure.</p> <p>NOTE 2: The default value of this timer is used if the network does not indicate a value in the REGISTRATION ACCEPT message and the UE does not have a stored value for this timer.</p> <p>NOTE 3: The value of this timer is UE implementation specific, with a minimum value of 60 seconds.</p> <p>NOTE 4: If the T3346 value received in the mobility management messages is greater than the value of the non-3GPP de-registration timer, the UE sets the non-3GPP de-registration timer value to be 4 minutes greater than the value of timer T3346.</p> <p>NOTE 5: The conditions for which this applies are described in subclause 5.5.1.3.7.</p>					

**Table 10.2.2: Timers of 5GS mobility management – AMF side**

TIMER NUM.	TIMER VALUE	STATE	CAUSE OF START	NORMAL STOP	ON EXPIRY
T3550	6s	5GMM-COMMON-PROCEDURE-INITIATED	Transmission of REGISTRATION ACCEPT message with 5G-GUTI, with SOR transparent container IE, the Extended emergency number list IE or the Operator-defined access category definitions IE Transmission of REGISTRATION ACCEPT message with any of a) Network slicing subscription changed indication, and b) new configured NSSAI and optionally new mapped S-NSSAI(s)	REGISTRATION COMPLETE message received	Retransmission of REGISTRATION ACCEPT message
T3560	6s	5GMM-COMMON-PROCEDURE-INITIATED	Transmission of AUTHENTICATION REQUEST message Transmission of SECURITY MODE COMMAND message	AUTHENTICATION RESPONSE message received AUTHENTICATION FAILURE message received SECURITY MODE COMPLETE message received SECURITY MODE REJECT message received	Retransmission of AUTHENTICATION REQUEST message or SECURITY MODE COMMAND message
T3570	6s	5GMM-COMMON-PROCEDURE-INITIATED	Transmission of IDENTITY REQUEST message	IDENTITY RESPONSE message received	Retransmission of IDENTITY REQUEST message
T3513	NOTE 4	5GMM-REGISTERED	Paging procedure initiated	Paging procedure completed as specified in subclause 5.6.2.2.1	Network dependent
T3522	6s	5GMM-DEREGISTERED-INITIATED	Transmission of DEREGISTRATION REQUEST message	DEREGISTRATION ACCEPT message received	Retransmission of DEREGISTRATION REQUEST message
T3555	6s	5GMM-REGISTERED	Transmission of CONFIGURATION UPDATE COMMAND message with Acknowledgement requested flag IE	CONFIGURATION UPDATE COMPLETE message received	Retransmission of CONFIGURATION UPDATE COMMAND message
T3565	6s	5GMM-REGISTERED	Transmission of NOTIFICATION message	SERVICE REQUEST message received NOTIFICATION RESPONSE message received REGISTRATION REQUEST Message received	Retransmission of NOTIFICATION message

TIMER NUM.	TIMER VALUE	STATE	CAUSE OF START	NORMAL STOP	ON EXPIRY
Mobile reachable timer	NOTE 1	All except 5GMM-DEREGISTERED	Entering 5GMM-IDLE mode	N1 NAS signalling connection established	Network dependent, but typically paging is halted on 1 <sup>st</sup> expiry, and start implicit de-registration timer, if the UE is not registered for emergency services.  Implicitly de-register the UE which is registered for emergency services
Implicit de-registration timer	NOTE 2	All except 5GMM-DEREGISTERED	The mobile reachable timer expires while the network is in 5GMM-IDLE mode	N1 NAS signalling connection established	Implicitly de-register the UE on 1 <sup>st</sup> expiry
Non-3GPP implicit de-registration timer	NOTE 3	All except 5GMM-DEREGISTERED	Entering 5GMM-IDLE mode over non-3GPP access	N1 NAS signalling connection over non-3GPP access established	Implicitly de-register the UE for non-3GPP access on 1 <sup>s</sup> expiry
<p>NOTE 1: The default value of this timer is 4 minutes greater than the value of timer T3512. If the UE is registered for emergency services, the value of this timer is set equal to the value of timer T3512. If the T3346 value provided in the mobility management messages is greater than the value of the timer T3512, the AMF sets the mobile reachable timer and the implicit de-registration timer such that the sum of the timer values is greater than the value of timer T3346.</p> <p>NOTE 2: The value of this timer is network dependent. If MICO is activated, the default value of this timer is 4 minutes greater than the value of timer T3512.</p> <p>NOTE 3: The value of this timer is network dependent. The default value of this timer is 4 minutes greater than the non-3GPP de-registration timer. If the T3346 value provided in the mobility management messages is greater than the value of the non-3GPP de-registration timer, the AMF sets the non-3GPP implicit de-registration timer value to be 8 minutes greater than the value of timer T3346.</p> <p>NOTE 4: The value of this timer is network dependent.</p>					

### 10.3 Timers of 5GS session management

Timers of 5GS session management are shown in table 10.3.1 and table 10.3.2.

NOTE: Timer T3396 is defined in 3GPP TS 24.008 [12].

**Table 10.3.1: Timers of 5GS session management – UE side**

TIMER NUM.	TIMER VALUE	STATE	CAUSE OF START	NORMAL STOP	ON THE 1 <sup>st</sup> , 2 <sup>nd</sup> , 3 <sup>rd</sup> , 4 <sup>th</sup> EXPIRY (NOTE 1)
T3580	16s	PDU SESSION ACTIVE PENDING	Transmission of PDU SESSION ESTABLISHMENT REQUEST message	PDU SESSION ESTABLISHMENT ACCEPT message received or PDU SESSION ESTABLISHMENT REJECT message received	Retransmission of PDU SESSION ESTABLISHMENT REQUEST message
T3581	16s	PDU SESSION MODIFICATION PENDING	Transmission of PDU SESSION MODIFICATION REQUEST message	PDU SESSION MODIFICATION COMMAND message with the same PTI is received or PDU SESSION MODIFICATION REJECT message received	Retransmission of PDU SESSION MODIFICATION REQUEST message
T3582	16s	PDU SESSION INACTIVE PENDING	Transmission of PDU SESSION RELEASE REQUEST message	PDU SESSION RELEASE COMMAND message with the same PTI is received or PDU SESSION RELEASE REJECT message received	Retransmission of PDU SESSION RELEASE REQUEST message
T3583	Default 1 min. NOTE 2	PDU SESSION ACTIVE	UE creates or updates a derived QoS rule	UE deletes the derived QoS rule (see subclause 6.2.5.1.4.5)	On 1 <sup>st</sup> expiry: Deletion of the derived QoS rule
T3584	NOTE 3	PDU SESSION ACTIVE PENDING  PDU SESSION MODIFICATION PENDING  PDU SESSION ACTIVE or PDU SESSION INACTIVE PENDING	PDU SESSION ESTABLISHMENT REJECT, PDU SESSION MODIFICATION REJECT, or PDU SESSION RELEASE COMMAND received with 5GSM cause #67 and with a timer value for T3584  PDU SESSION ESTABLISHMENT REQUEST, or PDU SESSION MODIFICATION REQUEST received in a DL NAS TRANSPORT message with 5GMM cause #67 and with a timer value for T3584 (see subclause 5.4.5.3.3)	PDU SESSION RELEASE COMMAND or PDU SESSION MODIFICATION COMMAND or DEREGISTRATION REQUEST with the re-registration type "re-registration required"	None



TIMER NUM.	TIMER VALUE	STATE	CAUSE OF START	NORMAL STOP	ON THE 1 <sup>st</sup> , 2 <sup>nd</sup> , 3 <sup>rd</sup> , 4 <sup>th</sup> EXPIRY (NOTE 1)
T3585	NOTE 3	PDU SESSION ACTIVE PENDING  PDU SESSION MODIFICATION PENDING  PDU SESSION ACTIVE or PDU SESSION INACTIVE PENDING	PDU SESSION ESTABLISHMENT REJECT, PDU SESSION MODIFICATION REJECT, or PDU SESSION RELEASE COMMAND received with 5GSM cause #69 and with a timer value for T3585  PDU SESSION ESTABLISHMENT REQUEST, or PDU SESSION MODIFICATION REQUEST received in a DL NAS TRANSPORT message with 5GMM cause #69 and with a timer value for T3585(see subclause 5.4.5.3.3)	PDU SESSION RELEASE COMMAND or PDU SESSION MODIFICATION COMMAND or DEREGISTRATION REQUEST with the re-registration type "re-registration required"	None
<p>NOTE 1: Typically, the procedures are aborted on the fifth expiry of the relevant timer. Exceptions are described in the corresponding procedure description.</p> <p>NOTE 2: The network may provide the value of this timer applicable to the derived QoS rules of a specific PDU session as RQ timer value in the PDU SESSION ESTABLISHMENT ACCEPT message and PDU SESSION MODIFICATION COMMAND message. The maximum value of the timer is 30 min. If the network indicates a value greater than the maximum value, then the UE shall use the maximum value.</p> <p>NOTE 3: The value of this timer is provided by the network.</p>					

Table 10.3.2: Timers of 5GS session management – SMF side

TIMER NUM.	TIMER VALUE	STATE	CAUSE OF START	NORMAL STOP	ON THE 1 <sup>st</sup> , 2 <sup>nd</sup> , 3 <sup>rd</sup> , 4 <sup>th</sup> EXPIRY (NOTE 1)
T3590	15s	PROCEDURE TRANSACTION PENDING	Transmission of PDU SESSION AUTHENTICATION COMMAND message	PDU SESSION AUTHENTICATION COMPLETE message received	Retransmission of PDU SESSION AUTHENTICATION COMMAND message
T3591	16s	PDU SESSION MODIFICATION PENDING	Transmission of PDU SESSION MODIFICATION COMMAND message	PDU SESSION MODIFICATION COMPLETE message received or PDU SESSION MODIFICATION COMMAND REJECT message received	Retransmission of PDU SESSION MODIFICATION COMMAND message
T3592	16s	PDU SESSION INACTIVE PENDING	Transmission of PDU SESSION RELEASE COMMAND message	PDU SESSION RELEASE COMPLETE message received or N1 SM delivery skipped indication received	Retransmission of PDU SESSION RELEASE COMMAND message
T3593	Default 60s (NOTE 2)	PDU SESSION MODIFICATION PENDING	Reception of PDU SESSION MODIFICATION COMPLETE message for transmitted PDU SESSION MODIFICATION COMMAND message where the PDU SESSION MODIFICATION COMMAND message included 5GSM cause #39	PDU SESSION RELEASE REQUEST message received	Network-requested PDU session release procedure performed
NOTE 1: Typically, the procedures are aborted on the fifth expiry of the relevant timer. Exceptions are described in the corresponding procedure description.					
NOTE 2: If the PDU Session Address Lifetime value is sent to the UE in the PDU SESSION MODIFICATION COMMAND message then timer T3593 shall be started with the same value, otherwise it shall use a default value.					

---

# Annex A (informative): Cause values for 5GS mobility management

## A.1 Causes related to UE identification

### Cause #3 – Illegal UE

This 5GMM cause is sent to the UE when the network refuses service to the UE either because an identity of the UE is not acceptable to the network or because the UE does not pass the authentication check.

### Cause #6 – Illegal ME

This 5GMM cause is sent to the UE if the ME used is not acceptable to the network, e.g. blacklisted.

### Cause #9 – UE identity cannot be derived by the network.

This 5GMM cause is sent to the UE when the network cannot derive the UE's identity from the 5G-GUTI or 5G-S-TMSI because of e.g. no matching identity/context in the network, failure to validate the UE's identity due to integrity check failure of the received message.

### Cause #10 – Implicitly de-registered

This 5GMM cause is sent to the UE either if the network has implicitly de-registered the UE, e.g. after the implicit de-registration timer has expired, or if the 5GMM context data related to the subscription does not exist in the AMF e.g. because of a AMF restart, or because of a registration request for mobility or registration update is routed to a new AMF.

## A.2 Cause related to subscription options

### Cause #5 – PEI not accepted

This cause is sent to the UE if the network does not accept an initial registration procedure for emergency services using a PEI.

### Cause #7 – 5GS services not allowed

This 5GMM cause is sent to the UE when it is not allowed to operate 5GS services.

### Cause #11 – PLMN not allowed

This 5GMM cause is sent to the UE if it requests service, or if the network initiates a de-registration request, in a PLMN where the UE, by subscription or due to operator determined barring, is not allowed to operate.

### Cause #12 – Tracking area not allowed

This 5GMM cause is sent to the UE if it requests service, or if the network initiates a de-registration request, in a tracking area where the HPLMN determines that the UE, by subscription, is not allowed to operate.

NOTE 1: If 5GMM cause #12 is sent to a roaming subscriber the subscriber is denied service even if other PLMNs are available on which registration was possible.

### Cause #13 – Roaming not allowed in this tracking area

This 5GMM cause is sent to a UE which requests service, or if the network initiates a de-registration request, in a tracking area of a PLMN which by subscription offers roaming to that UE but not in that tracking area.

### Cause #15 – No suitable cells in tracking area

This 5GMM cause is sent to the UE if it requests service, or if the network initiates a de-registration request, in a tracking area where the UE, by subscription, is not allowed to operate, but when it should find another allowed tracking area in the same PLMN or an equivalent PLMN.

NOTE 2: Cause #15 and cause #12 differ in the fact that cause #12 does not trigger the UE to search for another allowed tracking area on the same PLMN.

#### Cause #27 – N1 mode not allowed

This 5GMM cause is sent to the UE if it requests service, or if the network initiates a de-registration request, in a PLMN where the UE by subscription, is not allowed to operate in N1 mode.

#### Cause #72 – Non-3GPP access to 5GCN not allowed

This 5GMM cause is sent to the UE if it requests accessing 5GCN over non-3GPP access in a PLMN, where the UE by subscription, is not allowed to access 5GCN over non-3GPP access.

## A.3 Causes related to PLMN specific network failures and congestion/authentication failures

#### Cause #20 – MAC failure

This 5GMM cause is sent to the network if the USIM detects that the MAC in the AUTHENTICATION REQUEST message is not fresh.

#### Cause #21 – Synch failure

This 5GMM cause is sent to the network if the USIM detects that the SQN in the AUTHENTICATION REQUEST message is out of range.

#### Cause #22 – Congestion

This 5GMM cause is sent to the UE because of congestion in the network (e.g. no channel, facility busy/congested etc.).

#### Cause #23 – UE security capabilities mismatch

This 5GMM cause is sent to the network if the UE detects that the UE security capability does not match the one sent back by the network.

#### Cause #24 – Security mode rejected, unspecified

This 5GMM cause is sent to the network if the security mode command is rejected by the UE for unspecified reasons.

#### Cause #26 – Non-5G authentication unacceptable

This 5GMM cause is sent to the network in N1 mode if the "separation bit" in the AMF field of AUTN is set to 0 in the AUTHENTICATION REQUEST message (see 3GPP TS 33.501 [24]).

#### Cause #28 – Restricted service area

This 5GMM cause is sent to the UE if it requests service in a tracking area which is a part of the UE's non-allowed area or is not a part of the UE's allowed area.

#### Cause #43 – LADN not available

This 5GMM cause is sent to the UE if the user-plane resources of the PDU session are not established when the UE is located outside the LADN service area.

#### Cause #65 – Maximum number of PDU sessions reached

This 5GMM cause is used by the network to indicate that the procedure requested by the UE was rejected as the network has reached the maximum number of simultaneously active PDU sessions for the UE.

#### Cause #67 – Insufficient resources for specific slice and DNN

This 5GMM cause is sent by the network to indicate that the requested service cannot be provided due to insufficient resources for specific slice and DNN.

**Cause #69 – Insufficient resources for specific slice**

This 5GMM cause is sent by the network to indicate that the requested service cannot be provided due to insufficient resources for specific slice.

**Cause #71 – ngKSI already in use**

This 5GMM cause is sent to the network in N1 mode if the ngKSI value received in the AUTHENTICATION REQUEST message is already associated with one of the 5G security contexts stored in the UE.

**Cause #73 – Serving network not authorized**

This 5GMM cause is sent to the UE if the UE initiates registration towards a serving network and the serving network fails to be authorized by the UE's home network.

**Cause #90 – Payload was not forwarded**

This 5GMM cause is sent by the network to indicate that the requested service cannot be provided due to payload could not be forwarded by AMF.

**Cause #91 – DNN not supported or not subscribed in the slice**

This 5GMM cause is sent by the network to indicate that the requested service cannot be provided due to payload could not be forwarded by AMF because the DNN is not supported or not subscribed in the slice selected by the network if the UE did not indicate a slice, or the DNN is not supported or not subscribed in the slice indicated by the UE.

**Cause #92 – Insufficient user-plane resources for the PDU session**

This 5GMM cause is sent by the network to indicate that the requested service cannot be provided due to insufficient user-plane resources for the PDU session.

## A.4 Causes related to invalid messages

**Cause #95 – Semantically incorrect message**

This 5GMM cause is used to report receipt of a message with semantically incorrect contents.

**Cause #96 – Invalid mandatory information**

This cause 5GMM indicates that the equipment sending this 5GMM cause has received a message with a non-semantical mandatory IE error.

**Cause #97 – Message type non-existent or not implemented**

This 5GMM cause indicates that the equipment sending this 5GMM cause has received a message with a message type it does not recognize either because this is a message not defined, or defined but not implemented by the equipment sending this 5GMM cause.

**Cause #98 – Message type not compatible with protocol state**

This 5GMM cause indicates that the equipment sending this 5GMM cause has received a message not compatible with the protocol state.

**Cause #99 – Information element non-existent or not implemented**

This 5GMM cause indicates that the equipment sending this 5GMM cause has received a message which includes information elements not recognized because the information element identifier is not defined or it is defined but not implemented by the equipment sending the 5GMM cause. However, the information element is not required to be present in the message in order for the equipment sending the 5GMM cause to process the message.

**Cause #100 – Conditional IE error**

This 5GMM cause indicates that the equipment sending this cause has received a message with conditional IE errors.

Cause #101 – Message not compatible with protocol state

This 5GMM cause indicates that a message has been received which is incompatible with the protocol state.

Cause #111 – Protocol error, unspecified

This 5GMM cause is used to report a protocol error event only when no other 5GMM cause in the protocol error class applies.

---

# Annex B (informative): Cause values for 5GS session management

## B.1 Causes related to nature of request

### Cause #8 – Operator Determined Barring

This 5GSM cause is used by the network to indicate that the requested service was rejected by the SMF due to Operator Determined Barring.

### Cause #26 – Insufficient resources

This 5GSM cause is used by the UE or by the network to indicate that the requested service cannot be provided due to insufficient resources.

### Cause #27 – Missing or unknown DNN

This 5GSM cause is used by the network to indicate that the requested service was rejected by the external DN because the DNN was not included although required or if the DNN could not be resolved.

### Cause #28 – Unknown PDU session type

This 5GSM cause is used by the network to indicate that the requested service was rejected by the external DN because the requested PDU session type could not be recognised or is not allowed.

### Cause #29 – User authentication or authorization failed

This 5GSM cause is used by the network to indicate that the requested service was rejected by the external DN due to a failed user authentication, revoked by the external DN, or rejected by 5GCN due to a failed user authentication or authorization.

### Cause #31 – Request rejected, unspecified

This 5GSM cause is used by the network or by the UE to indicate that the requested service or operation or the request for a resource was rejected due to unspecified reasons.

### Cause #32 – Service option not supported

This 5GSM cause is used by the network when the UE requests a service which is not supported by the PLMN.

### Cause #33 – Requested service option not subscribed

This 5GSM cause is sent when the UE requests a service option for which it has no subscription.

### Cause #35 – PTI already in use

This 5GSM cause is used by the network to indicate that the PTI included by the UE is already in use by another active UE requested procedure for this UE.

### Cause #36 – Regular deactivation

This 5GSM cause is used to indicate a regular UE or network initiated release of PDU session resources.

### Cause #38 – Network failure

This 5GSM cause is used by the network to indicate that the requested service was rejected due to an error situation in the network.

### Cause #39 – Reactivation requested

This 5GSM cause is used by the network to request a PDU session reactivation.

### Cause #41 – Semantic error in the TFT operation

This 5GSM cause is used by the UE to indicate a semantic error in the TFT operation included in the request.

Cause #42 – Syntactical error in the TFT operation

This 5GSM cause is used by the UE to indicate a syntactical error in the TFT operation included in the request.

Cause #43 –Invalid PDU session identity

This 5GSM cause is used by the network or the UE to indicate that the PDU session identity value provided to it is not a valid value or the PDU session identified by the PDU session identity IE in the request or the command is not active.

Cause #44 – Semantic errors in packet filter(s)

This 5GSM cause is used by the network or the UE to indicate that the requested service was rejected due to one or more semantic errors in packet filter(s) of the QoS rule included in the request.

Cause #45 – Syntactical error in packet filter(s)

This 5GSM cause is used by the network or the UE to indicate that the requested service was rejected due to one or more syntactical errors in packet filter(s) of the QoS rule included in the request.

Cause #46 –Out of LADN service area

This 5GSM cause is used by the network to indicate the UE is out of the LADN service area.

Cause #47 –PTI mismatch

This 5GSM cause is used by the network or UE to indicate that the PTI provided to it does not match any PTI in use.

Cause #50 – PDU session type IPv4 only allowed

This 5GSM cause is used by the network to indicate that only PDU session type IPv4 is allowed for the requested IP connectivity.

Cause #51 – PDU session type IPv6 only allowed

This 5GSM cause is used by the network to indicate that only PDU session type IPv6 is allowed for the requested IP connectivity.

Cause #54 –PDU session does not exist

This 5GSM cause is used by the network to indicate that the network does not have any information about the PDU session which is requested by the UE to transfer between 3GPP access and non-3GPP access or from the EPS to the 5GS.

Cause #67 – Insufficient resources for specific slice and DNN

This 5GSM cause is by the network to indicate that the requested service cannot be provided due to insufficient resources for specific slice and DNN.

Cause #68 – Not supported SSC mode

This 5GSM cause is used by the network to indicate that the requested SSC mode is not supported.

Cause #69 –Insufficient resources for specific slice

This 5GSM cause is used by the network to indicate that the requested service cannot be provided due to insufficient resources for specific slice.

Cause #70 – Missing or unknown DNN in a slice

This 5GSM cause is used by the network to indicate that the requested service was rejected by the external DN because the DNN was not included although required or if the DNN could not be resolved, in the slice.

Cause #81 – Invalid PTI value



This 5GSM cause is used by the network or UE to indicate that the PTI provided to it is unassigned or reserved.

Cause #82 – Maximum data rate per UE for user-plane integrity protection is too low

This 5GSM cause is used by the network to indicate that the requested service cannot be provided due to the maximum data rate per UE for user-plane integrity protection is too low.

Cause #83 – Semantic error in the QoS operation

This 5GSM cause is used by the network or the UE to indicate that the requested service was rejected due to a semantic error in the QoS operation included in the request.

Cause #84 – Syntactical error in the QoS operation

This 5GSM cause is used by the network or the UE to indicate that the requested service was rejected due to a syntactical error in the QoS operation included in the request.

Cause #85 – Invalid mapped EPS bearer identity

This 5GSM cause is used by the network or the UE to indicate that the mapped EPS bearer identity value provided to it is not a valid value or the mapped EPS bearer identified by the mapped EPS bearer identity does not exist.

## B.2 Protocol errors (e.g., unknown message)

Cause #95 – Semantically incorrect message

This 5GSM cause is used to report receipt of a message with semantically incorrect contents.

Cause #96 – Invalid mandatory information

This 5GSM cause indicates that the equipment sending this 5GSM cause has received a message with a non-semantical mandatory IE error.

Cause #97 – Message type non-existent or not implemented

This 5GSM cause indicates that the equipment sending this 5GSM cause has received a message with a message type it does not recognize either because this is a message not defined, or defined but not implemented by the equipment sending this 5GSM cause.

Cause #98 – Message type not compatible with protocol state

This 5GSM cause indicates that the equipment sending this 5GSM cause has received a message not compatible with the protocol state.

Cause #99 – Information element non-existent or not implemented

This 5GSM cause indicates that the equipment sending this 5GSM cause has received a message which includes information elements not recognized because the information element identifier is not defined or it is defined but not implemented by the equipment sending the 5GSM cause. However, the information element is not required to be present in the message in order for the equipment sending the 5GSM cause to process the message.

Cause #100 – Conditional IE error

This 5GSM cause indicates that the equipment sending this cause has received a message with conditional IE errors.

Cause #101 – Message not compatible with protocol state

This 5GSM cause indicates that a message has been received which is incompatible with the protocol state.

Cause #111 – Protocol error, unspecified

This 5GSM cause is used to report a protocol error event only when no other 5GSM cause in the protocol error class applies.

## Annex C (normative): Storage of 5GMM information

The following 5GMM parameters shall be stored on the USIM if the corresponding file is present:

- a) 5G-GUTI;
- b) last visited registered TAI;
- c) 5GS update status; and
- d) 5G NAS security context parameters from a full native 5G NAS security context (see 3GPP TS 33.501 [24]).

The presence and format of corresponding files on the USIM is specified in 3GPP TS 31.102 [22].

If the corresponding file is not present on the USIM, these 5GMM parameters are stored in a non-volatile memory in the ME together with the SUPI from the USIM. These 5GMM parameters can only be used if the SUPI from the USIM matches the SUPI stored in the non-volatile memory; else the UE shall delete the 5GMM parameters.

The following 5GMM parameters shall be stored in a non-volatile memory in the ME together with the SUPI from the USIM:

- configured NSSAI(s);
- NSSAI inclusion mode(s);
- MPS indicator;
- MCS indicator; and
- operator-defined access category definitions.

Each configured NSSAI consists of S-NSSAIs stored together with a PLMN identity, if it is associated with a PLMN. The UE shall store the S-NSSAI(s) of the HPLMN. If the UE is in the VPLMN, the UE shall also store the configured NSSAI for the serving PLMN and any necessary mapping of the configured NSSAI for the serving PLMN to the S-NSSAI(s) of the HPLMN. The configured NSSAI(s) can only be used if the SUPI from the USIM matches the SUPI stored in the non-volatile memory of the ME; else the UE shall delete the configured NSSAI(s).

Each NSSAI inclusion mode is associated with a PLMN identity and access type. The NSSAI inclusion mode(s) can only be used if the SUPI from the USIM matches the SUPI stored in the non-volatile memory of the ME; else the UE shall delete the NSSAI inclusion mode(s).

The MPS indicator is stored together with a PLMN identity of the PLMN that provided it, and is valid in that RPLMN or equivalent PLMN. The MPS indicator can only be used if the SUPI from the USIM matches the SUPI stored in the non-volatile memory of the ME, else the UE shall delete the MPS indicator.

The MCS indicator is stored together with a PLMN identity of the PLMN that provided it, and is valid in that RPLMN or equivalent PLMN. The MCS indicator can only be used if the SUPI from the USIM matches the SUPI stored in the non-volatile memory of the ME, else the UE shall delete the MCS indicator.

Operator-defined access category definitions are stored together with a PLMN identity of the PLMN that provided them, and is valid in that PLMN or equivalent PLMN. The operator-defined access category definitions can only be used if the SUPI from the USIM matches the SUPI stored in the non-volatile memory of the ME, else the UE shall delete the operator-defined access category definitions. The maximum number of stored operator-defined access category definitions is UE implementation dependent.

If the UE is registered for emergency services, the UE shall not store the 5GMM parameters described in this annex on the USIM or in non-volatile memory. Instead the UE shall temporarily store these parameters locally in the ME and the UE shall delete these parameters when the UE is deregistered.

If the UE is configured for eCall only mode as specified in 3GPP TS 31.102 [22], the UE shall not store the 5GMM parameters described in this annex on the USIM or in non-volatile memory. Instead the UE shall temporarily store these parameters locally in the ME and the UE shall delete these parameters when the UE enters 5GMM-DEREGISTERED.eCALL-INACTIVE state, the UE is switched-off or the USIM is removed.

## Annex D (normative): UE policy delivery service

### D.1 General

#### D.1.1 Overview

The PCF may provide the UE with one or more UE policies using the network-requested UE policy management procedure. The UE provides the PCF with a list of one or more stored UE policy section identifiers (UPSIs), and the PCF provides each UE policy using one or more UE policy sections, each identified by aUPSI. The UPSI is composed of two parts:

- a) a PLMN ID part containing the PLMN ID for the PLMN of the PCF which provides the UE policies; and
- b) a UE policy section code (UPSC) containing a value assigned by the PCF.

The UE processes the UE policy sections, each identified by the UPSI, received from the PCF and informs the PCF of the result.

The UE provides the PCF with the UE policy related capabilities such as the UE's support for ANDSP and the UE's OS Id.

#### D.1.2 Principles of PTI handling for UE policy delivery service procedures

When the PCF or the UE initiates a procedure, it shall include a valid PTI value in the message header of the command message or the request message.

When the PCF initiates a transaction related procedure (i.e. a procedure consisting of more than one message and the messages are related), it shall include a valid PTI value in the message header of the command message.

If a response message is sent as result of a received command message, the UE shall include in the response message the PTI value received within the command message (see examples in figure D.1.2.1).

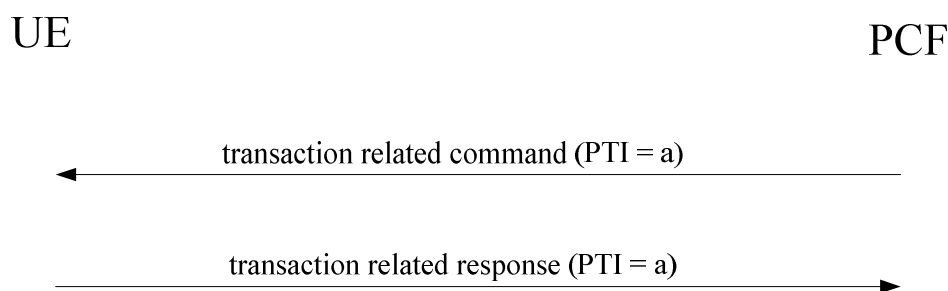

**Figure D.1.2.1: Network-requested transaction related procedure**

**NOTE:** In earlier versions of this protocol, the UE can include in the response message a PTI value which is not the same as the one received within the command message, and therefore the PCF could not associate the response message from the UE to the command message sent.

## D.2 Procedures

### D.2.1 Network-requested UE policy management procedure

#### D.2.1.1 General

The purpose of the network-requested UE policy management procedure is to enable the network to:

- add one or more new UE policy sections to the UE;
- modify one or more UE policy sections stored at the UE; or
- delete one or more UE policy sections stored at the UE.

#### D.2.1.2 Network-requested UE policy management procedure initiation

In order to initiate the network-requested UE policy management procedure, the PCF shall:

- allocate a PTI value currently not used and set the PTI IE to the allocated PTI value;
- encode the information about the UE policy sections to be added, modified or deleted in a UE policy section management list IE as specified in subclause D.6.2 and include it in a MANAGE UE POLICY COMMAND message;
- send the MANAGE UE POLICY COMMAND message to the UE via the AMF as specified in 3GPP TS 23.502 [9]; and
- start timer T3501 (see example in figure D.2.1.2.1).

NOTE: The PCF starts a different timer T3501 for each allocated PTI value.

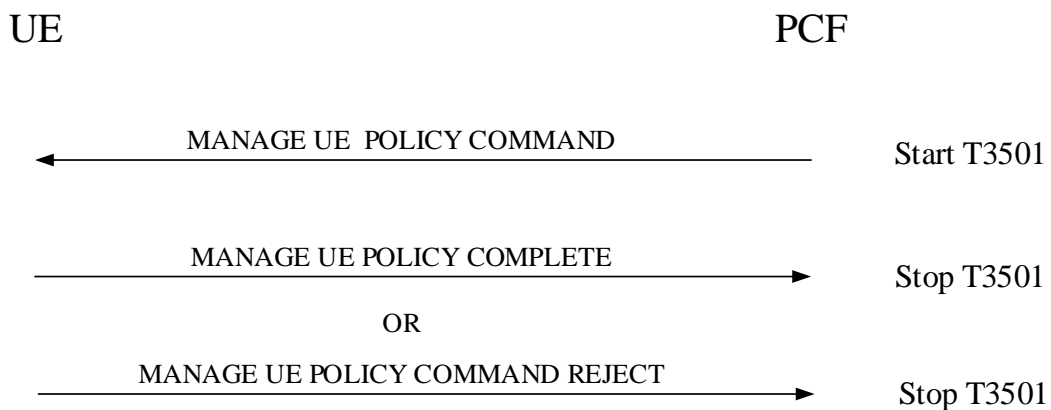

**Figure D.2.1.2.1: Network-requested UE policy management procedure**

Upon receipt of the MANAGE UE POLICY COMMAND message with a PTI value currently not used, for each instruction included in the UE policy section management list IE, the UE shall:

- store the received UE policy section of the instruction, if the UE has no stored UE policy section associated with the same UPSI as the UPSI associated with the instruction;
- replace the stored UE policy section with the received UE policy section of the instruction, if the UE has a stored UE policy section associated with the same UPSI as the UPSI associated with the instruction; or

- c) delete the stored UE policy section, if the UE has a stored UE policy section associated with the same UPSI as the UPSI associated with the instruction and the UE policy section contents of the instruction is empty.

The UE may continue storing a received UE policy section for a PLMN when the UE registers in another PLMN. If necessary, the UE may delete UE policy sections stored for a PLMN other than the RPLMN and the HPLMN, before storing the new received UE policy sections.

NOTE: The maximum number of UE policy sections for PLMNs other than the HPLMN and the RPLMN that the UE can store and how the UE selects the UE policy sections to be deleted are up to the UE implementation.

#### D.2.1.3 Network-requested UE policy management procedure accepted by the UE

If all instructions included in the UE policy section management list IE were executed successfully by the UE, the UE shall:

- a) create a MANAGE UE POLICY COMPLETE message including the PTI value received within the MANAGE UE POLICY COMMAND message; and
- b) transport the MANAGE UE POLICY COMPLETE message using the NAS transport procedure as specified in subclause 5.4.5.

Upon receipt of the MANAGE UE POLICY COMPLETE message, the PCF shall stop timer T3501. The PCF should ensure that the PTI value assigned to this procedure is not released immediately.

NOTE: The way to achieve this is implementation dependent. For example, the PCF can ensure that the PTI value assigned to this procedure is not released during the time equal to or greater than the default value of timer T3501.

#### D.2.1.4 Network-requested UE policy management procedure not accepted by the UE

If the UE could not execute all instructions included in the UE policy section management list IE successfully, the UE shall:

- a) set the PTI IE to the PTI value received within the MANAGE UE POLICY COMMAND message and encode the UPSI associated with the instructions which could not be executed successfully and the associated UE policy delivery service cause indicating the cause of the failure in a UE policy section management result IE as specified in subclause D.5.3 and include it in a MANAGE UE POLICY COMMAND REJECT message, and
- b) transport the MANAGE UE POLICY COMMAND REJECT message using the NAS transport procedure as specified in subclause 5.4.5.

Upon receipt of the MANAGE UE POLICY COMMAND REJECT message, the PCF shall stop timer T3501. Any instruction that was included in the UE policy section management list IE and whose associated UPSI is not included in a UE policy section management result IE of the received MANAGE UE POLICY COMMAND REJECT message is considered as successfully executed.

The PCF should ensure that the PTI value assigned to this procedure is not released immediately.

NOTE: The way to achieve this is implementation dependent. For example, the PCF can ensure that the PTI value assigned to this procedure is not released during the time equal to or greater than the default value of timer T3501.

Upon receipt of the notification from the AMF that the UE is not reachable, the PCF shall stop the T3501.

#### D.2.1.5 Abnormal cases on the network side

The following abnormal cases can be identified:

- a) T3501 expired.

The PCF shall, on the first expiry of the timer T3501, retransmit the MANAGE UE POLICY COMMAND message and shall reset and start timer T3501. This retransmission is repeated four times, i.e. on the fifth expiry of timer T3501, the PCF shall abort the procedure and release the allocated PTI.

### D.2.1.6 Abnormal cases in the UE

The following abnormal cases can be identified:

- a) Receipt of an instruction associated with a UPSI which has a PLMN ID part that is not equal to the PLMN ID of the UE's HPLMN and the instruction contains a UE policy part with a UE policy part type set to "URSP".

The UE shall set the UE policy delivery service cause to #111 (Protocol error, unspecified) for the instruction in the UE policy section management result IE of the MANAGE UE POLICY COMMAND REJECT message.

- b) Receipt of an instruction associated with a UPSI which has a PLMN ID part that is not equal to the PLMN ID of the UE's HPLMN or the UE's RPLMN and the instruction contains a UE policy part with a UE policy part type set to "ANDSP".

The UE shall set the UE policy delivery service cause to #111 (Protocol error, unspecified) for the instruction in the UE policy section management result IE of the MANAGE UE POLICY COMMAND REJECT message.

- c) Transmission failure of the MANAGE UE POLICY COMPLETE message indication from lower layers.

The UE shall not diagnose an error and consider the network-initiated UE policy delivery procedure complete.

NOTE 1: Considering the network-initiated UE policy delivery procedure complete as a result of this abnormal case does not cause the UE to revert the execution of the instructions included in the MANAGE UE POLICY COMMAND message.

- d) Transmission failure of the MANAGE UE POLICY COMMAND REJECT message indication from lower layers.

The UE shall not diagnose an error and consider the network-initiated UE policy delivery procedure complete.

NOTE 2: Considering the network-initiated UE policy delivery procedure complete as a result of this abnormal case does not cause the UE to revert the execution of the instructions included in the MANAGE UE POLICY COMMAND message and successfully processed by the UE.

- e) Receipt of a MANAGE UE POLICY COMMAND message with a PTI set to the same value as the PTI of a previously received MANAGE UE POLICY COMMAND message.

The UE shall discard the message and retransmit the MANAGE UE POLICY COMMAND COMPLETE or MANAGE UE POLICY COMMAND REJECT message transmitted in response to the previously received MANAGE UE POLICY COMMAND message.

NOTE 3: The way to achieve this is UE implementation dependent. For example, the UE can assume that on the fifth expiry of timer T3501, the PCF will abort the procedure and that the PTI value assigned to the procedure will be released.

## D.2.2 UE-initiated UE state indication procedure

### D.2.2.1 General

The purpose of the UE-initiated UE state indication procedure is:

- a) to deliver the UPSI(s) of the UE policy section(s) which are:
- identified by a UPSI with the PLMN ID part indicating the HPLMN or the selected PLMN; and
  - stored in the UE;

to the PCF if the UE has one or more stored UE policy sections identified by a UPSI with the PLMN ID part indicating the HPLMN or the selected PLMN; and

- b) to indicate whether UE supports ANDSP; and
- c) to deliver the UE's one or more OS Ids.

### D.2.2.2 UE-initiated UE state indication procedure initiation

In order to initiate the UE-initiated UE state indication procedure, the UE shall create a UE STATE INDICATION message. The UE:

- a) shall allocate a PTI value currently not used and set the PTI IE to the allocated PTI value;
- b) shall include the UPSI(s) of the UE policy section(s) which are identified by a UPSI with the PLMN ID part indicating the HPLMN or the selected PLMN available in the UE in the UPSI list IE;
- c) shall specify whether the UE supports ANDSP in the UE policy classmark IE; and
- d) may include the UE's one or more OS Ids in the UE OS Id IE.

The UE shall send the UE STATE INDICATION message (see example in figure D.2.2.2.1). The UE shall transport the created UE STATE INDICATION message using the registration procedure (see subclause 5.5.1).

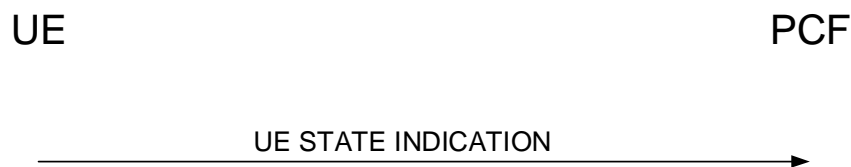

**Figure D.2.2.2.1: UE-initiated UE state indication procedure**

### D.2.2.3 UE-initiated UE state indication procedure accepted by the network

Upon receipt of the UE STATE INDICATION message, the PCF shall operate as described in 3GPP TS 23.502 [9] and 3GPP TS 29.525 [21].

### D.2.2.4 Abnormal cases on the network side

Apart from the case described in subclause D.2.2.3, no abnormal cases have been identified.

## D.3 UE policy re-assembly at the UE

When the UE needs to apply ANSDP as specified in 3GPP TS 24.502 [18], the UE shall consider all UE policy parts with ANSDP contents currently stored at the UE.

When the UE needs to apply URSP as specified in 3GPP TS 24.526 [19], the UE shall consider all UE policy parts with URSP contents currently stored at the UE.

## D.4 Void

## D.5 Message functional definition and contents

### D.5.1 Manage UE policy command

#### D.5.1.1 Message definition

The MANAGE UE POLICY COMMAND message is sent by the PCF to the UE to request the UE to manage UE policy sections, see table D.5.1.1.1

Message type: MANAGE UE POLICY COMMAND

Significance: dual

Direction: network to UE

**Table D.5.1.1.1: MANAGE UE POLICY COMMAND message content**

IEI	Information Element	Type/Reference	Presence	Format	Length
	PTI	Procedure transaction identity 9.6	M	V	1
	MANAGE UE POLICY COMMAND message identity	UE policy delivery service message type D.6.1	M	V	1
	UE policy section management list	UE policy section management list D.6.2	M	LV-E	11-65533
NOTE: The total length of the MANAGE UE POLICY COMMAND message cannot exceed 65535 octets (see Payload container contents maximum length as specified in subclause 9.11.3.39.1).					

## D.5.2 Manage UE policy complete

### D.5.2.1 Message definition

The MANAGE UE POLICY COMPLETE message is sent by the UE to the PCF to report that all received instructions have been successfully executed at the UE, see table D.5.2.1.1

Message type: MANAGE UE POLICY COMPLETE

Significance: dual

Direction: UE to network

**Table D.5.2.1.1: MANAGE UE POLICY COMPLETE message content**

IEI	Information Element	Type/Reference	Presence	Format	Length
	PTI	Procedure transaction identity 9.6	M	V	1
	MANAGE UE POLICY COMPLETE message identity	UE policy delivery service message type D.6.1	M	V	1

## D.5.3 Manage UE policy command reject

### D.5.3.1 Message definition

The MANAGE UE POLICY COMMAND REJECT message is sent by the UE to the PCF to report that one or more instructions could not be successfully executed at the UE, see table D.5.3.1.1

Message type: MANAGE UE POLICY COMMAND REJECT

Significance: dual

Direction: UE to network



**Table D.5.3.1.1: MANAGE UE POLICY COMMAND REJECT message content**

IEI	Information Element	Type/Reference	Presence	Format	Length
	PTI	Procedure transaction identity 9.6	M	V	1
	MANAGE UE POLICY COMMAND REJECT message identity	UE policy delivery service message type D.6.1.	M	V	1
	UE policy section management result	UE policy section management result D.6.3	M	LV-E	11-65533
NOTE: The total length of the MANAGE UE POLICY COMMAND REJECT message cannot exceed 65535 octets (see Payload container contents maximum length as specified in subclause 9.11.3.39.1).					

## D.5.4 UE state indication

### D.5.4.1 Message definition

The UE STATE INDICATION message is sent by the UE to the PCF:

- a) to deliver the UPSI(s) of the UE policy section(s) stored in the UE;
- b) to indicate whether the UE supports ANDSP; and
- c) to deliver the the UE's one or more OS Ids;

see table D.5.4.1.1.

Message type: UE STATE INDICATION

Significance: dual

Direction: UE to network

**Table D.5.4.1.1: UE STATE INDICATION message content**

IEI	Information Element	Type/Reference	Presence	Format	Length
	PTI	Procedure transaction identity 9.6	M	V	1
	UE STATE INDICATION message identity	UE policy delivery service message type D.6.1	M	V	1
	UPSI list	UPSI list D.6.4	M	LV-E	9-65531
	UE policy classmark	UE policy classmark D.6.5	M	LV	2-4
41	UE OS Id	OS Id D.6.6	O	TLV	18-242
NOTE: The total length of the UE STATE INDICATION message content cannot exceed 65535 octets (see Payload container contents maximum length as specified in subclause 9.11.3.39.1).					

## D.6 Information elements coding

### D.6.1 UE policy delivery service message type

**Table D.6.1.1: UE policy delivery service message type**

Bits								
8	7	6	5	4	3	2	1	
0	0	0	0	0	0	0	0	Reserved
0	0	0	0	0	0	0	1	MANAGE UE POLICY COMMAND message
0	0	0	0	0	0	1	0	MANAGE UE POLICY COMPLETE message
0	0	0	0	0	0	1	1	MANAGE UE POLICY COMMAND REJECT message
0	0	0	0	0	1	0	0	UE STATE INDICATION message
All other values are reserved								

### D.6.2 UE policy section management list

The purpose of the UE policy section management list information element is to transfer from the PCF to the UE a list of instructions to be performed at the UE for management of UE policy section stored at the UE.

The UE policy section management list information element is coded as shown in figure D.6.2.1, figure D.6.2.2, figure D.6.2.3, figure D.6.2.4, figure D.6.2.5, figure D.6.2.6, figure D.6.2.7 and table D.6.2.1.

The UE policy section management list information element has a minimum length of 12 octets and a maximum length of 65534 octets.

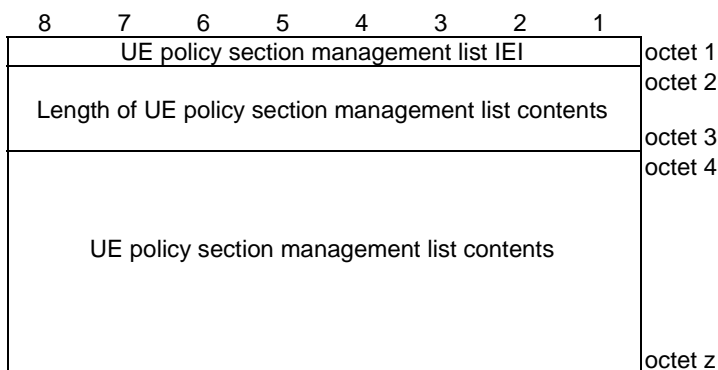

**Figure D.6.2.1: UE policy section management list information element**

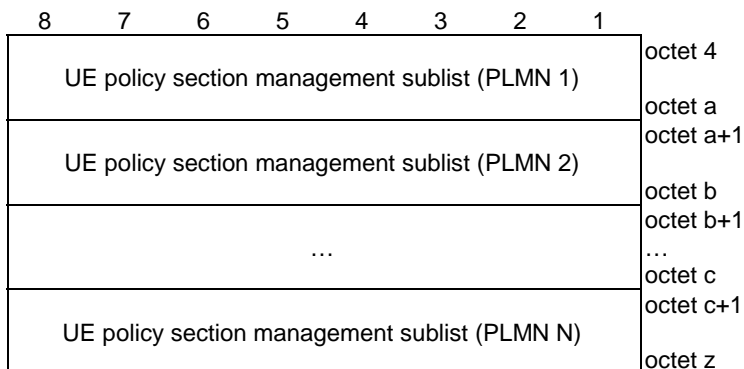

**Figure D.6.2.2: UE policy section management list contents**

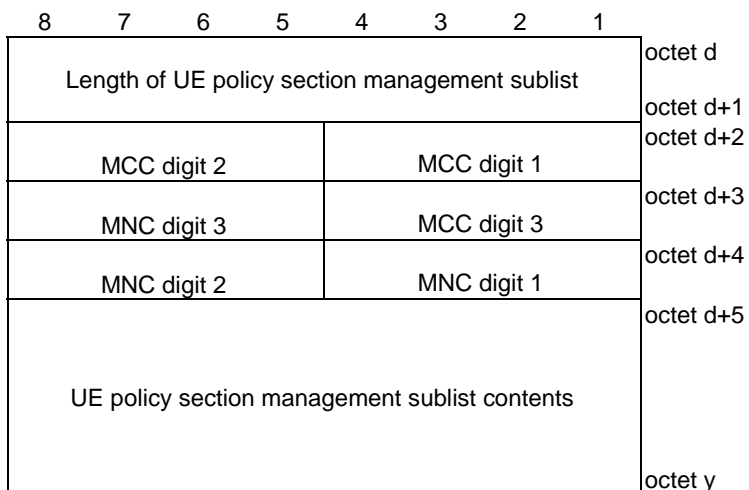

**Figure D.6.2.3: UE policy section management sublist**

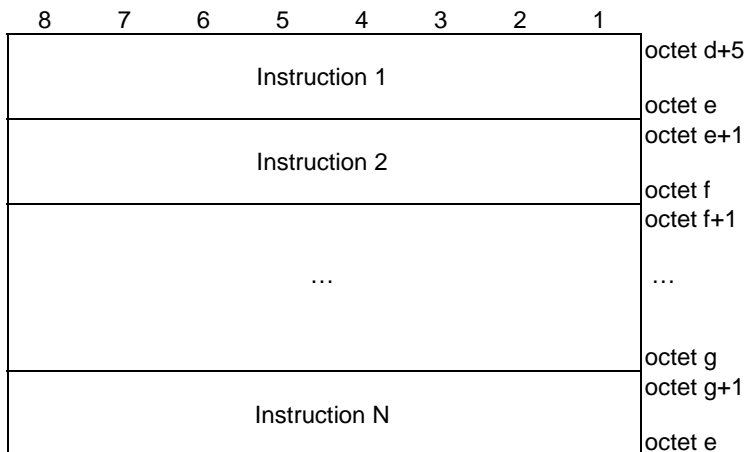

**Figure D.6.2.4: UE policy section management sublist contents**

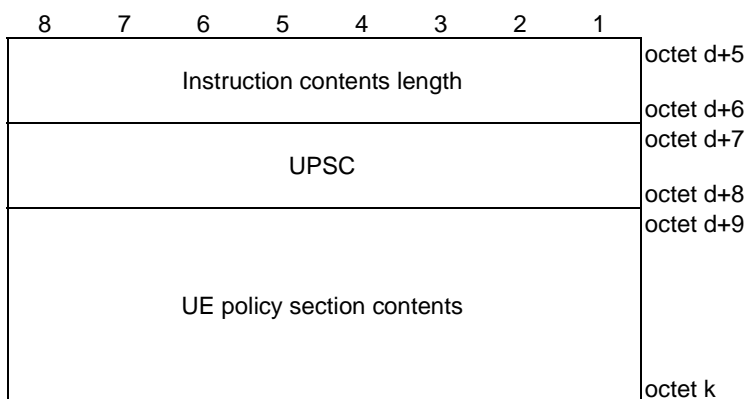

**Figure D.6.2.5: Instruction**

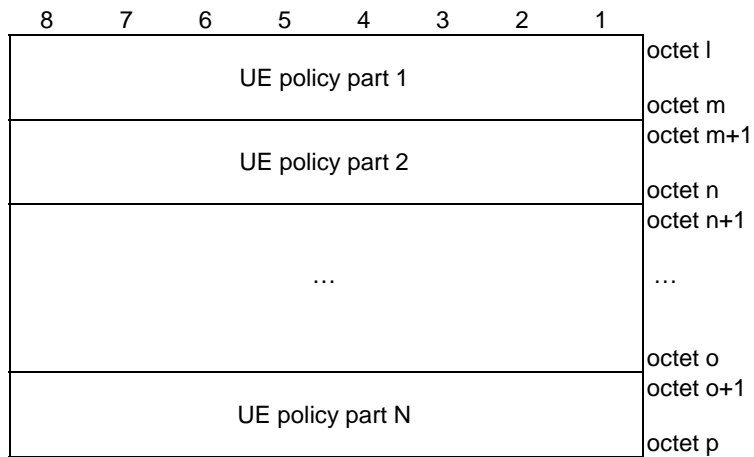

**Figure D.6.2.6: UE policy section contents**

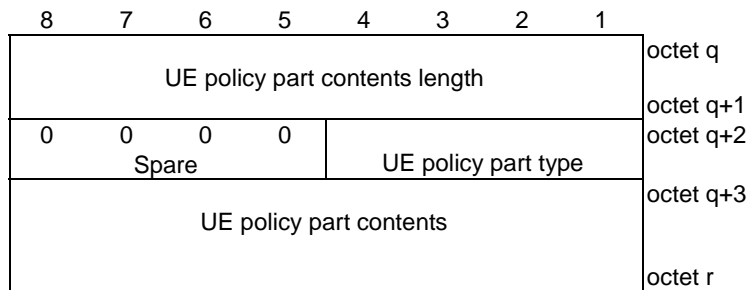

**Figure D.6.2.7: UE policy part**

**Table D.6.2.1: UE policy section management list information element**

Value part of the UE policy section management list information element (octets 4 to z)
The value part of the UE policy section management list information element consists of one or several UE policy section management sublists.
UE policy section management sublist:
Length of UE policy section management sublist (octets d to d+1)
This field contains the binary encoding of the length of the UE policy section management sublist in units of octets.
MCC, Mobile country code (octet d+2, and bits 4 to 1 of octet d+3)
The MCC field is coded as in ITU-T Recommendation E.212 [42], annex A.
MNC, Mobile network code (bits 8 to 5 of octet d+3, and octet d+4)
The coding of this field is the responsibility of each administration but BCD coding shall be used. The MNC shall consist of 2 or 3 digits. If a network operator decides to use only two digits in the MNC, MNC digit 3 shall be coded as "1111".
UE policy section management sublist contents (octets d+5 to y)
The UE policy section management sublist contents consist of one or several instructions.
Instruction:
Instruction contents length (octets d+5 to d+6)
This field contains the binary encoding of the instruction contents length in units of octets.
UPSC (octets d+7 to d+8)
This field contains the binary encoding of the UPSC. The value of the UPSC is set by the PCF.
UE policy section contents (octets d+9 to k)
The UE policy section contents consist of one or several UE policy parts.
UE policy part:
UE policy part contents length (octets q to q+1)
This field contains the binary encoding of the UE policy part contents length in units of octets.
UE policy part type (bits 4 to 1 of octet q+2)
Bits
<b>4 3 2 1</b>
0 0 0 0 Reserved
0 0 0 1 URSP
0 0 1 0 ANDSP
All other values are reserved.
Bits 8 to 5 of octet q+2 are spare and shall be coded as zero.
UE policy part contents
This field contains a UE policy part encoded as specified in 3GPP TS 24.526 [19].

### D.6.3 UE policy section management result

The purpose of the UE policy section management result information element is to transfer from the UE to the PCF information about instructions for UE policy section management which the UE could not execute successfully.

The UE policy section management result information element is coded as shown in figure D.6.3.1, figure D.6.3.2, figure D.6.3.3, figure D.6.3.4, figure D.6.3.5 and table D.6.3.1.

The UE policy section management result information element has a minimum length of 12 octets and a maximum length of 65534 octets.

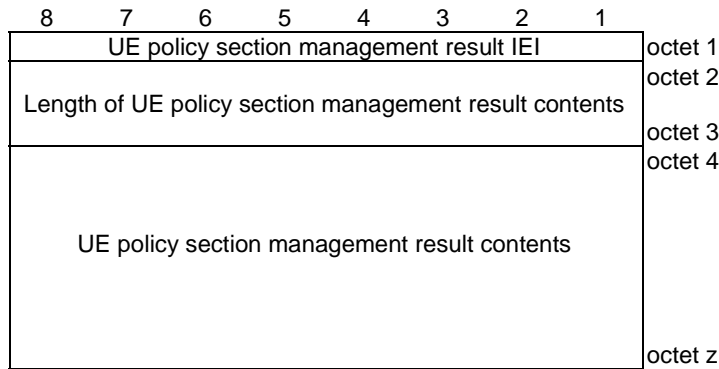

**Figure D.6.3.1: UE policy section management result information element**

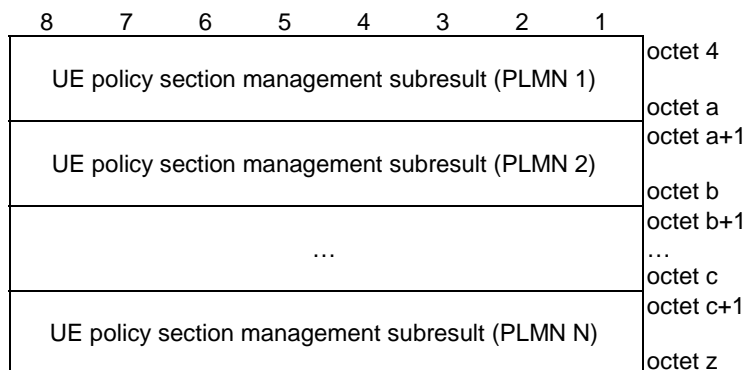

**Figure D.6.3.2: UE policy section management result contents**

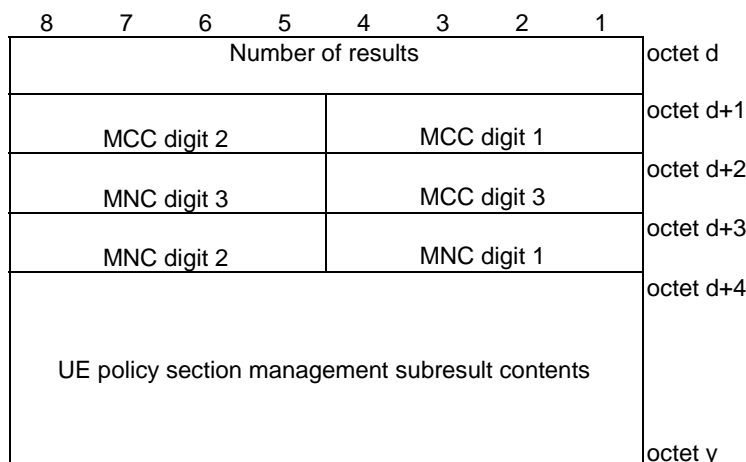

**Figure D.6.3.3: UE policy section management subresult**

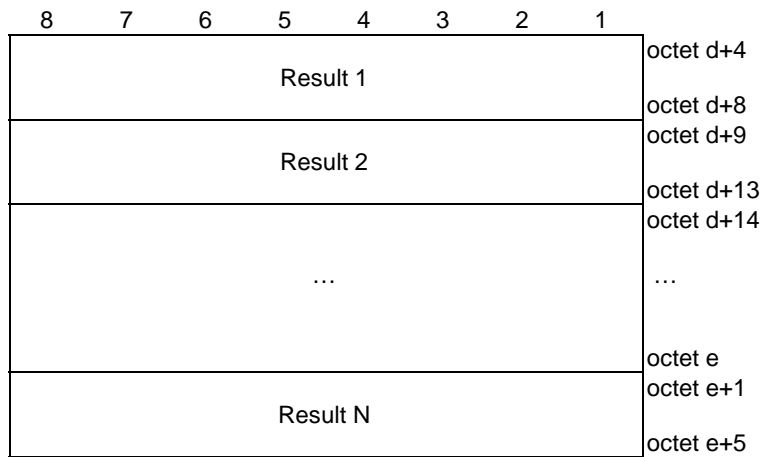

**Figure D.6.3.4: UE policy section management subresult contents**

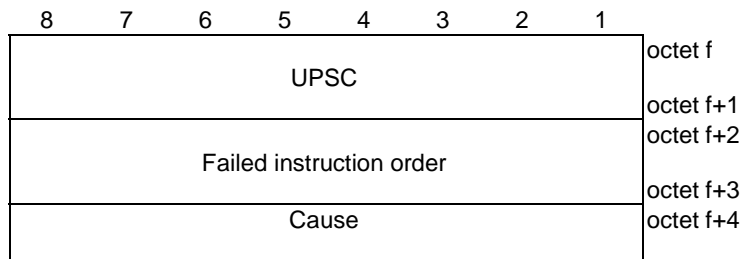

**Figure D.6.3.5: Result**

**Table D.6.3.1: UE policy section management result information element**

Value part of the UE policy section management result information element (octets 4 to z)
The value part of the UE policy section management result information element consists of one or several UE policy section management subresults.
UE policy section management subresult:
Number of results (octet d)
This field contains the binary encoding of number of results included in the UE policy section management subresult.
MCC, Mobile country code (octet d+1, and bits 4 to 1 of octet d+2)
The MCC field is coded as in ITU-T Recommendation E.212 [42], annex A.
MNC, Mobile network code (bits 8 to 5 of octet d+2, and octet d+3)
The coding of this field is the responsibility of each administration but BCD coding shall be used. The MNC shall consist of 2 or 3 digits. If a network operator decides to use only two digits in the MNC, MNC digit 3 shall be coded as "1111".
UE policy section management subresult contents (octets d+4 to y)
The UE policy section management subresult contents consist of one or several results.
Result (octet f to f+4)
UPSC (octet f to f+1)
This field contains the binary encoding of the UPSC. The value of the UPSC is set by the PCF
Failed instruction order (octets f+2 to f+3)
This field contains the binary encoding of the order of the failed instruction in the UE policy section management sublist.
Cause (octet f+4)
Bits
<b>8 7 6 5 4 3 2 1</b>
0 1 1 0 1 1 1 1                      Protocol error, unspecified
The receiving entity shall treat any other value as 0110 1111, "protocol error, unspecified".

## D.6.4 UPSI list

The purpose of the UPSI list information element is to transfer from the UE to the PCF a list of UPSIs.

The UPSI list information element is coded as shown in figure D.6.4.1, figure D.6.4.2, and table D.6.4.1.

The UPSI list information element has a minimum length of 10 octets and a maximum length of 65532 octets.



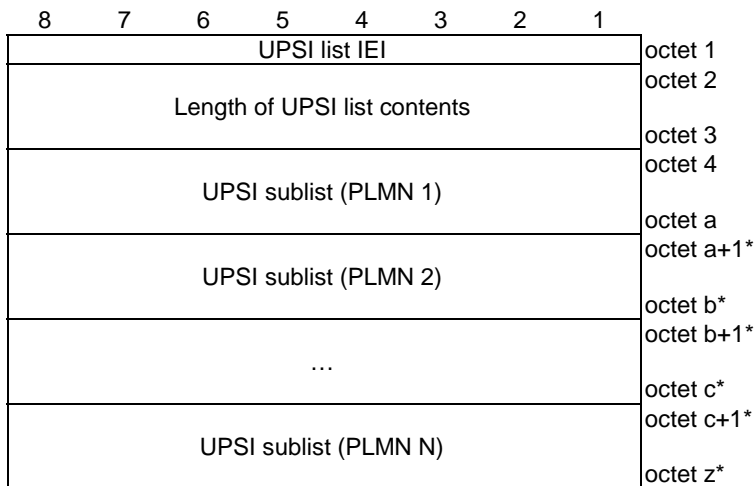

**Figure D.6.4.1: UPSI list information element**

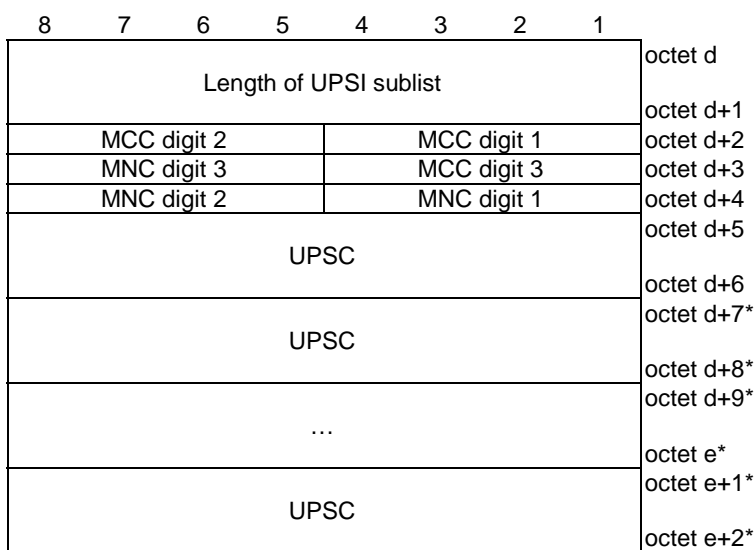

**Figure D.6.4.2: UPSI sublist**

**Table D.6.4.1: UPSI list information element**

<p>MCC, Mobile country code (octet d+2, and bits 4 to 1 of octet d+3)</p> <p>The MCC field is coded as in ITU-T Recommendation E.212 [42], annex A.</p> <p>MNC, Mobile network code (bits 8 to 5 of octet d+3, and octet d+4)</p> <p>The coding of this field is the responsibility of each administration but BCD coding shall be used. The MNC shall consist of 2 or 3 digits. If a network operator decides to use only two digits in the MNC, MNC digit 3 shall be coded as "1111".</p> <p>UPSC (octets d+5 to d+6)</p> <p>This field contains the binary encoding of the UPSC. The value of the UPSC is set by the PCF.</p>
--

### D.6.5 UE policy classmark

The purpose of the UE policy classmark information element is to provide the network with information about the policy aspects of the UE.

The UE policy classmark information element is coded as shown in figure D.6.5.1 and table D.6.5.1.

The UE policy classmark is a type 4 information element with a minimum length of 3 octets and a maximum length of 5 octets.

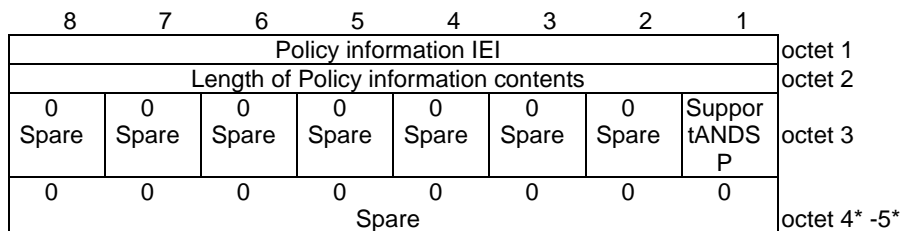

**Figure D.6.5.1: UE policy classmark information element**

**Table D.6.5.1: UE policy classmark information element**

Support of ANDSP by the UE (SupportANDSP) (octet 3, bit 1) Bit <b>1</b> 0 ANDSP not supported by the UE 1 ANDSP supported by the UE  All other bits in octet 3 to 5 are spare and shall be coded as zero, if the respective octet is included in the information element.
---

### D.6.6 UE OS Id

The purpose of the UE OS Id information element is to provide the network with information about the OS of the UE.

The UE OS Id information element is coded as shown in figure D.6.6.1 and table D.6.6.1.

The UE OS Id is a type 4 information element with a minimum length of 18 octet and a maximum length of 242 octets.

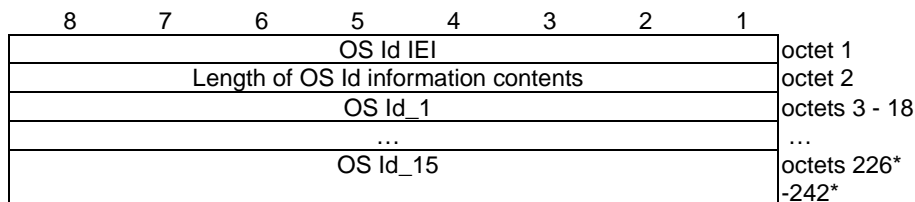

**Figure D.6.6.1: UE OS Id information element**

**Table D.6.6.1: UE OS Id information element**

OS Id: The OS Id is coded as a sequence of a sixteen octet OS Id value field. The OS Id value field is defined as Universally Unique Identifier (UUID) as specified in IETF RFC 4122 [35A].
--

### D.7 Timers of UE policy delivery service

Timers of UE policy delivery service are shown in table D.7.1.

**Table D.7.1: Timers of UE policy delivery service – PCF side**

<b>TIMER NUM.</b>	<b>TIMER VALUE</b>	<b>CAUSE OF START</b>	<b>NORMAL STOP</b>	<b>ON THE 1<sup>st</sup>, 2<sup>nd</sup>, 3<sup>rd</sup>, 4<sup>th</sup> EXPIRY</b>
T3501	NOTE 1	Transmission of MANAGE UE POLICY COMMAND	MANAGE UE POLICY COMMAND COMPLETE or MANAGE UE POLICY COMMAND REJECT message received	Retransmission of MANAGE UE POLICY COMMAND message

NOTE 1: The value of this timer is network dependent.

## Annex E (informative): Change history

Change history							
Date	Meeting	Tdoc	CR	Rev	Cat	Subject/Comment	New version
2017-10	CT1#106	C1-174182				Draft skeleton provided by the rapporteur.	0.0.0
2017-11	CT1#106					Implementing the following p-CRs agreed by CT1: C1-174183, C1-174184, C1-174185.	0.1.0
2017-12	CT1#107					Implementing the following p-CRs agreed by CT1: C1-175098, C1-175313. Corrections done by the rapporteur.	0.2.0
2017-12	CT1 e-mail review					Editorial corrections.	0.2.1
2017-12	CT1 e-mail review					Re-introduction of table in subclause 8.2.23.1	0.2.2
2018-02	CT1#108					Implementing the following p-CRs agreed by CT1: C1-180663, C1-180224, C1-180046, C1-180437, C1-180438, C1-180448, C1-180307, C1-180211, C1-180316, C1-180221, C1-180281, C1-180339, C1-180361, C1-180148, C1-180415, C1-180451, C1-180453, C1-180455, C1-180459, C1-180482, C1-180483, C1-180484, C1-180619, C1-180620, C1-180623, C1-180624, C1-180627, C1-180628, C1-180664, C1-180665, C1-180668, C1-180672, C1-180673, C1-180679, C1-180680, C1-180684, C1-180707, C1-180721, C1-180725, C1-180736, C1-180737, C1-180738, C1-180739, C1-180740, C1-180741, C1-180750, C1-180751, C1-180013, C1-180311, C1-180312, C1-180197, C1-180313, C1-180283, C1-180037, C1-180041, C1-180464, C1-180465, C1-180466, C1-180469, C1-180645, C1-180646, C1-180648, C1-180688, C1-180689, C1-180690, C1-180473, C1-180720, C1-180226, C1-180632, C1-180633, C1-180635, C1-180640, C1-180669, C1-180731, C1-180732, C1-180734, C1-180735, C1-180746, C1-180209, C1-180040, C1-180015, C1-180035, C1-180198, C1-180421, C1-180487, C1-180488, C1-180490, C1-180621, C1-180622, C1-180701, C1-180162, C1-180190, C1-180604, C1-180605, C1-180606, C1-180611, C1-180614, C1-180616, C1-180704, C1-180719, C1-180722, C1-180747, C1-180755, C1-180756 Corrections done by the rapporteur.	0.3.0
2018-02	CT1 e-mail review					Resolution of collision among C1-180679, C1-180721 and C1-180740. Resolution of collision among C1-180605, C1-180616 and C1-180704. Re-implementation of parts of C1-180035, C1-180488, C1-180605, C1-180606, C1-180729 and C1-180734 as some of the proposed changes were not implemented correctly in the previous version. Implementation of C1-180646 which was missed. Editorial corrections. Corrections done by the rapporteur.	0.3.1

2018-03	CT1#109				Implementing the following p-CRs agreed by CT1: C1-181362, C1-181377, C1-181456, C1-181457, C1-181703, C1-181748, C1-181462, C1-181786, C1-181168, C1-181269, C1-181278, C1-181307, C1-181180, C1-181279, C1-181280, C1-181281, C1-181354, C1-181283, C1-181284, C1-181287, C1-181305, C1-181352, C1-181364, C1-181365, C1-181366, C1-181399, C1-181466, C1-181467, C1-181468, C1-181470, C1-181471, C1-181473, C1-181474, C1-181477, C1-181628, C1-181629, C1-181633, C1-181661, C1-181663, C1-181666, C1-181668, C1-181670, C1-181681, C1-181682, C1-181683, C1-181684, C1-181695, C1-181696, C1-181707, C1-181713, C1-181715, C1-181716, C1-181717, C1-181718, C1-181733, C1-181734, C1-181735, C1-181736, C1-181737, C1-181738, C1-181739, C1-181740, C1-181741, C1-181747, C1-181752, C1-181764, C1-181770, C1-181771, C1-181781, C1-181782, C1-181785, C1-181182, C1-181120, C1-181121, C1-181395, C1-181480, C1-181482, C1-181484, C1-181485, C1-181486, C1-181487, C1-181488, C1-181650, C1-181651, C1-181652, C1-181678, C1-181726, C1-181751, C1-181273, C1-181274, C1-181276, C1-181277, C1-181496, C1-181784, C1-181312, C1-181357, C1-181605, C1-181606, C1-181609, C1-181645, C1-181674, C1-181675, C1-181677, C1-181679, C1-181708, C1-181710, C1-181728, C1-181613, C1-181615, C1-181680, C1-181750, C1-181618, C1-181619, C1-181779, C1-181360, C1-181636, C1-181640, C1-181643, C1-181729, C1-181730, C1-181731, C1-181732 Corrections done by the rapporteur.	0.4.0
2018-03	CT1 e-mail review				Re-implementation of C1-181168 and C1-181307. Re-implementation of C1-181656 and C1-181606 so that C1-181656 is implemented first. Reverting to the old title. Editorial corrections of some of the implemented p-CRs as well as adding some missing parts. Corrections done by the rapporteur.	0.4.1
2018-03	CT#79	CP-180101			Version 1.0.0 created for presentation to TSG CT#79 for information.	1.0.0
2018-05	CT1#110				Implementing the following p-CRs agreed by CT1: C1-182219, C1-182493, C1-182496, C1-182202, C1-182497, C1-182053, C1-182311, C1-182019, C1-182359, C1-182360, C1-182361, C1-182358, C1-182305, C1-182306, C1-182354, C1-182117, C1-182182, C1-182455, C1-182459, C1-182491, C1-182600, C1-182601, C1-182605, C1-182606, C1-182607, C1-182608, C1-182609, C1-182610, C1-182614, C1-182615, C1-182621, C1-182662, C1-182664, C1-182665, C1-182708, C1-182728, C1-182730, C1-182733, C1-182724, C1-182757, C1-182759, C1-182760, C1-182768, C1-182772, C1-182775, C1-182786, C1-182787, C1-182791, C1-182831, C1-182832, C1-182833, C1-182834, C1-182835, C1-183836, C1-182838, C1-182840, C1-182844, C1-182067, C1-182073, C1-182303, C1-182321, C1-182352, C1-182385, C1-182645, C1-182646, C1-182647, C1-182648, C1-182650, C1-182651, C1-182657, C1-182659, C1-182660, C1-182741, C1-182742, C1-182761, C1-182762, C1-182763, C1-182764, C1-182765, C1-182774, C1-182789, C1-182789, C1-182815, C1-182845, C1-182797, C1-182232, C1-182230, C1-182666, C1-182667, C1-182671, C1-182673, C1-182677, C1-182800, C1-182824, C1-182710, C1-182072, C1-182078, C1-182174, C1-182190, C1-182456, C1-182636, C1-182637, C1-182638, C1-182639, C1-182726, C1-182729, C1-182747, C1-182749, C1-182766, C1-182767, C1-182841, C1-182847, C1-182043, C1-182057, C1-182260, C1-182044, C1-182617, C1-182618, C1-182619, C1-182620, C1-182622, C1-182623, C1-182624, C1-182627, C1-182628, C1-182629, C1-182802, C1-182808, C1-182345, C1-182461, C1-182630 Corrections done by the rapporteur.	1.1.0

2018-05	CT1 e-mail review					Re-implementation of C1-182768, C1-182841, C1-182841, C1-182619, C1-182665, C1-182497, C1-182067 and C1-182078 to correct some editorials as well as adding some missing parts. Corrections done by the rapporteur.	1.1.1
2018-06	CT1#111					Implementing the following p-CRs agreed by CT1: C1-183268, C1-183109, C1-183281, C1-183517, C1-183518, C1-183519, C1-183791, C1-183115, C1-183527, C1-183812, C1-183813, C1-183141, C1-183148, C1-183406, C1-183070, C1-183207, C1-183273, C1-183276, C1-183277, C1-183415, C1-183143, C1-183146, C1-183197, C1-183260, C1-183142, C1-183151, C1-183154, C1-183225, C1-183205, C1-183223, C1-183314, C1-183278, C1-183367, C1-183279, C1-183381, C1-183399, C1-183413, C1-183467, C1-183530, C1-183532, C1-183533, C1-183534, C1-183535, C1-183538, C1-183539, C1-183715, C1-183716, C1-183717, C1-183718, C1-183720, C1-183721, C1-183737, C1-183739, C1-183741, C1-183744, C1-183745, C1-183748, C1-183749, C1-183750, C1-183751, C1-183774, C1-183775, C1-183779, C1-183780, C1-183781, C1-183809, C1-183822, C1-183824, C1-183825, C1-183826, C1-183845, C1-183858, C1-183761, C1-183147, C1-183237, C1-183329, C1-183353, C1-183378, C1-183387, C1-183401, C1-183408, C1-183499, C1-183541, C1-183542, C1-183543, C1-183545, C1-183726, C1-183756, C1-183757, C1-183758, C1-183759, C1-183762, C1-183795, C1-183796, C1-183802, C1-183827, C1-183846, C1-183847, C1-183848, C1-183211, C1-183731, C1-183784, C1-183578, C1-183585, C1-183831, C1-183861, C1-183247, C1-183562, C1-183563, C1-183798, C1-183194, C1-183238, C1-183256, C1-183528, C1-183427, C1-183706, C1-183707, C1-183709, C1-183763, C1-183766, C1-183767, C1-183768, C1-183769, C1-183770, C1-183771, C1-183772, C1-183773, C1-183785, C1-183787, C1-183788, C1-183789, C1-183799, C1-183805, C1-183816, C1-183832, C1-183834, C1-183849, C1-183850, C1-183114, C1-183457, C1-183458, C1-183510, C1-183511, C1-183512, C1-183513, C1-183515, C1-183800, C1-183806, C1-183470 Corrections done by the rapporteur.	1.2.0
2018-06	CT1 e-mail review					Re-implementation of C1-183535, C1-183813, C1-183408, C1-183766 and C1-183831. Implementation of C1-183816 which was missed. Editorial corrections of some of the implemented p-CRs. Corrections done by the rapporteur.	1.2.1
2018-06	CT#80	CP-181094				Version 2.0.0 created for presentation to TSG CT#80 for approval.	2.0.0
2018-06	CT#80					Version 15.0.0 created after approval	15.0.0
2018-09	CT#81	CP-182139	0001		F	Replace unknown "registration update accept"	15.1.0
2018-09	CT#81	CP-182142	0003	2	F	Pass (Extended) Emergency Number List to upper layers	15.1.0
2018-09	CT#81	CP-182132	0004		F	Correcting access selection for SMS over NAS	15.1.0
2018-09	CT#81	CP-182138	0006	1	F	Referring to the correct bits for SMS over NAS during the registration procedure	15.1.0
2018-09	CT#81	CP-182140	0007	1	F	Setting and checking 5GS update status	15.1.0
2018-09	CT#81	CP-182132	0008	1	F	Clarifications on MICO indication	15.1.0
2018-09	CT#81	CP-182141	0009	1	F	Timer T3540 clarifications	15.1.0
2018-09	CT#81	CP-182137	0010	3	F	Network Slicing Subscription Change Indication	15.1.0
2018-09	CT#81	CP-182133	0012		F	Correction for PDU session context	15.1.0
2018-09	CT#81	CP-182133	0013	1	F	Correction for establishment of user-plane resources	15.1.0
2018-09	CT#81	CP-182133	0014	1	F	Correction for establishment cause	15.1.0
2018-09	CT#81	CP-182133	0016	4	F	Correction for maximum data rate per UE for integrity protection for DRBs	15.1.0
2018-09	CT#81	CP-182137	0018	3	F	Invalid DNN	15.1.0
2018-09	CT#81	CP-182132	0020	1	F	Correction for 5GMM cause #90 in subclause A.3	15.1.0
2018-09	CT#81	CP-182135	0021		F	Editor's notes in UPDP	15.1.0
2018-09	CT#81	CP-182136	0023	2	F	Exchange of extended protocol configuration options	15.1.0
2018-09	CT#81	CP-182130	0024	1	F	5G QoS - restructuring QoS rules IE	15.1.0

2018-09	CT#81	CP-182133	0025	1	F	Correction for editor's note on further 5GSM causes and further minor issues	15.1.0
2018-09	CT#81	CP-182132	0026		F	Correction and alignment of cause code values	15.1.0
2018-09	CT#81	CP-182141	0027	2	F	UAC information and establishment cause when uplink user data packet is to be sent for a PDU session with suspended user-plane resources	15.1.0
2018-09	CT#81	CP-182134	0028	2	F	Corrections for operator-defined access categories	15.1.0
2018-09	CT#81	CP-182131	0030	1	F	AMF Region ID (8 bits), AMF Set ID (10 bits), and AMF Pointer (6 bits)	15.1.0
2018-09	CT#81	CP-182132	0031	1	F	Correcting message definition of message including EENL	15.1.0
2018-09	CT#81	CP-182141	0032	2	F	SMF knowledge that a UE is configured for high priority access	15.1.0
2018-09	CT#81	CP-182131	0035	2	F	Authentication for normal services not accepted by network	15.1.0
2018-09	CT#81	CP-182130	0036	4	C	Addition of ABBA in 5G based primary authentication procedure	15.1.0
2018-09	CT#81	CP-182131	0037	2	C	Alignment and correction of mapped security context creation at S1 to N1 mode HO	15.1.0
2018-09	CT#81	CP-182130	0038	1	C	Addition of NAS container IE for N1 mode HO	15.1.0
2018-09	CT#81	CP-182132	0039	1	F	Correction and update of S1 mode to N1 mode NAS transparent container	15.1.0
2018-09	CT#81	CP-182139	0040	1	C	Removal of MAC editor's note	15.1.0
2018-09	CT#81	CP-182139	0041	1	F	Removal of transparent container at N1 mode to S1 mode HO	15.1.0
2018-09	CT#81	CP-182133	0042		F	Correction of 5GS TAC LSB	15.1.0
2018-09	CT#81	CP-182136	0043	1	B	Handling of Emergency PDU sessions and null algorithms	15.1.0
2018-09	CT#81	CP-182139	0044	2	B	Request for Kamf re-derivation	15.1.0
2018-09	CT#81	CP-182137	0045	1	F	Mobility Registration when T3346 running	15.1.0
2018-09	CT#81	CP-182135	0046		F	DL NAS Transport message	15.1.0
2018-09	CT#81	CP-182140	0047	1	F	Single-registration mode	15.1.0
2018-09	CT#81	CP-182131	0048		F	Authentication Response	15.1.0
2018-09	CT#81	CP-182138	0049	2	F	Parameters for PDU session establishment due to change of SSC mode 3 or 2 PSA	15.1.0
2018-09	CT#81	CP-182136	0054	2	F	Equivalent PLMNs	15.1.0
2018-09	CT#81	CP-182139	0055	2	F	Remove the remaining instance of SUPI paging	15.1.0
2018-09	CT#81	CP-182138	0056	2	F	PDU session status	15.1.0
2018-09	CT#81	CP-182131	0058	1	F	Clarification on NAS level MM congestion Control	15.1.0
2018-09	CT#81	CP-182141	0060	3	B	SM cause for out of LADN service area	15.1.0
2018-09	CT#81	CP-182139	0064	1	F	Removal of redundant MICO statement	15.1.0
2018-09	CT#81	CP-182137	0065	4	C	LADN indication from UE at registration	15.1.0
2018-09	CT#81	CP-182137	0066		F	Mapping to configured NSSAI for HPLM shall be included if available	15.1.0
2018-09	CT#81	CP-182130	0069	2	F	Abnormal Cases in the UE for mobility and periodic Registration Update Procedures	15.1.0
2018-09	CT#81	CP-182134	0070	1	D	Correction to 5GMM Substate	15.1.0
2018-09	CT#81	CP-182135	0071	1	F	Definition of emergency and non-emergency PDU sessions	15.1.0
2018-09	CT#81	CP-182138	0074	2	F	PDU session establish criteria for emergency PDU sessions	15.1.0
2018-09	CT#81	CP-182140	0075	3	F	Service request allowed for PDU release outside LADN	15.1.0
2018-09	CT#81	CP-182136	0076	2	F	Handling of Transmission failure for Service request message.	15.1.0
2018-09	CT#81	CP-182136	0077	4	B	How to determine the maximum number of established PDU sessions	15.1.0
2018-09	CT#81	CP-182141	0079	2	F	UAC and setting of the Uplink data status IE	15.1.0
2018-09	CT#81	CP-182137	0080	1	C	Non-3GPP access to 5GCN not allowed	15.1.0
2018-09	CT#81	CP-182136	0082	2	B	Including S-NSSAI received in EPS in Requested NSSAI and in PDU session establishment request upon inter-system change from S1 mode to N1 mode	15.1.0
2018-09	CT#81	CP-182141	0083		B	UE configuration for AC 11-15 and MCS (access identity 2)	15.1.0
2018-09	CT#81	CP-182142	0084		B	UE configuration for NAS signalling low priority via OMA-DM or USIM not applicable in 5GS	15.1.0
2018-09	CT#81	CP-182137	0085	2	F	Miscellaneous corrections	15.1.0
2018-09	CT#81	CP-182132	0086	2	F	Clarifications on ATTEMPTING-REGISTRATION-UPDATE	15.1.0
2018-09	CT#81	CP-182141	0087	2	F	UE behaviour in substate ATTEMPTING-REGISTRATION-UPDATE	15.1.0
2018-09	CT#81	CP-182140	0090		F	Service area list IE	15.1.0



2018-09	CT#81	CP-182136	0091	1	F	Handling of forbidden tracking area list	15.1.0
2018-09	CT#81	CP-182134	0092	2	F	Corrections for authentication	15.1.0
2018-09	CT#81	CP-182141	0094	4	F	Trigger for mobility and periodic registration update	15.1.0
2018-09	CT#81	CP-182130	0095		F	Abnormal cases in the UE for network-initiated de-registration procedure	15.1.0
2018-09	CT#81	CP-182130	0096	4	F	Add attempt counter to Service Request procedure	15.1.0
2018-09	CT#81	CP-182131	0097	1	F	Authentication procedure during registration procedure for mobility and periodic registration update	15.1.0
2018-09	CT#81	CP-182138	0098	4	F	Registration procedure for mobility and periodic registration update	15.1.0
2018-09	CT#81	CP-182138	0099	3	F	Release of the N1 NAS signalling connection	15.1.0
2018-09	CT#81	CP-182139	0100	2	F	Resetting of registration attempt counter	15.1.0
2018-09	CT#81	CP-182138	0101	4	F	On #27 N1 mode not allowed	15.1.0
2018-09	CT#81	CP-182130	0102	3	F	Adding EPLMN list related descriptions	15.1.0
2018-09	CT#81	CP-182138	0104	2	F	Provision of IWK N26 indication in registration update procedure	15.1.0
2018-09	CT#81	CP-182134	0105		F	Corrections for interworking with EPS	15.1.0
2018-09	CT#81	CP-182135	0106	4	F	Emergency Services Support indicator for non-3GPP access	15.1.0
2018-09	CT#81	CP-182219	0107	7	C	Network control for always-on PDU sessions	15.1.0
2018-09	CT#81	CP-182135	0108		F	Corrections on inconsistent descriptions for 5GSM and 5GMM	15.1.0
2018-09	CT#81	CP-182135	0110		F	Corrections on the timers of 5GMM	15.1.0
2018-09	CT#81	CP-182137	0112	1	F	No operation code for UE policy management	15.1.0
2018-09	CT#81	CP-182134	0113	1	F	Correction on UE behaviour for 5GSM congestion control	15.1.0
2018-09	CT#81	CP-182134	0114		F	Correction on UE security capability IE	15.1.0
2018-09	CT#81	CP-182136	0115	5	F	Including SD when Mapped configured SD is included in S-NSSAI	15.1.0
2018-09	CT#81	CP-182142	0116	3	F	Updates to deleting a derived QoS rule in the UE	15.1.0
2018-09	CT#81	CP-182138	0117		F	Provisioning of ANDSP for non-3GPP access	15.1.0
2018-09	CT#81	CP-182136	0118		D	Fix incorrect references	15.1.0
2018-09	CT#81	CP-182130	0120	2	F	Addition of ngKSI in DEREGISTRATION REQUEST	15.1.0
2018-09	CT#81	CP-182141	0123	2	F	Storing of MPS indicator in non-volatile memory of mobile	15.1.0
2018-09	CT#81	CP-182138	0124	4	C	NW slicing and delayed re-registration due to emergency services	15.1.0
2018-09	CT#81	CP-182131	0125	1	F	Addition of cause values for service request reject	15.1.0
2018-09	CT#81	CP-182141	0126	3	F	UE actions when other causes received at SERVICE REJECT	15.1.0
2018-09	CT#81	CP-182137	0128		F	Missing general description on sub-clause 9.10	15.1.0
2018-09	CT#81	CP-182134	0130		F	Correction to general message format	15.1.0
2018-09	CT#81	CP-182138	0131		F	Plain 5GS NAS message	15.1.0
2018-09	CT#81	CP-182134	0134	1	F	Correction to the 5GMM capability IE	15.1.0
2018-09	CT#81	CP-182134	0135		F	Correction to the 5GS identity type IE	15.1.0
2018-09	CT#81	CP-182134	0136	1	F	Correction to the 5GS network feature support IE	15.1.0
2018-09	CT#81	CP-182135	0137	1	F	Editorials and minor corrections	15.1.0
2018-09	CT#81	CP-182140	0138		F	Security procedures and handling after inter-system change	15.1.0
2018-09	CT#81	CP-182130	0140		F	5GMM aspects of NAS over non-3GPP access	15.1.0
2018-09	CT#81	CP-182139	0141	2	F	Resolution of editor's note on equivalent PLMN list	15.1.0
2018-09	CT#81	CP-182140	0142		F	Resolution of editor's notes on 5GMM sub-layer design	15.1.0
2018-09	CT#81	CP-182139	0143		F	Resolution of editor's note on UE behaviour in substate 5GMM-DEREGISTERED.ATTEMPTING-REGISTRATION	15.1.0
2018-09	CT#81	CP-182139	0144		F	Resolution of editor's note on other sub-states of state 5GMM-DEREGISTERED	15.1.0
2018-09	CT#81	CP-182139	0145	3	F	Resolution of editor's note on sub-states of state 5GMM-REGISTERED	15.1.0
2018-09	CT#81	CP-182139	0146	1	F	Resolution of editor's note on the key derivation function field	15.1.0
2018-09	CT#81	CP-182139	0147		F	Resolution of editor's note on security context coordination	15.1.0
2018-09	CT#81	CP-182139	0148		F	Removal of unnecessary editor's notes FFS	15.1.0

2018-09	CT#81	CP-182139	0151		F	Resolution of editor's note on handling of unknown, unforeseen, and erroneous protocol data	15.1.0
2018-09	CT#81	CP-182131	0153	2	C	AMF taking both EMC and EMC BS availability into account in setting EMF	15.1.0
2018-09	CT#81	CP-182131	0154	1	F	Clarification on SM congestion control specific to PLMN	15.1.0
2018-09	CT#81	CP-182131	0155	1	F	Aligning T35cd handling upon NW initiated SM request with T3396 and T35ef	15.1.0
2018-09	CT#81	CP-182132	0156	2	F	Clarification on stopping back-off timers upon reception of NW initiated SM request	15.1.0
2018-09	CT#81	CP-182131	0157	1	F	Clarification for registration attempt counter handling and introduction of lower layer failure	15.1.0
2018-09	CT#81	CP-182137	0158	2	B	Introduction of 5GMM cause #15	15.1.0
2018-09	CT#81	CP-182141	0159	1	F	Timer for re-enabling N1 mode capability	15.1.0
2018-09	CT#81	CP-182137	0160		F	Lists of 5GS forbidden tracking areas	15.1.0
2018-09	CT#81	CP-182137	0162	1	F	Local release of a persistent PDU session	15.1.0
2018-09	CT#81	CP-182134	0163	1	F	Correction on retry of PDU session establishment procedure	15.1.0
2018-09	CT#81	CP-182134	0164		F	Correction to 5GSM/ESM coordination	15.1.0
2018-09	CT#81	CP-182133	0165		F	Correction on PDU address IE	15.1.0
2018-09	CT#81	CP-182130	0166	1	F	5GSM congestion control over AMF on PDU session modification procedure	15.1.0
2018-09	CT#81	CP-182136	0167	3	F	Exception handling in QoS operation	15.1.0
2018-09	CT#81	CP-182134	0168	1	F	Correction on PTI mismatch	15.1.0
2018-09	CT#81	CP-182136	0169	1	B	Establishment of N1 NAS signalling connection due to change in the network slicing information	15.1.0
2018-09	CT#81	CP-182138	0170	2	F	Release of N1 NAS signalling connection due to change in the network slicing information	15.1.0
2018-09	CT#81	CP-182137	0171	3	F	Multiple S-NSSAIs in PDU session establishment	15.1.0
2018-09	CT#81	CP-182132	0173	3	F	Clarifications on UE 5GSM capabilities and procedures during inter-working with EPS	15.1.0
2018-09	CT#81	CP-182136	0174	1	B	Interworking between ePDG/EPC and NG-RAN/5GCN	15.1.0
2018-09	CT#81	CP-182136	0176	1	B	Interworking between E-UTRAN/EPC and N3IWF/5GCN	15.1.0
2018-09	CT#81	CP-182142	0178	2	F	UE re-registration when the AMF cannot determine an Allowed NSSAI	15.1.0
2018-09	CT#81	CP-182137	0180	2	F	Local release of a PDU session due to 5GSM cause #43: Invalid PDU session identity	15.1.0
2018-09	CT#81	CP-182132	0182	2	C	Common NAS security transparent container IE for intra-5G HO and S1 to N1 inter-system HO	15.1.0
2018-09	CT#81	CP-182136	0184	1	F	Handling of PDU session type after intersystem change from N1 mode to S1 mode	15.1.0
2018-09	CT#81	CP-182131	0185	2	F	Allowed NSSAI of a single-registration mode UE within a network with N26	15.1.0
2018-09	CT#81	CP-182141	0187	1	F	SMF selection based on DNN for transfer a PDN connection from EPS to 5GS	15.1.0
2018-09	CT#81	CP-182141	0188	1	F	UE behaviour for determination of the UE presence in LADN service area	15.1.0
2018-09	CT#81	CP-182133	0189	3	F	Correction on emergency PDU session handling	15.1.0
2018-09	CT#81	CP-182137	0190	1	F	No EMM parameters handling for DR mode UEs due to rejected service request	15.1.0
2018-09	CT#81	CP-182131	0192	3	F	Clarification on activation of UP resources of PDU session	15.1.0
2018-09	CT#81	CP-182130	0194	1	B	Access attempt barred for the UE-initiated NAS transport procedure	15.1.0
2018-09	CT#81	CP-182142	0195	5	F	UE configured for EAB and access category 1	15.1.0
2018-09	CT#81	CP-182137	0197	1	F	No bearer for N1 NAS	15.1.0
2018-09	CT#81	CP-182133	0198	4	F	Correction of S-NSSAI based congestion control	15.1.0
2018-09	CT#81	CP-182132	0199	1	F	Clean-up in definitions	15.1.0

2018-09	CT#81	CP-182132	0200	4	F	Clarify abnormal cases in the UE for independency of 5GMM procedures between accesses	15.1.0
2018-09	CT#81	CP-182141	0203	2	B	Storing Configured NSSAI when the PLMN is changed	15.1.0
2018-09	CT#81	CP-182136	0206		F	Incorrect statement for handling of security context at IWK	15.1.0
2018-09	CT#81	CP-182134	0207	2	F	Correction to SSC mode selection	15.1.0
2018-09	CT#81	CP-182135	0208	2	F	Corrections to terms and references	15.1.0
2018-09	CT#81	CP-182140	0209	1	C	Revision on AMF transport behaviour of 5GSM message	15.1.0
2018-09	CT#81	CP-182135	0210	2	F	Differences between NAS over 3GPP access and NAS over non-3GPP access	15.1.0
2018-09	CT#81	CP-182138	0212	6	B	Preferred list terminating at ME or USIM	15.1.0
2018-09	CT#81	CP-182131	0213	4	F	Clarification on network-initiated de-registration procedure	15.1.0
2018-09	CT#81	CP-182133	0214		F	Correction of detach terminology	15.1.0
2018-09	CT#81	CP-182132	0215		F	Clarification on S-NSSAI based congestion control for PDU session modification procedure	15.1.0
2018-09	CT#81	CP-182141	0216	4	B	SOR acknowledge message coding	15.1.0
2018-09	CT#81	CP-182141	0232	1	F	SMS over NAS re-transmission upon delivery failure on one Access Type	15.1.0
2018-09	CT#81	CP-182134	0233	2	F	Corrections in EAP based primary authentication procedure (alternative 2)	15.1.0
2018-09	CT#81	CP-182133	0234		F	Correction for multi-homed IPv6 PDU session	15.1.0
2018-09	CT#81	CP-182133	0235	1	F	Correction for transfer of a PDN connection from untrusted non-3GPP access connected to EPC	15.1.0
2018-09	CT#81	CP-182133	0237	1	F	Correction for generation of QoS rules	15.1.0
2018-09	CT#81	CP-182137	0239		F	Interworking for multi-homed IPv6 PDU session	15.1.0
2018-09	CT#81	CP-182131	0241	1	F	Clarification of N1 NAS signalling connection release in AMF on generic UE configuration update completion	15.1.0
2018-09	CT#81	CP-182139	0242	1	F	Requests for emergency services fallback from upper layers	15.1.0
2018-09	CT#81	CP-182135	0245		F	Corrections to the Identification and Registration procedures	15.1.0
2018-09	CT#81	CP-182132	0246		F	Correct abnormal procedures reference when handling CC #22 (Congestion)	15.1.0
2018-09	CT#81	CP-182137	0247	1	F	Non-IP PDN connection type for S1 to N1 interworking	15.1.0
2018-09	CT#81	CP-182137	0248	1	F	Non-3GPP de-registration timer	15.1.0
2018-09	CT#81	CP-182141	0250	3	F	Substates for registration result	15.1.0
2018-09	CT#81	CP-182142	0251	1	F	Updating NS Configuration via registration procedure	15.1.0
2018-09	CT#81	CP-182141	0254	4	B	SUCI encoding format and protection scheme	15.1.0
2018-09	CT#81	CP-182132	0255	1	C	Clarify the method of configuring the UE to use Access Identity 1	15.1.0
2018-09	CT#81	CP-182136	0256	1	B	Handling of error case when UE gets URSP from VPLMN	15.1.0
2018-09	CT#81	CP-182132	0258	2	F	Correction for abnormal cases in the UE of service request procedure	15.1.0
2018-09	CT#81	CP-182140	0259	1	F	Setting of RRC establishment cause for operator-defined access categories	15.1.0
2018-09	CT#81	CP-182131	0262		F	Alignment with terminology "emergency PDU session" throughout TS 24.501	15.1.0
2018-09	CT#81	CP-182141	0263	1	F	TAI removed from list of Service area lists after reject from network	15.1.0
2018-09	CT#81	CP-182135	0264	1	F	EAP message IE mandatory in PDU SESSION AUTHENTICATION messages	15.1.0
2018-09	CT#81	CP-182135	0269	1	F	Corrections related to the authentication procedure	15.1.0
2018-09	CT#81	CP-182140	0271	2	F	Security parameter carrying DL NAS COUNT during N1 to S1 mode HO	15.1.0

2018-09	CT#81	CP-182130	0272	2	F	Adding procedures for updating local emergency numbers in other modes	15.1.0
2018-09	CT#81	CP-182131	0275		F	Authentication response parameter IE to be of fixed length (24.501)	15.1.0
2018-09	CT#81	CP-182134	0276		F	Correction to the PDU Session ID value in Allowed PDU session status IE	15.1.0
2018-09	CT#81	CP-182138	0277	2	F	Reactivation result indicating insufficient resources during service request procedure	15.1.0
2018-09	CT#81	CP-182138	0278	1	C	Registration procedure triggered by a change of UE Radio Capability	15.1.0
2018-09	CT#81	CP-182142	0280	2	F	Updates to RRC fallback indication while in 5GMM-CONNECTED mode, or while in 5GMM-CONNECTED mode with RRC inactive indication	15.1.0
2018-09	CT#81	CP-182138	0281	2	C	PDU Session Release due to Semantic or Syntactical Errors	15.1.0
2018-09	CT#81	CP-182138	0282	3	F	Removal of 5GSM cause from ePCO for PDU Session Release Complete	15.1.0
2018-09	CT#81	CP-182134	0283		F	Correction on PTI definition	15.1.0
2018-09	CT#81	CP-182140	0284	1	F	Resolving EN on fatal causes in 5GMM/5GSM state machine	15.1.0
2018-09	CT#81	CP-182130	0285	1	F	Uplink data handling for MT notification	15.1.0
2018-09	CT#81	CP-182136	0286	1	F	Fallback handling for RRC inactive	15.1.0
2018-09	CT#81	CP-182134	0287	1	F	Correction on PDU session modification procedure	15.1.0
2018-09	CT#81	CP-182140	0289	1	F	RRC establishment cause for EAB	15.1.0
2018-09	CT#81	CP-182138	0290	2	C	NW slicing and delayed registration due to emergency services, reject PDU session request	15.1.0
2018-09	CT#81	CP-182134	0291	1	F	Correction to the UE security capability IE encoding	15.1.0
2018-09	CT#81	CP-182130	0292	3	F	Additions to UE configuration update completion clause	15.1.0
2018-09	CT#81	CP-182139	0293	2	F	Removal of local PDU session release statement in UCU procedure	15.1.0
2018-09	CT#81	CP-182140	0294		F	Resolution of editor's notes in D.3 and D.6.2	15.1.0
2018-09	CT#81	CP-182140	0295		F	Resolution of the editor's note on value of the non-3GPP de-registration timer value	15.1.0
2018-09	CT#81	CP-182139	0296		F	Resolution of editor's note on the format of the authentication parameters	15.1.0
2018-09	CT#81	CP-182140	0297	2	F	Resolution of editor's note on unknown or unforeseen PDU session identity	15.1.0
2018-09	CT#81	CP-182139	0298		F	Resolution of editor's note on other types of payload for the NAS transport procedure(s)	15.1.0
2018-09	CT#81	CP-182140	0300	2	F	Serving network name format for primary authentication	15.1.0
2018-09	CT#81	CP-182136	0301	1	B	Initial registration not accepted due to serving network not authorized	15.1.0
2018-09	CT#81	CP-182130	0303	1	F	5GSM cause #xx –out of LADN service area	15.1.0
2018-09	CT#81	CP-182142	0304	1	F	UE policy delivery protocol in the scope	15.1.0
2018-09	CT#81	CP-182131	0305	1	F	AMF pointer pointing one or more AMFs	15.1.0
2018-09	CT#81	CP-182135	0306		F	Corrections in the conditions for SMS via non-3GPP access	15.1.0
2018-09	CT#81	CP-182130	0308		F	5GMM STATUS message sent by the AMF when certain error conditions are detected upon receipt of 5GMM protocol data in the AMF	15.1.0
2018-09	CT#81	CP-182137	0311	1	F	Interworking with E-UTRAN connected to EPC of a UE registered to 5GC via non-3GPP access	15.1.0
2018-09	CT#81	CP-182142	0313	2	F	Use of S-NSSAI and session-AMBR provided during the EPS bearer context modification procedure	15.1.0
2018-09	CT#81	CP-182136	0314	1	F	Handling of inter-access handover of a PDU session whose S-NSSAI is not allowed for the target access	15.1.0

2018-09	CT#81	CP-182130	0319	1	F	5GSM sublayer states for PDU session inactive	15.1.0
2018-09	CT#81	CP-182139	0321	1	F	Rename of T3584 and T3585	15.1.0
2018-09	CT#81	CP-182133	0322		F	Correction on acknowledgement handling of UE configuration update	15.1.0
2018-09	CT#81	CP-182133	0323	1	F	Correction on NW initiated de-registration procedure	15.1.0
2018-09	CT#81	CP-182140	0326	1	F	Service area restrictions	15.1.0
2018-09	CT#81	CP-182135	0327	3	F	Disabling and re-enabling N1 mode capability	15.1.0
2018-09	CT#81	CP-182131	0328	1	F	Clarification on packet filters	15.1.0
2018-09	CT#81	CP-182133	0329	1	F	Correction on 5G-GUTI type encoding	15.1.0
2018-09	CT#81	CP-182133	0330	1	F	Correction on EAP-AKA' based primary authentication	15.1.0
2018-09	CT#81	CP-182133	0331		F	Correction on 5GSM state mapping when interworking	15.1.0
2018-09	CT#81	CP-182138	0333	1	F	Removal of Default EPS Bearer (DEB) indication	15.1.0
2018-09	CT#81	CP-182133	0334	1	F	Correction on interaction with upper layers	15.1.0
2018-09	CT#81	CP-182140	0337	2	F	Security Context	15.1.0
2018-09	CT#81	CP-182135	0339	3	B	Emergency call in limited service state	15.1.0
2018-09	CT#81	CP-182201	0340	3	C	Emergency call error handling	15.1.0
2018-09	CT#81	CP-182138	0341	2	F	PDU session status in notification response message	15.1.0
2018-09	CT#81	CP-182132	0342	1	F	Clarifications on inclusion of S-NSSAI in 5GSM request	15.1.0
2018-09	CT#81	CP-182133	0344		F	Correction for LADN	15.1.0
2018-09	CT#81	CP-182135	0345	1	F	Definition of user-plane resources	15.1.0
2018-09	CT#81	CP-182136	0346	1	F	Handling of PDU session(s) not supporting interworking with EPS	15.1.0
2018-09	CT#81	CP-182141	0350		D	Terminology correction	15.1.0
2018-09	CT#81	CP-182131	0351	3	F	Clarification on MICO indication and LADN information via generic UE configuration update procedure	15.1.0
2018-09	CT#81	CP-182132	0352	1	F	Clarification on the temporary identity in the service request procedure	15.1.0
2018-09	CT#81	CP-182130	0353		F	Abbreviation update for NITZ	15.1.0
2018-09	CT#81	CP-182135	0355		D	Duplicated subclause for registration request message	15.1.0
2018-09	CT#81	CP-182135	0356	1	D	Editorial corrections	15.1.0
2018-09	CT#81	CP-182135	0357	2	B	DL and UL NAS Transport procedure updates for SOR	15.1.0
2018-09	CT#81	CP-182132	0358	1	F	Conditions to send registration complete message.	15.1.0
2018-09	CT#81	CP-182132	0359	1	F	Condition for starting timer T3540	15.1.0
2018-09	CT#81	CP-182140	0361	2	F	Security context mapping at 5GS to EPS HO	15.1.0
2018-09	CT#81	CP-182134	0363	2	F	Correction to reset registration attempt counter	15.1.0
2018-09	CT#81	CP-182130	0365	3	F	Adding the reference to T3346	15.1.0
2018-09	CT#81	CP-182130	0367	1	F	Access attempt due to delivery of LPP message/transparent container/UE policy container	15.1.0
2018-12	CT#82	CP-183032	0103	6	F	Clarification on coordination between 5GMM and 5GSM	15.2.0
2018-12	CT#82	CP-183032	0121	10	F	Clarification to VoPS indicator	15.2.0
2018-12	CT#82	CP-183032	0274	4	F	Correct Extended Local Emergency Numbers List deletion upon PLMN change	15.2.0
2018-12	CT#82	CP-183032	0315	4	F	Operator-controlled inclusion of NSSAI in access stratum connection establishment	15.2.0
2018-12	CT#82	CP-183032	0371	2	F	Correction for maximum data rate per UE for integrity protection for DRBs for PDU sessions in non-3GPP access which are transferable to 3GPP access	15.2.0
2018-12	CT#82	CP-183032	0372	1	F	Correction for 3GPP PS data off and non-IP user data packets	15.2.0
2018-12	CT#82	CP-183032	0373	2	F	Corrections for determination of RRC establishment cause and establishment cause for non-3GPP access	15.2.0

2018-12	CT#82	CP-183032	0374		F	Corrections for MTU PCO parameters handling	15.2.0
2018-12	CT#82	CP-183032	0376	2	F	Correction for SM PDU DN request container coding	15.2.0
2018-12	CT#82	CP-183032	0379	1	F	UAC: Correction for SMS over DNN other than "IMS"	15.2.0
2018-12	CT#82	CP-183032	0380	2	F	UAC: Correction for operator-defined access categories	15.2.0
2018-12	CT#82	CP-183032	0381	1	F	DRX parameters IE definition	15.2.0
2018-12	CT#82	CP-183032	0383	1	F	Removal of UE security capability from Intra N1 mode NAS container	15.2.0
2018-12	CT#82	CP-183032	0385		F	Correct procedure for determining registered PLMN	15.2.0
2018-12	CT#82	CP-183032	0392	1	F	Definition of emergency registration	15.2.0
2018-12	CT#82	CP-183032	0393	1	F	Correction for EAP based primary authentication and AUTHENTICATION REJECT	15.2.0
2018-12	CT#82	CP-183032	0394		F	Correction for LADN information encoding	15.2.0
2018-12	CT#82	CP-183032	0395	3	B	Dynamic Routing indicator update description	15.2.0
2018-12	CT#82	CP-183032	0398	1	F	ABBA handling for 5G-AKA based authentication procedure	15.2.0
2018-12	CT#82	CP-183032	0399	2	F	ABBA handling when initiating EAP procedures	15.2.0
2018-12	CT#82	CP-183032	0401	3	F	Clarification on NAS message field format and mapping	15.2.0
2018-12	CT#82	CP-183032	0402	1	F	Correction to home country definition	15.2.0
2018-12	CT#82	CP-183032	0403	1	F	Signalling Default Configured NSSAI indication in the registration procedure	15.2.0
2018-12	CT#82	CP-183032	0404	1	F	Rename "configured NSSAI not associated with a PLMN" to align to new stage 2 terminology	15.2.0
2018-12	CT#82	CP-183032	0405	1	F	"SMS subscribed indication" in CONFIGURATION UPDATE COMMAND	15.2.0
2018-12	CT#82	CP-183033	0406	1	F	S-NSSAI not allowed by AMF	15.2.0
2018-12	CT#82	CP-183033	0407		F	Continued need to align with terminology "emergency PDU session" throughout TS 24.501	15.2.0
2018-12	CT#82	CP-183033	0408	1	F	Ambiguity in the use of the terms "no other parameter" and "no parameters"	15.2.0
2018-12	CT#82	CP-183033	0409		F	Change EMCW to EMCN3	15.2.0
2018-12	CT#82	CP-183033	0410	2	F	Miscellaneous wording, terminology and reference corrections	15.2.0
2018-12	CT#82	CP-183033	0411		F	Rejected NSSAI clarifications	15.2.0
2018-12	CT#82	CP-183033	0413	1	F	Rejected NSSAI sent in CONFIGURATION UPDATE COMMAND – Alt 2	15.2.0
2018-12	CT#82	CP-183033	0415		F	UAC – meaning of "the broadcast of categories a, b or c"	15.2.0
2018-12	CT#82	CP-183033	0416	2	F	Clarification of "registration requested" in CONFIGURATION UPDATE COMMAND	15.2.0
2018-12	CT#82	CP-183033	0417	5	F	Updates on steering of roaming handling and information coding	15.2.0
2018-12	CT#82	CP-183033	0419	3	F	Security context usage during NAS security mode control procedure	15.2.0
2018-12	CT#82	CP-183033	0420	1	F	Corrections on GBR parameter for QoS flow	15.2.0
2018-12	CT#82	CP-183033	0421	1	F	Correction to UE behavior when disabling N1 mode for non-3GPP access	15.2.0
2018-12	CT#82	CP-183033	0423	1	F	Mapped QoS information validation (Solution 1)	15.2.0
2018-12	CT#82	CP-183033	0424	4	B	Protection of initial NAS messages – overall description	15.2.0
2018-12	CT#82	CP-183033	0425	4	B	Support for protection of initial NAS messages	15.2.0
2018-12	CT#82	CP-183033	0426	2	B	Update to 5GS registration type IE and introduction of a new 5GS update type IE	15.2.0
2018-12	CT#82	CP-183033	0427	1	F	S-NSSAI received in Notify payload during PDN connection establishment over ePDG/EPC	15.2.0

2018-12	CT#82	CP-183033	0428		F	No interworking to ePDG/EPC for Ethernet and unstructured PDU sessions	15.2.0
2018-12	CT#82	CP-183033	0429		F	Addition of UE capability for LPP in 5GMM capability IE	15.2.0
2018-12	CT#82	CP-183033	0430	1	F	Correct superfluous test for N1 mode and S1 mode capability	15.2.0
2018-12	CT#82	CP-183033	0431	1	F	Change UE policy classmark as mandatory IE	15.2.0
2018-12	CT#82	CP-183033	0432	2	F	Forward compatibility for UE security capability IE and a few other IEs	15.2.0
2018-12	CT#82	CP-183033	0433	1	F	Introduction of Replayed S1 UE security capabilities	15.2.0
2018-12	CT#82	CP-183033	0434	1	F	Applicability of UAC for other cases of NAS message transport	15.2.0
2018-12	CT#82	CP-183034	0435	5	F	Emergency registered	15.2.0
2018-12	CT#82	CP-183034	0436	3	F	Correction to domain selection rules for EPS/RAT Fallback	15.2.0
2018-12	CT#82	CP-183034	0438		F	UL data status upon fallback indication from lower layers	15.2.0
2018-12	CT#82	CP-183034	0440	1	F	Misc. corrections to 24.501	15.2.0
2018-12	CT#82	CP-183034	0441	2	F	Clarification on handling of PDU session for LADN	15.2.0
2018-12	CT#82	CP-183034	0442	2	F	Correction to determination method of LADN DNN	15.2.0
2018-12	CT#82	CP-183034	0443	1	F	Correction to trigger of the mobility and periodic registration update procedure	15.2.0
2018-12	CT#82	CP-183034	0444	1	F	Abnormal cases in the network side for Configuration update procedure.	15.2.0
2018-12	CT#82	CP-183034	0445	1	F	Correction in emergency reg cause name	15.2.0
2018-12	CT#82	CP-183034	0446		F	UE behavior on NW initiated deregistration procedure with #22	15.2.0
2018-12	CT#82	CP-183034	0447	1	F	Miscellaneous corrections	15.2.0
2018-12	CT#82	CP-183034	0448	3	F	Resetting service request attempt counter upon receipt of the REGISTRATION ACCEPT message	15.2.0
2018-12	CT#82	CP-183034	0450		F	Correction in determining syntactic errors for PDU session establishment accept	15.2.0
2018-12	CT#82	CP-183034	0451		F	T3540 started by the UE on getting 5GMM cause #27 – N1 mode not allowed	15.2.0
2018-12	CT#82	CP-183034	0452	2	F	Clarification on UE identities used for registration	15.2.0
2018-12	CT#82	CP-183034	0454	1	F	Transition from 5GMM-CONNECTED mode with RRC inactive indication to 5GMM-IDLE mode triggered by radio capability update	15.2.0
2018-12	CT#82	CP-183034	0455	1	F	Finalizing 5GSM timers on the UE and SMF side	15.2.0
2018-12	CT#82	CP-183034	0458	1	F	Local PDU session release upon receipt of PDU Session Release Reject with 5GSM cause #34 (service option temporarily out of order) or #35 (PTI already in use)	15.2.0
2018-12	CT#82	CP-183034	0460	3	F	Clarifications on the EAP based AKA procedure	15.2.0
2018-12	CT#82	CP-183034	0461	1	F	Applicability of the Service area list IE indicating all TAIs to equivalent PLMNs	15.2.0
2018-12	CT#82	CP-183034	0464	1	F	Clarification on PDU session transfer from non-3GPP to 3GPP access when 3GPP PS data off UE status is activated	15.2.0
2018-12	CT#82	CP-183034	0465	1	F	EAP-Identification in EAP-AKA' primary authentication and key agreement procedure	15.2.0
2018-12	CT#82	CP-183034	0467	1	F	Excluding mobility procedures from ODAC access control checks	15.2.0
2018-12	CT#82	CP-183034	0470	3	F	Alignment of 5G-GUTI assignment with SA3	15.2.0
2018-12	CT#82	CP-183034	0471	1	F	Network initiated de-registration in case of emergency PDU session	15.2.0
2018-12	CT#82	CP-183035	0472		F	Resolution of editor's note on always-on PDU session	15.2.0
2018-12	CT#82	CP-183035	0473		F	Addition of 5GSM cause values	15.2.0

2018-12	CT#82	CP-183035	0474		F	Resolution of editor's note on operator-defined access category	15.2.0
2018-12	CT#82	CP-183035	0476	6	C	Support for Traffic Segregation	15.2.0
2018-12	CT#82	CP-183035	0479		F	Correct reference to Mapped EPS bearer contexts	15.2.0
2018-12	CT#82	CP-183035	0480		F	Aborted UE-initiated NAS transport procedure for delivery of SMS/LPP message/UE policy container	15.2.0
2018-12	CT#82	CP-183035	0484	3	F	Clarification on back-off timer upon PLMN change	15.2.0
2018-12	CT#82	CP-183035	0485	2	F	Emergency call in limited service state	15.2.0
2018-12	CT#82	CP-183035	0490	2	F	Correction on Network slicing indication	15.2.0
2018-12	CT#82	CP-183035	0491		F	Correction on De-registration procedure	15.2.0
2018-12	CT#82	CP-183035	0492	1	F	Correction on dual-registration mode	15.2.0
2018-12	CT#82	CP-183035	0494	1	F	Correction to Configured NSSAI for the HPLMN	15.2.0
2018-12	CT#82	CP-183035	0499		F	Updates to 5GS mobility management aspects subclause	15.2.0
2018-12	CT#82	CP-183035	0500	5	F	Editorials and minor corrections	15.2.0
2018-12	CT#82	CP-183035	0501	3	F	Adding necessary term definitions	15.2.0
2018-12	CT#82	CP-183035	0502	1	F	Resolution of editor's notes on abnormal case handling when rejection with "Extended wait time" received from lower layers	15.2.0
2018-12	CT#82	CP-183035	0503	1	F	Resolution of editor's note on maximum length of the 5GS mobile identity IE	15.2.0
2018-12	CT#82	CP-183035	0505	1	F	Resolution of editor's note in sub-clause 4.8.3	15.2.0
2018-12	CT#82	CP-183035	0506	1	F	Correct unified access control applicability in 5GMM-REGISTERED.UPDATE-NEEDED	15.2.0
2018-12	CT#82	CP-183035	0507	3	F	Correct non-3GPP registration accept procedure when local emergency numbers are received from a different country	15.2.0
2018-12	CT#82	CP-183035	0509	1	F	Remove editor's note for MT LCS	15.2.0
2018-12	CT#82	CP-183035	0510	1	F	Reusing T3519 for Initial Registration procedure	15.2.0
2018-12	CT#82	CP-183035	0511	2	F	Abnormal cases for Registration procedure for mobility and periodic registration update	15.2.0
2018-12	CT#82	CP-183035	0516	1	F	Correction on handling of mandatory IE errors	15.2.0
2018-12	CT#82	CP-183035	0517	1	F	Correction on handling of invalid PSI	15.2.0
2018-12	CT#82	CP-183036	0518	2	F	Clarification on PLMN's maximum number of PDU sessions	15.2.0
2018-12	CT#82	CP-183036	0519	1	F	Handling on collision of PDU session establishment and release procedures	15.2.0
2018-12	CT#82	CP-183036	0521		F	Correction on QoS rules IE	15.2.0
2018-12	CT#82	CP-183036	0522	2	F	Correction on QoS flow description IE	15.2.0
2018-12	CT#82	CP-183036	0523	1	F	Correction of storage of operator-defined access categories	15.2.0
2018-12	CT#82	CP-183036	0525	2	F	Clarification on coordination between 5GMM and EMM for a UE in DRM	15.2.0
2018-12	CT#82	CP-183036	0526		F	The UE behavior in non-3GPP access and in state ATTEMPTING-REGISTRATION	15.2.0
2018-12	CT#82	CP-183036	0528	1	F	Enabling use of and disabling use of MICO mode	15.2.0
2018-12	CT#82	CP-183036	0529	2	F	Apply service area restrictions in NAS procedures	15.2.0
2018-12	CT#82	CP-183036	0530	1	F	Abnormal cases in 5GSM procedures	15.2.0
2018-12	CT#82	CP-183036	0532		F	Clarifications on UE behaviour upon receiving RRC fallback indication	15.2.0
2018-12	CT#82	CP-183036	0533	2	F	Corrections for interworking with EPS	15.2.0
2018-12	CT#82	CP-183036	0534	1	F	Release of the N1 NAS signalling connection upon Service Accept message	15.2.0
2018-12	CT#82	CP-183036	0535	1	F	QoS rules verification during PDU session establishment procedure	15.2.0
2018-12	CT#82	CP-183036	0536	1	F	Clarifications on UE and network state	15.2.0
2018-12	CT#82	CP-183036	0537	1	F	T3517 handling and emergency services fallback	15.2.0



2018-12	CT#82	CP-183036	0540	2	F	Revisions on N1 NAS signaling connection establishment and release	15.2.0
2018-12	CT#82	CP-183036	0541	1	F	Disabling N1 mode capability for 3GPP access and impacts to PLMN selection	15.2.0
2018-12	CT#82	CP-183036	0543	1	F	UE's homogeneous support of emergency services fallback per RAT	15.2.0
2018-12	CT#82	CP-183036	0544		F	Context management for 3GPP access and non-3GPP access due to SR rejection	15.2.0
2018-12	CT#82	CP-183036	0545	2	F	Clarification on setting a service type of a SERVICE REQUEST message	15.2.0
2018-12	CT#82	CP-183036	0546	1	F	UL NAS TRNAPORT message pending due to network slicing information update	15.2.0
2018-12	CT#82	CP-183036	0547		F	Distinction in AMF-side abnormal cases for generic UE configuration update procedure with respect to 5G-GUTI update	15.2.0
2018-12	CT#82	CP-183036	0548	1	F	Handling of security contexts by a UE operating in dual-registration mode	15.2.0
2018-12	CT#82	CP-183036	0549	2	F	Establishment of secure exchange of NAS messages during inter-system change between N1 mode and S1 mode	15.2.0
2018-12	CT#82	CP-183037	0550	2	D	Terminology alignment regarding support for interworking without N26	15.2.0
2018-12	CT#82	CP-183037	0551	3	F	Correction on reporting change of 3GPP PS data off UE status	15.2.0
2018-12	CT#82	CP-183037	0553	1	F	Correction on Uplink data status handling	15.2.0
2018-12	CT#82	CP-183037	0557	2	F	Correction of LADN information for generic UE configuration update procedure	15.2.0
2018-12	CT#82	CP-183037	0559		F	Management of the registration attempt counter and the attach attempt counter during inter-system change	15.2.0
2018-12	CT#82	CP-183037	0560	1	F	No direct security protection to 5GSM	15.2.0
2018-12	CT#82	CP-183037	0562	1	F	No S-NSSAI for emergency PDU sessions	15.2.0
2018-12	CT#82	CP-183037	0563	1	F	S-NSSAI selection for S-NSSAI based congestion control	15.2.0
2018-12	CT#82	CP-183037	0565	2	F	UE in registered state without registration complete	15.2.0
2018-12	CT#82	CP-183037	0569	1	F	Abnormal Cases in the UE for initial registration	15.2.0
2018-12	CT#82	CP-183037	0571	2	F	Addition of 24.501 overview	15.2.0
2018-12	CT#82	CP-183037	0572	2	F	Service area restrictions applicable for PLMNs in registration area	15.2.0
2018-12	CT#82	CP-183037	0573	1	F	Periodically erase of service area restriction list	15.2.0
2018-12	CT#82	CP-183037	0574	1	F	Completion of mobile identity IE definition in messages	15.2.0
2018-12	CT#82	CP-183037	0575		F	Correction of erroneously encoded IE	15.2.0
2018-12	CT#82	CP-183037	0576	2	F	Correction for local release	15.2.0
2018-12	CT#82	CP-183037	0577	3	F	UAC - providing access identities for barring checks of AS triggered access attempts	15.2.0
2018-12	CT#82	CP-183037	0578	2	F	Correction for indicating 3GPP PS data off status	15.2.0
2018-12	CT#82	CP-183037	0580	1	F	UPSIs in UE STATE INDICATION	15.2.0
2018-12	CT#82	CP-183037	0582	1	F	Initial registration for emergency PDU session	15.2.0
2018-12	CT#82	CP-183037	0583	2	F	Multiple 5G-GUTIs	15.2.0
2018-12	CT#82	CP-183037	0584		F	Correction on Maximum number of supported packet filters	15.2.0
2018-12	CT#82	CP-183037	0585		F	T3584 and T3585 update in Timer table	15.2.0
2018-12	CT#82	CP-183037	0586	1	F	Abnormal case for T3550	15.2.0
2018-12	CT#82	CP-183038	0590	1	F	No UPF Resources at PDU Session Establishment	15.2.0
2018-12	CT#82	CP-183038	0591	2	F	Clarifications on NAS level mobility management congestion control	15.2.0
2018-12	CT#82	CP-183038	0592	1	F	SOR over control plane in non-3GPP access	15.2.0
2018-12	CT#82	CP-183038	0593	1	F	Handling of target CN type by NAS upon redirection to E-UTRA cell	15.2.0
2018-12	CT#82	CP-183038	0594	3	C	Procedure for UDM-triggered UE parameters update	15.2.0

2018-12	CT#82	CP-183038	0595	1	F	Sending of 5GSM capability IE and Maximum number of supported packet filters IE in in PDU SESSION ESTABLISHMENT REQUEST with request type "existing PDU session"	15.2.0
2018-12	CT#82	CP-183038	0597	3	F	Correction of reference	15.2.0
2018-12	CT#82	CP-183038	0598	2	C	Clarification on 5GSM cause_#46 out of LADN service area	15.2.0
2018-12	CT#82	CP-183038	0604	2	C	Clarification on congestion control upon intersystem change	15.2.0
2018-12	CT#82	CP-183038	0605		F	Editorial correction related to LADN	15.2.0
2018-12	CT#82	CP-183038	0606	1	F	Correcting the structure of LADN related description	15.2.0
2018-12	CT#82	CP-183038	0607	2	F	N3GPP de-registration timers handling at long MM back-off time	15.2.0
2018-12	CT#82	CP-183038	0608	1	F	Abnormal cases in the network side for Configuration update procedure.	15.2.0
2018-12	CT#82	CP-183038	0609	1	F	Abnormal cases in the UE side for Configuration update procedure.	15.2.0
2018-12	CT#82	CP-183038	0610	1	F	Handling of 5GSM reject causes #50 and #51 for PDU types IPv4v6.	15.2.0
2018-12	CT#82	CP-183038	0611	1	F	Correction to QoS rules verification during PDU session establishment.	15.2.0
2018-12	CT#82	CP-183038	0612	1	F	QoS rules verification during PDU session modification.	15.2.0
2018-12	CT#82	CP-183038	0613	1	F	QoS flow descriptions IE to be set by SMF mandatory in PDU establishment accept for initial request.	15.2.0
2018-12	CT#82	CP-183038	0614	1	B	MCS Indicator and Access Identity 2	15.2.0
2018-12	CT#82	CP-183038	0615	3	F	SUCI encoding and support of NAI format	15.2.0
2018-12	CT#82	CP-183038	0617	1	F	UAC for simultaneous access attempt triggers	15.2.0
2018-12	CT#82	CP-183038	0618	1	F	Reset of registration attempt counter	15.2.0
2018-12	CT#82	CP-183038	0619		F	Reset of service request attempt counter	15.2.0
2018-12	CT#82	CP-183038	0622		F	CN paging handling in RRC inactive	15.2.0
2018-12	CT#82	CP-183038	0623	2	F	Procedure collision handling in paging and notification procedure	15.2.0
2018-12	CT#82	CP-183039	0624		F	Resolution of editor's note on different TAI for 4G and for 5G	15.2.0
2018-12	CT#82	CP-183039	0625		F	Correction on 'E' bit for deleting QoS flow description	15.2.0
2018-12	CT#82	CP-183039	0626		F	EMM parameters handling for EPC interworking	15.2.0
2018-12	CT#82	CP-183039	0627	1	F	Registration rejected because of non-3GPP access to 5GCN is not allowed	15.2.0
2018-12	CT#82	CP-183039	0628	2	F	Correction to SUPI definition due to NAI format	15.2.0
2018-12	CT#82	CP-183039	0629		F	Correct secured packet procedures	15.2.0
2018-12	CT#82	CP-183039	0630	2	F	Abnormal cases for EAP-based AKA	15.2.0
2018-12	CT#82	CP-183039	0631	1	F	CONFIGURATION UPDATE COMMAND with no parameters other than registraion requested.	15.2.0
2018-12	CT#82	CP-183039	0633	1	F	Correction of the UE-initiated de-registration procedure	15.2.0
2018-12	CT#82	CP-183039t	0634	1	F	Definition of a 5GMM cause for DNN subscription check failure	15.2.0
2018-12	CT#82	CP-183039	0635	1	F	Stopping T3511 after transitioning to 5GMM-CONNECTED mode	15.2.0
2018-12	CT#82	CP-183039	0636	2	F	Clarification on storage of UE policy sections of multiple PLMNs	15.2.0
2018-12	CT#82	CP-183039	0637	1	F	Corrections to UE handling of reject with cause #13	15.2.0
2018-12	CT#82	CP-183039	0639	1	F	Clarification on the Selected EPS NAS security algorithms	15.2.0
2018-12	CT#82	CP-183039	0641	3	F	Handling errors due to missing QoS flow descriptions parameters for GBR QoS flows	15.2.0
2018-12	CT#82	CP-183039	0642	2	F	Clarification on inclusion of Requested NSSAI during periodic registration updating	15.2.0

2018-12	CT#82	CP-183039	0643	1	F	The release of the existing N1 NAS signalling connection after UCU	15.2.0
2018-12	CT#82	CP-183039	0646	1	F	Always-on PDU sessions and associated access	15.2.0
2018-12	CT#82	CP-183039	0647	1	F	Clarification on the applicability of NSSAI to the EPLMNs	15.2.0
2018-12	CT#82	CP-183039	0648	1	F	Clarification on the applicability of service area restrictions to the EPLMNs	15.2.0
2018-12	CT#82	CP-183039	0649	1	F	QFI and QRI values in 5GSM messages	15.2.0
2018-12	CT#82	CP-183039	0650	2	F	Corrections on operation mode selection	15.2.0
2018-12	CT#82	CP-183039	0651	1	F	Clarification on handling of PDU sessions associated with 3GPP access and non-3GPP access for interworking	15.2.0
2018-12	CT#82	CP-183039	0652		F	Clarifications on Configuration Update procedure	15.2.0
2018-12	CT#82	CP-183039	0653		F	Correction on timer T3511	15.2.0
2018-12	CT#82	CP-183040	0654	2	F	Clarification on Notification procedure	15.2.0
2018-12	CT#82	CP-183040	0655	1	F	Clarification on handling of invalid LADN DNN in registration procedure – Alt 1	15.2.0
2018-12	CT#82	CP-183040	0657	1	F	Correction for LADN information IE	15.2.0
2018-12	CT#82	CP-183040	0659		F	Editorial correction for the generic UE configuration update procedure	15.2.0
2018-12	CT#82	CP-183040	0660	1	F	UE behavior in ATTEMPTING-REGISTRATION state	15.2.0
2018-12	CT#82	CP-183040	0661	1	F	UE-AMF selected PLMN ID mismatch in INACTIVE state	15.2.0
2018-12	CT#82	CP-183040	0662		F	UL NAS Transport behavior due to transmission failure	15.2.0
2018-12	CT#82	CP-183029	0663	1	F	UAC: Correction for operator-defined access categories of acknowledgement	15.2.0
2018-12	CT#82	CP-183040	0664	2	F	Lower layer indication on the establishment/release of user plane resources	15.2.0
2018-12	CT#82	CP-183040	0665	3	F	Setting the Uplink data status and Service type IEs after receiving a fallback indication from the lower layers	15.2.0
2018-12	CT#82	CP-183040	0666	2	F	Indication of a reason for failure in reactivating a PDU session	15.2.0
2018-12	CT#82	CP-183040	0667	1	F	Adding the case that UE initiates the registration procedure for mobility and periodic registration	15.2.0
2018-12	CT#82	CP-183040	0668	1	F	Handling of network rejection with 5GSM cause values #50, #51, and #54	15.2.0
2018-12	CT#82	CP-183040	0669	2	F	Mobility and periodic registration update triggered by indications from lower layers	15.2.0
2018-12	CT#82	CP-183040	0673	1	F	UE STATE INDICATION message delivered in a REGISTRATION REQUEST message	15.2.0
2018-12	CT#82	CP-183040	0674	1	F	Correction to operator-defined access category criteria type values	15.2.0
2018-12	CT#82	CP-183040	0677	1	F	Exceptions for UEs configured for high priority access in handling T3396, T3584, and T3585	15.2.0
2018-12	CT#82	CP-183040	0678		D	Removal of non-seamless non-3GPP offload from definitions	15.2.0
2018-12	CT#82	CP-183040	0679	4	F	UE identifier provided during an initial registration procedure	15.2.0
2018-12	CT#82	CP-183040	0680	1	F	Revisions on PDU Session Establishment procedure	15.2.0
2018-12	CT#82	CP-183040	0682	1	F	UE registered for emergency services upon authentication failure	15.2.0
2018-12	CT#82	CP-183040	0683		F	Update the trigger of mobility registration update initiation	15.2.0
2018-12	CT#82	CP-183040	0684	2	F	Clarification on T3346 for registration procedure	15.2.0
2018-12	CT#82	CP-183040	0686	2	F	Support sending multiple payloads via Payload container	15.2.0
2018-12	CT#82	CP-183040	0687	1	F	Correction on LADN information handling	15.2.0

2018-12	CT#82	CP-183040	0688	2	F	Mapping of a NOTIFICATION message to an access category	15.2.0
2018-12	CT#82	CP-183041	0690	2	F	Transmission of SUCI in DEREGISTRATION REQUEST	15.2.0
2018-12	CT#82	CP-183041	0691		F	Clarification on missing subclause	15.2.0
2018-12	CT#82	CP-183041	0692		F	Stop T3516 when authentication reject received	15.2.0
2018-12	CT#82	CP-183041	0693	1	F	Limited service and no SUPI states in 5GMM instance for non-3GPP accesst	15.2.0
2018-12	CT#82	CP-183041	0695	1	F	QoS flow and mapped EPS bearer context	15.2.0
2018-12	CT#82	CP-183041	0696	1	F	Corrections on 5GSM IEs	15.2.0
2018-12	CT#82	CP-183041	0697	1	F	Correction on 5GSM congestion control	15.2.0
2018-12	CT#82	CP-183041	0698		F	Correction on PTI value release	15.2.0
2018-12	CT#82	CP-183041	0699	1	F	Corrections on QoS rules IE	15.2.0
2018-12	CT#82	CP-183041	0700	1	F	UE handling for semantic error in the QoS operation	15.2.0
2018-12	CT#82	CP-183041	0701		F	Resolution of editor's note on abnormal case handling for the UE-initiated UE state indication procedure	15.2.0
2018-12	CT#82	CP-183041	0702	1	F	Resolution of editor's note on abnormal case handling for the network-requested UE policy management procedure	15.2.0
2018-12	CT#82	CP-183041	0703		F	Resolution of editor's note on the information the N3IWF maintains for a registered UE	15.2.0
2018-12	CT#82	CP-183041	0709	2	F	Congestion control	15.2.0
2018-12	CT#82	CP-183041	0711	1	F	Correction to authentication abnormal cases	15.2.0
2018-12	CT#82	CP-183041	0712	1	F	Corrections for non-3GPP access idle mode	15.2.0
2018-12	CT#82	CP-183041	0715	1	F	Integrity protection maximum data rate for UL and DL	15.2.0
2018-12	CT#82	CP-183041	0717	1	F	General section for limited service state over non-3GPP access	15.2.0
2018-12	CT#82	CP-183041	0718		F	T35xx in Annex D	15.2.0
2019-01	CT#82					Change of IEI values from 7E to 74 and from 7F to 75	15.2.1
2019-03	CT#83	CP-190084	0382	9	F	Correct Extended Local Emergency Numbers List use involving WLAN	15.3.0
2019-03	CT#83	CP-190084	0468	5	F	Resolving Editor's note on suitability of 5QI as criteria type for ODAC	15.3.0
2019-03	CT#83	CP-190084	0638	3	F	Clarification for abnormal case handling of registration procedure after inter-system change from S1 mode to N1 mode	15.3.0
2019-03	CT#83	CP-190084	0706	6	F	Resolution on the editor's note on abnormal cases in the UE for the PDU EAP message reliable transport procedure	15.3.0
2019-03	CT#83	CP-190084	0721	2	F	Clarification on inclusion of the Uplink data status IE in the SERVICE REQUEST message after an RRC fallback indication	15.3.0
2019-03	CT#83	CP-190084	0724	4	F	Corrections to Annex D	15.3.0
2019-03	CT#83	CP-190084	0725	2	F	Update reference for UE policy control service	15.3.0
2019-03	CT#83	CP-190084	0728	1	F	Completion of correction for local release	15.3.0
2019-03	CT#83	CP-190084	0729	2	F	UAC - access attempt matching criteria of operator-defined access categoryt	15.3.0
2019-03	CT#83	CP-190084	0731	2	F	Correcting the name of ITU-T Recommendation E.212	15.3.0
2019-03	CT#83	CP-190084	0732	2	F	5GSM - request type not included in PDU SESSION ESTABLISHMENT REQUEST	15.3.0
2019-03	CT#83	CP-190084	0734	2	F	AMF rejecting PDU session establishment when the DNN is not subscribed	15.3.0
2019-03	CT#83	CP-190084	0735	1	F	Correction for acknowledgement of extended emergency number list	15.3.0
2019-03	CT#83	CP-190084	0741	3	F	Mobility between 5GS over non-3GPP access and EPS over 3GPP access	15.3.0
2019-03	CT#83	CP-190084	0743	1	F	PDU session status for IWK without N26	15.3.0
2019-03	CT#83	CP-190084	0744	2	F	EPS GUTI provided to lower layer	15.3.0
2019-03	CT#83	CP-190084	0745	1	F	Length of 5G-S-TMSI	15.3.0
2019-03	CT#83	CP-190084	0746	3	F	S1 UE security capability	15.3.0

2019-03	CT#83	CP-190084	0747	2	F	Clarification on creating new QoS flowst	15.3.0
2019-03	CT#83	CP-190084	0750	1	F	Correction to handling of #50 and #51t	15.3.0
2019-03	CT#83	CP-190085	0752	1	F	PDU session modification for emergency PDU sessions.	15.3.0
2019-03	CT#83	CP-190085	0753	1	F	Removal of unnecessary text.	15.3.0
2019-03	CT#83	CP-190085	0754	1	F	QoS flow description to be added in PDU session modification command	15.3.0
2019-03	CT#83	CP-190100	0758		F	Correction of the erroneous length of EAP messageIE	15.3.0
2019-03	CT#83	CP-190085	0759	2	F	Update of SUCI encoding	15.3.0
2019-03	CT#83	CP-190085	0762		F	Minor corrections to TS 24.501	15.3.0
2019-03	CT#83	CP-190085	0763	2	F	Cleanup on support of multiple payloads for NAS transport	15.3.0
2019-03	CT#83	CP-190085	0765	1	F	Correction on initial NAS message protection	15.3.0
2019-03	CT#83	CP-190085	0766	2	F	Correction on 5GS mobile identity IE name	15.3.0
2019-03	CT#83	CP-190085	0767	1	F	Addition of the 5GSM cause IE in the PDU SESSION MODIFICATION COMPLETE message	15.3.0
2019-03	CT#83	CP-190085	0768	2	D	Minor corrections for interworking	15.3.0
2019-03	CT#83	CP-190085	0769	1	F	Change of "a wildcard DNN" to "the wildcard DNN"	15.3.0
2019-03	CT#83	CP-190085	0771	2	F	Adding missing abnormal cases for initial registration (UE side)	15.3.0
2019-03	CT#83	CP-190085	0772	2	F	Clarification for the use of the default value for T3512	15.3.0
2019-03	CT#83	CP-190085	0773	3	F	Removal of UE security capabilities from the S1 mode to N1 mode NAS transparent container	15.3.0
2019-03	CT#83	CP-190085	0774	2	F	Clarification on NSSAI inclusion mode after an inter-system change from S1 mode to N1 mode	15.3.0
2019-03	CT#83	CP-190085	0780	1	F	Corrections to UE policy section management result	15.3.0
2019-03	CT#83	CP-190085	0785	1	F	Removal of abnormal case handling for collision between initial registration and paging or notification	15.3.0
2019-03	CT#83	CP-190085	0788		D	DNN as a common IE	15.3.0
2019-03	CT#83	CP-190085	0791	2	F	Generic UE configuration update procedure during registration procedure	15.3.0
2019-03	CT#83	CP-190085	0792		D	References for NAS signalling connection recovery and a fallback indication from the lower layers	15.3.0
2019-03	CT#83	CP-190086	0796	1	F	Corrections on fallback indication from lower layers	15.3.0
2019-03	CT#83	CP-190086	0798	2	F	Correction to the notification procedure	15.3.0
2019-03	CT#83	CP-190086	0801	1	D	Correction on sub-clause numbering	15.3.0
2019-03	CT#83	CP-190086	0802	3	F	Handling of QoS flow description without valid EPS bearer contextt	15.3.0
2019-03	CT#83	CP-190086	0803		F	Correction on the lengths of 5GSM procedures	15.3.0
2019-03	CT#83	CP-190086	0804	2	F	Corrections on Mapped EPS bearer context IE	15.3.0
2019-03	CT#83	CP-190086	0805	2	F	Handling of missing QoS flow description and QoS rule	15.3.0
2019-03	CT#83	CP-190086	0806	3	F	UE re-registration following UE parameters update	15.3.0
2019-03	CT#83	CP-190086	0807	1	F	Clarification on providing NSSAI to the lower layer	15.3.0
2019-03	CT#83	CP-190086	0808	1	F	Adjustment of relevent timers when T3346 is included in the 5GMM message	15.3.0
2019-03	CT#83	CP-190086	0809	1	F	Clarification on PDU Session Modification procedure	15.3.0
2019-03	CT#83	CP-190086	0810	1	F	Clarification on the behaviors of UE and SMF during the inter-system change	15.3.0
2019-03	CT#83	CP-190086	0812	2	F	Several corrections to messages and IEs	15.3.0
2019-03	CT#83	CP-190086	0814	2	F	Correction to IEI values	15.3.0

2019-03	CT#83	CP-190086	0815	2	F	Resolution on editor's notes on whether explicit start and stop indications for SMS over NAS is needed	15.3.0
2019-03	CT#83	CP-190086	0817		F	Correction to the definition of UE STATE INDICATION message content	15.3.0
2019-03	CT#83	CP-190086	0819	1	F	Reference corrections on UE's state change due to congestion control	15.3.0
2019-03	CT#83	CP-190086	0820	3	F	Correction to behaviour upon receipt of 5GMM reject cause for a UE in single-registration mode	15.3.0
2019-03	CT#83	CP-190086	0821	1	F	Informing the UE about the integrity protection failure at S1 to N1 mode change	15.3.0
2019-03	CT#83	CP-190086	0823	1	F	Handling of abnormal case when UE gets UE policies with incorrect PLMN ID	15.3.0
2019-03	CT#83	CP-190087	0824		F	Abnormal case handling for cause#72	15.3.0
2019-03	CT#83	CP-190087	0829	3	F	Correction on handling of invalid PSI	15.3.0
2019-03	CT#83	CP-190087	0831		F	Correction for missing 5QIs	15.3.0
2019-03	CT#83	CP-190174	0833	4	F	Possible criterion for the selection of the requested NSSAI	15.3.0
2019-03	CT#83	CP-190087	0834	2	F	Skip barring checks during fallback handling	15.3.0
2019-03	CT#83	CP-190087	0835	1	F	Correct missing Non-3GPP NW policies IE	15.3.0
2019-03	CT#83	CP-190087	0836	1	F	5G-GUTI provided to lower layer	15.3.0
2019-03	CT#83	CP-190087	0838	1	F	Handling of abnormal authentication errors	15.3.0
2019-03	CT#83	CP-190087	0839	1	F	Update the conditions on the AMF to provide the configured NSSAI to the UE	15.3.0
2019-03	CT#83	CP-190087	0844	1	F	Rejected NSSAI for current registration area	15.3.0
2019-03	CT#83	CP-190087	0845	1	F	Removal of Editor's note on home network public key and home network public key identifier update and removal of protection scheme identifier	15.3.0
2019-03	CT#83	CP-190087	0846	1	F	Update of PDU session authentication and authorization messages	15.3.0
2019-03	CT#83	CP-190087	0847	2	F	Update of error handling for Mapped EPS bearer contexts IE	15.3.0
2019-03	CT#83	CP-190087	0849	1	F	Correction for Cause code #7	15.3.0
2019-03	CT#83	CP-190087	0854	1	F	3GPP PS Data Off UE status change and congestion control in AMF - alternative 2	15.3.0
2019-03	CT#83	CP-190087	0855	1	F	Retransmission of PDU SESSION ESTABLISHMENT REQUEST	15.3.0
2019-03	CT#83	CP-190087	0856	1	F	Retransmission of PDU SESSION MODIFICATION REQUEST	15.3.0
2019-03	CT#83	CP-190087	0857	1	F	Retransmission of PDU SESSION RELEASE REQUEST	15.3.0
2019-03	CT#83	CP-190087	0859	1	F	Correction in EAP handling	15.3.0
2019-03	CT#83	CP-190087	0860		F	Issue in SNN	15.3.0
2019-03	CT#83	CP-190087	0862	2	F	Temporary identity allocation	15.3.0
2019-03	CT#83	CP-190088	0863		F	Initial maximum number of packet filters for associated PDU session	15.3.0
2019-03	CT#83	CP-190088	0864	1	F	SUCI to be used for the registration for emergency services	15.3.0
2019-03	CT#83	CP-190088	0867		F	Correction to the inclusion of requested QoS rule and requested QoS flow description in PDU session modification request.	15.3.0
2019-03	CT#83	CP-190088	0868	1	F	Wrong message name	15.3.0
2019-03	CT#83	CP-190088	0870	2	F	SUCI applicability	15.3.0
2019-03	CT#83	CP-190088	0873	1	F	Transmission failure at UE side for UE policy delivery procedure	15.3.0
2019-03	CT#83	CP-190088	0875	2	F	Upper layer request while T3540 is running	15.3.0
2019-03	CT#83	CP-190088	0876	1	F	Encoding of Routing indicator set to default value 0	15.3.0
2019-03	CT#83	CP-190088	0877	2	F	OS Id information element	15.3.0
2019-03	CT#83	CP-190088	0878	1	F	Clarification on deregistration procedure.	15.3.0
2019-03	CT#83	CP-190088	0880	1	D	Correction of the use of word "wants"	15.3.0
2019-03	CT#83	CP-190088	0883	1	F	Handling on errors of QoS flow description operations	15.3.0

2019-03	CT#83	CP-190088	0885	1	F	Addressing missing scenarios and providing other clarifications related to fallback indication	15.3.0
2019-03	CT#83	CP-190088	0888	2	F	Handling when the UE indicated security capabilities are invalid or unacceptable	15.3.0
2019-03	CT#83	CP-190088	0889	1	F	Correction in UE-initiated de-registration procedure initiation	15.3.0
2019-03	CT#83	CP-190088	0891	1	F	Reporting QoS error when a delete or modify operation is received for a non-existent QoS rule	15.3.0
2019-03	CT#83	CP-190088	0892	1	F	Presence of the precedence and QFI fields in QoS rules	15.3.0
2019-03	CT#83	CP-190088	0894	2	F	Mandating UE sending registration complete for SOR	15.3.0
2019-03	CT#83	CP-190088	0895	1	F	Improvement on 5G-GUTI allocation after network triggered service request	15.3.0
2019-03	CT#83	CP-190088	0899	2	F	Clarification on the authorized QoS rule modification	15.3.0
2019-03	CT#83	CP-190089	0901	1	F	Clarification on congestion control upon intersystem change	15.3.0
2019-03	CT#83	CP-190089	0902	4	F	Default EPS bearer associates with the default QoS rule	15.3.0
2019-03	CT#83	CP-190089	0907	2	F	NSSAI inclusion mode, EPLMNs, and registration area	15.3.0
2019-03	CT#83	CP-190089	0910	2	F	5GSM messages for a PDU session associated with non-3GPP access exchanged via 3GPP access	15.3.0
2019-03	CT#83	CP-190089	0911	1	F	Mobility and periodic registration update initiation by a UE in inactive mode reselecting an EPLMN cell	15.3.0
2019-03	CT#83	CP-190089	0912	1	F	Change of N1 mode capability on UE mode change or on IMS availability change	15.3.0
2019-03	CT#83	CP-190089	0914	1	F	Inclusion of a 5G-GUTI mapped from the valid 4G-GUTI in the REGISTRATION REQUEST message during an initial registration is not available in Rel-15	15.3.0
2019-03	CT#83	CP-190209	0915	3	F	Correction to the REGISTRATION REQUEST msg when the Payload container IE is included	15.3.0
2019-03	CT#83	CP-190089	0917	1	F	Correction to the length of the IMEISV	15.3.0
2019-03	CT#83	CP-190089	0918	1	F	Correction on handling of downlink signalling and data for non-3GPP PDU session	15.3.0
2019-03	CT#83	CP-190089	0919		F	Correction to the Payload container IE	15.3.0
2019-03	CT#83	CP-190089	0920		F	Correction to several 5GMM IEs	15.3.0
2019-03	CT#83	CP-190089	0921	1	F	Mapped configured S-NSSAI from the S-NSSAI(s) of the HPLMN	15.3.0
2019-03	CT#83	CP-190089	0922		F	Use of stored NSSAI inclusion mode during initial registration	15.3.0
2019-03	CT#83	CP-190089	0923		F	Correction to the Operator-defined access category definitions IE t	15.3.0
2019-03	CT#83	CP-190089	0925	1	F	Non-delivery of PDU SESSION ESTABLISHMENT ACCEPT	15.3.0
2019-03	CT#83	CP-190089	0926	1	F	Correction to Service area list IE Type of list "11"	15.3.0
2019-03	CT#83	CP-190089	0927	1	F	Setting of 5GSM cause value #36 regular deactivation	15.3.0
2019-03	CT#83	CP-190092	0929	3	F	Local release	15.3.0
2019-03	CT#83	CP-190089	0930	1	F	Adding the UE local configuration option in 24.501	15.3.0
2019-03	CT#83	CP-190089	0933		F	Handling of Replayed S1 UE security capabilities IE in Security Mode Command message	15.3.0
2019-03	CT#83	CP-190089	0934	2	F	Clarifications on use of PCF-provided PTI for UE policies delivery	15.3.0

2019-06	CT#84	CP-191124	0947	2	F	Precedence between access identities for derivation of RRC establishment cause and for derivation of establishment cause for non-3GPP access	15.4.0
2019-06	CT#84	CP-191122	0952	1	F	Correction on T3396	15.4.0
2019-06	CT#84	CP-191123	0956	2	F	Handling of PS Data Off status update	15.4.0
2019-06	CT#84	CP-191124	0958	1	F	SR procedure for emergency services fallback when T3346 timer running	15.4.0
2019-06	CT#84	CP-191122	0991	2	F	Correction on the 5GSM S-NSSAI congestion control	15.4.0
2019-06	CT#84	CP-191122	0994	1	F	Correction on the SMS over NAS	15.4.0
2019-06	CT#84	CP-191123	1001	1	F	EPS bearer synchronization when moving from EPC to 5GC	15.4.0
2019-06	CT#84	CP-191122	1024		F	Correction of timer table	15.4.0
2019-06	CT#84	CP-191124	1032	1	F	Network initiated deregistration update for cause #3 and #6	15.4.0
2019-06	CT#84	CP-191122	1040	1	F	Correct UE parameters update data type	15.4.0
2019-06	CT#84	CP-191124	1049	1	F	PDU SESSION ESTABLISHMENT message sent via target access in case of handover of an existing PDU session between 3GPP access and non-3GPP access	15.4.0
2019-06	CT#84	CP-191124	1063	2	F	Indication of resume failure from the lower layer	15.4.0
2019-06	CT#84	CP-191123	1069	4	F	Correction to the Payload container IE	15.4.0
2019-06	CT#84	CP-191122	1072	3	F	Correction because of wrong implementation of CR0763 and CR0919	15.4.0
2019-06	CT#84	CP-191124	1074	2	F	Resolution of editor's notes on handling at emergency registration and emergency PDU sessions	15.4.0
2019-06	CT#84	CP-191124	1076	2	F	Resolution of editor's notes on handling at non-existing 5G NAS security context indicated by the UE when an emergency PDU session exists	15.4.0
2019-06	CT#84	CP-191122	1093	1	F	Correction on handling of mapped EPS bearer contexts IE	15.4.0
2019-06	CT#84	CP-191122	1108	1	F	Addition of missing codepoints for 5GSM causes	15.4.0
2019-06	CT#84	CP-191122	1120	3	F	Access control and indication that access barring is applicable for all access categories except categories '0' and '2'	15.4.0
2019-06	CT#84	CP-191122	1123	1	F	5GSM cause value #29 semantic extension	15.4.0
2019-06	CT#84	CP-191124	1127	4	F	NSSAI inclusion mode in ePLMN	15.4.0
2019-06	CT#84	CP-191123	1132	1	F	Handling of PDU session modification while a back-off timer is running	15.4.0
2019-06	CT#84	CP-191124	1139	1	F	UE policy length mismatch	15.4.0
2019-06	CT#84	CP-191123	1150	1	F	Indicating PS data off status report for the UE in the Non-allowed Area	15.4.0
2019-06	CT#84	CP-191123	1163	3	F	Handling of the ABBA parameter with a non-zero value and a length of more than 2 octets	15.4.0
2019-06	CT#84	CP-191123	1167		F	IEI for the Non-3GPP NW provided policies IE	15.4.0
2019-06	CT#84	CP-191123	1170		F	Correction to serving network name (SNN) reference	15.4.0
2019-06	CT#84	CP-191123	1172	1	F	IEI for the UE OS Id IE	15.4.0
2019-06	CT#84	CP-191122	1184	1	F	Always-on PDU session	15.4.0
2019-06	CT#84	CP-191123	1194	1	F	DNN based congestion control for PDU session for LADN	15.4.0
2019-06	CT#84	CP-191124	1202	2	F	Network initiated EPS bearer synchronization when moving from EPC to 5GC	15.4.0
2019-06	CT#84	CP-191122	1218	1	F	Alignment of the 5G ciphering and integrity algorithm identifiers	15.4.0
2019-06	CT#84	CP-191124	1237	1	F	QoS flow for SIP signalling after inter-system change	15.4.0



2019-06	CT#84	CP-191124	1244	I	F	Indication of syntactical or semantic errors related to SM policy association to UE	15.4.0
2019-06	CT#84	CP-191123	1250	I	F	Correction to handling of cause #72	15.4.0
2019-06	CT#84	CP-191123	1267		F	Deletion of the 5GSM cause IE in the PDU SESSION MODIFICATION COMPLETE message	15.4.0

---

## History

<b>Document history</b>		
V15.0.0	July 2018	Publication
V15.1.0	October 2018	Publication
V15.2.1	April 2019	Publication
V15.3.0	May 2019	Publication
V15.4.0	July 2019	Publication