

ETSI TS 124 519 V16.3.0 (2021-01)



**5G;
5G System (5GS);
Time-Sensitive Networking (TSN) Application Function (AF)
to Device-Side TSN Translator (DS-TT)
and Network-Side TSN Translator (NW-TT) protocol aspects;
Stage 3
(3GPP TS 24.519 version 16.3.0 Release 16)**



Reference

RTS/TSGC-0124519vg30

Keywords

5G

ETSI

650 Route des Lucioles
F-06921 Sophia Antipolis Cedex - FRANCE

Tel.: +33 4 92 94 42 00 Fax: +33 4 93 65 47 16

Siret N° 348 623 562 00017 - NAF 742 C
Association à but non lucratif enregistrée à la
Sous-Préfecture de Grasse (06) N° 7803/88

Important notice

The present document can be downloaded from:

<http://www.etsi.org/standards-search>

The present document may be made available in electronic versions and/or in print. The content of any electronic and/or print versions of the present document shall not be modified without the prior written authorization of ETSI. In case of any existing or perceived difference in contents between such versions and/or in print, the prevailing version of an ETSI deliverable is the one made publicly available in PDF format at www.etsi.org/deliver.

Users of the present document should be aware that the document may be subject to revision or change of status.

Information on the current status of this and other ETSI documents is available at

<https://portal.etsi.org/TB/ETSIDeliverableStatus.aspx>

If you find errors in the present document, please send your comment to one of the following services:

<https://portal.etsi.org/People/CommitteeSupportStaff.aspx>

Copyright Notification

No part may be reproduced or utilized in any form or by any means, electronic or mechanical, including photocopying and microfilm except as authorized by written permission of ETSI.

The content of the PDF version shall not be modified without the written authorization of ETSI.

The copyright and the foregoing restriction extend to reproduction in all media.

© ETSI 2021.

All rights reserved.

DECT™, **PLUGTESTS™**, **UMTS™** and the ETSI logo are trademarks of ETSI registered for the benefit of its Members.

3GPP™ and **LTE™** are trademarks of ETSI registered for the benefit of its Members and of the 3GPP Organizational Partners.

oneM2M™ logo is a trademark of ETSI registered for the benefit of its Members and of the oneM2M Partners.

GSM® and the GSM logo are trademarks registered and owned by the GSM Association.

Intellectual Property Rights

Essential patents

IPRs essential or potentially essential to normative deliverables may have been declared to ETSI. The information pertaining to these essential IPRs, if any, is publicly available for **ETSI members and non-members**, and can be found in ETSI SR 000 314: "*Intellectual Property Rights (IPRs); Essential, or potentially Essential, IPRs notified to ETSI in respect of ETSI standards*", which is available from the ETSI Secretariat. Latest updates are available on the ETSI Web server (<https://ipr.etsi.org/>).

Pursuant to the ETSI IPR Policy, no investigation, including IPR searches, has been carried out by ETSI. No guarantee can be given as to the existence of other IPRs not referenced in ETSI SR 000 314 (or the updates on the ETSI Web server) which are, or may be, or may become, essential to the present document.

Trademarks

The present document may include trademarks and/or tradenames which are asserted and/or registered by their owners. ETSI claims no ownership of these except for any which are indicated as being the property of ETSI, and conveys no right to use or reproduce any trademark and/or tradename. Mention of those trademarks in the present document does not constitute an endorsement by ETSI of products, services or organizations associated with those trademarks.

Legal Notice

This Technical Specification (TS) has been produced by ETSI 3rd Generation Partnership Project (3GPP).

The present document may refer to technical specifications or reports using their 3GPP identities. These shall be interpreted as being references to the corresponding ETSI deliverables.

The cross reference between 3GPP and ETSI identities can be found under <http://webapp.etsi.org/key/queryform.asp>.

Modal verbs terminology

In the present document "**shall**", "**shall not**", "**should**", "**should not**", "**may**", "**need not**", "**will**", "**will not**", "**can**" and "**cannot**" are to be interpreted as described in clause 3.2 of the [ETSI Drafting Rules](#) (Verbal forms for the expression of provisions).

"**must**" and "**must not**" are **NOT** allowed in ETSI deliverables except when used in direct citation.

Contents

Intellectual Property Rights	2
Legal Notice	2
Modal verbs terminology.....	2
Foreword.....	6
1 Scope	8
2 References	8
3 Definitions of terms, symbols and abbreviations	8
3.1 Terms.....	8
3.2 Abbreviations	9
4 General	9
5 Elementary procedures between TSN AF and DS-TT	9
5.1 General	9
5.2 Procedures	10
5.2.1 Network-requested Ethernet port management procedure	10
5.2.1.1 General	10
5.2.1.2 Network-requested Ethernet port management procedure initiation	10
5.2.1.3 Network-requested Ethernet port management procedure completion	10
5.2.1.4 Abnormal cases on the network side	11
5.2.1.5 Abnormal cases in the DS-TT	11
5.2.2 DS-TT-initiated Ethernet port management procedure.....	11
5.2.2.1 General	11
5.2.2.2 DS-TT-initiated Ethernet port management procedure initiation.....	11
5.2.2.3 DS-TT-initiated Ethernet port management procedure accepted by the TSN AF.....	12
5.2.2.4 DS-TT-initiated Ethernet port management procedure completion	12
5.2.2.5 Abnormal cases on the network side	12
5.2.2.6 Abnormal cases in the DS-TT.....	12
5.2.3 DS-TT-initiated Ethernet port management capability procedure	13
5.2.3.1 General	13
5.2.3.2 DS-TT-initiated Ethernet port management capability procedure	13
6 Elementary procedures between TSN AF and NW-TT.....	13
6.1 General	13
6.2 Procedures for Ethernet port management service	14
6.2.1 TSN AF-requested Ethernet port management procedure	14
6.2.1.1 General	14
6.2.1.2 TSN AF-requested Ethernet port management procedure initiation	14
6.2.1.3 TSN AF-requested Ethernet port management procedure completion.....	14
6.2.1.4 Abnormal cases in the TSN AF.....	15
6.2.1.5 Abnormal cases in the NW-TT	15
6.2.2 NW-TT-initiated Ethernet port management procedure	15
6.2.2.1 General	15
6.2.2.2 NW-TT-initiated Ethernet port management procedure initiation	15
6.2.2.3 NW-TT-initiated Ethernet port management procedure completion.....	16
6.2.2.4 Abnormal cases in the TSN AF.....	16
6.2.2.5 Abnormal cases in the NW-TT	16
6.3 Procedures for Bridge management service	16
6.3.1 TSN AF-requested Bridge management procedure	16
6.3.1.1 General	16
6.3.1.2 TSN AF-requested Bridge management procedure initiation	17
6.3.1.3 TSN AF-requested Bridge management procedure completion.....	17
6.3.1.4 Abnormal cases in the TSN AF.....	18
6.3.1.5 Abnormal cases in the NW-TT	18
6.3.2 NW-TT-initiated Bridge management procedure	18

6.3.2.1	General	18
6.3.2.2	NW-TT-initiated Bridge management procedure initiation	18
6.3.2.3	NW-TT-initiated Bridge management procedure completion.....	19
6.3.2.4	Abnormal cases in the TSN AF.....	19
6.3.2.5	Abnormal cases in the NW-TT	19
7	Handling of unknown, unforeseen, and erroneous Ethernet port management service and bridge management service data.....	20
7.1	General	20
7.2	Message too short or too long	20
7.2.1	Message too short	20
7.2.2	Message too long	20
7.3	Unknown or unforeseen message type	20
7.4	Non-semantic mandatory information element errors	21
7.5	Unknown and unforeseen IEs in the non-imperative message part.....	21
7.5.1	IEs unknown in the message	21
7.5.2	Out of sequence IEs	21
7.5.3	Repeated IEs	21
7.6	Non-imperative message part errors.....	22
7.6.1	General.....	22
7.6.2	Syntactically incorrect optional IEs	22
7.6.3	Conditional IE errors	22
7.7	Messages with semantically incorrect contents	22
8	Message functional definition and contents	22
8.1	Manage Ethernet port command	22
8.1.1	Message definition	22
8.2	Manage Ethernet port complete.....	23
8.2.1	Message definition	23
8.2.2	Ethernet port management capability	23
8.2.3	Ethernet port status	23
8.2.4	Ethernet port update result.....	23
8.3	Ethernet port management notify	23
8.3.1	Message definition	23
8.4	Ethernet port management notify ack.....	24
8.4.1	Message definition.....	24
8.5	Ethernet port management notify complete.....	24
8.5.1	Message definition	24
8.6	Ethernet port management capability.....	25
8.6.1	Message definition	25
8.6.2	Void	25
8.7	Manage Bridge command	25
8.7.1	Message definition	25
8.8	Manage Bridge complete.....	25
8.8.1	Message definition	25
8.8.2	Bridge management capability	26
8.8.3	Bridge status	26
8.8.4	Bridge update result	26
8.9	Bridge management notify	26
8.9.1	Message definition	26
8.10	Bridge management notify ack.....	26
8.10.1	Message definition	26
9	Information elements coding.....	27
9.1	Ethernet port management service message type	27
9.2	Ethernet port management list.....	27
9.3	Ethernet port management capability	35
9.4	Ethernet port status	36
9.5	Ethernet port update result.....	38
9.5A	Bridge management service message type	41
9.5B	Bridge management list.....	42
9.5C	Bridge management capability	48
9.5D	Bridge status.....	49

9.5E	Bridge update result.....	51
9.6	Static filtering entries	54
9.7	Traffic class table	55
9.8	Stream filter instance table	59
9.9	Stream gate instance table	64
9.10	DS-TT port neighbor discovery configuration for DS-TT ports	66
9.11	Discovered neighbor information for DS-TT ports	68
9.12	TSN AF feature support	69
9.13	TT feature support	70
9.14	NW-TT port numbers	70
10	Timers of Ethernet port management service.....	71
Annex A (informative): Change history		73
History		74

Foreword

This Technical Specification has been produced by the 3rd Generation Partnership Project (3GPP).

The contents of the present document are subject to continuing work within the TSG and may change following formal TSG approval. Should the TSG modify the contents of the present document, it will be re-released by the TSG with an identifying change of release date and an increase in version number as follows:

Version x.y.z

where:

- x the first digit:
 - 1 presented to TSG for information;
 - 2 presented to TSG for approval;
 - 3 or greater indicates TSG approved document under change control.
- y the second digit is incremented for all changes of substance, i.e. technical enhancements, corrections, updates, etc.
- z the third digit is incremented when editorial only changes have been incorporated in the document.

In the present document, modal verbs have the following meanings:

- shall** indicates a mandatory requirement to do something
- shall not** indicates an interdiction (prohibition) to do something

The constructions "shall" and "shall not" are confined to the context of normative provisions, and do not appear in Technical Reports.

The constructions "must" and "must not" are not used as substitutes for "shall" and "shall not". Their use is avoided insofar as possible, and they are not used in a normative context except in a direct citation from an external, referenced, non-3GPP document, or so as to maintain continuity of style when extending or modifying the provisions of such a referenced document.

- should** indicates a recommendation to do something
- should not** indicates a recommendation not to do something
- may** indicates permission to do something
- need not** indicates permission not to do something

The construction "may not" is ambiguous and is not used in normative elements. The unambiguous constructions "might not" or "shall not" are used instead, depending upon the meaning intended.

- can** indicates that something is possible
- cannot** indicates that something is impossible

The constructions "can" and "cannot" are not substitutes for "may" and "need not".

- will** indicates that something is certain or expected to happen as a result of action taken by an agency the behaviour of which is outside the scope of the present document
- will not** indicates that something is certain or expected not to happen as a result of action taken by an agency the behaviour of which is outside the scope of the present document
- might** indicates a likelihood that something will happen as a result of action taken by some agency the behaviour of which is outside the scope of the present document

might not indicates a likelihood that something will not happen as a result of action taken by some agency the behaviour of which is outside the scope of the present document

In addition:

is (or any other verb in the indicative mood) indicates a statement of fact

is not (or any other negative verb in the indicative mood) indicates a statement of fact

The constructions "is" and "is not" do not indicate requirements.

1 Scope

The present document specifies the protocols of communication between a DS-TT and a TSN AF or a NW-TT and a TSN AF as specified in 3GPP TS 23.501 [2] for:

- a) Ethernet port management; and
- b) Bridge management.

2 References

The following documents contain provisions which, through reference in this text, constitute provisions of the present document.

- References are either specific (identified by date of publication, edition number, version number, etc.) or non-specific.
- For a specific reference, subsequent revisions do not apply.
- For a non-specific reference, the latest version applies. In the case of a reference to a 3GPP document (including a GSM document), a non-specific reference implicitly refers to the latest version of that document *in the same Release as the present document*.

- [1] 3GPP TR 21.905: "Vocabulary for 3GPP Specifications".
- [2] 3GPP TS 23.501: "System Architecture for the 5G System; Stage 2".
- [3] 3GPP TS 23.502: "Procedures for the 5G System; Stage 2".
- [4] 3GPP TS 24.007: "Mobile radio interface signalling layer 3; General aspects".
- [5] 3GPP TS 24.501: "Non-Access-Stratum (NAS) protocol for 5G System (5GS); Stage 3".
- [5A] 3GPP TS 29.244: "Interface between the Control Plane and the User Plane nodes".
- [5B] 3GPP TS 29.512: "5G System; Session Management Policy Control Service; Stage 3".
- [6] IEEE Std 802.1AB-2016: "IEEE Standard for Local and metropolitan area networks -- Station and Media Access Control Connectivity Discovery".
- [7] IEEE Std 802.1Q-2018: "Standard for Local and metropolitan area networks--Bridges and Bridged Networks".
- [8] Void
- [9] IEEE Std 802.1Qcc-2018: "Standard for Local and metropolitan area networks - Bridges and Bridged Networks - Amendment: Stream Reservation Protocol (SRP) Enhancements and Performance Improvements".
- [10] IEEE Std 802.1CB-2017: "IEEE Standard for Local and metropolitan area networks-Frame Replication and Elimination for Reliability".

3 Definitions of terms, symbols and abbreviations

3.1 Terms

For the purposes of the present document, the terms given in 3GPP TR 21.905 [1] and the following apply. A term defined in the present document takes precedence over the definition of the same term, if any, in 3GPP TR 21.905 [1].

example: text used to clarify abstract rules by applying them literally.

For the purposes of the present document, the following terms and definitions given in 3GPP TS 23.501 [2] apply:

**5G System
Time Sensitive Communication**

3.2 Abbreviations

For the purposes of the present document, the abbreviations given in 3GPP TR 21.905 [1] and the following apply. An abbreviation defined in the present document takes precedence over the definition of the same abbreviation, if any, in 3GPP TR 21.905 [1].

5GS	5G System
AF	Application function
BMS	Bridge Management Service
CNC	Centralized Network Configuration
DS-TT	Device-Side TSN Translator
EPMS	Ethernet port management service
NW-TT	Network-Side TSN Translator
TSC	Time Sensitive Communication
TSN	Time-Sensitive Networking

4 General

For time sensitive communication (TSC), a 5G system (5GS) can be integrated as a bridge in a time-sensitive networking (TSN) network (i.e. a TSN bridge).

The device-side TSN translator (DS-TT) is deployed at the UE-side edge and the network-side TSN translator (NW-TT) is deployed at the network-side edge in order to interface with a TSN network while achieving transparency (see 3GPP TS 23.501 [2]). In addition, the TSN application function (TSN AF) is deployed to exchange TSN bridge information with the centralized network configuration (CNC) as defined in IEEE Std 802.1Qcc-2018 [9]. The TSN bridge information includes port management information and bridge management information. Port management information is related to Ethernet ports located in the DS-TT and NW-TT. Bridge management information is related to the NW-TT.

In order to support TSN bridge information exchange between TSN AF and CNC, the DS-TT, NW-TT, and TSN AF support procedures for Ethernet port management and Bridge management. Clause 5 describes details of the elementary procedures between TSN AF and DS-TT for Ethernet port management. Clause 6 describes details of the elementary procedures between TSN AF and NW-TT for Ethernet port management (clause 6.2) and Bridge management (clause 6.3).

5 Elementary procedures between TSN AF and DS-TT

5.1 General

The UE and the network may support transfer of standardized and deployment-specific Ethernet port management information between a time-sensitive networking (TSN) AF and the DS-TT at the UE, to manage the Ethernet port used at the DS-TT for a PDU session of "Ethernet" PDU session type. The Ethernet port management messages are included in a Port management information container IE and transported using the UE-requested PDU session establishment procedure, the network-requested PDU session modification procedure or the UE-requested PDU session modification procedure as specified in 3GPP TS 24.501 [5] subclauses 6.4.1.2, 6.3.2 and 6.4.2.

5.2 Procedures

5.2.1 Network-requested Ethernet port management procedure

5.2.1.1 General

The purpose of the network-requested Ethernet port management procedure is to enable the TSN AF to:

- obtain the list of port management parameters supported by the DS-TT;
- obtain the current values of port management parameters at the DS-TT Ethernet port;
- set the values of port management parameters at the DS-TT Ethernet port;
- subscribe to be notified by the DS-TT if the values of certain port management parameters change at the DS-TT Ethernet port; or
- unsubscribe to be notified by the DS-TT for one or more port management parameters.

5.2.1.2 Network-requested Ethernet port management procedure initiation

In order to initiate the network-requested Ethernet port management procedure, the TSN AF shall:

- encode the information about the port management parameters values to be read, the port management parameters values to be set, the port management parameters changes to (un)subscribe to and whether the TSN AF requests the list of port management parameters supported by the DS-TT in an Ethernet port management list IE as specified in clause 9.2 and include it in a MANAGE ETHERNET PORT COMMAND message;
- send the MANAGE ETHERNET PORT COMMAND message to the UE via the PCF and the SMF as specified in 3GPP TS 23.502 [3]; and
- start timer T100 (see example in figure 5.2.1.2.1).

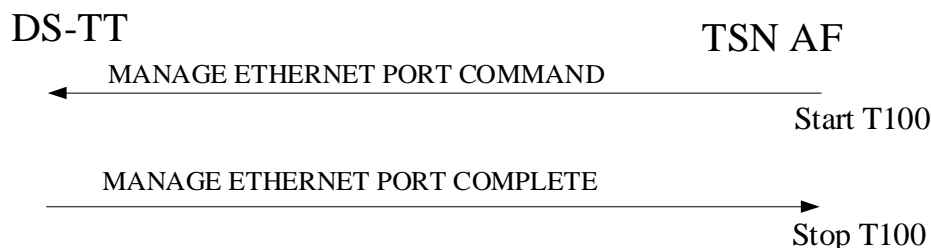

Figure 5.2.1.2.1: Network-requested Ethernet port management procedure

5.2.1.3 Network-requested Ethernet port management procedure completion

Upon receipt of the MANAGE ETHERNET PORT COMMAND message, for each operation included in the Ethernet port management list IE, the DS-TT shall:

- if the operation code is "get capabilities", include the list of Ethernet port management parameters supported by the DS-TT in the Ethernet port management capability IE of the MANAGE ETHERNET PORT COMPLETE message;
- if the operation code is "read parameter", attempt to read the value of the parameter at the DS-TT Ethernet port, and:
 - if the value of the parameter at the DS-TT Ethernet port is read successfully, include the parameter and its current value in the Ethernet port status IE of the MANAGE ETHERNET PORT COMPLETE message; and

- 2) if the value of the parameter at the DS-TT Ethernet port was not read successfully, include the parameter and associated Ethernet port management service cause value in the Ethernet port status IE of the MANAGE ETHERNET PORT COMPLETE message;
- c) if the operation code is "set parameter", attempt to set the value of the parameter at the DS-TT Ethernet port to the value specified in the operation, and:
 - 1) if the value of the parameter at the DS-TT Ethernet port is set successfully, include the parameter and its current value in the Ethernet port update result IE of the MANAGE ETHERNET PORT COMPLETE message; and
 - 2) if the value of the parameter at the DS-TT Ethernet port was not set successfully, include the parameter and associated Ethernet port management service cause value in the Ethernet port update result IE of the MANAGE ETHERNET PORT COMPLETE message;
- d) if the operation code is "subscribe-notify for parameter", store the request from the TSN AF to be notified of changes in the value of the corresponding parameter;
- e) if the operation code is "unsubscribe for parameter", delete the stored request from the TSN AF to be notified of changes in the value of the corresponding parameter, if any; and
- f) send the MANAGE ETHERNET PORT COMPLETE to the TSN AF via the SMF and the PCF as specified in 3GPP TS 23.502 [3].

5.2.1.4 Abnormal cases on the network side

The following abnormal cases can be identified:

- a) T100 expired.

The TSN AF shall, on the first expiry of the timer T100, retransmit the MANAGE ETHERNET PORT COMMAND message and shall reset and start timer T100. This retransmission is repeated four times, i.e. on the fifth expiry of timer T100, the TSN AF shall abort the procedure.

5.2.1.5 Abnormal cases in the DS-TT

The following abnormal cases can be identified:

- a) Transmission failure of the MANAGE ETHERNET PORT COMPLETE message indication from lower layers.

The DS-TT shall not diagnose an error and consider the network-initiated Ethernet port management procedure complete.

NOTE: Considering the network-initiated Ethernet port management procedure complete as a result of this abnormal case does not cause the DS-TT to revert the execution of the operations included in the MANAGE ETHERNET PORT COMMAND message.

5.2.2 DS-TT-initiated Ethernet port management procedure

5.2.2.1 General

The purpose of the DS-TT-initiated Ethernet port management procedure is to notify the TSN AF of one or more changes in the value of Ethernet port management parameters for which the TSN AF had requested to be notified of changes via the network-initiated Ethernet port management procedure.

5.2.2.2 DS-TT-initiated Ethernet port management procedure initiation

In order to initiate the DS-TT-initiated Ethernet port management procedure, the DS-TT shall create an ETHERNET PORT MANAGEMENT NOTIFY message and shall:

- a) include the Ethernet port management parameters to be reported to the TSN AF with their current value in the Ethernet port status IE of the ETHERNET PORT MANAGEMENT NOTIFY message;

- b) start timer T200; and
- c) send the ETHERNET PORT MANAGEMENT NOTIFY message to the TSN AF via the SMF and the PCF as specified in 3GPP TS 23.502 [3].

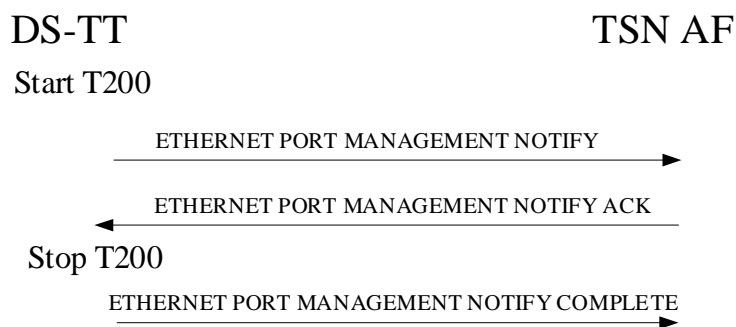

Figure 5.2.2.2.1: DS-TT-initiated Ethernet port management procedure

5.2.2.3 DS-TT-initiated Ethernet port management procedure accepted by the TSN AF

Upon receipt of the ETHERNET PORT MANAGEMENT NOTIFY message, the TSN AF shall:

- a) create a MANAGE ETHERNET PORT MANAGEMENT NOTIFY ACK message; and
- b) send the MANAGE ETHERNET PORT MANAGEMENT NOTIFY ACK message to the UE via the PCF and the SMF as specified in 3GPP TS 23.502 [3].

5.2.2.4 DS-TT-initiated Ethernet port management procedure completion

Upon receipt of the ETHERNET PORT MANAGEMENT NOTIFY ACK message, the DS-TT shall:

- a) stop timer T200;
- b) create an ETHERNET PORT MANAGEMENT NOTIFY COMPLETE message; and
- c) send the ETHERNET PORT MANAGEMENT NOTIFY COMPLETE message to the TSN AF via the SMF and the PCF as specified in 3GPP TS 23.502 [3].

5.2.2.5 Abnormal cases on the network side

The following abnormal cases can be identified:

- a) Transmission failure of the ETHERNET PORT MANAGEMENT NOTIFY ACK indication from lower layers.
The TSN AF shall not diagnose an error and consider the DS-TT-initiated Ethernet port management procedure complete.

5.2.2.6 Abnormal cases in the DS-TT

The following abnormal cases can be identified:

- a) T200 expired.
The DS-TT shall, on the first expiry of the timer T200, retransmit the ETHERNET PORT MANAGEMENT NOTIFY message and shall reset and start timer T200. This retransmission is repeated four times, i.e. on the fifth expiry of timer T200, the DS-TT shall abort the procedure.
- b) Transmission failure of the ETHERNET PORT MANAGEMENT NOTIFY COMPLETE message indication from lower layers.

The DS-TT shall not diagnose an error and consider the DS-TT-initiated Ethernet port management procedure complete.

5.2.3 DS-TT-initiated Ethernet port management capability procedure

5.2.3.1 General

The purpose of the DS-TT-initiated Ethernet port management capability procedure is to provide the DS-TT supported Ethernet port management capabilities to the TSN AF during PDU session establishment as specified in 3GPP TS 23.502 [3].

5.2.3.2 DS-TT-initiated Ethernet port management capability procedure

In order to initiate the DS-TT-initiated Ethernet port management capability procedure, the DS-TT shall create an ETHERNET PORT MANAGEMENT CAPABILITY message and shall:

- a) include the DS-TT Ethernet port management capabilities in the Ethernet port management capability IE of the ETHERNET PORT MANAGEMENT CAPABILITY message; and
- b) send the ETHERNET PORT MANAGEMENT CAPABILITY message to the TSN AF via the SMF and the PCF as specified in 3GPP TS 23.502 [3].



Figure 5.2.3.2.1: DS-TT-initiated Ethernet port management capability procedure

6 Elementary procedures between TSN AF and NW-TT

6.1 General

The TSN AF and NW-TT supports transfer of standardized and deployment-specific Ethernet port management information, to manage the Ethernet port used at the NW-TT. The TSN AF and NW-TT supports transfer of standardized and deployment-specific Bridge management information, to manage the NW-TT. The Ethernet port management messages are included in the "PortManagementContainer" data type (as specified in 3GPP TS 29.512 [5B]) and the Port Management Information Container IE (as specified in 3GPP TS 29.244 [5A]) and the Bridge management messages are included in the "BridgeManagementContainer" data type (as specified in 3GPP TS 29.512 [5B]) and the Bridge Management Information Container IE (as specified in 3GPP TS 29.244 [5A]). Both the Ethernet port management messages and the Bridge management messages are transported using the N4 Session Level Reporting Procedure and the SM policy association modification procedure as specified in 3GPP TS 23.502 [3].

6.2 Procedures for Ethernet port management service

6.2.1 TSN AF-requested Ethernet port management procedure

6.2.1.1 General

The purpose of the TSN AF-requested Ethernet port management procedure is to enable the TSN AF to:

- obtain the list of port management parameters supported by the NW-TT;
- obtain the current values of port management parameters at the NW-TT Ethernet port;
- set the values of port management parameters at the NW-TT Ethernet port; or
- subscribe to be notified by the NW-TT if the values of certain port management parameters change at the NW-TT Ethernet port; or
- unsubscribe to be notified by the NW-TT for one or more port management parameters.

6.2.1.2 TSN AF-requested Ethernet port management procedure initiation

In order to initiate the TSN AF-requested Ethernet port management procedure, the TSN AF shall:

- encode the information about the port management parameters values to be read, the port management parameters values to be set, the port management parameters changes to (un)subscribe to and whether the TSN AF requests the list of port management parameters supported by the NW-TT in an Ethernet port management list IE as specified in clause 9.2 and include it in a MANAGE ETHERNET PORT COMMAND message;
- send the MANAGE ETHERNET PORT COMMAND message to the NW-TT via the PCF and the SMF as specified in 3GPP TS 23.502 [3]; and
- start timer T100 (see example in figure 6.2.1.2.1).

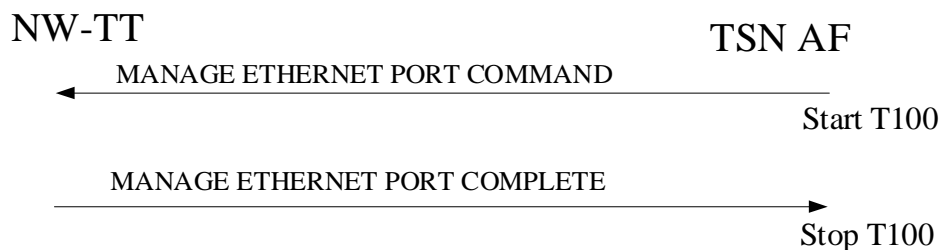

Figure 6.2.1.2.1: TSN AF-requested Ethernet port management procedure

6.2.1.3 TSN AF-requested Ethernet port management procedure completion

Upon receipt of the MANAGE ETHERNET PORT COMMAND message, for each operation included in the Ethernet port management list IE, the NW-TT shall:

- if the operation code is "get capabilities", include the list of Ethernet port management parameters supported by the NW-TT in the Ethernet port management capability IE of the MANAGE ETHERNET PORT COMPLETE message;
- if the operation code is "read parameter", attempt to read the value of the parameter at the NW-TT Ethernet port, and:
 - if the value of the parameter at the NW-TT Ethernet port is read successfully, include the parameter and its current value in the Ethernet port status IE of the MANAGE ETHERNET PORT COMPLETE message; and

- 2) if the value of the parameter at the NW-TT Ethernet port was not read successfully, include the parameter and associated Ethernet port management service cause value in the Ethernet port status IE of the MANAGE ETHERNET PORT COMPLETE message;
- c) if the operation code is "set parameter", attempt to set the value of the parameter at the NW-TT Ethernet port to the value specified in the operation, and:
 - 1) if the value of the parameter at the NW-TT Ethernet port is set successfully, include the parameter and its current value in the Ethernet port update result IE of the MANAGE ETHERNET PORT COMPLETE message; and
 - 2) if the value of the parameter at the NW-TT Ethernet port was not set successfully, include the parameter and associated Ethernet port management service cause value in the Ethernet port update result IE of the MANAGE ETHERNET PORT COMPLETE message;
- d) if the operation code is "subscribe-notify for parameter", store the request from the TSN AF to be notified of changes in the value of the corresponding parameter;
- e) if the operation code is "unsubscribe for parameter", delete the stored request from the TSN AF to be notified of changes in the value of the corresponding parameter, if any; and
- f) send the MANAGE ETHERNET PORT COMPLETE to the TSN AF via the SMF and the PCF as specified in 3GPP TS 23.502 [3].

6.2.1.4 Abnormal cases in the TSN AF

The following abnormal cases can be identified:

- a) T100 expired.

The TSN AF shall, on the first expiry of the timer T100, retransmit the MANAGE ETHERNET PORT COMMAND message and shall reset and start timer T100. This retransmission is repeated four times, i.e. on the fifth expiry of timer T35xx, the TSN AF shall abort the procedure.

6.2.1.5 Abnormal cases in the NW-TT

The following abnormal cases can be identified:

- a) Transmission failure of the MANAGE ETHERNET PORT COMPLETE message indication from lower layers.

The NW-TT shall not diagnose an error and consider the TSN AF-initiated Ethernet port management procedure complete.

NOTE: Considering that the TSN AF-initiated Ethernet port management procedure complete as a result of this abnormal case does not cause the NW-TT to revert the execution of the operations included in the MANAGE ETHERNET PORT COMMAND message.

6.2.2 NW-TT-initiated Ethernet port management procedure

6.2.2.1 General

The purpose of the NW-TT-initiated Ethernet port management procedure is to notify the TSN AF of one or more changes in the value of Ethernet port management parameters for which the TSN AF had requested to be notified of changes via the TSN AF-initiated Ethernet port management procedure.

6.2.2.2 NW-TT-initiated Ethernet port management procedure initiation

In order to initiate the NW-TT-initiated Ethernet port management procedure, the NW-TT shall create an ETHERNET PORT MANAGEMENT NOTIFY message and shall:

- a) include the Ethernet port management parameters to be reported to the TSN AF with their current value in the Ethernet port status IE of the ETHERNET PORT MANAGEMENT NOTIFY message;

- b) start timer T300; and
- c) send the ETHERNET PORT MANAGEMENT NOTIFY message to the TSN AF via the SMF and the PCF as specified in 3GPP TS 23.502 [3].

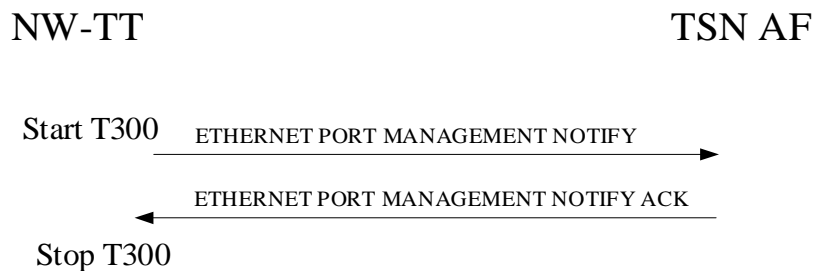

Figure 6.2.2.2.1: NW-TT-initiated Ethernet port management procedure

6.2.2.3 NW-TT-initiated Ethernet port management procedure completion

Upon receipt of the ETHERNET PORT MANAGEMENT NOTIFY message, the TSN AF shall:

- a) create an ETHERNET PORT MANAGEMENT NOTIFY ACK message; and
- b) send the ETHERNET PORT MANAGEMENT NOTIFY ACK message to the NW-TT via the PCF and the SMF as specified in 3GPP TS 23.502 [3].

Upon receipt of the ETHERNET PORT MANAGEMENT NOTIFY ACK message, the NW-TT shall stop timer T300.

6.2.2.4 Abnormal cases in the TSN AF

The following abnormal cases can be identified:

- a) Transmission failure of the ETHERNET PORT MANAGEMENT NOTIFY ACK indication from lower layers.
The TSN AF shall not diagnose an error and consider the NW-TT-initiated Ethernet port management procedure complete.

6.2.2.5 Abnormal cases in the NW-TT

The following abnormal cases can be identified:

- a) T300 expired.
The NW-TT shall, on the first expiry of the timer T300, retransmit the ETHERNET PORT MANAGEMENT NOTIFY message and shall reset and start timer T300. This retransmission is repeated four times, i.e. on the fifth expiry of timer T300, the NW-TT shall abort the procedure.

6.3 Procedures for Bridge management service

6.3.1 TSN AF-requested Bridge management procedure

6.3.1.1 General

The purpose of the TSN AF-requested Bridge management procedure is to enable the TSN AF to:

- a) obtain the list of bridge management parameters supported at the NW-TT;
- b) obtain the current values of bridge management parameters at the NW-TT;
- c) set the values of bridge management parameters at the NW-TT; or

- d) subscribe to be notified by the NW-TT if the values of certain bridge management parameters change at the NW-TT; or
- e) unsubscribe to be notified by the NW-TT for one or more bridge management parameters.

6.3.1.2 TSN AF-requested Bridge management procedure initiation

In order to initiate the TSN AF-requested Bridge management procedure, the TSN AF shall:

- a) encode the information about the bridge management parameters values to be read, the bridge management parameters values to be set, the bridge management parameters changes to (un)subscribe to and whether the TSN AF requests the list of bridge management parameters supported by the NW-TT in an Bridge management list IE as specified in clause 9.5B and include it in a MANAGE BRIDGE COMMAND message;
- b) send the MANAGE BRIDGE COMMAND message to the NW-TT via the PCF and the SMF as specified in 3GPP TS 23.502 [3]; and
- c) start timer T150 (see example in figure 6.3.1.2.1).

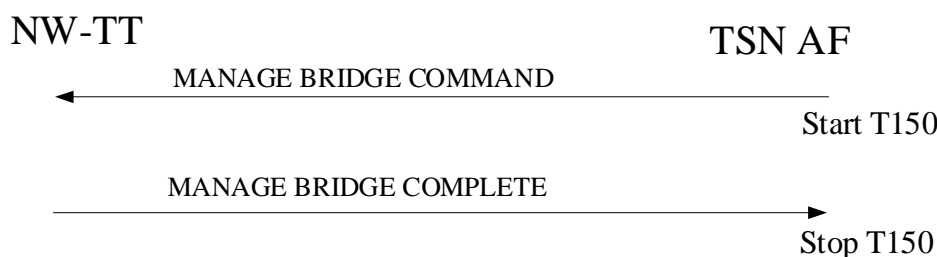

Figure 6.3.1.2.1: TSN AF-requested Bridge management procedure

6.3.1.3 TSN AF-requested Bridge management procedure completion

Upon receipt of the MANAGE BRIDGE COMMAND message, for each operation included in the Bridge management list IE, the NW-TT shall:

- a) if the operation code is "get capabilities", include the list of Bridge management parameters supported by the NW-TT in the Bridge management capability IE of the MANAGE BRIDGE COMPLETE message;
- b) if the operation code is "read parameter", attempt to read the value of the bridge management parameter at the NW-TT, and:
 - 1) if the value of the parameter at the NW-TT is read successfully, include the parameter and its current value in the Bridge status IE of the MANAGE BRIDGE COMPLETE message; and
 - 2) if the value of the parameter at the NW-TT was not read successfully, include the parameter and associated Bridge management service cause value in the Bridge status IE of the MANAGE BRIDGE COMPLETE message;
- c) if the operation code is "set parameter", attempt to set the value of the bridge management parameter at the NW-TT to the value specified in the operation, and:
 - 1) if the value of the parameter at the NW-TT is set successfully, include the parameter and its current value in the Bridge update result IE of the MANAGE BRIDGE COMPLETE message; and
 - 2) if the value of the parameter at the NW-TT was not set successfully, include the parameter and associated Bridge management service cause value in the Bridge update result IE of the MANAGE BRIDGE COMPLETE message;
- d) if the operation code is "subscribe-notify for parameter", store the request from the TSN AF to be notified of changes in the value of the corresponding bridge management parameter;

- e) if the operation code is "unsubscribe for parameter", delete the stored request from the TSN AF to be notified of changes in the value of the corresponding bridge management parameter, if any; and
- f) send the MANAGE BRIDGE COMPLETE to the TSN AF via the SMF and the PCF as specified in 3GPP TS 23.502 [3].

6.3.1.4 Abnormal cases in the TSN AF

The following abnormal cases can be identified:

- a) T150 expired.

The TSN AF shall, on the first expiry of the timer T150, retransmit the MANAGE BRIDGE COMMAND message and shall reset and start timer T150. This retransmission is repeated four times, i.e. on the fifth expiry of timer T150, the TSN AF shall abort the procedure.

6.3.1.5 Abnormal cases in the NW-TT

The following abnormal cases can be identified:

- a) Transmission failure of the MANAGE BRIDGE COMPLETE message indication from lower layers.

The NW-TT shall not diagnose an error and consider the TSN AF-initiated Bridge management procedure complete.

NOTE: Considering that the TSN AF-initiated Bridge management procedure complete as a result of this abnormal case does not cause the NW-TT to revert the execution of the operations included in the MANAGE BRIDGE COMMAND message.

6.3.2 NW-TT-initiated Bridge management procedure

6.3.2.1 General

The purpose of the NW-TT-initiated Bridge management procedure is to notify the TSN AF of one or more changes in the value of Bridge management parameters for which the TSN AF had requested to be notified of changes via the TSN AF-initiated Bridge management procedure.

6.3.2.2 NW-TT-initiated Bridge management procedure initiation

In order to initiate the NW-TT-initiated Bridge management procedure, the NW-TT shall create a BRIDGE MANAGEMENT NOTIFY message and shall:

- a) include the Bridge management parameters to be reported to the TSN AF with their current value in the Bridge status IE of the BRIDGE MANAGEMENT NOTIFY message;
- b) start timer T350; and
- c) send the BRIDGE MANAGEMENT NOTIFY message to the TSN AF via the SMF and the PCF as specified in 3GPP TS 23.502 [3].

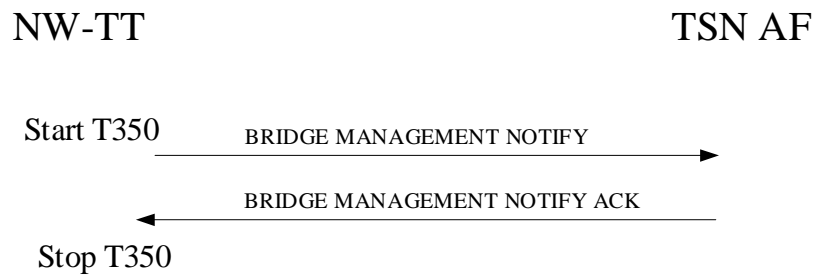

Figure 6.3.2.2.1: NW-TT-initiated Bridge management procedure

6.3.2.3 NW-TT-initiated Bridge management procedure completion

Upon receipt of the BRIDGE MANAGEMENT NOTIFY message, the TSN AF shall:

- a) create a MANAGE BRIDGE MANAGEMENT NOTIFY ACK message; and
- b) send the MANAGE BRIDGE MANAGEMENT NOTIFY ACK message to the NW-TT via the PCF and the SMF as specified in 3GPP TS 23.502 [3].

Upon receipt of the BRIDGE MANAGEMENT NOTIFY ACK message, the NW-TT shall stop timer T350.

6.3.2.4 Abnormal cases in the TSN AF

The following abnormal cases can be identified:

- a) Transmission failure of the BRIDGE MANAGEMENT NOTIFY ACK indication from lower layers.

The TSN AF shall not diagnose an error and consider the NW-TT-initiated Bridge management procedure complete.

6.3.2.5 Abnormal cases in the NW-TT

The following abnormal cases can be identified:

- a) T350 expired.

The NW-TT shall, on the first expiry of the timer T350, retransmit the BRIDGE MANAGEMENT NOTIFY message and shall reset and start timer T350. This retransmission is repeated four times, i.e. on the fifth expiry of timer T350, the NW-TT shall abort the procedure.

- b) Transmission failure of the BRIDGE MANAGEMENT NOTIFY COMPLETE message indication from lower layers.

The NW-TT shall not diagnose an error and consider the NW-TT-initiated Bridge management procedure complete.

7 Handling of unknown, unforeseen, and erroneous Ethernet port management service and bridge management service data

7.1 General

The procedures specified in clause 5 and clause 6 apply to those messages which pass the checks described in clause 7.

Clause 7 also specifies procedures for the handling of unknown, unforeseen, and erroneous Ethernet port management service (EPMS) and Bridge management service (BMS) data by the receiving entity. These procedures are called "error handling procedures", but in addition to providing recovery mechanisms for error situations they define a compatibility mechanism for future extensions of the EPMS or BMS.

Clauses 7.1 to 7.7 shall be applied in order of precedence.

Detailed error handling procedures in the TSN AF are implementation dependent and may vary from network to network. However, when extensions of EPMS or BMS are developed, TSN AFs are assumed to have the error handling which is indicated in this clause as mandatory ("shall") and that is indicated as strongly recommended ("should").

Also, the error handling of the TSN AF is only considered as mandatory or strongly recommended when certain thresholds for errors are not reached during a dedicated connection.

For definition of semantical and syntactical errors see 3GPP TS 24.007 [4], clause 11.4.2.

The procedures specified for TT are applicable for DS-TT or NW-TT.

7.2 Message too short or too long

7.2.1 Message too short

When a message is received that is too short to contain a complete message type information element, that message shall be ignored, cf. 3GPP TS 24.007 [4].

7.2.2 Message too long

The maximum size of an EPMS message sent by the DS-TT to the TSN AF or sent by the TSN AF to the DS-TT is 65535 octets. The maximum size of an EPMS message sent by the NW-TT to the TSN AF or sent by the TSN AF to the NW-TT is 65523 octets. The maximum size of a BMS message is 65531 octets.

7.3 Unknown or unforeseen message type

If the TT or the TSN AF receives an EPMS message with message type not defined for the EPMS or not implemented by the receiver, it shall ignore the EPMS message.

NOTE: A message type not defined for the EPMS in the given direction is regarded by the receiver as a message type not defined for the EPMS, see 3GPP TS 24.007 [4].

If the TT receives a message not compatible with the EPMS state, the TT shall ignore the EPMS message.

If the TSN AF receives a message not compatible with the EPMS state, the TSN AF actions are implementation dependent.

If the NW-TT or the TSN AF receives a BMS message with message type not defined for the BMS or not implemented by the receiver, it shall ignore the BMS message. If the DS-TT receives a BMS message with message type defined for the BMS or implemented by the receiver, it shall ignore the BMS message.

NOTE: A message type not defined for the BMS in the given direction is regarded by the receiver as a message type not defined for the BMS, see 3GPP TS 24.007 [4].

If the NW-TT receives a message not compatible with the BMS state, the NW-TT shall ignore the BMS message.

If the TSN AF receives a message not compatible with the BMS state, the TSN AF actions are implementation dependent.

7.4 Non-semantical mandatory information element errors

When on receipt of a message,

- a) an "imperative message part" error; or
- b) a "missing mandatory IE" error

is diagnosed or when a message containing:

- a) a syntactically incorrect mandatory IE;
- b) an IE unknown in the message, but encoded as "comprehension required" (see 3GPP TS 24.007 [4]); or
- c) an out of sequence IE encoded as "comprehension required" (see 3GPP TS 24.007 [4]) is received,

If the message is an EPMS message, the TT shall ignore the EPMS message. If the message is a BMS message, the NW-TT shall ignore the BMS message;

the TSN AF shall proceed as follows:

the TSN AF shall:

- 1) try to treat the message (the exact further actions are implementation dependent); or
- 2) ignore the message.

7.5 Unknown and unforeseen IEs in the non-imperative message part

7.5.1 IEs unknown in the message

The TT shall ignore all IEs unknown in a message which are not encoded as "comprehension required" (see 3GPP TS 24.007 [4]).

The TSN AF shall take the same approach.

7.5.2 Out of sequence IEs

The TT shall ignore all out of sequence IEs in a message which are not encoded as "comprehension required" (see 3GPP TS 24.007 [4]).

The TSN AF should take the same approach.

7.5.3 Repeated IEs

If an information element with format T, TV, TLV, or TLV-E is repeated in a message in which repetition of the information element is not specified in clause 8, the TT shall handle only the contents of the information element appearing first and shall ignore all subsequent repetitions of the information element. When repetition of information elements is specified, the TT shall handle only the contents of specified repeated information elements. If the limit on repetition of information elements is exceeded, the TT shall handle the contents of information elements appearing first up to the limit of repetitions and shall ignore all subsequent repetitions of the information element.

The TSN AF should follow the same procedures.

7.6 Non-imperative message part errors

7.6.1 General

This category includes:

- a) syntactically incorrect optional IEs; and
- b) conditional IE errors.

7.6.2 Syntactically incorrect optional IEs

The TT shall treat all optional IEs that are syntactically incorrect in a message as not present in the message.

The TSN AF shall take the same approach.

7.6.3 Conditional IE errors

When upon receipt of an EPMS message the TT diagnoses a "missing conditional IE" error or an "unexpected conditional IE" error, or when it receives an EPMS message containing at least one syntactically incorrect conditional IE, the TT shall ignore the message.

When upon receipt of a BMS message the NW-TT diagnoses a "missing conditional IE" error or an "unexpected conditional IE" error, or when it receives a BMS message containing at least one syntactically incorrect conditional IE, the NW-TT shall ignore the message.

When the TSN AF receives a message and diagnoses a "missing conditional IE" error or an "unexpected conditional IE" error or when it receives a message containing at least one syntactically incorrect conditional IE, the TSN AF shall either:

- a) try to treat the message (the exact further actions are implementation dependent); or
- b) ignore the message.

7.7 Messages with semantically incorrect contents

When a message with semantically incorrect contents is received, the TT shall perform the foreseen reactions of the procedural part of clause 5 and clause 6. If, however no such reactions are specified, the TT shall ignore the message.

The TSN AF should follow the same procedure.

8 Message functional definition and contents

8.1 Manage Ethernet port command

8.1.1 Message definition

The MANAGE ETHERNET PORT COMMAND message is sent by the TSN AF to the DS-TT or NW-TT to manage the Ethernet port at the DS-TT or NW-TT, see table 8.1.1.1

Message type: MANAGE ETHERNET PORT COMMAND

Significance: dual

Direction: TSN AF to DS-TT, TSN AF to NW-TT

Table 8.1.1.1: MANAGE ETHERNET PORT COMMAND message content

IEI	Information Element	Type/Reference	Presence	Format	Length
	MANAGE ETHERNET PORT COMMAND message identity	Ethernet port management service message type 9.1	M	V	1
	Ethernet port management list	Ethernet port management list 9.2	M	LV-E	3-65534

8.2 Manage Ethernet port complete

8.2.1 Message definition

The MANAGE ETHERNET PORT COMPLETE message is sent by the DS-TT or NW-TT to the TSN AF to complete the network-initiated Ethernet port management procedure or the TSN AF-initiated Ethernet port management procedure, see table 8.2.1.1

Message type: MANAGE ETHERNET PORTCOMPLETE

Significance: dual

Direction: DS-TT to TSN AF, NW-TT to TSN AF

Table 8.2.1.1: MANAGE ETHERNET PORT COMPLETE message content

IEI	Information Element	Type/Reference	Presence	Format	Length
	MANAGE ETHERNET PORT COMPLETE message identity	Ethernet port management service message type 9.1	M	V	1
70	Ethernet port management capability	Ethernet port management capability 9.3	O	TLV-E	5-65534
71	Ethernet port status	Ethernet port status 9.4	O	TLV-E	5-65534
72	Ethernet port update result	Ethernet port update result 9.5	O	TLV-E	5-65534

8.2.2 Ethernet port management capability

This IE shall be included if the TSN AF has included an operation with operation code set to "get capabilities" in the MANAGE ETHERNET PORT COMMAND message.

8.2.3 Ethernet port status

This IE shall be included if the TSN AF has included one or more operations with operation code set to "read parameter" in the MANAGE ETHERNET PORT COMMAND message.

8.2.4 Ethernet port update result

This IE shall be included if the TSN AF has included one or more operations with operation code set to "set parameter" in the MANAGE ETHERNET PORT COMMAND message.

8.3 Ethernet port management notify

8.3.1 Message definition

The ETHERNET PORT MANAGEMENT NOTIFY message is sent by the DS-TT or NW-TT to the TSN AF to notify the TSN AF of one or more changes in the value of Ethernet port management parameters, see table 8.3.1.1

Message type: ETHERNET PORT MANAGEMENT NOTIFY

Significance: dual

Direction: DS-TT to TSN AF, NW-TT to TSN AF

Table 8.3.1.1: ETHERNET PORT MANAGEMENT NOTIFY message content

IEI	Information Element	Type/Reference	Presence	Format	Length
	ETHERNET PORT MANAGEMENT NOTIFY message identity	Ethernet port management service message type 9.1	M	V	1
	Ethernet port status	Ethernet port status 9.4	M	LV-E	4-65533

8.4 Ethernet port management notify ack

8.4.1 Message definition

The ETHERNET PORT MANAGEMENT NOTIFY ACK message is sent by the TSN AF to the DS-TT or NW-TT to acknowledge an ETHERNET PORT MANAGEMENT NOTIFY message, see table 8.4.1.1

Message type: ETHERNET PORT MANAGEMENT NOTIFY ACK

Significance: dual

Direction: TSN AF to DS-TT, TSN AF to NW-TT

Table 8.4.1.1: ETHERNET PORT MANAGEMENT NOTIFY ACK message content

IEI	Information Element	Type/Reference	Presence	Format	Length
	ETHERNET PORT MANAGEMENT NOTIFY ACK message identity	Ethernet port management service message type 9.1	M	V	1

8.5 Ethernet port management notify complete

8.5.1 Message definition

The ETHERNET PORT MANAGEMENT NOTIFY COMPLETE message is sent by the DS-TT to the TSN AF to complete the DS-TT-initiated Ethernet port management procedure, see table 8.5.1.1

Message type: ETHERNET PORT MANAGEMENT NOTIFY COMPLETE

Significance: dual

Direction: DS-TT to TSN AF

Table 8.5.1.1: ETHERNET PORT MANAGEMENT NOTIFY COMPLETE message content

IEI	Information Element	Type/Reference	Presence	Format	Length
	ETHERNET PORT MANAGEMENT NOTIFY COMPLETE message identity	Ethernet port management service message type 9.1	M	V	1

8.6 Ethernet port management capability

8.6.1 Message definition

The ETHERNET PORT MANAGEMENT CAPABILITY message is sent by the DS-TT to provide the DS-TT supported Ethernet port management capabilities to the TSN AF, see table 8.6.1.1

Message type: ETHERNET PORT MANAGEMENT CAPABILITY

Significance: dual

Direction: DS-TT to TSN AF

Table 8.6.1.1: ETHERNET PORT MANAGEMENT CAPABILITY message content

IEI	Information Element	Type/Reference	Presence	Format	Length
	ETHERNET PORT MANAGEMENT CAPABILITY message identity	Ethernet port management service message type 9.1	M	V	1
	Ethernet port management capability	Ethernet port management capability 9.3	M	LV-E	4-65533

8.6.2 Void

8.7 Manage Bridge command

8.7.1 Message definition

The MANAGE BRIDGE COMMAND message is sent by the TSN AF to the NW-TT to manage the Bridge functionalities, see table 8.7.1.1

Message type: MANAGE BRIDGE COMMAND

Significance: dual

Direction: TSN AF to NW-TT

Table 8.7.1.1: MANAGE BRIDGE COMMAND message content

IEI	Information Element	Type/Reference	Presence	Format	Length
	MANAGE BRIDGE COMMAND message identity	Bridge management service message type 9.5A	M	V	1
	Bridge management list	Bridge management list 9.5B	M	LV-E	3-65530

8.8 Manage Bridge complete

8.8.1 Message definition

The MANAGE BRIDGE COMPLETE message is sent by the NW-TT to the TSN AF to complete the TSN AF-initiated Bridge management procedure, see table 8.8.1.1

Message type: MANAGE BRIDGE COMPLETE

Significance: dual

Direction: NW-TT to TSN AF

Table 8.8.1.1: MANAGE BRIDGE COMPLETE message content

IEI	Information Element	Type/Reference	Presence	Format	Length
	MANAGE BRIDGE COMPLETE message identity	Bridge management service message type 9.5A	M	V	1
70	Bridge management capability	Bridge management capability 9.5C	O	TLV-E	5-65530
71	Bridge status	Bridge status 9.5D	O	TLV-E	5-65530
72	Bridge update result	Bridge update result 9.5E	O	TLV-E	5-65530

8.8.2 Bridge management capability

This IE shall be included if the TSN AF has included an operation with operation code set to "get capabilities" in the MANAGE BRIDGE COMMAND message.

8.8.3 Bridge status

This IE shall be included if the TSN AF has included one or more operations with operation code set to "read parameter" in the MANAGE BRIDGE COMMAND message.

8.8.4 Bridge update result

This IE shall be included if the TSN AF has included one or more operations with operation code set to "set parameter" in the MANAGE BRIDGE COMMAND message.

8.9 Bridge management notify

8.9.1 Message definition

The BRIDGE MANAGEMENT NOTIFY message is sent by the NW-TT to the TSN AF to notify the TSN AF of one or more changes in the value of Bridge management parameters, see table 8.9.1.1

Message type: BRIDGE MANAGEMENT NOTIFY

Significance: dual

Direction: NW-TT to TSN AF

Table 8.9.1.1: BRIDGE MANAGEMENT NOTIFY message content

IEI	Information Element	Type/Reference	Presence	Format	Length
	BRIDGE MANAGEMENT NOTIFY message identity	Bridge management service message type 9.5A	M	V	1
	Bridge status	Bridge status 9.5D	M	LV-E	4-65530

8.10 Bridge management notify ack

8.10.1 Message definition

The BRIDGE MANAGEMENT NOTIFY ACK message is sent by the TSN AF to the NW-TT to acknowledge a BRIDGE MANAGEMENT NOTIFY message, see table 8.10.1.1

Message type: BRIDGE MANAGEMENT NOTIFY ACK

Significance: dual

Direction: TSN AF to NW-TT

Table 8.10.1.1: BRIDGE MANAGEMENT NOTIFY ACK message content

IEI	Information Element	Type/Reference	Presence	Format	Length
	BRIDGE MANAGEMENT NOTIFY ACK message identity	Bridge management service message type 9.5A	M	V	1

9 Information elements coding

9.1 Ethernet port management service message type

Table 9.1.1: Ethernet port management service message type

Bits								
8	7	6	5	4	3	2	1	
0	0	0	0	0	0	0	0	Reserved
0	0	0	0	0	0	0	1	MANAGE ETHERNET PORT COMMAND message
0	0	0	0	0	0	1	0	MANAGE ETHERNET PORT COMPLETE message
0	0	0	0	0	0	1	1	ETHERNET PORT MANAGEMENT NOTIFY message
0	0	0	0	0	1	0	0	ETHERNET PORT MANAGEMENT NOTIFY ACK message
0	0	0	0	0	1	0	1	ETHERNET PORT MANAGEMENT NOTIFY COMPLETE message
0	0	0	0	0	1	1	0	ETHERNET PORT MANAGEMENT CAPABILITY message
All other values are reserved								

9.2 Ethernet port management list

The purpose of the Ethernet port management list information element is to transfer from the TSN AF to the DS-TT or NW-TT a list of operations related to Ethernet port management of the DS-TT or NW-TT to be performed at the DS-TT or NW-TT.

The Ethernet port management list information element is coded as shown in figure 9.2.1, figure 9.2.2, figure 9.2.3, figure 9.2.4, figure 9.2.5, and table 9.2.1.

The Ethernet port management list information element has a minimum length of 4 octets and a maximum length of 65535 octets.

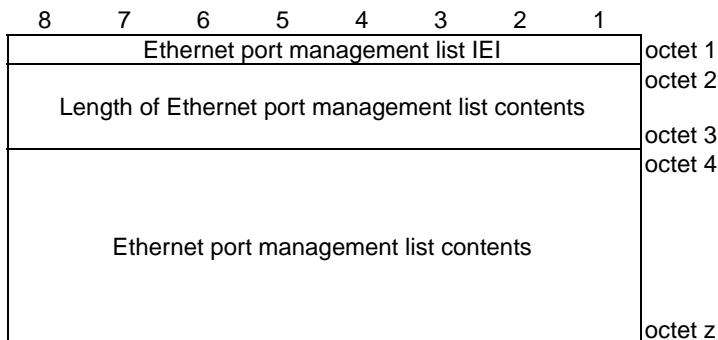

Figure 9.2.1: Ethernet port management list information element

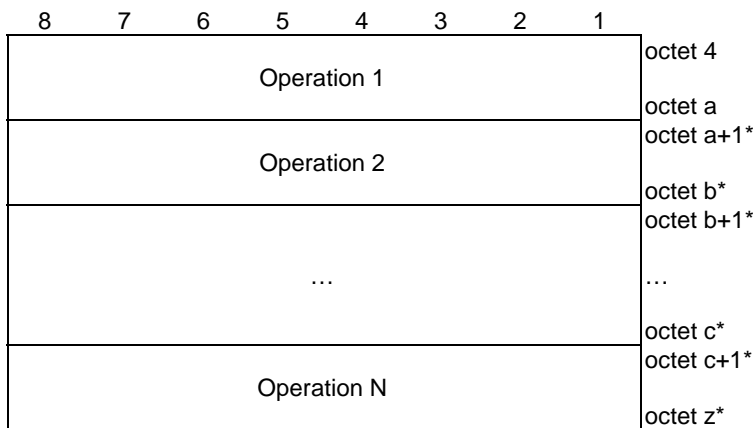

Figure 9.2.2: Ethernet port management list contents

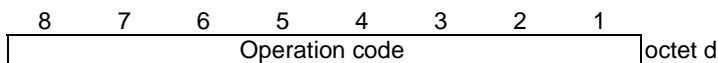

Figure 9.2.3: Operation for operation code set to "00000001"

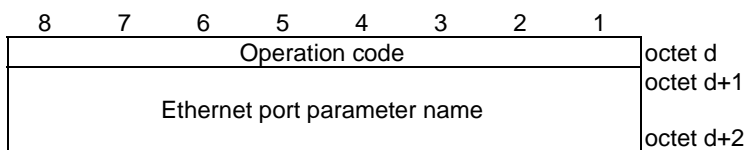

Figure 9.2.4: Operation for operation code set to "00000010", "00000100", or "00000101"

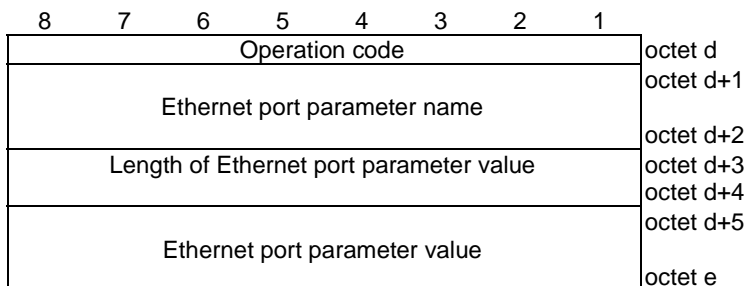

Figure 9.2.5: Operation for operation code set to "00000011"

Table 9.2.1: Ethernet port management list information element

Value part of the Ethernet port management list information element (octets 4 to z)

The value part of the Ethernet port management list information element consists of one or several operations.

Operation

Operation code (octet d)

Bits

8 7 6 5 4 3 2 1

0 0 0 0 0 0 0 0 Reserved

0 0 0 0 0 0 0 1 Get capabilities

0 0 0 0 0 0 1 0 Read parameter

0 0 0 0 0 0 1 1 Set parameter (NOTE)

0 0 0 0 0 1 0 0 Subscribe-notify for parameter

0 0 0 0 0 1 0 1 Unsubscribe for parameter

All other values are spare.

Ethernet port parameter name (octets d+1 to d+2)

This field contains the name of the Ethernet port parameter to which the operation applies, encoded as follows:

- 0000H Reserved;
- 0001H txPropagationDelay;
- 0002H Traffic class table;
- 0003H GateEnabled;
- 0004H AdminBaseTime;
- 0005H AdminControlListLength;
- 0006H AdminControlList;
- 0007H AdminCycleTime;
- 0008H Tick granularity;
- 0009H
to Spare
- 003FH
- 0040H IldpV2PortConfigAdminStatusV2;
- 0041H IldpV2LocChassisIdSubtype;
- 0042H IldpV2LocChassisId;
- 0043H IldpV2MessageTxInterval;
- 0044H IldpV2MessageTxHoldMultiplier;
- 0045H
to Spare
- 005FH
- 0060H IldpV2LocPortIdSubtype;
- 0061H IldpV2LocPortId;
- 0062H
to Spare
- 009FH
- 00A0H IldpV2RemChassisIdSubtype;
- 00A1H IldpV2RemChassisId;
- 00A2H IldpV2RemPortIdSubtype;
- 00A3H IldpV2RemPortId;
- 00A4H IldpTTL;
- 00A5H
to Spare
- 00CFH
- 00D0H PSFPMaxStreamFilterInstances;
- 00D1H PSFPMaxStreamGateInstances;
- 00D2H PSFPMaxFlowMeterInstances;
- 00D3H PSFPSupportedListMax;
- 00D4H
to Spare
- 00DFH
- 00E0H Stream filter instance table
- 00E1H Stream gate instance table
- 00E2H
to Spare
- 7FFFH
- 8000H
to Reserved for deployment specific parameters
- FFFFH

Length of Ethernet port parameter value (octets d+3 to d+4)

This field contains the binary encoding of the length of the Ethernet port parameter value

Ethernet port parameter value (octet d+5 to e)

This field contains the value to be set for the Ethernet port parameter.

When the Ethernet port parameter name indicates txPropagationDelay, the Ethernet port parameter value field contains the binary representation of the txPropagationDelay as defined in IEEE Std 802.1Qcc [9], expressed in unit of nanoseconds and multiplied by 2^{16} , with the LSB bit included in bit 1 of the first octet. If the txPropagationDelay is too big to be represented, all bits of the Ethernet port parameter value field shall be coded as "1" except the MSB bit. The length of Ethernet port parameter value indicates a value of 8.

When the Ethernet port parameter name indicates Traffic class table, the Ethernet port parameter value field contains the traffic class table as defined in IEEE Std 802.1Q [7], encoded as the value part of the Traffic class information element as specified in clause 9.7.

When the Ethernet port parameter name indicates GateEnabled, the Ethernet port parameter value field contains the value of GateEnabled as defined in IEEE Std 802.1Q [7], with a Boolean value of FALSE encoded as "00000000" and a Boolean value of TRUE encoded as "00000001". The length of Ethernet port parameter value field indicates a value of 1.

When the Ethernet port parameter name indicates AdminBaseTime, the Ethernet port parameter value field contains the value of the administrative base time as specified in IEEE Std 802.1Q [7]. The length of Ethernet port parameter value field indicates a value of 10.

When the Ethernet port parameter name indicates AdminControlListLength, the Ethernet port parameter value field contains the value of the AdminControlListLength as specified in IEEE Std 802.1Q [7]. The length of Ethernet port parameter value field indicates a value of 2.

When the Ethernet port parameter name indicates AdminControlList, the Ethernet port parameter value field contains the concatenation of AdminControlListLength entries, each encoded as a GateControlEntry as specified in IEEE Std 802.1Q [7].

When the Ethernet port parameter name indicates AdminCycleTime, the Ethernet port parameter value field contains the value of the AdminCycleTime as specified in IEEE Std 802.1Q [7]. The length of Ethernet port parameter value field indicates a value of 8.

When the Ethernet port parameter name indicates Tick granularity, the Ethernet port parameter value field contains the value of the Tick granularity as specified in IEEE Std 802.1Q [7]. The length of Ethernet port parameter value field indicates a value of 4.

When the Ethernet port parameter name indicates IldpV2PortConfigAdminStatusV2, the Ethernet port parameter value field contains values of IldpV2PortConfigAdminStatusV2 as specified in IEEE Std 802.1AB [6] clause 9.2.5.1 with value of txOnly encoded as 01H, rxOnly encoded as 02H, txAndRx encoded as 03H, and disabled encoded as 04H. The length of Ethernet port parameter value field indicates a value of 1.

When the Ethernet port parameter name indicates IldpV2LocChassisIdSubtype, the Ethernet port parameter value field contains values of IldpV2LocChassisIdSubtype as specified in IEEE Std 802.1AB [6] clause 8.5.2.2. The length of Ethernet port parameter value field indicates a value of 1.

When the Ethernet port parameter name indicates IldpV2LocChassisId, the Ethernet port parameter value field contains values of IldpV2LocChassisId in the form of an octet string as specified in IEEE Std 802.1AB [6] clause 8.5.2.3. The length of Ethernet port parameter value field indicates the length of the octet string with a maximum value of 255.

When the Ethernet port parameter name indicates IldpV2MessageTxInterval, the Ethernet port parameter value field contains the value of IldpV2MessageTxInterval as specified in IEEE Std 802.1AB [6] table 11-2. The length of Ethernet port parameter value field indicates a value of 2.

When the Ethernet port parameter name indicates `IldpV2MessageTxHoldMultiplier`, the Ethernet port parameter value field contains the value of `IldpV2MessageTxHoldMultiplier` as specified in IEEE Std 802.1AB [6] table 11-2. The length of Ethernet port parameter value field indicates a value of 1.

When the Ethernet port parameter name indicates `IldpV2LocPortIdSubtype`, the Ethernet port parameter value field contains values of `IldpV2LocPortIdSubtype` as specified in IEEE Std 802.1AB [6] clause 8.5.3.2. The length of Ethernet port parameter value field indicates a value of 1.

When the Ethernet port parameter name indicates `IldpV2LocPortId`, the Ethernet port parameter value field contains values of `IldpV2LocPortId` in the form of an octet string as specified in IEEE Std 802.1AB [6] clause 8.5.3.3. The length of Ethernet port parameter value field indicates the length of the octet string with a maximum value of 255.

When the Ethernet port parameter name indicates `IldpV2RemChassisIdSubtype`, the Ethernet port parameter value field contains values of `IldpV2RemChassisIdSubtype` as specified in IEEE Std 802.1AB [6] clause 8.5.2.2. The length of Ethernet port parameter value field indicates a value of 1.

When the Ethernet port parameter name indicates `IldpV2RemChassisId`, the Ethernet port parameter value field contains values of `IldpV2RemChassisId` in the form of an octet string as specified in IEEE Std 802.1AB [6] clause 8.5.2.3. The length of Ethernet port parameter value field indicates the length of the octet string with a maximum value of 255.

When the Ethernet port parameter name indicates `IldpV2RemPortIdSubtype`, the Ethernet port parameter value field contains values of `IldpV2RemPortIdSubtype` as specified in IEEE Std 802.1AB [6] clause 8.5.3.2. The length of Ethernet port parameter value field indicates a value of 1.

When the Ethernet port parameter name indicates `IldpV2RemPortId`, the Ethernet port parameter value field contains values of `IldpV2RemPortId` in the form of an octet string as specified in IEEE Std 802.1AB [6] clause 8.5.3.3. The length of Ethernet port parameter value field indicates the length of the octet string with a maximum value of 255.

When the Ethernet port parameter name indicates `IldpTTL`, the Ethernet port parameter value field contains the value of TTL as specified in IEEE Std 802.1AB [6] clause 8.5.4. The length of Ethernet port parameter value field indicates a value of 2.

When the Ethernet port parameter name indicates `PSFPMaxStreamFilterInstances`, the Ethernet parameter value field contains the value of `MaxStreamFilterInstances` as specified in IEEE Std 802.1Q [7] clause 12.31.1.1. The length of Ethernet port parameter value field indicates a value of 4.

When the Ethernet port parameter name indicates `PSFPMaxStreamGateInstances`, the Ethernet parameter value field contains the value of `MaxStreamGateInstances` as specified in IEEE Std 802.1Q [7] clause 12.31.1.2. The length of Ethernet port parameter value field indicates a value of 4.

When the Ethernet port parameter name indicates `PSFPMaxFlowMeterInstances`, the Ethernet parameter value field contains the value of `MaxFlowMeterInstances` as specified in IEEE Std 802.1Q [7] clause 12.31.1.3. The length of Ethernet port parameter value field indicates a value of 4.

When the Ethernet port parameter name indicates `PSFPSupportedListMax`, the Ethernet parameter value field contains the value of `SupportedListMax` as specified in IEEE Std 802.1Q [7] clause 12.31.1.4. The length of Ethernet port parameter value field indicates a value of 4.

When the Ethernet port parameter name indicates `Stream filter instance table`, the Ethernet port parameter value field contains a Stream filter instance table as defined in 3GPP TS 23.501 [2] table 5.28.3.1-1, encoded as the value part of the Stream filter instance table information element as specified in clause 9.8.

<p>When the Ethernet port parameter name indicates Stream gate instance table, the Ethernet port parameter value field contains a Stream gate instance table as defined in 3GPP TS 23.501 [2] table 5.28.3.1-1, encoded as the value part of the Stream gate instance table information element as specified in clause 9.9.</p> <p>When the hexadecimal encoding of the Ethernet port parameter name is in the "8000H" to "FFFFH" range, the encoding of the Ethernet port parameter value field and the value of the length of Ethernet port parameter value field are deployment-specific.</p>
<p>NOTE: The "Set parameter" operation shall not be applicable for the following Ethernet port parameter names:</p> <ul style="list-style-type: none"> - 0001H txPropagationDelay; - 0008H Tick granularity; - 00A0H IldpV2RemChassisIdSubtype; - 00A1H IldpV2RemChassisId; - 00A2H IldpV2RemPortIdSubtype; - 00A3H IldpV2RemPortId; - 00A4H IldpTTL; - 00D0H PSFPMaxStreamFilterInstances; - 00D1H PSFPMaxStreamGateInstances; - 00D2H PSFPMaxFlowMeterInstances; and - 00D3H PSFPSupportedListMax.

9.3 Ethernet port management capability

The purpose of the Ethernet port management capability information element is to inform the TSN AF of the Ethernet port parameters supported by the DS-TT or NW-TT.

The Ethernet port management capability information element is coded as shown in figure 9.3.1, figure 9.3.2, and table 9.31.

The Ethernet port management capability information element has a minimum length of 5 octets and a maximum length of 65534 octets.

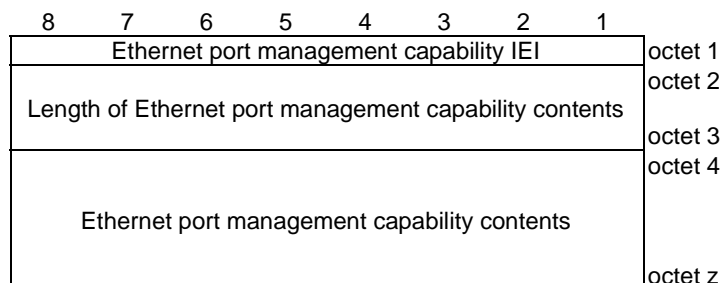

Figure 9.3.1: Ethernet port management capability information element

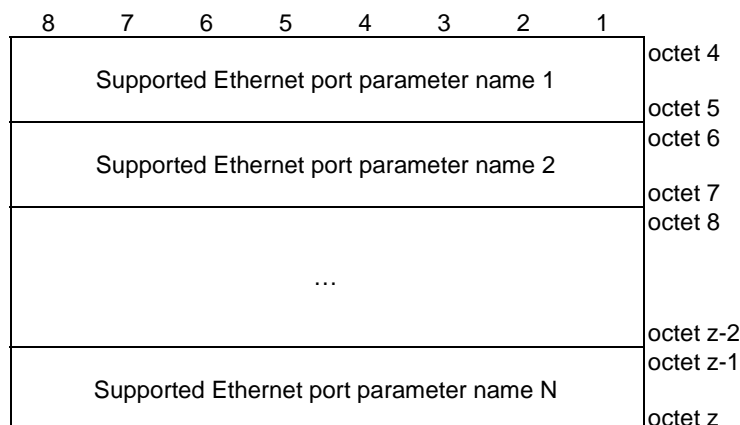

Figure 9.3.2: Ethernet port management capability contents

Table 9.3.1: Ethernet port management capability information element

<p>Value part of the Ethernet port management capability information element (octets 4 to z)</p> <p>The value part of the Ethernet port management capability information element consists of one or several supported Ethernet port parameter names, each encoded over 2 octets as specified in table 9.2.1 for the DS-TT or NW-TT to TSN AF direction.</p>
--

9.4 Ethernet port status

The purpose of the Ethernet port status information element is to report the values of Ethernet port parameters of the DS-TT or NW-TT to the TSN AF.

The Ethernet port status information element is coded as shown in figure 9.4.1, figure 9.4.2, figure 9.4.3, figure 9.4.4, figure 9.4.5, and table 9.4.1.

The Ethernet port status information element has a minimum length of 5 octets and a maximum length of 65534 octets.

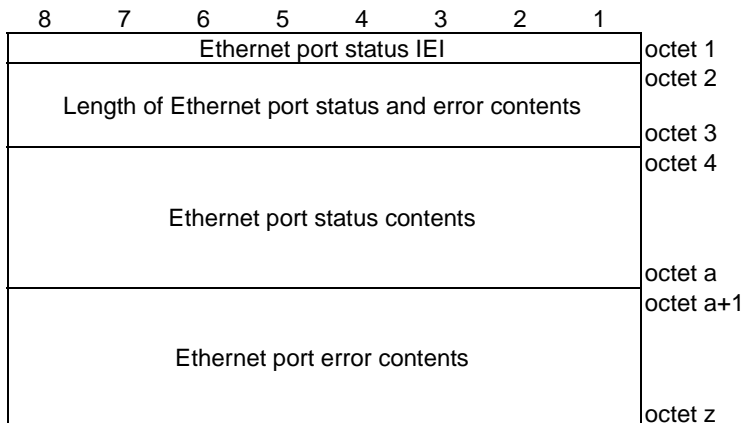

Figure 9.4.1: Ethernet port status information element

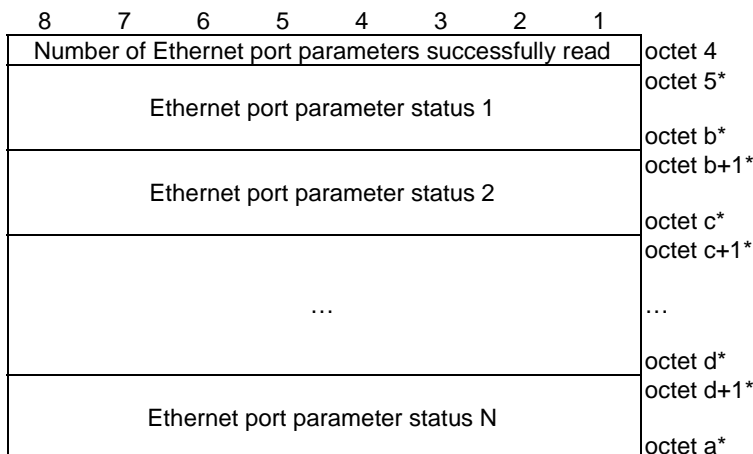

Figure 9.4.2: Ethernet port status contents

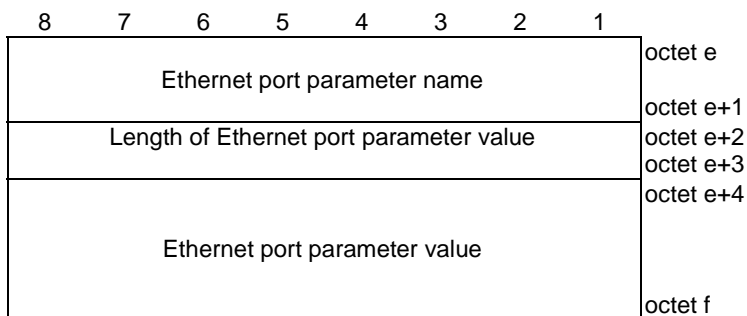

Figure 9.4.3: Ethernet port parameter status

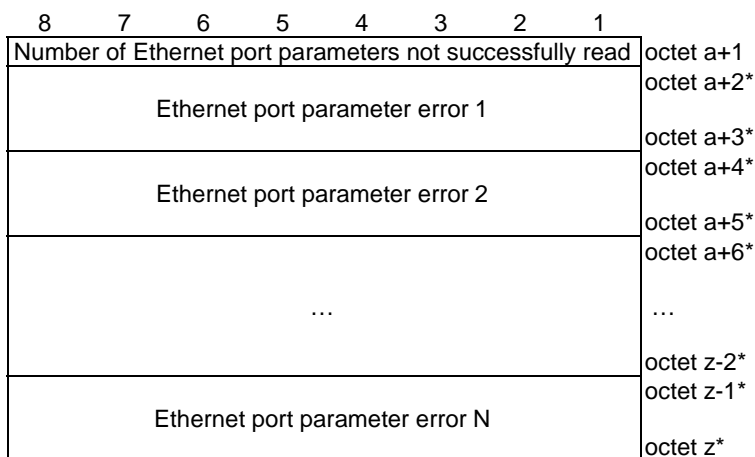

Figure 9.4.4: Ethernet port error contents

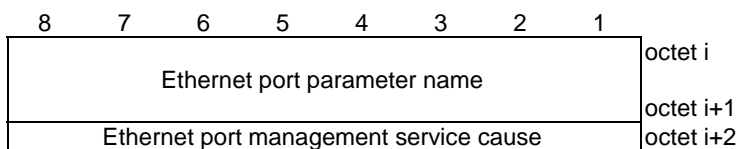

Figure 9.4.5: Ethernet port parameter error

Table 9.4.1: Ethernet port status information element

Value part of the Ethernet port status information element (octets 4 to z)	
Ethernet port status contents (octets 4 to a)	
This field consists of zero or several Ethernet port parameter statuses.	
Ethernet port parameter status	
Ethernet port parameter name (octets e to e+1)	
This field contains the name of the Ethernet port parameter which could be read successfully, encoded over 2 octets as specified in table 9.2.1 for the DS-TT or NW-TT to TSN AF direction.	
Length of Ethernet port parameter value (octets e+2 to e+3)	
This field contains the binary encoding of the length of the Ethernet port parameter value	
Ethernet port parameter value (octets e+4 to f)	
This field contains the value for the Ethernet port parameter, encoded as specified in table 9.2.1.	
Ethernet port error contents (octets a+1 to z)	
This field consists of zero or several Ethernet port parameter errors.	
Ethernet port parameter error	
Ethernet port parameter name (octets to i+1)	
This field contains the name of the Ethernet port parameter whose value could not be read successfully, encoded over 2 octets as specified in table 9.2.1 for the DS-TT or NW-TT to TSN AF direction.	
Ethernet port management service cause (octet i+2)	
This field contains the Ethernet port management service cause indicating the reason why the value of the Ethernet port parameter could not be read successfully, encoded as follows:	
Bits	
8 7 6 5 4 3 2 1	
0 0 0 0 0 0 0 0	Reserved
0 0 0 0 0 0 0 1	Ethernet port parameter not supported
0 0 0 0 0 0 1 0	Invalid Ethernet port parameter value
0 1 1 0 1 1 1 1	Protocol error, unspecified
The receiving entity shall treat any other value as 0110 1111, "protocol error, unspecified".	

9.5 Ethernet port update result

The purpose of the Ethernet port update result information element is to report to the TSN AF the outcome of the request from the TSN AF to set one or more Ethernet port parameters to a specific value.

The Ethernet port update result information element is coded as shown in figure 9.5.1, figure 9.5.2, figure 9.5.3, figure 9.5.4, figure 9.5.5, and table 9.5.1.

The Ethernet port update result information element has a minimum length of 5 octets and a maximum length of 65534 octets.

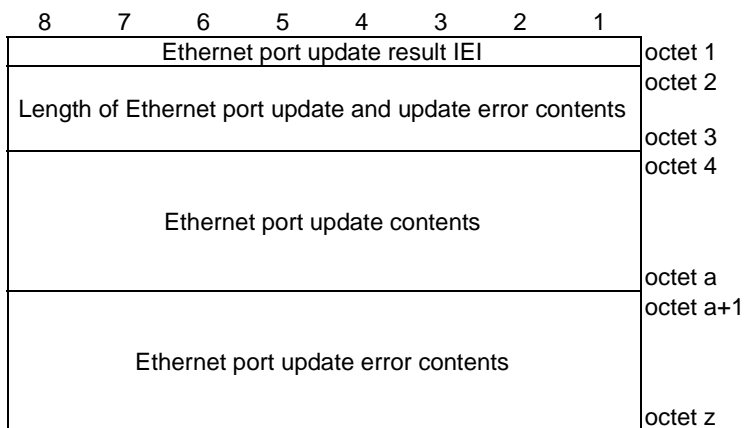

Figure 9.5.1: Ethernet port update result information element

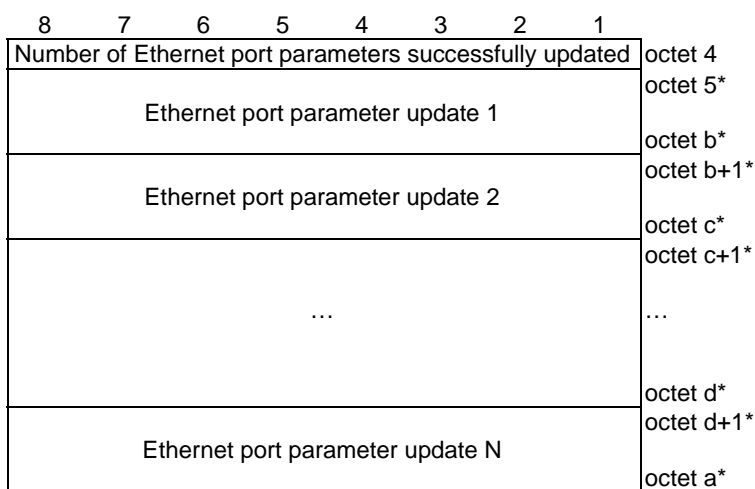

Figure 9.5.2: Ethernet port update contents

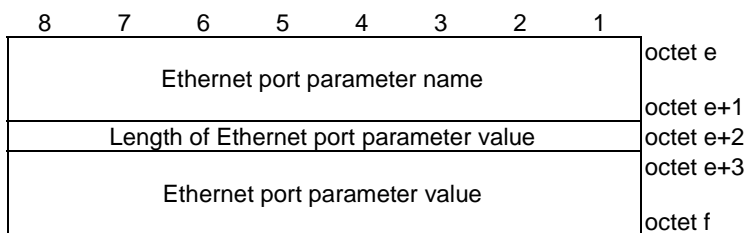

Figure 9.5.3: Ethernet port parameter update

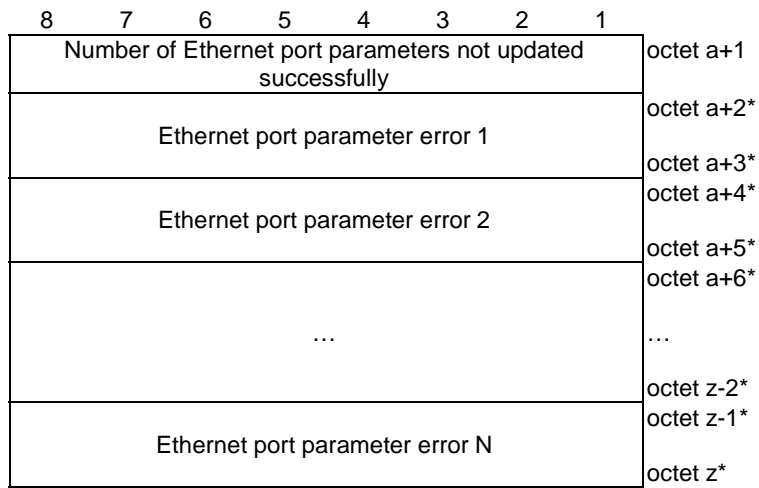

Figure 9.5.4: Ethernet port update error contents

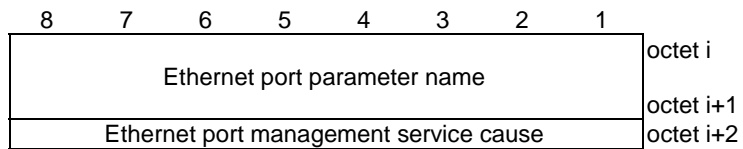

Figure 9.5.5: Ethernet port parameter error

Table 9.5.1: Ethernet port update result information element

Value part of the Ethernet port update result information element (octets 4 to z)
Ethernet port update contents (octets 4 to a)
This field consists of zero or several Ethernet port parameter updates.
Ethernet port parameter update
Ethernet port parameter name (octets e to e+1)
This field contains the name of the Ethernet port parameter which could be set successfully, encoded over 2 octets as specified in table 9.2.1 for the DS-TT or NW-TT to TSN AF direction.
Length of Ethernet port parameter value (octet e+2)
This field contains the binary encoding of the length of the Ethernet port parameter value
Ethernet port parameter value (octets e+3 to f)
Ethernet port error contents (octets a+1 to z)
This field consists of zero or several Ethernet port parameter errors.
Ethernet port parameter error
Ethernet port parameter name (octets to i+1)
This field contains the name of the Ethernet port parameter whose value could not be set successfully, encoded over 2 octets as specified in table 9.2.1 for the DS-TT or NW-TT to TSN AF direction.
Ethernet port management service cause (octet i+2)
This field contains the Ethernet port management service cause indicating the reason why the value of the Ethernet port parameter could not be set successfully, encoded as follows:
Bits
8 7 6 5 4 3 2 1
0 0 0 0 0 0 0 0 Reserved
0 0 0 0 0 0 0 1 Ethernet port parameter not supported
0 0 0 0 0 0 1 0 Invalid Ethernet port parameter value
0 1 1 0 1 1 1 1 Protocol error, unspecified
The receiving entity shall treat any other value as 0110 1111, "protocol error, unspecified".

9.5A Bridge management service message type

Table 9.5A.1: Bridge management service message type

Bits	
8 7 6 5 4 3 2 1	
0 0 0 0 0 0 0 0	Reserved
0 0 0 0 0 0 0 1	MANAGE BRIDGE COMMAND message
0 0 0 0 0 0 1 0	MANAGE BRIDGE COMPLETE message
0 0 0 0 0 0 1 1	BRIDGE MANAGEMENT NOTIFY message
0 0 0 0 0 1 0 0	BRIDGE MANAGEMENT ACK message
All other values are reserved	

9.5B Bridge management list

The purpose of the Bridge management list information element is to transfer from the TSN AF to the NW-TT a list of operations related to Bridge management of the NW-TT to be performed at the NW-TT.

The Bridge management list information element is coded as shown in figure 9.5B.1, figure 9.5B.2, figure 9.5B.3, figure 9.5B.4, figure 9.5B.5, and table 9.5B.1.

The Bridge management list information element has a minimum length of 4 octets and a maximum length of 65530 octets.

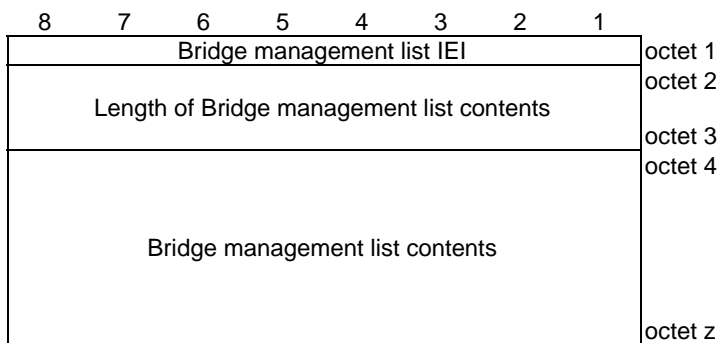

Figure 9.5B.1: Bridge management list information element

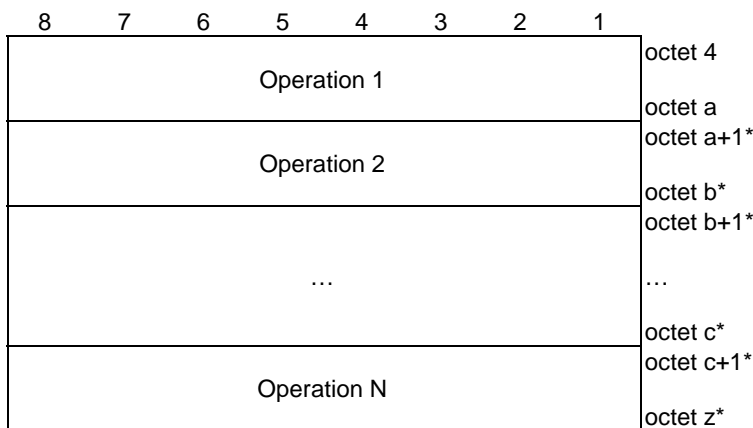

Figure 9.5B.2: Bridge management list contents

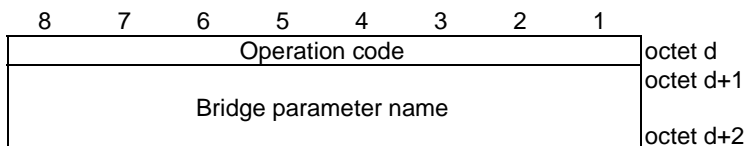
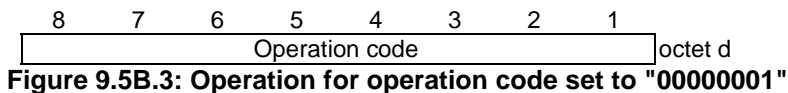

Figure 9.5B.4: Operation for operation code set to "00000010", "00000100", or "00000101"

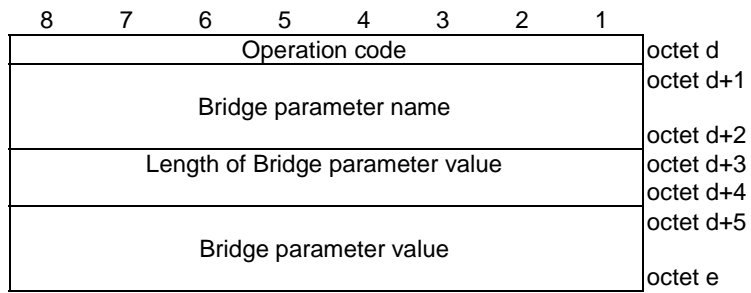

Figure 9.5B.5: Operation for operation code set to "00000011"

Table 9.5B.1: Bridge management list information element

Value part of the Bridge management list information element (octets 4 to z)

The value part of the Bridge management list information element consists of one or several operations.

Operation

Operation code (octet d)

Bits

8 7 6 5 4 3 2 1

0 0 0 0 0 0 0 0	Reserved
0 0 0 0 0 0 0 1	Get capabilities
0 0 0 0 0 0 1 0	Read parameter
0 0 0 0 0 0 1 1	Set parameter (NOTE 1)
0 0 0 0 0 1 0 0	Subscribe-notify for parameter
0 0 0 0 0 1 0 1	Unsubscribe for parameter

All other values are spare.

Bridge parameter name (octets d+1 to d+2)

This field contains the name of the Bridge parameter to which the operation applies, encoded as follows:

- 0000H Reserved;
- 0001H Bridge Address;
- 0002H Spare (NOTE 2)
- 0003H Bridge ID;
- 0004H NW-TT port numbers;
- 0005H to Spare
- 0009H
- 0010H Spare (NOTE 3)
- 0010H Spare (NOTE 4)
- 0012H Static filtering entries;
- 0013H to Spare
- 0019H
- 0020H IldpV2PortConfigAdminStatusV2;
- 0021H IldpV2LocChassisIdSubtype;
- 0022H IldpV2LocChassisId;
- 0023H IldpV2MessageTxInterval;
- 0024H IldpV2MessageTxHoldMultiplier;
- 0025H to Spare
- 004FH
- 0050H DS-TT port neighbor discovery configuration for DS-TT ports
- 0051H Discovered neighbor information for DS-TT ports
- 0052H to Spare
- 006FH
- 0070H PSFPMaxStreamFilterInstances;
- 0071H PSFPMaxStreamGateInstances;
- 0072H PSFPMaxFlowMeterInstances;
- 0073H PSFPSupportedListMax;
- 0074H to Spare
- 7FFFH
- 8000H to Reserved for deployment specific parameters
- FFFFH

Length of Bridge parameter value (octets d+3 to d+4)

This field contains the binary encoding of the length of the Bridge parameter value

Bridge parameter value (octet d+5 to e)

This field contains the value to be set for the Bridge parameter.

When the Bridge parameter name indicates Bridge Address, the Bridge parameter value field contains the values of Bridge Address as defined in IEEE Std 802.1Q [7] clause 8.13.8. The length of Bridge parameter value field indicates a value of 6.

When the Bridge parameter name indicates Bridge ID, the Bridge parameter value field contains the values of Bridge Identifier as defined in IEEE Std 802.1Q [7] clause 14.2.5. The length of Bridge parameter value field indicates a value of 8.

When the Bridge parameter name indicates NW-TT port numbers, the Bridge parameter value field contains NW-TT port numbers as defined in 3GPP TS 23.501 [2] table 5.28.3.1-2, encoded as the value part of the NW-TT port numbers information element as specified in clause 9.14.

When the Bridge parameter name indicates Static filtering entries, the Bridge parameter value field contains Static filtering entries as defined in 3GPP TS 23.501 [2] table 5.28.3.1-2, encoded as the value part of the Static filtering entries information element as specified in clause 9.6.

When the Bridge parameter name indicates IldpV2PortConfigAdminStatusV2, the Bridge parameter value field contains values of IldpV2PortConfigAdminStatusV2 as specified in IEEE Std 802.1AB [6] clause 9.2.5.1 with value of txOnly encoded as 01H, rxOnly encoded as 02H, txAndRx encoded as 03H, and disabled encoded as 04H. The length of Bridge parameter value field indicates a value of 1.

When the Bridge parameter name indicates IldpV2LocChassisIdSubtype, the Bridge parameter value field contains values of IldpV2LocChassisIdSubtype as specified in IEEE Std 802.1AB [6] clause 8.5.2.2. The length of Bridge parameter value field indicates a value of 1.

When the Bridge parameter name indicates IldpV2LocChassisId, the Bridge parameter value field contains values of IldpV2LocChassisId in the form of an octet string as specified in IEEE Std 802.1AB [6] clause 8.5.2.3. The length of Bridge parameter value field indicates the length of the octet string with a maximum value of 255.

When the Bridge parameter name indicates IldpV2MessageTxInterval, the Bridge parameter value field contains the value of IldpV2MessageTxInterval as specified in IEEE Std 802.1AB [6] table 11-2. The length of Bridge parameter value field indicates a value of 2.

When the Bridge parameter name indicates IldpV2MessageTxHoldMultiplier, the Bridge parameter value field contains the value of IldpV2MessageTxHoldMultiplier as specified in IEEE Std 802.1AB [6] table 11-2. The length of Bridge parameter value field indicates a value of 1.

When the Bridge parameter name indicates DS-TT port neighbor discovery configuration for DS-TT ports, the Bridge parameter value field contains DS-TT port neighbor discovery configuration for DS-TT ports as defined in 3GPP TS 23.501 [2] table 5.28.3.1-2, encoded as the value part of the DS-TT port neighbor discovery configuration for DS-TT ports information element as specified in clause 9.10.

When the Bridge parameter name indicates Discovered neighbor information for DS-TT ports, the Bridge parameter value field contains Discovered neighbor information for DS-TT ports as defined in 3GPP TS 23.501 [2] table 5.28.3.1-2, encoded as the value part of the Discovered neighbor information for DS-TT ports information element as specified in clause 9.11.

When the Bridge parameter name indicates MaxStreamFilterInstances, the Bridge parameter value field contains the value of PSFPMaxStreamFilterInstances as specified in IEEE Std 802.1Q [7] clause 12.31.1.1. The length of Bridge parameter value field indicates a value of 4.

When the Bridge parameter name indicates PSFPMaxStreamGateInstances, the Bridge parameter value field contains the value of MaxStreamGateInstances as specified in IEEE Std 802.1Q [7] clause 12.31.1.1. The length of Bridge parameter value field indicates a value of 4.

<p>When the Bridge parameter name indicates PSFPMaxFlowMeterInstances, the Bridge parameter value field contains the value of MaxFlowMeterInstances as specified in IEEE Std 802.1Q [7] Table 12-31. The length of Bridge parameter value field indicates a value of 4.</p> <p>When the Bridge parameter name indicates PSFPSupportedListMax, the Bridge parameter value field contains the value of SupportedListMax as specified in IEEE Std 802.1Q [7] clause 12. 31.1.4. The length of Bridge parameter value field indicates a value of 4.</p> <p>When the hexadecimal encoding of the Bridge parameter name is in the "8000H" to "FFFFH" range, the encoding of the Bridge parameter value field and the value of the length of Bridge parameter value field are deployment-specific.</p>
<p>NOTE 1: The "Set parameter" operation shall not be applicable for the following bridge parameter names:</p> <ul style="list-style-type: none"> - 0001H Bridge Address; - 0003H Bridge ID; - 0004H NW-TT port numbers; - 0051H Discovered neighbor information for DS-TT ports; - 0070H PSFPMaxStreamFilterInstances; - 0071H PSFPMaxStreamGateInstances; - 0072H PSFPMaxFlowMeterInstances; and - 0073H PSFPSupportedListMax. <p>NOTE 2: Implementations compliant with earlier versions of this release of the specification can interpret these values as signalling the Bridge Name.</p> <p>NOTE 3: Implementations compliant with earlier versions of this release of the specification can interpret these values as signalling the Chassis ID subtype.</p> <p>NOTE 4: Implementations compliant with earlier versions of this release of the specification can interpret these values as signalling the Chassis ID.</p>

9.5C Bridge management capability

The purpose of the Bridge management capability information element is to inform the TSN AF of the Bridge parameters supported by the NW-TT.

The Bridge management capability information element is coded as shown in figure 9.5C.1, figure 9.5C.2, and table 9.5C.1.

The Bridge management capability information element has a minimum length of 5 octets and a maximum length of 65530 octets.

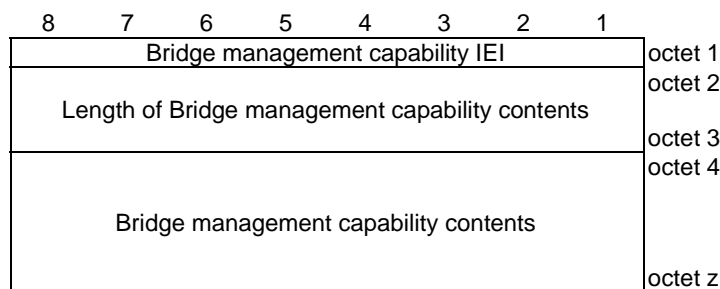

Figure 9.5C.1: Bridge management capability information element

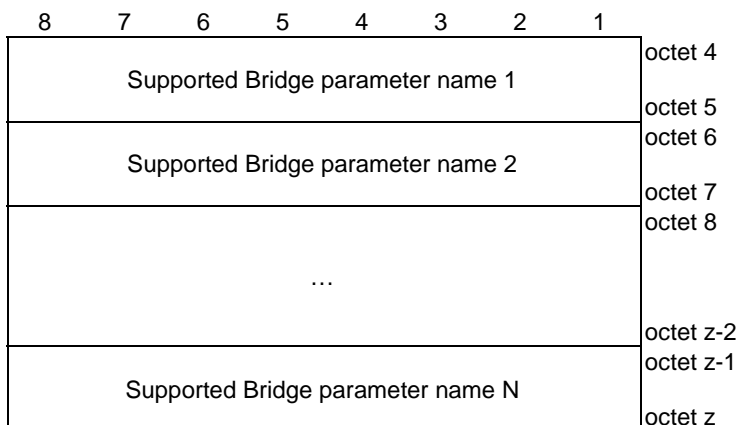

Figure 9.5C.2: Bridge management capability contents

Table 9.5C.1: Bridge management capability information element

<p>Value part of the Bridge management capability information element (octets 4 to z)</p> <p>The value part of the Bridge management capability information element consists of one or several supported Bridge parameter names, each encoded over 2 octets as specified in table 9.5B.1 for the NW-TT to TSN AF direction.</p>

9.5D Bridge status

The purpose of the Bridge status information element is to report the values of Bridge parameters of the NW-TT to the TSN AF.

The Bridge status information element is coded as shown in figure 9.5D.1, figure 9.5D.2, figure 9.5D.3, figure 9.5D.4, figure 9.5D.5, and table 9.5D.1.

The Bridge status information element has a minimum length of 5 octets and a maximum length of 65530 octets.

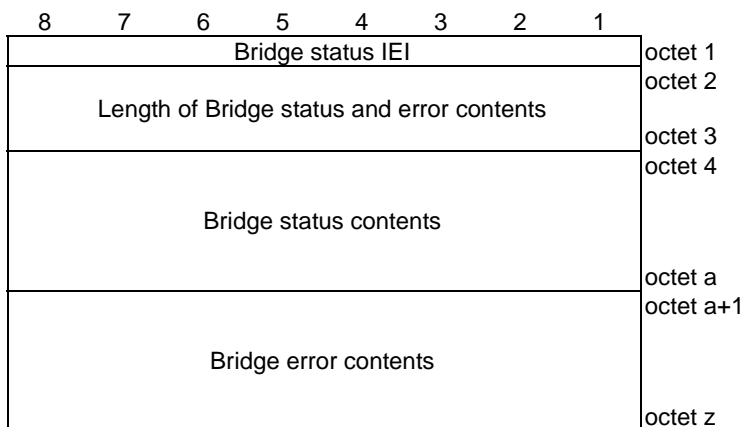

Figure 9.5D.1: Bridge status information element

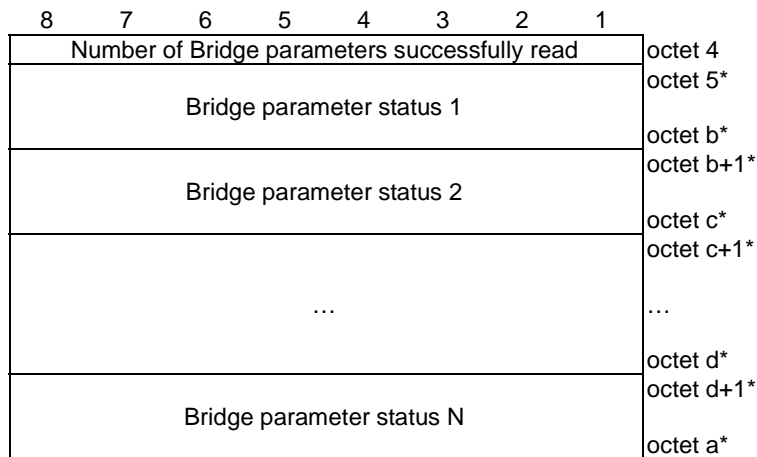

Figure 9.5D.2: Bridge status contents

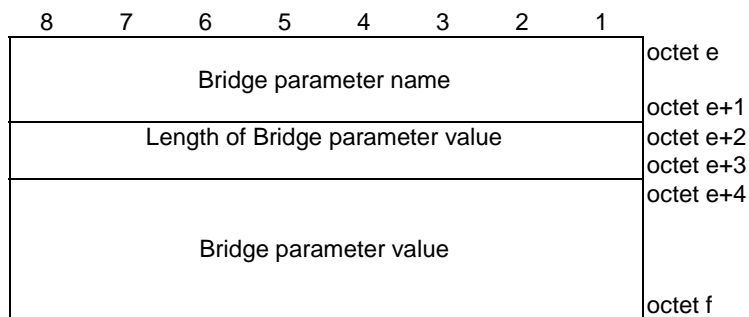

Figure 9.5D.3: Bridge parameter status

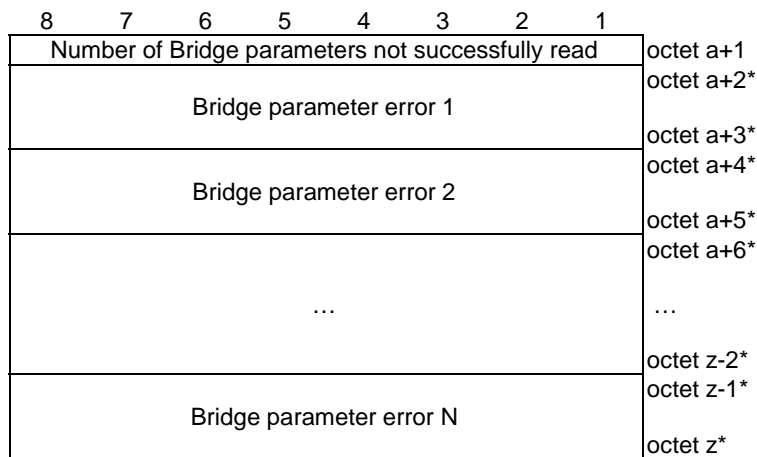

Figure 9.5D.4: Bridge error contents

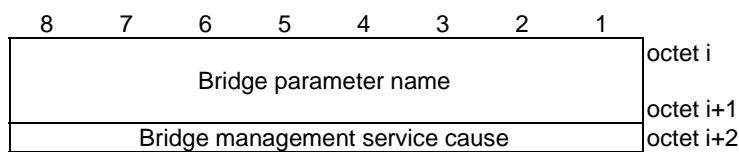

Figure 9.5D.5: Bridge parameter error

Table 9.4.1: Bridge status information element

Value part of the Bridge status information element (octets 4 to z)
Bridge status contents (octets 4 to a)
This field consists of zero or several Bridge parameter statuses.
Bridge parameter status
Bridge parameter name (octets e to e+1)
This field contains the name of the Bridge parameter which could be read successfully, encoded over 2 octets as specified in table 9.2.1 for the NW-TT to TSN AF direction.
Length of Bridge parameter value (octets e+2 to e+3)
This field contains the binary encoding of the length of the Bridge parameter value
Bridge parameter value (octets e+4 to f)
This field contains the value for the Bridge parameter, encoded as specified in table 9.2.1.
Bridge error contents (octets a+1 to z)
This field consists of zero or several Bridge parameter errors.
Bridge parameter error
Bridge parameter name (octets to i+1)
This field contains the name of the Bridge parameter whose value could not be read successfully, encoded over 2 octets as specified in table 9.2.1 for the NW-TT to TSN AF direction.
Bridge management service cause (octet i+2)
This field contains the Bridge management service cause indicating the reason why the value of the Bridge parameter could not be read successfully, encoded as follows:
Bits
8 7 6 5 4 3 2 1
0 0 0 0 0 0 0 0 Reserved
0 0 0 0 0 0 0 1 Bridge parameter not supported
0 0 0 0 0 0 1 0 Invalid Bridge parameter value
0 1 1 0 1 1 1 1 Protocol error, unspecified
The receiving entity shall treat any other value as 0110 1111, "protocol error, unspecified".

9.5E Bridge update result

The purpose of the Bridge update result information element is to report to the TSN AF the outcome of the request from the TSN AF to set one or more Bridge parameters to a specific value.

The Bridge update result information element is coded as shown in figure 9.5E.1, figure 9.5E.2, figure 9.5E.3, figure 9.5E.4, figure 9.5E.5, and table 9.5E.1.

The Bridge update result information element has a minimum length of 5 octets and a maximum length of 65530 octets.

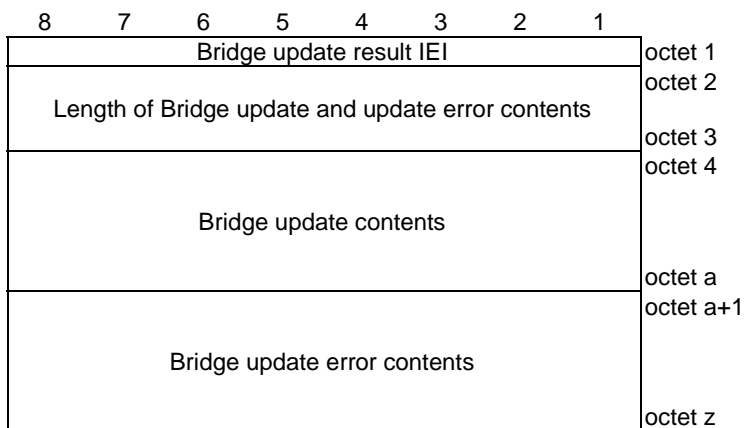

Figure 9.5E.1: Bridge update result information element

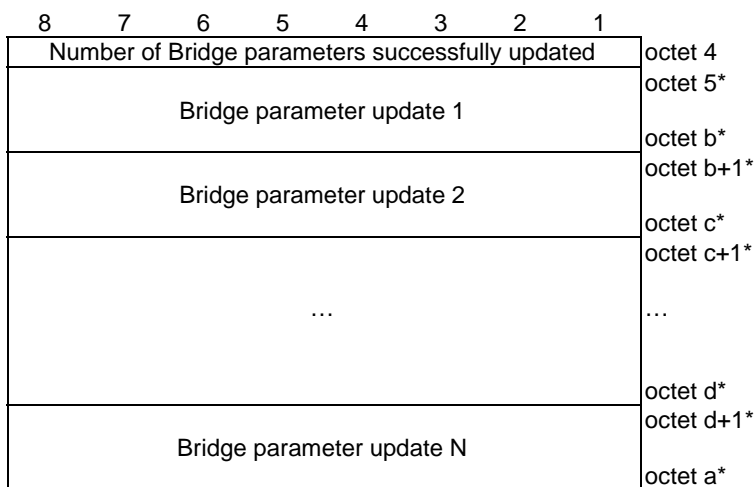

Figure 9.5E.2: Bridge update contents

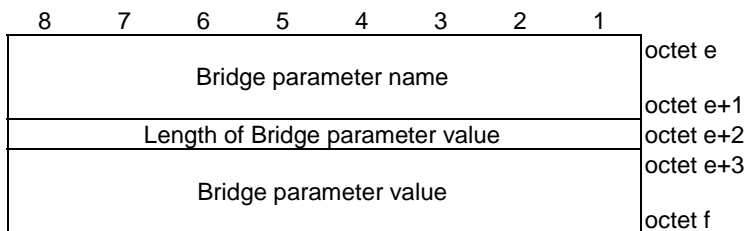

Figure 9.5E.3: Bridge parameter update

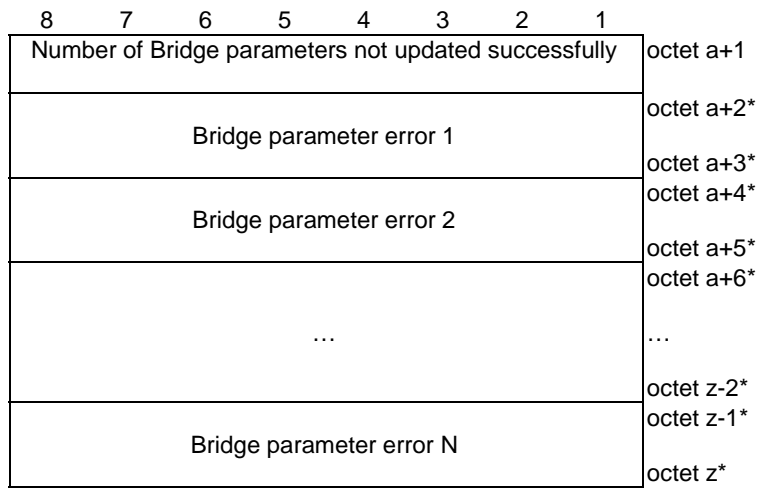

Figure 9.5E.4: Bridge update error contents

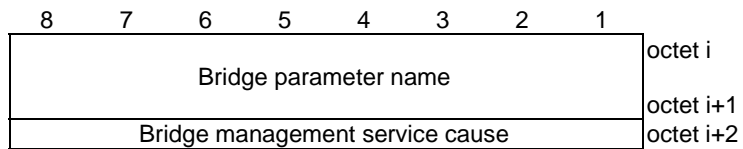

Figure 9.5E.5: Bridge parameter error

Table 9.5E.1: Bridge update result information element

Value part of the Bridge update result information element (octets 4 to z)
Bridge update contents (octets 4 to a)
This field consists of zero or several Bridge parameter updates.
Bridge parameter update
Bridge parameter name (octets e to e+1)
This field contains the name of the Bridge parameter which could be set successfully, encoded over 2 octets as specified in table 9.5B.1 for the NW-TT to TSN AF direction.
Length of Bridge parameter value (octet e+2)
This field contains the binary encoding of the length of the Bridge parameter value
Bridge parameter value (octets e+3 to f)
Bridge error contents (octets a+1 to z)
This field consists of zero or several Bridge parameter errors.
Bridge parameter error
Bridge parameter name (octets i to i+1)
This field contains the name of the Bridge parameter whose value could not be set successfully, encoded over 2 octets as specified in table 9.5B.1 for the NW-TT to TSN AF direction.
Bridge management service cause (octet i+2)
This field contains the Bridge management service cause indicating the reason why the value of the Bridge parameter could not be set successfully, encoded as follows:
Bits
8 7 6 5 4 3 2 1
0 0 0 0 0 0 0 0 Reserved
0 0 0 0 0 0 0 1 Bridge parameter not supported
0 0 0 0 0 0 1 0 Invalid Bridge parameter value
0 1 1 0 1 1 1 1 Protocol error, unspecified
The receiving entity shall treat any other value as 0110 1111, "protocol error, unspecified".

9.6 Static filtering entries

The purpose of the Static filtering entries information element is to convey Static filtering entries as defined in 3GPP TS 23.501 [2] table 5.28.3.1-2.

The Static filtering entries information element is coded as shown in figure 9.6.1, figure 9.6.2 and table 9.6.1.

The Static filtering entries information element has a minimum length of 3 octets.

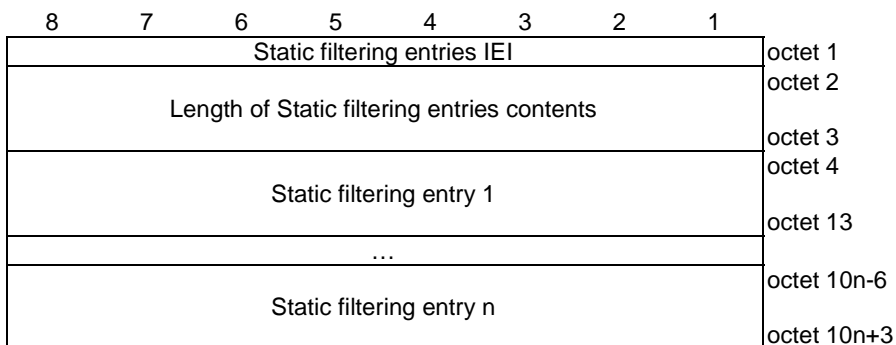

Figure 9.6.1: Static filtering entries information element

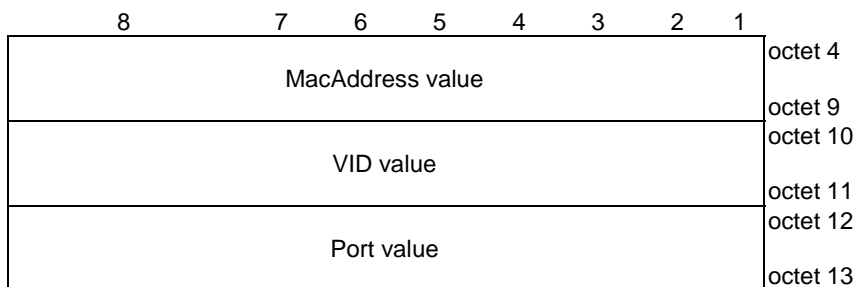

Figure 9.6.2: Static filtering entry

Table 9.6.1: Static filtering entries

Value part of the Static filtering entries information element (octets 4 to 10n+3)
Static filtering entries contents (octets 4 to 10n+3)
This field consists of zero or more Static filtering entries.
Static filtering entry (octets 4 to 13)
MacAddress value (octets 4 to 9)
MacAddress value contains the value of MAC address as specified in IEEE Std 802.1Q [7] clause 8.8.1.
VID value (octets 10 to 11)
VID value contains the value of VID specification as specified in IEEE Std 802.1Q [7] clause 8.8.1.
Port value (octets 12 to 13)
Port value contains the value of outbound Port as specified in IEEE Std 802.1Q [7] clause 8.8.1.

9.7 Traffic class table

The purpose of the Traffic class table information element is to convey a traffic class table as defined in IEEE Std 802.1Q [7].

The Traffic class table information element is coded as shown in figure 9.7.1, figure 9.7.2, figure 9.7.3, and table 9.7.1.

The Traffic class table information element has a minimum length of 3 octets and a maximum length of 19 octets.

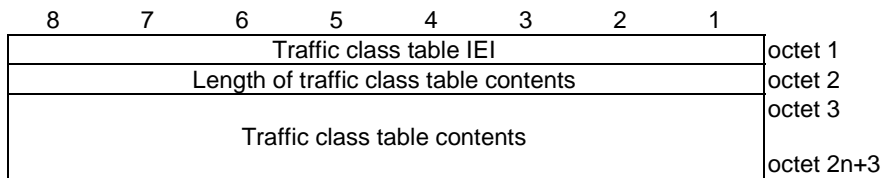

Figure 9.7.1: Traffic class table information element

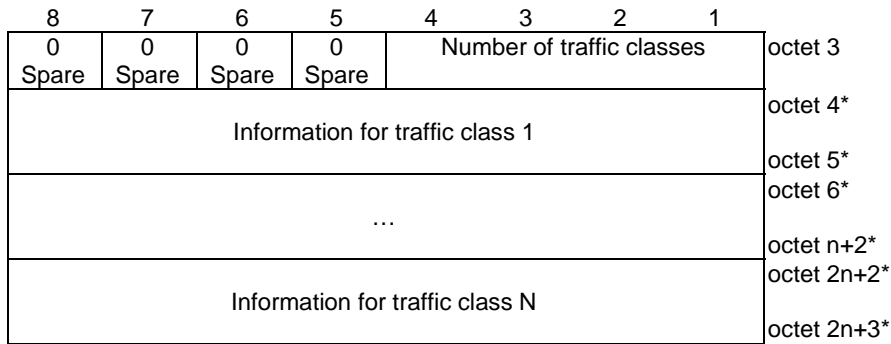

Figure 9.7.2: Traffic class table contents

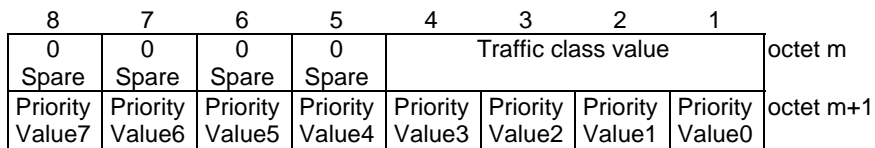

Figure 9.7.3: Information for traffic class

Table 9.7.1: Traffic class information

Number of traffic classes (bit 1 to bit 3 of octet 3)	
Bits	
4 3 2 1	
0 0 0 0	No traffic class information is included
0 0 0 1	Information on one traffic class is included
0 0 1 0	Information on two traffic classes is included
0 0 1 1	Information on three traffic classes is included
0 1 0 0	Information on four traffic classes is included
0 1 0 1	Information on five traffic classes is included
0 1 1 0	Information on six traffic classes is included
0 1 1 1	Information on seven traffic classes is included
1 0 0 0	Information on eight traffic classes is included
1 0 0 1	
	to Reserved
1 1 1 1	
Traffic class value (bit 1 to bit 3 of octet m)	
Bits	
3 2 1	
0 0 0	The value of the traffic class is 0
0 0 1	The value of the traffic class is 1
0 1 0	The value of the traffic class is 2
0 1 1	The value of the traffic class is 3
1 0 0	The value of the traffic class is 4
1 0 1	The value of the traffic class is 5
1 1 0	The value of the traffic class is 6
1 1 1	The value of the traffic class is 7
PriorityValue0 (bit 1 of octet m+1)	
Bit	
1	
0	Priority value 0 is not assigned to the traffic class
1	Priority value 0 is assigned to the traffic class
PriorityValue1 (bit 2 of octet m+1)	
Bit	
2	
0	Priority value 1 is not assigned to the traffic class
1	Priority value 1 is assigned to the traffic class
PriorityValue2 (bit 3 of octet m+1)	
Bit	
3	
0	Priority value 2 is not assigned to the traffic class
1	Priority value 2 is assigned to the traffic class
PriorityValue3 (bit 4 of octet m+1)	
Bit	
4	
0	Priority value 3 is not assigned to the traffic class
1	Priority value 3 is assigned to the traffic class
PriorityValue4 (bit 5 of octet m+1)	
Bit	
5	
0	Priority value 4 is not assigned to the traffic class
1	Priority value 4 is assigned to the traffic class
PriorityValue5 (bit 6 of octet m+1)	
Bit	
6	
0	Priority value 5 is not assigned to the traffic class
1	Priority value 5 is assigned to the traffic class
PriorityValue6 (bit 7 of octet m+1)	
Bit	
7	
0	Priority value 6 is not assigned to the traffic class

1	Priority value 6 is assigned to the traffic class
PriorityValue7 (bit 8 of octet m+1)	
Bit	
8	
0	Priority value 7 is not assigned to the traffic class
1	Priority value 7 is assigned to the traffic class

9.8 Stream filter instance table

The purpose of the Stream filter instance table information element is to convey a Stream filter instance table as defined 3GPP TS 23.501 [2] table 5.28.3.1-1.

The Stream filter instance table information element is coded as shown in figure 9.8.1, figure 9.8.2, figure 9.8.3, figure 9.8.4, figure 9.8.5, and table 9.8.1.

The Stream filter instance table is a type 6 information element with a minimum length of 3 octets.

8	7	6	5	4	3	2	1	
Stream filter instance table IEI								octet 1
Length of Stream filter instance table contents								octet 2
Stream filter instance 1								octet 3
...								octet 4*
Stream filter instance n								octet m*
								octet o*

Figure 9.8.1: Stream filter instance table information element

8	7	6	5	4	3	2	1	
Length of Stream filter instance contents								octet 4
PrioritySpec value								octet 5
StreamGateInstanceID value								octet 8
tsnStreamIdIdentificationType value								octet 9
tsnStreamIdParameters								octet 12
StreamFilterInstanceIndex value (NOTE)								octet 13
								octet 16
								octet 17
								octet m-4
								octet m-3*
								octet m*

Figure 9.8.2: Stream filter instance

8	7	6	5	4	3	2	1	
Length of tsnStreamIdParameters contents								octet 17
tsnCpeNullDownDestMac value								octet 18
tsnCpeNullDownTagged value								octet 23
tsnCpeNullDownVlan value								octet 24
								octet 25
								octet 26

Figure 9.8.3: tsnStreamIdParameters for tsnStreamIdIdentificationType = 00-80-C2 01

8	7	6	5	4	3	2	1	
Length of tsnStreamIdParameters contents								octet 17
tsnCpeSmacVlanDownSrcMac value								octet 18
tsnCpeSmacVlanDownTagged value								octet 23
tsnCpeSmacVlanDownVlan value								octet 24
tsnCpeSmacVlanDownVlan value								octet 25
tsnCpeSmacVlanDownVlan value								octet 26

Figure 9.8.4: tsnStreamIdParameters for tsnStreamIdIdentificationType = 00-80-C2 02

8	7	6	5	4	3	2	1	
Length of tsnStreamIdParameters contents								octet 17
tsnCpeDmacVlanDownDestMac value								octet 18
tsnCpeDmacVlanDownTagged value								octet 23
tsnCpeDmacVlanDownTagged value								octet 24
tsnCpeDmacVlanDownVlan value								octet 25
tsnCpeDmacVlanDownVlan value								octet 26
tsnCpeDmacVlanDownPriority value								octet 27
tsnCpeDmacVlanUpDestMac value								octet 28
tsnCpeDmacVlanUpDestMac value								octet 33
tsnCpeDmacVlanUpTagged value								octet 34
tsnCpeDmacVlanUpVlan value								octet 35
tsnCpeDmacVlanUpVlan value								octet 36
tsnCpeDmacVlanUpPriority value								octet 37

Figure 9.8.5: tsnStreamIdParameters for tsnStreamIdIdentificationType = 00-80-C2 03

Table 9.8.1: Stream filter instance table

Value part of the Stream filter instance table information element (octets 4 to o)
Stream filter instance table contents (octets 4 to o)
This field consists of zero or more Stream filter instances.
Stream filter instance (octets 4 to m)
Length of Stream filter instance contents (octet 4)
Length of Stream filter instance contents contains the length of the value part of Stream filter instance in octets.
PrioritySpec value (octets 5 to 8)
PrioritySpec value contains the value of PrioritySpec as specified in IEEE Std 802.1Q [7] table 12-32.

StreamGateInstanceID value (octets 9 to 12)

StreamGateInstanceID value contains the value of StreamGateInstanceID as specified in IEEE Std 802.1Q [7] table 12-32.

tsnStreamIdIdentificationType value (octets 13 to 16)

tsnStreamIdIdentificationType value contains the value of tsnStreamIdIdentificationType in the form of four octets as specified in IEEE Std 802.1CB [10] clause 9.1.1.6. The first 3 octets contain the binary encoding of Organizationally Unique Identifier (OUI) or Company ID (CID). The 4th octet contains the binary encoded value of type number. In this document only OUI/CID value 00-80-C2 with type number value 1, 2 and 3 are specified. Other type number values are reserved. Other OUI/CID values are outside the scope of the present document.

tsnStreamIdParameters (octets 17 to m-4)

Length of tsnStreamIdParameters (octet 17)

Length of tsnStreamIdParameters contents contains the length of the value part of tsnStreamIdParameters in octets.

tsnCpeNullDownDestMac value (octets 18 to 23)

tsnCpeNullDownDestMac value contains the value of tsnCpeNullDownDestMac as specified in IEEE Std 802.1CB [10] clause 9.1.2.1.

tsnCpeNullDownTagged value (octet 24)

tsnCpeNullDownTagged value contains an enumerated value of tsnCpeNullDownTagged as specified in IEEE Std 802.1CB [10] clause 9.1.2.2 in the form of a binary encoded octet. Value "tagged" is encoded as binary 0, value "priority" is encoded as binary 1, and value "all" is encoded as binary 2. All other values are reserved.

tsnCpeNullDownVlan value (octets 25 to 26)

tsnCpeNullDownVlan value contains the value of tsnCpeNullDownVlan as specified in IEEE Std 802.1CB [10] clause 9.1.2.3.

tsnCpeSmacVlanDownSrcMac value (octets 18 to 23)

tsnCpeSmacVlanDownSrcMac value contains the value of tsnCpeSmacVlanDownSrcMac as specified in IEEE Std 802.1CB [10] clause 9.1.3.1. tsnCpeSmacVlanDownTagged value (octet 24)

tsnCpeSmacVlanDownTagged value contains an enumerated value of tsnCpeSmacVlanDownTagged as specified in IEEE Std 802.1CB [10] clause 9.1.3.2 in the form of a binary encoded octet. Value "tagged" is encoded as binary 0, value "priority" is encoded as binary 1, and value "all" is encoded as binary 2. All other values are reserved.

tsnCpeSmacVlanDownVlan value (octets 25 to 26)

tsnCpeSmacVlanDownVlan value contains the value of tsnCpeSmacVlanDownVlan as specified in IEEE Std 802.1CB [10] clause 9.1.3.3.

tsnCpeDmacVlanDownDestMac value (octets 18 to 23)

tsnCpeDmacVlanDownDestMac value contains the value of tsnCpeDmacVlanDownDestMac as specified in IEEE Std 802.1CB [10] clause 9.1.4.1.

tsnCpeDmacVlanDownTagged value (octet 24)

tsnCpeDmacVlanDownTagged value contains an enumerated value of tsnCpeDmacVlanDownTagged as specified in IEEE Std 802.1CB [10] clause 9.1.4.2 in the form of a binary encoded octet. Value "tagged" is encoded as binary 0, value

<p>“priority” is encoded as binary 1, and value “all” is encoded as binary 2. All other values are reserved.</p> <p>tsnCpeDmacVlanDownVlan value (octets 25 to 26)</p> <p>tsnCpeDmacVlanDownVlan value contains the value of tsnCpeDmacVlanDownVlan as specified in IEEE Std 802.1CB [10] clause 9.1.4.3.</p> <p>tsnCpeDmacVlanDownPriority value (octet 27)</p> <p>tsnCpeDmacVlanDownPriority value contains the value of tsnCpeDmacVlanDownPriority as specified in IEEE Std 802.1CB [10] clause 9.1.4.4.</p> <p>tsnCpeDmacVlanUpDestMac value (octets 28 to 33)</p> <p>tsnCpeDmacVlanUpDestMac value contains the value of tsnCpeDmacVlanUpDestMac as specified in IEEE Std 802.1CB [10] clause 9.1.4.5.</p> <p>tsnCpeDmacVlanUpTagged value (octet 34)</p> <p>tsnCpeDmacVlanUpTagged value contains an enumerated value of tsnCpeDmacVlanUpTagged as specified in IEEE Std 802.1CB [10] clause 9.1.4.6 in the form of a binary encoded octet. Value “tagged” is encoded as binary 0, value “priority” is encoded as binary 1, and value “all” is encoded as binary 2. All other values are reserved.</p> <p>tsnCpeDmacVlanUpVlan value (octets 35 to 36)</p> <p>tsnCpeDmacVlanUpVlan value contains the value of tsnCpeDmacVlanUpVlan as specified in IEEE Std 802.1CB [10] clause 9.1.4.7.</p> <p>tsnCpeDmacVlanUpPriority value (octet 37)</p> <p>tsnCpeDmacVlanUpPriority value contains the value of tsnCpeDmacVlanUpPriority as specified in IEEE Std 802.1CB [10] clause 9.1.4.8.</p> <p>StreamFilterInstanceIndex value (octet m-3 to m)</p> <p>StreamFilterInstanceIndex value contains the value of StreamFilterInstance as specified in IEEE Std 802.1Q [7] table 12-32.</p>
<p>NOTE: A sender compliant with this release of the specification shall include the StreamFilterInstanceIndex value in the Stream filter instance of the Stream filter instance table information element. A sender compliant with earlier versions of this specification does not include the StreamFilterInstanceIndex value in the Stream filter instance of the Stream filter instance table information element.</p>

9.9 Stream gate instance table

The purpose of the Stream gate instance table information element is to convey a Stream gate instance table as defined in 3GPP TS 23.501 [2] table 5.28.3.1-1.

The Stream gate instance table information element is coded as shown in figure 9.9.1, figure 9.9.2, and table 9.9.1.

The Stream gate instance table is a type 6 information element with a minimum length of 3 octets.

8	7	6	5	4	3	2	1	
Stream gate instance table IEI								octet 1
Length of Stream gate instance table contents								octet 2 octet 3
Stream gate instance 1								octet 4* octet a*
...								
Stream gate instance N								octet b* octet c*

Figure 9.9.1: Stream gate instance table information element

8	7	6	5	4	3	2	1	
Length of Stream gate instance contents								octet 4 octet 5
StreamGateInstance								octet 6 octet 9
PSFPAdminBaseTime value								octet 10 octet 19
PSFPAdminCycleTime value								octet 20 octet 27
PSFPTickGranularity value								octet 28 octet 31
PSFPAdminControlListLength value								octet 32 octet 33
PSFPAdminControlList contents								octet 34 octet a

Figure 9.9.2: Stream gate instance

Table 9.9.1: Stream gate instance table

Value part of the Stream gate instance table information element (octets 4 to c)
Stream gate instance table contents (octets 4 to c)
This field consists of zero or more Stream gate instances.
Stream gate instance (octets 4 to a)
Length of Stream gate instance (octets 4 to 5)
Length of Stream gate instance contents contains the length of the vale part of Stream gate instance in octets.
StreamGateIndexInstance value (octets 6 to 9)
StreamGateIndexInstance value contains the value of StreamGateInstance as specified in IEEE Std 802.1Q [7] table 12-33.
PSFPAdminBaseTime value (octets 10 to 19)
PSFPAdminBaseTime value contains the value of PSFPAdminBaseTime as specified in IEEE Std 802.1Q [7] table 12-33.
PSFPAdminCycleTime value (octets 20 to 27)
PSFPAdminCycleTime value contains the value of PSFPAdminCycleTime as specified in IEEE Std 802.1Q [7] table 12-33.
PSFPTickGranularity value (octets 28 to 31)
PSFPTickGranularity value contains the value of PSFPTickGranularity as specified in IEEE Std 802.1Q [7] table 12-33.
PSFPAdminControlListLength value (octets 32 to 33)
PSFPAdminControlListLength value contains the value of PSFPAdminControlListLength as specified in IEEE Std 802.1Q [7] table 12-33.
PSFPAdminControlList contents (octets 34 to a)
This field contains the concatenation of entries, each encoded as a PSFPGateControlEntry as specified in IEEE Std 802.1Q [7] table 12-33. PSFPAdminControlListLength value indicates number of entries in this field.

9.10 DS-TT port neighbor discovery configuration for DS-TT ports

The purpose of the DS-TT port neighbor discovery configuration for DS-TT ports information element is to convey DS-TT port neighbor discovery configuration for DS-TT ports as defined in 3GPP TS 23.501 [2] table 5.28.3.1-2.

The DS-TT port neighbor discovery configuration for DS-TT ports information element is coded as shown in figure 9.10.1, figure 9.10.2 and table 9.10.1.

The DS-TT port neighbor discovery configuration for DS-TT ports information element has a minimum length of 3 octets.

8	7	6	5	4	3	2	1	
DS-TT port neighbor discovery configuration for DS-TT ports IEI								octet 1
Length of DS-TT port neighbor discovery configuration for DS-TT ports contents								octet 2 octet 3
DS-TT port neighbor discovery configuration for DS-TT ports instance 1								octet 4* octet x*
...								
DS-TT port neighbor discovery configuration for DS-TT ports instance n								octet y* octet z*

Figure 9.10.1: DS-TT port neighbor discovery configuration for DS-TT ports information element

8	7	6	5	4	3	2	1	
Length of DS-TT port neighbor discovery configuration for DS-TT ports instance								octet 4 octet 5
DS-TT port number value								octet 6 octet 7
IldpV2LocPortIdSubtype value								octet 8
Length of IldpV2LocPortId value								octet 9
IldpV2LocPortId value								octet 10 octet x

Figure 9.10.2: DS-TT port neighbor discovery configuration for DS-TT ports instance

Table 9.10.1: DS-TT port neighbor discovery configuration for DS-TT ports

Value part of the DS-TT port neighbor discovery configuration for DS-TT ports information element (octets 4 to z)
DS-TT port neighbor discovery configuration for DS-TT ports contents (octets 4 to z)
This field consists of zero or more DS-TT port neighbor discovery configuration for DS-TT ports instances.
DS-TT port neighbor discovery configuration for DS-TT ports instance (octets 4 to x)
Length of DS-TT port neighbor discovery configuration for DS-TT ports instance (octets 4 to 5)
Length of DS-TT port neighbor discovery configuration for DS-TT ports instance contains the length of the value part of DS-TT port neighbor discovery configuration for DS-TT ports instance in octets.
DS-TT port number value (octets 6 to 7)
DS-TT port number value contains the value of Port Number as specified in IEEE Std 802.1Q [7].
IldpV2LocPortIdSubtype value (octet 8)
IldpV2LocPortIdSubtype value contains the value of IldpV2LocPortIdSubtype as specified in IEEE Std 802.1AB [6] clause 8.5.3.2.
Length of IldpV2LocPortId value (octet 9)
Length of IldpV2LocPortId value contains the binary coded length in octets of IldpV2LocPortId value.
IldpV2LocPortId value (octets 10 to x)
IldpV2LocPortId value contains the value of IldpV2LocPortId in the form of an octet string as specified in IEEE Std 802.1AB [6] clause 8.5.3.3.

9.11 Discovered neighbor information for DS-TT ports

The purpose of the Discovered neighbor information for DS-TT ports information element is to convey Discovered neighbor information for DS-TT ports as defined in 3GPP TS 23.501 [2] table 5.28.3.1-2.

The Discovered neighbor information for DS-TT ports information element is coded as shown in figure 9.11.1, figure 9.11.2 and table 9.11.1.

The Neighbor discovery information information element has a minimum length of 3 octets.

8	7	6	5	4	3	2	1	
Discovered neighbor information for DS-TT ports IEI								octet 1
Length of Discovered neighbor information for DS-TT ports contens								octet 2 octet 3
Discovered neighbor information for DS-TT ports instance 1								octet 4* octet x*
...								
Discovered neighbor information for DS-TT ports instance n								octet y* octet z*

Figure 9.11.1: Discovered neighbor information for DS-TT ports information element

8	7	6	5	4	3	2	1	
Length of Discovered neighbor information for DS-TT ports instance								octet 4 octet 5
DS-TT port number value								octet 6 octet 7
lldpTTL value								octet 8 octet 9
lldpV2RemChassisIdSubtype value								octet 10
Length of lldpV2RemChassisId value								octet 11
lldpV2RemChassisId value								octet 12 octet a
lldpV2RemPortIdSubtype value								octet a+1
Length of lldpV2RemPortId value								octet a+2
lldpV2RemPortId value								octet a+3 octet x

Figure 9.11.2: Discovered neighbor information for DS-TT ports instance

Table 9.11.1: Discovered neighbor information for DS-TT ports

Value part of the Discovered neighbor information for DS-TT ports information element (octets 4 to z)
Neighbor discovery information contents (octets 4 to z)
This field consists of zero or more Neighbor discovery information instances.
Neighbor discovery information instance (octets 4 to x)
Length of Discovered neighbor information for DS-TT ports instance (octets 4 to 5)
Length of Discovered neighbor information for DS-TT ports instance contains the length of the value part of Discovered neighbor information for DS-TT ports instance in octets.
DS-TT port number value (octets 6 to 7)
DS-TT port number value contains the value of Port Number as specified in IEEE Std 802.1Q [7].
IldpTTL value (octets 8 to 9)
IldpTTL value contains the value of TTL as specified in IEEE Std 802.1AB [6] clause 8.5.4.
IldpV2RemChassisIdSubtype value (octet 10)
IldpV2RemChassisIdSubtype value contains the value of IldpV2RemChassisIdSubtype as specified in IEEE Std 802.1AB [6] clause 8.5.2.2.
Length of IldpV2RemChassisId value (octet 11)
Length of IldpV2RemChassisId value contains the binary coded length in octets of IldpV2RemChassisId value.
IldpV2RemChassisId value (octets 12 to a)
IldpV2RemChassisId value contains the value of IldpV2RemChassisId in the form of an octet string as specified in IEEE Std 802.1AB [6] clause 8.5.2.3.
IldpV2RemPortIdSubtype value (octet a+1)
IldpV2RemPortIdSubtype value contains the value of IldpV2RemPortIdSubtype as specified in IEEE Std 802.1AB [6] clause 8.5.3.2.
Length of IldpV2RemPortId value (octet a+2)
Length of IldpV2RemPortId value contains the binary coded length in octets of IldpV2RemPortId value.
IldpV2RemPortId value (octets a+3 to x)
IldpV2RemPortId value contains the value of IldpV2RemPortId in the form of an octet string as specified in IEEE Std 802.1AB [6] clause 8.5.3.3.

9.12 TSN AF feature support

The purpose of the TSN AF feature support information element is to indicate whether certain features are supported by the TSN AF.

The TSN AF feature support information element is coded as shown in figure 9.12.1 and table 9.12.1.

The TSN AF feature support is a type 4 information element with a length of 3 octets.

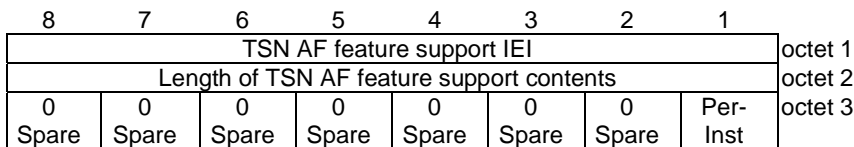

Figure 9.12.1: TSN AF feature support information element

Table 9.12.1: TSN AF feature support information element

Per-instance parameter handling for stream filter instance table indicator (Per-Inst) (octet 3, bit 1) This bit indicates the support of per-instance parameter handling for stream filter instance table. Bit 1 0 Per-instance parameter handling for stream filter instance table not supported 1 Per-instance parameter handling for stream filter instance table supported
--

9.13 TT feature support

The purpose of the TT feature support information element is to indicate whether certain features are supported by the DS-TT or NW-TT.

The TT feature support information element is coded as shown in figure 9.13.1 and table 9.13.1.

The TT feature support is a type 4 information element with a length of 3 octets.

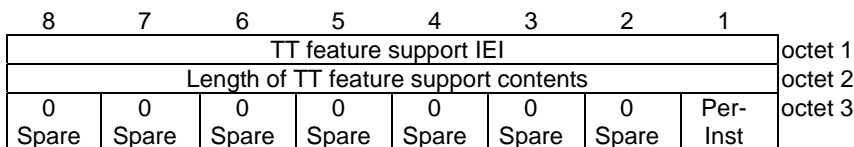

Figure 9.13.1: TT feature support information element

Table 9.13.1: TT feature support information element

Per-instance parameter handling for stream filter instance table indicator (Per-Inst) (octet 3, bit 1) This bit indicates the support of per-instance parameter handling for stream filter instance table. Bit 1 0 Per-instance parameter handling for stream filter instance table not supported 1 Per-instance parameter handling for stream filter instance table supported
--

9.14 NW-TT port numbers

The purpose of the NW-TT port numbers information element is to convey NW-TT Ethernet port numbers as defined in 3GPP TS 23.501 [2] table 5.28.3.1-2.

The NW-TT port numbers information element is coded as shown in figure 9.14.1 and table 9.14.1.

The NW-TT port numbers information element has a minimum length of 3 octets.

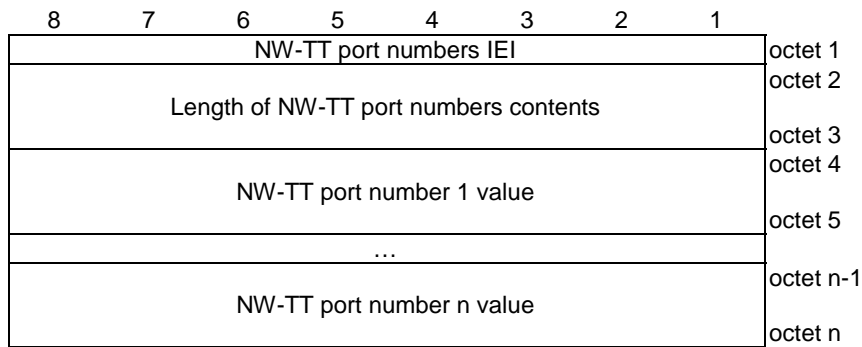

Figure 9.14.1: NW-TT port numbers information element

Table 9.14.1: NW-TT port numbers

Value part of the NW-TT port numbers information element (octets 4 to n)
NW-TT port numbers contents (octets 4 to n)
This field consists of zero or more NW-TT port numbers.
NW-TT port number (octets 4 to 5)
NW-TT port number value contains the value of Port Number as specified in IEEE Std 802.1Q [7].

10 Timers of Ethernet port management service

Timers of Ethernet port management service are shown in table 10.1, table 10.2, table 10.3, table 10.4 and table 10.5.

Table 10.1: Timers of Ethernet port management service – TSN AF side

TIMER NUM.	TIMER VALUE	CAUSE OF START	NORMAL STOP	ON THE 1 st , 2 nd , 3 rd , 4 th EXPIRY
T100	NOTE	Transmission of MANAGE ETHERNET PORT COMMAND message	MANAGE ETHERNET PORT COMPLETE message received	Retransmission of MANAGE ETHERNET PORT COMMAND message

NOTE: The value of this timer is network dependent.

Table 10.2: Timers of Bridge management service – TSN AF side

TIMER NUM.	TIMER VALUE	CAUSE OF START	NORMAL STOP	ON THE 1 st , 2 nd , 3 rd , 4 th EXPIRY
T150	NOTE	Transmission of MANAGE BRIDGE COMMAND message	MANAGE BRIDGE COMPLETE message received	Retransmission of MANAGE BRIDGE PORT COMMAND message

NOTE: The value of this timer is network dependent.

Table 10.3: Timers of Ethernet port management service – DS-TT side

TIMER NUM.	TIMER VALUE	CAUSE OF START	NORMAL STOP	ON THE 1 st , 2 nd , 3 rd , 4 th EXPIRY
T200	NOTE	Transmission of ETHERNET PORT MANAGEMENT NOTIFY message	ETHERNET PORT MANAGEMENT NOTIFY ACK message received	Retransmission of ETHERNET PORT MANAGEMENT NOTIFY message
NOTE: The value of this timer is DS-TT dependent.				

Table 10.4: Timers of Ethernet port management service – NW-TT side

TIMER NUM.	TIMER VALUE	CAUSE OF START	NORMAL STOP	ON THE 1 st , 2 nd , 3 rd , 4 th EXPIRY
T300	NOTE	Transmission of ETHERNET PORT MANAGEMENT NOTIFY message	ETHERNET PORT MANAGEMENT NOTIFY ACK message received	Retransmission of ETHERNET PORT MANAGEMENT NOTIFY message
NOTE: The value of this timer is NW-TT dependent.				

Table 10.5: Timers of Bridge management service – NW-TT side

TIMER NUM.	TIMER VALUE	CAUSE OF START	NORMAL STOP	ON THE 1 st , 2 nd , 3 rd , 4 th EXPIRY
T350	NOTE	Transmission of BRIDGE MANAGEMENT NOTIFY message	BRIDGE MANAGEMENT NOTIFY ACK message received	Retransmission of BRIDGE MANAGEMENT NOTIFY message
NOTE: The value of this timer is NW-TT dependent.				

Annex A (informative): Change history

Change history							
Date	Meeting	TDoc	CR	Rev	Cat	Subject/Comment	New version
2019-11	CT1#121	C1-198752				Draft skeleton provided by the rapporteur	0.0.0
2019-11	CT1#121					Implementation of the following pseudo CRs agreed by CT1: C1-198019, C1-198174, C1-198482, C1-198753, C1-198757, C1-198758, and C1-199024 Corrections made by the rapporteur	0.1.0
2019-12	CT#86	CP-193159				Presentation for information at TSG CT	1.0.0
2019-12	CT#86	CP-193292				A title corrected	1.0.1
2020-03	CT1#122					Implementation of the following pseudo CRs agreed by CT1: C1-200330, C10200331, C1-200573, C1-200687, C1-200706, C1-200708, C1-200832 Corrections made by the rapporteur	1.1.0
2020-03	CT-87e	CP-200166				Presentation for approval at TSG CT	2.0.0
2020-03	CT-87e	CP-200288				Revision after implementation of CP-200095. Presentation for approval at TSG CT	2.1.0
2020-03	CT-87e	CP-200292				Correction of implementation of CP-200095	2.2.0
2020-03	CT-87e					Version 16.0.0 created after approval	16.0.0
2020-06	CT-88e	CP-201137	0001	1	F	Correction of the abnormal case in NW-TT-initiated Ethernet port management procedure	16.1.0
2020-06	CT-88e	CP-201137	0002		D	Abbreviation correction	16.1.0
2020-06	CT-88e	CP-201137	0003		F	IEEE Std 802.1Qbv-2016 rolled into IEEE Std 802.1Q-2018	16.1.0
2020-06	CT-88e	CP-201137	0004	1	F	Introduction of Bridge management information	16.1.0
2020-06	CT-88e	CP-201137	0005		F	Updating definitions for Ethernet port management messages	16.1.0
2020-06	CT-88e	CP-201137	0006	1	F	Assignment of timer numbers and IELs	16.1.0
2020-06	CT-88e	CP-201137	0007		F	Splitting port management information into port- and bridge-specific information	16.1.0
2020-06	CT-88e	CP-201137	0008		F	Correct the ETHERNET PORT MANAGEMENT NOTIFY ACK message name	16.1.0
2020-09	CT-89e	CP-202170	0009		F	Clarification on CNC	16.2.0
2020-09	CT-89e	CP-202170	0010r2		F	Update PSFP stream identification parameters	16.2.0
2020-09	CT-89e	CP-202170	0011		F	Maximum size of EPMS/BMS messages	16.2.0
2020-09	CT-89e	CP-202170	0012		F	Bridge management information correction	16.2.0
2020-12	CT-90e	CP-203219	0016		F	The "Set parameter" operation not applicable for read-only parameters	16.3.0
2020-12	CT-90e	CP-203219	0017		F	Correction in stream parameters in BMIC	16.3.0
2020-12	CT-90e	CP-203219	0018	1	F	Adding NW-TT port numbers to BMIC	16.3.0
2020-12	CT-90e	CP-203219	0019		F	Adding Stream parameters to PMIC	16.3.0
2020-12	CT-90e	CP-203219	0020	1	F	Bridge name and Chassis ID no more needed	16.3.0
2020-12	CT-90e	CP-203219	0021	2	F	Correction to transfer of Ethernet port management information between a time-sensitive networking (TSN) AF and the DS-TT at the UE	16.3.0
2020-12	CT-90e	CP-203267	0022	2	F	Per-instance parameter handling for stream filter table	16.3.0
2020-12	CT-90e	CP-203219	0023		F	Clarification on max BMS message length	16.3.0

History

Document history		
V16.1.0	July 2020	Publication
V16.2.0	October 2020	Publication
V16.3.0	January 2021	Publication