

ETSI TS 124 555 V18.4.0 (2024-05)



**5G;
Proximity-services (ProSe) in 5G System (5GS);
User Equipment (UE) policies;
Stage 3
(3GPP TS 24.555 version 18.4.0 Release 18)**



Reference

RTS/TSGC-0124555vi40

Keywords

5G

ETSI

650 Route des Lucioles
F-06921 Sophia Antipolis Cedex - FRANCE

Tel.: +33 4 92 94 42 00 Fax: +33 4 93 65 47 16

Siret N° 348 623 562 00017 - APE 7112B
Association à but non lucratif enregistrée à la
Sous-Préfecture de Grasse (06) N° w061004871

Important notice

The present document can be downloaded from:

<https://www.etsi.org/standards-search>

The present document may be made available in electronic versions and/or in print. The content of any electronic and/or print versions of the present document shall not be modified without the prior written authorization of ETSI. In case of any existing or perceived difference in contents between such versions and/or in print, the prevailing version of an ETSI deliverable is the one made publicly available in PDF format at www.etsi.org/deliver.

Users of the present document should be aware that the document may be subject to revision or change of status.

Information on the current status of this and other ETSI documents is available at

<https://portal.etsi.org/TB/ETSIDeliverableStatus.aspx>

If you find errors in the present document, please send your comment to one of the following services:

<https://portal.etsi.org/People/CommitteeSupportStaff.aspx>

If you find a security vulnerability in the present document, please report it through our
Coordinated Vulnerability Disclosure Program:

<https://www.etsi.org/standards/coordinated-vulnerability-disclosure>

Notice of disclaimer & limitation of liability

The information provided in the present deliverable is directed solely to professionals who have the appropriate degree of experience to understand and interpret its content in accordance with generally accepted engineering or other professional standard and applicable regulations.

No recommendation as to products and services or vendors is made or should be implied.

No representation or warranty is made that this deliverable is technically accurate or sufficient or conforms to any law and/or governmental rule and/or regulation and further, no representation or warranty is made of merchantability or fitness for any particular purpose or against infringement of intellectual property rights.

In no event shall ETSI be held liable for loss of profits or any other incidental or consequential damages.

Any software contained in this deliverable is provided "AS IS" with no warranties, express or implied, including but not limited to, the warranties of merchantability, fitness for a particular purpose and non-infringement of intellectual property rights and ETSI shall not be held liable in any event for any damages whatsoever (including, without limitation, damages for loss of profits, business interruption, loss of information, or any other pecuniary loss) arising out of or related to the use of or inability to use the software.

Copyright Notification

No part may be reproduced or utilized in any form or by any means, electronic or mechanical, including photocopying and microfilm except as authorized by written permission of ETSI.

The content of the PDF version shall not be modified without the written authorization of ETSI.

The copyright and the foregoing restriction extend to reproduction in all media.

© ETSI 2024.
All rights reserved.

Intellectual Property Rights

Essential patents

IPRs essential or potentially essential to normative deliverables may have been declared to ETSI. The declarations pertaining to these essential IPRs, if any, are publicly available for **ETSI members and non-members**, and can be found in ETSI SR 000 314: "*Intellectual Property Rights (IPRs); Essential, or potentially Essential, IPRs notified to ETSI in respect of ETSI standards*", which is available from the ETSI Secretariat. Latest updates are available on the ETSI Web server (<https://ipr.etsi.org/>).

Pursuant to the ETSI Directives including the ETSI IPR Policy, no investigation regarding the essentiality of IPRs, including IPR searches, has been carried out by ETSI. No guarantee can be given as to the existence of other IPRs not referenced in ETSI SR 000 314 (or the updates on the ETSI Web server) which are, or may be, or may become, essential to the present document.

Trademarks

The present document may include trademarks and/or tradenames which are asserted and/or registered by their owners. ETSI claims no ownership of these except for any which are indicated as being the property of ETSI, and conveys no right to use or reproduce any trademark and/or tradename. Mention of those trademarks in the present document does not constitute an endorsement by ETSI of products, services or organizations associated with those trademarks.

DECT™, **PLUGTESTS™**, **UMTS™** and the ETSI logo are trademarks of ETSI registered for the benefit of its Members. **3GPP™** and **LTE™** are trademarks of ETSI registered for the benefit of its Members and of the 3GPP Organizational Partners. **oneM2M™** logo is a trademark of ETSI registered for the benefit of its Members and of the oneM2M Partners. **GSM®** and the GSM logo are trademarks registered and owned by the GSM Association.

Legal Notice

This Technical Specification (TS) has been produced by ETSI 3rd Generation Partnership Project (3GPP).

The present document may refer to technical specifications or reports using their 3GPP identities. These shall be interpreted as being references to the corresponding ETSI deliverables.

The cross reference between 3GPP and ETSI identities can be found under <https://webapp.etsi.org/key/queryform.asp>.

Modal verbs terminology

In the present document "**shall**", "**shall not**", "**should**", "**should not**", "**may**", "**need not**", "**will**", "**will not**", "**can**" and "**cannot**" are to be interpreted as described in clause 3.2 of the [ETSI Drafting Rules](#) (Verbal forms for the expression of provisions).

"**must**" and "**must not**" are **NOT** allowed in ETSI deliverables except when used in direct citation.

Contents

Intellectual Property Rights	2
Legal Notice	2
Modal verbs terminology.....	2
Foreword.....	4
1 Scope	6
2 References	6
3 Definitions of terms, symbols and abbreviations	6
3.1 Terms.....	6
3.2 Abbreviations	7
4 Descriptions of UE policies for 5G ProSe.....	7
4.1 Overview	7
4.2 UE policies for 5G ProSe direct discovery.....	7
4.3 UE policies for 5G ProSe direct communications	7
4.4 UE policies for 5G ProSe UE-to-network relay	7
4.5 UE policies for 5G ProSe usage information reporting.....	7
4.6 UE policies for 5G ProSe UE-to-UE relay	8
5 Encoding of UE policies for 5G ProSe.....	8
5.1 Overview	8
5.2 Encoding of 5G ProSe policy UE policy part.....	8
5.3 Encoding of UE policies for 5G ProSe direct discovery	10
5.3.1 General.....	10
5.3.2 Information elements coding	11
5.4 Encoding of UE policies for 5G ProSe direct communications	21
5.4.1 General.....	21
5.4.2 Information elements coding	22
5.5 Encoding of UE policies for 5G ProSe UE-to-network relay UE	63
5.5.1 General.....	63
5.5.2 Information elements coding	64
5.6 Encoding of UE policies for 5G ProSe remote UE	89
5.6.1 General.....	89
5.6.2 Information elements coding	90
5.7 Encoding of UE policies for 5G ProSe usage information reporting	110
5.7.1 General.....	110
5.7.2 Information elements coding	111
5.8 Encoding of UE policies for 5G ProSe UE-to-UE relay UE	115
5.8.1 General.....	115
5.8.2 Information elements coding	116
5.9 Encoding of UE policies for 5G ProSe end UE.....	126
5.9.1 General.....	126
5.9.2 Information elements coding	127
Annex A (informative): Change history	139
History	141

Foreword

This Technical Specification has been produced by the 3rd Generation Partnership Project (3GPP).

The contents of the present document are subject to continuing work within the TSG and may change following formal TSG approval. Should the TSG modify the contents of the present document, it will be re-released by the TSG with an identifying change of release date and an increase in version number as follows:

Version x.y.z

where:

- x the first digit:
 - 1 presented to TSG for information;
 - 2 presented to TSG for approval;
 - 3 or greater indicates TSG approved document under change control.
- y the second digit is incremented for all changes of substance, i.e. technical enhancements, corrections, updates, etc.
- z the third digit is incremented when editorial only changes have been incorporated in the document.

In the present document, modal verbs have the following meanings:

- shall** indicates a mandatory requirement to do something
- shall not** indicates an interdiction (prohibition) to do something

The constructions "shall" and "shall not" are confined to the context of normative provisions, and do not appear in Technical Reports.

The constructions "must" and "must not" are not used as substitutes for "shall" and "shall not". Their use is avoided insofar as possible, and they are not used in a normative context except in a direct citation from an external, referenced, non-3GPP document, or so as to maintain continuity of style when extending or modifying the provisions of such a referenced document.

- should** indicates a recommendation to do something
- should not** indicates a recommendation not to do something
- may** indicates permission to do something
- need not** indicates permission not to do something

The construction "may not" is ambiguous and is not used in normative elements. The unambiguous constructions "might not" or "shall not" are used instead, depending upon the meaning intended.

- can** indicates that something is possible
- cannot** indicates that something is impossible

The constructions "can" and "cannot" are not substitutes for "may" and "need not".

- will** indicates that something is certain or expected to happen as a result of action taken by an agency the behaviour of which is outside the scope of the present document
- will not** indicates that something is certain or expected not to happen as a result of action taken by an agency the behaviour of which is outside the scope of the present document
- might** indicates a likelihood that something will happen as a result of action taken by some agency the behaviour of which is outside the scope of the present document

might not indicates a likelihood that something will not happen as a result of action taken by some agency the behaviour of which is outside the scope of the present document

In addition:

is (or any other verb in the indicative mood) indicates a statement of fact

is not (or any other negative verb in the indicative mood) indicates a statement of fact

The constructions "is" and "is not" do not indicate requirements.

1 Scope

The present document defines User Equipment (UE) policies that are used to configure the UE for Proximity-based Services (ProSe) in 5G System (5GS) based on the architectural requirements defined in 3GPP TS 23.304 [2].

The protocol aspects for 5G ProSe are described in 3GPP TS 24.554 [3].

2 References

The following documents contain provisions which, through reference in this text, constitute provisions of the present document.

- References are either specific (identified by date of publication, edition number, version number, etc.) or non-specific.
- For a specific reference, subsequent revisions do not apply.
- For a non-specific reference, the latest version applies. In the case of a reference to a 3GPP document (including a GSM document), a non-specific reference implicitly refers to the latest version of that document in the same Release as the present document.

- [1] 3GPP TR 21.905: "Vocabulary for 3GPP Specifications".
 - [2] 3GPP TS 23.304: "Proximity based Services (ProSe) in the 5G System (5GS); Stage 2".
 - [3] 3GPP TS 24.554: " Proximity-services (ProSe) in 5G System (5GS) protocol aspects; Stage 3".
 - [4] 3GPP TS 24.501: "Non-Access-Stratum (NAS) protocol for 5G System (5GS); Stage 3".
 - [5] ITU-T Recommendation E.212: "The international identification plan for public networks and subscriptions", 2016-09-23.
 - [6] 3GPP TS 23.032: "Universal Geographical Area Description (GAD)".
 - [7] 3GPP TS 38.331: "NR; Radio Resource Control (RRC) protocol specification".
 - [8] 3GPP TS 38.101-1: "NR; User Equipment (UE) radio transmission and reception; Part 1: Range 1 Standalone".
 - [9] 3GPP TS 38.101-2: "NR; User Equipment (UE) radio transmission and reception; Part 2: Range 2 Standalone".
 - [10] 3GPP TS 23.003: "Numbering, addressing and identification".
 - [11] 3GPP TS 24.526: "User Equipment (UE) policies for 5G System (5GS); Stage 3".
 - [12] IETF RFC 4122: "A Universally Unique IDentifier (UUID) URN Namespace".
 - [13] 3GPP TS 33.503: "Security Aspects of Proximity based Services (ProSe) in the 5G System (5GS)".
 - [14] 3GPP TS 32.277: " Proximity-based Services (ProSe) charging".
-

3 Definitions of terms, symbols and abbreviations

3.1 Terms

For the purposes of the present document, the terms given in 3GPP TR 21.905 [1] and the following apply. A term defined in the present document takes precedence over the definition of the same term, if any, in 3GPP TR 21.905 [1].

3.2 Abbreviations

For the purposes of the present document, the abbreviations given in 3GPP TR 21.905 [1] and the following apply. An abbreviation defined in the present document takes precedence over the definition of the same abbreviation, if any, in 3GPP TR 21.905 [1].

5G ProSe	5G Proximity-based Services
5G PKMF	5G ProSe Key Management Function
DUCK	Discovery User Confidentiality Key
DUIK	Discovery User Integrity Key
DUSK	Discovery User Scrambling Key
FQDN	Fully Qualified Domain Name
ProSeP	5G ProSe Policy
RSC	Relay Service Code

4 Descriptions of UE policies for 5G ProSe

4.1 Overview

The ProSe policy in 5GS includes:

- a) UE policies for 5G ProSe direct discovery (see clause 4.2);
- b) UE policies for 5G ProSe direct communications (see clause 4.3);
- c) UE policies for 5G ProSe UE-to-network relay (see clause 4.4);
- d) UE policies for 5G ProSe usage information reporting (see clause 4.5); and
- e) UE policies for 5G ProSe UE-to-UE relay (see clause 4.6).

The ProSe policy can be delivered from the PCF to the UE. The UE policy delivery procedure is specified in 3GPP TS 24.501 [4].

4.2 UE policies for 5G ProSe direct discovery

The UE policies for 5G ProSe direct discovery are defined in clause 5.2.3 of 3GPP TS 24.554 [3]. The generic description of the UE policies for 5G ProSe direct discovery is specified in 3GPP TS 23.304 [2].

4.3 UE policies for 5G ProSe direct communications

The UE policies for 5G ProSe direct communications are defined in clause 5.2.4 of 3GPP TS 24.554 [3]. The generic description of the UE policies for 5G ProSe direct communications is specified in 3GPP TS 23.304 [2].

4.4 UE policies for 5G ProSe UE-to-network relay

The UE policies for 5G ProSe UE-to-network relay UE are defined in clause 5.2.5 of 3GPP TS 24.554 [3]. The generic description of the UE policies for 5G ProSe UE-to-network relay is specified in 3GPP TS 23.304 [2].

The UE policies for 5G ProSe remote UE are defined in clause 5.2.5 of 3GPP TS 24.554 [3]. The generic description of the UE policies for 5G ProSe remote UE is specified in 3GPP TS 23.304 [2].

4.5 UE policies for 5G ProSe usage information reporting

The UE policies for 5G ProSe usage information reporting are defined in clause 5.2.6 of 3GPP TS 24.554 [3]. The generic description of the UE policies for 5G ProSe usage information reporting is specified in 3GPP TS 32.277 [14].

4.6 UE policies for 5G ProSe UE-to-UE relay

The UE policies for 5G ProSe UE-to-UE relay UE are defined in clause 5.2.7 of 3GPP TS 24.554 [3]. The generic description of the UE policies for 5G ProSe UE-to-UE relay UE is specified in 3GPP TS 23.304 [2].

The UE policies for 5G ProSe end UE are defined in clause 5.2.7 of 3GPP TS 24.554 [3]. The generic description of the UE policies for 5G ProSe end UE is specified in 3GPP TS 23.304 [2].

5 Encoding of UE policies for 5G ProSe

5.1 Overview

The UE policies for 5G ProSe are provided to the UE in a 5G ProSe policy (ProSeP) UE policy part using the UE policy delivery service as specified in 3GPP TS 24.501 [4] annex D.

5.2 Encoding of 5G ProSe policy UE policy part

The purpose of the ProSeP is to indicate UE policies for 5G ProSe direct discovery, 5G ProSe direct communications, 5G ProSe UE-to-network relay UE, 5G ProSe remote UE, UE policies for 5G ProSe usage information reporting, UE policies for 5G ProSe UE-to-UE relay UE, and UE policies for 5G ProSe end UE.

The ProSeP is encoded as shown in figures 5.2.1 to 5.2.3 and table 5.2.1 according to the UE policy part top level format (see annex D of 3GPP TS 24.501 [4]).

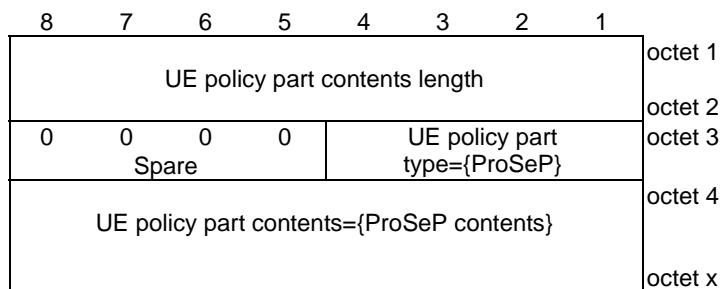

Figure 5.2.1: UE policy part when UE policy part type = {ProSeP}

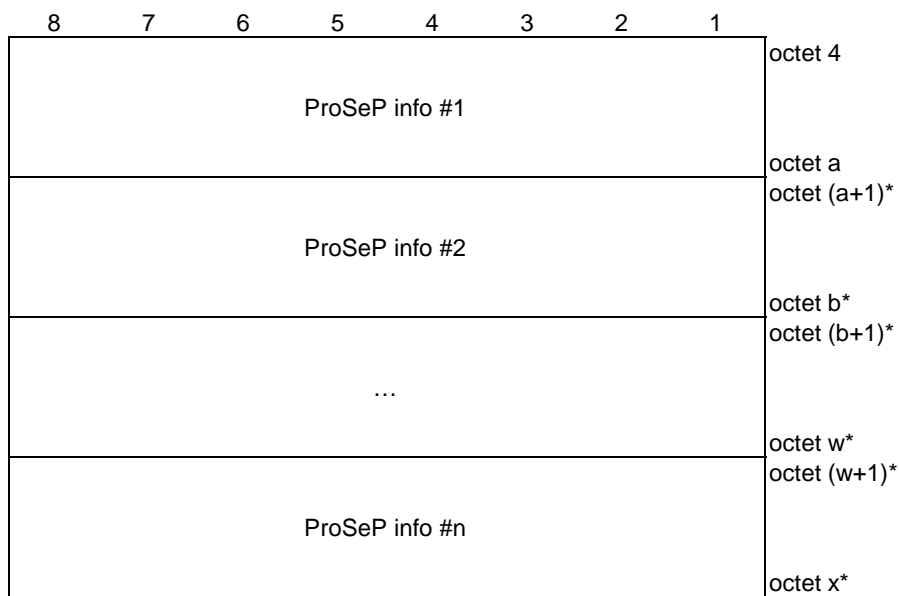

Figure 5.2.2: ProSeP contents

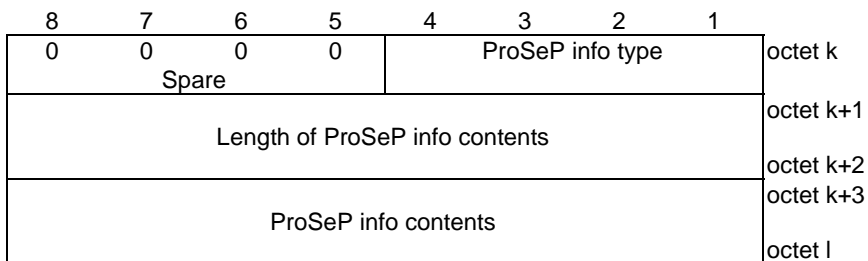

Figure 5.2.3: ProSeP info

Table 5.2.1: ProSeP information format

<p>UE policy part type field is set to '0100' (=ProSeP) as specified in 3GPP TS 24.501 [4] annex D.</p> <p>UE policy part contents length field indicate the length of the ProSeP contents in octets.</p> <p>ProSeP contents (octets 4 to x)</p> <p>ProSeP contents consist of 1 or more ProSeP info(s) (see figure 5.2.2).</p> <p>ProSeP info type (bit 1 to 4 of octet k) shall be set according to the following:</p> <p>Bits</p> <table> <thead> <tr> <th>4</th> <th>3</th> <th>2</th> <th>1</th> <th></th> </tr> </thead> <tbody> <tr> <td>0</td> <td>0</td> <td>0</td> <td>1</td> <td>UE policies for 5G ProSe direct discovery</td> </tr> <tr> <td>0</td> <td>0</td> <td>1</td> <td>0</td> <td>UE policies for 5G ProSe direct communications</td> </tr> <tr> <td>0</td> <td>0</td> <td>1</td> <td>1</td> <td>UE policies for 5G ProSe UE-to-network relay UE</td> </tr> <tr> <td>0</td> <td>1</td> <td>0</td> <td>0</td> <td>UE policies for 5G ProSe remote UE</td> </tr> <tr> <td>0</td> <td>1</td> <td>0</td> <td>1</td> <td>UE policies for 5G ProSe usage information reporting</td> </tr> <tr> <td>0</td> <td>1</td> <td>1</td> <td>0</td> <td>UE policies for 5G ProSe UE-to-UE relay UE</td> </tr> <tr> <td>0</td> <td>1</td> <td>1</td> <td>1</td> <td>UE policies for 5G ProSe end UE</td> </tr> </tbody> </table> <p>All other values are reserved.</p> <p>Bits 8 to 5 of octet k are spare and shall be encoded as zero.</p> <p>Length of ProSeP info contents (octets k+1 to k+2) indicates the length of the ProSeP info contents field.</p> <p>ProSeP info contents (octets k+3 to l) can be UE policies for 5G ProSe direct discovery (see clause 5.3), UE policies for 5G ProSe direct communications (see clause 5.4), UE policies for 5G ProSe UE-to-network relay UE (see clause 5.5), UE policies for 5G ProSe remote UE (clause 5.6), UE policies for 5G ProSe usage information reporting (clause 5.7), UE policies for 5G ProSe UE-to-UE relay UE (see clause 5.8), or UE policies for 5G ProSe end UE (see clause 5.9).</p>	4	3	2	1		0	0	0	1	UE policies for 5G ProSe direct discovery	0	0	1	0	UE policies for 5G ProSe direct communications	0	0	1	1	UE policies for 5G ProSe UE-to-network relay UE	0	1	0	0	UE policies for 5G ProSe remote UE	0	1	0	1	UE policies for 5G ProSe usage information reporting	0	1	1	0	UE policies for 5G ProSe UE-to-UE relay UE	0	1	1	1	UE policies for 5G ProSe end UE
4	3	2	1																																					
0	0	0	1	UE policies for 5G ProSe direct discovery																																				
0	0	1	0	UE policies for 5G ProSe direct communications																																				
0	0	1	1	UE policies for 5G ProSe UE-to-network relay UE																																				
0	1	0	0	UE policies for 5G ProSe remote UE																																				
0	1	0	1	UE policies for 5G ProSe usage information reporting																																				
0	1	1	0	UE policies for 5G ProSe UE-to-UE relay UE																																				
0	1	1	1	UE policies for 5G ProSe end UE																																				

5.3 Encoding of UE policies for 5G ProSe direct discovery

5.3.1 General

The UE policies for 5G ProSe direct discovery are coded as shown in figures 5.3.1.1 and table 5.3.1.1.

5.3.2 Information elements coding

8	7	6	5	4	3	2	1	
0	0	0	0	ProSeP info type = {UE policies for 5G ProSe direct discovery}				octet k
Spare								
Length of ProSeP info contents								octet k+1
Validity timer								octet k+2 octet k+3
Served by NG-RAN								octet k+7 octet k+8
Not served by NG-RAN								octet o1 octet o1+1
ProSe direct discovery UE ID								octet o2 octet o2+1
Group member discovery parameters								octet o2+3 octet o2+4
ProSe identifiers								octet o3 octet o3+1
ProSe identifier to default destination layer-2 ID for initial discovery signalling mapping rules								octet o4 octet o4+1
0	0	0	0	0	H5DAI			octet l octet l+1
Spare	Spare	Spare	Spare	Spare				
HPLMN 5G DDNMF address information								octet (l+2)* octet m*

Figure 5.3.2.1: ProSeP Info = {UE policies for 5G ProSe direct discovery}

Table 5.3.2.1: ProSeP Info = {UE policies for 5G ProSe direct discovery}

<p>ProSeP info type (bit 1 to 4 of octet k) shall be set to "0001" (UE policies for 5G ProSe direct discovery)</p> <p>Length of ProSeP info contents (octets k+1 to k+2) indicates the length of ProSeP info contents.</p> <p>Validity timer (octet k+3 to k+7): The validity timer field provides the expiration time of validity of the UE policies for 5G ProSe direct discovery. The validity timer field is a binary coded representation of a UTC time, in seconds since midnight UTC of January 1, 1970 (not counting leap seconds).</p> <p>Served by NG-RAN (octet k+8 to o1): The served by NG-RAN field is coded according to figure 5.3.2.2 and table 5.3.2.2, and contains configuration parameters for 5G ProSe direct discovery when the UE is served by NG-RAN.</p> <p>Not served by NG-RAN (octet o1+1 to o2): The not served by NG-RAN field is coded according to figure 5.3.2.6 and table 5.3.2.6, and contains configuration parameters for 5G ProSe direct discovery when the UE is not served by NG-RAN.</p> <p>ProSe Direct Discovery UE ID (octet o2+1 to o2+3): The ProSe Direct Discovery UE ID is a 24-bit long bit string.</p> <p>Group member discovery parameters (octet o2+4 to o3): The group member discovery parameters field is coded according to figure 5.3.2.12 and table 5.3.2.12 and contains group member discovery parameters.</p> <p>ProSe identifiers (octet o3+1 to o4): The ProSe identifiers field is coded according to figure 5.3.2.14 and table 5.3.2.14 and contains ProSe identifiers.</p> <p>ProSe identifier to default destination layer-2 ID for initial discovery signalling mapping rules (octet o4+1 to o5) (NOTE 2): The ProSe identifier to default destination layer-2 ID for initial discovery signalling mapping rules field is coded according to figure 5.3.2.15 and table 5.3.2.15 and contains ProSe identifier to default destination layer-2 ID for initial discovery signalling mapping rules. The ProSe identifier to default destination layer-2 ID for initial discovery signalling mapping rules field may contain a default ProSe identifier to default destination layer-2 ID for initial discovery signalling mapping rule for the ProSe services that do not have dedicated mapping rules.</p> <p>HPLMN 5G DDNMF address information indicator (H5DAI) (octet l+1 bit 1 to bit 3): (NOTE) Bits</p> <table border="0"> <tr> <td>3</td> <td>2</td> <td>1</td> <td></td> </tr> <tr> <td>0</td> <td>0</td> <td>0</td> <td>HPLMN 5G DDNMF address information is absent</td> </tr> <tr> <td>0</td> <td>0</td> <td>1</td> <td>HPLMN 5G DDNMF FQDN is present</td> </tr> <tr> <td>0</td> <td>1</td> <td>0</td> <td>HPLMN 5G DDNMF IPv4 address is present</td> </tr> <tr> <td>1</td> <td>0</td> <td>0</td> <td>HPLMN 5G DDNMF IPv6 address is present</td> </tr> <tr> <td>1</td> <td>1</td> <td>0</td> <td>HPLMN 5G DDNMF IPv4 address and IPv6 address are present</td> </tr> </table> <p>All other values are reserved.</p> <p>HPLMN 5G DDNMF address information (octet l+2 to octet m) (NOTE 1): The HPLMN 5G DDNMF address information field is coded according to figure 5.3.2.17 and table 5.3.2.17 and contains the 5G DDNMF address information in HPLMN.</p> <p>If the length of ProSeP info contents field is bigger than indicated in figure 5.3.2.1, receiving entity shall ignore any superfluous octets located at the end of the ProSeP info contents.</p>	3	2	1		0	0	0	HPLMN 5G DDNMF address information is absent	0	0	1	HPLMN 5G DDNMF FQDN is present	0	1	0	HPLMN 5G DDNMF IPv4 address is present	1	0	0	HPLMN 5G DDNMF IPv6 address is present	1	1	0	HPLMN 5G DDNMF IPv4 address and IPv6 address are present
3	2	1																						
0	0	0	HPLMN 5G DDNMF address information is absent																					
0	0	1	HPLMN 5G DDNMF FQDN is present																					
0	1	0	HPLMN 5G DDNMF IPv4 address is present																					
1	0	0	HPLMN 5G DDNMF IPv6 address is present																					
1	1	0	HPLMN 5G DDNMF IPv4 address and IPv6 address are present																					

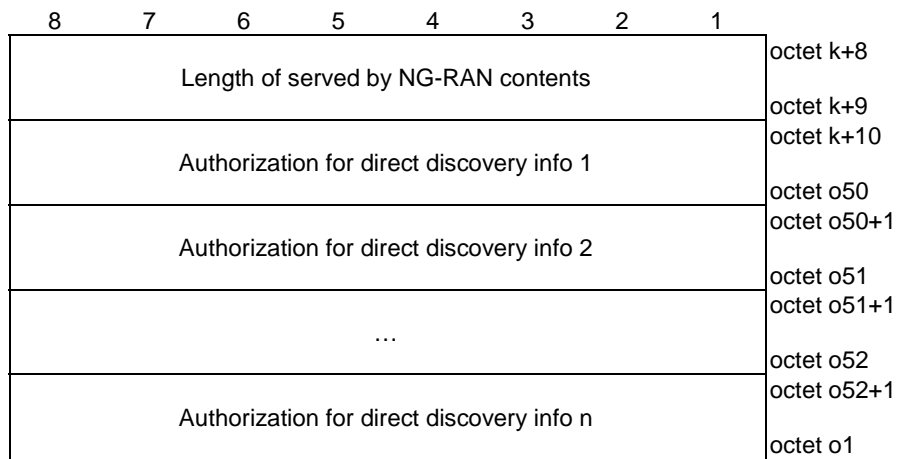

Figure 5.3.2.2: Served by NG-RAN

Table 5.3.2.2: Served by NG-RAN

Authorization for direct discovery info:
The authorization for direct discovery info field is coded according to figure 5.3.2.3 and table 5.3.2.3.

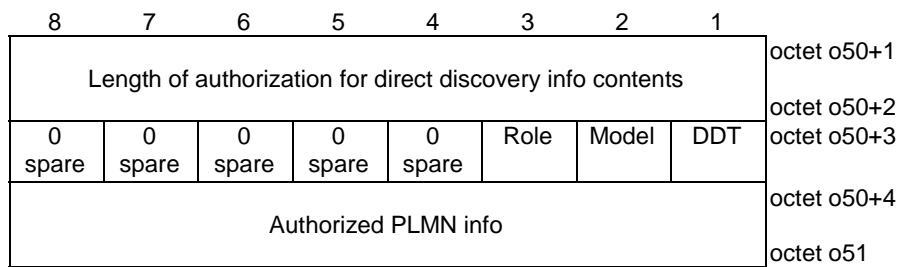

Figure 5.3.2.3: Authorization for direct discovery info

Table 5.3.2.3: Authorization for direct discovery info

<p>Direct discovery type (DDT) (octet o50+3 bit 1): Bit 1 0 Open 1 Restricted</p> <p>Model (octet o50+3 bit 2): Bit 2 0 A 1 B</p> <p>If Model bit is set to "A", Role (octet o50+3 bit 3): Bit 3 0 Announcing 1 Monitoring</p> <p>If Model bit is set to "B", Role (octet o50+3 bit 3): Bit 3 0 Discoverer 1 Discoveree</p> <p>Authorized PLMN info (octet o50+4 to o51): The authorized PLMN info field is coded according to figure 5.3.2.4 and table 5.3.2.4.</p> <p>If the length of authorization for direct discovery info field is bigger than indicated in figure 5.3.2.3, receiving entity shall ignore any superfluous octets located at the end of the authorization for direct discovery info.</p>

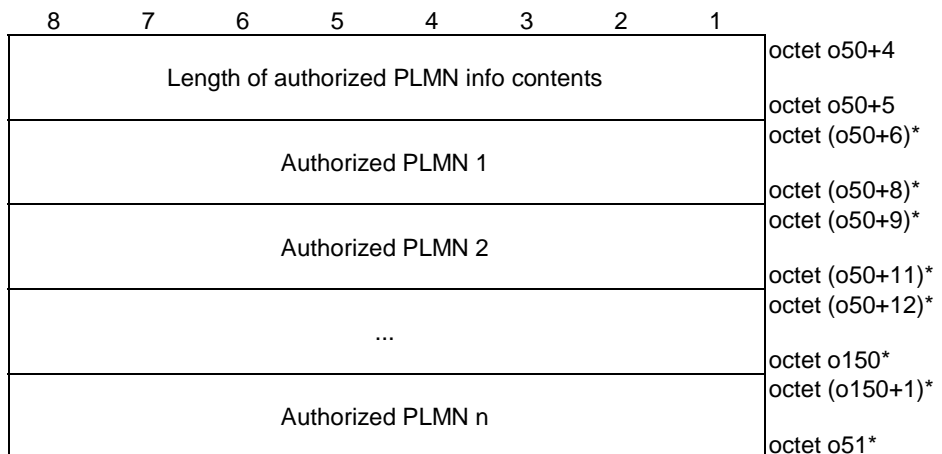

Figure 5.3.2.4: Authorized PLMN info

Table 5.3.2.4: Authorized PLMN

<p>Authorized PLMN: The authorized PLMN field is coded according to figure 5.3.2.5 and table 5.3.2.5.</p>

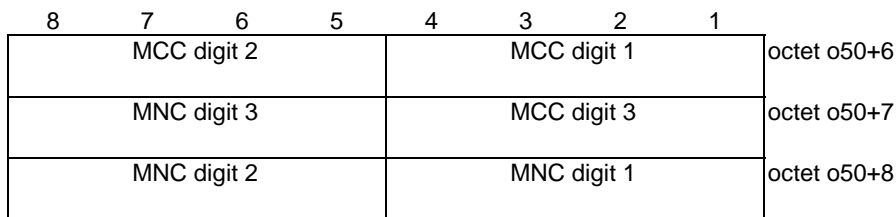

Figure 5.3.2.5: PLMN ID

Table 5.3.2.5: PLMN ID

Mobile country code (MCC) (octet o50+5, octet o50+6 bit 1 to 4):
 The MCC field is coded as in ITU-T Recommendation E.212 [5], annex A.

Mobile network code (MNC) (octet o50+6 bit 5 to 8, octet o50+7):
 The coding of MNC field is the responsibility of each administration but BCD coding shall be used. The MNC shall consist of 2 or 3 digits. If a network operator decides to use only two digits in the MNC, MNC digit 3 shall be coded as "1111".

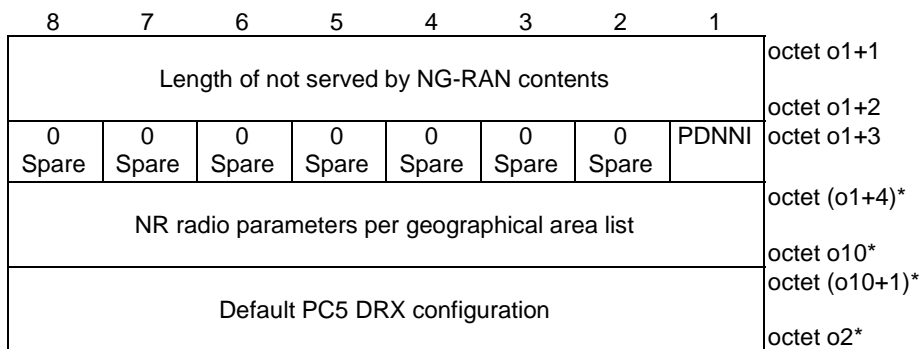

Figure 5.3.2.6: Not served by NG-RAN

Table 5.3.2.6: Not served by NG-RAN

5G ProSe direct discovery when not served by NG-RAN indicator (PDNNI) (octet o1+3 bit 1):
 The PDNNI bit indicates whether the UE is authorized to perform 5G ProSe direct discovery when not served by NG-RAN.

Bit
1
 0 Not authorized
 1 Authorized

NR radio parameters per geographical area list (octet o1+4 to o2):
 If PNNI bit is set to "Authorized", the NR radio parameters per geographical area list field is present otherwise the NR radio parameters per geographical area list field is absent. It is coded according to figure 5.3.2.7 and table 5.3.2.7.

Default PC5 DRX configuration (octet o10+1 to o2):
 If PDNNI bit is set to "Authorized", the default PC5 DRX configuration is present otherwise the default PC5 DRX configuration is absent. It is coded according to figure 5.3.2.11a and table 5.3.2.11a.

If the length of not served by NG-RAN contents field is bigger than indicated in figure 5.3.2.6, receiving entity shall ignore any superfluous octets located at the end of the not served by NG-RAN contents.

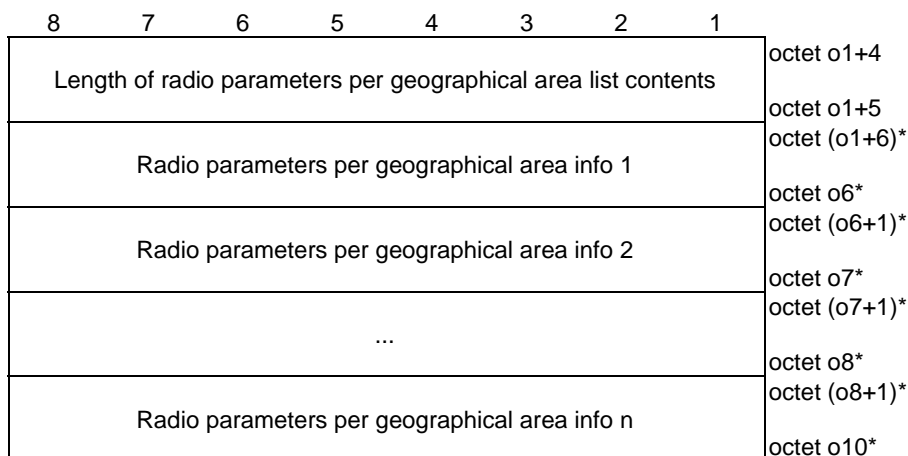

Figure 5.3.2.7: Radio parameters per geographical area list

Table 5.3.2.7: Radio parameters per geographical area list

Radio parameters per geographical area info: The radio parameters per geographical area info field is coded according to figure 5.3.2.8 and table 5.3.2.8.

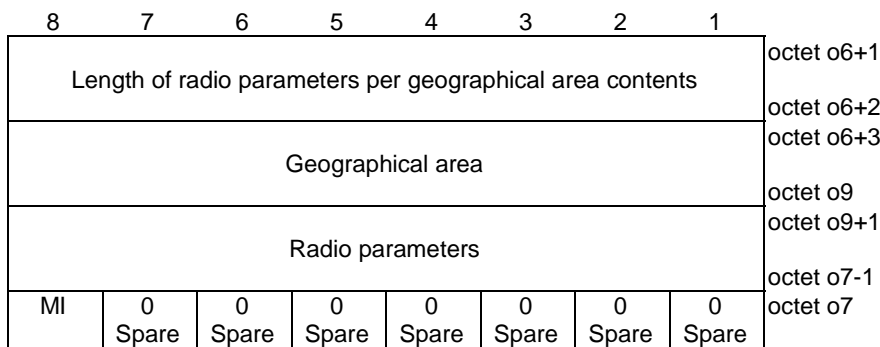

Figure 5.3.2.8: Radio parameters per geographical area info

Table 5.3.2.8: Radio parameters per geographical area info

<p>Geographical area (octet o6+3 to o9): The geographical area field is coded according to figure 5.3.2.9 and table 5.3.2.9.</p> <p>Radio parameters (octet o9 to o7-1): The radio parameters field is coded according to figure 5.3.2.11 and table 5.3.2.11, applicable in the geographical area indicated by the geographical area field when not served by NG-RAN.</p> <p>Managed indicator (MI) (octet o7 bit 8): The managed indicator indicates how the radio parameters indicated in the radio parameters field in the geographical area indicated by the geographical area field are managed.</p> <p>Bit 8 0 Non-operator managed 1 Operator managed</p> <p>If the length of radio parameters per geographical area contents field is bigger than indicated in figure 5.3.2.8, receiving entity shall ignore any superfluous octets located at the end of the radio parameters per geographical area contents.</p>

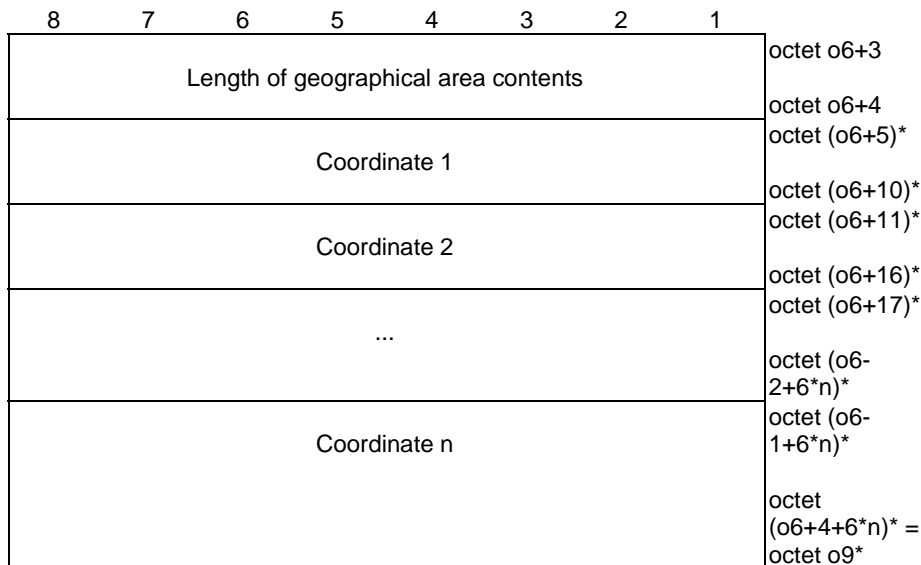

Figure 5.3.2.9: Geographical area

Table 5.3.2.9: Geographical area

<p>Coordinate: The coordinate field is coded according to figure 5.3.2.10 and table 5.3.2.10.</p>

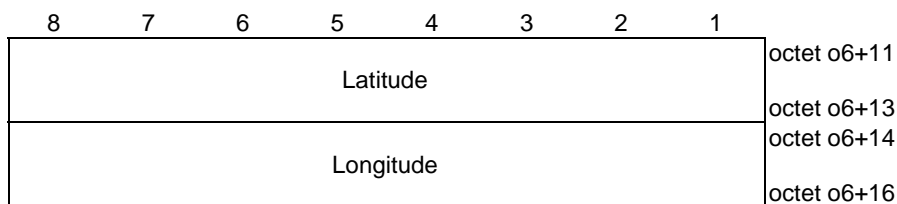

Figure 5.3.2.10: Coordinate area

Table 5.3.2.10: Coordinate area

<p>Latitude: The latitude field is coded according to clause 6.1 of 3GPP TS 23.032 [6].</p> <p>Longitude: The longitude field is coded according to clause 6.1 of 3GPP TS 23.032 [6].</p>

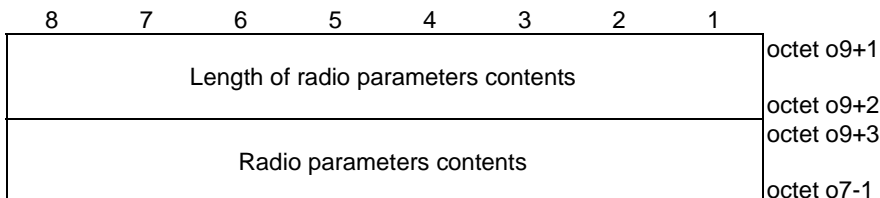

Figure 5.3.2.11: Radio parameters

Table 5.3.2.11: Radio parameters

<p>Radio parameters contents: Radio parameters are defined as <i>SL-PreconfigurationNR</i> in clause 9.3 of 3GPP TS 38.331 [7].</p>

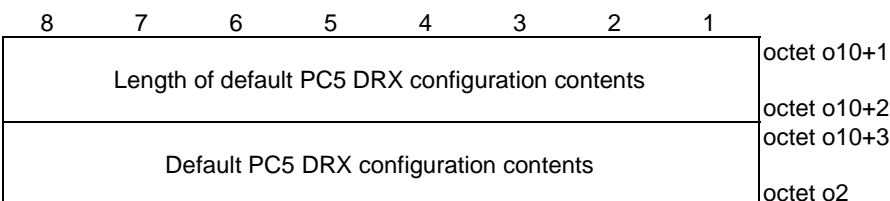

Figure 5.3.2.11a: Default PC5 DRX configuration

Table 5.3.2.11a: Default PC5 DRX configuration

<p>Default PC5 DRX configuration contents: The default PC5 DRX configuration field is coded as <i>sl-DefaultDRX-GC-BC-r17</i> in clause 6.3.5 of 3GPP TS 38.331 [7].</p>

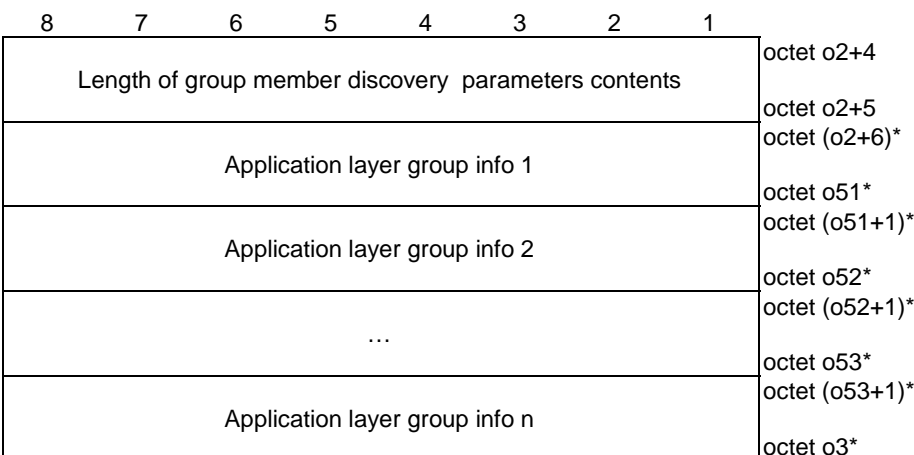

Figure 5.3.2.12: Group member discovery parameters

Table 5.3.2.12: Group member discovery parameters

Application layer group info:
 The application layer group info field is coded according to figure 5.3.2.13 and table 5.3.2.13.

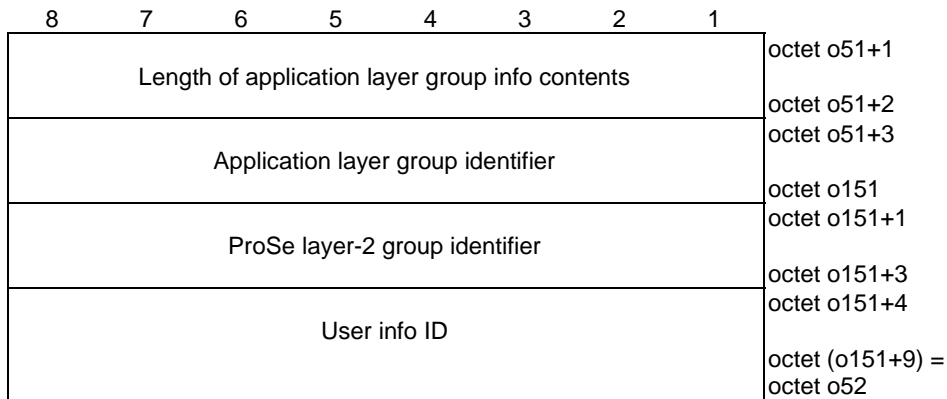

Figure 5.3.2.13: Application layer group info

Table 5.3.2.13: Application layer group info

Application layer group identifier (octet o51+3 to o151):
 The first octet of application layer group identifier field is the length of application group identifier. The value of application group identifier field is a bit string. The format of application group identifier parameter is out of scope of this specification.

ProSe layer-2 group identifier (octet o151+1 to o151+3)
 The ProSe layer-2 group identifier field is a binary coded layer-2 identifier.

User info ID (octet o151+4 to o52)
 The value of the User info ID parameter is a 48-bit long bit string. The format of the User info ID parameter is out of scope of this specification.

If the length of application layer group info contents field is bigger than indicated in figure 5.3.2.13, receiving entity shall ignore any superfluous octets located at the end of the application layer group info contents.

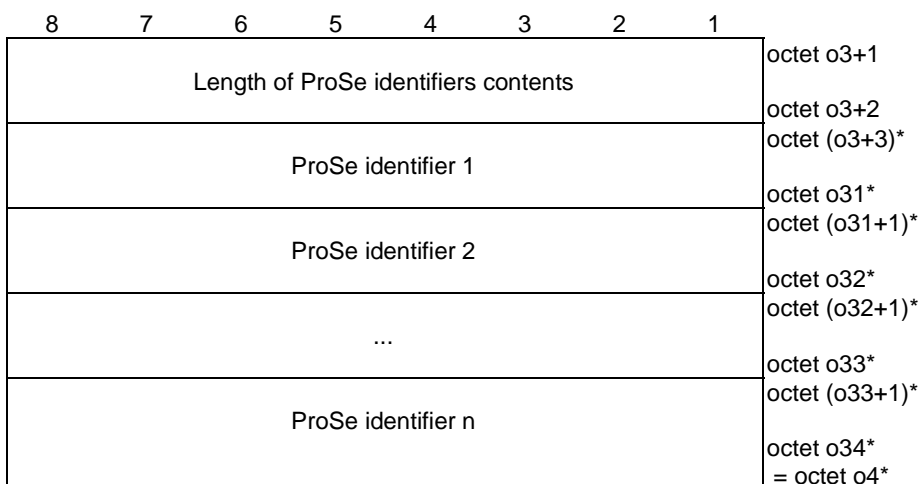

Figure 5.3.2.14: ProSe identifiers

Table 5.3.2.14: ProSe identifiers

ProSe identifier (NOTE 1, NOTE 2):
 The ProSe identifier field contains a sequence of a sixteen octet OS Id field, a one octet OS App Id length field, and an OS App Id field. The OS Id field shall be transmitted first. The OS Id field contains a Universally Unique Identifier (UUID) as specified in IETF RFC 4122 [12].

8	7	6	5	4	3	2	1	
Length of ProSe identifier to default destination layer-2 ID for initial discovery signalling mapping rules contents								octet o4+1
ProSe identifier to default destination layer-2 ID for initial discovery signalling mapping rule 1								octet o4+2 octet (o4+3)*
ProSe identifier to default destination layer-2 ID for initial discovery signalling mapping rule 2								octet o54* octet (o54+1)*
...								octet o55* octet (o55+1)*
ProSe identifier to default destination layer-2 ID for initial discovery signalling mapping rule n								octet o56* octet (o56+1)* octet l*

Figure 5.3.2.15: ProSe identifier to default destination layer-2 ID for initial discovery signalling mapping rules

Table 5.3.2.15: ProSe identifier to default destination layer-2 ID for initial discovery signalling mapping rules

ProSe identifier to destination layer-2 ID for initial discovery signalling mapping rule:
 The ProSe identifier to destination layer-2 ID for initial discovery signalling mapping rule field is coded according to figure 5.3.2.16 and table 5.3.2.16.

8	7	6	5	4	3	2	1	
Length of ProSe identifier to default destination layer-2 ID for initial discovery signalling mapping rule contents								octet o54+1
ProSe identifiers								octet o54+2 octet o54+3
Destination layer-2 ID for initial discovery signalling								octet o154 octet o154+1 octet (o154+3) = octet o55

Figure 5.3.2.16: ProSe identifier to default destination layer-2 ID for initial discovery signalling mapping rule

Table 5.3.2.16: ProSe identifier to default destination layer-2 ID for initial discovery signalling mapping rule

ProSe identifiers (octet o54+3 to o154):
 The ProSe identifiers field is coded according to figure 5.3.2.14 and table 5.3.2.14. In case of the default ProSe identifier to default destination layer-2 ID for initial discovery signalling mapping rule, the ProSe identifier is coded as the default ProSe identifier (see table 5.4.2.14).

Destination layer-2 ID for initial discovery signalling (octet o154+1 to o55):
 The destination layer-2 ID for initial discovery signalling field is a binary coded layer-2 identifier.

If the length of ProSe identifier to default destination layer-2 ID for initial discovery signalling mapping rule contents field is bigger than indicated in figure 5.3.2.16, receiving entity shall ignore any superfluous octets located at the end of the ProSe identifier to default destination layer-2 ID for initial discovery signalling mapping rule contents.

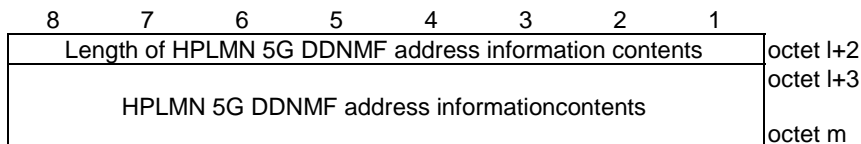

Figure 5.3.2.17: HPLMN 5G DDNMF address information

Table 5.3.2.17: HPLMN 5G DDNMF address information

Length of HPLMN 5G DDNMF address information (octet l+2):
 When the H5DAI is set to "HPLMN 5G DDNMF FQDN is present", the value of the length is the length of the HPLMN 5G DDNMF FQDN.
 When the H5DAI is set to "HPLMN 5G DDNMF IPv4 address is present", the value of the length is 4.
 When the H5DAI is set to "HPLMN 5G DDNMF IPv6 address is present", the value of the length is 16.
 When the H5DAI is set to "HPLMN 5G DDNMF IPv4 address and IPv6 address are present", the value of the length is 20.

HPLMN 5G DDNMF address information contents (octet l+3 to octet m):
 When the H5DAI is set to "HPLMN 5G DDNMF FQDN is present", HPLMN 5G DDNMF address information field contains the HPLMN 5G DDNMF FQDN and shall be coded as defined in clause 28.3.2.11 in 3GPP TS 23.003 [10].
 When the H5DAI is to "HPLMN 5G DDNMF IPv4 address is present", HPLMN 5G DDNMF address information field contains an IPv4 address in 4 octets.
 When the H5DAI is set to "HPLMN 5G DDNMF IPv6 address is present", HPLMN 5G DDNMF address information field contains an IPv6 address in 16 octets.
 When the H5DAI is set to "HPLMN 5G DDNMF IPv4 address and IPv6 address are present", HPLMN 5G DDNMF address information field contains a sequence of an IPv4 address in 4 octets and an IPv6 address in 16 octets.

5.4 Encoding of UE policies for 5G ProSe direct communications

5.4.1 General

The UE policies for 5G ProSe direct communication are coded as shown in figures 5.4.1.1 and table 5.4.1.1.

5.4.2 Information elements coding

8	7	6	5	4	3	2	1	
0	0	0	0	ProSeP info type = {UE policies for 5G ProSe direct communication}			0	octet k
Spare							1	
Length of ProSeP info contents								octet k+1
Validity timer								octet k+2 octet k+3
Served by NG-RAN								octet k+7 octet k+8
Not served by NG-RAN								octet o1 octet o1+1
Privacy config								octet o2 octet o2+1
5G ProSe direct communication in NR-PC5								octet o4 octet o4+1
ProSe application to path preference mapping rules								octet o5 octet o5+1
ProSe identifiers to NR Tx profile for broadcast and groupcast mapping rules								octet o10 octet o10+1
ProSe identifiers to NR Tx profile for broadcast and groupcast mapping rules								octet l

Figure 5.4.2.1: ProSeP Info = {UE policies for 5G ProSe direct communication}

Table 5.4.2.1: ProSeP Info = {UE policies for 5G ProSe direct communication}

<p>ProSeP info type (bit 1 to 4 of octet k) shall be set to "0010" (UE policies for 5G ProSe direct communication)</p> <p>Length of ProSeP info contents (octets k+1 to k+2) indicates the length of ProSeP info contents.</p> <p>Validity timer (octet k+3 to k+7): The validity timer field provides the expiration time of validity of the UE policies for 5G ProSe direct communication. The validity timer field is a binary coded representation of a UTC time, in seconds since midnight UTC of January 1, 1970 (not counting leap seconds).</p> <p>Served by NG-RAN (octet k+8 to o1): The served by NG-RAN field is coded according to figure 5.4.2.2 and table 5.4.2.2, and contains configuration parameters for 5G ProSe direct communication when the UE is served by NG-RAN.</p> <p>Not served by NG-RAN (octet o1+1 to o2): The not served by NG-RAN field is coded according to figure 5.4.2.5 and table 5.4.2.5, and contains configuration parameters for 5G ProSe direct communication when the UE is not served by NG-RAN.</p> <p>Privacy config (octet o2+1 to o4): The privacy config field is coded according to figure 5.4.2.11 and table 5.4.2.11, and contains configuration parameters for privacy configuration.</p> <p>5G ProSe direct communication in NR-PC5 (octet o4+1 to o5): The 5G ProSe direct communication in NR-PC5 field is coded according to figure 5.4.2.16 and table 5.4.2.16, and contains configuration parameters for 5G ProSe direct communication in NR-PC5.</p> <p>ProSe application to path preference mapping rules (octet o5+1 to o10): The ProSe application to path preference mapping rules field is coded according to figure 5.4.2.41 and table 5.4.2.41, and contains configuration parameters for ProSe application to path preference mapping rules.</p> <p>ProSe identifiers to NR Tx profile for broadcast and groupcast mapping rules (octet o10+1 to l) (NOTE): The ProSe identifiers to NR Tx profiles for broadcast and groupcast mapping rules field is coded according to figure 5.4.2.43 and table 5.4.2.43, and contains configuration parameters for ProSe identifiers to NR Tx profile for broadcast and groupcast mapping rules. The ProSe identifiers to NR Tx profile for broadcast and groupcast mapping rules field may contain a default ProSe identifier to NR Tx profile for broadcast and groupcast mapping rule for the ProSe services that do not have dedicated mapping rules.</p> <p>If the length of ProSeP info contents field is bigger than indicated in figure 5.4.2.1, receiving entity shall ignore any superfluous octets located at the end of the ProSeP info contents.</p> <p>NOTE: This field is prioritized in decreasing order according to the local configuration of the network. The default mapping rule for the ProSe services that do not have dedicated mapping rules, if present, is recommended to be the last one and with the lowest priority of this field.</p>

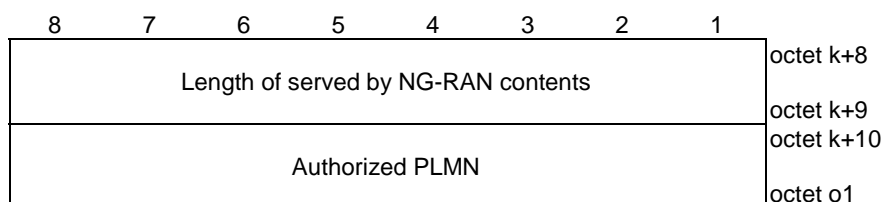

Figure 5.4.2.2: Served by NG-RAN

Table 5.4.2.2: Served by NG-RAN

Authorized PLMN (octet k+10 to o1):
 The authorized PLMN field is coded according to figure 5.4.2.3 and table 5.4.2.3.

If the length of served by NG-RAN contents field is bigger than indicated in figure 5.4.2.2, receiving entity shall ignore any superfluous octets located at the end of the served by NG-RAN contents.

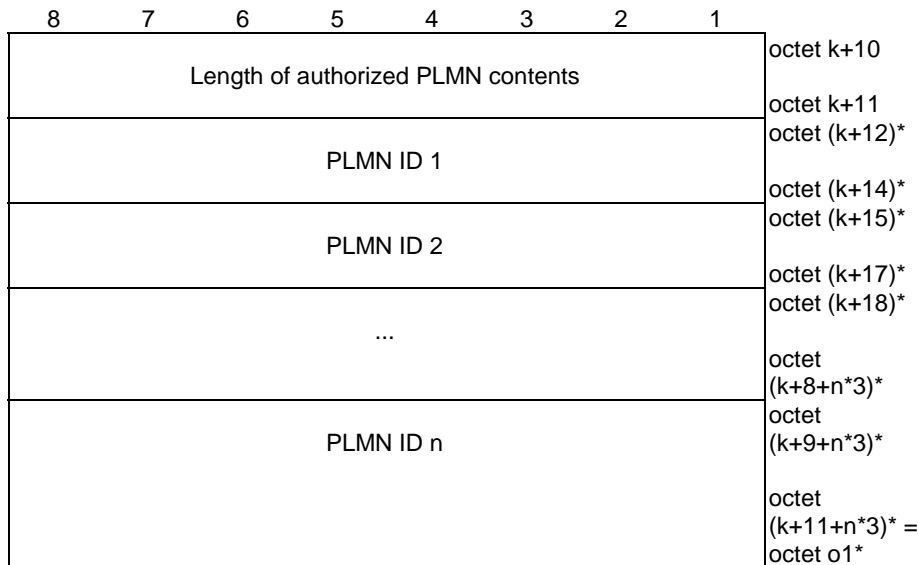

Figure 5.4.2.3: Authorized PLMN

Table 5.4.2.3: Authorized PLMN

PLMN ID:
 The PLMN ID field is coded according to figure 5.4.2.4 and table 5.4.2.4.

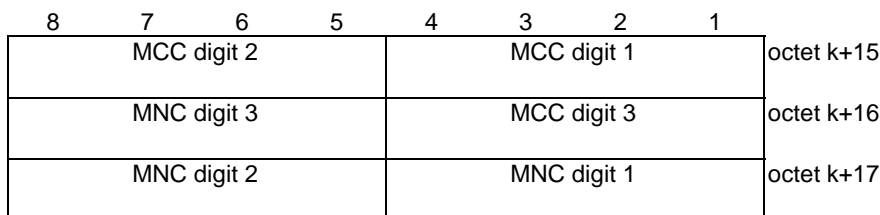

Figure 5.4.2.4: PLMN ID

Table 5.4.2.4: PLMN ID

Mobile country code (MCC) (octet k+15, octet k+16 bit 1 to 4):
 The MCC field is coded as in ITU-T Recommendation E.212 [5], annex A.

Mobile network code (MNC) (octet k+16 bit 5 to 8, octet k+17):
 The coding of MNC field is the responsibility of each administration but BCD coding shall be used. The MNC shall consist of 2 or 3 digits. If a network operator decides to use only two digits in the MNC, MNC digit 3 shall be coded as "1111".

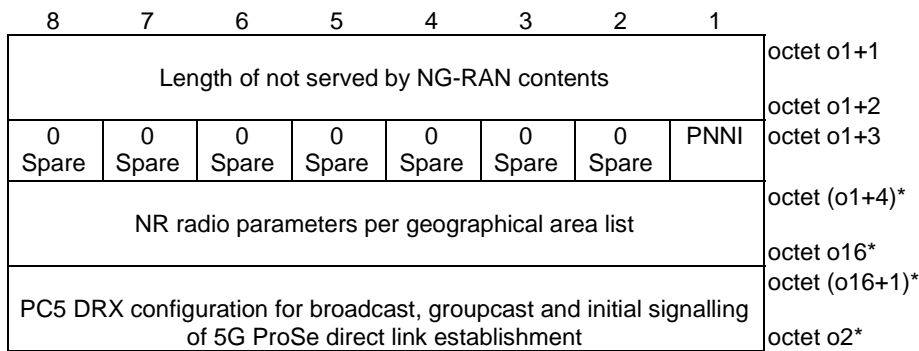

Figure 5.4.2.5: Not served by NG-RAN

Table 5.4.2.5: Not served by NG-RAN

<p>5G ProSe direct communication when not served by NG-RAN indicator (PNNI) (octet o1+3 bit 1): The PNNI bit indicates whether the UE is authorized to use 5G ProSe direct communication when not served by NG-RAN.</p> <p>Bit</p> <p>1</p> <p>0 Not authorized</p> <p>1 Authorized</p> <p>NR radio parameters per geographical area list (octet o1+4 to o16): If PNNI bit is set to "Authorized", the NR radio parameters per geographical area list field is present otherwise the NR radio parameters per geographical area list field is absent. It is coded according to figure 5.4.2.6 and table 5.4.2.6.</p> <p>PC5 DRX configuration for broadcast,groupcast and initial signalling of 5G ProSe direct link establishment (octet o16+1 to o2): If PNNI bit is set to "Authorized", the PC5 DRX configuration for broadcast, groupcast and initial signalling of 5G ProSe direct link establishment field is present otherwise the PC5 DRX configuration for broadcast, groupcast and initial signalling of 5G ProSe direct link establishment field is absent. It is coded according to figure 5.4.2.10a and table 5.4.2.10a.</p> <p>If the length of not served by NG-RAN contents field is bigger than indicated in figure 5.4.2.5, receiving entity shall ignore any superfluous octets located at the end of the not served by NG-RAN contents.</p>

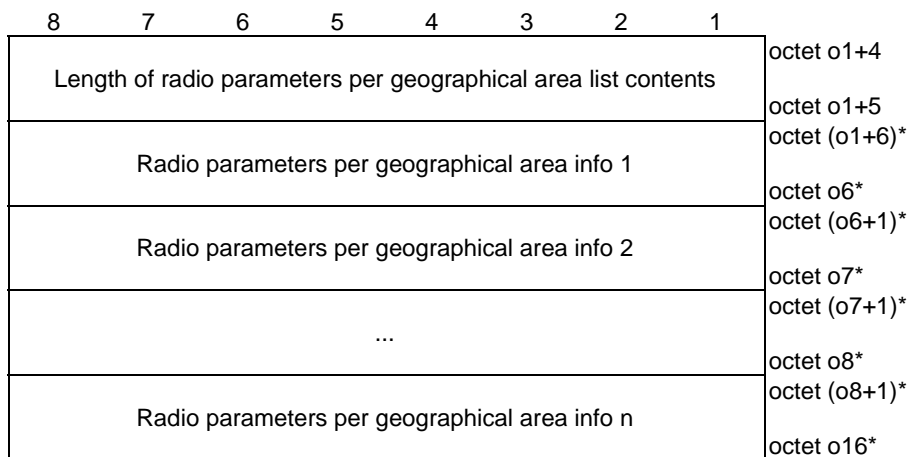

Figure 5.4.2.6: Radio parameters per geographical area list

Table 5.4.2.6: Radio parameters per geographical area list

Radio parameters per geographical area info:
 The radio parameters per geographical area info field is coded according to figure 5.4.2.7 and table 5.4.2.7.

8	7	6	5	4	3	2	1	
Length of radio parameters per geographical area contents								octet o6+1
Geographical area								octet o6+2 octet o6+3
Radio parameters								octet o9 octet o9+1
MI	0	0	0	0	0	0	0	octet o7-1 octet o7
	Spare	Spare	Spare	Spare	Spare	Spare	Spare	

Figure 5.4.2.7: Radio parameters per geographical area info

Table 5.4.2.7: Radio parameters per geographical area info

Geographical area (octet o6+3 to o9):
 The geographical area field is coded according to figure 5.4.2.8 and table 5.4.2.8.

Radio parameters (octet o9 to o7-1):
 The radio parameters field is coded according to figure 5.4.2.10 and table 5.4.2.10, applicable in the geographical area indicated by the geographical area field when not served by NG-RAN.

Managed indicator (MI) (octet o7 bit 8):
 The managed indicator indicates how the radio parameters indicated in the radio parameters field in the geographical area indicated by the geographical area field are managed.

Bit

8

0 Non-operator managed
 1 Operator managed

If the length of radio parameters per geographical area contents field is bigger than indicated in figure 5.4.2.7, receiving entity shall ignore any superfluous octets located at the end of the radio parameters per geographical area contents.

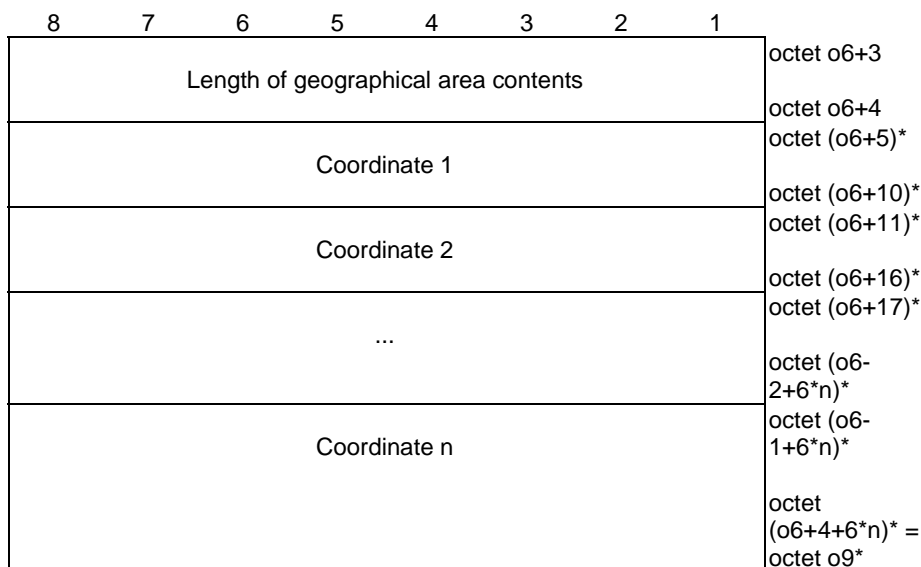

Figure 5.4.2.8: Geographical area

Table 5.4.2.8: Geographical area

<p>Coordinate: The coordinate field is coded according to figure 5.4.2.9 and table 5.4.2.9.</p>

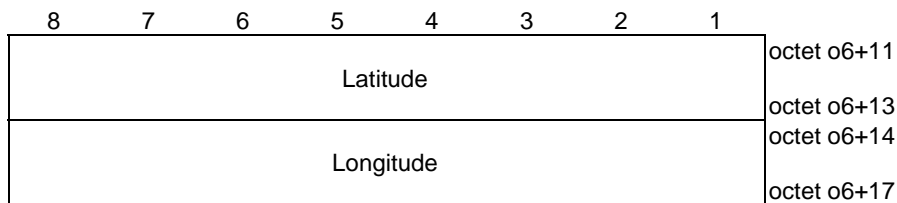

Figure 5.4.2.9: Coordinate area

Table 5.4.2.9: Coordinate area

<p>Latitude: The latitude field is coded according to clause 6.1 of 3GPP TS 23.032 [6].</p> <p>Longitude: The longitude field is coded according to clause 6.1 of 3GPP TS 23.032 [6].</p>

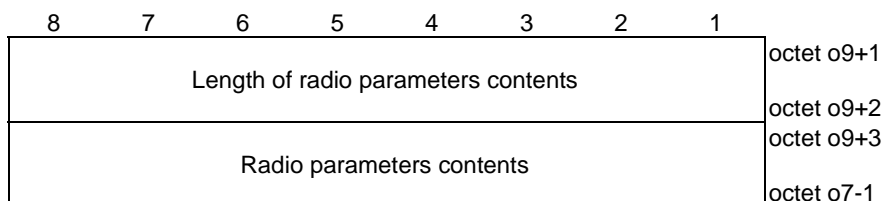

Figure 5.4.2.10: Radio parameters

Table 5.4.2.10: Radio parameters

Radio parameters contents:
Radio parameters are defined as *SL-PreconfigurationNR* in clause 9.3 of 3GPP TS 38.331 [7].

8	7	6	5	4	3	2	1	
Length of PC5 DRX configuration for broadcast, groupcast and initial signalling of 5G ProSe direct link establishment contents								octet o16+1
PC5 QoS profile to PC5 DRX cycle mapping rules								octet o16+2 octet o16+3
Default PC5 DRX configuration								octet o17 octet o17+1 octet o2

Figure 5.4.2.10a: PC5 DRX configuration for broadcast, groupcast and initial signalling of 5G ProSe direct link establishment

Table 5.4.2.10a: PC5 DRX configuration for broadcast, groupcast and initial signalling of 5G ProSe direct link establishment

PC5 QoS profile to PC5 DRX cycle mapping rules:
The PC5 QoS profile to PC5 DRX cycle mapping rules field is coded according to figure 5.4.2.10b and table 5.4.2.10b.

Default PC5 DRX configuration:
The default PC5 DRX configuration field is coded according to figure 5.3.2.11a and table 5.3.2.11a.

If the length of PC5 DRX configuration for broadcast, groupcast and initial signalling of 5G ProSe direct link establishment contents field indicates a length bigger than indicated in figure 5.4.2.5, receiving entity shall ignore any superfluous octets located at the end of the PC5 DRX configuration for broadcast, groupcast and initial signalling of 5G ProSe direct link establishment contents.

8	7	6	5	4	3	2	1	
Length of PC5 QoS profile to PC5 DRX cycle mapping rules contents								octet o16+3 octet o16+4
PC5 QoS profile to PC5 DRX cycle mapping rule 1								octet (o16+5)*
PC5 QoS profile to PC5 DRX cycle mapping rule 2								octet o160* octet (o160+1)*
...								octet o161* octet (o161+1)*
PC5 QoS profile to PC5 DRX cycle mapping rule n								octet o162* octet (o162+1)* octet o17*

Figure 5.4.2.10b: PC5 QoS profile to PC5 DRX cycle mapping rules

Table 5.4.2.10b: PC5 QoS profile to PC5 DRX cycle mapping rules

PC5 QoS profile to PC5 DRX cycle mapping rule:
 The PC5 QoS profile to PC5 DRX cycle mapping rule field is coded according to figure 5.4.2.10c and table 5.4.2.10c.

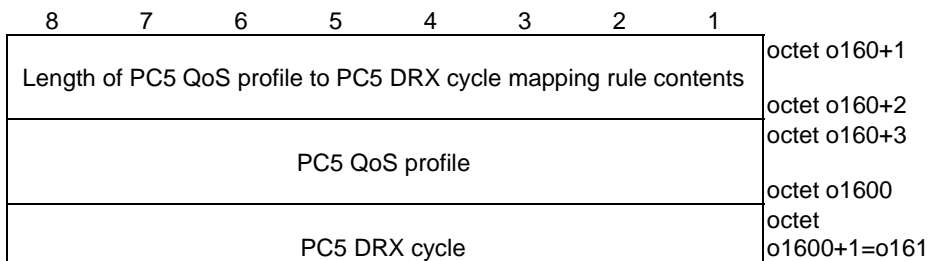

Figure 5.4.2.10c: PC5 QoS profile to PC5 DRX cycle mapping rule

Table 5.4.2.10c: PC5 QoS profile to PC5 DRX cycle mapping rule

PC5 QoS profile:
 The PC5 QoS profile field is coded according to figure 5.4.2.33 and table 5.4.2.33.

PC5 DRX cycle:
 The PC5 DRX cycle field is coded as *sl-DRX-GC-BC-Cycle-r17* in clause 6.3.5 of 3GPP TS 38.331 [7].

If the length of PC5 QoS profile to PC5 DRX cycle mapping rule contents field indicates a length bigger than indicated in figure 5.4.2.10b, receiving entity shall ignore any superfluous octets located at the end of the PC5 QoS profile to PC5 DRX cycle mapping rule contents.

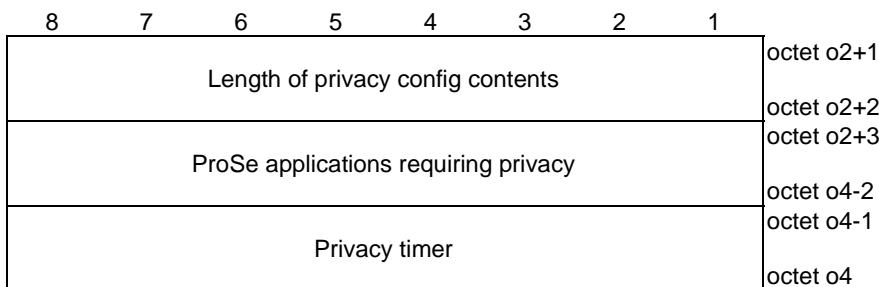

Figure 5.4.2.11: Privacy config

Table 5.4.2.11: Privacy config

ProSe applications requiring privacy (octet o2+3 to o4-2) (NOTE):
 The ProSe applications requiring privacy field is coded according to figure 5.4.2.12 and table 5.4.2.12. The ProSe applications requiring privacy field may contain a default ProSe application requiring privacy for the ProSe services that do not have dedicated ProSe application requiring privacy.

Privacy timer (octet o4-1, octet o4):
 The privacy timer field contains binary encoded duration, in units of seconds, after which the UE shall change the source layer-2 ID self-assigned by the UE while performing transmission of 5G ProSe direct communication when privacy is required. If the length of privacy config contents field is bigger than indicated in figure 5.4.2.11, receiving entity shall ignore any superfluous octets located at the end of the privacy config contents.

NOTE: This field is prioritized in decreasing order according to the local configuration of the network. The default mapping rule for the ProSe services that do not have dedicated mapping rules, if present, is recommended to be the last one and with the lowest priority of this field.

8	7	6	5	4	3	2	1	
Length of ProSe applications requiring privacy contents								octet o2+3
ProSe application requiring privacy 1								octet o2+4 octet (o2+5)*
ProSe application requiring privacy 2								octet o12* octet (o12+1)*
...								octet o13* octet (o13+1)*
ProSe application requiring privacy n								octet o14* octet (o14+1)* octet (o4-2)*

Figure 5.4.2.12: ProSe applications requiring privacy

Table 5.4.2.12: ProSe applications requiring privacy

ProSe application requiring privacy:
 The ProSe application requiring privacy field is coded according to figure 5.4.2.13 and table 5.4.2.13.

8	7	6	5	4	3	2	1	
Length of ProSe application requiring privacy contents								octet o12+1 octet o12+2 octet o12+3
ProSe identifiers								octet o15 octet o15+1
Geographical areas								octet o13

Figure 5.4.2.13: ProSe application requiring privacy

Table 5.4.2.13: ProSe application requiring privacy

ProSe identifiers (octet o12+3 to o15):
 The ProSe identifiers field is coded according to figure 5.4.2.14 and table 5.4.2.14. In case of the default ProSe application requiring privacy, the ProSe identifier is coded as the default ProSe identifier (see table 5.4.2.14).

Geographical areas (octet o15+1 to o13):
 The geographical areas field is coded according to figure 5.4.2.15 and table 5.4.2.15. If the length of ProSe applications requiring privacy contents field is bigger than indicated in figure 5.4.2.13, receiving entity shall ignore any superfluous octets located at the end of the ProSe applications requiring privacy contents.

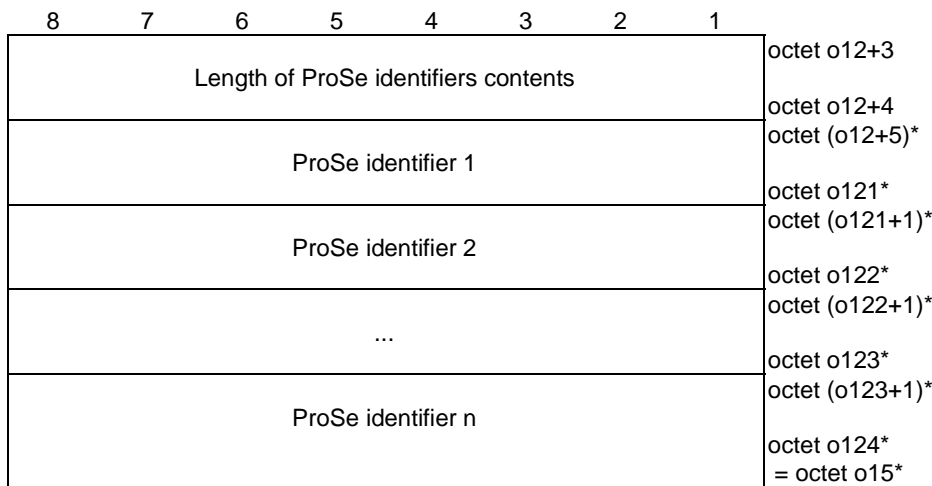

Figure 5.4.2.14: ProSe identifiers

Table 5.4.2.14: ProSe identifiers

ProSe identifier (NOTE 1, NOTE 2):
 The ProSe identifier field contains a sequence of a sixteen octet OS Id field, a one octet OS App Id length field, and an OS App Id field. The OS Id field shall be transmitted first. The OS Id field contains a Universally Unique Identifier (UUID) as specified in IETF RFC 4122 [12].

NOTE 1: Further definition of the format of OS App ID is beyond the scope of this specification.

NOTE 2: The default ProSe identifier for the ProSe services that do not have dedicated configurations is coded as a sequence of a seventeen octet of "0". The default ProSe identifier matches all the ProSe services.

8	7	6	5	4	3	2	1	
Length of geographical areas contents								octet o15+1
Geographical area 1								octet o15+2 octet (o15+3)*
Geographical area 2								octet o23* octet (o23+1)*
...								octet o24* octet (o24+1)*
Geographical area n								octet o25* octet (o25+1)* octet o13*

Figure 5.4.2.15: Geographical areas

Table 5.4.2.15: Geographical areas

Geographical area: The geographical area field is coded according to figure 5.4.2.8 and table 5.4.2.8.

8	7	6	5	4	3	2	1																	
Length of 5G ProSe direct communication in NR-PC5 contents								octet o4+1																
<table border="1" style="width: 100%; border-collapse: collapse;"> <tr> <td style="text-align: center;">0</td> <td style="text-align: center;">PINFM</td> <td style="text-align: center;">0</td> <td style="text-align: center;">0</td> <td style="text-align: center;">0</td> <td style="text-align: center;">0</td> <td style="text-align: center;">0</td> <td style="text-align: center;">0</td> </tr> <tr> <td style="text-align: center;">Spare</td> <td style="text-align: center;">RI</td> <td style="text-align: center;">Spare</td> <td style="text-align: center;">Spare</td> <td style="text-align: center;">Spare</td> <td style="text-align: center;">Spare</td> <td style="text-align: center;">Spare</td> <td style="text-align: center;">Spare</td> </tr> </table>								0	PINFM	0	0	0	0	0	0	Spare	RI	Spare	Spare	Spare	Spare	Spare	Spare	octet o4+2 octet o4+3
0	PINFM	0	0	0	0	0	0																	
Spare	RI	Spare	Spare	Spare	Spare	Spare	Spare																	
ProSe identifier to ProSe NR frequency mapping rules								octet (o4+4)*																
ProSe identifier to destination layer-2 ID for broadcast mapping rules								octet o45* octet o108 (see NOTE)																
Groupcast parameters								octet o46 octet o46+1																
ProSe identifier to destination layer-2 ID for unicast initial signalling mapping rules								octet o47 octet o47+1																
ProSe identifier to PC5 QoS parameters mapping rules								octet o48 octet o48+1																
AS configuration								octet o49 octet o49+1																
NR-PC5 unicast security policies								octet o50 octet (o50+1) = octet o93																
ProSe identifier to default mode of communication mapping rules								octet o84 octet (o84+1)																
ProSe identifier to destination layer-2 ID for groupcast mapping rules								octet o85 octet (o85+1) octet o86 = octet o5																

NOTE: The field is placed immediately after the last present preceding field.

Figure 5.4.2.16: 5G ProSe direct communication over PC5 in NR-PC5

Table 5.4.2.16: 5G ProSe direct communication over PC5 in NR-PC5

<p>ProSe identifier to ProSe NR frequency mapping rules indicator (PINFMRI) (octet o4+3 bit 7): The PINFMRI bit indicates presence of the ProSe identifier to ProSe NR frequency mapping rules field.</p> <p>Bit</p> <p>7</p> <p>0 ProSe identifier to ProSe NR frequency mapping rules field is absent 1 ProSe identifier to ProSe NR frequency mapping rules field is present</p> <p>ProSe identifier to ProSe NR frequency mapping rules (octet o4+4 to o45) (NOTE): The ProSe identifier to ProSe NR frequency mapping rules field is coded according to figure 5.4.2.17 and table 5.4.2.17. The ProSe identifier to ProSe NR frequency mapping rules field may contain a default ProSe identifier to ProSe NR frequency mapping rule for the ProSe services that do not have dedicated mapping rules.</p> <p>ProSe identifier to destination layer-2 ID for broadcast mapping rules (octet o108 to o46) (NOTE): The ProSe identifier to destination layer-2 ID for broadcast mapping rules field is coded according to figure 5.4.2.22 and table 5.4.2.22. The ProSe identifier to destination layer-2 ID for broadcast mapping rules field may contain a default ProSe identifier to destination layer-2 ID for broadcast mapping rule for the ProSe services that do not have dedicated mapping rules.</p> <p>Groupcast parameters (octet o46+1 to o47): The groupcast parameters field is coded according to figure 5.4.2.24 and table 5.4.2.24.</p> <p>ProSe identifier to destination layer-2 ID for unicast initial signalling mapping rules (octet o47+1 to o48) (NOTE): The ProSe identifier to destination layer-2 ID for unicast initial signalling mapping rules field is coded according to figure 5.4.2.26 and table 5.4.2.26. The ProSe identifier to destination layer-2 ID for unicast initial signalling mapping rules field may contain a default ProSe identifier to destination layer-2 ID for unicast initial signalling mapping rule for the ProSe services that do not have dedicated mapping rules.</p> <p>ProSe identifier to PC5 QoS parameters mapping rules (octet o48+1 to o49) (NOTE): The ProSe identifier to PC5 QoS parameters mapping rules field is coded according to figure 5.4.2.28 and table 5.4.2.28. The ProSe identifier to PC5 QoS parameters mapping rules field may contain a default ProSe identifier to PC5 QoS parameters mapping rule for the ProSe services that do not have dedicated mapping rules.</p> <p>AS configuration (octet o49+1 to o50): The AS configuration field is coded according to figure 5.4.2.30 and table 5.4.2.30.</p> <p>NR-PC5 unicast security policies (octet o93 to o84) (NOTE): The NR-PC5 unicast security policies field is coded according to figure 5.4.2.34 and table 5.4.2.34. The NR-PC5 unicast security policies field may contain a default NR-PC5 unicast security policy for the ProSe services that do not have dedicated mapping rules.</p> <p>ProSe identifier to default mode of communication mapping rules (o84+1 to o85) (NOTE):: The ProSe identifier to default mode of communication mapping rules is coded according to figure 5.4.2.37 and table 5.4.2.37. The ProSe identifier to default mode of communication mapping rules field may contain a default ProSe identifier to default mode of communication mapping rule for the ProSe services that do not have dedicated mapping rules.</p> <p>ProSe identifier to destination layer-2 ID for groupcast mapping rules (octet o85+1 to o5): The ProSe identifier to destination layer-2 ID for groupcast mapping rules field is coded according to figure 5.4.2.39 and table 5.4.2.39.</p> <p>If the length of 5G ProSe direct communication over PC5 in NR-PC5 contents field is bigger than indicated in figure 5.4.2.16, receiving entity shall ignore any superfluous octets located at the end of the 5G ProSe direct communication over PC5 in NR-PC5 contents.</p> <p>NOTE: This field is prioritized in decreasing order according to the local configuration of the network. The default mapping rule for the ProSe services that do not have dedicated mapping rules, if present, is recommended to be the last one and with the lowest priority of this field.</p>

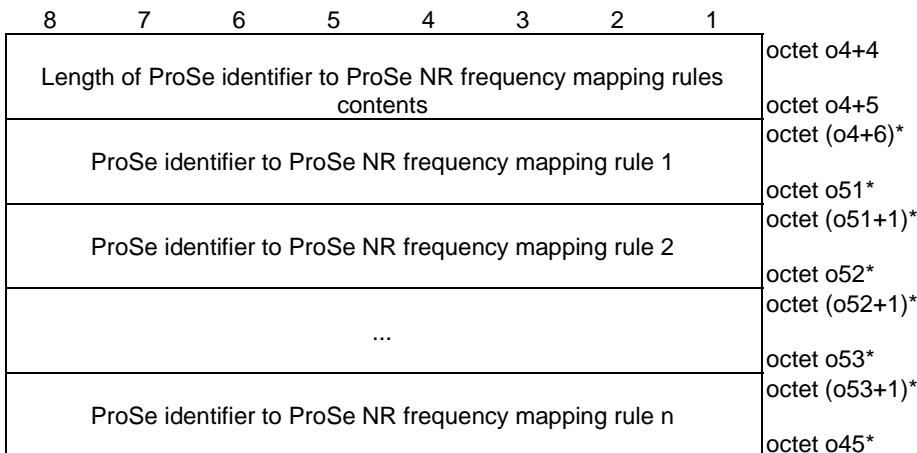

Figure 5.4.2.17: ProSe identifier to ProSe NR frequency mapping rules

Table 5.4.2.17: ProSe identifier to ProSe NR frequency mapping rules

ProSe identifier to ProSe NR frequency mapping rule:
The ProSe identifier to ProSe NR frequency mapping rule is coded according to figure 5.4.2.18 and table 5.4.2.18.

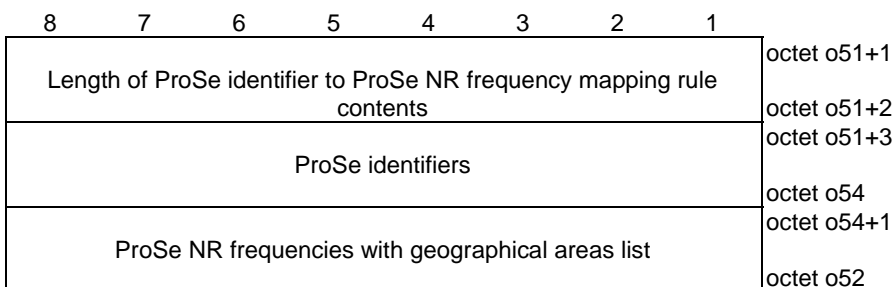

Figure 5.4.2.18: ProSe identifier to ProSe NR frequency mapping rule

Table 5.4.2.18: ProSe identifier to ProSe NR frequency mapping rule

ProSe identifiers (octet o51+3 to o54):
The ProSe identifiers field is coded according to figure 5.4.2.14 and table 5.4.2.14. In case of the default ProSe identifier to ProSe NR frequency mapping rule, the ProSe identifier is coded as the default ProSe identifier (see table 5.4.2.14).

ProSe NR frequencies with geographical areas list (octet o54+1 to o52):
The ProSe NR frequencies with geographical areas list field is coded according to figure 5.4.2.19 and table 5.4.2.19.

If the length of ProSe identifier to ProSe NR frequency mapping rule contents field is bigger than indicated in figure 5.4.2.18, receiving entity shall ignore any superfluous octets located at the end of the ProSe identifier to ProSe NR frequency mapping rule contents.

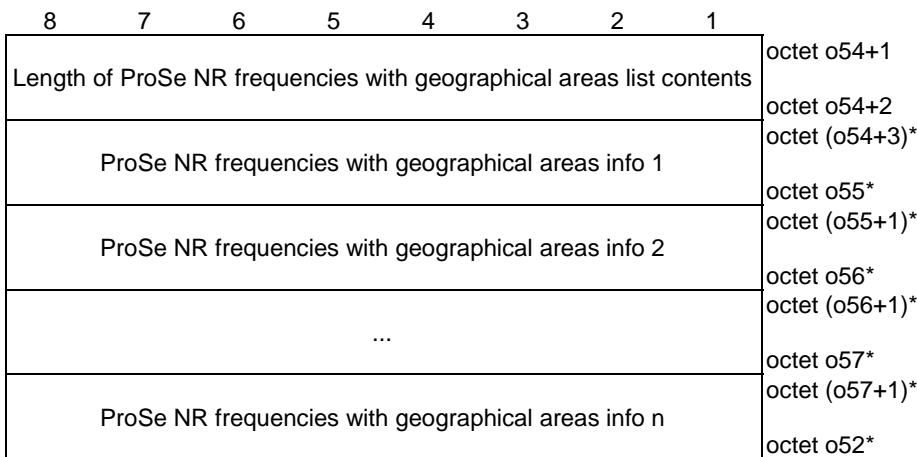

Figure 5.4.2.19: ProSe NR frequencies with geographical areas list

Table 5.4.2.19: ProSe NR frequencies with geographical areas list

ProSe NR frequencies with geographical areas info:
The ProSe NR frequencies with geographical areas info field is coded according to figure 5.4.2.20 and table 5.4.2.20.

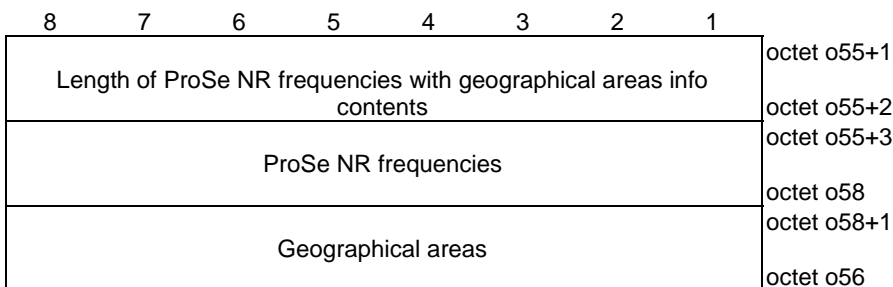

Figure 5.4.2.20: ProSe NR frequencies with geographical areas info

Table 5.4.2.20: ProSe NR frequencies with geographical areas info

ProSe NR frequencies (octet o55+3 to o58):
The ProSe NR frequencies field is coded according to figure 5.4.2.21 and table 5.4.2.21.
Geographical areas (octet o58+1 to o56):
The geographical areas field is coded according to figure 5.4.2.15 and table 5.4.2.15.

If the length of ProSe NR frequencies with geographical areas info contents field is bigger than indicated in figure 5.4.2.20, receiving entity shall ignore any superfluous octets located at the end of the ProSe NR frequencies with geographical areas info contents.

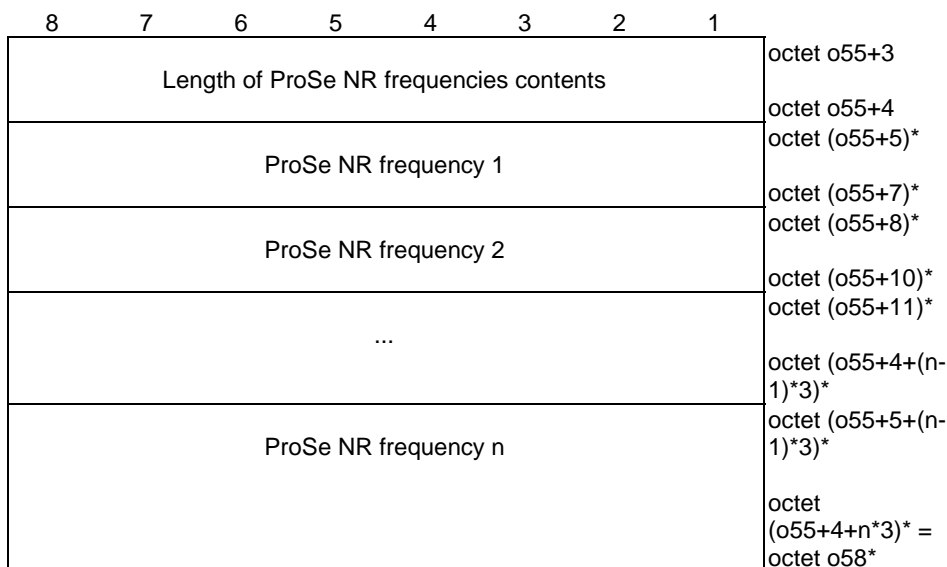

Figure 5.4.2.21: ProSe NR frequencies

Table 5.4.2.21: ProSe NR frequencies

ProSe NR frequency:
 ProSe NR frequency is coded according to the NR-ARFCN value defined in 3GPP TS 38.101-1 [8] and 3GPP TS 38.101-2 [9].

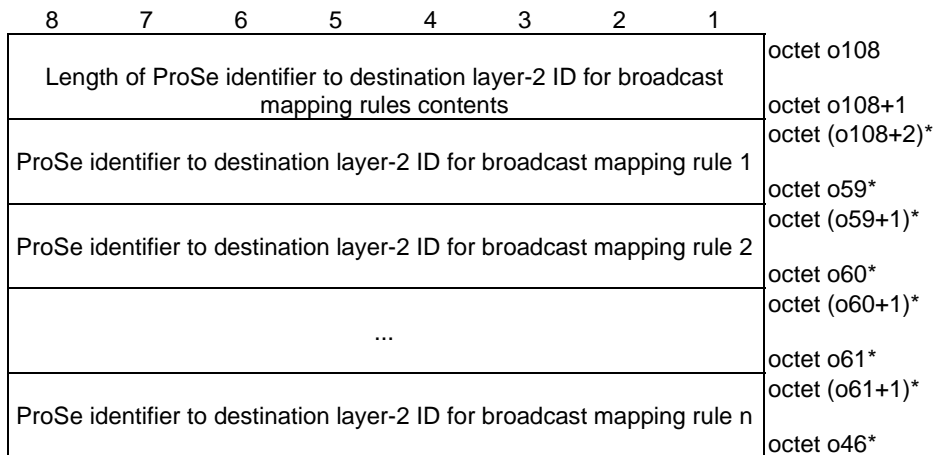

Figure 5.4.2.22: ProSe identifier to destination layer-2 ID for broadcast mapping rules

Table 5.4.2.22: ProSe identifier to destination layer-2 ID for broadcast mapping rules

ProSe identifier to destination layer-2 ID for broadcast mapping rule:
 The ProSe identifier to destination layer-2 ID for broadcast mapping rule field is coded according to figure 5.4.2.23 and table 5.4.2.23.

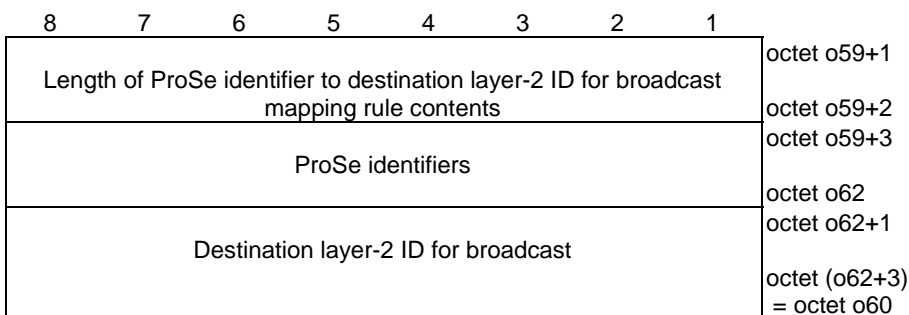

Figure 5.4.2.23: ProSe identifier to destination layer-2 ID for broadcast mapping rule

Table 5.4.2.23: ProSe identifier to destination layer-2 ID for broadcast mapping rule

ProSe identifiers (octet o59+3 to o62):
 The ProSe identifiers field is coded according to figure 5.4.2.14 and table 5.4.2.14. In case of the default ProSe identifier to destination layer-2 ID for broadcast mapping rule, the ProSe identifier is coded as the default ProSe identifier (see table 5.4.2.14).

Destination layer-2 ID for broadcast (octet o62+1 to o60):
 The destination layer-2 ID for broadcast field is a binary coded layer-2 identifier.

If the length of ProSe identifier to destination layer-2 ID for broadcast mapping rule contents field is bigger than indicated in figure 5.4.2.23, receiving entity shall ignore any superfluous octets located at the end of the ProSe identifier to destination layer-2 ID for broadcast mapping rule contents.

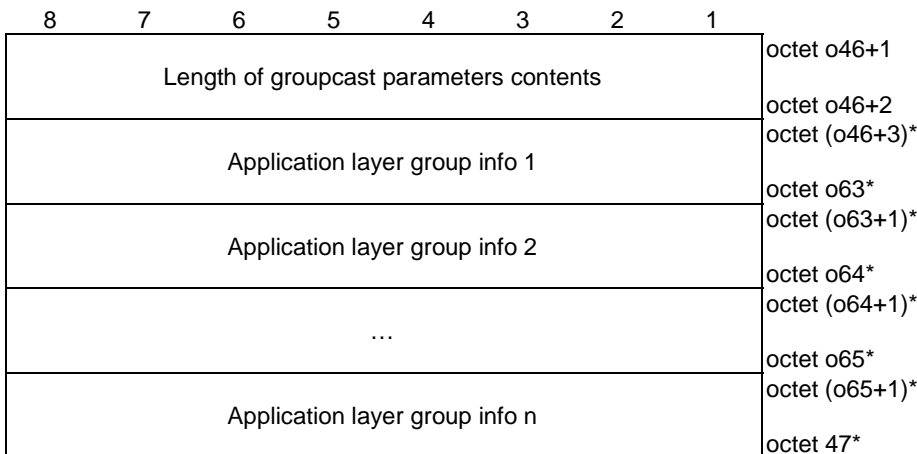

Figure 5.4.2.24: Groupcast parameters

Table 5.4.2.24: Groupcast parameters

Application layer group info:
 The application layer group info field is coded according to figure 5.4.2.25 and table 5.4.2.25.

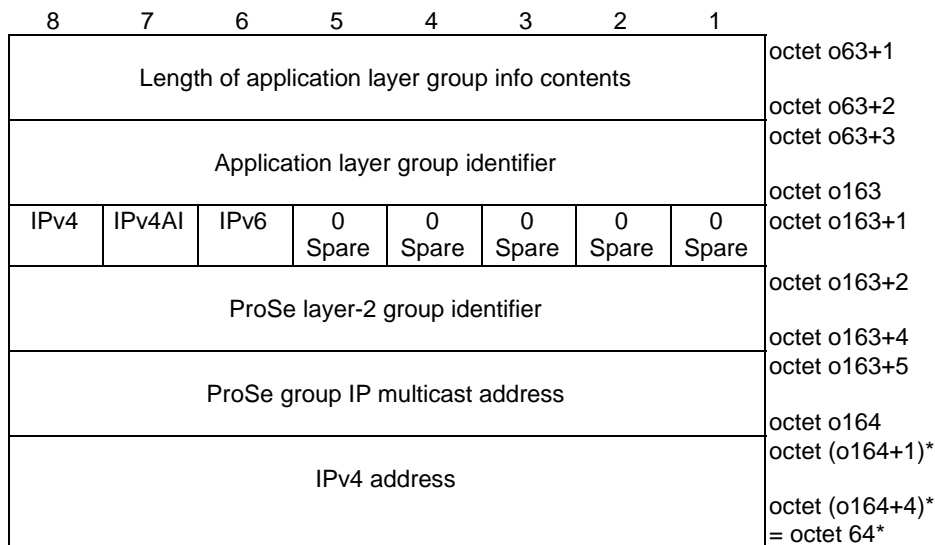

Figure 5.4.2.25: Application layer group info

Table 5.4.2.25: Application layer group info

<p>Application layer group identifier (octet o63+3 to o163): The first octet of application layer group identifier field is the length of application group identifier. The value of application group identifier field is a bit string. The format of application group identifier parameter is out of scope of this specification.</p> <p>IPv4 (octet o163+1 bit 8): Bit 8 0 IPv4 is not authorized 1 IPv4 is authorized</p> <p>IPv4 address indicator (IPv4AI) (octet o163+1 bit 7): Bit 7 0 IPv4 address is absent 1 IPv4 address is present</p> <p>IPv6 (octet o163+1 bit 6): Bit 6 0 IPv6 is not authorized 1 IPv6 is authorized</p> <p>ProSe layer-2 group identifier (octet o163+2 to o163+4): The ProSe layer-2 group identifier field is a binary coded layer-2 identifier.</p> <p>ProSe group IP multicast address (octet o163+5 to o164): The ProSe group IP multicast address field contains the IP multicast address for the group. If IPv4 field is set to "IPv4 is authorized" and IPv6 field is set to "IPv6 is not authorized", the ProSe group IP multicast address contains an IPv4 address. If IPv6 field is set to "IPv6 is authorized" and IPv4 field is set to "IPv4 is not authorized", the ProSe group IP multicast address contains an IPv6 address. If IPv4 field is set to "IPv4 is authorized" and IPv6 field is set to "IPv6 is authorized", the ProSe group IP multicast address contains an IPv4 address followed by an IPv6 address</p> <p>IPv4 address (octet o164+1 to o164+4): The IPv4 address field contains an IPv4 address as the source address for a specific group configured to operate using IPv4.</p>

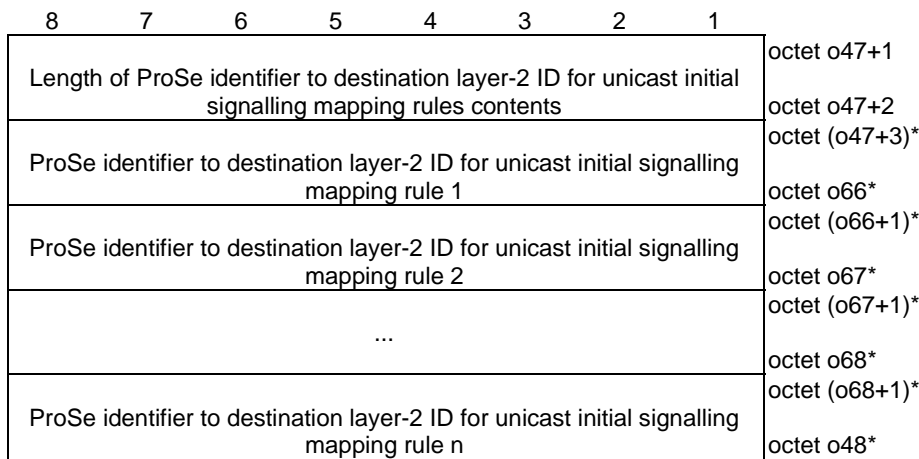

Figure 5.4.2.26: ProSe identifier to destination layer-2 ID for unicast initial signalling mapping rules

Table 5.4.2.26: ProSe identifier to destination layer-2 ID for unicast initial signalling mapping rules

ProSe identifier to destination layer-2 ID for unicast initial signalling mapping rule:
The ProSe identifier to destination layer-2 ID for unicast initial signalling mapping rule field is coded according to figure 5.4.2.27 and table 5.4.2.27.

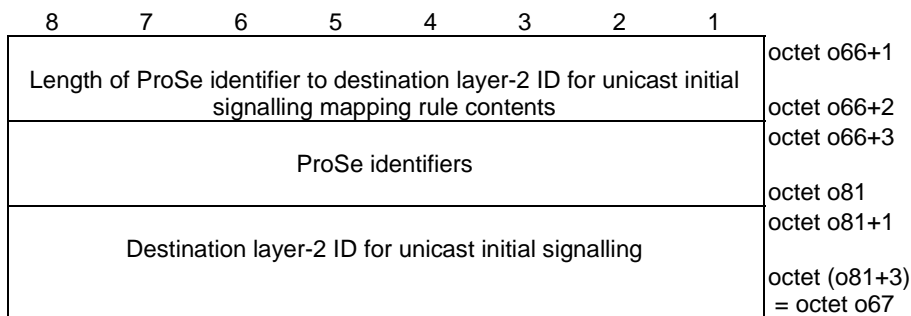

Figure 5.4.2.27: ProSe identifier to destination layer-2 ID for unicast initial signalling mapping rule

Table 5.4.2.27: ProSe identifier to destination layer-2 ID for unicast initial signalling mapping rule

ProSe identifiers (octet o66+3 to o81):
The ProSe identifiers field is coded according to figure 5.4.2.14 and table 5.4.2.14. In case of the default ProSe identifier to destination layer-2 ID for unicast initial signalling mapping rule, the ProSe identifier is coded as the default ProSe identifier (see table 5.4.2.14).

Destination layer-2 ID for unicast initial signalling (octet o81+1 to o67):
The destination layer-2 ID for unicast initial signalling field is a binary coded layer-2 identifier.

If the length of ProSe identifier to destination layer-2 ID for unicast initial signalling mapping rule contents field is bigger than indicated in figure 5.4.2.27, receiving entity shall ignore any superfluous octets located at the end of the ProSe identifier to destination layer-2 ID for unicast initial signalling mapping rule contents.

8	7	6	5	4	3	2	1	
Length of ProSe identifier to PC5 QoS parameters mapping rules contents								octet o48+1
ProSe identifier to PC5 QoS parameters mapping rule 1								octet o48+2 octet (o48+3)*
ProSe identifier to PC5 QoS parameters mapping rule 2								octet o70* octet (o70+1)*
...								octet o71* octet (o71+1)*
ProSe identifier to PC5 QoS parameters mapping rule n								octet o72* octet (o72+1)* octet o49*

Figure 5.4.2.28: ProSe identifier to PC5 QoS parameters mapping rules

Table 5.4.2.28: ProSe identifier to PC5 QoS parameters mapping rules

ProSe identifier to PC5 QoS parameters mapping rule:
 The ProSe identifier to PC5 QoS parameters mapping rule field is coded according to figure 5.4.2.29 and table 5.4.2.29.

8	7	6	5	4	3	2	1	
Length of ProSe identifier to PC5 QoS parameters mapping rule contents								octet o70+1
ProSe identifiers								octet o70+2 octet o70+3
GFBR	MFBR	PLAMB RI	RI	0 Spare	0 Spare	0 Spare	0 Spare	octet o74 octet o74+1
PQI								octet o74+2
Guaranteed flow bit rate								octet (o74+3)*
Maximum flow bit rate								octet (o74+5)* octet o94* (see NOTE)
Per-link aggregate maximum bit rate								octet (o94+2)* octet o95* (see NOTE)
Range								octet (o95+2)* octet o96* (see NOTE) octet (o96+1)* = octet o71*

NOTE: The field is placed immediately after the last present preceding field.

Figure 5.4.2.29: ProSe identifier to PC5 QoS parameters mapping rule

Table 5.4.2.29: ProSe identifier to PC5 QoS parameters mapping rule

ProSe identifiers (octet o70+3 to o74):

The ProSe identifiers field is coded according to figure 5.4.2.14 and table 5.4.2.14. In case of the default ProSe identifier to PC5 QoS parameters mapping rule, the ProSe identifier is coded as the default ProSe identifier (see table 5.4.2.14).

Guaranteed flow bit rate indicator (GFBRI) (octet o74+1 bit 8):

The GFBRI bit indicates presence of guaranteed flow bit rate field.

Bit

8

- 0 Guaranteed flow bit rate field is absent
- 1 Guaranteed flow bit rate field is present

Maximum flow bit rate indicator (MFBRI) (octet o74+1 bit 7):

The MFBRI bit indicates presence of maximum flow bit rate field.

Bit

7

- 0 Maximum flow bit rate field is absent
- 1 Maximum flow bit rate field is present

Per-link aggregate maximum bit rate indicator (PLAMBRI) (octet o74+1 bit 6):

The PLAMBRI bit indicates presence of per-link aggregate maximum bit rate field.

Bit

6

- 0 Per-link aggregate maximum bit rate field is absent
- 1 Per-link aggregate maximum bit rate field is present

Range indicator (RI) (octet o74+1 bit 5):

The RI bit indicates presence of range field.

Bit

5

- 0 Range field is absent
- 1 Range field is present

PQI (octet o74+2):	
Bits	
8 7 6 5 4 3 2 1	
0 0 0 0 0 0 0 0	Reserved
0 0 0 0 0 0 0 1	to Spare
0 0 0 1 0 1 0 0	
0 0 0 1 0 1 0 1	PQI 21
0 0 0 1 0 1 1 0	PQI 22
0 0 0 1 0 1 1 1	PQI 23
0 0 0 1 1 0 0 0	PQI 24
0 0 0 1 1 0 0 1	PQI 25
0 0 0 1 1 0 1 0	PQI 26
0 0 0 1 1 0 1 1	to Spare
0 0 0 1 1 1 1 1	
0 0 1 0 0 0 0 0	PQI 32
0 0 1 0 0 0 0 1	PQI 33
0 0 1 0 0 0 1 0	PQI 34
0 0 1 0 0 0 1 1	to Spare
0 0 1 1 0 1 1 0	
0 0 1 1 0 1 1 1	PQI 55
0 0 1 1 1 0 0 0	PQI 56
0 0 1 1 1 0 0 1	PQI 57
0 0 1 1 1 0 1 0	PQI 58
0 0 1 1 1 0 1 1	PQI 59
0 0 1 1 1 1 0 0	PQI 60
0 0 1 1 1 1 0 1	PQI 61
0 0 1 1 1 1 1 0	to Spare
0 1 0 1 0 0 0 1	
0 1 0 1 0 0 1 0	PQI 70
0 1 0 1 0 0 1 1	PQI 71
0 1 0 1 0 1 0 0	to Spare
0 1 0 1 1 0 0 1	
0 1 0 1 1 0 1 0	PQI 90
0 1 0 1 1 0 1 1	PQI 91
0 1 0 1 1 1 0 0	PQI 92
0 1 0 1 1 1 0 1	PQI 93
0 1 0 1 1 1 1 0	to Spare
0 1 1 1 1 1 1 1	
1 0 0 0 0 0 0 0	to Operator-specific PQIs
1 1 1 1 1 1 1 0	
1 1 1 1 1 1 1 1	Reserved

If the UE receives a PQI value (excluding the reserved PQI values) that it does not understand, the UE shall choose a PQI value from the set of PQI values defined in this version of the protocol (see 3GPP TS 23.304 [2]) and associated with:

- GBR resource type, if the ProSe identifier to PC5 QoS parameters mapping rule includes the guaranteed flow bit rate field; and
- non-GBR resource type, if the ProSe identifier to PC5 QoS parameters mapping rule does not include the guaranteed flow bit rate field.

The UE shall use this chosen PQI value for internal operations only. The UE shall use the received PQI value in subsequent 5G ProSe direct communication over PC5 signalling procedures.

Guaranteed flow bit rate (octet o74+3 to o74+5):

The guaranteed flow bit rate field indicates guaranteed flow bit rate for both sending and receiving and contains one octet indicating the unit of the guaranteed flow bit rate followed by two octets containing the value of the guaranteed flow bit rate.

Unit of the guaranteed flow bit rate:

Bits

8 7 6 5 4 3 2 1

0 0 0 0 0 0 0 0	value is not used
0 0 0 0 0 0 0 1	value is incremented in multiples of 1 Kbps
0 0 0 0 0 0 1 0	value is incremented in multiples of 4 Kbps
0 0 0 0 0 0 1 1	value is incremented in multiples of 16 Kbps
0 0 0 0 0 1 0 0	value is incremented in multiples of 64 Kbps
0 0 0 0 0 1 0 1	value is incremented in multiples of 256 Kbps
0 0 0 0 0 1 1 0	value is incremented in multiples of 1 Mbps
0 0 0 0 0 1 1 1	value is incremented in multiples of 4 Mbps
0 0 0 0 1 0 0 0	value is incremented in multiples of 16 Mbps
0 0 0 0 1 0 0 1	value is incremented in multiples of 64 Mbps
0 0 0 0 1 0 1 0	value is incremented in multiples of 256 Mbps
0 0 0 0 1 0 1 1	value is incremented in multiples of 1 Gbps
0 0 0 0 1 1 0 0	value is incremented in multiples of 4 Gbps
0 0 0 0 1 1 0 1	value is incremented in multiples of 16 Gbps
0 0 0 0 1 1 1 0	value is incremented in multiples of 64 Gbps
0 0 0 0 1 1 1 1	value is incremented in multiples of 256 Gbps
0 0 0 1 0 0 0 0	value is incremented in multiples of 1 Tbps
0 0 0 1 0 0 0 1	value is incremented in multiples of 4 Tbps
0 0 0 1 0 0 1 0	value is incremented in multiples of 16 Tbps
0 0 0 1 0 0 1 1	value is incremented in multiples of 64 Tbps
0 0 0 1 0 1 0 0	value is incremented in multiples of 256 Tbps
0 0 0 1 0 1 0 1	value is incremented in multiples of 1 Pbps
0 0 0 1 0 1 1 0	value is incremented in multiples of 4 Pbps
0 0 0 1 0 1 1 1	value is incremented in multiples of 16 Pbps
0 0 0 1 1 0 0 0	value is incremented in multiples of 64 Pbps
0 0 0 1 1 0 0 1	value is incremented in multiples of 256 Pbps

Other values shall be interpreted as multiples of 256 Pbps in this version of the protocol.

Value of the guaranteed flow bit rate is binary coded value of the guaranteed flow bit rate in units defined by the unit of the guaranteed flow bit rate.

Maximum flow bit rate (octet o94 to o94+2):

The maximum flow bit rate field indicates maximum flow bit rate for both sending and receiving and contains one octet indicating the unit of the maximum flow bit rate followed by two octets containing the value of the maximum flow bit rate.

Unit of the maximum flow bit rate:

Bits

8 7 6 5 4 3 2 1

0 0 0 0 0 0 0 0	value is not used
0 0 0 0 0 0 0 1	value is incremented in multiples of 1 Kbps
0 0 0 0 0 0 1 0	value is incremented in multiples of 4 Kbps
0 0 0 0 0 0 1 1	value is incremented in multiples of 16 Kbps
0 0 0 0 0 1 0 0	value is incremented in multiples of 64 Kbps
0 0 0 0 0 1 0 1	value is incremented in multiples of 256 Kbps
0 0 0 0 0 1 1 0	value is incremented in multiples of 1 Mbps
0 0 0 0 0 1 1 1	value is incremented in multiples of 4 Mbps
0 0 0 0 1 0 0 0	value is incremented in multiples of 16 Mbps
0 0 0 0 1 0 0 1	value is incremented in multiples of 64 Mbps
0 0 0 0 1 0 1 0	value is incremented in multiples of 256 Mbps
0 0 0 0 1 0 1 1	value is incremented in multiples of 1 Gbps
0 0 0 0 1 1 0 0	value is incremented in multiples of 4 Gbps
0 0 0 0 1 1 0 1	value is incremented in multiples of 16 Gbps
0 0 0 0 1 1 1 0	value is incremented in multiples of 64 Gbps
0 0 0 0 1 1 1 1	value is incremented in multiples of 256 Gbps
0 0 0 1 0 0 0 0	value is incremented in multiples of 1 Tbps
0 0 0 1 0 0 0 1	value is incremented in multiples of 4 Tbps
0 0 0 1 0 0 1 0	value is incremented in multiples of 16 Tbps
0 0 0 1 0 0 1 1	value is incremented in multiples of 64 Tbps
0 0 0 1 0 1 0 0	value is incremented in multiples of 256 Tbps
0 0 0 1 0 1 0 1	value is incremented in multiples of 1 Pbps
0 0 0 1 0 1 1 0	value is incremented in multiples of 4 Pbps
0 0 0 1 0 1 1 1	value is incremented in multiples of 16 Pbps
0 0 0 1 1 0 0 0	value is incremented in multiples of 64 Pbps
0 0 0 1 1 0 0 1	value is incremented in multiples of 256 Pbps

Other values shall be interpreted as multiples of 256 Pbps in this version of the protocol.

Value of the maximum flow bit rate is binary coded value of the maximum flow bit rate in units defined by the unit of the maximum flow bit rate.

Per-link aggregate maximum bit rate (octet o95 to o95+2):
 The per-link aggregate maximum bit rate field indicates per-link aggregate maximum bit rate for both sending and receiving and contains one octet indicating the unit of the per-link aggregate maximum bit rate followed by two octets containing the value of the per-link aggregate maximum bit rate.

Unit of the per-link aggregate maximum bit rate:

Bits

8 7 6 5 4 3 2 1

- 0 0 0 0 0 0 0 0 value is not used
- 0 0 0 0 0 0 0 1 value is incremented in multiples of 1 Kbps
- 0 0 0 0 0 0 1 0 value is incremented in multiples of 4 Kbps
- 0 0 0 0 0 0 1 1 value is incremented in multiples of 16 Kbps
- 0 0 0 0 0 1 0 0 value is incremented in multiples of 64 Kbps
- 0 0 0 0 0 1 0 1 value is incremented in multiples of 256 Kbps
- 0 0 0 0 0 1 1 0 value is incremented in multiples of 1 Mbps
- 0 0 0 0 0 1 1 1 value is incremented in multiples of 4 Mbps
- 0 0 0 0 1 0 0 0 value is incremented in multiples of 16 Mbps
- 0 0 0 0 1 0 0 1 value is incremented in multiples of 64 Mbps
- 0 0 0 0 1 0 1 0 value is incremented in multiples of 256 Mbps
- 0 0 0 0 1 0 1 1 value is incremented in multiples of 1 Gbps
- 0 0 0 0 1 1 0 0 value is incremented in multiples of 4 Gbps
- 0 0 0 0 1 1 0 1 value is incremented in multiples of 16 Gbps
- 0 0 0 0 1 1 1 0 value is incremented in multiples of 64 Gbps
- 0 0 0 0 1 1 1 1 value is incremented in multiples of 256 Gbps
- 0 0 0 1 0 0 0 0 value is incremented in multiples of 1 Tbps
- 0 0 0 1 0 0 0 1 value is incremented in multiples of 4 Tbps
- 0 0 0 1 0 0 1 0 value is incremented in multiples of 16 Tbps
- 0 0 0 1 0 0 1 1 value is incremented in multiples of 64 Tbps
- 0 0 0 1 0 1 0 0 value is incremented in multiples of 256 Tbps
- 0 0 0 1 0 1 0 1 value is incremented in multiples of 1 Pbps
- 0 0 0 1 0 1 1 0 value is incremented in multiples of 4 Pbps
- 0 0 0 1 0 1 1 1 value is incremented in multiples of 16 Pbps
- 0 0 0 1 1 0 0 0 value is incremented in multiples of 64 Pbps
- 0 0 0 1 1 0 0 1 value is incremented in multiples of 256 Pbps

Other values shall be interpreted as multiples of 256 Pbps in this version of the protocol.

Value of the per-link aggregate maximum bit rate is binary coded value of the per-link aggregate maximum bit rate in units defined by the unit of the per-link aggregate maximum bit rate.

Range (octet o96 to o71):

The range field indicates a binary encoded value of the range in meters.

If the length of ProSe identifier to PC5 QoS parameters mapping rule contents field is bigger than indicated in figure 5.4.2.28, receiving entity shall ignore any superfluous octets located at the end of the ProSe identifier to PC5 QoS parameters mapping rule contents.

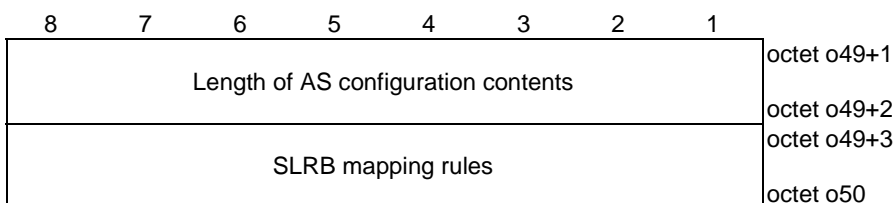

Figure 5.4.2.30: AS configuration

Table 5.4.2.30: AS configuration

SLRB mapping rules:
The SLRB mapping rules field is coded according to figure 5.4.2.31 and table 5.4.2.31.

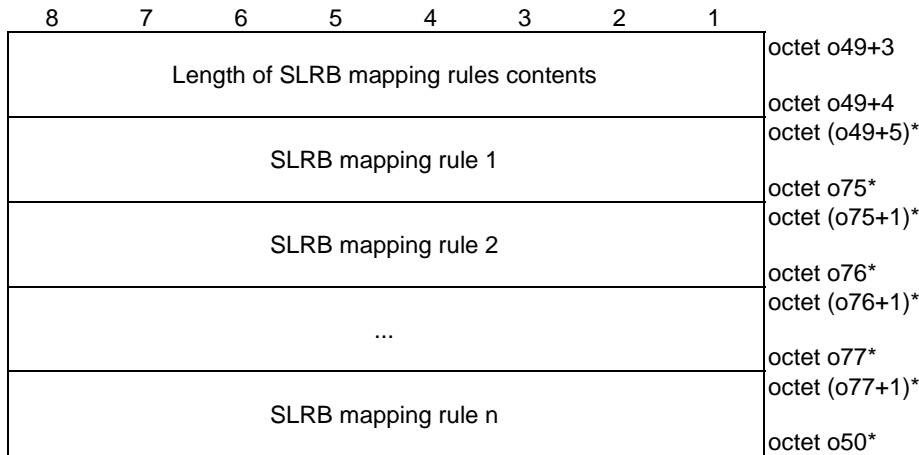

Figure 5.4.2.31: SLRB mapping rules

Table 5.4.2.31: SLRB mapping rules

SLRB mapping rule:
The SLRB mapping rule field is coded according to figure 5.4.2.32 and table 5.4.2.32.

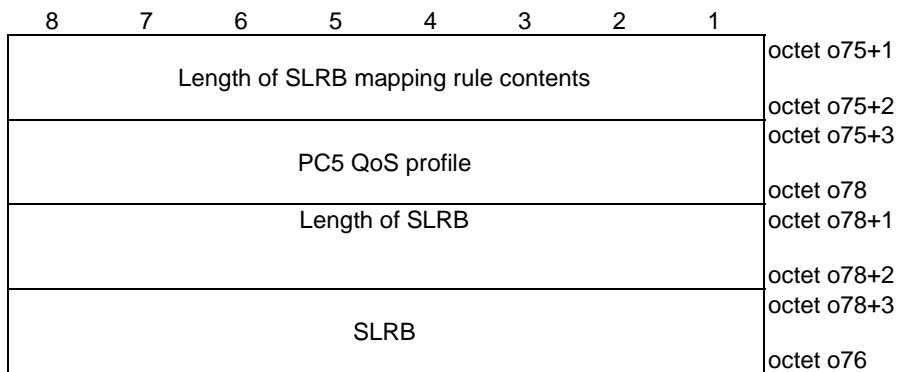

Figure 5.4.2.32: SLRB mapping rule

Table 5.4.2.32: SLRB mapping rule

PC5 QoS profile octet (o75+3 to o78):
The PC5 QoS profile field is coded according to figure 5.4.2.33 and table 5.4.2.33.

SLRB (o78+3 to o76):
SLRB is defined as *SL-PreconfigurationNR* in clause 9.3 of 3GPP TS 38.331 [7].

If the length of SLRB mapping rule contents field is bigger than indicated in figure 5.4.2.32, receiving entity shall ignore any superfluous octets located at the end of the SLRB mapping rule contents.

8	7	6	5	4	3	2	1	
Length of PC5 QoS profile contents								octet o75+3
GFBRl MFBRl PLAMB RI RI PLOl AWl MDBVI 0 Spare Spare								octet o75+4 octet o75+5
PQl								octet o75+6
Guaranteed flow bit rate								octet (o75+7)*
Maximum flow bit rate								octet (o75+9)* octet o97* (see NOTE)
Per-link aggregate maximum bit rate								octet (o97+2)* octet o98* (see NOTE)
Range								octet (o98+2)* octet o99* (see NOTE)
0 Spare	0 Spare	0 Spare	0 Spare	0 Spare	Priority level			octet (o99+1)* octet o100* (see NOTE)
Averaging window								octet o101* (see NOTE)
Maximum data burst volume								octet (o101+1)* octet o102* (see NOTE)
								octet (o102+1)* = octet o78*

NOTE: The field is placed immediately after the last present preceding field.

Figure 5.4.2.33:PC5 QoS profile

Table 5.4.2.33:PC5 QoS profile

Guaranteed flow bit rate indicator (GFBRI) (o75+5 bit 8): The GFBRI bit indicates presence of guaranteed flow bit rate field. Bit 8 0 Guaranteed flow bit rate field is absent 1 Guaranteed flow bit rate field is present
Maximum flow bit rate indicator (MFBRI) (o75+5 bit 7): The MFBRI bit indicates presence of maximum flow bit rate field. Bit 7 0 Maximum flow bit rate field is absent 1 Maximum flow bit rate field is present
Per-link aggregate maximum bit rate indicator (PLAMBRI) (o75+5 bit 6): The PLAMBRI bit indicates presence of per-link aggregate maximum bit rate field. Bit 6 0 Per-link aggregate maximum bit rate field is absent 1 Per-link aggregate maximum bit rate field is present
Range indicator (RI) (o75+5 bit 5): The RI bit indicates presence of range field. Bit 5 0 Range field is absent 1 Range field is present
Priority level octet indicator (OPLI) (o75+5 bit 4): The OPLI bit indicates presence of the octet of the priority level field. Bit 4 0 The octet of the priority level is absent 1 The octet of the priority level is present
Averaging window indicator (AWI) (o75+5 bit 3): The AWI bit indicates presence of averaging window field. Bit 3 0 Averaging window field is absent 1 Averaging window field is present
Maximum data burst volume indicator (MDBVI) (o75+5 bit 2): The MDBVI bit indicates presence of maximum data burst volume field. Bit 2 0 Maximum data burst volume field is absent 1 Maximum data burst volume field is present

PQI (o75+6):	
Bits	
8 7 6 5 4 3 2 1	
0 0 0 0 0 0 0 0	Reserved
0 0 0 0 0 0 0 1	
to Spare	
0 0 0 1 0 1 0 0	
0 0 0 1 0 1 0 1	PQI 21
0 0 0 1 0 1 1 0	PQI 22
0 0 0 1 0 1 1 1	PQI 23
0 0 0 1 1 0 0 0	PQI 24
0 0 0 1 1 0 0 1	PQI 25
0 0 0 1 1 0 1 0	PQI 26
0 0 0 1 1 0 1 1	
to Spare	
0 0 0 1 1 1 1 1	
0 0 1 0 0 0 0 0	PQI 32
0 0 1 0 0 0 0 1	PQI 33
0 0 1 0 0 0 1 0	PQI 34
0 0 1 0 0 0 1 1	
to Spare	
0 0 1 1 0 1 1 0	
0 0 1 1 0 1 1 1	PQI 55
0 0 1 1 1 0 0 0	PQI 56
0 0 1 1 1 0 0 1	PQI 57
0 0 1 1 1 0 1 0	PQI 58
0 0 1 1 1 0 1 1	PQI 59
0 0 1 1 1 1 0 0	PQI 60
0 0 1 1 1 1 0 1	PQI 61
0 0 1 1 1 1 1 0	
to Spare	
0 1 0 1 0 0 0 1	
0 1 0 1 0 0 1 0	PQI 70
0 1 0 1 0 0 1 1	PQI 71
0 1 0 1 0 1 0 0	
to Spare	
0 1 0 1 1 0 0 1	
0 1 0 1 1 0 1 0	PQI 90
0 1 0 1 1 0 1 1	PQI 91
0 1 0 1 1 1 0 0	PQI 92
0 1 0 1 1 1 0 1	PQI 93
0 1 0 1 1 1 1 0	
to Spare	
0 1 1 1 1 1 1 1	
1 0 0 0 0 0 0 0	
to Operator-specific PQIs	
1 1 1 1 1 1 1 0	
1 1 1 1 1 1 1 1	Reserved

If the UE receives a PQI value (excluding the reserved PQI values) that it does not understand, the UE shall choose a PQI value from the set of PQI values defined in this version of the protocol (see 3GPP TS 23.304 [2]) and associated with:

- GBR resource type, if the PC5 QoS profile includes the guaranteed flow bit rate field; and
- non-GBR resource type, if the PC5 QoS profile does not include the guaranteed flow bit rate field.

The UE shall use this chosen PQI value for internal operations only. The UE shall use the received PQI value in subsequent 5G ProSe direct communication over PC5 signalling procedures.

Guaranteed flow bit rate octet (o75+7 to o75+9):

The guaranteed flow bit rate field indicates guaranteed flow bit rate for both sending and receiving and contains one octet indicating the unit of the guaranteed flow bit rate followed by two octets containing the value of the guaranteed flow bit rate.

Unit of the guaranteed flow bit rate:

Bits

8 7 6 5 4 3 2 1

0 0 0 0 0 0 0 0	value is not used
0 0 0 0 0 0 0 1	value is incremented in multiples of 1 Kbps
0 0 0 0 0 0 1 0	value is incremented in multiples of 4 Kbps
0 0 0 0 0 0 1 1	value is incremented in multiples of 16 Kbps
0 0 0 0 0 1 0 0	value is incremented in multiples of 64 Kbps
0 0 0 0 0 1 0 1	value is incremented in multiples of 256 Kbps
0 0 0 0 0 1 1 0	value is incremented in multiples of 1 Mbps
0 0 0 0 0 1 1 1	value is incremented in multiples of 4 Mbps
0 0 0 0 1 0 0 0	value is incremented in multiples of 16 Mbps
0 0 0 0 1 0 0 1	value is incremented in multiples of 64 Mbps
0 0 0 0 1 0 1 0	value is incremented in multiples of 256 Mbps
0 0 0 0 1 0 1 1	value is incremented in multiples of 1 Gbps
0 0 0 0 1 1 0 0	value is incremented in multiples of 4 Gbps
0 0 0 0 1 1 0 1	value is incremented in multiples of 16 Gbps
0 0 0 0 1 1 1 0	value is incremented in multiples of 64 Gbps
0 0 0 0 1 1 1 1	value is incremented in multiples of 256 Gbps
0 0 0 1 0 0 0 0	value is incremented in multiples of 1 Tbps
0 0 0 1 0 0 0 1	value is incremented in multiples of 4 Tbps
0 0 0 1 0 0 1 0	value is incremented in multiples of 16 Tbps
0 0 0 1 0 0 1 1	value is incremented in multiples of 64 Tbps
0 0 0 1 0 1 0 0	value is incremented in multiples of 256 Tbps
0 0 0 1 0 1 0 1	value is incremented in multiples of 1 Pbps
0 0 0 1 0 1 1 0	value is incremented in multiples of 4 Pbps
0 0 0 1 0 1 1 1	value is incremented in multiples of 16 Pbps
0 0 0 1 1 0 0 0	value is incremented in multiples of 64 Pbps
0 0 0 1 1 0 0 1	value is incremented in multiples of 256 Pbps

Other values shall be interpreted as multiples of 256 Pbps in this version of the protocol.

Value of the guaranteed flow bit rate is binary coded value of the guaranteed flow bit rate in units defined by the unit of the guaranteed flow bit rate.

Maximum flow bit rate (o97 to o97+2):

The maximum flow bit rate field indicates maximum flow bit rate for both sending and receiving and contains one octet indicating the unit of the maximum flow bit rate followed by two octets containing the value of the maximum flow bit rate.

Unit of the maximum flow bit rate:

Bits

8 7 6 5 4 3 2 1

0 0 0 0 0 0 0 0	value is not used
0 0 0 0 0 0 0 1	value is incremented in multiples of 1 Kbps
0 0 0 0 0 0 1 0	value is incremented in multiples of 4 Kbps
0 0 0 0 0 0 1 1	value is incremented in multiples of 16 Kbps
0 0 0 0 0 1 0 0	value is incremented in multiples of 64 Kbps
0 0 0 0 0 1 0 1	value is incremented in multiples of 256 Kbps
0 0 0 0 0 1 1 0	value is incremented in multiples of 1 Mbps
0 0 0 0 0 1 1 1	value is incremented in multiples of 4 Mbps
0 0 0 0 1 0 0 0	value is incremented in multiples of 16 Mbps
0 0 0 0 1 0 0 1	value is incremented in multiples of 64 Mbps
0 0 0 0 1 0 1 0	value is incremented in multiples of 256 Mbps
0 0 0 0 1 0 1 1	value is incremented in multiples of 1 Gbps
0 0 0 0 1 1 0 0	value is incremented in multiples of 4 Gbps
0 0 0 0 1 1 0 1	value is incremented in multiples of 16 Gbps
0 0 0 0 1 1 1 0	value is incremented in multiples of 64 Gbps
0 0 0 0 1 1 1 1	value is incremented in multiples of 256 Gbps
0 0 0 1 0 0 0 0	value is incremented in multiples of 1 Tbps
0 0 0 1 0 0 0 1	value is incremented in multiples of 4 Tbps
0 0 0 1 0 0 1 0	value is incremented in multiples of 16 Tbps
0 0 0 1 0 0 1 1	value is incremented in multiples of 64 Tbps
0 0 0 1 0 1 0 0	value is incremented in multiples of 256 Tbps
0 0 0 1 0 1 0 1	value is incremented in multiples of 1 Pbps
0 0 0 1 0 1 1 0	value is incremented in multiples of 4 Pbps
0 0 0 1 0 1 1 1	value is incremented in multiples of 16 Pbps
0 0 0 1 1 0 0 0	value is incremented in multiples of 64 Pbps
0 0 0 1 1 0 0 1	value is incremented in multiples of 256 Pbps

Other values shall be interpreted as multiples of 256 Pbps in this version of the protocol.

Value of the maximum flow bit rate is binary coded value of the maximum flow bit rate in units defined by the unit of the maximum flow bit rate.

Per-link aggregate maximum bit rate (o98 to o98+2):

The per-link aggregate maximum bit rate field indicates per-link aggregate maximum bit rate for both sending and receiving and contains one octet indicating the unit of the per-link aggregate maximum bit rate followed by two octets containing the value of the per-link aggregate maximum bit rate.

Unit of the per-link aggregate maximum bit rate:

Bits

8 7 6 5 4 3 2 1

0 0 0 0 0 0 0 0	value is not used
0 0 0 0 0 0 0 1	value is incremented in multiples of 1 Kbps
0 0 0 0 0 0 1 0	value is incremented in multiples of 4 Kbps
0 0 0 0 0 0 1 1	value is incremented in multiples of 16 Kbps
0 0 0 0 0 1 0 0	value is incremented in multiples of 64 Kbps
0 0 0 0 0 1 0 1	value is incremented in multiples of 256 Kbps
0 0 0 0 0 1 1 0	value is incremented in multiples of 1 Mbps
0 0 0 0 0 1 1 1	value is incremented in multiples of 4 Mbps
0 0 0 0 1 0 0 0	value is incremented in multiples of 16 Mbps
0 0 0 0 1 0 0 1	value is incremented in multiples of 64 Mbps
0 0 0 0 1 0 1 0	value is incremented in multiples of 256 Mbps
0 0 0 0 1 0 1 1	value is incremented in multiples of 1 Gbps
0 0 0 0 1 1 0 0	value is incremented in multiples of 4 Gbps
0 0 0 0 1 1 0 1	value is incremented in multiples of 16 Gbps
0 0 0 0 1 1 1 0	value is incremented in multiples of 64 Gbps
0 0 0 0 1 1 1 1	value is incremented in multiples of 256 Gbps
0 0 0 1 0 0 0 0	value is incremented in multiples of 1 Tbps
0 0 0 1 0 0 0 1	value is incremented in multiples of 4 Tbps
0 0 0 1 0 0 1 0	value is incremented in multiples of 16 Tbps
0 0 0 1 0 0 1 1	value is incremented in multiples of 64 Tbps
0 0 0 1 0 1 0 0	value is incremented in multiples of 256 Tbps
0 0 0 1 0 1 0 1	value is incremented in multiples of 1 Pbps
0 0 0 1 0 1 1 0	value is incremented in multiples of 4 Pbps
0 0 0 1 0 1 1 1	value is incremented in multiples of 16 Pbps
0 0 0 1 1 0 0 0	value is incremented in multiples of 64 Pbps
0 0 0 1 1 0 0 1	value is incremented in multiples of 256 Pbps

Other values shall be interpreted as multiples of 256 Pbps in this version of the protocol.

Value of the per-link aggregate maximum bit rate is binary coded value of the per-link aggregate maximum bit rate in units defined by the unit of the per-link aggregate maximum bit rate.

Range (o99 to o99+1):

The range field indicates a binary encoded value of the range in meters.

Priority level (octet o100 bit 1 to 3):

The priority level field contains a ProSe per-packet priority value.

Bits

3 2 1

0 0 0	PPPP value 1
0 0 1	PPPP value 2
0 1 0	PPPP value 3
0 1 1	PPPP value 4
1 0 0	PPPP value 5
1 0 1	PPPP value 6
1 1 0	PPPP value 7
1 1 1	PPPP value 8

Averaging window (o101 to o101+1):

The averaging window field indicates a binary representation of the averaging window for both sending and receiving in milliseconds.

Maximum data burst volume (o102 to o78):

The maximum data burst volume field indicates a binary representation of the maximum data burst volume for both sending and receiving in octets.

If the length of PC5 QoS profile contents field is bigger than indicated in figure 5.4.2.33, receiving entity shall ignore any superfluous octets located at the end of the PC5 QoS profile contents.

8 7 6 5 4 3 2 1		
Length of NR-PC5 unicast security policies contents		octet o93
		octet o93+1
NR-PC5 unicast security policy 1		octet (o93+2)*
		octet o86*
NR-PC5 unicast security policy 2		octet (o86+1)*
		octet o87*
...		octet (o87+1)*
		octet o88*
NR-PC5 unicast security policy n		octet (o88+1)*
		octet o84*

Figure 5.4.2.34: NR-PC5 unicast security policies

Table 5.4.2.34: NR-PC5 unicast security policies

NR-PC5 unicast security policy:
The NR-PC5 unicast security policy field is coded according to figure 5.4.2.35 and table 5.4.2.35.

8 7 6 5 4 3 2 1		
Length of NR-PC5 unicast security policy contents		octet o86+1
		octet o86+2
ProSe identifiers		octet o86+3
		octet o89
Security policy		octet o89+1
		octet o89+2
		octet o89+3
Geographical areas		octet o87

Figure 5.4.2.35: NR-PC5 unicast security policy

Table 5.4.2.35: NR-PC5 unicast security policy

ProSe identifiers (o86+3 to o89):
 The ProSe identifiers field is coded according to figure 5.4.2.14 and table 5.4.2.14. In case of the default NR-PC5 unicast security policy, the ProSe identifier is coded as the default ProSe identifier (see table 5.4.2.14).

Security policy (o89+1 to o89+2):
 The security policy field is coded according to figure 5.4.2.36 and table 5.4.2.36.

Geographical areas (o89+3 to o87):
 The geographical areas field is coded according to figure 5.4.2.15 and table 5.4.2.15.

If the length of NR-PC5 unicast security policy contents field is bigger than indicated in figure 5.4.2.35, the receiving entity shall ignore any superfluous octets located at the end of the NR-PC5 unicast security policy contents.

	8	7	6	5	4	3	2	1	
	0 spare	Signalling ciphering policy			0 spare	Signalling integrity protection policy			octet o89+1
	0 spare	User plane ciphering policy			0 spare	User plane integrity protection policy			octet o89+2

Figure 5.4.2.36: Security policy

Table 5.4.2.36: Security policy

Signalling integrity protection policy (octet o89+1 bit 1 to 3):			
Bits			
3	2	1	
0	0	0	Signalling integrity protection not needed
0	0	1	Signalling integrity protection preferred
0	1	0	Signalling integrity protection required
0	1	1	to Spare
1	1	0	
1	1	1	Reserved
If the UE receives a signalling integrity protection policy value that the UE does not understand, the UE shall interpret the value as 010 "Signalling integrity protection required".			
Signalling ciphering policy (octet o89+1 bit 5 to 7):			
Bits			
7	6	5	
0	0	0	Signalling ciphering not needed
0	0	1	Signalling ciphering preferred
0	1	0	Signalling ciphering required
0	1	1	to Spare
1	1	0	
1	1	1	Reserved
If the UE receives a signalling ciphering policy value that the UE does not understand, the UE shall interpret the value as 010 "Signalling ciphering required".			
Bit 4 and 8 of octet o89+1 are spare and shall be coded as zero.			
User plane integrity protection policy (octet o89+2 bit 1 to 3):			
Bits			
3	2	1	
0	0	0	User plane integrity protection not needed
0	0	1	User plane integrity protection preferred
0	1	0	User plane integrity protection required
0	1	1	to Spare
1	1	0	
1	1	1	Reserved
If the UE receives a user plane integrity protection policy value that the UE does not understand, the UE shall interpret the value as 010 "User plane integrity protection required".			
User plane ciphering policy (octet o89+2 bit 5 to 7):			
Bits			
7	6	5	
0	0	0	User plane ciphering not needed
0	0	1	User plane ciphering preferred
0	1	0	User plane ciphering required
0	1	1	to Spare
1	1	0	
1	1	1	Reserved
If the UE receives a user plane ciphering policy value that the UE does not understand, the UE shall interpret the value as 010 "User plane ciphering required".			
Bit 4 and 8 of octet o89+2 are spare and shall be coded as zero.			

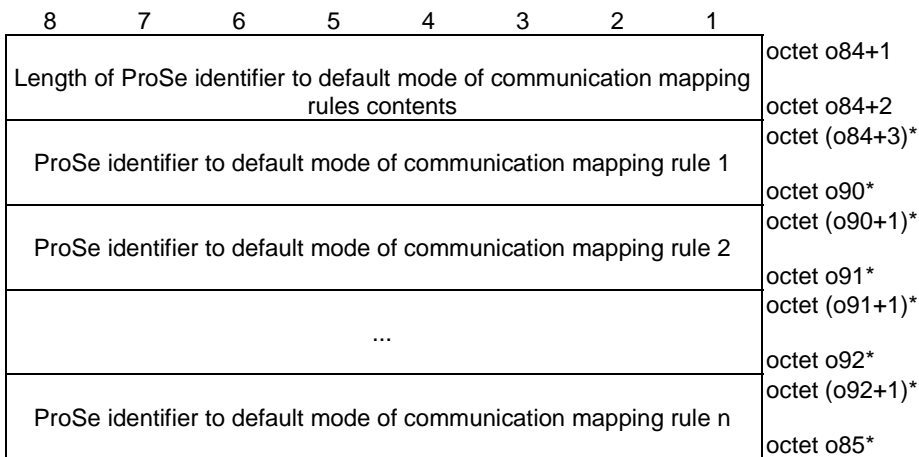

Figure 5.4.2.37: ProSe identifier to default mode of communication mapping rules

Table 5.4.2.37: ProSe identifier to default mode of communication mapping rules

ProSe identifier to default mode of communication mapping rule: The ProSe identifier to default mode of communication mapping rule field is coded according to figure 5.4.2.38 and table 5.4.2.38.

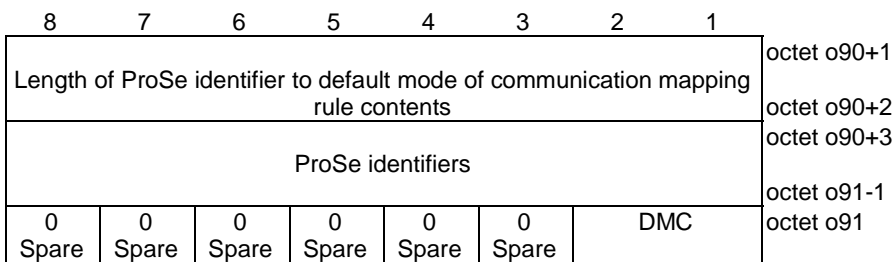

Figure 5.4.2.38: ProSe identifier to default mode of communication mapping rule

Table 5.4.2.38: ProSe identifier to default mode of communication mapping rule

<p>ProSe identifiers (o90+3 to o91-1): The ProSe identifiers field is coded according to figure 5.4.2.14 and table 5.4.2.14. In case of the default ProSe identifier to default mode of communication mapping rule, the ProSe identifier is coded as the default ProSe identifier (see table 5.4.2.14).</p> <p>Default mode of communication (DMC) (octet o91 bit 1 to 2): The DMC field indicates the default mode of communication.</p> <p>Bits 2 1 0 0 unicast 0 1 groupcast 1 0 broadcast 1 1 spare</p> <p>If the DMC field is set to a spare value, the receiving entity shall ignore the ProSe application identifier to default mode of communication mapping rule.</p> <p>If the length of ProSe identifier to default mode of communication mapping rule contents field is bigger than indicated in figure 5.4.2.37, receiving entity shall ignore any superfluous octets located at the end of the ProSe identifier to default mode of communication mapping rule contents.</p>

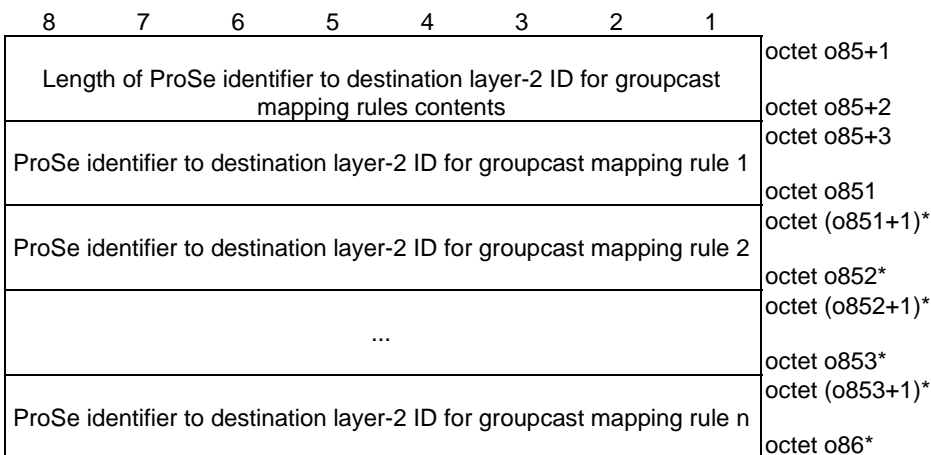

Figure 5.4.2.39: ProSe identifier to destination layer-2 ID for groupcast mapping rules

Table 5.4.2.39: ProSe identifier to destination layer-2 ID for groupcast mapping rules

<p>ProSe identifier to destination layer-2 ID for groupcast mapping rule (NOTE): The ProSe identifier to destination layer-2 ID for broadcast mapping rule field is coded according to figure 5.4.2.40 and table 5.4.2.40. The ProSe identifier to destination layer-2 ID for groupcast mapping rules field shall contain a default ProSe identifier to destination layer-2 ID for groupcast mapping rule for the ProSe services that do not have explicit mapping rules.</p> <p>NOTE: The default ProSe identifier to destination layer-2 ID for groupcast mapping rule should be the last one and with the lowest priority of the ProSe identifier to destination layer-2 ID for groupcast mapping rule field.</p>

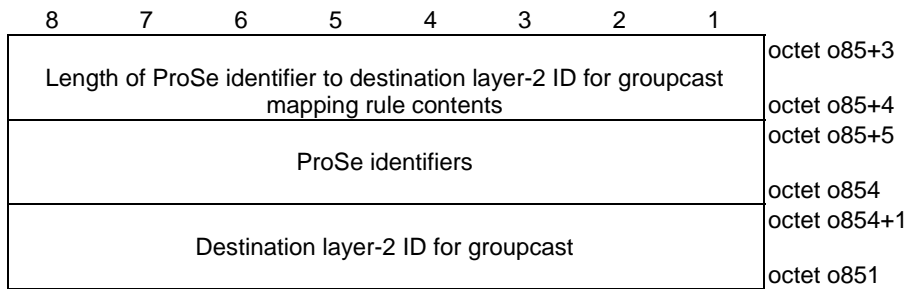

Figure 5.4.2.40: ProSe identifier to destination layer-2 ID for groupcast mapping rule

Table 5.4.2.40: ProSe identifier to destination layer-2 ID for groupcast mapping rule

<p>ProSe identifiers (octet o85+5 to o854): The ProSe identifiers field is coded according to figure 5.4.2.14 and table 5.4.2.14. In case of the default ProSe application requiring privacy, the ProSe identifier is coded as the default ProSe identifier (see table 5.4.2.14).</p> <p>Destination layer-2 ID for groupcast (octet o854+1 to o851): The destination layer-2 ID for groupcast field is a binary coded layer-2 identifier. If the length of ProSe identifier to destination layer-2 ID for groupcast mapping rule contents field is bigger than indicated in figure 5.4.2.40, receiving entity shall ignore any superfluous octets located at the end of the ProSe identifier to destination layer-2 ID for groupcast mapping rule contents.</p>

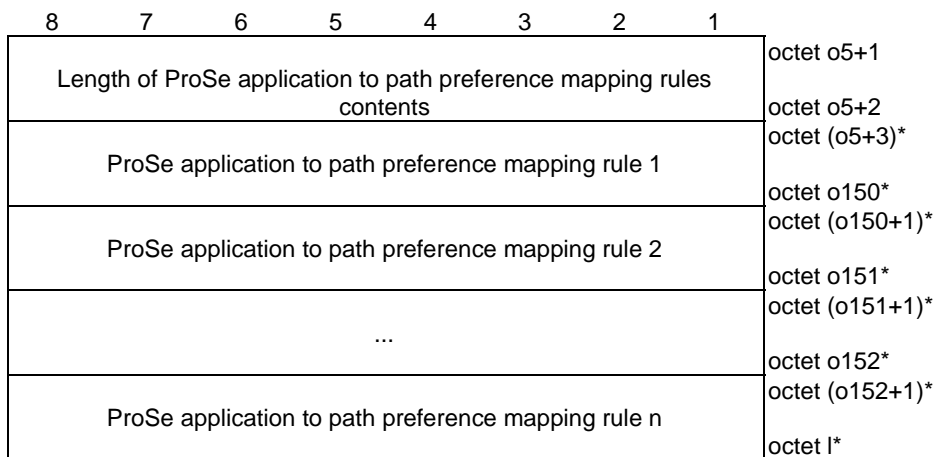

Figure 5.4.2.41: ProSe application to path preference mapping rules

Table 5.4.2.41: ProSe application to path preference mapping rules

<p>ProSe application to path preference mapping rule (NOTE): The ProSe application to path preference mapping rule field is coded according to figure 5.4.2.42 and table 5.4.2.42.</p> <p>NOTE: The ProSe application to path preference mapping rule field is prioritized in decreasing order according to the local configuration of the network. The ProSe application to path preference mapping rule field with the service indication field set to value 1 "For all ProSe services", if present, is recommended to be the last one of the ProSe application to path preference mapping rules.</p>

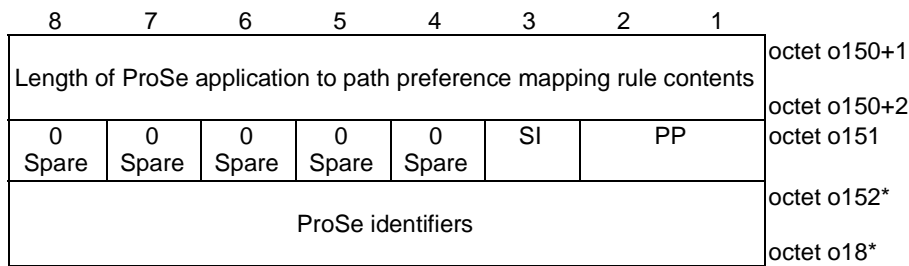

Figure 5.4.2.42: ProSe application to path preference mapping rule

Table 5.4.2.42: ProSe application to path preference mapping rule

<p>ProSe identifiers (o152 to o18):</p> <p>If the service indication field is set to value 1 "For all ProSe services", the ProSe identifiers field shall not be included in ProSe application to path preference mapping rule field.</p> <p>If the service indication field is set to value 0 "Not for all ProSe services", the ProSe identifiers field is coded according to figure 5.4.2.14 and table 5.4.2.14.</p> <p>Path preference (PP) (octet o151 bit 1 to 2):</p> <p>The PP field indicates the path preference.</p> <p>Bits</p> <p>2 1</p> <p>0 0 No preference</p> <p>0 1 PC5 preferred</p> <p>1 0 Uu preferred</p> <p>1 1 spare</p> <p>If the PP field is set to a spare value, the receiving entity shall interpret as "00".</p> <p>Service indication (SI) (octet o151 bit 3):</p> <p>The SI field indicates whether the path preference is for all ProSe services or not.</p> <p>Bits</p> <p>3</p> <p>1 For all ProSe services</p> <p>0 Not for all ProSe services</p> <p>If the length of ProSe application to path preference mapping rule contents field is bigger than indicated in figure 5.4.2.42, receiving entity shall ignore any superfluous octets located at the end of the ProSe application to path preference mapping rule contents.</p>

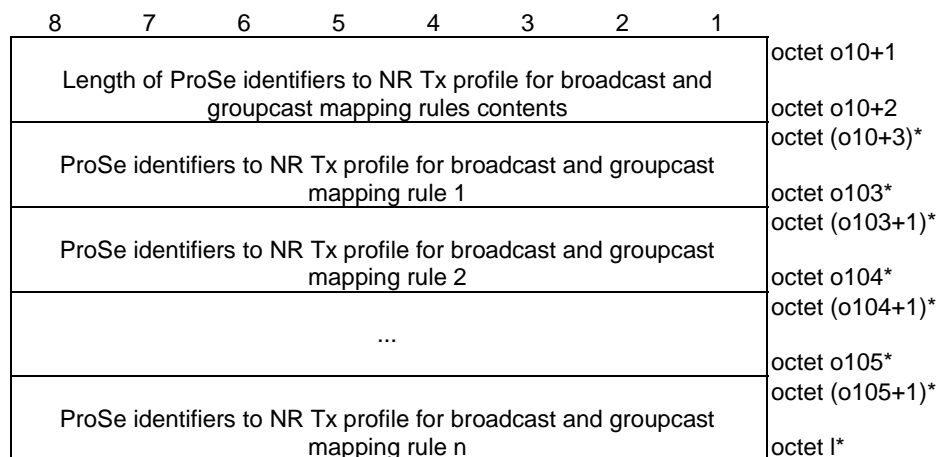

Figure 5.4.2.43: ProSe identifiers to NR Tx profile for broadcast and groupcast mapping rules

Table 5.4.2.43: ProSe identifiers to NR Tx profile for broadcast and groupcast mapping rules

ProSe identifiers to NR Tx profile for broadcast and groupcast mapping rule:
 The ProSe identifiers to NR Tx profile for broadcast and groupcast mapping rule field is coded according to figure 5.4.2.44 and table 5.4.2.44.

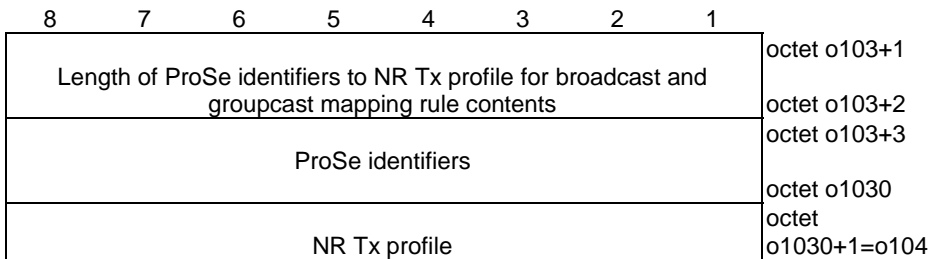

Figure 5.4.2.44: ProSe identifiers to NR Tx profile for broadcast and groupcast mapping rule

Table 5.4.2.44: ProSe identifiers to NR Tx profile for broadcast and groupcast mapping rule

ProSe identifiers:
 The ProSe identifiers field is coded according to figure 5.4.2.14 and table 5.4.2.14. In case of the default ProSe identifiers to NR Tx profile for broadcast and groupcast mapping rule, the ProSe identifier is coded as the default ProSe identifier (see table 5.4.2.14).

NR Tx profile:
 The NR Tx profile field is coded as *SL-TxProfile-r17* in clause 9.3 of 3GPP TS 38.331 [7].

5.5 Encoding of UE policies for 5G ProSe UE-to-network relay UE

5.5.1 General

The UE policies for 5G ProSe UE-to-network relay UE are coded as shown in figures 5.5.2.1 and table 5.5.2.1.

5.5.2 Information elements coding

8	7	6	5	4	3	2	1	
0	0	0	PAI	ProSeP info type = {UE policies for 5G ProSe UE-to-network relay UE}				octet k
Spare								
Length of ProSeP info contents								octet k+1
Validity timer								octet k+2 octet k+3
Served by NG-RAN								octet k+7 octet k+8
Not served by NG-RAN								octet o1 octet o1+1
Default destination layer-2 IDs for sending the discovery signalling for announcement and additional information and for receiving the discovery signalling for solicitation								octet o2 octet o2+1
User info ID for discovery								octet o3
RSC info list								octet o3+1 octet o3+6 octet o3+7
5QI to PC5 QoS parameters mapping rules								octet o4 octet o4+1
ProSe identifier to ProSe application server address mapping rules								octet o5 octet o5+1
5G PKMF address information								octet o6 octet (o6+1)*
Privacy timer								octet (l-2)* octet l-1
Warning message broadcast								octet l octet a* octet b*

Figure 5.5.2.1: ProSeP Info = {UE policies for 5G ProSe UE-to-network relay UE}

Table 5.5.2.1: ProSeP Info = {UE policies for 5G ProSe UE-to-network relay UE}

ProSeP info type (bit 1 to 4 of octet k) shall be set to "0011" (UE policies for 5G ProSe UE-to-network relay UE)

PKMF address indication (PAI) (bit 5 of octet k)

The PAI indicates whether the 5G PKMF address information is included in the IE or not

Bit

5

0 5G PKMF address information is not included

1 5G PKMF address information is included

Length of ProSeP info contents (octets k+1 to k+2) indicates the length of ProSeP info contents.

Validity timer (octet k+3 to k+7):

The validity timer field provides the expiration time of validity of the UE policies for 5G ProSe UE-to-network relay UE. The validity timer field is a binary coded representation of a UTC time, in seconds since midnight UTC of January 1, 1970 (not counting leap seconds).

Served by NG-RAN (octet k+8 to o1):

The served by NG-RAN field is coded according to figure 5.5.2.2 and table 5.5.2.2, and contains configuration parameters for 5G ProSe UE-to-network relay UE when the UE is served by NG-RAN.

Not served by NG-RAN (octet o1+1 to o2):

The not served by NG-RAN field is coded according to figure 5.5.2.5 and table 5.5.2.5, and contains configuration parameters for 5G ProSe UE-to-network relay discovery and communication when the UE is not served by NG-RAN.

Default destination layer-2 IDs for sending the discovery signalling for announcement and additional information and for receiving the discovery signalling for solicitation (octet o2+1 to o3):

The default destination layer-2 IDs for sending the discovery signalling for announcement and additional information and for receiving the discovery signalling for solicitation is coded according to figure 5.5.2.11b and table 5.5.2.11b and contains a list of the default destination layer-2 IDs for the initial UE-to-network relay discovery signalling.

User info ID for discovery (octet o3+1 to o3+6):

The value of the User info ID parameter is a 48-bit long bit string. The format of the User info ID parameter is out of scope of this specification.

RSC info list (octet o3+7 to o4):

The RSC info list field is coded according to figure 5.5.2.12 and table 5.5.2.12 and contains the RSCs related parameters.

5QI to PC5 QoS parameters mapping rules (octet o4+1 to o5):

The 5QI to PC5 QoS parameters mapping rules field is coded according to figure 5.5.2.17 and table 5.5.2.17 and contains the 5QI to PC5 QoS parameters mapping rules.

ProSe identifier to ProSe application server address mapping rules (octet o5+1 to o6):

The ProSe identifier to ProSe application server address mapping rules field is coded according to figure 5.5.2.19 and table 5.5.2.19 and contains the ProSe identifier to ProSe application server address mapping rules.

Privacy timer (octet l-1 to l):

The privacy timer field contains binary encoded duration, in units of seconds, after which the UE shall change the source layer-2 ID self-assigned by the UE while performing transmission of 5G ProSe direct communication.

If the length of ProSeP info contents field is bigger than indicated in figure 5.5.2.1, receiving entity shall ignore any superfluous octets located at the end of the ProSeP info contents.

5G PKMF address information (octet o6+1 to l-2):
 The 5G PKMF address information contains the IPv4 address(es), IPv6 address(es) and/or FQDN of the 5G PKMF and is coded according to figure 5.5.2.21, figure 5.5.2.22, figure 5.5.2.23 and table 5.5.2.21. At least one of the address parameters (FQDN, IPv4 address list or IPv6 address list) shall be included.

Warning message broadcast (octet a to b):
 The warning message broadcast field is coded according to figure 5.5.2.24 and table 5.5.2.24 and contains the parameters for broadcasting the warning messages.

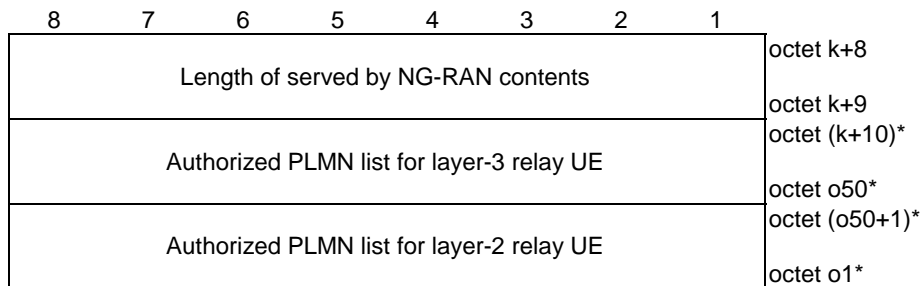

Figure 5.5.2.2: Served by NG-RAN

Table 5.5.2.2: Served by NG-RAN

Authorized PLMN list for layer-3 relay UE:
 The authorized PLMN list for layer-3 relay UE field is coded according to figure 5.5.2.3 and table 5.5.2.3.

Authorized PLMN list for layer-2 relay UE:
 The authorized PLMN list for layer-2 relay UE field is coded according to figure 5.5.2.3 and table 5.5.2.3.

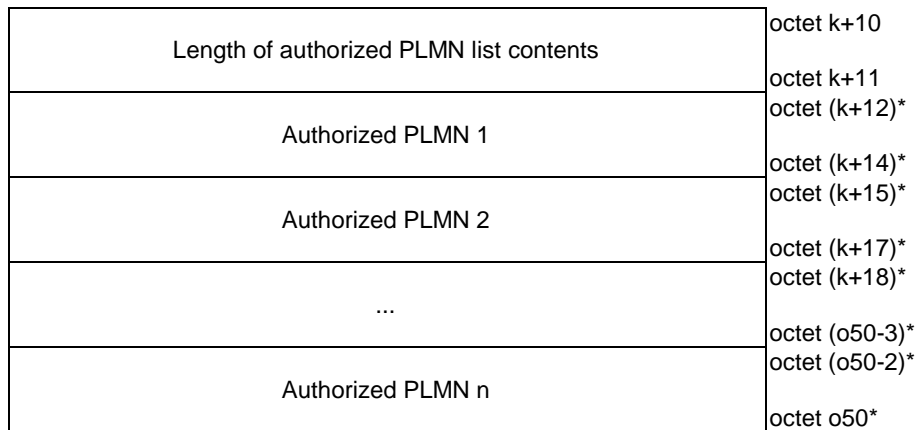

Figure 5.5.2.3: Authorized PLMN list

Table 5.5.2.3: Authorized PLMN list

Authorized PLMN:
 The authorized PLMN field is coded according to figure 5.5.2.4 and table 5.5.2.4.

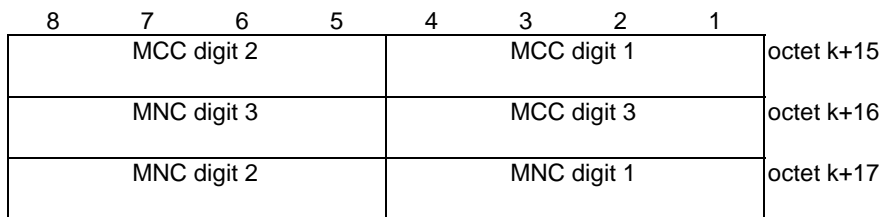

Figure 5.5.2.4: PLMN ID

Table 5.5.2.4: PLMN ID

Mobile country code (MCC) (octet k+15, octet k+16 bit 1 to 4):
 The MCC field is coded as in ITU-T Recommendation E.212 [5], annex A.

Mobile network code (MNC) (octet k+16 bit 5 to 8, octet k+17):
 The coding of MNC field is the responsibility of each administration but BCD coding shall be used. The MNC shall consist of 2 or 3 digits. If a network operator decides to use only two digits in the MNC, MNC digit 3 shall be coded as "1111".

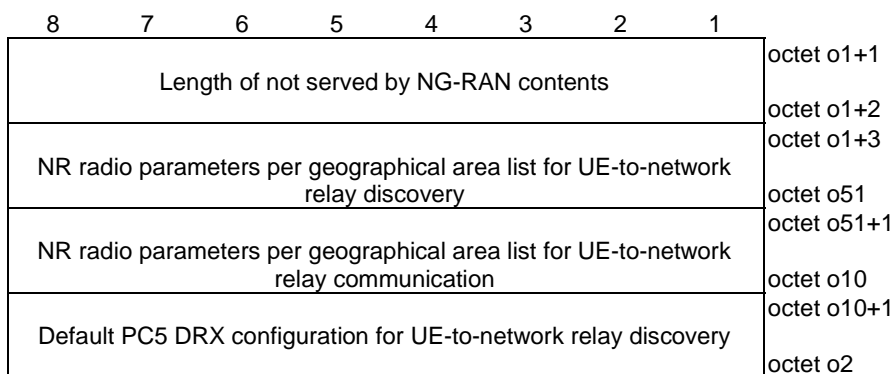

Figure 5.5.2.5: Not served by NG-RAN

Table 5.5.2.5: Not served by NG-RAN

NR radio parameters per geographical area list for UE-to-network relay discovery (octet o1+3 to o51):
 The NR radio parameters per geographical area list for UE-to-network relay discovery field is coded according to figure 5.5.2.6 and table 5.5.2.6.

NR radio parameters per geographical area list for UE-to-network relay communication (octet o51+1 to o2):
 The NR radio parameters per geographical area list for UE-to-network relay communication field is coded according to figure 5.5.2.7 and table 5.5.2.7.

Default PC5 DRX configuration for UE-to-network relay discovery (octet o10+1 to o2):
 The default PC5 DRX configuration for UE-to-network relay discovery field is coded according to figure 5.5.2.11a and table 5.5.2.11a.

If the length of not served by NG-RAN contents field is bigger than indicated in figure 5.5.2.5, receiving entity shall ignore any superfluous octets located at the end of the not served by NG-RAN contents.

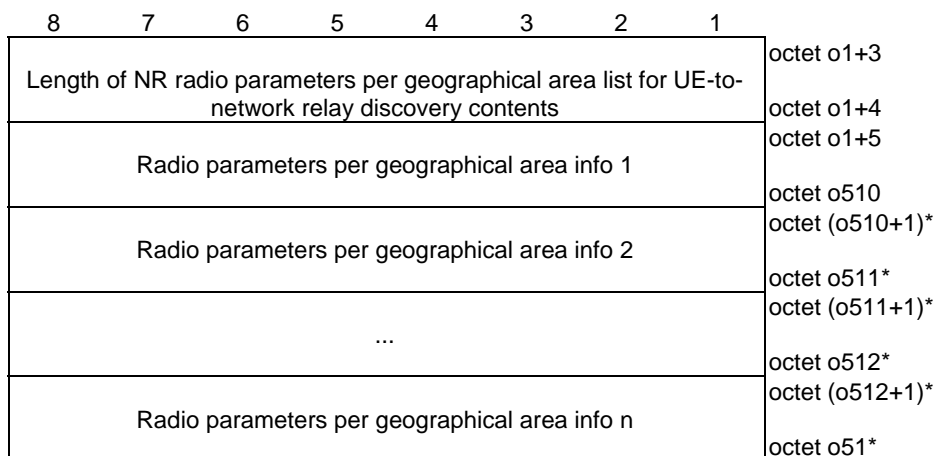

Figure 5.5.2.6: NR radio parameters per geographical area list for UE-to-network relay discovery

Table 5.5.2.6: NR radio parameters per geographical area list for UE-to-network relay discovery

Radio parameters per geographical area info: The radio parameters per geographical area info field is coded according to figure 5.5.2.8 and table 5.5.2.8.

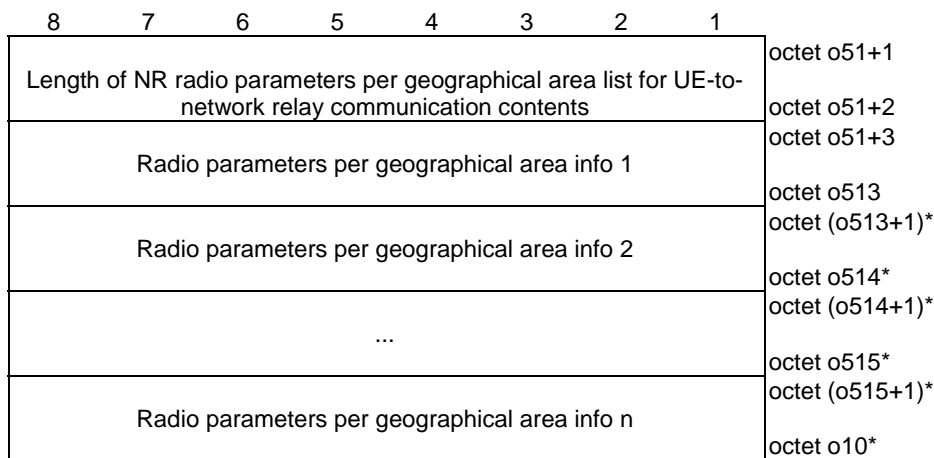

Figure 5.5.2.7: NR radio parameters per geographical area list for UE-to-network relay communication

Table 5.5.2.7: NR radio parameters per geographical area list for UE-to-network relay communication

Radio parameters per geographical area info: The radio parameters per geographical area info field is coded according to figure 5.5.2.8 and table 5.5.2.8.

8 7 6 5 4 3 2 1								
Length of radio parameters per geographical area contents								octet o510+1
Geographical area								octet o510+2 octet o510+3
Radio parameters								octet o5100 octet o5100+1
MI	0	0	0	0	0	0	0	octet o511-1 octet o511
	Spare	Spare	Spare	Spare	Spare	Spare	Spare	

Figure 5.5.2.8: Radio parameters per geographical area info

Table 5.5.2.8: Radio parameters per geographical area info

<p>Geographical area (octet o510+3 to o5100): The geographical area field is coded according to figure 5.5.2.9 and table 5.5.2.9.</p> <p>Radio parameters (octet o5100+1 to o511-1): The radio parameters field is coded according to figure 5.3.2.11 and table 5.3.2.11, applicable in the geographical area indicated by the geographical area field when not served by NG-RAN.</p> <p>Managed indicator (MI) (octet o511 bit 8): The managed indicator indicates how the radio parameters indicated in the radio parameters field in the geographical area indicated by the geographical area field are managed.</p> <p>Bit 8 0 Non-operator managed 1 Operator managed</p> <p>If the length of radio parameters per geographical area contents field is bigger than indicated in figure 5.5.2.8, receiving entity shall ignore any superfluous octets located at the end of the radio parameters per geographical area contents.</p>

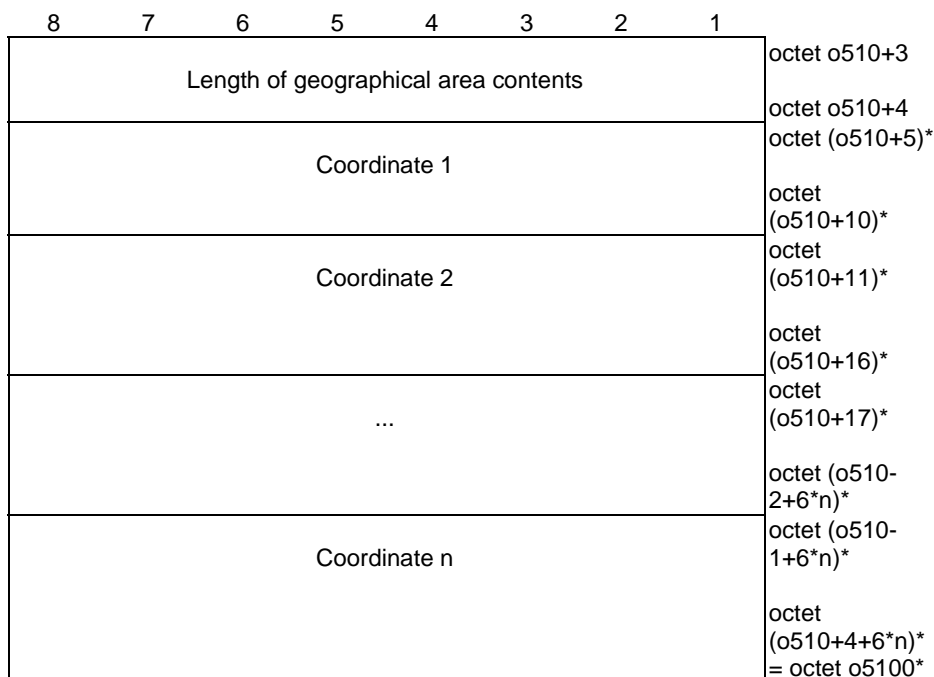

Figure 5.5.2.9: Geographical area

Table 5.5.2.9: Geographical area

Coordinate:
The coordinate field is coded according to figure 5.5.2.10 and table 5.5.2.10.

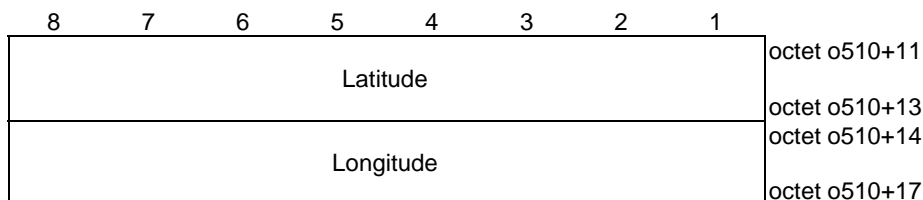

Figure 5.5.2.10: Coordinate area

Table 5.5.2.10: Coordinate area

Latitude (octet o510+11 to o510+13):
The latitude field is coded according to clause 6.1 of 3GPP TS 23.032 [6].

Longitude (octet o510+14 to o510+17):
The longitude field is coded according to clause 6.1 of 3GPP TS 23.032 [6].

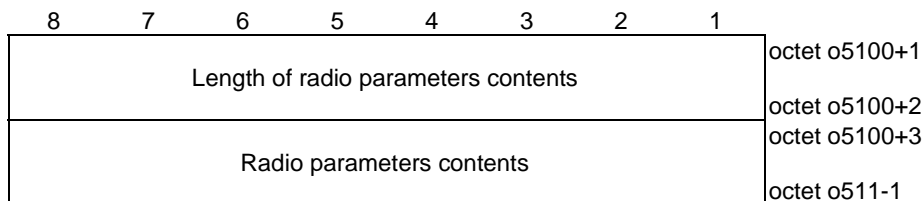

Figure 5.5.2.11: Radio parameters

Table 5.5.2.11: Radio parameters

Radio parameters contents:
Radio parameters are defined as *SL-PreconfigurationNR* in clause 9.3 of 3GPP TS 38.331 [7].

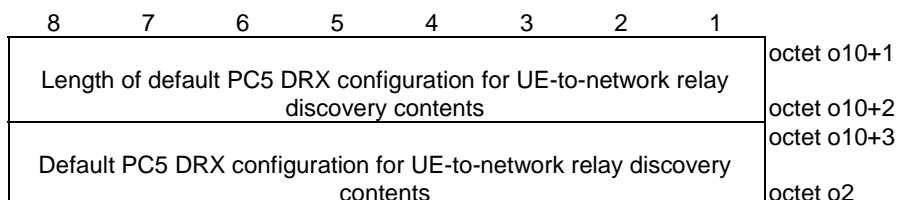

Figure 5.5.2.11a: Default PC5 DRX configuration for UE-to-network relay discovery

Table 5.5.2.11a: Default PC5 DRX configuration for UE-to-network relay discovery

Default PC5 DRX configuration contents for UE-to-network relay discovery:
Default PC5 DRX configuration for UE-to-network relay discovery field is coded as *s/-DefaultDRX-GC-BC-r17* in clause 6.3.5 of 3GPP TS 38.331 [7].

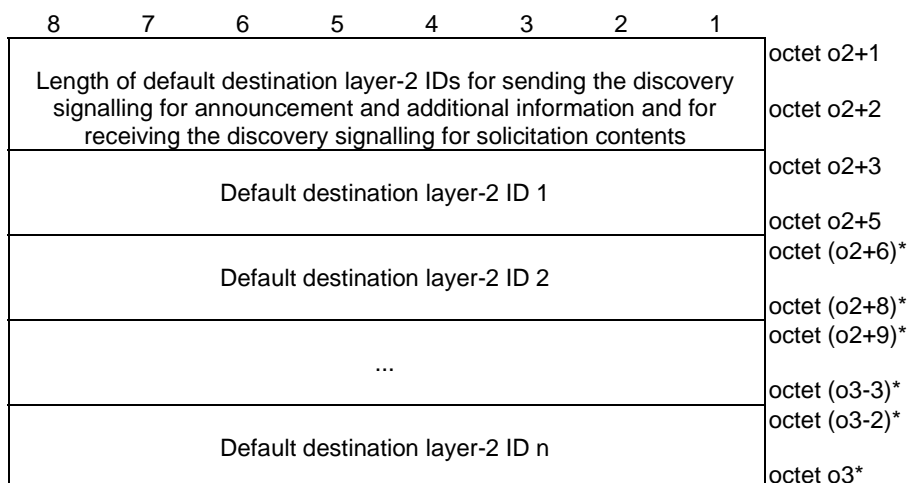

Figure 5.5.2.11b: Default destination layer-2 IDs for sending the discovery signalling for announcement and additional information and for receiving the discovery signalling for solicitation

Table 5.5.2.11b: Default destination layer-2 IDs for sending the discovery signalling for announcement and additional information and for receiving the discovery signalling for solicitation

Default destination layer-2 ID (octet o2+3 to o2+5):
 The default destination layer-2 ID is a 24-bit long bit string.

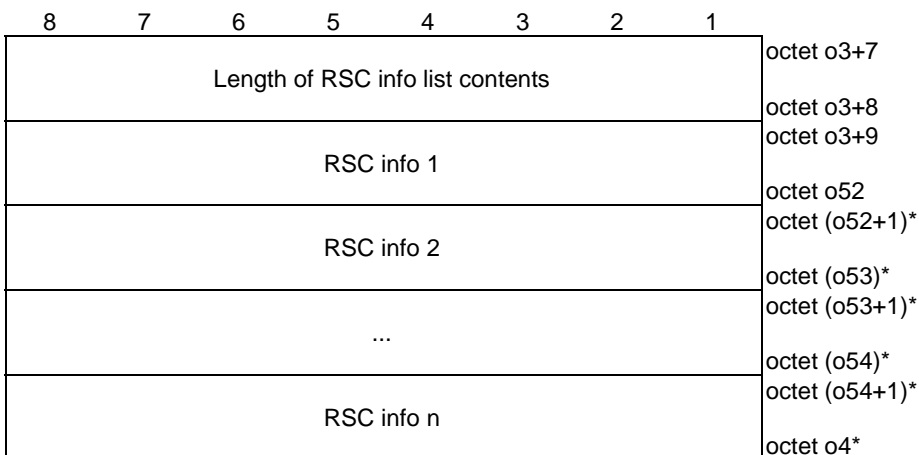

Figure 5.5.2.12: RSC info list

Table 5.5.2.12: RSC info list

RSC info:
 The RSC info field is coded according to figure 5.5.2.13 and table 5.5.2.13.

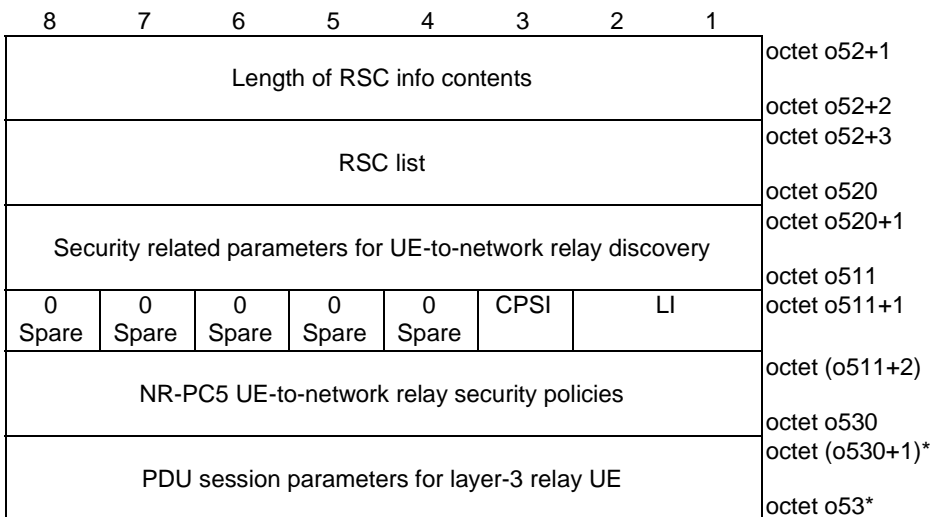

Figure 5.5.2.13: RSC info

Table 5.5.2.13: RSC info

<p>RSC list (octet o52+3 to o520): The RSC list field is coded according to figure 5.5.2.14 and table 5.5.2.14.</p> <p>Security related parameters for UE-to-network relay discovery (octet o520+1 to o511): The security related parameters for UE-to-network relay discovery field contains the security related parameters for UE-to-network relay discovery used when the security procedure over control plane as specified in 3GPP TS 33.503 [13] is used and is coded according to figure 5.5.2.15 and table 5.5.2.15.</p> <p>Layer indication (LI) (octet o511+1 bit 1 to 2): Bits 2 1 0 1 Layer 3 1 0 Layer 2 The other values are reserved.</p> <p>If LI is set to "Layer 3", the PDU session parameters for layer-3 relay UE is included in the RSC info, otherwise the PDU session parameters for layer-3 relay UE is not included.</p> <p>Control plane security indication (CPSI) (octet o511+1 bit 3): The control plane security indication field indicates whether to use the security procedure over control plane as specified in 3GPP TS 33.503 [13] or not. Bit 3 0 security procedure over control plane is not used 1 security procedure over control plane is used</p> <p>NR-PC5 UE-to-network relay security policies (octet o511+2 to o530): The NR-PC5 UE-to-network relay security policies is coded as the NR-PC5 unicast security policies defined in figure 5.4.2.34 and table 5.4.2.34.</p> <p>PDU session parameters for layer-3 relay UE (octet o530+1 to octet o53) The PDU session parameters for layer-3 relay UE field is coded according to figure 5.5.2.16 and table 5.5.2.16.</p>

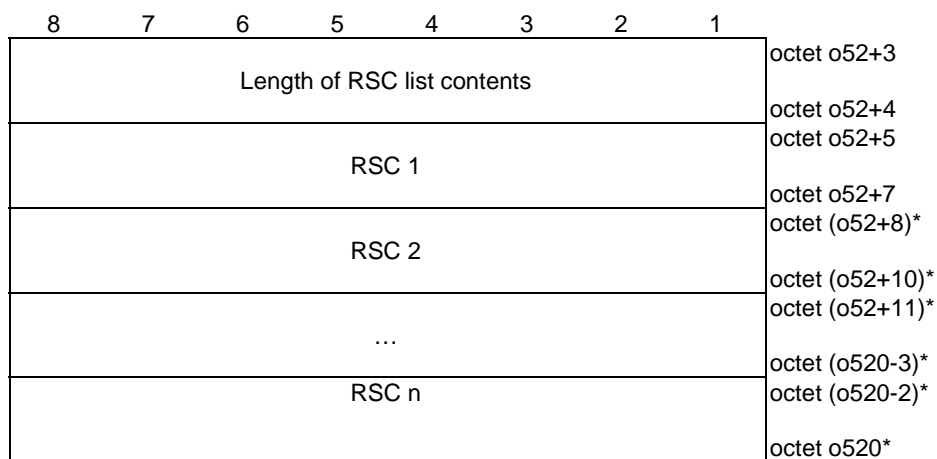

Figure 5.5.2.14: RSC list

Table 5.5.2.14: RSC list

RSC (octet o52+5 to o52+7):
 The RSC identifies a connectivity service the UE-to-Network relay provides. The value of the RSC is a 24-bit long bit string. The values of the RSCs from "000001" to "00000A" in hexadecimal representation indicate the RSCs for emergency services if the LI is set to "Layer-3" and the values of the RSCs from "00000B" to "00000D" in hexadecimal representation indicate the RSCs for emergency services if the LI is set to "Layer-2". The values of the RSCs from "00000E" to "00000F" in hexadecimal representation are spare and shall not be used in this release of specification. The UE shall ignore the spare value of the RSC in this release of specification. For all other values, the format of the RSC is out of scope of this specification.

8	7	6	5	4	3	2	1	
Security related parameters validity timer								octet o520+1
Code-sending security parameters								octet o520+5 octet (o520+6)*
Code-receiving security parameters								octet o524* octet (o524+1)* octet o511*

Figure 5.5.2.15: Security related parameters for UE-to-network relay discovery

8	7	6	5	4	3	2	1	
Spare					PDUC K	PDUIK	PDUS K	octet o520+6
DUSK								octet (o520+7)*
DUIK								octet o521* octet (o521+1)*
DUCK								octet o522* octet (o522+1)*
Encrypted bitmask								octet o523* octet (o523+1)* octet o524*

Figure 5.5.2.15a: Code-sending security parameters

8	7	6	5	4	3	2	1	
Spare				PDUC K	PDUIK	PDUS K		octet o524+1
DUSK								octet (o524+2)*
DUIK								octet o525* octet (o525+1)*
DUCK								octet o526* octet (o526+1)*
Encrypted bitmask								octet o527* octet (o527+1)* octet o511*

Figure 5.5.2.15b: Code-receiving security parameters

Table 5.5.2.15: Security related parameters for UE-to-network relay discovery

Security related parameters validity timer:

The security related parameters validity timer field provides the expiration time of validity of the security related parameters for UE-to-network relay discovery. The security related parameters validity timer field is a binary coded representation of a UTC time, in seconds since midnight UTC of January 1, 1970 (not counting leap seconds) (NOTE 1) (NOTE 2).

Code-sending security parameters:

The code-sending security parameters field contains the security parameters needed by a sending UE to protect a 5G ProSe direct discovery message over PC5 interface as specified in 3GPP TS 33.503 [13]. If the security related parameters validity timer field is set to zero, then the code-sending security parameters field is not present, otherwise the code-sending security parameters field is present.

Code-receiving security parameters

The code-receiving security parameters field contains the security parameters needed by a receiving UE to process a 5G ProSe direct discovery message over PC5 interface as specified in 3GPP TS 33.503 [13]. If the security related parameters validity timer field is set to zero, then the code-receiving security parameters field is not present, otherwise the code-receiving security parameters field is present.

Presence of DUSK (PDUSK):

PDUSK indicates whether the DUSK field is present or not.

Bit

1

0 DUSK field is not included

1 DUSK field is included

Presence of DUIK (PDUIK):

PDUIK indicates whether the DUIK field is present or not.

Bit

2

0 DUIK field is not included

1 DUIK field is included

Presence of DUCK (PDUCK):

PDUCK indicates whether the DUCK field and the encrypted bitmask field are present or not.

Bit

3

0 DUCK and encrypted bitmask fields are not included

1 DUCK and encrypted bitmask fields are included

DUSK:

The DUSK field contains the value of the DUSK. The use of the DUSK is defined in 3GPP TS 33.503 [13].

DUIK:

The DUIK field contains the value of the DUIK. The use of the DUIK is defined in 3GPP TS 33.503 [13].

DUCK:

The DUCK field contains the value of the DUCK. The use of the DUCK is defined in 3GPP TS 33.503 [13].

Encrypted bitmask:

The encrypted bitmask field contains the value of the encrypted bitmask, which is a 184-bit bitmask which uses bit "1" to mark the positions of the bits for which the DUCK encryption is applied.

NOTE 1: If the network does not have security related parameters for discovery in the UE policies or the security procedure over user plane as specified in 3GPP TS 33.503 [13] is used, the network shall set the security related parameters validity timer field (i.e. octet o520+1 to octet o520+5) to zero value. If the security related parameters validity timer field is set to zero value, the UE shall ignore the security related parameters validity timer.

NOTE 2: The network shall set the security related parameters validity timer field (i.e. octet o520+1 to octet o520+5) to zero value if the RSCs are for emergency services and there is no discovery security requirement based on regulation and the operator policy.

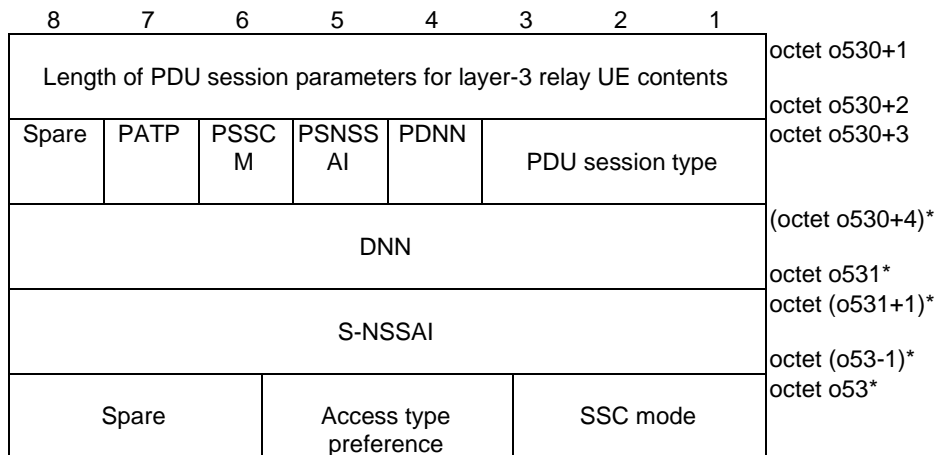

Figure 5.5.2.16: PDU session parameters for layer-3 relay UE

Table 5.5.2.16: PDU session parameters for layer-3 relay UE

<p>PDU session type (bits 3 to 1 of octet o530+3): The PDU session type field shall be encoded as the PDU session type value part of the PDU session type information element defined in clause 9.11.4.11 of 3GPP TS 24.501 [4].</p> <p>Presence of DNN (PDNN) (bit 4 of octet o530+3) PDNN indicates whether the DNN field is present or not (NOTE 1).</p> <p>Bit 4 0 DNN field is not included 1 DNN field is included</p> <p>Presence of S-NSSAI (PSNSSAI) (bit 5 of octet o53+3) PSNSSAI indicates whether the S-NSSAI field is present or not.</p> <p>Bit 5 0 S-NSSAI field is not included 1 S-NSSAI field is included</p> <p>Presence of SSC mode (PSSCM) (bit 6 of octet o530+3) PSSCM indicates whether the SSC mode field is present or not.</p> <p>Bit 6 0 SSC mode field is not included (NOTE 2) 1 SSC mode field is included</p> <p>Presence of access type preference (PATP) (bit 7 of octet o530+3) PATP indicates whether the access type preference mode field is present or not.</p> <p>Bit 7 0 Access type preference field is not included (NOTE 2) 1 Access type preference field is included</p> <p>DNN (octet o530+4 to o531): The DNN field shall be encoded as a sequence of a one octet DNN length field and a DNN value field of a variable size. The DNN value contains an APN as defined in 3GPP TS 23.003 [10].</p> <p>S-NSSAI (octet o531+1 to o53-1): The S-NSSAI field shall be encoded as a sequence of a one octet S-NSSAI length field and an S-NSSAI value field of a variable size. The S-NSSAI value shall be encoded as the value part of the S-NSSAI information element defined in clause 9.11.2.8 of 3GPP TS 24.501 [4].</p> <p>SSC mode (bits 3 to 1 of octet o53): The SSC mode field shall be encoded as the value part of the SSC mode information element defined in clause 9.11.4.16 of 3GPP TS 24.501 [4].</p> <p>Access type preference (bits 5 to 4 of octet o53): The access type preference field shall be encoded as the value part of the access type information element defined in clause 9.11.2.1A of 3GPP TS 24.501 [4].</p> <p>NOTE 1: PDNN shall be set to 1 if the 5G ProSe UE-to-network relay communication is not for emergency services. NOTE 2: Since SSC mode field and access type preference field are coded in the same octet, this octet is not included only when both PSSCM and PATP are set to 0.</p>

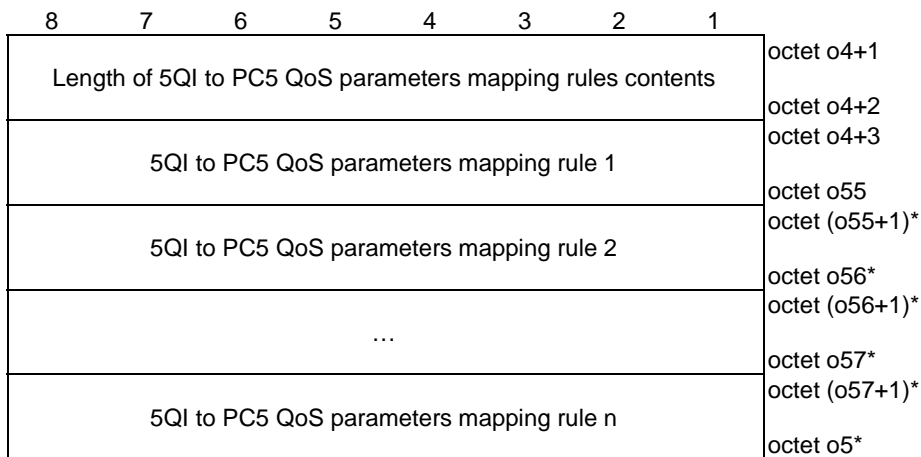

Figure 5.5.2.17: 5QI to PC5 QoS parameters mapping rules

Table 5.5.2.17: 5QI to PC5 QoS parameters mapping rules

5QI to PC5 QoS parameters mapping rule:
 The 5QI to PC5 QoS parameters mapping rule field is coded according to figure 5.5.2.18 and table 5.5.2.18 and contains the 5QI to PC5 QoS parameters mapping rule.

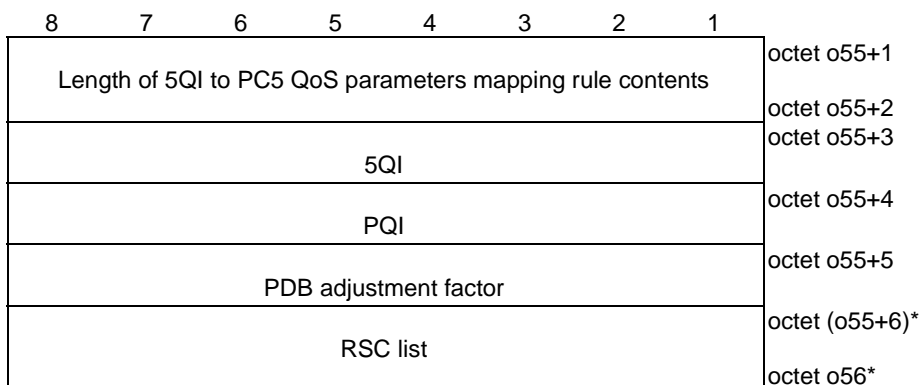

Figure 5.5.2.18: 5QI to PC5 QoS parameters mapping rule

Table 5.5.2.18: 5QI to PC5 QoS parameters mapping rule

5QI (octet o55+3):	
Bits	
8 7 6 5 4 3 2 1	
0 0 0 0 0 0 0 0	Reserved
0 0 0 0 0 0 0 1	5QI 1
0 0 0 0 0 0 1 0	5QI 2
0 0 0 0 0 0 1 1	5QI 3
0 0 0 0 0 1 0 0	5QI 4
0 0 0 0 0 1 0 1	5QI 5
0 0 0 0 0 1 1 0	5QI 6
0 0 0 0 0 1 1 1	5QI 7
0 0 0 0 1 0 0 0	5QI 8
0 0 0 0 1 0 0 1	5QI 9
0 0 0 0 1 0 1 0	5QI 10
0 0 0 0 1 0 1 1	
	to Spare
0 1 0 0 0 0 0 0	
0 1 0 0 0 0 0 1	5QI 65
0 1 0 0 0 0 1 0	5QI 66
0 1 0 0 0 0 1 1	5QI 67
0 1 0 0 0 1 0 0	Spare
0 1 0 0 0 1 0 1	5QI 69
0 1 0 0 0 1 1 0	5QI 70
0 1 0 0 0 1 1 1	5QI 71
0 1 0 0 1 0 0 0	5QI 72
0 1 0 0 1 0 0 1	5QI 73
0 1 0 0 1 0 1 0	5QI 74
0 1 0 0 1 0 1 1	5QI 75
0 1 0 0 1 1 0 0	5QI 76
0 1 0 0 1 1 0 1	
	to Spare
0 1 0 0 1 1 1 0	
0 1 0 0 1 1 1 1	5QI 79
0 1 0 1 0 0 0 0	5QI 80
0 1 0 1 0 0 0 1	Spare
0 1 0 1 0 0 1 0	5QI 82
0 1 0 1 0 0 1 1	5QI 83
0 1 0 1 0 1 0 0	5QI 84
0 1 0 1 0 1 0 1	5QI 85
0 1 0 1 0 1 1 0	5QI 86
0 1 0 1 0 1 1 1	5QI 87
0 1 0 1 1 0 0 0	5QI 88
0 1 0 1 1 0 0 1	5QI 89
0 1 0 1 1 0 1 0	5QI 90
0 1 0 1 1 0 1 1	
	to Spare
0 1 1 1 1 1 1 1	
1 0 0 0 0 0 0 0	
	to Operator-specific 5QIs
1 1 1 1 1 1 1 0	
1 1 1 1 1 1 1 1	Reserved

PQI (octet o55+4):

Bits

8 7 6 5 4 3 2 1

0 0 0 0 0 0 0 0 Reserved

0 0 0 0 0 0 0 1

to Spare

0 0 0 1 0 1 0 0

0 0 0 1 0 1 0 1 PQI 21

0 0 0 1 0 1 1 0 PQI 22

0 0 0 1 0 1 1 1 PQI 23

0 0 0 1 1 0 0 0 PQI 24

0 0 0 1 1 0 0 1 PQI 25

0 0 0 1 1 0 1 0 PQI 26

0 0 0 1 1 0 1 1

to Spare

0 0 0 1 1 1 1 1

0 0 1 0 0 0 0 0 PQI 32

0 0 1 0 0 0 0 1 PQI 33

0 0 1 0 0 0 1 0 PQI 34

0 0 1 0 0 0 1 1

to Spare

0 0 1 1 0 1 1 0

0 0 1 1 0 1 1 1 PQI 55

0 0 1 1 1 0 0 0 PQI 56

0 0 1 1 1 0 0 1 PQI 57

0 0 1 1 1 0 1 0 PQI 58

0 0 1 1 1 0 1 1 PQI 59

0 0 1 1 1 1 0 0 PQI 60

0 0 1 1 1 1 0 1 PQI 61

0 0 1 1 1 1 1 0

to Spare

0 1 0 1 0 0 0 1

0 1 0 1 0 0 1 0 PQI 70

0 1 0 1 0 0 1 1 PQI 71

0 1 0 1 0 1 0 0

to Spare

0 1 0 1 1 0 0 1

0 1 0 1 1 0 1 0 PQI 90

0 1 0 1 1 0 1 1 PQI 91

0 1 0 1 1 1 0 0 PQI 92

0 1 0 1 1 1 0 1 PQI 93

0 1 0 1 1 1 1 0

to Spare

0 1 1 1 1 1 1 1

1 0 0 0 0 0 0 0

to Operator-specific PQIs

1 1 1 1 1 1 1 0

1 1 1 1 1 1 1 1 Reserved

PDB adjustment factor (octet o55+5):

The PDB adjustment factor field is a binary coded representation of a percentage of the standardized PDB identified by the PQI.

RSC list (octet o55+6 to o56):

The RSC list field is coded according to figure 5.5.2.14 and table 5.5.2.14.

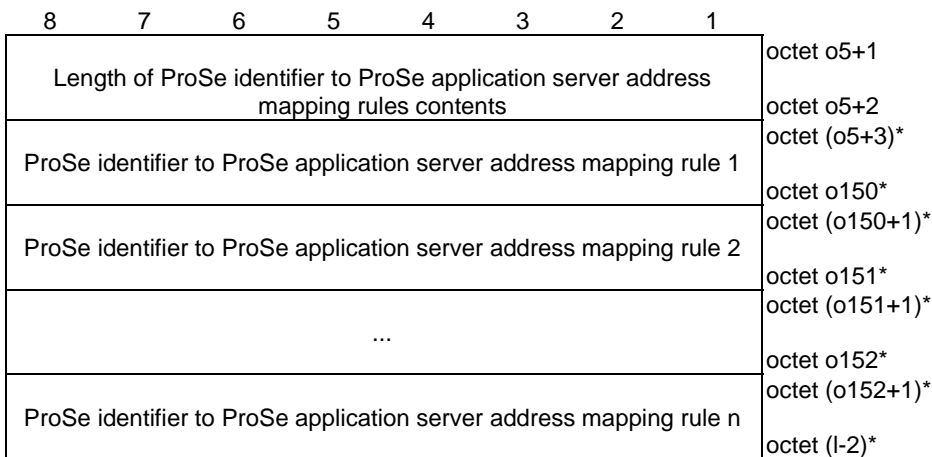

Figure 5.5.2.19: ProSe identifier to ProSe application server address mapping rules

Table 5.5.2.19: ProSe identifier to ProSe application server address mapping rules

ProSe identifier to ProSe application server address mapping rule: The ProSe identifier to ProSe application server address mapping rule field is coded according to figure 5.5.2.20 and table 5.5.2.20.

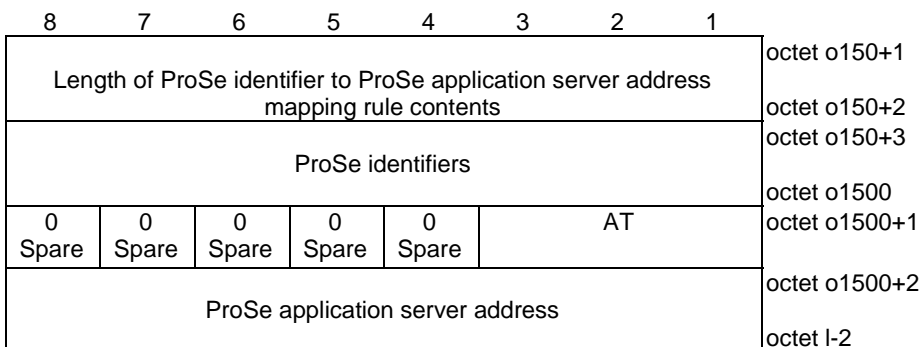

Figure 5.5.2.20: ProSe identifier to ProSe application server address mapping rule

Table 5.5.2.20: ProSe identifier to ProSe application server address mapping rule

ProSe identifiers (o150+3 to o1500):
 The ProSe identifiers field is coded according to figure 5.3.2.14 and table 5.3.2.14.

Address type (AT) (octet o1500+1 bit 1 to 3):
 The AT field indicates the ProSe application server address type.

Bits
3 2 1
 0 0 1 IPv4
 0 1 0 IPv6
 0 1 1 FQDN
 The other values are reserved.

If the AT indicates IPv4, then the ProSe application server address field contains an IPv4 address in 4 octets.

If the AT indicates IPv6, then the ProSe application server address field contains an IPv6 address in 16 octets.

If the AT indicates FQDN, then the ProSe application server address field contains a sequence of one octet FQDN length field and a FQDN value of variable size. The FQDN value field shall be encoded as defined in clause 28.3.2.1 in 3GPP TS 23.003 [10].

If the length of ProSe identifier to ProSe application server address mapping rule contents field is bigger than indicated in figure 5.5.2.19, receiving entity shall ignore any superfluous octets located at the end of the ProSe identifier to ProSe application server address mapping rule contents.

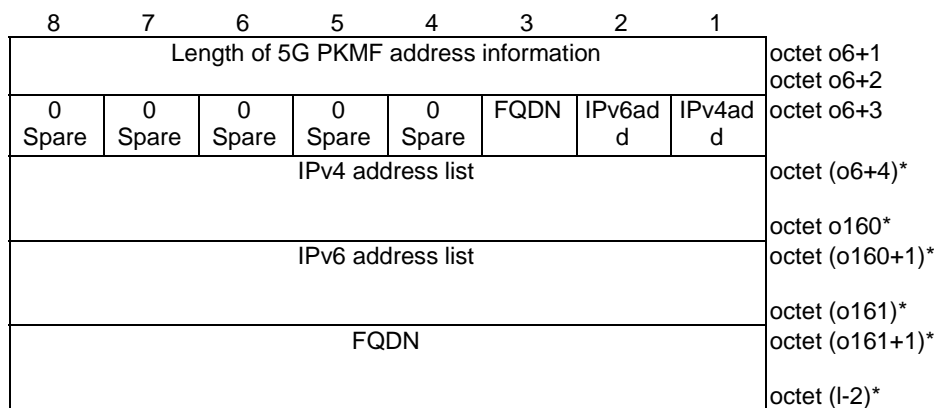

Figure 5.5.2.21: 5G PKMF address information

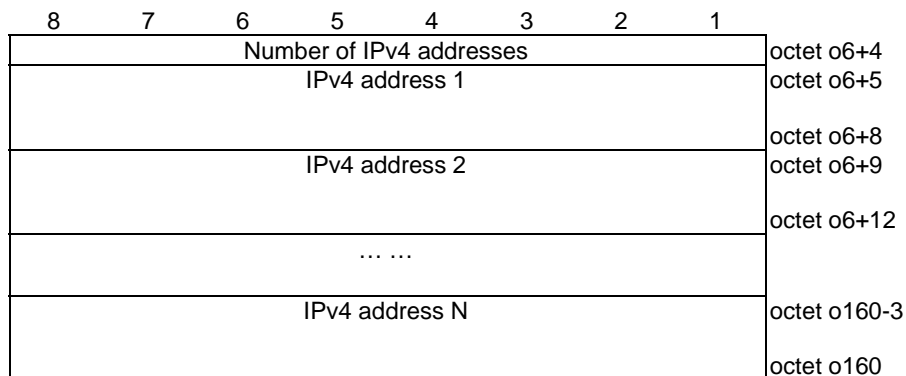

Figure 5.5.2.22: IPv4 address list

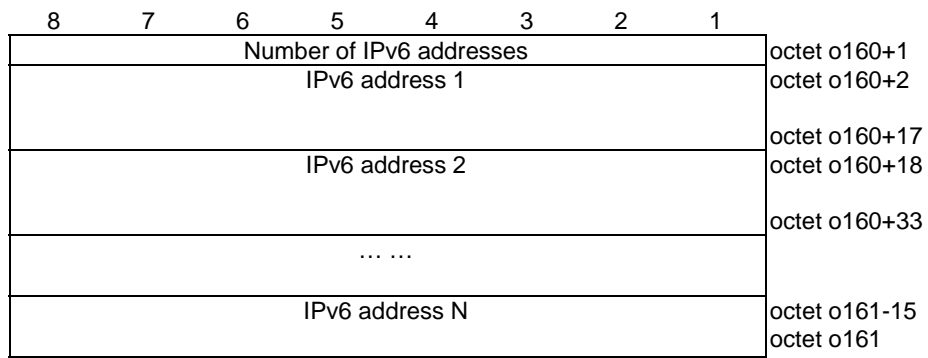

Figure 5.5.2.23: IPv6 address list

Table 5.5.2.21: 5G PKMF address information

IPv4 addresses (IPv4add) (o6+2 bit 1): (NOTE 1)
Bit
1
0 IPv4 address list is not present
1 IPv4 address list is present
IPv6 addresses (IPv6add) (octet o6+2 bit 2): (NOTE 1)
Bit
2
0 IPv6 address list is not present
1 IPv6 address list is present
FQDN (octet o6+3 bit 3): (NOTE 2)
Bit
3
0 FQDN is not present
1 FQDN is present
IPv4 address list (octet o6+4 to octet o160)
IPv4 address list contains the IPv4 address(es) of the 5G PKMF and shall be encoded as defined in figure 5.5.2.20.
IPv6 address list (octet o160+1 to octet o161)
IPv6 address list contains the IPv6 address(es) of the 5G PKMF and shall be encoded as defined in figure 5.5.2.20.
FQDN (octet o161+1 to l)
FQDN field contains a sequence of one octet FQDN length field and a FQDN value of variable size. The FQDN value field shall be encoded as defined in clause 28.3.2.1 in 3GPP TS 23.003 [10].
NOTE 1: If multiple IPv4 addresses and/or IPv6 addresses are included, which one of these addresses is selected is implementation dependent.
NOTE 2: If the 5G PKMF supports the 5G PKMF Services with "https" URI scheme (i.e. use of TLS is mandatory), then the FQDN shall be used to construct the target URI.

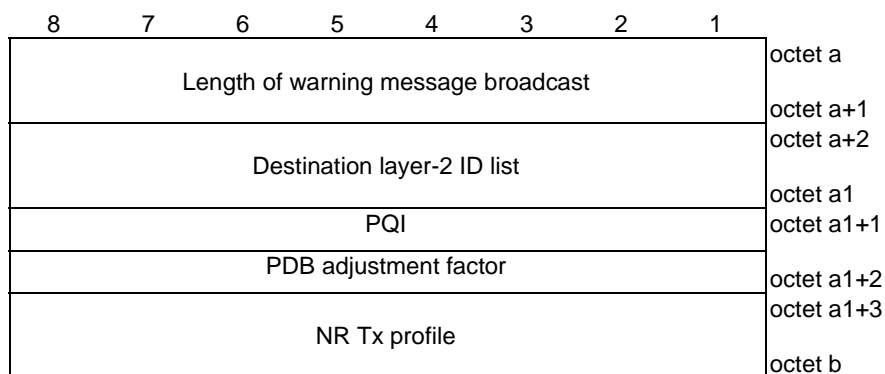

Figure 5.5.2.24: Warning message broadcast

Table 5.5.2.24: Warning message broadcast

<p>Destination layer-2 ID list (octet a+2 to a1): The destination layer-2 ID list field is coded according to figure 5.5.2.25 and table 5.5.2.25 and contains the list of destination layer-2 IDs.</p> <p>PQI (octet a1+1): The PQI field is coded according to figure 5.5.2.18 and table 5.5.2.18 and contains the PQI for broadcasting the warning messages.</p> <p>PDB adjustment factor (octet a1+2): The PDB adjustment factor field is coded according to figure 5.5.2.18 and table 5.5.2.18 and contains the PDB adjustment factor for broadcasting the warning messages.</p> <p>NR Tx profile (octet a1+3 to b): The NR Tx profile field is coded as <i>SL-TxProfile-r17</i> in clause 9.3 of 3GPP TS 38.331 [7].</p>

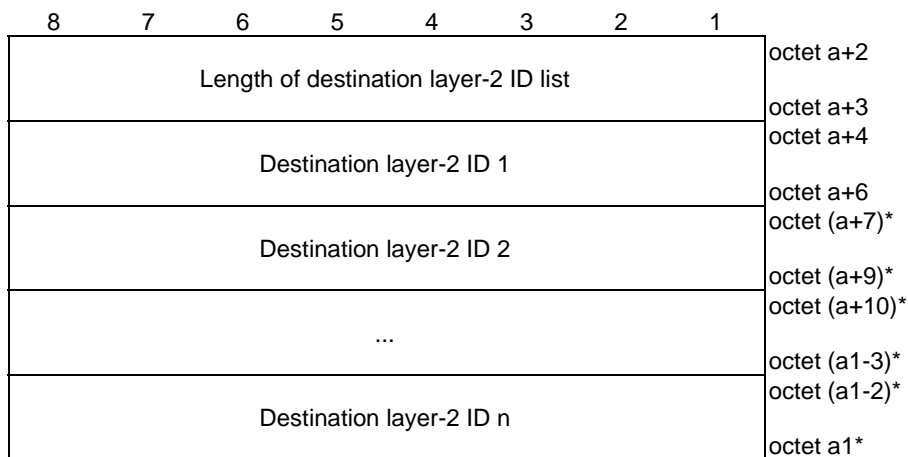

Figure 5.5.2.25: Destination layer-2 ID list

Table 5.5.2.25: Destination layer-2 ID

<p>Destination layer-2 ID (octet a+4 to a+6): The destination layer-2 ID is a 24-bit long bit string.</p>

5.6 Encoding of UE policies for 5G ProSe remote UE

5.6.1 General

The UE policies for 5G ProSe remote UE are coded as shown in figures 5.6.2.1 and table 5.6.2.1.

5.6.2 Information elements coding

8	7	6	5	4	3	2	1	
0	0	NSII	PAI	ProSeP info type = {UE policies for 5G ProSe remote UE}				octet k
Spare								octet k+1
Length of ProSeP info contents								octet k+2
Validity timer								octet k+3
Served by NG-RAN								octet k+7
Not served by NG-RAN								octet k+8
Default destination layer-2 IDs for sending the discovery signalling for solicitation and for receiving the discovery signalling for announcement and additional information								octet o1
User info ID for discovery								octet o1+1
RSC info list								octet o2
Privacy timer								octet o2+1
N3IWF selection information for 5G ProSe layer-3 remote UE								octet o3
5G PKMF address information								octet o3+1
Warning message broadcast								octet o3+6
Length of ProSeP info contents								octet o3+7
Validity timer								octet l
Served by NG-RAN								octet l+1
Not served by NG-RAN								octet l+2
Default destination layer-2 IDs for sending the discovery signalling for solicitation and for receiving the discovery signalling for announcement and additional information								octet (l+3)*
User info ID for discovery								octet m*
RSC info list								octet q*
Privacy timer								(see NOTE)
N3IWF selection information for 5G ProSe layer-3 remote UE								octet p*
5G PKMF address information								octet a*
Warning message broadcast								octet b*

NOTE: The field is placed immediately after the last present preceding field.

Figure 5.6.2.1: ProSeP Info = {UE policies for 5G ProSe remote UE}

Table 5.6.2.1: ProSeP Info = {UE policies for 5G ProSe remote UE}

ProSeP info type (bit 1 to 4 of octet k) shall be set to "0100" (UE policies for 5G ProSe remote UE)

PKMF address indication (PAI) (bit 5 of octet k)

The PAI indicates whether the 5G PKMF address information is included in the IE or not

Bit

5

0 5G PKMF address information is not included

1 5G PKMF address information is included

N3IWF selection information indication (NSII) (bit 6 of octet k)

The NSII indicates whether the N3IWF selection information for 5G ProSe layer-3 remote UE is included in the IE or not

Bit

6

0 N3IWF selection information for 5G ProSe layer-3 remote UE is not included

1 N3IWF selection information for 5G ProSe layer-3 remote UE is included

Length of ProSeP info contents (octets k+1 to k+2) indicates the length of ProSeP info contents.

Validity timer (octet k+3 to k+7):

The validity timer field provides the expiration time of validity of the UE policies for 5G ProSe remote UE. The validity timer field is a binary coded representation of a UTC time, in seconds since midnight UTC of January 1, 1970 (not counting leap seconds).

Served by NG-RAN (octet k+8 to o1):

The served by NG-RAN field is coded according to figure 5.6.2.2 and table 5.6.2.2, and contains configuration parameters for 5G ProSe remote UE when the UE is served by NG-RAN.

Not served by NG-RAN (octet o1+1 to o2):

The not served by NG-RAN field is coded according to figure 5.6.2.5 and table 5.6.2.5, and contains configuration parameters for 5G ProSe UE-to-network relay discovery and communication when the UE is not served by NG-RAN.

Default destination layer-2 IDs for sending the discovery signalling for solicitation and for receiving the discovery signalling for announcement and additional information (octet o2+1 to o3):

The default destination layer-2 IDs for sending the discovery signalling for solicitation and for receiving the discovery signalling for announcement and additional information is coded according to figure 5.6.2.11b and table 5.6.2.11b and contains a list of the default destination layer-2 IDs for the initial UE-to-network relay discovery signalling.

User info ID for discovery (octet o3+1 to o3+6):

The value of the User info ID parameter is a 48-bit long bit string. The format of the User info ID parameter is out of scope of this specification.

RSC info list (octet o3+7 to l):

The RSC info list field is coded according to figure 5.6.2.12 and table 5.6.2.12 and contains the RSCs related parameters.

Privacy timer (octet m+1 to m+2):

The privacy timer field contains binary encoded duration, in units of seconds, after which the UE shall change the source layer-2 ID self-assigned by the UE while performing transmission of 5G ProSe direct communication.

N3IWF selection information for 5G ProSe layer-3 remote UE (octet l+3 to m):

The N3IWF selection information for 5G ProSe layer-3 remote UE field is coded according to figure 5.6.2.17 and table 5.6.2.17, and contains two parts: 1) N3IWF identifier configuration (either FQDN or IP address) for 5G ProSe layer-3 remote UE; 2) 5G ProSe layer-3 UE-to-network relay access node selection information.

5G PKMF address information (octet m+3 to p)
 The 5G PKMF address information contains the IPv4 address(es), IPv6 address(es) and/or FQDN of the 5G PKMF and is coded according to figure 5.5.2.21, figure 5.5.2.22, figure 5.5.2.23 and table 5.5.2.21. At least one of the address parameters (FQDN, IPv4 address list or IPv6 address list) shall be included.

Warning message broadcast (octet a to b):
 The warning message broadcast field is coded according to figure 5.6.2.20 and table 5.6.2.20 and contains the parameters for broadcasting the warning messages.

If the length of ProSeP info contents field is bigger than indicated in figure 5.6.2.1, receiving entity shall ignore any superfluous octets located at the end of the ProSeP info contents.

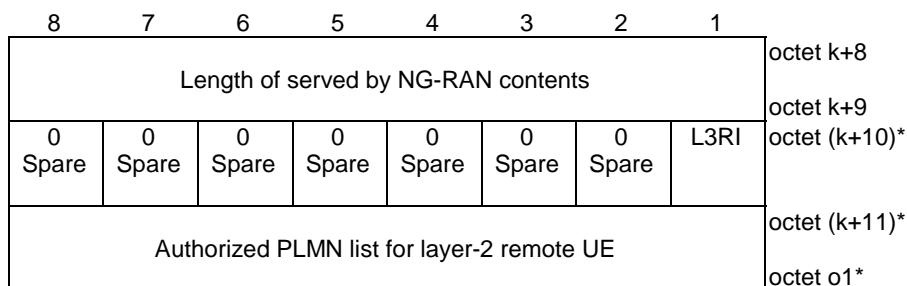

Figure 5.6.2.2: Served by NG-RAN

Table 5.6.2.2: Served by NG-RAN

Layer-3 remote UE authorization indication (L3RI) (octet k+10, bit 1):
 The layer-3 remote UE authorization indication field indicates whether the UE is authorized to act as a layer-3 remote UE.

Bits

1

0 Not authorized to act as a layer-3 remote UE

1 Authorized to act as a layer-3 remote UE

Authorized PLMN list for layer-2 remote UE (octet k+11 to o1):
 The authorized PLMN list for layer-2 remote UE field is coded according to figure 5.6.2.3 and table 5.6.2.3.

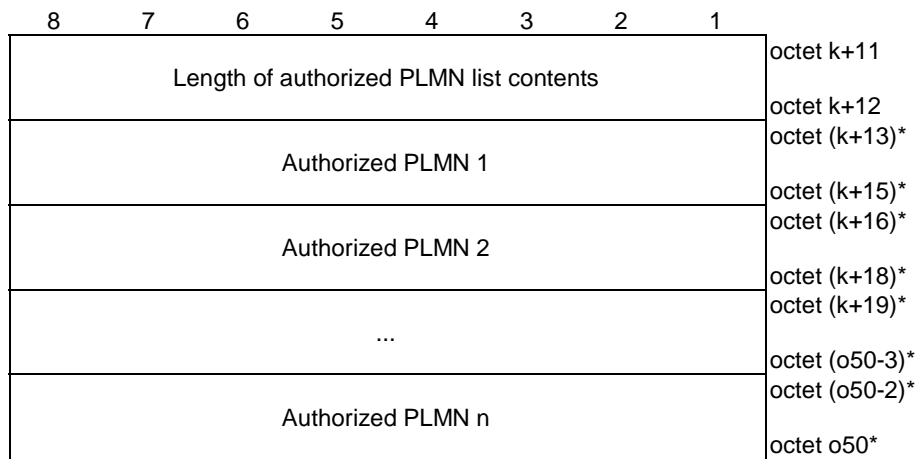

Figure 5.6.2.3: Authorized PLMN list

Table 5.6.2.3: Authorized PLMN list

Authorized PLMN:
The authorized PLMN field is coded according to figure 5.6.2.4 and table 5.6.2.4.

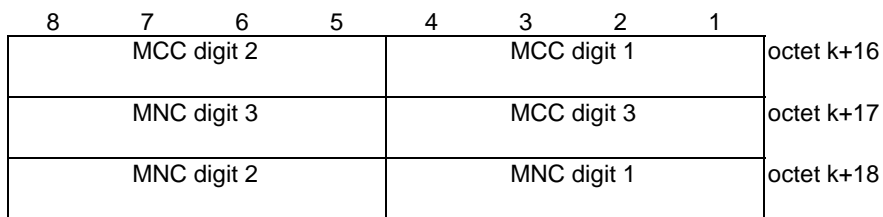

Figure 5.6.2.4: PLMN ID

Table 5.6.2.4: PLMN ID

Mobile country code (MCC) (octet k+16, octet k+17 bit 1 to 4):
The MCC field is coded as in ITU-T Recommendation E.212 [5], annex A.

Mobile network code (MNC) (octet k+17 bit 5 to 8, octet k+18):
The coding of MNC field is the responsibility of each administration but BCD coding shall be used. The MNC shall consist of 2 or 3 digits. If a network operator decides to use only two digits in the MNC, MNC digit 3 shall be coded as "1111".

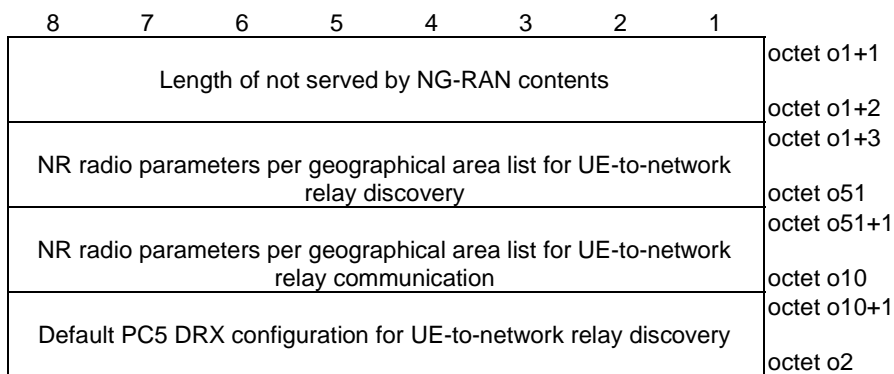

Figure 5.6.2.5: Not served by NG-RAN

Table 5.6.2.5: Not served by NG-RAN

<p>NR radio parameters per geographical area list for UE-to-network relay discovery (octet o1+3 to o51): The NR radio parameters per geographical area list for UE-to-network relay discovery field is coded according to figure 5.6.2.6 and table 5.6.2.6.</p> <p>NR radio parameters per geographical area list for UE-to-network relay communication (octet o51+1 to o2): The NR radio parameters per geographical area list for UE-to-network relay communication field is coded according to figure 5.6.2.7 and table 5.6.2.7.</p> <p>Default PC5 DRX configuration for UE-to-network relay discovery (octet o10+1 to o2): The default PC5 DRX configuration for UE-to-network relay discovery field is coded according to figure 5.6.2.11a and table 5.6.2.11a.</p> <p>If the length of not served by NG-RAN contents field is bigger than indicated in figure 5.6.2.5, receiving entity shall ignore any superfluous octets located at the end of the not served by NG-RAN contents.</p>

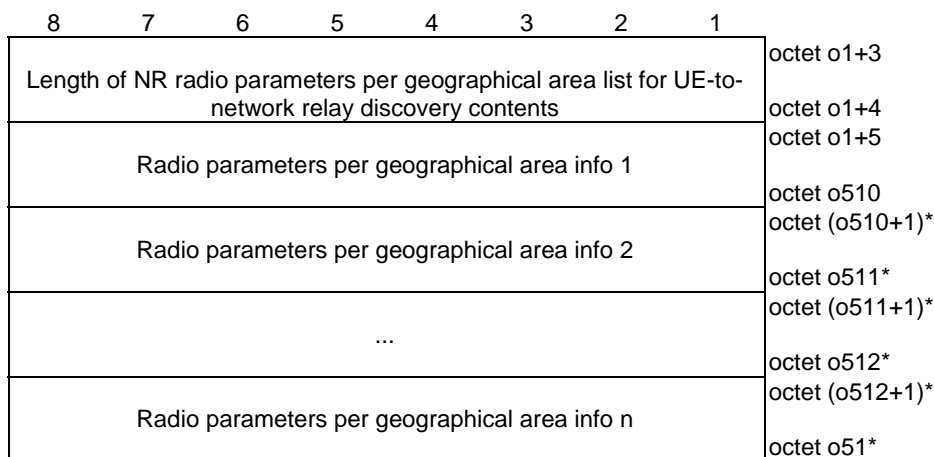

Figure 5.6.2.6: NR radio parameters per geographical area list for UE-to-network relay discovery

Table 5.6.2.6: NR radio parameters per geographical area list for UE-to-network relay discovery

Radio parameters per geographical area info:
 The radio parameters per geographical area info field is coded according to figure 5.6.2.8 and table 5.6.2.8.

8	7	6	5	4	3	2	1	
Length of NR radio parameters per geographical area list for UE-to-network relay communication contents								octet o51+1
Radio parameters per geographical area info 1								octet o51+2 octet o51+3
Radio parameters per geographical area info 2								octet o513 octet (o513+1)*
...								octet o514* octet (o514+1)*
Radio parameters per geographical area info n								octet o515* octet (o515+1)* octet o10*

Figure 5.6.2.7: NR radio parameters per geographical area list for UE-to-network relay communication

Table 5.6.2.7: NR radio parameters per geographical area list for UE-to-network relay communication

Radio parameters per geographical area info:
 The radio parameters per geographical area info field is coded according to figure 5.6.2.8 and table 5.6.2.8.

8	7	6	5	4	3	2	1	
Length of radio parameters per geographical area contents								octet o510+1
Geographical area								octet o510+2 octet o510+3
Radio parameters								octet o5100 octet o5100+1
MI	0	0	0	0	0	0	0	octet o511-1 octet o511
	Spare	Spare	Spare	Spare	Spare	Spare	Spare	

Figure 5.6.2.8: Radio parameters per geographical area info

Table 5.6.2.8: Radio parameters per geographical area info

<p>Geographical area (octet o510+3 to o5100): The geographical area field is coded according to figure 5.6.2.9 and table 5.6.2.9.</p> <p>Radio parameters (octet o5100+1 to o511-1): The radio parameters field is coded according to figure 5.3.2.11 and table 5.3.2.11, applicable in the geographical area indicated by the geographical area field when not served by NG-RAN.</p> <p>Managed indicator (MI) (octet o511 bit 8): The managed indicator indicates how the radio parameters indicated in the radio parameters field in the geographical area indicated by the geographical area field are managed.</p> <p>Bit 8 0 Non-operator managed 1 Operator managed</p> <p>If the length of radio parameters per geographical area contents field is bigger than indicated in figure 5.6.2.8, receiving entity shall ignore any superfluous octets located at the end of the radio parameters per geographical area contents.</p>

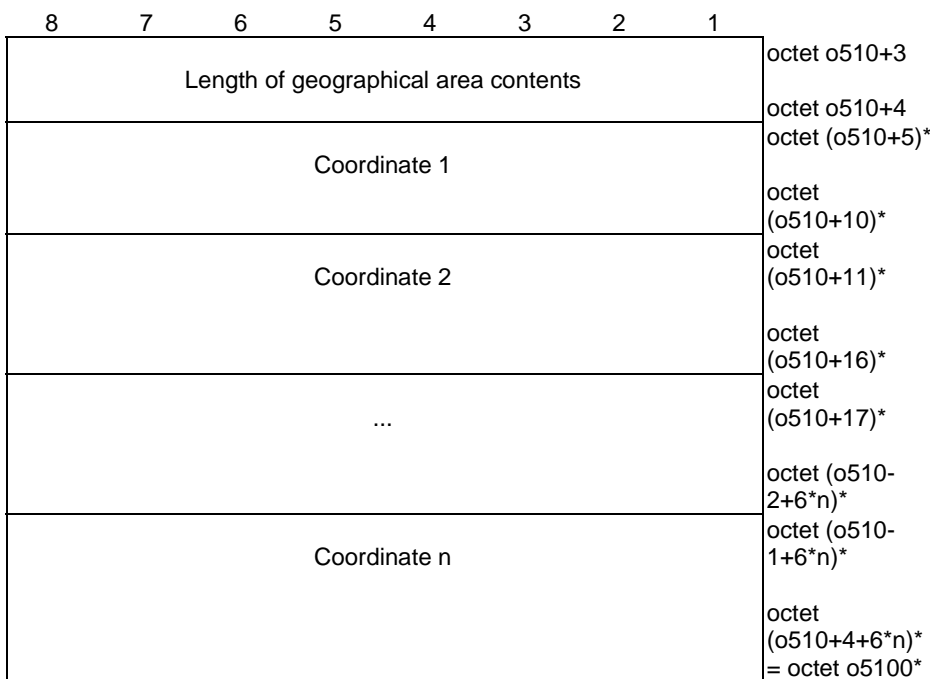

Figure 5.6.2.9: Geographical area

Table 5.6.2.9: Geographical area

<p>Coordinate: The coordinate field is coded according to figure 5.6.2.10 and table 5.6.2.10.</p>

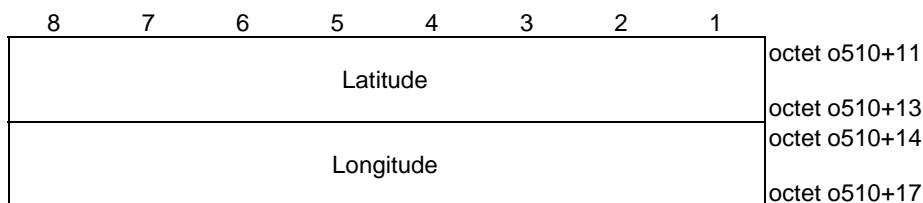

Figure 5.6.2.10: Coordinate area

Table 5.6.2.10: Coordinate area

Latitude (octet o510+11 to o510+13):
 The latitude field is coded according to clause 6.1 of 3GPP TS 23.032 [6].

Longitude (octet o510+14 to o510+17):
 The longitude field is coded according to clause 6.1 of 3GPP TS 23.032 [6].

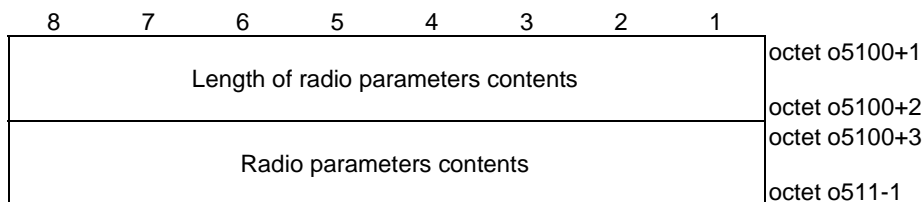

Figure 5.6.2.11: Radio parameters

Table 5.6.2.11: Radio parameters

Radio parameters contents (octet o5100+3 to o511-1):
 Radio parameters are defined as *SL-PreconfigurationNR* in clause 9.3 of 3GPP TS 38.331 [7].

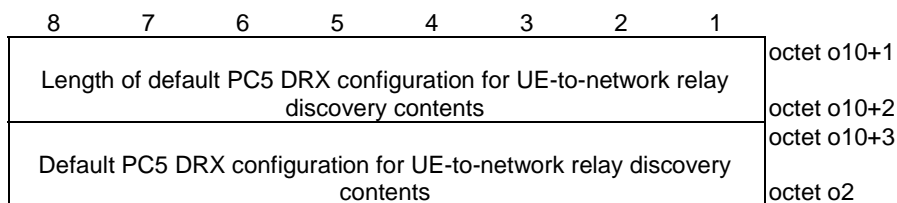

Figure 5.6.2.11a: Default PC5 DRX configuration for UE-to-network relay discovery

Table 5.6.2.11a: Default PC5 DRX configuration for UE-to-network relay discovery

Default PC5 DRX configuration contents for UE-to-network relay discovery:
 Default PC5 DRX configuration for UE-to-network relay discovery field is coded as *s-DefaultDRX-GC-BC-r17* in clause 6.3.5 of 3GPP TS 38.331 [7].

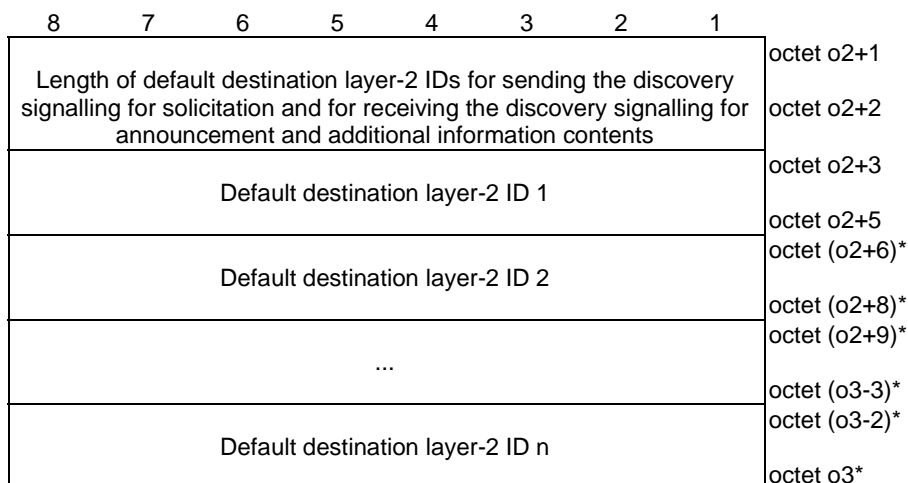

Figure 5.6.2.11b: Default destination layer-2 IDs for sending the discovery signalling for solicitation and for receiving the discovery signalling for announcement and additional information

Table 5.6.2.11b: Default destination layer-2 IDs for sending the discovery signalling for solicitation and for receiving the discovery signalling for announcement and additional information

Default destination layer-2 ID (octet o2+3 to o2+5): The default destination layer-2 ID is a 24-bit long bit string.

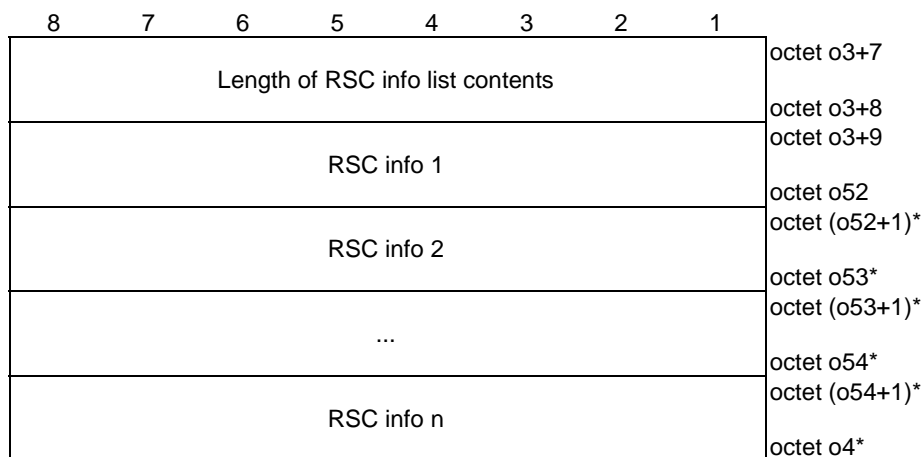

Figure 5.6.2.12: RSC info list

Table 5.6.2.12: RSC info list

RSC info: The RSC info field is coded according to figure 5.6.2.13 and table 5.6.2.13.

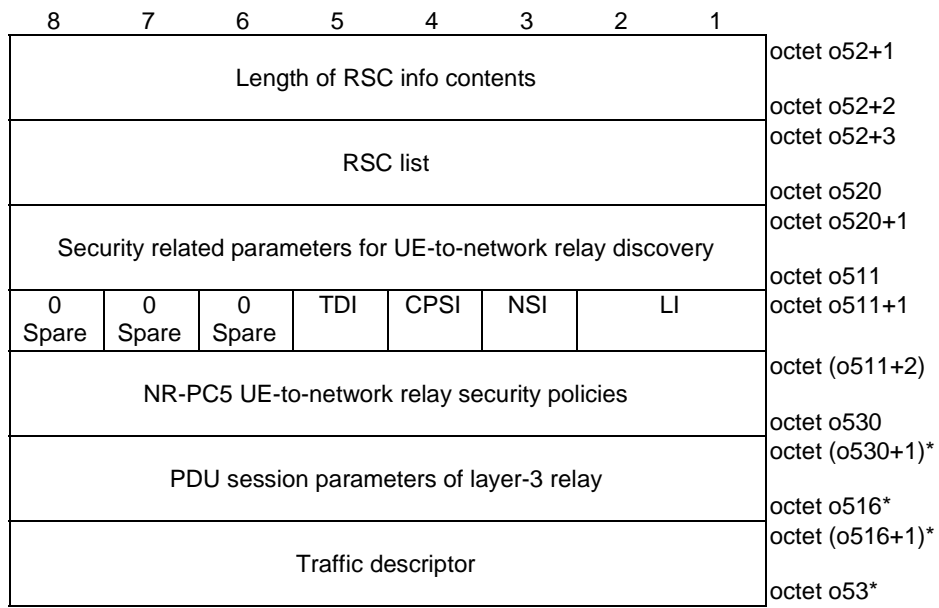

Figure 5.6.2.13: RSC info

Table 5.6.2.13: RSC info

<p>RSC list (octet o52+3 to o520): The RSC list field is coded according to figure 5.6.2.14 and table 5.6.2.14.</p> <p>Security related parameters for UE-to-network relay discovery (octet o520+1 to o511): The security related parameters for UE-to-network relay discovery field contains the security related parameters for UE-to-network relay discovery used when the security procedure over control plane as specified in 3GPP TS 33.503 [13] is used and is coded according to figure 5.6.2.15 and table 5.6.2.15.</p> <p>Layer indication (LI) (octet o511+1 bit 1 to 2): Bits 2 1 0 1 Layer 3 1 0 Layer 2 The other values are reserved.</p> <p>If LI is set to "Layer 3" and NSI is set to "Using N3IWF access for the relayed traffic is not supported", the PDU session parameters of layer-3 relay is included in the RSC info, otherwise the PDU session parameters of layer-3 relay is not included.</p> <p>N3IWF support indication (NSI) (octet o511+1 bit 3): Bit 3 0 Using N3IWF access for the relayed traffic is not supported 1 Using N3IWF access for the relayed traffic is supported</p> <p>The NSI is set to "Using N3IWF access for the relayed traffic is supported" only when the LI is set to "Layer 3".</p> <p>Control plane security indication (CPSI) (octet o511+1): The control plane security indication field indicates whether to use the security procedure over control plane as specified in 3GPP TS 33.503 [13] or not. Bit 4 0 security procedure over control plane is not used 1 security procedure over control plane is used</p> <p>Traffic descriptor indication (TDI) (octet o511+1 bit 5): Bit 5 0 Traffic descriptor field is not included 1 Traffic descriptor field is included</p> <p>NR-PC5 UE-to-network relay security policies (octet o511+2 to o530): The NR-PC5 UE-to-network relay security policies is coded as the NR-PC5 unicast security policies defined in figure 5.4.2.34 and table 5.4.2.34.</p> <p>PDU session parameters of layer-3 relay (octet o530+1 to o516): The PDU session parameters of layer-3 relay field is coded according to figure 5.6.2.16 and table 5.6.2.16.</p> <p>Traffic descriptor (octet o516+1 to o53): The traffic descriptor field is coded according to figure 5.6.2.16a and table 5.6.2.16a.</p>

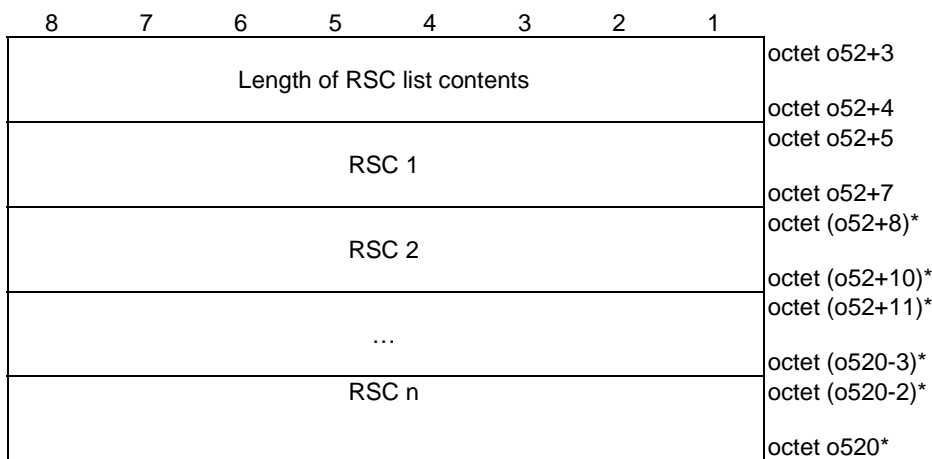

Figure 5.6.2.14: RSC list

Table 5.6.2.14: RSC list

RSC (octet o52+5 to o52+7):
 The RSC identifies a connectivity service that the remote UE wants. The value of the RSC is a 24-bit long bit string. The values of the RSCs from "000001" to "00000A" in hexadecimal representation indicate the RSCs for emergency services if the LI is set to "Layer-3" and the values of the RSCs from "00000B" to "00000D" in hexadecimal representation indicate the RSCs for emergency services if the LI is set to "Layer-2". The values of the RSCs from "00000E" to "00000F" in hexadecimal representation are spare and shall not be used in this release of specification. The UE shall ignore the spare value of the RSC in this release of specification. For all other values, the format of the RSC is out of scope of this specification.

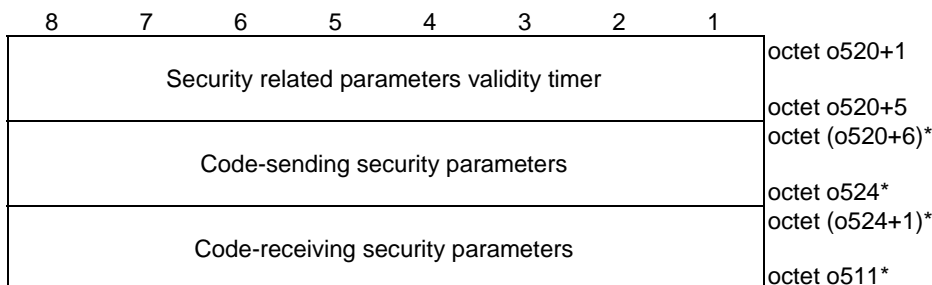

Figure 5.6.2.15: Security related parameters for UE-to-network relay discovery

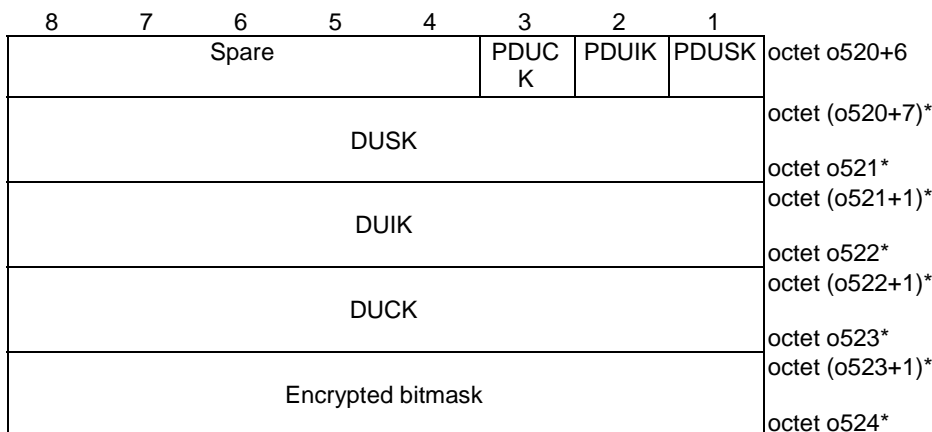

Figure 5.6.2.15a: Code-sending security parameters

8	7	6	5	4	3	2	1	
Spare				PDUC K	PDUIK	PDUSK		octet o524+1
DUSK								octet (o524+2)*
DUIK								octet o525* octet (o525+1)*
DUCK								octet o526* octet (o526+1)*
Encrypted bitmask								octet o527* octet (o527+1)* octet o511*

Figure 5.6.2.15b: Code-receiving security parameters

Table 5.6.2.15: Security related parameters for UE-to-network relay discovery

Security related parameters validity timer:

The security related parameters validity timer field provides the expiration time of validity of the security related parameters for UE-to-network relay discovery. The security related parameters validity timer field is a binary coded representation of a UTC time, in seconds since midnight UTC of January 1, 1970 (not counting leap seconds) (NOTE 1) (NOTE 2).

Code-sending security parameters:

The code-sending security parameters field contains the security parameters needed by a sending UE to protect a 5G ProSe direct discovery message over PC5 interface as specified in 3GPP TS 33.503 [13]. If the security related parameters validity timer field is set to zero, then the code-sending security parameters field is not present, otherwise the code-sending security parameters field is present.

Code-receiving security parameters

The code-receiving security parameters field contains the security parameters needed by a receiving UE to process a 5G ProSe direct discovery message over PC5 interface as specified in 3GPP TS 33.503 [13]. If the security related parameters validity timer field is set to zero, then the code-receiving security parameters field is not present, otherwise the code-receiving security parameters field is present.

Presence of DUSK (PDUSK):

PDUSK indicates whether the DUSK field is present or not.

Bit

1

0 DUSK field is not included

1 DUSK field is included

Presence of DUIK (PDUIK):

PDUIK indicates whether the DUIK field is present or not.

Bit

2

0 DUIK field is not included

1 DUIK field is included

Presence of DUCK (PDUCK):

PDUCK indicates whether the DUCK field and the encrypted bitmask field are present or not.

Bit

3

0 DUCK and encrypted bitmask fields are not included

1 DUCK and encrypted bitmask fields are included

DUSK:

The DUSK field contains the value of the DUSK. The use of the DUSK is defined in 3GPP TS 33.503 [13].

DUIK:

The DUIK field contains the value of the DUIK. The use of the DUIK is defined in 3GPP TS 33.503 [13].

DUCK:

The DUCK field contains the value of the DUCK. The use of the DUCK is defined in 3GPP TS 33.503 [13].

Encrypted bitmask:

The encrypted bitmask field contains the value of the encrypted bitmask, which is a 184-bit bitmask which uses bit "1" to mark the positions of the bits for which the DUCK encryption is applied.

NOTE 1: If the network does not have security related parameters for discovery in the UE policies or the security procedure over user plane as specified in 3GPP TS 33.503 [13] is used, the network shall set the security related parameters validity timer field (i.e. octet o520+1 to octet o520+5) to zero value. If the security related parameters validity timer field is set to zero value, the UE shall ignore the security related parameters validity timer.

NOTE 2: The network shall set the security related parameters validity timer field (i.e. octet o520+1 to octet o520+5) to zero value if the RSCs are for emergency services and there is no discovery security requirement based on regulation and the operator policy.

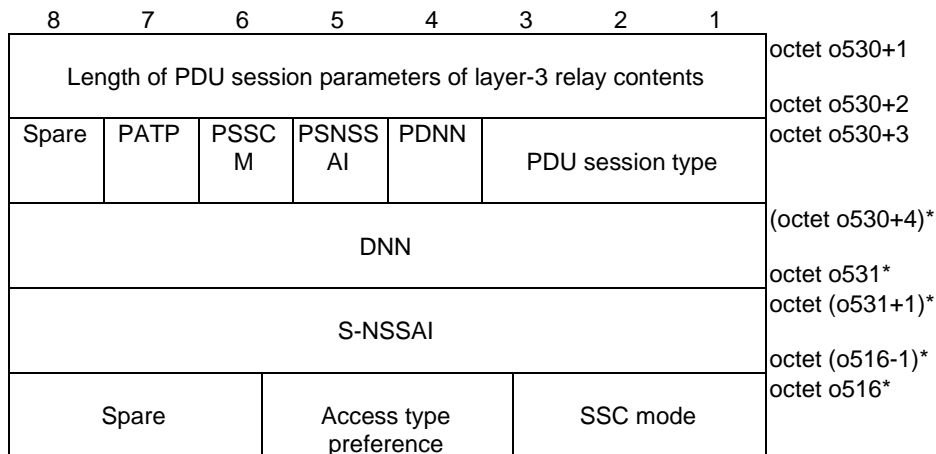

Figure 5.6.2.16: PDU session parameters of layer-3 relay

Table 5.6.2.16: PDU session parameters for layer-3 relay

<p>PDU session type (bits 3 to 1 of octet o530+3): The PDU session type field shall be encoded as the PDU session type value part of the PDU session type information element defined in clause 9.11.4.11 of 3GPP TS 24.501 [4].</p> <p>Presence of DNN (PDNN) (bit 4 of octet o530+3) PDNN indicates whether the DNN field is present or not (NOTE 1) Bit 4 0 DNN field is not included 1 DNN field is included</p> <p>Presence of S-NSSAI (PSNSSAI) (bit 5 of octet o530+3) PSNSSAI indicates whether the S-NSSAI field is present or not. Bit 5 0 S-NSSAI field is not included 1 S-NSSAI field is included</p> <p>Presence of SSC mode (PSSCM) (bit 6 of octet o530+3) PSSCM indicates whether the SSC mode field is present or not. Bit 6 0 SSC mode field is not included (NOTE 2) 1 SSC mode field is included</p> <p>Presence of access type preference (PATP) (bit 7 of octet o530+3) PATP indicates whether the access type preference mode field is present or not. Bit 7 0 Access type preference field is not included (NOTE 2) 1 Access type preference field is included</p> <p>DNN (octet o530+4 to o531): The DNN field shall be encoded as a sequence of a one octet DNN length field and a DNN value field of a variable size. The DNN value contains an APN as defined in 3GPP TS 23.003 [10].</p> <p>S-NSSAI (octet o531+1 to o516-1): The S-NSSAI field shall be encoded as a sequence of a one octet S-NSSAI length field and an S-NSSAI value field of a variable size. The S-NSSAI value shall be encoded as the value part of the S-NSSAI information element defined in clause 9.11.2.8 of 3GPP TS 24.501 [4].</p> <p>SSC mode (bits 3 to 1 of octet o516): The SSC mode field shall be encoded as the value part of the SSC mode information element defined in clause 9.11.4.16 of 3GPP TS 24.501 [4].</p> <p>Access type preference (bits 5 to 4 of octet o516): The access type preference field shall be encoded as the value part of the access type information element defined in clause 9.11.2.1A of 3GPP TS 24.501 [4].</p> <p>NOTE 1: PDNN shall be set to 1 if the 5G ProSe UE-to-network relay communication is not for emergency services. NOTE 2: Since SSC mode field and access type preference field are coded in the same octet, this octet is not included only when both PSSCM and PATP are set to 0.</p>

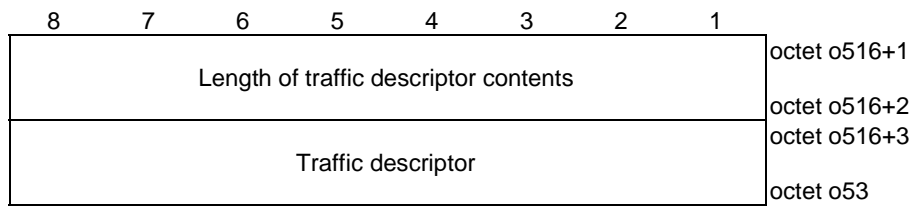

Figure 5.6.2.16a: Traffic descriptor

Table 5.6.2.16a: Traffic descriptor

Traffic descriptor (octet o516+3 to o53):
The traffic descriptor field is coded according to figure 5.2.2 and table 5.2.1 in clause 5.2 of 3GPP TS 24.526 [11].

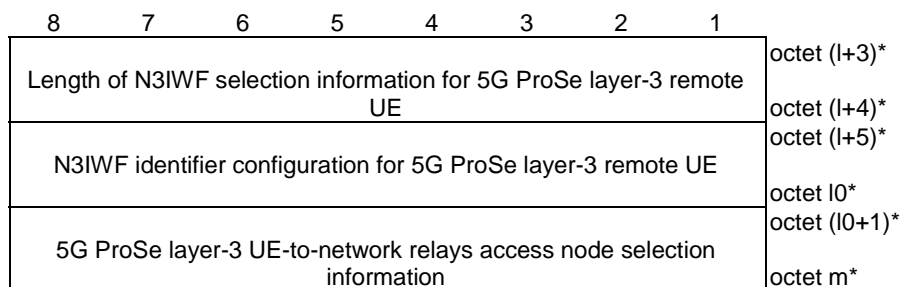

Figure 5.6.2.17: N3IWF selection information for 5G ProSe layer-3 remote UE

Table 5.6.2.17: N3IWF selection information for 5G ProSe layer-3 remote UE

N3IWF identifier configuration for 5G ProSe layer-3 remote UE (octet l+5 to l0):
The N3IWF identifier configuration for 5G ProSe layer-3 remote UE contains a list of home N3IWF identifier entries and is coded according to figure 5.6.2.18 and table 5.6.2.18.

5G ProSe layer-3 UE-to-network relays access node selection information (octet l0+1 to m):
The 5G ProSe layer-3 UE-to-network relays access node selection information contains a sequence of the N3AN node selection information entries and is coded according to figure 5.6.2.19 and table 5.6.2.19.

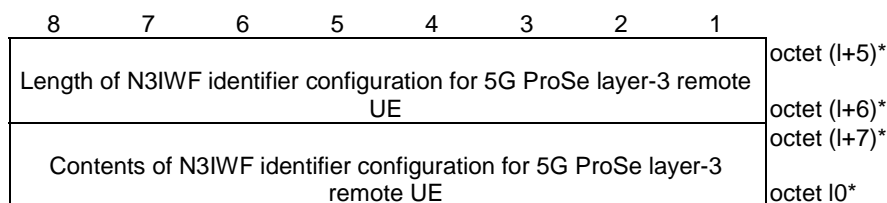

Figure 5.6.2.18: N3IWF identifier configuration for 5G ProSe layer-3 remote UE

Table 5.6.2.18: N3IWF identifier configuration for 5G ProSe layer-3 remote UE

Contents of N3IWF identifier configuration for 5G ProSe layer-3 remote UE (octet l+7 to l01):
 The contents of N3IWF identifier configuration for 5G ProSe layer-3 remote UE shall be encoded as the encoding of home N3IWF identifier configuration defined in clause 5.3.3.3 of 3GPP TS 24.526 [11].

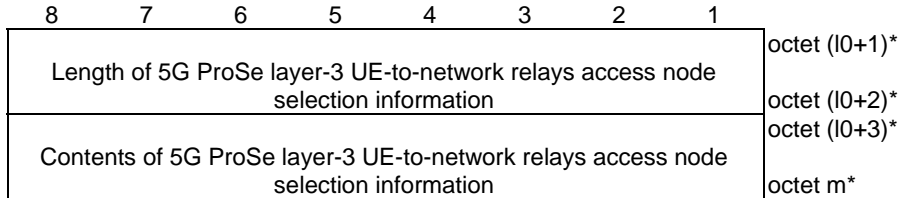

Figure 5.6.2.19: 5G ProSe layer-3 UE-to-network relays access node selection information

Table 5.6.2.19: 5G ProSe layer-3 UE-to-network relays access node selection information

Contents of 5G ProSe layer-3 UE-to-network relays access node selection information (octet l0+3 to m):
 The contents of 5G ProSe layer-3 UE-to-network relays access node selection information shall be encoded as the encoding of N3AN node selection information defined in clause 5.3.3.2 of 3GPP TS 24.526 [11].

NOTE: In this release of specification, the "preference" bit (as shown in figure 5.3.3.2.2 of 3GPP TS 24.526 [11]) is always set to "0".

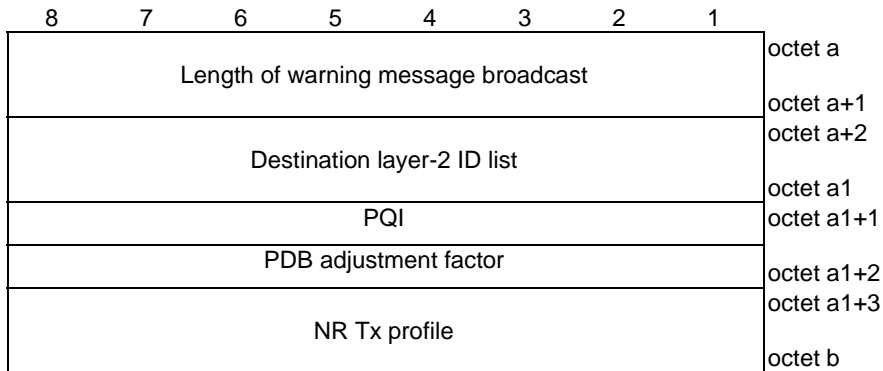

Figure 5.6.2.20: Warning message broadcast

Table 5.6.2.20: Warning message broadcast

<p>Destination layer-2 ID list (octet a+2 to a1): The destination layer-2 ID list field is coded according to figure 5.6.2.21 and table 5.6.2.21 and contains the list of destination layer-2 IDs.</p> <p>PQI (octet a1+1): The PQI field is coded according to figure 5.5.2.18 and table 5.5.2.18 and contains the PQI for broadcasting the warning messages.</p> <p>PDB adjustment factor (octet a1+2): The PDB adjustment factor field is coded according to figure 5.5.2.18 and table 5.5.2.18 and contains the PDB adjustment factor for broadcasting the warning messages.</p> <p>NR Tx profile (octet a1+3 to b): The NR Tx profile field is coded as <i>SL-TxProfile-r17</i> in clause 9.3 of 3GPP TS 38.331 [7].</p>

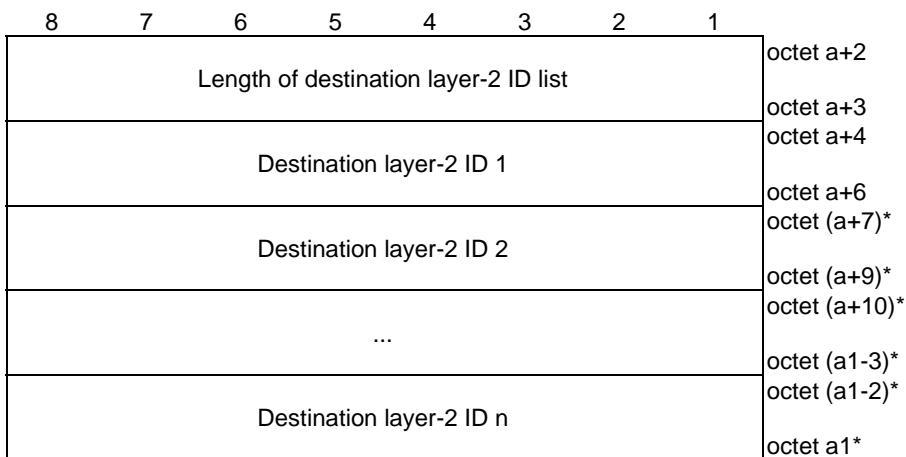

Figure 5.6.2.21: Destination layer-2 ID list

Table 5.6.2.21: Destination layer-2 ID

<p>Destination layer-2 ID (octet a+4 to a+6): The destination layer-2 ID is a 24-bit long bit string.</p>

5.7 Encoding of UE policies for 5G ProSe usage information reporting

5.7.1 General

The UE policies for 5G ProSe usage information reporting are coded as shown in figure 5.7.2.1 and table 5.7.2.1.

5.7.2 Information elements coding

8	7	6	5	4	3	2	1	
0	0	0	0	ProSeP info type = {UE policies for 5G ProSe usage information reporting}				octet k
Length of ProSeP info contents								octet k+1
Validity timer								octet k+2 octet k+3
Collection period								octet k+7 octet k+8
Reporting window								octet k+10 octet k+11
LRI	GPRI	TIORI	TTRRI	DTRI		DRRI		octet k+13 octet k+14
0 Spare	0 Spare	0 Spare	RPRI	QRI	AT			octet k+15
5G DDNMF CTF (ADF) address information for uploading the usage information reports								octet k+16 octet m

Figure 5.7.2.1: ProSeP Info = {UE policies for 5G ProSe usage information reporting }

ProSeP info type (bit 1 to 4 of octet k) shall be set to "0101" (UE policies for 5G ProSe usage information reporting)

Length of ProSeP info contents (octets k+1 to k+2) indicates the length of ProSeP info contents.

Validity timer (octet k+3 to k+7):

The validity timer field provides the expiration time of validity of the UE policies for 5G ProSe usage information reporting. The validity timer field is a binary coded representation of a UTC time, in seconds since midnight UTC of January 1, 1970 (not counting leap seconds).

Collection period (octet k+8 to octet k+10):

The collection period field indicates the time interval, in unit of minutes, at which the UE shall generate the usage information reports. Setting the value of collection period to 0 disables generation of usage information reports at the UE.

Reporting window (octet k+11 to k+13):

The reporting window field indicates the time window, in units of minutes, during which the UE shall upload the usage information report. Setting the value of reporting window to 0 disables upload of the usage information reports by the UE.

UE locations reporting indicator (LRI) (octet k+14 bit 8):

The UE locations reporting indicator field indicates whether or not the UE shall report the list of locations of the UE when in NG-RAN coverage during the reporting period in the usage information.

Bit

8

0 Not to report

1 Report

Group parameters reporting indicator (GPRI) (octet k+14 bit 7):

The Group parameters reporting indicator field indicates whether or not the UE shall report the group parameters in the usage information report, in the case of groupcast mode 5G ProSe direct communication.

Bit
7
0 Not to report
1 Report
Time stamps in and out of NG-RAN coverage reporting indicator (TIORI) (octet k+14 bit 6):
The time stamps in and out of NG-RAN coverage reporting indicator field indicates whether or not the UE shall report the time stamps when it went in and out of NG-RAN coverage during the collection period in the usage information.
Bit
6
0 Not to report
1 Report
Time stamps of the first transmission/reception reporting indicator (TTRRI) (octet k+14 bit 5):
The time stamps of the first transmission/reception reporting indicator field indicates whether or not the UE shall report the time stamps of the first transmission/reception during the collection period in the usage information.
Bit
5
0 Not to report
1 Report
Data transmitted reporting indicator (DTRI) (octet k+14 bits 4 to 3):
The data transmitted reporting indicator field indicates whether or not the UE shall report the amount of data transmitted during the collection period in the usage information report, and whether with location information.
Bits
4 3
0 0 Not to report
0 1 Report with location information
1 0 Report without location information
1 1 reserved
Data received reporting indicator (DRRI) (octet k+14 bits 2 to 1):
The data received reporting indicator field indicates whether or not the UE shall report the amount of data received during the collection period in the usage information report, and whether with location information.
Bits
2 1
0 0 Not to report
0 1 Report with location information
1 0 Report without location information
1 1 reserved
Bits 8 to 6 of octet k+15 are spare and shall be encoded as zero.
Radio parameters reporting indicator (RPRI) (octet k+15 bit 5):
The radio parameters reporting indicator field indicates whether or not the UE shall report the radio parameters used for ProSe direct communication during the reporting period in the usage information.
Bit
5
0 Not to report
1 Report
QoS flow reporting indicator (QRI) (octet k+15 bit 4):
The QoS flow reporting indicator field indicates whether or not the UE shall report the QoS flow information during the reporting period in the usage information.
Bit
4
0 Not to report
1 Report

Address type (AT) (octet k+15 bits 3 to 1):

The AT field indicates the type of the 5G DDNMF CTF (ADF) address information for uploading the usage information reports.

Bits

3 2 1

0 0 1 IPv4

0 1 0 IPv6

0 1 1 FQDN

1 0 0 IPv4v6

The other values are reserved.

If the AT indicates IPv4, then the 5G DDNMF CTF (ADF) address information for uploading the usage information reports field contains an IPv4 address in 4 octets.

If the AT indicates IPv6, then the 5G DDNMF CTF (ADF) address information for uploading the usage information reports field contains an IPv6 address in 16 octets.

If the AT indicates FQDN, then the 5G DDNMF CTF (ADF) address information for uploading the usage information reports field contains a sequence of one octet FQDN length field and a FQDN value of variable size. The FQDN value field shall be encoded as defined in clause 28.3.2.1 in 3GPP TS 23.003 [10].

If the AT indicates IPv4v6, then the 5G DDNMF CTF (ADF) address information for uploading the usage information reports field contains a sequence of an IPv4 address in 4 octets and an IPv6 address in 16 octets.

5G DDNMF CTF (ADF) address information for uploading the usage information reports (octet k+16 to octet m):

The 5G DDNMF CTF (ADF) address information for uploading the usage information reports field indicates the address to which the UE shall upload the usage information reports.

If the length of ProSeP info contents field is bigger than indicated in figure 5.7.2.1, receiving entity shall ignore any superfluous octets located at the end of the ProSeP info contents.

5.8 Encoding of UE policies for 5G ProSe UE-to-UE relay UE

5.8.1 General

The UE policies for 5G ProSe UE-to-UE relay UE are coded as shown in figures 5.8.2.1 and table 5.8.2.1.

5.8.2 Information elements coding

8	7	6	5	4	3	2	1	
0	0	0	PAI	ProSeP info type = {UE policies for 5G ProSe UE-to-UE relay UE}				octet k
Spare								
Length of ProSeP info contents								octet k+1
Validity timer								octet k+2 octet k+3
Served by NG-RAN								octet k+7 octet k+8
Not served by NG-RAN								octet o1 octet o1+1
Default destination layer-2 IDs for sending the discovery signalling for announcement and for sending and receiving the discovery signalling for solicitation								octet o2 octet o2+1
User info ID for discovery								octet o3 octet o3+1
RSC info list								octet o3+6 octet o3+7
Default destination layer-2 ID(s) for sending or receiving the direct communication signalling for 5G ProSe UE-to-UE relay communication with integrated discovery								octet o4 octet o4+1
5G PKMF address information								octet o5 octet (o5+1)*
								octet o6*

Figure 5.8.2.1: ProSeP Info = {UE policies for 5G ProSe UE-to-UE relay UE}

Table 5.8.2.1: ProSeP Info = {UE policies for 5G ProSe UE-to-UE relay UE}

<p>ProSeP info type (bit 1 to 4 of octet k) shall be set to "0110" (UE policies for 5G ProSe UE-to-UE relay UE)</p> <p>PKMF address indication (PAI) (bit 5 of octet k) The PAI indicates whether the 5G PKMF addressing information is included in the IE or not</p> <p>Bit 5</p> <p>0 5G PKMF addressing information is not included 1 5G PKMF addressing information is included</p> <p>Length of ProSeP info contents (octets k+1 to k+2) indicates the length of ProSeP info contents.</p> <p>Validity timer (octet k+3 to k+7): The validity timer field provides the expiration time of validity of the UE policies for 5G ProSe UE-to-UE relay UE. The validity timer field is a binary coded representation of a UTC time, in seconds since midnight UTC of January 1, 1970 (not counting leap seconds).</p> <p>Served by NG-RAN (octet k+8 to o1): The served by NG-RAN field is coded according to figure 5.8.2.2 and table 5.8.2.2, and contains configuration parameters for 5G ProSe UE-to-UE relay UE when the UE is served by NG-RAN.</p> <p>Not served by NG-RAN (octet o1+1 to o2): The not served by NG-RAN field is coded according to figure 5.8.2.5 and table 5.8.2.5, and contains configuration parameters for 5G ProSe UE-to-UE relay discovery and communication when the UE is not served by NG-RAN.</p> <p>Default destination layer-2 IDs for sending the discovery signalling for announcement and for sending and receiving the discovery signalling for solicitation (octet o2+1 to o3): The default destination layer-2 IDs for sending the discovery signalling for announcement and for sending and receiving the discovery signalling for solicitation is coded according to figure 5.8.2.11b and table 5.8.2.11b and contains a list of the default destination layer-2 IDs for the initial UE-to-UE relay discovery signalling.</p> <p>User info ID for discovery (octet o3+1 to o3+6): The value of the User info ID parameter is a 48-bit long bit string. The format of the User info ID parameter is out of scope of this specification.</p> <p>RSC info list (octet o3+7 to o4): The RSC info list field is coded according to figure 5.8.2.12 and table 5.8.2.12 and contains the RSCs related paramters.</p> <p>Default destination layer-2 ID(s) for sending or receiving the direct communication signalling for 5G ProSe UE-to-UE relay communication with integrated discovery (octet o4+1 to o5): The default destination layer-2 ID(s) for sending or receiving the direct communication signalling for 5G ProSe UE-to-UE relay communication with integrated discovery is coded according to figure 5.8.2.15 and table 5.8.2.15 and contains a list of the default destination layer-2 IDs for the initial UE-to-UE relay direct communication signalling.</p> <p>5G PKMF address information (octet o5+1 to o6): The 5G PKMF address information contains the IPv4 address(es), IPv6 address(es) and/or FQDN of the 5G PKMF and is coded according to figure 5.5.2.21, figure 5.5.2.22, figure 5.5.2.23 and table 5.5.2.21. At least one of the address parameters (FQDN, IPv4 address list or IPv6 address list) shall be included.</p> <p>If the length of ProSeP info contents field is bigger than indicated in figure 5.8.2.1, receiving entity shall ignore any superfluous octets located at the end of the ProSeP info contents.</p>

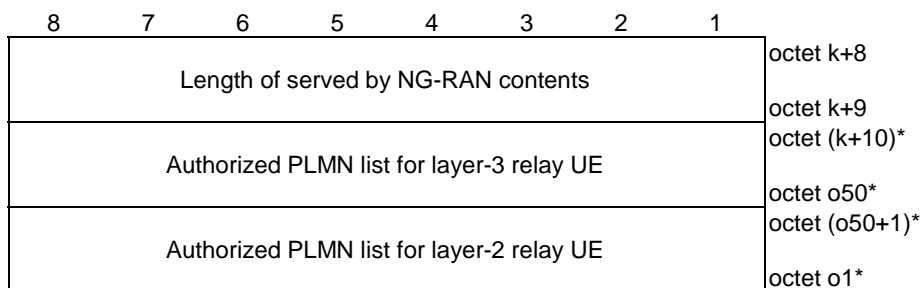

Figure 5.8.2.2: Served by NG-RAN

Table 5.8.2.2: Served by NG-RAN

Authorized PLMN list for layer-3 relay UE:
 The authorized PLMN list for layer-3 UE-to-UE relay UE field is coded according to figure 5.8.2.3 and table 5.8.2.3.

Authorized PLMN list for layer-2 relay UE:
 The authorized PLMN list for layer-2 UE-to-UE relay UE field is coded according to figure 5.8.2.3 and table 5.8.2.3.

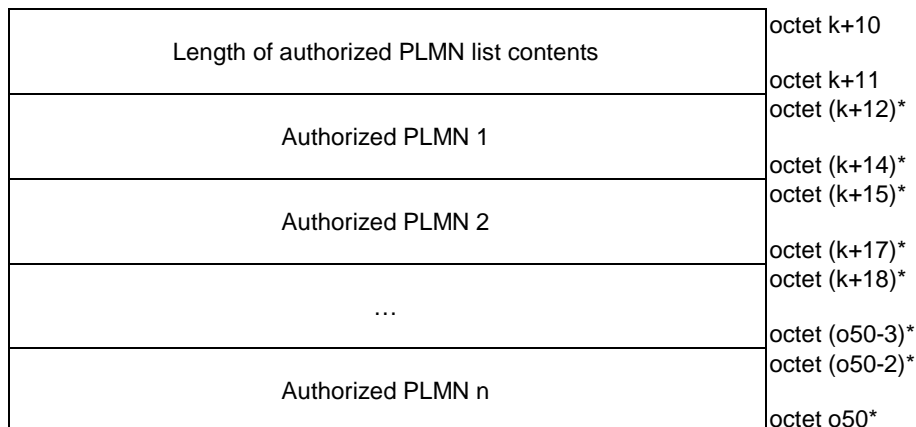

Figure 5.8.2.3: Authorized PLMN list

Table 5.8.2.3: Authorized PLMN list

Authorized PLMN:
 The authorized PLMN field is coded according to figure 5.8.2.4 and table 5.8.2.4.

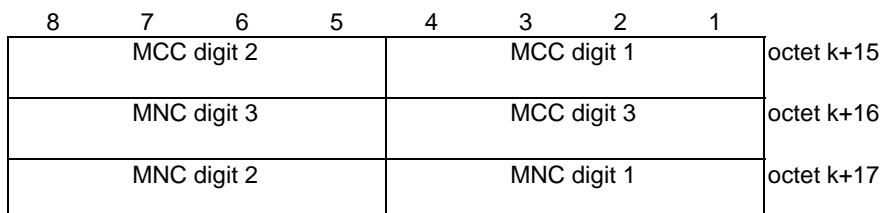

Figure 5.8.2.4: PLMN ID

Table 5.8.2.4: PLMN ID

Mobile country code (MCC) (octet k+15, octet k+16 bit 1 to 4):
 The MCC field is coded as in ITU-T Recommendation E.212 [5], annex A.

Mobile network code (MNC) (octet k+16 bit 5 to 8, octet k+17):
 The coding of MNC field is the responsibility of each administration but BCD coding shall be used. The MNC shall consist of 2 or 3 digits. If a network operator decides to use only two digits in the MNC, MNC digit 3 shall be coded as "1111".

8	7	6	5	4	3	2	1	
Length of not served by NG-RAN contents								octet o1+1
NR radio parameters per geographical area list for UE-to-UE relay discovery								octet o1+2
								octet o1+3
NR radio parameters per geographical area list for UE-to-UE relay communication								octet o51
								octet o51+1
Default PC5 DRX configuration for UE-to-UE relay discovery								octet o10
								octet o10+1
0	0	0	0	0	0	L2U2U	L3U2U	octet o2-1
Spare	Spare	Spare	Spare	Spare	Spare	RUI	RUI	octet o2

Figure 5.8.2.5: Not served by NG-RAN

Table 5.8.2.5: Not served by NG-RAN

<p>NR radio parameters per geographical area list for UE-to-UE relay discovery (octet o1+3 to o51): The NR radio parameters per geographical area list for UE-to-UE relay discovery field is coded according to figure 5.8.2.6 and table 5.8.2.6.</p> <p>NR radio parameters per geographical area list for UE-to-UE relay communication (octet o51+1 to o2): The NR radio parameters per geographical area list for UE-to-UE relay communication field is coded according to figure 5.8.2.7 and table 5.8.2.7.</p> <p>Default PC5 DRX configuration for UE-to-UE relay discovery (octet o10+1 to o2-1): The default PC5 DRX configuration for UE-to-UE relay discovery field is coded according to figure 5.8.2.11a and table 5.8.2.11a.</p> <p>5G ProSe layer-3 UE-to-UE relay UE when not served by NG-RAN indicator (L3U2URUI) (octet o2 bit 1): The L3U2URUI bit indicates whether the UE is authorized to act as a 5G ProSe layer-3 UE-to-UE relay UE when not served by NG-RAN. Bit 1 0 Not authorized 1 Authorized</p> <p>5G ProSe layer-2 UE-to-UE relay UE when not served by NG-RAN indicator (L2U2URUI) (octet o2 bit 2): The L2U2URUI bit indicates whether the UE is authorized to act as a 5G ProSe layer-2 UE-to-UE relay UE when not served by NG-RAN. Bit 2 0 Not authorized 1 Authorized</p> <p>If the length of not served by NG-RAN contents field is bigger than indicated in figure 5.8.2.5, receiving entity shall ignore any superfluous octets located at the end of the not served by NG-RAN contents.</p>

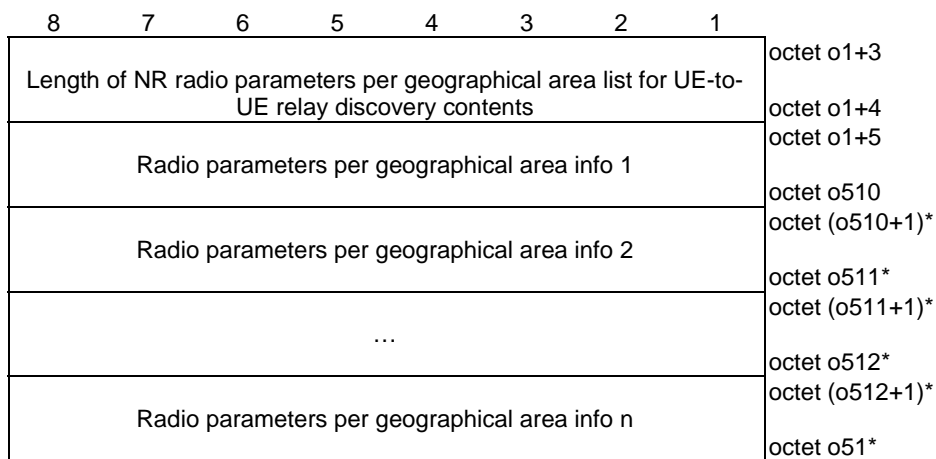

Figure 5.8.2.6: NR radio parameters per geographical area list for UE-to-UE relay discovery

Table 5.8.2.6: NR radio parameters per geographical area list for UE-to-UE relay discovery

<p>Radio parameters per geographical area info: The radio parameters per geographical area info field is coded according to figure 5.8.2.8 and table 5.8.2.8.</p>

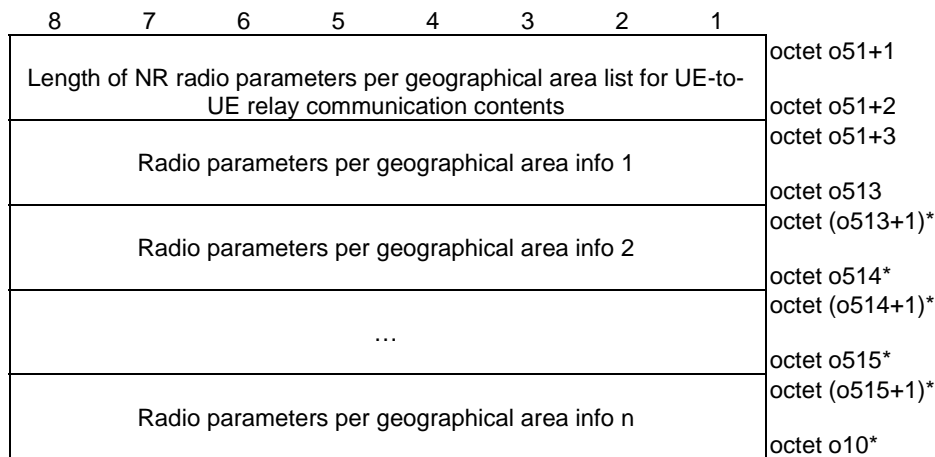

Figure 5.8.2.7: NR radio parameters per geographical area list for UE-to-UE relay communication

Table 5.8.2.7: NR radio parameters per geographical area list for UE-to-UE relay communication

Radio parameters per geographical area info: The radio parameters per geographical area info field is coded according to figure 5.5.2.8 and table 5.5.2.8.

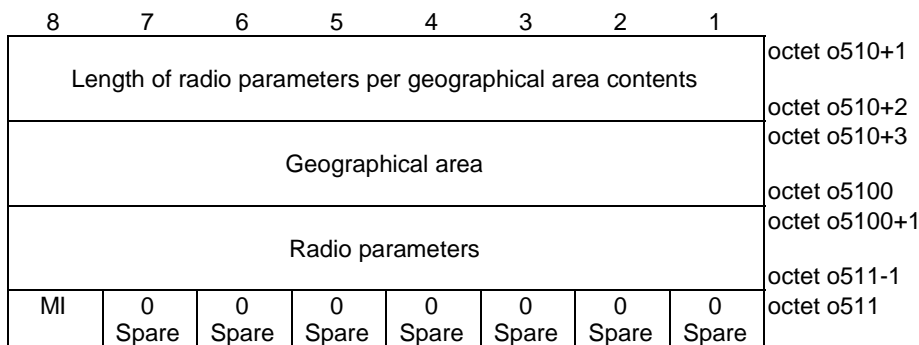

Figure 5.8.2.8: Radio parameters per geographical area info

Table 5.8.2.8: Radio parameters per geographical area info

Geographical area (octet o510+3 to o5100): The geographical area field is coded according to figure 5.8.2.9 and table 5.8.2.9. Radio parameters (octet o5100+1 to o511-1): The radio parameters field is coded according to figure 5.8.2.11 and table 5.8.2.11, applicable in the geographical area indicated by the geographical area field when not served by NG-RAN. Managed indicator (MI) (octet o511 bit 8): The managed indicator indicates how the radio parameters indicated in the radio parameters field in the geographical area indicated by the geographical area field are managed. Bit 8 0 Non-operator managed 1 Operator managed If the length of radio parameters per geographical area contents field is bigger than indicated in figure 5.8.2.8, receiving entity shall ignore any superfluous octets located at the end of the radio parameters per geographical area contents.

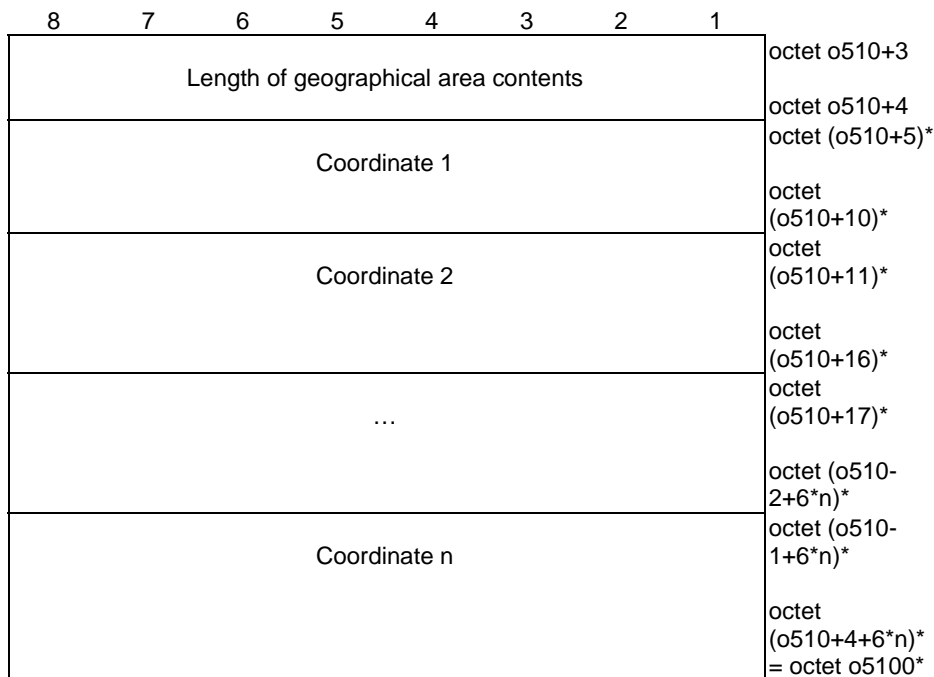

Figure 5.8.2.9: Geographical area

Table 5.8.2.9: Geographical area

<p>Coordinate: The coordinate field is coded according to figure 5.8.2.10 and table 5.8.2.10.</p>

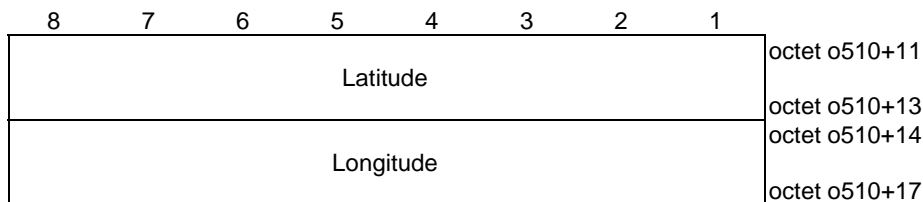

Figure 5.8.2.10: Coordinate area

Table 5.8.2.10: Coordinate area

<p>Latitude (octet o510+11 to o510+13): The latitude field is coded according to clause 6.1 of 3GPP TS 23.032 [6]. Longitude (octet o510+14 to o510+17): The longitude field is coded according to clause 6.1 of 3GPP TS 23.032 [6].</p>

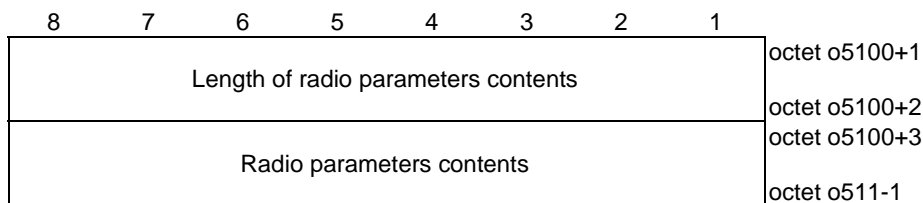

Figure 5.8.2.11: Radio parameters

Table 5.8.2.11: Radio parameters

Radio parameters contents:
 Radio parameters are defined as *SL-PreconfigurationNR* in clause 9.3 of 3GPP TS 38.331 [7].

8	7	6	5	4	3	2	1	
Length of default PC5 DRX configuration for UE-to-UE relay discovery contents								octet o10+1
Default PC5 DRX configuration for UE-to-UE relay discovery contents								octet o10+2 octet o10+3
								octet o2-1

Figure 5.8.2.11a: Default PC5 DRX configuration for UE-to-UE relay discovery

Table 5.8.2.11a: Default PC5 DRX configuration for UE-to-UE relay discovery

Default PC5 DRX configuration contents for UE-to-UE relay discovery:
 Default PC5 DRX configuration for UE-to-UE relay discovery field is coded as *s/DefaultDRX-GC-BC-r17* in clause 6.3.5 of 3GPP TS 38.331 [7].

8	7	6	5	4	3	2	1	
Length of default destination layer-2 IDs for sending the discovery signalling for announcement and for sending and receiving the discovery signalling for solicitation contents								octet o2+1
Default destination layer-2 ID 1								octet o2+2 octet o2+3
Default destination layer-2 ID 2								octet o2+5 octet (o2+6)*
...								octet (o2+8)* octet (o2+9)*
Default destination layer-2 ID n								octet (o3-3)* octet (o3-2)* octet o3*

Figure 5.8.2.11b: Default destination layer-2 IDs for sending the discovery signalling for announcement and for sending and receiving the discovery signalling for solicitation

Table 5.8.2.11b: Default destination layer-2 IDs for sending the discovery signalling for announcement and for sending and receiving the discovery signalling for solicitation

Default destination layer-2 ID (octet o2+3 to o2+5):
 The default destination layer-2 ID is a 24-bit long bit string.

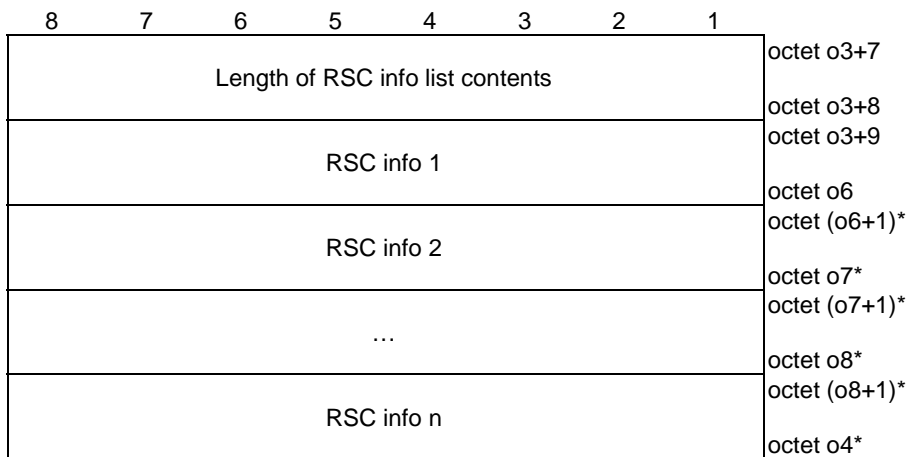

Figure 5.8.2.12: RSC info list

Table 5.8.2.12: RSC info list

<p>RSC info: The RSC info field is coded according to figure 5.8.2.13 and table 5.8.2.13.</p>

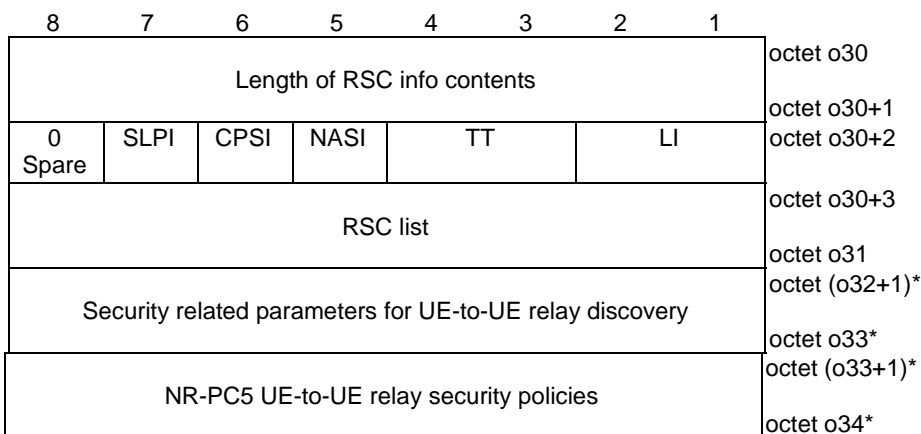

Figure 5.8.2.13: RSC info

Table 5.8.2.13: RSC info

<p>Layer indication (LI) (octet o30+2 bit 1 to 2):</p> <p>Bits</p> <p>2 1</p> <p>0 1 Layer 3</p> <p>1 0 Layer 2</p> <p>Traffic type (TT) (octet o30+2 bit 3 to 4):</p> <p>The traffic type field indicates the traffic type of the relayed service and exists when the LI is set to "Layer 3".</p> <p>Bits</p> <p>4 3</p> <p>0 0 No information</p> <p>0 1 IP</p> <p>1 0 Ethernet</p> <p>1 1 Unstructured</p> <p>Network assistance security indication (NASI) (octet o30+2 bit 5):</p> <p>The network assistance security indication field indicates whether to use the security procedure with network assistance or the security procedure without network assistance as specified in 3GPP TS 33.503 [13].</p> <p>Bit</p> <p>5</p> <p>0 the security procedure without network assistance</p> <p>1 the security procedure with network assistance is used</p> <p>Control plane security indication (CPSI) (octet o30+2 bit 6):</p> <p>The control plane security indication field indicates whether to use the security procedure over control plane as specified in 3GPP TS 33.503 [13], if the network assistance security indication indicates the security procedure with network assistance is to be used.</p> <p>Bit</p> <p>6</p> <p>0 security procedure over control plane is not used</p> <p>1 security procedure over control plane is used</p> <p>Security related parameters indication (SLPI) (octet o30+2 bit 5):</p> <p>The Security related parameters indication indicates whether the security related parameters for UE-to-UE relay discovery field is included or not.</p> <p>Bits</p> <p>5</p> <p>0 The security related parameters for UE-to-UE relay discovery not included</p> <p>1 The security related parameters for UE-to-UE relay discovery included</p> <p>The other values are reserved.</p> <p>RSC list (octet o30+3 to o31):</p> <p>The RSC list field is coded according to figure 5.8.2.14 and table 5.8.2.14.</p> <p>NR-PC5 UE-to-UE relay security policies (octet o33+1 to o34):</p> <p>The NR-PC5 UE-to-UE relay security policies are coded as the NR-PC5 unicast security policies defined in figure 5.4.2.36 and table 5.4.2.36.</p> <p>Security related parameters for UE-to-UE relay discovery (octet o32+1 to o33):</p> <p>The security related parameters for UE-to-UE relay discovery field contains the security related parameters for UE-to-UE relay discovery used when the security procedure over control plane as specified in 3GPP TS 33.503 [13] is used and is coded as security related parameters for discovery defined in figure 5.5.2.15 and table 5.5.2.15.</p>

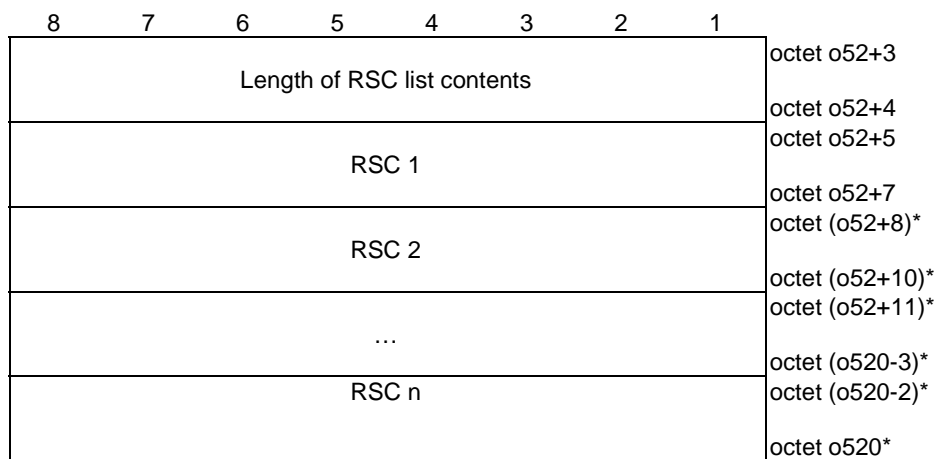

Figure 5.8.2.14: RSC list

Table 5.8.2.14: RSC list

RSC (octet o52+5 to o52+7):
 The RSC identifies a connectivity service the UE-to-UE relay provides. The value of the RSC is a 24-bit long bit string. The values of the RSC from "000001" to "00000F" in hexadecimal representation are spare and shall not be used in this release of specification. The UE shall ignore the spare value of the RSC in this release of specification. For all other values, the format of the RSC is out of scope of this specification.

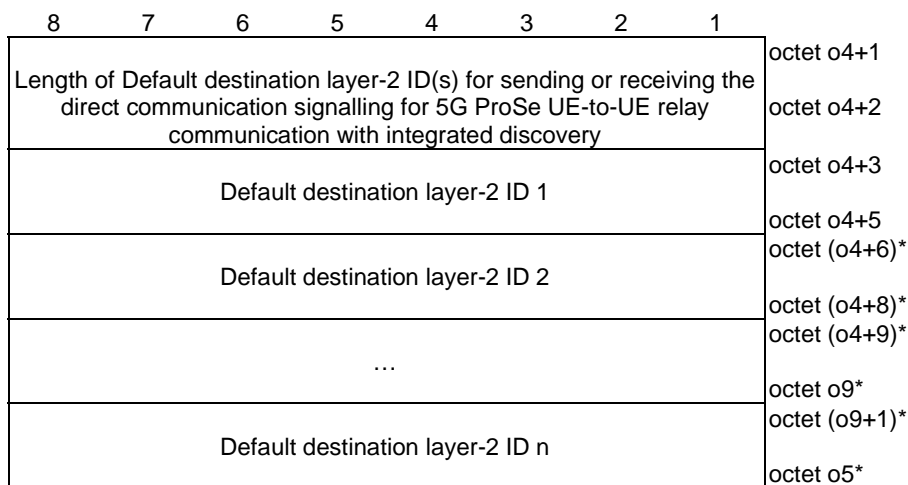

Figure 5.8.2.15: Default destination layer-2 ID(s) for sending or receiving the direct communication signalling for 5G ProSe UE-to-UE relay communication with integrated discovery

Table 5.8.2.15: Default destination layer-2 ID(s) for sending or receiving the direct communication signalling for 5G ProSe UE-to-UE relay communication with integrated discovery

Default destination layer-2 ID (octet o4+3 to o4+5):
 The default destination layer-2 ID is a 24-bit long bit string.

5.9 Encoding of UE policies for 5G ProSe end UE

5.9.1 General

The UE policies for 5G ProSe end UE are coded as shown in figures 5.9.2.1 and table 5.9.2.1.

5.9.2 Information elements coding

8	7	6	5	4	3	2	1	
0	0	0	PAI	ProSeP info type = {UE policies for 5G ProSe end UE}				octet k
Spare								
Length of ProSeP info contents								octet k+1
Validity timer								octet k+2 octet k+3
Served by NG-RAN								octet k+7 octet k+8
Not served by NG-RAN								octet o1 octet o1+1
Default destination layer-2 IDs for sending and receiving the discovery signalling for solicitation and for receiving the discovery signalling for announcement								octet o2 octet o2+1
RSC info list								octet o3 octet o3+1
Default destination layer-2 ID(s) for sending or receiving the direct communication signalling for 5G ProSe UE-to-UE relay communication with integrated discovery								octet l octet o4+1
5G PKMF address information								octet o5 octet (o5+1)* octet 6*

Figure 5.9.2.1: ProSeP Info = {UE policies for 5G ProSe end UE}

Table 5.9.2.1: ProSeP Info = {UE policies for 5G ProSe end UE}

<p>ProSeP info type (bit 1 to 4 of octet k) shall be set to "0111" (UE policies for 5G ProSe end UE)</p> <p>PKMF address indication (PAI) (bit 5 of octet k) The PAI indicates whether the 5G PKMF addressing information is included in the IE or not</p> <p>Bit 5</p> <p>0 5G PKMF addressing information is not included 1 5G PKMF addressing information is included</p> <p>Length of ProSeP info contents (octets k+1 to k+2) indicates the length of ProSeP info contents.</p> <p>Validity timer (octet k+3 to k+7): The validity timer field provides the expiration time of validity of the UE policies for 5G ProSe end UE. The validity timer field is a binary coded representation of a UTC time, in seconds since midnight UTC of January 1, 1970 (not counting leap seconds).</p> <p>Served by NG-RAN (octet k+8 to o1): The served by NG-RAN field is coded according to figure 5.9.2.2 and table 5.9.2.2, and contains configuration parameters for 5G ProSe end UE when the UE is served by NG-RAN.</p> <p>Not served by NG-RAN (octet o1+1 to o2): The not served by NG-RAN field is coded according to figure 5.9.2.3 and table 5.9.2.3, and contains configuration parameters for 5G ProSe UE-to-UE relay discovery and communication when the UE is not served by NG-RAN.</p> <p>Default destination layer-2 IDs for sending and receiving the discovery signalling for solicitation and for receiving the discovery signalling for announcement (octet o2+1 to o3): The default destination layer-2 IDs for sending and receiving the discovery signalling for solicitation and for receiving the discovery signalling for announcement is coded according to figure 5.9.2.9b and table 5.9.2.9b and contains a list of the default destination layer-2 IDs for the initial UE-to-UE relay discovery signalling.</p> <p>RSC info list (octet o3+1 to l): The RSC info list field is coded according to figure 5.9.2.10 and table 5.9.2.10 and contains the RSCs related parameters.</p> <p>Default destination layer-2 ID(s) for sending or receiving the direct communication signalling for 5G ProSe UE-to-UE relay communication with integrated discovery (octet o4+1 to o5): The default destination layer-2 ID(s) for sending or receiving the direct communication signalling for 5G ProSe UE-to-UE relay communication with integrated discovery is coded according to figure 5.9.2.13 and table 5.9.2.13s and contains a list of the default destination layer-2 IDs for the initial UE-to-UE relay direct communication signalling.</p> <p>5G PKMF address information (octet o5+1 to o6): The 5G PKMF address information contains the IPv4 address(es), IPv6 address(es) and/or FQDN of the 5G PKMF and is coded according to figure 5.5.2.21, figure 5.5.2.22, figure 5.5.2.23 and table 5.5.2.21. At least one of the address parameters (FQDN, IPv4 address list or IPv6 address list) shall be included.</p> <p>If the length of ProSeP info contents field is bigger than indicated in figure 5.9.2.1, receiving entity shall ignore any superfluous octets located at the end of the ProSeP info contents.</p>

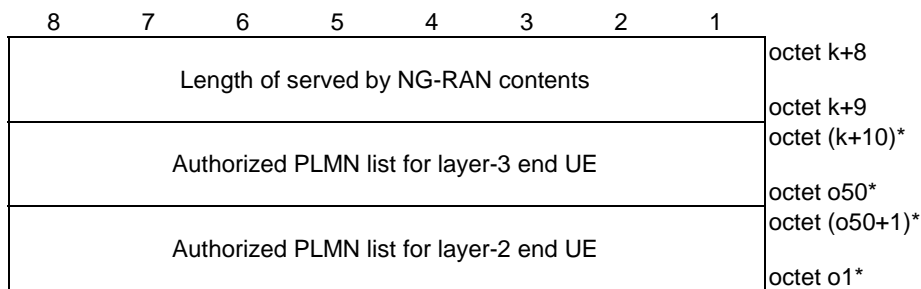

Figure 5.9.2.2: Served by NG-RAN

Table 5.9.2.2: Served by NG-RAN

Authorized PLMN list for layer-3 end UE:
 The authorized PLMN list for layer-3 end UE field is coded according to figure 5.8.2.3 and table 5.8.2.3.

Authorized PLMN list for layer-2 end UE:
 The authorized PLMN list for layer-2 end UE field is coded according to figure 5.8.2.3 and table 5.8.2.3.

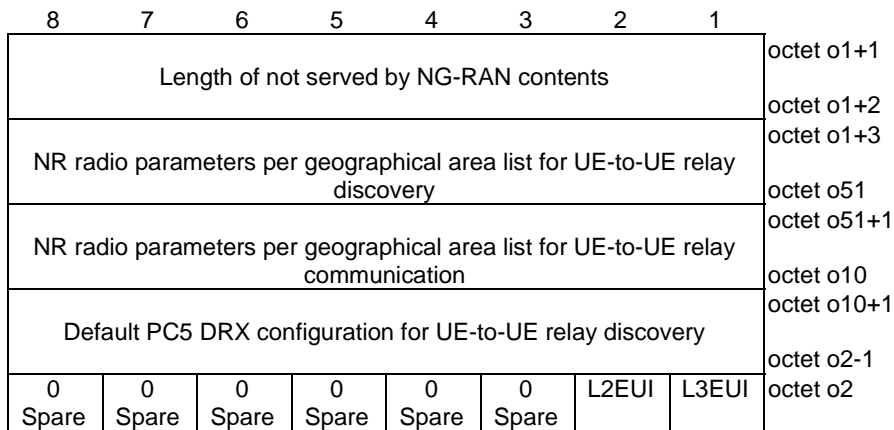

Figure 5.9.2.3: Not served by NG-RAN

Table 5.9.2.3: Not served by NG-RAN

<p>NR radio parameters per geographical area list for UE-to-UE relay discovery (octet o1+3 to o51): The NR radio parameters per geographical area list for UE-to-UE relay discovery field is coded according to figure 5.9.2.4 and table 5.9.2.4.</p> <p>NR radio parameters per geographical area list for UE-to-UE relay communication (octet o51+1 to o2): The NR radio parameters per geographical area list for UE-to-UE relay communication field is coded according to figure 5.9.2.5 and table 5.9.2.5.</p> <p>Default PC5 DRX configuration for UE-to-UE relay discovery (octet o10+1 to o2-1): The default PC5 DRX configuration for UE-to-UE relay discovery field is coded according to figure 5.9.2.9a and table 5.9.2.9a.</p> <p>5G ProSe layer-3 end UE when not served by NG-RAN indicator (L3EUI) (octet o2 bit 1): The L3EUI bit indicates whether the UE is authorized to use a 5G ProSe layer-3 UE-to-UE relay UE when not served by NG-RAN. Bit 1 0 Not authorized 1 Authorized</p> <p>5G ProSe layer-2 end UE when not served by NG-RAN indicator (L2EUI) (octet o2 bit 2): The L2U2URUI bit indicates whether the UE is authorized to use a 5G ProSe layer-2 UE-to-UE relay UE when not served by NG-RAN. Bit 2 0 Not authorized 1 Authorized</p> <p>If the length of not served by NG-RAN contents field is bigger than indicated in figure 5.9.2.3, receiving entity shall ignore any superfluous octets located at the end of the not served by NG-RAN contents.</p>

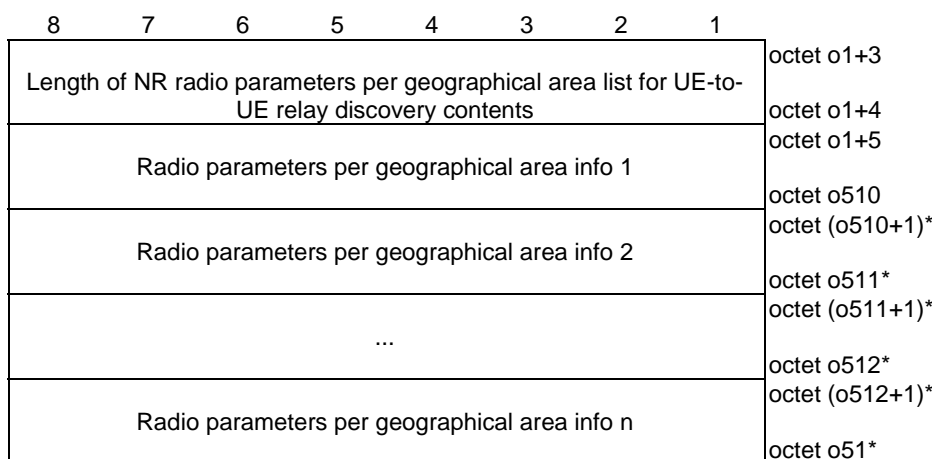

Figure 5.9.2.4: NR radio parameters per geographical area list for UE-to-UE relay discovery

Table 5.9.2.4: NR radio parameters per geographical area list for UE-to-UE relay discovery

<p>Radio parameters per geographical area info: The radio parameters per geographical area info field is coded according to figure 5.9.2.6 and table 5.9.2.6.</p>

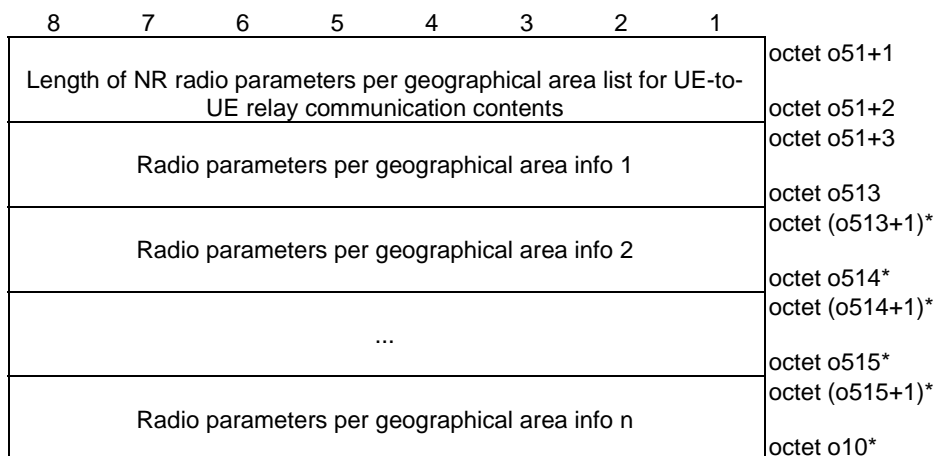

Figure 5.9.2.5: NR radio parameters per geographical area list for UE-to-UE relay communication

Table 5.9.2.5: NR radio parameters per geographical area list for UE-to-UE relay communication

Radio parameters per geographical area info: The radio parameters per geographical area info field is coded according to figure 5.9.2.6 and table 5.9.2.6.

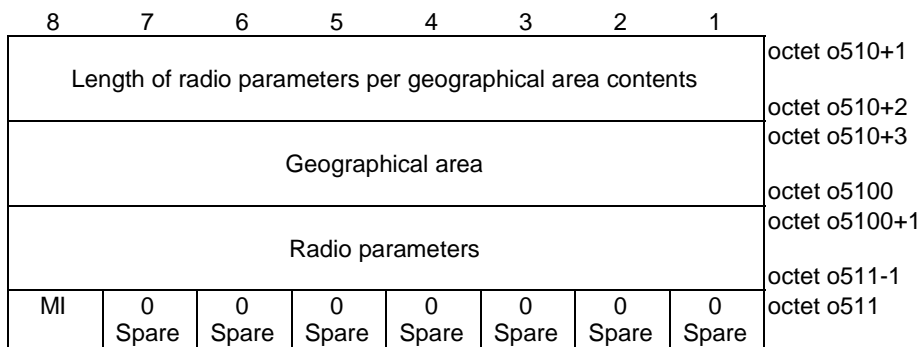

Figure 5.9.2.6: Radio parameters per geographical area info

Table 5.9.2.6: Radio parameters per geographical area info

<p>Geographical area (octet o510+3 to o5100): The geographical area field is coded according to figure 5.9.2.7 and table 5.9.2.7.</p> <p>Radio parameters (octet o5100+1 to o511-1): The radio parameters field is coded according to figure 5.3.2.11 and table 5.3.2.11, applicable in the geographical area indicated by the geographical area field when not served by NG-RAN.</p> <p>Managed indicator (MI) (octet o511 bit 8): The managed indicator indicates how the radio parameters indicated in the radio parameters field in the geographical area indicated by the geographical area field are managed.</p> <p>Bit 8 0 Non-operator managed 1 Operator managed</p> <p>If the length of radio parameters per geographical area contents field is bigger than indicated in figure 5.9.2.6, receiving entity shall ignore any superfluous octets located at the end of the radio parameters per geographical area contents.</p>

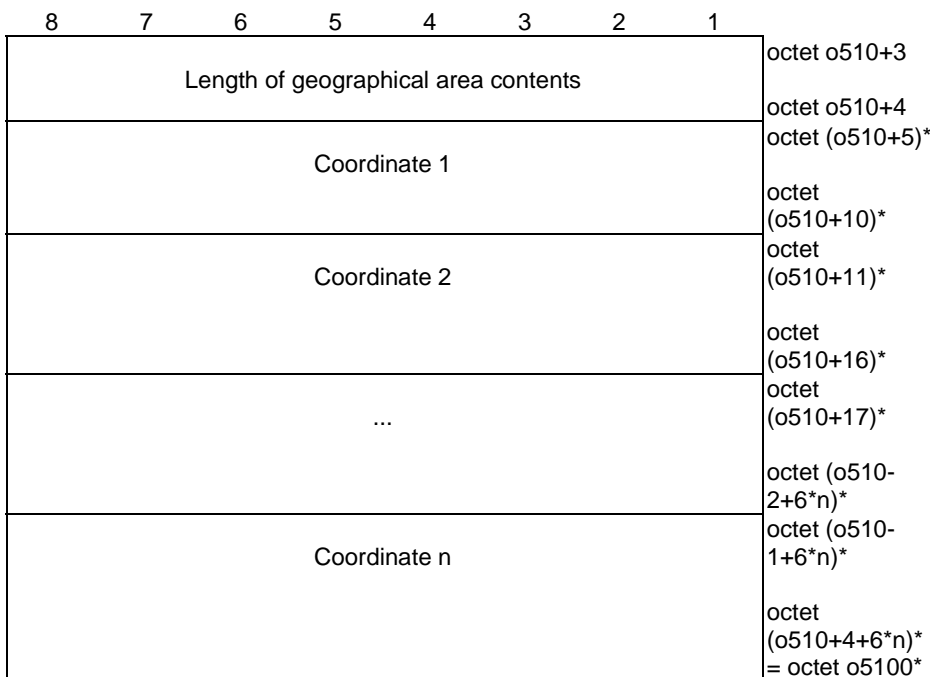

Figure 5.9.2.7: Geographical area

Table 5.9.2.7: Geographical area

<p>Coordinate: The coordinate field is coded according to figure 5.9.2.8 and table 5.9.2.8.</p>

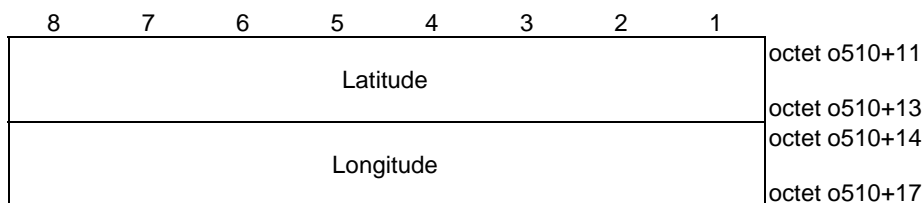

Figure 5.9.2.8: Coordinate area

Table 5.9.2.8: Coordinate area

Latitude (octet o510+11 to o510+13):
 The latitude field is coded according to clause 6.1 of 3GPP TS 23.032 [6].
 Longitude (octet o510+14 to o510+17):
 The longitude field is coded according to clause 6.1 of 3GPP TS 23.032 [6].

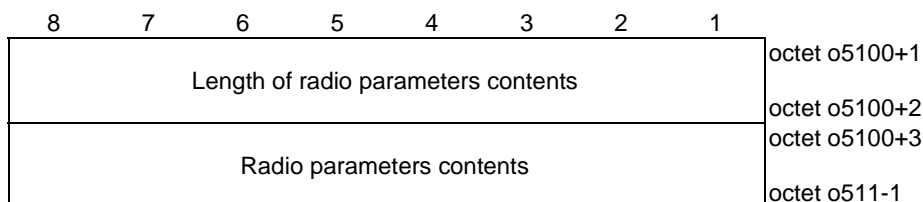

Figure 5.9.2.9: Radio parameters

Table 5.9.2.9: Radio parameters

Radio parameters contents (octet o5100+3 to o511-1):
 Radio parameters are defined as *SL-PreconfigurationNR* in clause 9.3 of 3GPP TS 38.331 [7].

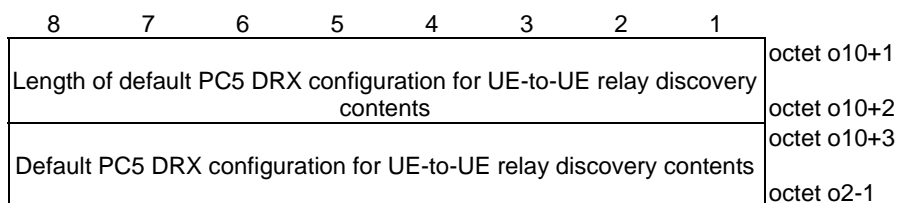

Figure 5.9.2.9a: Default PC5 DRX configuration for UE-to-UE relay discovery

Table 5.9.2.9a: Default PC5 DRX configuration for UE-to-UE relay discovery

Default PC5 DRX configuration contents for UE-to-UE relay discovery:
 Default PC5 DRX configuration for UE-to-UE relay discovery field is coded as *s/-DefaultDRX-GC-BC-r17* in clause 6.3.5 of 3GPP TS 38.331 [7].

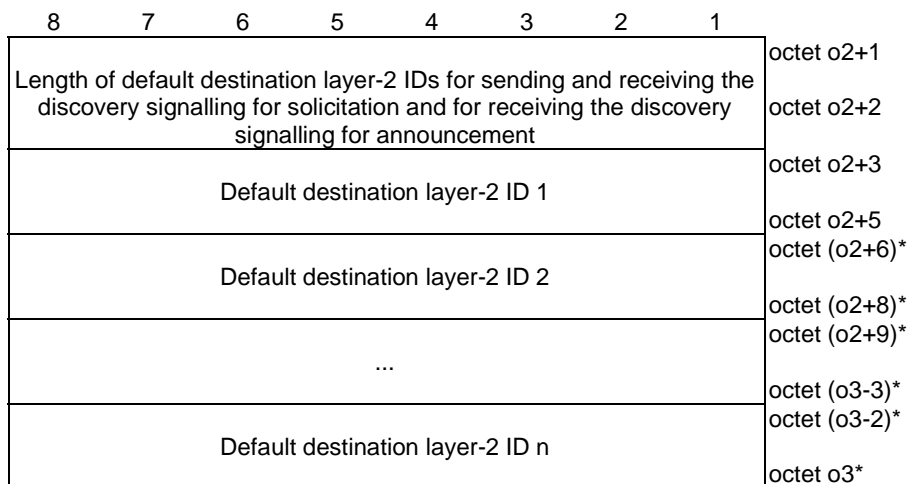

Figure 5.9.2.9b: Default destination layer-2 IDs for sending and receiving the discovery signalling for solicitation and for receiving the discovery signalling for announcement

Table 5.9.2.9b: Default destination layer-2 IDs for sending the discovery signalling for solicitation and for receiving the discovery signalling for announcement

Default destination layer-2 ID (octet o2+3 to o2+5): The default destination layer-2 ID is a 24-bit long bit string.

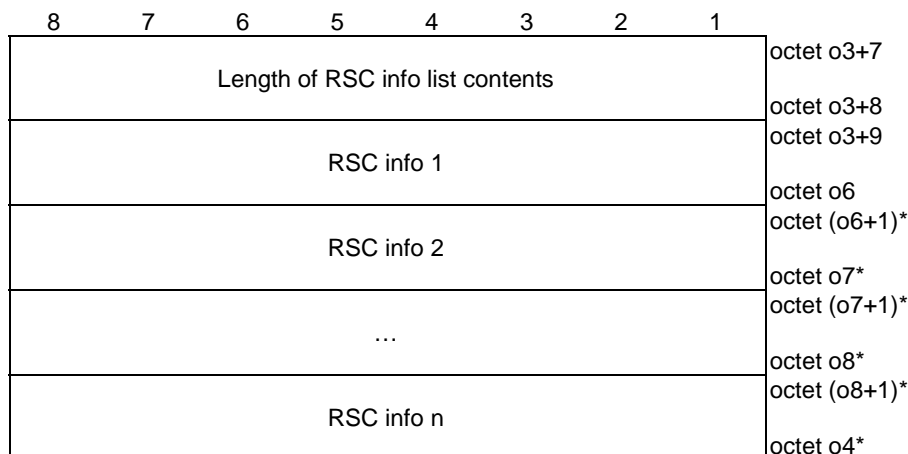

Figure 5.9.2.10: RSC info list

Table 5.9.2.10: RSC info list

RSC info: The RSC info field is coded according to figure 5.9.2.11 and table 5.9.2.11.

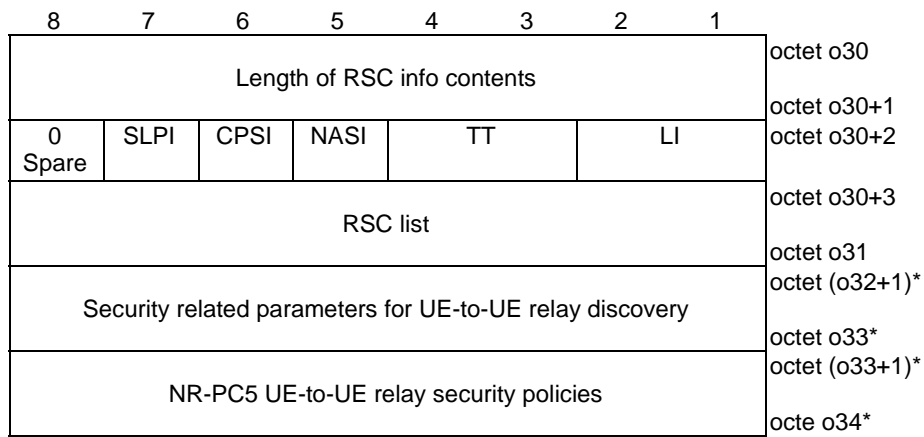

Figure 5.9.2.11: RSC info

Table 5.9.2.11: RSC info

<p>Layer indication (LI) (octet o30+2 bit 1 to 2):</p> <p>Bits</p> <p>2 1</p> <p>0 1 Layer 3</p> <p>1 0 Layer 2</p> <p>Traffic type (TT) (octet o30+2 bit 3 to 4):</p> <p>The traffic type field indicates the traffic type of the relayed service and exists when the LI is set to "Layer 3".</p> <p>Bits</p> <p>4 3</p> <p>0 0 No information</p> <p>0 1 IP</p> <p>1 0 Ethernet</p> <p>1 1 Unstructured</p> <p>Network assistance security indication (NASI) (octet o30+2 bit 5):</p> <p>The network assistance security indication field indicates whether to use the security procedure with network assistance or the security procedure without network assistance as specified in 3GPP TS 33.503 [13].</p> <p>Bit</p> <p>5</p> <p>0 the security procedure without network assistance</p> <p>1 the security procedure with network assistance is used</p> <p>Control plane security indication (CPSI) (octet o30+2 bit 6):</p> <p>The control plane security indication field indicates whether to use the security procedure over control plane as specified in 3GPP TS 33.503 [13], if the network assistance security indication indicates the security procedure with network assistance is to be used.</p> <p>Bit</p> <p>6</p> <p>0 security procedure over control plane is not used</p> <p>1 security procedure over control plane is used</p> <p>Security related parameters indication (SLPI) (octet o30+2 bit 5):</p> <p>The Security related parameters indication indicates whether the security related parameters for UE-to-UE relay discovery field is included or not.</p> <p>Bits</p> <p>5</p> <p>0 The security related parameters for UE-to-UE relay discovery not included</p> <p>1 The security related parameters for UE-to-UE relay discovery included</p> <p>The other values are reserved.</p> <p>RSC list (octet o30+3 to o31):</p> <p>The RSC list field is coded according to figure 5.9.2.12 and table 5.9.2.12.</p> <p>Security related parameters for UE-to-UE relay discovery (octet o32+1 to o33):</p> <p>The security related parameters for UE-to-UE relay discovery field contains the security related parameters for UE-to-UE relay discovery used when the security procedure over control plane as specified in 3GPP TS 33.503 [13] is used and is coded as security related parameters for discovery defined in figure 5.6.2.15 and table 5.6.2.15.</p> <p>NR-PC5 UE-to-UE relay security policies (octet o33+1 to o34):</p> <p>The NR-PC5 UE-to-UE relay security policies are coded as the NR-PC5 unicast security policies defined in figure 5.4.2.36 and table 5.4.2.36.</p>

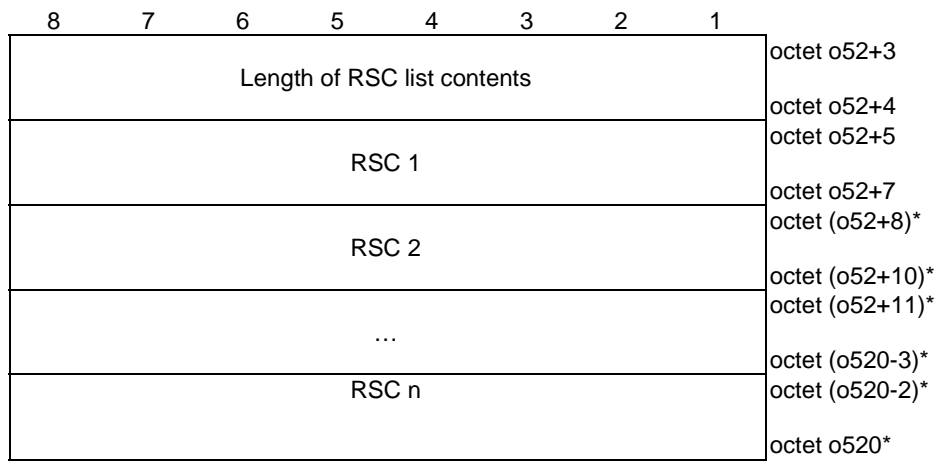

Figure 5.9.2.12: RSC list

Table 5.9.2.12: RSC list

RSC (octet o52+5 to o52+7):
 The RSC identifies a connectivity service the UE-to-UE relay provides. The value of the RSC is a 24-bit long bit string. The values of the RSC from "000001" to "00000F" in hexadecimal representation are spare and shall not be used in this release of specification. The UE shall ignore the spare value of the RSC in this release of specification. For all other values, the format of the RSC is out of scope of this specification.

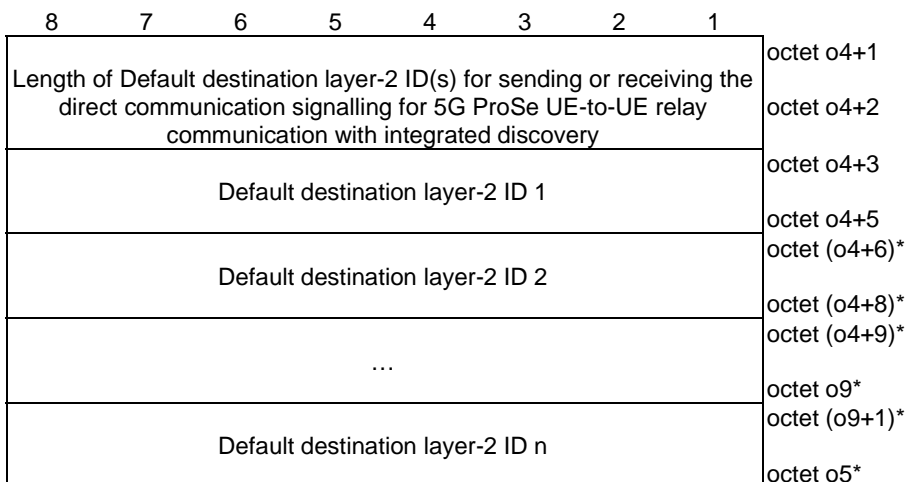

Figure 5.8.2.13: Default destination layer-2 ID(s) for sending or receiving the direct communication signalling for 5G ProSe UE-to-UE relay communication with integrated discovery

Table 5.8.2.13: Default destination layer-2 ID(s) for sending or receiving the direct communication signalling for 5G ProSe UE-to-UE relay communication with integrated discovery

Default destination layer-2 ID (octet o4+3 to o4+5):
 The default destination layer-2 ID is a 24-bit long bit string.

Annex A (informative): Change history

Change history							
Date	Meeting	TDoc	CR	Rev	Cat	Subject/Comment	New version
2021-2	CT1#128e	C1-211187	-	-	-	Draft skeleton provided by the rapporteur.	0.0.0
2021-2	CT1#128e	C1-210884	-	-	-	Implementing the following p-CR agreed by CT1: C1-210884 Editorial change from the rapporteur. Specification number added.	0.1.0
2021-4	CT1#129e	-	-	-	-	Implementing the following p-CR agreed by CT1: C1-212386, C1-212396, C1-212530 Editorial change by the rapporteur.	0.2.0
2021-5	CT1#130e	-	-	-	-	Implementing the following p-CR agreed by CT1: C1-213021, C1-213574, C1-213746 Editorial change by the rapporteur.	0.3.0
2021-8	CT1#131e	-	-	-	-	Implementing the following p-CR agreed by CT1: C1-214796, C1-214797 Editorial change by the rapporteur.	0.4.0
2021-10	CT1#132e	-	-	-	-	Implementing the following p-CR agreed by CT1: C1-215653, C1-216108 Editorial change by the rapporteur.	0.5.0
2021-12	CT#94-e	-	-	-	-	Implementing the following p-CR agreed by CT1: C1-217146, C1-217147 Editorial change by the rapporteur.	1.0.0
2022-01	CT1#133bis-e	-	-	-	-	Implementing the following p-CR agreed by CT1: C1-220067, C1-220068, C1-220743 Correction by rapporteur. Editorial change by the rapporteur.	1.1.0
2022-02	CT1#134e	-	-	-	-	Implementing the following p-CR agreed by CT1: C1-221160, C1-221161, C1-221315, C1-221497, C1-221498, C1-221825, C1-221874 Correction by rapporteur. Editorial change by the rapporteur.	1.2.0
2022-03	CT#95e	-	-	-	-	TS 25.555 v2.0.0 presented to TCT#95e for approval	2.0.0
2022-03	CT#95e	-	-	-	-	TS 25.555 v17.0.0 created by MCC after CT#95e	17.0.0
2022-06	CT#96	CP-221209	0001	3	F	ProSeP update	17.1.0
2022-06	CT#96	CP-221242	0002	1	F	Clarification on coding of path preference mapping rule	17.1.0
2022-06	CT#96	CP-221242	0003	1	F	Encoding of 5G PKMF addressing information	17.1.0
2022-06	CT#96	CP-221242	0004	1	F	Corrections for PC5 security policies and PDU session parameters for layer-3 relay UE in the ProSe policies	17.1.0
2022-06	CT#96	CP-221242	0005	1	F	Defining the ProSe group IP multicast address field	17.1.0
2022-06	CT#96	CP-221209	0009	-	F	Remove range in direct discovery configuration	17.1.0
2022-06	CT#96	CP-221210	0010	1	B	Resolving the EN related to security parameters used for the UE-to-network relay discovery over PC5 interface	17.1.0
2022-06	CT#96	CP-221210	0011	1	F	Remove coding for default destination layer-2 ID in direct communication when provisioning	17.1.0
2022-06	CT#96	CP-221210	0012	1	F	Corrections for the Authorized PLMN lists	17.1.0
2022-06	CT#96	CP-221076	0008	2	B	Encoding of UE policies for 5G ProSe usage reporting	17.1.0
2022-09	CT#97e	CP-222144	0013	1	F	Figure number correction	17.2.0
2022-09	CT#97e	CP-222146	0014	1	B	Introducing the configuration parameter for 5G ProSe UE-to-network relay control plane security solution	17.2.0
2022-09	CT#97e	CP-222146	0015	1	F	Resolving the EN of the security parameters for UE-to-network relay discovery	17.2.0
2022-09	CT#97e	CP-222146	0016	1	F	Fixing encoding, octets numbering and naming of multiple fields and parameters	17.2.0
2022-09	CT#97e	CP-222145	0020	2	F	FQDN of 5G DDNMF in HPLMN in UE policies for 5G ProSe direct discovery	17.2.0
2022-09	CT#97e					Editorial correction done by MCC	17.2.1
2022-12	CT#98e	CP-223149	0021		F	Correction on CPSI	17.3.0
2022-12	CT#98e	CP-223149	0023	1	F	Correcting the reference to FQDN encoding	17.3.0
2022-12	CT#98e	CP-223149	0024	1	F	Supporting PC5 DRX operations for layer-2 UE-to-network relay in the policy configurations	17.3.0
2022-12	CT#98e	CP-223149	0025	2	F	IP address of the 5G DDNMF provisioned by the network	17.3.0
2022-12	CT#98e	CP-223149	0026	1	F	Default DRX for direct link establishment – coding	17.3.0
2022-12	CT#98e	CP-223149	0027	1	F	Optional to provision N3IWF selection information to the UE - coding	17.3.0
2023-03	CT#99	CP-230312	0031	1	F	Coding aspects of adding the mapping of ProSe identifiers to destination layer-2 ID(s) for groupcast	17.4.0
2023-03	CT#99	CP-230312	0030	2	F	Mandate DNN parameter provisioning to L3 U2N relay	17.4.0

2023-03	CT#99	CP-230312	0032	2	F	Coding aspects of introducing the default mapping rules for 5G ProSe direct communication	17.4.0
2023-03	CT#99	CP-230312	0033	2	F	Coding aspects of introducing the default mapping rules for 5G ProSe direct discovery	17.4.0
2023-03	CT#99	CP-230213	0035	1	B	Coding aspects of authorization and provisioning for UE-to-UE Relay	18.0.0
2023-03	CT#99	CP-230285	0029	1	F	Correction on condition description of including PDU session parameters and update of 5G DDNMF FQDN reference	18.0.0
2023-06	CT#100	CP-231211	0037	-	F	Adding the reference for UE policies for 5G ProSe UE-to-UE relay	18.1.0
2023-06	CT#100	CP-231211	0036	1	B	Emergency RSC	18.1.0
2023-06	CT#100	CP-231211	0038	1	F	Updating UE policies for 5G ProSe UE-to-UE relay	18.1.0
2023-06	CT#100	CP-231211	0040	1	F	RSC to traffic type mapping rule for L3 U2U relay	18.1.0
2023-06	CT#100	CP-231211	0042	1	B	Coding aspects of destination layer-2 ID for U2U relay communication with integrated discovery	18.1.0
2023-09	CT#101	CP-232195	0043	-	F	Correction on octet numbering in the figure of coordinate area	18.2.0
2023-09	CT#101	CP-232202	0050	1	F	Provisioning DNN for emergency and non-emergency services, the encoding impact	18.2.0
2023-09	CT#101	CP-232193	0045	1	F	Update the ProSeP for U2N relay for PWS	18.2.0
2023-09	CT#101	CP-232193	0046	1	F	Correct authorization for L2 end UE	18.2.0
2023-09	CT#101	CP-232193	0047	1	F	Add new 5QI and PQI values	18.2.0
2023-09	CT#101	CP-232193	0044	1	F	Remove EN and editorial change	18.2.0
2023-12	CT#102	CP-233129	0056	1	A	Optionality of validity timer for security related parameters for UE-to-network relay discovery	18.3.0
2023-12	CT#102	CP-233130	0058	1	B	The encoding of the UE-to-UE Relay Discovery security materials	18.3.0
2023-12	CT#102	CP-233131	0051	1	F	Update ProSeP for U2U	18.3.0
2023-12	CT#102	CP-233131	0052	2	F	Clarification on security related parameters for discovery	18.3.0
2023-12	CT#102	CP-233131	0053	2	B	Coding aspect of AS and security related configuration parameters for U2U relay	18.3.0
2023-12	CT#102	CP-233131	0059	-	F	Correction on figure and table number	18.3.0
2024-03	CT#103	CP-240088	0061	-	F	Correction to group member discovery parameters field	18.4.0
2024-03	CT#103	CP-240089	0062	-	F	Security policies for U2U	18.4.0
2024-03	CT#103	CP-240089	0063	-	F	Miscellaneous corrections for TS 24.555	18.4.0
2024-03	CT#103	CP-240090	0064	1	F	Correction on UE policies for U2U relay	18.4.0

History

Document history		
V18.4.0	May 2024	Publication