

ETSI TS 125 101 V7.3.0 (2006-03)

Technical Specification

**Universal Mobile Telecommunications System (UMTS);
User Equipment (UE) radio transmission and reception (FDD)
(3GPP TS 25.101 version 7.3.0 Release 7)**



Reference

RTS/TSGR-0425101v730

Keywords

UMTS

ETSI

650 Route des Lucioles
F-06921 Sophia Antipolis Cedex - FRANCE

Tel.: +33 4 92 94 42 00 Fax: +33 4 93 65 47 16

Siret N° 348 623 562 00017 - NAF 742 C
Association à but non lucratif enregistrée à la
Sous-Préfecture de Grasse (06) N° 7803/88

Important notice

Individual copies of the present document can be downloaded from:

<http://www.etsi.org>

The present document may be made available in more than one electronic version or in print. In any case of existing or perceived difference in contents between such versions, the reference version is the Portable Document Format (PDF). In case of dispute, the reference shall be the printing on ETSI printers of the PDF version kept on a specific network drive within ETSI Secretariat.

Users of the present document should be aware that the document may be subject to revision or change of status. Information on the current status of this and other ETSI documents is available at

<http://portal.etsi.org/tb/status/status.asp>

If you find errors in the present document, please send your comment to one of the following services:

http://portal.etsi.org/chaicor/ETSI_support.asp

Copyright Notification

No part may be reproduced except as authorized by written permission.
The copyright and the foregoing restriction extend to reproduction in all media.

© European Telecommunications Standards Institute 2006.
All rights reserved.

DECTTM, **PLUGTESTS**TM and **UMTS**TM are Trade Marks of ETSI registered for the benefit of its Members.
TIPHONTM and the **TIPHON logo** are Trade Marks currently being registered by ETSI for the benefit of its Members.
3GPPTM is a Trade Mark of ETSI registered for the benefit of its Members and of the 3GPP Organizational Partners.

Intellectual Property Rights

IPRs essential or potentially essential to the present document may have been declared to ETSI. The information pertaining to these essential IPRs, if any, is publicly available for **ETSI members and non-members**, and can be found in ETSI SR 000 314: "*Intellectual Property Rights (IPRs); Essential, or potentially Essential, IPRs notified to ETSI in respect of ETSI standards*", which is available from the ETSI Secretariat. Latest updates are available on the ETSI Web server (<http://webapp.etsi.org/IPR/home.asp>).

Pursuant to the ETSI IPR Policy, no investigation, including IPR searches, has been carried out by ETSI. No guarantee can be given as to the existence of other IPRs not referenced in ETSI SR 000 314 (or the updates on the ETSI Web server) which are, or may be, or may become, essential to the present document.

Foreword

This Technical Specification (TS) has been produced by ETSI 3rd Generation Partnership Project (3GPP).

The present document may refer to technical specifications or reports using their 3GPP identities, UMTS identities or GSM identities. These should be interpreted as being references to the corresponding ETSI deliverables.

The cross reference between GSM, UMTS, 3GPP and ETSI identities can be found under <http://webapp.etsi.org/key/queryform.asp>.

Contents

| | |
|---|----|
| Intellectual Property Rights | 2 |
| Foreword..... | 2 |
| Foreword..... | 8 |
| 1 Scope | 9 |
| 2 References | 9 |
| 3 Definitions, symbols and abbreviations | 9 |
| 3.1 Definitions | 9 |
| 3.2 Abbreviations | 10 |
| 4 General | 12 |
| 4.1 Relationship between Minimum Requirements and Test Requirements | 12 |
| 4.2 Power Classes..... | 12 |
| 4.3 Control and monitoring functions | 12 |
| 4.3.1 Minimum requirement | 12 |
| 5 Frequency bands and channel arrangement..... | 12 |
| 5.1 General | 12 |
| 5.2 Frequency bands..... | 12 |
| 5.3 TX–RX frequency separation..... | 13 |
| 5.4 Channel arrangement..... | 13 |
| 5.4.1 Channel spacing | 13 |
| 5.4.2 Channel raster | 13 |
| 5.4.3 Channel number..... | 13 |
| 5.4.4 UARFCN..... | 15 |
| 6 Transmitter characteristics | 15 |
| 6.1 General | 15 |
| 6.2 Transmit power | 15 |
| 6.2.1 UE maximum output power..... | 15 |
| 6.2.2 UE maximum output power with HS-DPCCH and E-DCH..... | 16 |
| 6.3 Frequency Error..... | 16 |
| 6.4 Output power dynamics..... | 17 |
| 6.4.1 Open loop power control | 17 |
| 6.4.1.1 Minimum requirement | 17 |
| 6.4.2 Inner loop power control in the uplink..... | 17 |
| 6.4.2.1 Power control steps | 17 |
| 6.4.2.1.1 Minimum requirement..... | 17 |
| 6.4.3 Minimum output power | 18 |
| 6.4.3.1 Minimum requirement | 18 |
| 6.4.4 Out-of-synchronization handling of output power..... | 18 |
| 6.4.4.1 Minimum requirement | 18 |
| 6.4.4.2 Test case..... | 18 |
| 6.5 Transmit ON/OFF power | 20 |
| 6.5.1 Transmit OFF power..... | 20 |
| 6.5.1.1 Minimum requirement | 20 |
| 6.5.2 Transmit ON/OFF Time mask..... | 20 |
| 6.5.2.1 Minimum requirement | 20 |
| 6.5.3 Change of TFC | 22 |
| 6.5.3.1 Minimum requirement | 22 |
| 6.5.4 Power setting in uplink compressed mode..... | 23 |
| 6.5.4.1 Minimum requirement | 24 |
| 6.5.5 HS-DPCCH..... | 25 |
| 6.5.5.1 Minimum requirement | 25 |
| 6.6 Output RF spectrum emissions..... | 26 |
| 6.6.1 Occupied bandwidth | 26 |

| | | |
|-----------|---|----|
| 6.6.2 | Out of band emission | 26 |
| 6.6.2.1 | Spectrum emission mask | 27 |
| 6.6.2.1.1 | Minimum requirement | 27 |
| 6.6.2.2 | Adjacent Channel Leakage power Ratio (ACLR) | 27 |
| 6.6.2.2.1 | Minimum requirement | 27 |
| 6.6.3 | Spurious emissions | 28 |
| 6.6.3.1 | Minimum requirement | 28 |
| 6.7 | Transmit intermodulation | 30 |
| 6.7.1 | Minimum requirement | 30 |
| 6.8 | Transmit modulation | 30 |
| 6.8.1 | Transmit pulse shape filter | 30 |
| 6.8.2 | Error Vector Magnitude | 31 |
| 6.8.2.1 | Minimum requirement | 31 |
| 6.8.3 | Peak code domain error | 31 |
| 6.8.3.1 | Minimum requirement | 31 |
| 6.8.4 | Phase discontinuity | 31 |
| 6.8.4.1 | Minimum requirement | 32 |
| 7 | Receiver characteristics | 32 |
| 7.1 | General | 32 |
| 7.2 | Diversity characteristics | 32 |
| 7.3 | Reference sensitivity level | 33 |
| 7.3.1 | Minimum requirement | 33 |
| 7.4 | Maximum input level | 33 |
| 7.4.1 | Minimum requirement for DPCH reception | 33 |
| 7.4.2 | Minimum requirement for HS-PDSCH reception | 34 |
| 7.4.2.1 | Minimum requirement for 16QAM | 34 |
| 7.5 | Adjacent Channel Selectivity (ACS) | 34 |
| 7.5.1 | Minimum requirement | 34 |
| 7.6 | Blocking characteristics | 35 |
| 7.6.1 | Minimum requirement (In-band blocking) | 35 |
| 7.6.2 | Minimum requirement (Out of-band blocking) | 36 |
| 7.6.3 | Minimum requirement (Narrow band blocking) | 37 |
| 7.7 | Spurious response | 37 |
| 7.7.1 | Minimum requirement | 37 |
| 7.8 | Intermodulation characteristics | 37 |
| 7.8.1 | Minimum requirement | 37 |
| 7.8.2 | Minimum requirement (Narrow band) | 38 |
| 7.9 | Spurious emissions | 38 |
| 7.9.1 | Minimum requirement | 38 |
| 8 | Performance requirement | 40 |
| 8.1 | General | 40 |
| 8.2 | Demodulation in static propagation conditions | 40 |
| 8.2.1 | (void) | 40 |
| 8.2.2 | Demodulation of Forward Access Channel (FACH) | 40 |
| 8.2.3 | Demodulation of Dedicated Channel (DCH) | 40 |
| 8.2.3.1 | Minimum requirement | 40 |
| 8.3 | Demodulation of DCH in multi-path fading propagation conditions | 41 |
| 8.3.1 | Single Link Performance | 41 |
| 8.3.1.1 | Minimum requirement | 41 |
| 8.4 | Demodulation of DCH in moving propagation conditions | 43 |
| 8.4.1 | Single link performance | 43 |
| 8.4.1.1 | Minimum requirement | 44 |
| 8.5 | Demodulation of DCH in birth-death propagation conditions | 44 |
| 8.5.1 | Single link performance | 44 |
| 8.5.1.1 | Minimum requirement | 44 |
| 8.6 | Demodulation of DCH in downlink Transmit diversity modes | 45 |
| 8.6.1 | Demodulation of DCH in open-loop transmit diversity mode | 45 |
| 8.6.1.1 | Minimum requirement | 45 |
| 8.6.2 | Demodulation of DCH in closed loop transmit diversity mode | 45 |
| 8.6.2.1 | Minimum requirement | 45 |

| | | |
|-----------|--|----|
| 8.6.3 | Void | 46 |
| 8.7 | Demodulation in Handover conditions..... | 46 |
| 8.7.1 | Demodulation of DCH in Inter-Cell Soft Handover | 46 |
| 8.7.1.1 | Minimum requirement | 46 |
| 8.7.2 | Combining of TPC commands from radio links of different radio link sets..... | 47 |
| 8.7.2.1 | Minimum requirement | 47 |
| 8.7.3 | Combining of reliable TPC commands from radio links of different radio link sets | 47 |
| 8.7.3.1 | Minimum requirement | 47 |
| 8.8 | Power control in downlink | 48 |
| 8.8.1 | Power control in the downlink, constant BLER target | 48 |
| 8.8.1.1 | Minimum requirements | 48 |
| 8.8.2 | Power control in the downlink, initial convergence..... | 49 |
| 8.8.2.1 | Minimum requirements | 49 |
| 8.8.3 | Power control in downlink, wind up effects | 50 |
| 8.8.3.1 | Minimum requirements | 50 |
| 8.8.4 | Power control in the downlink, different transport formats | 50 |
| 8.8.4.1 | Minimum requirements | 50 |
| 8.8.5 | Power control in the downlink for F-DPCH | 51 |
| 8.8.5.1 | Minimum requirements | 51 |
| 8.9 | Downlink compressed mode | 52 |
| 8.9.1 | Single link performance | 52 |
| 8.9.1.1 | Minimum requirements | 52 |
| 8.10 | Blind transport format detection..... | 53 |
| 8.10.1 | Minimum requirement | 53 |
| 8.11 | Detection of Broadcast channel (BCH) | 54 |
| 8.11.1 | Minimum requirement without transmit diversity | 54 |
| 8.11.2 | Minimum requirement with open loop transmit diversity | 54 |
| 8.12 | Demodulation of Paging Channel (PCH) | 55 |
| 8.12.1 | Minimum requirement | 55 |
| 8.13 | Detection of Acquisition Indicator (AI) | 55 |
| 8.13.1 | Minimum requirement | 56 |
| 8.14 | Void..... | 56 |
| 8.15 | Void..... | 56 |
| 8.16 | Void..... | 56 |
| 9 | Performance requirement (HSDPA) | 57 |
| 9.1 | Void | 57 |
| 9.2 | Demodulation of HS-DSCH (Fixed Reference Channel)..... | 57 |
| 9.2.1 | Single Link performance | 59 |
| 9.2.1.1 | Requirement QPSK, Fixed Reference Channel (FRC) H-Set 1/2/3 | 59 |
| 9.2.1.2 | Requirement 16QAM, Fixed Reference Channel (FRC) H-Set 1/2/3 | 60 |
| 9.2.1.3 | Minimum requirement QPSK, Fixed Reference Channel (FRC) H-Set 4/5..... | 61 |
| 9.2.1.4 | Requirement QPSK, Fixed Reference Channel (FRC) H-Set 6 | 62 |
| 9.2.1.5 | Requirement 16QAM, Fixed Reference Channel (FRC) H-Set 6 | 64 |
| 9.2.2 | Open Loop Diversity performance | 65 |
| 9.2.2.1 | Requirement QPSK, Fixed Reference Channel (FRC) H-Set 1/2/3 | 65 |
| 9.2.2.2 | Requirement 16QAM, Fixed Reference Channel (FRC) H-Set 1/2/3 | 66 |
| 9.2.2.3 | Minimum requirement QPSK, Fixed Reference Channel (FRC) H-Set 4/5..... | 67 |
| 9.2.3 | Closed Loop Diversity Performance..... | 68 |
| 9.2.3.1 | Requirement QPSK, Fixed Reference Channel (FRC) H-Set 1/2/3 | 68 |
| 9.2.3.2 | Requirement 16QAM, Fixed Reference Channel (FRC) H-Set 1/2/3 | 70 |
| 9.2.3.3 | Minimum requirement QPSK, Fixed Reference Channel (FRC) H-Set 4/5..... | 71 |
| 9.2.3.4 | Requirement QPSK, Fixed Reference Channel (FRC) H-Set 6 | 72 |
| 9.2.3.5 | Requirement 16QAM, Fixed Reference Channel (FRC) H-Set 6 | 72 |
| 9.3 | Reporting of Channel Quality Indicator | 73 |
| 9.3.1 | Single Link Performance | 73 |
| 9.3.1.1 | AWGN propagation conditions | 73 |
| 9.3.1.1.1 | Minimum Requirement – UE capability categories 1-8 and 11, 12..... | 73 |
| 9.3.1.2 | Fading propagation conditions | 74 |
| 9.3.1.2.1 | Minimum Requirement – UE capability categories 1-8 and 11, 12..... | 74 |
| 9.3.2 | Open Loop Diversity Performance | 75 |
| 9.3.2.1 | AWGN propagation conditions | 75 |

| | | |
|-----------------------------|--|-----------|
| 9.3.2.1.1 | Minimum Requirement - UE capability categories 1-8 and 11, 12 | 75 |
| 9.3.2.2 | Fading propagation conditions | 76 |
| 9.3.2.2.1 | Minimum Requirement – UE capability categories 1-8 and 11, 12..... | 76 |
| 9.3.3 | Closed Loop Diversity Performance | 77 |
| 9.3.3.1 | AWGN propagation conditions | 77 |
| 9.3.3.1.1 | Minimum Requirement - UE capability categories 1-8 and 11, 12 | 77 |
| 9.3.3.2 | Fading propagation conditions | 78 |
| 9.3.3.2.1 | Minimum Requirement – UE capability categories 1-8 and 11, 12..... | 78 |
| 9.4 | HS-SCCH Detection Performance | 79 |
| 9.4.1 | Single Link Performance | 79 |
| 9.4.2 | Open Loop Diversity Performance | 80 |
| 10 | Performance requirement (E-DCH) | 81 |
| 10.1 | General | 81 |
| 10.2 | Detection of E-DCH HARQ ACK Indicator Channel (E-HICH)..... | 82 |
| 10.2.1 | Single link performance | 82 |
| 10.2.1.1 | Minimum requirement | 82 |
| 10.2.2 | Detection in Inter-Cell Handover conditions | 83 |
| 10.2.2.1 | Minimum requirement for RLS not containing the Serving E-DCH cell..... | 83 |
| 10.2.2.2 | Minimum requirement for RLS containing the serving E-DCH cell | 84 |
| 10.3 | Detection of E-DCH Relative Grant Channel (E-RGCH) | 85 |
| 10.3.1 | Single link performance | 85 |
| 10.3.1.1 | Minimum requirement | 85 |
| 10.3.2 | Detection in Inter-Cell Handover conditions | 86 |
| 10.3.2.1 | Minimum requirement for Non-serving E-DCH RL..... | 86 |
| 10.4 | Demodulation of E-DCH Absolute Grant Channel (E-AGCH) | 87 |
| 10.4.1 | Single link performance | 87 |
| 10.4.1.1 | Minimum requirement | 87 |
| 11 | Performance requirement (MBMS)..... | 87 |
| 11.1 | Demodulation of MCCH | 87 |
| 11.1.1 | Minimum requirement | 87 |
| 11.2 | Demodulation of MTCH | 88 |
| 11.2.1 | Minimum requirement | 88 |
| 11.3 | Demodulation of MTCH and cell identification..... | 88 |
| 11.3.1 | Minimum requirement | 89 |
| Annex A (normative): | Measurement channels..... | 90 |
| A.1 | General | 90 |
| A.2 | UL reference measurement channel | 90 |
| A.2.1 | UL reference measurement channel (12.2 kbps) | 90 |
| A.2.2 | UL reference measurement channel (64 kbps) | 91 |
| A.2.3 | UL reference measurement channel (144 kbps) | 92 |
| A.2.4 | UL reference measurement channel (384 kbps) | 93 |
| A.2.5 | UL reference measurement channel (768 kbps) | 94 |
| A.3 | DL reference measurement channel | 95 |
| A.3.0 | DL reference measurement channel (0 kbps) | 95 |
| A.3.1 | DL reference measurement channel (12.2 kbps) | 96 |
| A.3.2 | DL reference measurement channel (64 kbps) | 97 |
| A.3.3 | DL reference measurement channel (144 kbps) | 98 |
| A.3.4 | DL reference measurement channel (384 kbps) | 99 |
| A.3.5 | DL reference measurement channel 2 (64 kbps) | 100 |
| A.4 | DL reference measurement channel for BTFD performance requirements | 101 |
| A.4A | Void..... | 103 |
| A.5 | DL reference compressed mode parameters..... | 103 |
| A.6 | DL reference parameters for PCH tests..... | 104 |
| A.7 | DL reference channel parameters for HSDPA tests | 105 |
| A.7.1 | Fixed Reference Channel (FRC) | 105 |

| | | |
|---|---|------------|
| A.7.1.1 | Fixed Reference Channel Definition H-Set 1 | 105 |
| A.7.1.2 | Fixed Reference Channel Definition H-Set 2 | 106 |
| A.7.1.3 | Fixed Reference Channel Definition H-Set 3 | 107 |
| A.7.1.4 | Fixed Reference Channel Definition H-Set 4 | 108 |
| A.7.1.5 | Fixed Reference Channel Definition H-Set 5 | 109 |
| A.7.1.6 | Fixed Reference Channel Definition H-Set 6 | 109 |
| A.8 | DL reference parameters for MBMS tests..... | 110 |
| A.8.1 | MCCH | 110 |
| A.8.1 | MTCH | 111 |
| A.9 | DL reference parameters for combined MTCH demodulation and cell identification..... | 111 |
| Annex B (normative): Propagation conditions..... | | 113 |
| B.1 | General | 113 |
| B.2 | Propagation Conditions | 113 |
| B.2.1 | Static propagation condition..... | 113 |
| B.2.2 | Multi-path fading propagation conditions | 113 |
| B.2.3 | Moving propagation conditions..... | 115 |
| B.2.4 | Birth-Death propagation conditions | 115 |
| Annex C (normative): Downlink Physical Channels..... | | 117 |
| C.1 | General | 117 |
| C.2 | Connection Set-up | 117 |
| C.3 | During connection | 117 |
| C.3.1 | Measurement of Rx Characteristics..... | 117 |
| C.3.2 | Measurement of Performance requirements..... | 118 |
| C.3.3 | Connection with open-loop transmit diversity mode..... | 119 |
| C.3.4 | Connection with closed loop transmit diversity mode..... | 119 |
| C.3.5 | Void..... | 120 |
| C.4 | W-CDMA Modulated Interferer | 121 |
| C.5 | HSDPA DL Physical channels | 121 |
| C.5.1 | Downlink Physical Channels connection set-up..... | 121 |
| C.5.2 | OCNS Definition..... | 126 |
| C.6 | MBMS DL Physical channels | 127 |
| C.6.1 | Downlink Physical Channels connection set-up..... | 127 |
| Annex D (normative): Environmental conditions | | 128 |
| D.1 | General | 128 |
| D.2 | Environmental requirements | 128 |
| D.2.1 | Temperature | 128 |
| D.2.2 | Voltage | 128 |
| D.2.3 | Vibration..... | 129 |
| Annex E (informative): UARFCN numbers | | 130 |
| E.1 | General | 130 |
| E.2 | List of UARFCN used for UTRA FDD bands | 130 |
| Annex F (informative): Change history | | 132 |
| History | | 141 |

Foreword

This Technical Specification (TS) has been produced by the 3rd Generation Partnership Project (3GPP).

The contents of the present document are subject to continuing work within the TSG and may change following formal TSG approval. Should the TSG modify the contents of the present document, it will be re-released by the TSG with an identifying change of release date and an increase in version number as follows:

Version x.y.z

where:

- x the first digit:
 - 1 presented to TSG for information;
 - 2 presented to TSG for approval;
 - 3 or greater indicates TSG approved document under change control.
- y the second digit is incremented for all changes of substance, i.e. technical enhancements, corrections, updates, etc.
- z the third digit is incremented when editorial only changes have been incorporated in the document.

1 Scope

The present document establishes the minimum RF characteristics of the FDD mode of UTRA for the User Equipment (UE).

2 References

The following documents contain provisions which, through reference in this text, constitute provisions of the present document.

- References are either specific (identified by date of publication, edition number, version number, etc.) or non-specific.
- For a specific reference, subsequent revisions do not apply.
- For a non-specific reference, the latest version applies. In the case of a reference to a 3GPP document (including a GSM document), a non-specific reference implicitly refers to the latest version of that document *in the same Release as the present document*.

- | | |
|-----|--|
| [1] | (void) |
| [2] | ITU-R Recommendation SM.329: " Unwanted emissions in the spurious domain ". |
| [3] | (void) |
| [4] | 3GPP TS 25.433: "UTRAN Iub Interface NBAP Signalling". |
| [5] | ETSI ETR 273: "Electromagnetic compatibility and Radio spectrum Matters (ERM); Improvement of radiated methods of measurement (using test sites) and evaluation of the corresponding measurement uncertainties; Part 1: Uncertainties in the measurement of mobile radio equipment characteristics; Sub-part 2: Examples and annexes". |
| [6] | 3GPP TS 45.004: "Digital cellular telecommunications system (Phase 2+); Modulation". |
| [7] | 3GPP TS 25.331: 'Radio Resource Control (RRC); Protocol Specification' |
| [8] | 3GPP TS25.214: 'Physical layer procedures (FDD) |
-

3 Definitions, symbols and abbreviations

3.1 Definitions

For the purposes of the present document, the following definitions apply:

Enhanced performance requirements type 1: This defines performance requirements which are optional for the UE. The requirements are based on UEs which utilise receiver diversity.

Enhanced performance requirements type 2: This defines performance requirements which are optional for the UE. The requirements are based on UEs which utilise a chip equaliser receiver structure.

Power Spectral Density: The units of Power Spectral Density (PSD) are extensively used in this document. PSD is a function of power versus frequency and when integrated across a given bandwidth, the function represents the mean power in such a bandwidth. When the mean power is normalised to (divided by) the chip-rate it represents the mean energy per chip. Some signals are directly defined in terms of energy per chip, (DPCH_ E_c , E_c , OCNS_ E_c and S-CCPCH_ E_c) and others defined in terms of PSD (I_o , I_{oc} , I_{or} and \hat{I}_{or}). There also exist quantities that are a ratio of energy per chip to PSD (DPCH_ E_c/I_{or} , E_c/I_{or} etc.). This is the common practice of relating energy magnitudes in communication systems.

It can be seen that if both energy magnitudes in the ratio are divided by time, the ratio is converted from an energy ratio

to a power ratio, which is more useful from a measurement point of view. It follows that an energy per chip of X dBm/3.84 MHz can be expressed as a mean power per chip of X dBm. Similarly, a signal PSD of Y dBm/3.84 MHz can be expressed as a signal power of Y dBm.

Maximum Output Power: This is a measure of the maximum power the UE can transmit (i.e. the actual power as would be measured assuming no measurement error) in a bandwidth of at least $(1 + \alpha)$ times the chip rate of the radio access mode. The period of measurement shall be at least one timeslot.

Mean power: When applied to a W-CDMA modulated signal this is the power (transmitted or received) in a bandwidth of at least $(1 + \alpha)$ times the chip rate of the radio access mode. The period of measurement shall be at least one timeslot unless otherwise stated.

Nominal Maximum Output Power: This is the nominal power defined by the UE power class.

RRC filtered mean power: The mean power as measured through a root raised cosine filter with roll-off factor α and a bandwidth equal to the chip rate of the radio access mode.

NOTE 1: The RRC filtered mean power of a perfectly modulated W-CDMA signal is 0.246 dB lower than the mean power of the same signal.

NOTE 2: The roll-off factor α is defined in section 6.8.1.

Throughput: Number of information bits per second excluding CRC bits successfully received on HS-DSCH by a HSDPA capable UE.

3.2 Abbreviations

For the purposes of the present document, the following abbreviations apply:

| | |
|----------------------------|--|
| ACLR | Adjacent Channel Leakage power Ratio |
| ACS | Adjacent Channel Selectivity |
| AICH | Acquisition Indication Channel |
| BER | Bit Error Ratio |
| BLER | Block Error Ratio |
| CQI | Channel Quality Indicator |
| CW | Continuous Wave (un-modulated signal) |
| DCH | Dedicated Channel, which is mapped into Dedicated Physical Channel. |
| DL | Down Link (forward link) |
| DTX | Discontinuous Transmission |
| DPCCH | Dedicated Physical Control Channel |
| DPCH | Dedicated Physical Channel |
| $DPCH_E_c$ | Average energy per PN chip for DPCH. |
| $\frac{DPCH_E_c}{I_{or}}$ | The ratio of the transmit energy per PN chip of the DPCH to the total transmit power spectral density at the Node B antenna connector. |
| DPDCH | Dedicated Physical Data Channel |
| E-DCH | Enhanced Dedicated Channel |
| E-AGCH | E-DCH Absolute Grant Channel |
| E-HICH | E-DCH HARQ ACK Indicator Channel |
| E-RGCH | E-DCH Relative Grant Channel |
| EIRP | Effective Isotropic Radiated Power |
| E_c | Average energy per PN chip. |
| $\frac{E_c}{I_{or}}$ | The ratio of the average transmit energy per PN chip for different fields or physical channels to the total transmit power spectral density. |
| FACH | Forward Access Channel |
| FDD | Frequency Division Duplex |
| FDR | False transmit format Detection Ratio. A false Transport Format detection occurs when the receiver detects a different TF to that which was transmitted, and the decoded transport block(s) for this incorrect TF passes the CRC check(s). |

| | |
|---------------------------------|---|
| F_{uw} | Frequency of unwanted signal. This is specified in bracket in terms of an absolute frequency(s) or a frequency offset from the assigned channel frequency. |
| HARQ | Hybrid Automatic Repeat Request |
| HSDPA | High Speed Downlink Packet Access |
| HS-DSCH | High Speed Downlink Shared Channel |
| HS-PDSCH | High Speed Physical Downlink Shared Channel |
| HS-SCCH | High Speed Shared Control Channel |
| Information Data Rate | Rate of the user information, which must be transmitted over the Air Interface. For example, output rate of the voice codec. |
| I_o | The total received power spectral density, including signal and interference, as measured at the UE antenna connector. |
| I_{oc} | The power spectral density (integrated in a noise bandwidth equal to the chip rate and normalized to the chip rate) of a band limited white noise source (simulating interference from cells, which are not defined in a test procedure) as measured at the UE antenna connector. |
| I_{or} | The total transmit power spectral density (integrated in a bandwidth of $(1+\alpha)$ times the chip rate and normalized to the chip rate) of the downlink signal at the Node B antenna connector. |
| \hat{I}_{or} | The received power spectral density (integrated in a bandwidth of $(1+\alpha)$ times the chip rate and normalized to the chip rate) of the downlink signal as measured at the UE antenna connector. |
| MER | Message Error Ratio |
| Node B | A logical node responsible for radio transmission / reception in one or more cells to/from the User Equipment. Terminates the Iub interface towards the RNC |
| OCNS | Orthogonal Channel Noise Simulator, a mechanism used to simulate the users or control signals on the other orthogonal channels of a downlink link. |
| $OCNS_{-E_c}$ | Average energy per PN chip for the OCNS. |
| $\frac{OCNS_{-E_c}}{I_{or}}$ | The ratio of the average transmit energy per PN chip for the OCNS to the total transmit power spectral density. |
| P-CCPCH | Primary Common Control Physical Channel |
| PCH | Paging Channel |
| $P-CCPCH \frac{E_c}{I_o}$ | The ratio of the received P-CCPCH energy per chip to the total received power spectral density at the UE antenna connector. |
| $\frac{P-CCPCH_{-E_c}}{I_{or}}$ | The ratio of the average transmit energy per PN chip for the P-CCPCH to the total transmit power spectral density. |
| P-CPICH | Primary Common Pilot Channel |
| PICH | Paging Indicator Channel |
| PPM | Parts Per Million |
| R | Number of information bits per second excluding CRC bits successfully received on HS-DSCH by a HSDPA capable UE. |
| <REFSENS> | Reference sensitivity |
| <REF \hat{I}_{or} > | Reference \hat{I}_{or} |
| RACH | Random Access Channel |
| SCH | Synchronization Channel consisting of Primary and Secondary synchronization channels |
| $S-CCPCH$ | Secondary Common Control Physical Channel. |
| $S-CCPCH_{-E_c}$ | Average energy per PN chip for S-CCPCH. |
| SG | Serving Grant |
| SIR | Signal to Interference ratio |
| SML | Soft Metric Location (Soft channel bit) |
| STTD | Space Time Transmit Diversity |
| TDD | Time Division Duplexing |
| TFC | Transport Format Combination |
| TFCI | Transport Format Combination Indicator |
| TPC | Transmit Power Control |
| TSTD | Time Switched Transmit Diversity |
| UE | User Equipment |

UL Up Link (reverse link)
UTRA UMTS Terrestrial Radio Access

4 General

4.1 Relationship between Minimum Requirements and Test Requirements

The Minimum Requirements given in this specification make no allowance for measurement uncertainty. The test specification 34.121 Annex F defines Test Tolerances. These Test Tolerances are individually calculated for each test. The Test Tolerances are used to relax the Minimum Requirements in this specification to create Test Requirements.

The measurement results returned by the test system are compared – without any modification - against the Test Requirements as defined by the shared risk principle.

The Shared Risk principle is defined in ETR 273 Part 1 sub-part 2 section 6.5.

4.2 Power Classes

For UE power classes 1 and 2, a number of RF parameter are not specified. It is intended that these are part of a later release.

4.3 Control and monitoring functions

This requirement verifies that the control and monitoring functions of the UE prevent it from transmitting if no acceptable cell can be found by the UE.

4.3.1 Minimum requirement

The power of the UE, as measured with a thermal detector, shall not exceed -30dBm if no acceptable cell can be found by the UE.

5 Frequency bands and channel arrangement

5.1 General

The information presented in this subclause is based on a chip rate of 3.84 Mcps.

NOTE: Other chip rates may be considered in future releases.

5.2 Frequency bands

a) UTRA/FDD is designed to operate in the following paired bands:

Table 5.0: UTRA FDD frequency bands

| Operating Band | UL Frequencies UE transmit, Node B receive | DL frequencies UE receive, Node B transmit |
|----------------|---|---|
| I | 1920 – 1980 MHz | 2110 –2170 MHz |
| II | 1850 –1910 MHz | 1930 –1990 MHz |
| III | 1710-1785 MHz | 1805-1880 MHz |
| IV | 1710-1755 MHz | 2110-2155 MHz |
| V | 824 – 849 MHz | 869-894 MHz |
| VI | 830-840 MHz | 875-885 MHz |
| VII | 2500-2570 MHz | 2620-2690 MHz |
| VIII | 880 – 915 MHz | 925 – 960 MHz |
| IX | 1749.9-1784.9 MHz | 1844.9-1879.9 MHz |

- b) Deployment in other frequency bands is not precluded

5.3 TX–RX frequency separation

- a) UTRA/FDD is designed to operate with the following TX-RX frequency separation

Table 5.0A: TX-RX frequency separation

| Operating Band | TX-RX frequency separation |
|----------------|----------------------------|
| I | 190 MHz |
| II | 80 MHz. |
| III | 95 MHz. |
| IV | 400 MHz |
| V | 45 MHz |
| VI | 45 MHz |
| VII | 120 MHz |
| VIII | 45 MHz |
| IX | 95 MHz |

- b) UTRA/FDD can support both fixed and variable transmit to receive frequency separation.
- c) The use of other transmit to receive frequency separations in existing or other frequency bands shall not be precluded.

5.4 Channel arrangement

5.4.1 Channel spacing

The nominal channel spacing is 5 MHz, but this can be adjusted to optimise performance in a particular deployment scenario.

5.4.2 Channel raster

The channel raster is 200 kHz, for all bands which means that the centre frequency must be an integer multiple of 200 kHz. In addition a number of additional centre frequencies are specified according to table 5.1A, which means that the centre frequencies for these channels are shifted 100 kHz relative to the general raster.

5.4.3 Channel number

The carrier frequency is designated by the UTRA Absolute Radio Frequency Channel Number (UARFCN). For each operating Band, theUARFCN values are defined as follows:

Uplink: $N_U = 5 * (F_{UL} - F_{UL_Offset})$, for the carrier frequency range $F_{UL_low} \leq F_{UL} \leq F_{UL_high}$

Downlink: $N_D = 5 * (F_{DL} - F_{DL_Offset})$, for the carrier frequency range $F_{DL_low} \leq F_{DL} \leq F_{DL_high}$

For each operating Band, F_{UL_Offset} , F_{UL_low} , F_{UL_high} , F_{DL_Offset} , F_{DL_low} and F_{DL_high} are defined in Table 5.1 for the general UARFCN. For the additional UARFCN, F_{UL_Offset} , F_{DL_Offset} and the specific F_{UL} and F_{DL} are defined in Table 5.1A.

Table 5.1: UARFCN definition (general)

| Band | UPLINK (UL) UE transmit, Node B receive | | | DOWNLINK (DL) UE receive, Node B transmit | | |
|------|--|---|----------------|--|---|----------------|
| | UARFCN formula offset F_{UL_Offset} [MHz] | Carrier frequency (F_{UL}) range [MHz] | | UARFCN formula offset F_{DL_Offset} [MHz] | Carrier frequency (F_{DL}) range [MHz] | |
| | | F_{UL_low} | F_{UL_high} | | F_{DL_low} | F_{DL_high} |
| I | 0 | 1922.4 | 1977.6 | 0 | 2112.4 | 2167.6 |
| II | 0 | 1852.4 | 1907.6 | 0 | 1932.4 | 1987.6 |
| III | 1525 | 1712.4 | 1782.6 | 1575 | 1807.4 | 1877.6 |
| IV | 1450 | 1712.4 | 1752.6 | 1805 | 2112.4 | 2152.6 |
| V | 0 | 826.4 | 846.6 | 0 | 871.4 | 891.6 |
| VI | 0 | 832.4 | 837.6 | 0 | 877.4 | 882.6 |
| VII | 2100 | 2502.4 | 2567.6 | 2175 | 2622.4 | 2687.6 |
| VIII | 340 | 882.4 | 912.6 | 340 | 927.4 | 957.6 |
| IX | 0 | 1752.4 | 1782.4 | 0 | 1847.4 | 1877.4 |

Table 5.1A: UARFCN definition (additional channels)

| Band | UPLINK (UL) UE transmit, Node B receive | | DOWNLINK (DL) UE receive, Node B transmit | |
|------|--|--|--|--|
| | UARFCN formula offset F_{UL_Offset} [MHz] | Carrier frequency (F_{UL}) [MHz] | UARFCN formula offset F_{DL_Offset} [MHz] | Carrier frequency (F_{DL}) [MHz] |
| I | - | - | - | - |
| II | 1850.1 | 1852.5, 1857.5, 1862.5, 1867.5, 1872.5, 1877.5, 1882.5, 1887.5, 1892.5, 1897.5, 1902.5, 1907.5 | 1850.1 | 1932.5, 1937.5, 1942.5, 1947.5, 1952.5, 1957.5, 1962.5, 1967.5, 1972.5, 1977.5, 1982.5, 1987.5 |
| III | - | - | - | - |
| IV | 1380.1 | 1712.5, 1717.5, 1722.5, 1727.5, 1732.5, 1737.5, 1742.5, 1747.5, 1752.5 | 1735.1 | 2112.5, 2117.5, 2122.5, 2127.5, 2132.5, 2137.5, 2142.5, 2147.5, 2152.5 |
| V | 670.1 | 826.5, 827.5, 831.5, 832.5, 837.5, 842.5 | 670.1 | 871.5, 872.5, 876.5, 877.5, 882.5, 887.5 |
| VI | 670.1 | 832.5, 837.5 | 670.1 | 877.5, 882.5 |
| VII | 2030.1 | 2502.5, 2507.5, 2512.5, 2517.5, 2522.5, 2527.5, 2532.5, 2537.5, 2542.5, 2547.5, 2552.5, 2557.5, 2562.5, 2567.5 | 2105.1 | 2622.5, 2627.5, 2632.5, 2637.5, 2642.5, 2647.5, 2652.5, 2657.5, 2662.5, 2667.5, 2672.5, 2677.5, 2682.5, 2687.5 |
| VIII | - | - | - | - |
| IX | - | - | - | - |

5.4.4 UARFCN

The following UARFCN range shall be supported for each paired band

Table 5.2: UTRA Absolute Radio Frequency Channel Number

| Band | Uplink (UL) UE transmit, Node B receive | | Downlink (DL) UE receive, Node B transmit | |
|------|--|---|--|--|
| | General | Additional | General | Additional |
| I | 9612 to 9888 | - | 10562 to 10838 | - |
| II | 9262 to 9538 | 12, 37, 62, 87, 112, 137, 162, 187, 212, 237, 262, 287 | 9662 to 9938 | 412, 437, 462, 487, 512, 537, 562, 587, 612, 637, 662, 687 |
| III | 937 to 1288 | - | 1162 to 1513 | - |
| IV | 1312 to 1513 | 1662, 1687, 1712, 1737, 1762, 1787, 1812, 1837, 1862 | 1537 to 1738 | 1887, 1912, 1937, 1962, 1987, 2012, 2037, 2062, 2087 |
| V | 4132 to 4233 | 782, 787, 807, 812, 837, 862 | 4357 to 4458 | 1007, 1012, 1032, 1037, 1062, 1087 |
| VI | 4162 to 4188 | 812, 837 | 4387 to 4413 | 1037, 1062 |
| VII | 2012 to 2338 | 2362, 2387, 2412, 2437, 2462, 2487, 2512, 2537, 2562, 2587, 2612, 2637, 2662, 2687 | 2237 to 2563 | 2587, 2612, 2637, 2662, 2687, 2712, 2737, 2762, 2787, 2812, 2837, 2862, 2887, 2912 |
| VIII | 2712 to 2863 | - | 2937 to 3088 | - |
| IX | 8762 to 8912 | - | 9237 to 9387 | - |

NOTE: If the UE is on a network with Mobile Country Code set to Japan then it may assume that any DL UARFCN sent by the network from the overlapping region of Band V and Band VI is from Band VI. If the UE is on a network with a Mobile Country Code other than Japan then it may assume that any DL UARFCN sent by the network from the overlapping region of Band V and Band VI is from Band V.

6 Transmitter characteristics

6.1 General

Unless otherwise stated, the transmitter characteristics are specified at the antenna connector of the UE. For UE with integral antenna only, a reference antenna with a gain of 0 dBi is assumed. Transmitter characteristics for UE(s) with multiple antennas/antenna connectors are FFS.

The UE antenna performance has a significant impact on system performance, and minimum requirements on the antenna efficiency are therefore intended to be included in future versions of the present document. It is recognised that different requirements and test methods are likely to be required for the different types of UE.

6.2 Transmit power

6.2.1 UE maximum output power

The following Power Classes define the nominal maximum output power. The nominal power defined is the broadband transmit power of the UE, i.e. the power in a bandwidth of at least $(1+\alpha)$ times the chip rate of the radio access mode. The period of measurement shall be at least one timeslot.

Table 6.1: UE Power Classes

| Operating Band | Power Class 1 | | Power Class 2 | | Power Class 3 | | Power Class 3bis | | Power Class 4 | |
|----------------|---------------|----------|---------------|----------|---------------|----------|------------------|----------|---------------|----------|
| | Power (dBm) | Tol (dB) | Power (dBm) | Tol (dB) | Power (dBm) | Tol (dB) | Power (dBm) | Tol (dB) | Power (dBm) | Tol (dB) |
| Band I | +33 | +1/-3 | +27 | +1/-3 | +24 | +1/-3 | - | - | +21 | +2/-2 |
| Band II | - | - | - | - | +24 | +1/-3 | - | - | +21 | +2/-2 |
| Band III | - | - | - | - | +24 | +1/-3 | - | - | +21 | +2/-2 |
| Band IV | - | - | - | - | +24 | +1/-3 | - | - | +21 | +2/-2 |
| Band V | - | - | - | - | +24 | +1/-3 | - | - | +21 | +2/-2 |
| Band VI | - | - | - | - | +24 | +1/-3 | - | - | +21 | +2/-2 |
| Band VII | - | - | - | - | +24 | +1/-3 | 23 | +2/-2 | +21 | +2/-2 |
| Band VIII | - | - | - | - | +24 | +1/-3 | +23 | +2/-2 | +21 | +2/-2 |
| Band IX | - | - | - | - | +24 | +1/-3 | - | - | +21 | +2/-2 |

NOTE: The tolerance allowed for the nominal maximum output power applies even for the multi-code DPDCH transmission mode.

6.2.2 UE maximum output power with HS-DPCCH and E-DCH

The Maximum Power Reduction (MPR) for the nominal maximum output power defined in 6.2.1 is specified in table 6.1A for the values of β_c , β_d , β_{hs} , β_{ec} and β_{ed} defined in [8] fully or partially transmitted during a DPCCH timeslot

Table 6.1A: UE maximum output power with HS-DPCCH and E-DCH

| UE transmit channel configuration | CM (dB) | MPR (dB) |
|--|----------------------|---------------|
| For all combinations of; DPDCH, DPCCH, HS-DPCCH, E-DPDCH and E-DPCCH | $0 \leq CM \leq 3.5$ | MAX (CM-1, 0) |
| Note 1: CM = 1 for $\beta_c/\beta_d=12/15$, $\beta_{hs}/\beta_{ec}=24/15$. For all other combinations of DPDCH, DPCCH, HS-DPCCH, E-DPDCH and E-DPCCH the MPR is based on the relative CM difference. | | |

Where Cubic Metric (CM) is based on the UE transmit channel configuration and is given by

$$CM = \text{CEIL} \{ [20 * \log_{10} ((v_{\text{norm}})^3)_{\text{rms}}] - 20 * \log_{10} ((v_{\text{norm_ref}})^3)_{\text{rms}} \} / k, 0.5 \}$$

Where

- CEIL { x, 0.5 } means rounding upwards to closest 0.5dB, i.e. CM [0, 0.5, 1.0, 1.5, 2.0, 2.5, 3.0, 3.5]
- k is 1.85 for signals where all channelisations codes meet the following criteria CSF, N where $N < SF/2$
- k is 1.56 for signals where any channelisations codes meet the following criteria $C_{SF, N}$ where $N \geq SF/2$
- v_{norm} is the normalized voltage waveform of the input signal
- $v_{\text{norm_ref}}$ is the normalized voltage waveform of the reference signal (12.2 kbps AMR Speech) and
- $20 * \log_{10} ((v_{\text{norm_ref}})^3)_{\text{rms}} = 1.52$ dB

6.3 Frequency Error

The UE modulated carrier frequency shall be accurate to within ± 0.1 PPM observed over a period of one timeslot compared to the carrier frequency received from the Node B. For the PRACH preambles the measurement interval is lengthened to 3904 chips (being the 4096 chip nominal preamble period less a 25 μ s transient period allowance at each end of the burst). These signals will have an apparent error due to Node B frequency error and Doppler shift. In the later case, signals from the Node B must be averaged over sufficient time that errors due to noise or interference are allowed for within the above ± 0.1 PPM figure. The UE shall use the same frequency source for both RF frequency generation and the chip clock.

6.4 Output power dynamics

Power control is used to limit the interference level.

6.4.1 Open loop power control

Open loop power control is the ability of the UE transmitter to sets its output power to a specific value. The open loop power control tolerance is given in Table 6.3

6.4.1.1 Minimum requirement

The UE open loop power is defined as the mean power in a timeslot or ON power duration, whichever is available.

Table 6.3: Open loop power control tolerance

| Conditions | Tolerance |
|--------------------|-------------|
| Normal conditions | ± 9 dB |
| Extreme conditions | ± 12 dB |

6.4.2 Inner loop power control in the uplink

Inner loop power control in the Uplink is the ability of the UE transmitter to adjust its output power in accordance with one or more TPC commands received in the downlink.

6.4.2.1 Power control steps

The power control step is the change in the UE transmitter output power in response to a single TPC command, TPC_cmd, derived at the UE.

6.4.2.1.1 Minimum requirement

The UE transmitter shall have the capability of changing the output power with a step size of 1, 2 and 3 dB according to the value of Δ_{TPC} or $\Delta_{\text{RP.TPC}}$, in the slot immediately after the TPC_cmd can be derived

- The transmitter output power step due to inner loop power control shall be within the range shown in Table 6.4.
- The transmitter average output power step due to inner loop power control shall be within the range shown in Table 6.5. Here a TPC_cmd group is a set of TPC_cmd values derived from a corresponding sequence of TPC commands of the same duration.

The inner loop power step is defined as the relative power difference between the mean power of the original (reference) timeslot and the mean power of the target timeslot, not including the transient duration. The transient duration is from 25 μ s before the slot boundary to 25 μ s after the slot boundary.

Table 6.4: Transmitter power control range

| TPC_cmd | Transmitter power control range | | | | | |
|---------|---------------------------------|---------|----------------|---------|----------------|---------|
| | 1 dB step size | | 2 dB step size | | 3 dB step size | |
| | Lower | Upper | Lower | Upper | Lower | Upper |
| + 1 | +0.5 dB | +1.5 dB | +1 dB | +3 dB | +1.5 dB | +4.5 dB |
| 0 | -0.5 dB | +0.5 dB | -0.5 dB | +0.5 dB | -0.5 dB | +0.5 dB |
| -1 | -0.5 dB | -1.5 dB | -1 dB | -3 dB | -1.5 dB | -4.5 dB |

Table 6.5: Transmitter aggregate power control range

| TPC_cmd group | Transmitter power control range after 10 equal TPC_cmd groups | | | | Transmitter power control range after 7 equal TPC_cmd groups | |
|---------------|---|--------|----------------|--------|--|--------|
| | 1 dB step size | | 2 dB step size | | 3 dB step size | |
| | Lower | Upper | Lower | Upper | Lower | Upper |
| +1 | +8 dB | +12 dB | +16 dB | +24 dB | +16 dB | +26 dB |
| 0 | -1 dB | +1 dB | -1 dB | +1 dB | -1 dB | +1 dB |
| -1 | -8 dB | -12 dB | -16 dB | -24 dB | -16 dB | -26 dB |
| 0,0,0,0,+1 | +6 dB | +14 dB | N/A | N/A | N/A | N/A |
| 0,0,0,0,-1 | -6 dB | -14 dB | N/A | N/A | N/A | N/A |

The UE shall meet the above requirements for inner loop power control over the power range bounded by the Minimum output power as defined in subclause 6.4.3, and the Maximum output power supported by the UE (i.e. the actual power as would be measured assuming no measurement error). This power shall be in the range specified for the power class of the UE in subclause 6.2.1.

6.4.3 Minimum output power

The minimum controlled output power of the UE is when the power is set to a minimum value.

6.4.3.1 Minimum requirement

The minimum output power is defined as the mean power in one time slot. The minimum output power shall be less than -50 dBm.

6.4.4 Out-of-synchronization handling of output power

The UE shall monitor the DPCCH quality in order to detect a loss of the signal on Layer 1, as specified in TS 25.214. The thresholds Q_{out} and Q_{in} specify at what DPCCH quality levels the UE shall shut its power off and when it shall turn its power on respectively. The thresholds are not defined explicitly, but are defined by the conditions under which the UE shall shut its transmitter off and turn it on, as stated in this subclause.

The DPCCH quality shall be monitored in the UE and compared to the thresholds Q_{out} and Q_{in} for the purpose of monitoring synchronization. The threshold Q_{out} should correspond to a level of DPCCH quality where no reliable detection of the TPC commands transmitted on the downlink DPCCH can be made. This can be at a TPC command error ratio level of e.g. 30%. The threshold Q_{in} should correspond to a level of DPCCH quality where detection of the TPC commands transmitted on the downlink DPCCH is significantly more reliable than at Q_{out} . This can be at a TPC command error ratio level of e.g. 20%.

6.4.4.1 Minimum requirement

When the UE estimates the DPCCH quality over the last 160 ms period to be worse than a threshold Q_{out} , the UE shall shut its transmitter off within 40 ms. The UE shall not turn its transmitter on again until the DPCCH quality exceeds an acceptable level Q_{in} . When the UE estimates the DPCCH quality over the last 160 ms period to be better than a threshold Q_{in} , the UE shall again turn its transmitter on within 40 ms.

The UE transmitter shall be considered 'off' if the transmitted power is below the level defined in subclause 6.5.1 (Transmit off power). Otherwise the transmitter shall be considered as 'on'.

6.4.4.2 Test case

This subclause specifies a test case, which provides additional information for how the minimum requirement should be interpreted for the purpose of conformance testing.

The quality levels at the thresholds Q_{out} and Q_{in} correspond to different signal levels depending on the downlink conditions DCH parameters. For the conditions in Table 6.6, a signal with the quality at the level Q_{out} can be generated by a DPCCH_Ec/Ior ratio of -25 dB, and a signal with Q_{in} by a DPCCH_Ec/Ior ratio of -21 dB. The DL reference

measurement channel (12.2) kbps specified in subclause A.3.1 and with static propagation conditions. The downlink physical channels, other than those specified in Table 6.6, are as specified in Table C.3 of Annex C.

Figure 6.1 shows an example scenario where the $DPCCH_Ec/I_{or}$ ratio varies from a level where the DPCH is demodulated under normal conditions, down to a level below Q_{out} where the UE shall shut its power off and then back up to a level above Q_{in} where the UE shall turn the power back on.

Table 6.6: DCH parameters for the Out-of-synch handling test case

| Parameter | Unit | Value |
|-----------------------------|--------------|---|
| \hat{I}_{or}/I_{oc} | dB | -1 |
| I_{oc} | dBm/3.84 MHz | -60 |
| $\frac{DPDCH_E_c}{I_{or}}$ | dB | See figure 6.1: Before point A -16.6 After point A Not defined |
| $\frac{DPCCH_E_c}{I_{or}}$ | dB | See figure 6.1 |
| Information Data Rate | kbps | 12.2 |

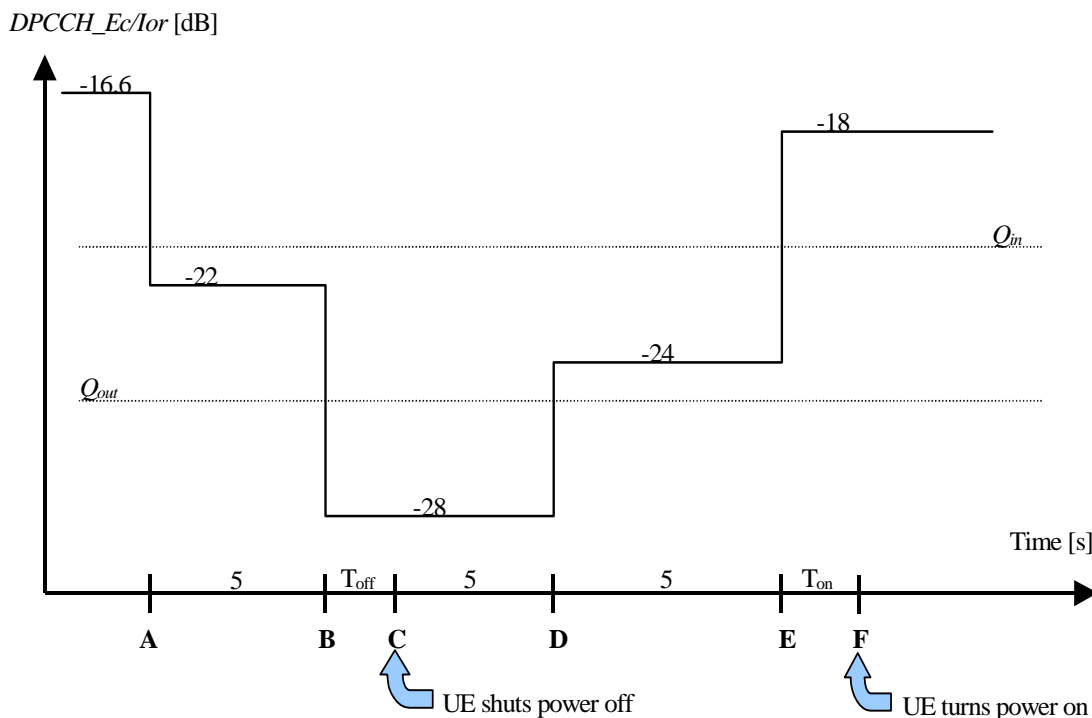

Figure 6.1: Test case for out-of-synch handling in the UE

In this test case, the requirements for the UE are that:

1. The UE shall not shut its transmitter off before point B.
2. The UE shall shut its transmitter off before point C, which is $T_{off} = 200$ ms after point B.
3. The UE shall not turn its transmitter on between points C and E.
4. The UE shall turn its transmitter on before point F, which is $T_{on} = 200$ ms after point E.

6.5 Transmit ON/OFF power

6.5.1 Transmit OFF power

Transmit OFF power is defined as the RRC filtered mean power when the transmitter is off. The transmitter is considered to be off when the UE is not allowed to transmit. During UL compressed mode gaps, the UE is not considered to be off.

6.5.1.1 Minimum requirement

The transmit OFF power is defined as the RRC filtered mean power in a duration of at least one timeslot excluding any transient periods. The requirement for the transmit OFF power shall be less than -56 dBm.

6.5.2 Transmit ON/OFF Time mask

The time mask for transmit ON/OFF defines the transient period allowed for the UE between transmit OFF power and transmit ON power. During the transient period there are no additional requirements on UE transmit power beyond what is required in subclause 6.2 maximum output power observed over a period of at least one timeslot. ON/OFF scenarios include PRACH preamble bursts, the beginning or end of PRACH message parts and the beginning or end of UL DPCH transmissions.

6.5.2.1 Minimum requirement

The transmit power levels versus time shall meet the requirements in figure 6.2 for PRACH preambles and the requirements in figure 6.3 for all other cases. The off power observation period is defined as the RRC filtered mean power in a duration of at least one timeslot excluding any transient periods. The on power observation period is defined as the mean power over one timeslot excluding any transient periods. For PRACH preambles, the on power observation period is 3904 chips (4096 chips less the transient periods).

The off power specification in figures 6.2 and 6.3 is as defined in 6.5.1.1.

The average on power specification in figures 6.2 and 6.3 depends on each possible case.

- First preamble of RACH: Open loop accuracy (Table 6.3).
- During preamble ramping of the RACH, and between final RACH preamble and RACH message part: Accuracy depending on size of the required power difference.(Table 6.7). The step in total transmitted power between final RACH preamble and RACH message (control part + data part) shall be rounded to the closest integer dB value. A power step exactly half-way between two integer values shall be rounded to the closest integer of greater magnitude.
- After transmission gaps in compressed mode: Accuracy as in Table 6.9.
- Power step to Maximum Power: Maximum power accuracy (Table 6.1).

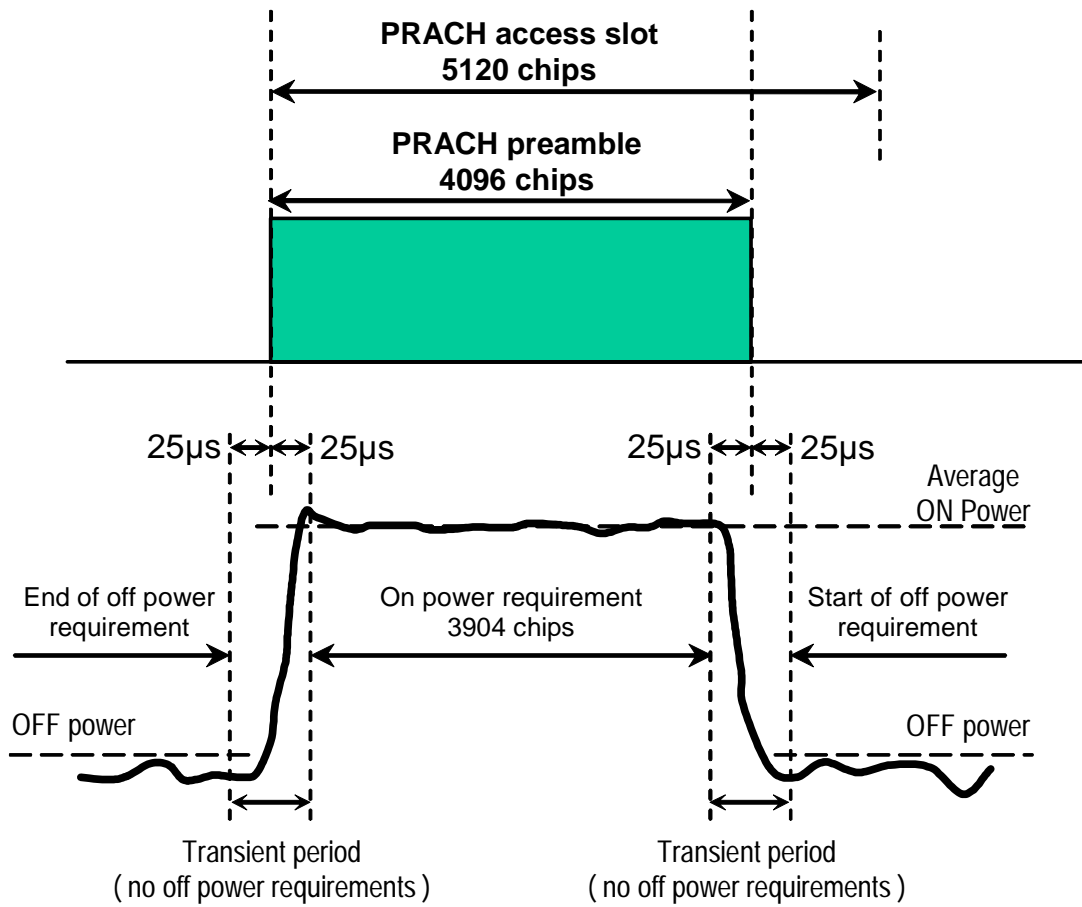

Figure 6.2: Transmit ON/OFF template for PRACH preambles

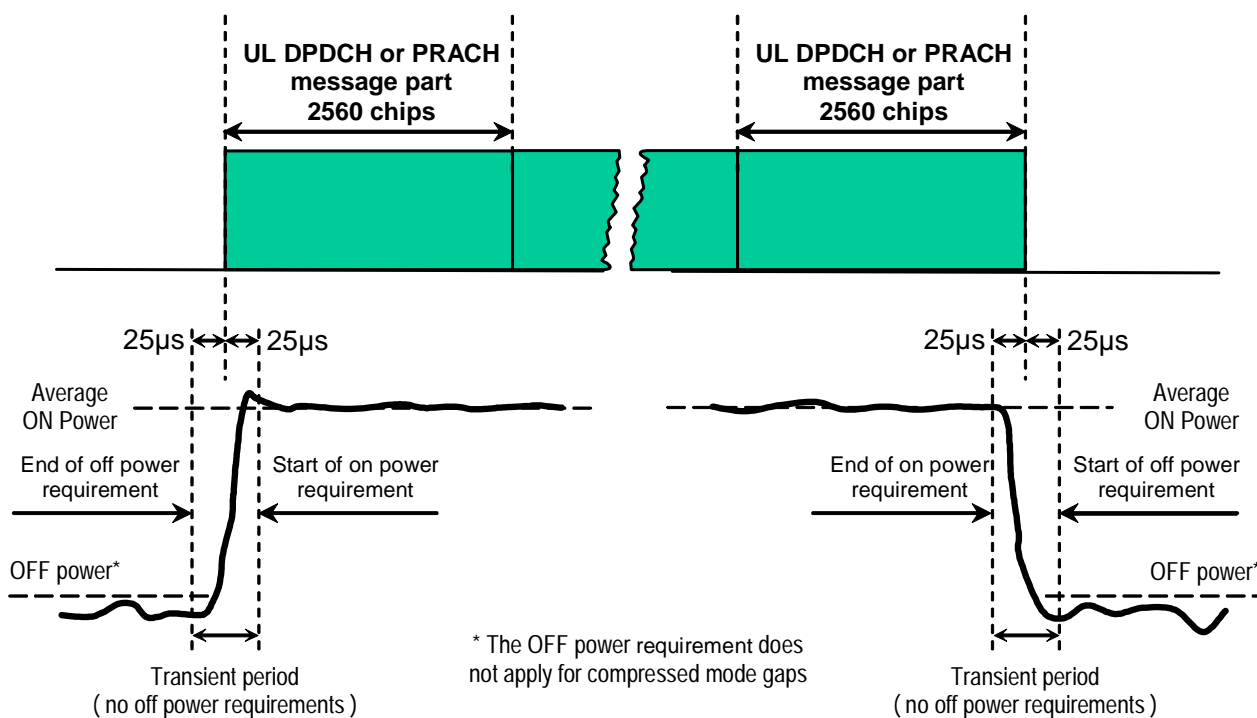

Figure 6.3: Transmit ON/OFF template for all other On/Off cases

Table 6.7: Transmitter power difference tolerance for RACH preamble ramping, and between final RACH preamble and RACH message part

| Power step size (Up or down)* ΔP [dB] | Transmitter power difference tolerance [dB] |
|--|---|
| 0 | +/- 1 |
| 1 | +/- 1 |
| 2 | +/- 1.5 |
| 3 | +/- 2 |
| $4 \leq \Delta P \leq 10$ | +/- 2.5 |
| $11 \leq \Delta P \leq 15$ | +/- 3.5 |
| $16 \leq \Delta P \leq 20$ | +/- 4.5 |
| $21 \leq \Delta P$ | +/- 6.5 |

NOTE: Power step size for RACH preamble ramping is from 1 to 8 dB with 1 dB steps.

6.5.3 Change of TFC

A change of TFC (Transport Format Combination) in uplink means that the power in the uplink varies according to the change in data rate. DTX, where the DPDCH is turned off, is a special case of variable data, which is used to minimise the interference between UE(s) by reducing the UE transmit power when voice, user or control information is not present.

6.5.3.1 Minimum requirement

A change of output power is required when the TFC, and thereby the data rate, is changed. The ratio of the amplitude between the DPDCH codes and the DPCCH code will vary. The power step due to a change in TFC shall be calculated in the UE so that the power transmitted on the DPCCH shall follow the inner loop power control. The step in total transmitted power (DPCCH + DPDCH) shall then be rounded to the closest integer dB value. A power step exactly half-way between two integer values shall be rounded to the closest integer of greater magnitude. The accuracy of the power step, given the step size, is specified in Table 6.8. The power change due to a change in TFC is defined as the relative power difference between the mean power of the original (reference) timeslot and the mean power of the target

timeslot, not including the transient duration. The transient duration is from 25µs before the slot boundary to 25µs after the slot boundary.

Table 6.8: Transmitter power step tolerance

| Power step size (Up or down) ΔP [dB] | Transmitter power step tolerance [dB] |
|---|---------------------------------------|
| 0 | +/- 0.5 |
| 1 | +/- 0.5 |
| 2 | +/- 1.0 |
| 3 | +/- 1.5 |
| $4 \leq \Delta P \leq 10$ | +/- 2.0 |
| $11 \leq \Delta P \leq 15$ | +/- 3.0 |
| $16 \leq \Delta P \leq 20$ | +/- 4.0 |
| $21 \leq \Delta P$ | +/- 6.0 |

The mean power of successive slots shall be calculated according to Figure 6.4.

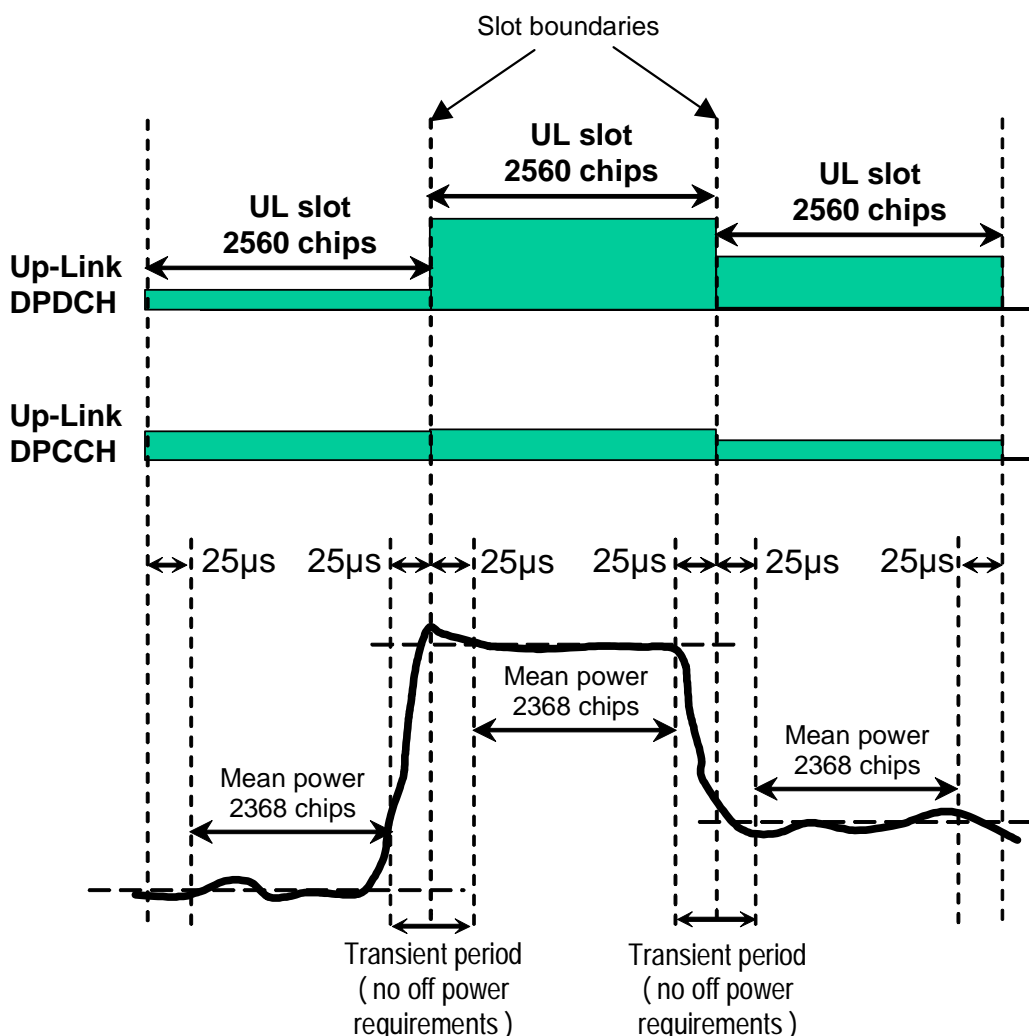

Figure 6.4: Transmit template during TFC change

6.5.4 Power setting in uplink compressed mode

Compressed mode in uplink means that the power in uplink is changed.

6.5.4.1 Minimum requirement

A change of output power is required during uplink compressed frames since the transmission of data is performed in a shorter interval. The ratio of the amplitude between the DPDCH codes and the DPCCH code will also vary. The power step due to compressed mode shall be calculated in the UE so that the energy transmitted on the pilot bits during each transmitted slot shall follow the inner loop power control.

Thereby, the power during compressed mode, and immediately afterwards, shall be such that the mean power of the DPCCH follows the steps due to inner loop power control combined with additional steps of $10\log_{10}(N_{\text{pilot,prev}} / N_{\text{pilot,curr}})$ dB where $N_{\text{pilot,prev}}$ is the number of pilot bits in the previously transmitted slot, and $N_{\text{pilot,curr}}$ is the current number of pilot bits per slot.

The resulting step in total transmitted power (DPCCH + DPDCH) shall then be rounded to the closest integer dB value. A power step exactly half-way between two integer values shall be rounded to the closest integer of greatest magnitude. The accuracy of the power step, given the step size, is specified in Table 6.8 in subclause 6.5.3.1. The power step is defined as the relative power difference between the mean power of the original (reference) timeslot and the mean power of the target timeslot, when neither the original timeslot nor the reference timeslot are in a transmission gap. The transient duration is not included, and is from 25µs before the slot boundary to 25µs after the slot boundary.

In addition to any power change due to the ratio $N_{\text{pilot,prev}} / N_{\text{pilot,curr}}$, the mean power of the DPCCH in the first slot after a compressed mode transmission gap shall differ from the mean power of the DPCCH in the last slot before the transmission gap by an amount Δ_{RESUME} , where Δ_{RESUME} is calculated as described in clause 5.1.2.3 of TS 25.214.

The resulting difference in the total transmitted power (DPCCH + DPDCH) shall then be rounded to the closest integer dB value. A power difference exactly half-way between two integer values shall be rounded to the closest integer of greatest magnitude. The accuracy of the resulting difference in the total transmitted power (DPCCH + DPDCH) after a transmission gap of up to 14 slots shall be as specified in Table 6.9.

Table 6.9: Transmitter power difference tolerance after a transmission gap of up to 14 slots

| Power difference (Up or down) ΔP [dB] | Transmitter power step tolerance after a transmission gap [dB] |
|--|--|
| $\Delta P \leq 2$ | +/- 3 |
| 3 | +/- 3 |
| $4 \leq \Delta P \leq 10$ | +/- 3.5 |
| $11 \leq \Delta P \leq 15$ | +/- 4 |
| $16 \leq \Delta P \leq 20$ | +/- 4.5 |
| $21 \leq \Delta P$ | +/- 6.5 |

The power difference is defined as the difference between the mean power of the original (reference) timeslot before the transmission gap and the mean power of the target timeslot after the transmission gap, not including the transient durations. The transient durations at the start and end of the transmission gaps are each from 25µs before the slot boundary to 25µs after the slot boundary.

The mean power of successive slots shall be calculated according to figure 6.5.

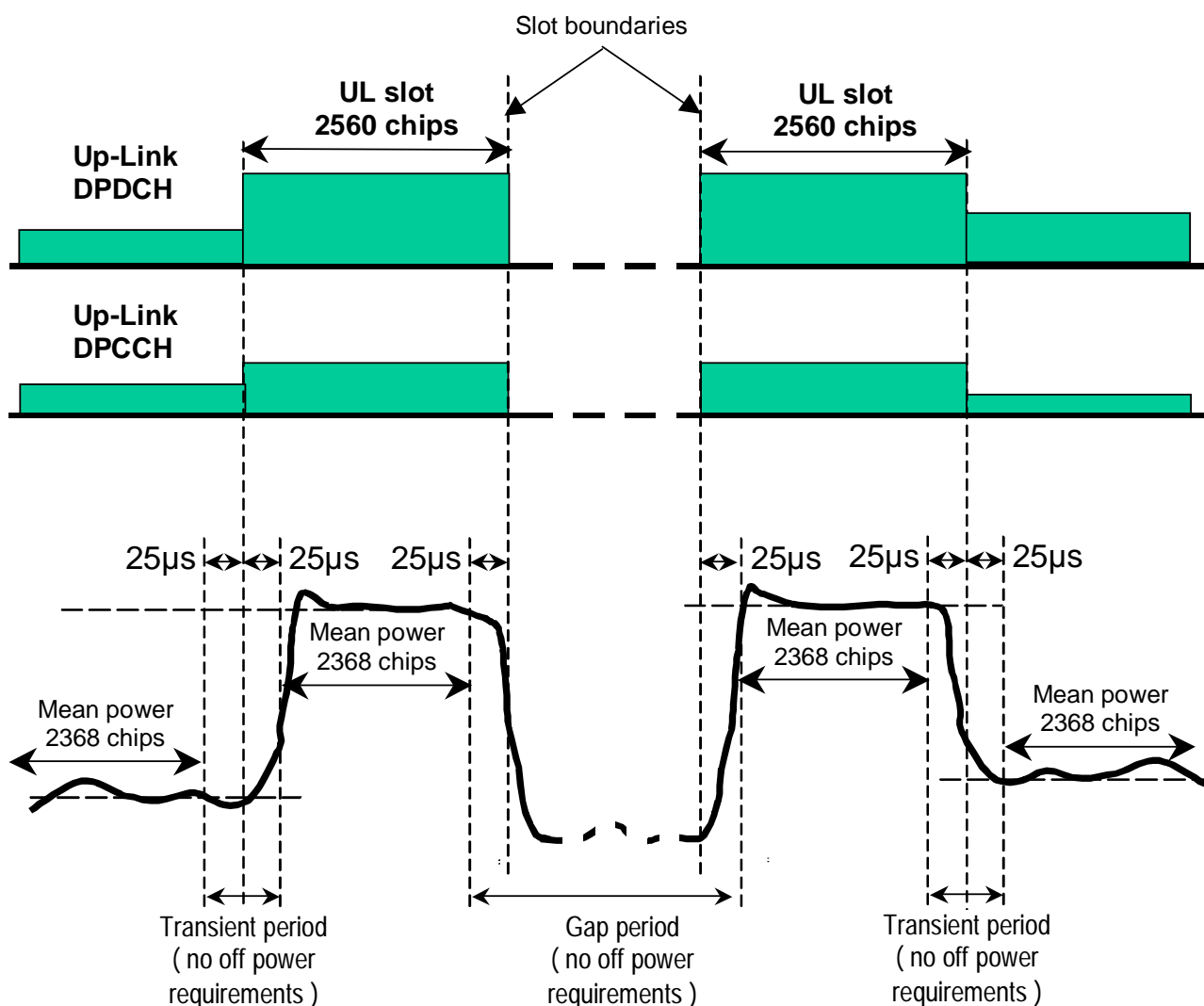

Figure 6.5: Transmit template during Compressed mode

6.5.5 HS-DPCCH

The transmission of Ack/Nack or CQI over the HS-DPCCH may cause the transmission power in the uplink to vary. The ratio of the amplitude between the DPCCH and the Ack/Nack and CQI respectively is signalled by higher layers.

6.5.5.1 Minimum requirement

The nominal sum power on DPCCH+DPDCH is independent of the transmission of Ack/Nack and CQI unless the UE output power when Ack/Nack or CQI is transmitted would exceed the maximum value specified in Table 6.1A or fall below the value specified in 6.4.3.1, whereupon the UE shall apply additional scaling to the total transmit power as defined in section 5.1.2.6 of TS.25.214 [8].

The composite transmitted power (DPCCH + DPDCH+HS-DPCCH) shall be rounded to the closest integer dB value. A power step exactly half-way between two integer values shall be rounded to the closest integer of greater magnitude.

The nominal power step due to transmission of Ack/Nack or CQI is defined as the difference between the nominal mean powers of two power evaluation periods either side of an HS-DPCCH boundary. The first evaluation period starts 25µs after a DPCCH slot boundary and ends 25µs before the following HS-DPCCH slot boundary. The second evaluation period starts 25µs after the same HS-DPCCH slot boundary and ends 25µs before the following DPCCH slot boundary. This is described graphically in figure 6.6.

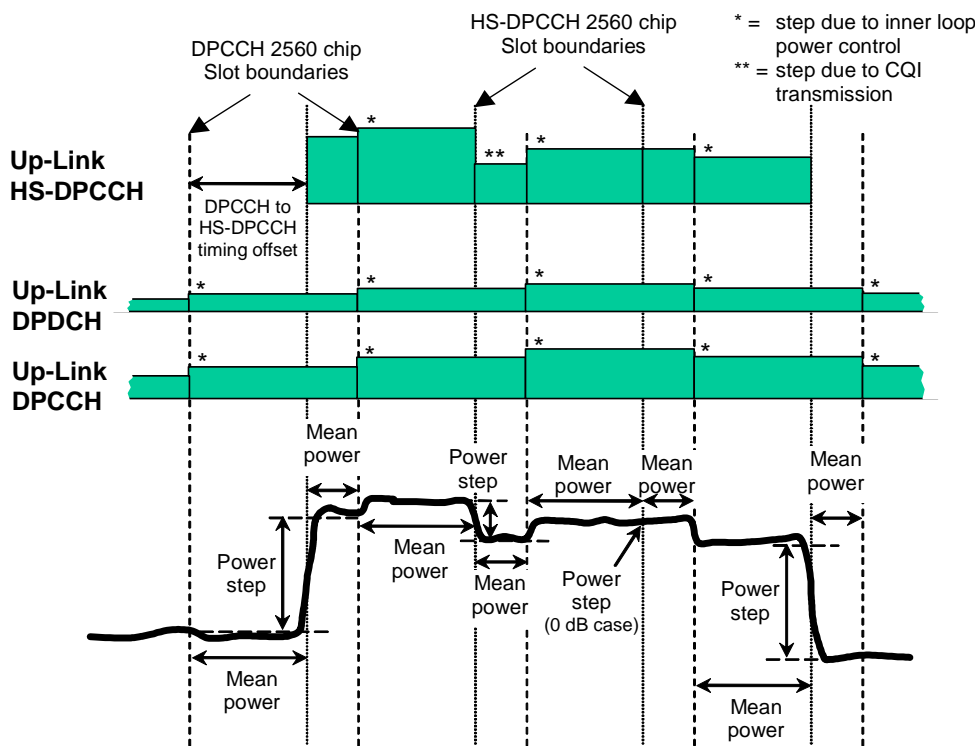

The power step due to HS-DPCCH transmission is the difference between the mean powers transmitted before and after an HS-DPCCH slot boundary. The mean power evaluation period excludes a 25µs period before and after any DPCCH or HS-DPCCH slot boundary.

Figure 6.6: Transmit power template during HS-DPCCH transmission

The tolerance of the power step due to transmission of the HS-DPCCH shall meet the requirements in table 6.9A.

Table 6.9A: Transmitter power step tolerance

| Nominal power step size (Up or down) ΔP [dB] | Transmitter power step tolerance [dB] |
|--|---------------------------------------|
| 0 | +/- 0.5 |
| 1 | +/- 0.5 |
| 2 | +/- 1.0 |
| 3 | +/- 1.5 |
| $4 \leq \Delta P \leq 7$ | +/- 2.0 |

6.6 Output RF spectrum emissions

6.6.1 Occupied bandwidth

Occupied bandwidth is a measure of the bandwidth containing 99 % of the total integrated power of the transmitted spectrum, centered on the assigned channel frequency. The occupied channel bandwidth shall be less than 5 MHz based on a chip rate of 3.84 Mcps.

6.6.2 Out of band emission

Out of band emissions are unwanted emissions immediately outside the nominal channel resulting from the modulation process and non-linearity in the transmitter but excluding spurious emissions. This out of band emission limit is specified in terms of a spectrum emission mask and Adjacent Channel Leakage power Ratio.

6.6.2.1 Spectrum emission mask

The spectrum emission mask of the UE applies to frequencies, which are between 2.5 MHz and 12.5 MHz away from the UE centre carrier frequency. The out of channel emission is specified relative to the RRC filtered mean power of the UE carrier.

6.6.2.1.1 Minimum requirement

The power of any UE emission shall not exceed the levels specified in Table 6.10. The absolute requirement is based on a -50 dBm/3.84 MHz minimum power threshold for the UE. This limit is expressed for the narrower measurement bandwidths as -55.8 dBm/1 MHz and -71.1 dBm/30 kHz. The requirements are applicable for all values of β_c , β_d , β_{hs} , β_{ec} and β_{ed} as specified in [8].

Table 6.10: Spectrum Emission Mask Requirement

| Δf in MHz (Note 1) | Minimum requirement (Note 2) | | Additional requirements Band II, Band IV and Band V (Note 3) | Measurement bandwidth (Note 6) |
|-------------------------------|---|----------------------|--|-----------------------------------|
| | Relative requirement | Absolute requirement | | |
| 2.5 - 3.5 | $\left\{ -35 - 15 \cdot \left(\frac{\Delta f}{\text{MHz}} - 2.5 \right) \right\} \text{dBc}$ | -71.1 dBm | -15 dBm | 30 kHz (Note 4) |
| 3.5 - 7.5 | $\left\{ -35 - 1 \cdot \left(\frac{\Delta f}{\text{MHz}} - 3.5 \right) \right\} \text{dBc}$ | -55.8 dBm | -13 dBm | 1 MHz (Note 5) |
| 7.5 - 8.5 | $\left\{ -39 - 10 \cdot \left(\frac{\Delta f}{\text{MHz}} - 7.5 \right) \right\} \text{dBc}$ | -55.8 dBm | -13 dBm | 1 MHz (Note 5) |
| 8.5 - 12.5 MHz | -49 dBc | -55.8 dBm | -13 dBm | 1 MHz (Note 5) |

Note 1: Δf is the separation between the carrier frequency and the centre of the measurement bandwidth.
Note 2: The minimum requirement is calculated from the relative requirement or the absolute requirement, whichever is the higher power.
Note 3: For operation in Band II, Band IV and Band V only, the minimum requirement is calculated from the minimum requirement calculated in Note 2 or the additional requirement for band II, whichever is the lower power.
Note 4: The first and last measurement position with a 30 kHz filter is at Δf equals to 2.515 MHz and 3.485 MHz.
Note 5: The first and last measurement position with a 1 MHz filter is at Δf equals to 4 MHz and 12 MHz.
Note 6: As a general rule, the resolution bandwidth of the measuring equipment should be equal to the measurement bandwidth. However, to improve measurement accuracy, sensitivity and efficiency, the resolution bandwidth may be smaller than the measurement bandwidth. When the resolution bandwidth is smaller than the measurement bandwidth, the result should be integrated over the measurement bandwidth in order to obtain the equivalent noise bandwidth of the measurement bandwidth.

6.6.2.2 Adjacent Channel Leakage power Ratio (ACLR)

Adjacent Channel Leakage power Ratio (ACLR) is the ratio of the RRC filtered mean power centered on the assigned channel frequency to the RRC filtered mean power centered on an adjacent channel frequency.

6.6.2.2.1 Minimum requirement

If the adjacent channel power is greater than -50 dBm then the ACLR shall be higher than the value specified in Table 6.11. The requirements are applicable for all values of β_c , β_d , β_{hs} , β_{ec} and β_{ed} as specified in [8].

Table 6.11: UE ACLR

| Power Class | Adjacent channel frequency relative to assigned channel frequency | ACLR limit |
|-------------|---|------------|
| 3 | + 5 MHz or – 5 MHz | 33 dB |
| 3 | + 10 MHz or – 10 MHz | 43 dB |
| 4 | + 5 MHz or – 5 MHz | 33 dB |
| 4 | + 10 MHz or – 10 MHz | 43 dB |

NOTE 1: The requirement shall still be met in the presence of switching transients.

NOTE 2: The ACLR requirements reflect what can be achieved with present state of the art technology.

NOTE 3: Requirement on the UE shall be reconsidered when the state of the art technology progresses.

6.6.3 Spurious emissions

Spurious emissions are emissions which are caused by unwanted transmitter effects such as harmonics emission, parasitic emission, intermodulation products and frequency conversion products, but exclude out of band emissions.

The frequency boundary and the detailed transitions of the limits between the requirement for out band emissions and spectrum emissions are based on ITU-R Recommendations SM.329 [2].

6.6.3.1 Minimum requirement

These requirements are only applicable for frequencies, which are greater than 12.5 MHz away from the UE centre carrier frequency.

Table 6.12: General spurious emissions requirements

| Frequency Bandwidth | Measurement Bandwidth | Minimum requirement |
|--|-----------------------|---------------------|
| $9 \text{ kHz} \leq f < 150 \text{ kHz}$ | 1 kHz | -36 dBm |
| $150 \text{ kHz} \leq f < 30 \text{ MHz}$ | 10 kHz | -36 dBm |
| $30 \text{ MHz} \leq f < 1000 \text{ MHz}$ | 100 kHz | -36 dBm |
| $1 \text{ GHz} \leq f < 12.75 \text{ GHz}$ | 1 MHz | -30 dBm |

Table 6.13: Additional spurious emissions requirements

| Operating Band | Frequency Bandwidth | Measurement Bandwidth | Minimum requirement |
|-----------------------------------|---------------------------------------|-----------------------|---------------------|
| I | 860 MHz \leq f \leq 895 MHz | 3.84 MHz | -60 dBm |
| | 921 MHz \leq f < 925 MHz | 100 kHz | -60 dBm * |
| | 925 MHz \leq f \leq 935 MHz | 100 kHz | -67 dBm * |
| | | 3.84 MHz | -60 dBm |
| | 935 MHz < f \leq 960 MHz | 100 kHz | -79 dBm * |
| | 1805 MHz \leq f \leq 1880 MHz | 100 kHz | -71 dBm * |
| | 1844.9 MHz \leq f \leq 1879.9 MHz | 3.84 MHz | -60 dBm |
| | 1884.5 MHz < f < 1919.6 MHz | 300 kHz | -41 dBm |
| 2110 MHz \leq f \leq 2170 MHz | 3.84 MHz | -60 dBm | |
| 2620 MHz \leq f \leq 2690 MHz | 3.84 MHz | -60 dBm | |
| II | 869 MHz \leq f \leq 894 MHz | 3.84 MHz | -60 dBm |
| | 1930 MHz \leq f \leq 1990 MHz | 3.84 MHz | -60 dBm |
| | 2110 MHz \leq f \leq 2155 MHz | 3.84 MHz | -60 dBm |
| III | 921 MHz \leq f < 925 MHz | 100 kHz | -60 dBm * |
| | 925 MHz \leq f \leq 935 MHz | 100 kHz | -67 dBm * |
| | | 3.84 MHz | -60 dBm |
| | 935 MHz < f \leq 960 MHz | 100 kHz | -79 dBm * |
| | 1805 MHz \leq f \leq 1880 MHz | 3.84 MHz | -60 dBm |
| | 2110 MHz \leq f \leq 2170 MHz | 3.84 MHz | -60 dBm |
| 2620 MHz \leq f \leq 2690 MHz | 3.84 MHz | -60 dBm | |
| IV | 869 MHz \leq f \leq 894 MHz | 3.84 MHz | -60 dBm |
| | 1930 MHz \leq f \leq 1990 MHz | 3.84 MHz | -60 dBm |
| | 2110 MHz \leq f \leq 2155 MHz | 3.84 MHz | -60 dBm |
| V | 869 MHz \leq f \leq 894 MHz | 3.84 MHz | -60 dBm |
| | 1930 MHz \leq f \leq 1990 MHz | 3.84 MHz | -60 dBm |
| | 2110 MHz \leq f \leq 2155 MHz | 3.84 MHz | -60 dBm |
| VI | 860 MHz \leq f < 875 MHz | 1 MHz | -37 dBm |
| | 875 MHz \leq f \leq 895 MHz | 3.84 MHz | -60 dBm |
| | 1844.9 MHz \leq f \leq 1879.9 MHz | 3.84 MHz | -60 dBm |
| | 1884.5 MHz \leq f \leq 1919.6 MHz | 300 kHz | -41 dBm |
| | 2110 MHz \leq f \leq 2170 MHz | 3.84 MHz | -60 dBm |
| VII | 921 MHz \leq f < 925 MHz | 100 kHz | -60 dBm * |
| | 925 MHz \leq f \leq 935 MHz | 100 kHz | -67 dBm * |
| | | 3.84 MHz | -60 dBm |
| | 935 MHz < f \leq 960 MHz | 100 kHz | -79 dBm * |
| | 1805 MHz \leq f \leq 1880 MHz | 100 kHz | -71 dBm * |
| | 2110 MHz \leq f \leq 2170 MHz | 3.84 MHz | -60 dBm |
| | 2620 MHz \leq f \leq 2690 MHz | 3.84 MHz | -60 dBm |
| 2590 MHz \leq f \leq 2620 MHz | 3.84 MHz | -50 dBm | |
| VIII | 925 MHz \leq f \leq 935 MHz | 100 kHz | -67 dBm * |
| | | 3.84 MHz | -60 dBm |
| | 935 MHz < f \leq 960 MHz | 100 kHz | -79 dBm * |
| | 1805 MHz < f \leq 1830 MHz | 3.84 MHz | 60 dBm |
| | | 100 kHz | -71 dBm ** & * |
| | 1830 MHz < f \leq 1880 MHz | 3.84 MHz | -60 dBm ** |
| | | 100 kHz | -71 dBm * |
| 2110 MHz \leq f \leq 2170 MHz | 3.84 MHz | -60 dBm | |
| 2620 MHz \leq f \leq 2640 MHz | 3.84 MHz | -60 dBm | |
| 2640 MHz \leq f \leq 2690 MHz | 3.84 MHz | -60 dBm ** | |
| IX | 860 MHz \leq f \leq 895 MHz | 3.84 MHz | -60 dBm |
| | 1844.9 MHz \leq f \leq 1879.9 MHz | 3.84 MHz | -60 dBm |
| | 1884.5 MHz \leq f \leq 1919.6 MHz | 300 kHz | -41 dBm |
| | 2110 MHz \leq f \leq 2170 MHz | 3.84 MHz | -60 dBm |

| | |
|---------|---|
| Note * | The measurements are made on frequencies which are integer multiples of 200 kHz. As exceptions, up to five measurements with a level up to the applicable requirements defined in Table 6.12 are permitted for each UARFCN used in the measurement |
| Note ** | The measurements are made on frequencies which are integer multiples of 200 kHz. As exceptions, measurements with a level up to the applicable requirements defined in Table 6.12 are permitted for each UARFCN used in the measurement due to 2nd or 3rd harmonic spurious emissions |

6.7 Transmit intermodulation

The transmit intermodulation performance is a measure of the capability of the transmitter to inhibit the generation of signals in its non linear elements caused by presence of the wanted signal and an interfering signal reaching the transmitter via the antenna.

6.7.1 Minimum requirement

User Equipment(s) transmitting in close vicinity of each other can produce intermodulation products, which can fall into the UE, or Node B receive band as an unwanted interfering signal. The UE intermodulation attenuation is defined by the ratio of the RRC filtered mean power of the wanted signal to the RRC filtered mean power of the intermodulation product when an interfering CW signal is added at a level below the wanted signal.

The requirement of transmitting intermodulation for a carrier spacing of 5 MHz is prescribed in Table 6.14.

Table 6.14: Transmit Intermodulation

| | | |
|--------------------------------------|--------|--------|
| Interference Signal Frequency Offset | 5MHz | 10MHz |
| Interference CW Signal Level | -40dBc | |
| Intermodulation Product | -31dBc | -41dBc |

6.8 Transmit modulation

Transmit modulation defines the modulation quality for expected in-channel RF transmissions from the UE. The requirements apply to all transmissions including the PRACH/PCPCH pre-amble and message parts and all other expected transmissions. In cases where the mean power of the RF signal is allowed to change versus time e.g. PRACH, DPCH in compressed mode, change of TFC, inner loop power control and for HSDPA transmissions with non-constant HS-DPCCH code power, the EVM and Peak Code Domain Error requirements do not apply during the 25 us period before and after the nominal time when the mean power is expected to change.

6.8.1 Transmit pulse shape filter

The transmit pulse shaping filter is a root-raised cosine (RRC) with roll-off $\alpha = 0.22$ in the frequency domain. The impulse response of the chip impulse filter $RC_0(t)$ is:

$$RC_0(t) = \frac{\sin\left(\pi \frac{t}{T_c}(1-\alpha)\right) + 4\alpha \frac{t}{T_c} \cos\left(\pi \frac{t}{T_c}(1+\alpha)\right)}{\pi \frac{t}{T_c} \left(1 - \left(4\alpha \frac{t}{T_c}\right)^2\right)}$$

Where the roll-off factor $\alpha = 0.22$ and the chip duration is

$$T = \frac{1}{\text{chiprate}} \approx 0.26042 \mu s$$

6.8.2 Error Vector Magnitude

The Error Vector Magnitude is a measure of the difference between the reference waveform and the measured waveform. This difference is called the error vector. Both waveforms pass through a matched Root Raised Cosine filter with bandwidth 3,84 MHz and roll-off $\alpha=0,22$. Both waveforms are then further modified by selecting the frequency, absolute phase, absolute amplitude and chip clock timing so as to minimise the error vector. The EVM result is defined as the square root of the ratio of the mean error vector power to the mean reference power expressed as a %. The measurement interval is one timeslot except when the mean power between slots is expected to change whereupon the measurement interval is reduced by 25 μ s at each end of the slot. For the PRACH and PCPCH preambles the measurement interval is 4096 chips less 25 μ s at each end of the burst (3904 chips).

For signals containing more than one spreading code where the slot alignment of the codes is not the same and the code power is varying, the period over which the nominal mean power remains constant can be less than one timeslot. For such time-varying signals it is not possible to define EVM across one timeslot since this interval contains an expected change in mean power, and the exact timing and trajectory of the power change is not defined. For these signals, the EVM minimum requirements apply only for intervals of at least one half timeslot (less any 25 μ s transient periods) during which the nominal code power of each individual code is constant.

Note: The reason for setting a lower limit for the EVM measurement interval is that for any given impaired signal, the EVM would be expected to improve for measurement intervals less than one timeslot while the frequency error would be expected to degrade.

6.8.2.1 Minimum requirement

The Error Vector Magnitude shall not exceed 17.5 % for the parameters specified in Table 6.15. The requirements are applicable for all values of β_c , β_d , β_{hs} , β_{ec} and β_{ed} as specified in [8].

Table 6.15: Parameters for Error Vector Magnitude/Peak Code Domain Error

| Parameter | | Unit | Level |
|--|-------------|-------|----------------------------|
| UE Output Power | | dBm | ≥ -20 |
| Operating conditions | | | Normal conditions |
| Power control step size | | dB | 1 |
| Measurement period (Note 1) | PRACH/PCPCH | Chips | 3904 |
| | Any DPCH | | From 1280 to 2560 (Note 2) |
| Note 1: Less any 25 μ s transient periods | | | |
| Note 2: The longest period over which the nominal power remains constant | | | |

6.8.3 Peak code domain error

The Peak Code Domain Error is computed by projecting power of the error vector (as defined in 6.8.2) onto the code domain at a specific spreading factor. The Code Domain Error for every code in the domain is defined as the ratio of the mean power of the projection onto that code, to the mean power of the composite reference waveform. This ratio is expressed in dB. The Peak Code Domain Error is defined as the maximum value for the Code Domain Error for all codes. The measurement interval is one timeslot except when the mean power between slots is expected to change whereupon the measurement interval is reduced by 25 μ s at each end of the slot.

The requirement for peak code domain error is only applicable for multi-code DPDCH transmission and therefore does not apply for the PRACH and PCPCH preamble and message parts.

6.8.3.1 Minimum requirement

The peak code domain error shall not exceed -15 dB at spreading factor 4 for the parameters specified in Table 6.15 . The requirements are defined using the UL reference measurement channel specified in subclause A.2.5.

6.8.4 Phase discontinuity

Phase discontinuity is the change in phase between any two adjacent timeslots. The EVM for each timeslot (excluding the transient periods of 25 μ s on either side of the nominal timeslot boundaries), shall be measured according to

subclause 6.8.2. The frequency, absolute phase, absolute amplitude and chip clock timing used to minimise the error vector are chosen independently for each timeslot. The phase discontinuity result is defined as the difference between the absolute phase used to calculate EVM for the preceding timeslot, and the absolute phase used to calculate EVM for the succeeding timeslot.

6.8.4.1 Minimum requirement

The rate of occurrence of any phase discontinuity on an uplink DPCH for the parameters specified in table 6.16 shall not exceed the values specified in table 6.17. Phase shifts that are caused by changes of the UL transport format combination (TFC) and compressed mode are not included. When calculating the phase discontinuity, the requirements for frequency error and EVM in subclauses 6.3 and 6.8.2 for each timeslot shall be met.

Table 6.16: Parameters for Phase discontinuity

| Parameter | Unit | Level |
|-------------------------|------|-------|
| Power control step size | dB | 1 |

Table 6.17: Phase discontinuity minimum requirement

| Phase discontinuity $\Delta\theta$ in degrees | Maximum allowed rate of occurrence in Hz |
|---|--|
| $\Delta\theta \leq 30$ | 1500 |
| $30 < \Delta\theta \leq 60$ | 300 |
| $\Delta\theta > 60$ | 0 |

7 Receiver characteristics

7.1 General

Unless otherwise stated the receiver characteristics are specified at the antenna connector of the UE. For UE(s) with an integral antenna only, a reference antenna with a gain of 0 dBi is assumed. UE with an integral antenna may be taken into account by converting these power levels into field strength requirements, assuming a 0 dBi gain antenna. For UEs with more than one receiver antenna connector the AWGN signals applied to each receiver antenna connector shall be uncorrelated. The levels of the test signal applied to each of the antenna connectors shall be as defined in the respective sections below

The UE antenna performance has a significant impact on system performance, and minimum requirements on the antenna efficiency are therefore intended to be included in future versions of the present document. It is recognised that different requirements and test methods are likely to be required for the different types of UE.

All the parameters in clause 7 are defined using the DL reference measurement channel (12.2 kbps) specified in subclause A.3.1 and unless otherwise stated with DL power control OFF.

7.2 Diversity characteristics

A suitable receiver structure using coherent reception in both channel impulse response estimation and code tracking procedures is assumed. Three forms of diversity are considered to be available in UTRA/FDD.

Table 7.1: Diversity characteristics for UTRA/FDD

| | |
|----------------------|--|
| Time diversity | Channel coding and interleaving in both up link and down link |
| Multi-path diversity | Rake receiver or other suitable receiver structure with maximum combining. Additional processing elements can increase the delay-spread performance due to increased capture of signal energy. |
| Antenna diversity | Antenna diversity with maximum ratio combining in the Node B and optionally in the UE. Possibility for downlink transmit diversity in the Node B. |

7.3 Reference sensitivity level

The reference sensitivity level <REFSENS> is the minimum mean power received at the UE antenna port at which the Bit Error Ratio (BER) shall not exceed a specific value.

7.3.1 Minimum requirement

The BER shall not exceed 0.001 for the parameters specified in Table 7.2.

Table 7.2: Test parameters for reference sensitivity

| Operating Band | Unit | DPCH_Ec <REFSENS> | <REF \hat{I}_{or} > |
|----------------|---|-------------------|-----------------------|
| I | dBm/3.84 MHz | -117 | -106.7 |
| II | dBm/3.84 MHz | -115 | -104.7 |
| III | dBm/3.84 MHz | -114 | -103.7 |
| IV | dBm/3.84 MHz | -117 | -106.7 |
| V | dBm/3.84 MHz | -115 | -104.7 |
| VI | dBm/3.84 MHz | -117 | -106.7 |
| VII | dBm/3.84 MHz | -115 | -104.7 |
| VIII | dBm/3.84 MHz | -114 | -103.7 |
| IX | dBm/3.84 MHz | -116 | -105.7 |
| NOTE 1 | For Power class 3 this shall be at the maximum output power | | |
| NOTE 2 | For Power class 4 this shall be at the maximum output power | | |
| NOTE 3 | For the UE which supports both Band III and Band IX operating frequencies, the reference sensitivity level of -114.5 dBm DPCH_Ec <REFSENS> shall apply for Band IX. The corresponding <REF \hat{I}_{or} > is -104.2 dBm | | |

7.4 Maximum input level

This is defined as the maximum mean power received at the UE antenna port, at which the specified BER performance shall be met.

7.4.1 Minimum requirement for DPCH reception

The BER shall not exceed 0.001 for the parameters specified in Table 7.3.

Table 7.3: Maximum input level

| Parameter | Unit | Level |
|---------------------------|--------------|--|
| $\frac{DPCH_Ec}{I_{or}}$ | dB | -19 |
| \hat{I}_{or} | dBm/3.84 MHz | -25 |
| UE transmitted mean power | dBm | 20 (for Power class 3) 18 (for Power class 4) |

NOTE: Since the spreading factor is large ($10\log(SF)=21\text{dB}$), the majority of the total input signal consists of the OCNS interference. The structure of OCNS signal is defined in Annex C.3.2.

7.4.2 Minimum requirement for HS-PDSCH reception

7.4.2.1 Minimum requirement for 16QAM

The requirements are specified in terms of a minimum information bit throughput R for the DL reference channel H-Set 1 (16QAM version) specified in Annex A.7.1.1. with the addition of the parameters in Table 7.3A and the downlink physical channel setup according to table C.8.

Using this configuration the throughput shall meet or exceed the minimum requirements specified in table 7.3B.

Table 7.3A

| Parameter | Unit | Value |
|--------------------------------------|---|--|
| Phase reference | | P-CPICH |
| \hat{I}_{or} | dBm/3.84 MHz | -25 |
| UE transmitted mean power | dBm | 20 (for Power class 3) 18 (for Power class 4) |
| DPCH_Ec/I _{or} | dB | -13 |
| HS-SCCH_1_Ec/I _{or} | dB | -13 |
| Redundancy and constellation version | | 6 |
| Maximum number of HARQ transmissions | | 1 |
| Note: | The HS-SCCH and corresponding HS-PDSCH shall be transmitted continuously with constant power but the HS-SCCH shall only use the identity of the UE under test every third TTI | |

Table 7.3B

| HS-PDSCH E_c/I_{or} (dB) | T-put R (kbps) |
|-------------------------------|------------------|
| -3 | 700 |

7.5 Adjacent Channel Selectivity (ACS)

Adjacent Channel Selectivity (ACS) is a measure of a receiver's ability to receive a W-CDMA signal at its assigned channel frequency in the presence of an adjacent channel signal at a given frequency offset from the centre frequency of the assigned channel. ACS is the ratio of the receive filter attenuation on the assigned channel frequency to the receive filter attenuation on the adjacent channel(s).

7.5.1 Minimum requirement

The UE shall fulfil the minimum requirement specified in Table 7.4 for all values of an adjacent channel interferer up to -25 dBm.

However it is not possible to directly measure the ACS, instead the lower and upper range of test parameters are chosen in Table 7.5 where the BER shall not exceed 0.001.

Table 7.4: Adjacent Channel Selectivity

| Power Class | Unit | ACS |
|-------------|------|-----|
| 3 | dB | 33 |
| 4 | dB | 33 |

Table 7.5: Test parameters for Adjacent Channel Selectivity

| Parameter | Unit | Case 1 | Case 2 |
|---|--------------|--|--|
| DPCH_Ec | dBm/3.84 MHz | <REFSENS> + 14 dB | <REFSENS> + 41 dB |
| I _{or} | dBm/3.84 MHz | <REFI _{or} > + 14 dB | REFI _{or} > + 41 dB |
| I _{oac} mean power (modulated) | dBm | -52 | -25 |
| F _{uw} (offset) | MHz | +5 or -5 | +5 or -5 |
| UE transmitted mean power | dBm | 20 (for Power class 3) 18 (for Power class 4) | 20 (for Power class 3) 18 (for Power class 4) |

NOTE: The I_{oac} (modulated) signal consists of the common channels needed for tests as specified in Table C.7 and 16 dedicated data channels as specified in Table C.6.

7.6 Blocking characteristics

The blocking characteristic is a measure of the receiver's ability to receive a wanted signal at its assigned channel frequency in the presence of an unwanted interferer on frequencies other than those of the spurious response or the adjacent channels, without this unwanted input signal causing a degradation of the performance of the receiver beyond a specified limit. The blocking performance shall apply at all frequencies except those at which a spurious response occur.

7.6.1 Minimum requirement (In-band blocking)

The BER shall not exceed 0.001 for the parameters specified in Table 7.6. In-band blocking is defined for an unwanted interfering signal falling into the UE receive band or into the first 15 MHz below or above the UE receive band.

Table 7.6: In-band blocking

| Parameter | Unit | Level | |
|--|--------------|--|---------------------------|
| DPCH_Ec | dBm/3.84 MHz | <REFSENS>+3 dB | |
| I _{or} | dBm/3.84 MHz | <REFI _{or} > + 3 dB | |
| I _{blocking} mean power (modulated) | dBm | -56 | -44 |
| F _{uw} offset | | ±10 MHz | ≤-15 MHz & ≥15 MHz |
| F _{uw} (Band I operation) | MHz | 2102.4 ≤ f ≤ 2177.6 (Note 2) | 2095 ≤ f ≤ 2185 |
| F _{uw} (Band II operation) | MHz | 1922.4 ≤ f ≤ 1997.6 (Note 2) | 1915 ≤ f ≤ 2005 |
| F _{uw} (Band III operation) | MHz | 1797.4 ≤ f ≤ 1887.6 (Note 2) | 1790 ≤ f ≤ 1895 |
| F _{uw} (Band IV operation) | MHz | 2102.4 ≤ f ≤ 2162.6 (Note 2) | 2095 ≤ f ≤ 2170 |
| F _{uw} (Band V operation) | MHz | 861.4 ≤ f ≤ 901.6 (Note 2) | 854 ≤ f ≤ 909 |
| F _{uw} (Band VI operation) | MHz | 867.4 ≤ f ≤ 892.6 (Note 2 and 3) | 860 ≤ f ≤ 900 (Note 3) |
| F _{uw} (Band VII operation) | MHz | 2612.4 ≤ f ≤ 2697.6 (Note 2) | 2605 ≤ f ≤ 2705 |
| F _{uw} (Band VIII operation) | MHz | 917.4 ≤ f ≤ 967.6 (Note 2) | 910 ≤ f ≤ 975 |
| F _{uw} (Band IX operation) | MHz | 1837.4 ≤ f ≤ 1887.4 (Note 2) | 1829.9 ≤ f ≤ 1894.9 |
| UE transmitted mean power | dBm | 20 (for Power class 3) 18 (for Power class 4) | |

Note 1: I_{blocking} (modulated) consists of the common channels needed for tests as specified in Table C.7 and 16 dedicated data channels as specified in Table C.6.

Note 2: For each carrier frequency the requirement is valid for two frequencies, the carrier frequency +/- 10 MHz.

Note 3: For Band VI, the unwanted interfering signal does not fall inside the UE receive band, but within the first 15 MHz below or above the UE receive band.

7.6.2 Minimum requirement (Out of-band blocking)

The BER shall not exceed 0.001 for the parameters specified in Table 7.7. Out-of-band band blocking is defined for an unwanted interfering signal falling more than 15 MHz below or above the UE receive band.

For Table 7.7 in frequency range 1, 2 and 3, up to 24 exceptions are allowed for spurious response frequencies in each assigned frequency channel when measured using a 1 MHz step size. For these exceptions the requirements of clause 7.7 Spurious response are applicable.

For Table 7.7 in frequency range 4, up to 8 exceptions are allowed for spurious response frequencies in each assigned frequency channel when measured using a 1 MHz step size. For these exceptions the requirements of clause 7.7 Spurious response are applicable

Table 7.7: Out of band blocking

| Parameter | Unit | Frequency range 1 | Frequency range 2 | Frequency range 3 | Frequency range 4 |
|-----------------------------------|--|--|--|--------------------------------------|------------------------------|
| DPCH_Ec | dBm/3.84 MHz | <REFSENS>+3 dB | <REFSENS>+3 dB | <REFSENS>+3 dB | <REFSENS> +3 dB |
| \hat{I}_{or} | dBm/3.84 MHz | <REF \hat{I}_{or} > + 3 dB | <REF \hat{I}_{or} > + 3 dB | <REF \hat{I}_{or} > + 3 dB | <REF \hat{I}_{or} > + 3 dB |
| $I_{blocking}$ (CW) | dBm | -44 | -30 | -15 | -15 |
| F_{uw} (Band I operation) | MHz | 2050 < f < 2095 2185 < f < 2230 | 2025 < f ≤ 2050 2230 ≤ f < 2255 | 1 < f ≤ 2025 2255 ≤ f < 12750 | - |
| F_{uw} (Band II operation) | MHz | 1870 < f < 1915 2005 < f < 2050 | 1845 < f ≤ 1870 2050 ≤ f < 2075 | 1 < f ≤ 1845 2075 ≤ f < 12750 | 1850 ≤ f ≤ 1910 |
| F_{uw} (Band III operation) | MHz | 1745 < f < 1790 1895 < f < 1940 | 1720 < f ≤ 1745 1940 ≤ f < 1965 | 1 < f ≤ 1720 1965 ≤ f < 12750 | - |
| F_{uw} (Band IV operation) | MHz | 2050 < f < 2095 2170 < f < 2215 | 2025 < f ≤ 2050 2215 ≤ f < 2240 | 1 < f ≤ 2025 2240 ≤ f < 12750 | - |
| F_{uw} (Band V operation) | MHz | 809 < f < 854 909 < f < 954 | 784 < f ≤ 809 954 ≤ f < 979 | 1 < f ≤ 784 979 ≤ f < 12750 | 824 ≤ f ≤ 849 |
| F_{uw} (Band VI operation) | MHz | 815 < f < 860 900 < f < 945 | 790 < f ≤ 815 945 ≤ f < 970 | 1 < f ≤ 790 970 ≤ f < 12750 | - |
| F_{uw} (Band VII operation) | MHz | 2570 < f < 2605 2705 < f < 2750 | na 2750 ≤ f < 2775 | 1 < f ≤ 2570 2775 ≤ f < 12750 | - |
| F_{uw} (Band IX operation) | MHz | 1784.9 < f < 1829.9 1894.9 < f < 1939.9 | 1759.9 < f ≤ 1784.9 1939.9 ≤ f < 1964.9 | 1 < f ≤ 1759.9 1964.9 ≤ f < 12750 | - |
| F_{uw} (Band VIII operation) | MHz | 865 < f < 910 975 < f < 1020 | 840 < f < 865 1020 ≤ f < 1045 | 1 < f ≤ 840 1045 ≤ f < 12750 | - |
| UE transmitted mean power | dBm | 20 (for Power class 3) 18 (for Power class 4) | | | |
| Band I operation | For 2095 ≤ f ≤ 2185 MHz, the appropriate in-band blocking or adjacent channel selectivity in subclause 7.5.1 and subclause 7.6.1 shall be applied. | | | | |
| Band II operation | For 1915 ≤ f ≤ 2005 MHz, the appropriate in-band blocking or adjacent channel selectivity in subclause 7.5.1 and subclause 7.6.1 shall be applied | | | | |
| Band III operation | For 1790 ≤ f ≤ 1895 MHz, the appropriate in-band blocking or adjacent channel selectivity in subclause 7.5.1 and subclause 7.6.1 shall be applied. | | | | |
| Band IV operation | For 2095 ≤ f ≤ 2170 MHz, the appropriate in-band blocking or adjacent channel selectivity in subclause 7.5.1 and subclause 7.6.1 shall be applied. | | | | |
| Band V operation | For 854 ≤ f ≤ 909 MHz, the appropriate in-band blocking or adjacent channel selectivity in subclause 7.5.1 and subclause 7.6.1 shall be applied. | | | | |
| Band VI operation | For 860 ≤ f ≤ 900 MHz, the appropriate in-band blocking or adjacent channel selectivity in subclause 7.5.1 and subclause 7.6.1 shall be applied. | | | | |
| Band VII operation | For 2605 ≤ f ≤ 2705 MHz, the appropriate in-band blocking or adjacent channel selectivity in subclause 7.5.1 and subclause 7.6.1 shall be applied. | | | | |
| Band VIII operation | For 910 ≤ f ≤ 975 MHz, the appropriate in-band blocking or adjacent channel selectivity in subclause 7.5.1 and subclause 7.6.1 shall be applied. | | | | |
| Band IX operation | For 1829.9 ≤ f ≤ 1894.9 MHz, the appropriate in-band blocking or adjacent channel selectivity in subclause 7.5.1 and subclause 7.6.1 shall be applied. | | | | |

7.6.3 Minimum requirement (Narrow band blocking)

The BER shall not exceed 0.001 for the parameters specified in Table 7.7A. This requirement is measure of a receiver's ability to receive a W-CDMA signal at its assigned channel frequency in the presence of an unwanted narrow band interferer at a frequency, which is less than the nominal channel spacing

Table 7.7A: Narrow band blocking characteristics

| Parameter | Unit | Band II, Band IV and Band V | Band III, VIII |
|---------------------------|--------------|--|-------------------------------|
| DPCH_Ec | dBm/3.84 MHz | <REFSENS> + 10 dB | <REFSENS> + 10 dB |
| \hat{I}_{or} | dBm/3.84 MHz | <REF \hat{I}_{or} > + 10 dB | <REF \hat{I}_{or} > + 10 dB |
| $I_{blocking}$ (GMSK) | dBm | -57 | -56 |
| F_{uw} (offset) | MHz | 2.7 | 2.8 |
| UE transmitted mean power | dBm | 20 (for Power class 3) 18 (for Power class 4) | |

NOTE: $I_{blocking}$ (GMSK) is an interfering signal as defined in TS 45.004 [6]

7.7 Spurious response

Spurious response is a measure of the receiver's ability to receive a wanted signal on its assigned channel frequency without exceeding a given degradation due to the presence of an unwanted CW interfering signal at any other frequency at which a response is obtained i.e. for which the out of band blocking limit as specified in subclause 7.6.2 is not met.

7.7.1 Minimum requirement

The BER shall not exceed 0.001 for the parameters specified in Table 7.8.

Table 7.8: Spurious Response

| Parameter | Unit | Level |
|---------------------------|--------------|--|
| DPCH_Ec | dBm/3.84 MHz | <REFSENS> +3 dB |
| \hat{I}_{or} | dBm/3.84 MHz | <REF \hat{I}_{or} > +3 dB |
| $I_{blocking}$ (CW) | dBm | -44 |
| F_{uw} | MHz | Spurious response frequencies |
| UE transmitted mean power | dBm | 20 (for Power class 3) 18 (for Power class 4) |

7.8 Intermodulation characteristics

Third and higher order mixing of the two interfering RF signals can produce an interfering signal in the band of the desired channel. Intermodulation response rejection is a measure of the capability of the receiver to receiver a wanted signal on its assigned channel frequency in the presence of two or more interfering signals which have a specific frequency relationship to the wanted signal.

7.8.1 Minimum requirement

The BER shall not exceed 0.001 for the parameters specified in Table 7.9.

Table 7.9: Receive intermodulation characteristics

| Parameter | Unit | Level | |
|-----------------------------------|--------------|--|-----|
| DPCH_Ec | dBm/3.84 MHz | <REFSENS> +3 dB | |
| \hat{I}_{or} | dBm/3.84 MHz | <REF \hat{I}_{or} > +3 dB | |
| I_{ouw1} (CW) | dBm | -46 | |
| I_{ouw2} mean power (modulated) | dBm | -46 | |
| F_{uw1} (offset) | MHz | 10 | -10 |
| F_{uw2} (offset) | MHz | 20 | -20 |
| UE transmitted mean power | dBm | 20 (for Power class 3) 18 (for Power class 4) | |

NOTE: I_{ouw2} (modulated) consists of the common channels needed for tests as specified in Table C.7 and 16 dedicated data channels as specified in Table C.6.

7.8.2 Minimum requirement (Narrow band)

The BER shall not exceed 0.001 for the parameters specified in Table 7.9A.

Table 7.9A: Receive intermodulation characteristics

| Parameter | Unit | Band II, Band IV and Band V | | Band III, VIII | |
|---------------------------|--------------|--|------|-------------------------------|------|
| | | | | | |
| DPCH_Ec | dBm/3.84 MHz | <REFSENS>+ 10 dB | | <REFSENS>+ 10 dB | |
| \hat{I}_{or} | dBm/3.84 MHz | <REF \hat{I}_{or} > + 10 dB | | [<REF \hat{I}_{or} > +10 dB | |
| I_{ouw1} (CW) | dBm | -44 | | -43 | |
| I_{ouw2} (GMSK) | dBm | -44 | | -43 | |
| F_{uw1} (offset) | MHz | 3.5 | -3.5 | 3.6 | -3.6 |
| F_{uw2} (offset) | MHz | 5.9 | -5.9 | 6.0 | -6.0 |
| UE transmitted mean power | dBm | 20 (for Power class 3) 18 (for Power class 4) | | | |

NOTE: I_{ouw2} (GMSK) is an interfering signal as defined in TS 45.004 [6].

7.9 Spurious emissions

The spurious emissions power is the power of emissions generated or amplified in a receiver that appear at the UE antenna connector.

7.9.1 Minimum requirement

The power of any narrow band CW spurious emission shall not exceed the maximum level specified in Table 7.10 and Table 7.11

Table 7.10: General receiver spurious emission requirements

| Frequency Band | Measurement Bandwidth | Maximum level | Note |
|---|-----------------------|---------------|------|
| $30\text{MHz} \leq f < 1\text{GHz}$ | 100 kHz | -57 dBm | |
| $1\text{GHz} \leq f \leq 12.75\text{GHz}$ | 1 MHz | -47 dBm | |

Table 7.11: Additional receiver spurious emission requirements

| Band | Frequency Band | Measurement Bandwidth | Maximum level | Note |
|-------------------------|-----------------------------|-----------------------|----------------------|--|
| I | 860 MHz ≤ f ≤ 895 MHz | 3.84 MHz | -60 dBm | |
| | 921 MHz ≤ f < 925 MHz | 100 kHz | -60 dBm * | |
| | 925 MHz ≤ f ≤ 935 MHz | 100 kHz 3.84MHz | -67 dBm * -60 dBm | |
| | 935 MHz < f ≤ 960 MHz | 100 kHz | -79 dBm * | |
| | 1805 MHz ≤ f ≤ 1880 MHz | 100 kHz | -71 dBm * | |
| | 1844.9 MHz ≤ f ≤ 1879.9 MHz | 3.84 MHz | -60 dBm | |
| | 1920 MHz ≤ f ≤ 1980 MHz | 3.84 MHz | -60 dBm | UE transmit band in URA_PCH, Cell_PCH and idle state |
| | 2110 MHz ≤ f ≤ 2170 MHz | 3.84 MHz | -60 dBm | UE receive band |
| | 2620 MHz ≤ f ≤ 2690 MHz | 3.84 MHz | -60 dBm | |
| II | 869 MHz ≤ f ≤ 894 MHz | 3.84 MHz | -60 dBm | |
| | 1850 MHz ≤ f ≤ 1910 MHz | 3.84 MHz | -60 dBm | UE transmit band in URA_PCH, Cell_PCH and idle state |
| | 1930 MHz ≤ f ≤ 1990 MHz | 3.84 MHz | -60 dBm | UE receive band |
| | 2110 MHz ≤ f ≤ 2155 MHz | 3.84 MHz | -60 dBm | |
| III | 921 MHz ≤ f < 925 MHz | 100 kHz | -60 dBm* | |
| | 925 MHz ≤ f ≤ 935 MHz | 100 kHz 3.84 MHz | -67 dBm* -60 dBm | |
| | 935 MHz < f ≤ 960 MHz | 100 kHz | -79 dBm* | |
| | 1710 MHz ≤ f ≤ 1785 MHz | 3.84 MHz | -60 dBm | UE transmit band in URA_PCH, Cell_PCH and idle state |
| | 1805 MHz ≤ f ≤ 1880 MHz | 3.84 MHz | -60 dBm | UE receive band |
| | 2110 MHz ≤ f ≤ 2170 MHz | 3.84 MHz | -60 dBm | |
| | 2620 MHz ≤ f ≤ 2690 MHz | 3.84 MHz | -60 dBm | |
| IV | 869 MHz ≤ f < 894 MHz | 3.84 MHz | -60 dBm | |
| | 1710 MHz ≤ f < 1755 MHz | 3.84 MHz | -60 dBm | UE transmit band in URA_PCH, Cell_PCH and idle state |
| | 1930 MHz ≤ f ≤ 1990 MHz | 3.84 MHz | -60 dBm | |
| | 2110 MHz ≤ f ≤ 2155 MHz | 3.84 MHz | -60 dBm | UE receive band |
| V | 824 MHz ≤ f ≤ 849 MHz | 3.84 MHz | -60 dBm | UE transmit band in URA_PCH, Cell_PCH and idle state |
| | 869 MHz ≤ f < 894 MHz | 3.84 MHz | -60 dBm | UE receive band |
| | 1930 MHz ≤ f ≤ 1990 MHz | 3.84 MHz | -60 dBm | |
| | 2110 MHz ≤ f ≤ 2155 MHz | 3.84 MHz | -60 dBm | |
| VI | 815 MHz ≤ f ≤ 850 MHz | 3.84 MHz | -60 dBm | UE in URA_PCH, Cell_PCH and idle state |
| | 860 MHz ≤ f ≤ 895 MHz | 3.84 MHz | -60 dBm | UE in URA_PCH, Cell_PCH and idle state |
| | 1844.9 MHz ≤ f ≤ 1879.9 MHz | 3.84 MHz | -60 dBm | |
| | 2110 MHz ≤ f ≤ 2170 MHz | 3.84 MHz | -60 dBm | |
| VII | 921 MHz ≤ f < 925 MHz | 100 kHz | -60 dBm * | |
| | 925 MHz ≤ f ≤ 935 MHz | 100 kHz | -67 dBm * | |
| | 935 MHz < f ≤ 960 MHz | 100 kHz | -60 dBm | |
| | 935 MHz < f ≤ 960 MHz | 100 kHz | -79 dBm * | |
| | 1805 MHz ≤ f ≤ 1880 MHz | 100 kHz | -71 dBm * | |
| | 2110 MHz ≤ f ≤ 2170 MHz | 3.84 MHz | -60 dBm | |
| | 2500 MHz ≤ f ≤ 2570 MHz | 3.84 MHz | -60 dBm | UE transmit band in URA_PCH, Cell_PCH and idle state |
| 2620 MHz ≤ f ≤ 2690 MHz | 3.84 MHz | -60 dBm | UE receive band | |
| VIII | 880 MHz ≤ f ≤ 915 MHz | 3.84 MHz | -60 dBm | UE in URA_PCH, Cell_PCH and idle state |
| | 921 MHz ≤ f < 925 MHz | 100 kHz | -60 dBm * | |
| | 925 MHz ≤ f ≤ 935 MHz | 100 kHz 3.84 MHz | -67 dBm * -60 dBm | |
| | 935 MHz < f ≤ 960 MHz | 100 kHz | -79 dBm * | |
| | 1805 MHz < f ≤ 1880 MHz | 3.84 MHz | -60 dBm | |
| | 2110 MHz ≤ f ≤ 2170 MHz | 3.84 MHz | -60 dBm | |
| 2620 MHz ≤ f ≤ 2690 MHz | 3.84 MHz | -60 dBm | | |
| IX | 860 MHz ≤ f ≤ 895 MHz | 3.84 MHz | -60 dBm | |

| | | | | |
|--------|--|----------|---------|--|
| | 1749.9 MHz ≤ f ≤ 1784.9 MHz | 3.84 MHz | -60 dBm | UE transmit band in URA_PCH, Cell_PCH and idle state |
| | 1844.9 MHz ≤ f ≤ 1879.9 MHz | 3.84 MHz | -60 dBm | UE receive band |
| | 2110 MHz ≤ f ≤ 2170 MHz | 3.84 MHz | -60 dBm | |
| Note * | The measurements are made on frequencies which are integer multiples of 200 kHz. As exceptions, up to five measurements with a level up to the applicable requirements defined in Table 7.10 are permitted for each UARFCN used in the measurement | | | |

8 Performance requirement

8.1 General

The performance requirements for the UE in this subclause are specified for the measurement channels specified in Annex A, the propagation conditions specified in Annex B and the Down link Physical channels specified in Annex C. Unless stated DL power control is OFF. Unless otherwise stated the performance requirements are specified at the antenna connector of the UE. For UE(s) with an integral antenna only, a reference antenna with a gain of 0 dBi is assumed. UE with an integral antenna may be taken into account by converting these power levels into field strength requirements, assuming a 0 dBi gain antenna. For UE(s) with more than one receiver antenna connector the fading of the signals and the AWGN signals applied to each receiver antenna connector shall be uncorrelated. The levels of the test signal applied to each of the antenna connectors shall be as defined in the respective sections below.

8.2 Demodulation in static propagation conditions

8.2.1 (void)

8.2.2 Demodulation of Forward Access Channel (FACH)

void

8.2.3 Demodulation of Dedicated Channel (DCH)

The receive characteristic of the Dedicated Channel (DCH) in the static environment is determined by the Block Error Ratio (BLER). BLER is specified for each individual data rate of the DCH. DCH is mapped into the Dedicated Physical Channel (DPCH).

8.2.3.1 Minimum requirement

For the parameters specified in Table 8.5 the average downlink $\frac{DPCH_E_c}{I_{or}}$ power ratio shall be below the specified value for the BLER shown in Table 8.6. These requirements are applicable for TFCS size 16.

Table 8.5: DCH parameters in static propagation conditions

| Parameter | Unit | Test 1 | Test 2 | Test 3 | Test 4 |
|-----------------------|--------------|---------|--------|--------|--------|
| Phase reference | | P-CPICH | | | |
| \hat{I}_{or}/I_{oc} | dB | -1 | | | |
| I_{oc} | dBm/3.84 MHz | -60 | | | |
| Information Data Rate | kbps | 12.2 | 64 | 144 | 384 |

Table 8.6: DCH requirements in static propagation conditions

| Test Number | $\frac{DPCH - E_c}{I_{or}}$ | BLER |
|-------------|-----------------------------|-----------|
| 1 | -16.6 dB | 10^{-2} |
| 2 | -13.1 dB | 10^{-1} |
| | -12.8 dB | 10^{-2} |
| 3 | -9.9 dB | 10^{-1} |
| | -9.8 dB | 10^{-2} |
| 4 | -5.6 dB | 10^{-1} |
| | -5.5 dB | 10^{-2} |

8.3 Demodulation of DCH in multi-path fading propagation conditions

8.3.1 Single Link Performance

The receive characteristics of the Dedicated Channel (DCH) in different multi-path fading environments are determined by the Block Error Ratio (BLER) values. BLER is measured for the each of the individual data rate specified for the DPCH. DCH is mapped into in Dedicated Physical Channel (DPCH).

8.3.1.1 Minimum requirement

For the parameters specified in Table 8.7, 8.9, 8.11, 8.13 and 8.14A the average downlink $\frac{DPCH - E_c}{I_{or}}$ power ratio shall be below the specified value for the BLER shown in Table 8.8, 8.10, 8.12, 8.14 and 8.14B. These requirements are applicable for TFCS size 16.

Table 8.7: Test Parameters for DCH in multi-path fading propagation conditions (Case 1)

| Parameter | Unit | Test 1 | Test 2 | Test 3 | Test 4 |
|-----------------------|--------------|---------|--------|--------|--------|
| Phase reference | | P-CPICH | | | |
| \hat{I}_{or}/I_{oc} | dB | 9 | | | |
| I_{oc} | dBm/3.84 MHz | -60 | | | |
| Information Data Rate | kbps | 12.2 | 64 | 144 | 384 |

Table 8.8: Test requirements for DCH in multi-path fading propagation conditions (Case 1)

| Test Number | $\frac{DPCH - E_c}{I_{or}}$ | BLER |
|-------------|-----------------------------|-----------|
| 1 | -15.0 dB | 10^{-2} |
| 2 | -13.9 dB | 10^{-1} |
| | -10.0 dB | 10^{-2} |
| 3 | -10.6 dB | 10^{-1} |
| | -6.8 dB | 10^{-2} |
| 4 | -6.3 dB | 10^{-1} |
| | -2.2 dB | 10^{-2} |

Table 8.9: DCH parameters in multi-path fading propagation conditions (Case 2)

| Parameter | Unit | Test 5 | Test 6 | Test 7 | Test 8 |
|-----------------------|--------------|---------|--------|--------|--------|
| Phase reference | | P-CPICH | | | |
| \hat{I}_{or}/I_{oc} | dB | -3 | -3 | 3 | 6 |
| I_{oc} | dBm/3.84 MHz | -60 | | | |
| Information Data Rate | kbps | 12.2 | 64 | 144 | 384 |

Table 8.10: DCH requirements in multi-path fading propagation (Case 2)

| Test Number | $\frac{DPCH - E_c}{I_{or}}$ | BLER |
|-------------|-----------------------------|-----------|
| 5 | -7.7 dB | 10^{-2} |
| 6 | -6.4 dB | 10^{-1} |
| | -2.7 dB | 10^{-2} |
| 7 | -8.1 dB | 10^{-1} |
| | -5.1 dB | 10^{-2} |
| 8 | -5.5 dB | 10^{-1} |
| | -3.2 dB | 10^{-2} |

Table 8.11: DCH parameters in multi-path fading propagation conditions (Case 3)

| Parameter | Unit | Test 9 | Test 10 | Test 11 | Test 12 |
|-----------------------|--------------|---------|---------|---------|---------|
| Phase reference | | P-CPICH | | | |
| \hat{I}_{or}/I_{oc} | dB | -3 | -3 | 3 | 6 |
| I_{oc} | dBm/3.84 MHz | -60 | | | |
| Information Data Rate | kbps | 12.2 | 64 | 144 | 384 |

Table 8.12: DCH requirements in multi-path fading propagation conditions (Case 3)

| Test Number | $\frac{DPCH - E_c}{I_{or}}$ | BLER |
|-------------|-----------------------------|-----------|
| 9 | -11.8 dB | 10^{-2} |
| 10 | -8.1 dB | 10^{-1} |
| | -7.4 dB | 10^{-2} |
| | -6.8 dB | 10^{-3} |
| 11 | -9.0 dB | 10^{-1} |
| | -8.5 dB | 10^{-2} |
| | -8.0 dB | 10^{-3} |
| 12 | -5.9 dB | 10^{-1} |
| | -5.1 dB | 10^{-2} |
| | -4.4 dB | 10^{-3} |

Table 8.13: DCH parameters in multi-path fading propagation conditions (Case 1) with S-CPICH

| Parameter | Unit | Test 13 | Test 14 | Test 15 | Test 16 |
|-----------------------|--------------|---------|---------|---------|---------|
| Phase reference | | S-CPICH | | | |
| \hat{I}_{or}/I_{oc} | dB | 9 | | | |
| I_{oc} | dBm/3.84 MHz | -60 | | | |
| Information Data Rate | kbps | 12.2 | 64 | 144 | 384 |

Table 8.14: DCH requirements in multi-path fading propagation conditions (Case 1) with S-CPICH

| Test Number | $\frac{DPCH_E_c}{I_{or}}$ | BLER |
|-------------|----------------------------|-----------|
| 13 | -15.0 dB | 10^{-2} |
| 14 | -13.9 dB | 10^{-1} |
| | -10.0 dB | 10^{-2} |
| 15 | -10.6 dB | 10^{-1} |
| | -6.8 dB | 10^{-2} |
| 16 | -6.3 dB | 10^{-1} |
| | -2.2 dB | 10^{-2} |

Table 8.14A: DCH parameters in multi-path fading propagation conditions (Case 6)

| Parameter | Unit | Test 17 | Test 18 | Test 19 | Test 20 |
|-----------------------|--------------|---------|---------|---------|---------|
| Phase reference | | P-CPICH | | | |
| \hat{I}_{or}/I_{oc} | dB | -3 | -3 | 3 | 6 |
| I_{oc} | dBm/3.84 MHz | -60 | | | |
| Information Data Rate | kbps | 12.2 | 64 | 144 | 384 |

Table 8.14B: DCH requirements in multi-path fading propagation conditions (Case 6)

| Test Number | $\frac{DPCH_E_c}{I_{or}}$ | BLER |
|-------------|----------------------------|-----------|
| 17 | -8.8 dB | 10^{-2} |
| 18 | -5.1 dB | 10^{-1} |
| | -4.4 dB | 10^{-2} |
| | -3.8 dB | 10^{-3} |
| 19 | -6.0 dB | 10^{-1} |
| | -5.5 dB | 10^{-2} |
| | -5.0 dB | 10^{-3} |
| 20 | -2.9 dB | 10^{-1} |
| | -2.1 dB | 10^{-2} |
| | -1.4 dB | 10^{-3} |

Table 8.14C: Void**Table 8.14D: Void****Table 8.14E: Void****Table 8.14F: Void**

8.4 Demodulation of DCH in moving propagation conditions

8.4.1 Single link performance

The receive single link performance of the Dedicated Channel (DCH) in dynamic moving propagation conditions are determined by the Block Error Ratio (BLER) values. BLER is measured for the each of the individual data rate specified for the DPCH. DCH is mapped into Dedicated Physical Channel (DPCH).

8.4.1.1 Minimum requirement

For the parameters specified in Table 8.15 the average downlink $\frac{DPCH_E_c}{I_{or}}$ power ratio shall be below the specified value for the BLER shown in Table 8.16.

Table 8.15: DCH parameters in moving propagation conditions

| Parameter | Unit | Test 1 | Test 2 |
|-----------------------|--------------|---------|--------|
| Phase reference | | P-CPICH | |
| \hat{I}_{or}/I_{oc} | dB | -1 | |
| I_{oc} | dBm/3.84 MHz | -60 | |
| Information Data Rate | kbps | 12.2 | 64 |

Table 8.16: DCH requirements in moving propagation conditions

| Test Number | $\frac{DPCH_E_c}{I_{or}}$ | BLER |
|-------------|----------------------------|-----------|
| 1 | -14.5 dB | 10^{-2} |
| 2 | -10.9 dB | 10^{-2} |

8.5 Demodulation of DCH in birth-death propagation conditions

8.5.1 Single link performance

The receive single link performance of the Dedicated Channel (DCH) in dynamic birth-death propagation conditions are determined by the Block Error Ratio (BLER) values. BER is measured for the each of the individual data rate specified for the DPCH. DCH is mapped into Dedicated Physical Channel (DPCH).

8.5.1.1 Minimum requirement

For the parameters specified in Table 8.17 the average downlink $\frac{DPCH_E_c}{I_{or}}$ power ratio shall be below the specified value for the BLER shown in Table 8.18.

Table 8.17: DCH parameters in birth-death propagation conditions

| Parameter | Unit | Test 1 | Test 2 |
|-----------------------|--------------|---------|--------|
| Phase reference | | P-CPICH | |
| \hat{I}_{or}/I_{oc} | dB | -1 | |
| I_{oc} | dBm/3.84 MHz | -60 | |
| Information Data Rate | kbps | 12.2 | 64 |

Table 8.18: DCH requirements in birth-death propagation conditions

| Test Number | $\frac{DPCH_E_c}{I_{or}}$ | BLER |
|-------------|----------------------------|-----------|
| 1 | -12.6 dB | 10^{-2} |
| 2 | -8.7 dB | 10^{-2} |

8.6 Demodulation of DCH in downlink Transmit diversity modes

8.6.1 Demodulation of DCH in open-loop transmit diversity mode

The receive characteristic of the Dedicated Channel (DCH) in open loop transmit diversity mode is determined by the Block Error Ratio (BLER). DCH is mapped into in Dedicated Physical Channel (DPCH).

8.6.1.1 Minimum requirement

For the parameters specified in Table 8.19 the average downlink $\frac{DPCH_E_c}{I_{or}}$ power ratio shall be below the specified value for the BLER shown in Table 8.20.

Table 8.19: Test parameters for DCH reception in an open loop transmit diversity scheme. (Propagation condition: Case 1)

| Parameter | Unit | Test 1 |
|-----------------------|--------------|---------|
| Phase reference | | P-CPICH |
| \hat{I}_{or}/I_{oc} | dB | 9 |
| I_{oc} | dBm/3.84 MHz | -60 |
| Information data rate | kbps | 12.2 |

Table 8.20: Test requirements for DCH reception in open loop transmit diversity scheme

| Test Number | $\frac{DPCH_E_c}{I_{or}}$ (antenna 1/2) | BLER |
|-------------|---|-----------|
| 1 | -16.8 dB | 10^{-2} |

8.6.2 Demodulation of DCH in closed loop transmit diversity mode

The receive characteristic of the dedicated channel (DCH) in closed loop transmit diversity mode is determined by the Block Error Ratio (BLER). DCH is mapped into in Dedicated Physical Channel (DPCH).

8.6.2.1 Minimum requirement

For the parameters specified in Table 8.21 the average downlink $\frac{DPCH_E_c}{I_{or}}$ power ratio shall be below the specified value for the BLER shown in Table 8.22.

Table 8.21: Test Parameters for DCH Reception in closed loop transmit diversity mode (Propagation condition: Case 1)

| Parameter | Unit | Test 1 (Mode 1) |
|------------------------------------|--------------|--------------------|
| \hat{I}_{or}/I_{oc} | dB | 9 |
| I_{oc} | dBm/3.84 MHz | -60 |
| Information data rate | kbps | 12.2 |
| Feedback error rate | % | 4 |
| Closed loop timing adjustment mode | - | 1 |

Table 8.22: Test requirements for DCH reception in closed loop transmit diversity mode

| Test Number | $\frac{DPCH_E_c}{I_{or}}$ (see note) | BLER |
|--|---------------------------------------|-----------|
| 1 | -18.0 dB | 10^{-2} |
| NOTE: This is the total power from both antennas. Power sharing between antennas are feedback mode dependent as specified in TS25.214. | | |

8.6.3 Void

Table 8.23: Void**Table 8.24: Void**

8.7 Demodulation in Handover conditions

8.7.1 Demodulation of DCH in Inter-Cell Soft Handover

The bit error rate characteristics of UE is determined during an inter-cell soft handover. During the soft handover a UE receives signals from different cells. A UE has to be able to demodulate two PCCPCH channels and to combine the energy of DCH channels. Delay profiles of signals received from different cells are assumed to be the same but time shifted by 10 chips.

The receive characteristics of the different channels during inter-cell handover are determined by the average Block Error Ratio (BLER) values.

8.7.1.1 Minimum requirement

For the parameters specified in Table 8.25 the average downlink $\frac{DPCH_E_c}{I_{or}}$ power ratio shall be below the specified value for the BLER shown in Table 8.26.

Table 8.25: DCH parameters in multi-path propagation conditions during Soft Handoff (Case 3)

| Parameter | Unit | Test 1 | Test 2 | Test 3 | Test 4 |
|---|--------------|---------|--------|--------|--------|
| Phase reference | | P-CPICH | | | |
| \hat{I}_{or1}/I_{oc} and \hat{I}_{or2}/I_{oc} | dB | 0 | 0 | 3 | 6 |
| I_{oc} | dBm/3.84 MHz | -60 | | | |
| Information data Rate | kbps | 12.2 | 64 | 144 | 384 |

Table 8.26: DCH requirements in multi-path propagation conditions during Soft Handoff (Case 3)

| Test Number | $\frac{DPCH_E_c}{I_{or}}$ | BLER |
|-------------|----------------------------|-----------|
| 1 | -15.2 dB | 10^{-2} |
| 2 | -11.8 dB | 10^{-1} |
| | -11.3 dB | 10^{-2} |
| 3 | -9.9 dB | 10^{-1} |
| | -9.5 dB | 10^{-2} |
| 4 | -6.3 dB | 10^{-1} |
| | -5.8 dB | 10^{-2} |

8.7.2 Combining of TPC commands from radio links of different radio link sets

8.7.2.1 Minimum requirement

Test parameters are specified in Table 8.27. The delay profiles of the signals received from the different cells are the same but time-shifted by 10 chips.

For Test 1, the sequence of uplink power changes between adjacent slots shall be as shown in Table 8.28 over the 4 consecutive slots more than 99% of the time. Note that this case is without an additional noise source I_{oc} .

For Test 2, the Cell1 and Cell2 TPC patterns are repeated a number of times. If the transmitted power of a given slot is increased compared to the previous slot, then a variable "Transmitted power UP" is increased by one, otherwise a variable "Transmitted power DOWN" is increased by one. The requirements for "Transmitted power UP" and "Transmitted power DOWN" are shown in Table 8.28A.

Table 8.27: Parameters for TPC command combining

| Parameter | Unit | Test 1 | Test 2 |
|-------------------------------------|--------------|-------------------------------------|--------------------------|
| Phase reference | - | P-CPICH | |
| DPCH_Ec/Ior | dB | -12 | |
| \hat{I}_{or1} and \hat{I}_{or2} | dBm/3.84 MHz | -60 | |
| I_{oc} | dBm/3.84 MHz | - | -60 |
| Power-Control-Algorithm | - | Algorithm 1 | |
| Cell 1 TPC commands over 4 slots | - | {0,0,1,1} | |
| Cell 2 TPC commands over 4 slots | - | {0,1,0,1} | |
| Information data Rate | kbps | 12.2 | |
| Propagation condition | - | Static without AWGN source I_{oc} | Multi-path fading case 3 |

Table 8.28: Test requirements for Test 1

| Test Number | Required power changes over the 4 consecutive slots |
|-------------|---|
| 1 | Down, Down, Down, Up |

Table 8.28A: Requirements for Test 2

| Test Number | Ratio (Transmitted power UP) / (Total number of slots) | Ratio (Transmitted power DOWN) / (Total number of slots) |
|-------------|--|--|
| 2 | ≥ 0.25 | ≥ 0.5 |

8.7.3 Combining of reliable TPC commands from radio links of different radio link sets

8.7.3.1 Minimum requirement

Test 1 verifies that the UE follows only the reliable TPC commands in soft handover. Test 2 verifies that the UE follows all the reliable TPC commands in soft handover.

Test parameters are specified in Table 8.28B. Before the start of the tests, the UE transmit power shall be initialised to -15 dBm. An actual UE transmit power may vary from the target level of -15 dBm due to inaccurate UE output power step.

During tests 1 and 2 the UE transmit power samples, which are defined as the mean power over one timeslot, shall stay 90% of the time within the range defined in Table 8.28C.

Table 8.28B: Parameters for reliable TPC command combining

| Parameter | Unit | Test 1 | Test 2 |
|---|--------------|-------------------|------------------|
| Phase reference | - | P-CPICH | |
| DPCH_Ec/Ior1 | dB | Note 1 | Note 1 & Note 3 |
| DPCH_Ec/Ior2 | dB | DPCH_Ec/Ior1 - 10 | DPCH_Ec/Ior1 + 6 |
| DPCH_Ec/Ior3 | dB | DPCH_Ec/Ior1 - 10 | - |
| \hat{I}_{or1}/I_{oc} | dB | -1 | -1 |
| \hat{I}_{or2}/I_{oc} | dB | -1 | -1 |
| \hat{I}_{or3}/I_{oc} | dB | -1 | - |
| I_{oc} | dBm/3.84 MHz | -60 | |
| Power-Control-Algorithm | - | Algorithm 1 | |
| UL Power Control step size, Δ_{TPC} | dB | 1 | |
| Cell 1 TPC commands | - | Note 2 | Note 2 |
| Cell 2 TPC commands | - | '1' | '1' |
| Cell 3 TPC commands | - | '1' | - |
| Information data Rate | kbps | 12.2 | |
| Propagation condition | - | Static | |
| Note 1: The DPCH_Ec/Ior1 is set at the level corresponding to 5% TPC error rate. | | | |
| Note 2: The uplink power control from cell1 shall be such that the UE transmit power would stay at -15 dBm. | | | |
| Note 3: The maximum DPCH_Ec/Ior1 level in cell1 is -9 dB. | | | |

Table 8.28C: Test requirements for reliable TPC command combining

| Parameter | Unit | Test 1 | Test 2 |
|-----------------|------|------------|------------|
| UE output power | dBm | -15 ± 5 dB | -15 ± 3 dB |

8.8 Power control in downlink

Power control in the downlink is the ability of the UE receiver to converge to required link quality set by the network while using as low power as possible in downlink. If a BLER target has been assigned to a DCCH (See Annex A.3), then it has to be such that outer loop is based on DTCH and not on DCCH.

The requirements in this subclause were derived with the assumption that the UTRAN responds immediately to the uplink TPC commands by adjusting the power of the first pilot field of the DL DPCCH that commences after end of the received TPC command.

8.8.1 Power control in the downlink, constant BLER target

8.8.1.1 Minimum requirements

For the parameters specified in Table 8.29 the downlink $\frac{DPCH_Ec}{I_{or}}$ power ratio measured values, which are

averaged over one slot, shall be below the specified value in Table 8.30 more than 90% of the time. BLER shall be as shown in Table 8.30. Power control in downlink is ON during the test.

Table 8.29: Test parameter for downlink power control

| Parameter | Unit | Test 1 | Test 2 | Test 3 | Test 4 |
|--|--------------|------------|--------|--------|--------|
| \hat{I}_{or}/I_{oc} | dB | 9 | -1 | 4 | 9 |
| I_{oc} | dBm/3.84 MHz | -60 | | -60 | |
| Information Data Rate | kbps | 12.2 | | 64 | |
| Reference channel in Annex A | | A.3.1 | | A.3.5 | |
| Target quality value on DTCH | BLER | 0.01 | | 0.1 | 0.001 |
| Target quality value on DCCH | BLER | - | | 0.1 | 0.1 |
| Propagation condition | | Case 4 | | | |
| Maximum_DL_Power * | dB | 7 | | | |
| Minimum_DL_Power * | dB | -18 | | | |
| DL Power Control step size, Δ_{TPC} | dB | 1 | | | |
| Limited Power Increase | - | "Not used" | | | |

NOTE: Power is compared to P-CPICH as specified in [4].

Table 8.30: Requirements in downlink power control

| Parameter | Unit | Test 1 | Test 2 | Test 3 | Test 4 |
|----------------------------|------|----------|----------|---------|-----------|
| $\frac{DPCH_E_c}{I_{or}}$ | dB | -16.0 | -9.0 | -9.0 | -10.3 |
| Measured quality on DTCH | BLER | 0.01±30% | 0.01±30% | 0.1±30% | 0.001±30% |

8.8.2 Power control in the downlink, initial convergence

This requirement verifies that DL power control works properly during the first seconds after DPCH connection is established

8.8.2.1 Minimum requirements

For the parameters specified in Table 8.31 the downlink DPCH_Ec/I_{or} power ratio measured values, which are averaged over 50 ms, shall be within the range specified in Table 8.32 more than 90% of the time. T1 equals to 500 ms and it starts 10 ms after the DPDCH physical channel is considered established and the first uplink frame is transmitted. T2 equals to 500 ms and it starts when T1 has expired. Power control is ON during the test.

The first 10 ms shall not be used for averaging, ie the first sample to be input to the averaging filter is at the beginning of T1. The averaging shall be performed with a sliding rectangular window averaging filter. The window size of the averaging filter is linearly increased from 0 up to 50 ms during the first 50 ms of T1, and then kept equal to 50ms.

Table 8.31: Test parameters for downlink power control

| Parameter | Unit | Test 1 | Test 2 | Test 3 | Test 4 |
|--|--------------|------------|--------|--------|--------|
| Target quality value on DTCH | BLER | 0.01 | 0.01 | 0.1 | 0.1 |
| Initial DPCH_Ec/I _{or} | dB | -5.9 | -25.9 | -3 | -22.8 |
| Information Data Rate | kbps | 12.2 | 12.2 | 64 | 64 |
| \hat{I}_{or}/I_{oc} | dB | -1 | | | |
| I_{oc} | dBm/3.84 MHz | -60 | | | |
| Propagation condition | | Static | | | |
| Maximum_DL_Power | dB | 7 | | | |
| Minimum_DL_Power | dB | -18 | | | |
| DL Power Control step size, Δ_{TPC} | dB | 1 | | | |
| Limited Power Increase | - | "Not used" | | | |

Table 8.32: Requirements in downlink power control

| Parameter | Unit | Test 1 and Test 2 | Test 3 and Test 4 |
|---------------------------------------|------|--------------------------------------|--------------------------------------|
| $\frac{DPCH - E_c}{I_{or}}$ during T1 | dB | $-18.9 \leq DPCH_Ec/lor \leq -11.9$ | $-15.1 \leq DPCH_Ec/lor \leq -8.1$ |
| $\frac{DPCH - E_c}{I_{or}}$ during T2 | dB | $-18.9 \leq DPCH_Ec/lor \leq -14.9$ | $-15.1 \leq DPCH_Ec/lor \leq -11.1$ |

Note: The lower limit is decreased by 3 dB for a UE with more than one antenna connector.

8.8.3 Power control in downlink, wind up effects

8.8.3.1 Minimum requirements

This test is run in three stages where stage 1 is for convergence of the power control loop. In stage two the maximum downlink power for the dedicated channel is limited not to be higher than the value specified in Table 8.33. All parameters used in the three stages are specified in Table 8.33. The downlink $\frac{DPCH - E_c}{I_{or}}$ power ratio measured values,

which are averaged over one slot, during stage 3 shall be lower than the value specified in Table 8.34 more than 90% of the time.

Power control of the UE is ON during the test.

Table 8.33: Test parameter for downlink power control, wind-up effects

| Parameter | Unit | Test 1 | | |
|--|--------------|------------|--------------------------|---------|
| | | Stage 1 | Stage 2 | Stage 3 |
| Time in each stage | s | 5 | 5 | 0.5 |
| \hat{I}_{or}/I_{oc} | dB | 5 | | |
| I_{oc} | dBm/3.84 MHz | -60 | | |
| Information Data Rate | kbps | 12.2 | | |
| Quality target on DTCH | BLER | 0.01 | | |
| Propagation condition | | Case 4 | | |
| Maximum_DL_Power | dB | 7 | $\min(-6.2, P)$. Note 1 | 7 |
| Minimum_DL_Power | dB | -18 | | |
| DL Power Control step size, Δ_{TPC} | dB | 1 | | |
| Limited Power Increase | - | 'Not used' | | |

Note 1: P is the level corresponding to the average $\frac{DPCH - E_c}{I_{or}}$ power ratio - 2 dB compared to the P-CPICH level. The average $\frac{DPCH - E_c}{I_{or}}$ power ratio is measured during the initialisation stage after the power control loop has converged before the actual test starts.

Table 8.34: Requirements in downlink power control, wind-up effects

| Parameter | Unit | Test 1, stage 3 |
|-----------------------------|------|-----------------|
| $\frac{DPCH - E_c}{I_{or}}$ | dB | -13.3 |

8.8.4 Power control in the downlink, different transport formats

8.8.4.1 Minimum requirements

Test 1 verifies that UE outer loop power control has proper behaviour with different transport formats.

The downlink reference measurement channel used in this subclause shall have two different transport formats. The different transport formats of the downlink reference measurement channel used shall correspond to the measurement channels specified in Annex A.3.0 and A.3.1. The transport format used in downlink reference measurement channel during different stages of the test shall be set according to the information data rates specified in Table 8.34A. During stage 1 a downlink transport format combination using the 12.2kbps information data rate DTCH shall be used, and during stage 2 the downlink transport format combination shall be changed such that a 0kbps information data rate transport format combination is then used.

For the parameters specified in Table 8.34A the downlink $\frac{DPCH - E_c}{I_{or}}$ power ratio measured values, which are averaged over one slot, shall be below the specified value in Table 8.34B more than 90% of the time. BLER shall be as shown in Table 8.34B. Power control in downlink is ON during the test.

Table 8.34A: Parameters for downlink power control in case of different transport formats

| Parameter | Unit | Test 1 | |
|--|--------------|------------|---------|
| | | Stage 1 | Stage 2 |
| Time in each stage | s | Note 1 | Note 1 |
| \hat{I}_{or}/I_{oc} | dB | 9 | |
| I_{oc} | dBm/3.84 MHz | -60 | |
| Information Data Rate | kbps | 12.2 | 0 |
| Quality target on DTCH | BLER | 0.01 | |
| Quality target on DCCH | BLER | 1 | |
| Propagation condition | | Case4 | |
| Maximum_DL_Power | dB | 7 | |
| Minimum_DL_Power | dB | -18 | |
| DL Power Control step size, Δ_{TPC} | dB | 1 | |
| Limited Power Increase | - | 'Not used' | |
| Note 1: The stage lasts until the DTCH quality has converged to the quality target | | | |

NOTE: Power is compared to P-CPICH as specified in [4].

Table 8.34B: Requirements in downlink power control in case of different transport formats

| Parameter | Unit | Test 1, stage 1 | Test 1, stage 2 |
|-----------------------------|------|-----------------|-----------------|
| $\frac{DPCH - E_c}{I_{or}}$ | dB | -16.0 | -18.0 |
| Measured quality on DTCH | BLER | 0.01±30% | 0.01±30% |

8.8.5 Power control in the downlink for F-DPCH

8.8.5.1 Minimum requirements

For the parameters specified in Table 8.34C the downlink $\frac{F - DPCH - E_c}{I_{or}}$ power ratio measured values, which are averaged over TPC symbols of the F-DPCH frame, shall be below the specified value in Table 8.34D more than 90% of the time. TPC command error rate shall be as shown in Table 8.34D. Power control in downlink is ON during the tests.

Table 8.34C: Test parameters for Fractional downlink power control

| Parameter | Unit | Test 1 | Test 2 |
|--|--------------|-------------|--------|
| \hat{I}_{or}/I_{oc} | dB | 9 | -1 |
| I_{oc} | dBm/3.84 MHz | -60 | |
| SF | | 256 | |
| Target quality value on F DPCH | % | 1 | 5 |
| Propagation condition | | Case 4 | |
| Maximum_DL_Power * | dB | 7 | |
| Minimum_DL_Power * | dB | -18 | |
| DL Power Control step size, Δ_{TPC} | dB | 1 | |
| Limited Power Increase | - | "Not used" | |
| Power-Control-Algorithm | - | Algorithm 1 | |

Table 8.34D: Requirements in Fractional downlink power control

| Parameter | Unit | Test 1 | Test 2 |
|--------------------------------|------|-----------|------------|
| $\frac{F - DPCH_E_c}{I_{or}}$ | dB | -15.9 | -12.0 |
| TPC command Error Rate | % | 0,01± 50% | 0,05 ± 30% |

8.9 Downlink compressed mode

Downlink compressed mode is used to create gaps in the downlink transmission, to allow the UE to make measurements on other frequencies.

The requirements in this subclause were derived with the assumption that the UTRAN responds immediately to the uplink TPC commands by adjusting the power of the first pilot field of the DL DPCCCH that commences after end of the received TPC command.

8.9.1 Single link performance

The receiver single link performance of the Dedicated Traffic Channel (DCH) in compressed mode is determined by the Block Error Ratio (BLER) and transmitted DPCH_Ec/I_{or} power ratio in the downlink.

The compressed mode parameters are given in clause A.5.

8.9.1.1 Minimum requirements

For the parameters specified in Table 8.35 the downlink $\frac{DPCH_E_c}{I_{or}}$ power ratio measured values, which are averaged over one slot, shall be below the specified value in Table 8.36 more than 90% of the time. The measured quality on DTCH shall be as required in Table 8.36.

Downlink power control is ON during the test. Uplink TPC commands shall be error free.

Table 8.35: Test parameter for downlink compressed mode

| Parameter | Unit | Test 1 | Test 2 |
|---|--------------|--|--|
| Delta SIR1 | dB | 0 | 3 |
| Delta SIR after1 | dB | 0 | 3 |
| Delta SIR2 | dB | 0 | 0 |
| Delta SIR after2 | dB | 0 | 0 |
| Compressed mode patterns | - | Set 2 in table A.21 in clause A.5 of TS 25.101 | Set 1 in table A.21 in clause A.5 of TS 25.101 |
| \hat{I}_{or}/I_{oc} | dB | 9 | |
| I_{oc} | dBm/3.84 MHz | -60 | |
| Information Data Rate | kbps | 12.2 | |
| Propagation condition | | Case 3 | Case 2 |
| Target quality value on DTCH | BLER | 0.01 | |
| Maximum_DL_Power | dB | 7 | |
| Minimum_DL_Power | dB | -18 | |
| DL Power Control step size, Δ_{TPC} | dB | 1 | |
| Limited Power Increase | - | "Not used" | |

Table 8.36: Requirements in downlink compressed mode

| Parameter | Unit | Test 1 | Test 2 |
|--|------|-----------------|-----------------|
| $\frac{DPCH_E_c}{I_{or}}$ | dB | -13.7 | No requirements |
| Measured quality of compressed and recovery frames | BLER | No requirements | <0.001 |
| Measured quality on DTCH | BLER | 0.01 ± 30 % | |

8.10 Blind transport format detection

Performance of Blind transport format detection is determined by the Block Error Ratio (BLER) values and by the measured average transmitted $DPCH_E_c/I_{or}$ value.

8.10.1 Minimum requirement

For the parameters specified in Table 8.37 the average downlink $\frac{DPCH_E_c}{I_{or}}$ power ratio shall be below the specified value for the BLER shown in Table 8.38.

Table 8.37: Test parameters for Blind transport format detection

| Parameter | Unit | Test 1 | Test 2 | Test 3 | Test 4 | Test 5 | Test 6 |
|-----------------------|--------------|------------------|------------------|------------------|--------------------------|------------------|------------------|
| \hat{I}_{or}/I_{oc} | dB | -1 | | | -3 | | |
| I_{oc} | dBm/3.84 MHz | -60 | | | | | |
| Information Data Rate | kbps | 12.2 (rate 1) | 7.95 (rate 2) | 1.95 (rate 3) | 12.2 (rate 1) | 7.95 (rate 2) | 1.95 (rate 3) |
| propagation condition | - | static | | | multi-path fading case 3 | | |
| TFCI | - | off | | | | | |

Table 8.38: The Requirements for DCH reception in Blind transport format detection

| Test Number | $\frac{DPCH - E_c}{I_{or}}$ | BLER | FDR |
|-------------|-----------------------------|-----------|-----------|
| 1 | -17.7 dB | 10^{-2} | 10^{-4} |
| 2 | -17.8 dB | 10^{-2} | 10^{-4} |
| 3 | -18.4 dB | 10^{-2} | 10^{-4} |
| 4 | -13.0 dB | 10^{-2} | 10^{-4} |
| 5 | -13.2 dB | 10^{-2} | 10^{-4} |
| 6 | -13.8 dB | 10^{-2} | 10^{-4} |

* The value of DPCH_Ec/Ior, Ioc, and Ior/Ioc are defined in case of DPCH is transmitted

NOTE: In this test, 9 different Transport Format Combinations (Table 8.39) are sent during the call set up procedure, so that the UE has to detect the correct transport format from these 9 candidates.

Table 8.39: Transport format combinations informed during the call set up procedure in the test

| | 1 | 2 | 3 | 4 | 5 | 6 | 7 | 8 | 9 |
|------|-------|-------|-------|------|------|------|-------|-------|-------|
| DTCH | 12.2k | 10.2k | 7.95k | 7.4k | 6.7k | 5.9k | 5.15k | 4.75k | 1.95k |
| DCCH | 2.4k | | | | | | | | |

8.11 Detection of Broadcast channel (BCH)

The receiver characteristics of Broadcast Channel (BCH) are determined by the Block Error Ratio (BLER) values. BCH is mapped into the primary common control physical channel (P-CCPCH).

8.11.1 Minimum requirement without transmit diversity

For the parameters specified in Table 8.40 the average downlink power P-CCPCH_Ec/Ior shall be below the specified value for the BLER shown in Table 8.41. (The Down link Physical channels are specified in Annex C).

This requirement doesn't need to be tested.

Table 8.40: Parameters for BCH detection

| Parameter | Unit | Test 1 | Test 2 |
|-----------------------|--------------|---------|--------|
| Phase reference | - | P-CPICH | |
| I_{oc} | dBm/3.84 MHz | -60 | |
| \hat{I}_{or}/I_{oc} | dB | -1 | -3 |
| Propagation condition | | Static | Case 3 |

Table 8.41: Test requirements for BCH detection

| Test Number | P-CCPCH_Ec/Ior | BLER |
|-------------|----------------|------|
| 1 | -18.5 dB | 0.01 |
| 2 | -12.8 dB | 0.01 |

8.11.2 Minimum requirement with open loop transmit diversity

For the parameters specified in Table 8.41A the average downlink power P-CCPCH_Ec/Ior shall be below the specified value for the BLER shown in Table 8.41B. (The Down link Physical channels are specified in Annex C).

This requirement doesn't need to be tested.

Table 8.41A: Test parameters for BCH detection in an open loop transmit diversity scheme (STTD). (Propagation condition: Case 1)

| Parameter | Unit | Test 3 |
|-----------------------|--------------|---------|
| Phase reference | - | P-CPICH |
| I_{oc} | dBm/3.84 MHz | -60 |
| \hat{I}_{or}/I_{oc} | dB | 9 |

Table 8.41B: Test requirements for BCH detection in open loop transmit diversity scheme

| Test Number | P-CCPCH_Ec/lor (Total power from antenna 1 and 2) | BLER |
|-------------|--|------|
| 3 | -18.5 | 0.01 |

8.12 Demodulation of Paging Channel (PCH)

The receiver characteristics of paging channel are determined by the probability of missed paging message (P_{m-p}). PCH is mapped into the S-CCPCH and it is associated with the transmission of Paging Indicators (PI) to support efficient sleep-mode procedures.

8.12.1 Minimum requirement

For the parameters specified in Table 8.42 the average probability of missed paging (P_{m-p}) shall be below the specified value in Table 8.43. Power of downlink channels other than S-CCPCH and PICH are as defined in Table C.3 of Annex C. S-CCPCH structure is as defined in Annex A.6.

Table 8.42: Parameters for PCH detection

| Parameter | Unit | Test 1 | Test 2 |
|---|--------------|---------|--------|
| Number of paging indicators per frame (N_p) | - | 72 | |
| Phase reference | - | P-CPICH | |
| I_{oc} | dBm/3.84 MHz | -60 | |
| \hat{I}_{or}/I_{oc} | dB | -1 | -3 |
| Propagation condition | | Static | Case 3 |

Table 8.43: Test requirements for PCH detection

| Test Number | S-CCPCH_Ec/lor | PICH_Ec/lor | P_{m-p} |
|-------------|----------------|-------------|-----------|
| 1 | -14.8 | -19 | 0.01 |
| 2 | -9.8 | -12 | 0.01 |

8.13 Detection of Acquisition Indicator (AI)

The receiver characteristics of Acquisition Indicator (AI) are determined by the probability of false alarm P_{fa} and probability of correct detection P_d . P_{fa} is defined as a conditional probability of detection of AI signature given that a AI signature was not transmitted. P_d is defined as a conditional probability of correct detection of AI signature given that the AI signature is transmitted.

8.13.1 Minimum requirement

For the parameters specified in Table 8.44 the Pfa and 1-Pd shall not exceed the specified values in Table 8.45. Power of downlink channels other than AICH is as defined in Table C.3 of Annex C.

Table 8.44: Parameters for AI detection

| Parameter | Unit | Test 1 |
|---|--------------|---------|
| Phase reference | - | P-CPICH |
| I_{oc} | dBm/3.84 MHz | -60 |
| Number of other transmitted AI signatures on AICH | - | 0 |
| \hat{I}_{or}/I_{oc} | dB | -1 |
| AICH_Ec/Ior | dB | -22.0 |
| AICH Power Offset | dB | -12.0 |
| Propagation condition | - | Static |

Note that AICH_Ec/Ior can not be set. Its value is calculated from other parameters and it is given for information only. (AICH_Ec/Ior = AICH Power Offset + CPICH_Ec/Ior)

Table 8.45: Test requirements for AI detection

| Test Number | Pfa | 1-Pd |
|-------------|------|------|
| 1 | 0.01 | 0.01 |

8.14 Void

8.15 Void

8.16 Void

Table 8.46: Void

Table 8.47: Void

Table 8.48: Void

Table 8.49: Void

Table 8.50: Void

Table 8.51: Void

Table 8.52: Void

9 Performance requirement (HSDPA)

The performance requirements for the UE in this clause apply for the reference measurement channels specified in Annex A.7, the propagation conditions specified in Annex B.2.2 and the Down link Physical channels specified in Annex C.5. The specific references are provided separately for each requirement.

Unless otherwise stated the performance requirements are specified at the antenna connector of the UE. For UE(s) with an integral antenna only, a reference antenna with a gain of 0 dBi is assumed. UE with an integral antenna may be taken into account by converting these power levels into field strength requirements, assuming a 0 dBi gain antenna. For UEs with more than one antenna connector testing the fading of the signals and the AWGN signals applied to each receiver antenna connector shall be uncorrelated. The levels of the test signal applied to each of the antenna connectors shall be as defined in the respective sections below.

9.1 Void

9.2 Demodulation of HS-DSCH (Fixed Reference Channel)

The minimum performance requirement for a particular UE belonging to certain HS-DSCH category are determined according to Table 9.1. The performance requirements for a particular UE belonging to certain HS-DSCH category and supporting the optional enhanced performance requirements type 1 are determined according to Table 9.1AA. The performance requirements for a particular UE belonging to HS-DSCH categories 7 or 8 and supporting the optional enhanced performance requirements type 2 are determined according to Table 9.1AB. The performance requirements for a particular UE belonging to HS-DSCH categories 7 or 8 and supporting the optional enhanced performance requirements type 3 are determined according to Table 9.1AC.

The propagation conditions for this subclause are defined in table B.1B.

Table 9.1: FRC for minimum performance requirements for different HS-DSCH categories

| HS-DSCH category | Corresponding requirement | | |
|---------------------|---|---------------------|-----------------------|
| | Single Link | Open Loop Diversity | Closed Loop Diversity |
| Category 1 | H-Set 1 | H-Set 1 | H-Set 1 |
| Category 2 | H-Set 1 | H-Set 1 | H-Set 1 |
| Category 3 | H-Set 2 | H-Set 2 | H-Set 2 |
| Category 4 | H-Set 2 | H-Set 2 | H-Set 2 |
| Category 5 | H-Set 3 | H-Set 3 | H-Set 3 |
| Category 6 | H-Set 3 | H-Set 3 | H-Set 3 |
| Category 7 (Note 1) | H-Set 6, H-Set 3 | H-Set 3 | H-Set 3 |
| Category 8 (Note 1) | H-Set 6, H-Set 3 | H-Set 3 | H-Set 3 |
| Category 11 | H-Set 4 | H-Set 4 | H-Set 4 |
| Category 12 | H-Set 5 | H-Set 5 | H-Set 5 |
| Note 1 | Single link minimum performance requirements for Categories 7 and 8 in Pedestrian A with $\hat{I}_{or}/I_{oc}=10\text{dB}$ are set according to H-Set 6. Requirements in other conditions are according to H-Set 3. | | |
| Note 2 | For UE supporting the minimum performance requirements for HS-DSCH the requirements for HS-SCCH detection for single link are determined in Table 9.51 and for open loop transmit diversity in Table 9.53. | | |

Table 9.1AA: FRC for enhanced performance requirements type 1 for different HS-DSCH categories

| HS-DSCH category | Corresponding requirement | | |
|---------------------|---|---------------------|-----------------------|
| | Single Link | Open Loop Diversity | Closed Loop Diversity |
| Category 1 | H-Set 1 | H-Set 1 | H-Set 1 |
| Category 2 | H-Set 1 | H-Set 1 | H-Set 1 |
| Category 3 | H-Set 2 | H-Set 2 | H-Set 2 |
| Category 4 | H-Set 2 | H-Set 2 | H-Set 2 |
| Category 5 | H-Set 3 | H-Set 3 | H-Set 3 |
| Category 6 | H-Set 3 | H-Set 3 | H-Set 3 |
| Category 7 (Note 1) | H-Set 6, H-Set 3 | H-Set 3 | H-Set 3 |
| Category 8 (Note 1) | H-Set 6, H-Set 3 | H-Set 3 | H-Set 3 |
| Note 1 | Single link enhanced performance requirements type 1 for Categories 7 and 8 in Pedestrian A with $\hat{I}_{or}/I_{oc}=10\text{dB}$ are set according to H-Set 6. Requirements in other conditions are according to H-Set 3. | | |
| Note 2 | For UE supporting the enhanced performance requirements type 1 for HS-DSCH the requirements for HS-SCCH detection for single link are determined in Table 9.51A and for open loop transmit diversity in Table 9.54. | | |

Table 9.1AB: FRC for enhanced performance requirements type 2 for different HS-DSCH categories

| HS-DSCH category | Corresponding requirement | | |
|------------------|---|------------------------------|--------------------------------|
| | Single Link (Note 1) | Open Loop Diversity (Note 2) | Closed Loop Diversity (Note 3) |
| Category 7 | H-Set 6, H-Set 3 | H-Set 3 | H-set 6, H-Set 3 |
| Category 8 | H-Set 6, H-Set 3 | H-Set 3 | H-set 6, H-Set 3 |
| Note 1 | Single link enhanced performance requirements type 2 for Categories 7 and 8 with $\hat{I}_{or}/I_{oc}=10\text{dB}$ are set according to H-Set 6. Requirements in other conditions are according to H-Set 3 minimum performance requirements. | | |
| Note 2 | Open loop transmit diversity requirements are set according to H-Set 3 minimum performance requirements. | | |
| Note 3 | Closed loop transmit diversity enhanced performance requirements type 2 for Categories 7 and 8 in Pedestrian B 3km/h with $\hat{I}_{or}/I_{oc}=10\text{dB}$ and $E_c/I_{or}=-3\text{dB}$ are set according to H-Set 6. Requirements in other conditions are set according to H-Set 3 minimum performance requirements | | |
| Note 4 | For UE supporting the enhanced performance requirements type 2 for HS-DSCH the minimum requirements for HS-SCCH detection for single link are determined in Table 9.51 and for open loop transmit diversity in Table 9.53. | | |

Table 9.1AC: FRC for enhanced performance requirements type 3 for different HS-DSCH categories

| HS-DSCH category | Corresponding requirement | | |
|------------------|--|------------------------------|--------------------------------|
| | Single Link (Note 1) | Open Loop Diversity (Note 2) | Closed Loop Diversity (Note 3) |
| Category 7 | H-Set 6, H-Set 3 | H-Set 3 | H-Set 3 |
| Category 8 | H-Set 6, H-Set 3 | H-Set 3 | H-Set 3 |
| Note 1 | Single link enhanced performance requirements type 3 for Categories 7 and 8 with $\hat{I}_{or}/I_{oc}=10\text{dB}$ and $\hat{I}_{or}/I_{oc}=5\text{dB}$ are set according to H-Set 6. Requirements in other conditions are according to H-Set 3 type1 enhanced performance requirements. | | |
| Note 2 | Open loop transmit diversity requirements are set according to H-Set 3 type1 enhanced performance requirements. | | |
| Note 3 | Closed loop transmit diversity requirements are set according to H-Set 3 type1 enhanced performance requirements. | | |
| Note 4 | For UE supporting the enhanced performance requirements type 3 for HS-DSCH the requirements for HS-SCCH detection for single link are determined in Table 9.51A and for open loop transmit diversity in Table 9.54. | | |

During the Fixed Reference Channel tests the behaviour of the Node-B emulator in response to the ACK/NACK signalling field of the HS-DPCCH is specified in Table 9.1A:

Table 9.1A: Node-B Emulator Behaviour in response to ACK/NACK/DTX

| HS-DPCCH ACK/NACK Field State | Node-B Emulator Behaviour |
|-------------------------------|---|
| ACK | ACK: new transmission using 1 st redundancy and constellation version (RV) |
| NACK | NACK: retransmission using the next RV (up to the maximum permitted number or RV's) |
| DTX | DTX: retransmission using the RV previously transmitted to the same H-ARQ process |

NOTE: Performance requirements in this section assume a sufficient power allocation to HS-SCCH_1 so that probability of reporting DTX is very low.

9.2.1 Single Link performance

The receiver single link performance of the High Speed Physical Downlink Shared Channel (HS-DSCH) in different multi-path fading environments are determined by the information bit throughput R

9.2.1.1 Requirement QPSK, Fixed Reference Channel (FRC) H-Set 1/2/3

The requirements are specified in terms of a minimum information bit throughput R for the DL reference channels H-set 1/2/3 (QPSK version) specified in Annex A.7.1.1, A.7.1.2 and A.7.1.3 respectively, with the addition of the parameters in Table 9.2 and the downlink physical channel setup according to table C.8.

Using this configuration the throughput shall meet or exceed the minimum requirements specified in table 9.3. Enhanced performance requirements type 1 specified in Table 9.3A are based on receiver diversity.

Table 9.2: Test Parameters for Testing QPSK FRCs H-Set 1/H-Set 2/H-Set 3

| Parameter | Unit | Test 1 | Test 2 | Test 3 | Test 4 |
|--|---|-----------|--------|--------|--------|
| Phase reference | | P-CPICH | | | |
| I_{oc} | dBm/3.84 MHz | -60 | | | |
| Redundancy and constellation version coding sequence | | {0,2,5,6} | | | |
| Maximum number of HARQ transmission | | 4 | | | |
| Note: | The HS-SCCH-1 and HS-PDSCH shall be transmitted continuously with constant power. HS-SCCH-1 shall only use the identity of the UE under test for those TTI intended for the UE. | | | | |

Table 9.3: Minimum requirement QPSK, Fixed Reference Channel (FRC) H-Set 1/2/3

| Test Number | Propagation Conditions | Reference value | | |
|-------------|------------------------|---------------------------------|--|---|
| | | HS-PDSCH E_c / I_{or} (dB) | T-put R (kbps) * $\hat{I}_{or} / I_{oc} = 0$ dB | T-put R (kbps) * $\hat{I}_{or} / I_{oc} = 10$ dB |
| 1 | PA3 | -6 | 65 | 309 |
| | | -3 | N/A | 423 |
| 2 | PB3 | -6 | 23 | 181 |
| | | -3 | 138 | 287 |
| 3 | VA30 | -6 | 22 | 190 |
| | | -3 | 142 | 295 |
| 4 | VA120 | -6 | 13 | 181 |
| | | -3 | 140 | 275 |

* Notes: 1) The reference value R is for the Fixed Reference Channel (FRC) H-Set 1
 2) For Fixed Reference Channel (FRC) H-Set 2 the reference values for R should be scaled (multiplied by 1.5 and rounding to the nearest integer t-put in kbps, where values of $i+1/2$ are rounded up to $i+1$, i integer)
 3) For Fixed Reference Channel (FRC) H-Set 3 the reference values for R should be scaled (multiplied by 3 and rounding to the nearest integer t-put in kbps, where values of $i+1/2$ are rounded up to $i+1$, i integer)

Table 9.3A: Enhanced requirement type 1 QPSK, Fixed Reference Channel (FRC) H-Set 1/2/3

| Test Number | Propagation Conditions | Reference value | | |
|-------------|------------------------|---------------------------------|--|---|
| | | HS-PDSCH E_c / I_{or} (dB) | T-put R (kbps) * $\hat{I}_{or} / I_{oc} = 0$ dB | T-put R (kbps) * $\hat{I}_{or} / I_{oc} = 10$ dB |
| 1 | PA3 | -12 | N/A | 247 |
| | | -9 | N/A | 379 |
| | | -6 | 195 | N/A |
| | | -3 | 329 | N/A |
| 2 | PB3 | -9 | N/A | 195 |
| | | -6 | 156 | 316 |
| | | -3 | 263 | N/A |
| 3 | VA30 | -9 | N/A | 212 |
| | | -6 | 171 | 329 |
| | | -3 | 273 | N/A |
| 4 | VA120 | -9 | N/A | 191 |
| | | -6 | 168 | 293 |
| | | -3 | 263 | N/A |

* Notes: 1) The reference value R is for the Fixed Reference Channel (FRC) H-Set 1
 2) For Fixed Reference Channel (FRC) H-Set 2 the reference values for R should be scaled (multiplied by 1.5 and rounding to the nearest integer t-put in kbps, where values of $i+1/2$ are rounded up to $i+1$, i integer)
 3) For Fixed Reference Channel (FRC) H-Set 3 the reference values for R should be scaled (multiplied by 3 and rounding to the nearest integer t-put in kbps, where values of $i+1/2$ are rounded up to $i+1$, i integer)

9.2.1.2 Requirement 16QAM, Fixed Reference Channel (FRC) H-Set 1/2/3

The requirements are specified in terms of a minimum information bit throughput R for the DL reference channels H-set 1/2/3 (16QAM version) specified in Annex A.7.1.1, A.7.1.2 and A.7.1.3 respectively, with the addition of the parameters in Table 9.4 and the downlink physical channel setup according to table C.8.

Using this configuration the throughput shall meet or exceed the minimum requirements specified in table 9.5. Enhanced performance requirements type 1 specified in Table 9.5A are based on receiver diversity.

Table 9.4: Test Parameters for Testing 16QAM FRCs H-Set 1/H-Set 2/H-Set 3

| Parameter | Unit | Test 1 | Test 2 | Test 3 | Test 4 |
|--|---|-----------|--------|--------|--------|
| Phase reference | | P-CPICH | | | |
| I_{oc} | dBm/3.84 MHz | -60 | | | |
| Redundancy and constellation version coding sequence | | {6,2,1,5} | | | |
| Maximum number of HARQ transmission | | 4 | | | |
| Note: | The HS-SCCH-1 and HS-PDSCH shall be transmitted continuously with constant power. HS-SCCH-1 shall only use the identity of the UE under test for those TTI intended for the UE. | | | | |

Table 9.5: Minimum requirement 16QAM, Fixed Reference Channel (FRC) H-Set 1/2/3

| Test Number | Propagation Conditions | Reference value | |
|---|------------------------|---------------------------------|---|
| | | HS-PDSCH E_c / I_{or} (dB) | T-put R (kbps) * $\hat{I}_{or} / I_{oc} = 10$ dB |
| 1 | PA3 | -6 | 198 |
| | | -3 | 368 |
| 2 | PB3 | -6 | 34 |
| | | -3 | 219 |
| 3 | VA30 | -6 | 47 |
| | | -3 | 214 |
| 4 | VA120 | -6 | 28 |
| | | -3 | 167 |
| * Notes: 1)The reference value R is for the Fixed Reference Channel (FRC) H-Set 1 2) For Fixed Reference Channel (FRC) H-Set 2 the reference values for R should be scaled (multiplied by 1.5 and rounding to the nearest integer t-put in kbps, where values of i+1/2 are rounded up to i+1, i integer) 3) For Fixed Reference Channel (FRC) H-Set 3 the reference values for R should be scaled (multiplied by 3 and rounding to the nearest integer t-put in kbps, where values of i+1/2 are rounded up to i+1, i integer) | | | |

Table 9.5A: Enhanced requirement type 1 16QAM, Fixed Reference Channel (FRC) H-Set 1/2/3

| Test Number | Propagation Conditions | Reference value | |
|---|------------------------|---------------------------------|---|
| | | HS-PDSCH E_c / I_{or} (dB) | T-put R (kbps) * $\hat{I}_{or} / I_{oc} = 10$ dB |
| 1 | PA3 | -9 | 312 |
| | | -6 | 487 |
| 2 | PB3 | -6 | 275 |
| | | -3 | 408 |
| 3 | VA30 | -6 | 296 |
| | | -3 | 430 |
| 4 | VA120 | -6 | 271 |
| | | -3 | 392 |
| * Notes: 1)The reference value R is for the Fixed Reference Channel (FRC) H-Set 1 2) For Fixed Reference Channel (FRC) H-Set 2 the reference values for R should be scaled (multiplied by 1.5 and rounding to the nearest integer t-put in kbps, where values of i+1/2 are rounded up to i+1, i integer) 3) For Fixed Reference Channel (FRC) H-Set 3 the reference values for R should be scaled (multiplied by 3 and rounding to the nearest integer t-put in kbps, where values of i+1/2 are rounded up to i+1, i integer) | | | |

9.2.1.3 Minimum requirement QPSK, Fixed Reference Channel (FRC) H-Set 4/5

The requirements are specified in terms of a minimum information bit throughput R for the DL reference channels H-set 4/5 specified in Annex A.7.1.4 and A.7.1.5 respectively, with the addition of the parameters in Table 9.6 and the downlink physical channel setup according to table C.8.

Using this configuration the throughput shall meet or exceed the minimum requirements specified in table 9.7 for H-Set 4 and table 9.8 for H-Set 5.

Table 9.6: Test Parameters for Testing QPSK FRCs H-Set 4/H-Set 5

| Parameter | Unit | Test 1 | Test 2 | Test 3 | Test 4 |
|--|---|-----------|--------|--------|--------|
| Phase reference | | P-CPICH | | | |
| I_{oc} | dBm/3.84 MHz | -60 | | | |
| Redundancy and constellation version coding sequence | | {0,2,5,6} | | | |
| Maximum number of HARQ transmission | | 4 | | | |
| Note: | The HS-SCCH-1 and HS-PDSCH shall be transmitted continuously with constant power. HS-SCCH-1 shall only use the identity of the UE under test for those TTI intended for the UE. | | | | |

Table 9.7: Minimum requirement QPSK, Fixed Reference Channel (FRC) H-Set 4

| Test Number | Propagation Conditions | Reference value | | |
|--|------------------------|-------------------------------|--|---|
| | | HS-PDSCH E_c/I_{or} (dB) | T-put R (kbps) * $\hat{I}_{or}/I_{oc} = 0$ dB | T-put R (kbps) * $\hat{I}_{or}/I_{oc} = 10$ dB |
| 1 | PA3 | -6 | 72 | 340 |
| | | -3 | N/A | 439 |
| 2 | PB3 | -6 | 24 | 186 |
| | | -3 | 142 | 299 |
| 3 | VA30 | -6 | 19 | 183 |
| | | -3 | 148 | 306 |
| 4 | VA120 | -6 | 11 | 170 |
| | | -3 | 144 | 284 |
| * Note: The reference value R is for the Fixed Reference Channel (FRC) H-Set 4 | | | | |

Table 9.8: Minimum requirement QPSK, Fixed Reference Channel (FRC) H-Set 5

| Test Number | Propagation Conditions | Reference value | | |
|--|------------------------|-------------------------------|--|---|
| | | HS-PDSCH E_c/I_{or} (dB) | T-put R (kbps) * $\hat{I}_{or}/I_{oc} = 0$ dB | T-put R (kbps) * $\hat{I}_{or}/I_{oc} = 10$ dB |
| 1 | PA3 | -6 | 98 | 464 |
| | | -3 | N/A | 635 |
| 2 | PB3 | -6 | 35 | 272 |
| | | -3 | 207 | 431 |
| 3 | VA30 | -6 | 33 | 285 |
| | | -3 | 213 | 443 |
| 4 | VA120 | -6 | 20 | 272 |
| | | -3 | 210 | 413 |
| * Note: The reference value R is for the Fixed Reference Channel (FRC) H-Set 5 | | | | |

9.2.1.4 Requirement QPSK, Fixed Reference Channel (FRC) H-Set 6

The requirements are specified in terms of a minimum information bit throughput R for the DL reference channel H-Set 6 specified in Annex A.7.1.6 with the addition of the parameters in Table 9.8A and the downlink physical channel setup according to table C.8.

Using this configuration the throughput shall meet or exceed the minimum requirements specified in table 9.8B. Enhanced performance requirements type 1 as specified in Table 9.8B1 are based on receiver diversity. Enhanced performance requirements type 2 as specified in Table 9.8B2 are based on chip level equaliser. Enhanced performance requirements type 3 as specified in Table 9.8B3 and in Table 9.8B4 are based on receiver diversity and chip level equaliser.

Table 9.8A: Test Parameters for Testing QPSK FRCs H-Set 6

| Parameter | Unit | Test 1 | Test 2 | Test 3 | Test 4 |
|--|---|-----------|--------|--------|--------|
| Phase reference | | P-CPICH | | | |
| I_{oc} | dBm/3.84 MHz | -60 | | | |
| Redundancy and constellation version coding sequence | | {0,2,5,6} | | | |
| Maximum number of HARQ transmission | | 4 | | | |
| Note: | The HS-SCCH-1 and HS-PDSCH shall be transmitted continuously with constant power. HS-SCCH-1 shall only use the identity of the UE under test for those TTI intended for the UE. | | | | |

Table 9.8B: Minimum requirement QPSK, Fixed Reference Channel (FRC) H-Set 6

| Test Number | Propagation Conditions | Reference value | |
|-------------|------------------------|-------------------------------|---|
| | | HS-PDSCH E_c/I_{or} (dB) | T-put R (kbps) * $\hat{I}_{or}/I_{oc} = 10$ dB |
| 1 | PA3 | -6 | 1407 |
| | | -3 | 2090 |

Table 9.8B1: Enhanced requirements type 1 QPSK, Fixed Reference Channel (FRC) H-Set 6

| Test Number | Propagation Conditions | Reference value | |
|-------------|------------------------|-------------------------------|---|
| | | HS-PDSCH E_c/I_{or} (dB) | T-put R (kbps) * $\hat{I}_{or}/I_{oc} = 10$ dB |
| 1 | PA3 | -12 | 672 |
| | | -9 | 1305 |

Table 9.8B2: Enhanced requirement type 2 QPSK, Fixed Reference Channel (FRC) H-Set 6

| Test Number | Propagation Conditions | Reference value | |
|-------------|------------------------|-------------------------------|---|
| | | HS-PDSCH E_c/I_{or} (dB) | T-put R (kbps) * $\hat{I}_{or}/I_{oc} = 10$ dB |
| 1 | PA3 | -6 | 1494 |
| | | -3 | 2153 |
| 2 | PB3 | -6 | 1038 |
| | | -3 | 1744 |
| 3 | VA30 | -6 | 1142 |
| | | -3 | 1782 |
| 4 | VA120 | -6 | 909 |
| | | -3 | 1467 |

Table 9.8B3: Enhanced requirement type 3 QPSK at $\hat{I}_{or}/I_{oc} = 10$ dB, Fixed Reference Channel (FRC) H-Set 6

| Test Number | Propagation Conditions | Reference value | |
|-------------|------------------------|-------------------------------|---|
| | | HS-PDSCH E_c/I_{or} (dB) | T-put R (kbps) * $\hat{I}_{or}/I_{oc} = 10$ dB |
| 1 | PA3 | -9 | 1554 |
| | | -6 | 2495 |
| 2 | PB3 | -9 | 1190 |
| | | -6 | 2098 |
| 3 | VA30 | -9 | 1229 |
| | | -6 | 2013 |
| 4 | VA120 | -9 | 1060 |
| | | -6 | 1674 |

Table 9.8B4: Enhanced requirement type 3 QPSK at $\hat{I}_{or}/I_{oc} = 5$ dB, Fixed Reference Channel (FRC) H-Set 6

| Test Number | Propagation Conditions | Reference value | |
|-------------|------------------------|-------------------------------|--|
| | | HS-PDSCH E_c/I_{or} (dB) | T-put R (kbps) * $\hat{I}_{or}/I_{oc} = 5$ dB |
| 5 | PB3 | -6 | 1248 |
| | | -3 | 2044 |

9.2.1.5 Requirement 16QAM, Fixed Reference Channel (FRC) H-Set 6

The requirements are specified in terms of a minimum information bit throughput R for the DL reference channel H Set-6 specified in Annex A.7.1.6 with the addition of the parameters in Table 9.8C and the downlink physical channel setup according to table C.8.

Using this configuration the throughput shall meet or exceed the minimum requirements specified in table 9.8D. Enhanced performance requirements type 1 as specified in Table 9.8D1 are based on receiver diversity. Enhanced performance requirements type 2 as specified in Table 9.8D2 are based on chip level equaliser. Enhanced performance requirements type 3 as specified in Table 9.8D3 and in Table 9.8D4 are based on receiver diversity and chip level equaliser.

Table 9.8C: Test Parameters for Testing 16-QAM FRCs H-Set 6

| Parameter | Unit | Test 1 | Test 2 | Test 3 | Test 4 | Test 5 |
|--|---|-----------|--------|--------|--------|--------|
| Phase reference | | P-CPICH | | | | |
| I_{oc} | dBm/3.84 MHz | -60 | | | | |
| Redundancy and constellation version coding sequence | | {6,2,1,5} | | | | |
| Maximum number of HARQ transmission | | 4 | | | | |
| Note: | The HS-SCCH-1 and HS-PDSCH shall be transmitted continuously with constant power. HS-SCCH-1 shall only use the identity of the UE under test for those TTI intended for the UE. | | | | | |

Table 9.8D: Minimum requirement 16QAM, Fixed Reference Channel (FRC) H-Set 6

| Test Number | Propagation Conditions | Reference value | |
|-------------|------------------------|-------------------------------|---|
| | | HS-PDSCH E_c/I_{or} (dB) | T-put R (kbps) * $\hat{I}_{or}/I_{oc} = 10$ dB |
| 1 | PA3 | -6 | 887 |
| | | -3 | 1664 |

Table 9.8D1: Enhanced requirements type 1 16QAM, Fixed Reference Channel (FRC) H-Set 6

| Test Number | Propagation Conditions | Reference value | |
|-------------|------------------------|-------------------------------|---|
| | | HS-PDSCH E_c/I_{or} (dB) | T-put R (kbps) * $\hat{I}_{or}/I_{oc} = 10$ dB |
| 1 | PA3 | -9 | 912 |
| | | -6 | 1730 |

Table 9.8D2: Enhanced requirement type 2 16QAM, Fixed Reference Channel (FRC) H-Set 6

| Test Number | Propagation Conditions | Reference value | |
|-------------|------------------------|---------------------------------|---|
| | | HS-PDSCH E_c / I_{or} (dB) | T-put R (kbps) * $\hat{I}_{or} / I_{oc} = 10$ dB |
| 1 | PA3 | -6 | 991 |
| | | -3 | 1808 |
| 2 | PB3 | -6 | 465 |
| | | -3 | 1370 |
| 3 | VA30 | -6 | 587 |
| | | -3 | 1488 |
| 4 | VA120 | -6 | 386 |
| | | -3 | 1291 |

Table 9.8D3: Enhanced requirement type 3 16QAM at $\hat{I}_{or} / I_{oc} = 10$ dB, Fixed Reference Channel (FRC) H-Set 6

| Test Number | Propagation Conditions | Reference value | |
|-------------|------------------------|---------------------------------|---|
| | | HS-PDSCH E_c / I_{or} (dB) | T-put R (kbps) * $\hat{I}_{or} / I_{oc} = 10$ dB |
| 1 | PA3 | -6 | 1979 |
| | | -3 | 3032 |
| 2 | PB3 | -6 | 1619 |
| | | -3 | 2464 |
| 3 | VA30 | -6 | 1710 |
| | | -3 | 2490 |
| 4 | VA120 | -6 | 1437 |
| | | -3 | 2148 |

Table 9.8D4: Enhanced requirement type 3 16QAM at $\hat{I}_{or} / I_{oc} = 5$ dB, Fixed Reference Channel (FRC) H-Set 6

| Test Number | Propagation Conditions | Reference value | |
|-------------|------------------------|---------------------------------|--|
| | | HS-PDSCH E_c / I_{or} (dB) | T-put R (kbps) * $\hat{I}_{or} / I_{oc} = 5$ dB |
| 5 | PB3 | -6 | 779 |
| | | -3 | 1688 |

9.2.2 Open Loop Diversity performance

The receiver single open loop transmit diversity performance of the High Speed Physical Downlink Shared Channel (HS-DSCH) in multi-path fading environments are determined by the information bit throughput R .

9.2.2.1 Requirement QPSK, Fixed Reference Channel (FRC) H-Set 1/2/3

The requirements are specified in terms of a minimum information bit throughput R for the DL reference channels H-Set 1/2/3 (QPSK version) specified in Annex A.7.1.1, A.7.1.2 and A.7.1.3 respectively, with the addition of the parameters in Table 9.9 and the downlink physical channel setup according to table C.9.

Using this configuration the throughput shall meet or exceed the minimum requirements specified in table 9.10. Enhanced performance requirements type 1 specified in Table 9.10A are based on receiver diversity.

Table 9.9: Test Parameters for Testing QPSK FRCs H-Set 1/H-Set 2/H-Set 3

| Parameter | Unit | Test 1 | Test 2 | Test 3 |
|--|---|-----------|--------|--------|
| Phase reference | | P-CPICH | | |
| I_{oc} | dBm/3.84 MHz | -60 | | |
| Redundancy and constellation version coding sequence | | {0,2,5,6} | | |
| Maximum number of HARQ transmission | | 4 | | |
| Note: | The HS-SCCH-1 and HS-PDSCH shall be transmitted continuously with constant power. HS-SCCH-1 shall only use the identity of the UE under test for those TTI intended for the UE. | | | |

Table 9.10: Minimum requirement QPSK, Fixed Reference Channel (FRC) H-Set 1/2/3

| Test Number | Propagation Conditions | Reference value | | |
|--|------------------------|-------------------------------|--|---|
| | | HS-PDSCH E_c/I_{or} (dB) | T-put R (kbps) * $\hat{I}_{or}/I_{oc} = 0$ dB | T-put R (kbps) * $\hat{I}_{or}/I_{oc} = 10$ dB |
| 1 | PA3 | -6 | 77 | 375 |
| | | -3 | 180 | 475 |
| 2 | PB3 | -6 | 20 | 183 |
| | | -3 | 154 | 274 |
| 3 | VA30 | -6 | 15 | 187 |
| | | -3 | 162 | 284 |
| * Notes: 1) The reference value R is for the Fixed Reference Channel (FRC) H-Set 1 2) For Fixed Reference Channel (FRC) H-Set 2 the reference values for R should be scaled (multiplied by 1.5 and rounding to the nearest integer t-put in kbps, where values of $i+1/2$ are rounded up to $i+1$, i integer) 3) For Fixed Reference Channel (FRC) H-Set 3 the reference values for R should be scaled (multiplied by 3 and rounding to the nearest integer t-put in kbps, where values of $i+1/2$ are rounded up to $i+1$, i integer) | | | | |

Table 9.10A: Enhanced requirement type 1 QPSK, Fixed Reference Channel (FRC) H-Set 1/2/3

| Test Number | Propagation Conditions | Reference value | | |
|--|------------------------|-------------------------------|--|---|
| | | HS-PDSCH E_c/I_{or} (dB) | T-put R (kbps) * $\hat{I}_{or}/I_{oc} = 0$ dB | T-put R (kbps) * $\hat{I}_{or}/I_{oc} = 10$ dB |
| 1 | PA3 | -12 | N/A | 268 |
| | | -9 | N/A | 407 |
| | | -6 | 197 | N/A |
| | | -3 | 333 | N/A |
| 2 | PB3 | -9 | N/A | 183 |
| | | -6 | 152 | 288 |
| | | -3 | 251 | N/A |
| 3 | VA30 | -9 | N/A | 197 |
| | | -6 | 164 | 307 |
| | | -3 | 261 | N/A |
| * Notes: 1) The reference value R is for the Fixed Reference Channel (FRC) H-Set 1 2) For Fixed Reference Channel (FRC) H-Set 2 the reference values for R should be scaled (multiplied by 1.5 and rounding to the nearest integer t-put in kbps, where values of $i+1/2$ are rounded up to $i+1$, i integer) 3) For Fixed Reference Channel (FRC) H-Set 3 the reference values for R should be scaled (multiplied by 3 and rounding to the nearest integer t-put in kbps, where values of $i+1/2$ are rounded up to $i+1$, i integer) | | | | |

9.2.2.2 Requirement 16QAM, Fixed Reference Channel (FRC) H-Set 1/2/3

The requirements are specified in terms of a minimum information bit throughput R for the DL reference channels H-Set 1/2/3 (16QAM version) specified in Annex A.7.1.1, A.7.1.2 and A.7.1.3 respectively, with the addition of the parameters in Table 9.11 and the downlink physical channel setup according to table C.9.

Using this configuration the throughput shall meet or exceed the minimum requirements specified in table 9.12. Enhanced performance requirements type 1 specified in Table 9.12A are based on receiver diversity.

Table 9.11: Test Parameters for Testing 16QAM FRCs H-Set 1/H-Set 2/H-Set 3

| Parameter | Unit | Test 1 | Test 2 | Test 3 |
|--|---|-----------|--------|--------|
| Phase reference | | P-CPICH | | |
| I_{oc} | dBm/3.84 MHz | -60 | | |
| Redundancy and constellation version coding sequence | | {6,2,1,5} | | |
| Maximum number of HARQ transmission | | 4 | | |
| Note: | The HS-SCCH-1 and HS-PDSCH shall be transmitted continuously with constant power. HS-SCCH-1 shall only use the identity of the UE under test for those TTI intended for the UE. | | | |

Table 9.12: Minimum requirement 16QAM, Fixed Reference Channel (FRC) H-Set 1/2/3

| Test Number | Propagation Conditions | Reference value | |
|---|------------------------|---------------------------------|---|
| | | HS-PDSCH E_c / I_{or} (dB) | T-put R (kbps) * $\hat{I}_{or} / I_{oc} = 10$ dB |
| 1 | PA3 | -6 | 295 |
| | | -3 | 463 |
| 2 | PB3 | -6 | 24 |
| | | -3 | 243 |
| 3 | VA30 | -6 | 35 |
| | | -3 | 251 |
| * Notes: 1)The reference value R is for the Fixed Reference Channel (FRC) H-Set 1 2) For Fixed Reference Channel (FRC) H-Set 2 the reference values for R should be scaled (multiplied by 1.5 and rounding to the nearest integer t-put in kbps, where values of $i+1/2$ are rounded up to $i+1$, i integer) 3) For Fixed Reference Channel (FRC) H-Set 3 the reference values for R should be scaled (multiplied by 3 and rounding to the nearest integer t-put in kbps, where values of $i+1/2$ are rounded up to $i+1$, i integer) | | | |

Table 9.12A: Enhanced requirement type 1 16QAM, Fixed Reference Channel (FRC) H-Set 1/2/3

| Test Number | Propagation Conditions | Reference value | |
|---|------------------------|---------------------------------|---|
| | | HS-PDSCH E_c / I_{or} (dB) | T-put R (kbps) * $\hat{I}_{or} / I_{oc} = 10$ dB |
| 1 | PA3 | -9 | 340 |
| | | -6 | 513 |
| 2 | PB3 | -6 | 251 |
| | | -3 | 374 |
| 3 | VA30 | -6 | 280 |
| | | -3 | 398 |
| * Notes: 1)The reference value R is for the Fixed Reference Channel (FRC) H-Set 1 2) For Fixed Reference Channel (FRC) H-Set 2 the reference values for R should be scaled (multiplied by 1.5 and rounding to the nearest integer t-put in kbps, where values of $i+1/2$ are rounded up to $i+1$, i integer) 3) For Fixed Reference Channel (FRC) H-Set 3 the reference values for R should be scaled (multiplied by 3 and rounding to the nearest integer t-put in kbps, where values of $i+1/2$ are rounded up to $i+1$, i integer) | | | |

9.2.2.3 Minimum requirement QPSK, Fixed Reference Channel (FRC) H-Set 4/5

The requirements are specified in terms of a minimum information bit throughput R for the DL reference channels H-Set 4/5 specified in Annex A.7.1.4 and A.7.1.5 respectively, with the addition of the parameters in Table 9.13 and the downlink physical channel setup according to table C.9.

Using this configuration the throughput shall meet or exceed the minimum requirements specified in table 9.14 for H-Set 4 and table 9.15 for H-Set 5.

Table 9.13: Test Parameters for Testing QPSK FRCs H-Set 4/H-Set 5

| Parameter | Unit | Test 1 | Test 2 | Test 3 | Test 4 |
|--|---|-----------|--------|--------|--------|
| Phase reference | | P-CPICH | | | |
| I_{oc} | dBm/3.84 MHz | -60 | | | |
| Redundancy and constellation version coding sequence | | {0,2,5,6} | | | |
| Maximum number of HARQ transmission | | 4 | | | |
| Note: | The HS-SCCH-1 and HS-PDSCH shall be transmitted continuously with constant power. HS-SCCH-1 shall only use the identity of the UE under test for those TTI intended for the UE. | | | | |

Table 9.14: Minimum requirement QPSK, Fixed Reference Channel (FRC) H-Set 4

| Test Number | Propagation Conditions | Reference value | | |
|-------------|------------------------|-------------------------------|--|---|
| | | HS-PDSCH E_c/I_{or} (dB) | T-put R (kbps) * $\hat{I}_{or}/I_{oc} = 0$ dB | T-put R (kbps) * $\hat{I}_{or}/I_{oc} = 10$ dB |
| 1 | PA3 | -6 | 70 | 369 |
| | | -3 | 171 | 471 |
| 2 | PB3 | -6 | 14 | 180 |
| | | -3 | 150 | 276 |
| 3 | VA30 | -6 | 11 | 184 |
| | | -3 | 156 | 285 |

* Note: The reference value R is for the Fixed Reference Channel (FRC) H-Set 4

Table 9.15: Minimum requirement QPSK, Fixed Reference Channel (FRC) H-Set 5

| Test Number | Propagation Conditions | Reference value | | |
|-------------|------------------------|-------------------------------|--|---|
| | | HS-PDSCH E_c/I_{or} (dB) | T-put R (kbps) * $\hat{I}_{or}/I_{oc} = 0$ dB | T-put R (kbps) * $\hat{I}_{or}/I_{oc} = 10$ dB |
| 1 | PA3 | -6 | 116 | 563 |
| | | -3 | 270 | 713 |
| 2 | PB3 | -6 | 30 | 275 |
| | | -3 | 231 | 411 |
| 3 | VA30 | -6 | 23 | 281 |
| | | -3 | 243 | 426 |

* Note: The reference value R is for the Fixed Reference Channel (FRC) H-Set 5

9.2.3 Closed Loop Diversity Performance

The closed loop transmit diversity (Mode 1) performance of the High Speed Physical Downlink Shared Channel (HS-DSCH) in multi-path fading environments are determined by the information bit throughput R.

9.2.3.1 Requirement QPSK, Fixed Reference Channel (FRC) H-Set 1/2/3

The requirements are specified in terms of a minimum information bit throughput R for the DL reference channels H-Set 1/2/3 (QPSK version) specified in Annex A.7.1.1, A.7.1.2 and A.7.1.3 respectively, with the addition of the parameters in Table 9.16 and the downlink physical channel setup according to table C.10.

Using this configuration the throughput shall meet or exceed the minimum requirements specified in table 9.17. Enhanced performance requirements type 1 specified in Table 9.17A are based on receiver diversity.

Table 9.16: Test Parameters for Testing QPSK FRCs H-Set 1/H-Set 2/H-Set 3

| Parameter | Unit | Test 1 | Test 2 | Test 3 |
|--|---|-----------|--------|--------|
| Phase reference | | P-CPICH | | |
| I_{oc} | dBm/3.84 MHz | -60 | | |
| DPCH frame offset ($\tau_{DPCH,n}$) | Chip | 0 | | |
| Redundancy and constellation version coding sequence | | {0,2,5,6} | | |
| Maximum number of HARQ transmission | | 4 | | |
| Feedback Error Rate | % | 4 | | |
| Closed loop timing adjustment mode | | 1 | | |
| Note: | The HS-SCCH-1 and HS-PDSCH shall be transmitted continuously with constant power. HS-SCCH-1 shall only use the identity of the UE under test for those TTI intended for the UE. | | | |

Table 9.17: Minimum requirement QPSK, Fixed Reference Channel (FRC) H-Set 1/2/3

| Test Number | Propagation Conditions | Reference value | | |
|--|------------------------|---------------------------------|--|---|
| | | HS-PDSCH E_c / I_{or} (dB) | T-put R (kbps) * $\hat{I}_{or} / I_{oc} = 0$ dB | T-put R (kbps) * $\hat{I}_{or} / I_{oc} = 10$ dB |
| 1 | PA3 | -6 | 118 | 399 |
| | | -3 | 225 | 458 |
| 2 | PB3 | -6 | 50 | 199 |
| | | -3 | 173 | 301 |
| 3 | VA30 | -6 | 47 | 204 |
| | | -3 | 172 | 305 |
| * Notes: 1) The reference value R is for the Fixed Reference Channel (FRC) H-Set 1 2) For Fixed Reference Channel (FRC) H-Set 2 the reference values for R should be scaled (multiplied by 1.5 and rounding to the nearest integer t-put in kbps, where values of $i+1/2$ are rounded up to $i+1$, i integer) 3) For Fixed Reference Channel (FRC) H-Set 3 the reference values for R should be scaled (multiplied by 3 and rounding to the nearest integer t-put in kbps, where values of $i+1/2$ are rounded up to $i+1$, i integer) | | | | |

Table 9.17A: Enhanced requirement type 1 QPSK, Fixed Reference Channel (FRC) H-Set 1/2/3

| Test Number | Propagation Conditions | Reference value | | |
|--|------------------------|---------------------------------|--|---|
| | | HS-PDSCH E_c / I_{or} (dB) | T-put R (kbps) * $\hat{I}_{or} / I_{oc} = 0$ dB | T-put R (kbps) * $\hat{I}_{or} / I_{oc} = 10$ dB |
| 1 | PA3 | -12 | N/A | 297 |
| | | -9 | N/A | 410 |
| | | -6 | 242 | N/A |
| | | -3 | 369 | N/A |
| 2 | PB3 | -9 | N/A | 194 |
| | | -6 | 170 | 308 |
| | | -3 | 272 | N/A |
| 3 | VA30 | -9 | N/A | 204 |
| | | -6 | 172 | 315 |
| | | -3 | 270 | N/A |
| * Notes: 1) The reference value R is for the Fixed Reference Channel (FRC) H-Set 1 2) For Fixed Reference Channel (FRC) H-Set 2 the reference values for R should be scaled (multiplied by 1.5 and rounding to the nearest integer t-put in kbps, where values of $i+1/2$ are rounded up to $i+1$, i integer) 3) For Fixed Reference Channel (FRC) H-Set 3 the reference values for R should be scaled (multiplied by 3 and rounding to the nearest integer t-put in kbps, where values of $i+1/2$ are rounded up to $i+1$, i integer) | | | | |

9.2.3.2 Requirement 16QAM, Fixed Reference Channel (FRC) H-Set 1/2/3

The requirements are specified in terms of a minimum information bit throughput R for the DL reference channels H-set 1/2/3 (16QAM version) specified in Annex A.7.1.1, A.7.1.2 and A.7.1.3 respectively, with the addition of the parameters in Table 9.18 and the downlink physical channel setup according to table C.10.

Using this configuration the throughput shall meet or exceed the minimum requirements specified in table 9.19. Enhanced performance requirements type 1 specified in Table 9.19A are based on receiver diversity.

Table 9.18: Test Parameters for Testing 16-QAM FRCs H-Set 1/H-Set 2/H-Set 3

| Parameter | Unit | Test 1 | Test 2 | Test 3 |
|--|---|-----------|--------|--------|
| Phase reference | | P-CPICH | | |
| I_{oc} | dBm/3.84 MHz | -60 | | |
| DPCH frame offset ($\tau_{DPCH,n}$) | Chip | 0 | | |
| Redundancy and constellation version coding sequence | | {6,2,1,5} | | |
| Maximum number of HARQ transmission | | 4 | | |
| Feedback Error Rate | % | 4 | | |
| Closed loop timing adjustment mode | | 1 | | |
| Note: | The HS-SCCH-1 and HS-PDSCH shall be transmitted continuously with constant power. HS-SCCH-1 shall only use the identity of the UE under test for those TTI intended for the UE. | | | |

Table 9.19: Minimum requirement 16QAM, Fixed Reference Channel (FRC) H-Set 1/2/3

| Test Number | Propagation Conditions | Reference value | |
|---|------------------------|---------------------------------|---|
| | | HS-PDSCH E_c / I_{or} (dB) | T-put R (kbps) * $\hat{I}_{or} / I_{oc} = 10$ dB |
| 1 | PA3 | -6 | 361 |
| | | -3 | 500 |
| 2 | PB3 | -6 | 74 |
| | | -3 | 255 |
| 3 | VA30 | -6 | 84 |
| | | -3 | 254 |
| * Notes: 1)The reference value R is for the Fixed Reference Channel (FRC) H-Set 1 2) For Fixed Reference Channel (FRC) H-Set 2 the reference values for R should be scaled (multiplied by 1.5 and rounding to the nearest integer t-put in kbps, where values of $i+1/2$ are rounded up to $i+1$, i integer) 3) For Fixed Reference Channel (FRC) H-Set 3 the reference values for R should be scaled (multiplied by 3 and rounding to the nearest integer t-put in kbps, where values of $i+1/2$ are rounded up to $i+1$, i integer) | | | |

Table 9.19A: Enhanced requirement type 1 16QAM, Fixed Reference Channel (FRC) H-Set 1/2/3

| Test Number | Propagation Conditions | Reference value | |
|-------------|------------------------|-------------------------------|---|
| | | HS-PDSCH E_c/I_{or} (dB) | T-put R (kbps) * $\hat{I}_{or}/I_{oc} = 10$ dB |
| 1 | PA3 | -9 | 376 |
| | | -6 | 532 |
| 2 | PB3 | -6 | 267 |
| | | -3 | 393 |
| 3 | VA30 | -6 | 279 |
| | | -3 | 404 |

* Notes: 1)The reference value R is for the Fixed Reference Channel (FRC) H-Set 1
2) For Fixed Reference Channel (FRC) H-Set 2 the reference values for R should be scaled (multiplied by 1.5 and rounding to the nearest integer t-put in kbps, where values of $i+1/2$ are rounded up to $i+1$, i integer)
3) For Fixed Reference Channel (FRC) H-Set 3 the reference values for R should be scaled (multiplied by 3 and rounding to the nearest integer t-put in kbps, where values of $i+1/2$ are rounded up to $i+1$, i integer)

9.2.3.3 Minimum requirement QPSK, Fixed Reference Channel (FRC) H-Set 4/5

The requirements are specified in terms of a minimum information bit throughput R for the DL reference channels H-set 4/5 specified in Annex A.7.1.4 and A.7.1.5 respectively, with the addition of the parameters in Table 9.20 and the downlink physical channel setup according to table C.10.

Using this configuration the throughput shall meet or exceed the minimum requirements specified in table 9.21 for H-Set 4 and table 9.22 for H-Set 5.

Table 9.20: Test Parameters for Testing QPSK FRCs H-Set 4/H-Set 5

| Parameter | Unit | Test 1 | Test 2 | Test 3 |
|--|--------------|---------|-----------|--------|
| Phase reference | | P-CPICH | | |
| I_{oc} | dBm/3.84 MHz | | -60 | |
| DPCH frame offset ($\tau_{DPCH,n}$) | Chip | | 0 | |
| Redundancy and constellation version coding sequence | | | {0,2,5,6} | |
| Maximum number of HARQ transmission | | | 4 | |
| Feedback Error Rate | % | | 4 | |
| Closed loop timing adjustment mode | | | 1 | |

Note: The HS-SCCH-1 and HS-PDSCH shall be transmitted continuously with constant power. HS-SCCH-1 shall only use the identity of the UE under test for those TTI intended for the UE.

Table 9.21: Minimum requirement QPSK, Fixed Reference Channel (FRC) H-Set 4

| Test Number | Propagation Conditions | Reference value | | |
|-------------|------------------------|-------------------------------|--|---|
| | | HS-PDSCH E_c/I_{or} (dB) | T-put R (kbps) * $\hat{I}_{or}/I_{oc} = 0$ dB | T-put R (kbps) * $\hat{I}_{or}/I_{oc} = 10$ dB |
| 1 | PA3 | -6 | 114 | 398 |
| | | -3 | 223 | 457 |
| 2 | PB3 | -6 | 43 | 196 |
| | | -3 | 167 | 292 |
| 3 | VA30 | -6 | 40 | 199 |
| | | -3 | 170 | 305 |

* Notes: 1) The reference value R is for the Fixed Reference Channel (FRC) H-Set 4

Table 9.22: Minimum requirement QPSK, Fixed Reference Channel (FRC) H-Set 5

| Test Number | Propagation Conditions | Reference value | | |
|-------------|------------------------|-------------------------------|--|---|
| | | HS-PDSCH E_c/I_{or} (dB) | T-put R (kbps) * $\hat{I}_{or}/I_{oc} = 0$ dB | T-put R (kbps) * $\hat{I}_{or}/I_{oc} = 10$ dB |
| 1 | PA3 | -6 | 177 | 599 |
| | | -3 | 338 | 687 |
| 2 | PB3 | -6 | 75 | 299 |
| | | -3 | 260 | 452 |
| 3 | VA30 | -6 | 71 | 306 |
| | | -3 | 258 | 458 |

* Note: The reference value R is for the Fixed Reference Channel (FRC) H-Set 5

9.2.3.4 Requirement QPSK, Fixed Reference Channel (FRC) H-Set 6

The requirements are specified in terms of a minimum information bit throughput R for the DL reference channel H-Set 6 specified in Annex A.7.1.6 with the addition of the parameters in Table 9.22A and the downlink physical channel setup according to table C.10.

Using this configuration the throughput shall meet or exceed the requirements specified in table 9.22B. Enhanced performance requirements type 2 as specified in Table 9.22B are based on chip level equaliser.

Table 9.22A: Test Parameters for Testing QPSK FRCs H-Set 6

| Parameter | Unit | Test 1 |
|--|--------------|-----------|
| Phase reference | | P-CPICH |
| I_{oc} | dBm/3.84 MHz | -60 |
| DPCH frame offset ($T_{DPCH,n}$) | Chip | 0 |
| Redundancy and constellation version coding sequence | | {0,2,5,6} |
| Maximum number of HARQ transmission | | 4 |
| Feedback Error Rate | % | 4 |
| Closed loop timing adjustment mode | | 1 |

Note: The HS-SCCH-1 and HS-PDSCH shall be transmitted continuously with constant power. HS-SCCH-1 shall only use the identity of the UE under test for those TTI intended for the UE.

Table 9.22B: Enhanced requirement type 2 QPSK, Fixed Reference Channel (FRC) H-Set 6

| Test Number | Propagation Conditions | Reference value | |
|-------------|------------------------|-------------------------------|---|
| | | HS-PDSCH E_c/I_{or} (dB) | T-put R (kbps) * $\hat{I}_{or}/I_{oc} = 10$ dB |
| 1 | PB3 | -3 | 1536 |

9.2.3.5 Requirement 16QAM, Fixed Reference Channel (FRC) H-Set 6

The requirements are specified in terms of a minimum information bit throughput R for the DL reference channel H-Set-6 specified in Annex A.7.1.6 with the addition of the parameters in Table 9.22C and the downlink physical channel setup according to table C.10.

Using this configuration the throughput shall meet or exceed the requirements specified in table 9.22D. Enhanced performance requirements type 2 specified in Table 9.22D are based on chip level equaliser.

Table 9.22C: Test Parameters for Testing 16-QAM FRCs H-Set 6

| Parameter | Unit | Test 1 |
|---|--------------|-----------|
| Phase reference | | P-CPICH |
| I_{oc} | dBm/3.84 MHz | -60 |
| DPCH frame offset ($\tau_{DPCH,n}$) | Chip | 0 |
| Redundancy and constellation version coding sequence | | {6,2,1,5} |
| Maximum number of HARQ transmission | | 4 |
| Feedback Error Rate | % | 4 |
| Closed loop timing adjustment mode | | 1 |
| Note: The HS-SCCH-1 and HS-PDSCH shall be transmitted continuously with constant power. HS-SCCH-1 shall only use the identity of the UE under test for those TTI intended for the UE. | | |

Table 9.22D: Enhanced requirement type 2 16QAM, Fixed Reference Channel (FRC) H-Set 6

| Test Number | Propagation Conditions | Reference value | |
|-------------|------------------------|---------------------------------|---|
| | | HS-PDSCH E_c / I_{or} (dB) | T-put R (kbps) * $\hat{I}_{or} / I_{oc} = 10$ dB |
| 1 | PB3 | -3 | 1154 |

9.3 Reporting of Channel Quality Indicator

The propagation conditions for this subclause are defined in table B.1C.

For the cases in this subclause where CQI reporting is evaluated under fading conditions it is expected that the UE will not always detect the HS-SCCH, resulting in a DTX for the uplink ACK/NACK transmission. The downlink configuration for evaluating CQI performance does not use retransmission. Therefore any BLER calculations must exclude any packets where the UE may have attempted to combine data from more than one transmission due to having missed one or more new data indicators from lost HS-SCCH transmissions.

9.3.1 Single Link Performance

9.3.1.1 AWGN propagation conditions

The reporting accuracy of channel quality indicator (CQI) under AWGN environments is determined by the reporting variance and the BLER performance using the transport format indicated by the reported CQI median.

9.3.1.1.1 Minimum Requirement – UE capability categories 1-8 and 11, 12

For the parameters specified in Table 9.23, and using the downlink physical channels specified in table C.8, the reported CQI value shall be in the range of ± 2 of the reported median more than 90% of the time. If the HS-PDSCH BLER using the transport format indicated by median CQI is less than or equal to 0.1, the BLER using the transport format indicated by the (median CQI +2) shall be greater than 0.1. If the HS-PDSCH BLER using the transport format indicated by the median CQI is greater than 0.1, the BLER using transport format indicated by (median CQI -1) shall be less than or equal to 0.1.

Table 9.23: Test Parameter for CQI test in AWGN – single link

| Parameter | Unit | Test 1 | Test 2 | Test 3 |
|---------------------------------------|---|--|--------|--------|
| \hat{I}_{or}/I_{oc} | dB | 0 | 5 | 10 |
| I_{oc} | dBm/3.84 MHz | -60 | | |
| Phase reference | - | P-CPICH | | |
| HS-PDSCH E_c/I_{or} | dB | -3 | | |
| HS-SCCH_1 E_c/I_{or} | dB | -10 | | |
| DPCH E_c/I_{or} | dB | -10 | | |
| Maximum number of H-ARQ transmission | - | 1 | | |
| Number of HS-SCCH set to be monitored | - | 1 | | |
| CQI feedback cycle | ms | 2 | | |
| CQI repetition factor | - | 1 | | |
| HS-SCCH-1 signalling pattern | - | To incorporate inter-TTI=3 the six sub-frame HS-SCCH-1 signalling pattern shall be '...XOOXOO...', where 'X' indicates TTI in which the HS-SCCH-1 uses the identity of the UE under test, and 'O' indicates TTI in which the HS-SCCH-1 uses a different UE identity. | | |
| Note1: | Measurement power offset 'I' is configured by RRC accordingly and as defined in [7] | | | |
| Note2: | TF for HS-PDSCH is configured according to the reported CQI statistics. TF based on median CQI, median CQI -1, median CQI+2 are used. Other physical channel parameters are configured according to the CQI mapping table described in TS25.214 | | | |
| Note3: | HS-PDSCH E_c/I_{or} is decreased according to reference power adjustment Δ described in TS 25.214 | | | |
| Note 4: | For any given transport format the power of the HS-SCCH and HS-PDSCH shall be transmitted continuously with constant power. | | | |

9.3.1.2 Fading propagation conditions

The reporting accuracy of the channel quality indicator (CQI) under fading environments is determined by the BLER performance using the transport format indicated by the reported CQI median.

The specified requirements may be subject to further simulations to verify assumptions.

9.3.1.2.1 Minimum Requirement – UE capability categories 1-8 and 11, 12

For the parameters specified in Table 9.26, and using the downlink physical channels specified in table C.8, the requirements are specified in terms of maximum BLERs at particular reported CQIs when transmitting a fixed transport format given by the CQI median as shown in Table 9.27. The BLER at a particular reported CQI is obtained by associating a particular CQI reference measurement period with the HS-PDSCH subframe overlapping with the end of this CQI reference measurement period and calculating the fraction of erroneous HS-PDSCH subframes.

Table 9.26: Test Parameters for CQI test in fading – single link

| Parameter | Unit | Test 1 | Test 2 |
|---------------------------------------|---|--|--------|
| HS-PDSCH E_c/I_{or} | dB | -8 | -4 |
| \hat{I}_{or}/I_{oc} | dB | 0 | 5 |
| I_{oc} | dBm/3.84 MHz | -60 | |
| Phase reference | - | P-CPICH | |
| HS-SCCH_1 E_c/I_{or} | dB | -8.5 | |
| DPCH E_c/I_{or} | dB | -6 | |
| Maximum number of H-ARQ transmission | - | 1 | |
| Number of HS-SCCH set to be monitored | - | 1 | |
| CQI feedback cycle | ms | 2 | |
| CQI repetition factor | - | 1 | |
| HS-SCCH-1 signalling pattern | - | To incorporate inter-TTI=3 the six sub-frame HS-SCCH-1 signalling pattern shall be '...XOOXOO...', where 'X' indicates TTI in which the HS-SCCH-1 uses the identity of the UE under test, and 'O' indicates TTI in which the HS-SCCH-1 uses a different UE identity. | |
| Propagation Channel | | Case 8 | |
| Note1: | Measurement power offset 'T' is configured by RRC accordingly and as defined in [7] | | |
| Note2: | TF for HS-PDSCH is configured according to the reported CQI statistics. TF based on median CQI is used. Other physical channel parameters are configured according to the CQI mapping table described in TS25.214 | | |
| Note3: | HS-PDSCH E_c/I_{or} is decreased according to reference power adjustment Δ described in TS 25.214 | | |
| Note 4: | For any given transport format the power of the HS-SCCH and HS-PDSCH shall be transmitted continuously with constant power. | | |

Table 9.27: Minimum requirement for CQI test in fading – single link

| Reported CQI | Maximum BLER | |
|----------------|--------------|-------|
| | Test 1 | Test2 |
| CQI median | 60% | 60% |
| CQI median + 3 | 15% | 15% |

9.3.2 Open Loop Diversity Performance

9.3.2.1 AWGN propagation conditions

The reporting accuracy of channel quality indicator (CQI) under AWGN environments is determined by the reporting variance and the BLER performance using the transport format indicated by the reported CQI median.

9.3.2.1.1 Minimum Requirement - UE capability categories 1-8 and 11, 12

For the parameters specified in Table 9.32, and using the downlink physical channels specified in table C.9, the reported CQI value shall be in the range of +/-2 of the reported median more than 90% of the time. If the HS-PDSCH (BLER) using the transport format indicated by median CQI is less than or equal to 0.1, the BLER using the transport format indicated by the (median CQI +2) shall be greater than 0.1. If the HS-PDSCH (BLER) using the transport format indicated by the median CQI is greater than 0.1, the BLER using transport format indicated by (median CQI -1) shall be less than or equal to 0.1.

Table 9.32: Test Parameter for CQI test in AWGN – open loop diversity

| Parameter | Unit | Test 1 | Test 2 | Test 3 |
|---------------------------------------|---|--|--------|--------|
| \hat{I}_{or}/I_{oc} | dB | 0 | 5 | 10 |
| I_{oc} | dBm/3.84 MHz | -60 | | |
| Phase reference | - | P-CPICH | | |
| HS-PDSCH E_c/I_{or} | dB | -3 | | |
| HS-SCCH_1 E_c/I_{or} | dB | -10 | | |
| DPCH E_c/I_{or} | dB | -10 | | |
| Maximum number of H-ARQ transmission | - | 1 | | |
| Number of HS-SCCH set to be monitored | - | 1 | | |
| CQI feedback cycle | ms | 2 | | |
| CQI repetition factor | - | 1 | | |
| HS-SCCH-1 signalling pattern | - | To incorporate inter-TTI=3 the six sub-frame HS-SCCH-1 signalling pattern shall be '...XOOXOO...', where 'X' indicates TTI in which the HS-SCCH-1 uses the identity of the UE under test, and 'O' indicates TTI in which the HS-SCCH-1 uses a different UE identity. | | |
| Note1: | Measurement power offset 'I' is configured by RRC accordingly and as defined in [7] | | | |
| Note2: | TF for HS-PDSCH is configured according to the reported CQI statistics. TF based on median CQI, median CQI -1, median CQI+2 are used. Other physical channel parameters are configured according to the CQI mapping table described in TS25.214 | | | |
| Note3: | HS-PDSCH E_c/I_{or} is decreased according to reference power adjustment Δ described in TS 25.214 | | | |
| Note 4: | For any given transport format the power of the HS-SCCH and HS-PDSCH shall be transmitted continuously with constant power. | | | |

9.3.2.2 Fading propagation conditions

The reporting accuracy of the channel quality indicator (CQI) under fading environments is determined by the BLER performance using the transport format indicated by the reported CQI median.

The specified requirements may be subject to further simulations to verify assumptions.

9.3.2.2.1 Minimum Requirement – UE capability categories 1-8 and 11, 12

For the parameters specified in Table 9.35, and using the downlink physical channels specified in table C.9, the requirements are specified in terms of maximum BLERs at particular reported CQIs when transmitting a fixed transport format given by the CQI median as shown in Table 9.36. The BLER at a particular reported CQI is obtained by associating a particular CQI reference measurement period with the HS-PDSCH subframe overlapping with the end of this CQI reference measurement period and calculating the fraction of erroneous HS-PDSCH subframes.

Table 9.35: Test Parameters for CQI test in fading – open loop diversity

| Parameter | Unit | Test 1 | Test 2 |
|---------------------------------------|---|--|--------|
| HS-PDSCH E_c/I_{or} | dB | -8 | -4 |
| \hat{I}_{or}/I_{oc} | dB | 0 | 5 |
| I_{oc} | dBm/3.84 MHz | -60 | |
| Phase reference | - | P-CPICH | |
| HS-SCCH_1 E_c/I_{or} | dB | -8.5 | |
| DPCH E_c/I_{or} | dB | -6 | |
| Maximum number of H-ARQ transmission | - | 1 | |
| Number of HS-SCCH set to be monitored | - | 1 | |
| CQI feedback cycle | ms | 2 | |
| CQI repetition factor | - | 1 | |
| HS-SCCH-1 signalling pattern | - | To incorporate inter-TTI=3 the six sub-frame HS-SCCH-1 signalling pattern shall be '...XOOXOO...', where 'X' indicates TTI in which the HS-SCCH-1 uses the identity of the UE under test, and 'O' indicates TTI in which the HS-SCCH-1 uses a different UE identity. | |
| Propagation Channel | | Case 8 | |
| Note1: | Measurement power offset 'T' is configured by RRC accordingly and as defined in [7] | | |
| Note2: | TF for HS-PDSCH is configured according to the reported CQI statistics. TF based on median CQI is used. Other physical channel parameters are configured according to the CQI mapping table described in TS25.214 | | |
| Note3: | HS-PDSCH E_c/I_{or} is decreased according to reference power adjustment Δ described in TS 25.214 | | |
| Note 4: | For any given transport format the power of the HS-SCCH and HS-PDSCH shall be transmitted continuously with constant power. | | |

Table 9.36: Minimum requirement for CQI test in fading – open loop diversity

| Reported CQI | Maximum BLER | |
|----------------|--------------|-------|
| | Test 1 | Test2 |
| CQI median | 60% | 60% |
| CQI median + 3 | 15% | 15% |

9.3.3 Closed Loop Diversity Performance

9.3.3.1 AWGN propagation conditions

The reporting accuracy of channel quality indicator (CQI) under AWGN environments is determined by the reporting variance and the BLER performance using the transport format indicated by the reported CQI median.

9.3.3.1.1 Minimum Requirement - UE capability categories 1-8 and 11, 12

For the parameters specified in Table 9.41, and using the downlink physical channels specified in table C.10, the reported CQI value shall be in the range of ± 2 of the reported median more than 90% of the time. If the HS-PDSCH (BLER) using the transport format indicated by median CQI is less than or equal to 0.1, the BLER using the transport format indicated by the (median CQI +2) shall be greater than 0.1. If the HS-PDSCH (BLER) using transport format indicated by the median CQI is greater than 0.1, the BLER using the transport format indicated by (median CQI -1) shall be less than or equal to 0.1.

Table 9.41: Test Parameters for CQI in AWGN – closed loop diversity

| Parameter | Unit | Test 1 | Test 2 | Test 3 |
|---------------------------------------|---|--|--------|--------|
| \hat{I}_{or}/I_{oc} | dB | 0 | 5 | 10 |
| I_{oc} | dBm/3.84 MHz | -60 | | |
| Phase reference | - | P-CPICH | | |
| HS-PDSCH E_c/I_{or} | dB | -3 | | |
| HS-SCCH_1 E_c/I_{or} | dB | -10 | | |
| DPCH E_c/I_{or} | dB | -10 | | |
| Maximum number of H-ARQ transmission | - | 1 | | |
| Number of HS-SCCH set to be monitored | - | 1 | | |
| CQI feedback cycle | ms | 2 | | |
| CQI repetition factor | - | 1 | | |
| Feedback Error Rate | % | 0 | | |
| Closed loop timing adjustment mode | - | 1 | | |
| HS-SCCH-1 signalling pattern | - | To incorporate inter-TTI=3 the six sub-frame HS-SCCH-1 signalling pattern shall be '...XOOXOO...', where 'X' indicates TTI in which the HS-SCCH-1 uses the identity of the UE under test, and 'O' indicates TTI in which the HS-SCCH-1 uses a different UE identity. | | |
| Note1: | Measurement power offset 'T' is configured by RRC accordingly and as defined in [7] | | | |
| Note2: | TF for HS-PDSCH is configured according to the reported CQI statistics. TF based on median CQI, median CQI -1, median CQI+2 are used. Other physical channel parameters are configured according to the CQI mapping table described in TS25.214 | | | |
| Note3: | HS-PDSCH E_c/I_{or} is decreased according to reference power adjustment Δ described in TS 25.214 | | | |
| Note 4: | For any given transport format the power of the HS-SCCH and HS-PDSCH shall be transmitted continuously with constant power. | | | |

9.3.3.2 Fading propagation conditions

The reporting accuracy of the channel quality indicator (CQI) under fading environments is determined by the BLER performance using the transport format indicated by the reported CQI median.

The specified requirements may be subject to further simulations to verify assumptions.

9.3.3.2.1 Minimum Requirement – UE capability categories 1-8 and 11, 12

For the parameters specified in Table 9.44, and using the downlink physical channels specified in table C.10, the requirements are specified in terms of maximum BLERs at particular reported CQIs when transmitting a fixed transport format given by the CQI median as shown in Table 9.45. The BLER at a particular reported CQI is obtained by associating a particular CQI reference measurement period with the HS-PDSCH subframe overlapping with the end of this CQI reference measurement period and calculating the fraction of erroneous HS-PDSCH subframes.

Table 9.44: Test Parameters for CQI test in fading– closed loop diversity

| Parameter | Unit | Test 1 | Test 2 |
|---------------------------------------|---|--|--------|
| HS-PDSCH E_c/I_{or} | dB | -8 | -4 |
| \hat{I}_{or}/I_{oc} | dB | 0 | 5 |
| I_{oc} | dBm/3.84 MHz | -60 | |
| Phase reference | - | P-CPICH | |
| HS-SCCH_1 E_c/I_{or} | dB | -8.5 | |
| DPCH E_c/I_{or} | dB | -6 | |
| Maximum number of H-ARQ transmission | - | 1 | |
| Number of HS-SCCH set to be monitored | - | 1 | |
| CQI feedback cycle | ms | 2 | |
| CQI repetition factor | - | 1 | |
| Feedback Error Rate | % | 0 | |
| Closed loop timing adjustment mode | | 1 | |
| HS-SCCH-1 signalling pattern | - | To incorporate inter-TTI=3 the six sub-frame HS-SCCH-1 signalling pattern shall be '...XOOXOO...', where 'X' indicates TTI in which the HS-SCCH-1 uses the identity of the UE under test, and 'O' indicates TTI in which the HS-SCCH-1 uses a different UE identity. | |
| Propagation Channel | | Case 8 | |
| Note1: | Measurement power offset 'Γ' is configured by RRC accordingly and as defined in [7] | | |
| Note2: | TF for HS-PDSCH is configured according to the reported CQI statistics. TF based on median CQI is used. Other physical channel parameters are configured according to the CQI mapping table described in TS25.214 | | |
| Note3: | HS-PDSCH E_c/I_{or} is decreased according to reference power adjustment Δ described in TS 25.214 | | |
| Note 4: | For any given transport format the power of the HS-SCCH and HS-PDSCH shall be transmitted continuously with constant power. | | |

Table 9.45: Minimum requirement for CQI test in fading – closed loop diversity

| Reported CQI | Maximum BLER | |
|----------------|--------------|-------|
| | Test 1 | Test2 |
| CQI median | 60% | 60% |
| CQI median + 3 | 15% | 15% |

9.4 HS-SCCH Detection Performance

The detection performance of the HS-SCCH is determined by the probability of event E_m , which is declared when the UE is signaled on HS-SCCH-1, but DTX is observed in the corresponding HS-DPCCH ACK/NACK field. The probability of event E_m is denoted $P(E_m)$.

9.4.1 Single Link Performance

For the test parameters specified in Table 9.50, for each value of HS-SCCH-1 E_c/I_{or} specified in Table 9.51 and Table 9.51A the measured $P(E_m)$ shall be less than or equal to the corresponding specified value of $P(E_m)$. Enhanced performance requirements type 1 specified in Table 9.51A are based on receiver diversity.

Table 9.50: Test parameters for HS-SCCH detection – single link

| Parameter | Unit | Test 1 | Test 2 | Test 3 |
|---|--------------|---|--------|--------|
| I_{oc} | dBm/3.84 MHz | -60 | | |
| Phase reference | - | P-CPICH | | |
| P-CPICH E_c/I_{or} (*) | dB | -10 | | |
| HS-SCCH UE Identity ($x_{ue,1}, x_{ue,2}, \dots, x_{ue,16}$) | | HS-SCCH-1: 1010101010101010 (every third TTI only, UE under test addressed solely via HS-SCCH-1) HS-SCCH-2: 0001001010101010 HS-SCCH-3: 0001101010101010 HS-SCCH-4: 0001111110101010 | | |
| HS-DSCH TF of UE1 | | TF corresponding to CQI1 | | |
| HS-SCCH-1 transmission pattern | | The HS-SCCH-1 shall be transmitted continuously with constant power. | | |
| HS-PDSCH transmission pattern | | The HS-PDSCH shall be transmitted continuously with constant power. | | |
| HS-SCCH-1 TTI Signalling Pattern | - | The six sub-frame HS-SCCH-1 signalling pattern shall be '...XOOXOO...', where 'X' indicates TTI in which the HS-SCCH-1 uses the identity of the UE under test, and 'O' indicates TTI in which the HS-SCCH-1 uses a different UE identity. | | |

Table 9.51: Minimum requirement for HS-SCCH detection – single link

| Test Number | Propagation Conditions | Reference value | | |
|-------------|------------------------|--------------------------------|----------------------------|----------|
| | | HS-SCCH-1 E_c/I_{or} (dB) | \hat{I}_{or}/I_{oc} (dB) | $P(E_m)$ |
| 1 | PA3 | -9 | 0 | 0.05 |
| 2 | PA3 | -9.9 | 5 | 0.01 |
| 3 | VA30 | -10 | 0 | 0.01 |

Table 9.51A: Enhanced requirement type 1 for HS-SCCH detection – single link

| Test Number | Propagation Conditions | Reference value | | |
|-------------|------------------------|--------------------------------|----------------------------|----------|
| | | HS-SCCH-1 E_c/I_{or} (dB) | \hat{I}_{or}/I_{oc} (dB) | $P(E_m)$ |
| 1 | PA3 | -12.0 | 0 | 0.01 |
| 2 | VA30 | -15.6 | 0 | 0.01 |

9.4.2 Open Loop Diversity Performance

For the test parameters specified in Table 9.52, for each value of HS-SCCH-1 E_c/I_{or} specified in Table 9.53 and Table 9.54 the measured $P(E_m)$ shall be less than or equal to the corresponding specified value of $P(E_m)$. Enhanced performance requirements type 1 specified in Table 9.54 are based on receiver diversity.

Table 9.52: Test parameters for HS-SCCH detection – open loop diversity

| Parameter | Unit | Test 1 | Test 2 | Test 3 |
|---|--------------|---|--------|--------|
| I_{oc} | dBm/3.84 MHz | -60 | | |
| Phase reference | - | P-CPICH | | |
| P-CPICH E_c/I_{or} (*) | dB | -10 | | |
| HS-SCCH UE Identity ($x_{ue,1}, x_{ue,2}, \dots, x_{ue,16}$) | | HS-SCCH-1: 1010101010101010 (every third TTI only, UE under test addressed solely via HS-SCCH-1) HS-SCCH-2: 0001001010101010 HS-SCCH-3: 0001101010101010 HS-SCCH-4: 0001111110101010 | | |
| HS-DSCH TF of UE1 | | TF corresponding to CQI1 | | |
| HS-SCCH-1 transmission pattern | | The HS-SCCH-1 shall be transmitted continuously with constant power. | | |
| HS-PDSCH transmission pattern | | The HS-PDSCH shall be transmitted continuously with constant power. | | |
| HS-SCCH-1 TTI Signalling Pattern | - | The six sub-frame HS-SCCH-1 signalling pattern shall be '...XOOXOO...', where 'X' indicates TTI in which the HS-SCCH-1 uses the identity of the UE under test, and 'O' indicates TTI in which the HS-SCCH-1 uses a different UE identity. | | |

Table 9.53: Minimum requirement for HS-SCCH detection – open loop diversity

| Test Number | Propagation Conditions | Reference value | | |
|-------------|------------------------|--------------------------------|----------------------------|----------|
| | | HS-SCCH-1 E_c/I_{or} (dB) | \hat{I}_{or}/I_{oc} (dB) | $P(E_m)$ |
| 1 | PA3 | -11.6 | 0 | 0.05 |
| 2 | PA3 | -13.4 | 5 | 0.01 |
| 3 | VA30 | -11.5 | 0 | 0.01 |

Table 9.54: Enhanced requirement type 1 for HS-SCCH detection – open loop diversity

| Test Number | Propagation Conditions | Reference value | | |
|-------------|------------------------|--------------------------------|----------------------------|----------|
| | | HS-SCCH-1 E_c/I_{or} (dB) | \hat{I}_{or}/I_{oc} (dB) | $P(E_m)$ |
| 1 | PA3 | -15.2 | 0 | 0.01 |
| 2 | VA30 | -16.4 | 0 | 0.01 |

10 Performance requirement (E-DCH)

10.1 General

The performance requirements for the UE in this subclause are specified for the propagation conditions specified in Annex B.2.2 and the Downlink Physical channels specified in Annex C.3.2.

Unless otherwise stated the receiver characteristics are specified at the antenna connector of the UE. For UE(s) with an integral antenna only, a reference antenna with a gain of 0 dBi is assumed. UE with an integral antenna may be taken into account by converting these power levels into field strength requirements, assuming a 0 dBi gain antenna. For UEs with more than one receiver antenna connector the fading of the signals and the AWGN signals applied to each receiver antenna connector shall be uncorrelated. The levels of the test signal applied to each of the antenna connectors shall be as defined in the respective sections below.

10.2 Detection of E-DCH HARQ ACK Indicator Channel (E-HICH)

10.2.1 Single link performance

The receive characteristics of the E-DCH HARQ ACK Indicator Channel (E-HICH) in different multi-path fading environments are determined by the missed ACK and false ACK values.

10.2.1.1 Minimum requirement

For the parameters specified in Table 10.1 the average downlink E-HICH E_c/I_{or} power ratio shall be below the specified value for the missed ACK probabilities in Table 10.2 and 10.3. For the parameters specified in Table 10.1 the false ACK probability shall be below the specified value in Table 10.4 and 10.5.

Table 10.1: Requirement scenario parameters for E-HICH – RLS containing the Serving E-DCH cell

| Parameter | Unit | Missed ACK | False ACK |
|---------------------------|--------------|------------|-----------|
| I_{oc} | dBm/3.84 MHz | -60 | |
| Phase reference | - | P-CPICH | |
| P-CPICH E_c/I_{or} (*) | dB | -10 | |
| E-HICH signalling pattern | - | 100% ACK | 100% DTX |

Table 10.2: Minimum requirement for Missed ACK when hybrid ARQ acknowledgement indicator is transmitted using 3 consecutive slots – RLS containing the Serving E-DCH cell

| Test Number | Propagation Conditions | Reference value | | |
|-------------|------------------------|--------------------------|----------------------------|------------------------|
| | | E-HICH E_c/I_{or} (dB) | \hat{I}_{or}/I_{oc} (dB) | Missed ACK probability |
| 1 | VA30 | -28.3 | 0 | 0.01 |

Table 10.3: Minimum requirement for Missed ACK when hybrid ARQ acknowledgement indicator is transmitted using 12 consecutive slots – RLS containing the Serving E-DCH cell

| Test Number | Propagation Conditions | Reference value | | |
|-------------|------------------------|--------------------------|----------------------------|------------------------|
| | | E-HICH E_c/I_{or} (dB) | \hat{I}_{or}/I_{oc} (dB) | Missed ACK probability |
| 2 | VA30 | -35.1 | 0 | 0.01 |

Table 10.4: Minimum requirement for False ACK when hybrid ARQ acknowledgement indicator is transmitted using 3 consecutive slots – RLS containing the Serving E-DCH cell

| Test Number | Propagation Conditions | Reference value | |
|-------------|------------------------|----------------------------|-----------------------|
| | | \hat{I}_{or}/I_{oc} (dB) | False ACK probability |
| 3 | VA30 | 0 | 0.5 |

Table 10.5: Minimum requirement for False ACK when hybrid ARQ acknowledgement indicator is transmitted using 12 consecutive slots – RLS containing the Serving E-DCH cell

| Test Number | Propagation Conditions | Reference value | |
|-------------|------------------------|----------------------------|-----------------------|
| | | \hat{I}_{or}/I_{oc} (dB) | False ACK probability |
| 4 | VA30 | 0 | 0.5 |

10.2.2 Detection in Inter-Cell Handover conditions

The receive characteristics of the E-DCH HARQ ACK Indicator Channel (E-HICH) is determined during an inter-cell soft handover by the missed ACK and false ACK error probabilities. During the soft handover a UE receives signals from different cells. A UE has to be able to detect E-HICH signalling from different cells belonging to different RLS, containing and not containing the Serving E-DCH cell.

10.2.2.1 Minimum requirement for RLS not containing the Serving E-DCH cell

For the parameters specified in Table 10.6 the average downlink E-HICH E_c/I_{or} power ratio of cell belonging to RLS not containing the Serving E-DCH cell shall be below the specified value for the missed ACK probabilities in Table 10.7 and 10.8. For the parameters specified in Table 10.X6 the false ACK probability shall be below the specified value in Table 10.9 and 10.10.

Table 10.6: Requirement scenario parameters for E-HICH – cell belonging to RLS not containing the Serving E-DCH cell

| Parameter | Unit | Missed ACK | False ACK |
|--|--------------|-----------------------------|-----------------------------|
| I_{oc} | dBm/3.84 MHz | -60 | |
| Phase reference | - | P-CPICH | |
| P-CPICH E_c/I_{or} (*) | dB | -10 | |
| E-HICH signalling pattern for the Serving E-DCH cell | - | 100% NACK (-1) ¹ | 100% NACK (-1) ¹ |
| E-HICH signalling pattern for cell belonging to RLS not containing the Serving E-DCH cell | | 100% ACK (+1) | 100% NACK (0) |
| Note 1 The Serving E-DCH cell E-HICH E_c/I_{or} power level is set to -16 dB when hybrid ARQ acknowledgement indicator is transmitted using 3 consecutive slots and to -23 dB when hybrid ARQ acknowledgement indicator is transmitted using 12 consecutive slots. | | | |

Table 10.7: Minimum requirement for Missed ACK when hybrid ARQ acknowledgement indicator is transmitted using 3 consecutive slots – cell belonging to RLS not containing the Serving E-DCH cell

| Test Number | Propagation Conditions | Reference value | | |
|-------------|------------------------|--------------------------|--|------------------------|
| | | E-HICH E_c/I_{or} (dB) | \hat{I}_{or1}/I_{oc} and \hat{I}_{or2}/I_{oc} (dB) | Missed ACK probability |
| 1 | VA30 | -16.3 | 0 | 0.05 |

Table 10.8: Minimum requirement for Missed ACK when hybrid ARQ acknowledgement indicator is transmitted using 12 consecutive slots – cell belonging to RLS not containing the Serving E-DCH cell

| Test Number | Propagation Conditions | Reference value | | |
|-------------|------------------------|--------------------------|--|------------------------|
| | | E-HICH E_c/I_{or} (dB) | \hat{I}_{or1}/I_{oc} and \hat{I}_{or2}/I_{oc} (dB) | Missed ACK probability |
| 2 | VA30 | -23.6 | 0 | 0.05 |

Table 10.9: Minimum requirement for False ACK when hybrid ARQ acknowledgement indicator is transmitted using 3 consecutive slots – cell belonging to RLS not containing the Serving E-DCH cell

| Test Number | Propagation Conditions | Reference value | |
|-------------|------------------------|--|-----------------------|
| | | \hat{I}_{or1}/I_{oc} and \hat{I}_{or2}/I_{oc} (dB) | False ACK probability |
| 3 | VA30 | 0 | 2E-4 |

Table 10.10: Minimum requirement for False ACK when hybrid ARQ acknowledgement indicator is transmitted using 12 consecutive slots – cell belonging to RLS not containing the Serving E-DCH cell

| Test Number | Propagation Conditions | Reference value | |
|-------------|------------------------|--|-----------------------|
| | | \hat{I}_{or1}/I_{oc} and \hat{I}_{or2}/I_{oc} (dB) | False ACK probability |
| 4 | VA30 | 0 | 2E-4 |

10.2.2.2 Minimum requirement for RLS containing the serving E-DCH cell

For the parameters specified in Table 10.11 the average downlink E-HICH E_c/I_{or} power ratio of cell belonging to RLS containing the serving E-DCH cell shall be below the specified value for the missed ACK probabilities in Table 10.12 and 10.13. For the parameters specified in Table 10.11 the false ACK probability shall be below the specified value in Table 10.14 and 10.15.

Table 10.11: Requirement scenario parameters for E-HICH – RLS containing the serving cell in SHO

| Parameter | Unit | Missed ACK | False ACK |
|---|--------------|---------------|---------------|
| I_{oc} | dBm/3.84 MHz | -60 | |
| Phase reference | - | P-CPICH | |
| P-CPICH E_c/I_{or} (*) | dB | -10 | |
| E-HICH signalling pattern for Serving E-DCH cell | - | 100% ACK (+1) | 100% DTX (0) |
| E-HICH signalling pattern for cell belonging to RLS not containing the Serving E-DCH cell | - | 100% NACK (0) | 100% NACK (0) |

Table 10.12: Minimum requirement for Missed ACK when hybrid ARQ acknowledgement indicator is transmitted using 3 consecutive slots – RLS containing the Serving E-DCH cell

| Test Number | Propagation Conditions | Reference value | | |
|-------------|------------------------|---|--|------------------------|
| | | E-HICH E_c/I_{or} (dB) for Serving E-DCH cell (ACK) | \hat{I}_{or1}/I_{oc} and \hat{I}_{or2}/I_{oc} (dB) | Missed ACK probability |
| 1 | VA30 | -23.2 | 0 | 0.05 |

Table 10.13: Minimum requirement for Missed ACK when hybrid ARQ acknowledgement indicator is transmitted using 12 consecutive slots – RLS containing the Serving E-DCH cell

| Test Number | Propagation Conditions | Reference value | | |
|-------------|------------------------|---|--|------------------------|
| | | E-HICH E_c/I_{or} (dB) for Serving E-DCH cell (ACK) | \hat{I}_{or1}/I_{oc} and \hat{I}_{or2}/I_{oc} (dB) | Missed ACK probability |
| 2 | VA30 | -29.7 | 0 | 0.05 |

Table 10.14: Minimum requirement for False ACK when hybrid ARQ acknowledgement indicator is transmitted using 3 consecutive slots – RLS containing the Serving E-DCH cell

| Test Number | Propagation Conditions | Reference value | |
|-------------|------------------------|--|-----------------------|
| | | \hat{I}_{or1}/I_{oc} and \hat{I}_{or2}/I_{oc} (dB) | False ACK probability |
| 3 | PA3 | 0 | 0.1 |
| 4 | VA120 | 0 | 0.1 |

Table 10.15: Minimum requirement for False ACK when hybrid ARQ acknowledgement indicator is transmitted using 12 consecutive slots – RLS containing the Serving E-DCH cell

| Test Number | Propagation Conditions | Reference value | |
|-------------|------------------------|--|-----------------------|
| | | \hat{I}_{or1}/I_{oc} and \hat{I}_{or2}/I_{oc} (dB) | False ACK probability |
| 5 | PA3 | 0 | 0.1 |
| 6 | VA120 | 0 | 0.1 |

10.3 Detection of E-DCH Relative Grant Channel (E-RGCH)

10.3.1 Single link performance

The receive characteristics of the E-DCH Relative Grant Channel (E-RGCH) in multi-path fading environment is determined by the missed UP/DOWN and missed HOLD.

10.3.1.1 Minimum requirement

For the parameters specified in Table 10.16 the average downlink E-RGCH E_c/I_{or} power ratio shall be below the specified value for the missed UP/DOWN probabilities in Table 10.17 and 10.18. For the parameters specified in Table 10.16 the missed HOLD probability shall be below the specified value in Table 10.19 and 10.20.

Table 10.16: Requirement scenario parameters for E-RGCH – Serving E-DCH RLS

| Parameter | Unit | Missed UP/DOWN | Missed HOLD |
|---------------------------|--------------|--------------------|-------------|
| I_{oc} | dBm/3.84 MHz | -60 | |
| Phase reference | - | P-CPICH | |
| P-CPICH E_c/I_{or} | dB | -10 | |
| E-RGCH signalling pattern | - | 50% UP 50% DOWN | 100% HOLD |

Table 10.17: Minimum requirement for Missed UP/DOWN when relative scheduling grant is transmitted using 3 consecutive slots – Serving E-DCH RLS

| Test Number | Propagation Conditions | Reference value | | |
|-------------|------------------------|--------------------------|----------------------------|----------------------------|
| | | E-RGCH E_c/I_{or} (dB) | \hat{I}_{or}/I_{oc} (dB) | Missed UP/DOWN probability |
| 1 | VA30 | -24.4 | 0 | 0.05/0.05 |

Table 10.18: Minimum requirement for Missed UP/DOWN when relative scheduling grant is transmitted using 12 consecutive slots – Serving E-DCH RLS

| Test Number | Propagation Conditions | Reference value | | |
|-------------|------------------------|--------------------------|----------------------------|----------------------------|
| | | E-RGCH E_c/I_{or} (dB) | \hat{I}_{or}/I_{oc} (dB) | Missed UP/DOWN probability |
| 1 | VA30 | -31 | 0 | 0.05/0.05 |

Table 10.19: Minimum requirement for Missed HOLD when relative scheduling grant is transmitted using 3 consecutive slots – Serving E-DCH RLS

| Test Number | Propagation Conditions | Reference value | |
|-------------|------------------------|----------------------------|-------------------------|
| | | \hat{I}_{or}/I_{oc} (dB) | Missed HOLD probability |
| 3 | VA30 | 0 | 0.1 |

Table 10.20: Minimum requirement for Missed HOLD when relative scheduling grant is transmitted using 12 consecutive slots – Serving E-DCH RLS

| Test Number | Propagation Conditions | Reference value | |
|-------------|------------------------|----------------------------|-------------------------|
| | | \hat{I}_{or}/I_{oc} (dB) | Missed HOLD probability |
| 4 | VA30 | 0 | 0.1 |

10.3.2 Detection in Inter-Cell Handover conditions

The receive characteristics of the E-DCH Relative Grant Channel (E-RGCH) is determined during an inter-cell soft handover by the missed UP/DOWN and missed HOLD error probabilities. During the soft handover a UE receives signals from different cells. A UE has to be able to detect E-RGCH signalling from different cells, Serving E-DCH cell and Non-serving E-DCH RL.

10.3.2.1 Minimum requirement for Non-serving E-DCH RL

For the parameters specified in Table 10.21 the missed HOLD probability shall be below the specified value in Table 10.22. For the parameters specified in Table 10.21 the average downlink E-RGCH E_c/I_{or} power ratio shall be below the specified value for the missed DOWN probabilities in Table 10.23.

Table 10.21: Requirement scenario parameters for E-RGCH – Non-serving E-DCH RL

| Parameter | Unit | Missed HOLD | Missed DOWN |
|--|--|-----------------------|-----------------------|
| I_{oc} | dBm/3.84 MHz | -60 | |
| Phase reference | - | P-CPICH | |
| P-CPICH E_c/I_{or} | dB | -10 | |
| E-RGCH signalling pattern for Serving E-DCH cell | - | 100% UP ¹ | 100% UP ¹ |
| E-AGCH information | | Fixed SG ² | Fixed SG ² |
| E-RGCH signalling pattern for Non-serving E-DCH RL | | 100% HOLD | 100% DOWN |
| Note 1 | Serving E-DCH cell E-RGCH E_c/I_{or} power level is set to -22 dB and relative scheduling grant is transmitted using 12 consecutive slots. | | |
| Note 2 | Serving E-DCH cell E-AGCH E_c/I_{or} power level is set to -15 dB and E-AGCH TTI length is 10ms. | | |

Table 10.22: Minimum requirement for Missed HOLD when relative scheduling grant is transmitted using 15 consecutive slots – Non-serving E-DCH RL

| Test Number | Propagation Conditions | Reference value | |
|-------------|------------------------|--|-------------------------|
| | | \hat{I}_{or1}/I_{oc} and \hat{I}_{or2}/I_{oc} (dB) | Missed HOLD probability |
| 1 | VA30 | 0 | 0.005 |

Table 10.23: Minimum requirement for Missed DOWN when relative scheduling grant is transmitted using 15 consecutive slots – Non-serving E-DCH RL

| Test Number | Propagation Conditions | Reference value | | |
|-------------|------------------------|--------------------------|--|-------------------------|
| | | E-RGCH E_c/I_{or} (dB) | \hat{I}_{or1}/I_{oc} and \hat{I}_{or2}/I_{oc} (dB) | Missed DOWN probability |
| 2 | VA30 | -27.3 | 0 | 0.05 |

10.4 Demodulation of E-DCH Absolute Grant Channel (E-AGCH)

10.4.1 Single link performance

The receive characteristics of the E-DCH Absolute Grant Channel (E-AGCH) in multi-path fading environment is determined by the missed detection probability.

10.4.1.1 Minimum requirement

For the parameters specified in Table 10.24 the average downlink E-AGCH E_c/I_{or} power ratio shall be below the specified value for the missed detection probability in Table 10.25.

Table 10.24: Test parameters for E-AGCH detection – single link

| Parameter | Unit | Missed detection |
|----------------------|--------------|------------------|
| I_{oc} | dBm/3.84 MHz | -60 |
| Phase reference | - | P-CPICH |
| P-CPICH E_c/I_{or} | dB | -10 |
| E-AGCH information | - | Varying SG |
| E-AGCH TTI length | ms | 10 |

Table 10.25: Minimum requirement for E-AGCH detection – single link

| Test Number | Propagation Conditions | Reference value | | |
|-------------|------------------------|--------------------------|----------------------------|----------------------------|
| | | E-AGCH E_c/I_{or} (dB) | \hat{I}_{or}/I_{oc} (dB) | Miss detection probability |
| 1 | VA30 | -23.2 | 0 | 0.01 |

11 Performance requirement (MBMS)

Unless otherwise stated the receiver characteristics are specified at the antenna connector of the UE. For UE(s) with an integral antenna only, a reference antenna with a gain of 0 dBi is assumed. UE with an integral antenna may be taken into account by converting these power levels into field strength requirements, assuming a 0 dBi gain antenna. For UEs with more than one receiver antenna connector the fading of the signals and the AWGN signals applied to each receiver antenna connector shall be uncorrelated. The levels of the test signal applied to each of the antenna connectors shall be as defined in the respective sections below.

11.1 Demodulation of MCCH

The receive characteristic of the MCCH is determined by the RLC SDU error rate (RLC SDU ER). The requirement is valid for all RRC states for which the UE has capabilities for MBMS.

11.1.1 Minimum requirement

For the parameters specified in Table 11.1 the average downlink S-CCPCH E_c/I_{or} power ratio shall be below the specified value for the RLC SDU ER shown in Table 11.2.

Table 11.1: Parameters for MCCH detection

| Parameter | Unit | Test 1 |
|-----------------------|--------------|----------|
| Phase reference | - | P-CPICH |
| I_{oc} | dBm/3.84 MHz | -60 |
| \hat{I}_{or}/I_{oc} | dB | -3 |
| MCCH Data Rate | | 7.6 kbps |
| Propagation condition | | VA3 |

Table 11.2: Test requirements for MCCH detection

| Test Number | S-CCPCH_Ec/I _{or} (dB) | RLC SDU ER |
|-------------|------------------------------------|------------|
| 1 | -11.6 | 0.01 |

11.2 Demodulation of MTCH

The receive characteristic of the MTCH is determined by RLC SDU error rate (RLC SDU ER). RLC SDU ER is specified for each individual data rate of the MTCH. The requirement is valid for all RRC states for which the UE has capabilities for MBMS.

11.2.1 Minimum requirement

For the parameters specified in Table 11.3 the average downlink S-CCPCH_Ec / I_{or} power ratio shall be below the specified value for the RLC SDU ER shown in Table 11.4.

Table 11.3: Parameters for MTCH detection

| Parameter | Unit | Test 1 | Test 2 | Test 3 |
|--|--------------|----------|------------------------------|------------------------------|
| Phase reference | - | P-CPICH | | |
| I_{oc} | dBm/3.84 MHz | -60 | | |
| \hat{I}_{or}/I_{oc} | dB | -3 | -3 | -3 |
| MTCH Data Rate | | 128 kbps | 256 kbps | 128 kbps |
| Transmission Time Interval | | 40 | 40 | 80 |
| Propagation condition | | VA3 | | |
| Number of Radio Links p | | 3 | 3 | 3 |
| Delay of Radio Link 2 compared with Radio Link 1 | | 160ms | 20 ms | 20 ms |
| Delay of Radio Link 3 compared with Radio Link 1 | | 1240ms | 40.67 ms (1 TTI + 1 slot) | 80.67 ms (1 TTI + 1 slot) |

Table 11.4: Test requirements for MTCH detection

| Test Number | S-CCPCH_Ec/I _{or} (dB) | RLC SDU ER |
|-------------|------------------------------------|------------|
| 1 | -4.9 | 0.1 |
| 2 | -5.6 | 0.1 |
| 3 | -8.5 | 0.1 |

11.3 Demodulation of MTCH and cell identification

MBMS combining is not controlled by a network but instead it is autonomously handled by a terminal. UE has to be able to receive MTCH and identify intra-frequency neighbour cells according to the requirements. The receive characteristic of the MTCH combined with cell identification is determined by RLC SDU error rate (RLC SDU ER).

11.3.1 Minimum requirement

For the parameters specified in Table 11.5 the average downlink S-CCPCH_Ec/I_{or} power ratio shall be below the specified value for the RLC SDU error rate shown in Table 11.6. The cell reselection parameters are given in clause A.9 in Table A.34. The different cells are assumed to be time aligned.

Table 11.5: Parameters for MTCH demodulation requirements with cell identification

| Parameter | Unit | Test 1 | | |
|------------------------------|--------------|-----------|---------|-----------|
| | | Stage 1 | Stage 2 | Stage 2 |
| Time in each stage | S | 2 | 0.8 | 2 |
| Phase reference | - | P-CPICH | | |
| I_{oc} | dBm/3.84 MHz | -70 | -73 | -70 |
| Cell1 \hat{I}_{or1}/I_{oc} | dB | -3 | 0 | -3 |
| Cell2 \hat{I}_{or2}/I_{oc} | dB | -3 | 0 | -infinity |
| Cell3 \hat{I}_{or3}/I_{oc} | dB | -infinity | 0 | -3 |
| Propagation condition | | Case1 | | |
| MTCH Data Rate | Kbps | 128 | | |
| Number of Radio Links | | 2 | 3 | 2 |

Table 11.6: Requirements for MTCH detection

| Test Number | S-CCPCH_Ec/I _{or} (dB) | RLC SDU ER |
|-------------|------------------------------------|------------|
| 1 | -5.6 | 0.05 |

Annex A (normative): Measurement channels

A.1 General

The measurement channels in this annex are defined to derive the requirements in clauses 6, 7 and 8. The measurement channels represent example configuration of radio access bearers for different data rates.

The measurement channel for 12.2 kbps shall be supported by any UE both in up- and downlink. Support for other measurement channels is depending on the UE Radio Access capabilities.

A.2 UL reference measurement channel

A.2.1 UL reference measurement channel (12.2 kbps)

The parameters for the 12.2 kbps UL reference measurement channel are specified in Table A.1 and Table A.2. The channel coding for information is shown in figure A.1.

Table A.1: UL reference measurement channel physical parameters (12.2 kbps)

| Parameter | Unit | Level |
|-------------------------|---|-------|
| Information bit rate | kbps | 12.2 |
| DPDCH | kbps | 60 |
| DPCCH | kbps | 15 |
| DPCCH Slot Format #i | - | 0 |
| DPCCH/DPDCH power ratio | dB | -5.46 |
| TFCI | - | On |
| Repetition | % | 23 |
| NOTE: | Slot Format #2 is used for closed loop tests in subclause 8.6.2. Slot Format #2 and #5 are used for site selection diversity transmission tests in subclause 8.6.3 | |

Table A.2: UL reference measurement channel, transport channel parameters (12.2 kbps)

| Parameters | DTCH | DCCH |
|----------------------------|--------------------|--------------------|
| Transport Channel Number | 1 | 2 |
| Transport Block Size | 244 | 100 |
| Transport Block Set Size | 244 | 100 |
| Transmission Time Interval | 20 ms | 40 ms |
| Type of Error Protection | Convolution Coding | Convolution Coding |
| Coding Rate | 1/3 | 1/3 |
| Rate Matching attribute | 256 | 256 |
| Size of CRC | 16 | 12 |

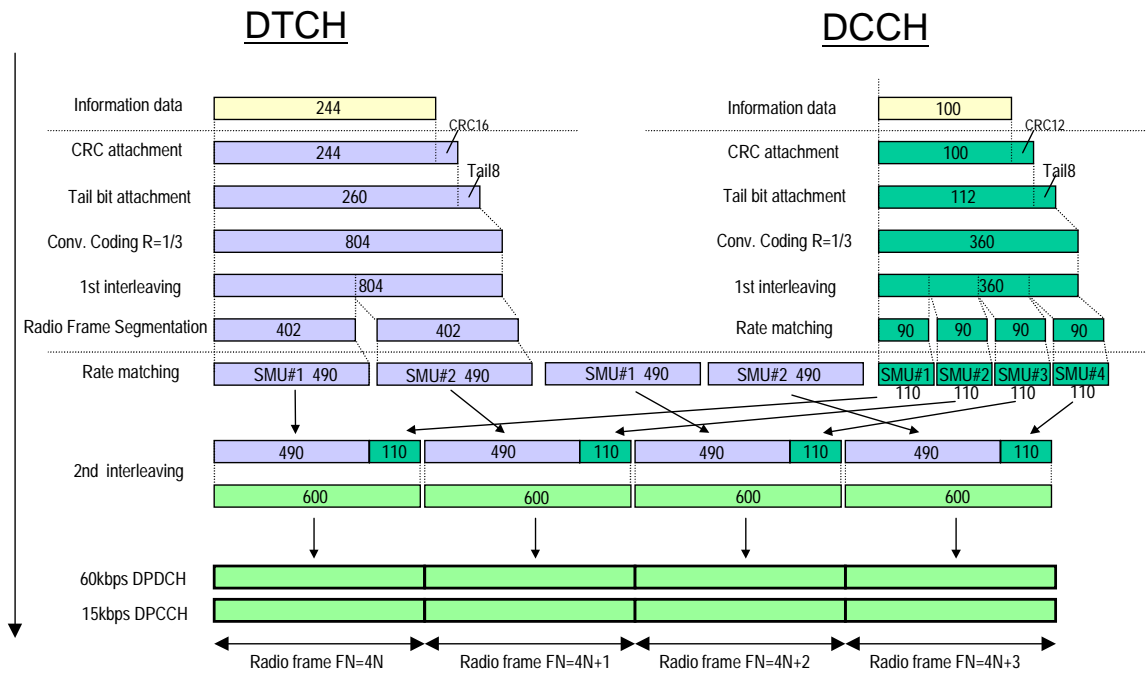

Figure A.1 (Informative): Channel coding of UL reference measurement channel (12.2 kbps)

A.2.2 UL reference measurement channel (64 kbps)

The parameters for the 64 kbps UL reference measurement channel are specified in Table A.3 and Table A.4. The channel coding for information is shown in figure A.2. This measurement channel is not currently used in TS 25.101 but can be used for future requirements.

Table A.3: UL reference measurement channel (64 kbps)

| Parameter | Unit | Level |
|-------------------------|------|-------|
| Information bit rate | kbps | 64 |
| DPDCH | kbps | 240 |
| DPCCH | kbps | 15 |
| DPCCH Slot Format #i | - | 0 |
| DPCCH/DPDCH power ratio | dB | -9.54 |
| TFCI | - | On |
| Repetition | % | 18 |

Table A.4: UL reference measurement channel, transport channel parameters (64 kbps)

| Parameter | DTCH | DCCH |
|----------------------------|--------------|--------------------|
| Transport Channel Number | 1 | 2 |
| Transport Block Size | 1280 | 100 |
| Transport Block Set Size | 1280 | 100 |
| Transmission Time Interval | 20 ms | 40 ms |
| Type of Error Protection | Turbo Coding | Convolution Coding |
| Coding Rate | 1/3 | 1/3 |
| Rate Matching attribute | 256 | 256 |
| Size of CRC | 16 | 12 |

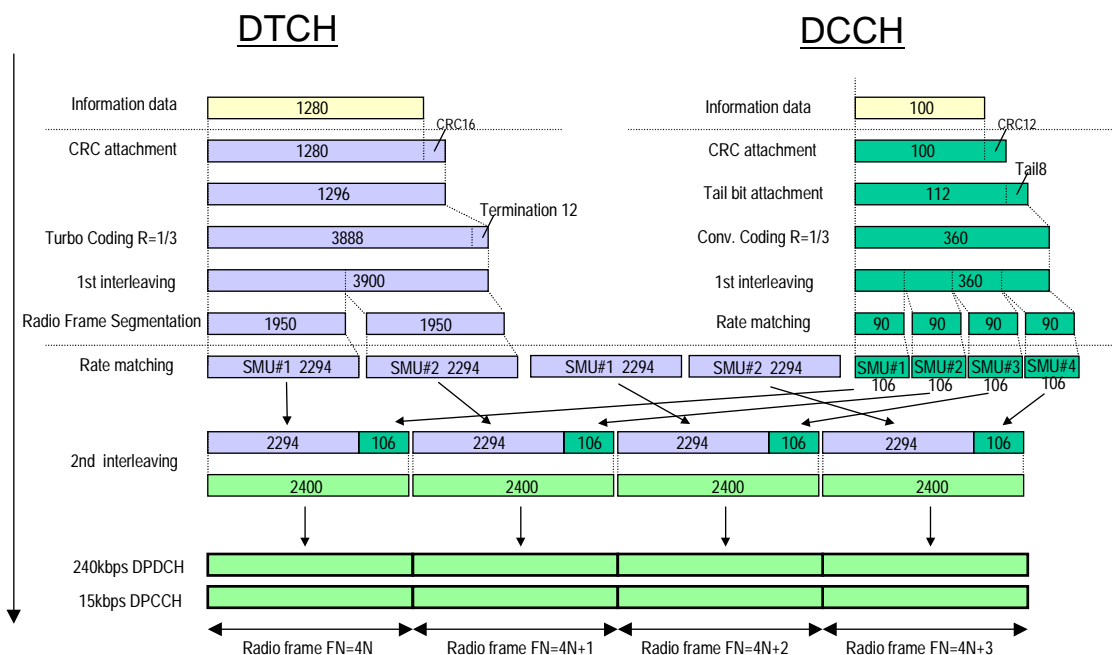

Figure A.2 (Informative): Channel coding of UL reference measurement channel (64 kbps)

A.2.3 UL reference measurement channel (144 kbps)

The parameters for the 144 kbps UL reference measurement channel are specified in Table A.5 and Table A.6. The channel coding for information is shown in Figure A.3. This measurement channel is not currently used in the present document but can be used for future requirements.

Table A.5: UL reference measurement channel (144 kbps)

| Parameter | Unit | Level |
|-------------------------|------|--------|
| Information bit rate | kbps | 144 |
| DPDCH | kbps | 480 |
| DPCCH | kbps | 15 |
| DPCCH Slot Format #i | - | 0 |
| DPCCH/DPDCH power ratio | dB | -11.48 |
| TFCI | - | On |
| Repetition | % | 8 |

Table A.6: UL reference measurement channel, transport channel parameters (144kbps)

| Parameters | DTCH | DCCH |
|----------------------------|--------------|--------------------|
| Transport Channel Number | 1 | 2 |
| Transport Block Size | 2880 | 100 |
| Transport Block Set Size | 2880 | 100 |
| Transmission Time Interval | 20 ms | 40 ms |
| Type of Error Protection | Turbo Coding | Convolution Coding |
| Coding Rate | 1/3 | 1/3 |
| Rate Matching attribute | 256 | 256 |
| Size of CRC | 16 | 12 |

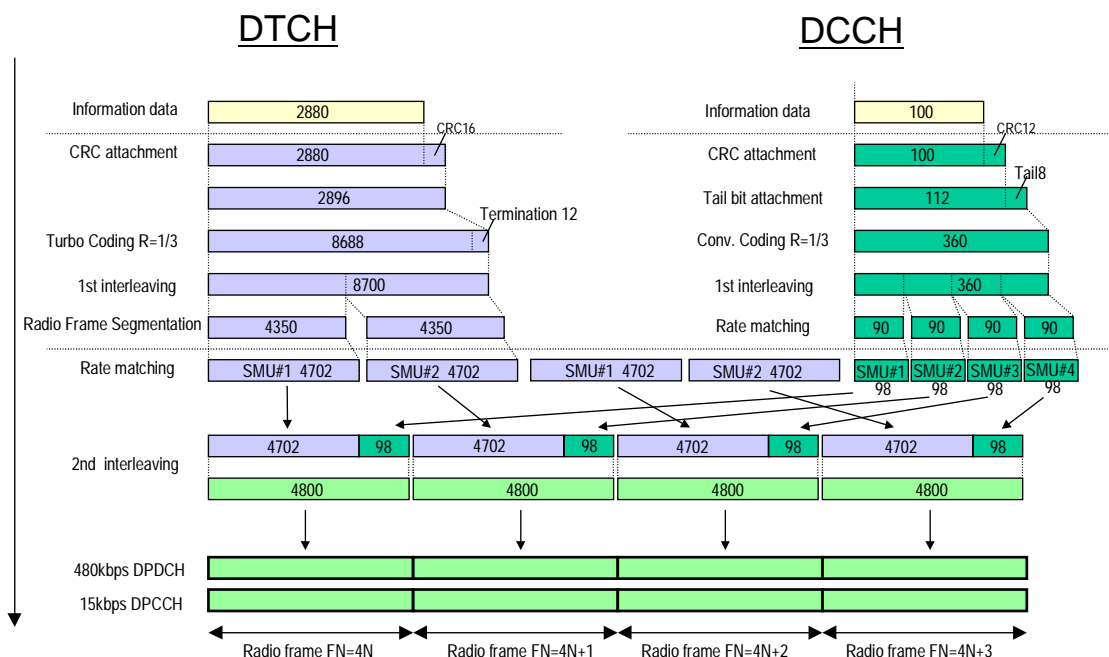

Figure A.3 (Informative): Channel coding of UL reference measurement channel (144 kbps)

A.2.4 UL reference measurement channel (384 kbps)

The parameters for the 384 kbps UL reference measurement channel are specified in Table A.7 and Table A.8. The channel coding for information is shown in Figure A.4. This measurement channel is not currently used in TS 25.101 but can be used for future requirements.

Table A.7: UL reference measurement channel (384 kbps)

| Parameter | Unit | Level |
|-------------------------|------|--------|
| Information bit rate | kbps | 384 |
| DPDCH | kbps | 960 |
| DPCCH | kbps | 15 |
| DPCCH Slot Format #1 | - | 0 |
| DPCCH/DPDCH power ratio | dB | -11.48 |
| TFCI | - | On |
| Puncturing | % | 18 |

Table A.8: UL reference measurement channel, transport channel parameters (384 kbps)

| Parameter | DTCH | DCCH |
|----------------------------|--------------|--------------------|
| Transport Channel Number | 1 | 2 |
| Transport Block Size | 3840 | 100 |
| Transport Block Set Size | 3840 | 100 |
| Transmission Time Interval | 10 ms | 40 ms |
| Type of Error Protection | Turbo Coding | Convolution Coding |
| Coding Rate | 1/3 | 1/3 |
| Rate Matching attribute | 256 | 256 |
| Size of CRC | 16 | 12 |

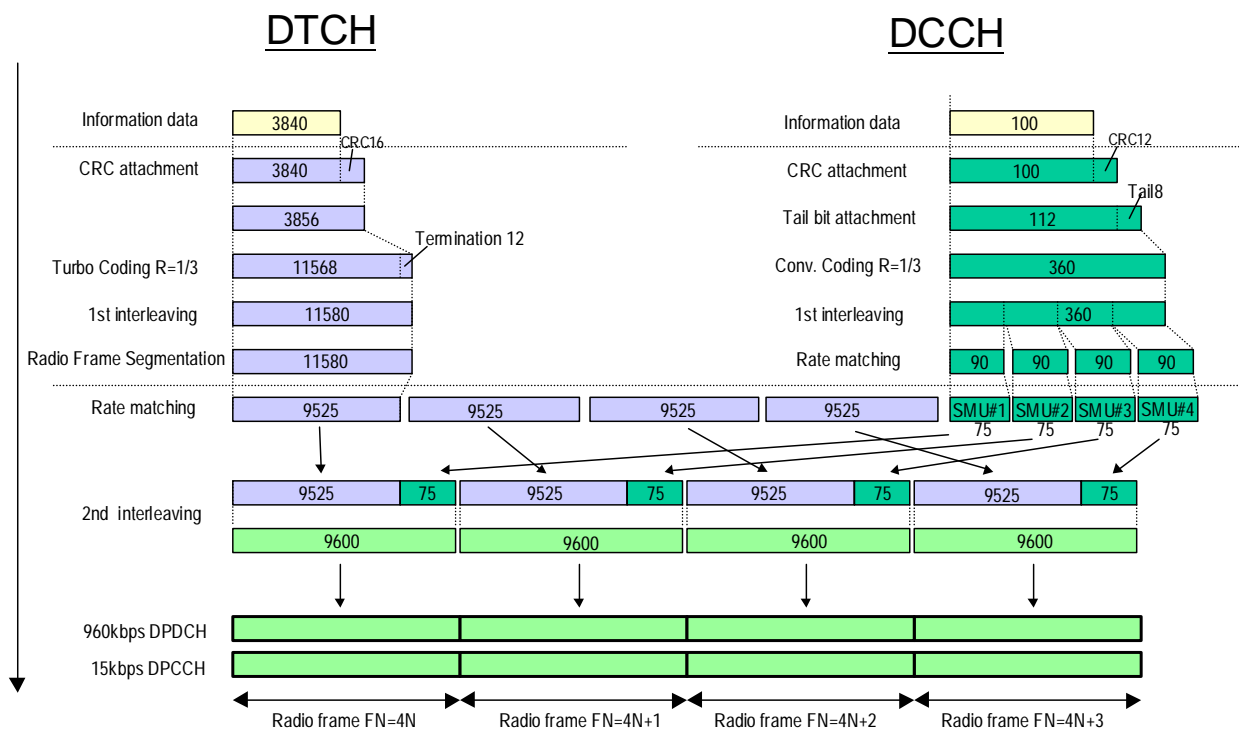

Figure A.4 (Informative): Channel coding of UL reference measurement channel (384 kbps)

A.2.5 UL reference measurement channel (768 kbps)

The parameters for the UL measurement channel for 768 kbps are specified in Table A.9 and Table A.10.

Table A.9: UL reference measurement channel, physical parameters (768 kbps)

| Parameter | Unit | Level |
|-------------------------|------|--------|
| Information bit rate | kbps | 2*384 |
| DPDCH ₁ | kbps | 960 |
| DPDCH ₂ | kbps | 960 |
| DPCCH | kbps | 15 |
| DPCCH Slot Format #i | - | 0 |
| DPCCH/DPDCH power ratio | dB | -11.48 |
| TFCI | - | On |
| Puncturing | % | 18 |

Table A.10: UL reference measurement channel, transport channel parameters (768 kbps)

| Parameter | DTCH | DCCH |
|----------------------------|--------------|--------------------|
| Transport Channel Number | 1 | 2 |
| Transport Block Size | 3840 | 100 |
| Transport Block Set Size | 7680 | 100 |
| Transmission Time Interval | 10 ms | 40 ms |
| Type of Error Protection | Turbo Coding | Convolution Coding |
| Coding Rate | 1/3 | 1/3 |
| Rate Matching attribute | 256 | 256 |
| Size of CRC | 16 | 12 |

A.3 DL reference measurement channel

A.3.0 DL reference measurement channel (0 kbps)

The parameters for the 0 kbps DL reference measurement channel are specified in Table A.10A and Table A.10B. The channel coding is shown for information in figure A.4A.

Table A.10A: DL reference measurement channel physical parameters (0 kbps)

| Parameter | Unit | Level |
|--------------------------------|------|-------|
| Information bit rate | kbps | 0 |
| DPCH | ksps | 30 |
| Slot Format #1 | - | 11 |
| TFCI | - | On |
| Power offsets PO1, PO2 and PO3 | dB | 0 |
| Puncturing | % | 13.9 |

Table A.10B: DL reference measurement channel, transport channel parameters (0 kbps)

| Parameter | DTCH | DCCH |
|---------------------------------|--------------------|--------------------|
| Transport Channel Number | 1 | 2 |
| Transport Block Size | 0 | 100 |
| Transport Block Set Size | 0 | 100 |
| Transmission Time Interval | 20 ms | 40 ms |
| Type of Error Protection | Convolution Coding | Convolution Coding |
| Coding Rate | 1/3 | 1/3 |
| Rate Matching attribute | 256 | 256 |
| Size of CRC | 16 | 12 |
| Position of TrCH in radio frame | fixed | fixed |

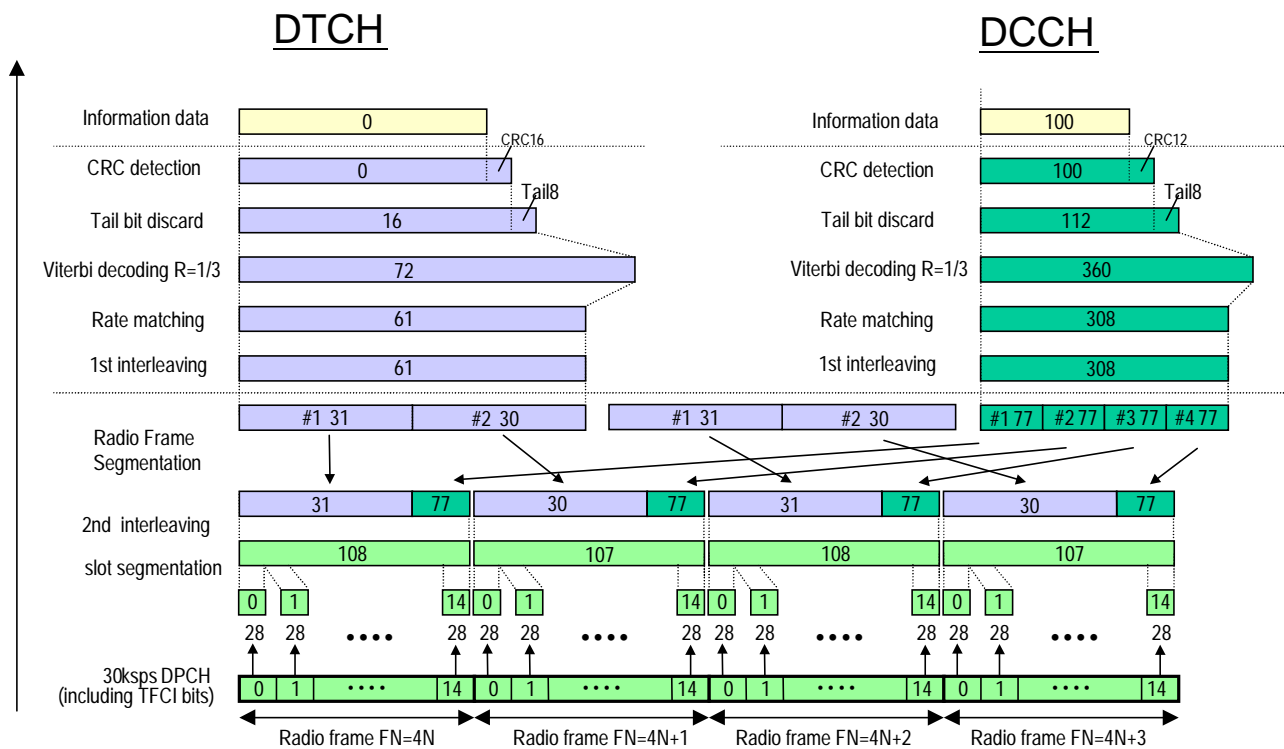

Figure A.4A (Informative): Channel coding of DL reference measurement channel (0 kbps)

A.3.1 DL reference measurement channel (12.2 kbps)

The parameters for the 12.2 Kbps DL reference measurement channel are specified in Table A.11 and Table A.12. The channel coding is shown for information in figure A.5.

Table A.11: DL reference measurement channel physical parameters (12.2 kbps)

| Parameter | Unit | Level |
|--------------------------------|------|-------|
| Information bit rate | kbps | 12.2 |
| DPCH | ksps | 30 |
| Slot Format #i | - | 11 |
| TFCI | - | On |
| Power offsets PO1, PO2 and PO3 | dB | 0 |
| Puncturing | % | 14.7 |

Table A.12: DL reference measurement channel, transport channel parameters (12.2 kbps)

| Parameter | DTCH | DCCH |
|---------------------------------|--------------------|--------------------|
| Transport Channel Number | 1 | 2 |
| Transport Block Size | 244 | 100 |
| Transport Block Set Size | 244 | 100 |
| Transmission Time Interval | 20 ms | 40 ms |
| Type of Error Protection | Convolution Coding | Convolution Coding |
| Coding Rate | 1/3 | 1/3 |
| Rate Matching attribute | 256 | 256 |
| Size of CRC | 16 | 12 |
| Position of TrCH in radio frame | fixed | fixed |

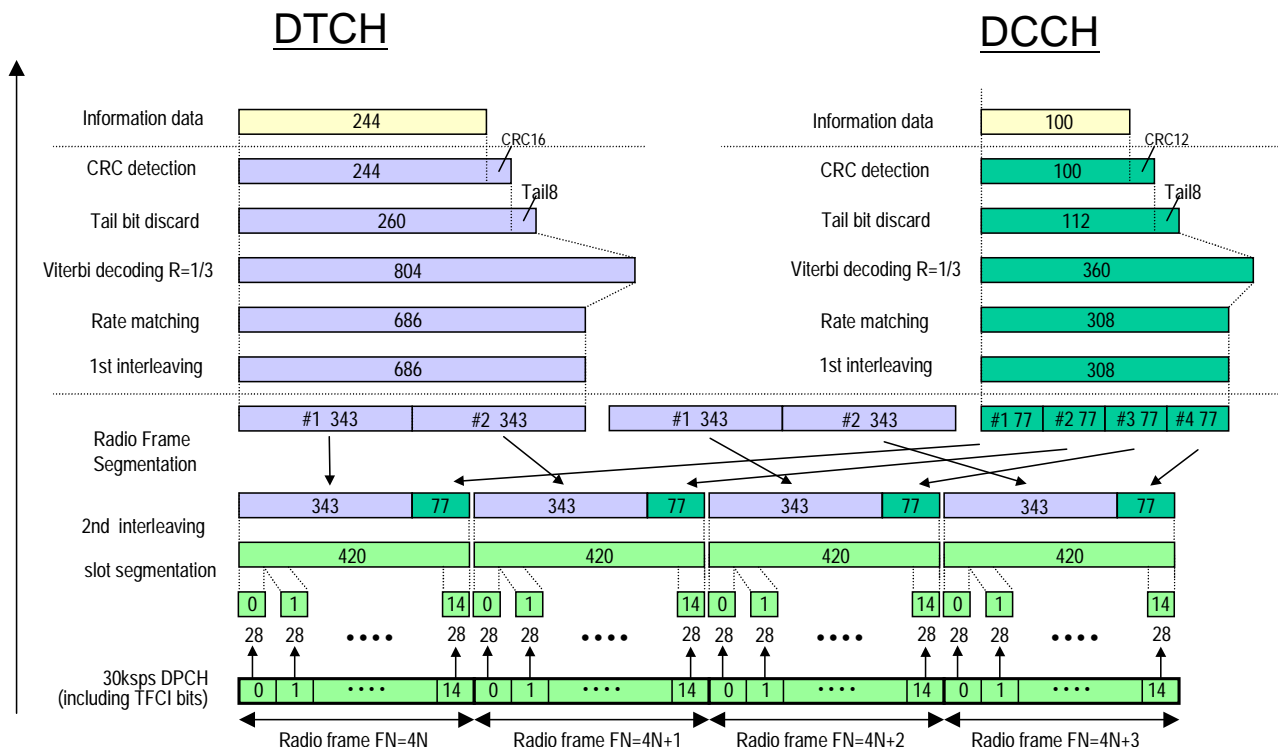

Figure A.5 (Informative): Channel coding of DL reference measurement channel (12.2 kbps)

A.3.2 DL reference measurement channel (64 kbps)

The parameters for the DL reference measurement channel for 64 kbps are specified in Table A.13 and Table A.14. The channel coding is shown for information in Figure A.6.

Table A.13: DL reference measurement channel physical parameters (64 kbps)

| Parameter | Unit | Level |
|--------------------------------|------|-------|
| Information bit rate | kbps | 64 |
| DPCH | ksps | 120 |
| Slot Format #i | - | 13 |
| TFCI | - | On |
| Power offsets PO1, PO2 and PO3 | dB | 0 |
| Repetition | % | 2.9 |

Table A.14: DL reference measurement channel, transport channel parameters (64 kbps)

| Parameter | DTCH | DCCH |
|---------------------------------|--------------|--------------------|
| Transport Channel Number | 1 | 2 |
| Transport Block Size | 1280 | 100 |
| Transport Block Set Size | 1280 | 100 |
| Transmission Time Interval | 20 ms | 40 ms |
| Type of Error Protection | Turbo Coding | Convolution Coding |
| Coding Rate | 1/3 | 1/3 |
| Rate Matching attribute | 256 | 256 |
| Size of CRC | 16 | 12 |
| Position of TrCH in radio frame | fixed | fixed |

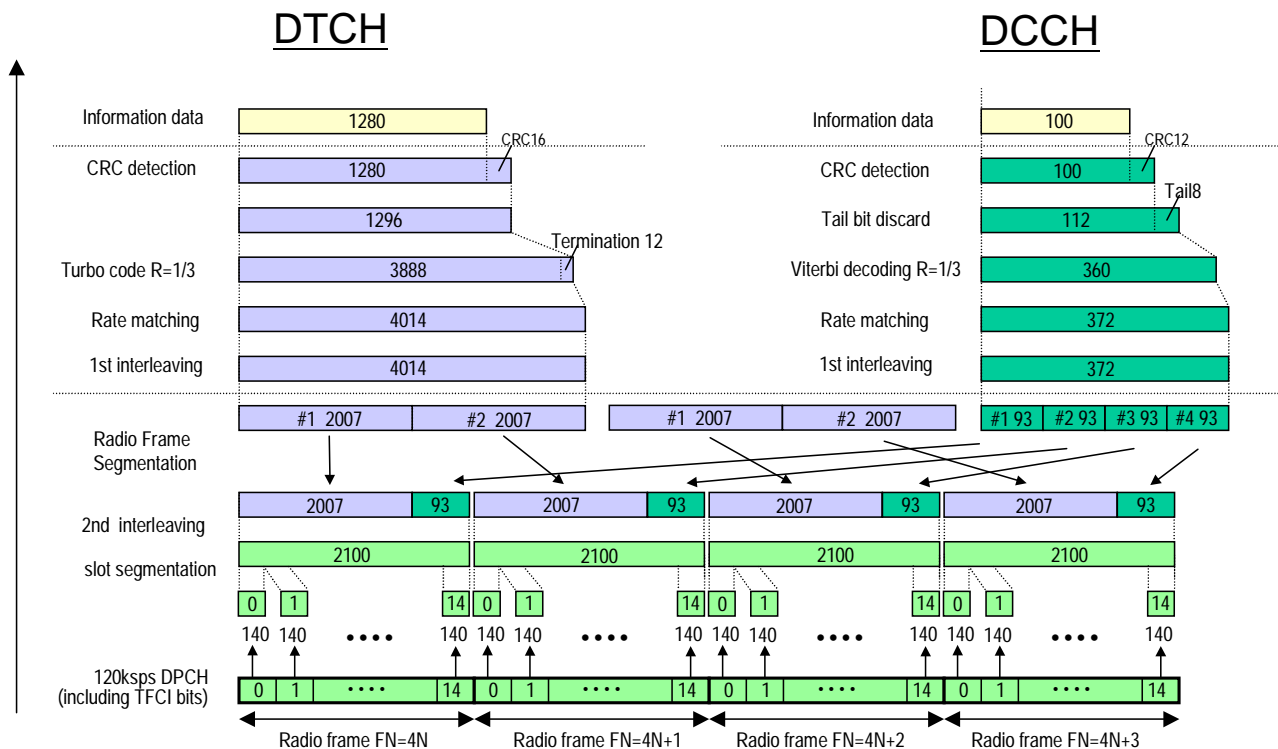

Figure A.6 (Informative): Channel coding of DL reference measurement channel (64 kbps)

A.3.3 DL reference measurement channel (144 kbps)

The parameters for the DL measurement channel for 144 kbps are specified in Table A.15 and Table A.16. The channel coding is shown for information in Figure A.7.

Table A.15: DL reference measurement channel physical parameters (144 kbps)

| Parameter | Unit | Level |
|--------------------------------|-------|-------|
| Information bit rate | kbps | 144 |
| DPCH | ksp/s | 240 |
| Slot Format #i | - | 14 |
| TFCI | - | On |
| Power offsets PO1, PO2 and PO3 | dB | 0 |
| Puncturing | % | 2.7 |

Table A.16: DL reference measurement channel, transport channel parameters (144 kbps)

| Parameter | DTCH | DCCH |
|---------------------------------|--------------|--------------------|
| Transport Channel Number | 1 | 2 |
| Transport Block Size | 2880 | 100 |
| Transport Block Set Size | 2880 | 100 |
| Transmission Time Interval | 20 ms | 40 ms |
| Type of Error Protection | Turbo Coding | Convolution Coding |
| Coding Rate | 1/3 | 1/3 |
| Rate Matching attribute | 256 | 256 |
| Size of CRC | 16 | 12 |
| Position of TrCH in radio frame | fixed | fixed |

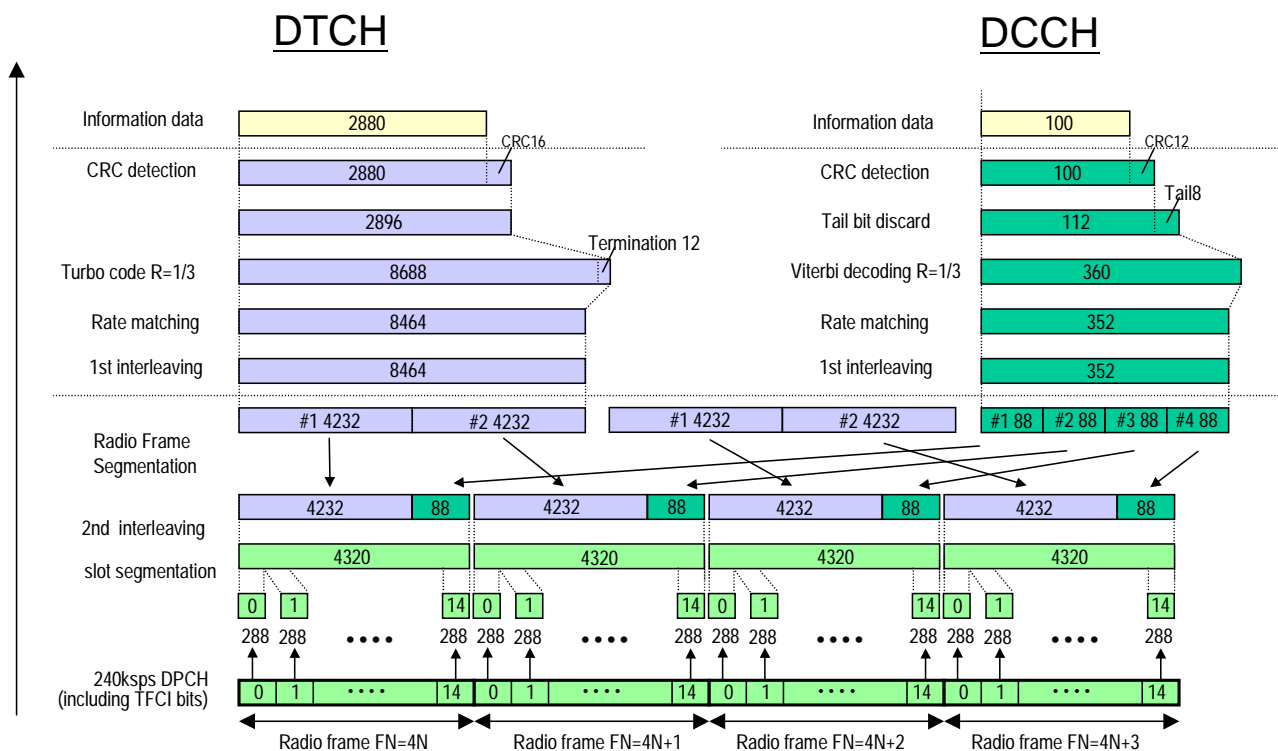

Figure A.7 (Informative): Channel coding of DL reference measurement channel (144 kbps)

A.3.4 DL reference measurement channel (384 kbps)

The parameters for the DL measurement channel for 384 kbps are specified in Table A.17 and Table A.18. The channel coding is shown for information in Figure A.8

Table A.17: DL reference measurement channel, physical parameters (384 kbps)

| Parameter | Unit | Level |
|--------------------------------|------|-------|
| Information bit rate | kbps | 384 |
| DPCH | ksps | 480 |
| Slot Format # i | - | 15 |
| TFCI | | On |
| Power offsets PO1, PO2 and PO3 | dB | 0 |
| Puncturing | % | 22 |

Table A.18: DL reference measurement channel, transport channel parameters (384 kbps)

| Parameter | DTCH | DCCH |
|---------------------------------|--------------|--------------------|
| Transport Channel Number | 1 | 2 |
| Transport Block Size | 3840 | 100 |
| Transport Block Set Size | 3840 | 100 |
| Transmission Time Interval | 10 ms | 40 ms |
| Type of Error Protection | Turbo Coding | Convolution Coding |
| Coding Rate | 1/3 | 1/3 |
| Rate Matching attribute | 256 | 256 |
| Size of CRC | 16 | 12 |
| Position of TrCH in radio frame | fixed | Fixed |

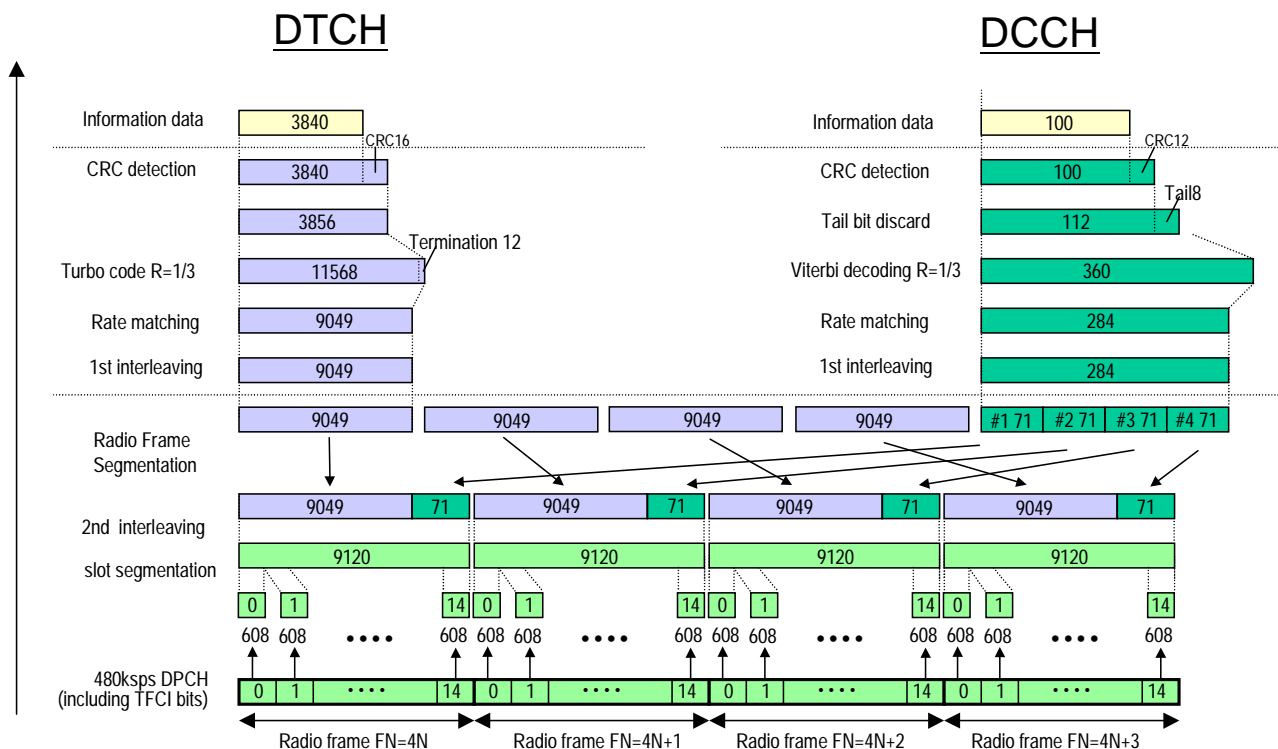

Figure A.8 (Informative): Channel coding of DL reference measurement channel (384 kbps)

A.3.5 DL reference measurement channel 2 (64 kbps)

The parameters for the DL reference measurement channel for 64 kbps are specified in Table A.18A and Table A.18B. The channel coding is shown for information in Figure A.8A.

Table A.18A: DL reference measurement channel physical parameters (64 kbps)

| Parameter | Unit | Level |
|-----------------------------|------|-------|
| Information bit rate (DTCH) | kbps | 64 |
| Information bit rate (DCCH) | kbps | 3.4 |
| DPCH | ksps | 120 |
| Slot Format #i | - | 13 |
| TFCI | - | On |
| Puncturing (DTCH) | % | 8.6 |
| Repetition (DCCH) | % | 27.9 |

Table A.18B: DL reference measurement channel, transport channel parameters (64 kbps)

| Parameter | DTCH | DCCH |
|---------------------------------|--------------|--------------------|
| Transport Channel Number | 1 | 2 |
| Transport Block Size | 336 | 148 |
| Transport Block Set Size | 1344 | 148 |
| Transport blocks per TTI | 4 | 1 |
| Transmission Time Interval | 20 ms | 40 ms |
| Type of Error Protection | Turbo Coding | Convolution Coding |
| Coding Rate | 1/3 | 1/3 |
| Rate Matching attribute | 143 | 200 |
| Size of CRC | 16 | 16 |
| Position of TrCH in radio frame | fixed | fixed |

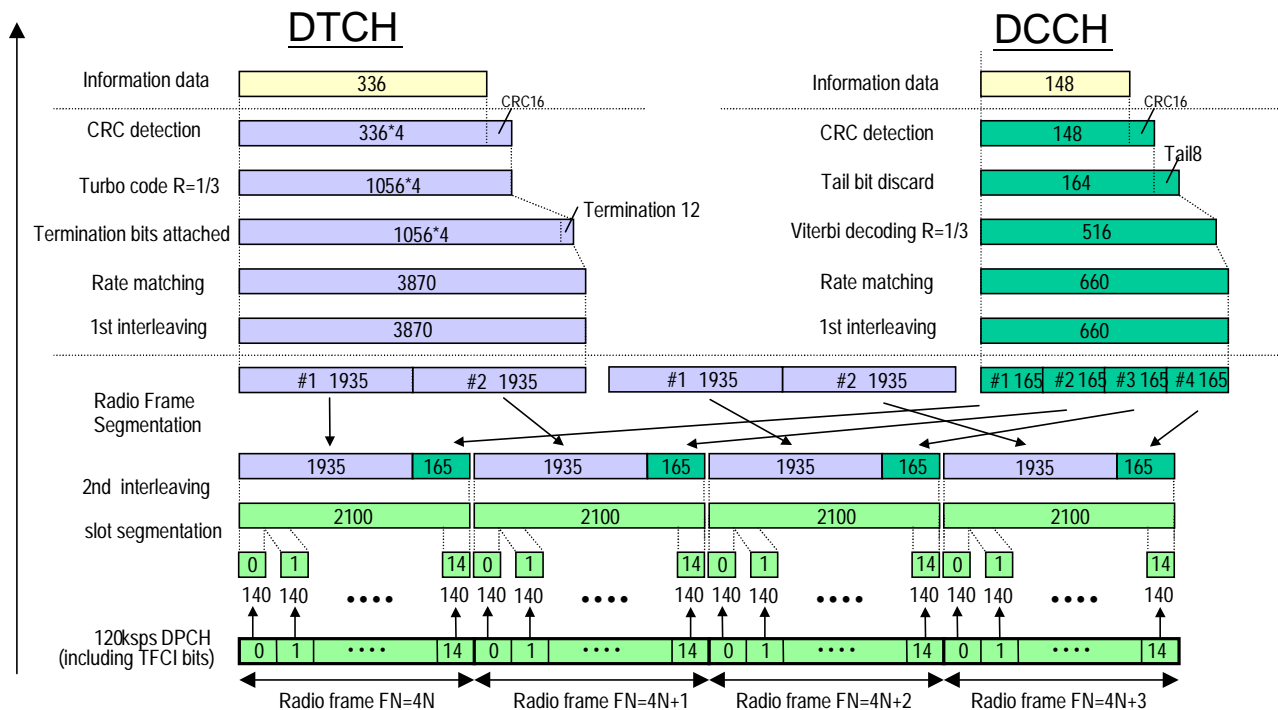

Figure A.8A (Informative): Channel coding of DL reference measurement channel 2 (64 kbps)

A.4 DL reference measurement channel for BTFD performance requirements

The parameters for DL reference measurement channel for BTFD are specified in Table A.19 and Table A.20. The channel coding for information is shown in figures A.9, A.10, and A11.

Table A.19: DL reference measurement channel physical parameters for BTFD

| Parameter | Unit | Rate 1 | Rate 2 | Rate 3 |
|--------------------------------|------|--------|--------|--------|
| Information bit rate | kbps | 12.2 | 7.95 | 1.95 |
| DPCH | ksps | 30 | | |
| Slot Format # i | - | 8 | | |
| TFCI | - | Off | | |
| Power offsets PO1, PO2 and PO3 | dB | 0 | | |
| Repetition | % | 5 | | |

Table A.20: DL reference measurement channel, transport channel parameters for BTFD

| Parameter | DTCH | | | DCCH |
|---------------------------------|--------------------|--------|--------|--------------------|
| | Rate 1 | Rate 2 | Rate 3 | |
| Transport Channel Number | 1 | | | 2 |
| Transport Block Size | 244 | 159 | 39 | 100 |
| Transport Block Set Size | 244 | 159 | 39 | 100 |
| Transmission Time Interval | 20 ms | | | 40 ms |
| Type of Error Protection | Convolution Coding | | | Convolution Coding |
| Coding Rate | 1/3 | | | 1/3 |
| Rate Matching attribute | 256 | | | 256 |
| Size of CRC | 12 | | | 12 |
| Position of TrCH in radio frame | fixed | | | fixed |

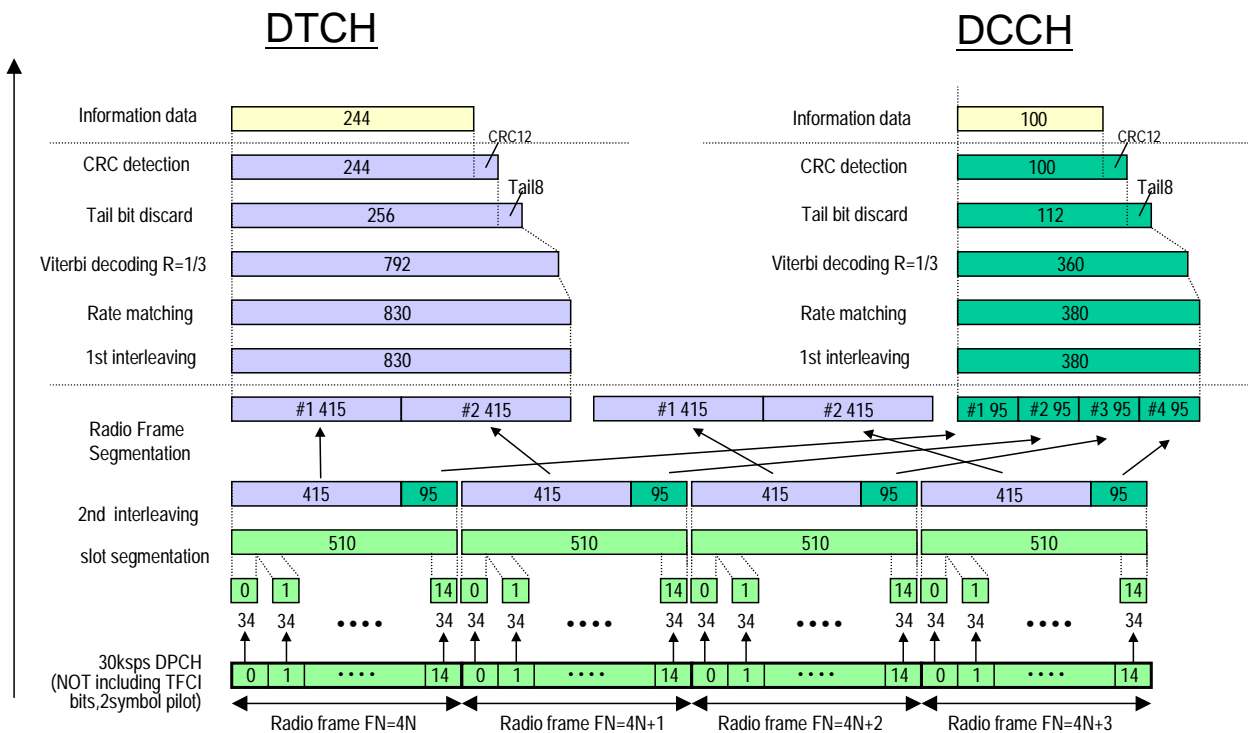

Figure A.9 (Informative): Channel coding of DL reference measurement channel for BTFD (Rate 1)

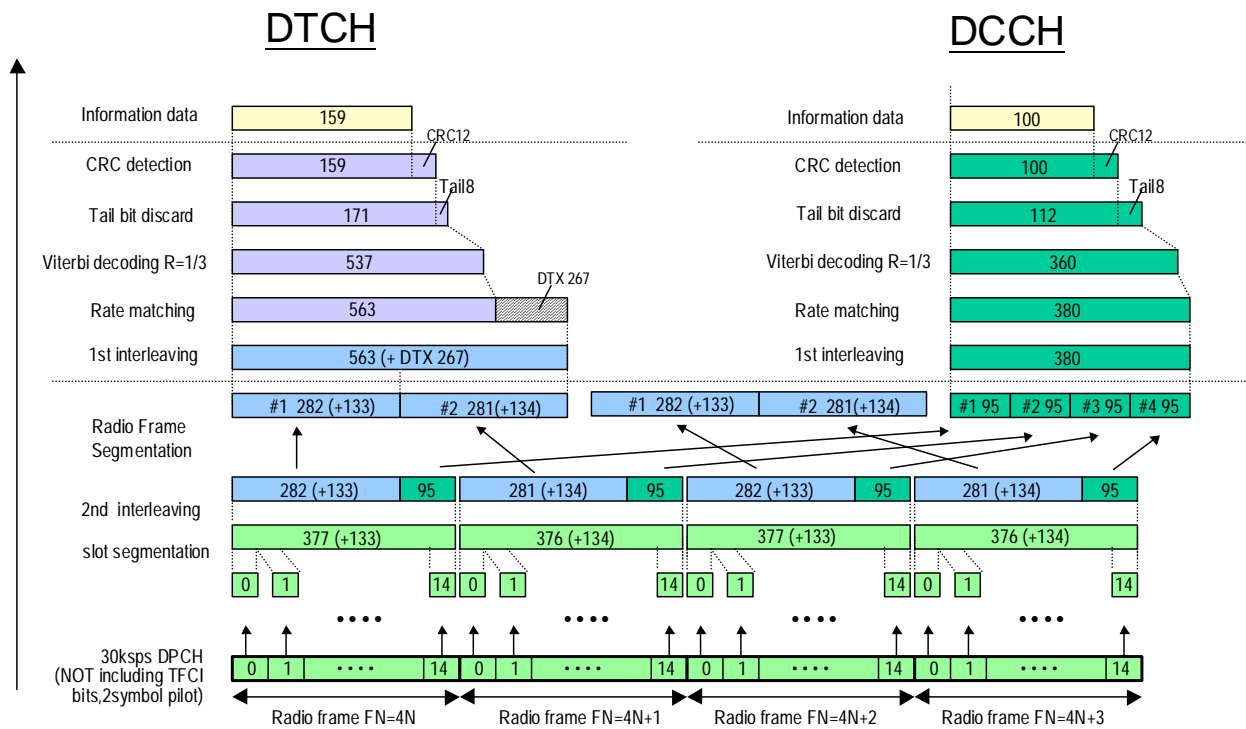

Figure A.10 (Informative): Channel coding of DL reference measurement channel for BTFD (Rate 2)

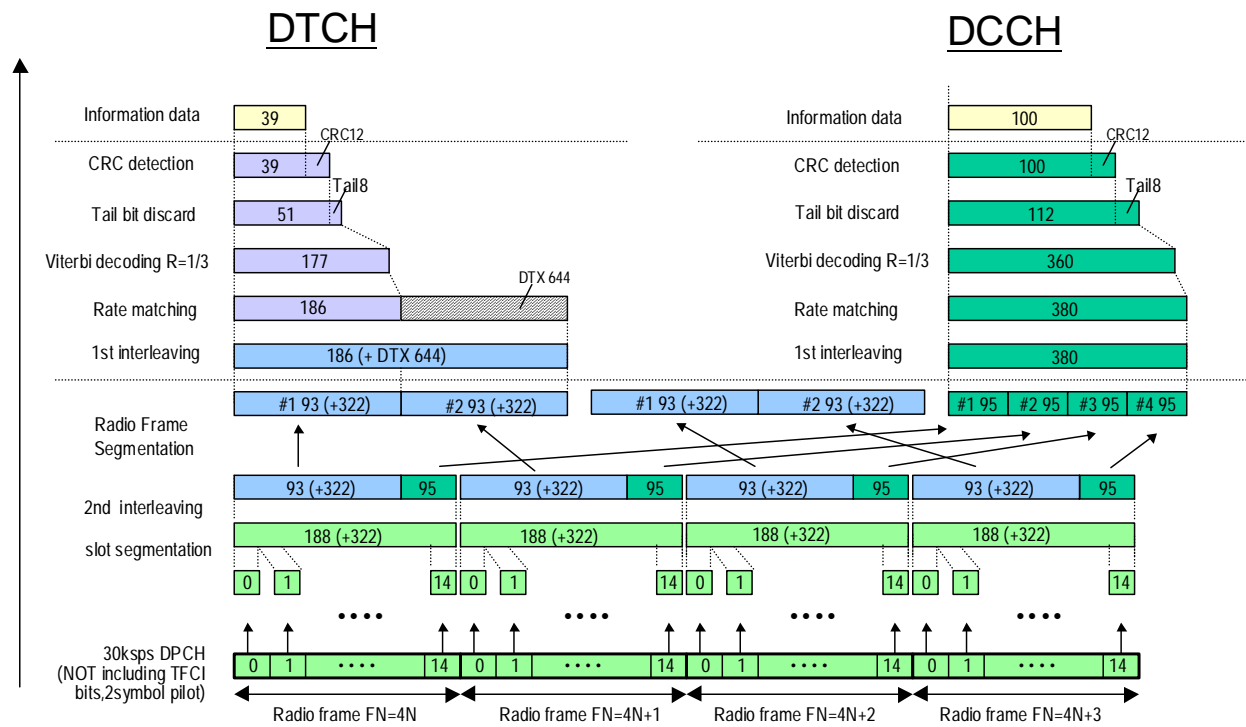

Figure A.11 (Informative): Channel coding of DL reference measurement channel for BTFD (Rate 3)

A.4A Void

Table A.20A: Void

Table A.20B: Void

Figure A.11A Void

A.5 DL reference compressed mode parameters

Parameters described in Table A.21 are used in some test specified in TS 25.101 while parameters described in Table A.22 and Table A.22A are used in some tests specified in TS 25.133.

Parameters in Table A.21 are applicable when compressed mode by spreading factor reduction is used in downlink.

Table A.21: Compressed mode reference pattern 1 parameters

| Parameter | Set 1 | Set 2 | Note |
|---|---------|---------|---|
| TGSN (Transmission Gap Starting Slot Number) | 11 | 4 | |
| TGL1 (Transmission Gap Length 1) | 7 | 7 | |
| TGL2 (Transmission Gap Length 2) | - | 7 | Only one gap in use. |
| TGD (Transmission Gap Distance) | 0 | 15 | Only one gap in use. |
| TGPL1 (Transmission Gap Pattern Length) | 4 | 4 | |
| TGPRC (Transmission Gap Pattern Repetition Count) | NA | NA | Defined by higher layers |
| TGCFN (Transmission Gap Connection Frame Number): | NA | 0 | Defined by higher layers |
| UL/DL compressed mode selection | DL & UL | DL & UL | 2 configurations possible DL & UL / DL |
| UL compressed mode method | SF/2 | SF/2 | |
| DL compressed mode method | SF/2 | SF/2 | |
| Downlink frame type and Slot format | 11B | 11B | |
| Scrambling code change | No | No | |
| RPP (Recovery period power control mode) | 0 | 0 | |
| ITP (Initial transmission power control mode) | 0 | 0 | |

Table A.22: Compressed mode reference pattern 2 parameters

| Parameter | Set 1 | Set 2 | Set 4 | Note |
|---|---------|---------|---------|---|
| TGSN (Transmission Gap Starting Slot Number) | 4 | 4 | 8 | |
| TGL1 (Transmission Gap Length 1) | 7 | 7 | 14 | |
| TGL2 (Transmission Gap Length 2) | - | - | - | Only one gap in use. |
| TGD (Transmission Gap Distance) | 0 | 0 | 0 | |
| TGPL1 (Transmission Gap Pattern Length) | 3 | 12 | 4 | |
| TGPRC (Transmission Gap Pattern Repetition Count) | NA | NA | NA | Defined by higher layers |
| TGCFN (Transmission Gap Connection Frame Number): | NA | NA | NA | Defined by higher layers |
| UL/DL compressed mode selection | DL & UL | DL & UL | DL & UL | 2 configurations possible. DL & UL / DL |
| UL compressed mode method | SF/2 | SF/2 | SF/2 | |
| DL compressed mode method | SF/2 | SF/2 | SF/2 | |
| Downlink frame type and Slot format | 11B | 11B | 11B | |
| Scrambling code change | No | No | No | |
| RPP (Recovery period power control mode) | 0 | 0 | 0 | |
| ITP (Initial transmission power control mode) | 0 | 0 | 0 | |

Table A.22A: Compressed mode reference pattern 3 parameters

| Parameter | Set 1 | Set 2 | Set 3 | Set 4 | Note |
|---|---------|---------|---------|---------|---|
| TGSN (Transmission Gap Starting Slot Number) | 8 | 8 | 8 | 8 | |
| TGL1 (Transmission Gap Length 1) | 14 | 14 | 14 | 14 | |
| TGL2 (Transmission Gap Length 2) | - | - | - | - | Only one gap in use. |
| TGD (Transmission Gap Distance) | 0 | 0 | 0 | 0 | |
| TGPL1 (Transmission Gap Pattern Length) | 8 | 24 | 24 | 24 | |
| TGPRC (Transmission Gap Pattern Repetition Count) | NA | NA | NA | NA | Defined by higher layers |
| TGCFN (Transmission Gap Connection Frame Number): | 0 | 4 | 12 | 20 | |
| UL/DL compressed mode selection | DL & UL | DL & UL | DL & UL | DL & UL | 2 configurations possible. DL & UL / DL |
| UL compressed mode method | SF/2 | SF/2 | SF/2 | SF/2 | |
| DL compressed mode method | SF/2 | SF/2 | SF/2 | SF/2 | |
| Downlink frame type and Slot format | 11B | 11B | 11B | 11B | |
| Scrambling code change | No | No | No | No | |
| RPP (Recovery period power control mode) | 0 | 0 | 0 | 0 | |
| ITP (Initial transmission power control mode) | 0 | 0 | 0 | 0 | |

A.6 DL reference parameters for PCH tests

The parameters for the PCH demodulation tests are specified in Table A.23 and Table A.24.

Table A.23: Physical channel parameters for S-CCPCH

| Parameter | Unit | Level |
|---|------|-------|
| Channel bit rate | kbps | 60 |
| Channel symbol rate | ksps | 30 |
| Slot Format # | - | 4 |
| TFCI | - | OFF |
| Power offsets of TFCI and Pilot fields relative to data field | dB | 0 |

Table A.24: Transport channel parameters for S-CCPCH

| Parameter | PCH |
|---------------------------------|--------------------|
| Transport Channel Number | 1 |
| Transport Block Size | 240 |
| Transport Block Set Size | 240 |
| Transmission Time Interval | 10 ms |
| Type of Error Protection | Convolution Coding |
| Coding Rate | 1/2 |
| Rate Matching attribute | 256 |
| Size of CRC | 16 |
| Position of TrCH in radio frame | fixed |

A.7 DL reference channel parameters for HSDPA tests

A.7.1 Fixed Reference Channel (FRC)

A.7.1.1 Fixed Reference Channel Definition H-Set 1

Table A.25: Fixed Reference Channel H-Set 1

| Parameter | Unit | Value | |
|---|-----------|-------|-------|
| Nominal Avg. Inf. Bit Rate | kbps | 534 | 777 |
| Inter-TTI Distance | TTI"s | 3 | 3 |
| Number of HARQ Processes | Processes | 2 | 2 |
| Information Bit Payload (N_{INF}) | Bits | 3202 | 4664 |
| Number Code Blocks | Blocks | 1 | 1 |
| Binary Channel Bits Per TTI | Bits | 4800 | 7680 |
| Total Available SML"s in UE | SML"s | 19200 | 19200 |
| Number of SML"s per HARQ Proc. | SML"s | 9600 | 9600 |
| Coding Rate | | 0.67 | 0.61 |
| Number of Physical Channel Codes | Codes | 5 | 4 |
| Modulation | | QPSK | 16QAM |
| Note: The HS-DSCH shall be transmitted continuously with constant power but only every third TTI shall be allocated to the UE under test. | | | |

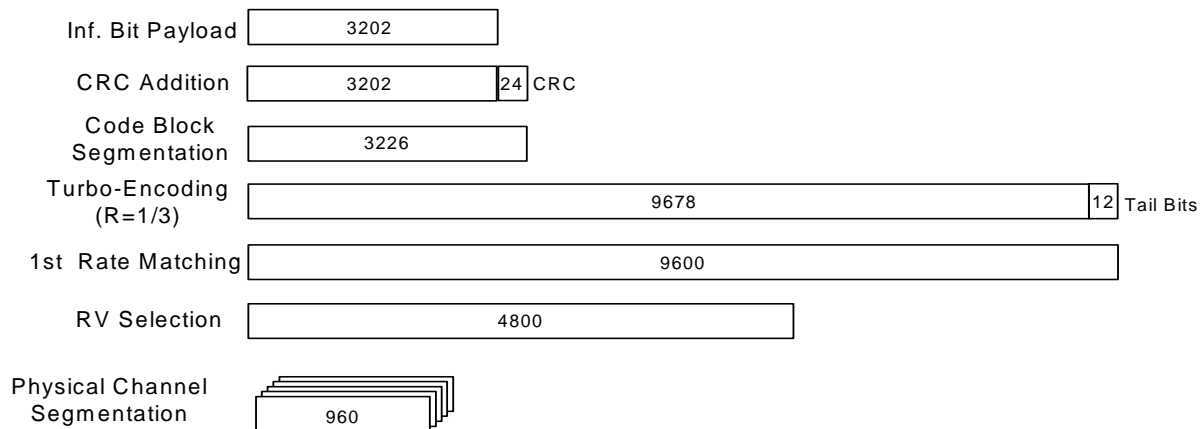

Figure A.12: Coding rate for Fixed reference Channel H-Set 1 (QPSK)

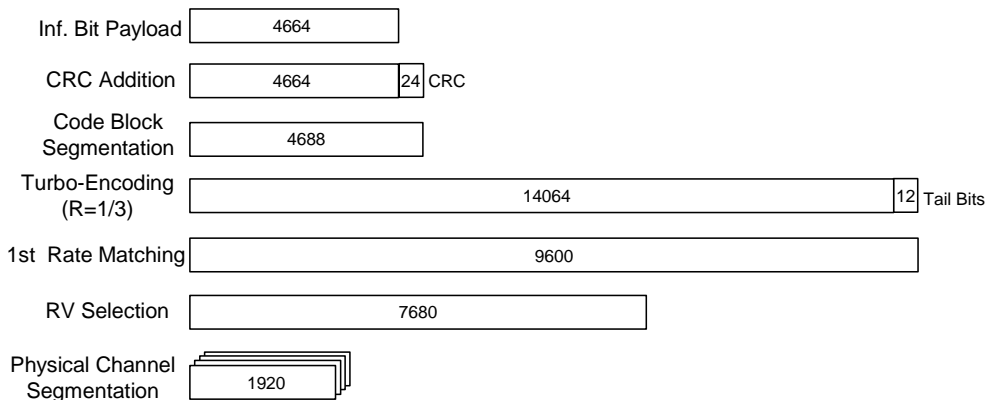

Figure A.13: Coding rate for Fixed reference Channel H-Set 1 (16 QAM)

A.7.1.2 Fixed Reference Channel Definition H-Set 2

Table A.26: Fixed Reference Channel H-Set 2

| Parameter | Unit | Value | |
|---------------------------------------|--|-------|-------|
| Nominal Avg. Inf. Bit Rate | kbps | 801 | 1166 |
| Inter-TTI Distance | TTI"s | 2 | 2 |
| Number of HARQ Processes | Processes | 3 | 3 |
| Information Bit Payload (N_{INF}) | Bits | 3202 | 4664 |
| Number Code Blocks | Blocks | 1 | 1 |
| Binary Channel Bits Per TTI | Bits | 4800 | 7680 |
| Total Available SML"s in UE | SML"s | 28800 | 28800 |
| Number of SML"s per HARQ Proc. | SML"s | 9600 | 9600 |
| Coding Rate | | 0.67 | 0.61 |
| Number of Physical Channel Codes | Codes | 5 | 4 |
| Modulation | | QPSK | 16QAM |
| Note: | The HS-DSCH shall be transmitted continuously with constant power but only every second TTI shall be allocated to the UE under test. | | |

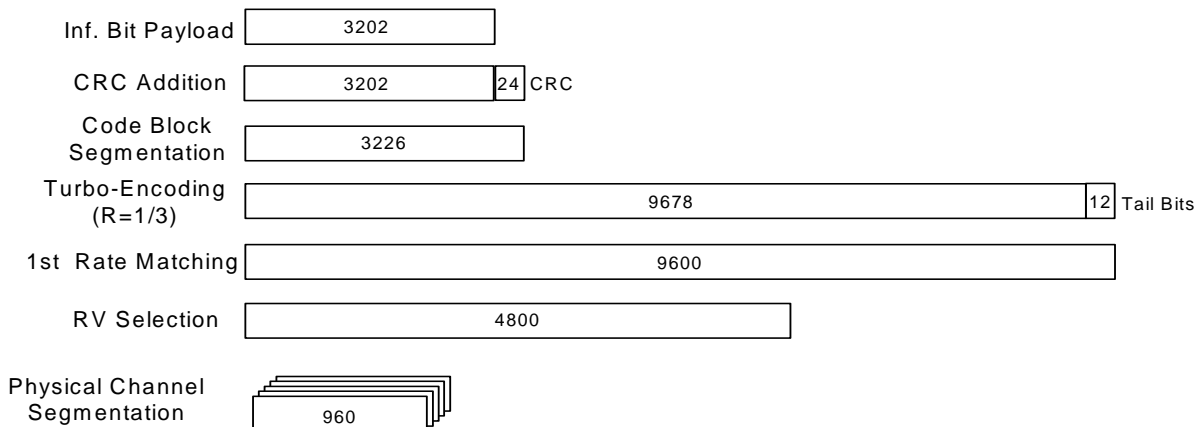

Figure A.14: Coding rate for Fixed Reference Channel H-Set 2 (QPSK)

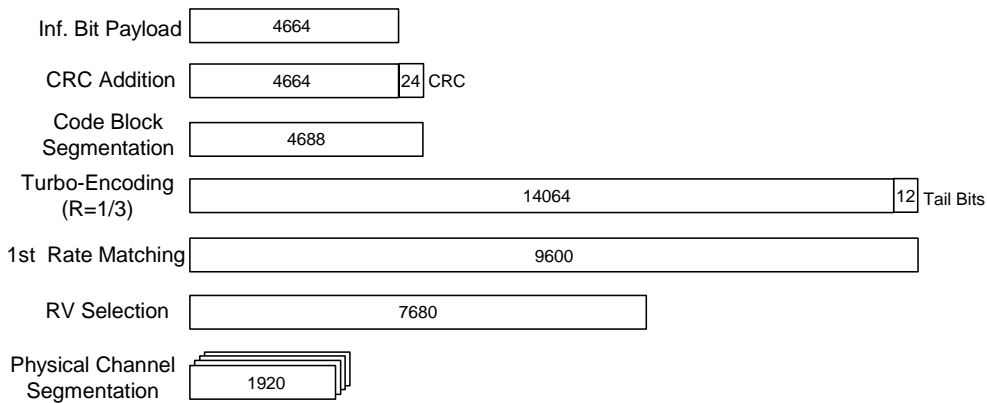

Figure A.15: Coding rate for Fixed Reference Channel H-Set 2 (16QAM)

A.7.1.3 Fixed Reference Channel Definition H-Set 3

Table A.27: Fixed Reference Channel H-Set 3

| Parameter | Unit | Value | |
|---------------------------------------|-----------|-------|-------|
| | | 1 | 2 |
| Nominal Avg. Inf. Bit Rate | kbps | 1601 | 2332 |
| Inter-TTI Distance | TTI"s | 1 | 1 |
| Number of HARQ Processes | Processes | 6 | 6 |
| Information Bit Payload (N_{INF}) | Bits | 3202 | 4664 |
| Number Code Blocks | Blocks | 1 | 1 |
| Binary Channel Bits Per TTI | Bits | 4800 | 7680 |
| Total Available SML"s, in UE | SML"s | 57600 | 57600 |
| Number of SML"s per HARQ Proc. | SML"s | 9600 | 9600 |
| Coding Rate | | 0.67 | 0.61 |
| Number of Physical Channel Codes | Codes | 5 | 4 |
| Modulation | | QPSK | 16QAM |

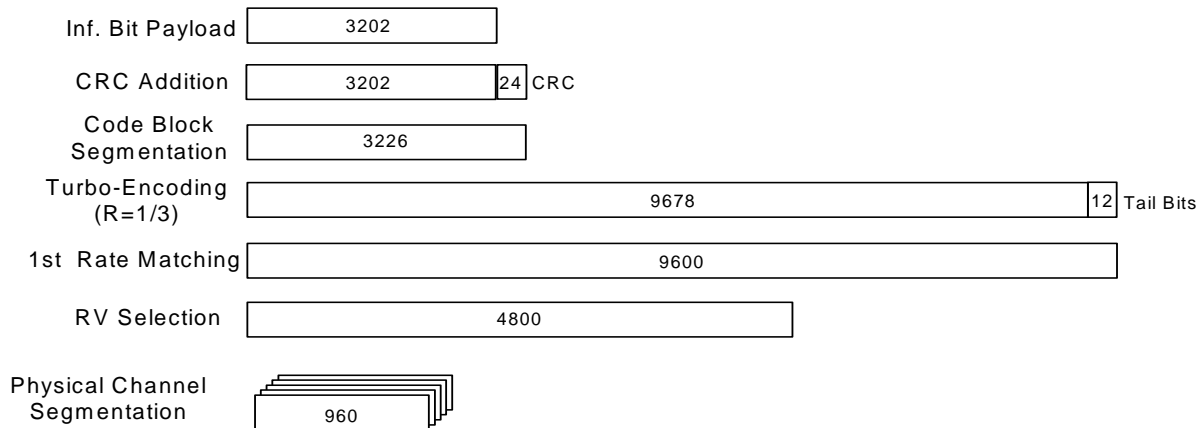

Figure A.16: Coding rate for Fixed reference Channel H-Set 3 (QPSK)

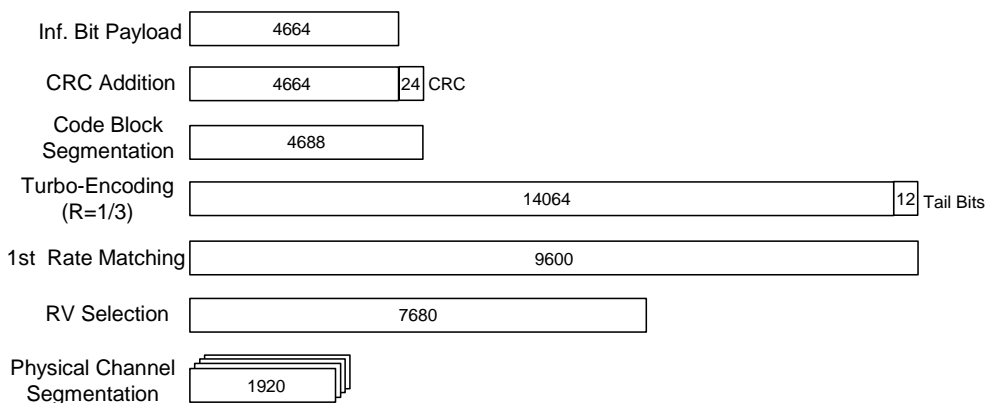

Figure A.17: Coding rate for Fixed reference Channel H-Set 3 (16QAM)

A.7.1.4 Fixed Reference Channel Definition H-Set 4

Table A.28: Fixed Reference Channel H-Set 4

| Parameter | Unit | Value |
|---------------------------------------|---|-------|
| Nominal Avg. Inf. Bit Rate | kbps | 534 |
| Inter-TTI Distance | TTI"s | 2 |
| Number of HARQ Processes | Processes | 2 |
| Information Bit Payload (N_{INF}) | Bits | 3202 |
| Number Code Blocks | Blocks | 1 |
| Binary Channel Bits Per TTI | Bits | 4800 |
| Total Available SML"s in UE | SML"s | 14400 |
| Number of SML"s per HARQ Proc. | SML"s | 7200 |
| Coding Rate | | 0.67 |
| Number of Physical Channel Codes | Codes | 5 |
| Modulation | | QPSK |
| Note: | This FRC is used to verify the minimum inter-TTI distance for UE category 11. The HS-PDSCH shall be transmitted continuously with constant power. The six sub-frame HS-SCCH signalling pattern shall repeat as follows: ...OOXOXOOXOXO..., where "X" marks TTI in which HS-SCCH uses the identity of the UE under test and "O" marks TTI, in which HS-SCCH uses a different identity. | |

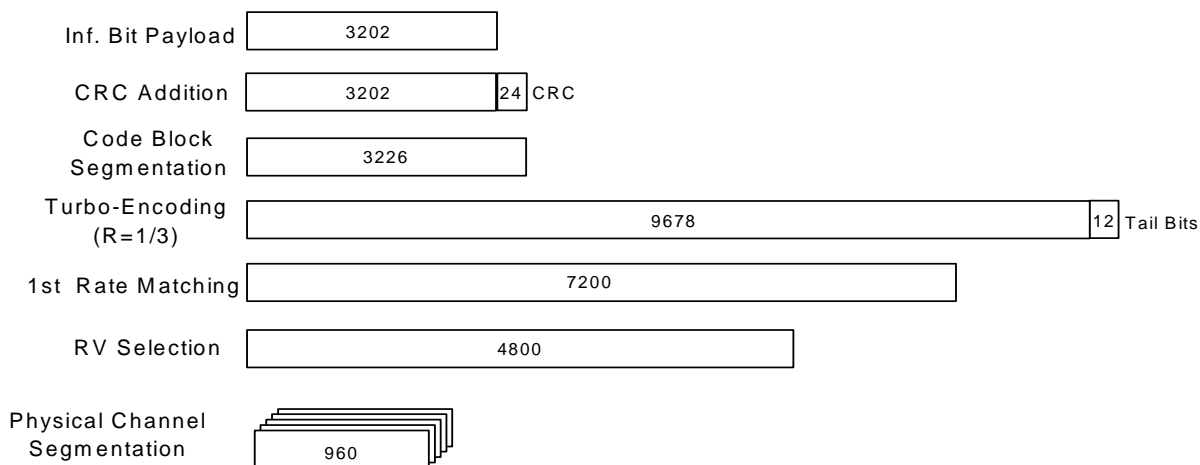

Figure A.18: Coding rate for Fixed Reference Channel H-Set 4

A.7.1.5 Fixed Reference Channel Definition H-Set 5

Table A.29: Fixed Reference Channel H-Set 5

| Parameter | Unit | Value |
|---------------------------------------|--|-------|
| Nominal Avg. Inf. Bit Rate | kbps | 801 |
| Inter-TTI Distance | TTI"s | 1 |
| Number of HARQ Processes | Processes | 3 |
| Information Bit Payload (N_{INF}) | Bits | 3202 |
| Number Code Blocks | Blocks | 1 |
| Binary Channel Bits Per TTI | Bits | 4800 |
| Total Available SML"s in UE | SML"s | 28800 |
| Number of SML"s per HARQ Proc. | SML"s | 9600 |
| Coding Rate | | 0.67 |
| Number of Physical Channel Codes | Codes | 5 |
| Modulation | | QPSK |
| Note: | This FRC is used to verify the minimum inter-TTI distance for UE category 12. The HS-PDSCH shall be transmitted continuously with constant power. The six sub-frame HS-SCCH signalling pattern shall repeat as follows: ...OOXXXOOOXXXO..., where "X" marks TTI in which HS-SCCH uses the identity of the UE under test and "O" marks TTI, in which HS-SCCH uses a different identity. | |

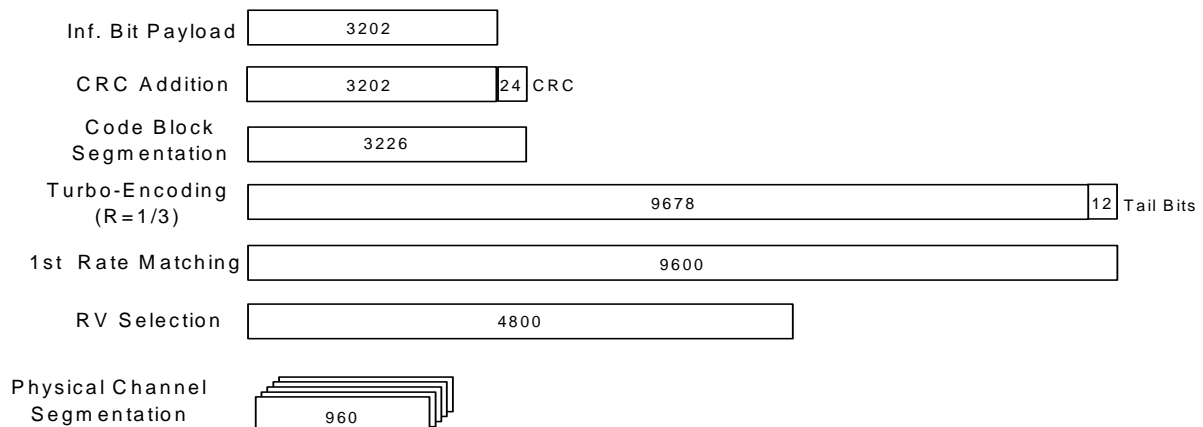

Figure A.19: Coding rate for Fixed Reference Channel H-Set 5

A.7.1.6 Fixed Reference Channel Definition H-Set 6

Table A.30: Fixed Reference Channel H-Set 6

| Parameter | Unit | Value | |
|---------------------------------------|-----------|--------|--------|
| Nominal Avg. Inf. Bit Rate | kbps | 3219 | 4689 |
| Inter-TTI Distance | TTI"s | 1 | 1 |
| Number of HARQ Processes | Processes | 6 | 6 |
| Information Bit Payload (N_{INF}) | Bits | 6438 | 9377 |
| Number Code Blocks | Blocks | 2 | 2 |
| Binary Channel Bits Per TTI | Bits | 9600 | 15360 |
| Total Available SML"s in UE | SML"s | 115200 | 115200 |
| Number of SML"s per HARQ Proc. | SML"s | 19200 | 19200 |
| Coding Rate | | 0.67 | 0.61 |
| Number of Physical Channel Codes | Codes | 10 | 8 |
| Modulation | | QPSK | 16QAM |

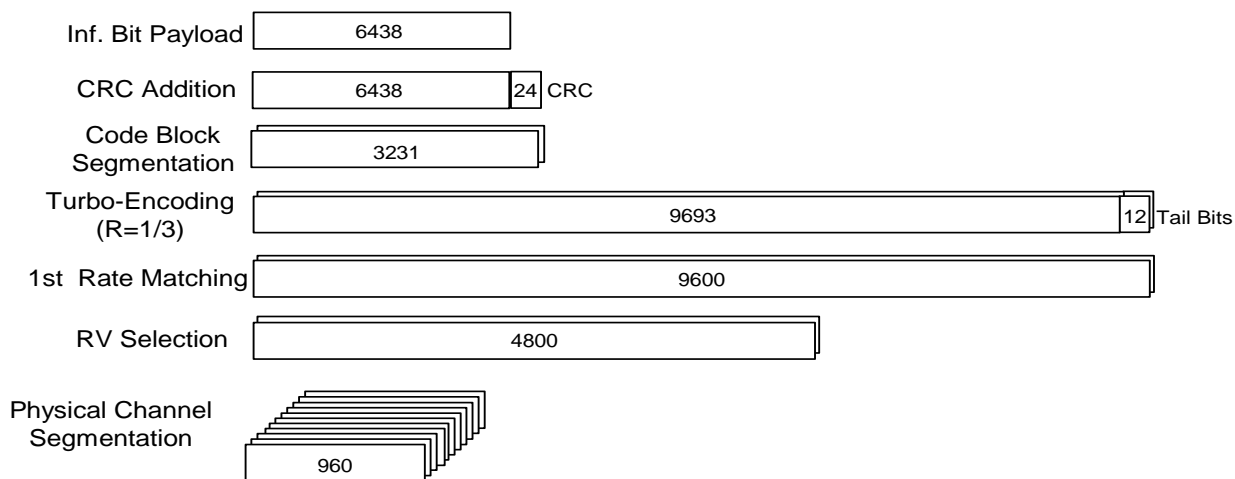

Figure A.20: Coding rate for Fixed reference Channel H-Set 6 (QPSK)

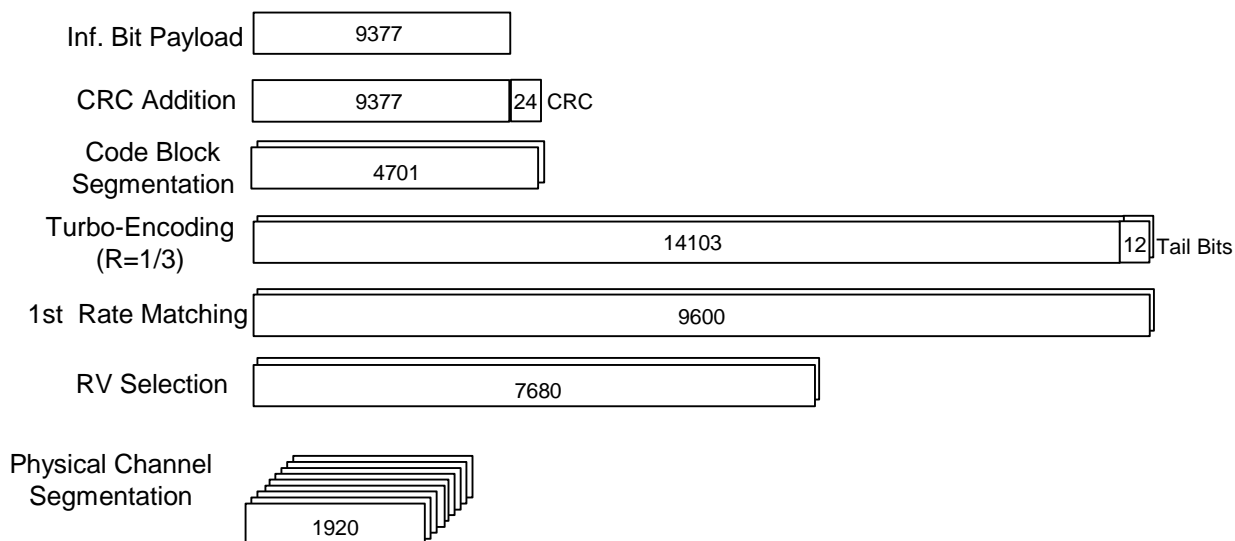

Figure A.21: Coding rate for Fixed reference Channel H-Set 6 (16 QAM)

A.8 DL reference parameters for MBMS tests

A.8.1 MCCH

The parameters for the MCCH demodulation tests are specified in Table A.30 and Table A.31.

Table A.30: Physical channel parameters for S-CCPCH

| Parameter | Unit | Level |
|---|------|-------|
| Channel bit rate | kbps | 30 |
| Channel symbol rate | ksps | 15 |
| Slot Format #i | - | 2 |
| TFCI | - | ON |
| Power offsets of TFCI and Pilot fields relative to data field | dB | 0 |

Table A.31: Transport channel parameters for S-CCPCH

| Parameter | MCCH |
|---------------------------------|--------------------|
| User Data Rate | 7.6 kbps |
| Transport Channel Number | 1 |
| Transport Block Size | 72 |
| Transport Block Set Size | 72 |
| RLC SDU block size | 4088 |
| Transmission Time Interval | 10 ms |
| Repetition period | 640 ms |
| Modification period | 1280 ms |
| Type of Error Protection | Convolution Coding |
| Coding Rate | 1/3 |
| Rate Matching attribute | 256 |
| Size of CRC | 16 |
| Position of TrCH in radio frame | Flexible |

A.8.1 MTCH

The parameters for the MTCH demodulation tests are specified in Table A.32 and Table A.33.

Table A.32: Physical channel parameters for S-CCPCH

| Parameter | Unit | Level | Level |
|---|-------------|------------|------------|
| User Data Rate | kbps | 256 | 128 |
| Channel bit rate | kbps | 960 | 480 |
| Channel symbol rate | ksps | 480 | 240 |
| Slot Format #i | - | 14 | 12 |
| TFCI | - | ON | ON |
| Power offsets of TFCI and Pilot fields relative to data field | dB | 0 | 0 |

Table A.33: Transport channel parameters for S-CCPCH

| Parameter | MTCH | | |
|---------------------------------|----------|-----------------------|------------------------|
| | 256 kbps | 128 kbps 40 ms TTI | 128 kbps, 80 ms TTI |
| Transport Channel Number | 1 | 1 | 1 |
| Transport Block Size | 2560 | 2560 | 2560 |
| Transport Block Set Size | 10240 | 5120 | 10240 |
| Nr of transport blocks/TTI | 4 | 2 | 4 |
| RLC SDU block size | 10160 | 5072 | 10160 |
| Transmission Time Interval | 40 ms | 40 ms | 80 ms |
| Type of Error Protection | Turbo | Turbo | Turbo |
| Rate Matching attribute | 256 | 256 | 256 |
| Size of CRC | 16 | 16 | 16 |
| Position of TrCH in radio frame | Flexible | Flexible | Flexible |

A.9 DL reference parameters for combined MTCH demodulation and cell identification

Parameters for combined MTCH demodulation and cell identification requirements are defined in Table A.34.

Table A.34: Cell reselection parameters

| Parameter | Unit | Value |
|--|-------------|--|
| Serving cell in the initial condition | | Cell1 |
| Neighbour cells | | 32 intra-frequency neighbour cells are indicated including Cell2 and Cell3 |
| Cell_selection_and_reselection_quality_measure | | CPICH E_c/N_0 |
| Qqualmin | dB | -20 |
| Qrxlevmin | dBm | -115 |
| UE_TXPWR_MAX_RACH | dB | 21 |
| Qhyst2 | dB | 20 dB |
| Treselection | seconds | 4 |
| Sintrasearch | dB | not sent |
| IE 'FACH Measurement occasion info' | | not sent |

Annex B (normative): Propagation conditions

B.1 General

Void

B.2 Propagation Conditions

B.2.1 Static propagation condition

The propagation for the static performance measurement is an Additive White Gaussian Noise (AWGN) environment. No fading and multi-paths exist for this propagation model.

B.2.2 Multi-path fading propagation conditions

Table B1 shows propagation conditions that are used for the performance measurements in multi-path fading environment. All taps have classical Doppler spectrum.

Table B.1: Propagation Conditions for Multi path Fading Environments (Cases 1 to 6)

| Case 1 | | Case 2 | | Case 3 | | Case 4 | | Case 5 (Note 1) | | Case 6 | |
|---|--------------------------|---|--------------------------|--|--------------------------|---|--------------------------|--|--------------------------|--|--------------------------|
| Speed for Band I, II, III, IV and IX: 3 km/h | | Speed for Band I, II, III, IV and IX: 3 km/h | | Speed for Band I, II, III, IV and IX: 120 km/h | | Speed for Band I, II, III, IV and IX: 3 km/h | | Speed for Band I, II, III, IV and IX: 50 km/h | | Speed for Band I, II, III, IV and IX: 250 km/h | |
| Speed for Band V, VI and VIII: 7 km/h | | Speed for Band V, VI and VIII: 7 km/h | | Speed for Band V, VI and VIII: 282 km/h (Note 2) | | Speed for Band V, VI and VIII: 7 km/h | | Speed for Band V, VI and VIII: 118 km/h | | Speed for Band V, VI and VIII: 583 km/h (Note 2) | |
| Speed for Band VII: 2.3 km/h | | Speed for Band VII: 2.3 km/h | | Speed for Band VII: 92 km/h | | Speed for Band VII: 2.3 km/h | | Speed for Band VII: 38 km/h | | Speed for Band VII: 192 km/h | |
| Relative Delay [ns] | Relative mean Power [dB] | Relative Delay [ns] | Relative mean Power [dB] | Relative Delay [ns] | Relative mean Power [dB] | Relative Delay [ns] | Relative mean Power [dB] | Relative Delay [ns] | Relative mean Power [dB] | Relative Delay [ns] | Relative mean Power [dB] |
| 0 | 0 | 0 | 0 | 0 | 0 | 0 | 0 | 0 | 0 | 0 | 0 |
| 976 | -10 | 976 | 0 | 260 | -3 | 976 | 0 | 976 | -10 | 260 | -3 |
| | | 20000 | 0 | 521 | -6 | | | | | 521 | -6 |
| | | | | 781 | -9 | | | | | 781 | -9 |

NOTE 1: Case 5 is only used in TS25.133.

NOTE 2: Speed above 250km/h is applicable to demodulation performance requirements only.

Table B.1A Void

Table B.1B shows propagation conditions that are used for HSDPA performance measurements in multi-path fading environment. For HSDPA enhanced performance requirements, the fading of the signals and the AWGN signals provided in each receiver antenna port shall be independent.

Table B.1B: Propagation Conditions for Multi-Path Fading Environments for HSDPA Performance Requirements

| ITU Pedestrian A Speed 3km/h (PA3) | | ITU Pedestrian B Speed 3km/h (PB3) | | ITU vehicular A Speed 30km/h (VA30) | | ITU vehicular A Speed 120km/h (VA120) | |
|--|--------------------------|--|--------------------------|---|--------------------------|--|--------------------------|
| Speed for Band I, II, III, IV and IX 3 km/h | | Speed for Band I, II, III, IV and IX 3 km/h | | Speed for Band I, II, III, IV and IX 30 km/h | | Speed for Band I, II, III, IV and IX 120 km/h | |
| Speed for Band V, VI, VIII 7 km/h | | Speed for Band V, VI, VIII 7 km/h | | Speed for Band V, VI, VIII 71 km/h | | Speed for Band V, VI, VIII 282 km/h (Note 1) | |
| Speed for Band VII 2.3 km/h | | Speed for Band VII 2.3 km/h | | Speed for Band VII 23 km/h | | Speed for Band VII 92 km/h | |
| Relative Delay [ns] | Relative Mean Power [dB] | Relative Delay [ns] | Relative Mean Power [dB] | Relative Delay [ns] | Relative Mean Power [dB] | Relative Delay [ns] | Relative Mean Power [dB] |
| 0 | 0 | 0 | 0 | 0 | 0 | 0 | 0 |
| 110 | -9.7 | 200 | -0.9 | 310 | -1.0 | 310 | -1.0 |
| 190 | -19.2 | 800 | -4.9 | 710 | -9.0 | 710 | -9.0 |
| 410 | -22.8 | 1200 | -8.0 | 1090 | -10.0 | 1090 | -10.0 |
| | | 2300 | -7.8 | 1730 | -15.0 | 1730 | -15.0 |
| | | 3700 | -23.9 | 2510 | -20.0 | 2510 | -20.0 |

NOTE 1: Speed above 120km/h is applicable to demodulation performance requirements only.

Table B.1C shows propagation conditions that are used for CQI test in multi-path fading. For HSDPA enhanced performance requirements, the fading of the signals and the AWGN signals provided in each receiver antenna port shall be independent.

Table B.1C: Propagation Conditions for CQI test in multi-path fading

| Case 8, Speed for Band I, II, III, IV and IX: 30km/h Speed for Band V, VI and VIII 71km/h Speed for Band VII: 23km/h | |
|---|--------------------------|
| Relative Delay [ns] | Relative mean Power [dB] |
| 0 | 0 |
| 976 | -10 |

Table B.1D shows propagation conditions that are used for MBMS demodulation performance measurements in multi-path fading environment.

Table B.1D: Propagation Conditions for Multi-Path Fading Environments for MBMS Performance Requirements

| | |
|---|---------------------------------|
| ITU vehicular A Speed 3km/h (VA 3) | |
| Speed for Band I, II, III and IV and IX 3 km/h | |
| Speed for Band V, VI and VIII 7 km/h | |
| Speed for Band VII: 2.3 km/h | |
| Relative Delay [ns] | Relative Mean Power [dB] |
| 0 | 0 |
| 310 | -1.0 |
| 710 | -9.0 |
| 1090 | -10.0 |
| 1730 | -15.0 |
| 2510 | -20.0 |

B.2.3 Moving propagation conditions

The dynamic propagation conditions for the test of the baseband performance are non fading channel models with two taps. The moving propagation condition has two tap, one static, Path0, and one moving, Path1. The time difference between the two paths is according Equation (B.1). The taps have equal strengths and equal phases.

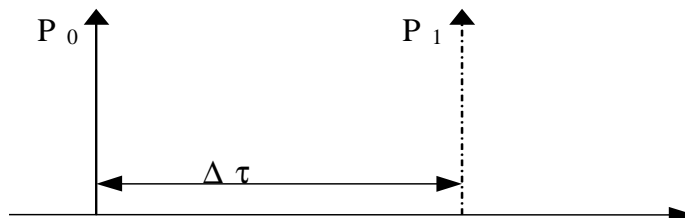

Figure B.1: The moving propagation conditions

$$\Delta\tau = B + \frac{A}{2}(1 + \sin(\Delta\omega \cdot t)) \tag{B.1}$$

The parameters in the equation are shown in the following table.

Table B.2

| Parameter | Value |
|-----------|-------------------------------------|
| A | 5 μs |
| B | 1 μs |
| Δω | 40*10 ⁻³ s ⁻¹ |

B.2.4 Birth-Death propagation conditions

The dynamic propagation conditions for the test of the base band performance is a non fading propagation channel with two taps. The moving propagation condition has two taps, Path1 and Path2 which alternate between 'birth' and 'death'. The positions the paths appear are randomly selected with an equal probability rate and is shown in Figure B.2.

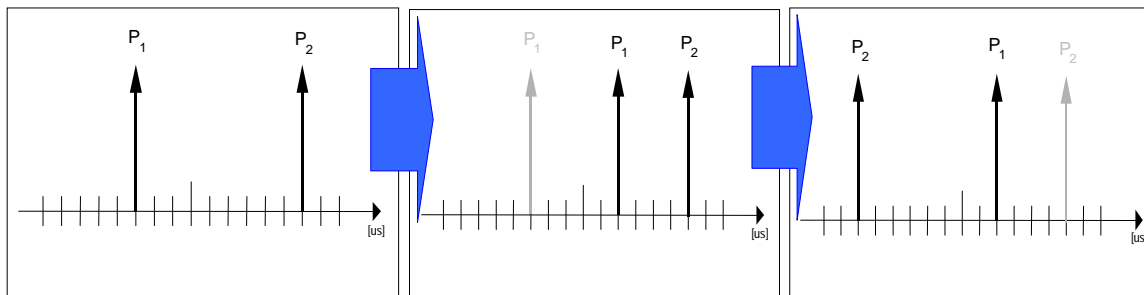

Figure B.2: Birth death propagation sequence

1. Two paths, Path1 and Path2 are randomly selected from the group $[-5, -4, -3, -2, -1, 0, 1, 2, 3, 4, 5]$ μs . The paths have equal magnitudes and equal phases.
2. After 191 ms, Path1 vanishes and reappears immediately at a new location randomly selected from the group $[-5, -4, -3, -2, -1, 0, 1, 2, 3, 4, 5]$ μs but excludes the point Path 2. The magnitudes and the phases of the tap coefficients of Path 1 and Path 2 shall remain unaltered.
3. After an additional 191 ms, Path2 vanishes and reappears immediately at a new location randomly selected from the group $[-5, -4, -3, -2, -1, 0, 1, 2, 3, 4, 5]$ μs but excludes the point Path 1. The magnitudes and the phases of the tap coefficients of Path 1 and Path 2 shall remain unaltered.

The sequence in 2) and 3) is repeated.

Annex C (normative): Downlink Physical Channels

C.1 General

This annex specifies the downlink physical channels that are needed for setting a connection and channels that are needed during a connection.

C.2 Connection Set-up

Table C.1 describes the downlink Physical Channels that are required for connection set up.

**Table C.1: Downlink Physical Channels required
for connection set-up**

| Physical Channel |
|------------------|
| P-CPICH |
| P-CCPCH |
| SCH |
| S-CCPCH |
| PICH |
| AICH |
| DPCH |

C.3 During connection

The following clauses, describes the downlink Physical Channels that are transmitted during a connection i.e., when measurements are done. For these measurements the offset between DPCH and SCH shall be zero chips at Node B meaning that SCH is overlapping with the first symbols in DPCH in the beginning of DPCH slot structure.

C.3.1 Measurement of Rx Characteristics

Table C.2 is applicable for measurements on the Receiver Characteristics (clause 7) with the exception of subclause 7.4 (Maximum input level).

Table C.2: Downlink Physical Channels transmitted during a connection

| Physical Channel | Power ratio |
|------------------|--|
| P-CPICH | $P\text{-CPICH_Ec} / DPCH_Ec = 7 \text{ dB}$ |
| P-CCPCH | $P\text{-CCPCH_Ec} / DPCH_Ec = 5 \text{ dB}$ |
| SCH | $SCH_Ec / DPCH_Ec = 5 \text{ dB}$ |
| PICH | $PICH_Ec / DPCH_Ec = 2 \text{ dB}$ |
| DPCH | Test dependent power |

C.3.2 Measurement of Performance requirements

Table C.3 is applicable for measurements on the Performance requirements (clause 8), including subclause 7.4 (Maximum input level) and subclause 6.4.4 (Out-of-synchronization handling of output power).

Table C.3: Downlink Physical Channels transmitted during a connection¹

| Physical Channel | Power ratio | NOTE |
|------------------|--|--|
| P-CPICH | $P\text{-CPICH}_{Ec/Ior} = -10 \text{ dB}$ | Use of P-CPICH or S-CPICH as phase reference is specified for each requirement and is also set by higher layer signalling. |
| S-CPICH | $S\text{-CPICH}_{Ec/Ior} = -10 \text{ dB}$ | When S-CPICH is the phase reference in a test condition, the phase of S-CPICH shall be 180 degrees offset from the phase of P-CPICH. When S-CPICH is not the phase reference, it is not transmitted. |
| P-CCPCH | $P\text{-CCPCH}_{Ec/Ior} = -12 \text{ dB}$ | When BCH performance is tested the $P\text{-CCPCH}_{Ec/Ior}$ is test dependent |
| SCH | $SCH_{Ec/Ior} = -12 \text{ dB}$ | This power shall be divided equally between Primary and Secondary Synchronous channels |
| PICH | $PICH_{Ec/Ior} = -15 \text{ dB}$ | |
| DPCH | Test dependent power | When S-CPICH is the phase reference in a test condition, the phase of DPCH shall be 180 degrees offset from the phase of P-CPICH. When BCH performance is tested the DPCH is not transmitted. |
| OCNS | Necessary power so that total transmit power spectral density of Node B (lor) adds to one ¹ | OCNS interference consists of 16 dedicated data channels as specified in table C.6. |

NOTE 1 For dynamic power correction required to compensate for the presence of transient channels, e.g. control channels, a subset of the DPCH channels may be used.

C.3.3 Connection with open-loop transmit diversity mode

Table C.4 is applicable for measurements for subclause 8.6.1 (Demodulation of DCH in open loop transmit diversity mode).

Table C.4: Downlink Physical Channels transmitted during a connection¹

| Physical Channel | Power ratio | NOTE |
|---------------------|--|---|
| P-CPICH (antenna 1) | P-CPICH_Ec1/lor = -13 dB | 1. Total P-CPICH_Ec/lor = -10 dB |
| P-CPICH (antenna 2) | P-CPICH_Ec2/lor = -13 dB | |
| P-CCPCH (antenna 1) | P-CCPCH_Ec1/lor = -15 dB | 1. STTD applied 2. Total P-CCPCH_Ec/lor = -12 dB |
| P-CCPCH (antenna 2) | P-CCPCH_Ec2/lor = -15 dB | |
| SCH (antenna 1 / 2) | SCH_Ec/lor = -12 dB | 1. TSTD applied. 2. This power shall be divided equally between Primary and Secondary Synchronous channels 3. When BCH performance is tested the P-CCPCH_Ec/lor is test dependent |
| PICH (antenna 1) | PICH_Ec1/lor = -18 dB | 1. STTD applied 2. Total PICH_Ec/lor = -15 dB |
| PICH (antenna 2) | PICH_Ec2/lor = -18 dB | |
| DPCH | Test dependent power | 1. STTD applied 2. Total power from both antennas |
| OCNS | Necessary power so that total transmit power spectral density of Node B (lor) adds to one ¹ | 1.This power shall be divided equally between antennas 2.OCNS interference consists of 16 dedicated data channels as specified in Table C.6. |

NOTE 1 For dynamic power correction required to compensate for the presence of transient channels, e.g. control channels, a subset of the DPCH channels may be used.

C.3.4 Connection with closed loop transmit diversity mode

Table C.5 is applicable for measurements for subclause 8.6.2 (Demodulation of DCH in closed loop transmit diversity mode).

Table C.5: Downlink Physical Channels transmitted during a connection¹

| Physical Channel | Power ratio | NOTE |
|---------------------|---|---|
| P-CPICH (antenna 1) | P-CPICH_Ec1/lor = -13 dB | 1. Total P-CPICH_Ec/lor = -10 dB |
| P-CPICH (antenna 2) | P-CPICH_Ec2/lor = -13 dB | |
| P-CCPCH (antenna 1) | P-CCPCH_Ec1/lor = -15 dB | 1. STTD applied |
| P-CCPCH (antenna 2) | P-CCPCH_Ec2/lor = -15 dB | 1. STTD applied, 2. total P-CCPCH_Ec/lor = -12 dB |
| SCH (antenna 1 / 2) | SCH_Ec/lor = -12 dB | 1. TSTD applied |
| PICH (antenna 1) | PICH_Ec1/lor = -18 dB | 1. STTD applied 2. STTD applied, total PICH_Ec/lor = -15 dB |
| PICH (antenna 2) | PICH_Ec2/lor = -18 dB | |
| DPCH | Test dependent power | 1. Total power from both antennas |
| OCNS | Necessary power so that total transmit power spectral density of Node B (lor) adds to one (Notes 1 & 2) | 1.This power shall be divided equally between antennas 2. OCNS interference consists of 16 dedicated data channels. as specified in Table C.6. |

Note 1 For dynamic power correction required to compensate for the presence of transient channels, e.g. control channels, a subset of the DPCH channels may be used.

Note 2 For the case of DPCH with transmit diversity, the OCNS power calculation shall be based on the addition of the power from Antenna 1 and Antenna 2, i.e. disregarding any phase relationship between the antennas.

Table C.6: DPCH Channelization Code and relative level settings for OCNS signal

| Channelization Code at SF=128 | Relative Level setting (dB) (Note 1) | DPCH Data |
|-------------------------------|--------------------------------------|--|
| 2 | -1 | The DPCH data for each channelization code shall be uncorrelated with each other and with any wanted signal over the period of any measurement. For OCNS with transmit diversity the DPCH data sent to each antenna shall be either STTD encoded or generated from uncorrelated sources. |
| 11 | -3 | |
| 17 | -3 | |
| 23 | -5 | |
| 31 | -2 | |
| 38 | -4 | |
| 47 | -8 | |
| 55 | -7 | |
| 62 | -4 | |
| 69 | -6 | |
| 78 | -5 | |
| 85 | -9 | |
| 94 | -10 | |
| 125 | -8 | |
| 113 | -6 | |
| 119 | 0 | |

NOTE 1: The relative level setting specified in dB refers only to the relationship between the OCNS channels. The level of the OCNS channels relative to the Ior of the complete signal is a function of the power of the other channels in the signal with the intention that the power of the group of OCNS channels is used to make the total signal add up to 1.

NOTE: The DPCH Channelization Codes and relative level settings are chosen to simulate a signal with realistic Peak to Average Ratio.

C.3.5 Void

Table C.6A: Void

C.4 W-CDMA Modulated Interferer

Table C.7 describes the downlink Channels that are transmitted as part of the W-CDMA modulated interferer.

Table C.7: Spreading Code, Timing offsets and relative level settings for W-CDMA Modulated Interferer signal channels

| Channel Type | Spreading Factor | Channelization Code | Timing offset ($\times 256T_{\text{chip}}$) | Power | NOTE |
|--------------|------------------|---------------------|---|---|---|
| P-CCPCH | 256 | 1 | 0 | P-CCPCH_Ec/Ior = -10 dB | |
| SCH | 256 | - | 0 | SCH_Ec/Ior = -10 dB | The SCH power shall be divided equally between Primary and Secondary Synchronous channels |
| P-CPICH | 256 | 0 | 0 | P-CPICH_Ec/Ior = -10 dB | |
| PICH | 256 | 16 | 16 | PICH_Ec/Ior = -15 dB | |
| OCNS | See table C.6 | | | Necessary power so that total transmit power spectral density of Node B (Ior) adds to one | OCNS interference consists of the dedicated data channels, as specified in Table C.6. |

C.5 HSDPA DL Physical channels

C.5.1 Downlink Physical Channels connection set-up

Table C.8 is applicable for the measurements for tests in subclause 7.4.2, 9.2.1 and 9.3. Table C.9 is applicable for the measurements for tests in subclause 9.2.2. Table C.10 is applicable for the measurements for tests in subclause 9.2.3. Table C.11 is applicable for the measurements for tests in subclause 9.4.1. Table C.12 is applicable for the measurements in subclause 9.4.2

Table C.8: Downlink physical channels for HSDPA receiver testing for Single Link performance.

| Physical Channel | Parameter | Value | Note |
|------------------|-----------------|---|---|
| P-CPICH | P-CPICH_Ec/Ior | -10dB | |
| P-CCPCH | P-CCPCH_Ec/Ior | -12dB | Mean power level is shared with SCH. |
| SCH | SCH_Ec/Ior | -12dB | Mean power level is shared with P-CCPCH – SCH includes P- and S-SCH, with power split between both. P-SCH code is S_dl,0 as per TS25.213 S-SCH pattern is scrambling code group 0 |
| PICH | PICH_Ec/Ior | -15dB | |
| DPCH | DPCH_Ec/Ior | Test-specific | 12.2 kbps DL reference measurement channel as defined in Annex A.3.1 |
| HS-SCCH-1 | HS-SCCH_Ec/Ior | Test-specific | Specifies fraction of Node-B radiated power transmitted when TTI is active (i.e. due to minimum inter-TTI interval). |
| HS-SCCH-2 | HS-SCCH_Ec/Ior | DTX"d | No signalling scheduled, or power radiated, on this HS-SCCH, but signalled to the UE as present. |
| HS-SCCH-3 | HS-SCCH_Ec/Ior | DTX"d | As HS-SCCH-2. |
| HS-SCCH-4 | HS-SCCH_Ec/Ior | DTX"d | As HS-SCCH-2. |
| HS-PDSCH | HS-PDSCH_Ec/Ior | Test-specific | . |
| OCNS | | Necessary power so that total transmit power spectral density of Node B (Ior) adds to one | OCNS interference consists of 6 dedicated data channels as specified in table C.13. |

Table C.9: Downlink physical channels for HSDPA receiver testing for Open Loop Transmit Diversity performance.

| Physical Channel | Parameter | Value | Note |
|---------------------|-----------------|--|---|
| P-CPICH (antenna 1) | P-CPICH_Ec1/lor | -13dB | 1. Total P-CPICH_Ec/lor = -10dB |
| P-CPICH (antenna 2) | P-CPICH_Ec2/lor | -13dB | |
| P-CCPCH (antenna 1) | P-CCPCH_Ec1/lor | -15dB | 1. STTD applied. 2. Total P-CCPCH Ec/lor is -12dB. |
| P-CCPCH (antenna 2) | P-CCPCH_Ec2/lor | -15dB | |
| SCH (antenna 1/2) | SCH_Ec/lor | -12dB | 1. TSTD applied. 2. Power divided equally between primary and secondary SCH. |
| PICH (antenna 1) | PICH_Ec1/lor | -18dB | 1. STTD applied. 2. Total PICH Ec/lor is -15dB. |
| PICH (antenna 2) | PICH_Ec2/lor | -18dB | |
| DPCH | DPCH_Ec/lor | Test-specific | 1. STTD applied. |
| HS-SCCH-1 | HS-SCCH_Ec/lor | Test-specific | 1. STTD applied. 2. Specifies fraction of Node-B radiated power transmitted when TTI is active (i.e. due to minimum inter-TTI interval). |
| HS-SCCH-2 | HS-SCCH_Ec/lor | DTX"d | 1. UE assumes STTD applied. 2. No signalling scheduled, or power radiated, on this HS-SCCH, but signalled to the UE as present. |
| HS-SCCH-3 | HS-SCCH_Ec/lor | DTX"d | 1. As HS-SCCH-2. |
| HS-SCCH-4 | HS-SCCH_Ec/lor | DTX"d | 2. As HS-SCCH-2. |
| HS-PDSCH | HS-PDSCH_Ec/lor | Test-specific | 1. STTD applied. |
| OCNS | | Necessary power so that total transmit power spectral density of Node B (lor) adds to one (Note 1) | 1. Balance of power I_{or} of the Node-B is assigned to OCNS. 2. Power divided equally between antennas. 3. OCNS interference consists of 6 dedicated data channels as specified in table C.13. |

Note 1 For the case of DPCH with transmit diversity, the OCNS power calculation shall be based on the addition of the power from Antenna 1 and Antenna 2, i.e. disregarding any phase relationship between the antennas.

Table C.10: Downlink physical channels for HSDPA receiver testing for Closed Loop. Transmit Diversity (Mode-1) performance.

| Physical Channel | Parameter | Value | Note |
|---------------------|-----------------|--|---|
| P-CPICH (antenna 1) | P-CPICH_Ec1/lor | -13dB | 1. Total P-CPICH_Ec/lor = -10dB |
| P-CPICH (antenna 2) | P-CPICH_Ec2/lor | -13dB | |
| P-CCPCH (antenna 1) | P-CCPCH_Ec1/lor | -15dB | 1. STTD applied. 2. Total P-CCPCH Ec/lor is -12dB. |
| P-CCPCH (antenna 2) | P-CCPCH_Ec2/lor | -15dB | |
| SCH (antenna 1/2) | SCH_Ec/lor | -12dB | 1. TSTD applied. 2. Power divided equally between primary and secondary SCH. |
| PICH (antenna 1) | PICH_Ec1/lor | -18dB | 1. STTD applied. 2. Total PICH Ec/lor is -15dB. |
| PICH (antenna 2) | PICH_Ec2/lor | -18dB | |
| DPCH | DPCH_Ec/lor | Test-specific | 1. CL1 applied. |
| HS-SCCH-1 | HS-SCCH_Ec/lor | Test-specific | 1. STTD applied. 2. Specifies fraction of Node-B radiated power transmitted when TTI is active (i.e. due to minimum inter-TTI interval). |
| HS-SCCH-2 | HS-SCCH_Ec/lor | DTX"d | 1. UE assumes STDD] applied. 2. No signalling scheduled, or power radiated, on this HS-SCCH, but signalled to the UE as present. |
| HS-SCCH-3 | HS-SCCH_Ec/lor | DTX"d | 1. As HS-SCCH-2. |
| HS-SCCH-4 | HS-SCCH_Ec/lor | DTX"d | 2. As HS-SCCH-2. |
| HS-PDSCH | HS-PDSCH_Ec/lor | Test-specific | 1. CL1 applied. |
| OCNS | | Necessary power so that total transmit power spectral density of Node B (lor) adds to one (Note 1) | 1. Balance of power I_{or} of the Node-B is assigned to OCNS. 2. Power divided equally between antennas. 3. OCNS interference consists of 6 dedicated data channels as specified in table C.13. |

Note 1 For the case of DPCH with transmit diversity, the OCNS power calculation shall be based on the addition of the power from Antenna 1 and Antenna 2, i.e. disregarding any phase relationship between the antennas.

Table C.11: Downlink physical channels for HSDPA receiver testing for HS-SCCH detection performance

| Parameter | Units | Value | Comment |
|-------------------------|-------|--|---|
| CPICH E_c/I_{or} | dB | -10 | |
| P-CCPCH E_c/I_{or} | dB | -12 | Mean power level is shared with SCH. |
| SCH E_c/I_{or} | dB | -12 | Mean power level is shared with P-CCPCH – SCH includes P- and S-SCH, with power split between both. P-SCH code is S_dl,0 as per TS25.213 S-SCH pattern is scrambling code group 0 |
| PICH E_c/I_{or} | dB | -15 | |
| HS-PDSCH-1 E_c/I_{or} | dB | -10 | HS-PDSCH associated with HS-SCCH-1. The HS-PDSCH shall be transmitted continuously with constant power. |
| HS-PDSCH-2 E_c/I_{or} | dB | DTX | HS-PDSCH associated with HS-SCCH-2 |
| HS-PDSCH-3 E_c/I_{or} | dB | DTX | HS-PDSCH associated with HS-SCCH-3 |
| HS-PDSCH-4 E_c/I_{or} | dB | DTX | HS-PDSCH associated with HS-SCCH-4 |
| DPCH E_c/I_{or} | dB | -8 | 12.2 kbps DL reference measurement channel as defined in Annex A.3.1 |
| HS-SCCH-1 E_c/I_{or} | dB | Test Specific | All HS-SCCH"s allocated equal E_c/I_{or} . Specifies E_c/I_{or} when TTI is active. |
| HS-SCCH-2 E_c/I_{or} | dB | | |
| HS-SCCH-3 E_c/I_{or} | dB | | |
| HS-SCCH-4 E_c/I_{or} | dB | | |
| OCNS E_c/I_{or} | dB | Necessary power so that total transmit power spectral density of Node B (lor) adds to one (Note 1) | 1. Balance of power I_{or} of the Node-B is assigned to OCNS. 2. OCNS interference consists of 6 dedicated data channels as specified in table C.13. |

Note 1 For the case of DPCH with transmit diversity, the OCNS power calculation shall be based on the addition of the power from Antenna 1 and Antenna 2, i.e. disregarding any phase relationship between the antennas.

Table C.12: Downlink physical channels for HSDPA receiver testing for HS-SCCH detection performance in Open Loop Diversity

| Parameter | Units | Value | Comment |
|----------------------------------|-------|---|---|
| P-CPICH E_c/I_{or} (antenna 1) | dB | -13 | 1. Total P-CPICH $E_c/I_{or} = -10$ dB |
| P-CPICH E_c/I_{or} (antenna 2) | dB | -13 | |
| P-CCPCH E_c/I_{or} (antenna 1) | dB | -15 | 1. STTD applied 2. Total P-CCPCH $E_c/I_{or} = -12$ dB |
| P-CCPCH E_c/I_{or} (antenna 2) | dB | -15 | |
| SCH E_c/I_{or} (antenna 1/2) | dB | -12 | 1. TSTD applied 2. Mean power level is shared with P-CCPCH – SCH includes P- and S-SCH, with power split between both. 3. P-SCH code is S_dl,0 as per TS25.213 4. S-SCH pattern is scrambling code group 0 |
| PICH E_c/I_{or} (antenna 1) | dB | -15 | 1. STTD applied 2. Total PICH $E_c/I_{or} = -12$ dB |
| PICH E_c/I_{or} (antenna 2) | dB | -15 | |
| HS-PDSCH-1 E_c/I_{or} | dB | -10 | 1. STTD applied 2. HS-PDSCH assoc. with HS-SCCH-1 |
| HS-PDSCH-2 E_c/I_{or} | dB | DTX | 1. STTD applied 2. HS-PDSCH assoc. with HS-SCCH-2 |
| HS-PDSCH-3 E_c/I_{or} | dB | DTX | 1. STTD applied 2. HS-PDSCH assoc. with HS-SCCH-3 |
| HS-PDSCH-4 E_c/I_{or} | dB | DTX | 1. STTD applied 2. HS-PDSCH assoc. with HS-SCCH-4 |
| DPCH E_c/I_{or} | dB | -8 | 1. STTD applied 2. 12.2 kbps DL reference measurement channel as defined in Annex A.3.1 |
| HS-SCCH-1 E_c/I_{or} | dB | Test Specific | 1. STTD applied 2. All HS-SCCH"s allocated equal E_c/I_{or} . 3. Specifies E_c/I_{or} when TTI is active. |
| HS-SCCH-2 E_c/I_{or} | dB | | |
| HS-SCCH-3 E_c/I_{or} | dB | | |
| HS-SCCH-4 E_c/I_{or} | dB | | |
| OCNS E_c/I_{or} | dB | Remaining power at Node-B (including HS-SCCH power allocation when HS-SCCH"s inactive). | 1. STTD applied 2. OCNS interference consists of 6 dedicated data channels as specified in table C.13. 3. Power divided equally between antennas |

C.5.2 OCNS Definition

The selected channelization codes and relative power levels for OCNS transmission during for HSDPA performance assessment are defined in Table C.13. The selected codes are designed to have a single length-16 parent code.

Table C.13: OCNS definition for HSDPA receiver testing.

| Channelization Code at SF=128 | Relative Level setting (dB) (Note 1) | DPCH Data |
|-------------------------------|---|--|
| 122 | 0 | The DPCH data for each channelization code shall be uncorrelated with each other and with any wanted signal over the period of any measurement. For OCNS with transmit diversity the DPCH data sent to each antenna shall be either STTD encoded or generated from uncorrelated sources. |
| 123 | -2 | |
| 124 | -2 | |
| 125 | -4 | |
| 126 | -1 | |
| 127 | -3 | |

Note 1 The relative level setting specified in dB refers only to the relationship between the OCNS channels. The level of the OCNS channels relative to the I_{or} of the complete signal is a function of the power of the other channels in the signal with the intention that the power of the group of OCNS channels is used to make the total signal add up to 1.

C.6 MBMS DL Physical channels

C.6.1 Downlink Physical Channels connection set-up

Table C.14 is applicable for measurements on the Performance requirements in Clause 11.

Table C.14: Downlink Physical Channels on each radiolink

| Physical Channel | Power ratio | NOTE |
|------------------|---|--|
| P-CPICH | $P\text{-CPICH_Ec/lor} = -10 \text{ dB}$ | Only P-CPICH is used as phase reference for S-CCPCH carrying MCCH or MTCH. |
| P-CCPCH | $P\text{-CCPCH_Ec/lor} = -12 \text{ dB}$ | |
| SCH | $SCH_Ec/lor = -12 \text{ dB}$ | This power shall be divided equally between Primary and Secondary Synchronous channels |
| PICH | $PICH_Ec/lor = -15 \text{ dB}$ | |
| S-CCPCH | $S\text{-CCPCH_Ec/lor} = \text{test dependent}$ | |
| DPCH | TBD | DPCH is enable only when UE has capability to receive MBMS in CELL_DCH state |
| OCNS | Necessary power so that total transmit power spectral density of Node B (lor) adds to one | OCNS interference consists of 16 dedicated data channels as specified in table C.6. |

Annex D (normative): Environmental conditions

D.1 General

This normative annex specifies the environmental requirements of the UE. Within these limits the requirements of the present documents shall be fulfilled.

D.2 Environmental requirements

The requirements in this clause apply to all types of UE(s).

D.2.1 Temperature

The UE shall fulfil all the requirements in the full temperature range of:

Table D.1

| | |
|------------------|---|
| +15 °C to +35 °C | for normal conditions (with relative humidity of 25 % to 75 %) |
| -10 °C to +55 °C | for extreme conditions (see IEC publications 68-2-1 and 68-2-2) |

Outside this temperature range the UE, if powered on, shall not make ineffective use of the radio frequency spectrum. In no case shall the UE exceed the transmitted levels as defined in TS 25.101 for extreme operation.

D.2.2 Voltage

The UE shall fulfil all the requirements in the full voltage range, i.e. the voltage range between the extreme voltages.

The manufacturer shall declare the lower and higher extreme voltages and the approximate shutdown voltage. For the equipment that can be operated from one or more of the power sources listed below, the lower extreme voltage shall not be higher, and the higher extreme voltage shall not be lower than that specified below.

Table D.2

| Power source | Lower extreme voltage | Higher extreme voltage | Normal conditions voltage |
|---|----------------------------------|------------------------|---------------------------|
| AC mains | 0,9 * nominal | 1,1 * nominal | nominal |
| Regulated lead acid battery | 0,9 * nominal | 1,3 * nominal | 1,1 * nominal |
| Non regulated batteries: Leclanché / lithium Mercury/nickel & cadmium | 0,85 * nominal 0,90 * nominal | Nominal Nominal | Nominal Nominal |

Outside this voltage range the UE if powered on, shall not make ineffective use of the radio frequency spectrum. In no case shall the UE exceed the transmitted levels as defined in TS 25.101 for extreme operation. In particular, the UE shall inhibit all RF transmissions when the power supply voltage is below the manufacturer declared shutdown voltage.

D.2.3 Vibration

The UE shall fulfil all the requirements when vibrated at the following frequency/amplitudes.

Table D.3

| Frequency | ASD (Acceleration Spectral Density) random vibration |
|------------------|---|
| 5 Hz to 20 Hz | 0,96 m ² /s ³ |
| 20 Hz to 500 Hz | 0,96 m ² /s ³ at 20 Hz, thereafter -3 dB/Octave |

Outside the specified frequency range the UE, if powered on, shall not make ineffective use of the radio frequency spectrum. In no case shall the UE exceed the transmitted levels as defined in TS 25.101 for extreme operation

Annex E (informative): UARFCN numbers

E.1 General

This Annex lists the UARFCN numbers used for the frequency bands implemented in the current specification.

E.2 List of UARFCN used for UTRA FDD bands

The UARFCN numbering scheme detailed in clauses 5.4.3 and 5.4.4 of this specification is summarized for information in Table E.1. The table shows the UARFCN assigned to all UTRA FDD operating bands, starting with the lowest UARFCN and continuing up to the highest one assigned.

Each band may have two table entries, one for the 'general' numbers and one for the 'additional' ones, as specified in Table 5.2. The entries in Table E.1 are explained as follows:

Band range: The size of the frequency range for the UTRA FDD band specified in Table 5.0.

Range res.: The size of the frequency range corresponding to the UARFCN range that has been 'reserved' in 3GPP for possible future extensions of the band.

Formula offset: The offset parameter (F_{UL_Offset} or F_{DL_Offset}) in the formula, used to calculate the UARFCN as specified in Clause 5.4.3.

Assigned/reserved: Indicates the significance of the UARFCN and corresponding frequencies listed as follows:

- Start res.** Start of the UARFCN range reserved for the band.
- Min.** The lowest UARFCN assigned to the band.
- Max.** The highest UARFCN assigned to the band.
- End res.** End of the UARFCN range reserved for the band.

N_U, N_D : Uplink and downlink UARFCN.

F_{UL}, F_{DL} : Corresponding uplink and downlink frequencies.

(Add.): Refers to the additional UARFCN (on the 100 kHz raster) as specified in Table 5.1A.

Note that bands V and VI are shown with common entries in Table E.1, since their UARFCN ranges are completely overlapping.

Table E.1: UARFCN used for the UTRA FDD bands

| UTRA FDD Band | Band range [MHz] | Range res. [MHz] | Uplink UARFCN | | | | Downlink UARFCN | | | | |
|-----------------|-----------------------|------------------|---------------------------------------|-------------------|-------|----------------|---------------------------------------|-------------------|------------|----------------|--------|
| | | | Formula offset F_{UL_Offset} [MHz] | Assigned/Reserved | N_U | F_{UL} [MHz] | Formula offset F_{DL_Offset} [MHz] | Assigned/Reserved | N_D | F_{DL} [MHz] | |
| II (Add.) | 2x60 | 2x60 | 1850.1 | Start res. | | 0 | 1850.1 | 1850.1 | Start res. | 400 | 1930.1 |
| | | | | Min. | 12 | 1852.5 | Min. | | 412 | 1932.5 | |
| | | | | Max. | 287 | 1907.5 | Max. | | 687 | 1987.5 | |
| | | | | End res. | 299 | 1909.9 | End res. | | 699 | 1989.9 | |
| V and VI (Add.) | 2x25 (V) 2x10 (VI) | 2x45 | 670.1 | Start res. | 700 | 810.1 | 670.1 | Start res. | 925 | 855.1 | |
| | | | | Min. (V) | 782 | 826.5 | | Min. (V) | 1007 | 871.5 | |
| | | | | Min. (VI) | 812 | 832.5 | | Min. (VI) | 1037 | 877.5 | |
| | | | | Max. (VI) | 837 | 837.5 | | Max. (VI) | 1062 | 882.5 | |
| | | | | Max. (V) | 862 | 842.5 | | Max. (V) | 1087 | 887.5 | |
| | | | | End res. | 924 | 854.9 | | End res. | 1149 | 899.9 | |
| III | 2x75 | 2x75 | 1525 | Start res. | 925 | 1710.0 | 1575 | Start res. | 1150 | 1805.0 | |
| | | | | Min. | 937 | 1712.4 | | Min. | 1162 | 1807.4 | |
| | | | | Max. | 1288 | 1782.6 | | Max. | 1513 | 1877.6 | |
| | | | | End res. | 1299 | 1784.8 | | End res. | 1524 | 1879.8 | |
| IV | 2x45 | 2x70 | 1450 | Start res. | 1300 | 1710.0 | 1805 | Start res. | 1525 | 2110.0 | |
| | | | | Min. | 1312 | 1712.4 | | Min. | 1537 | 2112.4 | |
| | | | | Max. | 1513 | 1752.6 | | Max. | 1738 | 2152.6 | |
| | | | | End res. | 1649 | 1779.8 | | End res. | 1874 | 2179.8 | |
| IV (Add.) | 2x45 | 2x70 | 1380.1 | Start res. | 1650 | 1710.1 | 1735.1 | Start res. | 1875 | 2110.1 | |
| | | | | Min. | 1662 | 1712.5 | | Min. | 1887 | 2112.5 | |
| | | | | Max. | 1862 | 1752.5 | | Max. | 2087 | 2152.5 | |
| | | | | End res. | 1999 | 1779.9 | | End res. | 2224 | 2179.9 | |
| VII | 2x70 | 2x70 | 2100 | Start res. | 2000 | 2500.0 | 2175 | Start res. | 2225 | 2620.0 | |
| | | | | Min. | 2012 | 2502.4 | | Min. | 2237 | 2622.4 | |
| | | | | Max. | 2338 | 2567.6 | | Max. | 2563 | 2687.6 | |
| | | | | End res. | 2349 | 2569.8 | | End res. | 2574 | 2689.8 | |
| VII (Add.) | 2x70 | 2x70 | 2030.1 | Start res. | 2350 | 2500.1 | 2105.1 | Start res. | 2575 | 2620.1 | |
| | | | | Min. | 2362 | 2502.5 | | Min. | 2587 | 2622.5 | |
| | | | | Max. | 2687 | 2567.5 | | Max. | 2912 | 2687.5 | |
| | | | | End res. | 2699 | 2569.9 | | End res. | 2924 | 2689.9 | |
| VIII | 2x35 | 2x35 | 340 | Start res. | 2700 | 880.0 | 340 | Start res. | 2925 | 925.0 | |
| | | | | Min. | 2712 | 882.4 | | Min. | 2937 | 927.4 | |
| | | | | Max. | 2863 | 912.6 | | Max. | 3088 | 957.6 | |
| | | | | End res. | 2874 | 914.8 | | End res. | 3099 | 959.8 | |
| V and VI | 2x25 (V) 2x10 (VI) | 2x45 | 0 | Start res. | 4050 | 810.0 | 0 | Start res. | 4275 | 855.0 | |
| | | | | Min. (V) | 4132 | 826.4 | | Min. (V) | 4357 | 871.4 | |
| | | | | Min. (VI) | 4162 | 832.4 | | Min. (VI) | 4387 | 877.4 | |
| | | | | Max. (VI) | 4188 | 837.6 | | Max. (VI) | 4413 | 882.6 | |
| | | | | Max. (V) | 4233 | 846.6 | | Max. (V) | 4458 | 891.6 | |
| | | | | End res. | 4274 | 854.8 | | End res. | 4499 | 899.8 | |
| IX | 2x45 | 2x75 | 0 | Start res. | 8550 | 1710.0 | 0 | Start res. | 9025 | 1805.0 | |
| | | | | Min. | 8762 | 1752.4 | | Min. | 9237 | 1847.4 | |
| | | | | Max. | 8912 | 1782.4 | | Max. | 9387 | 1877.4 | |
| | | | | End res. | 8924 | 1784.8 | | End res. | 9399 | 1879.8 | |
| II | 2x60 | 2x60 | 0 | Start res. | 9250 | 1850.0 | 0 | Start res. | 9650 | 1930.0 | |
| | | | | Min. | 9262 | 1852.4 | | Min. | 9662 | 1932.4 | |
| | | | | Max. | 9538 | 1907.6 | | Max. | 9938 | 1987.6 | |
| | | | | End res. | 9549 | 1909.8 | | End res. | 9949 | 1989.8 | |
| I | 2x60 | 2x60 | 0 | Start res. | 9600 | 1920.0 | 0 | Start res. | 10550 | 2110.0 | |
| | | | | Min. | 9612 | 1922.4 | | Min. | 10562 | 2112.4 | |
| | | | | Max. | 9888 | 1977.6 | | Max. | 10838 | 2167.6 | |
| | | | | End res. | 9899 | 1979.8 | | End res. | 10849 | 2169.8 | |

Annex F (informative): Change history

Table F.1: Inclusion of CRs approved by TSG-RAN#6

| RAN Doc | Spec | CR | R | Ph | Subject | Cat | Curr | New |
|----------|--------|-----|---|-----|--|-----|-------|-------|
| RP-99772 | 25.101 | 001 | 2 | R99 | Correction of UE Measurement Channels Rev.2 | F | 3.0.0 | 3.1.0 |
| RP-99772 | 25.101 | 003 | | R99 | Modifications for Receiver Characteristics | F | 3.0.0 | 3.1.0 |
| RP-99772 | 25.101 | 004 | | R99 | Corrections to Tx Diversity testing assumptions | F | 3.0.0 | 3.1.0 |
| RP-99771 | 25.101 | 005 | | R99 | UE DL performance requirements | D | 3.0.0 | 3.1.0 |
| RP-99772 | 25.101 | 006 | 1 | R99 | Corrections to Annex C Down link Physical Channels | F | 3.0.0 | 3.1.0 |
| RP-99772 | 25.101 | 007 | | R99 | Proposal for ACLR/ACS specifications for class 3 | F | 3.0.0 | 3.1.0 |
| RP-99773 | 25.101 | 008 | | R99 | Addition of propagation condition to inner and outer loop PC tests in downlink | B | 3.0.0 | 3.1.0 |
| RP-99772 | 25.101 | 009 | | R99 | Clarification of Uplink inner loop power control requirements | C | 3.0.0 | 3.1.0 |
| RP-99773 | 25.101 | 010 | | R99 | Modifications to demodulation test parameters and requirements in inter-cell soft handover | B | 3.0.0 | 3.1.0 |
| RP-99772 | 25.101 | 011 | | R99 | Power setting of DPCH | C | 3.0.0 | 3.1.0 |
| RP-99771 | 25.101 | 012 | | R99 | Editorial changes to 25.101v3.0.0 | D | 3.0.0 | 3.1.0 |
| RP-99826 | 25.101 | 013 | | R99 | Update of UE RF capabilities | F | 3.0.0 | 3.1.0 |
| RP-99772 | 25.101 | 014 | | R99 | Update of ITU Region 2 Specific Specifications and proposed universal channel numbering | C | 3.0.0 | 3.1.0 |
| RP-99772 | 25.101 | 015 | | R99 | Performance requirements for demodulation of DCH in Site Selection Diversity Transmission mode for Subclause 8.6.3 of 25.101v3.0.0 | F | 3.0.0 | 3.1.0 |
| RP-99830 | 25.101 | 016 | 1 | R99 | Change of propagation conditions | F | 3.0.0 | 3.1.0 |
| RP-99772 | 25.101 | 017 | | R99 | CR for minimum requirements for UE power class 1 and 2 in 25.101 | F | 3.0.0 | 3.1.0 |
| RP-99772 | 25.101 | 018 | | R99 | Downlink Inner loop power control | C | 3.0.0 | 3.1.0 |
| RP-99773 | 25.101 | 019 | | R99 | Performance requirements in downlink compressed mode | B | 3.0.0 | 3.1.0 |

Table F.2: Inclusion of CRs approved by TSG-RAN#7

| RAN Doc | Spec | CR | R | Ph | Subject | Cat | Curr | New |
|-----------|--------|-----|---|-----|--|-----|-------|-------|
| RP-000015 | 25.101 | 020 | | R99 | Clarifications to measurement channels | F | 3.1.0 | 3.2.0 |
| RP-000015 | 25.101 | 021 | | R99 | Power measurement definitions for wanted signal (in-channel signal) | D | 3.1.0 | 3.2.0 |
| RP-000015 | 25.101 | 022 | | R99 | Change of propagation conditions for Case 2 | F | 3.1.0 | 3.2.0 |
| RP-000015 | 25.101 | 023 | | R99 | Editorial corrections | D | 3.1.0 | 3.2.0 |
| RP-000015 | 25.101 | 024 | | R99 | Birth-Death tap delays | F | 3.1.0 | 3.2.0 |
| RP-000015 | 25.101 | 025 | | R99 | Out-of-synchronization handling of the UE | C | 3.1.0 | 3.2.0 |
| RP-000015 | 25.101 | 026 | | R99 | UE Modulation performance requirements | F | 3.1.0 | 3.2.0 |
| RP-000015 | 25.101 | 027 | | R99 | Measurement channel for UE PCDE test | F | 3.1.0 | 3.2.0 |
| RP-000015 | 25.101 | 028 | | R99 | CR for performance requirement of BTFD | F | 3.1.0 | 3.2.0 |
| RP-000015 | 25.101 | 029 | | R99 | CPCH | B | 3.1.0 | 3.2.0 |
| RP-000015 | 25.101 | 030 | | R99 | Clarification of ACLR | D | 3.1.0 | 3.2.0 |
| RP-000015 | 25.101 | 031 | | R99 | Correction for reference measurement channel in TS 25.101 | F | 3.1.0 | 3.2.0 |
| RP-000015 | 25.101 | 032 | | R99 | Modifications to requirements for power control steps in uplink | F | 3.1.0 | 3.2.0 |
| RP-000015 | 25.101 | 033 | | R99 | Performance requirement | F | 3.1.0 | 3.2.0 |
| RP-000015 | 25.101 | 034 | | R99 | Power Control in downlink, constant BLER target | F | 3.1.0 | 3.2.0 |
| RP-000015 | 25.101 | 035 | | R99 | UE Minimum TX power change | F | 3.1.0 | 3.2.0 |
| RP-000015 | 25.101 | 036 | | R99 | Performance requirements for demodulation of DCH in Site Selection Diversity Transmission mode | F | 3.1.0 | 3.2.0 |
| RP-000015 | 25.101 | 037 | | R99 | Reference compressed mode patterns | F | 3.1.0 | 3.2.0 |
| RP-000015 | 25.101 | 038 | | R99 | 384kbps measurement channel is replaced with 10ms TTI | F | 3.1.0 | 3.2.0 |
| RP-000015 | 25.101 | 039 | | R99 | Modification to the handling of measurement equipment uncertainty | F | 3.1.0 | 3.2.0 |
| | | | | | Correction to figure A6 | | 3.2.0 | 3.2.1 |
| | | | | | Correction to version number in title/header (April 2000) | | 3.2.1 | 3.2.2 |

Table F.3: Inclusion of CRs approved by TSG-RAN#8

| RAN Doc | Spec | CR | R | Ph | Subject | Cat | Curr | New |
|-----------|--------|-----|---|-----|--|-----|-------|-------|
| RP-000204 | 25.101 | 040 | 1 | R99 | A test for UE's SIR target setting in a call set up | F | 3.2.2 | 3.3.0 |
| RP-000204 | 25.101 | 041 | 1 | R99 | Reception of TPC commands in a soft handover | F | 3.2.2 | 3.3.0 |
| RP-000204 | 25.101 | 042 | | R99 | DCH requirement for 64 kbps measurement channel in birth-death propagation condition | F | 3.2.2 | 3.3.0 |
| RP-000204 | 25.101 | 043 | | R99 | Power control in the downlink, constant BLER target | F | 3.2.2 | 3.3.0 |
| RP-000204 | 25.101 | 044 | | R99 | Value update for 384 kbps measurement channel requirements | F | 3.2.2 | 3.3.0 |
| RP-000204 | 25.101 | 045 | 1 | R99 | CR for demodulation of DCH | F | 3.2.2 | 3.3.0 |
| RP-000204 | 25.101 | 046 | | R99 | Correction for measurement channel in TS 25.101 | F | 3.2.2 | 3.3.0 |
| RP-000204 | 25.101 | 047 | | R99 | Editorial CR on section 8.6.3 of TS25.101 v3.2.0 | D | 3.2.2 | 3.3.0 |
| RP-000204 | 25.101 | 048 | | R99 | Correction of frequency numbering scheme | F | 3.2.2 | 3.3.0 |
| RP-000204 | 25.101 | 049 | | R99 | Correction - Propagation conditions | F | 3.2.2 | 3.3.0 |
| RP-000204 | 25.101 | 050 | | R99 | Compressed mode tests | F | 3.2.2 | 3.3.0 |
| RP-000204 | 25.101 | 051 | | R99 | Correction of Out-of-sync criteria | F | 3.2.2 | 3.3.0 |
| RP-000204 | 25.101 | 052 | | R99 | Editorial corrections for TS25.101. | F | 3.2.2 | 3.3.0 |
| RP-000204 | 25.101 | 053 | | R99 | Clarification of the specification on Peak Code Domain Error (PCDE) | F | 3.2.2 | 3.3.0 |
| RP-000204 | 25.101 | 054 | | R99 | Transients for uplink power steps | F | 3.2.2 | 3.3.0 |
| RP-000204 | 25.101 | 055 | | R99 | Power setting for uplink compressed mode and RACH preambles | F | 3.2.2 | 3.3.0 |
| RP-000204 | 25.101 | 056 | | R99 | UE interfering signal definition | F | 3.2.2 | 3.3.0 |
| RP-000204 | 25.101 | 057 | | R99 | Downlink Power Control, wind up effects | F | 3.2.2 | 3.3.0 |
| RP-000204 | 25.101 | 058 | | R99 | Use of P-CPICH and S-CPICH for performance requirements | F | 3.2.2 | 3.3.0 |
| RP-000204 | 25.101 | 059 | | R99 | Performance of Closed Loop Diversity mode 2 and Mode 1 | F | 3.2.2 | 3.3.0 |
| RP-000204 | 25.101 | 060 | | R99 | Removal of brackets from Inter-Cell SHO test case | F | 3.2.2 | 3.3.0 |
| RP-000204 | 25.101 | 061 | | R99 | Editorial corrections on moving propagation conditions | F | 3.2.2 | 3.3.0 |
| | | | | | Correct page numbering problem and other minor editorials | | 3.3.0 | 3.3.1 |

Table F.4: Inclusion of CRs approved by TSG-RAN#9

| RAN Doc | Spec | CR | R | Ph | Subject | Cat | Curr | New |
|-----------|--------|----|---|-----|---|-----|-------|-------|
| RP-000394 | 25.101 | 71 | | R99 | Downlink power control, wind up effects | F | 3.3.1 | 3.4.0 |
| RP-000394 | 25.101 | 72 | | R99 | Inclusion of OCNS definition for performance tests | F | 3.3.1 | 3.4.0 |
| RP-000394 | 25.101 | 63 | | R99 | Corrections to DL compressed mode tests in TS 25.101 | F | 3.3.1 | 3.4.0 |
| RP-000394 | 25.101 | 64 | | R99 | Combining of TPC commands in soft handover | F | 3.3.1 | 3.4.0 |
| RP-000394 | 25.101 | 65 | | R99 | Clarifications for power steps in RACH/CPCH message transmission | F | 3.3.1 | 3.4.0 |
| RP-000394 | 25.101 | 66 | | R99 | Editorial corrections for TS 25.101 | F | 3.3.1 | 3.4.0 |
| RP-000394 | 25.101 | 67 | | R99 | Corrections to power control | F | 3.3.1 | 3.4.0 |
| RP-000394 | 25.101 | 68 | | R99 | Corrections for compressed mode patterns | F | 3.3.1 | 3.4.0 |
| RP-000394 | 25.101 | 69 | | R99 | Editorial modification for BTFD measurement channels | F | 3.3.1 | 3.4.0 |
| RP-000394 | 25.101 | 75 | | R99 | Editorial modification to Annex A.5 of TS 25.101 | F | 3.3.1 | 3.4.0 |
| RP-000394 | 25.101 | 76 | | R99 | Tap magnitudes and phases for Birth-Death propagation conditions | F | 3.3.1 | 3.4.0 |
| RP-000394 | 25.101 | 73 | | R99 | Removal of confidence levels | F | 3.3.1 | 3.4.0 |
| RP-000394 | 25.101 | 74 | | R99 | Corrections to all tests with power control ON in TS 25.101 | F | 3.3.1 | 3.4.0 |
| RP-000394 | 25.101 | 70 | | R99 | Definition of period for frequency error | F | 3.3.1 | 3.4.0 |
| RP-000394 | 25.101 | 77 | | R99 | UE emission mask measurement filter definition correction for TS 25.101 | F | 3.3.1 | 3.4.0 |
| RP-000394 | 25.101 | 78 | | R99 | Handling of measurement uncertainties in UE radio conformance testing (FDD) | F | 3.3.1 | 3.4.0 |
| | | | | | Re-inclusion of reference [4] which had been accidentally deleted. | | 3.4.0 | 3.4.1 |

Table F.5: CRs approved at RAN#10

| RAN Doc | Spec | CR | R | Ph | Subject | Cat | Curr | New |
|-----------|--------|----|---|-----|---|-----|-------|-------|
| R4-000885 | 25.101 | 79 | | R99 | Proposed CR to TS 25.101 on subclause 7.8 RX Intermodulation | F | 3.4.1 | 3.5.0 |
| R4-000901 | 25.101 | 80 | | R99 | Corrections to DL compressed mode tests in TS 25.101 | F | 3.4.1 | 3.5.0 |
| R4-000902 | 25.101 | 81 | | R99 | Correction to DL 384 kbps and BTFD measurement channels | F | 3.4.1 | 3.5.0 |
| R4-000917 | 25.101 | 82 | | R99 | Compressed mode, proposal for specification | F | 3.4.1 | 3.5.0 |
| R4-000973 | 25.101 | 82 | | R99 | RX spurious emissions | F | 3.4.1 | 3.5.0 |
| R4-000982 | 25.101 | 84 | | R99 | Correction for 25.101 concerning the channel number calculation | F | 3.4.1 | 3.5.0 |
| R4-000990 | 25.101 | 85 | | R99 | Definition of multi-code OCNS signal for receiver and performance tests | F | 3.4.1 | 3.5.0 |

Table F.6: CRs approved at RAN#11

| RAN Doc | Spec | CR | R | Ph | Subject | Cat | Curr | New |
|-----------|--------|----|---|-----|---|-----|-------|-------|
| RP-010085 | 25.101 | 86 | | R99 | CR to 25.101 for Test Tolerances | F | 3.5.0 | 3.6.0 |
| RP-010085 | 25.101 | 87 | | R99 | Proposed CR to TS 25.101 on subclause 3.2 Abbreviations | F | 3.5.0 | 3.6.0 |
| RP-010085 | 25.101 | 88 | | R99 | Correction of version number of the ITU-R Recommendation SM.329 | F | 3.5.0 | 3.6.0 |
| RP-010085 | 25.101 | 89 | | R99 | REL 99 Corrections | F | 3.5.0 | 3.6.0 |
| RP-010085 | 25.101 | 90 | | R99 | Tx power during measurement on Rx characteristics | F | 3.5.0 | 3.6.0 |
| RP-010085 | 25.101 | 91 | | R99 | Removal of square brackets and TBDs from TS 25.101 | F | 3.5.0 | 3.6.0 |
| RP-010085 | 25.101 | 92 | | R99 | Correction of Definition of multi-code OCNS signal | F | 3.5.0 | 3.6.0 |
| RP-010085 | 25.101 | 93 | | R99 | Performance requirement for 250km/h | F | 3.5.0 | 3.6.0 |
| RP-010085 | 25.101 | 94 | | R99 | TS25.101 Rel 99 Clarification of UARFCN (channel number) | F | 3.5.0 | 3.6.0 |

Table F.7: Release 4 CRs approved at RAN#11

| RAN Doc | Spec | CR | R | Ph | Subject | Cat | Curr | New |
|-----------|--------|----|---|----|---|-----|-------|-------|
| RP-010100 | 25.101 | 96 | | R4 | Performance requirements BCH | B | 3.6.0 | 4.0.0 |
| RP-010100 | 25.101 | 97 | | R4 | Performance requirements for paging channel | B | 3.6.0 | 4.0.0 |
| RP-010100 | 25.101 | 98 | | R4 | Performance requirements for AI channel | B | 3.6.0 | 4.0.0 |

Table F.8: Release 4 CRs approved at RAN#12

| RAN Doc | Spec | CR | R | Ph | Title | Cat | Curr | New |
|-----------|--------|-----|---|-------|---|-----|-------|-------|
| RP-010347 | 25.101 | 100 | | Rel-4 | Correction for SSDT test parameters | A | 4.0.0 | 4.1.0 |
| RP-010347 | 25.101 | 104 | | Rel-4 | UL DPCCCH slot format for performance tests | A | 4.0.0 | 4.1.0 |
| RP-010347 | 25.101 | 108 | | Rel-4 | Terminology for power definition | A | 4.0.0 | 4.1.0 |
| RP-010347 | 25.101 | 110 | | Rel-4 | out of synchronization handling | A | 4.0.0 | 4.1.0 |
| RP-010347 | 25.101 | 112 | | Rel-4 | Clarification of limits for inner loop power control | A | 4.0.0 | 4.1.0 |
| RP-010347 | 25.101 | 114 | | Rel-4 | UE EVM definition | A | 4.0.0 | 4.1.0 |
| RP-010347 | 25.101 | 116 | | Rel-4 | CR on the Modification to OCNS code channels to allow for 384 kbps allocation | A | 4.0.0 | 4.1.0 |
| RP-010358 | 25.101 | 117 | | Rel-4 | Correction of AICH performance | F | 4.0.0 | 4.1.0 |

Table F.9: Release 4 CRs approved at RAN#13

| RAN Tdoc | Spec | CR | R | Ph | Title | Cat | Curr | New |
|-----------|--------|-----|---|-------|---|-----|-------|-------|
| RP-010614 | 25.101 | 119 | | Rel-4 | Compressed mode, correction of reference pattern 1, Set1 | A | 4.1.0 | 4.2.0 |
| RP-010614 | 25.101 | 121 | | Rel-4 | DL Power Control Step Size in performance requirements | A | 4.1.0 | 4.2.0 |
| RP-010614 | 25.101 | 123 | | Rel-4 | Correction for test numbers in fading propagation tests | A | 4.1.0 | 4.2.0 |
| RP-010614 | 25.101 | 125 | | Rel-4 | Correction of frequency range for receiver spurious emission requirements | A | 4.1.0 | 4.2.0 |
| RP-010614 | 25.101 | 127 | | Rel-4 | UE Maximum Output Power | A | 4.1.0 | 4.2.0 |
| RP-010614 | 25.101 | 129 | | Rel-4 | Clarification of definition of Df | A | 4.1.0 | 4.2.0 |
| RP-010614 | 25.101 | 131 | | Rel-4 | CR to TS25.101 for clarification of modulated interferer | A | 4.1.0 | 4.2.0 |

Table F.10: Release 5 CR approved at RAN#13

| RAN Tdoc | Spec | CR | R | Ph | Title | Cat | Curr | New | Work Item |
|-----------|--------|-----|---|-------|---|-----|-------|-------|-----------|
| RP-010636 | 25.101 | 132 | | Rel-5 | Addition of UE performance requirement for CPCH | B | 4.1.0 | 5.0.0 | TEI5 |

Table F.11: Release 5 CRs approved at RAN#14

| RAN Tdoc | Spec | CR | R | Ph | Title | Cat | Curr | New | Work Item |
|-----------|--------|-----|---|-------|--|-----|-------|-------|---------------------------------|
| RP-010777 | 25.101 | 135 | | Rel-5 | Clarification on 25.101 sec 8.8.2 averaging method. | A | 5.0.0 | 5.1.0 | TEI |
| RP-010777 | 25.101 | 138 | | Rel-5 | Correction of power control in downlink, initial convergence | A | 5.0.0 | 5.1.0 | TEI |
| RP-010789 | 25.101 | 141 | | Rel-5 | UMTS1800/1900 changes | B | 5.0.0 | 5.1.0 | RInImp-UMTS19, RInImp-UMTS18 |
| RP-010790 | 25.101 | 142 | | Rel-5 | Performance requirement for dedicated pilot | B | 5.0.0 | 5.1.0 | RANImp-BeamF |

Table F.12: Release 5 CRs approved at RAN#15

| RAN Tdoc | Spec | CR | R | Ph | Title | Cat | Curr | New | Work Item |
|-----------|--------|-----|---|-------|--|-----|-------|-------|---------------------------------|
| RP-020039 | 25.101 | 145 | 1 | Rel-5 | Correction of Change of TFC | F | 5.1.0 | 5.2.0 | TEI5 |
| RP-020034 | 25.101 | 148 | | Rel-5 | Corrections to UMTS1800/1900 requirements | F | 5.1.0 | 5.2.0 | RInImp-UMTS18, RInImp-UMTS19 |
| RP-020034 | 25.101 | 149 | | Rel-5 | Additional spurious emission requirements for band III | B | 5.1.0 | 5.2.0 | RInImp-UMTS18 |
| RP-020014 | 25.101 | 156 | 1 | Rel-5 | Power setting for uplink compressed mode | A | 5.1.0 | 5.2.0 | TEI |
| RP-020014 | 25.101 | 160 | | Rel-5 | Correction of power terms and definitions | A | 5.1.0 | 5.2.0 | TEI |
| RP-020014 | 25.101 | 162 | | Rel-5 | Correction of power spectral density | A | 5.1.0 | 5.2.0 | TEI |

Table F.13: Release 5 CRs approved at RAN#16

| RAN Tdoc | Spec | CR | R | Ph | Title | Cat | Curr | New | Work Item |
|-----------|--------|-----|---|-------|--|-----|-------|-------|-----------|
| RP-020303 | 25.101 | 164 | | Rel-5 | Correction of ITU-R SM.329 references | F | 5.2.0 | 5.3.0 | TEI5 |
| RP-020279 | 25.101 | 169 | 1 | Rel-5 | Control and monitoring function of UE requirement | A | 5.2.0 | 5.3.0 | TEI |
| RP-020279 | 25.101 | 171 | | Rel-5 | Addition of a set of Compressed mode reference pattern 2 parameters for FDD-TDD test cases in 25.133 | A | 5.2.0 | 5.3.0 | TEI |
| RP-020302 | 25.101 | 177 | | Rel-5 | UE HSDPA performance requirements (fixed reference channel) | B | 5.2.0 | 5.3.0 | HSDPA-RF |
| RP-020279 | 25.101 | 180 | | Rel-5 | Compressed mode performance requirements | A | 5.2.0 | 5.3.0 | TEI |

Table F.14: Release 5 CRs approved at RAN#17

| RAN Tdoc | Spec | CR | R | Ph | Title | Cat | Curr | New | Work Item |
|-----------|--------|-----|---|-------|--|-----|-------|-------|---------------|
| RP-020484 | 25.101 | 184 | 2 | Rel-5 | Requirements in case of dedicated pilot | F | 5.3.0 | 5.4.0 | RANImp-BFR-UE |
| RP-020495 | 25.101 | 188 | 2 | Rel-5 | Performance requirements for the HSDPA Fixed Reference Channel (FRC) | F | 5.3.0 | 5.4.0 | HSDPA-RF |
| RP-020484 | 25.101 | 189 | 1 | Rel-5 | Corrections to Spectrum Emission Mask | F | 5.3.0 | 5.4.0 | TEI5 |
| RP-020484 | 25.101 | 191 | | Rel-5 | PRACH modulation quality | F | 5.3.0 | 5.4.0 | TEI5 |

Table F.15: Release 5 CRs approved at RAN#18

| RAN Tdoc | Spec | CR | R | Ph | Title | Cat | Curr | New | Work Item |
|-----------|--------|-----|---|-------|--|-----|-------|-------|-----------|
| RP-020778 | 25.101 | 195 | | Rel-5 | Correction for TPC combining test case 1 | A | 5.4.0 | 5.5.0 | TEI |
| RP-020803 | 25.101 | 198 | | Rel-5 | Correction to Specified TBS for HSDPA Reference Channels | F | 5.4.0 | 5.5.0 | HSDPA-RF |
| RP-020803 | 25.101 | 200 | 1 | Rel-5 | Introduction of requirements for HSDPA UE categories 11 and 12 | B | 5.4.0 | 5.5.0 | HSDPA-RF |

Table F.16: Release 5 CRs approved at RAN#19

| RAN Tdoc | Spec | CR | R | Ph | Title | Cat | Curr | New | Work Item |
|-----------|--------|-----|---|-------|--|-----|-------|-------|-----------|
| RP-030037 | 25.101 | 205 | 1 | Rel-5 | Phase shift due to power steps | F | 5.5.0 | 5.6.0 | TEI5 |
| RP-030046 | 25.101 | 212 | 1 | Rel-5 | Specification of HSDPA FRC Performance for H-Sets 4 & 5 | F | 5.5.0 | 5.6.0 | HSDPA-RF |
| RP-030046 | 25.101 | 213 | 1 | Rel-5 | Specification of HSDPA FRC Performance with Open Loop Transmit Diversity | F | 5.5.0 | 5.6.0 | HSDPA-RF |
| RP-030046 | 25.101 | 215 | 1 | Rel-5 | Clarification of HSDPA FRC Test Procedure on HS-SCCH Signalling Error | F | 5.5.0 | 5.6.0 | HSDPA-RF |
| RP-030025 | 25.101 | 219 | | Rel-5 | The Closed Loop Timing Adjustment Mode parameter for the transmit diversity performance requirements | A | 5.5.0 | 5.6.0 | TEI |
| RP-030037 | 25.101 | 223 | | Rel-5 | Correction to PRACH modulation quality | F | 5.5.0 | 5.6.0 | TEI5 |
| RP-030025 | 25.101 | 226 | | Rel-5 | Downlink power control during compressed mode tests | A | 5.5.0 | 5.6.0 | TEI |
| RP-030032 | 25.101 | 228 | | Rel-5 | Correction to PCH demodulation test | A | 5.5.0 | 5.6.0 | TEI4 |

Table F.17: Release 6 CRs approved at RAN#19

| RAN Tdoc | Spec | CR | R | Ph | Title | Cat | Curr | New | Work Item |
|-----------|--------|-----|---|-------|--|-----|-------|-------|------------------|
| RP-020300 | 25.101 | 166 | 1 | Rel-6 | FDD UE Performance Requirements | C | 5.5.0 | 6.0.0 | RInImp-UERecPerf |
| RP-030048 | 25.101 | 201 | 1 | Rel-6 | Addition of requirement of CSICH demodulation when CA is active. | F | 5.5.0 | 6.0.0 | TEI6 |

Note: CR166r1 was approved at TSG RAN #16, but put on hold until another CR to Rel-6 of this specification was produced. It was then implemented after TSG RAN #19 together with CR201r1

Table F.18: Release 6 CRs approved at RAN#20

| RAN Tdoc | Spec | CR | R | Ph | Title | Cat | Curr | New | Work Item |
|-----------|--------|-----|---|-------|--|-----|-------|-------|-----------|
| RP-030217 | 25.101 | 232 | | Rel-6 | Maximum input power for the UE | A | 6.0.0 | 6.1.0 | HSDPA-RF |
| RP-030220 | 25.101 | 234 | 1 | Rel-6 | Requirements on common channels with TX diversity | F | 6.0.0 | 6.1.0 | TEI6 |
| RP-030207 | 25.101 | 238 | 1 | Rel-6 | Problems with "Out of sync" in Initial convergence test | A | 6.0.0 | 6.1.0 | TEI |
| RP-030207 | 25.101 | 243 | 1 | Rel-6 | Correction of SSDT performance requirements | A | 6.0.0 | 6.1.0 | TEI |
| RP-030213 | 25.101 | 245 | | Rel-6 | Correction of TPC dynamic range in tests using DPCCH as a phase reference | A | 6.0.0 | 6.1.0 | TEI5 |
| RP-030217 | 25.101 | 252 | | Rel-6 | Removal of some of the FRC test cases with PA3 channel | A | 6.0.0 | 6.1.0 | HSDPA-RF |
| RP-030217 | 25.101 | 253 | | Rel-6 | Specification of HSDPA CQI test | A | 6.0.0 | 6.1.0 | HSDPA-RF |
| RP-030217 | 25.101 | 256 | | Rel-6 | Specification of HSDPA FRC Performance with Closed Loop Transmit Diversity | A | 6.0.0 | 6.1.0 | HSDPA-RF |
| RP-030217 | 25.101 | 258 | | Rel-6 | Specification of HS-SCCH Performance | A | 6.0.0 | 6.1.0 | HSDPA-RF |
| RP-030217 | 25.101 | 260 | | Rel-6 | Specification of HSDPA CQI test in fading | A | 6.0.0 | 6.1.0 | HSDPA-RF |

Table F.19: Release 6 CRs approved at RAN#21

| RAN Tdoc | Spec | CR | R | Ph | Title | Cat | Curr | New | Work Item |
|-----------|--------|-----|---|-------|---|-----|-------|-------|---|
| RP-030417 | 25.101 | 251 | 3 | Rel-6 | Addition of transmitter characteristics for HS-DPCCH | A | 6.1.0 | 6.2.0 | HSDPA-RF |
| RP-030415 | 25.101 | 264 | 1 | Rel-6 | Problems with "Out of sync" in Initial Convergence test | A | 6.1.0 | 6.2.0 | TEI |
| RP-030423 | 25.101 | 265 | 1 | Rel-6 | UE blocking requirements | F | 6.1.0 | 6.2.0 | TEI6 |
| RP-030423 | 25.101 | 267 | 1 | Rel-6 | Spurious Emission in GSM bands | F | 6.1.0 | 6.2.0 | TEI6 |
| RP-030418 | 25.101 | 270 | | Rel-6 | Correction of CR 160 implementation for Correction of power terms and definitions | A | 6.1.0 | 6.2.0 | TEI5 |
| RP-030515 | 25.101 | 271 | 1 | Rel-6 | Frequency bands for UMTS1.7/2.1, UMTS800 and UMTS850 | B | 6.1.0 | 6.2.0 | RInImp-UMTS850, RInImp-UMTS800, RInImp-UMTS1721 |

Table F.20: Release 6 CRs approved at RAN#22

| RAN Tdoc | Spec | CR | R | Ph | Title | Cat | Curr | New | Workitem |
|-----------|--------|-----|---|-------|---|-----|-------|-------|----------------------------------|
| RP-030720 | 25.101 | 274 | 2 | Rel-6 | SML definition | F | 6.2.0 | 6.3.0 | TEI6 |
| RP-030596 | 25.101 | 278 | | Rel-6 | Correction of references to ITU recommendations | A | 6.2.0 | 6.3.0 | TEI5 |
| RP-030605 | 25.101 | 280 | 1 | Rel-6 | DS-CDMA Introduction in the 800 MHz Band | B | 6.2.0 | 6.3.0 | RInImp-UMTS800 |
| RP-030608 | 25.101 | 281 | | Rel-6 | Specification of HSDPA FRC Performance for H-Set 6 | F | 6.2.0 | 6.3.0 | HSDPA-RF |
| RP-030608 | 25.101 | 282 | 1 | Rel-6 | Specification of HS-SCCH Performance with Open Loop Transmit Diversity | F | 6.2.0 | 6.3.0 | HSDPA-RF |
| RP-030608 | 25.101 | 284 | 1 | Rel-6 | Specification of CQI Testing for UE Capability Categories 11, 12 and 1-6 in Open and Closed Loop Transmit Diversities | F | 6.2.0 | 6.3.0 | HSDPA-RF |
| RP-030608 | 25.101 | 285 | 1 | Rel-6 | Specification of CQI Testing for UE Capability Categories 7 and 8 | F | 6.2.0 | 6.3.0 | HSDPA-RF |
| RP-030604 | 25.101 | 286 | 2 | Rel-6 | Introduction of UMTS 850 requirements | B | 6.2.0 | 6.3.0 | RInImp-UMTS850 |
| RP-030607 | 25.101 | 294 | | Rel-6 | New Compressed Mode Reference Pattern | F | 6.2.0 | 6.3.0 | TEI6 |
| RP-030595 | 25.101 | 297 | 3 | Rel-6 | Clarification to HSDPA OCNS definition | A | 6.2.0 | 6.3.0 | HSDPA-RF |
| RP-030595 | 25.101 | 302 | | Rel-6 | Power allocation for HS-SCCH in FRC test | A | 6.2.0 | 6.3.0 | HSDPA-RF |
| RP-030595 | 25.101 | 303 | | Rel-6 | Corrections of CQI reporting section | A | 6.2.0 | 6.3.0 | HSDPA-RF |
| RP-030595 | 25.101 | 304 | | Rel-6 | Correction for FRC test in Closed loop mode 1 | A | 6.2.0 | 6.3.0 | HSDPA-RF |
| RP-030595 | 25.101 | 305 | | Rel-6 | DTX handling for CQI test in fading channel | A | 6.2.0 | 6.3.0 | HSDPA-RF |
| RP-030590 | 25.101 | 307 | | Rel-6 | Correction of W-CDMA modulated interferer definition | A | 6.2.0 | 6.3.0 | TEI |
| RP-030603 | 25.101 | 308 | | Rel-6 | Introduction of new channel arrangement for bands IV, V and VI | B | 6.2.0 | 6.3.0 | RInImp-UMTS850, UMTS800,UMTS1721 |
| RP-030595 | 25.101 | 309 | 1 | Rel-6 | Additional Specification of CQI Testing for UE Capability Categories 11 and 12 | A | 6.2.0 | 6.3.0 | HSDPA-RF |
| RP-030605 | 25.101 | 314 | | Rel-6 | DS CDMA introduction in the 800 MHz band (performance requirement in Band VI) | B | 6.2.0 | 6.3.0 | RInImp-UMTS800 |
| RP-030605 | 25.101 | 315 | | Rel-6 | DS CDMA introduction in the 800 MHz band (Addition of spurious emissions requirement) | B | 6.2.0 | 6.3.0 | RInImp-UMTS800 |
| RP-030607 | 25.101 | 316 | | Rel-6 | Additional spurious emission requirements for Band II to protect UMTS850 | F | 6.2.0 | 6.3.0 | TEI6 |
| RP-030607 | 25.101 | 317 | | Rel-6 | Clarification of UE blocking definition | F | 6.2.0 | 6.3.0 | TEI6 |

Table F.21: Release 6 CRs approved at RAN#23

| RAN Tdoc | Spec | CR | R | Ph | Title | Cat | Curr | New | Work Item |
|-----------|--------|-----|---|-------|---|-----|-------|-------|-----------------|
| RP-040039 | 25.101 | 324 | | Rel-6 | Introduction of UMTS 1.7/2.1 GHz requirements | B | 6.3.0 | 6.4.0 | RInImp-UMTS1721 |
| RP-040042 | 25.101 | 325 | | Rel-6 | Additional spurious emission requirements for Bands II and V to protect 1.7/2.1 GHz | F | 6.3.0 | 6.4.0 | TEI6 |
| RP-040042 | 25.101 | 326 | | Rel-6 | Additional spurious emission requirements for Band I to protect UMTS800 | F | 6.3.0 | 6.4.0 | TEI6 |
| RP-040036 | 25.101 | 328 | | Rel-6 | Clarification of frequency error observation period for PRACH preambles | A | 6.3.0 | 6.4.0 | TEI5 |
| RP-040042 | 25.101 | 329 | 1 | Rel-6 | Clarification to Power on/off time mask diagram | F | 6.3.0 | 6.4.0 | TEI6 |
| RP-040043 | 25.101 | 331 | | Rel-6 | Reduction of channel number for UMTS800(band VI) | F | 6.3.0 | 6.4.0 | RInImp-UMTS800 |
| RP-040036 | 25.101 | 334 | | Rel-6 | Minimum requirements for UE ACS | A | 6.3.0 | 6.4.0 | TEI5 |
| RP-040044 | 25.101 | 338 | 1 | Rel-6 | Minimum requirements for TPC combining in soft Handover | A | 6.3.0 | 6.4.0 | TEI |

Table F.22: Release 6 CRs approved at RAN#25

| RAN Tdoc | Spec | CR | R | Ph | Title | Cat | Curr | New | Work Item |
|-----------|--------|-----|---|-------|---|-----|-------|-------|---------------------|
| RP-040291 | 25.101 | 342 | 2 | Rel-6 | UE maximum output power with HS-DPCCH | A | 6.4.0 | 6.5.0 | HSDPA-RF |
| RP-040291 | 25.101 | 344 | 3 | Rel-6 | Correction of maximum allowed power and range in TFC selection with HS-DPCCH and other clarifications | F | 6.4.0 | 6.5.0 | HSDPA-RF |
| RP-040292 | 25.101 | 346 | 1 | Rel-6 | Correction in the Band V (850MHz) additional frequency channel - UARFCN | F | 6.4.0 | 6.5.0 | RInImp-UMTS850 |
| RP-040288 | 25.101 | 352 | | Rel-6 | Clarification of test parameter of reliable TPC command combining | F | 6.4.0 | 6.5.0 | TEI6 |
| RP-040292 | 25.101 | 353 | | Rel-6 | Frequency range correction of out-of-band blocking for Band IV | F | 6.4.0 | 6.5.0 | RInImp-UMTS1721 |
| RP-040288 | 25.101 | 354 | 1 | Rel-6 | UE maximum input level for HS-PDSCH | F | 6.4.0 | 6.5.0 | TEI6, HSDPA-RF |
| RP-040288 | 25.101 | 358 | | Rel-6 | Clarification to change of TFC and compressed mode time mask diagrams | F | 6.4.0 | 6.5.0 | TEI6 |
| RP-040284 | 25.101 | 361 | | Rel-6 | Clarification of HS-DSCH level | A | 6.4.0 | 6.5.0 | HSDPA-RF |
| RP-040284 | 25.101 | 363 | 1 | Rel-6 | Correction to OCNS code allocation for HSDPA testing | A | 6.4.0 | 6.5.0 | HSDPA-RF |
| RP-040287 | 25.101 | 364 | 1 | Rel-6 | Specification of enhanced performance requirements for HSDPA based on receiver diversity | B | 6.4.0 | 6.5.0 | RInImp-HSPerf-RxDiv |
| RP-040384 | 25.101 | 365 | | Rel-6 | UE maximum output power for HSDPA-only terminal | B | 6.4.0 | 6.5.0 | EDCH-RF |

Table F.23: Release 6 CRs approved at RAN#26

| RAN Tdoc | Spec | CR | R | Ph | Title | Cat | Curr | New | Work Item |
|-----------|--------|-----|---|-------|--|-----|-------|-------|---------------------|
| RP-040412 | 25.101 | 368 | 1 | Rel-6 | Correction to Windup testcase | F | 6.5.0 | 6.6.0 | TEI6 |
| RP-040414 | 25.101 | 373 | 2 | Rel-6 | Corrections to 7.4.2 maximum input level for HS-PDSCH reception | F | 6.5.0 | 6.6.0 | HSDPA-RF |
| RP-040414 | 25.101 | 377 | 1 | Rel-6 | Corrections to 9.3 reporting of CQI | F | 6.5.0 | 6.6.0 | HSDPA-RF |
| RP-040414 | 25.101 | 379 | 2 | Rel-6 | Corrections to 9.4 detection of HS-SCCH | F | 6.5.0 | 6.6.0 | HSDPA-RF |
| RP-040414 | 25.101 | 383 | 3 | Rel-6 | H Set-4/5 pattern length | F | 6.5.0 | 6.6.0 | HSDPA-RF |
| RP-040406 | 25.101 | 385 | 1 | Rel-6 | Omissions in 7.6 (Blocking) | A | 6.5.0 | 6.6.0 | TEI5 |
| RP-040534 | 25.101 | 386 | | Rel-6 | Enhanced performance requirement on FRC throughput for PA3 cases | B | 6.5.0 | 6.6.0 | RInImp-HSPerf-RxDiv |

Table F.24: Release 6 CRs approved at RAN#27

| RAN Tdoc | Spec | CR | R | Ph | Title | Cat | Curr | New | Work Item |
|-----------|--------|-----|---|-------|---|-----|-------|-------|---------------------|
| RP-050040 | 25.101 | 391 | | Rel-6 | Specification of enhanced performance requirements for HS-SCCH with open loop diversity based on receiver diversity | B | 6.6.0 | 6.7.0 | RInImp-HSPerf-RxDiv |
| RP-050040 | 25.101 | 392 | | Rel-6 | Modification of enhanced performance requirements for HS-SCCH based on receiver diversity | C | 6.6.0 | 6.7.0 | RInImp-HSPerf-RxDiv |
| RP-050038 | 25.101 | 396 | | Rel-6 | Removal of TGPL2 | C | 6.6.0 | 6.7.0 | TEI5 |
| RP-050041 | 25.101 | 397 | | Rel-6 | Minimum performance for constant BLER testcases | F | 6.6.0 | 6.7.0 | TEI6 |
| RP-050040 | 25.101 | 400 | 1 | Rel-6 | Clarification of mapping of HS-DSCH requirements | F | 6.6.0 | 6.7.0 | RInImp-HSPerf-RxDiv |
| RP-050041 | 25.101 | 401 | 1 | Rel-6 | OCNS definition for transmit diversity | F | 6.6.0 | 6.7.0 | TEI6 |
| RP-050041 | 25.101 | 402 | | Rel-6 | Corrections to 9.2 demodulation of HS-DSCH | F | 6.6.0 | 6.7.0 | TEI6, HSDPA-RF |
| RP-050039 | 25.101 | 404 | 2 | Rel-6 | HS-DPCCH time mask requirements | A | 6.6.0 | 6.7.0 | HSDPA-RF |
| RP-050041 | 25.101 | 406 | | Rel-6 | Update UMTS FDD Receiver Blocking Specifications | F | 6.6.0 | 6.7.0 | TEI6 |
| RP-050040 | 25.101 | 407 | 1 | Rel-6 | Enhanced performance requirements for HSDPA cat 7 & 8 capable receivers | B | 6.6.0 | 6.7.0 | RInImp-HSPerf-RxDiv |

Table F.25: Release 6 CRs approved at RAN#28

| RAN Tdoc | Spec | CR | R | Ph | Title | Cat | Curr | New | Work Item |
|-----------|--------|-----|---|-------|--|-----|-------|-------|----------------------|
| RP-050257 | 25.101 | 408 | 3 | Rel-6 | UE maximum output power with HS-DPCCH and E-DCH | F | 6.7.0 | 6.8.0 | EDCH-RF |
| RP-050213 | 25.101 | 411 | | Rel-6 | Feature Clean Up: Removal of dedicated pilot as sole phase reference | C | 6.7.0 | 6.8.0 | TEI6 |
| RP-050211 | 25.101 | 413 | | Rel-6 | Feature Clean Up: Removal of SSdT | C | 6.7.0 | 6.8.0 | TEI6 |
| RP-050216 | 25.101 | 415 | | Rel-6 | Feature Clean Up: Removal of CPCH | C | 6.7.0 | 6.8.0 | TEI6 |
| RP-050214 | 25.101 | 417 | | Rel-6 | Feature Clean Up: Removal of Tx diversity closed loop mode2 | C | 6.7.0 | 6.8.0 | TEI6 |
| RP-050215 | 25.101 | 419 | | Rel-6 | Feature Clean Up: Removal of Compressed mode by puncturing | C | 6.7.0 | 6.8.0 | TEI6 |
| RP-050208 | 25.101 | 420 | | Rel-6 | Correction of error in the implementation of CR 368 (in R4-040779) to 25.101 | F | 6.7.0 | 6.8.0 | TEI6 |
| RP-050202 | 25.101 | 425 | 1 | Rel-6 | Clarification to HS-DPCCH time mask requirements | A | 6.7.0 | 6.8.0 | TEI5 |
| RP-050205 | 25.101 | 430 | | Rel-6 | Specification of enhanced performance requirements type 2 | B | 6.7.0 | 6.8.0 | RInImp-HSPerf-10code |
| RP-050208 | 25.101 | 431 | | Rel-6 | Addition of DL power control response time | F | 6.7.0 | 6.8.0 | TEI6 |

Table F.26: Release 7 CR approved at RAN#28

| RAN Tdoc | Spec | CR | R | Ph | Title | Cat | Curr | New | Work Item |
|-----------|--------|-----|---|-------|---|-----|-------|-------|-----------------|
| RP-050206 | 25.101 | 409 | 1 | Rel-7 | Introduction of UMTS 2.6 GHz requirements | B | 6.7.0 | 7.0.0 | RInImp-UMTS2600 |

Table F.27: Release 7 CR approved at RAN#29

| RAN Tdoc | Spec | CR | R | Ph | Title | Cat | Curr | New | Work Item |
|-----------|--------|------|---|-------|--|-----|-------|-------|----------------------|
| RP-050489 | 25.101 | 0436 | 1 | Rel-7 | Modification of the protection band for PHS | A | 7.0.0 | 7.1.0 | TEI |
| RP-050496 | 25.101 | 0440 | 1 | Rel-7 | Revision of additional receiver spurious emissions requirements on 800MHz band in Japan | A | 7.0.0 | 7.1.0 | RInImp-UMTS800 |
| RP-050507 | 25.101 | 0451 | 1 | Rel-7 | Clarification of BLER for CQI under fading | A | 7.0.0 | 7.1.0 | TEI6, HSDPA-RF |
| RP-050598 | 25.101 | 0452 | 1 | Rel-7 | Specification of enhanced performance requirements type 2 for HSDPA with CL transmit diversity based on chip level equaliser | A | 7.0.0 | 7.1.0 | RInImp-HSPerf-10code |
| RP-050504 | 25.101 | 0453 | | Rel-7 | UE performance requirements for E-DCH DL signalling channels | A | 7.0.0 | 7.1.0 | EDCH-RF |
| RP-050615 | 25.101 | 0457 | | Rel-7 | Band V and Band VI UARFCN | A | 7.0.0 | 7.1.0 | TEI6 |

Table F.27: Release 7 CR approved at RAN#30

| RAN Tdoc | Spec | CR | R | Ph | Title | Cat | Curr | New | Work Item |
|-----------|--------|------|---|-------|---|-----|-------|-------|-------------------------|
| RP-050840 | 25.101 | 0459 | 1 | Rel-7 | Compressed Mode Layer 1 Requirements | A | 7.1.0 | 7.2.0 | TEI6 |
| RP-050840 | 25.101 | 0461 | | Rel-7 | Combined compressed mode patterns for RRM test | A | 7.1.0 | 7.2.0 | TEI6 |
| RP-050744 | 25.101 | 0462 | | Rel-7 | Addition of spurious emission requirements for protection of UMTS band VII | F | 7.1.0 | 7.2.0 | RInImp-UMTS2600 |
| RP-050734 | 25.101 | 0464 | 1 | Rel-7 | Fractional DPCH DL power control test | B | 7.1.0 | 7.2.0 | RANImp-RABSE-CodeOptFDD |
| RP-050736 | 25.101 | 0466 | 1 | Rel-7 | UE additional spurious emissions required in the 800MHz band in Japan | A | 7.1.0 | 7.2.0 | RInImp-UMTS800 |
| RP-050743 | 25.101 | 0468 | 3 | Rel-7 | MBMS requirements in 25.101 | A | 7.1.0 | 7.2.0 | MBMS-RAN-RF |
| RP-050742 | 25.101 | 0469 | 1 | Rel-7 | Introduction of UMTS1700 requirements | B | 7.1.0 | 7.2.0 | RInImp-UMTS1700 |
| RP-050735 | 25.101 | 0471 | 1 | Rel-7 | Corrections to UE E-DCH performance requirements | A | 7.1.0 | 7.2.0 | EDCH-RF |
| RP-050731 | 25.101 | 0474 | 1 | Rel-7 | Introduction of requirements for UE outer loop power control behaviour with different transport formats | A | 7.1.0 | 7.2.0 | TEI5 |
| RP-050735 | 25.101 | 0476 | | Rel-7 | ACLR and Spectrum mask for E-DCH | A | 7.1.0 | 7.2.0 | EDCH-RF |
| RP-050741 | 25.101 | 0477 | 1 | Rel-7 | Band VIII in UTRA-FDD UE spec TS25.101 | B | 7.1.0 | 7.2.0 | RInImp-UMTS900 |
| RP-050732 | 25.101 | 0487 | 1 | Rel-7 | New UARFCN scheme and re-numbering | A | 7.1.0 | 7.2.0 | TEI5 |

Table F.28: Release 7 CR approved at RAN#31

| RAN Tdoc | Spec | CR | R | Ph | Title | Cat | Curr | New | Work Item |
|-----------------|-------------|-----------|----------|-----------|---|------------|-------------|------------|---------------------|
| RP-060101 | 25.101 | 0493 | 1 | Rel-7 | Minimum performance requirements for MBMS testing of 80 ms TTI | A | 7.2.0 | 7.3.0 | MBMS-RAN-RF |
| RP-060103 | 25.101 | 0495 | 2 | Rel-7 | Clarification for testing of receiver diversity terminals | A | 7.2.0 | 7.3.0 | TEI6 |
| RP-060112 | 25.101 | 0496 | 1 | Rel-7 | Specification of enhanced performance requirements type 3 for HSDPA based on receiver diversity and chip level equaliser. | B | 7.2.0 | 7.3.0 | RInImp-HSPerf-Type3 |
| RP-060110 | 25.101 | 0497 | 1 | Rel-7 | Band VIII TX spurious emission | F | 7.2.0 | 7.3.0 | RInImp-UMTS900 |
| RP-060103 | 25.101 | 0502 | 2 | Rel-7 | Clarification of modulation accuracy requirements for signals containing HS-DPCCH | A | 7.2.0 | 7.3.0 | TEI5 |
| RP-060103 | 25.101 | 0506 | 1 | Rel-7 | Clarification of HS-SCCH performance requirements | A | 7.2.0 | 7.3.0 | TEI6 |
| RP-060181 | 25.101 | 0508 | | Rel-7 | UE maximum output, power with HS-DPCCH and E-DCH | A | 7.2.0 | 7.3.0 | EDCH-RF |

History

| Document history | | |
|-------------------------|---------------|-------------|
| V7.2.0 | December 2005 | Publication |
| V7.3.0 | March 2006 | Publication |
| | | |
| | | |
| | | |