

# ETSI TS 125 101 V12.9.0 (2015-10)



**Universal Mobile Telecommunications System (UMTS);  
User Equipment (UE) radio transmission and reception (FDD)  
(3GPP TS 25.101 version 12.9.0 Release 12)**





---

Reference

RTS/TSGR-0425101vc90

---

Keywords

UMTS

**ETSI**

650 Route des Lucioles  
F-06921 Sophia Antipolis Cedex - FRANCE

---

Tel.: +33 4 92 94 42 00 Fax: +33 4 93 65 47 16

Siret N° 348 623 562 00017 - NAF 742 C  
Association à but non lucratif enregistrée à la  
Sous-Préfecture de Grasse (06) N° 7803/88

---

**Important notice**

---

The present document can be downloaded from:

<http://www.etsi.org/standards-search>

The present document may be made available in electronic versions and/or in print. The content of any electronic and/or print versions of the present document shall not be modified without the prior written authorization of ETSI. In case of any existing or perceived difference in contents between such versions and/or in print, the only prevailing document is the print of the Portable Document Format (PDF) version kept on a specific network drive within ETSI Secretariat.

Users of the present document should be aware that the document may be subject to revision or change of status.

Information on the current status of this and other ETSI documents is available at

<http://portal.etsi.org/tb/status/status.asp>

If you find errors in the present document, please send your comment to one of the following services:

<https://portal.etsi.org/People/CommitteeSupportStaff.aspx>

---

**Copyright Notification**

---

No part may be reproduced or utilized in any form or by any means, electronic or mechanical, including photocopying and microfilm except as authorized by written permission of ETSI.

The content of the PDF version shall not be modified without the written authorization of ETSI.

The copyright and the foregoing restriction extend to reproduction in all media.

© European Telecommunications Standards Institute 2015.

All rights reserved.

**DECT™**, **PLUGTESTS™**, **UMTS™** and the ETSI logo are Trade Marks of ETSI registered for the benefit of its Members.  
**3GPP™** and **LTE™** are Trade Marks of ETSI registered for the benefit of its Members and  
of the 3GPP Organizational Partners.  
**GSM®** and the GSM logo are Trade Marks registered and owned by the GSM Association.



---

## Intellectual Property Rights

IPRs essential or potentially essential to the present document may have been declared to ETSI. The information pertaining to these essential IPRs, if any, is publicly available for **ETSI members and non-members**, and can be found in ETSI SR 000 314: *"Intellectual Property Rights (IPRs); Essential, or potentially Essential, IPRs notified to ETSI in respect of ETSI standards"*, which is available from the ETSI Secretariat. Latest updates are available on the ETSI Web server (<http://ipr.etsi.org>).

Pursuant to the ETSI IPR Policy, no investigation, including IPR searches, has been carried out by ETSI. No guarantee can be given as to the existence of other IPRs not referenced in ETSI SR 000 314 (or the updates on the ETSI Web server) which are, or may be, or may become, essential to the present document.

---

## Foreword

This Technical Specification (TS) has been produced by ETSI 3rd Generation Partnership Project (3GPP).

The present document may refer to technical specifications or reports using their 3GPP identities, UMTS identities or GSM identities. These should be interpreted as being references to the corresponding ETSI deliverables.

The cross reference between GSM, UMTS, 3GPP and ETSI identities can be found under <http://webapp.etsi.org/key/queryform.asp>.

---

## Modal verbs terminology

In the present document "**shall**", "**shall not**", "**should**", "**should not**", "**may**", "**need not**", "**will**", "**will not**", "**can**" and "**cannot**" are to be interpreted as described in clause 3.2 of the [ETSI Drafting Rules](#) (Verbal forms for the expression of provisions).

"**must**" and "**must not**" are **NOT** allowed in ETSI deliverables except when used in direct citation.



# Contents

Intellectual Property Rights .....	2
Foreword.....	2
Modal verbs terminology.....	2
Foreword.....	14
1 Scope .....	15
2 References .....	15
3 Definitions, symbols and abbreviations .....	15
3.1 Definitions .....	15
3.2 Abbreviations .....	17
4 General .....	19
4.1 Relationship between Minimum Requirements and Test Requirements .....	19
4.2 Power Classes.....	19
4.3 Control and monitoring functions .....	19
4.3.1 Minimum requirement .....	20
4.4 RF requirements in later releases .....	20
5 Frequency bands and channel arrangement.....	20
5.1 General .....	20
5.2 Frequency bands.....	20
5.3 TX-RX frequency separation .....	22
5.4 Channel arrangement.....	23
5.4.1 Channel spacing.....	23
5.4.2 Channel raster .....	24
5.4.3 Channel number.....	24
5.4.4 UARFCN .....	26
6 Transmitter characteristics .....	27
6.1 General .....	27
6.2 Transmit power .....	27
6.2.1 UE maximum output power.....	27
6.2.1A UE maximum output power for UL OLTD .....	29
6.2.1B UE maximum output power for UL CLTD .....	30
6.2.1C UE maximum output power for UL MIMO.....	30
6.2.2 UE maximum output power with HS-DPCCH and E-DCH.....	31
6.2.2A UE maximum output power for DC-HSUPA.....	32
6.2.2B UE maximum output power with HS-DPCCH and E-DCH for UL OLTD.....	33
6.2.2C UE maximum output power with HS-DPCCH and E-DCH for UL CLTD.....	33
6.2.2D UE maximum output power with HS-DPCCH and E-DCH for UL MIMO .....	34
6.2.3 UE Relative code domain power accuracy .....	34
6.2.3A UE Relative code domain power accuracy for DC-HSUPA.....	35
6.2.3B UE Relative code domain power accuracy for UL OLTD.....	36
6.2.3C UE Relative code domain power accuracy for UL CLTD .....	36
6.2.3D UE Relative code domain power accuracy for UL MIMO .....	36
6.3 Frequency Error.....	36
6.3A Frequency Error for DC-HSUPA .....	36
6.3B Frequency error for UL OLTD.....	36
6.3C Frequency error for UL CLTD.....	36
6.3D Frequency error for UL MIMO .....	37
6.4 Output power dynamics.....	37
6.4.1 Open loop power control .....	37
6.4.1.1 Minimum requirement .....	37
6.4.1.1A Additional requirement for DC-HSUPA.....	37
6.4.2 Inner loop power control in the uplink.....	37



6.4.2.1	Power control steps .....	37
6.4.2.1.1	Minimum requirement .....	37
6.4.2.1.1A	Additional requirement for DC-HSUPA .....	38
6.4.2.1.1B	Additional requirement for UL OLTD .....	39
6.4.2.1.1C	Additional requirement for UL CLTD .....	39
6.4.2.1.1D	Additional requirement for UL MIMO .....	39
6.4.3	Minimum output power .....	39
6.4.3.1	Minimum requirement .....	39
6.4.3.1A	Additional requirement for DC-HSUPA .....	39
6.4.3.1B	Additional requirement for UL OLTD .....	39
6.4.3.1C	Additional requirement for UL CLTD .....	39
6.4.3.1D	Additional requirement for UL MIMO .....	40
6.4.4	Out-of-synchronization handling of output power .....	40
6.4.4.1	Minimum requirement .....	40
6.4.4.1A	Additional requirement for UL OLTD .....	40
6.4.4.1B	Additional requirement for UL CLTD .....	40
6.4.4.1C	Additional requirement for UL MIMO .....	41
6.4.4.2	Test case .....	41
6.4A	Output pattern dynamics .....	43
6.4A.1	Out-of-quality handling of TPI applicability .....	43
6.4A.1.1	Minimum requirement .....	43
6.4A.1.2	Test case .....	43
6.5	Transmit ON/OFF power .....	45
6.5.1	Transmit OFF power .....	45
6.5.1.1	Minimum requirement .....	45
6.5.1.1A	Additional requirement for DC-HSUPA .....	45
6.5.1.1B	Additional requirement for UL OLTD .....	46
6.5.1.1C	Additional requirement for UL CLTD .....	46
6.5.1.1D	Additional requirement for UL MIMO .....	46
6.5.2	Transmit ON/OFF Time mask .....	46
6.5.2.1	Minimum requirement .....	46
6.5.2.1A	Additional requirement for UL OLTD .....	49
6.5.2.1B	Additional requirement for UL CLTD .....	49
6.5.2.1C	Additional requirement for UL MIMO .....	49
6.5.3	Change of TFC .....	49
6.5.3.1	Minimum requirement .....	49
6.5.3.1A	Additional requirement for UL OLTD .....	51
6.5.3.1B	Additional requirement for UL CLTD .....	51
6.5.4	Power setting in uplink compressed mode .....	51
6.5.4.1	Minimum requirement .....	51
6.5.4.1A	Additional requirement for UL OLTD .....	53
6.5.4.1B	Additional requirement for UL CLTD .....	53
6.5.5	HS-DPCCH .....	53
6.5.5.1	Minimum requirement .....	53
6.5.5.1A	Additional requirement for UL OLTD .....	54
6.5.5.1B	Additional requirement for UL CLTD .....	54
6.5.5.1C	Additional requirement for UL MIMO .....	55
6.6	Output RF spectrum emissions .....	55
6.6.1	Occupied bandwidth .....	55
6.6.1A	Occupied bandwidth for DC-HSUPA .....	55
6.6.1B	Occupied bandwidth for UL OLTD .....	55
6.6.1C	Occupied bandwidth for UL CLTD .....	56
6.6.1D	Occupied bandwidth for UL MIMO .....	56
6.6.2	Out of band emission .....	56
6.6.2.1	Spectrum emission mask .....	56
6.6.2.1.1	Minimum requirement .....	56
6.6.2.1A	Additional Spectrum emission mask for DC-HSUPA .....	58
6.6.2.1A.1	Minimum requirement .....	58
6.6.2.1A.2	Additional requirement for band II, IV, V, X, XXV and XXVI .....	58
6.6.2.1B	Additional requirement for UL OLTD .....	59
6.6.2.1C	Additional requirement for UL CLTD .....	59
6.6.2.1D	Additional requirement for UL MIMO .....	59



6.6.2.2	Adjacent Channel Leakage power Ratio (ACLR) .....	59
6.6.2.2.1	Minimum requirement .....	59
6.6.2.2.1A	Additional requirement for DC-HSUPA .....	59
6.6.2.2.1B	Additional requirement for UL OLTD .....	60
6.6.2.2.1C	Additional requirement for UL CLTD .....	60
6.6.2.2.1D	Additional requirement for UL MIMO .....	60
6.6.3	Spurious emissions .....	60
6.6.3.1	Minimum requirement .....	60
6.6.3.1.1	Additional requirement .....	66
6.6.3.1A	Additional requirement for DC-HSUPA .....	67
6.6.3.1A.1	Additional requirement for DC-HSUPA .....	72
6.6.3.1B	Additional requirement for UL OLTD .....	72
6.6.3.1C	Additional requirement for UL CLTD .....	72
6.6.3.1D	Additional requirement for UL MIMO .....	73
6.7	Transmit intermodulation .....	73
6.7.1	Minimum requirement .....	73
6.7.1A	Additional requirement for DC-HSUPA .....	73
6.7.1B	Additional requirement for UL OLTD .....	73
6.7.1C	Additional requirement for UL CLTD .....	73
6.7.1D	Additional requirement for UL MIMO .....	74
6.8	Transmit modulation .....	74
6.8.1	Transmit pulse shape filter .....	74
6.8.1A	Additional requirement for UL OLTD .....	74
6.8.1B	Additional requirement for UL CLTD .....	74
6.8.1C	Additional requirement for UL MIMO .....	74
6.8.2	Error Vector Magnitude .....	74
6.8.2.1	Minimum requirement .....	75
6.8.2.1A	Additional requirement for DC-HSUPA .....	75
6.8.2.1B	Additional requirement for UL OLTD .....	76
6.8.2.1C	Additional requirement for UL CLTD .....	76
6.8.2.1D	Additional requirement for UL MIMO .....	76
6.8.3	Peak code domain error .....	77
6.8.3.1	Minimum requirement .....	77
6.8.3.1A	Additional requirement for UL OLTD .....	77
6.8.3.1B	Additional requirement for UL CLTD .....	77
6.8.3a	Relative code domain error .....	77
6.8.3a.1	Relative Code Domain Error .....	77
6.8.3a.1.1	Minimum requirement .....	78
6.8.3a.1.1a	Additional requirement for DC-HSUPA .....	79
6.8.3a.1.1b	Additional requirement for UL OLTD .....	79
6.8.3a.1.1c	Additional requirement for UL CLTD .....	79
6.8.3a.1.1d	Additional requirement for UL MIMO .....	79
6.8.3b	In-band emission for DC-HSUPA .....	79
6.8.3b.1	Minimum requirement for DC-HSUPA .....	79
6.8.4	Phase discontinuity for uplink DPCH .....	80
6.8.4.1	Minimum requirement .....	80
6.8.4.1A	Additional requirement for UL OLTD .....	80
6.8.4.1B	Additional requirement for UL CLTD .....	80
6.8.5	Phase discontinuity for HS-DPCCH .....	80
6.8.5.1	Minimum requirement .....	81
6.8.5.1A	Additional requirement for UL OLTD .....	81
6.8.5.1B	Additional requirement for UL CLTD .....	81
6.8.6	Phase discontinuity for E-DCH .....	81
6.8.6.1	Minimum requirement .....	82
6.8.6.1A	Additional requirement for UL OLTD .....	82
6.8.6.1B	Additional requirement for UL CLTD .....	83
6.8.7	Time alignment error for DC-HSUPA .....	83
6.8.7.1	Minimum requirement .....	83
6.8.7A	Time alignment error for UL OLTD .....	83
6.8.7A.1	Minimum requirement .....	83
6.8.7B	Time alignment error for UL CLTD .....	83
6.8.7B.1	Minimum requirement .....	83



6.8.7C	Time alignment error for UL MIMO .....	83
6.8.7C.1	Minimum requirement .....	83
7	Receiver characteristics .....	83
7.1	General .....	83
7.2	Diversity characteristics .....	85
7.3	Reference sensitivity level.....	85
7.3.1	Minimum requirement .....	85
7.3.2	Additional requirement for DC-HSDPA.....	87
7.3.3	Additional requirement for DB-DC-HSDPA.....	89
7.3.4	Additional requirement for single band 4C-HSDPA .....	90
7.3.5	Additional requirement for dual band 4C-HSDPA.....	91
7.3.6	Additional requirement for single band 8C-HSDPA .....	91
7.3.7	Additional requirement for single band NC-4C-HSDPA .....	92
7.4	Maximum input level .....	93
7.4.1	Minimum requirement for DPCH reception .....	93
7.4.2	Minimum requirement for HS-PDSCH reception.....	93
7.4.2.1	Minimum requirement for 16QAM.....	93
7.4.2.2	Minimum requirement for 64QAM.....	94
7.4.3	Additional requirement for DC-HSDPA and DB-DC-HSDPA .....	95
7.4.3.1	Additional requirement for 16QAM.....	95
7.4.3.2	Additional requirement for 64QAM.....	95
7.4.4	Additional requirement for single band/dual band 4C-HSDPA or single band 8C-HSDPA and single band NC-4C-HSDPA.....	96
7.4.4.1	Additional requirement for 16QAM.....	96
7.4.4.2	Additional requirement for 64QAM.....	97
7.5	Adjacent Channel Selectivity (ACS).....	97
7.5.1	Minimum requirement .....	98
7.5.2	Additional requirement for DC-HSDPA and DB-DC-HSDPA .....	98
7.5.3	Additional requirement for single band/dual band 4C-HSDPA.....	99
7.5.4	Additional requirement for single band 8C-HSDPA .....	102
7.5.5	Additional requirement for single band NC-4C-HSDPA .....	103
7.6	Blocking characteristics .....	104
7.6.1	Minimum requirement (In-band blocking) .....	105
7.6.1A	Additional requirement for DC-HSDPA and DB-DC-HSDPA (In-band blocking) .....	106
7.6.1B	Additional requirement for DC-HSUPA (In-band blocking).....	108
7.6.1C	Additional requirement for single band 4C-HSDPA (In-band blocking) .....	110
7.6.1C.1	Single uplink operation .....	110
7.6.1C.2	Dual uplink operation.....	111
7.6.1D	Additional requirement for dual band 4C-HSDPA (In-band blocking) .....	112
7.6.1D.1	Single uplink operation .....	112
7.6.1D.2	Dual uplink operation.....	113
7.6.1E	Additional requirement for single band 8C-HSDPA (In-band blocking) .....	115
7.6.1E.1	Single uplink operation .....	115
7.6.1E.2	Dual uplink operation.....	115
7.6.1F	Additional requirement for single band NC-4C-HSDPA (In-band blocking).....	116
7.6.1F.1	Single uplink operation .....	116
7.6.1F.2	Dual uplink operation.....	117
7.6.2	Minimum requirement (Out-of-band blocking).....	118
7.6.2A	Additional requirement for DC-HSDPA (Out-of-band blocking) .....	120
7.6.2B	Additional requirement for DB-DC-HSDPA (Out-of-band blocking).....	122
7.6.2C	Additional requirement for single band 4C-HSDPA (Out-of-band blocking) .....	123
7.6.2D	Additional requirement for dual band 4C-HSDPA (Out-of-band blocking).....	124
7.6.2E	Additional requirement for single band 8C-HSDPA (Out-of-band blocking) .....	126
7.6.2F	Additional requirement for single band NC-4C-HSDPA (Out-of-band blocking) .....	127
7.6.3	Minimum requirement (Narrow band blocking).....	128
7.6.3A	Additional requirement for DC-HSDPA and DB-DC-HSDPA (Narrow band blocking).....	128
7.6.3B	Additional requirement for DC-HSUPA (Narrow band blocking) .....	129
7.6.3C	Additional requirement for single band 4C-HSDPA (Narrow band blocking) .....	129
7.6.3C.1	Single uplink operation .....	129
7.6.3C.2	Dual uplink operation.....	130
7.6.3D	Additional requirement for dual band 4C-HSDPA (Narrow band blocking).....	130



7.6.3D.1	Single uplink operation .....	131
7.6.3D.2	Dual uplink operation.....	131
7.6.3E	Additional requirement for single band NC-4C-HSDPA (Narrow band blocking).....	132
7.6.3E.1	Single uplink operation .....	132
7.6.3E.2	Dual uplink operation.....	133
7.7	Spurious response.....	134
7.7.1	Minimum requirement .....	134
7.7.2	Additional requirement for DC-HSDPA, DB-DC-HSDPA, single band/dual band 4C-HSDPA and single band 8C-HSDPA and single band NC-4C-HSDPA .....	135
7.8	Intermodulation characteristics .....	135
7.8.1	Minimum requirement .....	135
7.8.1A	Additional requirement for DC-HSDPA and DB-DC-HSDPA .....	136
7.8.1B	Additional requirement for DC-HSUPA.....	136
7.8.1C	Additional requirement for single band 4C-HSDPA .....	138
7.8.1C.1	Single uplink operation .....	138
7.8.1C.2	Dual uplink operation.....	138
7.8.1D	Additional requirement for dual band 4C-HSDPA .....	139
7.8.1D.1	Single uplink operation .....	139
7.8.1D.2	Dual uplink operation.....	140
7.8.1E	Additional requirement for single band 8C-HSDPA .....	141
7.8.1E.1	Single uplink operation .....	141
7.8.1E.2	Dual uplink operation.....	142
7.8.1F	Additional requirement for single band NC-4C-HSDPA .....	143
7.8.1F.1	Single uplink operation .....	143
7.8.1F.2	Dual uplink operation.....	143
7.8.2	Minimum requirement (Narrow band).....	144
7.8.2A	Additional requirement for DC-HSDPA and DB-DC-HSDPA (Narrow band).....	145
7.8.2B	Additional requirement for DC-HSUPA (Narrow band) .....	145
7.8.2C	Additional requirement for single band 4C-HSDPA (Narrow band).....	146
7.8.2C.1	Single uplink operation .....	146
7.8.2C.2	Dual uplink operation.....	147
7.8.2D	Additional requirement for dual band 4C-HSDPA (Narrow band) .....	147
7.8.2D.1	Single uplink operation .....	147
7.8.2D.2	Dual uplink operation.....	148
7.8.2E	Additional requirement for single band NC-4C-HSDPA (Narrow band).....	150
7.8.2E.1	Single uplink operation .....	150
7.8.2E.2	Dual uplink operation.....	150
7.9	Spurious emissions .....	151
7.9.1	Minimum requirement .....	151
7.9.1A	Minimum requirement .....	152
7.10	Reference input power adjustment for a dual band device .....	153
8	Performance requirement .....	153
8.1	General .....	153
8.2	Demodulation in static propagation conditions .....	154
8.2.1	(void) .....	154
8.2.2	(void) .....	154
8.2.3	Demodulation of Dedicated Channel (DCH).....	154
8.2.3.1	Minimum requirement .....	154
8.2.4	Demodulation of Dedicated Channel (DCH) when DL_DCH_FET_Config [10] is configured by higher layers.....	154
8.2.4.1	Minimum requirement .....	155
8.3	Demodulation of DCH in multi-path fading propagation conditions .....	155
8.3.1	Single Link Performance .....	155
8.3.1.1	Minimum requirement .....	155
8.3.2	Single Link Performance when DL_DCH_FET_Config [10] is configured by higher layers .....	158
8.3.2.1	Minimum requirement .....	158
8.4	Demodulation of DCH in moving propagation conditions.....	160
8.4.1	Single link performance .....	160
8.4.1.1	Minimum requirement .....	160
8.5	Demodulation of DCH in birth-death propagation conditions .....	161
8.5.1	Single link performance .....	161



8.5.1.1	Minimum requirement .....	161
8.5A	Demodulation of DCH in high speed train condition .....	161
8.5A.1	General .....	161
8.5A.2	Minimum requirement .....	161
8.6	Demodulation of DCH in downlink Transmit diversity modes .....	162
8.6.1	Demodulation of DCH in open-loop transmit diversity mode .....	162
8.6.1.1	Minimum requirement .....	162
8.6.2	Demodulation of DCH in closed loop transmit diversity mode .....	163
8.6.2.1	Minimum requirement .....	163
8.6.3	(void) .....	164
8.7	Demodulation in Handover conditions .....	164
8.7.1	Demodulation of DCH in Inter-Cell Soft Handover .....	164
8.7.1.1	Minimum requirement .....	164
8.7.1A	Demodulation of DCH in Inter-Cell Soft Handover when DL_DCH_FET_Config [10] is configured by higher layers .....	165
8.7.1A.1	Minimum requirement .....	165
8.7.2	Combining of TPC commands from radio links of different radio link sets .....	166
8.7.2.1	Minimum requirement .....	166
8.7.2A	Combining of TPC commands from radio links of different radio link sets when DL_DCH_FET_Config [10] is configured by higher layers .....	166
8.7.2A.1	Minimum requirement .....	166
8.7.2B	Combining of TPC commands from radio links of different radio link sets when DPCCH2 is configured .....	167
8.7.2B.1	Minimum requirement .....	167
8.7.3	Combining of reliable TPC commands from radio links of different radio link sets .....	168
8.7.3.1	Minimum requirement .....	168
8.7.4	Combining of reliable TPC commands from radio links of different radio link sets when DL_DCH_FET_Config [10] is configured by higher layers .....	169
8.7.4.1	Minimum requirement .....	169
8.8	Power control in downlink .....	170
8.8.1	Power control in the downlink, constant BLER target .....	170
8.8.1.1	Minimum requirements .....	170
8.8.1A	Power control in the downlink, constant BLER target when DL_DCH_FET_Config [10] is configured by higher layers .....	172
8.8.1A.1	Minimum requirements .....	172
8.8.2	Power control in the downlink, initial convergence .....	173
8.8.2.1	Minimum requirements .....	173
8.8.2A	Power control in the downlink, initial convergence when DL_DCH_FET_Config [10] is configured by higher layers .....	175
8.8.2A.1	Minimum requirements .....	175
8.8.3	Power control in downlink, wind up effects .....	176
8.8.3.1	Minimum requirements .....	176
8.8.3A	Power control in downlink, wind up effects when DL_DCH_FET_Config [10] is configured by higher layers .....	177
8.8.3A.1	Minimum requirements .....	177
8.8.4	Power control in the downlink, different transport formats .....	179
8.8.4.1	Minimum requirements .....	179
8.8.4A	Power control in the downlink, different transport formats .....	180
8.8.4A.1	Minimum requirements .....	180
8.8.5	Power control in the downlink for F-DPCH .....	182
8.8.5.1	Minimum requirements .....	182
8.9	Downlink compressed mode .....	182
8.9.1	Single link performance .....	182
8.9.1.1	Minimum requirements .....	183
8.10	Blind transport format detection .....	183
8.10.1	Minimum requirement .....	183
8.11	Detection of Broadcast channel (BCH) .....	184
8.11.1	Minimum requirement without transmit diversity .....	184
8.11.2	Minimum requirement with open loop transmit diversity .....	185
8.11A	Detection of Broadcast channel (BCH) mapped to S-CCPCH .....	185
8.11A.1	Minimum requirement without transmit diversity .....	185
8.11.2	Minimum requirement with open loop transmit diversity .....	186



8.12	Demodulation of Paging Channel (PCH) .....	186
8.12.1	Minimum requirement .....	186
8.13	Detection of Acquisition Indicator (AI) .....	187
8.13.1	Minimum requirement .....	187
8.13A	Detection of E-DCH Acquisition Indicator (E-AI) .....	187
8.13A.1	Minimum requirement .....	187
8.14	UE UL power control operation with discontinuous UL DPCCH transmission operation .....	188
8.14.1	Minimum requirement .....	188
8.15	(void) .....	189
8.16	(void) .....	189
9	Performance requirement (HSDPA) .....	189
9.1	(void) .....	190
9.2	Demodulation of HS-DSCH (Fixed Reference Channel) .....	190
9.2.1	Single Link performance .....	204
9.2.1.1	Requirement QPSK, Fixed Reference Channel (FRC) H-Set 1/2/3/3A/3B/3C/3E .....	204
9.2.1.2	Requirement 16QAM, Fixed Reference Channel (FRC) H-Set 1/2/3 .....	206
9.2.1.3	Minimum requirement QPSK, Fixed Reference Channel (FRC) H-Set 4/5 .....	207
9.2.1.4	Requirement QPSK, Fixed Reference Channel (FRC) H-Set 6/6A/6B/6C/6E .....	208
9.2.1.5	Requirement 16QAM, Fixed Reference Channel (FRC) H-Set 6/6A/6B/6C/6E .....	210
9.2.1.6	Requirement 64QAM, Fixed Reference Channel (FRC) H-Set 8/8A/8B/8C/8E .....	212
9.2.1.7	Requirement QPSK, Fixed Reference Channel (FRC) H-Set 10/10A/10B/10C/10E .....	214
9.2.1.8	Requirement 16QAM, Fixed Reference Channel (FRC) H-Set 10/10A/10B/10C/10E .....	215
9.2.2	Open Loop Diversity performance .....	216
9.2.2.1	Requirement QPSK, Fixed Reference Channel (FRC) H-Set 1/2/3/3A/3B/3C/3E .....	216
9.2.2.2	Requirement 16QAM, Fixed Reference Channel (FRC) H-Set 1/2/3/3A/3B/3C/3E .....	217
9.2.2.3	Minimum requirement QPSK, Fixed Reference Channel (FRC) H-Set 4/5 .....	218
9.2.3	Closed Loop Diversity Performance .....	219
9.2.3.1	Requirement QPSK, Fixed Reference Channel (FRC) H-Set 1/2/3 .....	219
9.2.3.2	Requirement 16QAM, Fixed Reference Channel (FRC) H-Set 1/2/3 .....	221
9.2.3.3	Minimum requirement QPSK, Fixed Reference Channel (FRC) H-Set 4/5 .....	222
9.2.3.4	Requirement QPSK, Fixed Reference Channel (FRC) H-Set 6 .....	223
9.2.3.5	Requirement 16QAM, Fixed Reference Channel (FRC) H-Set 6 .....	223
9.2.4	MIMO Performance .....	224
9.2.4.1	Requirement Fixed Reference Channel (FRC) H-Set 9/9A/9B/9C/9E .....	224
9.2.4.2	Requirement Fixed Reference Channel (FRC) H-Set 11/11A/11B/11C/11E .....	226
9.2.4A	MIMO only with single-stream restriction Performance .....	228
9.2.4A.1	Requirement QPSK, Fixed Reference Channel (FRC) H-Set 1/1A/1B/1C/1E .....	228
9.2.4A.2	Requirement 16QAM, Fixed Reference Channel (FRC) H-Set 1/1A/1B/1C/1E .....	230
9.2.4B	Four Transmit Antennas MIMO Performance .....	232
9.2.4B.1	Requirement Fixed Reference Channel (FRC) H-Set 13A/13C .....	232
9.2.4B.2	Requirement Fixed Reference Channel (FRC) H-Set 14A/14C .....	233
9.2.4C	MIMO Mode with Four Transmit Antennas Only With Dual-stream Restriction Performance .....	234
9.2.4C.1	Requirement Fixed Reference Channel (FRC) H-Set 9A/9C .....	234
9.2.4C.2	Requirement Fixed Reference Channel (FRC) H-Set 11A/11C .....	235
9.2.5	Multiflow HSDPA performance .....	236
9.2.5.1	Requirement Fixed Reference Channel (FRC) H-Set 6 16QAM/QPSK .....	236
9.3	Reporting of Channel Quality Indicator .....	237
9.3.1	Single Link Performance .....	238
9.3.1.1	AWGN propagation conditions .....	238
9.3.1.1.1	Minimum Requirement – UE HS-DSCH categories 1-20 .....	238
9.3.1.1.2	Minimum Requirement – UE HS-DSCH categories 13,14,17,18, 19 and 20 .....	238
9.3.1.1.3	Additional Requirements – UE HS-DSCH categories 21, 22, 23, 24, 25, 26, 27, 28, 29, 30, 31, 32, 35 and 36 .....	239
9.3.1.2	Fading propagation conditions .....	240
9.3.1.2.1	Minimum Requirement – UE HS-DSCH categories 1-20 .....	240
9.3.1.2.2	Minimum Requirement – UE HS-DSCH categories 13,14,17,18, 19 and 20 .....	241
9.3.1.2.3	Additional Requirements – UE HS-DSCH categories 21, 22, 23, 24, 25, 26, 27, 28, 29, 30, 31, 32, 35 and 36 .....	242
9.3.1.3	Periodically varying radio conditions .....	243
9.3.1.3.1	Minimum Requirement – UE HS-DSCH categories 1-20 .....	243
9.3.2	Open Loop Diversity Performance .....	245



9.3.2.1	AWGN propagation conditions.....	245
9.3.2.1.1	Minimum Requirement – UE HS-DSCH categories 1-20 .....	245
9.3.2.1.2	Additional Requirements – UE HS-DSCH categories 21, 22, 23, 24, 25, 26, 27, 28, 29, 30, 31, 32, 35 and 36 .....	245
9.3.2.2	Fading propagation conditions .....	246
9.3.2.2.1	Minimum Requirement – UE HS-DSCH categories 1-20 .....	246
9.3.2.2.2	Additional Requirements – UE HS-DSCH categories 21, 22, 23, 24, 25, 26, 27, 28, 29, 30, 31, 32, 35 and 36 .....	247
9.3.2.3	Periodically varying radio conditions.....	247
9.3.2.3.1	Minimum Requirement – UE HS-DSCH categories 1-20 .....	248
9.3.3	Closed Loop Diversity Performance.....	249
9.3.3.1	AWGN propagation conditions.....	249
9.3.3.1.1	Minimum Requirement – UE HS-DSCH categories 1-20 .....	249
9.3.3.2	Fading propagation conditions .....	250
9.3.3.2.1	Minimum Requirement – UE HS-DSCH categories 1-20 .....	250
9.3.3.3	Periodically varying radio conditions.....	251
9.3.3.3.1	Minimum Requirement – UE HS-DSCH categories 1-20 .....	251
9.3.4	MIMO Performance.....	253
9.3.4.1	MIMO Single Stream Fading Conditions .....	253
9.3.4.1.1	Minimum Requirement - UE HS-DSCH categories 15-20.....	253
9.3.4.1.2	Additional Requirement – UE HS-DSCH categories 25-28, 30, 32 and 36 .....	254
9.3.4.2	MIMO Dual Stream Fading Conditions .....	255
9.3.4.2.1	Minimum Requirement – UE HS-DSCH categories 15-20 .....	256
9.3.4.2.2	Minimum Requirement – UE HS-DSCH categories 19-20 .....	257
9.3.4.2.3	Additional Requirement – UE HS-DSCH categories 25-28, 30, 32 and 36 .....	258
9.3.4.2.4	Additional Requirement – UE HS-DSCH categories 27, 28, 30, 32 and 36.....	260
9.3.4.3	MIMO Dual Stream Static Orthogonal Conditions .....	261
9.3.4.3.1	Minimum Requirement –UE HS-DSCH categories 15-20.....	262
9.3.4.3.2	Minimum Requirement –UE HS-DSCH categories 19-20.....	262
9.3.4.3.3	Additional Requirement – UE HS-DSCH categories 25-28, 30, 32 and 36 .....	263
9.3.4.3.4	Additional Requirement – UE HS-DSCH categories 27, 28, 30, 32 and 36.....	264
9.3.5	MIMO only with single-stream restriction Performance .....	265
9.3.5.1	MIMO only with single-stream restriction Fading Conditions .....	265
9.3.5.1.1	Minimum Requirement .....	265
9.3.6	Multiflow HSDPA performance .....	266
9.3.6.1	Fading propagation conditions .....	266
9.3.6.1.1	Minimum Requirement .....	267
9.3.7	MIMO Performance with four transmit antennas .....	267
9.3.7.1	Four Streams Static Orthogonal Conditions.....	267
9.3.7.1.1	Minimum Requirement – UE HS-DSCH categories 37 and 38.....	268
9.3.8	MIMO with Four Transmit Antennas only with Dual-Stream Restriction Performance .....	269
9.3.8.1	MIMO with four transmit antennas only with dual-stream restriction fading conditions .....	269
9.3.8.1.1	Minimum Requirement .....	270
9.4	HS-SCCH Detection Performance .....	271
9.4.1	HS-SCCH Type 1 Single Link Performance .....	272
9.4.2	HS-SCCH Type 1 Open Loop Diversity Performance .....	272
9.4.3	HS-SCCH Type 3 Performance .....	273
9.4.4	HS-SCCH Type 3 Performance for MIMO only with single-stream restriction.....	275
9.4.5	HS-SCCH Type 4 Performance .....	277
9.4.6	HS-SCCH Type 4 Performance for MIMO mode with Four Transmit Antennas Only with Dual- stream Restriction .....	278
9.5	HS-SCCH-less demodulation of HS-DSCH (Fixed Reference Channel).....	279
9.5.1	Requirement QPSK, Fixed Reference Channel (FRC) H-Set 7 .....	280
9.6	Requirements for HS-DSCH and HS-SCCH reception in CELL_FACH state .....	280
9.6.1	HS-DSCH demodulation requirements (Single Link) .....	280
9.6.1.1	Requirement QPSK, Fixed Reference Channel (FRC) H-Set 3 .....	281
9.6.2	HS-SCCH Detection Performance.....	281
9.6.2.1	HS-SCCH Type 1 Single Link Performance.....	281
10	Performance requirement (E-DCH) .....	282
10.1	General .....	282
10.2	Detection of E-DCH HARQ ACK Indicator Channel (E-HICH).....	282



10.2.1	Single link performance .....	282
10.2.1.1	Performance requirement .....	282
10.2.2	Detection in Inter-Cell Handover conditions .....	283
10.2.2.1	Performance requirement for RLS not containing the Serving E-DCH cell .....	283
10.2.2.2	Performance requirement for RLS containing the serving E-DCH cell .....	285
10.3	Detection of E-DCH Relative Grant Channel (E-RGCH) .....	286
10.3.1	Single link performance .....	286
10.3.1.1	Performance requirement .....	286
10.3.2	Detection in Inter-Cell Handover conditions .....	288
10.3.2.1	Performance requirement for Non-serving E-DCH RL .....	288
10.3A	Determination of common E-RGCH radio links in CELL_FACH state .....	289
10.3A.1	Introduction.....	289
10.3A.2	Requirements .....	289
10.3A.2.1	Determination when a cell for common E-RGCH RL has been already identified.....	289
10.3A.2.2	Determination when a cell for common E-RGCH RL has not been identified .....	290
10.4	Demodulation of E-DCH Absolute Grant Channel (E-AGCH) .....	291
10.4.1	Single link performance .....	291
10.4.1.1	Performance requirement .....	292
10.4A	Demodulation of E-DCH Absolute Grant Channel (E-AGCH) with Time Multiplexed UE grants.....	292
10.4A.1	Single link performance .....	292
10.4A.1.1	Performance requirement .....	292
11	Performance requirement (MBMS).....	293
11.1	Demodulation of MCCH .....	294
11.1.1	Minimum requirement .....	294
11.1.2	Minimum requirement for MBSFN .....	294
11.2	Demodulation of MTCH .....	295
11.2.1	Minimum requirement .....	295
11.2.2	Minimum requirement for MBSFN .....	295
11.3	Demodulation of MTCH and cell identification.....	296
11.3.1	Minimum requirement .....	296
<b>Annex A (normative):</b>	<b>Measurement channels .....</b>	<b>297</b>
A.1	General .....	297
A.2	UL reference measurement channel .....	297
A.2.1	UL reference measurement channel (12.2 kbps) .....	297
A.2.2	UL reference measurement channel (64 kbps) .....	298
A.2.3	UL reference measurement channel (144 kbps) .....	299
A.2.4	UL reference measurement channel (384 kbps) .....	300
A.2.5	UL reference measurement channel (768 kbps) .....	301
A.2.5A	UL reference measurement channel (768 kbps) .....	301
A.2.6	UL E-DCH reference measurement channel for DC-HSUPA using BPSK modulation .....	302
A.2.7	UL E-DCH reference measurement channel for DC-HSUPA using 16QAM modulation.....	303
A.2.8	Combinations of UL E-DCH reference measurement channel for DC-HSUPA tests .....	304
A.3	DL reference measurement channel .....	304
A.3.0	DL reference measurement channel (0 kbps) .....	304
A.3.1	DL reference measurement channel (12.2 kbps) .....	305
A.3.2	DL reference measurement channel (64 kbps) .....	306
A.3.3	DL reference measurement channel (144 kbps) .....	307
A.3.4	DL reference measurement channel (384 kbps) .....	308
A.3.5	DL reference measurement channel 2 (64 kbps) .....	309
A.3A	DL reference measurement channel .....	310
A.3A.0	DL reference measurement channel (0 kbps without DCCH) .....	310
A.3A.1	DL reference measurement channel (0 kbps with DCCH) .....	311
A.3A.2	DL reference measurement channel (12.2 kbps without DCCH) .....	312
A.3A.3	DL reference measurement channel (12.2 kbps with DCCH) .....	313
A.4	DL reference measurement channel for BTFD performance requirements .....	315
A.4A	Reference parameters for discontinuous UL DPCCCH transmission.....	317



A.5	DL reference compressed mode parameters.....	317
A.6	DL reference parameters for PCH tests.....	319
A.7	DL reference channel parameters for HSDPA tests.....	320
A.7.1	Fixed Reference Channel (FRC) .....	320
A.7.1.1	Fixed Reference Channel Definition H-Set 1/1A/1B/1C/1E .....	320
A.7.1.2	Fixed Reference Channel Definition H-Set 2 .....	321
A.7.1.3	Fixed Reference Channel Definition H-Set 3/3A/3B/3C/3E .....	322
A.7.1.4	Fixed Reference Channel Definition H-Set 4 .....	323
A.7.1.5	Fixed Reference Channel Definition H-Set 5 .....	324
A.7.1.6	Fixed Reference Channel Definition H-Set 6/6A/6B/6C/6E .....	325
A.7.1.7	Fixed Reference Channel Definition H-Set 7 .....	326
A.7.1.8	Fixed Reference Channel Definition H-Set 8/8A/8B/8C/8E .....	327
A.7.1.9	Fixed Reference Channel Definition H-Set 9/9A/9B/9C/9E .....	328
A.7.1.10	Fixed Reference Channel Definition H-Set 10/10A/10B/10C/10E .....	329
A.7.1.11	Fixed Reference Channel Definition H-Set 11/11A/11B/11C/11E .....	331
A.7.1.12	Fixed Reference Channel Definition H-Set 12 .....	332
A.7.1.13	Fixed Reference Channel Definition H-Set 13/13A/13C.....	333
A.7.1.14	Fixed Reference Channel Definition H-Set 14/14A/14C.....	334
A.8	DL reference parameters for MBMS tests.....	335
A.8.1	MCCH .....	335
A.8.1	MTCH .....	336
A.9	DL reference parameters for combined MTCH demodulation and cell identification.....	336
<b>Annex B (normative) : Propagation conditions.....</b>		<b>338</b>
B.1	(void) .....	338
B.2	Propagation Conditions .....	338
B.2.1	Static propagation condition.....	338
B.2.2	Multi-path fading propagation conditions .....	338
B.2.3	Moving propagation conditions.....	341
B.2.4	Birth-Death propagation conditions .....	342
B.2.5	High speed train condition.....	342
B.2.6	MIMO propagation conditions .....	343
B.2.6.1	MIMO Single Stream Fading Conditions .....	344
B.2.6.2	MIMO Dual Stream Fading Conditions.....	345
B.2.6.3	MIMO Dual Stream Static Orthogonal Conditions .....	346
B.2.7	Propagation conditions for MIMO with four transmit antennas.....	346
B.2.7.1	MIMO with Four Transmit Antennas and Four Streams Static Orthogonal Conditions.....	347
B.2.7.2	MIMO with Four Transmit Antennas Only With Dual Stream Fading Conditions.....	347
<b>Annex C (normative): Downlink Physical Channels.....</b>		<b>349</b>
C.1	General .....	349
C.2	Connection Set-up .....	349
C.3	During connection .....	349
C.3.1	Measurement of Rx Characteristics.....	349
C.3.2	Measurement of Performance requirements .....	350
C.3.3	Connection with open-loop transmit diversity mode.....	351
C.3.4	Connection with closed loop transmit diversity mode.....	351
C.3.5	(void) .....	352
C.4	W-CDMA Modulated Interferer .....	352
C.5	HSDPA DL Physical channels .....	353
C.5.1	Downlink Physical Channels connection set-up.....	353
C.5.2	OCNS Definition.....	363
C.5.3	Test Definition for Enhanced Performance Type 3i.....	364
C.5.3.1	Transmitted code and power characteristics for serving cell .....	364
C.5.3.2	Transmitted code and power characteristics for interfering cells.....	366



C.5.3.3	Model for power control sequence generation.....	367
C.5.4	Simplified Multi Carrier HSDPA testing method .....	367
C.5.4A	Simplified Multiflow HSDPA testing method .....	368
C.5.5	Test Definition for Multiflow HSDPA.....	368
C.5.5.1	Test configuration when 2 cells are configured in Multiflow mode .....	368
C.5.5.2	Test configuration when 3 cells are configured in Multiflow mode .....	370
C.5.5.3	Test configuration when 4 cells are configured in Multiflow mode .....	370
C.6	MBMS DL Physical channels .....	371
C.6.1	Downlink Physical Channels connection set-up.....	371
C.6.2	Downlink Physical Channels connection set-up for MBSFN .....	371
<b>Annex D (normative) :</b>	<b>Environmental conditions .....</b>	<b>372</b>
D.1	General .....	372
D.2	Environmental requirements .....	372
D.2.1	Temperature .....	372
D.2.2	Voltage .....	372
D.2.3	Vibration.....	373
<b>Annex E (informative):</b>	<b>UARFCN numbers .....</b>	<b>374</b>
E.1	General .....	374
E.2	List of UARFCN used for UTRA FDD bands .....	374
<b>Annex F (informative):</b>	<b>Change history .....</b>	<b>378</b>
History .....		384



---

# Foreword

This Technical Specification (TS) has been produced by the 3<sup>rd</sup> Generation Partnership Project (3GPP).

The contents of the present document are subject to continuing work within the TSG and may change following formal TSG approval. Should the TSG modify the contents of the present document, it will be re-released by the TSG with an identifying change of release date and an increase in version number as follows:

Version x.y.z

where:

- x the first digit:
  - 1 presented to TSG for information;
  - 2 presented to TSG for approval;
  - 3 or greater indicates TSG approved document under change control.
- y the second digit is incremented for all changes of substance, i.e. technical enhancements, corrections, updates, etc.
- z the third digit is incremented when editorial only changes have been incorporated in the document.



---

# 1 Scope

The present document establishes the minimum RF characteristics of the FDD mode of UTRA for the User Equipment (UE).

---

# 2 References

The following documents contain provisions which, through reference in this text, constitute provisions of the present document.

- References are either specific (identified by date of publication, edition number, version number, etc.) or non-specific.
- For a specific reference, subsequent revisions do not apply.
- For a non-specific reference, the latest version applies. In the case of a reference to a 3GPP document (including a GSM document), a non-specific reference implicitly refers to the latest version of that document *in the same Release as the present document*.

- [1] (void)
- [2] ITU-R Recommendation SM.329: "Unwanted emissions in the spurious domain".
- [3] (void)
- [4] 3GPP TS 25.433: "UTRAN Iub Interface NBAP Signalling".
- [5] ETSI ETR 273: "Electromagnetic compatibility and Radio spectrum Matters (ERM); Improvement of radiated methods of measurement (using test sites) and evaluation of the corresponding measurement uncertainties; Part 1: Uncertainties in the measurement of mobile radio equipment characteristics; Sub-part 2: Examples and annexes".
- [6] 3GPP TS 45.004: "Modulation".
- [7] 3GPP TS 25.331: "Radio Resource Control (RRC); Protocol Specification".
- [8] 3GPP TS25.214: "Physical layer procedures (FDD)".
- [9] 3GPP TS 25.307: "Requirements on User Equipments (UEs) supporting a release-independent frequency band".
- [10] 3GPP TS25.212: "Multiplexing and channel coding (FDD)".
- [11] 3GPP TS 36.101: "E-UTRA User Equipment (UE) radio transmission and reception".

---

# 3 Definitions, symbols and abbreviations

## 3.1 Definitions

For the purposes of the present document, the following definitions apply:

**Assisting secondary serving HS-DSCH Cell:** In addition to the serving HS-DSCH cell, a cell in the secondary downlink frequency, where the UE is configured to simultaneously monitor a HS-SCCH set and receive HS-DSCH if it is scheduled in that cell.



**Assisting serving HS-DSCH Cell:** In addition to the serving HS-DSCH cell, a cell in the same frequency, where the UE is configured to simultaneously monitor a HS-SCCH set and receive HS-DSCH if it is scheduled in that cell.

**Cell group:** A group of (one or two) Multiflow mode cells that have the same CPICH timing. The CQI reports for all the cells in a cell group are reported together in the same sub frame. The cells that belong to a cell group are indicated by higher layers.

**Enhanced performance requirements type 1:** This defines performance requirements which are optional for the UE. The requirements are based on UEs which utilise receiver diversity.

**Enhanced performance requirements type 2:** This defines performance requirements which are optional for the UE. The requirements are based on UEs which utilise a chip equaliser receiver structure.

**Enhanced performance requirements type 3:** This defines performance requirements which are optional for the UE. The requirements are based on UEs which utilise a chip equaliser receiver structure with receiver diversity.

**Enhanced performance requirements type 3i:** This defines performance requirements which are optional for the UE. The requirements are based on UEs which utilise an interference-aware chip equaliser receiver structure with receiver diversity.

**Power Spectral Density:** The units of Power Spectral Density (PSD) are extensively used in this document. PSD is a function of power versus frequency and when integrated across a given bandwidth, the function represents the mean power in such a bandwidth. When the mean power is normalised to (divided by) the chip-rate it represents the mean energy per chip. Some signals are directly defined in terms of energy per chip, (DPCH\_ $E_c$ ,  $E_c$ , OCNS\_ $E_c$  and S-CCPCH\_ $E_c$ ) and others defined in terms of PSD ( $I_o$ ,  $I_{oc}$ ,  $I_{or}$  and  $\hat{I}_{or}$ ). There also exist quantities that are a ratio of energy per chip to PSD (DPCH\_ $E_c/I_{or}$ ,  $E_c/I_{or}$  etc.). This is the common practice of relating energy magnitudes in communication systems.

It can be seen that if both energy magnitudes in the ratio are divided by time, the ratio is converted from an energy ratio to a power ratio, which is more useful from a measurement point of view. It follows that an energy per chip of X dBm/3.84 MHz can be expressed as a mean power per chip of X dBm. Similarly, a signal PSD of Y dBm/3.84 MHz can be expressed as a signal power of Y dBm.

**Maximum Output Power:** This is a measure of the maximum power the UE can transmit (i.e. the actual power as would be measured assuming no measurement error) in a bandwidth of at least  $(1 + \alpha)$  times the chip rate of the radio access mode. The period of measurement shall be at least one timeslot. For DC-HSUPA the maximum output power is defined by the sum of the broadband transmit power of each carrier in the UE.

**Mean power:** When applied to a W-CDMA modulated signal this is the power (transmitted or received) in a bandwidth of at least  $(1 + \alpha)$  times the chip rate of the radio access mode. The period of measurement shall be at least one timeslot unless otherwise stated.

**Multiflow mode:** The UE is configured in Multiflow mode when it is configured with assisting serving HS-DSCH cell.

**Nominal Maximum Output Power:** This is the nominal power defined by the UE power class.

**Primary uplink frequency:** If a single uplink frequency is configured for the UE, then it is the primary uplink frequency. In case more than one uplink frequency is configured for the UE, then the primary uplink frequency is the frequency on which the E-DCH corresponding to the serving E-DCH cell associated with the serving HS-DSCH cell is transmitted. The association between a pair of uplink and downlink frequencies is indicated by higher layers.

**RRC filtered mean power:** The mean power as measured through a root raised cosine filter with roll-off factor  $\alpha$  and a bandwidth equal to the chip rate of the radio access mode.

NOTE 1: The RRC filtered mean power of a perfectly modulated W-CDMA signal is 0.246 dB lower than the mean power of the same signal.

NOTE 2: The roll-off factor  $\alpha$  is defined in section 6.8.1.

**Secondary serving HS-DSCH cell(s):** In addition to the serving HS-DSCH cell, the set of cells where the UE is configured to simultaneously monitor an HS-SCCH set and receive the HS-DSCH if it is scheduled in that cell. There can be up to 7 secondary serving HS-DSCH cells.

**Secondary uplink frequency:** A secondary uplink frequency is a frequency on which an E-DCH corresponding to a serving E-DCH cell associated with a secondary serving HS-DSCH cell is transmitted. The association between a pair of uplink and downlink frequencies is indicated by higher layers.



**Time reference cell:** The (Serving or Assisting Serving, but not Secondary Serving or Assisting Secondary Serving) HS-DSCH cell that carries the HS-PDSCH acting as the time reference for the uplink HS-DPCCH when in Multiflow mode. There is one and only one Time reference cell.

**Throughput:** Number of information bits per second excluding CRC bits successfully received on HS-DSCH by a HSDPA capable UE.

**1<sup>st</sup> secondary serving HS-DSCH cell:** If the UE is configured with two uplink frequencies, the 1<sup>st</sup> secondary serving HS-DSCH cell is the secondary serving HS-DSCH cell that is associated with the secondary uplink frequency. If the UE is configured with a single uplink frequency, the 1<sup>st</sup> secondary serving HS-DSCH cell is a secondary serving HS-DSCH cell whose index is indicated by higher layers.

## 3.2 Abbreviations

For the purposes of the present document, the following abbreviations apply:

4C-HSDPA	Four-Carrier HSDPA. HSDPA operation configured on 3 or 4 DL carriers.
ACLR	Adjacent Channel Leakage power Ratio
ACS	Adjacent Channel Selectivity
AICH	Acquisition Indication Channel
BER	Bit Error Ratio
BLER	Block Error Ratio
CQI	Channel Quality Indicator
CW	Continuous Wave (un-modulated signal)
DB-DC-HSDPA	Dual Band Dual Cell HSDPA
DC-HSDPA	Dual Cell HSDPA
DC-HSUPA	Dual Cell HSUPA
DCH	Dedicated Channel, which is mapped into Dedicated Physical Channel.
DIP	Dominant Interferer Proportion ratio
DL	Down Link (forward link)
DTX	Discontinuous Transmission
DPCCH	Dedicated Physical Control Channel
DPCH	Dedicated Physical Channel
$DPCH\_E_c$	Average energy per PN chip for DPCH.
$\frac{DPCH\_E_c}{I_{or}}$	The ratio of the transmit energy per PN chip of the DPCH to the total transmit power spectral density at the Node B antenna connector.
DPDCH	Dedicated Physical Data Channel
E-AGCH	E-DCH Absolute Grant Channel
E-DCH	Enhanced Dedicated Channel
E-DPCCH	E-DCH Dedicated Physical Control Channel
E-DPDCH	E-DCH Dedicated Physical Data Channel
E-HICH	E-DCH HARQ ACK Indicator Channel
E-RGCH	E-DCH Relative Grant Channel
EIRP	Effective Isotropic Radiated Power
$E_c$	Average energy per PN chip.
$\frac{E_c}{I_{or}}$	The ratio of the average transmit energy per PN chip for different fields or physical channels to the total transmit power spectral density.
FACH	Forward Access Channel
FDD	Frequency Division Duplex
FDR	False transmit format Detection Ratio. A false Transport Format detection occurs when the receiver detects a different TF to that which was transmitted, and the decoded transport block(s) for this incorrect TF passes the CRC check(s).
F-TPICH	Fractional Transmitted Precoding Indicator Channel
$F_{uw}$	Frequency of unwanted signal. This is specified in bracket in terms of an absolute frequency(s) or a frequency offset from the assigned channel frequency. For DC-HSDPA, negative offset refers to the assigned channel frequency of the lowest carrier frequency used and positive offset refers to the assigned channel frequency of the highest carrier frequency used. For DB-DC-HSDPA, offset refers to the assigned channel frequencies of the individual cells.



HARQ	Hybrid Automatic Repeat Request
HSDPA	High Speed Downlink Packet Access
HSUPA	High Speed Uplink Packet Access
HS-DPCCH	Dedicated Physical Control Channel (uplink) for HS-DSCH
HS-DPCCH <sub>2</sub>	Secondary Dedicated Physical Control Channel (uplink) for HS-DSCH, when Secondary_Cell_Enabled is greater than 3
HS-DSCH	High Speed Downlink Shared Channel
HS-PDSCH	High Speed Physical Downlink Shared Channel
HS-SCCH	High Speed Shared Control Channel
Information Data Rate	Rate of the user information, which must be transmitted over the Air Interface. For example, output rate of the voice codec.
$I_o$	The total received power spectral density, including signal and interference, as measured at the UE antenna connector.
$I_{oc}$	The power spectral density (integrated in a noise bandwidth equal to the chip rate and normalized to the chip rate) of a band limited white noise source (simulating interference from cells, which are not defined in a test procedure) as measured at the UE antenna connector. For DC-HSDPA and DB-DC-HSDPA, $I_{oc}$ is defined for each of the cells individually and is assumed to be equal for both cells unless explicitly stated per cell.
$I_{oc}''$	The received power spectral density (integrated in a noise bandwidth equal to the chip rate and normalized to the chip rate) of the summation of the received power spectral densities of the two strongest interfering cells plus $I_{oc}$ as measured at the UE antenna connector. The respective power spectral density of each interfering cell relative to $I_{oc}''$ is defined by its associated DIP value.
$I_{otx}$	The power spectral density (integrated in a noise bandwidth equal to the chip rate and normalized to the chip rate) of a band limited white noise source (simulating Node B transmitter impairments) as measured at the Node B transmit antenna connector(s). For DC-HSDPA and DB-DC-HSDPA, $I_{otx}$ is defined for each of the cells individually and is assumed to be equal for both cells unless explicitly stated per cell.
$I_{or}$	The total transmit power spectral density (integrated in a bandwidth of $(1+\alpha)$ times the chip rate and normalized to the chip rate) of the downlink signal at the Node B antenna connector. For DC-HSDPA and DB-DC-HSDPA, $I_{or}$ is defined for each of the cells individually and is assumed to be equal for both cells unless explicitly stated per cell.
$\hat{I}_{or}$	The received power spectral density (integrated in a bandwidth of $(1+\alpha)$ times the chip rate and normalized to the chip rate) of the downlink signal as measured at the UE antenna connector. For DC-HSDPA and DB-DC-HSDPA, $\hat{I}_{or}$ is defined for each of the cells individually and is assumed to be equal for both cells unless explicitly stated per cell.
MBSFN	MBMS over a Single Frequency Network
MER	Message Error Ratio
MIMO	Multiple Input Multiple Output
NC-4C-HSDPA	Non-Contiguous Four-Carrier HSDPA. HSDPA operation configured on 2, 3 or 4 DL carriers with two non contiguous subblocks of adjacent carriers.
Node B	A logical node responsible for radio transmission / reception in one or more cells to/from the User Equipment. Terminates the Iub interface towards the RNC
OCNS	Orthogonal Channel Noise Simulator, a mechanism used to simulate the users or control signals on the other orthogonal channels of a downlink link.
OCNS_ $E_c$	Average energy per PN chip for the OCNS.
$\frac{OCNS\_E_c}{I_{or}}$	The ratio of the average transmit energy per PN chip for the OCNS to the total transmit power spectral density.
P-CCPCH	Primary Common Control Physical Channel
PCH	Paging Channel
$P-CCPCH \frac{E_c}{I_o}$	The ratio of the received P-CCPCH energy per chip to the total received power spectral density at the UE antenna connector.



$\frac{P-CCPCH-E_c}{I_{or}}$	The ratio of the average transmit energy per PN chip for the P-CCPCH to the total transmit power spectral density.
P-CPICH	Primary Common Pilot Channel
PICH	Paging Indicator Channel
PPM	Parts Per Million
R	Number of information bits per second excluding CRC bits successfully received on HS-DSCH by a HSDPA capable UE.
<REFSENS>	Reference sensitivity
<REF $\hat{I}_{or}$ >	Reference $\hat{I}_{or}$
RACH	Random Access Channel
SCH	Synchronization Channel consisting of Primary and Secondary synchronization channels
$S-CCPCH$	Secondary Common Control Physical Channel.
$S-CCPCH-E_c$	Average energy per PN chip for S-CCPCH.
S-DPCCH	Secondary Dedicated Physical Control Channel
S-E-DPCCH	Secondary Dedicated Physical Control Channel for E-DCH
S-E-DPDCH	Secondary Dedicated Physical Data Channel for E-DCH
SG	Serving Grant
SIR	Signal to Interference ratio
SML	Soft Metric Location (Soft channel bit)
STTD	Space Time Transmit Diversity
TDD	Time Division Duplexing
TFC	Transport Format Combination
TFCI	Transport Format Combination Indicator
TPC	Transmit Power Control
TPI	Transmitted Precoding Indicator
TSTD	Time Switched Transmit Diversity
UE	User Equipment
UL	Up Link (reverse link)
UL CLTD	Up Link Closed-Loop Transmit Diversity
UL OLTD	Up Link Open-Loop Transmit Diversity
UTRA	UMTS Terrestrial Radio Access

## 4 General

### 4.1 Relationship between Minimum Requirements and Test Requirements

The Minimum Requirements given in this specification make no allowance for measurement uncertainty. The test specification 34.121 Annex F defines Test Tolerances. These Test Tolerances are individually calculated for each test. The Test Tolerances are used to relax the Minimum Requirements in this specification to create Test Requirements.

The measurement results returned by the test system are compared - without any modification - against the Test Requirements as defined by the shared risk principle.

The Shared Risk principle is defined in ETR 273 Part 1 sub-part 2 section 6.5.

### 4.2 Power Classes

For UE power classes 1 and 2, a number of RF parameter are not specified. It is intended that these are part of a later release.

### 4.3 Control and monitoring functions

This requirement verifies that the control and monitoring functions of the UE prevent it from transmitting if no acceptable cell can be found by the UE.



### 4.3.1 Minimum requirement

The power of the UE, as measured with a thermal detector, shall not exceed -30dBm if no acceptable cell can be found by the UE.

## 4.4 RF requirements in later releases

The standardisation of new frequency bands may be independent of a release. However, in order to implement a UE that conforms to a particular release but supports a band of operation that is specified in a later release, it is necessary to specify some extra requirements. TS 25.307 [9] specifies requirements on UEs supporting a frequency band that is independent of release.

NOTE: For UEs conforming to the 3GPP release of the present document, some RF requirements of later releases may be mandatory independent of whether the UE supports the bands specified in later releases or not. The set of RF requirements of later releases that is also mandatory for UEs conforming to the 3GPP release of the present document is determined by regional regulation.

---

## 5 Frequency bands and channel arrangement

### 5.1 General

The information presented in this subclause is based on a chip rate of 3.84 Mcps.

NOTE: Other chip rates may be considered in future releases.

### 5.2 Frequency bands

- a) UTRA/FDD is designed to operate in the following paired bands:



**Table 5.0: UTRA FDD frequency bands**

Operating Band	UL Frequencies UE transmit, Node B receive	DL frequencies UE receive, Node B transmit
I	1920 - 1980 MHz	2110 -2170 MHz
II	1850 -1910 MHz	1930 -1990 MHz
III	1710-1785 MHz	1805-1880 MHz
IV	1710-1755 MHz	2110-2155 MHz
V	824 - 849 MHz	869-894 MHz
VI	830-840 MHz	875-885 MHz
VII	2500-2570 MHz	2620-2690 MHz
VIII	880 - 915 MHz	925 - 960 MHz
IX	1749.9-1784.9 MHz	1844.9-1879.9 MHz
X	1710-1770 MHz	2110-2170 MHz
XI	1427.9 - 1447.9 MHz	1475.9 - 1495.9 MHz
XII	699 – 716 MHz	729 – 746 MHz
XIII	777 - 787 MHz	746 - 756 MHz
XIV	788 – 798 MHz	758 – 768 MHz
XV	Reserved	Reserved
XVI	Reserved	Reserved
XVII	Reserved	Reserved
XVIII	Reserved	Reserved
XIX	830 – 845MHz	875 – 890 MHz
XX	832 – 862 MHz	791 – 821 MHz
XXI	1447.9 – 1462.9 MHz	1495.9 – 1510.9 MHz
XXII	3410 – 3490 MHz	3510 – 3590 MHz
XXV	1850 – 1915 MHz	1930 – 1995 MHz
XXVI	814 – 849 MHz	859 – 894 MHz
XXXII <sup>1</sup>	N/A	1452 – 1496 MHz

NOTE 1: Restricted to UTRA operation when dual band is configured (e.g., DB-DC-HSDPA or dual band 4C-HSDPA). The down link frequenc(ies) of this band are paired with the uplink frequenc(ies) of the other FDD band (external) of the dual band configuration.

b) Deployment in other frequency bands is not precluded

c) DB-DC-HSDPA is designed to operate in the following configurations:

**Table 5.0aA DB-DC-HSDPA configurations**

DB-DC-HSDPA Configuration	UL Band	DL Band A	DL Band B
1	I or VIII	I	VIII
2	II or IV	II	IV
3	I or V	I	V
4	I or XI	I	XI
5	II or V	II	V
6	I	I	XXXII

d) Single band 4C-HSDPA is designed to operate in the following configurations:

**Table 5.0aB Single band 4C-HSDPA configurations**

Single band 4C-HSDPA Configuration	Operating Band	Number of DL carriers
I-3	I	3
II-3	II	3
II-4	II	4

NOTE: Single band 4C-HSDPA configuration is numbered as (X-M) where X denotes the operating band and M denotes the number of DL carriers.

e) Dual band 4C-HSDPA is designed to operate in the following configurations:



**Table 5.0aC Dual band 4C-HSDPA configurations**

Dual band 4C-HSDPA Configuration	UL Band	DL Band A	Number of DL carriers in Band A	DL Band B	Number of DL carriers in Band B
I-2-VIII-1	I or VIII	I	2	VIII	1
I-2-VIII-2	I or VIII	I	2	VIII	2
I-1-VIII-2	I or VIII	I	1	VIII	2
I-3-VIII-1	I or VIII	I	3	VIII	1
II-1-IV-2	II or IV	II	1	IV	2
II-2-IV-1	II or IV	II	2	IV	1
II-2-IV-2	II or IV	II	2	IV	2
I-1-V-2	I or V	I	1	V	2
I-2-V-1	I or V	I	2	V	1
I-2-V-2	I or V	I	2	V	2
II-1-V-2	II or V	II	1	V	2
I-1-XXXII-2	I	I	1	XXXII	2
I-2-XXXII-1	I	I	2	XXXII	1

NOTE: Dual band 4C-HSDPA configuration is numbered as (X-M-Y-N) where X denotes the DL Band A, M denotes the number DL carriers in the DL Band A, Y denotes the DL Band B, and N denotes the number of DL carriers in the DL Band B

f) Single band 8C-HSDPA is designed to operate in the following configurations:

**Table 5.0aD Single band 8C-HSDPA configurations**

Single band 8C-HSDPA Configuration	Operating Band	Number of DL carriers
I-8	I	8

NOTE: Single band 8C-HSDPA configuration is numbered as (X-M) where X denotes the operating band and M denotes the number of DL carriers.

g) Single band NC-4C-HSDPA is designed to operate in the following configurations:

**Table 5.0aE Single band NC-4C-HSDPA configurations**

Single band NC-4C-HSDPA Configuration	Operating Band	Number of DL carriers in one subblock	Gap between subblocks [MHz]	Number of DL carriers in the other subblock
I-1-5-1	I	1	5	1
I-2-5-1	I	2	5	1
I-3-10-1	I	3	10	1
IV-1-5-1	IV	1	5	1
IV-2-10-1	IV	2	10	1
IV-2-15-2	IV	2	15	2
IV-2-20-1	IV	2	20	1
IV-2-25-2	IV	2	25	2

NOTE: Single band NC-4C-HSDPA configuration is numbered as (X-M-Y-N) where X denotes the operating band, M denotes the number of DL carriers in one subblock, Y denotes the gap between subblocks in MHz and N denotes the number of DL carriers in the other subblock. M and N can be switched

## 5.3 TX-RX frequency separation

a) UTRA/FDD is designed to operate with the following TX-RX frequency separation



**Table 5.0A: TX-RX frequency separation**

Operating Band	TX-RX frequency separation
I	190 MHz
II	80 MHz
III	95 MHz
IV	400 MHz
V	45 MHz
VI	45 MHz
VII	120 MHz
VIII	45 MHz
IX	95 MHz
X	400 MHz
XI	48 MHz
XII	30 MHz
XIII	31 MHz
XIV	30 MHz
XIX	45 MHz
XX	41 MHz
XXI	48 MHz
XXII	100 MHz
XXV	80 MHz
XXVI	45MHz

- b) UTRA/FDD can support both fixed and variable transmit to receive frequency separation.
- c) The use of other transmit to receive frequency separations in existing or other frequency bands shall not be precluded.
- d) When configured to operate on dual cells in the DL with a single UL frequency, the TX-RX frequency separation in Table 5.0A shall be applied for the serving HS-DSCH cell. For bands XII, XIII and XIV, the TX-RX frequency separation in Table 5.0A shall be the minimum spacing between the UL and either of the DL carriers.
- e) When configured to operate on dual cells in both the DL and UL, the TX-RX frequency separation in Table 5.0A shall be applied to the primary UL frequency and DL frequency of the serving HS-DSCH cell, and to the secondary UL frequency and the frequency of the secondary serving HS-DSCH cell respectively.
- f) When configured to operate on single/dual band 4C-HSDPA or single band 8C-HSDPA or single band NC-4C-HSDPA with a single UL frequency, the TX-RX frequency separation in Table 5.0A shall be applied for the DL frequency of the serving HS-DSCH cell. When configured to operate on single/dual band 4C-HSDPA or single band 8C-HSDPA or single band NC-4C-HSDPA with dual UL frequencies, the TX-RX frequency separation in Table 5.0A shall be applied to the primary UL frequency and DL frequency of the serving HS-DSCH cell, and to the secondary UL frequency and the frequency of the 1<sup>st</sup> secondary serving HS-DSCH cell respectively.
- g) For bands XII, XIII and XIV, all the requirements in TS 25.101 are applicable only for a single uplink carrier frequency, however dual cell uplink operation may be considered in future releases.

## 5.4 Channel arrangement

### 5.4.1 Channel spacing

The nominal channel spacing is 5 MHz, but this can be adjusted to optimise performance in a particular deployment scenario. In DC-HSDPA and DB-DC-HSDPA mode, the UE receives two cells simultaneously. In context of DC-HSDPA and DB-DC-HSDPA, a cell is characterized by a combination of scrambling code and a carrier frequency, see [21.905].



## 5.4.2 Channel raster

The channel raster is 200 kHz, for all bands which means that the centre frequency must be an integer multiple of 200 kHz. In addition a number of additional centre frequencies are specified according to table 5.1A, which means that the centre frequencies for these channels are shifted 100 kHz relative to the general raster.

## 5.4.3 Channel number

The carrier frequency is designated by the UTRA Absolute Radio Frequency Channel Number (UARFCN). For each operating Band, the UARFCN values are defined as follows:

Uplink:  $N_U = 5 * (F_{UL} - F_{UL\_Offset})$ , for the carrier frequency range  $F_{UL\_low} \leq F_{UL} \leq F_{UL\_high}$

Downlink:  $N_D = 5 * (F_{DL} - F_{DL\_Offset})$ , for the carrier frequency range  $F_{DL\_low} \leq F_{DL} \leq F_{DL\_high}$

For each operating Band,  $F_{UL\_Offset}$ ,  $F_{UL\_low}$ ,  $F_{UL\_high}$ ,  $F_{DL\_Offset}$ ,  $F_{DL\_low}$  and  $F_{DL\_high}$  are defined in Table 5.1 for the general UARFCN. For the additional UARFCN,  $F_{UL\_Offset}$ ,  $F_{DL\_Offset}$  and the specific  $F_{UL}$  and  $F_{DL}$  are defined in Table 5.1A.

**Table 5.1: UARFCN definition (general)**

Band	UPLINK (UL) UE transmit, Node B receive			DOWNLINK (DL) UE receive, Node B transmit		
	UARFCN formula offset F <sub>UL_Offset</sub> [MHz]	Carrier frequency (F <sub>UL</sub> ) range [MHz]		UARFCN formula offset F <sub>DL_Offset</sub> [MHz]	Carrier frequency (F <sub>DL</sub> ) range [MHz]	
		F <sub>UL_low</sub>	F <sub>UL_high</sub>		F <sub>DL_low</sub>	F <sub>DL_high</sub>
I	0	1922.4	1977.6	0	2112.4	2167.6
II	0	1852.4	1907.6	0	1932.4	1987.6
III	1525	1712.4	1782.6	1575	1807.4	1877.6
IV	1450	1712.4	1752.6	1805	2112.4	2152.6
V	0	826.4	846.6	0	871.4	891.6
VI	0	832.4	837.6	0	877.4	882.6
VII	2100	2502.4	2567.6	2175	2622.4	2687.6
VIII	340	882.4	912.6	340	927.4	957.6
IX	0	1752.4	1782.4	0	1847.4	1877.4
X	1135	1712.4	1767.6	1490	2112.4	2167.6
XI	733	1430.4	1445.4	736	1478.4	1493.4
XII	-22	701.4	713.6	-37	731.4	743.6
XIII	21	779.4	784.6	-55	748.4	753.6
XIV	12	790.4	795.6	-63	760.4	765.6
XIX	770	832.4	842.6	735	877.4	887.6
XX	-23	834.4	859.6	-109	793.4	818.6
XXI	1358	1450.4	1460.4	1326	1498.4	1508.4
XXII	2525	3412.4	3487.6	2580	3512.4	3587.6
XXV	875	1852.4	1912.6	910	1932.4	1992.6
XXVI	-291	816.4	846.6	-291	861.4	891.6
XXXII <sup>1</sup>	N/A			131	1454.4	1493.6
NOTE 1: Restricted to UTRA operation when dual band is configured (e.g., DB-DC-HSDPA or dual band 4C-HSDPA)						



Table 5.1A: UARFCN definition (additional channels)

Band	UPLINK (UL) UE transmit, Node B receive		DOWNLINK (DL) UE receive, Node B transmit	
	UARFCN formula offset $F_{UL\_Offset}$ [MHz]	Carrier frequency [MHz] ( $F_{UL}$ )	UARFCN formula offset $F_{DL\_Offset}$ [MHz]	Carrier frequency [MHz] ( $F_{DL}$ )
I	-	-	-	-
II	1850.1	1852.5, 1857.5, 1862.5, 1867.5, 1872.5, 1877.5, 1882.5, 1887.5, 1892.5, 1897.5, 1902.5, 1907.5	1850.1	1932.5, 1937.5, 1942.5, 1947.5, 1952.5, 1957.5, 1962.5, 1967.5, 1972.5, 1977.5, 1982.5, 1987.5
III	-	-	-	-
IV	1380.1	1712.5, 1717.5, 1722.5, 1727.5, 1732.5, 1737.5, 1742.5, 1747.5, 1752.5	1735.1	2112.5, 2117.5, 2122.5, 2127.5, 2132.5, 2137.5, 2142.5, 2147.5, 2152.5
V	670.1	826.5, 827.5, 831.5, 832.5, 837.5, 842.5	670.1	871.5, 872.5, 876.5, 877.5, 882.5, 887.5
VI	670.1	832.5, 837.5	670.1	877.5, 882.5
VII	2030.1	2502.5, 2507.5, 2512.5, 2517.5, 2522.5, 2527.5, 2532.5, 2537.5, 2542.5, 2547.5, 2552.5, 2557.5, 2562.5, 2567.5	2105.1	2622.5, 2627.5, 2632.5, 2637.5, 2642.5, 2647.5, 2652.5, 2657.5, 2662.5, 2667.5, 2672.5, 2677.5, 2682.5, 2687.5
VIII	-	-	-	-
IX	-	-	-	-
X	1075.1	1712.5, 1717.5, 1722.5, 1727.5, 1732.5, 1737.5, 1742.5, 1747.5, 1752.5, 1757.5, 1762.5, 1767.5	1430.1	2112.5, 2117.5, 2122.5, 2127.5, 2132.5, 2137.5, 2142.5, 2147.5, 2152.5, 2157.5, 2162.5, 2167.5
XI	-	-	-	-
XII	-39.9	701.5, 706.5, 707.5, 712.5, 713.5	-54.9	731.5, 736.5, 737.5, 742.5, 743.5
XIII	11.1	779.5, 784.5	-64.9	748.5, 753.5
XIV	2.1	790.5, 795.5	-72.9	760.5, 765.5
XIX	755.1	832.5, 837.5, 842.5	720.1	877.5, 882.5, 887.5
XX	-	-	-	-
XXI	-	-	-	-
XXII	-	-	-	-
XXV	639.1	1852.5, 1857.5, 1862.5, 1867.5, 1872.5, 1877.5, 1882.5, 1887.5, 1892.5, 1897.5, 1902.5, 1907.5, 1912.5	674.1	1932.5, 1937.5, 1942.5, 1947.5, 1952.5, 1957.5, 1962.5, 1967.5, 1972.5, 1977.5, 1982.5, 1987.5, 1992.5
XXVI	-325.9	816.5, 821.5, 826.5, 827.5, 831.5, 832.5, 836.5, 837.5, 841.5, 842.5, 846.5	-325.9	861.5, 866.5, 871.5, 872.5, 876.5, 877.5, 881.5, 882.5, 886.5, 887.5, 891.5
XXXII <sup>1</sup>	N/A		87.1	1454.5, 1459.5, 1464.5, 1469.5, 1474.5, 1479.5, 1484.5, 1489.5

NOTE 1: Restricted to UTRA operation when dual band is configured (e.g., DB-DC-HSDPA or dual band 4C-HSDPA)



## 5.4.4 UARFCN

The following UARFCN range shall be supported for each paired band

**Table 5.2: UTRA Absolute Radio Frequency Channel Number**

Band	Uplink (UL)		Downlink (DL)	
	UE transmit, Node B receive		UE receive, Node B transmit	
	General	Additional	General	Additional
I	9612 to 9888	-	10562 to 10838	-
II	9262 to 9538	12, 37, 62, 87, 112, 137, 162, 187, 212, 237, 262, 287	9662 to 9938	412, 437, 462, 487, 512, 537, 562, 587, 612, 637, 662, 687
III	937 to 1288	-	1162 to 1513	-
IV	1312 to 1513	1662, 1687, 1712, 1737, 1762, 1787, 1812, 1837, 1862	1537 to 1738	1887, 1912, 1937, 1962, 1987, 2012, 2037, 2062, 2087
V	4132 to 4233	782, 787, 807, 812, 837, 862	4357 to 4458	1007, 1012, 1032, 1037, 1062, 1087
VI	4162 to 4188	812, 837	4387 to 4413	1037, 1062
VII	2012 to 2338	2362, 2387, 2412, 2437, 2462, 2487, 2512, 2537, 2562, 2587, 2612, 2637, 2662, 2687	2237 to 2563	2587, 2612, 2637, 2662, 2687, 2712, 2737, 2762, 2787, 2812, 2837, 2862, 2887, 2912
VIII	2712 to 2863	-	2937 to 3088	-
IX	8762 to 8912	-	9237 to 9387	-
X	2887 to 3163	3187, 3212, 3237, 3262, 3287, 3312, 3337, 3362, 3387, 3412, 3437, 3462	3112 to 3388	3412, 3437, 3462, 3487, 3512, 3537, 3562, 3587, 3612, 3637, 3662, 3687
XI	3487 to 3562	-	3712 to 3787	-
XII	3617 to 3678	3707, 3732, 3737, 3762, 3767	3842 to 3903	3932, 3957, 3962, 3987, 3992
XIII	3792 to 3818	3842, 3867	4017 to 4043	4067, 4092
XIV	3892 to 3918	3942, 3967	4117 to 4143	4167, 4192
XIX	312 to 363	387, 412, 437	712 to 763	787, 812, 837
XX	4287 to 4413	-	4512 to 4638	-
XXI	462 to 512	-	862 to 912	-
XXII	4437 to 4813	-	4662 to 5038	-
XXV	4887 to 5188	6067, 6092, 6117, 6142, 6167, 6192, 6217, 6242, 6267, 6292, 6317, 6342, 6367	5112 to 5413	6292, 6317, 6342, 6367, 6392, 6417, 6442, 6467, 6492, 6517, 6542, 6567, 6592
XXVI	5537 to 5688	5712, 5737, 5762, 5767, 5787, 5792, 5812, 5817, 5837, 5842, 5862	5762 to 5913	5937, 5962, 5987, 5992, 6012, 6017, 6037, 6042, 6062, 6067, 6087
XXXII <sup>1</sup>	N/A		6617 to 6813	6837, 6862, 6887, 6912, 6937, 6962, 6987, 7012

NOTE 1: Restricted to UTRA operation when dual band is configured (e.g., DB-DC-HSDPA or dual band 4C-HSDPA)

NOTE: If the UE is on a network with Mobile Country Code set to Japan then it may assume that any DL UARFCN sent by the network from the overlapping region of Band V and Band VI is from Band VI. If the UE is on a network with a Mobile Country Code other than Japan then it may assume that any DL UARFCN sent by the network from the overlapping region of Band V and Band VI is from Band V.



## 6 Transmitter characteristics

### 6.1 General

Unless otherwise stated, the transmitter characteristics are specified at the antenna connector of the UE. For UE with integral antenna only, a reference antenna with a gain of 0 dBi is assumed. Transmitter characteristics for UE(s) with multiple antennas/antenna connectors are FFS.

The UE antenna performance has a significant impact on system performance, and minimum requirements on the antenna efficiency are therefore intended to be included in future versions of the present document. It is recognised that different requirements and test methods are likely to be required for the different types of UE.

UEs supporting DC-HSUPA shall support both minimum requirements, as well as additional requirements for DC-HSUPA.

Unless otherwise stated, for the additional requirements for DC-HSUPA, all the parameters in clause 6 are defined using the UL E-DCH reference measurement channel, specified in subclause A.2.6. For the additional requirements for DC-HSUPA, the spacing of the carrier frequencies of the two cells shall be 5 MHz.

UEs supporting Open-Loop uplink Transmitter Diversity shall support both minimum requirements for one of transmit antenna connectors, which one to be tested shall be declared by the manufacturer, and additional requirements for UL OLTD. In addition, the additional requirements for UL OLTD are applicable only in the case when equal power is transmitted from two active antenna ports.

DC-HSUPA and UL OLTD do not operate simultaneously in the UE.

UEs supporting UL CLTD shall support both minimum requirements, as well as additional requirements for UL CLTD.

The requirements in clause 6 for UEs supporting UL CLTD are specified for UL CLTD activation states 1, 2, 3 which are defined in sub-clause 4.6C.2.2.3 in TS 25.212[10].

DC-HSUPA and UL CLTD do not operate simultaneously in the UE.

UEs supporting UL MIMO shall support both minimum requirements, as well as additional requirements for UL MIMO.

The requirements in clause 6 specified for UL MIMO are applicable for UL MIMO rank-2 transmission. The requirements for UL MIMO rank-1 transmission are covered by UL CLTD requirements. UL MIMO rank-1 and rank-2 transmissions are defined in clause 11 of TS25.214 [8].

DC-HSUPA and UL MIMO do not operate simultaneously in the UE.

### 6.2 Transmit power

#### 6.2.1 UE maximum output power

The following Power Classes define the nominal maximum output power. The nominal power defined is the broadband transmit power of the UE, i.e. the power in a bandwidth of at least  $(1+\alpha)$  times the chip rate of the radio access mode. The period of measurement shall be at least one timeslot. For DC-HSUPA, the nominal transmit power is defined by the sum of the broadband transmit power of each carrier in the UE.

**Table 6.1: UE Power Classes**

Operating Band	Power Class 1		Power Class 2		Power Class 3		Power Class 3bis		Power Class 4	
	Power (dBm)	Tol (dB)	Power (dBm)	Tol (dB)	Power (dBm)	Tol (dB)	Power (dBm)	Tol (dB)	Power (dBm)	Tol (dB)



Band I	+33	+1/-3	+27	+1/-3	+24	+1/-3	23	+2/-2	+21	+2/-2
Band II	-	-	-	-	+24	+1/-3	23	+2/-2	+21	+2/-2
Band III	-	-	-	-	+24	+1/-3	23	+2/-2	+21	+2/-2
Band IV	-	-	-	-	+24	+1/-3	23	+2/-2	+21	+2/-2
Band V	-	-	-	-	+24	+1/-3	23	+2/-2	+21	+2/-2
Band VI	-	-	-	-	+24	+1/-3	23	+2/-2	+21	+2/-2
Band VII	-	-	-	-	+24	+1/-3	23	+2/-2	+21	+2/-2
Band VIII	-	-	-	-	+24	+1/-3	23	+2/-2	+21	+2/-2
Band IX	-	-	-	-	+24	+1/-3	23	+2/-2	+21	+2/-2
Band X	-	-	-	-	+24	+1/-3	23	+2/-2	+21	+2/-2
Band XI	-	-	-	-	+24	+1/-3	23	+2/-2	+21	+2/-2
Band XII	-	-	-	-	+24	+1/-3	23	+2/-2	+21	+2/-2
Band XIII	-	-	-	-	+24	+1/-3	23	+2/-2	+21	+2/-2
Band IV	-	-	-	-	+24	+1/-3	23	+2/-2	+21	+2/-2
Band XIX					+24	+1/-3	23	+2/-2	+21	+2/-2
Band XX					+24	+1/-3	23	+2/-2	+21	+2/-2
Band XXI					+24	+1/-3	23	+2/-2	+21	+2/-2
Band XXII	-	-	-	-	+24	+1/-4.5	23	+2/-3.5	+21	+2/-3.5
Band XXV					+24	+1/-4	23	+2/-3	+21	+2/-3
Band XXVI (Note 1)	-	-	-	-	+24	+1/-4	23	+2/-3	+21	+2/-3

NOTE 1 For the UE which supports both Band V and Band XXVI operating frequencies, the UE maximum output power of Band V shall apply for Band XXVI when the carrier frequency of the assigned UTRA channel is within 824-845 MHz.

NOTE: The tolerance allowed for the nominal maximum output power applies even for the multi-code DPDCH transmission mode.

For the UE which supports DB-DC-HSDPA configuration in Table 6.1aB, the lower side of the tolerance in Table 6.1 is allowed to be adjusted by the amount given in Table 6.1aB for the applicable bands.

**Table 6.1aB Allowed adjustment in lower side of tolerance for UE which supports DB-DC-HSDPA**

DB-DC-HSDPA Configuration	Maximum allowed adjustment in lower side of tolerance (dB)	Applicable bands
1	-0.3	I, VIII
2	-1	II, IV
3	-0.3	I, V
4	-1	I, XI
5	-0.3	II, V
6	-0.3	I
NOTE: The requirements reflect what can be achieved with the present state of the art technology. They shall be reconsidered when the state of the art technology progresses.		

For the UE which supports dual band 4C-HSDPA configuration in Table 6.1aC, the lower side of the tolerance in Table 6.1 is allowed to be adjusted by the amount given in Table 6.1aC for the applicable bands.

**Table 6.1aC Allowed adjustment in lower side of tolerance for UE which supports dual band 4C-HSDPA**

Dual Band 4C-HSDPA Configuration	Maximum allowed adjustment in lower side of tolerance (dB)	Applicable bands
I-2-VIII-1, I-3-VIII-1, I-2-VIII-2, I-1-VIII-2	-0.3	I, VIII
II-1-IV-2, II-2-IV-1, II-2-IV-2	-1	II, IV
I-1-V-2, I-2-V-1, I-2-V-2	-0.3	I, V
II-1-V-2	-0.3	II, V
I-1-XXXII-2, I-2-XXXII-1	-0.3	I
NOTE: The requirements reflect what can be achieved with the present state of the art technology. They shall be reconsidered when the state of the art technology progresses.		



For the UE which supports E-UTRA inter-band carrier aggregation, the lower side of the tolerance in Table 6.1 is allowed to be decreased by the amount given in Table 6.2.5A-3 of TS 36.101[11] for those UTRA operating bands corresponding to the E-UTRA operating bands that belong to the supported inter-band carrier aggregation configurations. The tolerance in Table 6.2.5A-3 of TS 36.101[11] does not apply to supported UTRA operating bands with frequency range below 1 GHz that correspond to the E-UTRA operating bands that belong to the supported inter-band carrier aggregation configurations when such bands are belonging only to band combination(s) where one band is <1GHz and another band is >1.7GHz and there is no harmonic relationship between the low band UL and high band DL.

In case the UE supports DB-DC-HSDPA or dual band 4C-HSDPA configurations and one or more of the E-UTRA inter-band carrier aggregation configurations listed in Table 6.2.5A-3 of TS36.101[11] with a UTRA operating band that belongs to UTRA and E-UTRA carrier aggregation configurations, then

- When the UTRA operating band frequency range is  $\leq 1$ GHz, the applicable additional tolerance shall be the average of the applicable tolerances, truncated to one decimal place for that operating band among the supported DB-DC-HSDPA, dual band 4C-HSDPA, and E-UTRA CA configurations, with the DB-DC-HSDPA, dual carrier 4C-HSDPA, and E-UTRA CA configurations counted separately. In case there is a harmonic relation between low band UL and high band DL, then the maximum tolerance among the different supported carrier aggregation configurations involving such band shall be applied
- When the UTRA operating band frequency range is  $>1$ GHz, the applicable additional tolerance shall be the maximum tolerance that applies for that operating band among the supported DB-DC-HSDPA, dual band 4C-HSDPA, and E-UTRA CA configurations.

## 6.2.1A UE maximum output power for UL OLTD

For UE with two active transmit antenna connectors in UL OLTD operation, the maximum output power is specified in Table 6.1aD. The nominal transmit power is defined by the sum of transmit power at each UE antenna connector.

**Table 6.1aD: UE Power Classes for UL OLTD**

Operating Band	Power Class 3		Power Class 3bis	
	Power (dBm)	Tol (dB)	Power (dBm)	Tol (dB)
Band I	+24	+1/-4	23	+2/-3
Band II	+24	+1/-4	23	+2/-3
Band III	+24	+1/-4	23	+2/-3
Band IV	+24	+1/-4	23	+2/-3
Band V	+24	+1/-4	23	+2/-3
Band VI	+24	+1/-4	23	+2/-3
Band VII	+24	+1/-4	23	+2/-3
Band VIII	+24	+1/-4	23	+2/-3
Band IX	+24	+1/-4	23	+2/-3
Band X	+24	+1/-4	23	+2/-3
Band XI	+24	+1/-4	23	+2/-3
Band XII	+24	+1/-4	23	+2/-3
Band XIII	+24	+1/-4	23	+2/-3
Band IV	+24	+1/-4	23	+2/-3
Band XIX	+24	+1/-4	23	+2/-3
Band XX	+24	+1/-4	23	+2/-3
Band XXI	+24	+1/-4	23	+2/-3
Band XXII	+24	+1/-5.5	23	+2/-4.5
Band XXV	+24	+1/-5	23	+2/-4
Band XXVI (Note 1)	+24	+1/-5	23	+2/-4
Note 1	For the UE which supports both Band V and Band XXVI operating frequencies, the UE maximum output power of Band V shall apply for Band XXVI when the carrier frequency of the assigned UTRA channel is within 824-845 MHz.			



## 6.2.1B UE maximum output power for UL CLTD

For UE with two active transmit antenna connectors in UL CLTD activation state 1, the nominal maximum output power is specified in Table 6.1aE. The nominal transmit power is defined by the sum of transmit power at each transmit antenna connector.

For UE configured in UL CLTD activation state 2 or activation state 3, the nominal maximum output power specified in sub-clause 6. 2.1 applies at the active transmit antenna connector.

**Table 6.1aE: UE Power Classes for UL CLTD**

Operating Band	Power Class 3		Power Class 3bis	
	Power (dBm)	Tol (dB)	Power (dBm)	Tol (dB)
Band I	+24	+1/-4	23	+2/-3
Band II	+24	+1/-4	23	+2/-3
Band III	+24	+1/-4	23	+2/-3
Band IV	+24	+1/-4	23	+2/-3
Band V	+24	+1/-4	23	+2/-3
Band VI	+24	+1/-4	23	+2/-3
Band VII	+24	+1/-4	23	+2/-3
Band VIII	+24	+1/-4	23	+2/-3
Band IX	+24	+1/-4	23	+2/-3
Band X	+24	+1/-4	23	+2/-3
Band XI	+24	+1/-4	23	+2/-3
Band XII	+24	+1/-4	23	+2/-3
Band XIII	+24	+1/-4	23	+2/-3
Band IV	+24	+1/-4	23	+2/-3
Band XIX	+24	+1/-4	23	+2/-3
Band XX	+24	+1/-4	23	+2/-3
Band XXI	+24	+1/-4	23	+2/-3
Band XXII	+24	+1/-5.5	23	+2/-4.5
Band XXV	+24	+1/-5	23	+2/-4
Band XXVI (Note 1)	+24	+1/-5	23	+2/-4
Note 1	For the UE which supports both Band V and Band XXVI operating frequencies, the UE maximum output power of Band V shall apply for Band XXVI when the carrier frequency of the assigned UTRA channel is within 824-845 MHz.			

## 6.2.1C UE maximum output power for UL MIMO

For UE with two active transmit antenna connectors in UL MIMO operation, the nominal maximum output power is specified in Table 6.1aF. The nominal transmit power is defined by the sum of transmit power at each transmit antenna connector.



**Table 6.1aF: UE Power Classes for UL MIMO**

Operating Band	Power Class 3		Power Class 3bis	
	Power (dBm)	Tol (dB)	Power (dBm)	Tol (dB)
Band I	+24	+1/-4	23	+2/-3
Band II	+24	+1/-4	23	+2/-3
Band III	+24	+1/-4	23	+2/-3
Band IV	+24	+1/-4	23	+2/-3
Band V	+24	+1/-4	23	+2/-3
Band VI	+24	+1/-4	23	+2/-3
Band VII	+24	+1/-4	23	+2/-3
Band VIII	+24	+1/-4	23	+2/-3
Band IX	+24	+1/-4	23	+2/-3
Band X	+24	+1/-4	23	+2/-3
Band XI	+24	+1/-4	23	+2/-3
Band XII	+24	+1/-4	23	+2/-3
Band XIII	+24	+1/-4	23	+2/-3
Band XIV	+24	+1/-4	23	+2/-3
Band XV	+24	+1/-4	23	+2/-3
Band XVI	+24	+1/-4	23	+2/-3
Band XVII	+24	+1/-4	23	+2/-3
Band XVIII	+24	+1/-4	23	+2/-3
Band XIX	+24	+1/-4	23	+2/-3
Band XX	+24	+1/-4	23	+2/-3
Band XXI	+24	+1/-4	23	+2/-3
Band XXII	+24	+1/-5.5	23	+2/-4.5
Band XXIII	+24	+1/-5	23	+2/-4
Band XXIV	+24	+1/-5	23	+2/-4
Band XXV	+24	+1/-5	23	+2/-4
Band XXVI (Note 1)	+24	+1/-5	23	+2/-4
Note 1 For the UE which supports both Band V and Band XXVI operating frequencies, the UE maximum output power of Band V shall apply for Band XXVI when the carrier frequency of the assigned UTRA channel is within 824-845 MHz.				

## 6.2.2 UE maximum output power with HS-DPCCH and E-DCH

The Maximum Power Reduction (MPR) for the nominal maximum output power defined in 6.2.1 is specified in table 6.1A for the values of  $\beta_c$ ,  $\beta_d$ ,  $\beta_{hs}$ ,  $\beta_{ec}$  and  $\beta_{ed}$  defined in [8] fully or partially transmitted during a DPCCH timeslot

**Table 6.1A: UE maximum output power with HS-DPCCH and E-DCH**

UE transmit channel configuration	CM (dB)	MPR (dB)
When DPCCH2 is not configured: For all combinations of; DPDCH, DPCCH, HS-DPCCH, E-DPDCH and E-DPCCH	$0 \leq CM \leq 4$	MAX (CM-1, 0)
When DPCCH2 is configured: For all combinations of; DPDCH, DPCCH, HS-DPCCH, E-DPDCH, E-DPCCH and DPCCH2	$0 \leq CM \leq 4$	MAX (CM-1, 0)
Note 1: CM = 1 for $\beta_c/\beta_d=12/15$ , $\beta_{hs}/\beta_c=24/15$ . For all other combinations of DPDCH, DPCCH, HS-DPCCH, E-DPDCH and E-DPCCH the MPR is based on the relative CM difference.		

Where Cubic Metric (CM) is based on the UE transmit channel configuration and is given by

$$CM = \text{CEIL} \{ [20 * \log_{10} ((v_{\text{norm}}^3)_{\text{rms}}) - 20 * \log_{10} ((v_{\text{norm\_ref}}^3)_{\text{rms}})] / k, 0.5 \}$$

Where

- CEIL { x, 0.5 } means rounding upwards to closest 0.5dB, i.e.  $CM \in [0, 0.5, 1.0, 1.5, 2.0, 2.5, 3.0, 3.5]$
- k is 1.85 for signals where all channelisations codes meet the following criteria  $CSF, N$  where  $N < SF/2$
- k is 1.56 for signals where any channelisations codes meet the following criteria  $C_{SF, N}$  where  $N \geq SF/2$



- $v_{\text{norm}}$  is the normalized voltage waveform of the input signal
- $v_{\text{norm\_ref}}$  is the normalized voltage waveform of the reference signal (12.2 kbps AMR Speech) and
- $20 * \log_{10} ((v_{\text{norm\_ref}})^3)_{\text{rms}} = 1.52 \text{ dB}$

## 6.2.2A UE maximum output power for DC-HSUPA

The Maximum Power Reduction (MPR) for the nominal maximum output power defined in 6.2.1 is specified for the values of  $\beta_c, \beta_{\text{hs}}, \beta_{\text{ec}}$  and  $\beta_{\text{ed}}$  defined in [8] fully or partially transmitted during a DPCCH timeslot, and defined through calculation of the Raw Cubic Metric (Raw CM) which is based on the UE transmit channel configuration and is given by

$$\text{Raw CM} = 20 * \log_{10} ((v_{\text{norm}})^3)_{\text{rms}} - 20 * \log_{10} ((v_{\text{norm\_ref}})^3)_{\text{rms}}$$

where

- $v_{\text{norm}}$  is the normalized voltage waveform of the input signal
- $v_{\text{norm\_ref}}$  is the normalized voltage waveform of the reference signal (12.2 kbps AMR Speech) and
- $20 * \log_{10} ((v_{\text{norm\_ref}})^3)_{\text{rms}} = 1.52 \text{ dB}$

For any DC-HSUPA signal not employing 16QAM modulation on any of the carriers, the MPR is specified in Table 6.1AA.

**Table 6.1AA: UE maximum output power for DC-HSUPA signals not employing 16QAM modulation on any of the carriers**

UE transmit channel configuration	CM (dB)	MPR (dB)
When DPCCH2 is not configured: For all combinations of; DPCCH, HS-DPCCH, E-DPDCH and E-DPCCH	$0.22 \leq \text{CM} \leq 3.72$	$\text{MAX}(\text{CM}-0.72, 0)$
When DPCCH2 is configured: For all combinations of; DPCCH, HS-DPCCH, E-DPDCH, E-DPCCH and DPCCH2	$0.22 \leq \text{CM} \leq 3.72$	$\text{MAX}(\text{CM}-0.72, 0)$

where Cubic Metric (CM) is based on the Raw CM and is given by

$$\text{CM} = \text{CEIL} \{ \text{Raw CM} / k, 0.22 \}$$

where

- $\text{CEIL} \{ x, 0.22 \}$  means rounding upwards to closest 0.22dB with 0.5 dB granularity, i.e.  $\text{CM} = [0.22, 0.72, 1.22, 1.72, 2.22, 2.72, 3.22, 3.72]$
- $k$  is 1.66

For any DC-HSUPA signal employing 16QAM modulation on any of the carriers, the MPR is specified in Table 6.1AB..



**Table 6.1AB: UE maximum output power for DC-HSUPA signals employing 16QAM modulation on any of the carriers**

UE transmit channel configuration	CM (dB)	MPR (dB)
When DPCCH2 is not configured: For all combinations of; DPCCH, HS-DPCCH, E-DPDCH and E-DPCCH	$[0.22 \leq \text{CM} \leq 3.72]$	$[\text{CM}+0.8]$
When DPCCH2 is configured: For all combinations of DPCCH, HS-DPCCH, E-DPDCH and E-DPCCH and DPCCH2	$[0.22 \leq \text{CM} \leq 3.72]$	$[\text{CM}+0.8]$

where Cubic Metric (CM) is based on the Raw CM and is given by

$$[\text{CM} = \text{CEIL} \{ \text{Raw CM} / k, 0.2 \}]$$

where

- $\text{CEIL} \{ x, 0.2 \}$  means rounding upwards to closest 0.2dB with 0.5 dB granularity, i.e.  $\text{CM} = [0.2, 0.7, 1.2, 1.7, 2.2, 2.7, 3.2, 3.7]$
- $k$  is 1.66.

The reference measurement channels for the requirements in subclause 6.2.2A are provided in subclause A.2.8.

## 6.2.2B UE maximum output power with HS-DPCCH and E-DCH for UL OLTD

For the UE with two active transmit antenna connectors in UL OLTD operation, the allowed Maximum Power Reduction (MPR) for the nominal maximum output power of each antenna is specified in Table 6.1A. The amount of applied power reduction on each antenna shall be the same.

NOTE: CM is measured at each transmit antenna connector.

## 6.2.2C UE maximum output power with HS-DPCCH and E-DCH for UL CLTD

The Maximum Power Reduction (MPR) for the nominal maximum output power defined in 6.2.1 is specified in table 6.1AB for the values of  $\beta_c, \beta_d, \beta_{hs}, \beta_{ec}, \beta_{ed}$  and  $\beta_{sc}$  defined in [8] fully or partially transmitted during a DPCCH timeslot

**Table 6.1AB: UE maximum output power with HS-DPCCH and E-DCH for UL CLTD**

UE transmit channel configuration	CM (dB)	MPR (dB)
For all combinations of; DPDCH, DPCCH, HS-DPCCH, E-DPDCH, E-DPCCH and S-DPCCH	$0 \leq \text{CM} \leq 4$	$\text{MAX}(\text{CM}-1, 0)$
For all combinations of; DPDCH, DPCCH, HS-DPCCH, E-DPDCH, E-DPCCH, S-DPCCH and DPCCH2	$0 \leq \text{CM} \leq 4$	$\text{MAX}(\text{CM}-1, 0)$

Where Cubic Metric (CM) is based on the UE transmit channel configuration and is given by

$$\text{CM} = \text{CEIL} \{ [20 * \log_{10} ((v_{\text{norm}})^3)_{\text{rms}}] - 20 * \log_{10} ((v_{\text{norm\_ref}})^3)_{\text{rms}}] / k, 0.5 \}$$

Where

- $\text{CEIL} \{ x, 0.5 \}$  means rounding upwards to closest 0.5dB, i.e.  $\text{CM} = [0, 0.5, 1.0, 1.5, 2.0, 2.5, 3.0, 3.5]$
- $k$  is 1.85 for signals where all channelisations codes meet the following criteria  $C_{\text{SF}, N}$  where  $N < \text{SF}/2$
- $k$  is 1.56 for signals where any channelisations codes meet the following criteria  $C_{\text{SF}, N}$  where  $N \geq \text{SF}/2$
- $v_{\text{norm}}$  is the normalized voltage waveform of the input signal



- $v_{\text{norm\_ref}}$  is the normalized voltage waveform of the reference signal (12.2 kbps AMR Speech) and
- $20 * \log_{10} ((v_{\text{norm\_ref}})^3)_{\text{rms}} = 1.52 \text{ dB}$

For UE with two active transmit antenna connectors in UL CLTD activation state 1, the allowed Maximum Power Reduction (MPR) for the nominal maximum output power of each antenna is specified in Table 6.1AA. The amount of applied power reduction on each antenna shall be the same.

NOTE: CM is measured at each transmit antenna connector.

For UE configured in UL CLTD activation state 2 or activation state 3, the allowed Maximum Power Reduction (MPR) for the nominal maximum output power specified in sub-clause 6.2.2 applies at the active transmit antenna connector.

## 6.2.2D UE maximum output power with HS-DPCCH and E-DCH for UL MIMO

The Maximum Power Reduction (MPR) for the nominal maximum output power defined in 6.2.1 is specified in table 6.1AC for the values of  $\beta_c, \beta_{\text{hs}}, \beta_{\text{ec}}, \beta_{\text{sec}}, \beta_{\text{ed}}, \beta_{\text{sed}}$  and  $\beta_{\text{sc}}$  defined in [8] fully or partially transmitted during a DPCCH timeslot

**Table 6.1AC: UE maximum output power with HS-DPCCH and E-DCH for UL MIMO**

UE transmit channel configuration	CM (dB)	MPR (dB)
For all combinations of; DPCCH, HS-DPCCH, E-DPDCH, S-E-DPDCH E-DPCCH, S-E-DPCCH and S-DPCCH	$0 \leq \text{CM} \leq 4$	MAX (CM-1, 0)
For all combinations of; DPCCH, HS-DPCCH, E-DPDCH, S-E-DPDCH E-DPCCH, S-E-DPCCH, S-DPCCH and DPCCH2	$0 \leq \text{CM} \leq 4$	MAX (CM-1, 0)

Where Cubic Metric (CM) is based on the UE transmit channel configuration and is given by

$$\text{CM} = \text{CEIL} \{ [20 * \log_{10} ((v_{\text{norm}})^3)_{\text{rms}} - 20 * \log_{10} ((v_{\text{norm\_ref}})^3)_{\text{rms}}] / k, 0.5 \}$$

Where

- $\text{CEIL} \{ x, 0.5 \}$  means rounding upwards to closest 0.5dB, i.e.  $\text{CM} = [0, 0.5, 1.0, 1.5, 2.0, 2.5, 3.0, 3.5]$
- $k$  is 1.85 for signals where all channelisations codes meet the following criteria  $C_{\text{SF}, N}$  where  $N < \text{SF}/2$
- $k$  is 1.56 for signals where any channelisations codes meet the following criteria  $C_{\text{SF}, N}$  where  $N \geq \text{SF}/2$
- $v_{\text{norm}}$  is the normalized voltage waveform of the input signal
- $v_{\text{norm\_ref}}$  is the normalized voltage waveform of the reference signal (12.2 kbps AMR Speech) and
- $20 * \log_{10} ((v_{\text{norm\_ref}})^3)_{\text{rms}} = 1.52 \text{ dB}$

For UE with two active transmit antenna connectors in UL MIMO operation, the allowed Maximum Power Reduction (MPR) for the nominal maximum output power of each antenna is specified in Table 6.1AC. The amount of applied power reduction on each antenna shall be the same.

NOTE: CM is measured at each transmit antenna connector.

## 6.2.3 UE Relative code domain power accuracy

The UE Relative code domain power accuracy is a measure of the ability of the UE to correctly set the level of individual code powers relative to the total power of all active codes. When the UE uses 16QAM modulation on any of the uplink code channels the IQ origin offset power shall be removed from the Measured CDP ratio; however, the removed relative IQ origin offset power (relative carrier leakage power) also has to satisfy the applicable requirement. The measure of accuracy is the difference between two dB ratios:

$$\text{UE Relative CDP accuracy} = (\text{Measured CDP ratio}) - (\text{Nominal CDP ratio})$$



where

$$\text{Measured CDP ratio} = 10 \cdot \log((\text{Measured code power}) / (\text{Measured total power of all active codes}))$$

$$\text{Nominal CDP ratio} = 10 \cdot \log((\text{Nominal CDP}) / (\text{Sum of all nominal CDPs}))$$

The nominal CDP of a code is relative to the total of all codes and is derived from beta factors.

When the UE uses 16QAM modulation a correction factor shall be applied to the  $\beta_{ed}$  value used to compute the Nominal CDP equal to  $\{A_1 \cdot (0.4472)^2 + A_2 \cdot (1.3416)^2 + A_3 \cdot (-0.4472)^2 + A_4 \cdot (-1.3416)^2\}^{1/2}$  where  $A_1$ ,  $A_2$ ,  $A_3$  and  $A_4$  are the fractions of symbols (00, 01, 10, 11 respectively) transmitted during the test.

The sum of all nominal CDPs will equal 1 by definition.

NOTE: The above definition of UE relative CDP accuracy is independent of variations in the actual total power of the signal and of noise in the signal that falls on inactive codes.

The required accuracy of the UE relative CDP is given in table 6.1B. The UE relative CDP accuracy shall be maintained over the period during which the total of all active code powers remains unchanged or one timeslot, whichever is the longer.

**Table 6.1B: UE Relative CDP accuracy**

Nominal CDP ratio	Accuracy (dB)
$\geq -10$ dB	$\pm 1.5$
-10 dB to $\geq -15$ dB	$\pm 2.0$
-15 dB to $\geq -20$ dB	$\pm 2.5$
-20 dB to $\geq -30$ dB	$\pm 3.0$

### 6.2.3A UE Relative code domain power accuracy for DC-HSUPA

The requirement and corresponding measurements apply to each individual carrier when the total power in each of the assigned carriers is equal to each other

The UE Relative code domain power accuracy is a measure of the ability of the UE to correctly set the level of individual code powers in a carrier relative to the total power of all active codes in that carrier. When the UE uses 16QAM modulation on any of the uplink code channels in a carrier the IQ origin offset power measured in that carrier shall be removed from the Measured CDP ratio in that carrier; however, the removed relative IQ origin offset power (relative carrier leakage power) measured in that carrier also has to satisfy the applicable requirement in that carrier. The measure of accuracy is the difference between two dB ratios measured per carrier configured on the uplink:

$$\text{UE Relative CDP accuracy} = (\text{Measured CDP ratio}) - (\text{Nominal CDP ratio})$$

where

$$\text{Measured CDP ratio} = 10 \cdot \log((\text{Measured code power}) / (\text{Measured total power of all active codes}))$$

$$\text{Nominal CDP ratio} = 10 \cdot \log((\text{Nominal CDP}) / (\text{Sum of all nominal CDPs}))$$

The nominal CDP of a code is relative to the total of all codes in each carrier and is derived from beta factors. The sum of all nominal CDPs will equal 1 by definition.

NOTE: The above definition of UE relative CDP accuracy is independent of variations in the actual total power of the signal in each carrier and of noise in the signal that falls on inactive codes.

The required accuracy of the UE relative CDP is given in table 6.1B. The UE relative CDP accuracy shall be maintained over the period during which the total of all active code powers remains unchanged or one timeslot, whichever is the longer.

The reference measurement channels for the requirements in subclause 6.2.3A are provided in subclause A.2.6 and A.2.7.



### 6.2.3B UE Relative code domain power accuracy for UL OLTD

For the UE with two active transmit antenna connectors in UL OLTD operation, the relative code domain power accuracy specified in sub-clause 6.2.3 applies at each transmit antenna connector.

### 6.2.3C UE Relative code domain power accuracy for UL CLTD

For UE with two active transmit antenna connectors in UL CLTD activation state 1, the relative code domain power accuracy specified in sub-clause 6.2.3 applies at each transmit antenna connector.

For UE configured in UL CLTD activation state 2 or activation state 3, the relative code domain power accuracy specified in sub-clause 6.2.3 applies at the active transmit antenna connector.

### 6.2.3D UE Relative code domain power accuracy for UL MIMO

For UE with two active transmit antenna connectors in UL MIMO operation, the relative code domain power accuracy specified in sub-clause 6.2.3 applies at each transmit antenna connector.

## 6.3 Frequency Error

The UE modulated carrier frequency shall be accurate to within  $\pm 0.1$  PPM observed over a period of one timeslot compared to the carrier frequency received from the Node B. For the PRACH preambles the measurement interval is lengthened to 3904 chips (being the 4096 chip nominal preamble period less a 25  $\mu$ s transient period allowance at each end of the burst). These signals will have an apparent error due to Node B frequency error and Doppler shift. The signals from the Node B must be averaged over sufficient time that errors due to noise or interference are within the above  $\pm 0.1$  PPM figure. The UE shall use the same frequency source for both RF frequency generation and the chip clock.

### 6.3A Frequency Error for DC-HSUPA

The UE modulated carrier frequencies shall be accurate to within  $\pm 0.1$  PPM observed over a period of one timeslot compared to the average of the carrier frequencies received from the Node B. When the signal from one Node B cell is out-of-sync, the UE modulated carrier frequency shall be compared to the remaining carrier frequency received from the other Node B cell. These signals will have an apparent error due to Node B frequency error and Doppler shift. The signals from the Node B must be averaged over sufficient time such that errors due to noise or interference are within the above  $\pm 0.1$  PPM figure. The frequency error of the carrier frequencies received from the Node B shall be the same in average. The UE shall use the same frequency source for both RF frequency generation and the chip clock.

### 6.3B Frequency error for UL OLTD

The UE modulated carrier frequency at each transmit antenna connector shall be accurate to within  $\pm 0.1$  PPM observed over a period of one timeslot compared to the carrier frequency received from the Node B. These signals will have an apparent error due to Node B frequency error and Doppler shift. The signals from the Node B must be averaged over sufficient time that errors due to noise or interference are within the above  $\pm 0.1$  PPM figure. The UE shall use the same frequency source for both RF frequency generation and the chip clock.

### 6.3C Frequency error for UL CLTD

The UE modulated carrier frequency at each transmit antenna connector shall be accurate to within  $\pm 0.1$  PPM observed over a period of one timeslot compared to the carrier frequency received from the Node B. These signals will have an apparent error due to Node B frequency error and Doppler shift. The signals from the Node B must be averaged over sufficient time that errors due to noise or interference are within the above  $\pm 0.1$  PPM figure. The UE shall use the same frequency source for both RF frequency generation and the chip clock.



## 6.3D Frequency error for UL MIMO

For UE supporting UL MIMO, the UE modulated carrier frequency at each transmit antenna connector shall be accurate to within  $\pm 0.1$  PPM observed over a period of one timeslot compared to the carrier frequency received from the Node B. These signals will have an apparent error due to Node B frequency error and Doppler shift. The signals from the Node B must be averaged over sufficient time that errors due to noise or interference are within the above  $\pm 0.1$  PPM figure. The UE shall use the same frequency source for both RF frequency generation and the chip clock.

## 6.4 Output power dynamics

Power control is used to limit the interference level.

### 6.4.1 Open loop power control

Open loop power control is the ability of the UE transmitter to sets its output power to a specific value. The open loop power control tolerance is given in Table 6.3

#### 6.4.1.1 Minimum requirement

The UE open loop power is defined as the mean power in a timeslot or ON power duration, whichever is available.

**Table 6.3: Open loop power control tolerance**

Conditions	Tolerance
Normal conditions	$\pm 9$ dB
Extreme conditions	$\pm 12$ dB

#### 6.4.1.1A Additional requirement for DC-HSUPA

The open loop power control tolerance per carrier is given in Table 6.3.

### 6.4.2 Inner loop power control in the uplink

Inner loop power control in the Uplink is the ability of the UE transmitter to adjust its output power in accordance with one or more TPC commands received in the downlink. There are two inner loop power control loops defined , one that controls the DPCCH and one that controls the DPCCH2 power when DPCCH2 is configured.

#### 6.4.2.1 Power control steps

The power control step is the change in the UE transmitter output power in response to a single TPC command, TPC\_cmd, derived at the UE.

##### 6.4.2.1.1 Minimum requirement

The UE transmitter shall when DPCCH2 is not configured have the capability of changing the output power with a step size of 1, 2 and 3 dB according to the value of  $\Delta_{\text{TPC}}$  or  $\Delta_{\text{RP-TPC}}$ , in the slot immediately after the TPC\_cmd as follows

- The transmitter output power step due to inner loop power control shall be within the range shown in Table 6.4.
- The transmitter average output power step due to inner loop power control shall be within the range shown in Table 6.5. Here a TPC\_cmd group is a set of TPC\_cmd values derived from a corresponding sequence of TPC commands of the same duration.

The inner loop power step is defined as the relative power difference between the mean power of the original (reference) timeslot and the mean power of the target timeslot, not including the transient duration. The transient duration is from 25 $\mu$ s before the slot boundary to 25 $\mu$ s after the slot boundary.



**Table 6.4: Transmitter power control range**

TPC_cmd	Transmitter power control range					
	1 dB step size		2 dB step size		3 dB step size	
	Lower	Upper	Lower	Upper	Lower	Upper
+1	+0.5 dB	+1.5 dB	+1 dB	+3 dB	+1.5 dB	+4.5 dB
0	-0.5 dB	+0.5 dB	-0.5 dB	+0.5 dB	-0.5 dB	+0.5 dB
-1	-0.5 dB	-1.5 dB	-1 dB	-3 dB	-1.5 dB	-4.5 dB

The UE transmitter shall when DPCCH2 is configured have the capability of changing the power for the DPCCH code as well as the DPCCH2 code with a step size of 1, 2 and 3 dB according to the value of  $\Delta_{\text{TPC}}$  or  $\Delta_{\text{RP-TPC}}$  in the slot immediately after the TPC\_cmd as follows

- These requirements are valid as long as the maximum code power difference between DPCCH2 and DPCCH is between -5 and +20 dB.
- The transmitter output power step due to inner loop power control shall be within the range shown in Table 6.4A.
- The transmitter average output power step due to inner loop power control shall be within the range shown in Table 6.5. Here a TPC\_cmd group is a set of TPC\_cmd values derived from a corresponding sequence of TPC commands of the same duration.

The inner loop power step is defined as the relative power difference between the mean code power of the original (reference) timeslot and the mean code power of the target timeslot, not including the transient duration. The transient duration is from 25 $\mu$ s before the slot boundary to 25 $\mu$ s after the slot boundary.

**Table 6.4A: Transmitter power control range**

TPC_cmd	Transmitter power control range					
	1 dB step size		2 dB step size		3 dB step size	
	Lower	Upper	Lower	Upper	Lower	Upper
+1	+1.0 dB	+2.0 dB	+1.5 dB	+3.5 dB	+2 dB	+5 dB
0	-1 dB	+1 dB	-1 dB	+1 dB	-1 dB	+1 dB
-1	-1 dB	-2 dB	-1.5 dB	-3.5 dB	-2 dB	-5 dB

**Table 6.5: Transmitter aggregate power control range**

TPC_cmd group	Transmitter power control range after 10 equal TPC_cmd groups				Transmitter power control range after 7 equal TPC_cmd groups	
	1 dB step size		2 dB step size		3 dB step size	
	Lower	Upper	Lower	Upper	Lower	Upper
+1	+8 dB	+12 dB	+16 dB	+24 dB	+16 dB	+26 dB
0	-1 dB	+1 dB	-1 dB	+1 dB	-1 dB	+1 dB
-1	-8 dB	-12 dB	-16 dB	-24 dB	-16 dB	-26 dB
0,0,0,0,+1	+6 dB	+14 dB	N/A	N/A	N/A	N/A
0,0,0,0,-1	-6 dB	-14 dB	N/A	N/A	N/A	N/A

The UE shall meet the above requirements for inner loop power control over the power range bounded by the Minimum output power as defined in subclause 6.4.3, and the Maximum output power supported by the UE (i.e. the actual power as would be measured assuming no measurement error). This power shall be in the range specified for the power class of the UE in subclause 6.2.1.

#### 6.4.2.1.1A Additional requirement for DC-HSUPA

The UE transmitter shall have the capability of changing the output power in each assigned carrier in the uplink with a step size of 1, 2 and 3 dB according to the value of  $\Delta_{\text{TPC}}$  or  $\Delta_{\text{RP-TPC}}$ , in the slot immediately after the TPC\_cmd for the corresponding carrier as follows



- a) The transmitter output power step due to inner loop power control in each assigned carrier in the uplink shall be within the range shown in Table 6.4, when the total transmit power in each of the assigned carriers is equal to each other.
- b) The transmitter average output power step due to inner loop power control in each assigned carrier in the uplink shall be within the range shown in Table 6.5, when the total transmit power in each of the assigned carriers is equal to each other. Here a TPC\_cmd group is a set of TPC\_cmd values derived from a corresponding sequence of TPC commands of the same duration.
- c) The requirements can be tested by sending the same TPC commands for each of the assigned carriers, assuming that the signal powers for the carriers (in terms of DPCCCH code power and total power) have been aligned prior to the beginning of the test procedure.

The inner loop power step is defined as the relative power difference between the mean power of the original (reference) timeslot and the mean power of the target timeslot in each carrier, not including the transient duration. The transient duration is from 25µs before the slot boundary to 25µs after the slot boundary.

#### 6.4.2.1.1B Additional requirement for UL OLTD

For the UE with two active transmit antenna connectors in UL OLTD operation, the inner loop power control in the uplink specified in sub-clause 6.4.2.1.1 applies at each transmit antenna connector.

#### 6.4.2.1.1C Additional requirement for UL CLTD

For UE with two active transmit antenna connectors in UL CLTD activation state 1, the inner loop power control in the uplink specified in sub-clause 6.4.2.1.1 applies at each transmit antenna connector.

For UE configured in UL CLTD activation state 2 or activation state 3, the inner loop power control in the uplink specified in sub-clause 6.4.2.1.1 applies at the active transmit antenna connector.

#### 6.4.2.1.1D Additional requirement for UL MIMO

For UE with two active transmit antenna connectors in UL MIMO operation, the inner loop power control in the uplink specified in sub-clause 6.4.2.1.1 applies at each transmit antenna connector.

### 6.4.3 Minimum output power

The minimum controlled output power of the UE is when the power is set to a minimum value.

#### 6.4.3.1 Minimum requirement

The minimum output power is defined as the mean power in one time slot. The minimum output power shall be less than -50 dBm.

##### 6.4.3.1A Additional requirement for DC-HSUPA

The minimum output power is defined as the mean power in one time slot in each carrier. The minimum output power in each carrier shall be less than -50 dBm, when both carriers are set to minimum output power.

##### 6.4.3.1B Additional requirement for UL OLTD

For the UE with two active transmit antenna connectors in UL OLTD operation, the minimum output power specified in sub-clause 6.4.3.1 applies at each transmit antenna connector, when the UE power is set to a minimum value.

##### 6.4.3.1C Additional requirement for UL CLTD

For UE with two active transmit antenna connectors in UL CLTD activation state 1, the minimum output power specified in sub-clause 6.4.3.1 applies at each transmit antenna connector, when the UE power is set to a minimum value.



For UE configured in UL CLTD activation state 2 or activation state 3, the minimum output power specified in sub-clause 6.4.3.1 applies at the active transmit antenna connector, when the UE power is set to a minimum value.

#### 6.4.3.1D Additional requirement for UL MIMO

For UE with two active transmit antenna connectors in UL MIMO operation, the minimum output power specified in sub-clause 6.4.3.1 applies at each transmit antenna connector, when the UE power is set to a minimum value.

### 6.4.4 Out-of-synchronization handling of output power

The receiver characteristics in this section are specified at the antenna connector of the UE. For UE(s) with an integral antenna only, a reference antenna with a gain of 0 dBi is assumed. UE with an integral antenna may be taken into account by converting these power levels into field strength requirements, assuming a 0 dBi gain antenna. For UEs with more than one receiver antenna connector the AWGN signals applied to each receiver antenna connector shall be uncorrelated. The levels of the test signal applied to each of the antenna connectors shall be as defined in section 6.4.4.2 below.

The UE shall monitor the DPCCH quality in order to detect a loss of the signal on Layer 1, as specified in TS 25.214. The thresholds  $Q_{out}$  and  $Q_{in}$  specify at what DPCCH quality levels the UE shall shut its power off and when it shall turn its power on respectively. The thresholds are not defined explicitly, but are defined by the conditions under which the UE shall shut its transmitter off and turn it on, as stated in this subclause.

The DPCCH quality shall be monitored in the UE and compared to the thresholds  $Q_{out}$  and  $Q_{in}$  for the purpose of monitoring synchronization. The threshold  $Q_{out}$  should correspond to a level of DPCCH quality where no reliable detection of the TPC commands transmitted on the downlink DPCCH can be made. This can be at a TPC command error ratio level of e.g. 30%. The threshold  $Q_{in}$  should correspond to a level of DPCCH quality where detection of the TPC commands transmitted on the downlink DPCCH is significantly more reliable than at  $Q_{out}$ . This can be at a TPC command error ratio level of e.g. 20%.

#### 6.4.4.1 Minimum requirement

When the UE estimates the DPCCH quality or the quality of the TPC fields of the F-DPCH frame received from the serving HS-DSCH cell over the last 160 ms period or quality of the TPC fields of the F-DPCH from the serving HS-DSCH cell over the previous 240 slots in which the TPC symbols are known to be present when the discontinuous uplink DPCCH transmission operation is enabled to be worse than a threshold  $Q_{out}$ , the UE shall shut its transmitter off within 40 ms. The UE shall not turn its transmitter on again until the DPCCH quality exceeds an acceptable level  $Q_{in}$ . When the UE estimates the DPCCH quality or the quality of the TPC fields of the F-DPCH frame received from the serving HS-DSCH cell over the last 160 ms period or quality of the TPC fields of the F-DPCH from the serving HS-DSCH cell over the previous 240 slots in which the TPC symbols are known to be present when the discontinuous uplink DPCCH transmission operation is enabled to be better than a threshold  $Q_{in}$ , the UE shall again turn its transmitter on within 40 ms.

The UE transmitter shall be considered "off" if the transmitted power is below the level defined in subclause 6.5.1 (Transmit off power). Otherwise the transmitter shall be considered as "on".

#### 6.4.4.1A Additional requirement for UL OLTD

For UE with two active transmit antenna connectors in UL OLTD operation, the minimum requirements specified in sub-clause 6.4.4.1 apply at each transmit antenna connector.

#### 6.4.4.1B Additional requirement for UL CLTD

For UE with two active transmit antenna connectors in UL CLTD activation state 1, the minimum requirements specified in sub-clause 6.4.4.1 apply at each transmit antenna connector.

For UE configured in UL CLTD activation state 2 or activation state 3, the minimum requirements specified in sub-clause 6.4.4.1 apply at the active transmit antenna connector.



#### 6.4.4.1C Additional requirement for UL MIMO

For UE with two active transmit antenna connectors in UL MIMO operation, the minimum requirements specified in sub-clause 6.4.4.1 apply at each transmit antenna connector.

#### 6.4.4.2 Test case

This subclause specifies a test case, which provides additional information for how the minimum requirement should be interpreted for the purpose of conformance testing.

The quality levels at the thresholds  $Q_{out}$  and  $Q_{in}$  correspond to different signal levels depending on the downlink conditions DCH parameters. For the conditions in Table 6.6, a signal with the quality at the level  $Q_{out}$  can be generated by a DPCCH\_Ec/Ior ratio of -25 dB, and a signal with  $Q_{in}$  by a DPCCH\_Ec/Ior ratio of -21 dB. For a UE which supports the optional enhanced performance requirements type1 for DCH a signal with the quality at the level  $Q_{out}$  can be instead generated by a DPCCH\_Ec/Ior ratio of -28 dB, and a signal with  $Q_{in}$  by a DPCCH\_Ec/Ior ratio of -24 dB for the conditions in Table 6.6. The DL reference measurement channel (12.2) kbps specified in subclause A.3.1 and with static propagation conditions. The downlink physical channels, other than those specified in Table 6.6, are as specified in Table C.3 of Annex C.

Figure 6.1 shows an example scenario where the DPCCH\_Ec/Ior ratio varies from a level where the DPCH is demodulated under normal conditions, down to a level below  $Q_{out}$  where the UE shall shut its power off and then back up to a level above  $Q_{in}$  where the UE shall turn the power back on. Figure 6.1A shows an example scenario for a UE which supports the optional enhanced performance requirements type1 for DCH, where the DPCCH\_Ec/Ior ratio varies from a level where the DPCH is demodulated under normal conditions, down to a level below  $Q_{out}$  where the UE shall shut its power off and then back up to a level above  $Q_{in}$  where the UE shall turn the power back on.

**Table 6.6: DCH parameters for the Out-of-synch handling test case**

Parameter	Unit	Value
$\hat{I}_{or}/I_{oc}$	dB	-1
$I_{oc}$	dBm/3.84 MHz	-60
$\frac{DPDCH\_E_c}{I_{or}}$	dB	See figure 6.1: Before point A -16.6 After point A Not defined
$\frac{DPCCH\_E_c}{I_{or}}$	dB	See figure 6.1
Information Data Rate	kbps	12.2



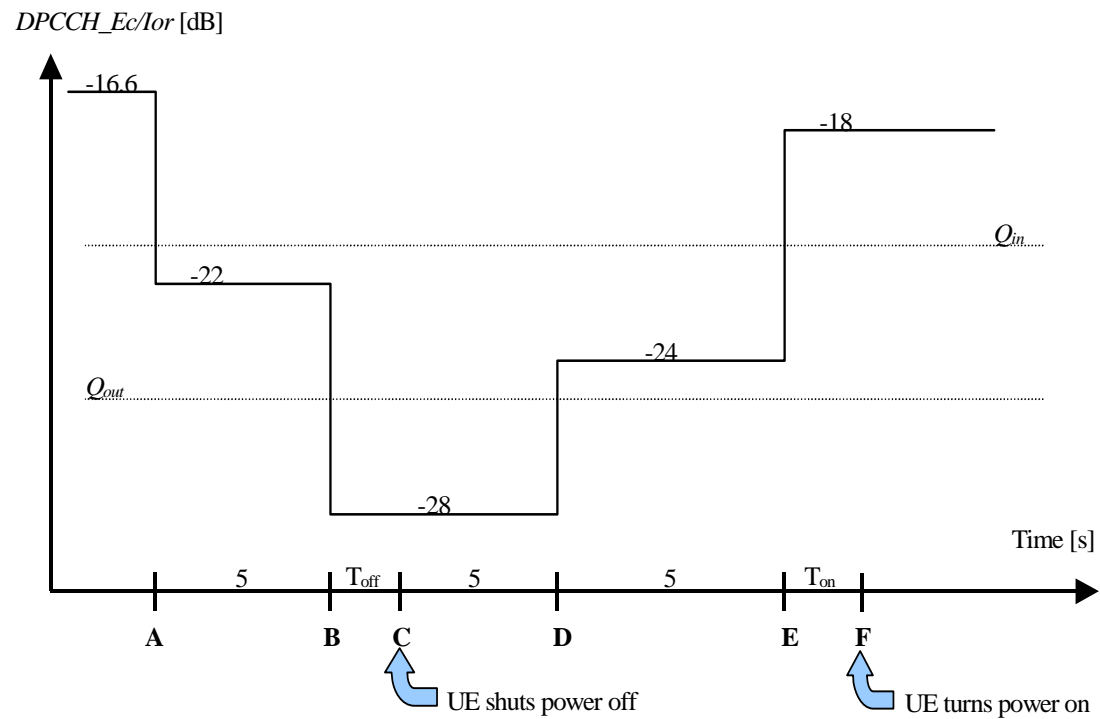


Figure 6.1: Test case for out-of-synch handling in the UE

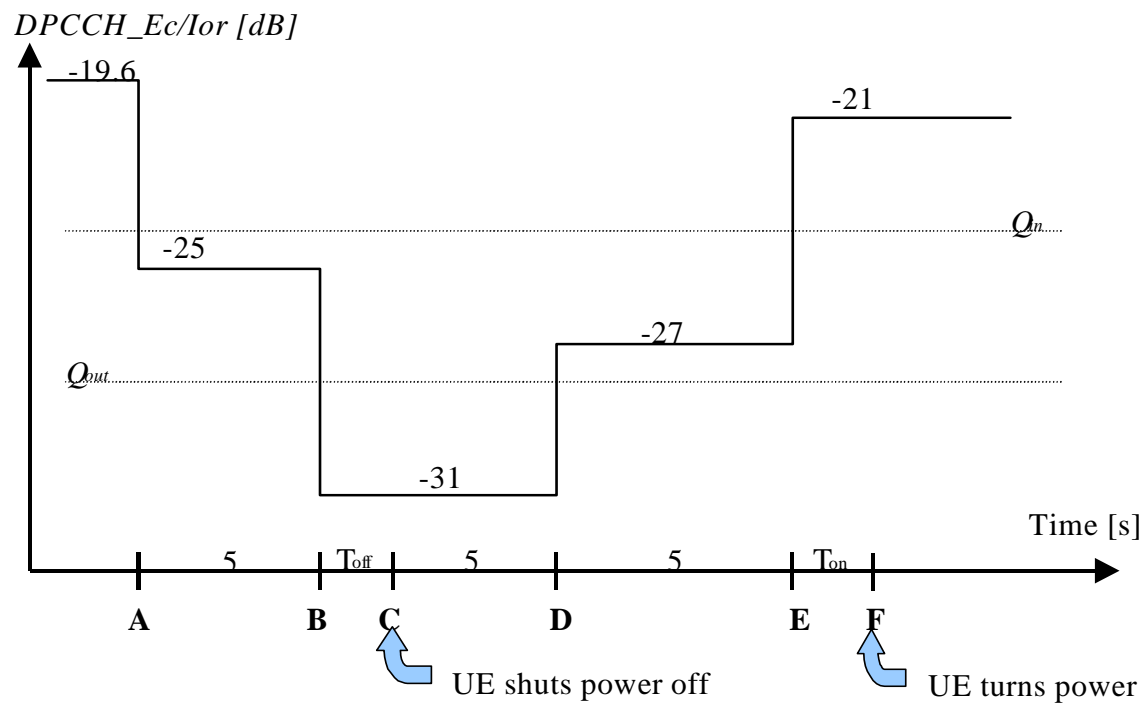


Figure 6.1A: Test case for out-of-synch handling in the UE supporting the enhanced performance requirements type1



In this test case, the requirements for the UE are that:

1. The UE shall not shut its transmitter off before point B.
2. The UE shall shut its transmitter off before point C, which is  $T_{\text{off}} = 200$  ms after point B.
3. The UE shall not turn its transmitter on between points C and E.
4. The UE shall turn its transmitter on before point F, which is  $T_{\text{on}} = 200$  ms after point E.

## 6.4A Output pattern dynamics

An F-TPICH carries transmitted precoding indicator generated at layer 1 for UL CLTD operation.

### 6.4A.1 Out-of-quality handling of TPI applicability

The UE shall measure the reliability of the received TPI bits over the 3 slot period in which the TPI bit pattern corresponding to a precoding weight is received, as specified in TS 25.214 [8]. The received TPI bits are mapped to precoding weights and applied by the UE only if the estimated quality of the TPI bits is determined to be better than a threshold  $Q_{\text{tpi}}$ . Otherwise, the UE shall apply the precoding weights corresponding to the last reliably received TPI bit pattern. The threshold is not defined explicitly, but is defined by the conditions under which the UE shall apply the precoding weights corresponding to the received TPI bits and apply the precoding weights corresponding to the last reliably received TPI bits, as stated in this subclause.

The threshold  $Q_{\text{tpi}}$  should correspond to a level of F-TPICH quality below which no reliable detection of the TPI bits transmitted on the downlink DPCCH can be made.

#### 6.4A.1.1 Minimum requirement

When the UE estimates the F-TPICH quality received over the 3 slot period to be worse than a threshold  $Q_{\text{tpi}}$ , the UE shall apply the precoding weights corresponding to the last reliably received TPI bit pattern. The UE shall not apply the precoding weights corresponding to the received TPI bits again until the F-TPICH quality exceeds a threshold  $Q_{\text{tpi}}$ . When the estimated F-TPICH quality is better than a threshold  $Q_{\text{tpi}}$ , the UE shall again apply the precoding weights corresponding to the received TPI bits.

#### 6.4A.1.2 Test case

This subclause specifies a test case, which provides additional information for how the minimum requirement should be interpreted for the purpose of conformance testing.

The quality level at the threshold  $Q_{\text{tpi}}$  corresponds to a signal level depending on the downlink conditions F-TPICH parameters. For the conditions in Table 6.6A, a signal with the quality below the level  $Q_{\text{tpi}}$  can be generated by an F-TPICH\_Ec/Ior ratio of -26 dB, and a signal with the quality above the level  $Q_{\text{tpi}}$  can be generated by an F-TPICH\_Ec/Ior ratio of -12 dB. For a UE which supports the optional enhanced requirements type1 specified based on receiver diversity for F-TPICH a signal with the quality below the level  $Q_{\text{tpi}}$  can be instead generated by an F-TPICH\_Ec/Ior ratio of -29 dB for the conditions in Table 6.6A, and a signal with the quality above the level  $Q_{\text{tpi}}$  by an F-TPICH\_Ec/Ior ratio of -15 dB. The downlink physical channels, other than those specified in Table 6.6A, are as specified in Table C.3 of Annex C.

Figure 6.1B shows an example scenario where the F-TPICH\_Ec/Ior ratio varies from a level where the F-TPICH is demodulated under normal conditions, down to a level below  $Q_{\text{tpi}}$  where the UE shall apply the precoding weights corresponding to the last reliably received TPI bit pattern and then back up to a level above  $Q_{\text{tpi}}$  where the UE shall apply the precoding weights corresponding to the received TPI bit pattern. Figure 6.1C shows an example scenario for a UE which supports the optional enhanced requirements type1 for F-TPICH, where the F-TPICH\_Ec/Ior ratio varies from a level where the F-TPICH is demodulated under normal conditions, down to a level below  $Q_{\text{tpi}}$  where the UE shall apply the precoding weights corresponding to the last reliably received TPI bit pattern and then back up to a level above  $Q_{\text{tpi}}$  where the UE shall apply the precoding weights corresponding to the received TPI bit pattern. Point B shall be at least 10 ms after point A, and point D shall be at least 10 ms after point C.

For a UE which supports the optional enhanced requirements type 1 for F-TPICH, the UE shall not be tested according to the minimum requirements.



Table 6.6A: parameters for the out-of-quality handling of F-TPICH test case

Parameter	Unit	Value
Propagation condition		Static
$\hat{I}_{or}/I_{oc}$	dB	-1
$I_{oc}$	dBm/3.84 MHz	-60
$\frac{F-TPICH_{Ec}}{I_{or}}$	dB	See figure 6.1B or figure 6.1C

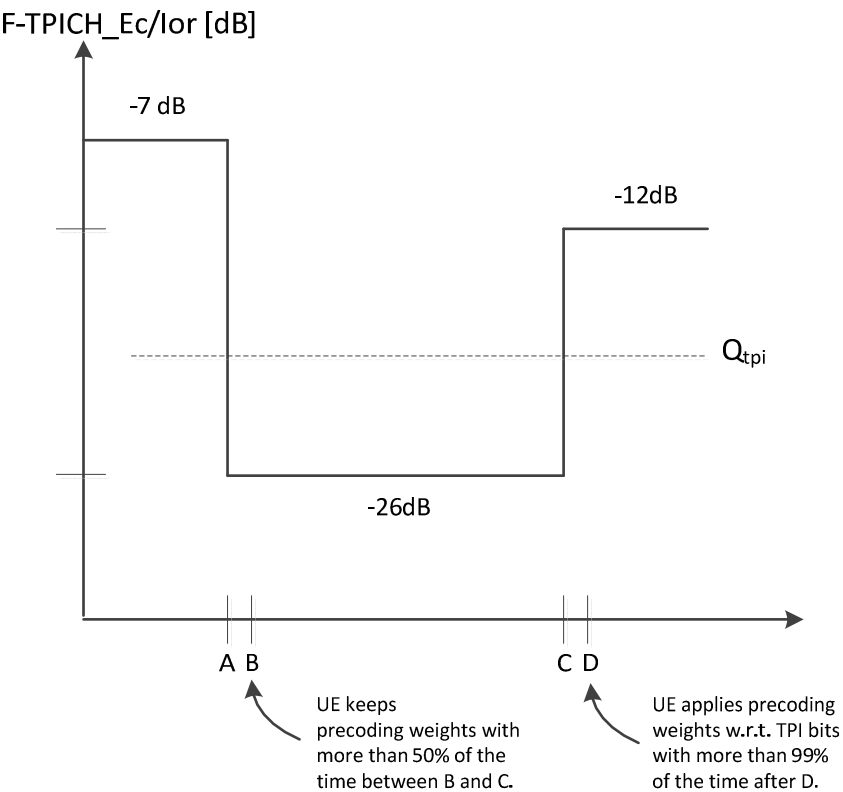
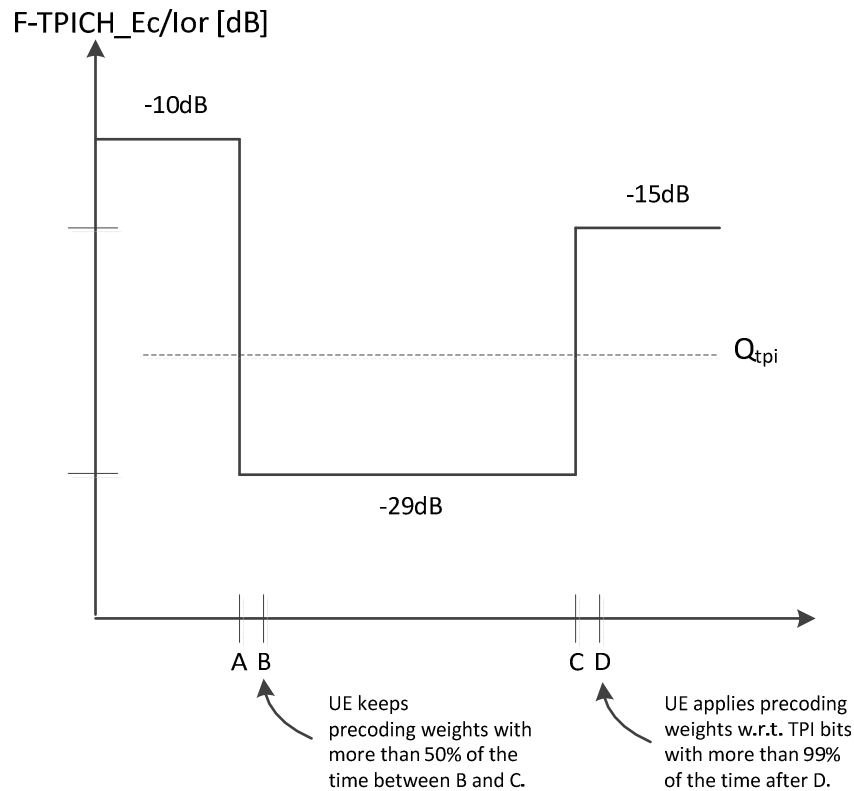


Figure 6.1B: Test case for F-TPICH out-of-quality handling in the UE supporting the minimum requirements for F-TPICH





**Figure 6.1C: Test case for F-TPICH out-of-quality handling in the UE supporting the optional enhanced requirements type1 for F-TPICH**

In these test cases, the requirements for the UE are that:

1. The UE shall keep precoding weights with more than 50% of the time between point B and point C.
2. The UE apply precoding weights w.r.t. TPI bits with more than 99% of the time after point D.

## 6.5 Transmit ON/OFF power

### 6.5.1 Transmit OFF power

Transmit OFF power is defined as the RRC filtered mean power when the transmitter is off. The transmitter is considered to be off when the UE is not allowed to transmit or during periods when the UE is not transmitting DPCCH due to discontinuous uplink DPCCH transmission. During UL compressed mode gaps, the UE is not considered to be off.

#### 6.5.1.1 Minimum requirement

The transmit OFF power is defined as the RRC filtered mean power in a duration of at least one timeslot excluding any transient periods. The requirement for the transmit OFF power shall be less than -56 dBm.

##### 6.5.1.1A Additional requirement for DC-HSUPA

The transmit OFF power is defined per carrier as the RRC filtered mean power in a duration of at least one timeslot excluding any transient periods. The requirement for the transmit OFF power in each carrier shall be less than -56 dBm, when the transmitters in both carriers are turned off.



### 6.5.1.1B Additional requirement for UL OLTD

For the UE with two active transmit antenna connectors in UL OLTD operation, the transmit OFF power specified in sub-clause 6.5.1.1 applies at each transmit antenna connector, when the transmitter is OFF on both transmit connectors.

### 6.5.1.1C Additional requirement for UL CLTD

For UE with two active transmit antenna connectors in UL CLTD activation state 1, the transmit OFF power specified in sub-clause 6.5.1.1 applies at each transmit antenna connector, when the transmitter is OFF on both transmit antenna connectors.

For UE configured in UL CLTD activation state 2 or activation state 3, the transmit OFF power specified in sub-clause 6.5.1.1 applies at the active transmit antenna connector, when the transmitter is OFF on both transmit antenna connectors.

### 6.5.1.1D Additional requirement for UL MIMO

For UE with two active transmit antenna connectors in UL MIMO operation, the transmit OFF power specified in sub-clause 6.5.1.1 applies at each transmit antenna connector, when the transmitter is OFF on both transmit antenna connectors.

## 6.5.2 Transmit ON/OFF Time mask

The time mask for transmit ON/OFF defines the transient period allowed for the UE between transmit OFF power and transmit ON power. During the transient period there are no additional requirements on UE transmit power beyond what is required in subclause 6.2 maximum output power observed over a period of at least one timeslot. ON/OFF scenarios include PRACH preamble bursts, the beginning or end of PRACH message parts, the beginning or end of each discontinuous uplink DPCH transmission gap and the beginning or end of UL DPCH transmissions.

### 6.5.2.1 Minimum requirement

The transmit power levels versus time shall meet the requirements in figure 6.2 for PRACH preambles, the requirements in figure 6.2A for discontinuous uplink DPCH transmission and the requirements in figure 6.3 for all other cases. The off power observation period is defined as the RRC filtered mean power in a duration of at least one timeslot excluding any transient periods. The on power observation period is defined as the mean power over one timeslot excluding any transient periods. For PRACH preambles, the on power observation period is 3904 chips (4096 chips less the transient periods).

The off power specification in figures 6.2 and 6.3 is as defined in 6.5.1.1.

The average on power specification in figures 6.2 and 6.3 depends on each possible case.

- First preamble of RACH: Open loop accuracy (Table 6.3).
- During preamble ramping of the RACH, and between final RACH preamble and RACH message part: Accuracy depending on size of the required power difference (Table 6.7). The step in total transmitted power between final RACH preamble and RACH message (control part + data part) shall be rounded to the closest integer dB value. A power step exactly half-way between two integer values shall be rounded to the closest integer of greater magnitude.
- Accuracy for the DPCH power loop:

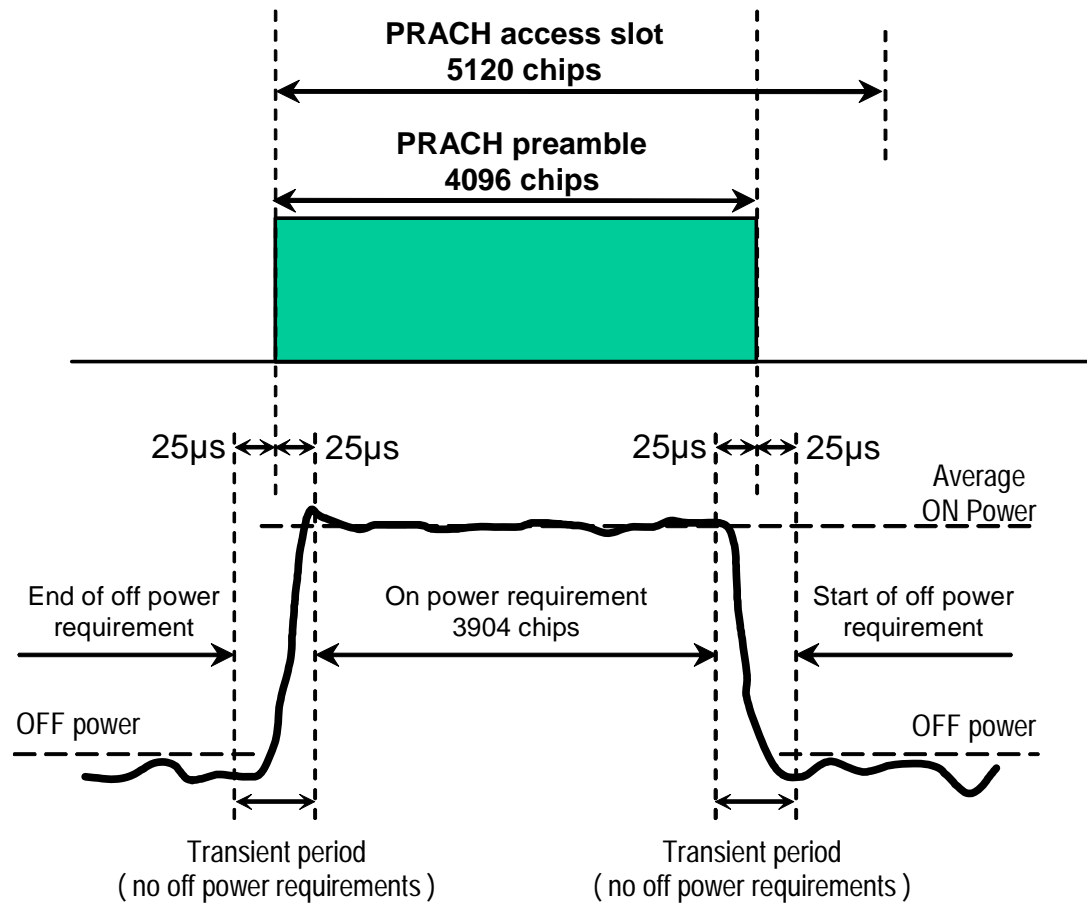
After transmission gaps due to discontinuous uplink DPCH transmission: Accuracy for the DPCH power loop as defined in Table 6.7A. The uplink transmitter power difference tolerance after a transmission gap of up to 10 sub-frames shall be within the range as defined in Table 6.7A. The TPC\_cmd value shown in Table 6.7A corresponds to the last TPC\_cmd value received before the transmission gap and applied by the UE after the transmission gap when discontinuous uplink DPCH transmission is activated.
- After transmission gaps in compressed mode: Accuracy for the DPCH power loop as in Table 6.9.
- Accuracy for the DPCH2 power loop:



The Accuracies are required when the power of DPCCH2 is within the range {DPCCH power + 20dB , DPCCH power – 5dB }

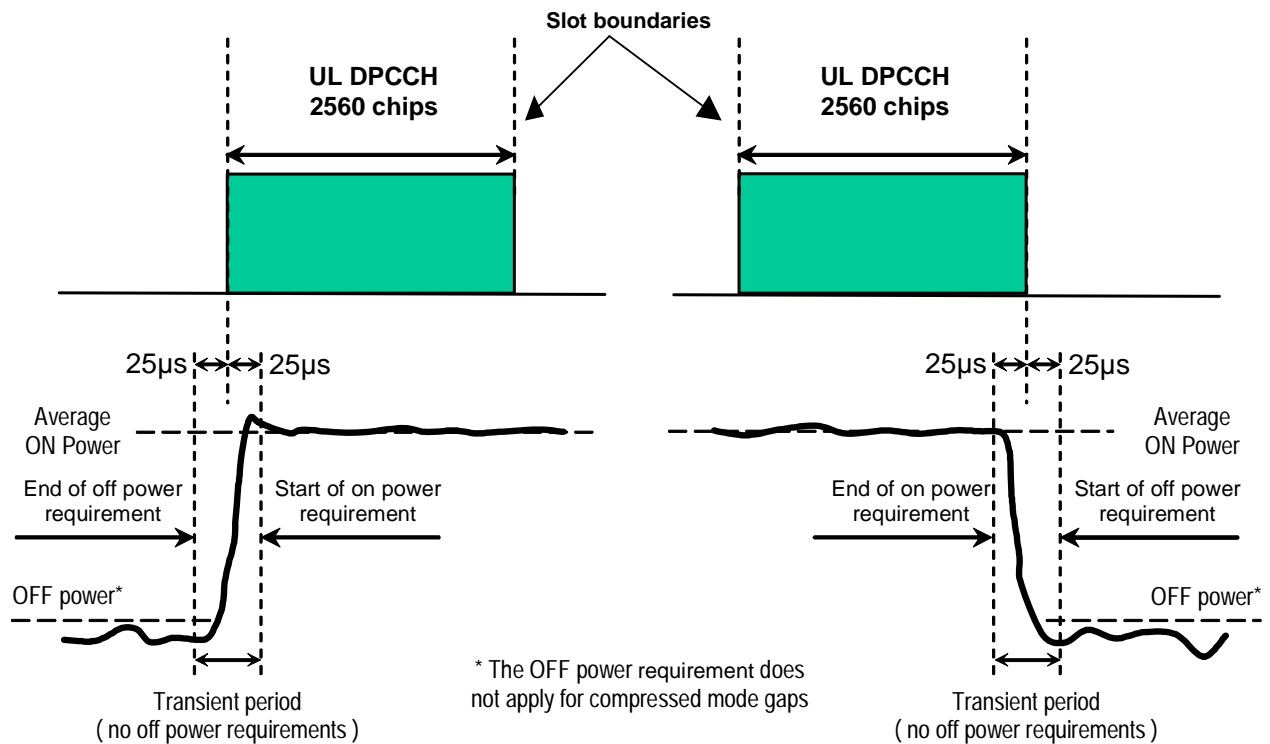
After transmission gaps due to discontinuous uplink DPCCH transmission: Accuracy for the DPCCH2 power loop has the same requirement from Table 6.7A as the DPCCH power loop

- After transmission gaps in compressed mode: Accuracy for the DPCCH2 power loop as in Table 6.9.
- Power step to Maximum Power: Maximum power accuracy (Table 6.1).

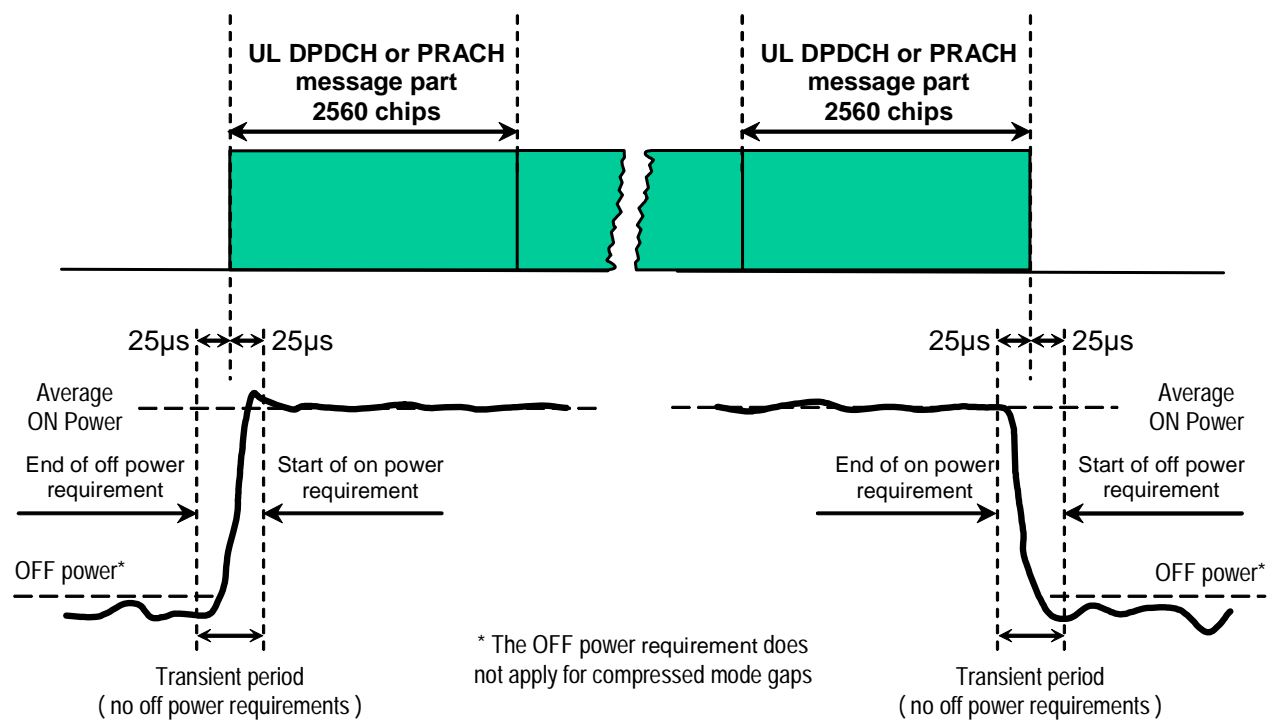


**Figure 6.2: Transmit ON/OFF template for PRACH preambles**





**Figure 6.2A: Transmit ON/OFF template for discontinuous uplink DPCCH transmission**



**Figure 6.3: Transmit ON/OFF template for all other On/Off cases**



**Table 6.7: Transmitter power difference tolerance for RACH preamble ramping, and between final RACH preamble and RACH message part**

Power step size (Up or down)* $\Delta P$ [dB]	Transmitter power difference tolerance [dB]
0	+/- 1
1	+/- 1
2	+/- 1.5
3	+/- 2
$4 \leq \Delta P \leq 10$	+/- 2.5
$11 \leq \Delta P \leq 15$	+/- 3.5
$16 \leq \Delta P \leq 20$	+/- 4.5
$21 \leq \Delta P$	+/- 6.5

NOTE: Power step size for RACH preamble ramping is from 1 to 8 dB with 1 dB steps.

**Table 6.7A: Transmitter power difference tolerance after a gap of up to 10 sub-frames due to discontinuous uplink DPCCH transmission**

Last TPC_cmd	Transmitter power step tolerance after discontinuous UL DPCCH transmission gap					
	1 dB step size		2 dB step size		3 dB step size	
	Lower	Upper	Lower	Upper	Lower	Upper
+ 1	-2 dB	+4 dB	-1 dB	+5 dB	0 dB	+6 dB
0	-3 dB	+3 dB	-3 dB	+3 dB	-3 dB	+3 dB
-1	-4 dB	+2 dB	-5 dB	+1 dB	-6 dB	0 dB

#### 6.5.2.1A Additional requirement for UL OLTD

For UE with two active transmit antenna connectors in UL OLTD operation, the minimum requirements except the requirement with PRACH specified in sub-clause 6.5.2.1 apply at each transmit antenna connector.

#### 6.5.2.1B Additional requirement for UL CLTD

For UE with two active transmit antenna connectors in UL CLTD activation state 1, the minimum requirements specified in sub-clause 6.5.2.1 except the requirement with PRACH apply at each transmit antenna connector.

For UE configured in UL CLTD activation state 2 or activation state 3, the minimum requirements in sub-clause 6.5.2.1 except the requirement with PRACH apply at the active transmit antenna connector.

#### 6.5.2.1C Additional requirement for UL MIMO

For UE with two active transmit antenna connectors in UL MIMO operation, the minimum requirements specified in sub-clause 6.5.2.1, except the requirement with PRACH, apply at each transmit antenna connector.

### 6.5.3 Change of TFC

A change of TFC (Transport Format Combination) in uplink means that the power in the uplink varies according to the change in data rate. DTX, where the DPDCH is turned off, is a special case of variable data, which is used to minimise the interference between UE(s) by reducing the UE transmit power when voice, user or control information is not present.

#### 6.5.3.1 Minimum requirement

A change of output power is required when the TFC, and thereby the data rate, is changed. The ratio of the amplitude between the DPDCH codes and the DPCCH code will vary. The power step due to a change in TFC shall be calculated in the UE so that the power transmitted on the DPCCH shall follow the inner loop power control. The step in total transmitted power (DPCCH + DPDCH) shall then be rounded to the closest integer dB value. A power step exactly half-way between two integer values shall be rounded to the closest integer of greater magnitude. The accuracy of the

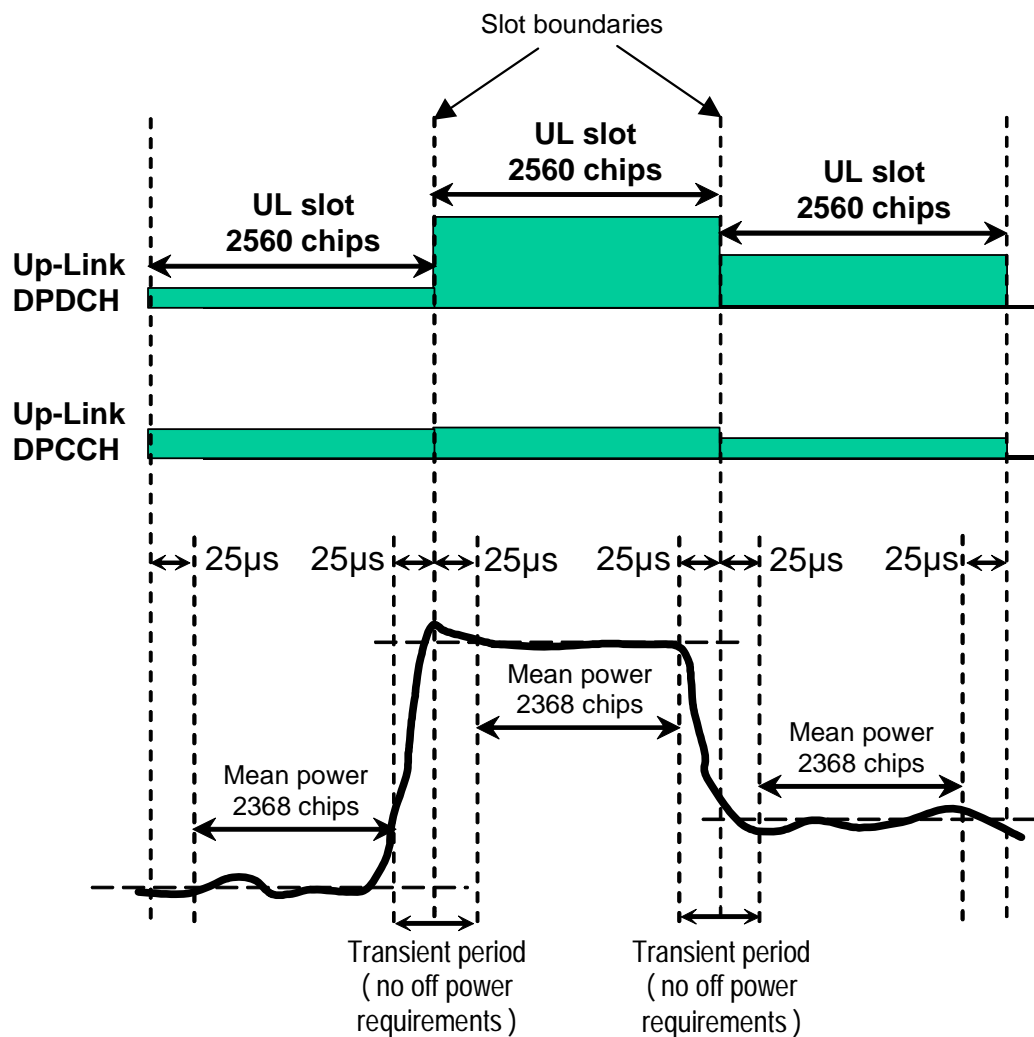


power step, given the step size, is specified in Table 6.8. The power change due to a change in TFC is defined as the relative power difference between the mean power of the original (reference) timeslot and the mean power of the target timeslot, not including the transient duration. The transient duration is from 25µs before the slot boundary to 25µs after the slot boundary.

**Table 6.8: Transmitter power step tolerance**

Power step size (Up or down) $\Delta P$ [dB]	Transmitter power step tolerance [dB]
0	+/- 0.5
1	+/- 0.5
2	+/- 1.0
3	+/- 1.5
$4 \leq \Delta P \leq 10$	+/- 2.0
$11 \leq \Delta P \leq 15$	+/- 3.0
$16 \leq \Delta P \leq 20$	+/- 4.0
$21 \leq \Delta P$	+/- 6.0

The mean power of successive slots shall be calculated according to Figure 6.4.



**Figure 6.4: Transmit template during TFC change**



### 6.5.3.1A Additional requirement for UL OLT

For UE with two active transmit antenna connectors in UL OLT operation, the minimum requirements specified in sub-clause 6.5.3.1 apply at each transmit antenna connector.

### 6.5.3.1B Additional requirement for UL CLTD

A change of output power is required when the TFC, and thereby the data rate, is changed. The ratio of the amplitude between the DPDCH codes and the DPCCH code will vary. The power step due to a change in TFC shall be calculated in the UE so that the power transmitted on the DPCCH shall follow the inner loop power control. The step in total transmitted power (DPCCH + S-DPCCH + DPDCH for UE configured in UL CLTD activation state 1, and DPCCH + DPDCH for UE configured in UL CLTD activation state 2 or activation state 3) shall then be rounded to the closest integer dB value. A power step exactly half-way between two integer values shall be rounded to the closest integer of greater magnitude. The accuracy of the power step, given the step size, is specified in Table 6.8 at each transmit antenna connector. The power change at each transmit antenna connector due to a change in TFC is defined as the relative power difference between the mean power of the original (reference) timeslot and the mean power of the target timeslot, not including the transient duration. The transient duration is from 25µs before the slot boundary to 25µs after the slot boundary.

## 6.5.4 Power setting in uplink compressed mode

Compressed mode in uplink means that the power in uplink is changed.

### 6.5.4.1 Minimum requirement

A change of output power is required during uplink compressed frames since the transmission of data is performed in a shorter interval. The ratio of the amplitude between the DPDCH codes and the DPCCH code will also vary. The power step due to compressed mode shall be calculated in the UE so that the energy transmitted on the pilot bits during each transmitted slot shall follow the inner loop power control.

Thereby, the power during compressed mode, and immediately afterwards, shall be such that the mean power of the DPCCH follows the steps due to inner loop power control combined with additional steps of  $10\log_{10}(N_{\text{pilot,prev}} / N_{\text{pilot,curr}})$  dB where  $N_{\text{pilot,prev}}$  is the number of pilot bits in the previously transmitted slot, and  $N_{\text{pilot,curr}}$  is the current number of pilot bits per slot.

The resulting step in total transmitted power (DPCCH + DPDCH) shall then be rounded to the closest integer dB value. A power step exactly half-way between two integer values shall be rounded to the closest integer of greatest magnitude. The accuracy of the power step, given the step size, is specified in Table 6.8 in subclause 6.5.3.1. The power step is defined as the relative power difference between the mean power of the original (reference) timeslot and the mean power of the target timeslot, when neither the original timeslot nor the reference timeslot are in a transmission gap. The transient duration is not included, and is from 25µs before the slot boundary to 25µs after the slot boundary.

In addition to any power change due to the ratio  $N_{\text{pilot,prev}} / N_{\text{pilot,curr}}$ , the mean power of the DPCCH in the first slot after a compressed mode transmission gap shall differ from the mean power of the DPCCH in the last slot before the transmission gap by an amount  $\Delta_{\text{RESUME}}$ , where  $\Delta_{\text{RESUME}}$  is calculated as described in clause 5.1.2.3 of TS 25.214.

The resulting difference in the total transmitted power (DPCCH + DPDCH) shall then be rounded to the closest integer dB value. A power difference exactly half-way between two integer values shall be rounded to the closest integer of greatest magnitude. The accuracy of the resulting difference in the total transmitted power (DPCCH + DPDCH) after a transmission gap of up to 14 slots shall be as specified in Table 6.9.

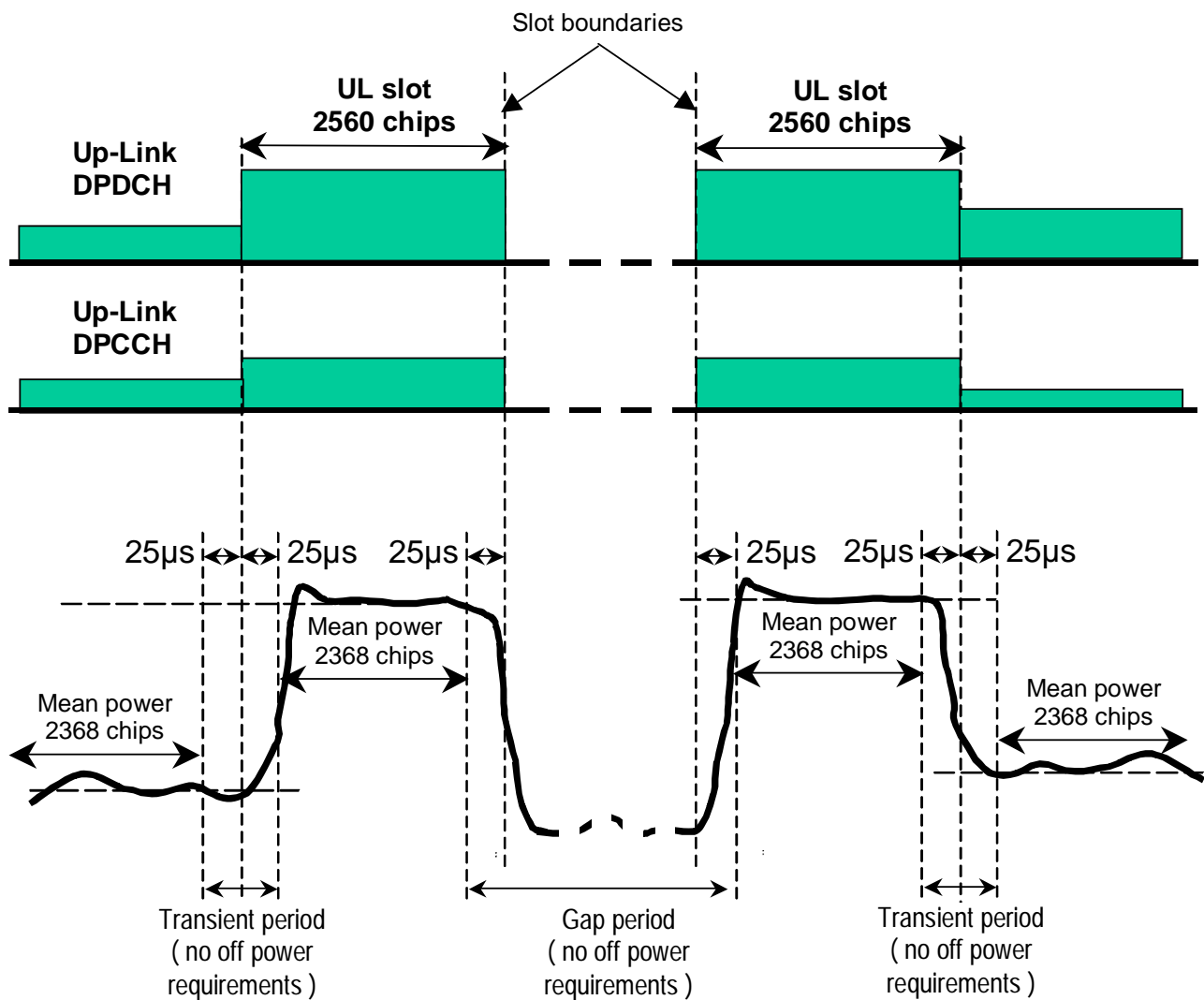


**Table 6.9: Transmitter power difference tolerance after a transmission gap of up to 14 slots**

Power difference (Up or down) $\Delta P$ [dB]	Transmitter power step tolerance after a transmission gap [dB]
$\Delta P \leq 2$	+/- 3
3	+/- 3
$4 \leq \Delta P \leq 10$	+/- 3.5
$11 \leq \Delta P \leq 15$	+/- 4
$16 \leq \Delta P \leq 20$	+/- 4.5
$21 \leq \Delta P$	+/- 6.5

The power difference is defined as the difference between the mean power of the original (reference) timeslot before the transmission gap and the mean power of the target timeslot after the transmission gap, not including the transient durations. The transient durations at the start and end of the transmission gaps are each from 25µs before the slot boundary to 25µs after the slot boundary.

The mean power of successive slots shall be calculated according to figure 6.5.

**Figure 6.5: Transmit template during compressed mode**



#### 6.5.4.1A Additional requirement for UL OLTD

For UE with two active transmit antenna connectors in UL OLTD operation, the minimum requirements specified in sub-clause 6.5.4.1 apply at each UE antenna connector.

#### 6.5.4.1B Additional requirement for UL CLTD

A change of output power is required during uplink compressed frames since the transmission of data is performed in a shorter interval. The ratio of the amplitude between the DPDCH codes and the DPCCH code will also vary. The power step due to compressed mode shall be calculated in the UE so that the energy transmitted on the pilot bits during each transmitted slot shall follow the inner loop power control.

Thereby, the power during compressed mode, and immediately afterwards, shall be such that the mean power of the DPCCH follows the steps due to inner loop power control combined with additional steps of  $10\log_{10}(N_{\text{pilot,prev}} / N_{\text{pilot,curr}})$  dB where  $N_{\text{pilot,prev}}$  is the number of pilot bits in the previously transmitted slot, and  $N_{\text{pilot,curr}}$  is the current number of pilot bits per slot.

The resulting step in total transmitted power (DPCCH + S-DPCCH + DPDCH for UE configured in UL CLTD activation state 1, and DPCCH + DPDCH for UE configured in UL CLTD activation state 2 or activation state 3) shall then be rounded to the closest integer dB value. A power step exactly half-way between two integer values shall be rounded to the closest integer of greatest magnitude. The accuracy of the power step at each transmit antenna connector, given the step size, is specified in Table 6.8 in subclause 6.5.3.1. The power step is defined as the relative power difference between the mean power of the original (reference) timeslot and the mean power of the target timeslot, when neither the original timeslot nor the reference timeslot are in a transmission gap. The transient duration is not included, and is from 25µs before the slot boundary to 25µs after the slot boundary.

In addition to any power change due to the ratio  $N_{\text{pilot,prev}} / N_{\text{pilot,curr}}$ , the mean power of the DPCCH in the first slot after a compressed mode transmission gap shall differ from the mean power of the DPCCH in the last slot before the transmission gap by an amount  $\Delta_{\text{RESUME}}$ , where  $\Delta_{\text{RESUME}}$  is calculated as described in clause 5.1.2.3 of TS 25.214.

The resulting difference in the total transmitted power (DPCCH + S-DPCCH + DPDCH for UE configured in UL CLTD activation state 1, and DPCCH + DPDCH for UE configured in UL CLTD activation state 2 or activation state 3) shall then be rounded to the closest integer dB value. A power difference exactly half-way between two integer values shall be rounded to the closest integer of greatest magnitude. The accuracy of the resulting difference in the total transmitted power (DPCCH + S-DPCCH + DPDCH for UE configured in UL CLTD activation state 1, and DPCCH + DPDCH for UE configured in UL CLTD activation state 2 or activation state 3) after a transmission gap of up to 14 slots shall be as specified in Table 6.9 at each transmit antenna connector.

The power difference at each transmit antenna connector is defined as the difference between the mean power of the original (reference) timeslot before the transmission gap and the mean power of the target timeslot after the transmission gap, not including the transient durations. The transient durations at the start and end of the transmission gaps are each from 25µs before the slot boundary to 25µs after the slot boundary. The mean power of successive slots shall be calculated according to figure 6.5.

### 6.5.5 HS-DPCCH

The transmission of Ack/Nack or CQI over the HS-DPCCH may cause the transmission power in the uplink to vary. The ratio of the amplitude between the DPCCH and the Ack/Nack and CQI respectively is signalled by higher layers.

#### 6.5.5.1 Minimum requirement

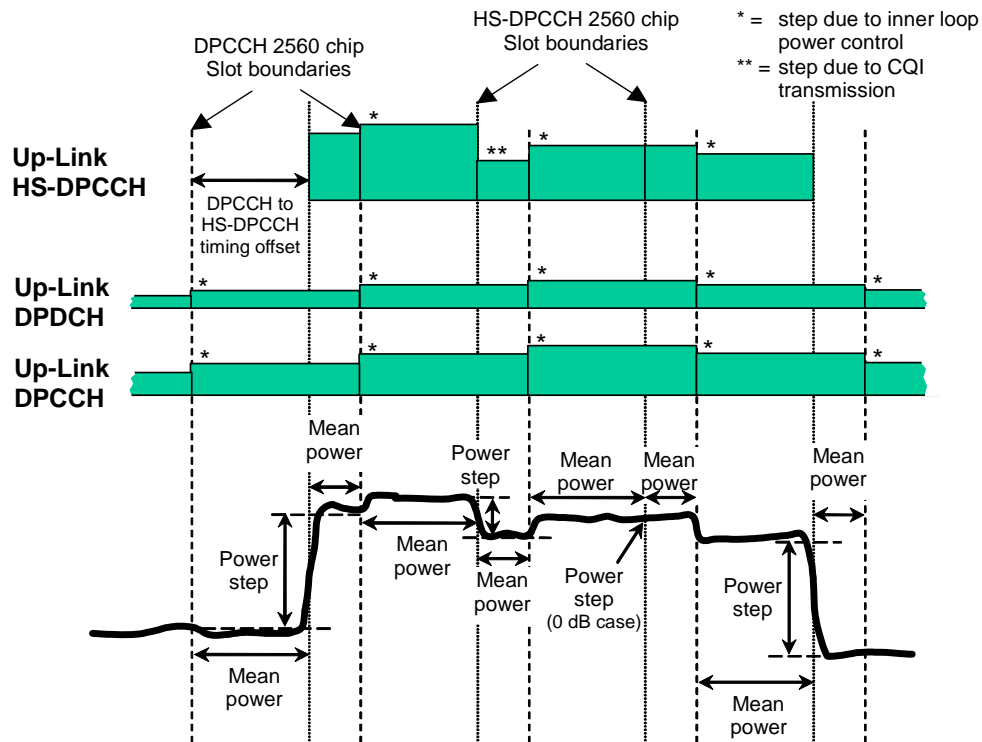
The nominal sum power on DPCCH+DPDCH is independent of the transmission of Ack/Nack and CQI unless the UE output power when Ack/Nack or CQI is transmitted would exceed the maximum value specified in Table 6.1A or fall below the value specified in 6.4.3.1, whereupon the UE shall apply additional scaling to the total transmit power as defined in section 5.1.2.6 of TS.25.214 [8].

The composite transmitted power (DPCCH + DPDCH+HS-DPCCH) may then also be rounded to the closest integer dB value. If rounding is done a power step exactly half-way between two integer values shall be rounded to the closest integer of greater magnitude.

The nominal power step due to transmission of Ack/Nack or CQI is defined as the difference between the nominal mean powers of two power evaluation periods either side of an HS-DPCCH boundary. The first evaluation period starts 25µs



after a DPCCH slot boundary and ends 25 $\mu$ s before the following HS-DPCCH slot boundary. The second evaluation period starts 25 $\mu$ s after the same HS-DPCCH slot boundary and ends 25 $\mu$ s before the following DPCCH slot boundary. This is described graphically in figure 6.6.



The power step due to HS-DPCCH transmission is the difference between the mean powers transmitted before and after an HS-DPCCH slot boundary. The mean power evaluation period excludes a 25 $\mu$ s period before and after any DPCCH or HS-DPCCH slot boundary.

**Figure 6.6: Transmit power template during HS-DPCCH transmission**

The tolerance of the power step due to transmission of the HS-DPCCH shall meet the requirements in table 6.9A.

**Table 6.9A: Transmitter power step tolerance**

Nominal power step size (Up or down) $\Delta P$ [dB]	Transmitter power step tolerance [dB]
0	+/- 0.5
1	+/- 0.5
2	+/- 1.0
3	+/- 1.5
$4 \leq \Delta P \leq 10$	+/- 2.0
$11 \leq \Delta P \leq 15$	+/- 3.0

#### 6.5.5.1A Additional requirement for UL OLTD

For UE with two active transmit antenna connectors in UL OLTD operation, the minimum requirements specified in sub-clause 6.5.5.1 apply at each transmit antenna connector.

#### 6.5.5.1B Additional requirement for UL CLTD

The nominal sum power on DPCCH+S-DPCCH+DPDCH is independent of the transmission of Ack/Nack and CQI unless the UE output power when Ack/Nack or CQI is transmitted would exceed the maximum value specified in Table



6.1A or fall below the value specified in 6.4.3.1, whereupon the UE shall apply additional scaling to the total transmit power as defined in section 5.1.2.6 of TS.25.214 [8].

The composite transmitted power (DPCCH + S-DPCCH + DPDCH+HS-DPCCH) may then also be rounded to the closest integer dB value. If rounding is done a power step exactly half-way between two integer values shall be rounded to the closest integer of greater magnitude.

The nominal power step due to transmission of Ack/Nack or CQI is defined as the difference between the nominal mean powers of two power evaluation periods either side of an HS-DPCCH boundary. The first evaluation period starts 25μs after a DPCCH slot boundary and ends 25μs before the following HS-DPCCH slot boundary. The second evaluation period starts 25μs after the same HS-DPCCH slot boundary and ends 25μs before the following DPCCH slot boundary.

The tolerance of the power step due to transmission of the HS-DPCCH shall meet the requirements in table 6.9A at each transmit antenna connector.

#### 6.5.5.1C Additional requirement for UL MIMO

The nominal sum power on DPCCH+S-DPCCH+E-DPDCH+S-E-DPDCH+E-DPCCH+S-E-DPCCH is independent of the transmission of Ack/Nack and CQI unless the UE output power when Ack/Nack or CQI is transmitted would exceed the maximum value specified in Table 6.1AC or fall below the value specified in 6.4.3.1D, whereupon the UE shall apply additional scaling to the total transmit power as defined in section 5.1.2.6 of TS.25.214 [8].

The composite transmitted power (DPCCH + S-DPCCH + E-DPDCH + S-E-DPDCH + E-DPCCH + S-E-DPCCH +HS-DPCCH) may then also be rounded to the closest integer dB value. If rounding is done a power step exactly half-way between two integer values shall be rounded to the closest integer of greater magnitude.

The nominal power step due to transmission of Ack/Nack or CQI is defined as the difference between the nominal mean powers of two power evaluation periods either side of an HS-DPCCH boundary. The first evaluation period starts 25μs after a DPCCH slot boundary and ends 25μs before the following HS-DPCCH slot boundary. The second evaluation period starts 25μs after the same HS-DPCCH slot boundary and ends 25μs before the following DPCCH slot boundary.

The tolerance of the power step due to transmission of the HS-DPCCH shall meet the requirements in table 6.9A at each transmit antenna connector.

## 6.6 Output RF spectrum emissions

### 6.6.1 Occupied bandwidth

Occupied bandwidth is a measure of the bandwidth containing 99 % of the total integrated power of the transmitted spectrum, centered on the assigned channel frequency. The occupied channel bandwidth shall be less than 5 MHz based on a chip rate of 3.84 Mcps.

#### 6.6.1A Occupied bandwidth for DC-HSUPA

In the case dual adjacent carriers are assigned in the uplink, occupied bandwidth is a measure of the bandwidth containing 99 % of the total integrated power of the transmitted spectrum, centered at the center of the assigned channel frequencies. The occupied channel bandwidth shall be less than 10 MHz on a chip rate of 3.84 Mcps.

#### 6.6.1B Occupied bandwidth for UL OLTD

For UE with two active transmit antenna connectors in UL OLTD operation, occupied bandwidth requirement is defined per UE.

The occupied bandwidth of the UL OLTD UE is determined by the occupied bandwidth (defined in 6.6.1) measured at each active antenna port of the UE. The upper boundary of the UE occupied bandwidth is the highest boundary of the two measured occupied bandwidths. The lower boundary of the UE occupied bandwidth is the lowest boundary of the two measured occupied bandwidths. The occupied channel bandwidth for UE shall be less than 5 MHz based on a chip rate of 3.84 Mcps.



### 6.6.1C Occupied bandwidth for UL CLTD

For UE with two active transmit antenna connectors in UL CLTD activation state 1, occupied bandwidth requirement is defined per UE.

The occupied bandwidth of the UL CLTD UE is determined by the occupied bandwidth (defined in 6.6.1) measured at each active antenna port of the UE. The upper boundary of the UE occupied bandwidth is the highest boundary of the two measured occupied bandwidths. The lower boundary of the UE occupied bandwidth is the lowest boundary of the two measured occupied bandwidths. The occupied channel bandwidth for UE shall be less than 5 MHz based on a chip rate of 3.84 Mcps.

For UE configured in UL CLTD activation state 2 or activation state 3, the requirement in sub-clause 6.6.1 apply at the active transmit antenna connector.

### 6.6.1D Occupied bandwidth for UL MIMO

For UE with two active transmit antenna connectors in UL MIMO operation, occupied bandwidth requirement is defined per UE.

The occupied bandwidth of the UL MIMO UE is determined by the occupied bandwidth (defined in 6.6.1) measured at each active antenna connector of the UE. The upper boundary of the UE occupied bandwidth is the higher upper boundary of the two measured occupied bandwidths. The lower boundary of the UE occupied bandwidth is the lower low boundary of the two measured occupied bandwidths. The occupied channel bandwidth for UE shall be less than 5 MHz based on a chip rate of 3.84 Mcps.

## 6.6.2 Out of band emission

Out of band emissions are unwanted emissions immediately outside the nominal channel resulting from the modulation process and non-linearity in the transmitter but excluding spurious emissions. This out of band emission limit is specified in terms of a spectrum emission mask and Adjacent Channel Leakage power Ratio.

### 6.6.2.1 Spectrum emission mask

The spectrum emission mask of the UE applies to frequencies, which are between 2.5 MHz and 12.5 MHz away from the UE centre carrier frequency. The out of channel emission is specified relative to the RRC filtered mean power of the UE carrier.

#### 6.6.2.1.1 Minimum requirement

The power of any UE emission shall not exceed the levels specified in Table 6.10. The absolute requirement is based on a -50 dBm/3.84 MHz minimum power threshold for the UE. This limit is expressed for the narrower measurement bandwidths as -55.8 dBm/1 MHz and -71.1 dBm/30 kHz. The requirements are applicable for all values of  $\beta_c$ ,  $\beta_d$ ,  $\beta_{hs}$ ,  $\beta_{ec}$  and  $\beta_{ed}$  as specified in [8].



**Table 6.10: Spectrum Emission Mask Requirement**

$\Delta f$ in MHz (Note 1)	Minimum requirement (Note 2)		Measurement bandwidth
	Relative requirement	Absolute requirement	
2.5 - 3.5	$\left\{ -35 - 15 \cdot \left( \frac{\Delta f}{\text{MHz}} - 2.5 \right) \right\} \text{dBc}$	-71.1 dBm	30 kHz (Note 3)
3.5 - 7.5	$\left\{ -35 - 1 \cdot \left( \frac{\Delta f}{\text{MHz}} - 3.5 \right) \right\} \text{dBc}$	-55.8 dBm	1 MHz (Note 4)
7.5 - 8.5	$\left\{ -39 - 10 \cdot \left( \frac{\Delta f}{\text{MHz}} - 7.5 \right) \right\} \text{dBc}$	-55.8 dBm	1 MHz (Note 4)
8.5 - 12.5 MHz	-49 dBc	-55.8 dBm	1 MHz (Note 4)
Note 1: $\Delta f$ is the separation between the carrier frequency and the centre of the measurement bandwidth. Note 2: The minimum requirement is calculated from the relative requirement or the absolute requirement, whichever is the higher power. Note 3: The first and last measurement position with a 30 kHz filter is at $\Delta f$ equals to 2.515 MHz and 3.485 MHz. Note 4: The first and last measurement position with a 1 MHz filter is at $\Delta f$ equals to 4 MHz and 12 MHz.			

For operation in band II, IV, V, X, XII, XIII, XIV, XXV and XXVI the minimum requirement is calculated from the minimum requirement in table 6.10 or the applicable additional requirement in Tables 6.10A, 6.10B or 6.10C, whichever is the tighter requirement.

**Table 6.10A: Additional spectrum emission limits for Bands II, IV, X and XXV**

$\Delta f$ in MHz (Note 1)	Frequency offset of measurement filter centre frequency, $f_{\text{offset}}$	Additional requirements Band II, IV, X	Measurement bandwidth
$2.5 \text{ MHz} \leq \Delta f < 3.5 \text{ MHz}$	$2.515 \text{ MHz} \leq f_{\text{offset}} < 3.485 \text{ MHz}$	-15 dBm	30 kHz
$3.5 \text{ MHz} \leq \Delta f \leq 12.5 \text{ MHz}$	$4.0 \text{ MHz} \leq f_{\text{offset}} < 12.0 \text{ MHz}$	-13 dBm	1 MHz
Note 1: $\Delta f$ is the separation between the carrier frequency and the centre of the measurement bandwidth.			

**Table 6.10B: Additional spectrum emission limits for Band V and XXVI**

$\Delta f$ in MHz (Note 1)	Frequency offset of measurement filter centre frequency, $f_{\text{offset}}$	Additional requirements Band V	Measurement bandwidth
$2.5 \text{ MHz} \leq \Delta f < 3.5 \text{ MHz}$	$2.515 \text{ MHz} \leq f_{\text{offset}} < 3.485 \text{ MHz}$	-15 dBm	30 kHz
$3.5 \text{ MHz} \leq \Delta f \leq 12.5 \text{ MHz}$	$3.55 \text{ MHz} \leq f_{\text{offset}} < 12.45 \text{ MHz}$	-13 dBm	100 kHz
Note 1: $\Delta f$ is the separation between the carrier frequency and the centre of the measurement bandwidth.			



**Table 6.10C: Additional spectrum emission limits for Bands XII, XIII, XIV**

$\Delta f$ in MHz (Note 1)	Frequency offset of measurement filter centre frequency, $f_{\text{offset}}$	Additional requirements Band XII, XIII, XIV	Measurement bandwidth
$2.5 \text{ MHz} \leq \Delta f < 2.6 \text{ MHz}$	$2.515 \text{ MHz} \leq f_{\text{offset}} < 2.585 \text{ MHz}$	-13 dBm	30 kHz
$2.6 \text{ MHz} \leq \Delta f \leq 12.45 \text{ MHz}$	$2.65 \text{ MHz} \leq f_{\text{offset}} < 12.45 \text{ MHz}$	-13 dBm	100 kHz
Note 1: $\Delta f$ is the separation between the carrier frequency and the centre of the measurement bandwidth.			

NOTE: As a general rule, the resolution bandwidth of the measuring equipment should be equal to the measurement bandwidth specified in tables 6.10, 6.10A, 6.10B and 6.10C. However, to improve measurement accuracy, sensitivity and efficiency, the resolution bandwidth may be smaller than the measurement bandwidth. When the resolution bandwidth is smaller than the measurement bandwidth, the result should be integrated over the measurement bandwidth in order to obtain the equivalent noise bandwidth of the measurement bandwidth.

### 6.6.2.1A Additional Spectrum emission mask for DC-HSUPA

The spectrum emission mask of the UE applies to frequencies, which are between 5 MHz and 20 MHz away from the UE centre frequency of the two assigned channel frequencies. The requirements assume that the UE output power shall be maximum level. The reference measurement channels for the requirements in subclause 6.6.2.1A.1 and 6.6.2.1A.2 are provided in subclause A.2.8.

#### 6.6.2.1A.1 Minimum requirement

The power of any UE emission shall not exceed the levels specified in Table 6.10D for the specified channel bandwidth.

**Table 6.10D: Spectrum emission mask for DC-HSUPA**

$\Delta f$ (MHz)	Frequency offset of measurement filter centre frequency, $f_{\text{offset}}$	Spectrum emission limit (dBm)	Measurement bandwidth
$\pm 5\text{-}6$	$5.015 \text{ MHz} \leq f_{\text{offset}} < 5.985 \text{ MHz}$	-18	30 kHz
$\pm 6\text{-}10$	$6.5 \text{ MHz} \leq f_{\text{offset}} < 10.0 \text{ MHz}$	-10	1 MHz
$\pm 10\text{-}19$	$10.0 \text{ MHz} \leq f_{\text{offset}} < 19.0 \text{ MHz}$	-13	1 MHz
$\pm 19\text{-}20$	$19.0 \text{ MHz} \leq f_{\text{offset}} < 19.5 \text{ MHz}$	-25	1 MHz
Note: $\Delta f$ is the separation between the center of two assigned channel frequencies and the centre of the measurement bandwidth.			

#### 6.6.2.1A.2 Additional requirement for band II, IV, V, X, XXV and XXVI

The UE shall meet an additional requirement specified in Table 6.10E for band II, IV, V, X, XXV and XXVI.

**Table 6.10E: Additional spectrum emission mask for DC-HSUPA in band II, IV, V, X, XXV and XXVI**

$\Delta f$ (MHz)	Frequency offset of measurement filter centre frequency, $f_{\text{offset}}$	Spectrum emission limit (dBm)	Measurement bandwidth
$\pm 5\text{-}6$	$5.015 \text{ MHz} \leq f_{\text{offset}} < 5.985 \text{ MHz}$	-18	30 kHz
$\pm 6\text{-}19$	$6.5 \text{ MHz} \leq f_{\text{offset}} < 19.0 \text{ MHz}$	-13	1 MHz
$\pm 19\text{-}20$	$19.0 \text{ MHz} \leq f_{\text{offset}} < 19.5 \text{ MHz}$	-25	1 MHz
Note: $\Delta f$ is the separation between the center of two assigned channel frequencies and the centre of the measurement bandwidth.			



### 6.6.2.1B Additional requirement for UL OLTD

For UE with two active transmit antenna connectors in UL OLTD operation, the spectrum emission mask specified in sub-clause 6.6.2.1 applies at each transmit antenna connector.

### 6.6.2.1C Additional requirement for UL CLTD

For UE with two active transmit antenna connectors in UL CLTD activation state 1, the spectrum emission mask specified in sub-clause 6.6.2.1 applies at each transmit antenna connector.

For UE configured in UL CLTD activation state 2 or activation state 3, the requirements in sub-clause 6.6.2.1 apply at the active transmit antenna connector.

### 6.6.2.1D Additional requirement for UL MIMO

For UE with two active transmit antenna connectors in UL MIMO operation, the spectrum emission mask specified in sub-clause 6.6.2.1 applies at each transmit antenna connector.

## 6.6.2.2 Adjacent Channel Leakage power Ratio (ACLR)

In the case a single carrier is assigned on the uplink, Adjacent Channel Leakage power Ratio (ACLR) is the ratio of the RRC filtered mean power centered on the assigned channel frequency to the RRC filtered mean power centered on an adjacent channel frequency.

In the case dual adjacent carriers are assigned on the uplink, ACLR is the ratio of the sum of the RRC filtered mean powers centered on each of the two assigned channel frequencies to the RRC filtered mean power centered on an adjacent channel frequency.

### 6.6.2.2.1 Minimum requirement

If the adjacent channel power is greater than -50dBm then the ACLR shall be higher than the value specified in Table 6.11. The requirements are applicable for all values of  $\beta_c$ ,  $\beta_d$ ,  $\beta_{hs}$ ,  $\beta_{ec}$  and  $\beta_{ed}$  as specified in [8].

**Table 6.11: UE ACLR**

Power Class	Adjacent channel frequency relative to assigned channel frequency	ACLR limit
3	+ 5 MHz or - 5 MHz	33 dB
3	+ 10 MHz or - 10 MHz	43 dB
4	+ 5 MHz or - 5 MHz	33 dB
4	+ 10 MHz or -10 MHz	43 dB

NOTE 1: The requirement shall still be met in the presence of switching transients.

NOTE 2: The ACLR requirements reflect what can be achieved with present state of the art technology.

NOTE 3: Requirement on the UE shall be reconsidered when the state of the art technology progresses.

### 6.6.2.2.1A Additional requirement for DC-HSUPA

If the adjacent channel power is greater than -50dBm then the ACLR shall be higher than the value specified in Table 6.11A. The requirements are applicable for all values of  $\beta_c$ ,  $\beta_{hs}$ ,  $\beta_{ec}$  and  $\beta_{ed}$  as specified in [8]. The reference measurement channels for the requirements in subclause 6.6.2.2.1A are provided in subclause A.2.8.



**Table 6.11A: UE ACLR for DC-HSUPA**

Power Class	Adjacent channel frequency relative to the center of two assigned channel frequencies	ACLR limit
3	+ 7.5 MHz or – 7.5 MHz	33 dB
3	+ 12.5 MHz or – 12.5 MHz	36 dB
4	+ 7.5 MHz or – 7.5 MHz	33 dB
4	+ 12.5 MHz or -12.5 MHz	36 dB

NOTE 1: The requirement shall still be met in the presence of switching transients.

NOTE 2: The ACLR requirements reflect what can be achieved with present state of the art technology.

NOTE 3: Requirement on the UE shall be reconsidered when the state of the art technology progresses.

#### 6.6.2.2.1B Additional requirement for UL OLTD

For UE with two active transmit antenna connectors in UL OLTD operation, the ACLR requirements specified in sub-clause 6.6.2.2.1 apply at each transmit antenna connector.

#### 6.6.2.2.1C Additional requirement for UL CLTD

For UE with two active transmit antenna connectors in UL CLTD activation state 1, the ACLR requirements specified in sub-clause 6.6.2.2.1 apply at each transmit antenna connector.

For UE configured in UL CLTD activation state 2 or activation state 3, the ACLR requirements specified in sub-clause 6.6.2.2.1 apply at the active transmit antenna connector.

#### 6.6.2.2.1D Additional requirement for UL MIMO

For UE with two active transmit antenna connectors in UL MIMO operation, the ACLR requirements specified in sub-clause 6.6.2.2.1 apply at each transmit antenna connector.

### 6.6.3 Spurious emissions

Spurious emissions are emissions which are caused by unwanted transmitter effects such as harmonics emission, parasitic emission, intermodulation products and frequency conversion products, but exclude out of band emissions.

The frequency boundary and the detailed transitions of the limits between the requirement for out band emissions and spectrum emissions are based on ITU-R Recommendations SM.329 [2].

#### 6.6.3.1 Minimum requirement

These requirements are only applicable for frequencies, which are greater than 12.5 MHz away from the UE centre carrier frequency.

**Table 6.12: General spurious emissions requirements**

Frequency Bandwidth	Measurement Bandwidth	Minimum requirement	Note
$9 \text{ kHz} \leq f < 150 \text{ kHz}$	1 kHz	-36 dBm	
$150 \text{ kHz} \leq f < 30 \text{ MHz}$	10 kHz	-36 dBm	
$30 \text{ MHz} \leq f < 1000 \text{ MHz}$	100 kHz	-36 dBm	
$1 \text{ GHz} \leq f < 12.75 \text{ GHz}$	1 MHz	-30 dBm	
$12.75 \text{ GHz} \leq f < 5^{\text{th}}$ harmonic of the upper frequency edge of the UL operating band in GHz	1 MHz	-30 dBm	Note 1
NOTE 1: Applies only for Band XXII.			



Table 6.13: Additional spurious emissions requirements

Operating Band	Frequency Bandwidth	Measurement Bandwidth	Minimum requirement
I	462.5 MHz $\leq f \leq$ 467.5 MHz	1 MHz	-50 dBm
	703 MHz $\leq f \leq$ 803 MHz	1 MHz	-50 dBm
	791 MHz $\leq f \leq$ 821 MHz	3.84 MHz	-60 dBm
	852 MHz $\leq f \leq$ 859 MHz	1 MHz	-50 dBm
	859 MHz $\leq f \leq$ 894 MHz	3.84 MHz	-60 dBm
	921 MHz $\leq f <$ 925 MHz	100 kHz	-60 dBm *
	925 MHz $\leq f \leq$ 935 MHz	100 kHz 3.84MHz	-67 dBm * -60 dBm
	935 MHz $< f \leq$ 960 MHz	100 kHz 3.84MHz	-79 dBm * -60 dBm
	1452 MHz $\leq f \leq$ 1510.9 MHz	3.84 MHz	-60 dBm
	1805 MHz $\leq f \leq$ 1880 MHz	100 kHz 3.84MHz	-71 dBm * -60 dBm
	1839.9 MHz $\leq f \leq$ 1879.9 MHz	3.84 MHz	-60 dBm
	1884.5 MHz $< f <$ 1915.7 MHz	300 kHz	-41 dBm
	2010 MHz $< f <$ 2025 MHz	3.84 MHz	-60 dBm
	2110 MHz $\leq f \leq$ 2170 MHz	3.84 MHz	-60 dBm
	2300 MHz $\leq f \leq$ 2400 MHz	3.84 MHz	-60 dBm
	2496 MHz $\leq f \leq$ 2570 MHz	1 MHz	-50 dBm
	2570 MHz $\leq f \leq$ 2690 MHz	3.84 MHz	-60 dBm
	3510 MHz $\leq f \leq$ 3590 MHz	3.84 MHz	-60 dBm
	3400 MHz $\leq f \leq$ 3800 MHz	1 MHz	-50 dBm
II	717 MHz $\leq f \leq$ 728 MHz	1 MHz	-50 dBm
	729 MHz $\leq f \leq$ 746 MHz	3.84 MHz	-60 dBm
	746 MHz $\leq f \leq$ 758 MHz	3.84 MHz	-60 dBm
	758 MHz $\leq f \leq$ 768 MHz	3.84 MHz	-60 dBm
	768 MHz $\leq f \leq$ 803 MHz	1 MHz	-50 dBm
	852 MHz $\leq f \leq$ 859 MHz	1 MHz	-50 dBm
	859 MHz $\leq f \leq$ 894 MHz	3.84 MHz	-60 dBm
	1525 MHz $\leq f \leq$ 1559 MHz	1 MHz	-50 dBm
	1930 MHz $\leq f \leq$ 1995 MHz	3.84 MHz	-60 dBm
	2110 MHz $\leq f \leq$ 2170 MHz	3.84 MHz	-60 dBm
	2180 MHz $\leq f \leq$ 2200 MHz	1 MHz	-50 dBm
	2350 MHz $\leq f \leq$ 2360 MHz	1 MHz	-50 dBm
	2496 MHz $\leq f \leq$ 2690 MHz	1 MHz	-50 dBm
	3510 MHz $\leq f \leq$ 3590 MHz	3.84 MHz	-60 dBm
	3400 MHz $\leq f \leq$ 3800 MHz	1 MHz	-50 dBm**
III	462.5 MHz $\leq f \leq$ 467.5 MHz	1 MHz	-50 dBm
	703 MHz $\leq f \leq$ 803 MHz	1 MHz	-50 dBm
	791 MHz $\leq f \leq$ 821 MHz	3.84 MHz	-60 dBm
	852 MHz $\leq f \leq$ 859 MHz	1 MHz	-50 dBm
	859 MHz $\leq f \leq$ 894 MHz	3.84 MHz	-60 dBm *****
	921 MHz $\leq f <$ 925 MHz	100 kHz	-60 dBm *
	925 MHz $\leq f \leq$ 935 MHz	100 kHz 3.84 MHz	-67 dBm * - 60 dBm
	935 MHz $< f \leq$ 960 MHz	100 kHz 3.84 MHz	-79 dBm * - 60 dBm
	1452 MHz $\leq f \leq$ 1496 MHz	3.84 MHz	-60 dBm
	1475.9 MHz $\leq f \leq$ 1510.9 MHz	3.84 MHz	-60 dBm *****
	1805 MHz $\leq f \leq$ 1880 MHz	3.84 MHz	-60 dBm
	1880 MHz $\leq f \leq$ 1920 MHz	3.84 MHz	-60 dBm
	1884.5 MHz $\leq f \leq$ 1915.7 MHz	300 kHz	-41 dBm *****
	2010 MHz $< f <$ 2025 MHz	3.84 MHz	-60 dBm
	2110 MHz $\leq f \leq$ 2170 MHz	3.84 MHz	-60 dBm
	2300 MHz $\leq f \leq$ 2400 MHz	3.84 MHz	-60 dBm
	2496 MHz $\leq f \leq$ 2570 MHz	1 MHz	-50 dBm
	2570 MHz $\leq f \leq$ 2690 MHz	3.84 MHz	-60 dBm
	3510 MHz $\leq f \leq$ 3590 MHz	3.84 MHz	-60 dBm **
	3400 MHz $\leq f \leq$ 3800 MHz	1 MHz	-50 dBm **



IV	717 MHz $\leq f \leq$ 728 MHz	1 MHz	-50 dBm
	729 MHz $\leq f \leq$ 746 MHz	3.84 MHz	-60 dBm
	746 MHz $\leq f \leq$ 756 MHz	3.84 MHz	-60 dBm
	758 MHz $\leq f \leq$ 768 MHz	3.84 MHz	-60 dBm
	768 MHz $\leq f \leq$ 803 MHz	1 MHz	-50 dBm
	852 MHz $\leq f \leq$ 859 MHz	1 MHz	-50 dBm
	859 MHz $\leq f \leq$ 894 MHz	3.84 MHz	-60 dBm
	1525 MHz $\leq f \leq$ 1559 MHz	1 MHz	-50 dBm
	1930 MHz $\leq f \leq$ 1995 MHz	3.84 MHz	-60 dBm
	2110 MHz $\leq f \leq$ 2170 MHz	3.84 MHz	-60 dBm
	2180 MHz $\leq f \leq$ 2200 MHz	1 MHz	-50 dBm
	2350 MHz $\leq f \leq$ 2360 MHz	1 MHz	-50 dBm
	2496 MHz $\leq f \leq$ 2690 MHz	1 MHz	-50 dBm
	2620 MHz $\leq f \leq$ 2690 MHz	3.84 MHz	-60 dBm
	3510 MHz $\leq f \leq$ 3590 MHz	3.84 MHz	-60 dBm
	3400 MHz $\leq f \leq$ 3800 MHz	1 MHz	-50 dBm**
V	462.5 MHz $\leq f \leq$ 467.5 MHz	1 MHz	-50 dBm
	717 MHz $\leq f \leq$ 728 MHz	1 MHz	-50 dBm
	703 MHz $\leq f \leq$ 803 MHz	1 MHz	-50 dBm
	729 MHz $\leq f \leq$ 746 MHz	3.84 MHz	-60 dBm
	746 MHz $\leq f \leq$ 756 MHz	3.84 MHz	-60 dBm
	758 MHz $\leq f \leq$ 768 MHz	3.84 MHz	-60 dBm
	859 MHz $\leq f \leq$ 869 MHz	1 MHz	-27 dBm
	869 MHz $\leq f \leq$ 894 MHz	3.84 MHz	-60 dBm
	1525 MHz $\leq f \leq$ 1559 MHz	1 MHz	-50 dBm
	1805 MHz $\leq f \leq$ 1880 MHz	3.84 MHz	-60 dBm
	1930 MHz $\leq f \leq$ 1995 MHz	3.84 MHz	-60 dBm
	2110 MHz $\leq f \leq$ 2170 MHz	3.84 MHz	-60 dBm
	2180 MHz $\leq f \leq$ 2200 MHz	1 MHz	-50 dBm
	2300 MHz $\leq f \leq$ 2400 MHz	3.84 MHz	-60 dBm
	2350 MHz $\leq f \leq$ 2360 MHz	1 MHz	-50 dBm
	2496 MHz $\leq f \leq$ 2690 MHz	1 MHz	-50 dBm**
	2570 MHz $\leq f \leq$ 2690 MHz	3.84 MHz	-60 dBm
	3510 MHz $\leq f \leq$ 3590 MHz	3.84 MHz	-60 dBm
	3400 MHz $\leq f \leq$ 3800 MHz	1 MHz	-50 dBm
VI	758 MHz $\leq f \leq$ 803 MHz	1 MHz	-50 dBm
	860 MHz $\leq f <$ 875 MHz	1 MHz	-37 dBm
	875 MHz $\leq f \leq$ 890 MHz	3.84 MHz	-60 dBm
	945 MHz $\leq f \leq$ 960 MHz	3.84 MHz	-60 dBm
	1475.9 MHz $\leq f \leq$ 1510.9 MHz	3.84 MHz	-60 dBm
	1839.9 MHz $\leq f \leq$ 1879.9 MHz	3.84 MHz	-60 dBm
	1884.5 MHz $\leq f \leq$ 1915.7 MHz	300 kHz	-41 dBm
	2010 MHz $< f <$ 2025 MHz	3.84 MHz	-60 dBm
	2110 MHz $\leq f \leq$ 2170 MHz	3.84 MHz	-60 dBm
	2545 MHz $\leq f \leq$ 2575 MHz	1 MHz	-50 dBm
	2595 MHz $\leq f \leq$ 2645 MHz	1 MHz	-50 dBm
	3400 MHz $\leq f \leq$ 3600 MHz	1 MHz	-50 dBm
VII	462.5 MHz $\leq f \leq$ 467.5 MHz	1 MHz	-50 dBm
	717 MHz $\leq f \leq$ 728 MHz	1 MHz	-50 dBm
	729 MHz $\leq f \leq$ 746 MHz	3.84 MHz	-60 dBm
	746 MHz $\leq f \leq$ 756 MHz	3.84 MHz	-60 dBm
	758 MHz $\leq f \leq$ 768 MHz	3.84 MHz	-60 dBm
	768 MHz $\leq f \leq$ 791 MHz	1 MHz	-50 dBm
	791 MHz $\leq f \leq$ 821 MHz	3.84 MHz	-60 dBm
	852 MHz $\leq f \leq$ 859 MHz	1 MHz	-50 dBm
	859 MHz $\leq f \leq$ 894 MHz	3.84 MHz	-60 dBm
	921 MHz $\leq f <$ 925 MHz	100 kHz	-60 dBm *
	925 MHz $\leq f \leq$ 935 MHz	100 kHz	-67 dBm *
		3.84 MHz	-60 dBm
	935 MHz $< f \leq$ 960 MHz	100 kHz	-79 dBm *
		3.84 MHz	-60 dBm
	1452 MHz $< f \leq$ 1496 MHz	3.84 MHz	-60 dBm



	1805 MHz $\leq f \leq$ 1880 MHz	100 kHz 3.84 MHz	-71 dBm * -60 dBm
	1900 MHz $\leq f \leq$ 1920 MHz	3.84 MHz	-60 dBm
	1930 MHz $\leq f \leq$ 1995 MHz	3.84 MHz	-60 dBm
	2010 MHz $< f <$ 2025 MHz	3.84 MHz	-60 dBm
	2110 MHz $\leq f \leq$ 2170 MHz	3.84 MHz	-60 dBm
	2300 MHz $< f <$ 2400 MHz	3.84 MHz	-60 dBm
	2350 MHz $\leq f \leq$ 2360 MHz	1 MHz	-50 dBm
	2620 MHz $\leq f \leq$ 2690 MHz	3.84 MHz	-60 dBm
	2595 MHz $\leq f \leq$ 2620 MHz	1 MHz	-40 dBm
	3510 MHz $\leq f \leq$ 3590 MHz	3.84 MHz	-60 dBm
VIII	3400 MHz $\leq f \leq$ 3800 MHz	1 MHz	-50 dBm
	462.5 MHz $\leq f \leq$ 467.5 MHz	1 MHz	-50 dBm
	703 MHz $\leq f \leq$ 803 MHz	1 MHz	-50 dBm
	791 MHz $\leq f \leq$ 821 MHz	3.84 MHz	-60 dBm
	860 MHz $\leq f \leq$ 890 MHz	1 MHz	-37 dBm ****
	925 MHz $\leq f \leq$ 935 MHz	100 kHz 3.84 MHz	-67 dBm * -60 dBm
	935 MHz $< f \leq$ 960 MHz	100 kHz 3.84 MHz	-79 dBm * -60 dBm
	1452 MHz $\leq f \leq$ 1496 MHz	3.84 MHz	-60 dBm
	1475.9 MHz $\leq f \leq$ 1510.9 MHz	3.84 MHz	-60 dBm ****
	1805 MHz $< f \leq$ 1830 MHz	100 kHz 3.84 MHz	-71 dBm ** & * -60 dBm **
	1830 MHz $< f \leq$ 1880 MHz	100 kHz 3.84 MHz	-71 dBm * -60 dBm
	1880 MHz $\leq f \leq$ 1920 MHz	3.84 MHz	-60 dBm
	1884.5 MHz $\leq f \leq$ 1915.7 MHz	300 kHz	-41 dBm ****
	2010 MHz $\leq f \leq$ 2025 MHz	3.84 MHz	-60 dBm
	2110 MHz $\leq f \leq$ 2170 MHz	3.84 MHz	-60 dBm
	2300 MHz $< f <$ 2400 MHz	3.84 MHz	-60 dBm
	2496 MHz $\leq f \leq$ 2570 MHz	1 MHz	-50 dBm
	2570 MHz $\leq f \leq$ 2640 MHz	3.84 MHz	-60 dBm
	2640 MHz $< f \leq$ 2690 MHz	3.84 MHz	-60 dBm **
	3510 MHz $\leq f \leq$ 3590 MHz	3.84 MHz	-60 dBm **
IX	3400 MHz $\leq f \leq$ 3800 MHz	1 MHz	-50 dBm **
	758 MHz $\leq f \leq$ 803 MHz	1 MHz	-50 dBm
	859 MHz $\leq f \leq$ 894 MHz	3.84 MHz	-60 dBm
	945 MHz $\leq f \leq$ 960 MHz	3.84 MHz	-60 dBm
	1475.9 MHz $\leq f \leq$ 1510.9 MHz	3.84 MHz	-60 dBm
	1839.9 MHz $\leq f \leq$ 1879.9 MHz	3.84 MHz	-60 dBm
	1884.5 MHz $\leq f \leq$ 1915.7 MHz	300 kHz	-41 dBm
	2010 MHz $\leq f \leq$ 2025 MHz	3.84 MHz	-60 dBm
	2110 MHz $\leq f \leq$ 2170 MHz	3.84 MHz	-60 dBm
	2545 MHz $\leq f \leq$ 2575 MHz	1 MHz	-50 dBm
X	2595 MHz $\leq f \leq$ 2645 MHz	1 MHz	-50 dBm
	3400 MHz $\leq f \leq$ 3600 MHz	1 MHz	-50 dBm **
	717 MHz $\leq f \leq$ 728 MHz	1 MHz	-50 dBm
	729 MHz $\leq f \leq$ 746 MHz	3.84 MHz	-60 dBm
	746 MHz $\leq f \leq$ 756 MHz	3.84 MHz	-60 dBm
	758 MHz $\leq f \leq$ 768 MHz	3.84 MHz	-60 dBm
	768 MHz $\leq f \leq$ 803 MHz	1 MHz	-50 dBm
	852 MHz $\leq f \leq$ 859 MHz	1 MHz	-50 dBm
	859 MHz $\leq f \leq$ 894 MHz	3.84 MHz	-60 dBm
	1525 MHz $\leq f \leq$ 1559 MHz	1 MHz	-50 dBm
	1930 MHz $\leq f \leq$ 1995 MHz	3.84 MHz	-60 dBm
	2110 MHz $\leq f \leq$ 2170 MHz	3.84 MHz	-60 dBm
	2180 MHz $\leq f \leq$ 2200 MHz	1 MHz	-50 dBm
	2350 MHz $\leq f \leq$ 2360 MHz	1 MHz	-50 dBm
	2496 MHz $\leq f \leq$ 2570 MHz	1 MHz	-50 dBm
	3510 MHz $\leq f \leq$ 3590 MHz	3.84 MHz	-60 dBm **
	3400 MHz $\leq f \leq$ 3800 MHz	1 MHz	-50 dBm **



XI	758 MHz $\leq f \leq$ 803 MHz	1 MHz	-50 dBm
	860 MHz $\leq f \leq$ 890 MHz	3.84 MHz	-60 dBm
	945 MHz $\leq f \leq$ 960 MHz	3.84 MHz	-60 dBm
	1475.9 MHz $\leq f \leq$ 1510.9 MHz	3.84 MHz	-60 dBm
	1839.9 MHz $\leq f \leq$ 1879.9 MHz	3.84 MHz	-60 dBm
	1884.5 MHz $\leq f \leq$ 1915.7 MHz	300 kHz	-41 dBm
	2010 MHz $\leq f \leq$ 2025 MHz	3.84 MHz	-60 dBm
	2110 MHz $\leq f \leq$ 2170 MHz	3.84 MHz	-60 dBm
	2545 MHz $\leq f \leq$ 2575 MHz	1 MHz	-50 dBm
	2595 MHz $\leq f \leq$ 2645 MHz	1 MHz	-50 dBm
	3400 MHz $\leq f \leq$ 3600 MHz	1 MHz	-50 dBm
XII	729 MHz $\leq f \leq$ 746 MHz	3.84 MHz	-60 dBm
	746 MHz $\leq f \leq$ 756 MHz	3.84 MHz	-60 dBm
	758 MHz $\leq f \leq$ 768 MHz	3.84 MHz	-60 dBm
	852 MHz $\leq f \leq$ 859 MHz	1 MHz	-50 dBm
	859 MHz $\leq f \leq$ 894 MHz	3.84 MHz	-60 dBm
	1525 MHz $\leq f \leq$ 1559 MHz	1 MHz	-50 dBm
	1930 MHz $\leq f \leq$ 1995 MHz	3.84 MHz	-60 dBm
	2110 MHz $\leq f \leq$ 2170 MHz	3.84 MHz	-60 dBm
	2180 MHz $\leq f \leq$ 2200 MHz	1 MHz	-50 dBm
	2350 MHz $\leq f \leq$ 2360 MHz	1 MHz	-50 dBm
	2496 MHz $\leq f \leq$ 2690 MHz	1 MHz	-50 dBm
XIII	717 MHz $\leq f \leq$ 728 MHz	1 MHz	-50 dBm
	729 MHz $\leq f \leq$ 746 MHz	3.84 MHz	-60 dBm
	746 MHz $\leq f \leq$ 756 MHz	3.84 MHz	-60 dBm
	758 MHz $\leq f \leq$ 768 MHz	3.84 MHz	-60 dBm
	763 MHz $\leq f \leq$ 775 MHz	6.25 kHz	-35 dBm***
	793 MHz $\leq f \leq$ 805 MHz	6.25 kHz	-35 dBm***
	852 MHz $\leq f \leq$ 859 MHz	1 MHz	-50 dBm
	859 MHz $\leq f \leq$ 894 MHz	3.84 MHz	-60 dBm
	1525 MHz $\leq f \leq$ 1559 MHz	1 MHz	-50 dBm**
	1930 MHz $\leq f \leq$ 1995 MHz	3.84 MHz	-60 dBm
	2110 MHz $\leq f \leq$ 2170 MHz	3.84 MHz	-60 dBm
	2180 MHz $\leq f \leq$ 2200 MHz	1 MHz	-50 dBm
	2350 MHz $\leq f \leq$ 2360 MHz	1 MHz	-50 dBm**
	2496 MHz $\leq f \leq$ 2690 MHz	1 MHz	-50 dBm
XIV	717 MHz $\leq f \leq$ 728 MHz	1 MHz	-50 dBm
	729 MHz $\leq f \leq$ 746 MHz	3.84 MHz	-60 dBm
	746 MHz $\leq f \leq$ 756 MHz	3.84 MHz	-60 dBm
	758 MHz $\leq f \leq$ 768 MHz	3.84 MHz	-60 dBm
	769 MHz $\leq f \leq$ 775 MHz	6.25 kHz	-35 dBm ***
	799 MHz $\leq f \leq$ 805 MHz	6.25 kHz	-35 dBm ***
	852 MHz $\leq f \leq$ 859 MHz	1 MHz	-50 dBm
	859 MHz $\leq f \leq$ 894 MHz	3.84 MHz	-60 dBm
	1525 MHz $\leq f \leq$ 1559 MHz	1 MHz	-50 dBm
	1930 MHz $\leq f \leq$ 1995 MHz	3.84 MHz	-60 dBm
	2110 MHz $\leq f \leq$ 2170 MHz	3.84 MHz	-60 dBm
	2180 MHz $\leq f \leq$ 2200 MHz	1 MHz	-50 dBm
	2350 MHz $\leq f \leq$ 2360 MHz	1 MHz	-50 dBm
	2496 MHz $\leq f \leq$ 2690 MHz	1 MHz	-50 dBm
XIX	758 MHz $\leq f \leq$ 803 MHz	1 MHz	-50 dBm
	860 MHz $\leq f <$ 875 MHz	1 MHz	-37 dBm
	875 MHz $\leq f \leq$ 890 MHz	3.84 MHz	-60 dBm
	945 MHz $\leq f \leq$ 960 MHz	3.84 MHz	-60 dBm
	1475.9 MHz $\leq f \leq$ 1510.9 MHz	3.84 MHz	-60 dBm
	1839.9 MHz $\leq f \leq$ 1879.9 MHz	3.84 MHz	-60 dBm
	1884.5 MHz $\leq f \leq$ 1915.7 MHz	300 kHz	-41 dBm
	2010 MHz $\leq f \leq$ 2025 MHz	3.84 MHz	-60 dBm
	2110 MHz $\leq f \leq$ 2170 MHz	3.84 MHz	-60 dBm
	2545 MHz $\leq f \leq$ 2575 MHz	1 MHz	-50 dBm
	2595 MHz $\leq f \leq$ 2645 MHz	1 MHz	-50 dBm



	3400 MHz $\leq f \leq$ 3600 MHz	1 MHz	-50 dBm
XX	758 MHz $\leq f \leq$ 788 MHz	1 MHz	-50 dBm
	791 MHz $\leq f \leq$ 821 MHz	3.84 MHz	-60 dBm
	921 MHz $\leq f <$ 925 MHz	100 kHz	-60 dBm *
	925 MHz $\leq f \leq$ 935 MHz	100 kHz	-67 dBm *
		3.84 MHz	-60 dBm
	935 MHz $< f \leq$ 960 MHz	100 kHz	-79 dBm *
		3.84 MHz	-60 dBm
	1452 MHz $< f \leq$ 1496 MHz	3.84 MHz	-60 dBm
	1805 MHz $\leq f \leq$ 1880 MHz	100 kHz	-71 dBm *
		3.84 MHz	-60 dBm
	2010 MHz $\leq f \leq$ 2025 MHz	3.84 MHz	-60 dBm
	2110 MHz $\leq f \leq$ 2170 MHz	3.84 MHz	-60 dBm
	2300 MHz $\leq f \leq$ 2400 MHz	3.84 MHz	-60 dBm
	2620 MHz $\leq f \leq$ 2690 MHz	3.84 MHz	-60 dBm
XXI	2570 MHz $\leq f \leq$ 2620 MHz	3.84 MHz	-60 dBm**
	3510 MHz $\leq f \leq$ 3590 MHz	3.84 MHz	-60 dBm
	3400 MHz $\leq f \leq$ 3800 MHz	1 MHz	-50 dBm **
	758 MHz $\leq f \leq$ 803 MHz	1 MHz	-50 dBm
	860 MHz $\leq f \leq$ 890 MHz	3.84 MHz	-60 dBm
	945 MHz $\leq f \leq$ 960 MHz	3.84 MHz	-60 dBm
	1475.9 MHz $\leq f \leq$ 1510.9 MHz	1 MHz	-35 dBm
	1839.9 MHz $\leq f \leq$ 1879.9 MHz	3.84 MHz	-60 dBm
	1884.5 MHz $\leq f \leq$ 1915.7 MHz	300 kHz	-41 dBm
	2010 MHz $\leq f \leq$ 2025 MHz	3.84 MHz	-60 dBm
	2110 MHz $\leq f \leq$ 2170 MHz	3.84 MHz	-60 dBm
	2545 MHz $\leq f \leq$ 2575 MHz	1 MHz	-50 dBm
	2595 MHz $\leq f \leq$ 2645 MHz	1 MHz	-50 dBm
	3400 MHz $\leq f \leq$ 3600 MHz	1 MHz	-50 dBm
XXII	758 MHz $\leq f \leq$ 791 MHz	1 MHz	-50 dBm
	791 MHz $\leq f \leq$ 821 MHz	3.84 MHz	-60 dBm
	852 MHz $\leq f \leq$ 859 MHz	1 MHz	-50 dBm
	859 MHz $\leq f \leq$ 894 MHz	3.84 MHz	-60 dBm
	921 MHz $\leq f <$ 925 MHz	100 kHz	-60 dBm *
	925 MHz $\leq f \leq$ 935 MHz	100 kHz	-67 dBm *
		3.84 MHz	-60 dBm
	935 MHz $< f \leq$ 960 MHz	100 kHz	-79 dBm *
		3.84 MHz	-60 dBm
	1452 MHz $< f \leq$ 1496 MHz	3.84 MHz	-60 dBm
	1805 MHz $\leq f \leq$ 1880 MHz	100 kHz	-71 dBm *
		3.84 MHz	-60 dBm
	1880 MHz $\leq f \leq$ 1920 MHz	3.84 MHz	-60 dBm
	2010 MHz $\leq f \leq$ 2025 MHz	3.84 MHz	-60 dBm
	2110 MHz $\leq f \leq$ 2170 MHz	3.84 MHz	-60 dBm
	2300 MHz $\leq f \leq$ 2400 MHz	3.84 MHz	-60 dBm
	2620 MHz $\leq f \leq$ 2690 MHz	3.84 MHz	-60 dBm
	2570 MHz $\leq f \leq$ 2620 MHz	3.84 MHz	-60 dBm
	3510 MHz $\leq f \leq$ 3525 MHz	1 MHz	-40 dBm
	3525 MHz $\leq f \leq$ 3590 MHz	1 MHz	-50 dBm
	3600 MHz $\leq f \leq$ 3800 MHz	3.84 MHz	-50 dBm
XXV	717 MHz $\leq f \leq$ 728 MHz	1 MHz	-50 dBm
	729 MHz $\leq f \leq$ 746 MHz	3.84 MHz	-60 dBm
	746 MHz $\leq f \leq$ 756 MHz	3.84 MHz	-60 dBm
	758 MHz $\leq f \leq$ 768 MHz	3.84 MHz	-60 dBm
	768 MHz $\leq f \leq$ 803 MHz	1 MHz	-50 dBm
	852 MHz $\leq f \leq$ 859 MHz	1 MHz	-50 dBm
	859 MHz $\leq f \leq$ 894 MHz	3.84 MHz	-60 dBm
	1525 MHz $\leq f \leq$ 1559 MHz	3.84 MHz	-60 dBm
	1930 MHz $\leq f \leq$ 1995 MHz	3.84 MHz	-60 dBm
	2110 MHz $\leq f \leq$ 2170 MHz	3.84 MHz	-60 dBm
	2180 MHz $\leq f \leq$ 2200 MHz	1 MHz	-50 dBm
	2350 MHz $\leq f \leq$ 2360 MHz	1 MHz	-50 dBm



XXVI	$2496 \text{ MHz} \leq f \leq 2690 \text{ MHz}$	1 MHz	-50 dBm
	$3510 \text{ MHz} \leq f \leq 3590 \text{ MHz}$	3.84 MHz	-60 dBm
	$3400 \text{ MHz} \leq f \leq 3800 \text{ MHz}$	1 MHz	-50 dBm **
	$462.5 \text{ MHz} \leq f \leq 467.5 \text{ MHz}$	1 MHz	-50 dBm
	$717 \text{ MHz} \leq f \leq 728 \text{ MHz}$	1 MHz	-50 dBm
	$729 \text{ MHz} \leq f \leq 768 \text{ MHz}$	3.84 MHz	-60 dBm
	$768 \text{ MHz} \leq f \leq 799 \text{ MHz}$	1 MHz	-50 dBm
	$799 \text{ MHz} \leq f \leq 803 \text{ MHz}$	1 MHz	-40 dBm
	$859 \text{ MHz} \leq f \leq 894 \text{ MHz}$	3.84 MHz	-60 dBm
	$945 \text{ MHz} \leq f \leq 960 \text{ MHz}$	3.84 MHz	-60 dBm
	$1475.9 \text{ MHz} \leq f \leq 1510.9 \text{ MHz}$	3.84 MHz	-60 dBm
	$1525 \text{ MHz} \leq f \leq 1559 \text{ MHz}$	1 MHz	-50 dBm
	$1805 \text{ MHz} \leq f \leq 1880 \text{ MHz}$	3.84 MHz	-60 dBm
	$1839.9 \text{ MHz} \leq f \leq 1879.9 \text{ MHz}$	3.84 MHz	-60 dBm
	$1884.5 \text{ MHz} \leq f \leq 1915.7 \text{ MHz}$	300 kHz	-41 dBm
	$1930 \text{ MHz} \leq f \leq 1995 \text{ MHz}$	3.84 MHz	-60 dBm
	$2010 \text{ MHz} \leq f \leq 2025 \text{ MHz}$	3.84 MHz	-60 dBm
	$2110 \text{ MHz} \leq f \leq 2170 \text{ MHz}$	3.84 MHz	-60 dBm
	$2180 \text{ MHz} \leq f \leq 2200 \text{ MHz}$	1 MHz	-50 dBm
	$2300 \text{ MHz} \leq f \leq 2400 \text{ MHz}$	3.84 MHz	-60 dBm
	$2496 \text{ MHz} \leq f \leq 2690 \text{ MHz}$	1 MHz	-50 dBm **
	$3400 \text{ MHz} \leq f \leq 3800 \text{ MHz}$	1 MHz	-50 dBm
Note *	The transmitter additional spurious emission measurements are made on frequencies which are integer multiples of 200 kHz. As exceptions, up to five measurements with a level up to the applicable requirements defined in Table 6.12 are permitted for each UARFCN used in the measurement.		
Note **	The transmitter additional spurious emission measurements are made on frequencies which are integer multiples of 200 kHz. As exceptions, measurements with a level up to the applicable requirements defined in Table 6.12 are permitted for each UARFCN used in the measurement due to 2 <sup>nd</sup> , 3 <sup>rd</sup> and 4 <sup>th</sup> harmonic spurious emissions. Note *** This requirement is applicable also for frequencies, which are between 2.5 MHz and 12.5 MHz away from the UE transmit centre carrier frequency.		
Note ****	This requirement is applicable only when UE transmission is allocated within 900MHz to 915MHz.		
Note *****	This requirement is applicable only when UE transmission is allocated within 1744.9 MHz to 1784.9 MHz.		

#### 6.6.3.1.1 Additional requirement

The UE shall meet the requirements in Table 6.13a for the applicable band.



**Table 6.13a: Additional spurious emissions requirements**

Operating Band	Frequency Bandwidth	Measurement Bandwidth	Minimum requirement
XXVI	$806 \text{ MHz} \leq f \leq 813.5 \text{ MHz}$	6.25 kHz	-42 dBm (NOTE 1)
	$806 \text{ MHz} \leq f \leq 816 \text{ MHz}$	6.25 kHz	-42 dBm (NOTE 2)
	$852 \text{ MHz} \leq f \leq 859 \text{ MHz}$	1 MHz	-32 dBm (NOTE 3)
	$851 \text{ MHz} \leq f \leq 859 \text{ MHz}$	6.25 kHz	-53 dBm (NOTE 4)
<p>NOTE 1: Applicable for UE center frequencies <math>\geq 816.4 \text{ MHz}</math>. For UE center frequencies <math>\leq 819.6 \text{ MHz}</math> the IE "Maximum allowed UL TX power" shall be indicated and set to +17 dBm.</p> <p>NOTE 2: Applicable for UE center frequencies <math>\geq 819.4 \text{ MHz}</math>. For UE center frequencies <math>\leq 822 \text{ MHz}</math> the IE "Maximum allowed UL TX power" shall be indicated and set to +17 dBm.</p> <p>NOTE 3: Applicable for UE center frequencies <math>\leq 846.6 \text{ MHz}</math>. For UE center frequencies <math>\geq 842.4 \text{ MHz}</math> the IE "Maximum allowed UL TX power" shall be indicated and set to +10 dBm.</p> <p>NOTE 4: Applicable for UE center frequencies <math>\leq 846.6 \text{ MHz}</math>. For UE center frequencies <math>\geq 842.4 \text{ MHz}</math> the IE "Maximum allowed UL TX power" shall be indicated and set to +10 dBm.</p> <p>NOTE 5: For the 6.25kHz measurement bandwidth, the emissions measurement shall be sufficiently power averaged to ensure standard standard deviation <math>&lt; 0.5 \text{ dB}</math>.</p>			

### 6.6.3.1A Additional requirement for DC-HSUPA

The requirements in Table 6.12A are only applicable for frequencies, which are greater than 20 MHz away from the centre of the assigned carrier frequencies when dual adjacent carriers are assigned on the uplink.

**Table 6.12A: General spurious emissions requirements for DC-HSUPA**

Frequency Bandwidth	Measurement Bandwidth	Minimum requirement	Note
$9 \text{ kHz} \leq f < 150 \text{ kHz}$	1 kHz	-36 dBm	
$150 \text{ kHz} \leq f < 30 \text{ MHz}$	10 kHz	-36 dBm	
$30 \text{ MHz} \leq f < 1000 \text{ MHz}$	100 kHz	-36 dBm	
$1 \text{ GHz} \leq f < 12.75 \text{ GHz}$	1 MHz	-30 dBm	
$12.75 \text{ GHz} \leq f < 5\text{th harmonic of the upper frequency edge of the UL operating band in GHz}$	1 MHz	-30 dBm	Note 1
NOTE 1: Applies only for Band XXII.			

The requirements in Table 6.13A are only applicable for frequencies, which are greater than 25 MHz away from the centre of the assigned frequencies when dual adjacent carriers are assigned on the uplink.



Table 6.13A: Additional spurious emissions requirements for DC-HSUPA

Operating Band	Frequency Bandwidth	Measurement Bandwidth	Minimum requirement
I	462.5 MHz $\leq f \leq$ 467.5 MHz	1 MHz	-50 dBm
	703 MHz $\leq f \leq$ 803 MHz	1 MHz	-50 dBm
	791 MHz $\leq f \leq$ 821 MHz	3.84 MHz	-60 dBm
	852 MHz $\leq f \leq$ 859 MHz	1 MHz	-50 dBm
	859 MHz $\leq f \leq$ 894 MHz	3.84 MHz	-60 dBm
	921 MHz $\leq f <$ 925 MHz	100 kHz	-60 dBm *
	925 MHz $\leq f \leq$ 935 MHz	100 kHz	-67 dBm *
		3.84MHz	-60 dBm
	935 MHz $< f \leq$ 960 MHz	100 kHz	-79 dBm *
		3.84MHz	-60 dBm
	1452 MHz $\leq f \leq$ 1510.9 MHz	3.84 MHz	-60 dBm
	1805 MHz $\leq f \leq$ 1880 MHz	100 kHz	-71 dBm *
		3.84MHz	-60 dBm
	1844.9 MHz $\leq f \leq$ 1879.9 MHz	3.84 MHz	-55 dBm
	1884.5 MHz $< f <$ 1915.7 MHz	300 kHz	-41 dBm
	2010 MHz $< f <$ 2025 MHz	3.84 MHz	-60 dBm
	2110 MHz $\leq f \leq$ 2170 MHz	3.84 MHz	-60 dBm
	2300 MHz $< f <$ 2400 MHz	3.84 MHz	-60 dBm
	2496 MHz $\leq f \leq$ 2570 MHz	1 MHz	-50 dBm
	2570 MHz $\leq f \leq$ 2690 MHz	3.84 MHz	-60 dBm
	3510 MHz $\leq f \leq$ 3590 MHz	3.84 MHz	-60 dBm
	3400 MHz $\leq f \leq$ 3800 MHz	1 MHz	-50 dBm
II	717 MHz $\leq f \leq$ 728 MHz	1 MHz	-50 dBm
	729 MHz $\leq f \leq$ 746 MHz	3.84 MHz	-60 dBm
	746 MHz $\leq f \leq$ 758 MHz	3.84 MHz	-60 dBm
	758 MHz $\leq f \leq$ 768 MHz	3.84 MHz	-60 dBm
	768 MHz $\leq f \leq$ 803 MHz	1 MHz	-50 dBm
	852 MHz $\leq f \leq$ 859 MHz	1 MHz	-50 dBm
	859 MHz $\leq f \leq$ 894 MHz	3.84 MHz	-60 dBm
	1525 MHz $\leq f \leq$ 1559 MHz	1 MHz	-50 dBm
	1930 MHz $\leq f \leq$ 1995 MHz	3.84 MHz	-60 dBm
	2110 MHz $\leq f \leq$ 2170 MHz	3.84 MHz	-60 dBm
	2180 MHz $\leq f \leq$ 2200 MHz	1 MHz	-50 dBm
	2350 MHz $\leq f \leq$ 2360 MHz	1 MHz	-50 dBm
	2496 MHz $\leq f \leq$ 2620 MHz	1 MHz	-50 dBm
III	462.5 MHz $\leq f \leq$ 467.5 MHz	1 MHz	-50 dBm
	703 MHz $\leq f \leq$ 803 MHz	1 MHz	-50 dBm
	791 MHz $\leq f \leq$ 821 MHz	3.84 MHz	-60 dBm
	852 MHz $\leq f \leq$ 869 MHz	1 MHz	-50 dBm
	859 MHz $\leq f \leq$ 894 MHz	3.84 MHz	-60 dBm
	921 MHz $\leq f <$ 925 MHz	100 kHz	-60 dBm *
	925 MHz $\leq f \leq$ 935 MHz	100 kHz	-67 dBm *
		3.84 MHz	- 60 dBm
	935 MHz $< f \leq$ 960 MHz	100 kHz	-79 dBm
		3.84 MHz	- 60 dBm *
	1452 MHz $< f \leq$ 1496 MHz	3.84 MHz	-60 dBm
	1805 MHz $\leq f \leq$ 1880 MHz	3.84 MHz	-60 dBm
	1880 MHz $\leq f \leq$ 1920 MHz	3.84 MHz	-60 dBm
	2010 MHz $\leq f \leq$ 2025 MHz	3.84 MHz	-60 dBm
	2110 MHz $\leq f \leq$ 2170 MHz	3.84 MHz	-60 dBm
	2300 MHz $\leq f \leq$ 2400 MHz	3.84 MHz	-60 dBm
	2496 MHz $\leq f \leq$ 2570 MHz	1 MHz	-50 dBm
	2570 MHz $\leq f \leq$ 2620 MHz	3.84 MHz	-60 dBm
	2620 MHz $\leq f \leq$ 2690 MHz	3.84 MHz	-60 dBm
	3510 MHz $\leq f \leq$ 3590 MHz	3.84 MHz	-60 dBm **
	3400 MHz $\leq f \leq$ 3800 MHz	1 MHz	-50 dBm **
IV	717 MHz $\leq f \leq$ 728 MHz	1 MHz	-50 dBm
	729 MHz $\leq f \leq$ 746 MHz	3.84 MHz	-60 dBm
	746 MHz $\leq f \leq$ 756 MHz	3.84 MHz	-60 dBm



	758 MHz $\leq f \leq$ 768 MHz	3.84 MHz	-60 dBm
	768 MHz $\leq f \leq$ 803 MHz	1 MHz	-50 dBm
	852 MHz $\leq f \leq$ 859 MHz	1 MHz	-50 dBm
	859 MHz $\leq f \leq$ 894 MHz	3.84 MHz	-60 dBm
	1525 MHz $\leq f \leq$ 1559 MHz	1 MHz	-50 dBm
	1930 MHz $\leq f \leq$ 1995 MHz	3.84 MHz	-60 dBm
	2110 MHz $\leq f \leq$ 2170 MHz	3.84 MHz	-60 dBm
	2180 MHz $\leq f \leq$ 2200 MHz	1 MHz	-50 dBm
	2350 MHz $\leq f \leq$ 2360 MHz	1 MHz	-50 dBm
	2496 MHz $\leq f \leq$ 2690 MHz	1 MHz	-50 dBm
	2620 MHz $\leq f \leq$ 2690 MHz	3.84 MHz	-60 dBm
V	462.5 MHz $\leq f \leq$ 467.5 MHz	1 MHz	-50 dBm
	717 MHz $\leq f \leq$ 728 MHz	1 MHz	-50 dBm
	703 MHz $\leq f \leq$ 803 MHz	3.84 MHz	-50 dBm
	729 MHz $\leq f \leq$ 746 MHz	3.84 MHz	-60 dBm
	746 MHz $\leq f \leq$ 756 MHz	3.84 MHz	-60 dBm
	758 MHz $\leq f \leq$ 768 MHz	3.84 MHz	-60 dBm
	859 MHz $\leq f \leq$ 869 MHz	1 MHz	-27 dBm
	869 MHz $\leq f \leq$ 894 MHz	3.84 MHz	-60 dBm
	1525 MHz $\leq f \leq$ 1559 MHz	1 MHz	-50 dBm
	1805 MHz $\leq f \leq$ 1880 MHz	3.84 MHz	-60 dBm
	1930 MHz $\leq f \leq$ 1995 MHz	3.84 MHz	-60 dBm
	2110 MHz $\leq f \leq$ 2170 MHz	3.84 MHz	-60 dBm
	2180 MHz $\leq f \leq$ 2200 MHz	1 MHz	-50 dBm
	2300 MHz $\leq f \leq$ 2400 MHz	3.84 MHz	-60 dBm
	2350 MHz $\leq f \leq$ 2360 MHz	1 MHz	-50 dBm
	2496 MHz $\leq f \leq$ 2620 MHz	1 MHz	-50 dBm **
	2570 MHz $\leq f \leq$ 2690 MHz	1 MHz	-50 dBm **
VI	860 MHz $\leq f <$ 875 MHz	1 MHz	-37 dBm
	875 MHz $\leq f \leq$ 890 MHz	3.84 MHz	-60 dBm
	1475.9 MHz $\leq f \leq$ 1510.9 MHz	3.84 MHz	-60 dBm
	1844.9 MHz $\leq f \leq$ 1879.9 MHz	3.84 MHz	-60 dBm
	1884.5 MHz $\leq f \leq$ 1915.7 MHz	300 kHz	-41 dBm
	2010 MHz $< f <$ 2025 MHz	3.84 MHz	-60 dBm
	2110 MHz $\leq f \leq$ 2170 MHz	3.84 MHz	-60 dBm
	2545 MHz $\leq f \leq$ 2575 MHz	1 MHz	-50 dBm
	2595 MHz $\leq f \leq$ 2645 MHz	1 MHz	-50 dBm
	3400 MHz $\leq f \leq$ 3600 MHz	1 MHz	-50 dBm
VII	462.5 MHz $\leq f \leq$ 467.5 MHz	1 MHz	-50 dBm
	717 MHz $\leq f \leq$ 728 MHz	1 MHz	-50 dBm
	729 MHz $\leq f \leq$ 746 MHz	3.84 MHz	-60 dBm
	746 MHz $\leq f \leq$ 756 MHz	3.84 MHz	-60 dBm
	758 MHz $\leq f \leq$ 768 MHz	3.84 MHz	-60 dBm
	758 MHz $\leq f \leq$ 791 MHz	1 MHz	-50 dBm
	791 MHz $\leq f \leq$ 821 MHz	3.84 MHz	-60 dBm
	852 MHz $\leq f \leq$ 869 MHz	1 MHz	-50 dBm
	859 MHz $\leq f \leq$ 894 MHz	3.84 MHz	-60 dBm
	921 MHz $\leq f <$ 925 MHz	100 kHz	-60 dBm *
	925 MHz $\leq f \leq$ 935 MHz	100 kHz	-67 dBm *
		3.84 MHz	-60 dBm
	935 MHz $< f \leq$ 960 MHz	100 kHz	-79 dBm *
	1452 MHz $< f \leq$ 1496 MHz	3.84 MHz	-60 dBm
	1805 MHz $\leq f \leq$ 1880 MHz	100 kHz	-71 dBm *
	1900 MHz $\leq f \leq$ 1920 MHz	3.84 MHz	-60 dBm
	1930 MHz $\leq f \leq$ 1995 MHz	3.84 MHz	-60 dBm
	2010 MHz $< f <$ 2025 MHz	3.84 MHz	-60 dBm
	2110 MHz $\leq f \leq$ 2170 MHz	3.84 MHz	-60 dBm
	2300 MHz $< f <$ 2400 MHz	3.84 MHz	-60 dBm
	2350 MHz $\leq f \leq$ 2360 MHz	1 MHz	-50 dBm
	2620 MHz $\leq f \leq$ 2690 MHz	3.84 MHz	-60 dBm
	2595 MHz $\leq f \leq$ 2620 MHz	1 MHz	-37 dBm
VIII	462.5 MHz $\leq f \leq$ 467.5 MHz	1 MHz	-50 dBm



	703 MHz $\leq f \leq$ 803 MHz	1 MHz	-50 dBm
	791 MHz $\leq f \leq$ 821 MHz	3.84 MHz	-60 dBm
	925 MHz $\leq f \leq$ 935 MHz	100 kHz 3.84 MHz	-57 dBm *, *** -50 dBm
	935 MHz $< f \leq$ 960 MHz	100 kHz 3.84 MHz	-79 dBm * -60 dBm
	1452 MHz $< f \leq$ 1496 MHz	3.84 MHz	-60 dBm
	1805 MHz $< f \leq$ 1830 MHz	100 kHz 3.84 MHz	-71 dBm ** & * -60 dBm **
	1830 MHz $< f \leq$ 1880 MHz	100 kHz 3.84 MHz	-71 dBm * -60 dBm
	1880MHz $\leq f \leq$ 1920 MHz	3.84 MHz	-60 dBm
	2010MHz $\leq f \leq$ 2025 MHz	3.84 MHz	-60 dBm
	2110 MHz $\leq f \leq$ 2170 MHz	3.84 MHz	-60 dBm
	2496 MHz $\leq f \leq$ 2570 MHz	1 MHz	-50 dBm
	2300MHz $\leq f \leq$ 2400 MHz	3.84 MHz	-60 dBm
	2570 MHz $\leq f \leq$ 2620 MHz	3.84 MHz	-60 dBm
	2620 MHz $\leq f \leq$ 2640 MHz	3.84 MHz	-60 dBm
	2640 MHz $< f \leq$ 2690 MHz	3.84 MHz	-60 dBm **
	3510 MHz $\leq f \leq$ 3590 MHz	3.84 MHz	-60 dBm **
	3400 MHz $\leq f \leq$ 3800 MHz	1 MHz	-50 dBm **
IX	758 MHz $\leq f \leq$ 803 MHz	1 MHz	-50 dBm
	859 MHz $\leq f \leq$ 894 MHz	3.84 MHz	-60 dBm
	1475.9 MHz $\leq f \leq$ 1510.9 MHz	3.84 MHz	-60 dBm
	1844.9 MHz $\leq f \leq$ 1879.9 MHz	3.84 MHz	-60 dBm
	1884.5 MHz $\leq f \leq$ 1915.7 MHz	300 kHz	-41 dBm
	2010 MHz $\leq f \leq$ 2025 MHz	3.84 MHz	-60 dBm
	2110 MHz $\leq f \leq$ 2170 MHz	3.84 MHz	-60 dBm
	2545 MHz $\leq f \leq$ 2575 MHz	1 MHz	-50 dBm
	2595 MHz $\leq f \leq$ 2645 MHz	1 MHz	-50 dBm
	3400 MHz $\leq f \leq$ 3600 MHz	1 MHz	-50 dBm **
X	717 MHz $\leq f \leq$ 728 MHz	1 MHz	-50 dBm
	729 MHz $\leq f \leq$ 746 MHz	3.84 MHz	-60 dBm
	746 MHz $\leq f \leq$ 756 MHz	3.84 MHz	-60 dBm
	758 MHz $\leq f \leq$ 768 MHz	3.84 MHz	-60 dBm
	768 MHz $\leq f \leq$ 803 MHz	1 MHz	-50 dBm
	852 MHz $\leq f \leq$ 859 MHz	1 MHz	-50 dBm
	859 MHz $\leq f \leq$ 894 MHz	3.84 MHz	-60 dBm
	1525 MHz $\leq f \leq$ 1559 MHz	1 MHz	-50 dBm
	1930 MHz $\leq f \leq$ 1995 MHz	3.84 MHz	-60 dBm
	2110 MHz $\leq f \leq$ 2170 MHz	3.84 MHz	-60 dBm
	2180 MHz $\leq f \leq$ 2200 MHz	1 MHz	-50 dBm
	2350 MHz $\leq f \leq$ 2360 MHz	1 MHz	-50 dBm
	2496 MHz $\leq f \leq$ 2570 MHz	1 MHz	-50 dBm
	3510 MHz $\leq f \leq$ 3590 MHz	3.84 MHz	-60 dBm **
	3400 MHz $\leq f \leq$ 3800 MHz	1 MHz	-50 dBm **
XI	758 MHz $\leq f \leq$ 803 MHz	1 MHz	-50 dBm
	860 MHz $\leq f \leq$ 890 MHz	3.84 MHz	-60 dBm
	1475.9 MHz $\leq f \leq$ 1510.9 MHz	3.84 MHz	-60 dBm
	1844.9 MHz $\leq f \leq$ 1879.9 MHz	3.84 MHz	-60 dBm
	1884.5 MHz $\leq f \leq$ 1915.7 MHz	300 kHz	-41 dBm
	2010 MHz $\leq f \leq$ 2025 MHz	3.84 MHz	-60 dBm
	2110 MHz $\leq f \leq$ 2170 MHz	3.84 MHz	-60 dBm
	2545 MHz $\leq f \leq$ 2575 MHz	1 MHz	-50 dBm
	2595 MHz $\leq f \leq$ 2645 MHz	1 MHz	-50 dBm
	3400 MHz $\leq f \leq$ 3600 MHz	1 MHz	-50 dBm
XIX	758 MHz $\leq f \leq$ 803 MHz	1 MHz	-50 dBm
	860 MHz $\leq f <$ 875 MHz	1 MHz	-30 dBm
	875 MHz $\leq f \leq$ 890 MHz	3.84 MHz	-60 dBm
	1475.9 MHz $\leq f \leq$ 1510.9 MHz	3.84 MHz	-60 dBm
	1844.9 MHz $\leq f \leq$ 1879.9 MHz	3.84 MHz	-60 dBm



	1884.5 MHz $\leq f \leq$ 1915.7 MHz	300 kHz	-41 dBm
	2010 MHz $\leq f \leq$ 2025 MHz	3.84 MHz	-60 dBm
	2110 MHz $\leq f \leq$ 2170 MHz	3.84 MHz	-60 dBm
	2545 MHz $\leq f \leq$ 2575 MHz	1 MHz	-50 dBm
	2595 MHz $\leq f \leq$ 2645 MHz	1 MHz	-50 dBm
	3400 MHz $\leq f \leq$ 3600 MHz	1 MHz	-50 dBm
XX	758 MHz $\leq f \leq$ 788 MHz	1 MHz	-50 dBm
	811 MHz $\leq f \leq$ 821 MHz	3.84 MHz	-50 dBm ***
	791 MHz $\leq f \leq$ 811 MHz	3.84 MHz	-60 dBm
	921 MHz $\leq f <$ 925 MHz	100 kHz	-60 dBm *
	925 MHz $\leq f \leq$ 935 MHz	100 kHz	-67 dBm *
		3.84 MHz	-60 dBm
	935 MHz $< f \leq$ 960 MHz	100 kHz	-79 dBm *
		3.84 MHz	-60 dBm
	1452 MHz $< f \leq$ 1496 MHz	3.84 MHz	-60 dBm
	1805 MHz $\leq f \leq$ 1880 MHz	100 kHz	-71 dBm *
		3.84 MHz	-60 dBm
	2010 MHz $\leq f \leq$ 2025 MHz	3.84 MHz	-60 dBm
	2110 MHz $\leq f \leq$ 2170 MHz	3.84 MHz	-60 dBm
	2300 MHz $\leq f \leq$ 2400 MHz	3.84 MHz	-60 dBm
	2620 MHz $\leq f \leq$ 2690 MHz	3.84 MHz	-60 dBm
	2570 MHz $\leq f \leq$ 2620 MHz	3.84 MHz	-60 dBm **
	3510 MHz $\leq f \leq$ 3590 MHz	3.84 MHz	-60 dBm
	3400 MHz $\leq f \leq$ 3800 MHz	1 MHz	-50 dBm **
XXII	758 MHz $\leq f \leq$ 791 MHz	1 MHz	-50 dBm
	791 MHz $\leq f \leq$ 821 MHz	3.84 MHz	-60 dBm
	852 MHz $\leq f \leq$ 869 MHz	1 MHz	-50 dBm
	921 MHz $\leq f <$ 925 MHz	100 kHz	-60 dBm *
	925 MHz $\leq f \leq$ 935 MHz	100 kHz	-67 dBm *
		3.84 MHz	-60 dBm
	935 MHz $< f \leq$ 960 MHz	100 kHz	-79 dBm *
		3.84 MHz	-60 dBm
	1452 MHz $< f \leq$ 1496 MHz	3.84 MHz	-60 dBm
	1805 MHz $\leq f \leq$ 1880 MHz	100 kHz	-71 dBm *
		3.84 MHz	-60 dBm
	1880 MHz $\leq f \leq$ 1920 MHz	3.84 MHz	-60 dBm
	2010 MHz $\leq f \leq$ 2025 MHz	3.84 MHz	-60 dBm
	2110 MHz $\leq f \leq$ 2170 MHz	3.84 MHz	-60 dBm
	2300 MHz $\leq f \leq$ 2400 MHz	3.84 MHz	-60 dBm
	2620 MHz $\leq f \leq$ 2690 MHz	3.84 MHz	-60 dBm
	2570 MHz $\leq f \leq$ 2620 MHz	3.84 MHz	-60 dBm
	3510 MHz $\leq f \leq$ 3525 MHz	1 MHz	-40 dBm
	3525 MHz $\leq f \leq$ 3590 MHz	1 MHz	-50 dBm
	3600 MHz $\leq f \leq$ 3800 MHz	3.84 MHz	-50 dBm
XXV	717 MHz $\leq f \leq$ 728 MHz	1 MHz	-50 dBm
	729 MHz $\leq f \leq$ 746 MHz	3.84 MHz	-60 dBm
	746 MHz $\leq f \leq$ 756 MHz	3.84 MHz	-60 dBm
	758 MHz $\leq f \leq$ 768 MHz	3.84 MHz	-60 dBm
	768 MHz $\leq f \leq$ 803 MHz	1 MHz	-50 dBm
	852 MHz $\leq f \leq$ 859 MHz	1 MHz	-50 dBm
	859 MHz $\leq f \leq$ 894 MHz	3.84 MHz	-60 dBm
	1525 MHz $\leq f \leq$ 1559 MHz	3.84 MHz	-60 dBm
	1930 MHz $\leq f \leq$ 1995 MHz	3.84 MHz	-60 dBm
	2110 MHz $\leq f \leq$ 2170 MHz	3.84 MHz	-60 dBm
	2180 MHz $\leq f \leq$ 2200 MHz	1 MHz	-50 dBm
	2350 MHz $\leq f \leq$ 2360 MHz	1 MHz	-50 dBm
	2496 MHz $\leq f \leq$ 2690 MHz	1 MHz	-50 dBm
	3400 MHz $\leq f \leq$ 3800 MHz	1 MHz	-50 dBm
XXVI	462.5 MHz $\leq f \leq$ 467.5 MHz	1 MHz	-50 dBm
	717 MHz $\leq f \leq$ 728 MHz	1 MHz	-50 dBm
	729 MHz $\leq f \leq$ 768 MHz	3.84 MHz	-60 dBm
	768 MHz $\leq f \leq$ 799 MHz	1 MHz	-50 dBm



	$799 \text{ MHz} \leq f \leq 803 \text{ MHz}$	1 MHz	-40 dBm
	$859 \text{ MHz} \leq f \leq 894 \text{ MHz}$	3.84 MHz	-60 dBm
	$1475.9 \text{ MHz} \leq f \leq 1510.9 \text{ MHz}$	3.84 MHz	-60 dBm
	$1525 \text{ MHz} \leq f \leq 1559 \text{ MHz}$	1 MHz	-50 dBm
	$1805 \text{ MHz} \leq f \leq 1880 \text{ MHz}$	3.84 MHz	-60 dBm
	$1844.9 \text{ MHz} \leq f \leq 1879.9 \text{ MHz}$	3.84 MHz	-60 dBm
	$1884.5 \text{ MHz} \leq f \leq 1915.7 \text{ MHz}$	300 kHz	-41 dBm
	$1930 \text{ MHz} \leq f \leq 1995 \text{ MHz}$	3.84 MHz	-60 dBm
	$2010 \text{ MHz} \leq f \leq 2025 \text{ MHz}$	3.84 MHz	-60 dBm
	$2110 \text{ MHz} \leq f \leq 2170 \text{ MHz}$	3.84 MHz	-60 dBm
	$2180 \text{ MHz} \leq f \leq 2200 \text{ MHz}$	1 MHz	-50 dBm
	$2300 \text{ MHz} \leq f \leq 2400 \text{ MHz}$	3.84 MHz	-60 dBm
	$2496 \text{ MHz} \leq f \leq 2690 \text{ MHz}$	1 MHz	-50 dBm **
	$3400 \text{ MHz} \leq f \leq 3800 \text{ MHz}$	1 MHz	-50 dBm
Note *	The measurements are made on frequencies which are integer multiples of 200 kHz. As exceptions, up to five measurements with a level up to the applicable requirements defined in Table 6.12 are permitted for each UARFCN used in the measurement		
Note **	The measurements are made on frequencies which are integer multiples of 200 kHz. As exceptions, measurements with a level up to the applicable requirements defined in Table 6.12 are permitted for each UARFCN used in the measurement due to 2 <sup>nd</sup> , 3 <sup>rd</sup> and 4 <sup>th</sup> harmonic spurious emissions		
Note ***	This requirement is applicable also for frequencies, which are between 5 MHz and 25 MHz away from the UE centre carrier frequency.		

#### 6.6.3.1A.1 Additional requirement for DC-HSUPA

The UE shall meet the requirements in Table 6.13B for the applicable band.

**Table 6.13B: Additional spurious emissions requirements**

Operating Band	Frequency Bandwidth	Measurement Bandwidth	Minimum requirement
XXVI	$806 \text{ MHz} \leq f \leq 813.5 \text{ MHz}$	6.25 kHz	-42 dBm (NOTE 1)
	$806 \text{ MHz} \leq f \leq 816 \text{ MHz}$	6.25 kHz	-42 dBm (NOTE 2)
	$852 \text{ MHz} \leq f \leq 859 \text{ MHz}$	1 MHz	-32 dBm (NOTE 3)
	$851 \text{ MHz} \leq f \leq 859 \text{ MHz}$	6.25 kHz	-53 dBm (NOTE 4)
NOTE 1: Applicable for a UE center frequency of the two assigned channel frequencies $\geq 819 \text{ MHz}$ . For such UE center frequencies $\leq 826.6 \text{ MHz}$ the IE "Maximum allowed UL TX power" shall be indicated and set to +17 dBm.			
NOTE 2: Applicable for UE center frequency of the two assigned channel frequencies $\geq 822 \text{ MHz}$ . For such UE center frequencies $\leq 829 \text{ MHz}$ the IE "Maximum allowed UL TX power" shall be indicated and set to +17 dBm.			
NOTE 3: Applicable for UE center frequency of the two assigned channel frequencies $\leq 844 \text{ MHz}$ . For such UE center frequencies $\geq 831 \text{ MHz}$ the IE "Maximum allowed UL TX power" shall be indicated and set to +10 dBm.			
NOTE 4: Applicable for UE center frequency of the two assigned channel frequencies $\leq 844 \text{ MHz}$ . For such UE center frequencies $\geq 831 \text{ MHz}$ the IE "Maximum allowed UL TX power" shall be indicated and set to +10 dBm.			
NOTE 5: For the 6.25kHz measurement bandwidth, the emissions measurement shall be sufficiently power averaged to ensure standard standard deviation $< 0.5 \text{ dB}$ .			

#### 6.6.3.1B Additional requirement for UL OLTD

For UE with two active transmit antenna connectors in UL OLTD operation, the requirements specified in sub-clause 6.6.3.1 apply at each transmit antenna connector.

#### 6.6.3.1C Additional requirement for UL CLTD

For UE with two active transmit antenna connectors in UL CLTD activation state 1, the spectrum emission requirements specified in sub-clause 6.6.3.1 apply at each transmit antenna connector.



For UE configured in UL CLTD activation state 2 or activation state 3, the spectrum emission requirements in sub-clause 6.6.3.1 apply at the active transmit antenna connector.

### 6.6.3.1D Additional requirement for UL MIMO

For UE with two active transmit antenna connectors in UL MIMO operation, the spectrum emission requirements specified in sub-clause 6.6.3.1 apply at each transmit antenna connector.

## 6.7 Transmit intermodulation

The transmit intermodulation performance is a measure of the capability of the transmitter to inhibit the generation of signals in its non linear elements caused by presence of the wanted signal and an interfering signal reaching the transmitter via the antenna.

### 6.7.1 Minimum requirement

User Equipment(s) transmitting in close vicinity of each other can produce intermodulation products, which can fall into the UE, or Node B receive band as an unwanted interfering signal. The UE intermodulation attenuation is defined by the ratio of the RRC filtered mean power of the wanted signal to the RRC filtered mean power of the intermodulation product when an interfering CW signal is added at a level below the wanted signal.

The requirement of transmitting intermodulation for a carrier spacing of 5 MHz is prescribed in Table 6.14.

**Table 6.14: Transmit Intermodulation**

Interference Signal Frequency Offset	5MHz	10MHz
Interference CW Signal Level	-40dBc	
Intermodulation Product	-31dBc	-41dBc

### 6.7.1A Additional requirement for DC-HSUPA

The UE intermodulation attenuation is defined by the ratio of the sum of the RRC filtered mean powers of the wanted signal on the assigned carriers to the sum of the RRC filtered mean powers of the intermodulation product on two adjacent carriers when an interfering CW signal is added at a level below the wanted signal.

The requirement of transmitting intermodulation for a carrier spacing of 5 MHz is prescribed in Table 6.14A.

**Table 6.14A: Transmit Intermodulation requirement for DC-HSUPA**

Interference Signal Frequency Offset	10MHz	20MHz
Interference CW Signal Level	-40dBc	
Intermodulation Product	-31dBc	-41dBc

### 6.7.1B Additional requirement for UL OLTD

For UE with two active transmit antenna connectors in UL OLTD operation, the requirements specified in sub-clause 6.7.1 apply at each transmit antenna connector.

### 6.7.1C Additional requirement for UL CLTD

For UE with two active transmit antenna connectors in UL CLTD activation state 1, the requirements specified in sub-clause 6.7.1 apply at each transmit antenna connector.

For UE configured in UL CLTD activation state 2 or activation state 3, the requirements specified in sub-clause 6.7.1 apply at the active transmit antenna connector.



### 6.7.1D Additional requirement for UL MIMO

For UE with two active transmit antenna connectors in UL MIMO operation, the requirements specified in sub-clause 6.7.1 apply at each transmit antenna connector.

## 6.8 Transmit modulation

Transmit modulation defines the modulation quality for expected in-channel RF transmissions from the UE. The requirements apply to all transmissions including the PRACH pre-amble and message parts and all other expected transmissions. In cases where the mean power of the RF signal is allowed to change versus time e.g. PRACH, DPCH in compressed mode, change of TFC, inner loop power control and for HSDPA transmissions with non-constant HS-DPCCH code power, the EVM, Peak Code Domain Error and E-DCH Code Domain Error requirements do not apply during the 25  $\mu$ s period before and after the nominal time when the mean power is expected to change.

### 6.8.1 Transmit pulse shape filter

The transmit pulse shaping filter is a root-raised cosine (RRC) with roll-off  $\alpha=0.22$  in the frequency domain. The impulse response of the chip impulse filter  $RC_0(t)$  is:

$$RC_0(t) = \frac{\sin\left(\pi \frac{t}{T_c}(1-\alpha)\right) + 4\alpha \frac{t}{T_c} \cos\left(\pi \frac{t}{T_c}(1+\alpha)\right)}{\pi \frac{t}{T_c} \left(1 - \left(4\alpha \frac{t}{T_c}\right)^2\right)}$$

Where the roll-off factor  $\alpha=0.22$  and the chip duration is

$$T = \frac{1}{\text{chiprate}} \approx 0.26042 \mu\text{s}$$

#### 6.8.1A Additional requirement for UL OLTD

For UE with two active transmit antenna connectors in UL OLTD operation, the transmit pulse shape filter requirements specified in sub-clause 6.8.1 apply at each transmit antenna connector.

#### 6.8.1B Additional requirement for UL CLTD

For UE with two active transmit antenna connectors in UL CLTD activation state 1, the transmit pulse shape filter requirements specified in sub-clause 6.8.1 apply at each transmit antenna connector.

For UE configured in UL CLTD activation state 2 or activation state 3, the transmit pulse shape filter requirements specified in sub-clause 6.8.1 apply at the active transmit antenna connector.

#### 6.8.1C Additional requirement for UL MIMO

For UE with two active transmit antenna connectors in UL MIMO operation, the transmit pulse shape filter requirements specified in sub-clause 6.8.1 apply at each transmit antenna connector.

### 6.8.2 Error Vector Magnitude

The Error Vector Magnitude is a measure of the difference between the reference waveform and the measured waveform. This difference is called the error vector. Both waveforms pass through a matched Root Raised Cosine filter with bandwidth 3,84 MHz and roll-off  $\alpha=0.22$ . Both waveforms are then further modified by selecting the frequency, absolute phase, absolute amplitude and chip clock timing so as to minimise the error vector. The EVM result is defined as the square root of the ratio of the mean error vector power to the mean reference power expressed as a %. The measurement interval is one timeslot except when the mean power between slots is expected to change whereupon the measurement interval is reduced by 25  $\mu$ s at each end of the slot. For the PRACH preamble the measurement interval is 4096 chips less 25  $\mu$ s at each end of the burst (3904 chips).



When the UE uses 16QAM modulation on any of the uplink code channels in a carrier, the error minimization step also includes selecting an IQ origin offset besides selecting the frequency, absolute phase, absolute amplitude and chip clock timing to minimise the error vector. The IQ origin offset shall be removed from the evaluated signal before calculating the EVM; however, the removed relative IQ origin offset power (relative carrier leakage power) also has to satisfy the applicable requirement.

For signals containing more than one spreading code in a carrier where the slot alignment of the codes is not the same and the code power is varying, the period over which the nominal mean power in that carrier remains constant can be less than one timeslot. For such time-varying signals it is not possible to define EVM across one timeslot since this interval contains an expected change in mean power, and the exact timing and trajectory of the power change is not defined. For these signals, the EVM minimum requirements apply only for intervals of at least one half timeslot (less any 25µs transient periods) during which the nominal code power of each individual code is constant.

**NOTE:** The reason for setting a lower limit for the EVM measurement interval is that for any given impaired signal, the EVM would be expected to improve for measurement intervals less than one timeslot while the frequency error would be expected to degrade.

### 6.8.2.1 Minimum requirement

When 16QAM modulation is not used on any of the uplink code channels, the Error Vector Magnitude shall not exceed 17.5 % for the parameters specified in Table 6.15.

When 16QAM modulation is used on any of the uplink code channels, the modulation accuracy requirement shall meet one or both of the following requirements:

1. The Error Vector Magnitude does not exceed 14 % for the parameters specified in Table 6.15.
2. The Relative Code Domain Error requirements specified in 6.8.3a are met.

The requirements are applicable for all values of  $\beta_c$ ,  $\beta_d$ ,  $\beta_{hs}$ ,  $\beta_{ec}$  and  $\beta_{ed}$  as specified in [8].

**Table 6.15: Parameters for Error Vector Magnitude/Peak Code Domain Error**

Parameter		Unit	Level
UE Output Power, no 16QAM		dBm	≥ -20
UE Output Power, 16QAM		dBm	≥ -30
Operating conditions			Normal conditions
Power control step size		dB	1
Measurement period (Note 1)	PRACH	Chips	3904
	Any DPCH		From 1280 to 2560 (Note 2)
Note 1: Less any 25μs transient periods			
Note 2: The longest period over which the nominal power remains constant			

When 16QAM modulation is used on any of the uplink code channels, the relative carrier leakage power (IQ origin offset power) shall not exceed the values specified in Table 6.15a

**Table 6.15a: Relative Carrier Leakage Power**

UE Transmitted Mean Power	Relative Carrier Leakage Power (dB)
$P \geq -30$ dBm	$< -17$

### 6.8.2.1A Additional requirement for DC-HSUPA

When 16QAM modulation is not used on any of the uplink code channels in a carrier, the Error Vector Magnitude in that carrier shall not exceed 17.5 % for the parameters specified in Table 6.15AA.

When 16QAM modulation is used on any of the uplink code channels in a carrier, the modulation accuracy requirement shall meet one or both of the following requirements:

1. The Error Vector Magnitude does not exceed 14 % for the parameters specified in Table 6.15AA.



2. The Relative Code Domain Error requirements specified in 6.8.3a are met.

The requirements are applicable for all values of  $\beta_c$ ,  $\beta_{hs}$ ,  $\beta_{ec}$  and  $\beta_{ed}$  as specified in [8], when the total power in each of the assigned carriers is equal to each other. The reference measurement channels for the requirements in subclause 6.8.2.1A are provided in subclause A.2.6 and A.2.7.

**Table 6.15AA: Parameters for Error Vector Magnitude for DC-HSUPA**

Parameter	Unit	Level
UE Output Power, no 16QAM	dBm	$\geq -20$
UE Output Power, 16QAM	dBm	$\geq -30$
Operating conditions		Normal conditions
Power control step size	dB	1

#### 6.8.2.1B Additional requirement for UL OLTD

For UE with two active transmit antenna connectors in UL OLTD operation, the EVM requirements specified in subclause 6.8.2.1 except the requirement with PRACH apply at each transmit antenna connector.

#### 6.8.2.1C Additional requirement for UL CLTD

When 16QAM modulation is not used on any of the uplink code channels, the Error Vector Magnitude shall not exceed 17.5 % for the parameters specified in Table 6.15AB at each transmit antenna connector.

When 16QAM modulation is used on any of the uplink code channels, the modulation accuracy requirement shall meet one or both of the following requirements:

1. The Error Vector Magnitude does not exceed 14 % for the parameters specified in Table 6.15AB at each transmit antenna connector.
2. The Relative Code Domain Error requirements specified in 6.8.3a are met at each transmit antenna connector.

The requirements are applicable for all values of  $\beta_c$ ,  $\beta_{sc}$ ,  $\beta_d$ ,  $\beta_{hs}$ ,  $\beta_{ec}$  and  $\beta_{ed}$  as specified in [8].

**Table 6.15AB: Parameters for Error Vector Magnitude for UL CLTD**

Parameter		Unit	Level
UE Output Power, no 16QAM		dBm	$\geq -20$
UE Output Power, 16QAM		dBm	$\geq -30$
Operating conditions			Normal conditions
Power control step size		dB	1
Measurement period (Note 1)	Any DPCH	Chips	From 1280 to 2560 (Note 2)
Note 1: Less any 25 $\mu$ s transient periods			
Note 2: The longest period over which the nominal power remains constant			

When 16QAM modulation is used on any of the uplink code channels, the relative carrier leakage power (IQ origin offset power) shall not exceed the values specified in Table 6.15a at each transmit antenna connector

#### 6.8.2.1D Additional requirement for UL MIMO

When 16QAM modulation is not used on any of the uplink code channels, the Error Vector Magnitude shall not exceed 17.5 % for the parameters specified in Table 6.15AC at each transmit antenna connector.

When 16QAM modulation is used on any of the uplink code channels, the modulation accuracy requirement shall meet one or both of the following requirements:

1. The Error Vector Magnitude does not exceed 14 % for the parameters specified in Table 6.15AC.
2. The Relative Code Domain Error requirements specified in 6.8.3a are met.



The requirements are applicable for all values of  $\beta_c$ ,  $\beta_{sc}$ ,  $\beta_{hs}$ ,  $\beta_{ec}$ ,  $\beta_{sec}$ ,  $\beta_{ed}$  and  $\beta_{sed}$  as specified in [8].

**Table 6.15AC: Parameters for Error Vector Magnitude for UL MIMO**

Parameter	Unit	Level
UE Output Power, no 16QAM	dBm	$\geq -20$
UE Output Power, 16QAM	dBm	$\geq -30$
Operating conditions		Normal conditions
Power control step size	dB	1

When 16QAM modulation is used on any of the uplink code channels, the relative carrier leakage power (IQ origin offset power) shall not exceed the values specified in Table 6.15a at each transmit antenna connector.

### 6.8.3 Peak code domain error

The Peak Code Domain Error is computed by projecting power of the error vector (as defined in 6.8.2) onto the code domain at a specific spreading factor. The Code Domain Error for every code in the domain is defined as the ratio of the mean power of the projection onto that code, to the mean power of the composite reference waveform. This ratio is expressed in dB. The Peak Code Domain Error is defined as the maximum value for the Code Domain Error for all codes. The measurement interval is one timeslot except when the mean power between slots is expected to change whereupon the measurement interval is reduced by 25  $\mu$ s at each end of the slot.

The requirement for peak code domain error is only applicable for multi-code DPDCH transmission and therefore does not apply for the PRACH preamble and message parts.

#### 6.8.3.1 Minimum requirement

The peak code domain error shall not exceed -15 dB at spreading factor 4 for the parameters specified in Table 6.15. The requirements are defined using the UL reference measurement channel specified in subclause A.2.5.

##### 6.8.3.1A Additional requirement for UL OLTD

For UE with two active transmit antenna connectors in UL OLTD operation, the Peak code domain error requirements specified in sub-clause 6.8.3.1 apply at each transmit antenna connector.

##### 6.8.3.1B Additional requirement for UL CLTD

For UE with two active transmit antenna connectors in UL CLTD activation state 1, the peak code domain error shall not exceed -15 dB at spreading factor 4 for the parameters specified in Table 6.15. The requirements are defined using the UL reference measurement channel specified in subclause A.2.5A.

For UE configured in UL CLTD activation state 2 or activation state 3, the Peak code domain error requirements specified in sub-clause 6.8.3.1 apply at the active transmit antenna connector.

### 6.8.3a Relative code domain error

#### 6.8.3a.1 Relative Code Domain Error

The Relative Code Domain Error is computed by projecting the error vector (as defined in 6.8.2) onto the code domain. Only the code channels with non-zero betas in the composite reference waveform are considered for this requirement. The Relative Code Domain Error for every non-zero beta code in the domain is defined as the ratio of the mean power of the projection onto that non-zero beta code, to the mean power of the non-zero beta code in the composite reference waveform. This ratio is expressed in dB. The measurement interval is one timeslot except when the mean power between slots is expected to change whereupon the measurement interval is reduced by 25  $\mu$ s at each end of the slot.

In the mode of DC-HSUPA, the requirement and corresponding measurements apply to each individual carrier when the total power in each of the assigned carriers is equal to each other.



The Relative Code Domain Error is affected by both the spreading factor and beta value of the various code channels in the domain. The Effective Code Domain Power (ECDP) is defined to capture both considerations into one parameter. It uses the Nominal CDP ratio (as defined in 6.2.3), and is defined as follows for each used code,  $k$ , in the domain:

$$ECDP_k = (\text{Nominal CDP ratio})_k + 10 \cdot \log_{10}(SF_k/256)$$

When 16QAM is not used on any of the UL code channels in a carrier, the requirements for Relative Code Domain Error are not applicable when either or both the following channel combinations occur:

- when the ECDP of any code channel is  $< -30\text{dB}$
- when the nominal code domain power of any code channel is  $< -20\text{ dB}$

When 16QAM is used on any of the UL code channels in a carrier, the requirements for Relative Code Domain Error are not applicable when either or both the following channel combinations occur:

- when the ECDP of any code channel is  $< -30\text{dB}$
- when the nominal code domain power of any code channel is  $< -30\text{ dB}$

The requirement for Relative Code Domain Error also does not apply for the PRACH preamble and message parts.

#### 6.8.3a.1.1 Minimum requirement

When 16QAM is not used on any of the UL code channels, the Relative Code Domain Error shall meet the requirements in Table 6.15B for the parameters specified in Table 6.15

**Table 6.15B: Relative Code Domain Error minimum requirement**

ECDP dB	Relative Code Domain Error dB
$-21 < ECDP$	$\leq -16$
$-30 \leq ECDP \leq -21$	$\leq -37 - ECDP$
$ECDP < -30$	No requirement

When 16QAM is used on any of the UL code channels, the Relative Code Domain Error of the codes not using 16QAM shall meet the requirements in Table 6.15C for the parameters specified in Table 6.15.

**Table 6.15C: Relative Code Domain Error minimum requirement**

ECDP dB	Relative Code Domain Error dB
$-22 < ECDP$	$\leq -18$
$-30 \leq ECDP \leq -22$	$\leq -40 - ECDP$
$ECDP < -30$	No requirement

When 16QAM is used on any of the UL code channels, the Nominal CDP Ratio-weighted average of the Relative Code Domain Errors measured individually on each of the codes using 16QAM shall meet the requirements in Table 6.15D for the parameters specified in Table 6.15. The Nominal CDP Ratio-weighted average of the Relative Code Domain Errors means the sum  $\sum_k 10^{(\text{Nominal CDP ratio})_k / 10} \cdot 10^{(\text{Relative Code Domain Error})_k / 10}$  over all code  $k$  that uses 16QAM.

For the purposes of evaluating the requirements specified in Table 6.15D, the ECDP value is determined as the minimum of the individual ECDP values corresponding to the codes using 16QAM.

**Table 6.15D: Relative Code Domain Error minimum requirement**

ECDP dB	Average Relative Code Domain Error dB
$-25.5 < ECDP$	$\leq -18$
$-30 \leq ECDP \leq -25.5$	$\leq -43.5 - ECDP$
$ECDP < -30$	No requirement



### 6.8.3a.1.1a Additional requirement for DC-HSUPA

When 16QAM is not used on any of the UL code channels in a carrier, the Relative Code Domain Error in that carrier shall meet the requirements in Table 6.15B for the parameters specified in Table 6.15AA.

When 16QAM is used on any of the UL code channels in a carrier, the Relative Code Domain Error of the codes not using 16QAM in that carrier shall meet the requirements in Table 6.15C for the parameters specified in Table 6.15AA.

When 16QAM is used on any of the UL code channels in a carrier, the Nominal CDP Ratio-weighted average of the Relative Code Domain Errors measured individually on each of the codes using 16QAM in that carrier shall meet the requirements in Table 6.15D for the parameters specified in Table 6.15AA.

For the purposes of evaluating the requirements specified in Table 6.15D, the ECDP value is determined as the minimum of the individual ECDP values corresponding to the codes using 16QAM.

The reference measurement channels for the requirements in subclause 6.8.3a.1.1a are provided in subclause A.2.6 and A.2.7.

### 6.8.3a.1.1b Additional requirement for UL OLTD

For UE with two active transmit antenna connectors in UL OLTD operation, the relative code domain error requirements specified in sub-clause 6.8.3a.1.1 apply at each transmit antenna connector.

### 6.8.3a.1.1c Additional requirement for UL CLTD

For UE with two active transmit antenna connectors in UL CLTD activation state 1, the relative code domain error requirements specified in sub-clause 6.8.3a.1.1 apply at each transmit antenna connector.

For UE configured in UL CLTD activation state 2 or activation state 3, the relative code domain error requirements specified in sub-clause 6.8.3a.1.1 apply at the active transmit antenna connector.

### 6.8.3a.1.1d Additional requirement for UL MIMO

For UE with two active transmit antenna connectors in UL MIMO operation, the relative code domain error requirements specified in sub-clause 6.8.3a.1.1 apply at each transmit antenna connector.

## 6.8.3b In-band emission for DC-HSUPA

The in-band emission is measured as the ratio of the UE output power in one carrier in dual cells to the UE output power in the other carrier, where the power in the former carrier shall be set to the minimum output power and the power in the latter carrier to the maximum output power. The reference measurement channel for the requirements in subclause 6.8.3b.1 is provided in subclause A.2.6 with an adjusted power imbalance to set the power in one carrier to the minimum output power and the power in the other carrier to the maximum output power. The basic in-band emission measurement interval is defined over one slot in the time domain.

### 6.8.3b.1 Minimum requirement for DC-HSUPA

The in-band emission shall not exceed the value specified in Table 6.15E.

**Table 6.15E: In-band emission minimum requirements for DC-HSUPA**

Parameter Description	Unit	Limit
<b>In-band emission</b>	<b>dBc</b>	<b>-24</b>
Note : The measurement bandwidth is 3.84 MHz centered on each carrier frequency and the limit is expressed as a ratio of RRC filtered mean power in one carrier, transmitting at minimum output power, to the RRC filtered mean power in the other carrier, transmitting at maximum output power.		



## 6.8.4 Phase discontinuity for uplink DPCH

Phase discontinuity is the change in phase between any two adjacent timeslots. The EVM for each timeslot (excluding the transient periods of 25  $\mu$ s on either side of the nominal timeslot boundaries), shall be measured according to subclause 6.8.2. The frequency, absolute phase, absolute amplitude and chip clock timing used to minimise the error vector are chosen independently for each timeslot. The phase discontinuity result is defined as the difference between the absolute phase used to calculate EVM for the preceding timeslot, and the absolute phase used to calculate EVM for the succeeding timeslot.

### 6.8.4.1 Minimum requirement

The rate of occurrence of any phase discontinuity on an uplink DPCH for the parameters specified in table 6.16 shall not exceed the values specified in table 6.17. Phase shifts that are caused by changes of the UL transport format combination (TFC), compressed mode and HS-DPCCH are not included. When calculating the phase discontinuity, the requirements for frequency error and EVM in subclauses 6.3 and 6.8.2 for each timeslot shall be met.

**Table 6.16: Parameters for Phase discontinuity**

Parameter	Unit	Level
Power control step size	dB	1

**Table 6.17: Phase discontinuity minimum requirement**

Phase discontinuity $\Delta\theta$ in degrees	Maximum allowed rate of occurrence in Hz
$\Delta\theta \leq 30$	1500
$30 < \Delta\theta \leq 60$	300
$\Delta\theta > 60$	0

#### 6.8.4.1A Additional requirement for UL OLTD

For UE with two transmit antenna connectors in UL OLTD operation, the rate of occurrence of any phase discontinuity on an uplink DPCH for the parameters specified in table 6.16 shall not exceed the values specified in table 6.17 for each transmit antenna connector. In addition, the relative phase applied to the two transmit paths shall be fixed during the phase discontinuity test. Phase shifts that are caused by changes of the UL transport format combination (TFC), compressed mode and HS-DPCCH are not included. When calculating the phase discontinuity, the requirements for frequency error and EVM in subclauses 6.3B and 6.8.2 for each timeslot shall be met.

#### 6.8.4.1B Additional requirement for UL CLTD

For UE with two active transmit antenna connectors in UL CLTD activation state 1, the rate of occurrence of any phase discontinuity on an uplink DPCH for the parameters specified in table 6.16 shall not exceed the values specified in table 6.17 for each transmit antenna connector. In addition, TPI applied to the two transmit paths shall be fixed during the phase discontinuity test. Phase shifts that are caused by changes of the UL transport format combination (TFC), compressed mode and HS-DPCCH are not included. When calculating the phase discontinuity, the requirements for frequency error and EVM in subclauses 6.3C and 6.8.2 for each timeslot shall be met.

For UE configured in UL CLTD activation state 2 or activation state 3, the phase discontinuity for Uplink DPCH specified in sub-clause 6.8.4.1 applies at the active transmit antenna connector.

## 6.8.5 Phase discontinuity for HS-DPCCH

Phase discontinuity for HS-DPCCH is the change in phase due to the transmission of the HS-DPCCH. In the case where the HS-DPCCH timeslot is offset from the DPCH timeslot, the period of evaluation of the phase discontinuity shall be the DPCH timeslot that contains the HS-DPCCH slot boundary. The phase discontinuity for HS-DPCCH result is defined as the difference between the absolute phase used to calculate the EVM for that part of the DPCH timeslot prior to the HS-DPCCH slot boundary, and the absolute phase used to calculate the EVM for remaining part of the DPCH timeslot following the HS-DPCCH slot boundary. In all cases the subslot EVM is measured excluding the transient periods of 25  $\mu$ s.



Since subslot EVM is only defined for intervals of at least one half timeslot, the phase discontinuity for HS-DPCCH is only defined for non-aligned timeslots when the offset is 0.5 slots.

6.8.5.1 Minimum requirement

The phase discontinuity for HS-DPCCH shall not exceed the value specified in table 6.18 90% of the time. When calculating the phase discontinuity, the requirements for frequency error and EVM in sub clauses 6.3 and 6.8.2, respectively shall be met.

Table 6.18: Phase discontinuity minimum requirement for HS-DPCCH at HS-DPCCH slot boundary

Phase discontinuity for HS-DPCCH $\Delta\theta$ in degrees	$\Delta\theta \leq 30$
--	------------------------

6.8.5.1A Additional requirement for UL OLTD

For UE with two transmit antenna connectors in UL OLTD operation, the phase discontinuity for HS-DPCCH shall not exceed the value specified in table 6.18 90% of the time for each transmit antenna connector. In addition, the relative phase applied to the two transmit paths shall be fixed during the phase discontinuity test. When calculating the phase discontinuity, the requirements for frequency error and EVM in sub clauses 6.3B and 6.8.2, respectively shall be met.

6.8.5.1B Additional requirement for UL CLTD

For UE with two active transmit antenna connectors in UL CLTD activation state 1, the phase discontinuity for HS-DPCCH shall not exceed the value specified in table 6.18 90% of the time for each transmit antenna connector. In addition, TPI applied to the two transmit paths shall be fixed during the phase discontinuity test. When calculating the phase discontinuity, the requirements for frequency error and EVM in sub clauses 6.3C and 6.8.2, respectively shall be met.

For UE configured in UL CLTD activation state 2 or activation state 3, the phase discontinuity for HS-DPCCH specified in sub-clause 6.8.5.1 applies at the active transmit antenna connector.

6.8.6 Phase discontinuity for E-DCH

Phase discontinuity for E-DCH is the change in phase due to the transmission of DPCCH, HS-DPCCH, E-DPCCH and E-DCH with the combined transmit power profile as defined in Table 6.19. The phase discontinuity for E-DCH result is defined as the difference between the absolute phase used to calculate the EVM for the preceding timeslot, and the absolute phase used to calculate the EVM for the succeeding timeslot.



**Table 6.19 Transmit power profile for E-DCH phase discontinuity test**

Slot Number	$\left(\frac{\beta_{ec}}{\beta_c}\right)$	$\left(\frac{\beta_{ed}}{\beta_c}\right)$	$\left(\frac{\beta_{hs}}{\beta_c}\right)$
1	19/15	21/15	DTX
2	19/15	21/15	24/15
3	19/15	21/15	24/15
4	19/15	42/15	30/15
5	19/15	42/15	DTX
6	19/15	42/15	DTX
7	19/15	60/15	DTX
8	19/15	60/15	24/15
9	19/15	60/15	24/15
10	19/15	30/15	DTX
11	19/15	30/15	DTX
12	19/15	30/15	DTX
13	19/15	21/15	30/15
14	19/15	21/15	24/15
15	19/15	21/15	24/15
16	19/15	30/15	DTX
17	19/15	30/15	DTX
18	19/15	30/15	DTX
19	19/15	21/15	
20	19/15	21/15	
21	19/15	21/15	
22	19/15	42/15	
23	19/15	42/15	
24	19/15	42/15	
Note 1: E-DCH power profile has a period of 24 slots and will be repeated every 24 slots. Note 2: HS-DPCCH power profile has a period of 18 slots and will be repeated every 18 slots. Note 3: The total combined power profile has a period of 72 slots and will be repeated every 72 slots. Note 4: Power control will be turned off so that DPCCH power is kept constant for a specific run of the test.			

### 6.8.6.1 Minimum requirement

When transmitting according to the power profile specified in Table 6.19, the phase discontinuity for E-DCH shall not exceed the value specified in table 6.20 for the specified amount of time in table 6.20. The requirement applies for the range of DPCCH powers according to table 6.20. When calculating the phase discontinuity, the requirements for frequency error and EVM in sub clauses 6.3 and 6.8.2, respectively shall be met.

**Table 6.20: Phase discontinuity minimum requirement for E-DCH**

Phase discontinuity $\Delta\theta$ in degrees	Minimum allowed time in percentage	DPCCH power in dBm
$\Delta\theta \leq 15$	80	$-15 \leq \text{DPCCH power} \leq (P_{\max} - 20)$
$\Delta\theta \leq 35$	90	
$\Delta\theta \leq 45$	100	

### 6.8.6.1A Additional requirement for UL OLTD

For UE with two transmit antenna connectors in UL OLTD operation, when transmitting according to the power profile specified in Table 6.19, the phase discontinuity for E-DCH shall not exceed the value specified in table 6.20 for the specified amount of time in table 6.20 for each transmit antenna connector. The requirement applies for the range of DPCCH powers according to table 6.20. In addition, the relative phase applied to the two transmit paths shall be fixed



during the phase discontinuity test. When calculating the phase discontinuity, the requirements for frequency error and EVM in sub clauses 6.3B and 6.8.2, respectively shall be met.

#### 6.8.6.1B Additional requirement for UL CLTD

For UE configured in UL CLTD activation state 2 or activation state 3, the phase discontinuity for E-DCH specified in sub-clause 6.8.6.1 applies at the active transmit antenna connector.

### 6.8.7 Time alignment error for DC-HSUPA

In DC-HSUPA transmission, signals are transmitted for dual cells. These signals shall be aligned. The time alignment error in DC-HSUPA transmission is specified as the delay between the signals from primary and secondary uplink frequencies at the antenna port.

#### 6.8.7.1 Minimum requirement

The time alignment error shall not exceed  $\frac{3}{4} T_c$ .

### 6.8.7A Time alignment error for UL OLTD

For UE with two active transmit antenna connectors in UL OLTD operation, the signals transmitted in the two antenna connectors shall be aligned. The time alignment error in UL OLTD operation transmission is specified as the delay between the signals from two antenna connectors.

#### 6.8.7A.1 Minimum requirement

The time alignment error shall not exceed  $0.4T_c$ .

### 6.8.7B Time alignment error for UL CLTD

For UE with two active transmit antenna connectors in UL CLTD activation state 1, the signals transmitted in the two antenna connectors shall be aligned. The time alignment error in UL CLTD activation state 1 transmission is specified as the delay between the signals from two antenna connectors.

#### 6.8.7B.1 Minimum requirement

The time alignment error shall not exceed  $0.4T_c$ .

### 6.8.7C Time alignment error for UL MIMO

For UE with two active transmit antenna connectors in UL MIMO operation, the signals transmitted in the two antenna connectors shall be aligned. The time alignment error in UL MIMO transmission is specified as the delay between the signals from two antenna connectors.

#### 6.8.7C.1 Minimum requirement

The time alignment error shall not exceed  $0.4T_c$ .

---

## 7 Receiver characteristics

### 7.1 General

Unless otherwise stated the receiver characteristics are specified at the antenna connector of the UE. For UE(s) with an integral antenna only, a reference antenna with a gain of 0 dBi is assumed. UE with an integral antenna may be taken into account by converting these power levels into field strength requirements, assuming a 0 dBi gain antenna. For UEs



with more than one receiver antenna connector the AWGN signals applied to each receiver antenna connector shall be uncorrelated. The levels of the test signal applied to each of the antenna connectors shall be as defined in the respective sections below.

The UE antenna performance has a significant impact on system performance, and minimum requirements on the antenna efficiency are therefore intended to be included in future versions of the present document. It is recognised that different requirements and test methods are likely to be required for the different types of UE.

UEs supporting DC-HSDPA, regardless of MIMO configuration, shall support both minimum requirements, as well as additional requirements for DC-HSDPA.

UEs supporting DB-DC-HSDPA shall support both minimum requirements as well as additional requirements for DB-DC-HSDPA.

UEs supporting DC-HSUPA shall support both minimum requirements, as well as additional requirements for DC-HSUPA.

UEs supporting single band 4C-HSDPA shall support minimum requirements, additional requirements for DC-HSDPA as well as additional requirements for single band 4C-HSDPA.

UEs supporting dual band 4C-HSDPA shall support minimum requirements, additional requirements for DC-HSDPA, additional requirements for DB-DC-HSDPA as well as additional requirements for dual band 4C-HSDPA.

UEs supporting single band 8C-HSDPA shall support minimum requirements, additional requirements for DC-HSDPA and single band 4C-HSDPA as well as additional requirements for single band 8C-HSDPA.

UEs supporting single band NC-4C-HSDPA shall support minimum requirements, additional requirements for DC-HSDPA as well as additional requirements for NC-4C-HSDPA.

For minimum requirements, all the parameters in clause 7 are defined using the DL reference measurement channel (12.2 kbps) specified in subclause A.3.1 and unless otherwise stated with DL power control OFF.

For the additional requirements for DC-HSDPA, DB-DC-HSDPA, DC-HSUPA, single band/dual band 4C-HSDPA or single band 8C-HSDPA or single band NC-4C-HSDPA, all the parameters in clause 7 are defined using the DL reference measurement channel H-Set 12, specified in subclause A.7.1.12 and the downlink physical channel setup according to table C.12C.

For the additional requirements for DC-HSDPA, the spacing of the carrier frequencies of the two cells in downlink shall be 5 MHz, and it is assumed that the UE is configured with a single uplink carrier frequency.

For the additional requirements for DC-HSUPA, the spacing of the carrier frequencies of the two cells in both downlink and uplink shall be 5 MHz.

For the additional requirements for single band/dual band 4C-HSDPA or single band NC-4C-HSDPA, the spacing of the adjacent carrier frequencies in downlink and uplink shall be 5 MHz.

For the additional requirements for single 8C-HSDPA, the spacing of the adjacent carrier frequencies in downlink and uplink shall be 5 MHz.

For each single band/dual band 4C-HSDPA and single band 8C-HSDPA or single band NC-4C-HSDPA configuration, the UL-DL carrier separation is defined as minimum (maximum) when the UL carrier is placed at minimum (maximum) possible distance in frequency from the closest carrier in the corresponding DL band for which the requirement applies.

The requirements specified in Section 7 in general could be different for each single band/dual band 4C-HSDPA or single band NC-4C-HSDPA configuration within the same operating band(s).

For the additional requirements for single band NC-4C-HSDPA, in-gap test refers to the case when the interfering signal is located at a positive offset with respect to the assigned channel frequency of the highest carrier frequency of the left end subblock; or located at a negative offset with respect to the assigned channel frequency of the lowest carrier frequency of the right end subblock.

For the additional requirements for single band NC-4C-HSDPA out-of-gap test refers to the case when the interfering signal(s) is (are) located at a positive offset with respect to the assigned channel frequency of the highest carrier frequency, or located at a negative offset with respect to the assigned channel frequency of the lowest carrier frequency.



For the additional requirements for single band NC-4C-HSDPA, existing blocking characteristics requirements shall be supported for in-gap tests only if the gap length satisfies the following condition so that the interferer position does not change the nature of the core requirement tested:

$$\text{Gap length} \geq 2 * \text{Interferer frequency offset} - 5\text{MHz}$$

## 7.2 Diversity characteristics

A suitable receiver structure using coherent reception in both channel impulse response estimation and code tracking procedures is assumed. Three forms of diversity are considered to be available in UTRA/FDD.

**Table 7.1: Diversity characteristics for UTRA/FDD**

Time diversity	Channel coding and interleaving in both up link and down link
Multi-path diversity	Rake receiver or other suitable receiver structure with maximum combining. Additional processing elements can increase the delay-spread performance due to increased capture of signal energy.
Antenna diversity	Antenna diversity with maximum ratio combining in the Node B and optionally in the UE. Possibility for downlink transmit diversity in the Node B.

## 7.3 Reference sensitivity level

The reference sensitivity level <REFSENS> is the minimum mean power received at the UE antenna port at which the specified minimum requirement shall be met.

### 7.3.1 Minimum requirement

The BER shall not exceed 0.001 for the parameters specified in Table 7.2.



**Table 7.2: Test parameters for reference sensitivity, minimum requirement.**

Operating Band	Unit	DPCH_Ec <REFSENS>	<REF <sub>Ior</sub> >
I	dBm/3.84 MHz	-117	-106.7
II	dBm/3.84 MHz	-115	-104.7
III	dBm/3.84 MHz	-114	-103.7
IV	dBm/3.84 MHz	-117	-106.7
V	dBm/3.84 MHz	-115	-104.7
VI	dBm/3.84 MHz	-117	-106.7
VII	dBm/3.84 MHz	-115	-104.7
VIII	dBm/3.84 MHz	-114	-103.7
IX	dBm/3.84 MHz	-116	-105.7
X	dBm/3.84 MHz	-117	-106.7
XI	dBm/3.84 MHz	-117	-106.7
XII	dBm/3.84 MHz	-114	-103.7
XIII	dBm/3.84 MHz	-114	-103.7
XIV	dBm/3.84 MHz	-114	-103.7
XIX	dBm/3.84 MHz	-117	-106.7
XX	dBm/3.84 MHz	-114	-103.7
XXI	dBm/3.84 MHz	-117	-106.7
XXII	dBm/3.84 MHz	-114	-103.7
XXV	dBm/3.84 MHz	-113.5	-103.2
XXVI	dBm/3.84 MHz	-113.5	-103.2
NOTE 1 For Power class 3 and 3bis this shall be at the maximum output power			
NOTE 2 For Power class 4 this shall be at the maximum output power			
NOTE 3 For the UE which supports both Band III and Band IX operating frequencies, the reference sensitivity level of -114.5 dBm DPCH_Ec <REFSENS> shall apply for Band IX. The corresponding <REF <sub>Ior</sub> > is -104.2 dBm			
NOTE 4 For the UE which supports both Band XI and Band XXI operating frequencies, the reference sensitivity level is FFS.			
NOTE 5 For the UE which supports both Band V and Band XXVI operating frequencies, the reference sensitivity level of -115 dBm DPCH_Ec <REFSENS> shall apply for Band XXVI when the carrier frequency of the assigned UTRA channel is within 869-894 MHz. The corresponding <REF <sub>Ior</sub> > is -104.7 dBm.			

For the UE which supports DB-DC-HSDPA configuration in Table 7.2aA, the reference sensitivity level DPCH\_Ec <REFSENS> and corresponding <REF<sub>Ior</sub>> in Table 7.2 are allowed to be increased by the amount given in Table 7.2aA for the applicable bands.

**Table 7.2aA: Allowed de-sensitization relative to reference sensitivity for UE which supports DB-DC-HSDPA.**

DB-DC-HSDPA Configuration	Allowed de-sensitization (dB)	Applicable bands
2	1	II, IV
4	1	I, XI

For the UE which supports dual band 4C-HSDPA configuration in Table 7.2aB, the reference sensitivity level DPCH\_Ec <REFSENS> and corresponding <REF<sub>Ior</sub>> in Table 7.2 are allowed to be increased by the amount given in Table 7.2aB for the applicable bands.

**Table 7.2aB: Allowed de-sensitization relative to reference sensitivity for UE which supports dual band 4C-HSDPA.**

Dual Band 4C-HSDPA Configuration	Allowed de-sensitization (dB)	Applicable bands
II-1-IV-2 II-2-IV-1 II-2-IV-2	1	II, IV

For the UE which supports E-UTRA inter-band carrier aggregation the reference sensitivity level DPCH\_Ec <REFSENS> and corresponding <REF<sub>Ior</sub>> in Table 7.2 are allowed to be increased by the amount given in Table 7.3.1-



1A of TS 36.101[11] for those UTRA operating bands corresponding to the E-UTRA operating bands that belong to the supported inter-band carrier aggregation configurations. The tolerance in Table 7.3.1-1A of TS 36.101[11] does not apply to supported UTRA operating bands with frequency range below 1 GHz that correspond to the E-UTRA operating bands that belong to the supported inter-band carrier aggregation configurations when such bands are belonging only to band combination(s) where one band is <1GHz and another band is >1.7GHz and there is no harmonic relationship between the low band UL and high band DL.

In case the UE supports DB-DC-HSDPA or dual band 4C-HSDPA configurations and one or more of the E-UTRA inter-band carrier aggregation configurations listed in Table 7.3.1-1A of TS36.101[11] with a UTRA operating band that belongs to UTRA and E-UTRA carrier aggregation configurations, then

- When the UTRA operating band frequency range is  $\leq 1$ GHz, the applicable additional tolerance shall be the average of the applicable tolerances, truncated to one decimal place for that operating band among the supported DB-DC-HSDPA, dual band 4C-HSDPA, and E-UTRA CA configurations, with the DB-DC-HSDPA, dual carrier 4C-HSDPA, and E-UTRA CA configurations counted separately. In case there is a harmonic relation between low band UL and high band DL, then the maximum tolerance among the different supported carrier aggregation configurations involving such band shall be applied
- When the UTRA operating band frequency range is >1GHz, the applicable additional tolerance shall be the maximum tolerance that applies for that operating band among the supported DB-DC-HSDPA, dual band HSDPA, and E-UTRA CA configurations.

### 7.3.2 Additional requirement for DC-HSDPA

The BLER measured on each individual cell shall not exceed 0.1 for the parameters specified in Table 7.2A.

Note: The reference sensitivity level <REFSENS> requirement for DC-HSDPA is not applicable for dual uplink operation. However, there might be a substantial Rx de-sensitization for the UE operating in bands which have less than 80 MHz Tx-Rx frequency separation, transmitting on more than one uplink frequency, at maximum power.



**Table 7.2A: Test parameters for reference sensitivity, additional requirement for DC-HSDPA.**

Operating Band	Unit	HS-PDSCH_Ec <REFSENS>	<REF <sub>or</sub> >
I	dBm/3.84 MHz	-113	-102.7
II	dBm/3.84 MHz	-111	-100.7
III	dBm/3.84 MHz	-110	-99.7
IV	dBm/3.84 MHz	-113	-102.7
V	dBm/3.84 MHz	-111	-100.7
VI	dBm/3.84 MHz	-113	-102.7
VII	dBm/3.84 MHz	-111	-100.7
VIII	dBm/3.84 MHz	-110	-99.7
IX	dBm/3.84 MHz	-112	-101.7
X	dBm/3.84 MHz	-113	-102.7
XI	dBm/3.84 MHz	-113	-102.7
XII	dBm/3.84 MHz	-110	-99.7
XIII	dBm/3.84 MHz	-110	-99.7
XIV	dBm/3.84 MHz	-110	-99.7
XIX	dBm/3.84 MHz	-113	-102.7
XX	dBm/3.84 MHz	-110	-99.7
XXI	dBm/3.84 MHz	-113	-102.7
XXII	dBm/3.84 MHz	-110	-99.7
XXV	dBm/3.84 MHz	-109.5	-99.2
XXVI	dBm/3.84 MHz	-109.5	-99.2
NOTE 1 For Power class 3 and 3bis this shall be at the maximum output power NOTE 2 For Power class 4 this shall be at the maximum output power NOTE 3 For the UE which supports both Band III and Band IX operating frequencies, the reference sensitivity level of -110.5 dBm HS-PDSCH_Ec <REFSENS> shall apply for Band IX. The corresponding <REF <sub>or</sub> > is -100.2 dBm NOTE 4 For the UE which supports both Band XI and Band XXI operating frequencies, the reference sensitivity level is FFS. NOTE 5 For the UE which supports both Band V and Band XXVI operating frequencies, the reference sensitivity level of -111 dBm HS-PDSCH_Ec <REFSENS> shall apply for Band XXVI when any of the carrier frequencies of the assigned UTRA channel is within 869-894 MHz. The corresponding <REF <sub>or</sub> > is -100.7 dBm.			

For the UE which supports DB-DC-HSDPA configuration in Table 7.2AA, the reference sensitivity level HS-PDSCH\_Ec <REFSENS> and corresponding <REF<sub>or</sub>> in Table 7.2A are allowed to be increased by the amount given in Table 7.2AA for the applicable bands.

**Table 7.2AA: Allowed de-sensitization relative to reference sensitivity for UE which supports DB-DC-HSDPA.**

DB-DC-HSDPA Configuration	Allowed de-sensitization (dB)	Applicable bands
2	1	II, IV
4	1	I, XI

For the UE which supports dual band 4C-HSDPA configuration in Table 7.2AB, the reference sensitivity level HS-PDSCH\_Ec <REFSENS> and corresponding <REF<sub>or</sub>> in Table 7.2A are allowed to be increased by the amount given in Table 7.2AB for the applicable bands.

**Table 7.2AB: Allowed de-sensitization relative to reference sensitivity for UE which supports dual band 4C-HSDPA.**

Dual Band 4C-HSDPA Configuration	Allowed de-sensitization (dB)	Applicable bands
II-1-IV-2 II-2-IV-1 II-2-IV-2	1	II, IV



For the UE which supports E-UTRA inter-band carrier aggregation the reference sensitivity level HS-PDSCH\_Ec <REFSENS> and corresponding <REF<sub>or</sub>> in Table 7.2A are allowed to be increased by the amount given in Table 7.3.1-1A of TS 36.101[11] for those UTRA operating bands corresponding to the E-UTRA operating bands that belong to the supported inter-band carrier aggregation configurations. The tolerance in Table 7.3.1-1A of TS 36.101[11] does not apply to supported UTRA operating bands with frequency range below 1 GHz that correspond to the E-UTRA operating bands that belong to the supported inter-band carrier aggregation configurations when such bands are belonging only to band combination(s) where one band is <1GHz and another band is >1.7GHz and there is no harmonic relationship between the low band UL and high band DL.

In case the UE supports DB-DC-HSDPA or dual band 4C-HSDPA configurations and one or more of the E-UTRA inter-band carrier aggregation configurations listed in Table 7.3.1-1A of TS36.101[11] with a UTRA operating band that belongs to UTRA and E-UTRA carrier aggregation configurations, then

- When the UTRA operating band frequency range is  $\leq 1$ GHz, the applicable additional tolerance shall be the average of the applicable tolerances, truncated to one decimal place for that operating band among the supported DB-DC-HSDPA, dual band 4C-HSDPA, and E-UTRA CA configurations, with the DB-DC-HSDPA, dual carrier 4C-HSDPA, and E-UTRA CA configurations counted separately. In case there is a harmonic relation between low band UL and high band DL, then the maximum tolerance among the different supported carrier aggregation configurations involving such band shall be applied
- When the UTRA operating band frequency range is  $>1$ GHz, the applicable additional tolerance shall be the maximum tolerance that applies for that operating band among the supported DB-DC-HSDPA, dual band 4C-HSDPA, and E-UTRA CA configurations.

### 7.3.3 Additional requirement for DB-DC-HSDPA

For all requirements listed in Table 7.2.B, corresponding to the specific DB-DC-HSDPA configuration(s) supported by the UE, (see Table 5.0aA), the BLER measured on each individual cell shall not exceed 0.1.

**Table 7.2B: Test parameters for reference sensitivity, additional requirement for DB-DC-HSDPA.**

DB-DC-HSDPA configuration	DL Band	UL Band	Unit	HS-PDSCH_Ec <REFSENS>	<REF <sub>or</sub> >
1	I	I	dBm/3.84 MHz	-113	-102.7
	VIII		dBm/3.84 MHz	-110	-99.7
	I	VIII	dBm/3.84 MHz	-113	-102.7
	VIII		dBm/3.84 MHz	-110	-99.7
2	II	II	dBm/3.84 MHz	-110	-99.7
	IV		dBm/3.84 MHz	-112	-101.7
	II	IV	dBm/3.84 MHz	-110	-99.7
	IV		dBm/3.84 MHz	-112	-101.7
3	I	I	dBm/3.84 MHz	-113	-102.7
	V		dBm/3.84 MHz	-111	-100.7
	I	V	dBm/3.84 MHz	-113	-102.7
	V		dBm/3.84 MHz	-111	-100.7
4	I	I	dBm/3.84 MHz	-112	-101.7
	XI		dBm/3.84 MHz	-112	-101.7
	I	XI	dBm/3.84 MHz	-112	-101.7
	XI		dBm/3.84 MHz	-112	-101.7
5	II	II	dBm/3.84 MHz	-111	-100.7
	V		dBm/3.84 MHz	-111	-100.7
	II	V	dBm/3.84 MHz	-111	-100.7
	V		dBm/3.84 MHz	-111	-100.7
6	I	I	dBm/3.84 MHz	-113	-102.7
	XXXII		dBm/3.84 MHz	-113	-102.7
NOTE 1 For Power class 3 and 3bis this shall be at the maximum output power					
NOTE 2 For Power class 4 this shall be at the maximum output power					



### 7.3.4 Additional requirement for single band 4C-HSDPA

For all requirements listed in Table 7.2C, corresponding to the specific single band 4C-HSDPA configuration(s) supported by the UE, (see Table 5.0aB), the BLER measured on each individual cell shall not exceed 0.1.

Note: The reference sensitivity level  $\langle \text{REFSENS} \rangle$  requirement for single band 4C-HSDPA is not applicable for dual uplink operation. However, there might be a substantial Rx de-sensitization for the UE operating in bands which have less than 80 MHz Tx-Rx frequency separation, transmitting on more than one uplink frequency, at maximum power.

**Table 7.2C: Test parameters for reference sensitivity, additional requirement for single band 4C-HSDPA.**

Single band 4C-HSDPA configuration	DL Band	Unit	HS-PDSCH_Ec $\langle \text{REFSENS} \rangle$	$\langle \text{REFI}_{\text{or}} \rangle$	UL-DL carrier separation
I-3	I	dBm/3.84 MHz	-113	-102.7	Minimum
II-3, II-4	II	dBm/3.84 MHz	-111	-100.7	Minimum
NOTE 1 For Power class 3, 3bis and 4, this shall be at the maximum output power					

For the UE which supports DB-DC-HSDPA configuration in Table 7.2CA, the reference sensitivity level HS-PDSCH\_Ec  $\langle \text{REFSENS} \rangle$  and corresponding  $\langle \text{REFI}_{\text{or}} \rangle$  in Table 7.2C are allowed to be increased by the amount given in Table 7.2CA for the applicable bands.

**Table 7.2CA: Allowed de-sensitization relative to reference sensitivity for UE which supports DB-DC-HSDPA.**

DB-DC-HSDPA Configuration	Allowed de-sensitization (dB)	Applicable bands
2	1	II
4	1	I

For the UE which supports dual band 4C-HSDPA configuration in Table 7.2CB, the reference sensitivity level HS-PDSCH\_Ec  $\langle \text{REFSENS} \rangle$  and corresponding  $\langle \text{REFI}_{\text{or}} \rangle$  in Table 7.2C are allowed to be increased by the amount given in Table 7.2CB for the applicable bands.

**Table 7.2CB: Allowed de-sensitization relative to reference sensitivity for UE which supports dual band 4C-HSDPA.**

Dual Band 4C-HSDPA Configuration	Allowed de-sensitization (dB)	Applicable bands
II-1-IV-2 II-2-IV-1 II-2-IV-2	1	II

For the UE which supports E-UTRA inter-band carrier aggregation the reference sensitivity level HS-PDSCH\_Ec  $\langle \text{REFSENS} \rangle$  and corresponding  $\langle \text{REFI}_{\text{or}} \rangle$  in Table 7.2C are allowed to be increased by the amount given in Table 7.3.1-1A of TS 36.101[11] for those UTRA operating bands corresponding to the E-UTRA operating bands that belong to the supported inter-band carrier aggregation configurations. The tolerance in Table 7.3.1-1A of TS 36.101[11] does not apply to supported UTRA operating bands with frequency range below 1 GHz that correspond to the E-UTRA operating bands that belong to the supported inter-band carrier aggregation configurations when such bands are belonging only to band combination(s) where one band is  $<1\text{GHz}$  and another band is  $>1.7\text{GHz}$  and there is no harmonic relationship between the low band UL and high band DL.

In case the UE supports DB-DC-HSDPA configurations and one or more of the E-UTRA inter-band carrier aggregation configurations listed in Table 7.3.1-1A of TS36.101[11] with a UTRA operating band that belongs to UTRA and E-UTRA carrier aggregation configurations, then

- When the UTRA operating band frequency range is  $\leq 1\text{GHz}$ , the applicable additional tolerance shall be the average of the applicable tolerances, truncated to one decimal place for that operating band among the supported DB-DC-HSDPA and E-UTRA CA configurations, with the DB-DC-HSDPA and E-UTRA CA



configurations counted separately. In case there is a harmonic relation between low band UL and high band DL, then the maximum tolerance among the different supported carrier aggregation configurations involving such band shall be applied

- When the UTRA operating band frequency range is >1GHz, the applicable additional tolerance shall be the maximum tolerance that applies for that operating band among the supported DB-DC-HSDPA and E-UTRA CA configurations.

### 7.3.5 Additional requirement for dual band 4C-HSDPA

For all requirements listed in Table 7.2D, corresponding to the specific dual band 4C-HSDPA configuration(s) supported by the UE, (see Table 5.0aC), the BLER measured on each individual cell shall not exceed 0.1.

Note: The reference sensitivity level <REFSENS> requirement for dual band 4C-HSDPA is not applicable for dual uplink operation. However, there might be a substantial Rx de-sensitization for the UE operating in bands which have less than 80 MHz Tx-Rx frequency separation, transmitting on more than one uplink frequency, at maximum power.

**Table 7.2D: Test parameters for reference sensitivity, additional requirement for dual band 4C-HSDPA.**

Dual band 4C-HSDPA configuration	DL Band	UL Band	Unit	HS-PDSCH_Ec <REFSENS>	<REF $\hat{I}_{or}$ >	UL-DL carrier separation
I-2-VIII-1	I	I	dBm/3.84 MHz	-113	-102.7	Minimum
I-3-VIII-1	VIII		dBm/3.84 MHz	-110	-99.7	Minimum
I-2-VIII-2	I	VIII	dBm/3.84 MHz	-113	-102.7	Minimum
I-1-VIII-2	VIII		dBm/3.84 MHz	-110	-99.7	Minimum
II-1-IV-2	II	II	dBm/3.84 MHz	-110	-99.7	Minimum
II-2-IV-1	IV		dBm/3.84 MHz	-112	-101.7	Minimum
II-2-IV-1	II	IV	dBm/3.84 MHz	-110	-99.7	Minimum
II-2-IV-2	IV		dBm/3.84 MHz	-112	-101.7	Minimum
I-1-V-2	I	I	dBm/3.84 MHz	-113	-102.7	Minimum
I-2-V-1	V		dBm/3.84 MHz	-111	-100.7	Minimum
I-2-V-2	I	V	dBm/3.84 MHz	-113	-102.7	Minimum
	V		dBm/3.84 MHz	-111	-100.7	Minimum
II-1-V-2	II	II	dBm/3.84 MHz	-111	-100.7	Minimum
	V		dBm/3.84 MHz	-111	-100.7	Minimum
	II	V	dBm/3.84 MHz	-111	-100.7	Minimum
	V		dBm/3.84 MHz	-111	-100.7	Minimum
I-1-XXXII-2	I	I	dBm/3.84 MHz	-113	-102.7	Minimum
I-2-XXXII-1	XXXII		dBm/3.84 MHz	-113	-102.7	Minimum

NOTE 1 For Power class 3, 3bis and 4, this shall be at the maximum output power

### 7.3.6 Additional requirement for single band 8C-HSDPA

For all requirements listed in Table 7.2E, corresponding to the specific single band 8C-HSDPA configuration(s) supported by the UE, (see Table 5.0aD), the BLER measured on each individual cell shall not exceed 0.1.

Note: The reference sensitivity level <REFSENS> requirement for single band 8C-HSDPA is not applicable for dual uplink operation. However, there might be a substantial Rx de-sensitization for the UE operating in bands which have less than 80 MHz Tx-Rx frequency separation, transmitting on more than one uplink frequency, at maximum power.

**Table 7.2E: Test parameters for reference sensitivity, additional requirement for single band 8C-HSDPA.**

Single band 8C-HSDPA configuration	DL Band	Unit	HS-PDSCH_Ec <REFSENS>	<REF $\hat{I}_{or}$ >	UL-DL carrier separation
I-8	I	dBm/3.84 MHz	-113	-102.7	Minimum

NOTE 1 For Power class 3, 3bis and 4, this shall be at the maximum output power



### 7.3.7 Additional requirement for single band NC-4C-HSDPA

For all requirements listed in Table 7.2E, corresponding to the specific single band NC-4C-HSDPA configuration(s) supported by the UE, (see Table 5.0aE), the BLER measured on each individual cell shall not exceed 0.1.

Note: The reference sensitivity level <REFSENS> requirement for single band NC-4C-HSDPA is not applicable for dual uplink operation. However, there might be a substantial Rx de-sensitization for the UE operating in bands which have less than 80 MHz Tx-Rx frequency separation, transmitting on more than one uplink frequency, at maximum power.

**Table 7.2E: Test parameters for reference sensitivity, additional requirement for single band NC-4C-HSDPA.**

Single band NC-4C-HSDPA configuration	DL Band	Unit	HS-PDSCH_Ec <REFSENS>	<REF <sub>or</sub> >	UL-DL carrier separation
I-1-5-1, I-2-5-1, I-3-10-1	I	dBm/3.84 MHz	-113	-102.7	Minimum
IV-1-5-1, IV-2-10-1, IV-2-15-2, IV-2-20-1, IV-2-25-2	IV	dBm/3.84 MHz	-113	-102.7	Minimum
NOTE 1 For Power class 3, 3bis and 4, this shall be at the maximum output power					

For the UE which supports DB-DC-HSDPA configuration in Table 7.2F, the reference sensitivity level HS-PDSCH\_Ec <REFSENS> and corresponding <REF<sub>or</sub>> in Table 7.2E are allowed to be increased by the amount given in Table 7.2F for the applicable bands.

**Table 7.2F: Allowed de-sensitization relative to reference sensitivity for UE which supports DB-DC-HSDPA.**

DB-DC-HSDPA Configuration	Allowed de-sensitization (dB)	Applicable bands
2	1	IV
4	1	I

For the UE which supports dual band 4C-HSDPA configuration in Table 7.2G, the reference sensitivity level HS-PDSCH\_Ec <REFSENS> and corresponding <REF<sub>or</sub>> in Table 7.2E are allowed to be increased by the amount given in Table 7.2G for the applicable bands.

**Table 7.2G: Allowed de-sensitization relative to reference sensitivity for UE which supports dual band 4C-HSDPA.**

Dual Band 4C-HSDPA Configuration	Allowed de-sensitization (dB)	Applicable bands
II-1-IV-2 II-2-IV-1 II-2-IV-2	1	IV

For the UE which supports E-UTRA inter-band carrier aggregation the reference sensitivity level HS-PDSCH\_Ec <REFSENS> and corresponding <REF<sub>or</sub>> in Table 7.2E are allowed to be increased by the amount given in Table 7.3.1-1A of TS 36.101[11] for those UTRA operating bands corresponding to the E-UTRA operating bands that belong to the supported inter-band carrier aggregation configurations. The tolerance in Table 7.3.1-1A of TS 36.101[11] does not apply to supported UTRA operating bands with frequency range below 1 GHz that correspond to the E-UTRA operating bands that belong to the supported inter-band carrier aggregation configurations when such bands are belonging only to band combination(s) where one band is <1GHz and another band is >1.7GHz and there is no harmonic relationship between the low band UL and high band DL.

In case the UE supports DB-DC-HSDPA configurations and one or more of the E-UTRA inter-band carrier aggregation configurations listed in Table 7.3.1-1A of TS36.101[11] with a UTRA operating band that belongs to UTRA and E-UTRA carrier aggregation configurations, then



- When the UTRA operating band frequency range is  $\leq 1$ GHz, the applicable additional tolerance shall be the average of the applicable tolerances, truncated to one decimal place for that operating band among the supported DB-DC-HSDPA and E-UTRA CA configurations, with the DB-DC-HSDPA and E-UTRA CA configurations counted separately. In case there is a harmonic relation between low band UL and high band DL, then the maximum tolerance among the different supported carrier aggregation configurations involving such band shall be applied
- When the UTRA operating band frequency range is  $>1$ GHz, the applicable additional tolerance shall be the maximum tolerance that applies for that operating band among the supported DB-DC-HSDPA and E-UTRA CA configurations.

## 7.4 Maximum input level

This is defined as the maximum mean power received at the UE antenna port, at which the specified BER performance shall be met.

### 7.4.1 Minimum requirement for DPCH reception

The BER shall not exceed 0.001 for the parameters specified in Table 7.3.

**Table 7.3: Maximum input level**

Parameter	Unit	Level
$\frac{DPCH - Ec}{I_{or}}$	dB	-19
$\hat{I}_{or}$	dBm/3.84 MHz	-25
UE transmitted mean power	dBm	20 (for Power class 3 and 3bis) 18 (for Power class 4) NOTE 1
NOTE 1: The UE transmitted mean power shall be reduced by 0.5dB for a UE operating in band XXII.		

NOTE: Since the spreading factor is large ( $10\log(SF)=21$ dB), the majority of the total input signal consists of the OCNS interference. The structure of OCNS signal is defined in Annex C.3.2.

### 7.4.2 Minimum requirement for HS-PDSCH reception

#### 7.4.2.1 Minimum requirement for 16QAM

The requirements are specified in terms of a minimum information bit throughput R for the DL reference channel H-Set 1 (16QAM version) specified in Annex A.7.1.1 with the addition of the parameters in Table 7.3A and the downlink physical channel setup according to table C.8.

Using this configuration the throughput shall meet or exceed the minimum requirements specified in table 7.3B.



**Table 7.3A Test parameters for maximum input level**

Parameter	Unit	Value
Phase reference		P-CPICH
$\hat{I}_{or}$	dBm/3.84 MHz	-25
UE transmitted mean power	dBm	20 (for Power class 3 and 3bis) 18 (for Power class 4) NOTE 2
DPCH_Ec/lor	dB	-13
HS-SCCH_1_Ec/lor	dB	-13
Redundancy and constellation version		6
Maximum number of HARQ transmissions		1
NOTE 1: The HS-SCCH and corresponding HS-PDSCH shall be transmitted continuously with constant power but the HS-SCCH shall only use the identity of the UE under test every third TTI		
NOTE 2: The UE transmitted mean power shall be reduced by 0.5dB for a UE operating in band XXII.		

**Table 7.3B Minimum requirement**

HS-PDSCH $E_c / I_{or}$ (dB)	T-put R (kbps)
-3	700

#### 7.4.2.2 Minimum requirement for 64QAM

The requirements are specified in terms of a minimum information bit throughput R for the DL reference channel H-Set 8 specified in Annex A.7.1.8. with the addition of the parameters in Table 7.3C and the downlink physical channel setup according to table C.8.

Using this configuration the throughput shall meet or exceed the minimum requirements specified in table 7.3D.

**Table 7.3C Test parameters for maximum input level**

Parameter	Unit	Value
Phase reference		P-CPICH
$\hat{I}_{or}$	dBm/3.84 MHz	-25
UE transmitted mean power	dBm	0
DPCH_Ec/lor	dB	-13
HS-SCCH_1_Ec/lor	dB	-13
Redundancy and constellation version		6
Maximum number of HARQ transmissions		1
NOTE 1: The HS-SCCH and corresponding HS-PDSCH shall be transmitted continuously with constant power but the HS-SCCH shall only use the identity of the UE under test every third TTI.		



**Table 7.3D Minimum requirement**

<b>HS-PDSCH</b> $E_c / I_{or}$ (dB)	<b>T-put <math>R</math> (kbps)</b>
-2	11800

### 7.4.3 Additional requirement for DC-HSDPA and DB-DC-HSDPA

#### 7.4.3.1 Additional requirement for 16QAM

The additional requirements are specified in terms of a minimum information throughput per cell  $R$  with the DL reference channel H-Set 1 (16QAM version) specified in Annex A7.1.1, with the addition of the parameters in Table 7.3E, and the downlink physical channel setup according to table C.8, applied to both cells simultaneously. Using this configuration the throughput shall meet or exceed the minimum requirements specified in table 7.3F.

**Table 7.3E Test parameters for maximum input level**

<b>Parameter</b>	<b>Unit</b>	<b>Value</b>
Phase reference		P-CPICH
$\hat{I}_{or}$	dBm/3.84 MHz	-25
UE transmitted mean power	dBm	20 (for Power class 3 and 3bis) 18 (for Power class 4) NOTE 2
DPCH_ $E_c / I_{or}$	dB	-13
HS-SCCH_1_ $E_c / I_{or}$	dB	-13
Redundancy and constellation version		6
Maximum number of HARQ transmissions		1
NOTE 1: The HS-SCCH and corresponding HS-PDSCH shall be transmitted continuously with constant power but the HS-SCCH shall only use the identity of the UE under test every third TTI		
NOTE 2: The UE transmitted mean power shall be reduced by 0.5dB for a UE operating in band XXII.		

**Table 7.3F Minimum requirement**

<b>HS-PDSCH</b> $E_c / I_{or}$ (dB)	<b>T-put <math>R</math> (kbps)</b>
-3	700

#### 7.4.3.2 Additional requirement for 64QAM

The additional requirements are specified in terms of a minimum information throughput per cell  $R$  with the DL reference channel H-Set 8 specified in Annex A7.1.8, with the addition of the parameters in Table 7.3G, and the downlink physical channel setup according to table C.8, applied to both cells simultaneously. Using this configuration the throughput shall meet or exceed the minimum requirements specified in table 7.3H.



**Table 7.3G Test parameters for maximum input level**

Parameter	Unit	Value
Phase reference		P-CPICH
$\hat{I}_{or}$	dBm/3.84 MHz	-25
UE transmitted mean power	dBm	0
DPCH_Ec/lor	dB	-13
HS-SCCH_1_Ec/lor	dB	-13
Redundancy and constellation version		6
Maximum number of HARQ transmissions		1
NOTE 1: The HS-SCCH and corresponding HS-PDSCH shall be transmitted continuously with constant power but the HS-SCCH shall only use the identity of the UE under test every third TTI		

**Table 7.3H Minimum requirement**

HS-PDSCH $E_c / I_{or}$ (dB)	T-put $R$ (kbps)
-2	11800

#### 7.4.4 Additional requirement for single band/dual band 4C-HSDPA or single band 8C-HSDPA and single band NC-4C-HSDPA

##### 7.4.4.1 Additional requirement for 16QAM

The additional requirements are specified in terms of a minimum information throughput per cell  $R$  with the DL reference channel H-Set 1 (16QAM version) specified in Annex A7.1.1, with the addition of the parameters in Table 7.3I, and the downlink physical channel setup according to table C.8, applied to all the cells simultaneously. Using this configuration the throughput shall meet or exceed the minimum requirements specified in table 7.3J.



**Table 7.3I Test parameters for maximum input level**

Parameter	Unit	Value
Phase reference		P-CPICH
Wanted signal mean power per band (dBm)	dBm/band	-22
UE transmitted mean power	dBm	20 (for Power class 3 and 3bis) 18 (for Power class 4)
DPCH_Ec/lor	dB	-13
HS-SCCH_1_Ec/lor	dB	-13
Redundancy and constellation version		6
Maximum number of HARQ transmissions		1
Note 1: The HS-SCCH and corresponding HS-PDSCH shall be transmitted continuously with constant power but the HS-SCCH shall only use the identity of the UE under test every third TTI		
Note 2: Wanted signal mean power per band is the sum of measured mean power on each carrier in a band over 3.84 MHz.		

**Table 7.3J Minimum requirement**

HS-PDSCH $E_c/I_{or}$ (dB)	T-put $R$ (kbps)
-3	700

#### 7.4.4.2 Additional requirement for 64QAM

The additional requirements are specified in terms of a minimum information throughput per cell  $R$  with the DL reference channel H-Set 8 specified in Annex A7.1.8, with the addition of the parameters in Table 7.3K, and the downlink physical channel setup according to table C.8, applied to all the cells simultaneously. Using this configuration the throughput shall meet or exceed the minimum requirements specified in table 7.3L.

**Table 7.3K Parameters definition**

Parameter	Unit	Value
Phase reference		P-CPICH
Wanted signal mean power per band (dBm)	dBm/band	-22
UE transmitted mean power	dBm	0
DPCH_Ec/lor	dB	-13
HS-SCCH_1_Ec/lor	dB	-13
Redundancy and constellation version		6
Maximum number of HARQ transmissions		1
Note 1: The HS-SCCH and corresponding HS-PDSCH shall be transmitted continuously with constant power but the HS-SCCH shall only use the identity of the UE under test every third TTI		
Note 2: Wanted signal mean power per band is the sum of measured mean power on each carrier in a band over 3.84 MHz.		

**Table 7.3L Minimum requirement**

HS-PDSCH $E_c/I_{or}$ (dB)	T-put $R$ (kbps)
-2	11800

## 7.5 Adjacent Channel Selectivity (ACS)

Adjacent Channel Selectivity (ACS) is a measure of a receiver's ability to receive a W-CDMA signal at its assigned channel frequency in the presence of an adjacent channel signal at a given frequency offset from the centre frequency of



the assigned channel. ACS is the ratio of the receive filter attenuation on the assigned channel frequency to the receive filter attenuation on the adjacent channel(s).

### 7.5.1 Minimum requirement

The UE shall fulfill the minimum requirement specified in Table 7.4 for all values of an adjacent channel interferer up to -25 dBm.

However it is not possible to directly measure the ACS, instead the lower and upper range of test parameters are chosen in Table 7.5 where the BER shall not exceed 0.001.

**Table 7.4: Adjacent Channel Selectivity**

Unit	ACS
dB	33

**Table 7.5: Test parameters for Adjacent Channel Selectivity**

Parameter	Unit	Case 1	Case 2
DPCH_Ec	dBm/3.84 MHz	<REFSENS> + 14 dB	<REFSENS> + 41 dB
$\hat{I}_{or}$	dBm/3.84 MHz	<REF $\hat{I}_{or}$ > + 14 dB	REF $\hat{I}_{or}$ + 41 dB
$I_{oac}$ mean power (modulated)	dBm	-52	-25
$F_{uw}$ (offset)	MHz	+5 or -5	+5 or -5
UE transmitted mean power	dBm	20 (for Power class 3 and 3bis) 18 (for Power class 4) NOTE 3	20 (for Power class 3 and 3bis) 18 (for Power class 4) NOTE 3
NOTE 1: The $I_{oac}$ (modulated) signal consists of the common channels needed for tests as specified in Table C.7 and 16 dedicated data channels as specified in Table C.6.			
NOTE 2: <REFSENS> and <REF $\hat{I}_{or}$ > refers to the DPCH_Ec<REFSENS> and the DPCH<REF $\hat{I}_{or}$ > as specified in Table 7.2.			
NOTE 3: The UE transmitted mean power shall be reduced by 0.5dB for a UE operating in band XXII.			

### 7.5.2 Additional requirement for DC-HSDPA and DB-DC-HSDPA

The UE shall fulfill the additional requirement specified in Table 7.5A for all values of an adjacent channel interferer up to -25 dBm.

However it is not possible to directly measure the ACS, instead the lower and upper range of test parameters are chosen in Table 7.5B, where the HS-PDSCH BLER shall not exceed 0.1.

**Table 7.5A: Adjacent Channel Selectivity**

Unit	ACS
dB	33



**Table 7.5B: Test parameters for Adjacent Channel Selectivity**

Parameter	Unit	Case 1	Case 2
HS-PDSCH_Ec	dBm/3.84 MHz	<REFSENS> + 14 dB	<REFSENS> + 41 dB
I <sub>or</sub>	dBm/3.84 MHz	<REFI <sub>or</sub> > + 14 dB	<REFI <sub>or</sub> > + 41 dB
I <sub>oac</sub> mean power (modulated)	dBm	-52	-25
F <sub>uw</sub> (offset) (NOTE 2)	MHz	+5 or -5	+5 or -5
UE transmitted mean power	dBm	20 (for Power class 3 and 3bis) 18 (for Power class 4) NOTE 4	20 (for Power class 3 and 3bis) 18 (for Power class 4) NOTE 4
NOTE 1: The I <sub>oac</sub> (modulated) signal consists of the common channels needed for tests as specified in Table C.7 and 16 dedicated data channels as specified in Table C.6.			
NOTE 2: For DC-HSDPA, negative offset refers to the assigned channel frequency of the lowest carrier frequency used and positive offset refers to the assigned channel frequency of the highest carrier frequency used. For DB-DC-HSDPA, offset refers to the assigned channel frequencies of the individual cells.			
NOTE 3: <REFSENS> and <REFI <sub>or</sub> > refers to the HS-PDSCH_Ec<REFSENS> and the HS-PDSCH<REFI <sub>or</sub> > as specified in Table 7.2A for DC-HSDPA and Table 7.2B for DB-DC-HSDPA.			
NOTE 4: The UE transmitted mean power shall be reduced by 0.5dB for a UE operating in band XXII.			

### 7.5.3 Additional requirement for single band/dual band 4C-HSDPA

The UE shall fulfill the additional requirement specified in Table 7.5C for all values of an adjacent channel interferer up to -25 dBm.

However it is not possible to directly measure the ACS, instead the lower and upper range of test parameters are chosen in Table 7.5D and the requirements are given in Table 7.5E and Table 7.5EA for single band 4C-HSDPA and in 7.5F and 7.5G for dual band 4C-HSDPA, where the HS-PDSCH BLER shall not exceed 0.1.

The ACS requirement for single band/dual-band 4C-HSDPA is not applicable for dual uplink operation.

**Table 7.5C: Adjacent Channel Selectivity**

Rx Parameter	Unit	Number of adjacent downlink carriers in a band			
		1	2	3	4
ACS	dB	33	33	33	33

**Table 7.5D: Test parameters for Adjacent Channel Selectivity**

Parameter	Unit	Case 1	Case 2
I <sub>oac</sub> mean power (modulated)	dBm	-52	-25
F <sub>uw</sub> (offset) (NOTE 2)	MHz	+5 or -5	+5 or -5
UE transmitted mean power	dBm	20 (for Power class 3 and 3bis) 18 (for Power class 4)	
NOTE 1: The I <sub>oac</sub> (modulated) signal consists of the common channels needed for tests as specified in Table C.7 and 16 dedicated data channels as specified in Table C.6.			
NOTE 2: Negative offset refers to the assigned channel frequency of the lowest carrier frequenc(ies) in each band, and positive offset refers to the assigned channel frequency of the highest carrier frequenc(ies) in each band.			



**Table 7.5E: Single band 4C-HSDPA requirements for Adjacent Channel Selectivity, Case 1**

Single band 4C-HSDPA Configuration	DL Band	HS-PDSCH_Ec (dBm/3.84MHz)	$\hat{I}_{or}$ (dBm/3.84MHz)	UL-DL carrier separation
I-3	I	<REFSENS>+14 dB	<REF $\hat{I}_{or}$ >+14 dB	Minimum
II-3, II-4	II	<REFSENS>+14 dB	<REF $\hat{I}_{or}$ >+14 dB	Minimum
NOTE: <REFSENS> and <REF $\hat{I}_{or}$ > refers to the HS-PDSCH_Ec<REFSENS> and the HS-PDSCH<REF $\hat{I}_{or}$ > as specified in Table 7.2C for single band 4C-HSDPA.				

**Table 7.5EA: Single band 4C-HSDPA requirements for Adjacent Channel Selectivity, Case 2**

Single band 4C-HSDPA Configuration	DL Band	HS-PDSCH_Ec (dBm/3.84MHz)	$\hat{I}_{or}$ (dBm/3.84MHz)	UL-DL carrier separation
I-3	I	<REFSENS>+41 dB	<REF $\hat{I}_{or}$ >+41 dB	Minimum
II-3, II-4	II	<REFSENS>+41 dB	<REF $\hat{I}_{or}$ >+41 dB	Minimum
NOTE: <REFSENS> and <REF $\hat{I}_{or}$ > refers to the HS-PDSCH_Ec<REFSENS> and the HS-PDSCH<REF $\hat{I}_{or}$ > as specified in Table 7.2C for single band 4C-HSDPA.				



Table 7.5F: Dual band 4C-HSDPA requirements for Adjacent Channel Selectivity, Case 1

Dual band 4C-HSDPA Configuration	DL Band	UL Band	HS-PDSCH_Ec (dBm/3.84MHz)	$\hat{I}_{or}$ (dBm/3.84MHz)	UL-DL carrier separation
I-2-VIII-1 I-3-VIII-1, I-2- VIII-2, I-1-VIII- 2	I	I	<REFSENS>+14 dB	<REF $\hat{I}_{or}$ >+14 dB	Minimum
	VIII		<REFSENS>+14 dB	<REF $\hat{I}_{or}$ >+14 dB	Minimum
	I	VIII	<REFSENS>+14 dB	<REF $\hat{I}_{or}$ >+14 dB	Minimum
	VIII		<REFSENS>+14 dB	<REF $\hat{I}_{or}$ >+14 dB	Minimum
II-1-IV-2 II-2-IV-1 II-2-IV-2	II	II	<REFSENS>+14 dB	<REF $\hat{I}_{or}$ >+14 dB	Minimum
	IV		<REFSENS>+14 dB	<REF $\hat{I}_{or}$ >+14 dB	Minimum
	II	IV	<REFSENS>+14 dB	<REF $\hat{I}_{or}$ >+14 dB	Minimum
	IV		<REFSENS>+14 dB	<REF $\hat{I}_{or}$ >+14 dB	Minimum
I-1-V-2 I-2-V-1 I-2-V-2	I	I	<REFSENS>+14 dB	<REF $\hat{I}_{or}$ >+14 dB	Minimum
	V		<REFSENS>+14 dB	<REF $\hat{I}_{or}$ >+14 dB	Minimum
	I	V	<REFSENS>+14 dB	<REF $\hat{I}_{or}$ >+14 dB	Minimum
	V		<REFSENS>+14 dB	<REF $\hat{I}_{or}$ >+14 dB	Minimum
II-1-V-2	II	II	<REFSENS>+14 dB	<REF $\hat{I}_{or}$ >+14 dB	Minimum
	V		<REFSENS>+14 dB	<REF $\hat{I}_{or}$ >+14 dB	Minimum
	II	V	<REFSENS>+14 dB	<REF $\hat{I}_{or}$ >+14 dB	Minimum
	V		<REFSENS>+14 dB	<REF $\hat{I}_{or}$ >+14 dB	Minimum
I-1-XXXII-2 I-2-XXXII-1	I	I	<REFSENS>+14 dB	<REF $\hat{I}_{or}$ >+14 dB	Minimum
	XXXII		<REFSENS>+14 dB	<REF $\hat{I}_{or}$ >+14 dB	Minimum
NOTE: <REFSENS> and <REF $\hat{I}_{or}$ > refers to the HS-PDSCH_Ec<REFSENS> and the HS-PDSCH<REF $\hat{I}_{or}$ > as specified in Table 7.2D for dual band 4C-HSDPA.					



**Table 7.5G: Dual band 4C-HSDPA requirements for Adjacent Channel Selectivity, Case 2**

Dual band 4C-HSDPA Configuration	DL Band	UL Band	HS-PDSCH_Ec (dBm/3.84MHz)	$\hat{I}_{or}$ (dBm/3.84MHz)	UL-DL carrier separation
I-2-VIII-1 I-3-VIII-1, I-2- VIII-2, I-1-VIII- 2	I	I	<REFSENS>+41 dB	<REF $\hat{I}_{or}$ >+41 dB	Minimum
	VIII		<REFSENS>+41 dB	<REF $\hat{I}_{or}$ >+41 dB	Minimum
	I	VIII	<REFSENS>+41 dB	<REF $\hat{I}_{or}$ >+41 dB	Minimum
	VIII		<REFSENS>+41 dB	<REF $\hat{I}_{or}$ >+41 dB	Minimum
II-1-IV-2 II-2-IV-1 II-2-IV-2	II	II	<REFSENS>+41 dB	<REF $\hat{I}_{or}$ >+41 dB	Minimum
	IV		<REFSENS>+41 dB	<REF $\hat{I}_{or}$ >+41 dB	Minimum
	II	IV	<REFSENS>+41 dB	<REF $\hat{I}_{or}$ >+41 dB	Minimum
	IV		<REFSENS>+41 dB	<REF $\hat{I}_{or}$ >+41 dB	Minimum
I-1-V-2 I-2-V-1 I-2-V-2	I	I	<REFSENS>+41 dB	<REF $\hat{I}_{or}$ >+41 dB	Minimum
	V		<REFSENS>+41 dB	<REF $\hat{I}_{or}$ >+41 dB	Minimum
	I	V	<REFSENS>+41 dB	<REF $\hat{I}_{or}$ >+41 dB	Minimum
	V		<REFSENS>+41 dB	<REF $\hat{I}_{or}$ >+41 dB	Minimum
II-1-V-2	II	II	<REFSENS>+41 dB	<REF $\hat{I}_{or}$ >+41 dB	Minimum
	V		<REFSENS>+41 dB	<REF $\hat{I}_{or}$ >+41 dB	Minimum
	II	V	<REFSENS>+41 dB	<REF $\hat{I}_{or}$ >+41 dB	Minimum
	V		<REFSENS>+41 dB	<REF $\hat{I}_{or}$ >+41 dB	Minimum
I-1-XXXII-2 I-2-XXXII-1	I	I	<REFSENS>+41dB	<REF $\hat{I}_{or}$ >+41dB	Minimum
	XXXII		<REFSENS>+41 dB	<REF $\hat{I}_{or}$ >+41 dB	Minimum
NOTE: <REFSENS> and <REF $\hat{I}_{or}$ > refers to the HS-PDSCH_Ec<REFSENS> and the HS-PDSCH<REF $\hat{I}_{or}$ > as specified in Table 7.2D for dual band 4C-HSDPA.					

## 7.5.4 Additional requirement for single band 8C-HSDPA

The UE shall fulfill the additional requirement specified in Table 7.5H for all values of an adjacent channel interferer up to -25 dBm.

However it is not possible to directly measure the ACS, instead the lower and upper range of test parameters are chosen in Table 7.5I and the requirements are given in Table 7.5J and Table 7.5K where the HS-PDSCH BLER shall not exceed 0.1.

The ACS requirement for single band 8C-HSDPA is not applicable for dual uplink operation.

**Table 7.5H: Adjacent Channel Selectivity**

Rx Parameter	Unit	Number of adjacent downlink carriers in a band							
		1	2	3	4	5	6	7	8
ACS	dB	33	33	33	33	33	33	33	33



**Table 7.5I: Test parameters for Adjacent Channel Selectivity**

Parameter	Unit	Case 1	Case 2
$I_{\text{oac}}$ mean power (modulated)	dBm	-52	-25
$F_{\text{uw}}$ (offset) (NOTE 2)	MHz	+5 or -5	+5 or -5
UE transmitted mean power	dBm	20 (for Power class 3 and 3bis) 18 (for Power class 4)	
NOTE 1: The $I_{\text{oac}}$ (modulated) signal consists of the common channels needed for tests as specified in Table C.7 and 16 dedicated data channels as specified in Table C.6.			
NOTE 2: Negative offset refers to the assigned channel frequency of the lowest carrier frequency in each band, and positive offset refers to the assigned channel frequency of the highest carrier frequency in each band.			

**Table 7.5J: Single band 8C-HSDPA requirements for Adjacent Channel Selectivity, Case 1**

Single band 8C-HSDPA Configuration	DL Band	HS-PDSCH_Ec (dBm/3.84MHz)	$\hat{I}_{\text{or}}$ (dBm/3.84MHz)	UL-DL carrier separation
I-8	I	<REFSENS>+14 dB	<REF $\hat{I}_{\text{or}}$ >+14 dB	Minimum
NOTE: <REFSENS> and <REF $\hat{I}_{\text{or}}$ > refers to the HS-PDSCH_Ec<REFSENS> and the HS-PDSCH<REF $\hat{I}_{\text{or}}$ > as specified in Table 7.2E for single band 8C-HSDPA.				

**Table 7.5K: Single band 8C-HSDPA requirements for Adjacent Channel Selectivity, Case 2**

Single band 8C-HSDPA Configuration	DL Band	HS-PDSCH_Ec (dBm/3.84MHz)	$\hat{I}_{\text{or}}$ (dBm/3.84MHz)	UL-DL carrier separation
I-8	I	<REFSENS>+41 dB	<REF $\hat{I}_{\text{or}}$ >+41 dB	Minimum
NOTE: <REFSENS> and <REF $\hat{I}_{\text{or}}$ > refers to the HS-PDSCH_Ec<REFSENS> and the HS-PDSCH<REF $\hat{I}_{\text{or}}$ > as specified in Table 7.2E for single band 8C-HSDPA.				

### 7.5.5 Additional requirement for single band NC-4C-HSDPA

The UE shall fulfill the additional requirement specified in Table 7.5L for all values of an adjacent channel interferer up to -25 dBm.

However it is not possible to directly measure the ACS, instead the lower and upper range of test parameters are chosen in Table 7.5M and the requirements are given in Table 7.5N and Table 7.5P where the HS-PDSCH BLER shall not exceed 0.1.

The ACS requirement for single band NC-4C-HSDPA is not applicable for dual uplink operation.

**Table 7.5L: Adjacent Channel Selectivity**

Rx Parameter	Unit	Number of adjacent downlink carriers in a band		
		1	2	3
ACS	dB	33	33	33



**Table 7.5M: Test parameters for Adjacent Channel Selectivity**

Parameter	Unit	Case 1	Case 2
$I_{\text{OAC}}$ mean power (modulated)	dBm	-52	-25
$F_{\text{UW}}$ (offset) (NOTE 2,3)	MHz	+5 or -5	+5 or -5
UE transmitted mean power	dBm	20 (for Power class 3 and 3bis) 18 (for Power class 4)	
NOTE 1: The $I_{\text{OAC}}$ (modulated) signal consists of the common channels needed for tests as specified in Table C.7 and 16 dedicated data channels as specified in Table C.6.			
NOTE 2: For single band NC-4C-HSPDA out-of-gap, negative offset refers to the assigned channel frequency of the lowest carrier belonging to the lower subblock of carriers, and positive offset refers to the assigned channel frequency of the highest carrier belonging to the higher subblock of carriers.			
NOTE 3: For single band NC-4C-HSPDA in-gap, negative offset refers to the assigned channel frequency of the lowest carrier belonging to the higher subblock of carriers, and positive offset refers to the assigned channel frequency of the highest carrier belonging to the lower subblock of carriers.			

**Table 7.5N: Single band NC-4C-HSDPA requirements for Adjacent Channel Selectivity, Case 1**

Single band NC-4C-HSDPA Configuration	Test type	DL Band	HS-PDSCH $E_c$ (dBm/3.84MHz)	$\hat{I}_{\text{or}}$ (dBm/3.84MHz)	UL-DL carrier separation
I-1-5-1, I-2-5-1, I-3-10-1	In-gap	I	<REFSENS>+14 dB	<REF $\hat{I}_{\text{or}}$ >+14 dB	Minimum
I-1-5-1, I-2-5-1, I-3-10-1	Out-of-gap	I	<REFSENS>+14 dB	<REF $\hat{I}_{\text{or}}$ >+14 dB	Minimum
IV-1-5-1, IV-2-10-1, IV-2-15-2, IV-2-20-1, IV-2-25-2	In-gap	IV	<REFSENS>+14 dB	<REF $\hat{I}_{\text{or}}$ >+14 dB	Minimum
IV-1-5-1, IV-2-10-1, IV-2-15-2, IV-2-20-1, IV-2-25-2	Out-of-gap	IV	<REFSENS>+14 dB	<REF $\hat{I}_{\text{or}}$ >+14 dB	Minimum
NOTE: <REFSENS> and <REF $\hat{I}_{\text{or}}$ > refers to the HS-PDSCH $E_c$ <REFSENS> and the HS-PDSCH<REF $\hat{I}_{\text{or}}$ > as specified in Table 7.2E for single band NC-4C-HSDPA.					

**Table 7.5P: Single band NC-4C-HSDPA requirements for Adjacent Channel Selectivity, Case 2**

Single band NC-4C-HSDPA Configuration	Test type	DL Band	HS-PDSCH $E_c$ (dBm/3.84MHz)	$\hat{I}_{\text{or}}$ (dBm/3.84MHz)	UL-DL carrier separation
I-1-5-1, I-2-5-1, I-3-10-1	In-gap	I	<REFSENS>+41 dB	<REF $\hat{I}_{\text{or}}$ >+41 dB	Minimum
I-1-5-1, I-2-5-1, I-3-10-1	Out-of-gap	I	<REFSENS>+41 dB	<REF $\hat{I}_{\text{or}}$ >+41 dB	Minimum
IV-1-5-1, IV-2-10-1, IV-2-15-2, IV-2-20-1, IV-2-25-2	In-gap	IV	<REFSENS>+41 dB	<REF $\hat{I}_{\text{or}}$ >+41 dB	Minimum
IV-1-5-1, IV-2-10-1, IV-2-15-2, IV-2-20-1, IV-2-25-2	Out-of-gap	IV	<REFSENS>+41 dB	<REF $\hat{I}_{\text{or}}$ >+41 dB	Minimum
NOTE: <REFSENS> and <REF $\hat{I}_{\text{or}}$ > refers to the HS-PDSCH $E_c$ <REFSENS> and the HS-PDSCH<REF $\hat{I}_{\text{or}}$ > as specified in Table 7.2E for single band NC-4C-HSDPA.					

## 7.6 Blocking characteristics

The blocking characteristic is a measure of the receiver's ability to receive a wanted signal at its assigned channel frequency in the presence of an unwanted interferer on frequencies other than those of the spurious response or the adjacent channels, without this unwanted input signal causing a degradation of the performance of the receiver beyond a specified limit. The blocking performance shall apply at all frequencies except those at which a spurious response occur.



## 7.6.1 Minimum requirement (In-band blocking)

The BER shall not exceed 0.001 for the parameters specified in Table 7.6. In-band blocking is defined for an unwanted interfering signal falling into the UE receive band or into the first 15 MHz below or above the UE receive band.

**Table 7.6: In-band blocking**

Parameter	Unit	Level	
DPCH_Ec	dBm/3.84 MHz	<REFSENS>+3 dB	
I <sub>or</sub>	dBm/3.84 MHz	<REFI <sub>or</sub> > + 3 dB	
I <sub>blocking</sub> mean power (modulated)	dBm	-56	-44
F <sub>uw</sub> offset		=±10 MHz	≤-15 MHz & ≥15 MHz
F <sub>uw</sub> (Band I operation)	MHz	2102.4≤ f ≤2177.6	2095≤ f ≤2185
F <sub>uw</sub> (Band II operation)	MHz	1922.4≤ f ≤1997.6	1915≤ f ≤2005
F <sub>uw</sub> (Band III operation)	MHz	1797.4≤ f ≤1887.6	1790≤ f ≤1895
F <sub>uw</sub> (Band IV operation)	MHz	2102.4≤ f ≤2162.6	2095≤ f ≤2170
F <sub>uw</sub> (Band V operation)	MHz	861.4≤ f ≤901.6	854≤ f ≤909
F <sub>uw</sub> (Band VI operation)	MHz	867.4≤ f ≤892.6 (NOTE 2)	860≤ f ≤900 (NOTE 2)
F <sub>uw</sub> (Band VII operation)	MHz	2612.4≤ f ≤2697.6	2605 ≤ f ≤ 2705
F <sub>uw</sub> (Band VIII operation)	MHz	917.4≤ f ≤967.6	910 ≤ f ≤ 975
F <sub>uw</sub> (Band IX operation)	MHz	1837.4 ≤ f ≤ 1887.4	1829.9 ≤ f ≤ 1894.9
F <sub>uw</sub> (Band X operation)	MHz	2102.4 ≤ f ≤ 2177.6	2095 ≤ f ≤ 2185
F <sub>uw</sub> (Band XI operation)	MHz	1468.4 ≤ f ≤ 1503.4	1460.9 ≤ f ≤ 1510.9
F <sub>uw</sub> (Band XII operation)	MHz	721.4 ≤ f ≤ 753.6	714 ≤ f ≤ 761
F <sub>uw</sub> (Band XIII operation)	MHz	738.4 ≤ f ≤ 763.6	731 ≤ f ≤ 771
F <sub>uw</sub> (Band XIV operation)	MHz	750.4 ≤ f ≤ 775.6	743 ≤ f ≤ 783
F <sub>uw</sub> (Band XIX operation)	MHz	867.4≤ f ≤897.6	860≤ f ≤905 (NOTE 2)
F <sub>uw</sub> (Band XX operation)	MHz	783.4 ≤ f ≤ 828.6	776 ≤ f ≤ 836
F <sub>uw</sub> (Band XXI operation)	MHz	1488.4≤ f ≤1518.4	1480.9≤ f ≤1525.9 (NOTE 2)
F <sub>uw</sub> (Band XXII operation)	MHz	3502.4≤ f ≤3597.6	3495≤ f ≤3605
F <sub>uw</sub> (Band XXV operation)	MHz	1922.4≤ f ≤2002.6	1915≤ f ≤2010
F <sub>uw</sub> (Band XXVI operation)	MHz	851.4≤ f ≤901.6	844≤ f ≤909
UE transmitted mean power	dBm	20 (for Power class 3 and 3bis) 18 (for Power class 4) NOTE 4	
NOTE 1: I <sub>blocking</sub> (modulated) consists of the common channels needed for tests as specified in Table C.7 and 16 dedicated data channels as specified in Table C.6.			
NOTE 2: For Band VI, Band XIX and Band XXI, the unwanted interfering signal does not fall inside the UE receive band, but within the first 15 MHz below or above the UE receive band.			
NOTE 3: <REFSENS> and <REFI <sub>or</sub> > refer to the DPCH_Ec<REFSENS> and the DPCH<REFI <sub>or</sub> > as specified in Table 7.2.			
NOTE 4: The UE transmitted mean power shall be reduced by 0.5dB for a UE operating in band XXII.			



### 7.6.1A Additional requirement for DC-HSDPA and DB-DC-HSDPA (In-band blocking)

The BLER measured on each individual cell shall not exceed 0.1 for the parameters specified in Table 7.6A. In-band blocking is defined for an unwanted interfering signal falling into the UE receive band or into the first 15 MHz below or above the UE receive band.



Table 7.6A: In-band blocking for DC-HSDPA and DB-DC-HSDPA

Parameter	Unit	Level	
HS-PDSCH_Ec	dBm/3.84 MHz	<REFSENS>+3 dB	
I <sub>or</sub>	dBm/3.84 MHz	<REFI <sub>or</sub> > + 3 dB	
I <sub>blocking</sub> mean power (modulated)	dBm	-56	-44
F <sub>uw</sub> offset (NOTE 3)		=±10 MHz	≤-15 MHz & ≥15 MHz
F <sub>uw</sub> (Band I operation)	MHz	2102.4≤ f ≤2177.6	2095≤ f ≤2185
F <sub>uw</sub> (Band II operation)	MHz	1922.4≤ f ≤1997.6	1915≤ f ≤2005
F <sub>uw</sub> (Band III operation)	MHz	1797.4≤ f ≤1887.6	1790≤ f ≤1895
F <sub>uw</sub> (Band IV operation)	MHz	2102.4≤ f ≤2162.6	2095≤ f ≤2170
F <sub>uw</sub> (Band V operation)	MHz	861.4≤ f ≤901.6	854≤ f ≤909
F <sub>uw</sub> (Band VI operation)	MHz	867.4≤ f ≤892.6 (NOTE 2)	860≤ f ≤900 (NOTE 2)
F <sub>uw</sub> (Band VII operation)	MHz	2612.4≤ f ≤2697.6	2605 ≤ f ≤ 2705
F <sub>uw</sub> (Band VIII operation)	MHz	917.4≤ f ≤967.6	910 ≤ f ≤ 975
F <sub>uw</sub> (Band IX operation)	MHz	1837.4 ≤ f ≤ 1887.4	1829.9 ≤ f ≤ 1894.9
F <sub>uw</sub> (Band X operation)	MHz	2102.4 ≤ f ≤ 2177.6	2095 ≤ f ≤ 2185
F <sub>uw</sub> (Band XI operation)	MHz	1468.4 ≤ f ≤ 1503.4	1460.9 ≤ f ≤ 1510.9
F <sub>uw</sub> (Band XII operation)	MHz	721.4 ≤ f ≤ 753.6	714 ≤ f ≤ 761
F <sub>uw</sub> (Band XIII operation)	MHz	738.4 ≤ f ≤ 763.6	731 ≤ f ≤ 771
F <sub>uw</sub> (Band XIV operation)	MHz	750.4 ≤ f ≤ 775.6	743 ≤ f ≤ 783
F <sub>uw</sub> (Band XIX operation)	MHz	867.4≤ f ≤897.6	860≤ f ≤905 (NOTE 2)
F <sub>uw</sub> (Band XX operation)	MHz	783.4 ≤ f ≤ 828.6	776 ≤ f ≤ 836
F <sub>uw</sub> (Band XXI operation)	MHz	1488.4≤ f ≤1518.4	1480.9≤ f ≤1525.9 (NOTE 2)
F <sub>uw</sub> (Band XXII operation)	MHz	3502.4≤ f ≤3597.6	3495≤ f ≤3605
F <sub>uw</sub> (Band XXV operation)	MHz	1922.4≤ f ≤2002.6	1915≤ f ≤2010
F <sub>uw</sub> (Band XXVI operation)	MHz	851.4≤ f ≤901.6	844≤ f ≤909
F <sub>uw</sub> (Band XXXII operation) (NOTE 6)	MHz	1444.4≤ f ≤1503.6	1437≤ f ≤1511
UE transmitted mean power	dBm	20 (for Power class 3 and 3bis) 18 (for Power class 4) NOTE 5	
NOTE 1: I <sub>blocking</sub> (modulated) consists of the common channels needed for tests as specified in Table C.7 and 16 dedicated data channels as specified in Table C.6.			
NOTE 2: For Band VI, Band XIX and Band XXI, the unwanted interfering signal does not fall inside the UE receive band, but within the first 15 MHz below or above the UE receive band.			
NOTE 3: For DC-HSDPA, negative offset refers to the assigned channel frequency of the lowest carrier frequency used and positive offset refers to the assigned channel frequency of the highest carrier frequency used. For DB-DC-HSDPA, offset refers to the assigned channel frequencies of the individual cells.			
NOTE 4: <REFSENS> and <REFI <sub>or</sub> > refer to the HS-PDSCH_Ec<REFSENS> and the HS-PDSCH<REFI <sub>or</sub> > as specified in Table 7.2A for DC-HSDPA and Table 7.2B for DB-DC-HSDPA.			



NOTE 5: The UE transmitted mean power shall be reduced by 0.5dB for a UE operating in band XXII. NOTE 6: Restricted to UTRA operation when dual band is configured (e.g., DB-DC-HSDPA or dual band 4C-HSDPA)
---

### 7.6.1B Additional requirement for DC-HSUPA (In-band blocking)

The BLER measured on each individual cell shall not exceed 0.1 for the parameters specified in Table 7.6B and Table 7.6C. In-band blocking is defined for an unwanted interfering signal falling into the UE receive band or into the first 15 MHz below or above the UE receive band.



Table 7.6B: In-band blocking for DC-HSUPA

Parameter	Unit	Level	
I <sub>blocking</sub> mean power (modulated)	dBm	-56	-44
F <sub>uw</sub> offset (NOTE 3)		±10 MHz	≤-15 MHz & ≥15 MHz
F <sub>uw</sub> (Band I operation)	MHz	2102.4≤ f ≤2177.6	2095≤ f ≤2185
F <sub>uw</sub> (Band II operation)	MHz	1922.4≤ f ≤1997.6	1915≤ f ≤2005
F <sub>uw</sub> (Band III operation)	MHz	1797.4≤ f ≤1887.6	1790≤ f ≤1895
F <sub>uw</sub> (Band IV operation)	MHz	2102.4≤ f ≤2162.6	2095≤ f ≤2170
F <sub>uw</sub> (Band V operation)	MHz	861.4≤ f ≤901.6	854≤ f ≤909
F <sub>uw</sub> (Band VI operation)	MHz	867.4≤ f ≤892.6 (NOTE 2)	860≤ f ≤900 (NOTE 2)
F <sub>uw</sub> (Band VII operation)	MHz	2612.4≤ f ≤2697.6	2605 ≤ f ≤ 2705
F <sub>uw</sub> (Band VIII operation)	MHz	917.4≤ f ≤967.6	910 ≤ f ≤ 975
F <sub>uw</sub> (Band IX operation)	MHz	1837.4 ≤ f ≤ 1887.4	1829.9 ≤ f ≤ 1894.9
F <sub>uw</sub> (Band X operation)	MHz	2102.4 ≤ f ≤ 2177.6	2095 ≤ f ≤ 2185
F <sub>uw</sub> (Band XI operation)	MHz	1468.4 ≤ f ≤ 1503.4	1460.9 ≤ f ≤ 1510.9
F <sub>uw</sub> (Band XII operation)	MHz	721.4 ≤ f ≤ 753.6	714 ≤ f ≤ 761
F <sub>uw</sub> (Band XIII operation)	MHz	738.4 ≤ f ≤ 763.6	731 ≤ f ≤ 771
F <sub>uw</sub> (Band XIV operation)	MHz	750.4 ≤ f ≤ 775.6	743 ≤ f ≤ 783
F <sub>uw</sub> (Band XIX operation)	MHz	867.4≤ f ≤897.6	860≤ f ≤905 (NOTE 2)
F <sub>uw</sub> (Band XX operation)	MHz	783.4≤ f ≤828.6	776≤ f ≤836 (NOTE 2)
F <sub>uw</sub> (Band XXI operation)	MHz	1488.4≤ f ≤1518.4	1480.9≤ f ≤1525.9 (NOTE 2)
F <sub>uw</sub> (Band XXII operation)	MHz	3502.4≤ f ≤3597.6	3495≤ f ≤3605
F <sub>uw</sub> (Band XXV operation)	MHz	1922.4≤ f ≤2002.6	1915≤ f ≤2010
F <sub>uw</sub> (Band XXVI operation)	MHz	851.4≤ f ≤901.6	844≤ f ≤909
UE transmitted mean power	dBm	20 (for Power class 3 and 3bis) 18 (for Power class 4) NOTE 4	
NOTE 1: I <sub>blocking</sub> (modulated) consists of the common channels needed for tests as specified in Table C.7 and 16 dedicated data channels as specified in Table C.6.			
NOTE 2: For Band VI, Band XIX and Band XXI, the unwanted interfering signal does not fall inside the UE receive band, but within the first 15 MHz below or above the UE receive band.			
NOTE 3: For DC-HSUPA, negative offset refers to the assigned channel frequency of the lowest carrier frequency used and positive offset refers to the assigned channel frequency of the highest carrier frequency used.			
NOTE 4: The UE transmitted mean power shall be reduced by 0.5dB for a UE operating in band XXII.			



**Table 7.6C: Reference input powers for in-band blocking, DC-HSUPA.**

Operating Band	Unit	HS-PDSCH_Ec	$\hat{I}_{or}$
I	dBm/3.84 MHz	-110	-99.7
II	dBm/3.84 MHz	-108	-97.7
III	dBm/3.84 MHz	-107	-96.7
IV	dBm/3.84 MHz	-110	-99.7
V	dBm/3.84 MHz	-104.3	-94
VI	dBm/3.84 MHz	-104.7	-94.4
VII	dBm/3.84 MHz	-108	-97.7
VIII	dBm/3.84 MHz	-101.1	-90.8
IX	dBm/3.84 MHz	-109	-98.7
X	dBm/3.84 MHz	-110	-99.7
XI	dBm/3.84 MHz	-101.4	-91.1
XII	dBm/3.84 MHz	N/A	N/A
XIII	dBm/3.84 MHz	N/A	N/A
XIV	dBm/3.84 MHz	N/A	N/A
XIX	dBm/3.84 MHz	-104.7	-94.4
XX	dBm/3.84 MHz	N/A	N/A
XXI	dBm/3.84 MHz	-101.4	-91.1
XXII	dBm/3.84 MHz	-107	-96.7
XXV	dBm/3.84 MHz	-106.5	-96.2
XXVI	dBm/3.84 MHz	-101.1	-90.8
NOTE 1 For the UE which supports both Band III and Band IX operating frequencies, the reference sensitivity level of TBD dBm <REF_Ec,in-band> shall apply for Band IX. The corresponding <REF $\hat{I}_{or,in-band}$ > is TBD dBm			
NOTE 2 For the UE which supports both Band XI and Band XXI operating frequencies, the reference input power level is FFS.			
NOTE 3 For the UE which supports DB-DC-HSDPA configuration in Table 5.0aA the < HS-PDSCH_Ec > and < $\hat{I}_{or}$ > are allowed to be increased by an amount defined in Table 7.12.			
NOTE 4 For the UE which supports dual band 4C-HSDPA configuration in Table 5.0aC the < HS-PDSCH_Ec > and < $\hat{I}_{or}$ > are allowed to be increased by an amount defined in Table 7.13.			

## 7.6.1C Additional requirement for single band 4C-HSDPA (In-band blocking)

### 7.6.1C.1 Single uplink operation

The BLER measured on each individual cell shall not exceed 0.1 for the parameters specified in Table 7.6D and Table 7.6E. In-band blocking is defined for an unwanted interfering signal falling into the UE receive band or into the first 15 MHz below or above the UE receive band.



**Table 7.6D: Test parameters for in-band blocking, single band 4C-HSDPA, single uplink operation**

Parameter	Unit	Level	
I <sub>blocking</sub> mean power (modulated)	dBm	-56	-44
F <sub>uw</sub> offset (NOTE 2)		=±10 MHz	≤-15 MHz & ≥15 MHz
F <sub>uw</sub> (Band I operation)	MHz	2102.4≤ f ≤2177.6	2095≤ f ≤2185
F <sub>uw</sub> (Band II operation)	MHz	1922.4≤ f ≤1997.6	1915≤ f ≤2005
UE transmitted mean power	dBm	20 (for Power class 3 and 3bis) 18 (for Power class 4)	
NOTE 1: I <sub>blocking</sub> (modulated) consists of the common channels needed for tests as specified in Table C.7 and 16 dedicated data channels as specified in Table C.6.			
NOTE 2: For single band 4C-HSDPA, negative offset refers to the assigned channel frequency of the lowest carrier frequencies, and positive offset refers to the assigned channel frequency of the highest carrier frequencies.			

**Table 7.6E: In-band blocking requirements, single band 4C-HSDPA, single uplink operation**

Single band 4C-HSDPA Configuration	DL Band	HS-PDSCH_Ec (dBm/3.84MHz)	$\hat{I}_{\text{or}}$ (dBm/3.84MHz)	UL-DL carrier separation
I-3	I	<REFSENS>+3 dB	<REF $\hat{I}_{\text{or}}$ >+3 dB	Minimum
II-3, II-4	II	<REFSENS>+3 dB	<REF $\hat{I}_{\text{or}}$ >+3 dB	Minimum
NOTE: <REFSENS> and <REF $\hat{I}_{\text{or}}$ > refer to the HS-PDSCH_Ec<REFSENS> and the HS-PDSCH<REF $\hat{I}_{\text{or}}$ > as specified in Table 7.2C for single band 4C-HSDPA.				

### 7.6.1C.2 Dual uplink operation

The BLER measured on each individual cell shall not exceed 0.1 for the parameters specified in Table 7.6F and Table 7.6G. In-band blocking is defined for an unwanted interfering signal falling into the UE receive band or into the first 15 MHz below or above the UE receive band.

**Table 7.6F: Test parameters for in-band blocking, single band 4C-HSDPA, dual uplink operation**

Parameter	Unit	Level	
$I_{\text{blocking}}$ mean power (modulated)	dBm	-56	-44
$F_{\text{uw offset}}$ (NOTE 2)		$\pm 10$ MHz	$\leq -15$ MHz & $\geq 15$ MHz
$F_{\text{uw}}$ (Band I operation)	MHz	$2102.4 \leq f \leq 2177.6$	$2095 \leq f \leq 2185$
$F_{\text{uw}}$ (Band II operation)	MHz	$1922.4 \leq f \leq 1997.6$	$1915 \leq f \leq 2005$
NOTE 1: $I_{\text{blocking}}$ (modulated) consists of the common channels needed for tests as specified in Table C.7 and 16 dedicated data channels as specified in Table C.6.			
NOTE 2: For single band 4C-HSDPA, negative offset refers to the assigned channel frequency of the lowest carrier frequencies, and positive offset refers to the assigned channel frequency of the highest carrier frequencies.			



**Table 7.6G: In-band blocking requirements, single band 4C-HSDPA, dual uplink operation**

Single band 4C-HSDPA Configuration	DL Band	HS-PDSCH_Ec (dBm/3.84MHz)	$\hat{I}_{or}$ (dBm/3.84MHz)	UE transmitted mean power (dBm)	UL-DL carrier separation
I-3	I	-110	-99.7	20 (for Power class 3 and 3bis) 18 (for Power class 4)	Minimum
II-3, II-4	II	-108	-97.7	20 (for Power class 3 and 3bis) 18 (for Power class 4)	Minimum
NOTE 1 For the UE which supports DB-DC-HSDPA configuration in Table 5.0aA the < HS-PDSCH_Ec > and < $\hat{I}_{or}$ > are allowed to be increased by an amount defined in Table 7.12.					
NOTE 2 For the UE which supports dual band 4C-HSDPA configuration in Table 5.0aC the < HS-PDSCH_Ec > and < $\hat{I}_{or}$ > are allowed to be increased by an amount defined in Table 7.13.					

## 7.6.1D Additional requirement for dual band 4C-HSDPA (In-band blocking)

### 7.6.1D.1 Single uplink operation

The BLER measured on each individual cell shall not exceed 0.1 for the parameters specified in Table 7.6H and Table 7.6I. In-band blocking is defined for an unwanted interfering signal falling into the UE receive band or into the first 15 MHz below or above the UE receive band.

**Table 7.6H: Test parameters for in-band blocking, dual band 4C-HSDPA, single uplink operation**

Parameter	Unit	Level	
I <sub>blocking</sub> mean power (modulated)	dBm	-56	-44
F <sub>uw</sub> offset (NOTE 2)		=±10 MHz	≤-15 MHz & ≥15 MHz
F <sub>uw</sub> (Band I operation)	MHz	2102.4≤ f ≤2177.6	2095≤ f ≤2185
F <sub>uw</sub> (Band II operation)	MHz	1922.4≤ f ≤1997.6	1915≤ f ≤2005
F <sub>uw</sub> (Band IV operation)	MHz	2102.4≤ f ≤2162.6	2095≤ f ≤2170
F <sub>uw</sub> (Band V operation)	MHz	861.4≤ f ≤901.6	854≤ f ≤909
F <sub>uw</sub> (Band VIII operation)	MHz	917.4≤ f ≤967.6	910 ≤ f ≤ 975
F <sub>uw</sub> (Band XXXII operation)	MHz	1444.4≤ f ≤1503.6	1437≤ f ≤1511
UE transmitted mean power	dBm	20 (for Power class 3 and 3bis) 18 (for Power class 4)	
NOTE 1: I <sub>blocking</sub> (modulated) consists of the common channels needed for tests as specified in Table C.7 and 16 dedicated data channels as specified in Table C.6.			
NOTE 2: For dual band 4C-HSDPA, negative offset refers to the assigned channel frequency of the lowest carrier frequenc(ies) in each band, and positive offset refers to the assigned channel frequency of the highest carrier frequenc(ies) in each band.			



**Table 7.6I: In-band blocking requirements, dual band 4C-HSDPA, single uplink operation**

Dual band 4C-HSDPA Configuration	DL Band	UL Band	HS-PDSCH_Ec (dBm/3.84MHz)	$\hat{I}_{or}$ (dBm/3.84MHz)	UL-DL carrier separation
I-2-VIII-1	I	I	<REFSENS>+3 dB	<REF $\hat{I}_{or}$ >+3 dB	Minimum
I-3-VIII-1	VIII		<REFSENS>+3 dB	<REF $\hat{I}_{or}$ >+3 dB	Minimum
I-2-VIII-2	I	VIII	<REFSENS>+3 dB	<REF $\hat{I}_{or}$ >+3 dB	Minimum
I-1-VIII-2	VIII		<REFSENS>+3 dB	<REF $\hat{I}_{or}$ >+3 dB	Minimum
II-1-IV-2	II	II	<REFSENS>+3 dB	<REF $\hat{I}_{or}$ >+3 dB	Minimum
II-2-IV-1	IV		<REFSENS>+3 dB	<REF $\hat{I}_{or}$ >+3 dB	Minimum
II-2-IV-2	II	IV	<REFSENS>+3 dB	<REF $\hat{I}_{or}$ >+3 dB	Minimum
	IV		<REFSENS>+3 dB	<REF $\hat{I}_{or}$ >+3 dB	Minimum
I-1-V-2	I	I	<REFSENS>+3 dB	<REF $\hat{I}_{or}$ >+3 dB	Minimum
I-2-V-1	V		<REFSENS>+3 dB	<REF $\hat{I}_{or}$ >+3 dB	Minimum
I-2-V-2	I	V	<REFSENS>+3 dB	<REF $\hat{I}_{or}$ >+3 dB	Minimum
	V		<REFSENS>+3 dB	<REF $\hat{I}_{or}$ >+3 dB	Minimum
II-1-V-2	II	II	<REFSENS>+3 dB	<REF $\hat{I}_{or}$ >+3 dB	Minimum
	V		<REFSENS>+3 dB	<REF $\hat{I}_{or}$ >+3 dB	Minimum
	II	V	<REFSENS>+3 dB	<REF $\hat{I}_{or}$ >+3 dB	Minimum
	V		<REFSENS>+3 dB	<REF $\hat{I}_{or}$ >+3 dB	Minimum
I-1-XXXII-2	I	I	<REFSENS>+3 dB	<REF $\hat{I}_{or}$ >+3 dB	Minimum
I-2-XXXII-1	XXXII		<REFSENS>+ 3 dB	<REF $\hat{I}_{or}$ >+ 3dB	Minimum
NOTE: <REFSENS> and <REF $\hat{I}_{or}$ > refer to the HS-PDSCH_Ec<REFSENS> and the HS-PDSCH<REF $\hat{I}_{or}$ > as specified in Table 7.2D for dual band 4C-HSDPA.					

### 7.6.1D.2 Dual uplink operation

The BLER measured on each individual cell shall not exceed 0.1 for the parameters specified in Table 7.6J and Table 7.6K. In-band blocking is defined for an unwanted interfering signal falling into the UE receive band or into the first 15 MHz below or above the UE receive band.

**Table 7.6J: Test parameters for in-band blocking, dual band 4C-HSDPA, dual uplink operation**

Parameter	Unit	Level	
$I_{blocking}$ mean power (modulated)	dBm	-56	-44
$F_{uw}$ offset (NOTE 2)		$\pm 10$ MHz	$\leq 15$ MHz & $\geq 15$ MHz
$F_{uw}$ (Band I operation)	MHz	$2102.4 \leq f \leq 2177.6$	$2095 \leq f \leq 2185$
$F_{uw}$ (Band II operation)	MHz	$1922.4 \leq f \leq 1997.6$	$1915 \leq f \leq 2005$
$F_{uw}$ (Band IV operation)	MHz	$2102.4 \leq f \leq 2162.6$	$2095 \leq f \leq 2170$
$F_{uw}$ (Band V operation)	MHz	$861.4 \leq f \leq 901.6$	$854 \leq f \leq 909$
$F_{uw}$ (Band VIII operation)	MHz	$917.4 \leq f \leq 967.6$	$910 \leq f \leq 975$
$F_{uw}$ (Band XXXII operation)	MHz	$1444.4 \leq f \leq 1503.6$	$1437 \leq f \leq 1511$
NOTE 1: $I_{blocking}$ (modulated) consists of the common channels needed for tests as specified in Table C.7 and 16 dedicated data channels as specified in Table C.6.			
NOTE 2: For dual band 4C-HSDPA, negative offset refers to the assigned channel frequency of the lowest carrier frequenc(ies) in each band, and positive offset refers to the assigned channel frequency of the highest carrier frequenc(ies) in each band.			



Table 7.6K: In-band blocking requirements, dual band 4C-HSDPA, dual uplink operation

Dual band 4C-HSDPA Configuration	DL Band	UL Band	HS-PDSCH_Ec (dBm/3.84MHz)	$\hat{I}_{or}$ (dBm/3.84MHz)	UE transmitted mean power (dBm)	UL-DL carrier separation
I-2-VIII-1 I-3-VIII-1	I	I	-110	-99.7	20 (for Power class 3 and 3bis) 18 (for Power class 4)	Minimum
	VIII		-107	-96.7	20 (for Power class 3 and 3bis) 18 (for Power class 4)	Minimum
I-2-VIII-2	I	I	-110	-99.7	20 (for Power class 3 and 3bis) 18 (for Power class 4)	Minimum
	VIII		-107	-96.7	20 (for Power class 3 and 3bis) 18 (for Power class 4)	Minimum
	I	VIII	-110	-99.7	20 (for Power class 3 and 3bis) 18 (for Power class 4)	Minimum
	VIII		-99.7	-89.4	20 (for Power class 3 and 3bis) 18 (for Power class 4)	Minimum
I-1-VIII-2	I	VIII	-110	-99.7	20 (for Power class 3 and 3bis) 18 (for Power class 4)	Minimum
	VIII		-99.7	-89.4	20 (for Power class 3 and 3bis) 18 (for Power class 4)	Minimum
II-1-IV-2	II	IV	-107	-96.7	20 (for Power class 3 and 3bis) 18 (for Power class 4)	Minimum
	IV		-109	-98.7	20 (for Power class 3 and 3bis) 18 (for Power class 4)	Minimum
II-2-IV-1	II	II	-107	-96.7	20 (for Power class 3 and 3bis) 18 (for Power class 4)	Minimum
	IV		-109	-98.7	20 (for Power class 3 and 3bis) 18 (for Power class 4)	Minimum
II-2-IV-2	II	II	-107	-96.7	20 (for Power class 3 and 3bis) 18 (for Power class 4)	Minimum
	IV		-109	-98.7	20 (for Power class 3 and 3bis) 18 (for Power class 4)	Minimum
	II	IV	-107	-96.7	20 (for Power class 3 and 3bis) 18 (for Power class 4)	Minimum
	IV		-109	-98.7	20 (for Power class 3 and 3bis) 18 (for Power class 4)	Minimum
I-1-V-2	I	V	-110	-99.7	20 (for Power class 3 and 3bis) 18 (for Power class 4)	Minimum
	V		-103.2	-92.9	20 (for Power class 3 and 3bis) 18 (for Power class 4)	Minimum
I-2-V-1	I	I	-110	-99.7	20 (for Power class 3 and 3bis) 18 (for Power class 4)	Minimum
	V		-108	-97.7	20 (for Power class 3 and 3bis) 18 (for Power class 4)	Minimum
I-2-V-2	I	I	-110	-99.7	20 (for Power class 3 and 3bis) 18 (for Power class 4)	Minimum
	V		-108	-97.7	20 (for Power class 3 and 3bis) 18 (for Power class 4)	Minimum
	I	V	-110	-99.7	20 (for Power class 3 and 3bis) 18 (for Power class 4)	Minimum
	V		-103.2	-92.9	20 (for Power class 3 and 3bis) 18 (for Power class 4)	Minimum
II-1-V-2	II	V	-108	-97.7	20 (for Power class 3 and 3bis) 18 (for Power class 4)	Minimum
	V		-103.1	-92.8	20 (for Power class 3 and 3bis) 18 (for Power class 4)	Minimum
I-2-XXXII-1	I	I	-110	-99.7	20 (for Power class 3 and 3bis) 18 (for Power class 4)	Minimum
	XXXII		-110	-99.7	20 (for Power class 3 and 3bis) 18 (for Power class 4)	



## 7.6.1E Additional requirement for single band 8C-HSDPA (In-band blocking)

### 7.6.1E.1 Single uplink operation

The BLER measured on each individual cell shall not exceed 0.1 for the parameters specified in Table 7.6L and Table 7.6M. In-band blocking is defined for an unwanted interfering signal falling into the UE receive band or into the first 15 MHz below or above the UE receive band.

**Table 7.6L: Test parameters for in-band blocking, single band 8C-HSDPA, single uplink operation**

Parameter	Unit	Level	
$I_{\text{blocking}}$ mean power (modulated)	dBm	-56	-44
$F_{\text{uw}}$ offset (NOTE 2)		$\pm 10$ MHz	$\leq -15$ MHz & $\geq 15$ MHz
$F_{\text{uw}}$ (Band I operation)	MHz	$2102.4 \leq f \leq 2177.6$	$2095 \leq f \leq 2185$
$F_{\text{uw}}$ (Band II operation)	MHz	$1922.4 \leq f \leq 1997.6$	$1915 \leq f \leq 2005$
UE transmitted mean power	dBm	20 (for Power class 3 and 3bis) 18 (for Power class 4)	
NOTE 1: $I_{\text{blocking}}$ (modulated) consists of the common channels needed for tests as specified in Table C.7 and 16 dedicated data channels as specified in Table C.6.			
NOTE 2: For single band 8C-HSDPA, negative offset refers to the assigned channel frequency of the lowest carrier frequency, and positive offset refers to the assigned channel frequency of the highest carrier frequency.			

**Table 7.6M: In-band blocking requirements, single band 8C-HSDPA, single uplink operation**

Single band 8C-HSDPA Configuration	DL Band	HS-PDSCH_Ec (dBm/3.84MHz)	$\hat{I}_{\text{or}}$ (dBm/3.84MHz)	UL-DL carrier separation
I-8	I	<REFSENS>+3 dB	<REF $\hat{I}_{\text{or}}$ >+3 dB	Minimum
NOTE: <REFSENS> and <REF $\hat{I}_{\text{or}}$ > refer to the HS-PDSCH_Ec<REFSENS> and the HS-PDSCH<REF $\hat{I}_{\text{or}}$ > as specified in Table 7.2E for single band 8C-HSDPA.				

### 7.6.1E.2 Dual uplink operation

The BLER measured on each individual cell shall not exceed 0.1 for the parameters specified in Table 7.6N and Table 7.6O. In-band blocking is defined for an unwanted interfering signal falling into the UE receive band or into the first 15 MHz below or above the UE receive band.



**Table 7.6N: Test parameters for in-band blocking, single band 8C-HSDPA, dual uplink operation**

Parameter	Unit	Level	
$I_{\text{blocking}}$ mean power (modulated)	dBm	-56	-44
$F_{\text{uw}}$ offset (NOTE 2)		$\pm 10$ MHz	$\leq -15$ MHz & $\geq 15$ MHz
$F_{\text{uw}}$ (Band I operation)	MHz	$2102.4 \leq f \leq 2177.6$	$2095 \leq f \leq 2185$
$F_{\text{uw}}$ (Band II operation)	MHz	$1922.4 \leq f \leq 1997.6$	$1915 \leq f \leq 2005$
NOTE 1: $I_{\text{blocking}}$ (modulated) consists of the common channels needed for tests as specified in Table C.7 and 16 dedicated data channels as specified in Table C.6.			
NOTE 2: For single band 8C-HSDPA, negative offset refers to the assigned channel frequency of the lowest carrier frequency, and positive offset refers to the assigned channel frequency of the highest carrier frequency.			

**Table 7.6O: In-band blocking requirements, single band 8C-HSDPA, dual uplink operation**

Single band 8C-HSDPA Configuration	DL Band	HS-PDSCH_Ec (dBm/3.84MHz)	$\hat{I}_{\text{or}}$ (dBm/3.84MHz)	UE transmitted mean power (dBm)	UL-DL carrier separation
I-8	I	-110	-99.7	20 (for Power class 3 and 3bis) 18 (for Power class 4)	Minimum
NOTE 1 For the UE which supports DB-DC-HSDPA configuration in Table 5.0aA the $\langle \text{HS-PDSCH\_Ec} \rangle$ and $\langle \hat{I}_{\text{or}} \rangle$ are allowed to be increased by an amount defined in Table 7.12.					
NOTE 2 For the UE which supports dual band 4C-HSDPA configuration in Table 5.0aC the $\langle \text{HS-PDSCH\_Ec} \rangle$ and $\langle \hat{I}_{\text{or}} \rangle$ are allowed to be increased by an amount defined in Table 7.13.					

## 7.6.1F Additional requirement for single band NC-4C-HSDPA (In-band blocking)

### 7.6.1F.1 Single uplink operation

The BLER measured on each individual cell shall not exceed 0.1 for the parameters specified in Table 7.6P and Table 7.6Q. In-band blocking is defined for an unwanted interfering signal falling into the UE receive band or into the first 15 MHz below or above the UE receive band.



**Table 7.6P: Test parameters for in-band blocking, single band NC-4C-HSDPA, single uplink operation**

Parameter	Unit	Level	
$I_{\text{blocking}}$ mean power (modulated)	dBm	-56	-44 (NOTE 4)
$F_{\text{UW}}$ offset (NOTE 2,3)	MHz	$=\pm 10$ MHz	$\leq -15$ MHz & $\geq 15$ MHz
$F_{\text{UW}}$ (Band I operation)	MHz	$2102.4 \leq f \leq 2177.6$	$2095 \leq f \leq 2185$
$F_{\text{UW}}$ (Band IV operation)	MHz	$2102.4 \leq f \leq 2162.6$	$2095 \leq f \leq 2170$
UE transmitted mean power	dBm	20 (for Power class 3 and 3bis) 18 (for Power class 4)	
NOTE 1: $I_{\text{blocking}}$ (modulated) consists of the common channels needed for tests as specified in Table C.7 and 16 dedicated data channels as specified in Table C.6.			
NOTE 2: For single band NC-4C-HSPDA out-of-gap, negative offset refers to the assigned channel frequency of the lowest carrier belonging to the lower subblock of carriers, and positive offset refers to the assigned channel frequency of the highest carrier belonging to the higher subblock of carriers.			
NOTE 3: For single band NC-4C-HSPDA in-gap, negative offset refers to the assigned channel frequency of the lowest carrier belonging to the higher subblock of carriers, and positive offset refers to the assigned channel frequency of the highest carrier belonging to the lower subblock of carriers.			
NOTE 4: The $I_{\text{blocking}}$ (modulated) interferer with mean power equals to -44dBm is only applicable for scenario with gap length $\geq 25$ MHz.			

**Table 7.6Q: In-band blocking requirements, single band NC-4C-HSDPA, single uplink operation**

Single band NC-4C-HSDPA Configuration	Test type	DL Band	HS-PDSCH $E_c$ (dBm/3.84MHz)	$\hat{I}_{\text{or}}$ (dBm/3.84MHz)	UL-DL carrier separation
I-1-5-1, I-2-5-1, I-3-10-1	Out-of-gap	I	$\langle \text{REFSENS} \rangle + 3$ dB	$\langle \text{REF} \hat{I}_{\text{or}} \rangle + 3$ dB	Minimum
IV-2-15-2, IV-2-20-1, IV-2-25-2	In-gap	IV	$\langle \text{REFSENS} \rangle + 3$ dB	$\langle \text{REF} \hat{I}_{\text{or}} \rangle + 3$ dB	Minimum
IV-1-5-1, IV-2-10-1, IV-2-15-2, IV-2-20-1, IV-2-25-2	Out-of-gap	IV	$\langle \text{REFSENS} \rangle + 3$ dB	$\langle \text{REF} \hat{I}_{\text{or}} \rangle + 3$ dB	Minimum
NOTE: $\langle \text{REFSENS} \rangle$ and $\langle \text{REF} \hat{I}_{\text{or}} \rangle$ refer to the HS-PDSCH $E_c \langle \text{REFSENS} \rangle$ and the HS-PDSCH $\langle \text{REF} \hat{I}_{\text{or}} \rangle$ as specified in Table 7.2E for single band NC-4C-HSDPA.					

### 7.6.1F.2 Dual uplink operation

The BLER measured on each individual cell shall not exceed 0.1 for the parameters specified in Table 7.6R and Table 7.6S. In-band blocking is defined for an unwanted interfering signal falling into the UE receive band or into the first 15 MHz below or above the UE receive band.



**Table 7.6R: Test parameters for in-band blocking, single band NC-4C-HSDPA, dual uplink operation**

Parameter	Unit	Level	
$I_{\text{blocking}}$ mean power (modulated)	dBm	-56	-44 (NOTE 4)
$F_{\text{UW}}$ offset (NOTE 2,3)	MHz	$=\pm 10$ MHz	$\leq -15$ MHz & $\geq 15$ MHz
$F_{\text{UW}}$ (Band I operation)	MHz	$2102.4 \leq f \leq 2177.6$	$2095 \leq f \leq 2185$
$F_{\text{UW}}$ (Band IV operation)	MHz	$2102.4 \leq f \leq 2162.6$	$2095 \leq f \leq 2170$
UE transmitted mean power	dBm	20 (for Power class 3 and 3bis) 18 (for Power class 4)	
NOTE 1: $I_{\text{blocking}}$ (modulated) consists of the common channels needed for tests as specified in Table C.7 and 16 dedicated data channels as specified in Table C.6.			
NOTE 2: For single band NC-4C-HSPDA out-of-gap, negative offset refers to the assigned channel frequency of the lowest carrier belonging to the lower subblock of carriers, and positive offset refers to the assigned channel frequency of the highest carrier belonging to the higher subblock of carriers.			
NOTE 3: For single band NC-4C-HSPDA in-gap, negative offset refers to the assigned channel frequency of the lowest carrier belonging to the higher subblock of carriers, and positive offset refers to the assigned channel frequency of the highest carrier belonging to the lower subblock of carriers.			
NOTE 4: The $I_{\text{blocking}}$ (modulated) interferer with mean power equals to -44dBm is only applicable for scenario with gap length $\geq 25$ MHz.			

**Table 7.6S: In-band blocking requirements, single band NC-4C-HSDPA, dual uplink operation**

Single band NC-4C-HSDPA Configuration	Test type	DL Band	HS-PDSCH $E_c$ (dBm/3.84MHz)	$\hat{I}_{\text{or}}$ (dBm/3.84MHz)	UL-DL carrier separation
I-2-5-1, I-3-10-1	Out-of-gap	I	-110	-99.7	Minimum
IV-2-15-2, IV-2-20-1, IV-2-25-2	In-gap	IV	-110	-99.7	Minimum
IV-2-10-1, IV-2-15-2, IV-2-20-1, IV-2-25-2	Out-of-gap	IV	-110	-99.7	Minimum
NOTE 1 For the UE which supports DB-DC-HSDPA configuration in Table 5.0aA the $\langle \text{HS-PDSCH}_E_c \rangle$ and $\langle \hat{I}_{\text{or}} \rangle$ are allowed to be increased by an amount defined in Table 7.12.					
NOTE 2 For the UE which supports dual band 4C-HSDPA configuration in Table 5.0aC the $\langle \text{HS-PDSCH}_E_c \rangle$ and $\langle \hat{I}_{\text{or}} \rangle$ are allowed to be increased by an amount defined in Table 7.13.					

## 7.6.2 Minimum requirement (Out-of-band blocking)

The BER shall not exceed 0.001 for the parameters specified in Table 7.7. Out-of-band blocking is defined for an unwanted interfering signal falling more than 15 MHz below or above the UE receive band.

For Table 7.7 in frequency range 1, 2 and 3, up to 24 exceptions are allowed for spurious response frequencies in each assigned frequency channel when measured using a 1 MHz step size. For these exceptions the requirements of clause 7.7 Spurious response are applicable.

For Table 7.7 in frequency range 4, up to 8 exceptions are allowed for spurious response frequencies in each assigned frequency channel when measured using a 1 MHz step size. For these exceptions the requirements of clause 7.7 Spurious response are applicable



Table 7.7: Out of band blocking

Parameter	Unit	Frequency range 1	Frequency range 2	Frequency range 3	Frequency range 4
DPCH_Ec	dBm / 3.84 MHz	<REFSENS>+3 dB	<REFSENS>+3 dB	<REFSENS>+3 dB	<REFSENS> +3 dB
I <sub>or</sub>	dBm / 3.84 MHz	<REFI <sub>or</sub> > + 3 dB	<REFI <sub>or</sub> > + 3 dB	<REFI <sub>or</sub> > + 3 dB	<REFI <sub>or</sub> > + 3 dB
I <sub>blocking</sub> (CW)	dBm	-44	-30	-15	-15
F <sub>uw</sub> (Band I operation)	MHz	2050<f <2095 2185<f <2230	2025 <f ≤2050 2230 ≤f <2255	1< f ≤2025 2255≤f<12750	-
F <sub>uw</sub> (Band II operation)	MHz	1870<f <1915 2005<f <2050	1845 <f ≤1870 2050 ≤f <2075	1< f ≤1845 2075≤f<12750	1850 ≤ f ≤ 1910
F <sub>uw</sub> (Band III operation)	MHz	1745 <f <1790 1895<f <1940	1720 <f ≤ 1745 1940≤f < 1965	1< f ≤1720 1965≤f<12750	-
F <sub>uw</sub> (Band IV operation)	MHz	2050< f <2095 2170< f <2215	2025< f ≤2050 2215≤ f < 2240	1< f ≤2025 2240≤f<12750	-
F <sub>uw</sub> (Band V operation)	MHz	809< f <854 909< f <954	784< f ≤809 954≤ f < 979	1< f ≤784 979≤f<12750	824 ≤ f ≤ 849
F <sub>uw</sub> (Band VI operation)	MHz	815 < f < 860 900 < f < 945	790 < f ≤ 815 945 ≤ f < 970	1 < f ≤ 790 970 ≤ f < 12750	-
F <sub>uw</sub> (Band VII operation)	MHz	2570 < f < 2605 2705 < f < 2750	na 2750 ≤ f < 2775	1 < f ≤ 2570 2775 ≤ f < 12750	-
F <sub>uw</sub> (Band VIII operation)	MHz	865 < f < 910 975 < f < 1020	840 < f ≤ 865 1020 ≤ f < 1045	1 < f ≤ 840 1045 ≤ f < 12750	-
F <sub>uw</sub> (Band IX operation)	MHz	1784.9 < f < 1829.9 1894.9 < f < 1939.9	1759.9 < f ≤ 1784.9 1939.9 ≤ f < 1964.9	1 < f ≤ 1759.9 1964.9 ≤ f < 12750	-
F <sub>uw</sub> (Band X operation)	MHz	2050 < f < 2095 2185 < f < 2230	2025 < f ≤ 2050 2230 ≤ f < 2255	1 < f ≤ 2025 2255 ≤f< 12750	-
F <sub>uw</sub> (Band XI operation)	MHz	1415.9 < f < 1460.9 1510.9 < f < 1555.9	1390.9 < f ≤ 1415.9 1555.9 ≤ f < 1580.9	1 < f ≤ 1390.9 1580.9 ≤ f < 12750	-
F <sub>uw</sub> (Band XII operation)	MHz	669 < f < 714 761 < f < 806	644 < f ≤ 669 806 ≤ f < 831	1 < f ≤ 644 831 ≤f< 12750	699 ≤ f ≤ 716
F <sub>uw</sub> (Band XIII operation)	MHz	686 < f < 731 771 < f < 816	61 < f ≤ 686 816 ≤ f < 841	1 < f ≤ 661 841 ≤f< 12750	776 ≤ f ≤ 788
F <sub>uw</sub> (Band XIV operation)	MHz	698 < f < 743 783 < f < 828	673 < f ≤ 698 828 ≤ f < 853	1 < f ≤ 673 853 ≤f< 12750	788 ≤ f ≤ 798
F <sub>uw</sub> (Band XIX operation)	MHz	815 < f < 860 905 < f < 950	790 < f ≤ 815 950 ≤ f < 975	1 < f ≤ 790 975 ≤ f < 12750	-
F <sub>uw</sub> (Band XX operation)	MHz	731< f <776 836< f <881	706 < f ≤ 731 881 ≤ f < 906	1 < f ≤ 706 906 ≤ f < 12750	-
F <sub>uw</sub> (Band XXI operation)	MHz	1435.9 < f < 1480.9 1525.9 < f < 1570.9	1410.9 < f ≤ 1435.9 1570.9 ≤ f < 1595.9	1 < f ≤ 1410.9 1595.9 ≤ f < 12750	-
F <sub>uw</sub> (Band XXII operation)	MHz	3450 <f <3495 3605<f <3650	3425 <f ≤ 3450 3650≤f < 3675	1< f ≤3425 3675≤f<12750	-
F <sub>uw</sub> (Band XXV operation)	MHz	1870<f <1915 2010<f <2055	1845 <f ≤1870 2055 ≤f <2080	1< f ≤1845 2080≤f<12750	1850 ≤ f ≤ 1915
F <sub>uw</sub> (Band XXVI operation)	MHz	799< f <844 909< f <954	774< f ≤799 954≤ f < 979	1< f ≤774 979 ≤ f < 12750	814 ≤ f ≤ 849
UE transmitted mean power	dBm	20 (for Power class 3 and 3bis) 18 (for Power class 4) NOTE 3			
Band I operation	For 2095≤f ≤2185 MHz, the appropriate in-band blocking or adjacent channel selectivity in subclause 7.5.1 and subclause 7.6.1 shall be applied.				
Band II operation	For 1915≤f ≤2005 MHz, the appropriate in-band blocking or adjacent channel selectivity in subclause 7.5.1 and subclause 7.6.1 shall be applied				
Band III operation	For 1790≤f ≤1895 MHz, the appropriate in-band blocking or adjacent channel selectivity in subclause 7.5.1 and subclause 7.6.1 shall be applied.				
Band IV operation	For 2095≤f≤2170 MHz, the appropriate in-band blocking or adjacent channel selectivity in subclause 7.5.1 and subclause 7.6.1 shall be applied.				
Band V operation	For 854≤f≤909 MHz, the appropriate in-band blocking or adjacent channel selectivity in subclause 7.5.1 and subclause 7.6.1 shall be applied.				
Band VI operation	For 860≤f≤900 MHz, the appropriate in-band blocking or adjacent channel selectivity in subclause 7.5.1 and subclause 7.6.1 shall be applied.				



Band VII operation	For $2605 \leq f \leq 2705$ MHz, the appropriate in-band blocking or adjacent channel selectivity in subclause 7.5.1 and subclause 7.6.1 shall be applied.
Band VIII operation	For $910 \leq f \leq 975$ MHz, the appropriate in-band blocking or adjacent channel selectivity in subclause 7.5.1 and subclause 7.6.1 shall be applied.
Band IX operation	For $1829.9 \leq f \leq 1894.9$ MHz, the appropriate in-band blocking or adjacent channel selectivity in subclause 7.5.1 and subclause 7.6.1 shall be applied.
Band X operation	For $2095 \leq f \leq 2185$ MHz, the appropriate in-band blocking or adjacent channel selectivity in subclause 7.5.1 and subclause 7.6.1 shall be applied.
Band XI operation	For $1460.9 \leq f \leq 1510.9$ MHz, the appropriate in-band blocking or adjacent channel selectivity in subclause 7.5.1 and subclause 7.6.1 shall be applied.
Band XII operation	For $714 \leq f \leq 761$ MHz, the appropriate in-band blocking or adjacent channel selectivity in subclause 7.5.1 and subclause 7.6.1 shall be applied.
Band XIII operation	For $731 \leq f \leq 771$ MHz, the appropriate in-band blocking or adjacent channel selectivity in subclause 7.5.1 and subclause 7.6.1 shall be applied.
Band XIV operation	For $743 \leq f \leq 783$ MHz, the appropriate in-band blocking or adjacent channel selectivity in subclause 7.5.1 and subclause 7.6.1 shall be applied.
Band XIX operation	For $860 \leq f \leq 905$ MHz, the appropriate in-band blocking or adjacent channel selectivity in subclause 7.5.1 and subclause 7.6.1 shall be applied.
Band XX operation	For $776 \leq f \leq 836$ MHz, the appropriate in-band blocking or adjacent channel selectivity in subclause 7.5.1 and subclause 7.6.1 shall be applied.
Band XXI operation	For $1480.9 \leq f \leq 1525.9$ MHz, the appropriate in-band blocking or adjacent channel selectivity in subclause 7.5.1 and subclause 7.6.1 shall be applied.
Band XXII operation	For $3495 \leq f \leq 3605$ MHz, the appropriate in-band blocking or adjacent channel selectivity in subclause 7.5.1 and subclause 7.6.1 shall be applied. NOTE 3
Band XXV operation	For $1915 \leq f \leq 2010$ MHz, the appropriate in-band blocking or adjacent channel selectivity in subclause 7.5.1 and subclause 7.6.1 shall be applied
Band XXVI operation	For $844 \leq f \leq 909$ MHz, the appropriate in-band blocking or adjacent channel selectivity in subclause 7.5.1 and subclause 7.6.1 shall be applied.
NOTE 1: <REFSENS> and <REFI <sub>or</sub> > refer to the DPCH_Ec<REFSENS> and the DPCH<REFI <sub>or</sub> > as specified in Table 7.2.	
NOTE 2: For the UE which supports both Band XI and Band XXI operating frequencies, the Out of band blocking is FFS.	
NOTE 3: The UE transmitted mean power shall be reduced by 0.5dB for a UE operating in band XXII.	

## 7.6.2A Additional requirement for DC-HSDPA (Out-of-band blocking)

The BLER measured on each individual cell shall not exceed 0.1 for the parameters specified in Table 7.7AA. Out-of-band band blocking is defined for an unwanted interfering signal falling more than 15 MHz below or above the UE receive band.

For Table 7.7AA in frequency range 1, 2 and 3, up to 24 exceptions per received cell are allowed for spurious response frequencies in each assigned frequency channel when measured using a 1 MHz step size. For these exceptions the requirements of clause 7.7 Spurious response are applicable.

For Table 7.7AA in frequency range 4, up to 8 exceptions per received cell are allowed for spurious response frequencies in each assigned frequency channel when measured using a 1 MHz step size. For these exceptions the requirements of clause 7.7 Spurious response are applicable.



Table 7.7AA: Out of band blocking for DC-HSDPA

Parameter	Unit	Frequency range 1	Frequency range 2	Frequency range 3	Frequency range 4
HS-PDSCH_Ec	dBm / 3.84 MHz	<REFSENS>+3 dB	<REFSENS>+3 dB	<REFSENS>+3 dB	<REFSENS> +3 dB
I <sub>or</sub>	dBm / 3.84 MHz	<REFI <sub>or</sub> > + 3 dB	<REFI <sub>or</sub> > + 3 dB	<REFI <sub>or</sub> > + 3 dB	<REFI <sub>or</sub> > + 3 dB
I <sub>blocking</sub> (CW)	dBm	-44	-30	-15	-15
F <sub>uw</sub> (Band I operation)	MHz	2050<f <2095 2185<f <2230	2025 <f ≤2050 2230 ≤f <2255	1< f ≤2025 2255≤f<12750	-
F <sub>uw</sub> (Band II operation)	MHz	1870<f <1915 2005<f <2050	1845 <f ≤1870 2050 ≤f <2075	1< f ≤1845 2075≤f<12750	1850 ≤ f ≤ 1910
F <sub>uw</sub> (Band III operation)	MHz	1745 <f <1790 1895<f <1940	1720 <f ≤ 1745 1940≤f < 1965	1< f ≤1720 1965≤f<12750	-
F <sub>uw</sub> (Band IV operation)	MHz	2050< f <2095 2170< f <2215	2025< f ≤2050 2215≤ f < 2240	1< f ≤2025 2240≤f<12750	-
F <sub>uw</sub> (Band V operation)	MHz	809< f <854 909< f <954	784< f ≤809 954≤ f < 979	1< f ≤784 979≤f<12750	824 ≤ f ≤ 849
F <sub>uw</sub> (Band VI operation)	MHz	815 < f < 860 900 < f < 945	790 < f ≤ 815 945 ≤ f < 970	1 < f ≤ 790 970 ≤ f < 12750	-
F <sub>uw</sub> (Band VII operation)	MHz	2570 < f < 2605 2705 < f < 2750	na 2750 ≤ f < 2775	1 < f ≤ 2570 2775 ≤ f < 12750	-
F <sub>uw</sub> (Band VIII operation)	MHz	865 < f < 910 975 < f < 1020	840 < f ≤ 865 1020 ≤ f < 1045	1 < f ≤ 840 1045 ≤ f < 12750	-
F <sub>uw</sub> (Band IX operation)	MHz	1784.9 < f < 1829.9 1894.9 < f < 1939.9	1759.9 < f ≤ 1784.9 1939.9 ≤ f < 1964.9	1 < f ≤ 1759.9 1964.9 ≤ f < 12750	-
F <sub>uw</sub> (Band X operation)	MHz	2050 < f < 2095 2185 < f < 2230	2025 < f ≤ 2050 2230 ≤ f < 2255	1 < f ≤ 2025 2255 ≤f< 12750	-
F <sub>uw</sub> (Band XI operation)	MHz	1415.9 < f < 1460.9 1510.9 < f < 1555.9	1390.9 < f ≤ 1415.9 1555.9 ≤ f < 1580.9	1 < f ≤ 1390.9 1580.9 ≤ f < 12750	-
F <sub>uw</sub> (Band XII operation)	MHz	669 < f < 714 761 < f < 806	643 < f ≤ 669 806 ≤ f < 831	1 < f ≤ 644 831 ≤f< 12750	699 ≤ f ≤ 716
F <sub>uw</sub> (Band XIII operation)	MHz	686 < f < 731 771 < f < 816	61 < f ≤ 686 816 ≤ f < 841	1 < f ≤ 661 841 ≤f< 12750	776 ≤ f ≤ 788
F <sub>uw</sub> (Band XIV operation)	MHz	698 < f < 743 783 < f < 828	673 < f ≤ 698 828 ≤ f < 853	1 < f ≤ 673 853 ≤f< 12750	788 ≤ f ≤ 798
F <sub>uw</sub> (Band XIX operation)	MHz	815 < f < 860 905 < f < 950	790 < f ≤ 815 950 ≤ f < 975	1 < f ≤ 790 975 ≤ f < 12750	-
F <sub>uw</sub> (Band XX operation)	MHz	731< f <776 836< f <881	706 < f ≤ 731 881 ≤ f < 906	1 < f ≤ 706 906 ≤ f < 12750	-
F <sub>uw</sub> (Band XXI operation)	MHz	1435.9 < f < 1480.9 1525.9 < f < 1570.9	1410.9 < f ≤ 1435.9 1570.9 ≤ f < 1595.9	1 < f ≤ 1410.9 1595.9 ≤ f < 12750	-
F <sub>uw</sub> (Band XXII operation)	MHz	3450 <f <3495 3605<f <3650	3425 <f ≤ 3450 3650≤f < 3675	1< f ≤3425 3675≤f<12750	-
F <sub>uw</sub> (Band XXV operation)	MHz	1870<f <1915 2010<f <2055	1845 <f ≤1870 2055 ≤f <2080	1< f ≤1845 2080≤f<12750	1850 ≤ f ≤ 1915
F <sub>uw</sub> (Band XXVI operation)	MHz	799< f <844 909< f <954	774 < f ≤799 954 ≤ f < 979	1< f ≤774 979 ≤ f < 12750	814 ≤ f ≤ 849
UE transmitted mean power	dBm	20 (for Power class 3 and 3bis) 18 (for Power class 4) NOTE 3			
Band I operation	For 2095≤f ≤2185 MHz, the appropriate in-band blocking or adjacent channel selectivity in subclause 7.5.2 and subclause 7.6.1A shall be applied.				
Band II operation	For 1915≤f ≤2005 MHz, the appropriate in-band blocking or adjacent channel selectivity in subclause 7.5.2 and subclause 7.6.1A shall be applied				
Band III operation	For 1790≤f ≤1895 MHz, the appropriate in-band blocking or adjacent channel selectivity in subclause 7.5.2 and subclause 7.6.1A shall be applied.				
Band IV operation	For 2095≤f≤2170 MHz, the appropriate in-band blocking or adjacent channel selectivity in subclause 7.5.2 and subclause 7.6.1A shall be applied.				
Band V operation	For 854≤f≤909 MHz, the appropriate in-band blocking or adjacent channel selectivity in subclause 7.5.2 and subclause 7.6.1A shall be applied.				
Band VI operation	For 860≤f≤900 MHz, the appropriate in-band blocking or adjacent channel selectivity in subclause 7.5.2 and subclause 7.6.1A shall be applied.				



Band VII operation	For $2605 \leq f \leq 2705$ MHz, the appropriate in-band blocking or adjacent channel selectivity in subclause 7.5.2 and subclause 7.6.1A shall be applied.
Band VIII operation	For $910 \leq f \leq 975$ MHz, the appropriate in-band blocking or adjacent channel selectivity in subclause 7.5.2 and subclause 7.6.1A shall be applied.
Band IX operation	For $1829.9 \leq f \leq 1894.9$ MHz, the appropriate in-band blocking or adjacent channel selectivity in subclause 7.5.2 and subclause 7.6.1A shall be applied.
Band X operation	For $2095 \leq f \leq 2185$ MHz, the appropriate in-band blocking or adjacent channel selectivity in subclause 7.5.2 and subclause 7.6.1A shall be applied.
Band XI operation	For $1460.9 \leq f \leq 1510.9$ MHz, the appropriate in-band blocking or adjacent channel selectivity in subclause 7.5.2 and subclause 7.6.1A shall be applied.
Band XII operation	For $714 \leq f \leq 761$ MHz, the appropriate in-band blocking or adjacent channel selectivity in subclause 7.5.2 and subclause 7.6.1A shall be applied.
Band XIII operation	For $731 \leq f \leq 771$ MHz, the appropriate in-band blocking or adjacent channel selectivity in subclause 7.5.2 and subclause 7.6.1A shall be applied.
Band XIV operation	For $743 \leq f \leq 783$ MHz, the appropriate in-band blocking or adjacent channel selectivity in subclause 7.5.2 and subclause 7.6.1A shall be applied.
Band XIX operation	For $860 \leq f \leq 905$ MHz, the appropriate in-band blocking or adjacent channel selectivity in subclause 7.5.2 and subclause 7.6.1A shall be applied.
Band XX operation	For $776 \leq f \leq 836$ MHz, the appropriate in-band blocking or adjacent channel selectivity in subclause 7.5.2 and subclause 7.6.1A shall be applied.
Band XXI operation	For $1480.9 \leq f \leq 1525.9$ MHz, the appropriate in-band blocking or adjacent channel selectivity in subclause 7.5.2 and subclause 7.6.1A shall be applied.
Band XXII operation	For $3495 \leq f \leq 3605$ MHz, the appropriate in-band blocking or adjacent channel selectivity in subclause 7.5.2 and subclause 7.6.1A shall be applied. NOTE 3
Band XXV operation	For $1915 \leq f \leq 2010$ MHz, the appropriate in-band blocking or adjacent channel selectivity in subclause 7.5.1 and subclause 7.6.1 shall be applied
Band XXVI operation	For $844 \leq f \leq 909$ MHz, the appropriate in-band blocking or adjacent channel selectivity in subclause 7.5.2 and subclause 7.6.1A shall be applied.
NOTE 1: <REFSENS> and <REF <sub>or</sub> > refer to the DPCH <sub>Ec</sub> <REFSENS> and the DPCH<REF <sub>or</sub> > as specified in Table 7.2A.	
NOTE 2: For the UE which supports both Band XI and Band XXI operating frequencies, the Out of band blocking is FFS.	
NOTE 3: The UE transmitted mean power shall be reduced by 0.5dB for a UE operating in band XXII.	

## 7.6.2B Additional requirement for DB-DC-HSDPA (Out-of-band blocking)

The BLER measured on each individual cell shall not exceed 0.1 for the parameters specified in Table 7.7AB. Out-of-band blocking is defined for an unwanted interfering signal falling at frequencies outside of frequency regions defined as the UE receive bands extended by 15 MHz at their lower and upper ends. For Table 7.7AB in frequency range 1, 2 and 3, up to 24 exceptions per received cell are allowed for spurious response frequencies in each assigned frequency channel when measured using a 1 MHz step size. For these exceptions the requirements of clause 7.7 Spurious response are applicable.

For Table 7.7AB in frequency range 4, up to 8 exceptions per received cell are allowed for spurious response frequencies in each assigned frequency channel when measured using a 1 MHz step size. For these exceptions the requirements of clause 7.7 Spurious response are applicable.



Table 7.7AB: Out of band blocking for DB-DC-HSDPA

Parameter	Unit	Frequency range 1	Frequency range 2	Frequency range 3	Frequency range 4
HS-PDSCH_Ec	dBm / 3.84 MHz	<REFSENS>+3 dB	<REFSENS>+3 dB	<REFSENS>+3 dB	<REFSENS> +3 dB
$\hat{I}_{or}$	dBm / 3.84 MHz	<REF $\hat{I}_{or}$ > + 3 dB	<REF $\hat{I}_{or}$ > + 3 dB	<REF $\hat{I}_{or}$ > + 3 dB	<REF $\hat{I}_{or}$ > + 3 dB
$I_{blocking}$ (CW)	dBm	-44	-30	-15	-15
$F_{uw}$ (DB-DC-HSDPA Configuration 1)	MHz	865< f <910 975< f <1020 2050< f <2095 2185< f <2230	840< f ≤865 1020≤ f <1045 2025< f ≤2050 2230≤ f <2255	1< f ≤840 1045≤ f <2025 2255< f ≤ 12750	-
$F_{uw}$ (DB-DC-HSDPA Configuration 2)	MHz	1870< f <1915 2005< f <2095 2170< f <2215	1845< f ≤1870 2215≤ f <2240	1< f ≤1845 2240≤ f <12750	1850≤ f ≤1910
$F_{uw}$ (DB-DC-HSDPA Configuration 3)	MHz	809< f <854 909< f <954 2050< f <2095 2185< f <2230	784< f ≤809 954≤ f < 979 2025< f ≤2050 2230≤ f <2255	1< f ≤784 979≤ f <2025 2255< f ≤12750	824 ≤ f ≤ 849
$F_{uw}$ (DB-DC-HSDPA Configuration 4)	MHz	1415.9 < f < 1460.9 1510.9 < f < 1555.9 2050<f <2095 2185<f <2230	1390.9 < f ≤ 1415.9 1555.9 ≤ f < 1580.9 2025 <f ≤2050 2230 ≤f <2255	1 < f ≤ 1390.9 1580.9 ≤ f < 2025 2255≤f<12750	-
$F_{uw}$ (DB-DC-HSDPA Configuration 5)	MHz	809< f <854 909< f <954 1870<f <1915 2005<f <2050	784< f ≤809 954≤ f < 979 1845 <f ≤1870 2050 ≤f <2075	1< f ≤784 979< f ≤1845 2075≤f<12750	824 ≤ f ≤ 849 1850 ≤ f ≤ 1910
$F_{uw}$ (DB-DC-HSDPA Configuration 6)	MHz	1392< f <1437 1511< f <1556 2050< f <2095 2185< f <2230	1367< f ≤1392 1556≤ f <1581 2025< f ≤2050 2230≤ f <2255	1< f ≤1367 1581≤ f <2025 2255< f ≤ 12750	-
UE transmitted mean power	dBm	20 (for Power class 3 and 3bis) 18 (for Power class 4)			
DB-DC-HSDPA Configuration 1	For 910≤f ≤975 MHz and 2095≤f ≤2185 MHz, the appropriate in-band blocking or adjacent channel selectivity in subclause 7.5.2 and subclause 7.6.1A shall be applied.				
DB-DC-HSDPA Configuration 2	For 1915≤f ≤2005 MHz and 2095≤f ≤2070 MHz, the appropriate in-band blocking or adjacent channel selectivity in subclause 7.5.2 and subclause 7.6.1A shall be applied.				
DB-DC-HSDPA Configuration 3	For 854≤f≤909 MHz and 2095≤f ≤2185 MHz, the appropriate in-band blocking or adjacent channel selectivity in subclause 7.5.2 and subclause 7.6.1A shall be applied.				
DB-DC-HSDPA Configuration 4	For 1460.9≤f≤ 1510.9 MHz and 2095≤f ≤2185 MHz, the appropriate in-band blocking or adjacent channel selectivity in subclause 7.5.2 and subclause 7.6.1A shall be applied.				
DB-DC-HSDPA Configuration 5	For 854≤f≤909 MHz and 1915≤f ≤2005 MHz, the appropriate in-band blocking or adjacent channel selectivity in subclause 7.5.2 and subclause 7.6.1A shall be applied.				
DB-DC-HSDPA Configuration 6	For 1437≤f ≤1511 MHz and 2095≤f ≤2185 MHz, the appropriate in-band blocking or adjacent channel selectivity in subclause 7.5.2 and subclause 7.6.1A shall be applied.				
NOTE:	<REFSENS> and <REF $\hat{I}_{or}$ > refer to the HS-PDSCH_Ec<REFSENS> and the HS-PDSCH<REF $\hat{I}_{or}$ > as specified in Table 7.2B.				

## 7.6.2C Additional requirement for single band 4C-HSDPA (Out-of-band blocking)

The BLER measured on each individual cell shall not exceed 0.1 for the parameters specified in Table 7.7AC and Table 7.7AD. Out-of-band band blocking is defined for an unwanted interfering signal falling more than 15 MHz below or above the UE receive band. The requirement is not applicable for dual uplink operation.

For Table 7.7AC in frequency range 1, 2 and 3, up to 24 exceptions per received cell are allowed for spurious response frequencies in each assigned frequency channel when measured using a 1 MHz step size. For these exceptions the requirements of clause 7.7 Spurious response are applicable.



For Table 7.7AC in frequency range 4, up to 8 exceptions per received cell are allowed for spurious response frequencies in each assigned frequency channel when measured using a 1 MHz step size. For these exceptions the requirements of clause 7.7 Spurious response are applicable.

**Table 7.7AC: Test parameters for out of band blocking, single band 4C-HSDPA**

Parameter	Unit	Frequency range 1	Frequency range 2	Frequency range 3	Frequency range 4
$I_{\text{blocking}}$ (CW)	dBm	-44	-30	-15	-15
$F_{\text{uw}}$ (Single band 4C-HSDPA Configuration I-3)	MHz	2050<f <2095 2185<f <2230	2025 <f ≤2050 2230 ≤f <2255	1 <f ≤2025 2255≤f<12750	-
$F_{\text{uw}}$ (Single band 4C-HSDPA Configuration II-3, II-4)	MHz	1870<f <1915 2005<f <2050	1845 <f ≤1870 2050 ≤f <2075	1 <f ≤1845 2075≤f<12750	1850 ≤ f ≤ 1910
UE transmitted mean power	dBm	20 (for Power class 3 and 3bis) 18 (for Power class 4)			
Single band 4C-HSDPA Configuration I-3	For 2095≤f ≤2185 MHz, the appropriate in-band blocking or adjacent channel selectivity in subclause 7.5.3 and subclause 7.6.1C.1 shall be applied.				
Single band 4C-HSDPA Configuration II-3, II-4	For 1915≤f ≤2005 MHz, the appropriate in-band blocking or adjacent channel selectivity in subclause 7.5.3 and subclause 7.6.1C.1 shall be applied.				

**Table 7.7AD: Out of band blocking requirements, single band 4C-HSDPA**

Single band 4C-HSDPA Configuration	Parameter	Frequency range 1	Frequency range 2	Frequency range 3	Frequency range 4	UL-DL carrier separation
I-3	HS-PDSCH_Ec (dBm/3.84MHz)	<REFSENS> +3 dB	<REFSENS> +3 dB	<REFSENS> +3 dB	<REFSENS> +3 dB	Minimum
	$I_{or}$ (dBm/3.84MHz)	<REF $\hat{I}_{or}$ > + 3 dB	<REF $\hat{I}_{or}$ > + 3 dB	<REF $\hat{I}_{or}$ > + 3 dB	<REF $\hat{I}_{or}$ > + 3 dB	
II-3, II-4	HS-PDSCH_Ec (dBm/3.84MHz)	<REFSENS> +3 dB	<REFSENS> +3 dB	<REFSENS> +3 dB	<REFSENS> +3 dB	Minimum
	$I_{or}$ (dBm/3.84MHz)	<REF $\hat{I}_{or}$ > + 3 dB	<REF $\hat{I}_{or}$ > + 3 dB	<REF $\hat{I}_{or}$ > + 3 dB	<REF $\hat{I}_{or}$ > + 3 dB	
NOTE: <REFSENS> and <REF $\hat{I}_{or}$ > refer to the HS-PDSCH_Ec<REFSENS> and the HS-PDSCH<REF $\hat{I}_{or}$ > as specified in Table 7.2C.						

## 7.6.2D Additional requirement for dual band 4C-HSDPA (Out-of-band blocking)

The BLER measured on each individual cell shall not exceed 0.1 for the parameters specified in Table 7.7AE and Table 7.7AF. Out-of-band blocking is defined for an unwanted interfering signal falling at frequencies outside of frequency regions defined as the UE receive bands extended by 15 MHz at their lower and upper ends. The requirement is not applicable for dual uplink operation.

For Table 7.7AF in frequency range 1, 2 and 3, up to 24 exceptions per received cell are allowed for spurious response frequencies in each assigned frequency channel when measured using a 1 MHz step size. For these exceptions the requirements of clause 7.7 Spurious response are applicable.

For Table 7.7AF in frequency range 4, up to 8 exceptions per received cell are allowed for spurious response frequencies in each assigned frequency channel when measured using a 1 MHz step size. For these exceptions the requirements of clause 7.7 Spurious response are applicable.



**Table 7.7AE: Test parameters for out of band blocking, dual band 4C-HSDPA**

Parameter	Unit	Frequency range 1	Frequency range 2	Frequency range 3	Frequency range 4
I <sub>blocking</sub> (CW)	dBm	-44	-30	-15	-15
F <sub>uw</sub> (Dual band 4C-HSDPA Configuration I-2-VIII-1, I-3-VIII-1, I-2-VIII-2, I-1-VIII-2)	MHz	865< f <910 975< f <1020 2050< f <2095 2185< f <2230	840< f ≤865 1020≤ f <1045 2025< f ≤2050 2230≤ f <2255	1< f ≤840 1045≤ f <2025 2255< f ≤ 12750	-
F <sub>uw</sub> (Dual band 4C-HSDPA Configuration II-1-IV-2, II-2-IV-1, II-2-IV-2)	MHz	1870< f <1915 2005< f <2095 2170< f <2215	1845< f ≤1870 2215≤ f <2240	1< f ≤1845 2240≤ f <12750	1850≤ f ≤1910
F <sub>uw</sub> (Dual band 4C-HSDPA Configuration I-1-V-2, I-2-V-1, I-2-V-2)	MHz	809< f <854 909< f <954 2050< f <2095 2185< f <2230	784< f ≤809 954≤ f < 979 2025< f ≤2050 2230≤ f <2255	1< f ≤784 979≤ f <2025 2255< f ≤12750	824 ≤ f ≤ 849
F <sub>uw</sub> (Dual band 4C-HSDPA Configuration II-1-V-2)	MHz	809< f <854 909< f <954 1870< f <1915 2005< f <2050	784< f ≤809 954≤ f < 979 1845< f ≤1870 2050≤ f <2075	1< f ≤784 979≤ f <1845 2075< f ≤12750	824 ≤ f ≤ 849, 1850 ≤ f ≤1910
F <sub>uw</sub> (Dual band 4C-HSDPA Configuration I-1-XXXII-2, I-2-XXXII-1)	MHz	1392< f <1437 1511< f <1556 2050< f <2095 2185< f <2230	1367< f ≤1392 1556≤ f <1581 2025< f ≤2050 2230≤ f <2255	1< f ≤1367 1581≤ f <2025 2255< f ≤ 12750	-
UE transmitted mean power	dBm	20 (for Power class 3 and 3bis) 18 (for Power class 4)			
Dual band 4C-HSDPA Configuration I-2-VIII-1, I-3-VIII-1, I-2-VIII-2, I-1-VIII-2	For 910≤f ≤975 MHz and 2095≤f ≤2185 MHz, the appropriate in-band blocking or adjacent channel selectivity in subclause 7.5.2 and subclause 7.6.1D.1 shall be applied.				
Dual band 4C-HSDPA Configuration II-1-IV-2, II-2-IV-1, II-2-IV-2	For 1915≤f ≤2005 MHz and 2095≤f ≤2070 MHz, the appropriate in-band blocking or adjacent channel selectivity in subclause 7.5.2 and subclause 7.6.1D.1 shall be applied.				
Dual band 4C-HSDPA Configuration I-1-V-2, I-2-V-1, I-2-V-2	For 854≤f≤909 MHz and 2095≤f ≤2185 MHz, the appropriate in-band blocking or adjacent channel selectivity in subclause 7.5.2 and subclause 7.6.1D.1 shall be applied.				
Dual band 4C-HSDPA Configuration II-1-V-2	For 854≤f≤909 MHz and 1915 ≤f ≤ 2005 MHz, the appropriate in-band blocking or adjacent channel selectivity in subclause 7.5.2 and subclause 7.6.1D.1 shall be applied.				
Dual band 4C-HSDPA Configuration I-1-XXXII-2, I-2-XXXII-1	For 1437≤f ≤1511 MHz and 2095≤f ≤2185 MHz, the appropriate in-band blocking or adjacent channel selectivity in subclause 7.5.2 and subclause 7.6.1D.1 shall be applied.				



Table 7.7AF: Out of band blocking requirements, dual band 4C-HSDPA

Dual band 4C-HSDPA Configuration	DL Band	UL Band	Parameter	Frequency range 1	Frequency range 2	Frequency range 3	Frequency range 4	UL-DL carrier separation
I-2-VIII-1 I-3-VIII-1 I-2-VIII-2 I-1-VIII-2	I	I	HS-PDSCH_Ec (dBm/3.84MHz)	<REFSENS> +3 dB	<REFSENS> +3 dB	<REFSENS> +3 dB	<REFSENS> +3 dB	Minimum
	VIII		$\hat{I}_{or}$ (dBm/3.84MHz)	<REF $\hat{I}_{or}$ > + 3 dB	<REF $\hat{I}_{or}$ > + 3 dB	<REF $\hat{I}_{or}$ > + 3 dB	<REF $\hat{I}_{or}$ > + 3 dB	Minimum
	I	VIII	HS-PDSCH_Ec (dBm/3.84MHz)	<REFSENS> +3 dB	<REFSENS> +3 dB	<REFSENS> +3 dB	<REFSENS> +3 dB	Minimum
	VIII		$\hat{I}_{or}$ (dBm/3.84MHz)	<REF $\hat{I}_{or}$ > + 3 dB	<REF $\hat{I}_{or}$ > + 3 dB	<REF $\hat{I}_{or}$ > + 3 dB	<REF $\hat{I}_{or}$ > + 3 dB	Minimum
II-1-IV-2 II-2-IV-1 II-2-IV-2	II	II	HS-PDSCH_Ec (dBm/3.84MHz)	<REFSENS> +3 dB	<REFSENS> +3 dB	<REFSENS> +3 dB	<REFSENS> +3 dB	Minimum
	IV		$\hat{I}_{or}$ (dBm/3.84MHz)	<REF $\hat{I}_{or}$ > + 3 dB	<REF $\hat{I}_{or}$ > + 3 dB	<REF $\hat{I}_{or}$ > + 3 dB	<REF $\hat{I}_{or}$ > + 3 dB	Minimum
	II	IV	HS-PDSCH_Ec (dBm/3.84MHz)	<REFSENS> +3 dB	<REFSENS> +3 dB	<REFSENS> +3 dB	<REFSENS> +3 dB	Minimum
	IV		$\hat{I}_{or}$ (dBm/3.84MHz)	<REF $\hat{I}_{or}$ > + 3 dB	<REF $\hat{I}_{or}$ > + 3 dB	<REF $\hat{I}_{or}$ > + 3 dB	<REF $\hat{I}_{or}$ > + 3 dB	Minimum
I-1-V-2 I-2-V-1 I-2-V-2	I	I	HS-PDSCH_Ec (dBm/3.84MHz)	<REFSENS> +3 dB	<REFSENS> +3 dB	<REFSENS> +3 dB	<REFSENS> +3 dB	Minimum
	V		$\hat{I}_{or}$ (dBm/3.84MHz)	<REF $\hat{I}_{or}$ > + 3 dB	<REF $\hat{I}_{or}$ > + 3 dB	<REF $\hat{I}_{or}$ > + 3 dB	<REF $\hat{I}_{or}$ > + 3 dB	Minimum
	I	V	HS-PDSCH_Ec (dBm/3.84MHz)	<REFSENS> +3 dB	<REFSENS> +3 dB	<REFSENS> +3 dB	<REFSENS> +3 dB	Minimum
	V		$\hat{I}_{or}$ (dBm/3.84MHz)	<REF $\hat{I}_{or}$ > + 3 dB	<REF $\hat{I}_{or}$ > + 3 dB	<REF $\hat{I}_{or}$ > + 3 dB	<REF $\hat{I}_{or}$ > + 3 dB	Minimum
II-1-V-2	II	II	HS-PDSCH_Ec (dBm/3.84MHz)	<REFSENS> +3 dB	<REFSENS> +3 dB	<REFSENS> +3 dB	<REFSENS> +3 dB	Minimum
	V		$\hat{I}_{or}$ (dBm/3.84MHz)	<REF $\hat{I}_{or}$ > + 3 dB	<REF $\hat{I}_{or}$ > + 3 dB	<REF $\hat{I}_{or}$ > + 3 dB	<REF $\hat{I}_{or}$ > + 3 dB	Minimum
	II	V	HS-PDSCH_Ec (dBm/3.84MHz)	<REFSENS> +3 dB	<REFSENS> +3 dB	<REFSENS> +3 dB	<REFSENS> +3 dB	Minimum
	V		$\hat{I}_{or}$ (dBm/3.84MHz)	<REF $\hat{I}_{or}$ > + 3 dB	<REF $\hat{I}_{or}$ > + 3 dB	<REF $\hat{I}_{or}$ > + 3 dB	<REF $\hat{I}_{or}$ > + 3 dB	Minimum
I-1-XXXII-2 I-2-XXXII-1	I	I	HS-PDSCH_Ec (dBm/3.84MHz)	<REFSENS> +3 dB	<REFSENS> +3 dB	<REFSENS> +3 dB	<REFSENS> +3 dB	Minimum
	XXXII		$\hat{I}_{or}$ (dBm/3.84MHz)	<REF $\hat{I}_{or}$ > + 3 dB	<REF $\hat{I}_{or}$ > + 3 dB	<REF $\hat{I}_{or}$ > + 3 dB	<REF $\hat{I}_{or}$ > + 3 dB	

NOTE: <REFSENS> and <REF $\hat{I}_{or}$ > refer to the HS-PDSCH\_Ec<REFSENS> and the HS-PDSCH<REF $\hat{I}_{or}$ > as specified in Table 7.2D.

## 7.6.2E Additional requirement for single band 8C-HSDPA (Out-of-band blocking)

The BLER measured on each individual cell shall not exceed 0.1 for the parameters specified in Table 7.7AG and Table 7.7AH. Out-of-band band blocking is defined for an unwanted interfering signal falling more than 15 MHz below or above the UE receive band. The requirement is not applicable for dual uplink operation.

For Table 7.7AG in frequency range 1, 2 and 3, up to 24 exceptions per received cell are allowed for spurious response frequencies in each assigned frequency channel when measured using a 1 MHz step size. For these exceptions the requirements of clause 7.7 Spurious response are applicable.

For Table 7.7AG in frequency range 4, up to 8 exceptions per received cell are allowed for spurious response frequencies in each assigned frequency channel when measured using a 1 MHz step size. For these exceptions the requirements of clause 7.7 Spurious response are applicable.



**Table 7.7AG: Test parameters for out of band blocking, single band 8C-HSDPA**

Parameter	Unit	Frequency range 1	Frequency range 2	Frequency range 3	Frequency range 4
I <sub>blocking</sub> (CW)	dBm	-44	-30	-15	-15
F <sub>uw</sub> (Single band 8C-HSDPA Configuration I-8)	MHz	2050<f <2095 2185<f <2230	2025 <f ≤2050 2230 ≤f <2255	1< f ≤2025 2255≤f<12750	-
UE transmitted mean power	dBm	20 (for Power class 3 and 3bis) 18 (for Power class 4)			
Single band 8C-HSDPA Configuration I-8	For 2095≤f ≤2185 MHz, the appropriate in-band blocking or adjacent channel selectivity in subclause 7.5.4 and subclause 7.6.1E.1 shall be applied.				

**Table 7.7AH: Out of band blocking requirements, single band 8C-HSDPA**

Singe band 8C-HSDPA Configuration	Parameter	Frequency range 1	Frequency range 2	Frequency range 3	Frequency range 4	UL-DL carrier separation
I-8	HS-PDSCH_Ec (dBm/3.84MHz)	<REFSENS> +3 dB	<REFSENS> +3 dB	<REFSENS> +3 dB	<REFSENS> +3 dB	Minimum
	$\hat{I}_{or}$ (dBm/3.84MHz)	<REF $\hat{I}_{or}$ > + 3 dB	<REF $\hat{I}_{or}$ > + 3 dB	<REF $\hat{I}_{or}$ > + 3 dB	<REF $\hat{I}_{or}$ > + 3 dB	
NOTE: <REFSENS> and <REF $\hat{I}_{or}$ > refer to the HS-PDSCH_Ec<REFSENS> and the HS-PDSCH<REF $\hat{I}_{or}$ > as specified in Table 7.2E.						

## 7.6.2F Additional requirement for single band NC-4C-HSDPA (Out-of-band blocking)

The BLER measured on each individual cell shall not exceed 0.1 for the parameters specified in Table 7.7AI and Table 7.7AJ. Out-of-band band blocking is defined for an unwanted interfering signal falling more than 15 MHz below or above the UE receive band. The requirement is not applicable for dual uplink operation.

For Table 7.7AI in frequency range 1, 2 and 3, up to 24 exceptions per received cell are allowed for spurious response frequencies in each assigned frequency channel when measured using a 1 MHz step size. For these exceptions the requirements of clause 7.7 spurious response are applicable.

**Table 7.7AI: Test parameters for out of band blocking, single band NC-4C-HSDPA**

Parameter	Unit	Frequency range 1	Frequency range 2	Frequency range 3
$I_{\text{blocking}} \text{ (CW)}$	dBm	-44	-30	-15
$F_{\text{uw}}$ (Single band NC-4C-HSDPA Configuration I-1-5-1, I-2-5-1, I-3-10-1)	MHz	$2050 < f < 2095$ $2185 < f < 2230$	$2025 < f \leq 2050$ $2230 \leq f < 2255$	$1 < f \leq 2025$ $2255 \leq f < 12750$
$F_{\text{uw}}$ (Single band NC-4C-HSDPA Configuration IV-1-5-1, IV-2-10-1, IV-2-15-2, IV-2-20-1, IV-2-25-2)	MHz	$2050 < f < 2095$ $2170 < f < 2215$	$2025 < f \leq 2050$ $2215 \leq f < 2240$	$1 < f \leq 2025$ $2240 \leq f < 12750$
UE transmitted mean power	dBm	20 (for Power class 3 and 3bis) 18 (for Power class 4)		



**Table 7.7AJ: Out of band blocking requirements, single band NC-4C-HSDPA**

Single band NC-4C-HSDPA Configuration	Parameter	Frequency range 1	Frequency range 2	Frequency range 3	UL-DL carrier separation
I-1-5-1, I-2-5-1, I-3-10-1	HS-PDSCH_Ec (dBm/3.84MHz)	<REFSENS> +3 dB	<REFSENS> +3 dB	<REFSENS> +3 dB	Minimum
	$\uparrow_{or}$ (dBm/3.84MHz)	<REF $\uparrow_{or}$ > + 3 dB	<REF $\uparrow_{or}$ > + 3 dB	<REF $\uparrow_{or}$ > + 3 dB	
IV-1-5-1, IV-2-10-1, IV-2-15-2, IV-2-20-1, IV-2-25-2	HS-PDSCH_Ec (dBm/3.84MHz)	<REFSENS> +3 dB	<REFSENS> +3 dB	<REFSENS> +3 dB	Minimum
	$\uparrow_{or}$ (dBm/3.84MHz)	<REF $\uparrow_{or}$ > + 3 dB	<REF $\uparrow_{or}$ > + 3 dB	<REF $\uparrow_{or}$ > + 3 dB	
NOTE: <REFSENS> and <REF $\uparrow_{or}$ > refer to the HS-PDSCH_Ec<REFSENS> and the HS-PDSCH<REF $\uparrow_{or}$ > as specified in Table 7.2E.					

### 7.6.3 Minimum requirement (Narrow band blocking)

The BER shall not exceed 0.001 for the parameters specified in Table 7.7A. This requirement is measure of a receiver's ability to receive a W-CDMA signal at its assigned channel frequency in the presence of an unwanted narrow band interferer at a frequency, which is less than the nominal channel spacing.

**Table 7.7A: Narrow band blocking characteristics**

Parameter	Unit	Band II, IV, V, X, XXV, XXVI	Band III, VIII, XII, XIII, XIV
DPCH_Ec	dBm/3.84 MHz	<REFSENS> + 10 dB	<REFSENS> + 10 dB
$\hat{I}_{or}$	dBm/3.84 MHz	<REF $\hat{I}_{or}$ > + 10 dB	<REF $\hat{I}_{or}$ > + 10 dB
$I_{\text{blocking}}$ (GMSK)	dBm	-57	-56
$F_{\text{uw}}$ (offset)	MHz	2.7	2.8
UE transmitted mean power	dBm	20 (for Power class 3 and 3bis) 18 (for Power class 4)	
NOTE 1: $I_{\text{blocking}}$ (GMSK) is an interfering signal as defined in TS 45.004 [6].			
NOTE 2: <REFSENS> and <REF $\hat{I}_{or}$ > refer to the DPCH_Ec<REFSENS> and the DPCH<REF $\hat{I}_{or}$ > as specified in Table 7.2.			

### 7.6.3A Additional requirement for DC-HSDPA and DB-DC-HSDPA (Narrow band blocking)

The BLER measured on each individual cell shall not exceed 0.1 for the parameters specified in Table 7.7B. This requirement is measure of a receiver's ability to receive a W-CDMA signal at its assigned channel frequency in the presence of an unwanted narrow band interferer at a frequency, which is less than the nominal channel spacing.

**Table 7.7B: Narrow band blocking characteristics for DC-HSDPA**

Parameter	Unit	Band II, IV, V, X, XXV, XXVI	Band III, VIII, XII, XIII, XIV
HS-PDSCH_Ec	dBm/3.84 MHz	<REFSENS> + 10 dB	<REFSENS> + 10 dB
$I_{or}$	dBm/3.84 MHz	<REF $I_{or}$ > + 10 dB	<REF $I_{or}$ > + 10 dB
$I_{blocking}$ (GMSK)	dBm	-57	-56
$F_{uw}$ (offset) (NOTE 2)	MHz	±2.7	±2.8
UE transmitted mean power	dBm	20 (for Power class 3 and 3bis) 18 (for Power class 4)	
NOTE 1: $I_{blocking}$ (GMSK) is an interfering signal as defined in TS 45.004 [6].			
NOTE 2: For DC-HSDPA, negative offset refers to the assigned channel frequency of the lowest carrier frequency used and positive offset refers to the assigned channel frequency of the highest carrier frequency used. For DB-DC-HSDPA, offset refers to the assigned channel frequencies of the individual cells.			
NOTE 3: <REFSENS> and <REF $I_{or}$ > refer to the HS-PDSCH_Ec<REFSENS> and the HS-PDSCH<REF $I_{or}$ > as specified in Table 7.2A for DC-HSDPA and Table 7.2B for DB-DC-HSDPA.			



### 7.6.3B Additional requirement for DC-HSUPA (Narrow band blocking)

The BLER measured on each individual cell shall not exceed 0.1 for the parameters specified in Table 7.7C and Table 7.7D. This requirement is measure of a receiver's ability to receive a W-CDMA signal at its assigned channel frequency in the presence of an unwanted narrow band interferer at a frequency, which is less than the nominal channel spacing.

**Table 7.7C: Narrow band blocking characteristics for DC-HSUPA**

Parameter	Unit	Band II, IV, V, X, XXV, XXVI	Band III, VIII, XII, XIII, XIV
I <sub>blocking</sub> (GMSK)	dBm	-57	-56
F <sub>uw</sub> (offset) (NOTE 2)	MHz	±2.7	±2.8
UE transmitted mean power	dBm	20 (for Power class 3 and 3bis) 18 (for Power class 4)	
NOTE 1: I <sub>blocking</sub> (GMSK) is an interfering signal as defined in TS 45.004 [6]			
NOTE 2: For DC-HSUPA, negative offset refers to the assigned channel frequency of the lowest carrier frequency used and positive offset refers to the assigned channel frequency of the highest carrier frequency used.			

**Table 7.7D: Reference input powers for narrow-band blocking, DC-HSUPA.**

Operating Band	Unit	HS-PDSCH_Ec	$\bar{I}_{\text{or}}$
II	dBm/3.84 MHz	-101	-90.7
III	dBm/3.84 MHz	-100	-89.7
IV	dBm/3.84 MHz	-102.8	-92.5
V	dBm/3.84 MHz	-100.9	-90.6
VIII	dBm/3.84 MHz	-98.5	-88.2
X	dBm/3.84 MHz	-102.8	-92.5
XII	dBm/3.84 MHz	N/A	N/A
XIII	dBm/3.84 MHz	N/A	N/A
XIV	dBm/3.84 MHz	N/A	N/A
XXV	dBm/3.84 MHz	-99.5	-89.2
XXVI	dBm/3.84 MHz	-98.5	-88.2
NOTE 1 For the UE which supports DB-DC-HSDPA configuration in Table 5.0aA the < HS-PDSCH_Ec > and < $\bar{I}_{\text{or}}$ > are allowed to be increased by an amount defined in Table 7.12.			
NOTE 2 For the UE which supports dual band 4C-HSDPA configuration in Table 5.0aC the < HS-PDSCH_Ec > and < $\bar{I}_{\text{or}}$ > are allowed to be increased by an amount defined in Table 7.13.			

### 7.6.3C Additional requirement for single band 4C-HSDPA (Narrow band blocking)

This requirement is measure of a receiver's ability to receive a W-CDMA signal at its assigned channel frequency in the presence of an unwanted narrow band interferer at a frequency, which is less than the nominal channel spacing.

#### 7.6.3C.1 Single uplink operation

The BLER measured on each individual cell shall not exceed 0.1 for the parameters specified in Table 7.7DA and Table 7.7DB.



**Table 7.7DA: Test parameters for narrow band blocking characteristics, single band 4C-HSDPA, single uplink operation**

Parameter	Unit	Band II
$I_{\text{blocking}}$ (GMSK)	dBm	-57
$F_{\text{uw}}$ (offset) (NOTE 2)	MHz	$\pm 2.7$
UE transmitted mean power	dBm	20 (for Power class 3 and 3bis) 18 (for Power class 4)
NOTE 1: $I_{\text{blocking}}$ (GMSK) is an interfering signal as defined in TS 45.004 [6].		
NOTE 2: For single band 4C-HSDPA, negative offset refers to the assigned channel frequency of the lowest carrier frequencies, and positive offset refers to the assigned channel frequency of the highest carrier frequencies.		

**Table 7.7DB: Narrow band blocking requirements, single band 4C-HSDPA, single uplink operation**

Single band 4C-HSDPA Configuration	DL Band	HS-PDSCH_Ec (dBm/3.84MHz)	$\hat{I}_{\text{or}}$ (dBm/3.84MHz)	UL-DL carrier separation
II-3, II-4	II	<REFSENS>+10 dB	<REF $\hat{I}_{\text{or}}$ >+10 dB	Minimum
NOTE: <REFSENS> and <REF $\hat{I}_{\text{or}}$ > refer to the HS-PDSCH_Ec<REFSENS> and the HS-PDSCH<REF $\hat{I}_{\text{or}}$ > as specified in Table 7.2C for single band 4C-HSDPA.				

### 7.6.3C.2 Dual uplink operation

The BLER measured on each individual cell shall not exceed 0.1 for the parameters specified in Table 7.7DC and Table 7.7DD.

**Table 7.7DC: Test parameters for narrow band blocking characteristics for single band 4C-HSDPA, dual uplink operation**

Parameter	Unit	Band II
$I_{\text{blocking}}$ (GMSK)	dBm	-57
$F_{\text{uw}}$ (offset) (NOTE 2)	MHz	$\pm 2.7$
NOTE 1: $I_{\text{blocking}}$ (GMSK) is an interfering signal as defined in TS 45.004 [6].		
NOTE 2: For single band 4C-HSDPA, negative offset refers to the assigned channel frequency of the lowest carrier frequencies, and positive offset refers to the assigned channel frequency of the highest carrier frequencies.		

**Table 7.7DD: Narrow band blocking requirements, single band 4C-HSDPA, dual uplink operation**

Single band 4C-HSDPA Configuration	DL Band	HS-PDSCH_Ec (dBm/3.84MHz)	$\hat{I}_{\text{or}}$ (dBm/3.84MHz)	UE transmitted mean power (dBm)	UL-DL carrier separation
II-3, II-4	II	-101	-90.7	20 (for Power class 3 and 3bis) 18 (for Power class 4)	Minimum

### 7.6.3D Additional requirement for dual band 4C-HSDPA (Narrow band blocking)

This requirement is measure of a receiver's ability to receive a W-CDMA signal at its assigned channel frequency in the presence of an unwanted narrow band interferer at a frequency, which is less than the nominal channel spacing.



### 7.6.3D.1 Single uplink operation

The BLER measured on each individual cell shall not exceed 0.1 for the parameters specified in Table 7.7E and Table 7.7F.

**Table 7.7E: Test parameters for narrow band blocking characteristics, dual band 4C-HSDPA, single uplink operation**

Parameter	Unit	Band II, IV, V	Band VIII
I <sub>blocking</sub> (GMSK)	dBm	-57	-56
F <sub>uw</sub> (offset) (NOTE 2)	MHz	±2.7	±2.8
UE transmitted mean power	dBm	20 (for Power class 3 and 3bis) 18 (for Power class 4)	
NOTE 1: I <sub>blocking</sub> (GMSK) is an interfering signal as defined in TS 45.004 [6].			
NOTE 2: For dual band 4C-HSDPA, negative offset refers to the assigned channel frequency of the lowest carrier frequenc(ies) in each band, and positive offset refers to the assigned channel frequency of the highest carrier frequenc(ies) in each band.			

**Table 7.7F: Narrow band blocking requirements, dual band 4C-HSDPA, single uplink operation**

Dual band 4C-HSDPA Configuration	DL Band	UL Band	HS-PDSCH_Ec (dBm/3.84MHz)	$\hat{I}_{or}$ (dBm/3.84MHz)	UL-DL carrier separation
I-2-VIII-1	VIII	I	<REFSENS>+10 dB	<REF $\hat{I}_{or}$ >+10 dB	Minimum
I-3-VIII-1, I-2- VIII-2, I-1-VIII- 2	VIII	VIII	<REFSENS>+10 dB	<REF $\hat{I}_{or}$ >+10 dB	Minimum
II-1-IV-2	II	II	<REFSENS>+10 dB	<REF $\hat{I}_{or}$ >+10 dB	Minimum
II-2-IV-1	IV		<REFSENS>+10 dB	<REF $\hat{I}_{or}$ >+10 dB	Minimum
II-2-IV-2	II	IV	<REFSENS>+10 dB	<REF $\hat{I}_{or}$ >+10 dB	Minimum
	IV		<REFSENS>+10 dB	<REF $\hat{I}_{or}$ >+10 dB	Minimum
I-1-V-2	V	I	<REFSENS>+10 dB	<REF $\hat{I}_{or}$ >+10 dB	Minimum
I-2-V-1	V	V	<REFSENS>+10 dB	<REF $\hat{I}_{or}$ >+10 dB	Minimum
I-2-V-2					
II-1-V-2	II	II	<REFSENS>+10 dB	<REF $\hat{I}_{or}$ >+10 dB	Minimum
	V		<REFSENS>+10 dB	<REF $\hat{I}_{or}$ >+10 dB	Minimum
	II	V	<REFSENS>+10 dB	<REF $\hat{I}_{or}$ >+10 dB	Minimum
	V		<REFSENS>+10 dB	<REF $\hat{I}_{or}$ >+10 dB	Minimum
NOTE: <REFSENS> and <REF $\hat{I}_{or}$ > refer to the HS-PDSCH_Ec<REFSENS> and the HS-PDSCH<REF $\hat{I}_{or}$ > as specified in Table 7.2D for dual band 4C-HSDPA.					

### 7.6.3D.2 Dual uplink operation

The BLER measured on each individual cell shall not exceed 0.1 for the parameters specified in Table 7.7G and Table 7.7H.

**Table 7.7G: Test parameters for narrow band blocking characteristics for dual band 4C-HSDPA, dual uplink operation**

Parameter	Unit	Band II, IV, V	Band VIII
$I_{\text{blocking}}$ (GMSK)	dBm	-57	-56
$F_{\text{uw}}$ (offset) (NOTE 2)	MHz	$\pm 2.7$	$\pm 2.8$
NOTE 1: $I_{\text{blocking}}$ (GMSK) is an interfering signal as defined in TS 45.004 [6].			
NOTE 2: For dual band 4C-HSDPA, negative offset refers to the assigned channel frequency of the lowest carrier frequenc(ies) in each band, and positive offset refers to the assigned channel frequency of the highest carrier frequenc(ies) in each band.			



**Table 7.7H: Narrow band blocking requirements, dual band 4C-HSDPA, dual uplink operation**

Dual band 4C-HSDPA Configuration	DL Band	UL Band	HS-PDSCH_Ec (dBm/3.84MHz)	$\hat{I}_{or}$ (dBm/3.84MHz)	UE transmitted mean power (dBm)	UL-DL carrier separation
I-2-VIII-1 I-3-VIII-1	VIII	I	-100	-89.7	20 (for Power class 3 and 3bis) 18 (for Power class 4)	Minimum
I-2-VIII-2	VIII	I	-100	-89.7	20 (for Power class 3 and 3bis) 18 (for Power class 4)	Minimum
	VIII	VIII	-97.4	-87.1	20 (for Power class 3 and 3bis) 18 (for Power class 4)	Minimum
I-1-VIII-2	VIII	VIII	-97.4	-87.1	20 (for Power class 3 and 3bis) 18 (for Power class 4)	Minimum
II-1-IV-2	II	IV	-100	-89.7	20 (for Power class 3 and 3bis) 18 (for Power class 4)	Minimum
	IV		-101	-90.7	20 (for Power class 3 and 3bis) 18 (for Power class 4)	Minimum
II-2-IV-1	II	II	-100	-89.7	20 (for Power class 3 and 3bis) 18 (for Power class 4)	Minimum
	IV		-101	-90.7	20 (for Power class 3 and 3bis) 18 (for Power class 4)	Minimum
II-2-IV-2	II	II	-100	-89.7	20 (for Power class 3 and 3bis) 18 (for Power class 4)	Minimum
	IV		-101	-90.7	20 (for Power class 3 and 3bis) 18 (for Power class 4)	Minimum
	II	IV	-100	-89.7	20 (for Power class 3 and 3bis) 18 (for Power class 4)	Minimum
	IV		-101	-90.7	20 (for Power class 3 and 3bis) 18 (for Power class 4)	Minimum
I-1-V-2	V	V	-99.8	-89.5	20 (for Power class 3 and 3bis) 18 (for Power class 4)	Minimum
I-2-V-1	V	I	-101	-90.7	20 (for Power class 3 and 3bis) 18 (for Power class 4)	Minimum
I-2-V-2	V	I	-101	-90.7	20 (for Power class 3 and 3bis) 18 (for Power class 4)	Minimum
	V	V	-99.8	-89.5	20 (for Power class 3 and 3bis) 18 (for Power class 4)	Minimum
II-1-V-2	II	V	-100.3	-90	20 (for Power class 3 and 3bis) 18 (for Power class 4)	Minimum
	V		-99.8	-89.5	20 (for Power class 3 and 3bis) 18 (for Power class 4)	Minimum

### 7.6.3E Additional requirement for single band NC-4C-HSDPA (Narrow band blocking)

This requirement is measure of a receiver"s ability to receive a W-CDMA signal at its assigned channel frequency in the presence of an unwanted narrow band interferer at a frequency, which is less than the nominal channel spacing.

#### 7.6.3E.1 Single uplink operation

The BLER measured on each individual cell shall not exceed 0.1 for the parameters specified in Table 7.7I and Table 7.7J.



**Table 7.7I: Test parameters for narrow band blocking characteristics, single band NC-4C-HSDPA, single uplink operation**

Parameter	Unit	Band IV
$I_{\text{blocking}}$ (GMSK)	dBm	-57
$F_{\text{uw}}$ (offset) (NOTE 2, 3)	MHz	$\pm 2.7$
UE transmitted mean power	dBm	20 (for Power class 3 and 3bis) 18 (for Power class 4)
NOTE 1: $I_{\text{blocking}}$ (GMSK) is an interfering signal as defined in TS 45.004 [6].		
NOTE 2: For single band NC-4C-HSPDA out-of-gap, negative offset refers to the assigned channel frequency of the lowest carrier belonging to the lower subblock of carriers, and positive offset refers to the assigned channel frequency of the highest carrier belonging to the higher subblock of carriers.		
NOTE 3: For single band NC-4C-HSPDA in-gap, negative offset refers to the assigned channel frequency of the lowest carrier belonging to the higher subblock of carriers, and positive offset refers to the assigned channel frequency of the highest carrier belonging to the lower subblock of carriers.		

**Table 7.7J: Narrow band blocking requirements, single band NC-4C-HSDPA, single uplink operation**

Single band NC-4C-HSDPA Configuration	Test type	DL Band	HS-PDSCH $E_c$ (dBm/3.84MHz)	$\hat{I}_{\text{or}}$ (dBm/3.84MHz)	UL-DL carrier separation
IV-1-5-1, IV-2-10-1, IV-2-15-2, IV-2-20-1, IV-2-25-2	In-gap	IV	<REFSENS>+10 dB	<REF $\hat{I}_{\text{or}}$ >+10 dB	Minimum
IV-1-5-1, IV-2-10-1, IV-2-15-2, IV-2-20-1, IV-2-25-2	Out-of-gap	IV	<REFSENS>+10 dB	<REF $\hat{I}_{\text{or}}$ >+10 dB	Minimum
NOTE: <REFSENS> and <REF $\hat{I}_{\text{or}}$ > refer to the HS-PDSCH $E_c$ <REFSENS> and the HS-PDSCH<REF $\hat{I}_{\text{or}}$ > as specified in Table 7.2E for single band NC-4C-HSDPA.					

### 7.6.3E.2 Dual uplink operation

The BLER measured on each individual cell shall not exceed 0.1 for the parameters specified in Table 7.7K and Table 7.7L.

**Table 7.7K Test parameters for narrow band blocking characteristics for single band NC-4C-HSDPA, dual uplink operation**

Parameter	Unit	Band IV
$I_{\text{blocking}}$ (GMSK)	dBm	-57
$F_{\text{uw}}$ (offset) (NOTE 2, 3)	MHz	$\pm 2.7$
NOTE 1: $I_{\text{blocking}}$ (GMSK) is an interfering signal as defined in TS 45.004 [6].		
NOTE 2: For single band NC-4C-HSPDA out-of-gap, negative offset refers to the assigned channel frequency of the lowest carrier belonging to the lower subblock of carriers, and positive offset refers to the assigned channel frequency of the highest carrier belonging to the higher subblock of carriers.		
NOTE 3: For single band NC-4C-HSPDA in-gap, negative offset refers to the assigned channel frequency of the lowest carrier belonging to the higher subblock of carriers, and positive offset refers to the assigned channel frequency of the highest carrier belonging to the lower subblock of carriers.		



**Table 7.7L: Narrow band blocking requirements, single band NC-4C-HSDPA, dual uplink operation**

Single band NC-4C-HSDPA Configuration	Test type	DL Band	HS-PDSCH_Ec (dBm/3.84MHz)	$\hat{I}_{or}$ (dBm/3.84MHz)	UE transmitted mean power (dBm)	UL-DL carrier separation
IV-2-10-1, IV-2-15-2, IV-2-20-1, IV-2-25-2	In-gap	IV	-102.8	-92.5	20 (for Power class 3 and 3bis) 18 (for Power class 4)	Minimum
IV-2-10-1, IV-2-15-2, IV-2-20-1, IV-2-25-2	Out-of-gap	IV	-102.8	-92.5	20 (for Power class 3 and 3bis) 18 (for Power class 4)	Minimum
NOTE 1 For the UE which supports DB-DC-HSDPA configuration in Table 5.0aA the < HS-PDSCH_Ec > and < $\hat{I}_{or}$ > are allowed to be increased by an amount defined in Table 7.12.						
NOTE 2 For the UE which supports dual band 4C-HSDPA configuration in Table 5.0aC the < HS-PDSCH_Ec > and < $\hat{I}_{or}$ > are allowed to be increased by an amount defined in Table 7.13.						

## 7.7 Spurious response

### 7.7.1 Minimum requirement

Spurious response is a measure of the receiver's ability to receive a wanted signal on its assigned channel frequency without exceeding a given degradation due to the presence of an unwanted CW interfering signal at any other frequency at which a response is obtained i.e. for which the out of band blocking limit as specified in subclause 7.6.2 is not met.

The BER shall not exceed 0.001 for the parameters specified in Table 7.8.

**Table 7.8: Spurious Response**

Parameter	Unit	Level
DPCH_Ec	dBm/3.84 MHz	<REFSENS> +3 dB
$\hat{I}_{or}$	dBm/3.84 MHz	<REF $\hat{I}_{or}$ > +3 dB
$I_{blocking}$ (CW)	dBm	-44
$F_{uw}$	MHz	Spurious response frequencies
UE transmitted mean power	dBm	20 (for Power class 3 and 3bis) 18 (for Power class 4) NOTE 2
NOTE 1: <REFSENS> and <REF $\hat{I}_{or}$ > refer to the DPCH_Ec<REFSENS> and the DPCH<REF $\hat{I}_{or}$ > as specified in Table 7.2.		
NOTE 2 :The UE transmitted mean power shall be reduced by 0.5dB for a UE operating in band XXII.		



## 7.7.2 Additional requirement for DC-HSDPA, DB-DC-HSDPA, single band/dual band 4C-HSDPA and single band 8C-HSDPA and single band NC-4C-HSDPA

Spurious response is a measure of the receiver's ability to receive a wanted signal on its assigned channel frequency without exceeding a given degradation due to the presence of an unwanted CW interfering signal at any other frequency at which a response is obtained i.e. for which the out of band blocking limit as specified in subclause 7.6.2A, 7.6.2B, 7.6.2C, 7.6.2D or 7.6.2E or 7.6.2F is not met.

The BLER measured on each individual cell shall not exceed 0.1 for the parameters specified in Table 7.8A. The requirement is not applicable for dual uplink operation.

**Table 7.8A: Spurious Response**

Parameter	Unit	Level
HS-PDSCH_Ec	dBm/3.84 MHz	<REFSENS> +3 dB
$\hat{I}_{or}$	dBm/3.84 MHz	<REF $\hat{I}_{or}$ > +3 dB
$I_{blocking}$ (CW)	dBm	-44
$F_{uw}$	MHz	Spurious response frequencies
UE transmitted mean power	dBm	20 (for Power class 3 and 3bis) 18 (for Power class 4) NOTE 2
NOTE 1: <REFSENS> and <REF $\hat{I}_{or}$ > refer to the HS-PDSCH_Ec<REFSENS> and the HS-PDSCH<REF $\hat{I}_{or}$ > as specified in Table 7.2A for DC-HSDPA, Table 7.2B for DB-DC-HSDPA, Table 7.2C for single band 4C-HSDPA, Table 7.2D for dual band 4C-HSDPA and Table 7.2E for single band 8C-HSDPA and 7.2F for single band NC-4C-HSDPA.		
NOTE 2: The UE transmitted mean power shall be reduced by 0.5dB for a UE operating in band XXII.		

## 7.8 Intermodulation characteristics

Third and higher order mixing of the two interfering RF signals can produce an interfering signal in the band of the desired channel. Intermodulation response rejection is a measure of the capability of the receiver to receiver a wanted signal on its assigned channel frequency in the presence of two or more interfering signals which have a specific frequency relationship to the wanted signal.

### 7.8.1 Minimum requirement

The BER shall not exceed 0.001 for the parameters specified in Table 7.9.



**Table 7.9: Receive intermodulation characteristics**

Parameter	Unit	Level	
DPCH_Ec	dBm/3.84 MHz	<REFSENS> +3 dB	
$\hat{I}_{or}$	dBm/3.84 MHz	<REF $\hat{I}_{or}$ > +3 dB	
$I_{ouw1}$ (CW)	dBm	-46	
$I_{ouw2}$ mean power (modulated)	dBm	-46	
$F_{uw1}$ (offset)	MHz	10	-10
$F_{uw2}$ (offset)	MHz	20	-20
UE transmitted mean power	dBm	20 (for Power class 3 and 3bis) 18 (for Power class 4) NOTE 3	
NOTE 1: $I_{ouw2}$ (modulated) consists of the common channels needed for tests as specified in Table C.7 and 16 dedicated data channels as specified in Table C.6.			
NOTE 2: <REFSENS> and <REF $\hat{I}_{or}$ > refer to the DPCH_Ec<REFSENS> and the DPCH<REF $\hat{I}_{or}$ > as specified in Table 7.2.			
NOTE 3 :The UE transmitted mean power shall be reduced by 0.5dB for a UE operating in band XXII.			

### 7.8.1A Additional requirement for DC-HSDPA and DB-DC-HSDPA

The BLER measured on each individual cell shall not exceed 0.1 for the parameters specified in Table 7.9AA.

**Table 7.9AA: Receive intermodulation characteristics**

Parameter	Unit	Level	
HS-PDSCH_Ec	dBm/3.84 MHz	<REFSENS> +3 dB	
$\hat{I}_{or}$	dBm/3.84 MHz	<REF $\hat{I}_{or}$ > +3 dB	
$I_{ouw1}$ (CW)	dBm	-46	
$I_{ouw2}$ mean power (modulated)	dBm	-46	
$F_{uw1}$ (offset) (NOTE 2)	MHz	10	-10
$F_{uw2}$ (offset) (NOTE 2)	MHz	20	-20
UE transmitted mean power	dBm	20 (for Power class 3 and 3bis) 18 (for Power class 4) NOTE 4	
NOTE 1: $I_{ouw2}$ (modulated) consists of the common channels needed for tests as specified in Table C.7 and 16 dedicated data channels as specified in Table C.6.			
NOTE 2: For DC-HSDPA, negative offset refers to the assigned channel frequency of the lowest carrier frequency used and positive offset refers to the assigned channel frequency of the highest carrier frequency used. For DB-DC-HSDPA, offset refers to the assigned channel frequencies of the individual cells.			
NOTE 3: <REFSENS> and <REF $\hat{I}_{or}$ > refers to the HS-PDSCH_Ec<REFSENS> and the HS-PDSCH<REF $\hat{I}_{or}$ > as specified in Table 7.2A for DC-HSDPA and Table 7.2B for DB-DC-HSDPA.			
NOTE 4 :The UE transmitted mean power shall be reduced by 0.5dB for a UE operating in band XXII.			

### 7.8.1B Additional requirement for DC-HSUPA

The BLER measured on each individual cell shall not exceed 0.1 for the parameters specified in Table 7.9AB and Table 7.9AC.



**Table 7.9AB: Receive intermodulation characteristics**

Parameter	Unit	Level	
I <sub>ouw1</sub> (CW)	dBm	-46	
I <sub>ouw2</sub> mean power (modulated)	dBm	-46	
F <sub>uw1</sub> (offset) (NOTE 2)	MHz	10	-10
F <sub>uw2</sub> (offset) (NOTE 2)	MHz	20	-20
UE transmitted mean power	dBm	20 (for Power class 3 and 3bis) 18 (for Power class 4) NOTE 3	
NOTE 1: I <sub>ouw2</sub> (modulated) consists of the common channels needed for tests as specified in Table C.7 and 16 dedicated data channels as specified in Table C.6.			
NOTE 2: For DC-HSUPA, negative offset refers to the assigned channel frequency of the lowest carrier frequency used and positive offset refers to the assigned channel frequency of the highest carrier frequency used.			
NOTE 3 :The UE transmitted mean power shall be reduced by 0.5dB for a UE operating in band XXII.			

**Table 7.9AC: Reference input powers for intermod, DC-HSUPA.**

Operating Band	Unit	HS-PDSCH $E_c$	$I_{\text{or}}$
I	dBm/3.84 MHz	-105	-94.7
II	dBm/3.84 MHz	-105.3	-95
III	dBm/3.84 MHz	-104.1	-93.8
IV	dBm/3.84 MHz	-105	-94.7
V	dBm/3.84 MHz	-102	-91.7
VI	dBm/3.84 MHz	-102.2	-91.9
VII	dBm/3.84 MHz	-105.3	-95
VIII	dBm/3.84 MHz	-99.8	-89.5
IX	dBm/3.84 MHz	-104.6	-94.3
X	dBm/3.84 MHz	-105	-94.7
XI	dBm/3.84 MHz	-100	-89.7
XII	dBm/3.84 MHz	N/A	N/A
XIII	dBm/3.84 MHz	N/A	N/A
XIV	dBm/3.84 MHz	N/A	N/A
XIX	dBm/3.84 MHz	-102.2	-91.9
XX	dBm/3.84 MHz	TBD	TBD
XXI	dBm/3.84 MHz	-100	-89.7
XXII	dBm/3.84 MHz	-104.1	-93.8
XXV	dBm/3.84 MHz	-103.5	-93.2
XXVI	dBm/3.84 MHz	-99.8	-89.5
NOTE 1 For the UE which supports both Band III and Band IX operating frequencies, the reference sensitivity level of TBD dBm <REF_ $E_c$ ,intermod> shall apply for Band IX. The corresponding <REF_ $I_{\text{or}}$ ,intermod> is TBD dBm			
NOTE 2 For the UE which supports both Band XI and Band XXI operating frequencies, the reference input power level is FFS.			
NOTE 3 For the UE which supports DB-DC-HSDPA configuration in Table 5.0aA the < HS-PDSCH_ $E_c$ > and < $I_{\text{or}}$ > are allowed to be increased by an amount defined in Table 7.12.			
NOTE 4 For the UE which supports dual band 4C-HSDPA configuration in Table 5.0aC the < HS-PDSCH_ $E_c$ > and < $I_{\text{or}}$ > are allowed to be increased by an amount defined in Table 7.13.			



## 7.8.1C Additional requirement for single band 4C-HSDPA

### 7.8.1C.1 Single uplink operation

The BLER measured on each individual cell shall not exceed 0.1 for the parameters specified in Table 7.9AD and Table 7.9AE.

**Table 7.9AD: Test parameters for receive intermodulation characteristics, single band 4C-HSDPA, single uplink operation**

Parameter	Unit	Level	
$I_{\text{ouw1}}$ (CW)	dBm	-46	
$I_{\text{ouw2}}$ mean power (modulated)	dBm	-46	
$F_{\text{uw1}}$ (offset) (NOTE 2)	MHz	10	-10
$F_{\text{uw2}}$ (offset) (NOTE 2)	MHz	20	-20
UE transmitted mean power	dBm	20 (for Power class 3 and 3bis) 18 (for Power class 4)	
NOTE 1: $I_{\text{ouw2}}$ (modulated) consists of the common channels needed for tests as specified in Table C.7 and 16 dedicated data channels as specified in Table C.6.			
NOTE 2: For single band 4C-HSDPA, negative offset refers to the assigned channel frequency of the lowest carrier frequencies, and positive offset refers to the assigned channel frequency of the highest carrier frequencies.			

**Table 7.9AE: Intermodulation requirements, single band 4C-HSDPA, single uplink operation**

Single band 4C-HSDPA Configuration	DL Band	HS-PDSCH_Ec (dBm/3.84MHz)	$\hat{I}_{\text{or}}$ (dBm/3.84MHz)	UL-DL carrier separation
I-3	I	<REFSENS>+3 dB	<REF $\hat{I}_{\text{or}}$ >+3 dB	Minimum
II-3, II-4	II	<REFSENS>+3 dB	<REF $\hat{I}_{\text{or}}$ >+3 dB	Minimum
NOTE: <REFSENS> and <REF $\hat{I}_{\text{or}}$ > refer to the HS-PDSCH_Ec<REFSENS> and the HS-PDSCH<REF $\hat{I}_{\text{or}}$ > as specified in Table 7.2C for single band 4C-HSDPA.				

### 7.8.1C.2 Dual uplink operation

The BLER measured on each individual cell shall not exceed 0.1 for the parameters specified in Table 7.9AF and Table 7.9AG.



**Table 7.9AF: Receive intermodulation characteristics for single band 4C-HSDPA, dual uplink operation**

Parameter	Unit	Level	
$I_{\text{ouw1}}$ (CW)	dBm	-46	
$I_{\text{ouw2}}$ mean power (modulated)	dBm	-46	
$F_{\text{uw1}}$ (offset) (NOTE 2)	MHz	10	-10
$F_{\text{uw2}}$ (offset) (NOTE 2)	MHz	20	-20
NOTE 1: $I_{\text{ouw2}}$ (modulated) consists of the common channels needed for tests as specified in Table C.7 and 16 dedicated data channels as specified in Table C.6.			
NOTE 2: For single band 4C-HSDPA, negative offset refers to the assigned channel frequency of the lowest carrier frequencies, and positive offset refers to the assigned channel frequency of the highest carrier frequencies.			

**Table 7.9AG: Intermodulation requirements, single band 4C-HSDPA, dual uplink operation**

Single band 4C-HSDPA Configuration	DL Band	HS-PDSCH_Ec (dBm/3.84MHz)	$\hat{I}_{\text{or}}$ (dBm/3.84MHz)	UE transmitted mean power (dBm)	UL-DL carrier separation
I-3	I	-105	-94.7	20 (for Power class 3 and 3bis) 18 (for Power class 4)	Minimum
II-3, II-4	II	-105.3	-95.0	20 (for Power class 3 and 3bis) 18 (for Power class 4)	Minimum
NOTE 1 For the UE which supports DB-DC-HSDPA configuration in Table 5.0aA the < HS-PDSCH_Ec > and < $\hat{I}_{\text{or}}$ > are allowed to be increased by an amount defined in Table 7.12.					
NOTE 2 For the UE which supports dual band 4C-HSDPA configuration in Table 5.0aC the < HS-PDSCH_Ec > and < $\hat{I}_{\text{or}}$ > are allowed to be increased by an amount defined in Table 7.13.					

## 7.8.1D Additional requirement for dual band 4C-HSDPA

### 7.8.1D.1 Single uplink operation

The BLER measured on each individual cell shall not exceed 0.1 for the parameters specified in Table 7.9AH and Table 7.9AI.

**Table 7.9AH: Test parameters for receive intermodulation characteristics, dual band 4C-HSDPA, single uplink operation**

Parameter	Unit	Level	
$I_{\text{ouw1}}$ (CW)	dBm	-46	
$I_{\text{ouw2}}$ mean power (modulated)	dBm	-46	
$F_{\text{uw1}}$ (offset) (NOTE 2)	MHz	10	-10
$F_{\text{uw2}}$ (offset) (NOTE 2)	MHz	20	-20
UE transmitted mean power	dBm	20 (for Power class 3 and 3bis) 18 (for Power class 4)	
NOTE 1: $I_{\text{ouw2}}$ (modulated) consists of the common channels needed for tests as specified in Table C.7 and 16 dedicated data channels as specified in Table C.6.			
NOTE 2: For dual band 4C-HSDPA, negative offset refers to the assigned channel frequency of the lowest carrier frequenc(ies) in each band, and positive offset refers to the assigned channel frequency of the highest carrier frequenc(ies) in each band.			



**Table 7.9AI: Intermodulation requirements, dual band 4C-HSDPA, single uplink operation**

Dual band 4C-HSDPA Configuration	DL Band	UL Band	HS-PDSCH_Ec (dBm/3.84MHz)	$\hat{I}_{or}$ (dBm/3.84MHz)	UL-DL carrier separation
I-2-VIII-1 I-3-VIII-1, I-2-VIII-2, I-1-VIII-2	I	I	<REFSENS>+3 dB	<REF $\hat{I}_{or}$ >+3 dB	Minimum
	VIII		<REFSENS>+3 dB	<REF $\hat{I}_{or}$ >+3 dB	Minimum
	I	VIII	<REFSENS>+3 dB	<REF $\hat{I}_{or}$ >+3 dB	Minimum
	VIII		<REFSENS>+3 dB	<REF $\hat{I}_{or}$ >+3 dB	Minimum
II-1-IV-2 II-2-IV-1 II-2-IV-2	II	II	<REFSENS>+3 dB	<REF $\hat{I}_{or}$ >+3 dB	Minimum
	IV		<REFSENS>+3 dB	<REF $\hat{I}_{or}$ >+3 dB	Minimum
	II	IV	<REFSENS>+3 dB	<REF $\hat{I}_{or}$ >+3 dB	Minimum
	IV		<REFSENS>+3 dB	<REF $\hat{I}_{or}$ >+3 dB	Minimum
I-1-V-2 I-2-V-1 I-2-V-2	I	I	<REFSENS>+3 dB	<REF $\hat{I}_{or}$ >+3 dB	Minimum
	V		<REFSENS>+3 dB	<REF $\hat{I}_{or}$ >+3 dB	Minimum
	I	V	<REFSENS>+3 dB	<REF $\hat{I}_{or}$ >+3 dB	Minimum
	V		<REFSENS>+3 dB	<REF $\hat{I}_{or}$ >+3 dB	Minimum
II-1-V-2	II	I	<REFSENS>+3 dB	<REF $\hat{I}_{or}$ >+3 dB	Minimum
	V		<REFSENS>+3 dB	<REF $\hat{I}_{or}$ >+3 dB	Minimum
	II	V	<REFSENS>+3 dB	<REF $\hat{I}_{or}$ >+3 dB	Minimum
	V		<REFSENS>+3 dB	<REF $\hat{I}_{or}$ >+3 dB	Minimum
I-1-XXXII-2 I-2-XXXII-1	I	I	<REFSENS>+3 dB	<REF $\hat{I}_{or}$ >+3 dB	Minimum
	XXXII		<REFSENS>+3 dB	<REF $\hat{I}_{or}$ >+3 dB	Minimum
NOTE: <REFSENS> and <REF $\hat{I}_{or}$ > refer to the HS-PDSCH_Ec<REFSENS> and the HS-PDSCH<REF $\hat{I}_{or}$ > as specified in Table 7.2D for dual band 4C-HSDPA.					

### 7.8.1D.2 Dual uplink operation

The BLER measured on each individual cell shall not exceed 0.1 for the parameters specified in Table 7.9AJ and Table 7.9AK.

**Table 7.9AJ: Receive intermodulation characteristics for dual band 4C-HSDPA, dual uplink operation**

Parameter	Unit	Level	
$I_{ouw1}$ (CW)	dBm	-46	
$I_{ouw2}$ mean power (modulated)	dBm	-46	
$F_{uw1}$ (offset) (NOTE 2)	MHz	10	-10
$F_{uw2}$ (offset) (NOTE 2)	MHz	20	-20
UE transmitted mean power	dBm	20 (for Power class 3 and 3bis) 18 (for Power class 4)	
NOTE 1: $I_{ouw2}$ (modulated) consists of the common channels needed for tests as specified in Table C.7 and 16 dedicated data channels as specified in Table C.6.			
NOTE 2: For dual band 4C-HSDPA, negative offset refers to the assigned channel frequency of the lowest carrier frequenc(ies) in each band, and positive offset refers to the assigned channel frequency of the highest carrier frequenc(ies) in each band.			

**Table 7.9AK: Intermodulation requirements, dual band 4C-HSDPA, dual uplink operation**

Dual band 4C-HSDPA Configuration	DL Band	UL Band	HS-PDSCH_Ec (dBm/3.84MHz)	$\hat{I}_{or}$ (dBm/3.84MHz)	UE transmitted mean power (dBm)	UL-DL carrier separation
----------------------------------	---------	---------	---------------------------	------------------------------	---------------------------------	--------------------------



I-2-VIII-1 I-3-VIII-1	I	I	-104.2	-93.9	20 (for Power class 3 and 3bis) 18 (for Power class 4)	Minimum
	VIII		-103.6	-93.3	20 (for Power class 3 and 3bis) 18 (for Power class 4)	Minimum
I-2-VIII-2	I	I	-104.2	-93.9	20 (for Power class 3 and 3bis) 18 (for Power class 4)	Minimum
	VIII		-103.6	-93.3	20 (for Power class 3 and 3bis) 18 (for Power class 4)	Minimum
	I	VIII	-104.8	-94.5	20 (for Power class 3 and 3bis) 18 (for Power class 4)	Minimum
	VIII		-98.7	-88.4	20 (for Power class 3 and 3bis) 18 (for Power class 4)	Minimum
I-1-VIII-2	I	VIII	-104.8	-94.5	20 (for Power class 3 and 3bis) 18 (for Power class 4)	Minimum
	VIII		-98.7	-88.4	20 (for Power class 3 and 3bis) 18 (for Power class 4)	Minimum
II-1-IV-2	II	IV	-103.1	-92.8	20 (for Power class 3 and 3bis) 18 (for Power class 4)	Minimum
	IV		-103.4	-93.1	20 (for Power class 3 and 3bis) 18 (for Power class 4)	Minimum
II-2-IV-1	II	II	-103.1	-92.8	20 (for Power class 3 and 3bis) 18 (for Power class 4)	Minimum
	IV		-103.4	-93.1	20 (for Power class 3 and 3bis) 18 (for Power class 4)	Minimum
II-2-IV-2	II	II	-103.1	-92.8	20 (for Power class 3 and 3bis) 18 (for Power class 4)	Minimum
	IV		-103.4	-93.1	20 (for Power class 3 and 3bis) 18 (for Power class 4)	Minimum
	II	IV	-103.1	-92.8	20 (for Power class 3 and 3bis) 18 (for Power class 4)	Minimum
	IV		-103.4	-93.1	20 (for Power class 3 and 3bis) 18 (for Power class 4)	Minimum
I-1-V-2	I	V	-104.2	-93.9	20 (for Power class 3 and 3bis) 18 (for Power class 4)	Minimum
	V		-101.1	-90.8	20 (for Power class 3 and 3bis) 18 (for Power class 4)	Minimum
I-2-V-1	I	I	-104.2	-93.9	20 (for Power class 3 and 3bis) 18 (for Power class 4)	Minimum
	V		-103.9	-93.6	20 (for Power class 3 and 3bis) 18 (for Power class 4)	Minimum
I-2-V-2	I	I	-104.2	-93.9	20 (for Power class 3 and 3bis) 18 (for Power class 4)	Minimum
	V		-103.9	-93.6	20 (for Power class 3 and 3bis) 18 (for Power class 4)	Minimum
	I	V	-104.2	-93.9	20 (for Power class 3 and 3bis) 18 (for Power class 4)	Minimum
	V		-101.1	-90.8	20 (for Power class 3 and 3bis) 18 (for Power class 4)	Minimum
II-1-V-2	II	V	-104.4	-94.1	20 (for Power class 3 and 3bis) 18 (for Power class 4)	Minimum
	V		-101.1	-90.8	20 (for Power class 3 and 3bis) 18 (for Power class 4)	Minimum
I-2-XXXII-1	I	I	-104.7	-94.4	20 (for Power class 3 and 3bis) 18 (for Power class 4)	Minimum
	XXXII		-104.7	-94.4	20 (for Power class 3 and 3bis) 18 (for Power class 4)	Minimum

## 7.8.1E Additional requirement for single band 8C-HSDPA

### 7.8.1E.1 Single uplink operation

The BLER measured on each individual cell shall not exceed 0.1 for the parameters specified in Table 7.9AL and Table 7.9AM.



**Table 7.9AL: Test parameters for receive intermodulation characteristics, single band 8C-HSDPA, single uplink operation**

Parameter	Unit	Level	
$I_{\text{ouw1}}$ (CW)	dBm	-46	
$I_{\text{ouw2}}$ mean power (modulated)	dBm	-46	
$F_{\text{uw1}}$ (offset) (NOTE 2)	MHz	10	-10
$F_{\text{uw2}}$ (offset) (NOTE 2)	MHz	20	-20
UE transmitted mean power	dBm	20 (for Power class 3 and 3bis) 18 (for Power class 4)	
NOTE 1: $I_{\text{ouw2}}$ (modulated) consists of the common channels needed for tests as specified in Table C.7 and 16 dedicated data channels as specified in Table C.6.			
NOTE 2: For single band 8C-HSDPA, negative offset refers to the assigned channel frequency of the lowest carrier frequency, and positive offset refers to the assigned channel frequency of the highest carrier frequency.			

**Table 7.9AM: Intermodulation requirements, single band 8C-HSDPA, single uplink operation**

Single band 8C-HSDPA Configuration	DL Band	HS-PDSCH_Ec (dBm/3.84MHz)	$\hat{I}_{\text{or}}$ (dBm/3.84MHz)	UL-DL carrier separation
I-8	I	<REFSENS>+3 dB	<REF $\hat{I}_{\text{or}}$ >+3 dB	Minimum
NOTE: <REFSENS> and <REF $\hat{I}_{\text{or}}$ > refer to the HS-PDSCH_Ec<REFSENS> and the HS-PDSCH<REF $\hat{I}_{\text{or}}$ > as specified in Table 7.2E for single band 8C-HSDPA.				

### 7.8.1E.2 Dual uplink operation

The BLER measured on each individual cell shall not exceed 0.1 for the parameters specified in Table 7.9AN and Table 7.9AO.

**Table 7.9AN: Receive intermodulation characteristics for single band 8C-HSDPA, dual uplink operation**

Parameter	Unit	Level	
$I_{\text{ouw1}}$ (CW)	dBm	-46	
$I_{\text{ouw2}}$ mean power (modulated)	dBm	-46	
$F_{\text{uw1}}$ (offset) (NOTE 2)	MHz	10	-10
$F_{\text{uw2}}$ (offset) (NOTE 2)	MHz	20	-20
NOTE 1: $I_{\text{ouw2}}$ (modulated) consists of the common channels needed for tests as specified in Table C.7 and 16 dedicated data channels as specified in Table C.6.			
NOTE 2: For single band 8C-HSDPA, negative offset refers to the assigned channel frequency of the lowest carrier frequency, and positive offset refers to the assigned channel frequency of the highest carrier frequency.			

**Table 7.9AO: Intermodulation requirements, single band 8C-HSDPA, dual uplink operation**

Single band 8C-HSDPA Configuration	DL Band	HS-PDSCH_Ec (dBm/3.84MHz)	$\hat{I}_{\text{or}}$ (dBm/3.84MHz)	UE transmitted mean power (dBm)	UL-DL carrier separation
I-8	I	-105	-94.7	20 (for Power class 3 and 3bis)	Minimum



				18 (for Power class 4)	
NOTE 1	For the UE which supports DB-DC-HSDPA configuration in Table 5.0aA the $\langle \text{HS-PDSCH\_Ec} \rangle$ and $\langle \hat{I}_{or} \rangle$ are allowed to be increased by an amount defined in Table 7.12.				
NOTE 2	For the UE which supports dual band 4C-HSDPA configuration in Table 5.0aC the $\langle \text{HS-PDSCH\_Ec} \rangle$ and $\langle \hat{I}_{or} \rangle$ are allowed to be increased by an amount defined in Table 7.13.				

## 7.8.1F Additional requirement for single band NC-4C-HSDPA

### 7.8.1F.1 Single uplink operation

The BLER measured on each individual cell shall not exceed 0.1 for the parameters specified in Table 7.9AP and Table 7.9AQ.

**Table 7.9AP: Test parameters for receive intermodulation characteristics, single band NC-4C-HSDPA, single uplink operation**

Parameter	Unit	Level	
$I_{\text{ouw1}}$ (CW)	dBm	-46	
$I_{\text{ouw2}}$ mean power (modulated)	dBm	-46	
$F_{\text{uw1}}$ (offset) (NOTE 2)	MHz	10	-10
$F_{\text{uw2}}$ (offset) (NOTE 2)	MHz	20	-20
UE transmitted mean power	dBm	20 (for Power class 3 and 3bis) 18 (for Power class 4)	
NOTE 1: $I_{\text{ouw2}}$ (modulated) consists of the common channels needed for tests as specified in Table C.7 and 16 dedicated data channels as specified in Table C.6.			
NOTE 2: For single band NC-4C-HSPDA out-of-gap, negative offset refers to the assigned channel frequency of the lowest carrier belonging to the lower subblock of carriers, and positive offset refers to the assigned channel frequency of the highest carrier belonging to the higher subblock of carriers.			

**Table 7.9AQ: Intermodulation requirements, single band NC-4C-HSDPA, single uplink operation**

Single band NC-4C-HSDPA Configuration	Test type	DL Band	HS-PDSCH_Ec (dBm/3.84MHz)	$\hat{I}_{or}$ (dBm/3.84MHz)	UL-DL carrier separation
I-1-5-1, I-2-5-1, I-3-10-1	Out-of-gap	I	$\langle \text{REFSENS} \rangle + 3$ dB	$\langle \text{REF} \hat{I}_{or} \rangle + 3$ dB	Minimum
IV-1-5-1, IV-2-10-1, IV-2-15-2, IV-2-20-1, IV-2-25-2	Out-of-gap	IV	$\langle \text{REFSENS} \rangle + 3$ dB	$\langle \text{REF} \hat{I}_{or} \rangle + 3$ dB	Minimum
NOTE: $\langle \text{REFSENS} \rangle$ and $\langle \text{REF} \hat{I}_{or} \rangle$ refer to the HS-PDSCH_Ec $\langle \text{REFSENS} \rangle$ and the HS-PDSCH $\langle \text{REF} \hat{I}_{or} \rangle$ as specified in Table 7.2E for single band NC-4C-HSDPA.					

### 7.8.1F.2 Dual uplink operation

The BLER measured on each individual cell shall not exceed 0.1 for the parameters specified in Table 7.9AR and Table 7.9AS.



**Table 7.9AR: Receive intermodulation characteristics for single band NC-4C-HSDPA, dual uplink operation**

Parameter	Unit	Level	
$I_{\text{ouw1}}$ (CW)	dBm	-46	
$I_{\text{ouw2}}$ mean power (modulated)	dBm	-46	
$F_{\text{uw1}}$ (offset) (NOTE 2)	MHz	10	-10
$F_{\text{uw2}}$ (offset) (NOTE 2)	MHz	20	-20
NOTE 1: $I_{\text{ouw2}}$ (modulated) consists of the common channels needed for tests as specified in Table C.7 and 16 dedicated data channels as specified in Table C.6.			
NOTE 2: For single band NC-4C-HSDPA out-of-gap, negative offset refers to the assigned channel frequency of the lowest carrier belonging to the lower subblock of carriers, and positive offset refers to the assigned channel frequency of the highest carrier belonging to the higher subblock of carriers.			

**Table 7.9AS: Intermodulation requirements, single band NC-4C-HSDPA, dual uplink operation**

Single band NC-4C-HSDPA Configuration	Test type	DL Band	HS-PDSCH_Ec (dBm/3.84MHz)	$\hat{I}_{\text{or}}$ (dBm/3.84MHz)	UE transmitted mean power (dBm)	UL-DL carrier separation
I-2-5-1, I-3-10-1	Out-of-gap	I	-105	-94.7	20 (for Power class 3 and 3bis) 18 (for Power class 4)	Minimum
IV-2-10-1, IV-2-15-2, IV-2-20-1, IV-2-25-2	Out-of-gap	IV	-104.7	-94.4	20 (for Power class 3 and 3bis) 18 (for Power class 4)	Minimum
NOTE 1 For the UE which supports DB-DC-HSDPA configuration in Table 5.0aA the $\langle \text{HS-PDSCH\_Ec} \rangle$ and $\langle \hat{I}_{\text{or}} \rangle$ are allowed to be increased by an amount defined in Table 7.12.						
NOTE 2 For the UE which supports dual band 4C-HSDPA configuration in Table 5.0aC the $\langle \text{HS-PDSCH\_Ec} \rangle$ and $\langle \hat{I}_{\text{or}} \rangle$ are allowed to be increased by an amount defined in Table 7.13.						

## 7.8.2 Minimum requirement (Narrow band)

The BER shall not exceed 0.001 for the parameters specified in Table 7.9A.

**Table 7.9A: Receive intermodulation characteristics**

Parameter	Unit	Band II, IV, V, X, XXV, XXVI		Band III, VIII, XII, XIII, XIV	
DPCH_Ec	dBm/3.84 MHz	<REFSENS>+ 10 dB		<REFSENS>+ 10 dB	
$\hat{I}_{or}$	dBm/3.84 MHz	<REF $\hat{I}_{or}$ > + 10 dB		<REF $\hat{I}_{or}$ > +10 dB	
I <sub>ouw1</sub> (CW)	dBm	-44		-43	
I <sub>ouw2</sub> (GMSK)	dBm	-44		-43	
F <sub>uw1</sub> (offset)	MHz	3.5	-3.5	3.6	-3.6
F <sub>uw2</sub> (offset)	MHz	5.9	-5.9	6.0	-6.0
UE transmitted mean power	dBm	20 (for Power class 3 and 3bis) 18 (for Power class 4)			
NOTE 1: I <sub>ouw2</sub> (GMSK) is an interfering signal as defined in TS 45.004 [6].					
NOTE 2: <REFSENS> and <REF $\hat{I}_{or}$ > refer to the DPCH_Ec<REFSENS> and the DPCH<REF $\hat{I}_{or}$ > as specified in Table 7.2.					



## 7.8.2A Additional requirement for DC-HSDPA and DB-DC-HSDPA (Narrow band)

The BLER measured on each individual cell shall not exceed 0.1 for the parameters specified in Table 7.9B.

**Table 7.9B: Receive intermodulation characteristics**

Parameter	Unit	Band II, IV, V, X, XXV, XXVI		Band III, VIII, XII, XIII, XIV	
HS-PDSCH_Ec	dBm/3.84 MHz	<REFSENS>+ 10 dB		<REFSENS>+ 10 dB	
$\hat{I}_{or}$	dBm/3.84 MHz	<REF $\hat{I}_{or}$ > + 10 dB		<REF $\hat{I}_{or}$ > +10 dB	
$I_{ouw1}$ (CW)	dBm	-44		-43	
$I_{ouw2}$ (GMSK)	dBm	-44		-43	
$F_{uw1}$ (offset) (NOTE 2)	MHz	3.5	-3.5	3.6	-3.6
$F_{uw2}$ (offset) (NOTE 2)	MHz	5.9	-5.9	6.0	-6.0
UE transmitted mean power	dBm	20 (for Power class 3 and 3bis) 18 (for Power class 4)			
NOTE 1: $I_{ouw2}$ (GMSK) is an interfering signal as defined in TS 45.004 [6].					
NOTE 2: For DC-HSDPA, negative offset refers to the assigned channel frequency of the lowest carrier frequency used and positive offset refers to the assigned channel frequency of the highest carrier frequency used. For DB-DC-HSDPA, offset refers to the assigned channel frequencies of the individual cells.					
NOTE3: <REFSENS> and <REF $\hat{I}_{or}$ > refers to the HS-PDSCH_Ec<REFSENS> and the HS-PDSCH<REF $\hat{I}_{or}$ > as specified in Table 7.2A for DC-HSDPA and Table 7.2B for DB-DC-HSDPA.					

## 7.8.2B Additional requirement for DC-HSUPA (Narrow band)

The BLER measured on each individual cell shall not exceed 0.1 for the parameters specified in Table 7.9C and Table 7.9D.



**Table 7.9C: Receive intermodulation characteristics**

Parameter	Unit	Band II, IV, V, X,XXV, XXVI		Band III, VIII, XII, XIII, XIV	
I <sub>ouw1</sub> (CW)	dBm	-44		-43	
I <sub>ouw2</sub> (GMSK)	dBm	-44		-43	
F <sub>uw1</sub> (offset) (NOTE 2)	MHz	3.5	-3.5	3.6	-3.6
F <sub>uw2</sub> (offset) (NOTE 2)	MHz	5.9	-5.9	6.0	-6.0
UE transmitted mean power	dBm	20 (for Power class 3 and 3bis) 18 (for Power class 4)			
NOTE 1: I <sub>ouw2</sub> (GMSK) is an interfering signal as defined in TS 45.004 [6].					
NOTE 2: For DC-HSUPA, negative offset refers to the assigned channel frequency of the lowest carrier frequency used and positive offset refers to the assigned channel frequency of the highest carrier frequency used.					

**Table 7.9D: Reference input powers for intermodulation, narrow-band, DC-HSUPA.**

Operating Band	Unit	HS-PDSCH_Ec	$I_{\text{or}}$
II	dBm/3.84 MHz	-86.9	-76.6
III	dBm/3.84 MHz	-85.7	-75.4
IV	dBm/3.84 MHz	-86.9	-76.6
V	dBm/3.84 MHz	-86.9	-76.6
VIII	dBm/3.84 MHz	-85.6	-75.3
X	dBm/3.84 MHz	-86.9	-76.6
XII	dBm/3.84 MHz	N/A	N/A
XIII	dBm/3.84 MHz	N/A	N/A
XIV	dBm/3.84 MHz	N/A	N/A
XXV	dBm/3.84 MHz	-84.7	-74.4
XXVI	dBm/3.84 MHz	-85.6	-75.3
NOTE 1 For the UE which supports DB-DC-HSDPA configuration in Table 5.0aA the < HS-PDSCH_Ec > and < $I_{\text{or}}$ > are allowed to be increased by an amount defined in Table 7.12.			
NOTE 2 For the UE which supports dual band 4C-HSDPA configuration in Table 5.0aC the < HS-PDSCH_Ec > and < $I_{\text{or}}$ > are allowed to be increased by an amount defined in Table 7.13.			

## 7.8.2C Additional requirement for single band 4C-HSDPA (Narrow band)

### 7.8.2C.1 Single uplink operation

The BLER measured on each individual cell shall not exceed 0.1 for the parameters specified in Table 7.9DA and Table 7.9DB.

**Table 7.9DA: Test parameters for receive narrow-band intermodulation characteristics, single band 4C-HSDPA, single uplink operation**

Parameter	Unit	Band II	
I <sub>ouw1</sub> (CW)	dBm	-44	
I <sub>ouw2</sub> (GMSK)	dBm	-44	
F <sub>uw1</sub> (offset) (NOTE 2)	MHz	3.5	-3.5
F <sub>uw2</sub> (offset) (NOTE 2)	MHz	5.9	-5.9
UE transmitted mean power	dBm	20 (for Power class 3 and 3bis) 18 (for Power class 4)	
NOTE 1: I <sub>ouw2</sub> (GMSK) is an interfering signal as defined in TS 45.004 [6].			
NOTE 2: For single band 4C-HSDPA, negative offset refers to the assigned channel frequency of the lowest carrier frequencies, and positive offset refers to the assigned channel frequency of the highest carrier frequencies.			



**Table 7.9DB: Narrow-band intermodulation requirements, single band 4C-HSDPA, single uplink operation**

Single band 4C-HSDPA Configuration	DL Band	HS-PDSCH_Ec (dBm/3.84MHz)	$\hat{I}_{or}$ (dBm/3.84MHz)	UL-DL carrier separation
II-3, II-4	II	<REFSENS>+15.5 dB	<REF $\hat{I}_{or}$ >+15.5 dB	Minimum
NOTE: <REFSENS> and <REF $\hat{I}_{or}$ > refers to the HS-PDSCH_Ec<REFSENS> and the HS-PDSCH<REF $\hat{I}_{or}$ > as specified in Table 7.2C for single band 4C-HSDPA.				

### 7.8.2C.2 Dual uplink operation

The BLER measured on each individual cell shall not exceed 0.1 for the parameters specified in Table 7.9DC and Table 7.9DD.

**Table 7.9DC: Test parameters for receive narrow-band intermodulation characteristics, single band 4C-HSDPA, dual uplink operation**

Parameter	Unit	Band II	
$I_{ouw1}$ (CW)	dBm	-44	
$I_{ouw2}$ (GMSK)	dBm	-44	
$F_{uw1}$ (offset) (NOTE 2)	MHz	3.5	-3.5
$F_{uw2}$ (offset) (NOTE 2)	MHz	5.9	-5.9
NOTE 1: $I_{ouw2}$ (GMSK) is an interfering signal as defined in TS 45.004 [6].			
NOTE 2: For single band 4C-HSDPA, negative offset refers to the assigned channel frequency of the lowest carrier frequencies, and positive offset refers to the assigned channel frequency of the highest carrier frequencies.			

**Table 7.9DD: Narrow-band intermodulation requirements, single band 4C-HSDPA, dual uplink operation**

Single band 4C-HSDPA Configuration	DL Band	HS-PDSCH_Ec (dBm/3.84MHz)	$\hat{I}_{or}$ (dBm/3.84MHz)	UE transmitted mean power (dBm)	UL-DL carrier separation
II-3, II-4	II	-86.9	-76.6	20 (for Power class 3 and 3bis) 18 (for Power class 4)	Minimum

### 7.8.2D Additional requirement for dual band 4C-HSDPA (Narrow band)

#### 7.8.2D.1 Single uplink operation

The BLER measured on each individual cell shall not exceed 0.1 for the parameters specified in Table 7.9E and Table 7.9F.



**Table 7.9E: Test parameters for receive narrow-band intermodulation characteristics, dual band 4C-HSDPA, single uplink operation**

Parameter	Unit	Band II, IV, V		Band VIII	
$I_{\text{ouw1}}$ (CW)	dBm	-44		-43	
$I_{\text{ouw2}}$ (GMSK)	dBm	-44		-43	
$F_{\text{uw1}}$ (offset) (NOTE 2)	MHz	3.5	-3.5	3.6	-3.6
$F_{\text{uw2}}$ (offset) (NOTE 2)	MHz	5.9	-5.9	6.0	-6.0
UE transmitted mean power	dBm	20 (for Power class 3 and 3bis) 18 (for Power class 4)			
NOTE 1: $I_{\text{ouw2}}$ (GMSK) is an interfering signal as defined in TS 45.004 [6].					
NOTE 2: For dual band 4C-HSDPA, negative offset refers to the assigned channel frequency of the lowest carrier frequenc(ies) in each band, and positive offset refers to the assigned channel frequency of the highest carrier frequenc(ies) in each band.					

**Table 7.9F: Narrow-band intermodulation requirements, dual band 4C-HSDPA, single uplink operation**

Dual band 4C-HSDPA Configuration	DL Band	UL Band	HS-PDSCH_Ec (dBm/3.84MHz)	$\hat{I}_{or}$ (dBm/3.84MHz)	UL-DL carrier separation
I-2-VIII-1 I-3-VIII-1 I-2-VIII-2 I-1-VIII-2	VIII	I	<REFSENS>+16.6 dB	<REF $\hat{I}_{or}$ >+16.6 dB	Minimum
	VIII	VIII	<REFSENS>+16.6 dB	<REF $\hat{I}_{or}$ >+16.6 dB	Minimum
II-1-IV-2 II-2-IV-1 II-2-IV-2	II	II	<REFSENS>+17 dB	<REF $\hat{I}_{or}$ >+17 dB	Minimum
	IV		<REFSENS>+18.9 dB	<REF $\hat{I}_{or}$ >+18.9 dB	Minimum
	II	IV	<REFSENS>+17 dB	<REF $\hat{I}_{or}$ >+17 dB	Minimum
	IV		<REFSENS>+18.9 dB	<REF $\hat{I}_{or}$ >+18.9 dB	Minimum
I-1-V-2 I-2-V-1 I-2-V-2	V	I	<REFSENS>+17 dB	<REF $\hat{I}_{or}$ >+17 dB	Minimum
	V	V	<REFSENS>+17 dB	<REF $\hat{I}_{or}$ >+17 dB	Minimum
II-1-V-2	II	II	<REFSENS>+16.5 dB	<REF $\hat{I}_{or}$ >+16.5dB	Minimum
	V		<REFSENS>+16.5 dB	<REF $\hat{I}_{or}$ >+16.5dB	Minimum
	II	V	<REFSENS>+16.5dB	<REF $\hat{I}_{or}$ >+16.5 dB	Minimum
	V		<REFSENS>+16.5dB	<REF $\hat{I}_{or}$ >+16.5dB	Minimum
NOTE: <REFSENS> and <REF $\hat{I}_{or}$ > refers to the HS-PDSCH_Ec<REFSENS> and the HS-PDSCH<REF $\hat{I}_{or}$ > as specified in Table 7.2D for dual band 4C-HSDPA.					

### 7.8.2D.2 Dual uplink operation

The BLER measured on each individual cell shall not exceed 0.1 for the parameters specified in Table 7.9G and Table 7.9H.



**Table 7.9G: Test parameters for receive narrow-band intermodulation characteristics, dual band 4C-HSDPA, dual uplink operation**

Parameter	Unit	Band II, IV, V		Band VIII	
$I_{OUW1}$ (CW)	dBm	-44		-43	
$I_{OUW2}$ (GMSK)	dBm	-44		-43	
$F_{UW1}$ (offset) (NOTE 2)	MHz	3.5	-3.5	3.6	-3.6
$F_{UW2}$ (offset) (NOTE 2)	MHz	5.9	-5.9	6.0	-6.0
NOTE 1: $I_{OUW2}$ (GMSK) is an interfering signal as defined in TS 45.004 [6].					
NOTE 2: For dual band 4C-HSDPA, negative offset refers to the assigned channel frequency of the lowest carrier frequency(ies) in each band, and positive offset refers to the assigned channel frequency of the highest carrier frequency(ies) in each band.					

**Table 7.9H: Narrow-band intermodulation requirements, dual band 4C-HSDPA, dual uplink operation**

Dual band 4C-HSDPA Configuration	DL Band	UL Band	HS-PDSCH $E_c$ (dBm/3.84MHz)	$\hat{I}_{or}$ (dBm/3.84MHz)	UE transmitted mean power (dBm)	UL-DL carrier separation
I-2-VIII-1 I-3-VIII-1	VIII	I	-84.7	-74.4	20 (for Power class 3 and 3bis) 18 (for Power class 4)	Minimum
I-2-VIII-2	VIII	I	-84.7	-74.4	20 (for Power class 3 and 3bis) 18 (for Power class 4)	Minimum
	VIII	VIII	-84.6	-74.3	20 (for Power class 3 and 3bis) 18 (for Power class 4)	Minimum
I-1-VIII-2	VIII	VIII	-84.6	-74.3	20 (for Power class 3 and 3bis) 18 (for Power class 4)	Minimum
II-1-IV-2	II	IV	-84.7	-74.4	20 (for Power class 3 and 3bis) 18 (for Power class 4)	Minimum
	IV		-84.7	-74.4	20 (for Power class 3 and 3bis) 18 (for Power class 4)	Minimum
II-2-IV-1	II	II	-84.7	-74.4	20 (for Power class 3 and 3bis) 18 (for Power class 4)	Minimum
	IV		-84.7	-74.4	20 (for Power class 3 and 3bis) 18 (for Power class 4)	Minimum
II-2-IV-2	II	II	-84.7	-74.4	20 (for Power class 3 and 3bis) 18 (for Power class 4)	Minimum
	IV		-84.7	-74.4	20 (for Power class 3 and 3bis) 18 (for Power class 4)	Minimum
	II	IV	-84.7	-74.4	20 (for Power class 3 and 3bis) 18 (for Power class 4)	Minimum
	IV		-84.7	-74.4	20 (for Power class 3 and 3bis) 18 (for Power class 4)	Minimum
I-1-V-2	V	V	-85.7	-75.4	20 (for Power class 3 and 3bis) 18 (for Power class 4)	Minimum
I-2-V-1	V	I	-85.7	-75.4	20 (for Power class 3 and 3bis) 18 (for Power class 4)	Minimum
I-2-V-2	V	I	-85.7	-75.4	20 (for Power class 3 and 3bis) 18 (for Power class 4)	Minimum
	V	V	-85.7	-75.4	20 (for Power class 3 and 3bis) 18 (for Power class 4)	Minimum
II-1-V-2	II	V	-85.7	-75.4	20 (for Power class 3 and 3bis) 18 (for Power class 4)	Minimum
	V		-85.7	-75.4	20 (for Power class 3 and 3bis) 18 (for Power class 4)	Minimum



## 7.8.2E Additional requirement for single band NC-4C-HSDPA (Narrow band)

### 7.8.2E.1 Single uplink operation

The BLER measured on each individual cell shall not exceed 0.1 for the parameters specified in Table 7.9I and Table 7.9J.

**Table 7.9I: Test parameters for receive narrow-band intermodulation characteristics, single band NC-4C-HSDPA, single uplink operation**

Parameter	Unit	Band IV	
I <sub>ouw1</sub> (CW)	dBm	-44	
I <sub>ouw2</sub> (GMSK)	dBm	-44	
F <sub>uw1</sub> (offset) (NOTE 2)	MHz	3.5	-3.5
F <sub>uw2</sub> (offset) (NOTE 2)	MHz	5.9	-5.9
UE transmitted mean power	dBm	20 (for Power class 3 and 3bis) 18 (for Power class 4)	
NOTE 1: I <sub>ouw2</sub> (GMSK) is an interfering signal as defined in TS 45.004 [6].			
NOTE 2: For single band NC-4C-HSPDA out-of-gap, negative offset refers to the assigned channel frequency of the lowest carrier belonging to the lower subblock of carriers, and positive offset refers to the assigned channel frequency of the highest carrier belonging to the higher subblock of carriers.			

**Table 7.9J: Narrow-band intermodulation requirements, single band NC-4C-HSDPA, single uplink operation**

Single band NC-4C-HSDPA Configuration	Test type	DL Band	HS-PDSCH_Ec (dBm/3.84MHz)	$\hat{I}_{\text{or}}$ (dBm/3.84MHz)	UL-DL carrier separation
IV-1-5-1, IV-2-10-1, IV-2-15-2, IV-2-20-1, IV-2-25-2	Out-of-gap	IV	<REFSENS>+10 dB	<REF $\hat{I}_{\text{or}}$ >+10 dB	Minimum
NOTE: <REFSENS> and <REF $\hat{I}_{\text{or}}$ > refers to the HS-PDSCH_Ec<REFSENS> and the HS-PDSCH<REF $\hat{I}_{\text{or}}$ > as specified in Table 7.2E for single band NC-4C-HSDPA.					

### 7.8.2E.2 Dual uplink operation

The BLER measured on each individual cell shall not exceed 0.1 for the parameters specified in Table 7.9K and Table 7.9L.



**Table 7.9DC: Test parameters for receive narrow-band intermodulation characteristics, single band NC-4C-HSDPA, dual uplink operation**

Parameter	Unit	Band IV	
$I_{\text{ouw1}}$ (CW)	dBm	-44	
$I_{\text{ouw2}}$ (GMSK)	dBm	-44	
$F_{\text{uw1}}$ (offset) (NOTE 2)	MHz	3.5	-3.5
$F_{\text{uw2}}$ (offset) (NOTE 2)	MHz	5.9	-5.9
NOTE 1: $I_{\text{ouw2}}$ (GMSK) is an interfering signal as defined in TS 45.004 [6].			
NOTE 2: For single band NC-4C-HSDPA out-of-gap, negative offset refers to the assigned channel frequency of the lowest carrier belonging to the lower subblock of carriers, and positive offset refers to the assigned channel frequency of the highest carrier belonging to the higher subblock of carriers.			

**Table 7.9L: Narrow-band intermodulation requirements, single band NC-4C-HSDPA, dual uplink operation**

Single band NC-4C-HSDPA Configuration	Test type	DL Band	HS-PDSCH_Ec (dBm/3.84MHz)	$\hat{I}_{\text{or}}$ (dBm/3.84MHz)	UE transmitted mean power (dBm)	UL-DL carrier separation
IV-2-10-1, IV-2-15-2, IV-2-20-1, IV-2-25-2	Out-of-gap	IV	-86.7	-76.4	20 (for Power class 3 and 3bis) 18 (for Power class 4)	Minimum
NOTE 1 For the UE which supports DB-DC-HSDPA configuration in Table 5.0aA the < HS-PDSCH_Ec > and < $\hat{I}_{\text{or}}$ > are allowed to be increased by an amount defined in Table 7.12.						
NOTE 2 For the UE which supports dual band 4C-HSDPA configuration in Table 5.0aC the < HS-PDSCH_Ec > and < $\hat{I}_{\text{or}}$ > are allowed to be increased by an amount defined in Table 7.13.						

## 7.9 Spurious emissions

The spurious emissions power is the power of emissions generated or amplified in a receiver that appear at the UE antenna connector. The spurious emission is verified per antenna connector with the other(s) terminated.

### 7.9.1 Minimum requirement

The power of any narrow band CW spurious emission shall not exceed the maximum level specified in Table 7.10, Table 7.11 and Table 6.13.

**Table 7.10: General receiver spurious emission requirements**

Frequency Band	Measurement Bandwidth	Maximum level	Note
$30\text{MHz} \leq f < 1\text{GHz}$	100 kHz	-57 dBm	
$1\text{GHz} \leq f \leq 12.75\text{GHz}$	1 MHz	-47 dBm	
$12.75\text{GHz} \leq f \leq 5^{\text{th}}$ harmonic of the upper frequency edge of the DL operating band in GHz	1 MHz	-47 dBm	Note 1
NOTE 1: Applies only for Band XXII.			



**Table 7.11: Additional receiver spurious emission requirements**

Band	Frequency Band	Measurement Bandwidth	Maximum level	Note
I	$1920 \text{ MHz} \leq f \leq 1980 \text{ MHz}$	3.84 MHz	-60 dBm	UE transmit band in URA_PCH, Cell_PCH and idle state
II	$1850 \text{ MHz} \leq f \leq 1915 \text{ MHz}$	3.84 MHz	-60 dBm	UE transmit band in URA_PCH, Cell_PCH and idle state
III	$1710 \text{ MHz} \leq f \leq 1785 \text{ MHz}$	3.84 MHz	-60 dBm	UE transmit band in URA_PCH, Cell_PCH and idle state
IV	$1710 \text{ MHz} \leq f < 1755 \text{ MHz}$	3.84 MHz	-60 dBm	UE transmit band in URA_PCH, Cell_PCH and idle state
V	$824 \text{ MHz} \leq f \leq 849 \text{ MHz}$	3.84 MHz	-60 dBm	UE transmit band in URA_PCH, Cell_PCH and idle state
VI	$815 \text{ MHz} \leq f \leq 830 \text{ MHz}$	3.84 MHz	-60 dBm	
	$830 \text{ MHz} \leq f \leq 840 \text{ MHz}$	3.84 MHz	-60 dBm	UE transmit band in URA_PCH, Cell_PCH and idle state
	$840 \text{ MHz} \leq f \leq 845 \text{ MHz}$	3.84 MHz	-60 dBm	
	$860 \text{ MHz} \leq f \leq 875 \text{ MHz}$	3.84 MHz	-60 dBm	
VII	$2500 \text{ MHz} \leq f \leq 2570 \text{ MHz}$	3.84 MHz	-60 dBm	UE transmit band in URA_PCH, Cell_PCH and idle state
VIII	$880 \text{ MHz} \leq f \leq 915 \text{ MHz}$	3.84 MHz	-60 dBm	UE in URA_PCH, Cell_PCH and idle state
IX	$1749.9 \text{ MHz} \leq f \leq 1784.9 \text{ MHz}$	3.84 MHz	-60 dBm	UE transmit band in URA_PCH, Cell_PCH and idle state
X	$1710 \text{ MHz} \leq f < 1770 \text{ MHz}$	3.84 MHz	-60 dBm	UE transmit band in URA_PCH, Cell_PCH and idle state
XI	$1427.9 \text{ MHz} \leq f \leq 1447.9 \text{ MHz}$	3.84 MHz	-60 dBm	UE transmit band in URA_PCH, Cell_PCH and idle state
XII	$699 \text{ MHz} \leq f \leq 716 \text{ MHz}$	3.84 MHz	-60 dBm	UE transmit band in URA_PCH, Cell_PCH and idle state
XIII	$746 \text{ MHz} \leq f \leq 756 \text{ MHz}$	3.84 MHz	-60 dBm	UE receive band
	$776 \text{ MHz} \leq f \leq 788 \text{ MHz}$	3.84 MHz	-60 dBm	UE transmit band in URA_PCH, Cell_PCH and idle state
XIV	$788 \text{ MHz} \leq f \leq 798 \text{ MHz}$	3.84 MHz	-60 dBm	UE transmit band in URA_PCH, Cell_PCH and idle state
XIX	$815 \text{ MHz} \leq f \leq 830 \text{ MHz}$	3.84 MHz	-60 dBm	
	$830 \text{ MHz} \leq f \leq 845 \text{ MHz}$	3.84 MHz	-60 dBm	UE transmit band in URA_PCH, Cell_PCH and idle state
	$860 \text{ MHz} \leq f \leq 875 \text{ MHz}$	3.84 MHz	-60 dBm	
XX	$832 \text{ MHz} \leq f \leq 862 \text{ MHz}$	3.84 MHz	-60 dBm	UE transmit band in URA_PCH, Cell_PCH and idle state
XXI	$1447.9 \text{ MHz} \leq f \leq 1462.9 \text{ MHz}$	3.84 MHz	-60 dBm	UE transmit band in URA_PCH, Cell_PCH and idle state
XXII	$3410 \text{ MHz} \leq f \leq 3490 \text{ MHz}$	3.84 MHz	-60 dBm	UE transmit band in URA_PCH, Cell_PCH and idle state
XXV	$1850 \text{ MHz} \leq f \leq 1915 \text{ MHz}$	3.84 MHz	-60 dBm	UE transmit band in URA_PCH, Cell_PCH and idle state
XXVI	$814 \text{ MHz} \leq f \leq 849 \text{ MHz}$	3.84 MHz	-60 dBm	UE transmit band in URA_PCH, Cell_PCH and idle state
Note *	The receiver additional spurious emission measurements are made on frequencies which are integer multiples of 200 kHz. As exceptions, up to five measurements with a level up to the applicable requirements defined in Table 7.10 are permitted for each UARFCN used in the measurement. This note applies also to receiver additional spurious emission measurements according to Table 6.11.			

### 7.9.1A Minimum requirement

For DB-DC-HSDPA and Dual band 4C-HSDPA configurations including an operating band without UL Band, the power of any narrow band CW spurious emission shall not exceed the maximum level specified in Table 7.12.



**Table 7.12: General receiver spurious emission requirements**

Frequency Band	Measurement Bandwidth	Maximum level	Note
$30\text{MHz} \leq f < 1\text{GHz}$	100 kHz	-57 dBm	
$1\text{GHz} \leq f \leq 12.75\text{ GHz}$	1 MHz	-47 dBm	
NOTE 1: The requirements apply when the UE is configured for DL multicarrier operation but is not transmitting.			

## 7.10 Reference input power adjustment for a dual band device

For the UE which supports DB-DC-HSDPA configuration in Table 5.0aA, the reference input powers (HS-PDSCH\_Ec and  $\hat{I}_{or}$ ) of core requirements specified in subclause 7.6.1B, 7.6.1C.2, 7.6.3B, 7.8.1B, 7.8.1C.2, and 7.8.2B are allowed to be increased by the amount given in Table 7.12 for the applicable bands.

**Table 7.12: Allowed increase of HS-PDSCH Ec and  $\hat{I}_{or}$  for UE which supports DB-DC-HSDPA.**

DB-DC-HSDPA Configuration	Allowed increase of HS-PDSCH Ec and $\hat{I}_{or}$ (dB)	Applicable bands
1	0.5	I, VIII
2	1	II, IV
3	0.5	I, V
4	1	I, XI
5	0.5	II, V
6	0.6	I

For the UE which supports dual band 4C-HSDPA configuration in Table 5.0aC, the reference input powers (HS-PDSCH\_Ec and  $\hat{I}_{or}$ ) of core requirements specified in subclause 7.6.1B, 7.6.1C.2, 7.6.3B, 7.8.1B, 7.8.1C.2, and 7.8.2B are allowed to be increased by the amount given in Table 7.13 for the applicable bands.

**Table 7.13: Allowed increase of HS-PDSCH Ec and  $\hat{I}_{or}$  for UE which supports dual band 4C-HSDPA.**

Dual Band 4C-HSDPA Configuration	Allowed increase of HS-PDSCH Ec and $\hat{I}_{or}$ (dB)	Applicable bands
I-2-VIII-1 I-3-VIII-1 I-1-VIII-2 I-2-VIII-2	0.5	I, VIII
II-1-IV-2 II-2-IV-1 II-2-IV-2	1	II, IV
I-1-V-2 I-2-V-1 I-2-V-2	0.5	I, V
II-1-V-2	0.5	II, V
I-1-XXXII-2 I-2-XXXII-1	0.6	I

# 8 Performance requirement

## 8.1 General

The performance requirements for the UE in this subclause are specified for the measurement channels specified in Annex A, the propagation conditions specified in Annex B and the Down link Physical channels specified in Annex C. Unless stated DL power control is OFF. Unless otherwise stated the performance requirements are specified at the antenna connector of the UE. For UE(s) with an integral antenna only, a reference antenna with a gain of 0 dBi is



assumed. UE with an integral antenna may be taken into account by converting these power levels into field strength requirements, assuming a 0 dBi gain antenna. For UE(s) with more than one receiver antenna connector the fading of the signals and the AWGN signals applied to each receiver antenna connector shall be uncorrelated. The levels of the test signal applied to each of the antenna connectors shall be as defined in the respective sections below.

For a UE which supports optional enhanced performance requirements type1 for DCH and an alternative requirement is specified, the UE shall meet only the enhanced performance requirement type1. For those cases where the enhanced performance requirements type1 are not specified, the minimum performance requirements shall apply.

## 8.2 Demodulation in static propagation conditions

### 8.2.1 (void)

### 8.2.2 (void)

### 8.2.3 Demodulation of Dedicated Channel (DCH)

The receive characteristic of the Dedicated Channel (DCH) in the static environment is determined by the Block Error Ratio (BLER). BLER is specified for each individual data rate of the DCH. DCH is mapped into the Dedicated Physical Channel (DPCH).

#### 8.2.3.1 Minimum requirement

For the parameters specified in Table 8.5 the average downlink  $\frac{DPCH - E_c}{I_{or}}$  power ratio shall be below the specified value for the BLER shown in Table 8.6. These requirements are applicable for TFCS size 16.

**Table 8.5: DCH parameters in static propagation conditions**

Parameter	Unit	Test 1	Test 2	Test 3	Test 4
Phase reference		P-CPICH			
$\hat{I}_{or}/I_{oc}$	dB	-1			
$I_{oc}$	dBm/3.84 MHz	-60			
Information Data Rate	kbps	12.2	64	144	384

**Table 8.6: DCH requirements in static propagation conditions**

Test Number	$\frac{DPCH - E_c}{I_{or}}$	BLER
1	-16.6 dB	$10^{-2}$
2	-13.1 dB	$10^{-1}$
	-12.8 dB	$10^{-2}$
3	-9.9 dB	$10^{-1}$
	-9.8 dB	$10^{-2}$
4	-5.6 dB	$10^{-1}$
	-5.5 dB	$10^{-2}$

### 8.2.4 Demodulation of Dedicated Channel (DCH) when DL\_DCH\_FET\_Config [10] is configured by higher layers

The receive characteristic of the Dedicated Channel (DCH) in the static environment is determined by the Block Error Ratio (BLER). BLER is specified for each individual data rate of the DCH. DCH is mapped into the Dedicated Physical Channel (DPCH).



### 8.2.4.1 Minimum requirement

For the parameters specified in Table 8.6A the average downlink  $\frac{DPCH\_E_c}{I_{or}}$  power ratio shall be below the specified value for the BLER shown in Table 8.6B. These requirements are applicable for TFCS size 16.

**Table 8.6A: DCH parameters in static propagation conditions**

Parameter	Unit	Test 1	Test 2	Test 3	Test 4
Phase reference		P-CPICH			
$\hat{I}_{or}/I_{oc}$	dB	-1			
$I_{oc}$	dBm/3.84 MHz	-60			
Information Data Rate	kbps	12.2	12.2	0	0
DCCH Presence	-	Yes	No	Yes	No
DL_DCH_FET_Config	-	0 (Note 1)			
Note 1: UL is in 10ms transmission mode					

**Table 8.6B: DCH requirements in static propagation conditions**

Test Number	$\frac{DPCH\_E_c}{I_{or}}$	BLER
1	-17.6 dB	$10^{-2}$
2	-15.5 dB	$10^{-2}$
3	-19.3 dB	$10^{-2}$
4	-17.2 dB	$10^{-2}$

## 8.3 Demodulation of DCH in multi-path fading propagation conditions

### 8.3.1 Single Link Performance

The receive characteristics of the Dedicated Channel (DCH) in different multi-path fading environments are determined by the Block Error Ratio (BLER) values. BLER is measured for the each of the individual data rate specified for the DPCH. DCH is mapped into in Dedicated Physical Channel (DPCH).

#### 8.3.1.1 Minimum requirement

For the parameters specified in Table 8.7, 8.9, 8.11, 8.13 and 8.14A the average downlink  $\frac{DPCH\_E_c}{I_{or}}$  power ratio shall be below the specified value for the BLER shown in Table 8.8, 8.10, 8.12, 8.14 and 8.14B. If the UE supports optional enhanced performance requirements type1 for DCH then for the parameters specified in Table 8.10A the average downlink  $\frac{DPCH\_E_c}{I_{or}}$  power ratio shall be below the specified value for the BLER shown in 8.10B, and Test 5, Test 6 and Test 8 shall be replaced by Test 5a, Test 6a and Test 8a. These requirements are applicable for TFCS size 16.

**Table 8.7: Test Parameters for DCH in multi-path fading propagation conditions (Case 1)**

Parameter	Unit	Test 1	Test 2	Test 3	Test 4
Phase reference		P-CPICH			
$\hat{I}_{or}/I_{oc}$	dB	9			
$I_{oc}$	dBm/3.84 MHz	-60			
Information Data Rate	kbps	12.2	64	144	384



**Table 8.8: Test requirements for DCH in multi-path fading propagation conditions (Case 1)**

Test Number	$\frac{DPCH - E_c}{I_{or}}$	BLER
1	-15.0 dB	$10^{-2}$
2	-13.9 dB	$10^{-1}$
	-10.0 dB	$10^{-2}$
3	-10.6 dB	$10^{-1}$
	-6.8 dB	$10^{-2}$
4	-6.3 dB	$10^{-1}$
	-2.2 dB	$10^{-2}$

**Table 8.9: DCH parameters in multi-path fading propagation conditions (Case 2)**

Parameter	Unit	Test 5	Test 6	Test 7	Test 8
Phase reference		P-CPICH			
$\hat{I}_{or}/I_{oc}$	dB	-3	-3	3	6
$I_{oc}$	dBm/3.84 MHz	-60			
Information Data Rate	kbps	12.2	64	144	384

**Table 8.10: DCH requirements in multi-path fading propagation (Case 2)**

Test Number	$\frac{DPCH - E_c}{I_{or}}$	BLER
5	-7.7 dB	$10^{-2}$
6	-6.4 dB	$10^{-1}$
	-2.7 dB	$10^{-2}$
7	-8.1 dB	$10^{-1}$
	-5.1 dB	$10^{-2}$
8	-5.5 dB	$10^{-1}$
	-3.2 dB	$10^{-2}$

**Table 8.10A: DCH parameters in multi-path fading propagation conditions (VA30) for UE supporting the enhanced performance requirements type1 for DCH**

Parameter	Unit	Test 5a	Test 6a	Test 8a
Phase reference		P-CPICH		
$\hat{I}_{or}/I_{oc}$	dB	-3	-3	6
$I_{oc}$	dBm/3.84 MHz	-60		
Information Data Rate	kbps	12.2	64	384

**Table 8.10B: DCH requirements in multi-path fading propagation (VA30) for UE supporting the enhanced performance requirements type1 for DCH**

Test Number	$\frac{DPCH - E_c}{I_{or}}$	BLER
5a	-14.4 dB	$10^{-2}$
6a	-11.4 dB	$10^{-1}$
	-10.0 dB	$10^{-2}$
8a	-9.3 dB	$10^{-1}$
	-8.0 dB	$10^{-2}$



**Table 8.11: DCH parameters in multi-path fading propagation conditions (Case 3)**

Parameter	Unit	Test 9	Test 10	Test 11	Test 12
Phase reference		P-CPICH			
$\hat{I}_{or}/I_{oc}$	dB	-3	-3	3	6
$I_{oc}$	dBm/3.84 MHz	-60			
Information Data Rate	kbps	12.2	64	144	384

**Table 8.12: DCH requirements in multi-path fading propagation conditions (Case 3)**

Test Number	$\frac{DPCH - E_c}{I_{or}}$	BLER
9	-11.8 dB	$10^{-2}$
10	-8.1 dB	$10^{-1}$
	-7.4 dB	$10^{-2}$
	-6.8 dB	$10^{-3}$
11	-9.0 dB	$10^{-1}$
	-8.5 dB	$10^{-2}$
	-8.0 dB	$10^{-3}$
12	-5.9 dB	$10^{-1}$
	-5.1 dB	$10^{-2}$
	-4.4 dB	$10^{-3}$

**Table 8.13: DCH parameters in multi-path fading propagation conditions (Case 1) with S-CPICH**

Parameter	Unit	Test 13	Test 14	Test 15	Test 16
Phase reference		S-CPICH			
$\hat{I}_{or}/I_{oc}$	dB	9			
$I_{oc}$	dBm/3.84 MHz	-60			
Information Data Rate	kbps	12.2	64	144	384

**Table 8.14: DCH requirements in multi-path fading propagation conditions (Case 1) with S-CPICH**

Test Number	$\frac{DPCH - E_c}{I_{or}}$	BLER
13	-15.0 dB	$10^{-2}$
14	-13.9 dB	$10^{-1}$
	-10.0 dB	$10^{-2}$
15	-10.6 dB	$10^{-1}$
	-6.8 dB	$10^{-2}$
16	-6.3 dB	$10^{-1}$
	-2.2 dB	$10^{-2}$

**Table 8.14A: DCH parameters in multi-path fading propagation conditions (Case 6)**

Parameter	Unit	Test 17	Test 18	Test 19	Test 20
Phase reference		P-CPICH			
$\hat{I}_{or}/I_{oc}$	dB	-3	-3	3	6
$I_{oc}$	dBm/3.84 MHz	-60			
Information Data Rate	kbps	12.2	64	144	384



**Table 8.14B: DCH requirements in multi-path fading propagation conditions (Case 6)**

Test Number	$\frac{DPCH - E_c}{I_{or}}$	BLER
17	-8.8 dB	$10^{-2}$
18	-5.1 dB	$10^{-1}$
	-4.4 dB	$10^{-2}$
	-3.8 dB	$10^{-3}$
	-6.0 dB	$10^{-1}$
19	-5.5 dB	$10^{-2}$
	-5.0 dB	$10^{-3}$
	-2.9 dB	$10^{-1}$
20	-2.1 dB	$10^{-2}$
	-1.4 dB	$10^{-3}$

**Table 8.14C: (void)****Table 8.14D: (void)****Table 8.14E: (void)****Table 8.14F: (void)**

### 8.3.2 Single Link Performance when DL\_DCH\_FET\_Config [10] is configured by higher layers

The receive characteristics of the Dedicated Channel (DCH) in different multi-path fading environments are determined by the Block Error Ratio (BLER) values. BLER is measured for the each of the individual data rate specified for the DPCH. DCH is mapped into in Dedicated Physical Channel (DPCH).

#### 8.3.2.1 Minimum requirement

For the parameters specified in Table 8.14G, 8.14I, 8.14K, 8.14M and 8.14O, the average downlink  $\frac{DPCH - E_c}{I_{or}}$  power ratio shall be below the specified value for the BLER shown in Table 8.14H, 8.14J, 8.14L, 8.14N and 8.14P.

**Table 8.14G: Test Parameters for DCH in multi-path fading propagation conditions (Case 1)**

Parameter	Unit	Test 1	Test 2
Phase reference		P-CPICH	
$\hat{I}_{or}/I_{oc}$	dB	9	
$I_{oc}$	dBm/3.84 MHz	-60	
Information Data Rate	kbps	12.2	0
DCCH Presence	-	No	
DL_DCH_FET_Config	-	0 (Note 1)	
Note 1: UL is in 10ms transmission mode			

**Table 8.14H: Test requirements for DCH in multi-path fading propagation conditions (Case 1)**

Test Number	$\frac{DPCH - E_c}{I_{or}}$	BLER
1	-13.4 dB	$10^{-2}$
2	-16.6 dB	$10^{-2}$



**Table 8.14I: DCH parameters in multi-path fading propagation conditions (Case 2)**

Parameter	Unit	Test 3	Test 4
Phase reference		P-CPICH	
$\hat{I}_{or}/I_{oc}$	dB	-3	
$I_{oc}$	dBm/3.84 MHz	-60	
Information Data Rate	kbps	12.2	0
DCCH Presence	-	No	

**Table 8.14J: DCH requirements in multi-path fading propagation (Case 2)**

Test Number	$\frac{DPCH - E_c}{I_{or}}$	BLER
3	-5.5 dB	$10^{-2}$
4	-8.9 dB	$10^{-2}$

**Table 8.14K: DCH parameters in multi-path fading propagation conditions (Case 3)**

Parameter	Unit	Test 5	Test 6
Phase reference		P-CPICH	
$\hat{I}_{or}/I_{oc}$	dB	-3	
$I_{oc}$	dBm/3.84 MHz	-60	
Information Data Rate	kbps	12.2	0
DCCH Presence	-	No	

**Table 8.14L: DCH requirements in multi-path fading propagation conditions (Case 3)**

Test Number	$\frac{DPCH - E_c}{I_{or}}$	BLER
5	-10.0 dB	$10^{-2}$
6	-12.5 dB	$10^{-2}$

**Table 8.14M: DCH parameters in multi-path fading propagation conditions (Case 1) with S-CPICH**

Parameter	Unit	Test 7	Test 8
Phase reference		S-CPICH	
$\hat{I}_{or}/I_{oc}$	dB	9	
$I_{oc}$	dBm/3.84 MHz	-60	
Information Data Rate	kbps	12.2	0
DCCH Presence	-	No	



**Table 8.14N: DCH requirements in multi-path fading propagation conditions (Case 1) with S-CPICH**

Test Number	$\frac{DPCH - E_c}{I_{or}}$	BLER
7	-13.4 dB	$10^{-2}$
8	-16.6 dB	$10^{-2}$

**Table 8.14O: DCH parameters in multi-path fading propagation conditions (Case 6)**

Parameter	Unit	Test 9	Test 10
Phase reference		P-CPICH	
$\hat{I}_{or}/I_{oc}$	dB	-3	
$I_{oc}$	dBm/3.84 MHz	-60	
Information Data Rate	Kbps	12.2	0
DCCH Presence	-	No	

**Table 8.14P: DCH requirements in multi-path fading propagation conditions (Case 6)**

Test Number	$\frac{DPCH - E_c}{I_{or}}$	BLER
9	-9.9 dB	$10^{-2}$
10	-12.2 dB	$10^{-2}$

## 8.4 Demodulation of DCH in moving propagation conditions

### 8.4.1 Single link performance

The receive single link performance of the Dedicated Channel (DCH) in dynamic moving propagation conditions are determined by the Block Error Ratio (BLER) values. BLER is measured for the each of the individual data rate specified for the DPCH. DCH is mapped into Dedicated Physical Channel (DPCH).

#### 8.4.1.1 Minimum requirement

For the parameters specified in Table 8.15 the average downlink  $\frac{DPCH - E_c}{I_{or}}$  power ratio shall be below the specified value for the BLER shown in Table 8.16.

**Table 8.15: DCH parameters in moving propagation conditions**

Parameter	Unit	Test 1	Test 2
Phase reference		P-CPICH	
$\hat{I}_{or}/I_{oc}$	dB	-1	
$I_{oc}$	dBm/3.84 MHz	-60	
Information Data Rate	kbps	12.2	64

**Table 8.16: DCH requirements in moving propagation conditions**

Test Number	$\frac{DPCH - E_c}{I_{or}}$	BLER
1	-14.5 dB	$10^{-2}$
2	-10.9 dB	$10^{-2}$



## 8.5 Demodulation of DCH in birth-death propagation conditions

### 8.5.1 Single link performance

The receive single link performance of the Dedicated Channel (DCH) in dynamic birth-death propagation conditions are determined by the Block Error Ratio (BLER) values. BER is measured for the each of the individual data rate specified for the DPCH. DCH is mapped into Dedicated Physical Channel (DPCH).

#### 8.5.1.1 Minimum requirement

For the parameters specified in Table 8.17 the average downlink  $\frac{DPCH - E_c}{I_{or}}$  power ratio shall be below the specified value for the BLER shown in Table 8.18.

**Table 8.17: DCH parameters in birth-death propagation conditions**

Parameter	Unit	Test 1	Test 2
Phase reference		P-CPICH	
$\hat{I}_{or}/I_{oc}$	dB	-1	
$I_{oc}$	dBm/3.84 MHz	-60	
Information Data Rate	kbps	12.2	64

**Table 8.18: DCH requirements in birth-death propagation conditions**

Test Number	$\frac{DPCH - E_c}{I_{or}}$	BLER
1	-12.6 dB	$10^{-2}$
2	-8.7 dB	$10^{-2}$

## 8.5A Demodulation of DCH in high speed train condition

### 8.5A.1 General

The receiver performance of the DCH in high speed train condition is determined by the BLER values. BLER is measured for the individual data rate specified for the DPCH. DCH is mapped into DPCH.

#### 8.5A.2 Minimum requirement

For the parameters specified in Table 8.18A the average downlink  $\frac{DPCH - E_c}{I_{or}}$  power ratio shall be below the specified value for the BLER shown in Table 8.18B.

**Table 8.18A: DCH parameters in high speed train condition**

Parameter	Unit	Test 1
Phase reference		P-CPICH
$\hat{I}_{or}/I_{oc}$	dB	5
$I_{oc}$	dBm/3.84 MHz	-60
Information Data Rate	kbps	12.2



**Table 8.18B: DCH requirements in high speed train condition**

Test Number	$\frac{DPCH - E_c}{I_{or}}$	BLER
1	-21.8	$10^{-2}$

## 8.6 Demodulation of DCH in downlink Transmit diversity modes

### 8.6.1 Demodulation of DCH in open-loop transmit diversity mode

The receive characteristic of the Dedicated Channel (DCH) in open loop transmit diversity mode is determined by the Block Error Ratio (BLER). DCH is mapped into in Dedicated Physical Channel (DPCH).

#### 8.6.1.1 Minimum requirement

For the parameters specified in Table 8.19 the average downlink  $\frac{DPCH - E_c}{I_{or}}$  power ratio shall be below the specified value for the BLER shown in Table 8.20. If the UE supports optional enhanced performance requirements type1 for DCH then for the parameters specified in Table 8.20A the average downlink  $\frac{DPCH - E_c}{I_{or}}$  power ratio shall be below the specified value for the BLER shown in Table 8.20B and Test 1 shall be replaced by Test 1a.

**Table 8.19: Test parameters for DCH reception in an open loop transmit diversity scheme.  
(Propagation condition: Case 1)**

Parameter	Unit	Test 1
Phase reference		P-CPICH
$\hat{I}_{or}/I_{oc}$	dB	9
$I_{oc}$	dBm/3.84 MHz	-60
Information data rate	kbps	12.2

**Table 8.20: Test requirements for DCH reception in open loop transmit diversity scheme**

Test Number	$\frac{DPCH - E_c}{I_{or}}$ (antenna 1/2)	BLER
1	-16.8 dB	$10^{-2}$

**Table 8.20A: Test parameters for DCH reception in an open loop transmit diversity scheme for UE supporting the enhanced performance requirements type1 for DCH  
(Propagation condition: PA3)**

Parameter	Unit	Test 1a
Phase reference		P-CPICH
$\hat{I}_{or}/I_{oc}$	dB	9
$I_{oc}$	dBm/3.84 MHz	-60
Information	data	rate kbps 12.2



**Table 8.20B: Test requirements for DCH reception in open loop transmit diversity scheme for UE supporting the enhanced performance requirements type1 for DCH**

Test Number	$\frac{DPCH\_E_c}{I_{or}}$ (antenna 1/2)	BLER
1a	-22.7 dB	$10^{-2}$

## 8.6.2 Demodulation of DCH in closed loop transmit diversity mode

The receive characteristic of the dedicated channel (DCH) in closed loop transmit diversity mode is determined by the Block Error Ratio (BLER). DCH is mapped into in Dedicated Physical Channel (DPCH).

### 8.6.2.1 Minimum requirement

For the parameters specified in Table 8.21 the average downlink  $\frac{DPCH\_E_c}{I_{or}}$  power ratio shall be below the specified value for the BLER shown in Table 8.22. If the UE supports optional enhanced performance requirements type1 for DCH then for the parameters specified in Table 8.22A the average downlink  $\frac{DPCH\_E_c}{I_{or}}$  power ratio shall be below the specified value for the BLER shown in Table 8.22B and Test 1 shall be replaced by Test 1a.

**Table 8.21: Test Parameters for DCH Reception in closed loop transmit diversity mode (Propagation condition: Case 1)**

Parameter	Unit	Test 1 (Mode 1)
$\hat{I}_{or}/I_{oc}$	dB	9
$I_{oc}$	dBm/3.84 MHz	-60
Information data rate	kbps	12.2
Feedback error rate	%	4
Closed loop timing adjustment mode	-	1

**Table 8.22: Test requirements for DCH reception in closed loop transmit diversity mode**

Test Number	$\frac{DPCH\_E_c}{I_{or}}$ (see note)	BLER
1	-18.0 dB	$10^{-2}$
NOTE: This is the total power from both antennas. Power sharing between antennas are feedback mode dependent as specified in TS25.214.		

**Table 8.22A: Test Parameters for DCH Reception in closed loop transmit diversity mode for UE supporting the enhanced performance requirements type1 for DCH (Propagation condition: PA3)**

Parameter	Unit	Test 1a (Mode 1)
$\hat{I}_{or}/I_{oc}$	dB	9
$I_{oc}$	dBm/3.84 MHz	-60
Information data rate	kbps	12.2
Feedback error rate	%	4
Closed loop timing adjustment mode	-	1



**Table 8.22B: Test requirements for DCH reception in closed loop transmit diversity mode for UE supporting the enhanced performance requirements type1 for DCH**

Test Number	$\frac{DPCH - E_c}{I_{or}}$ (see note)	BLER
1a	-23.3 dB	$10^{-2}$
NOTE: This is the total power from both antennas.		

### 8.6.3 (void)

**Table 8.23: (void)****Table 8.24: (void)**

## 8.7 Demodulation in Handover conditions

### 8.7.1 Demodulation of DCH in Inter-Cell Soft Handover

The bit error rate characteristics of UE is determined during an inter-cell soft handover. During the soft handover a UE receives signals from different cells. A UE has to be able to demodulate two PCCPCH channels and to combine the energy of DCH channels. Delay profiles of signals received from different cells are assumed to be the same but time shifted by 10 chips.

The receive characteristics of the different channels during inter-cell handover are determined by the average Block Error Ratio (BLER) values.

#### 8.7.1.1 Minimum requirement

For the parameters specified in Table 8.25 the average downlink  $\frac{DPCH - E_c}{I_{or}}$  power ratio shall be below the specified value for the BLER shown in Table 8.26. If the UE supports optional enhanced performance requirements type1 for DCH then for the parameters specified in Table 8.26A the average downlink  $\frac{DPCH - E_c}{I_{or}}$  power ratio shall be below the specified value for the BLER shown in Table 8.26B and Test 1 shall be replaced by Test 1a.

**Table 8.25: DCH parameters in multi-path propagation conditions during Soft Handoff (Case 3)**

Parameter	Unit	Test 1	Test 2	Test 3	Test 4
Phase reference		P-CPICH			
$\hat{I}_{or1}/I_{oc}$ and $\hat{I}_{or2}/I_{oc}$	dB	0	0	3	6
$I_{oc}$	dBm/3.84 MHz	-60			
Information data Rate	kbps	12.2	64	144	384

**Table 8.26: DCH requirements in multi-path propagation conditions during Soft Handoff (Case 3)**

Test Number	$\frac{DPCH - E_c}{I_{or}}$	BLER
1	-15.2 dB	$10^{-2}$
2	-11.8 dB	$10^{-1}$
	-11.3 dB	$10^{-2}$
3	-9.9 dB	$10^{-1}$
	-9.5 dB	$10^{-2}$
4	-6.3 dB	$10^{-1}$
	-5.8 dB	$10^{-2}$



**Table 8.26A: DCH parameters in multi-path propagation conditions during Soft Handoff (VA120) for UE supporting the enhanced performance requirements type1 for DCH**

Parameter	Unit	Test 1a
Phase	reference P-CPICH	Phase
$\hat{I}_{or1}/I_{oc}$ and $\hat{I}_{or2}/I_{oc}$	dB	0
$I_{oc}$	dBm/3.84 MHz	-60
Information data Rate	kbps	12.2

**Table 8.26B: DCH requirements in multi-path propagation conditions during Soft Handoff (VA120) for UE supporting the enhanced performance requirements type1 for DCH**

Test Number	$\frac{DPCH\_E_c}{I_{or}}$	BLER
1a	-18.5 dB	$10^{-2}$

### 8.7.1A Demodulation of DCH in Inter-Cell Soft Handover when DL\_DCH\_FET\_Config [10] is configured by higher layers

The bit error rate characteristics of UE is determined during an inter-cell soft handover. During the soft handover a UE receives signals from different cells. A UE has to be able to demodulate two PCCPCH channels and to combine the energy of DCH channels. Delay profiles of signals received from different cells are assumed to be the same but time shifted by 10 chips.

The receive characteristics of the different channels during inter-cell handover are determined by the average Block Error Ratio (BLER) values.

#### 8.7.1A.1 Minimum requirement

For the parameters specified in Table 8.26C the average downlink  $\frac{DPCH\_E_c}{I_{or}}$  power ratio shall be below the specified value for the BLER shown in Table 8.26D.

**Table 8.26C: DCH parameters in multi-path propagation conditions during Soft Handoff (Case 3)**

Parameter	Unit	Test 1
Phase reference		P-CPICH
$\hat{I}_{or1}/I_{oc}$ and $\hat{I}_{or2}/I_{oc}$	dB	0
$I_{oc}$	dBm/3.84 MHz	-60
Information Data Rate	kbps	12.2
DCCH Presence	-	No
DL_DCH_FET_Config	-	0 (Note 1)

Note 1: UL is in 10ms transmission.mode

**Table 8.26D: DCH requirements in multi-path propagation conditions during Soft Handoff (Case 3)**

Test Number	$\frac{DPCH\_E_c}{I_{or}}$	BLER
1	-14.6 dB	$10^{-2}$



## 8.7.2 Combining of TPC commands from radio links of different radio link sets

### 8.7.2.1 Minimum requirement

Test parameters are specified in Table 8.27. The delay profiles of the signals received from the different cells are the same but time-shifted by 10 chips.

For Test 1, the sequence of uplink power changes between adjacent slots shall be as shown in Table 8.28 over the 4 consecutive slots more than 99% of the time. Note that this case is without an additional noise source  $I_{oc}$ .

For Test 2, the Cell1 and Cell2 TPC patterns are repeated a number of times. If the transmitted power of a given slot is increased compared to the previous slot, then a variable "Transmitted power UP" is increased by one, otherwise a variable "Transmitted power DOWN" is increased by one. The requirements for "Transmitted power UP" and "Transmitted power DOWN" are shown in Table 8.28A.

**Table 8.27: Parameters for TPC command combining**

Parameter	Unit	Test 1	Test 2
Phase reference	-		
DPCH_Ec/Ior	dB		-12
$\hat{I}_{or1}$ and $\hat{I}_{or2}$	dBm/3.84 MHz		-60
$I_{oc}$	dBm/3.84 MHz	-	-60
Power-Control-Algorithm	-	Algorithm 1	
Cell 1 TPC commands over 4 slots	-	{0,0,1,1}	
Cell 2 TPC commands over 4 slots	-	{0,1,0,1}	
Information data Rate	kbps	12.2	
Propagation condition	-	Static without AWGN source $I_{oc}$	Multi-path fading case 3

**Table 8.28: Test requirements for Test 1**

Test Number	Required power changes over the 4 consecutive slots
1	Down, Down, Down, Up

**Table 8.28A: Requirements for Test 2**

Test Number	Ratio (Transmitted power UP) / (Total number of slots)	Ratio (Transmitted power DOWN) / (Total number of slots)
2	$\geq 0.25$	$\geq 0.5$

## 8.7.2A Combining of TPC commands from radio links of different radio link sets when DL\_DCH\_FET\_Config [10] is configured by higher layers

### 8.7.2A.1 Minimum requirement

Test parameters are specified in Table 8.28AA. The delay profiles of the signals received from the different cells are the same but time-shifted by 10 chips.

For Test 1, the sequence of uplink power changes between adjacent slots shall be as shown in Table 8.28AB over the 4 consecutive slots more than 99% of the time. Note that this case is without an additional noise source  $I_{oc}$ .

For Test 2, the Cell1 and Cell2 TPC patterns are repeated a number of times. If the transmitted power of a given slot is increased compared to the previous slot, then a variable "Transmitted power UP" is increased by one, otherwise a



variable "Transmitted power DOWN" is increased by one. The requirements for "Transmitted power UP" and "Transmitted power DOWN" are shown in Table 8.28AC.

**Table 8.28AA: Parameters for TPC command combining**

Parameter	Unit	Test 1	Test 2
Phase reference	-		
DPCH_Ec/lor	dB	-12	
$\hat{I}_{or1}$ and $\hat{I}_{or2}$	dBm/3.84 MHz	-60	
$I_{oc}$	dBm/3.84 MHz	-	-60
Power-Control-Algorithm	-	Algorithm 1	
Cell 1 TPC commands over 4 slots	-	{0,0,1,1}	
Cell 2 TPC commands over 4 slots	-	{0,1,0,1}	
Information data Rate	kbps	12.2	
DCCH Presence	-	No	
Propagation condition	-	Static without AWGN source $I_{oc}$	Multi-path fading case 3
DL_DCH_FET_Config	-	0 (Note 1)	
Note 1: UL is in 20ms transmission.mode			

**Table 8.28AB: Test requirements for Test 1**

Test Number	Required power changes over the 4 consecutive slots
1	Down, Down, Down, Up

**Table 8.28AC: Requirements for Test 2**

Test Number	Ratio (Transmitted power UP) / (Total number of slots)	Ratio (Transmitted power DOWN) / (Total number of slots)
2	≥0.25	≥0.5

## 8.7.2B Combining of TPC commands from radio links of different radio link sets when DPCCH2 is configured

### 8.7.2B.1 Minimum requirement

This test verifies that UE follows the TPC commands for the DPCCH as well as the TPC commands for the DPCCH2 when DPCCH2 is configured.

Test parameters are specified in Table 8.28AD. The delay profiles of the signals received from the different cells are the same but time-shifted by 10 chips. Cell1 is the serving HS-DSCH cell on which the DPCCH2 is configured. Two F-DPCH channels are sent from Cell1, where one is associated with DPCCH and one is associated with DPCCH2.

The sequence of uplink DPCCH and DPCCH2 power changes between adjacent slots shall be as shown in Table 8.28AE over the 4 consecutive slots more than 99% of the time. Note that this case is without an additional noise source  $I_{oc}$ .



**Table 8.28AD: Parameters for TPC command combining**

Parameter	Unit	Test	Notes
Phase reference	-	P-CPICH	
F-DPCH $E_c / I_{or}$ Cell 1 associated with UL DPCCH	dB	-12	This F-DPCH channel is from Cell 1 and is associated with the UL DPCCH channel
F-DPCH $E_c / I_{or}$ Cell 1, associated with UL DPCCH2	dB	-12	This F-DPCH channel is from Cell1 and is associated with the UL DPCCH2 channel
F-DPCH $E_c / I_{or}$ Cell 2	dB	-12	This F-DPCH channel is from Cell 2 and is associated with the UL DPCCH channel
F-DPCH slot format	-	0	Valid for all F-DPCH channels.
HS-SCCH_1 $E_c / I_{or}$ (Cell 1)	dB	-	No signalling scheduled, and no power is transmitted on this HS- SCCH, but signalled to the UE as present in HSDPA configuration.
HS-PDSCH $E_c / I_{or}$ (Cell 1)	dB	-	No power is transmitted
OCNS			The power of the OCNS channels that is added shall make the total power from both cells to be equal to lor .
$\hat{I}_{or1}$ and $\hat{I}_{or2}$	dBm/3.84 MHz	-60	
$I_{oc}$	dBm/3.84 MHz	-	No interference is transmitted
Power-Control-Algorithm	-	Algorithm 1	
Cell 1 TPC commands for DPCCH over 4 slots	-	{1,1,1,1}	
Cell 1 TPC commands for DPCCH2 over 4 slots		{1,1,0,0}	
Cell 2 TPC commands for DPCCH over 4 slots	-	{0,0,1,1}	
Propagation condition	-	Static	

**Table 8.28AE: Test requirements**

	Required power changes over the 4 consecutive slots
DPCCH	Down, Down, Up, Up
DPCCH2	Up, Up, Down, Down

## 8.7.3 Combining of reliable TPC commands from radio links of different radio link sets

### 8.7.3.1 Minimum requirement

Test 1 verifies that the UE follows only the reliable TPC commands in soft handover. Test 2 verifies that the UE follows all the reliable TPC commands in soft handover.

Test parameters are specified in Table 8.28B. Before the start of the tests, the UE transmit power shall be initialised to -15 dBm. An actual UE transmit power may vary from the target level of -15 dBm due to inaccurate UE output power step.

During tests 1 and 2 the UE transmit power samples, which are defined as the mean power over one timeslot, shall stay 90% of the time within the range defined in Table 8.28C.



**Table 8.28B: Parameters for reliable TPC command combining**

Parameter	Unit	Test 1	Test 2
Phase reference	-	P-CPICH	
DPCH_Ec/Ior1	dB	Note 1	Note 1 & Note 3
DPCH_Ec/Ior2	dB	DPCH_Ec/Ior1 - 10	DPCH_Ec/Ior1 + 6
DPCH_Ec/Ior3	dB	DPCH_Ec/Ior1 - 10	-
$\hat{I}_{or1}/I_{oc}$	dB	-1	-1
$\hat{I}_{or2}/I_{oc}$	dB	-1	-1
$\hat{I}_{or3}/I_{oc}$	dB	-1	-
$I_{oc}$	dBm/3.84 MHz	-60	
Power-Control-Algorithm	-	Algorithm 1	
UL Power Control step size, $\Delta_{TPC}$	dB	1	
Cell 1 TPC commands	-	Note 2	Note 2
Cell 2 TPC commands	-	"1"	"1"
Cell 3 TPC commands	-	"1"	-
Information data Rate	kbps	12.2	
Propagation condition	-	Static	
Note 1: The DPCH_Ec/Ior1 is set at the level corresponding to 5% TPC error rate.			
Note 2: The uplink power control from cell1 shall be such that the UE transmit power would stay at -15 dBm.			
Note 3: The maximum DPCH_Ec/Ior1 level in cell1 is -9 dB.			

**Table 8.28C: Test requirements for reliable TPC command combining**

Parameter	Unit	Test 1	Test 2
UE output power	dBm	-15 ± 5 dB	-15 ± 3 dB

## 8.7.4 Combining of reliable TPC commands from radio links of different radio link sets when DL\_DCH\_FET\_Config [10] is configured by higher layers

### 8.7.4.1 Minimum requirement

Test 1 verifies that the UE follows only the reliable TPC commands in soft handover. Test 2 verifies that the UE follows all the reliable TPC commands in soft handover.

Test parameters are specified in Table 8.28D. Before the start of the tests, the UE transmit power shall be initialised to -15 dBm. An actual UE transmit power may vary from the target level of -15 dBm due to inaccurate UE output power step.

During tests 1 and 2 the UE transmit power samples, which are defined as the mean power over one timeslot, shall stay 90% of the time within the range defined in Table 8.28E.



**Table 8.28D: Parameters for reliable TPC command combining**

Parameter	Unit	Test 1	Test 2
Phase reference	-	P-CPICH	
DPCH_Ec/Ior1	dB	Note 1	Note 1 & Note 3
DPCH_Ec/Ior2	dB	DPCH_Ec/Ior1 - 10	DPCH_Ec/Ior1 + 6
DPCH_Ec/Ior3	dB	DPCH_Ec/Ior1 - 10	-
$\hat{I}_{or1}/I_{oc}$	dB	-1	-1
$\hat{I}_{or2}/I_{oc}$	dB	-1	-1
$\hat{I}_{or3}/I_{oc}$	dB	-1	-
$I_{oc}$	dBm/3.84 MHz	-60	
Power-Control-Algorithm	-	Algorithm 1	
UL Power Control step size, $\Delta_{TPC}$	dB	1	
Cell 1 TPC commands	-	Note 2	Note 2
Cell 2 TPC commands	-	"1"	"1"
Cell 3 TPC commands	-	"1"	-
Information data Rate	Kbps	12.2	
Propagation condition	-	Static	
DCCH Presence	-	No	
DL_DCH_FET_Config	-	0 (Note 4)	
Note 1:	The DPCH_Ec/Ior1 is set at the level corresponding to 5% TPC error rate.		
Note 2:	The uplink power control from cell1 shall be such that the UE transmit power would stay at -15 dBm.		
Note 3:	The maximum DPCH_Ec/Ior1 level in cell1 is -9 dB.		
Note 4:	UL is in 10ms transmission mode		

**Table 8.28E: Test requirements for reliable TPC command combining**

Parameter	Unit	Test 1	Test 2
UE output power	dBm	-15 ± 5 dB	-15 ± 3 dB

## 8.8 Power control in downlink

Power control in the downlink is the ability of the UE receiver to converge to required link quality set by the network while using as low power as possible in downlink. If a BLER target has been assigned to a DCCH (See Annex A.3), then it has to be such that outer loop is based on DTCH and not on DCCH.

The requirements in this subclause were derived with the assumption that the UTRAN responds immediately to the uplink TPC commands by adjusting the power of the first pilot field of the DL DPCCCH that commences after end of the received TPC command.

### 8.8.1 Power control in the downlink, constant BLER target

#### 8.8.1.1 Minimum requirements

For the parameters specified in Table 8.29 the downlink  $\frac{DPCH\_E_c}{I_{or}}$  power ratio measured values, which are averaged over one slot, shall be below the specified value in Table 8.30 more than 90% of the time. BLER shall be as shown in Table 8.30. If the UE supports optional enhanced performance requirements type1 for DCH then for the parameters specified in Table 8.30A the downlink  $\frac{DPCH\_E_c}{I_{or}}$  power ratio measured values, which are averaged over one slot, shall be below the specified value in Table 8.30B more than 90% of the time. BLER shall be as shown in Table 8.30B and Test 2 shall be replaced by Test 2a. Power control in downlink is ON during the test.



**Table 8.29: Test parameter for downlink power control**

Parameter	Unit	Test 1	Test 2	Test 3	Test 4
$\hat{I}_{or}/I_{oc}$	dB	9	-1	4	9
$I_{oc}$	dBm/3.84 MHz	-60		-60	
Information Data Rate	kbps	12.2		64	
Reference channel in Annex A		A.3.1		A.3.5	
Target quality value on DTCH	BLER	0.01		0.1	0.001
Target quality value on DCCH	BLER	-		0.1	0.1
Propagation condition		Case 4			
Maximum_DL_Power *	dB	7			
Minimum_DL_Power *	dB	-18			
DL Power Control step size, $\Delta_{TPC}$	dB	1			
Limited Power Increase	-	"Not used"			

NOTE: Power is compared to P-CPICH as specified in [4].

**Table 8.30: Requirements in downlink power control**

Parameter	Unit	Test 1	Test 2	Test 3	Test 4
$\frac{DPCH\_E_c}{I_{or}}$	dB	-16.0	-9.0	-9.0	-10.3
Measured quality on DTCH	BLER	0.01±30%	0.01±30%	0.1±30%	0.001±30%

**Table 8.30A: Test parameter for downlink power control for UE supporting the enhanced performance requirements type1 for DCH**

Parameter	Unit	Test 2a
$\hat{I}_{or}/I_{oc}$	dB	-1
$I_{oc}$	dBm/3.84 MHz	-60
Information Data Rate	kbps	12.2
Reference channel in Annex A		A.3.1
Target quality value on DTCH	BLER	0.01
Target quality value on DCCH	BLER	-
Propagation condition		PA3
Maximum_DL_Power *	dB	7
Minimum_DL_Power *	dB	-18
DL Power Control step size, $\Delta_{TPC}$	dB	1
Limited Power Increase	-	"Not used"

NOTE: Power is compared to P-CPICH as specified in [4].

**Table 8.30B: Requirements in downlink power control for UE supporting the enhanced performance requirements type1 for DCH**

Parameter	Unit	Test 2a
$\frac{DPCH\_E_c}{I_{or}}$	dB	-12.2
Measured quality on DTCH	BLER	0.01±30%



## 8.8.1A Power control in the downlink, constant BLER target when DL\_DCH\_FET\_Config [10] is configured by higher layers

### 8.8.1A.1 Minimum requirements

For the parameters specified in Table 8.30C and Table 8.30D, the downlink  $\frac{DPCH\_E_c}{I_{or}}$  power ratio measured values, which are averaged over one slot, shall be below the specified value in Table 8.30E, Table 8.30F, Table 8.30G and Table 8.30H more than 90% of the time. BLER shall be as shown in Table 8.30E, Table 8.30F, Table 8.30G and Table 8.30H. Test requirements in Table 8.30E, Table 8.30F, Table 8.30G and Table 8.30H correspond to DL\_DCH\_FET\_Config is set to 0 with UL in 20ms transmission mode, DL\_DCH\_FET\_Config is set to 0 with UL in 10ms transmission mode, DL\_DCH\_FET\_Config is set to 1 with UL in 10ms transmission mode and non-Null transmission in the UL, and, DL\_DCH\_FET\_Config is set to 1 with UL in 10ms transmission mode and Null transmission in the UL respectively.

**Table 8.30C: Test parameter for downlink power control**

Parameter	Unit	Test 1	Test 2
$\hat{I}_{or}/I_{oc}$	dB	9	
$I_{oc}$	dBm/3.84 MHz	-60	
Information Data Rate	kbps	12.2	0
Reference channel in Annex A		A.3A.2	A.3A.0
Target quality value on DTCH	BLER	0.01	
Target quality value on DCCH	BLER	-	
Propagation condition		Case 4	
Maximum_DL_Power *	dB	7	
Minimum_DL_Power *	dB	-18	-21
DL Power Control step size, $\Delta_{TPC}$	dB	1	
Limited Power Increase	-	"Not used"	

**Table 8.30D: Test parameter for downlink power control**

Parameter	Unit	Test 3	Test 4
$\hat{I}_{or}/I_{oc}$	dB	-1	
$I_{oc}$	dBm/3.84 MHz	-60	
Information Data Rate	kbps	12.2	0
Reference channel in Annex A		A.3A.2	A.3A.0
Target quality value on DTCH	BLER	0.01	
Target quality value on DCCH	BLER	-	
Propagation condition		Case 4	
Maximum_DL_Power *	dB	7	
Minimum_DL_Power *	dB	-18	-21
DL Power Control step size, $\Delta_{TPC}$	dB	1	
Limited Power Increase	-	"Not used"	

NOTE: Power is compared to P-CPICH as specified in [4].



**Table 8.30E: Requirements in downlink power control (DL\_DCH\_FET\_Config is set to 0 with 20ms UL transmission mode)**

Parameter	Unit	Test 1	Test 2	Test 3	Test 4
$\frac{DPCH\_E_c}{I_{or}}$	dB	-17.7	-19.8	-10.2	-11.7
Measured quality on DTCH	BLER	0.01± 30%	0.01± 30%	0.01± 30%	0.01± 30%

**Table 8.30F: Requirements in downlink power control (DL\_DCH\_FET\_Config is set to 0 with 10ms UL transmission mode)**

Parameter	Unit	Test 1	Test 2	Test 3	Test 4
$\frac{DPCH\_E_c}{I_{or}}$	dB	-14.4	-16.5	-6.0	-8.7
Measured quality on DTCH	BLER	0.01± 30%	0.01± 30%	0.01± 30%	0.01± 30%

**Table 8.30G: Requirements in downlink power control (DL\_DCH\_FET\_Config is set to 1 with 10ms UL transmission mode)**

Parameter	Unit	Test 1	Test 2	Test 3	Test 4
$\frac{DPCH\_E_c}{I_{or}}$	dB	-17.5	-19.8	-9.6	-11.6
Measured quality on DTCH	BLER	0.01± 30%	0.01± 30%	0.01± 30%	0.01± 30%

**Table 8.30H: Requirements in downlink power control (DL\_DCH\_FET\_Config is set to 1 with 10ms UL transmission mode and Null transmission in uplink)**

Parameter	Unit	Test 1	Test 2	Test 3	Test 4
$\frac{DPCH\_E_c}{I_{or}}$	dB	-17.5	-19.7	-9.6	-11.6
Measured quality on DTCH	BLER	0.01± 30%	0.01± 30%	0.01± 30%	0.01± 30%

## 8.8.2 Power control in the downlink, initial convergence

This requirement verifies that DL power control works properly during the first seconds after DPCH connection is established

### 8.8.2.1 Minimum requirements

For the parameters specified in Table 8.31 the downlink DPCH\_Ec/Ior power ratio measured values, which are averaged over 50 ms, shall be within the range specified in Table 8.32 more than 90% of the time. For UE supporting the enhanced performance requirements type1 for DCH with the parameters specified in Table 8.32A the downlink DPCH\_Ec/Ior power ratio measured values, which are averaged over 50 ms, shall be within the range specified in Table 8.32B more than 90% of the time. T1 equals to 500 ms and it starts 10 ms after the DPDCH physical channel is considered established and the first uplink frame is transmitted. T2 equals to 500 ms and it starts when T1 has expired. Power control is ON during the test. If the UE supports optional enhanced performance requirements type1 for DCH, Test 1, Test 2, Test 3 and Test 4 shall be replaced by Test 1a, Test 2a, Test 3a and Test 4a.



The first 10 ms shall not be used for averaging, ie the first sample to be input to the averaging filter is at the beginning of T1. The averaging shall be performed with a sliding rectangular window averaging filter. The window size of the averaging filter is linearly increased from 0 up to 50 ms during the first 50 ms of T1, and then kept equal to 50ms.

**Table 8.31: Test parameters for downlink power control**

Parameter	Unit	Test 1	Test 2	Test 3	Test 4
Target quality value on DTCH	BLER	0.01	0.01	0.1	0.1
Initial DPCH_Ec/I <sub>or</sub>	dB	-5.9	-25.9	-3	-22.8
Information Data Rate	kbps	12.2	12.2	64	64
$\hat{I}_{or}/I_{oc}$	dB	-1			
$I_{oc}$	dBm/3.84 MHz	-60			
Propagation condition		Static			
Maximum_DL_Power	dB	7			
Minimum_DL_Power	dB	-18			
DL Power Control step size, $\Delta_{TPC}$	dB	1			
Limited Power Increase	-	"Not used"			

**Table 8.32: Requirements in downlink power control**

Parameter	Unit	Test 1 and Test 2	Test 3 and Test 4
$\frac{DPCH\_E_c}{I_{or}}$ during T1	dB	$-18.9 \leq DPCH\_Ec/I_{or} \leq -11.9$	$-15.1 \leq DPCH\_Ec/I_{or} \leq -8.1$
$\frac{DPCH\_E_c}{I_{or}}$ during T2	dB	$-18.9 \leq DPCH\_Ec/I_{or} \leq -14.9$	$-15.1 \leq DPCH\_Ec/I_{or} \leq -11.1$
Note: The lower limit is decreased by 3 dB for a UE with more than one antenna connector.			

**Table 8.32A: Test parameters for downlink power control for UE supporting the enhanced performance requirements type1 for DCH**

Parameter	Unit	Test 1a	Test 2a	Test 3a	Test 4a
Target quality value on DTCH	BLER	0.01	0.01	0.1	0.1
Initial DPCH_Ec/I <sub>or</sub>	dB	-8.9	-28	-6	-25.8
Information Data Rate	kbps	12.2	12.2	64	64
$\hat{I}_{or}/I_{oc}$	dB	-1			
$I_{oc}$	dBm/3.84 MHz	-60			
Propagation condition		Static			
Maximum_DL_Power	dB	7			
Minimum_DL_Power	dB	-18			
DL Power Control step size, $\Delta_{TPC}$	dB	1			
Limited Power Increase	-	"Not used"			



**Table 8.32B: Requirements in downlink power control for UE supporting the enhanced performance requirements type1 for DCH**

Parameter	Unit	Test 1a and Test 2a	Test 3a and Test 4a
$\frac{DPCH\_E_c}{I_{or}}$ during T1	dB	$-21.9 \leq DPCH\_Ec/lor \leq -14.9$	$-18.1 \leq DPCH\_Ec/lor \leq -11.1$
$\frac{DPCH\_E_c}{I_{or}}$ during T2	dB	$-21.9 \leq DPCH\_Ec/lor \leq -17.9$	$-18.1 \leq DPCH\_Ec/lor \leq -14.1$

## 8.8.2A Power control in the downlink, initial convergence when DL\_DCH\_FET\_Config [10] is configured by higher layers

This requirement verifies that DL power control works properly during the first seconds after DPCH connection is established.

### 8.8.2A.1 Minimum requirements

For the parameters specified in Table 8.32C the downlink DPCH\_Ec/Ior power ratio measured values, which are averaged over 50 ms, shall be within the range specified in Table 8.32D, Table 8.32E and Table 8.32F more than 90% of the time. T1 equals to 500 ms and it starts 10 ms after the DPDCH physical channel is considered established and the first uplink frame is transmitted. T2 equals to 500 ms and it starts when T1 has expired. Power control is ON during the test.

The first 10 ms shall not be used for averaging, ie the first sample to be input to the averaging filter is at the beginning of T1. The averaging shall be performed with a sliding rectangular window averaging filter. The window size of the averaging filter is linearly increased from 0 up to 50 ms during the first 50 ms of T1, and then kept equal to 50ms. Test requirements in Table 8.32D, Table 8.32E and Table 8.32F correspond to DL\_DCH\_FET\_Config is set to 0 with UL in 20ms transmission mode, DL\_DCH\_FET\_Config is set to 1 with UL in 10ms transmission mode and non-Null transmission in the UL, and, DL\_DCH\_FET\_Config is set to 1 with UL in 10ms transmission mode and Null transmission in the UL respectively.

**Table 8.32C: Test parameters for downlink power control**

Parameter	Unit	Test 1	Test 2	Test 3	Test 4
Target quality value on DTCH	BLER	0.01		0.01	
Initial DPCH_Ec/Ior	dB	-5.9	-25.9	-5.9	-25.9
Information Data Rate	kbps	12.2		0	
DCCH Presence	-	No			
$\hat{I}_{or}/I_{oc}$	dB	-1			
$I_{oc}$	dBm/3.84 MHz	-60			
Propagation condition		Static			
Maximum_DL_Power	dB	7			
Minimum_DL_Power	dB	-18		-21	
DL Power Control step size, $\Delta_{TPC}$	dB	1			
Limited Power Increase	-	"Not used"			



**Table 8.32D: Requirements in downlink power control (DL\_DCH\_FET\_Config is set to 0 with 20ms UL transmission mode)**

Parameter	Unit	Test 1 & Test 2	Test 3 & Test 4
$\frac{DPCH\_E_c}{I_{or}}$ during T1	dB	$-20.6 \leq DPCH\_Ec/lor \leq -12.0$	$-20.6 \leq DPCH\_Ec/lor \leq -12.0$
$\frac{DPCH\_E_c}{I_{or}}$ during T2	dB	$-20.6 \leq DPCH\_Ec/lor \leq -15.5$	$-20.6 \leq DPCH\_Ec/lor \leq -15.6$

**Table 8.32E: Requirements in downlink power control (DL\_DCH\_FET\_Config is set to 1 with 10ms UL transmission mode)**

Parameter	Unit	Test 1 & Test 2	Test 3 & Test 4
$\frac{DPCH\_E_c}{I_{or}}$ during T1	dB	$-21.0 \leq DPCH\_Ec/lor \leq -11.5$	$-21.4 \leq DPCH\_Ec/lor \leq -11.6$
$\frac{DPCH\_E_c}{I_{or}}$ during T2	dB	$-21.0 \leq DPCH\_Ec/lor \leq -15.8$	$-21.4 \leq DPCH\_Ec/lor \leq -15.2$

**Table 8.32F: Requirements in downlink power control (DL\_DCH\_FET\_Config is set to 1 with 10ms UL transmission mode and Null transmission in uplink)**

Parameter	Unit	Test 1 & Test 2	Test 3 & Test 4
$\frac{DPCH\_E_c}{I_{or}}$ during T1	dB	$-21.3 \leq DPCH\_Ec/lor \leq -10.6$	$-22.1 \leq DPCH\_Ec/lor \leq -11.2$
$\frac{DPCH\_E_c}{I_{or}}$ during T2	dB	$-21.3 \leq DPCH\_Ec/lor \leq -15.0$	$-22.1 \leq DPCH\_Ec/lor \leq -14.9$

## 8.8.3 Power control in downlink, wind up effects

### 8.8.3.1 Minimum requirements

This test is run in three stages where stage 1 is for convergence of the power control loop. In stage two the maximum downlink power for the dedicated channel is limited not to be higher than the value specified in Table 8.33. All parameters used in the three stages are specified in Table 8.33. The downlink  $\frac{DPCH\_E_c}{I_{or}}$  power ratio measured values,

which are averaged over one slot, during stage 3 shall be lower than the value specified in Table 8.34 more than 90% of the time.

Power control of the UE is ON during the test.



**Table 8.33: Test parameter for downlink power control, wind-up effects**

Parameter	Unit	Test 1		
		Stage 1	Stage 2	Stage 3
Time in each stage	s	5	5	0.5
$\hat{I}_{or}/I_{oc}$	dB	5		
$I_{oc}$	dBm/3.84 MHz	-60		
Information Data Rate	kbps	12.2		
Quality target on DTCH	BLER	0.01		
Propagation condition		Case 4		
Maximum_DL_Power	dB	7	min(-6.2,P). Note 1	7
Minimum_DL_Power	dB	-18		
DL Power Control step size, $\Delta_{TPC}$	dB	1		
Limited Power Increase	-	"Not used"		

Note 1:  $P$  is the level corresponding to the average  $\frac{DPCH - E_c}{I_{or}}$  power ratio - 2 dB compared to the P-CPICH level. The average  $\frac{DPCH - E_c}{I_{or}}$  power ratio is measured during the initialisation stage after the power control loop has converged before the actual test starts.

**Table 8.34: Requirements in downlink power control, wind-up effects**

Parameter	Unit	Test 1, stage 3
$\frac{DPCH - E_c}{I_{or}}$	dB	-13.3

### 8.8.3A Power control in downlink, wind up effects when DL\_DCH\_FET\_Config [10] is configured by higher layers

#### 8.8.3A.1 Minimum requirements

This test is run in three stages where stage 1 is for convergence of the power control loop. In stage two the maximum downlink power for the dedicated channel is limited not to be higher than the value specified in Table 8.33A and Table 8.33B. All parameters used in the three stages are specified in Table 8.33A and Table 8.33B. The downlink  $\frac{DPCH - E_c}{I_{or}}$

power ratio measured values, which are averaged over one slot, during stage 3 shall be lower than the value specified in Table 8.34C, Table 8.34D, Table 8.34E and Table 8.34F more than 90% of the time. Test requirements in Table 8.34C, Table 8.34D, Table 8.34E and Table 8.34F correspond to DL\_DCH\_FET\_Config is set to 0 with UL in 20ms transmission mode, DL\_DCH\_FET\_Config is set to 0 with UL in 10ms transmission mode, DL\_DCH\_FET\_Config is set to 1 with UL in 10ms transmission mode and non-Null transmission in the UL, and, DL\_DCH\_FET\_Config is set to 1 with UL in 10ms transmission mode and Null transmission in the UL respectively.

Power control of the UE is ON during the test.

**Table 8.34A: Test parameter for downlink power control, wind-up effects (12.2 kbps without DCCH)**

Parameter	Unit	Test 1		
		Stage 1	Stage 2	Stage 3



Time in each stage	s	5	5	0.5
$\hat{I}_{or}/I_{oc}$	dB	5		
$I_{oc}$	dBm/3.84 MHz	-60		
Information Data Rate	kbps	12.2		
DCCH Presence		No		
Quality target on DTCH	BLER	0.01		
Propagation condition		Case 4		
Maximum_DL_Power	dB	7	min(-6.2,P). Note 1	7
Minimum_DL_Power	dB	-18		
DL Power Control step size, $\Delta_{TPC}$	dB	1		
Limited Power Increase	-	"Not used"		
Note 1: $P$ is the level corresponding to the average $\frac{DPCH - E_c}{I_{or}}$ power ratio - 2 dB compared to the P-CPICH level. The average $\frac{DPCH - E_c}{I_{or}}$ power ratio is measured during the initialisation stage after the power control loop has converged before the actual test starts.				

**Table 8.34B: Test parameter for downlink power control, wind-up effects (0 kbps without DCCH)**

Parameter	Unit	Test 1		
		Stage 1	Stage 2	Stage 3
Time in each stage	s	5	5	0.5
$\hat{I}_{or}/I_{oc}$	dB	5		
$I_{oc}$	dBm/3.84 MHz	-60		
Information Data Rate	kbps	0		
DCCH Presence		No		
Quality target on DTCH	BLER	0.01		
Propagation condition		Case 4		
Maximum_DL_Power	dB	7	min(-6.2,P). Note 1	7
Minimum_DL_Power	dB	-21		
DL Power Control step size, $\Delta_{TPC}$	dB	1		
Limited Power Increase	-	"Not used"		
Note 1: $P$ is the level corresponding to the average $\frac{DPCH - E_c}{I_{or}}$ power ratio - 2 dB compared to the P-CPICH level. The average $\frac{DPCH - E_c}{I_{or}}$ power ratio is measured during the initialisation stage after the power control loop has converged before the actual test starts.				

**Table 8.34C: Requirements in downlink power control, wind-up effects (DL\_DCH\_FET\_Config is set to 0 with 20ms UL transmission mode)**

Parameter	Unit	Test 1, stage 3	Test 1, stage 3
		Reference Measurement Channel (A.3A.2)	Reference Measurement Channel (A.3A.0)
$\frac{DPCH - E_c}{I_{or}}$	dB	-14.6	-17.3



**Table 8.34D: Requirements in downlink power control, wind-up effects (DL\_DCH\_FET\_Config is set to 0 with 10ms UL transmission mode)**

Parameter	Unit	Test 1, stage 3  Reference Measurement Channel (A.3A.2)	Test 1, stage 3  Reference Measurement Channel (A.3A.0)
$\frac{DPCH - E_c}{I_{or}}$	dB	-13.6	-15.7

**Table 8.34E: Requirements in downlink power control, wind-up effects (DL\_DCH\_FET\_Config is set to 1 with 10ms UL transmission mode)**

Parameter	Unit	Test 1, stage 3  Reference Measurement Channel (A.3A.2)	Test 1, stage 3  Reference Measurement Channel (A.3A.0)
$\frac{DPCH - E_c}{I_{or}}$	dB	-14.7	-17.1

**Table 8.34F: Requirements in downlink power control, wind-up effects (DL\_DCH\_FET\_Config is set to 1 with 10ms UL transmission mode and Null transmission in Uplink)**

Parameter	Unit	Test 1, stage 3  Reference Measurement Channel (A.3A.2)	Test 1, stage 3  Reference Measurement Channel (A.3A.0)
$\frac{DPCH - E_c}{I_{or}}$	dB	-14.7	-16.7

## 8.8.4 Power control in the downlink, different transport formats

### 8.8.4.1 Minimum requirements

Test 1 verifies that UE outer loop power control has proper behaviour with different transport formats.

The downlink reference measurement channel used in this subclause shall have two different transport formats. The different transport formats of the downlink reference measurement channel used shall correspond to the measurement channels specified in Annex A.3.0 and A.3.1. The transport format used in downlink reference measurement channel during different stages of the test shall be set according to the information data rates specified in Table 8.34A. During stage 1 a downlink transport format combination using the 12.2kbps information data rate DTCH shall be used, and during stage 2 the downlink transport format combination shall be changed such that a 0kbps information data rate transport format combination is then used.



For the parameters specified in Table 8.34A the downlink  $\frac{DPCH - E_c}{I_{or}}$  power ratio measured values, which are averaged over one slot, shall be below the specified value in Table 8.34B more than 90% of the time. BLER shall be as shown in Table 8.34B. Power control in downlink is ON during the test.

**Table 8.34A: Parameters for downlink power control in case of different transport formats**

Parameter	Unit	Test 1	
		Stage 1	Stage 2
Time in each stage	s	Note 1	Note 1
$\hat{I}_{or}/I_{oc}$	dB	9	
$I_{oc}$	dBm/3.84 MHz	-60	
Information Data Rate	kbps	12.2	0
Quality target on DTCH	BLER	0.01	
Quality target on DCCH	BLER	1	
Propagation condition		Case4	
Maximum_DL_Power	dB	7	
Minimum_DL_Power	dB	-18	
DL Power Control step size, $\Delta_{TPC}$	dB	1	
Limited Power Increase	-	"Not used"	
Note 1: The stage lasts until the DTCH quality has converged to the quality target			

NOTE: Power is compared to P-CPICH as specified in [4].

**Table 8.34B: Requirements in downlink power control in case of different transport formats**

Parameter	Unit	Test 1, stage 1	Test 1, stage 2
$\frac{DPCH - E_c}{I_{or}}$	dB	-16.0	-18.0
Measured quality on DTCH	BLER	0.01±30%	0.01±30%

## 8.8.4A Power control in the downlink, different transport formats

### 8.8.4A.1 Minimum requirements

Test 1 verifies that UE outer loop power control has proper behaviour with different transport formats.

The downlink reference measurement channel used in this subclause shall have two different transport formats. The different transport formats of the downlink reference measurement channel used shall correspond to the measurement channels specified in Annex A.3A.0 and A.3A.2. The transport format used in downlink reference measurement channel during different stages of the test shall be set according to the information data rates specified in Table 8.34BA. During stage 1 a downlink transport format combination using the 12.2kbps information data rate DTCH shall be used, and during stage 2 the downlink transport format combination shall be changed such that a 0kbps information data rate transport format combination is then used.

For the parameters specified in Table 8.34BA, the downlink  $\frac{DPCH - E_c}{I_{or}}$  power ratio measured values, which are

averaged over one slot, shall be below the specified value in Table 8.34BB, Table 8.34BC, Table 8.34BD and Table 8.34BE more than 90% of the time. BLER shall be as shown in Table 8.34BB, Table 8.34BC, Table 8.34BD and Table 8.34BE. Power control in downlink is ON during the test. Test requirements in Table 8.34BB, Table 8.34BC, Table 8.34BD and Table 8.34BE correspond to DL\_DCH\_FET\_Config is set to 0 with UL in 20ms transmission mode, DL\_DCH\_FET\_Config is set to 0 with UL in 10ms transmission mode, DL\_DCH\_FET\_Config is set to 1 with UL in



10ms transmission mode and non-Null transmission in the UL, and, DL\_DCH\_FET\_Config is set to 1 with UL in 10ms transmission mode and Null transmission in the UL respectively.

**Table 8.34BA: Parameters for downlink power control in case of different transport formats**

Parameter	Unit	Test 1	
		Stage 1	Stage 2
Time in each stage	s	Note 1	Note 1
$\hat{I}_{or}/I_{oc}$	dB	9	
$I_{oc}$	dBm/3.84 MHz	-60	
Information Data Rate	kbps	12.2	0
DCCH Presence		No	
Quality target on DTCH	BLER	0.01	
Quality target on DCCH	BLER	1	
Propagation condition		Case4	
Maximum_DL_Power	dB	7	
Minimum_DL_Power	dB	-18	
DL Power Control step size, $\Delta_{TPC}$	dB	1	
Limited Power Increase	-	"Not used"	
Note 1: The stage lasts until the DTCH quality has converged to the quality target			

NOTE: Power is compared to P-CPICH as specified in [4].

**Table 8.34BB: Requirements in downlink power control in case of different transport formats (DL\_DCH\_FET\_Config is set to 0 with 20ms UL transmission mode)**

Parameter	Unit	Test 1, stage 1	Test 1, stage 2
$\frac{DPCH - E_c}{I_{or}}$	dB	-17.7	-19.8
Measured quality on DTCH	BLER	0.01±30%	0.01±30%

**Table 8.34BC: Requirements in downlink power control in case of different transport formats (DL\_DCH\_FET\_Config is set to 0 with 10ms UL transmission mode)**

Parameter	Unit	Test 1, stage 1	Test 1, stage 2
$\frac{DPCH - E_c}{I_{or}}$	dB	-14.4	-16.6
Measured quality on DTCH	BLER	0.01±30%	0.01±30%

**Table 8.34BD: Requirements in downlink power control in case of different transport formats (DL\_DCH\_FET\_Config is set to 1 with 10ms UL transmission mode)**

Parameter	Unit	Test 1, stage 1	Test 1, stage 2
$\frac{DPCH - E_c}{I_{or}}$	dB	-17.5	-19.8
Measured quality on DTCH	BLER	0.01±30%	0.01±30%



**Table 8.34BE: Requirements in downlink power control in case of different transport formats (DL\_DCH\_FET\_Config is set to 1 with 10ms UL transmission mode and Null transmission in uplink)**

Parameter	Unit	Test 1, stage 1	Test 1, stage 2
$\frac{DPCH - E_c}{I_{or}}$	dB	-17.5	-19.8
Measured quality on DTCH	BLER	0.01±30%	0.01±30%

## 8.8.5 Power control in the downlink for F-DPCH

### 8.8.5.1 Minimum requirements

For the parameters specified in Table 8.34C the downlink  $\frac{F - DPCH - E_c}{I_{or}}$  power ratio measured values, which are

averaged over TPC symbols of the F-DPCH frame, shall be below the specified value in Table 8.34D more than 90% of the time. TPC command error ratio shall be in the limits given by Table 8.34D. Power control in downlink is ON during the tests.

**Table 8.34C: Test parameters for Fractional downlink power control**

Parameter	Unit	Test 1	Test 2
$\hat{I}_{or}/I_{oc}$	dB	9	-1
$I_{oc}$	dBm/3.84 MHz	-60	
SF		256	
Target quality value on F DPCH	%	0.01	0.05
Propagation condition		Case 4	
Maximum_DL_Power *	dB	7	
Minimum_DL_Power *	dB	-18	
DL Power Control step size, $\Delta_{TPC}$	dB	1	
Limited Power Increase	-	"Not used"	
Power-Control-Algorithm	-	Algorithm 1	

**Table 8.34D: Requirements in Fractional downlink power control**

Parameter	Unit	Test 1	Test 2
$\frac{F - DPCH - E_c}{I_{or}}$	dB	-15.9	-12.0
TPC command Error Ratio high	-	0.015	0.065
TPC command Error Ratio low	-	0.005	0.035

## 8.9 Downlink compressed mode

Downlink compressed mode is used to create gaps in the downlink transmission, to allow the UE to make measurements on other frequencies.

The requirements in this subclause were derived with the assumption that the UTRAN responds immediately to the uplink TPC commands by adjusting the power of the first pilot field of the DL DPCH that commences after end of the received TPC command.

### 8.9.1 Single link performance

The receiver single link performance of the Dedicated Traffic Channel (DCH) in compressed mode is determined by the Block Error Ratio (BLER) and transmitted DPCH\_Ec/Ior power ratio in the downlink.



The compressed mode parameters are given in clause A.5.

### 8.9.1.1 Minimum requirements

For the parameters specified in Table 8.35 the downlink  $\frac{DPCH\_E_c}{I_{or}}$  power ratio measured values, which are averaged

over one slot, shall be below the specified value in Table 8.36 more than 90% of the time. The measured quality on DTCH shall be as required in Table 8.36.

Downlink power control is ON during the test. Uplink TPC commands shall be error free.

**Table 8.35: Test parameter for downlink compressed mode**

Parameter	Unit	Test 1	Test 2
Delta SIR1	dB	0	3
Delta SIR after1	dB	0	3
Delta SIR2	dB	0	0
Delta SIR after2	dB	0	0
Compressed mode patterns	-	Set 2 in table A.21 in clause A.5 of TS 25.101	Set 1 in table A.21 in clause A.5 of TS 25.101
$\hat{I}_{or}/I_{oc}$	dB	9	
$I_{oc}$	dBm/3.84 MHz	-60	
Information Data Rate	kbps	12.2	
Propagation condition		Case 3	Case 2
Target quality value on DTCH	BLER	0.01	
Maximum_DL_Power	dB	7	
Minimum_DL_Power	dB	-18	
DL Power Control step size, $\Delta_{TPC}$	dB	1	
Limited Power Increase	-	"Not used"	

**Table 8.36: Requirements in downlink compressed mode**

Parameter	Unit	Test 1	Test 2
$\frac{DPCH\_E_c}{I_{or}}$	dB	-13.7	No requirements
Measured quality of compressed and recovery frames	BLER	No requirements	<0.001
Measured quality on DTCH	BLER	$0.01 \pm 30\%$	

## 8.10 Blind transport format detection

Performance of Blind transport format detection is determined by the Block Error Ratio (BLER) values and by the measured average transmitted  $DPCH\_E_c/I_{or}$  value.

### 8.10.1 Minimum requirement

For the parameters specified in Table 8.37 the average downlink  $\frac{DPCH\_E_c}{I_{or}}$  power ratio shall be below the specified value for the BLER shown in Table 8.38.



**Table 8.37: Test parameters for Blind transport format detection**

Parameter	Unit	Test 1	Test 2	Test 3	Test 4	Test 5	Test 6
$\hat{I}_{or}/I_{oc}$	dB	-1			-3		
$I_{oc}$	dBm/3.84 MHz	-60					
Information Data Rate	kbps	12.2 (rate 1)	7.95 (rate 2)	1.95 (rate 3)	12.2 (rate 1)	7.95 (rate 2)	1.95 (rate 3)
propagation condition	-	static			multi-path fading case 3		
TFCI	-	off					

**Table 8.38: The Requirements for DCH reception in Blind transport format detection**

Test Number	$\frac{DPCH\_E_c}{I_{or}}$	BLER	FDR
1	-17.7 dB	$10^{-2}$	$10^{-4}$
2	-17.8 dB	$10^{-2}$	$10^{-4}$
3	-18.4 dB	$10^{-2}$	$10^{-4}$
4	-13.0 dB	$10^{-2}$	$10^{-4}$
5	-13.2 dB	$10^{-2}$	$10^{-4}$
6	-13.8 dB	$10^{-2}$	$10^{-4}$

NOTE 1: The value of  $DPCH\_E_c/I_{or}$ ,  $I_{oc}$ , and  $I_{or}/I_{oc}$  are defined in case of DPCH is transmitted

NOTE 2: In this test, 9 different Transport Format Combinations (Table 8.39) are sent during the call set up procedure, so that the UE has to detect the correct transport format from these 9 candidates.

**Table 8.39: Transport format combinations informed during the call set up procedure in the test**

	1	2	3	4	5	6	7	8	9
DTCH	12.2k	10.2k	7.95k	7.4k	6.7k	5.9k	5.15k	4.75k	1.95k
DCCH	2.4k								

## 8.11 Detection of Broadcast channel (BCH)

The receiver characteristics of Broadcast Channel (BCH) are determined by the Block Error Ratio (BLER) values. BCH is mapped into the primary common control physical channel (P-CCPCH).

### 8.11.1 Minimum requirement without transmit diversity

For the parameters specified in Table 8.40 the average downlink power  $P\text{-CCPCH\_}E_c/I_{or}$  shall be below the specified value for the BLER shown in Table 8.41. (The Down link Physical channels are specified in Annex C).

This requirement doesn't need to be tested.

**Table 8.40: Parameters for BCH detection**

Parameter	Unit	Test 1	Test 2
Phase reference	-	P-CPICH	
$I_{oc}$	dBm/3.84 MHz	-60	
$\hat{I}_{or}/I_{oc}$	dB	-1	-3
Propagation condition		Static	Case 3



**Table 8.41: Test requirements for BCH detection**

Test Number	P-CCPCH_Ec/Ior	BLER
1	-18.5 dB	0.01
2	-12.8 dB	0.01

### 8.11.2 Minimum requirement with open loop transmit diversity

For the parameters specified in Table 8.41A the average downlink power P-CCPCH\_Ec/Ior shall be below the specified value for the BLER shown in Table 8.41B. (The Down link Physical channels are specified in Annex C).

This requirement doesn't need to be tested.

**Table 8.41A: Test parameters for BCH detection in an open loop transmit diversity scheme (STTD).  
(Propagation condition: Case 1)**

Parameter	Unit	Test 3
Phase reference	-	P-CPICH
$I_{oc}$	dBm/3.84 MHz	-60
$\hat{I}_{or}/I_{oc}$	dB	9

**Table 8.41B: Test requirements for BCH detection in open loop transmit diversity scheme**

Test Number	P-CCPCH_Ec/Ior (Total power from antenna 1 and 2)	BLER
3	-18.5	0.01

## 8.11A Detection of Broadcast channel (BCH) mapped to S-CCPCH

The requirements in this section shall apply for UEs that support reception of a broadcast channel mapped to S-CCPCH.

The receiver characteristics of a Broadcast Channel (BCH) mapped to S-CCPCH are determined by the Block Error Ratio (BLER) values during non DTX TTIs.

### 8.11A.1 Minimum requirement without transmit diversity

For the parameters specified in Table 8.41C the average downlink power S-CCPCH\_Ec/Ior during non DTX TTIs shall be below the specified value for the BLER shown in Table 8.41D. (The Downlink Physical channels are specified in Annex C).

This requirement doesn't need to be tested.

**Table 8.41C: Parameters for detection of BCH mapped to S-CCPCH**

Parameter	Unit	Test 1	Test 2
Phase reference	-	P-CPICH	
$I_{oc}$	dBm/3.84 MHz	-60	
$\hat{I}_{or}/I_{oc}$	dB	-1	-3
Propagation condition		Static	Case 3



**Table 8.41D: Test requirements for detection of BCH mapped to S-CCPCH**

Test Number	S-CCPCH_Ec/Ior	BLER
1	-18.5 dB	0.01
2	-12.8 dB	0.01

### 8.11.2 Minimum requirement with open loop transmit diversity

For the parameters specified in Table 8.41E the average downlink power S-CCPCH\_Ec/Ior during non DTX TTIs shall be below the specified value for the BLER shown in Table 8.41F. (The Downlink Physical channels are specified in Annex C).

This requirement doesn't need to be tested.

**Table 8.41E: Test parameters for detection of BCH mapped to S-CCPCH in an open loop transmit diversity scheme (STTD). (Propagation condition: Case 1)**

Parameter	Unit	Test 3
Phase reference	-	P-CPICH
$I_{oc}$	dBm/3.84 MHz	-60
$\hat{I}_{or}/I_{oc}$	dB	9

**Table 8.41F: Test requirements for detection of BCH mapped to S-CCPCH in open loop transmit diversity scheme**

Test Number	S-CCPCH_Ec/Ior (Total power from antenna 1 and 2)	BLER
3	-18.5	0.01

## 8.12 Demodulation of Paging Channel (PCH)

The receiver characteristics of paging channel are determined by the probability of missed paging message (Pm-p). PCH is mapped into the S-CCPCH and it is associated with the transmission of Paging Indicators (PI) to support efficient sleep-mode procedures.

### 8.12.1 Minimum requirement

For the parameters specified in Table 8.42 the average probability of missed paging (Pm-p) shall be below the specified value in Table 8.43. Power of downlink channels other than S-CCPCH and PICH are as defined in Table C.3 of Annex C. S-CCPCH structure is as defined in Annex A.6.

**Table 8.42: Parameters for PCH detection**

Parameter	Unit	Test 1	Test 2
Number of paging indicators per frame (Np)	-	72	
Phase reference	-	P-CPICH	
$I_{oc}$	dBm/3.84 MHz	-60	
$\hat{I}_{or}/I_{oc}$	dB	-1	-3
Propagation condition		Static	Case 3



**Table 8.43: Test requirements for PCH detection**

Test Number	S-CCPCH_Ec/Ior	PICH_Ec/Ior	Pm-p
1	-14.8	-19	0.01
2	-9.8	-12	0.01

## 8.13 Detection of Acquisition Indicator (AI)

The receiver characteristics of Acquisition Indicator (AI) are determined by the probability of false alarm Pfa and probability of correct detection Pd. Pfa is defined as a conditional probability of detection of AI signature given that a AI signature was not transmitted. Pd is defined as a conditional probability of correct detection of AI signature given that the AI signature is transmitted.

### 8.13.1 Minimum requirement

For the parameters specified in Table 8.44 the Pfa and 1-Pd shall not exceed the specified values in Table 8.45. Power of downlink channels other than AICH is as defined in Table C.3 of Annex C.

**Table 8.44: Parameters for AI detection**

Parameter	Unit	Test 1
Phase reference	-	P-CPICH
$I_{oc}$	dBm/3.84 MHz	-60
Number of other transmitted AI signatures on AICH	-	0
$\hat{I}_{or}/I_{oc}$	dB	-1
AICH_Ec/Ior	dB	-22.0
AICH Power Offset	dB	-12.0
Propagation condition	-	Static

Note that AICH\_Ec/Ior can not be set. Its value is calculated from other parameters and it is given for information only. (AICH\_Ec/Ior = AICH Power Offset + CPICH\_Ec/Ior)

**Table 8.45: Test requirements for AI detection**

Test Number	Pfa	1-Pd
1	0.01	0.01

## 8.13A Detection of E-DCH Acquisition Indicator (E-AI)

The receiver characteristics of E-DCH Acquisition Indicator (E-AI) are determined by the probability of correct detection Pde. Pde is defined as a conditional probability of correct detection of E-AI signature given that the E-AI signature is transmitted and AI signature was correctly received.

### 8.13A.1 Minimum requirement

For the parameters specified in Table 8.45C the 1-Pde shall not exceed the specified value in Table 8.45D. The power settings for downlink channels other than AICH and E-AICH are set as defined in Table C.3 of Annex C.



**Table 8.45C: Parameters for E-AI detection**

Parameter	Unit	Test 1
Phase reference	-	P-CPICH
$I_{oc}$	dBm/3.84 MHz	-60
Number of other transmitted AI signatures on AICH	-	0
Number of resources assumed for E-DCH random access	-	32
$\hat{I}_{or}/I_{oc}$	dB	-1
AICH_Ec/Ior	dB	-22.0
AICH Power Offset	dB	-12.0
E-AICH_Ec/Ior	dB	-22.0
E-AICH Power Offset	dB	-12.0
Propagation condition	-	Static

Note that AICH\_Ec/Ior and E-AICH\_Ec/Ior can not be set, their values are calculated from other parameters and are given for information only.

**Table 8.45D: Test requirements for E-AI detection**

Test Number	1- Pde
1	0.005

## 8.14 UE UL power control operation with discontinuous UL DPCCH transmission operation

### 8.14.1 Minimum requirement

This test verifies that the UE follows only those TPC commands that correspond to the UL DPCCH slots which are transmitted.

Test parameters are specified in Table 8.45A. The discontinuous UL DPCCH transmission is enabled during the test. The parameters for discontinuous UL DPCCH transmission operation are as specified in Table A.20A. Before the start of the tests, the UE transmit power shall be initialised to -15 dBm. An actual UE transmit power may vary from the target level of -15 dBm due to inaccurate UE output power step.

After transmission gaps due to discontinuous uplink DPCCH transmission the uplink transmitter power difference shall be within the range as defined in Table 8.45B. The transmit power difference is defined as the difference between the power of the last slot transmitted before the gap and the power of first slot transmitted after the gap. The on power observation period is defined as the mean power over one timeslot excluding any transient periods.



**Table 8.45A: Parameters for UE UL power control operation with discontinuous UL DPCCH transmission**

Parameter	Unit	Test 1
Phase reference	-	P-CPICH
HS-SCCH_1 $E_c / I_{or}$	dB	-10
F-DPCH $E_c / I_{or}$	dB	-10
F-DPCH slot format	-	0
$\hat{I}_{or1}$	dBm/3.84 MHz	-60
Power-Control-Algorithm	-	Algorithm 1
UL Power Control step size, $\Delta_{TPC}$	dB	1
Uplink TPC commands corresponding to the UL DPCCH slots which are transmitted	-	{0,1,0,1,0,1 } Note 1
Propagation condition	-	Static without AWGN source $I_{oc}$
Note 1: The sequence of uplink TPC commands corresponds to the UL DPCCH slots that are transmitted. During those slots which correspond to UL DPCCH slots that are not transmitted, UP-commands shall be transmitted.		

**Table 8.45B: Test requirements for UE UL power control operation with discontinuous UL DPCCH transmission**

Parameter	Unit	Test 1	
		Lower	Upper
UE output power difference tolerance	dB	-2	+4

8.15 (void)

8.16 (void)

Table 8.46: (void)

Table 8.47: (void)

Table 8.48: (void)

Table 8.49: (void)

Table 8.50: (void)

Table 8.51: (void)

Table 8.52: (void)

## 9 Performance requirement (HSDPA)

The performance requirements for the UE in this clause apply for the reference measurement channels specified in Annex A.7, the propagation conditions specified in Annex B.2.2 and the Down link Physical channels specified in Annex C.5. The specific references are provided separately for each requirement.



Unless otherwise stated the performance requirements are specified at the antenna connector of the UE. For UE(s) with an integral antenna only, a reference antenna with a gain of 0 dBi is assumed. UE with an integral antenna may be taken into account by converting these power levels into field strength requirements, assuming a 0 dBi gain antenna. For UEs with more than one antenna connector testing the fading of the signals and the AWGN signals applied to each receiver antenna connector shall be uncorrelated. The levels of the test signal applied to each of the antenna connectors shall be as defined in the respective sections below.

## 9.1 (void)

## 9.2 Demodulation of HS-DSCH (Fixed Reference Channel)

The minimum performance requirement for a particular UE supporting one of the HS-DSCH categories 1, 2, 3, 4, 5, 6, 7, 8, 9, 10, 11 or 12 are determined according to Table 9.1.

The minimum performance requirements for a particular UE supporting one of the HS-DSCH categories 1, 2, 3, 4, 5, 6, 7, 8, 9 or 10 and supporting the optional enhanced performance requirements type 1 are determined according to Table 9.1AA.

The minimum performance requirements for a particular UE supporting one of the HS-DSCH categories 7, 8, 9 or 10 and supporting the optional enhanced performance requirements type 2 are determined according to Table 9.1AB.

The minimum performance requirements for a particular UE supporting HS-DSCH category 13 or 14 are determined according to Table 9.1AB.

The minimum performance requirements for a particular UE supporting one of the HS-DSCH categories 7, 8, 9, 10, 13 or 14 and supporting the optional enhanced performance requirements type 3 are determined according to Table 9.1AC.

The minimum performance requirements for a particular UE supporting one of the HS-DSCH categories 15, 16, 17, 18, 19 or 20 are determined according to Table 9.1AC.

The minimum performance requirements for a particular UE supporting one of the HS-DSCH categories 7, 8, 9, 10, 13, 14, 15, 16, 17, 18, 19 or 20 and supporting the optional enhanced performance requirements type 3i are determined according to Table 9.1AD.

The minimum performance requirements for a particular UE supporting one of the HS-DSCH categories 21, 22, 23 and 24 are determined according to Table 9.1 AE.

The minimum performance requirements for a particular UE supporting one of the HS-DSCH categories 21, 22, 23, 24, 25, 26, 27 or 28 and supporting the optional enhanced performance requirements type 3 are determined according to Table 9.1 AF.

The minimum performance requirements for a particular UE supporting one of the HS-DSCH categories 21, 22, 23, 24, 25, 26, 27 or 28 and supporting the optional enhanced performance requirements type 3i are determined according to Table 9.1 AG.

The minimum performance requirements for a particular UE supporting one of the HS-DSCH categories 29 and 31 are determined according to Table 9.1AH.

The minimum performance requirements for a particular UE supporting one of the HS-DSCH categories 29, 30, 31 and 32 and supporting the optional enhanced performance requirements type 3 are determined according to Table 9.1AI.

The minimum performance requirements for a particular UE supporting one of the HS-DSCH categories 29, 30, 31 and 32 and supporting the optional enhanced performance requirements type 3i are determined according to Table 9.1AJ.

The minimum performance requirements for a particular UE supporting HS-DSCH category 35 are determined according to Table 9.1AK.

The minimum performance requirements for a particular UE supporting one of the HS-DSCH categories 35 and 36 and supporting the optional enhanced performance requirements type 3 are determined according to Table 9.1AL.

The minimum performance requirements for a particular UE supporting one of the HS-DSCH categories 35 and 36 and supporting the optional enhanced performance requirements type 3i are determined according to Table 9.1AM.



A UE supporting one of categories 21, 22, 23, 24, 29, 31 or 35 shall support either enhanced receiver type 2 requirements, or enhanced receiver type 3 requirements, or enhanced receiver type 3i requirements applicable for the other categories supported by this UE.

A UE supporting one of categories 21, 22, 23, 24, 29, 31 or 35 supporting enhanced receiver type 3 requirements shall support either enhanced receiver type 3 requirements, or enhanced receiver type 3i requirements applicable for the other categories supported by this UE.

A UE supporting one of categories 21, 22, 23, 24, 29, 31 or 35 supporting enhanced receiver type 3i requirements shall support enhanced receiver type 3i requirements applicable for the other categories supported by this UE.

The additional minimum performance requirements for UE supporting one of the HS-DSCH categories 7, 8, 9, 10, 13, 14, 21, 22, 23, 24, 29, 31 or 35 and the MIMO only with single-stream restriction are indicated in Table 9.1AB, Table 9.1AC, 9.1AD, Table 9.1AE, Table 9.1AF, Table 9.1AG, Table 9.1AH, Table 9.1AI, Table 9.1AJ, Table 9.1AK, Table 9.1AL and Table 9.1AM.

The additional minimum performance requirements for UE supporting one of the HS-DSCH categories 37 or 38 are indicated in Table 9.1AO.

The additional minimum performance requirements for UE supporting one of the HS-DSCH categories 28, 30, 32, 34 or 36 and the MIMO with four transmit antennas only with dual-stream restriction capability are indicated in Table 9.1AF, Table 9.1AG, Table 9.1AI, Table 9.1AJ, Table 9.1AL and Table 9.1AM.

The minimum performance requirements for a particular UE supporting the optional non-contiguous multi-cell operation are determined according to Table 9.1AN.

For the requirements for UEs supporting HS-DSCH categories 21, 22, 23, 24, 25, 26, 27, 28, 29, 30, 31, 32, 35, 36, 37 or 38, when the carriers are located in the same frequency band or the carriers belong to the same cell group in Multiflow mode, the spacing of the carrier frequencies of the two cells shall be 5 MHz.

For Multiflow HSDPA requirements in subclause 9.2.5, the serving HS-DSCH cell and the assisting serving HS-DSCH cell shall have the same carrier frequency, and the secondary serving HS-DSCH cell and the assisting secondary serving HS-DSCH cell shall have the same carrier frequency.

For the requirements for UEs supporting HS-DSCH categories 21, 22, 23, 24, 25, 26, 27, 28, 29, 30, 31 or 32 and supporting NC-4C-HSDPA, the spacing of the carrier frequencies belonging to the same subblock of carriers shall be 5MHz. The spacing of the highest carrier frequency of the lowest subblock of carriers and the lowest carrier frequency of the highest subblock of carriers depends on the configuration as indicated in Table 5.0aE and on the UE capability as indicated in the Information Element 'Gap size', [7].

For single link performance with a UE supporting one of the categories 21, 22, 23, 24, 25, 26, 27, 28, 29, 30, 31, 32, 35, 36, 37 or 38, and supporting enhanced receiver type 3i, the simplified testing method in Annex C.5.4 can be applied.

For open loop diversity performance with a UE supporting one of the categories 29, 30, 31, 32, 35, 36, 37 or 38, and supporting enhanced receiver type 1, type 3 or type 3i, the simplified testing method in Annex C.5.4 can be applied.

For MIMO performance with a UE supporting one of the categories 30 or 32, and supporting enhanced receiver type 3 or type 3i, the simplified testing method in Annex C.5.4 can be applied.

For Multiflow performance with a UE supporting one of the categories 21, 22, 23, 24, 25, 26, 27 or 28, the simplified testing method in Annex C.5.4A can be applied.

All aforementioned requirements are applicable to the UE when in CELL\_DCH state. Minimum performance requirements for UE being able to receive HS-DSCH and HS-SCCH in CELL\_FACH state are given in Section 9.6.

The propagation conditions for this subclause are defined in table B.1B.



**Table 9.1: FRC for minimum performance requirements for different HS-DSCH categories**

HS-DSCH category	Corresponding requirement		
	Single Link (Note 1)	Open Loop Diversity	Closed Loop Diversity
Category 1	H-Set 1	H-Set 1	H-Set 1
Category 2	H-Set 1	H-Set 1	H-Set 1
Category 3	H-Set 2	H-Set 2	H-Set 2
Category 4	H-Set 2	H-Set 2	H-Set 2
Category 5	H-Set 3	H-Set 3	H-Set 3
Category 6	H-Set 3	H-Set 3	H-Set 3
Category 7 (Note 1)	H-Set 6, H-Set 3	H-Set 3	H-Set 3
Category 8 (Note 1)	H-Set 6, H-Set 3	H-Set 3	H-Set 3
Category 9	H-Set 6, H-Set 3	H-Set 3	H-Set 3
Category 10	H-Set 6, H-Set 3	H-Set 3	H-Set 3
Category 11	H-Set 4	H-Set 4	H-Set 4
Category 12	H-Set 5	H-Set 5	H-Set 5
Note 1: Single link minimum performance requirements for Categories 7-10 in Pedestrian A with $\hat{I}_{or}/I_{oc}=10\text{dB}$ are set according to H-Set 6. Requirements in other conditions are according to H-Set 3.			
Note 2: For UE supporting the minimum performance requirements for HS-DSCH the requirements for HS-SCCH Type 1 detection for single link are determined in Table 9.51 and for open loop transmit diversity in Table 9.53.			

**Table 9.1AA: FRC for enhanced performance requirements type 1 for different HS-DSCH categories**

HS-DSCH category	Corresponding requirement		
	Single Link (Note 1)	Open Loop Diversity	Closed Loop Diversity
Category 1	H-Set 1	H-Set 1	H-Set 1
Category 2	H-Set 1	H-Set 1	H-Set 1
Category 3	H-Set 2	H-Set 2	H-Set 2
Category 4	H-Set 2	H-Set 2	H-Set 2
Category 5	H-Set 3	H-Set 3	H-Set 3
Category 6	H-Set 3	H-Set 3	H-Set 3
Category 7 (Note 1)	H-Set 6, H-Set 3	H-Set 3	H-Set 3
Category 8 (Note 1)	H-Set 6, H-Set 3	H-Set 3	H-Set 3
Category 9	H-Set 6, H-Set 3	H-Set 3	H-Set 3
Category 10	H-Set 6, H-Set 3	H-Set 3	H-Set 3
Note 1: Single link enhanced performance requirements type 1 for Categories 7 - 10 in Pedestrian A with $\hat{I}_{or}/I_{oc}=10\text{dB}$ are set according to H-Set 6. Requirements in other conditions are according to H-Set 3.			
Note 2: For UE supporting the enhanced performance requirements type 1 for HS-DSCH the requirements for HS-SCCH Type 1 detection for single link are determined in Table 9.51A and for open loop transmit diversity in Table 9.54.			



**Table 9.1AB: FRC for enhanced performance requirements type 2 for different HS-DSCH categories**

HS-DSCH category	Corresponding requirement		
	Single Link (Note 1)	Open Loop Diversity (Note 2)	Closed Loop Diversity (Note 3)
Category 7	H-Set 6, H-Set 3	H-Set 3	H-set 6, H-Set 3
Category 8	H-Set 6, H-Set 3	H-Set 3	H-set 6, H-Set 3
Category 9	H-Set 10, H-Set 6, H-Set 3	H-Set 3	H-set 6, H-Set 3
Category 10	H-Set 10, H-Set 6, H-Set 3	H-Set 3	H-set 6, H-Set 3
Category 13	H-Set-10, H-Set 8, H-Set 6, H-Set 3	H-Set 3	H-set 6, H-Set 3
Category 14	H-Set-10, H-Set 8, H-Set 6, H-Set 3	H-Set 3	H-set 6, H-Set 3
Note 1:	Single link enhanced performance requirements type 2 for Categories 9, 10, 13 and 14 with $\hat{I}_{or}/I_{oc} = 4$ dB and 8 dB are set according to H-Set 10. Single link enhanced performance requirements type 2 for Categories 13 and 14 with $\hat{I}_{or}/I_{oc} = 15$ and 18 dB are set according to H-Set 8. Single link enhanced performance requirements type 2 for Categories 7, 8, 9, 10, 13 and 14 with $\hat{I}_{or}/I_{oc} = 10$ dB are set according to H-Set 6. Requirements in other conditions are according to H-Set 3 minimum performance requirements.		
Note 2:	Open loop transmit diversity requirements are set according to H-Set 3 minimum performance requirements.		
Note 3:	Closed loop transmit diversity enhanced performance requirements type 2 for Categories 7, 8, 9, 10, 13 and 14 in Pedestrian B 3km/h with $\hat{I}_{or}/I_{oc} = 10$ dB and $E_c/I_{or} = -3$ dB are set according to H-Set 6. Requirements in other conditions are set according to H-Set 3 minimum performance requirements.		
Note 4:	For UE supporting the enhanced performance requirements type 2 for HS-DSCH the minimum requirements for HS-SCCH Type 1 detection for single link are determined in Table 9.51 and for open loop transmit diversity in Table 9.53.		
Note 5:	For UE supporting the MIMO only with single-stream restriction the additional minimum requirements for HS-DSCH are given in Table 9.22G2, 9.22G2A, 9.22H2 and 9.22H2A and for HS-SCCH type 3 in Table 9.57A2, 9.57A4 and 9.57A6.		



**Table 9.1AC: FRC for enhanced performance requirements type 3 for different HS-DSCH categories**

HS-DSCH category	Corresponding requirement			
	Single Link (Note 1)	Open Loop Diversity (Note 2)	Closed Loop Diversity (Note 3)	MIMO (Note 4)
Category 7	H-Set 6, H-Set 3	H-Set 3	H-Set 3	N/A
Category 8	H-Set 6, H-Set 3	H-Set 3	H-Set 3	N/A
Category 9	H-Set 10, H-Set 6, H-Set 3	H-Set 3	H-Set 3	N/A
Category 10	H-Set10, H-Set 6, H-Set 3	H-Set 3	H-Set 3	N/A
Category 13	H-Set 10, H-Set 8, H-Set 6, H-Set 3	H-Set 3	H-Set 3	N/A
Category 14	H-Set10, H-Set 8, H-Set 6, H-Set 3	H-Set 3	H-Set 3	N/A
Category 15	H-Set 10, H-Set 6, H-Set 3	H-Set 3	H-Set 3	H-Set 9
Category 16	H-Set 10, H-Set 6, H-Set 3	H-Set 3	H-Set 3	H-Set 9
Category 17	H-Set 10, H-Set 8, H-Set 6, H-Set 3	H-Set 3	H-Set 3	H-Set 9
Category 18	H-Set 10, H-Set 8, H-Set 6, H-Set 3	H-Set 3	H-Set 3	H-Set 9
Category 19	H-Set-10, H-Set 8, H-Set 6, H-Set 3	H-Set 3	H-Set 3	H-Set 11, H-Set 9
Category 20	H-Set 10, H-Set 8, H-Set 6, H-Set 3	H-Set 3	H-Set 3	H-Set 11, H-Set 9
<p>Note 1: Single link enhanced performance requirements type 3 for Categories 9, 10, 13, 14, 15, 16, 17, 18, 19 and 20 with <math>\hat{I}_{or}/I_{oc} = 4</math> dB and 8 dB are set according to H-Set 10. Single link enhanced performance requirements type 3 for Categories 13, 14, 17, 18, 19 and 20 with <math>\hat{I}_{or}/I_{oc} = 15</math> dB and 18 dB are set according to H-Set 8. Single link enhanced performance requirements type 3 for Categories 7, 8, 9, 10, 13, 14, 15, 16, 17, 18, 19 and 20 with <math>\hat{I}_{or}/I_{oc} = 10</math> dB and <math>\hat{I}_{or}/I_{oc} = 5</math> dB are set according to H-Set 6. Requirements in other conditions are according to H-Set 3 type1 enhanced performance requirements.</p> <p>Note 2: Open loop transmit diversity requirements are set according to H-Set 3 type1 enhanced performance requirements.</p> <p>Note 3: Closed loop transmit diversity requirements are set according to H-Set 3 type1 enhanced performance requirements.</p> <p>Note 4: MIMO requirements for categories 15-20, with <math>\hat{I}_{or}/I_{oc} = 6</math> and 10 dB are set according to H-Set 9. MIMO requirements for categories 19-20, with <math>\hat{I}_{or}/I_{oc} = 18</math> dB are set according to H-Set 11.</p> <p>Note 5: For UE supporting the enhanced performance requirements type 3 for HS-DSCH the requirements for HS-SCCH Type 1 detection for single link are determined in Table 9.51A and for open loop transmit diversity in Table 9.54.</p> <p>Note 6: For UEs supporting MIMO for HS-DSCH the requirements for HS-SCCH Type 3 detection are determined in Tables 9.56, Table 9.57, 9.57a, 9.57b, 9.57c and 9.57d.</p> <p>Note 7: For UE supporting the MIMO only with single-stream restriction the additional minimum requirements for HS-DSCH are given in Table 9.22G3, 9.22G4, 9.22H3 and 9.22H4 and for HS-SCCH type 3 in Table 9.57A3, 9.57A5 and 9.57A7.</p>				



**Table 9.1AD: FRC for enhanced performance requirements type 3i for different HS-DSCH categories**

HS-DSCH category	Corresponding requirement			
	Single Link (Note 1)	Open Loop Diversity (Note 2)	Closed Loop Diversity (Note 3)	MIMO (Note 4)
Category 7	H-Set 6, H-Set 3	H-Set 3	H-Set 3	N/A
Category 8	H-Set 6, H-Set 3	H-Set 3	H-Set 3	N/A
Category 9	H-Set10, H-Set 6, H-Set 3	H-Set 3	H-Set 3	N/A
Category 10	H-Set10, H-Set 6, H-Set 3	H-Set 3	H-Set 3	N/A
Category 13	H-Set10, H-Set 8, H-Set 6, H-Set 3	H-Set 3	H-Set 3	N/A
Category 14	H-Set10, H-Set 8, H-Set 6, H-Set 3	H-Set 3	H-Set 3	N/A
Category 15	H-Set10, H-Set 6, H-Set 3	H-Set 3	H-Set 3	H-Set 9
Category 16	H-Set10, H-Set 6, H-Set 3	H-Set 3	H-Set 3	H-Set 9
Category 17	H-Set10, H-Set 8, H-Set 6, H-Set 3	H-Set 3	H-Set 3	H-Set 9
Category 18	H-Set10, H-Set 8, H-Set 6, H-Set 3	H-Set 3	H-Set 3	H-Set 9
Category 19	H-Set-10, H-Set 8, H-Set 6, H-Set 3	H-Set 3	H-Set 3	H-Set 11, H-Set 9
Category 20	H-Set-10, H-Set 8, H-Set 6, H-Set 3	H-Set 3	H-Set 3	H-Set 11, H-Set 9
<p>Note 1: Single link enhanced performance requirements type 3i for Categories 7-20 with <math>\hat{I}_{or}/I_{oc} = 0</math> dB are set according to H-Set 6. Requirements in other conditions are according to type 3 enhanced performance requirements.</p> <p>Note 2: Open loop transmit diversity requirements are set according to H-Set 3 type1 enhanced performance requirements.</p> <p>Note 3: Closed loop transmit diversity requirements are set according to H-Set 3 type1 enhanced performance requirements.</p> <p>Note 4: MIMO requirements for categories 15-20, with <math>\hat{I}_{or}/I_{oc} = 6</math> and 10 dB are set according to H-Set 9.</p> <p>MIMO requirements for categories 19-20, with <math>\hat{I}_{or}/I_{oc} = 18</math> dB are set according to H-Set 11.</p> <p>Note 5: For UE supporting the enhanced performance requirements type 3i for HS-DSCH the requirements for HS-SCCH Type 1 detection for single link are determined in Table 9.51A and for open loop transmit diversity in Table 9.54.</p> <p>Note 6: For UE supporting MIMO for HS-DSCH the requirements for HS-SCCH Type 3 detection are determined in Tables 9.56, Table 9.57, 9.57a, 9.57b, 9.57c and 9.57d.</p> <p>Note 7: For UE supporting the MIMO only with single-stream restriction the additional minimum requirements for HS-DSCH are given in Table 9.22G3, 9.22G4, 9.22H3 and 9.22H4 and for HS-SCCH type 3 in Table 9.57A3, 9.57A5 and 9.57A7.</p>				



**Table 9.1AE: FRC for enhanced performance requirements type 2 for different DC-HSDPA and DB-DC-HSDPA categories**

HS-DSCH category	Corresponding requirement		
	Single Link (Note 1)	Open Loop Diversity (Note 2)	Closed Loop Diversity
Category 21	H-Set-10A, H-Set 6A, H-Set 3A	H-Set 3A	N/A
Category 22	H-Set-10A, H-Set 6A, H-Set 3A	H-Set 3A	N/A
Category 23	H-Set-10A, H-Set 8A, H-Set 6A, H-Set 3A	H-Set 3A	N/A
Category 24	H-Set-10A, H-Set 8A, H-Set 6A, H-Set 3A	H-Set 3A	N/A
<p>Note 1: Single link enhanced performance requirements type 2 for categories 21, 22, 23 and 24 with <math>\hat{I}_{or}/I_{oc} = 4</math> dB and 8 dB are set according to H-Set 10A.</p> <p>Single link enhanced performance requirements type 2 for categories 23 and 24 with <math>\hat{I}_{or}/I_{oc} = 15</math> and 18 dB are set according to H-Set 8A.</p> <p>Single link enhanced performance requirements type 2 for categories 21, 22, 23 and 24 with <math>\hat{I}_{or}/I_{oc} = 10</math> dB are set according to H-Set 6A.</p> <p>Single link requirements for categories 21, 22, 23 and 24 in other conditions are according to H-Set 3A minimum performance requirements.</p> <p>Note 2: Open loop transmit diversity requirements are set according to H-Set 3A minimum performance requirements.</p> <p>Note 3: For UE supporting the enhanced performance requirements type 2 for HS-DSCH the minimum requirements for HS-SCCH Type 1 detection for single link are determined in Table 9.51 and for open loop transmit diversity in Table 9.53.</p> <p>Note 4: For UE supporting the MIMO only with single-stream restriction the additional minimum requirements for HS-DSCH are given in Table 9.22G2, 9.22G2A, 9.22H2 and 9.22H2A and for HS-SCCH type 3 in Table 9.57A2, 9.57A4 and 9.57A6.</p>			



**Table 9.1AF: FRC for enhanced performance requirements type 3 for different DC-HSDPA and DB-DC-HSDPA categories**

HS-DSCH category	Corresponding requirement			
	Single Link (Note 1)	Open Loop Diversity (Note 2)	Closed Loop Diversity	MIMO
Category 21	H-Set-10A, H-Set 6A, H-Set 3A	H-Set 3A	N/A	N/A
Category 22	H-Set-10A, H-Set 6A, H-Set 3A	H-Set 3A	N/A	N/A
Category 23	H-Set-10A, H-Set 8A, H-Set 6A, H-Set 3A	H-Set 3A	N/A	N/A
Category 24	H-Set-10A, H-Set 8A, H-Set 6A, H-Set 3A	H-Set 3A	N/A	N/A
Category 25	H-Set-10A, H-Set 6A, H-Set 3A	H-Set 3A	N/A	H-Set 9A
Category 26	H-Set-10A, H-Set 6A, H-Set 3A	H-Set 3A	N/A	H-Set 9A
Category 27	H-Set-10A, H-Set 8A, H-Set 6A, H-Set 3A	H-Set 3A	N/A	H-Set 11A, H-Set 9A
Category 28	H-Set-10A, H-Set 8A, H-Set 6A, H-Set 3A	H-Set 3A	N/A	H-Set 11A, H-Set 9A

Note 1: Single link enhanced performance requirements type 3 for categories 21, 22, 23, 24, 25, 26, 27 and 28 with  $\hat{I}_{or}/I_{oc} = 4$  dB and 8 dB are set according to H-Set 10A.

Single link enhanced performance requirements type 3 for categories 23, 24, 27 and 28 with  $\hat{I}_{or}/I_{oc} = 15$  dB and 18 dB are set according to H-Set 8A.

Single link enhanced performance requirements type 3 for categories 21, 22, 23, 24, 25, 26, 27 and 28 with  $\hat{I}_{or}/I_{oc} = 10$  dB and  $\hat{I}_{or}/I_{oc} = 5$  dB are set according to H-Set 6A.

Single link minimum requirements for categories 21, 22, 23, 24, 25, 26, 27 and 28 in other conditions are according to H-Set 3A type 1 enhanced performance requirements.

Note 2: Open loop transmit diversity requirements are set according to H-Set 3A type 1 enhanced performance requirements.

Note 3: MIMO requirements for categories 25-26, with  $\hat{I}_{or}/I_{oc} = 6$  and 10 dB are set according to H-Set 9A.  
MIMO requirements for categories 27-28, with  $\hat{I}_{or}/I_{oc} = 18$  dB are set according to H-Set 11A.

Note 4: For UE supporting the enhanced performance requirements type 3 for HS-DSCH the requirements for HS-SCCH Type 1 detection for single link are determined in Table 9.51A and for open loop transmit diversity in Table 9.54.

Note 5: For UE supporting MIMO for HS-DSCH the requirements for HS-SCCH Type 3 detection are determined in Tables 9.56, Table 9.57, 9.57a, 9.57b, 9.57c and 9.57d.

Note 6: For UE supporting the MIMO only with single-stream restriction the additional minimum requirements for HS-DSCH are given in Table 9.22G3, 9.22G4, 9.22H3 and 9.22H1 and for HS-SCCH type 3 in Table 9.57A3, 9.57A5, and 9.57A7.

Note 7: For UE supporting MIMO mode with four transmit antennas only with dual-stream restriction capability the additional minimum requirements for HS-DSCH are given in Table 9.22K2, 9.22K4 and for HS-SCCH type 4 in Table 9.57B5, 9.57B6.



**Table 9.1AG: FRC for enhanced performance requirements type 3i for different DC-HSDPA and DB-DC-HSDPA categories**

HS-DSCH category	Corresponding requirement			
	Single Link (Note 1)	Open Loop Diversity (Note 2)	Closed Loop Diversity	MIMO
Category 21	H-Set-10A, H-Set 6A, H-Set 3A	H-Set 3A	N/A	N/A
Category 22	H-Set-10A, H-Set 6A, H-Set 3A	H-Set 3A	N/A	N/A
Category 23	H-Set-10A, H-Set 8A, H-Set 6A, H-Set 3A	H-Set 3A	N/A	N/A
Category 24	H-Set-10A, H-Set 8A, H-Set 6A, H-Set 3A	H-Set 3A	N/A	N/A
Category 25	H-Set-10A, H-Set 6A, H-Set 3A	H-Set 3A	N/A	H-Set 9A
Category 26	H-Set-10A, H-Set 6A, H-Set 3A	H-Set 3A	N/A	H-Set 9A
Category 27	H-Set-10A, H-Set 8A, H-Set 6A, H-Set 3A	H-Set 3A	N/A	H-Set 11A, H-Set 9A
Category 28	H-Set-10A, H-Set 8A, H-Set 6A, H-Set 3A	H-Set 3A	N/A	H-Set 11A, H-Set 9A
Note 1:	Single link enhanced performance requirements type 3i for Categories 21, 22, 23, 24, 25, 26, 27 and 28 with $\hat{I}_{or}/I_{oc} = 0\text{dB}$ are set according to H-Set 6A. Requirements in other conditions are according to type 3 enhanced performance requirements.			
Note 2:	Open loop transmit diversity requirements are set according to H-Set 3 type1 enhanced performance requirements.			
Note 3:	For UE supporting the enhanced performance requirements type 3i for HS-DSCH the requirements for HS-SCCH Type 1 detection for single link are determined in Table 9.51A and for open loop transmit diversity in Table 9.54			
Note 4:	For UE supporting the MIMO only with single-stream restriction the additional minimum requirements for HS-DSCH are given in Table 9.22G3, 9.22G4, 9.22H3 and 9.22H4 and for HS-SCCH type 3 in Table 9.57A3, 9.57A5, 9.57A7.			
Note 5:	For UE supporting MIMO for HS-DSCH the requirements for HS-SCCH Type 3 detection are determined in Tables 9.56, 9.57, 9.57a, 9.57b, 9.57c and 9.57d.			
Note 6:	For UE supporting MIMO mode with four transmit antennas only with dual-stream restriction capability the additional minimum requirements for HS-DSCH are given in Table 9.22K2, 9.22K4 and for HS-SCCH type 4 in Table 9.57B5, 9.57B6.			



**Table 9.1AH: FRC for enhanced performance requirements type 2 for different 4C-HSDPA categories**

HS-DSCH category	Corresponding requirement		
	Single Link (Note 1)	Open Loop Diversity (Note 2)	Closed Loop Diversity
Category 29	H-Set-10B, H-Set 8B, H-Set 6B, H-Set 3B	H-Set 3B	N/A
Category 31	H-Set-10C, H-Set 8C, H-Set 6C, H-Set 3C	H-Set 3C	N/A
<p>Note 1: Single link enhanced performance requirements type 2 for categories 29 and 31 with <math>\hat{I}_{or}/I_{oc} = 4</math> dB and 8 dB are set according to H-Set 10B and H-Set 10C respectively.</p> <p>Single link enhanced performance requirements type 2 for categories 29 and 31 with <math>\hat{I}_{or}/I_{oc} = 15</math> and 18 dB are set according to H-Set 8B and H-Set 8C respectively.</p> <p>Single link enhanced performance requirements type 2 for categories 29 and 31 with <math>\hat{I}_{or}/I_{oc} = 10</math> dB are set according to H-Set 6B and H-Set 6C respectively.</p> <p>Single link requirements for categories 29 and 31 in other conditions are according to H-Set 3B minimum performance requirements and H-Set 3C minimum performance requirements respectively.</p> <p>Note 2: Open loop transmit diversity requirements are set according to H-Set 3B minimum performance requirements and H-Set 3C minimum performance requirements.</p> <p>Note 3: For UE supporting the enhanced performance requirements type 2 for HS-DSCH the minimum requirements for HS-SCCH Type 1 detection for single link are determined in Table 9.51 and for open loop transmit diversity in Table 9.53.</p> <p>Note 4: For UE supporting the MIMO only with single-stream restriction the additional minimum requirements for HS-DSCH are given in Table 9.22G2, 9.22G2A, 9.22H2 and 9.22H2A and for HS-SCCH type 3 in Table 9.57A2, 9.57A4 and 9.57A6.</p>			



**Table 9.1A1: FRC for enhanced performance requirements type 3 for different 4C-HSDPA categories**

HS-DSCH category	Corresponding requirement			
	Single Link (Note 1)	Open Loop Diversity (Note 2)	Closed Loop Diversity	MIMO
Category 29	H-Set 10B, H-Set 6B, H-Set 8B, H-Set 3B	H-Set 3B	N/A	N/B
Category 30	H-Set 10B, H-Set 6B, H-Set 8B, H-Set 3B	H-Set 3B	N/A	H-Set 11B, H-Set 9B
Category 31	H-Set 10C, H-Set 8C, H-Set 6C, H-Set 3C	H-Set 3C	N/A	N/A
Category 32	H-Set 10C, H-Set 8C, H-Set 6C, H-Set 3C	H-Set 3C	N/A	H-Set 11C, H-Set 9C

Note 1: Single link enhanced performance requirements type 3 for categories 29, 30 with  $\hat{I}_{or}/I_{oc} = 4$  dB and 8 dB are set according to H-Set 10B.

Single link enhanced performance requirements type 3 for categories 31, 32 with  $\hat{I}_{or}/I_{oc} = 4$  dB and 8 dB are set according to H-Set 10C.

Single link enhanced performance requirements type 3 for categories 29, 30 with  $\hat{I}_{or}/I_{oc} = 15$  dB and 18 dB are set according to H-Set 8B.

Single link enhanced performance requirements type 3 for categories 31, 32 with  $\hat{I}_{or}/I_{oc} = 15$  dB and 18 dB are set according to H-Set 8C.

Single link enhanced performance requirements type 3 for categories 29, 30 with  $\hat{I}_{or}/I_{oc} = 10$  dB and  $\hat{I}_{or}/I_{oc} = 5$  dB are set according to H-Set 6B.

Single link enhanced performance requirements type 3 for categories 31, 32 with  $\hat{I}_{or}/I_{oc} = 10$  dB and  $\hat{I}_{or}/I_{oc} = 5$  dB are set according to H-Set 6C.

Single link minimum requirements for categories 29, 30 in other conditions are according to H-Set 3B type 1 enhanced performance requirements.

Single link minimum requirements for categories 31, 32 in other conditions are according to H-Set 3C type 1 enhanced performance requirements.

Note 2: Open loop transmit diversity requirements are set according to H-Set 3B type 1 enhanced performance requirements and H-Set 3C type 1 enhanced performance requirements.

Note 3: MIMO requirements for categories 30 and 32, with  $\hat{I}_{or}/I_{oc} = 6$  and 10 dB are set according to H-Set 9B and H-Set 9C respectively. MIMO requirements for categories 30 and 32, with  $\hat{I}_{or}/I_{oc} = 18$  dB are set according to H-Set 11B and H-set 11C respectively.

Note 4: For UE supporting the enhanced performance requirements type 3 for HS-DSCH the requirements for HS-SCCH Type 1 detection for single link are determined in Table 9.51A and for open loop transmit diversity in Table 9.54.

Note 5: For UE supporting MIMO for HS-DSCH the requirements for HS-SCCH Type 3 detection are determined in Tables 9.56, Table 9.57, 9.57a, 9.57b, 9.57c and 9.57d,

Note 6: For UE supporting the MIMO only with single-stream restriction the additional minimum requirements for HS-DSCH are given in Table 9.22G3, 9.22G4, 9.22H3 and 9.22H4 and for HS-SCCH type 3 in Table 9.57A3, 9.57A5 and 9.57A7.

Note 7: For UE supporting MIMO mode with four transmit antennas only with dual-stream restriction capability the additional minimum requirements for HS-DSCH are given in Table 9.22K2, 9.22K4 and for HS-SCCH type 4 in Table 9.57B5, 9.57B6.



**Table 9.1AJ: FRC for enhanced performance requirements type 3i for different 4C-HSDPA categories**

HS-DSCH category	Corresponding requirement			
	Single Link (Note 1)	Open Loop Diversity (Note 2)	Closed Loop Diversity	MIMO
Category 29	H-Set-10B, H-Set 6B, H-Set 8B, H-Set 3B	H-Set 3B	N/A	N/B
Category 30	H-Set-10B, H-Set 6B, H-Set 8B, H-Set 3B	H-Set 3B	N/A	H-Set 11B, H-Set 9B
Category 31	H-Set 10C, H-Set 8C, H-Set 6C, H-Set 3C	H-Set 3C	N/A	N/A
Category 32	H-Set 10C, H-Set 8C, H-Set 6C, H-Set 3C	H-Set 3C	N/A	H-Set 11C, H-Set 9C

Note 1: Single link enhanced performance requirements type 3i for Categories 29, 30 with  $\hat{I}_{or}/I_{oc} = 0$  dB are set according to H-Set 6B. Single link enhanced performance requirements type 3i for Categories 31, 32 with  $\hat{I}_{or}/I_{oc} = 0$  dB are set according to H-Set 6C. Requirements in other conditions are according to type 3 enhanced performance requirements.

Note 2: Open loop transmit diversity requirements are set according to H-Set 3 type1 enhanced performance requirements.

Note 3: For UE supporting the enhanced performance requirements type 3i for HS-DSCH the requirements for HS-SCCH Type 1 detection for single link are determined in Table 9.51A and for open loop transmit diversity in Table 9.54

Note 4: For UE supporting the MIMO only with single-stream restriction the additional minimum requirements for HS-DSCH are given in Table 9.22G3, 9.22G4, 9.22H3 and 9.22H4 and for HS-SCCH type 3 in Table 9.57A3, 9.57A5 and 9.57A7.

Note 5: For UE supporting MIMO for HS-DSCH the requirements for HS-SCCH Type 3 detection are determined in Tables 9.56, Table 9.57, 9.57a, 9.57b, 9.57c and 9.57d.

Note 6: For UE supporting MIMO mode with four transmit antennas only with dual-stream restriction capability the additional minimum requirements for HS-DSCH are given in Table 9.22K2, 9.22K4 and for HS-SCCH type 4 in Table 9.57B5, 9.57B6.

**Table 9.1AK: FRC for enhanced performance requirements type 2 for the 8C-HSDPA category**

HS-DSCH category	Corresponding requirement		
	Single Link (Note 1)	Open Loop Diversity (Note 2)	Closed Loop Diversity
Category 35	H-Set-10E, H-Set 8E, H-Set 6E, H-Set 3E	H-Set 3E	N/A

Note 1: Single link enhanced performance requirements type 2 for category 35 with  $\hat{I}_{or}/I_{oc} = 4$  dB and 8 dB are set according to H-Set 10E.

Single link enhanced performance requirements type 2 for category 35 with  $\hat{I}_{or}/I_{oc} = 15$  and 18 dB are set according to H-Set 8E.

Single link enhanced performance requirements type 2 for category 35 with  $\hat{I}_{or}/I_{oc} = 10$  dB are set according to H-Set 6E.

Single link requirements for category 35 in other conditions are according to H-Set 3E minimum performance requirements.

Note 2: Open loop transmit diversity requirements are set according to H-Set 3E minimum performance requirements.

Note 3: For UE supporting the enhanced performance requirements type 2 for HS-DSCH the minimum requirements for HS-SCCH Type 1 detection for single link are determined in Table 9.51 and for open loop transmit diversity in Table 9.53.

Note 4: For UE supporting the MIMO only with single-stream restriction the additional minimum requirements for HS-DSCH are given in Table 9.22G2, 9.22G2A, 9.22H2 and 9.22H2A and for HS-SCCH type 3 in Table 9.57A2, 9.57A4 and 9.57A6.



**Table 9.1AL: FRC for enhanced performance requirements type 3 for different 8C-HSDPA categories**

HS-DSCH category	Corresponding requirement			
	Single Link (Note 1)	Open Loop Diversity (Note 2)	Closed Loop Diversity	MIMO
Category 35	H-Set 10E, H-Set 6E, H-Set 8E, H-Set 3E	H-Set 3E	N/A	N/B
Category 36	H-Set-10E, H-Set 6E, H-Set 8E, H-Set 3E	H-Set 3E	N/A	H-Set 11E, H-Set 9E
Note 1:	<p>Single link enhanced performance requirements type 3 for categories 35, 36 with <math>\hat{I}_{or}/I_{oc} = 4</math> dB and 8 dB are set according to H-Set 10E.</p> <p>Single link enhanced performance requirements type 3 for categories 35, 36 with <math>\hat{I}_{or}/I_{oc} = 15</math> dB and 18 dB are set according to H-Set 8E.</p> <p>Single link enhanced performance requirements type 3 for categories 35, 36 with <math>\hat{I}_{or}/I_{oc} = 10</math> dB and <math>\hat{I}_{or}/I_{oc} = 5</math> dB are set according to H-Set 6E.</p> <p>Single link minimum requirements for categories 35, 36 in other conditions are according to H-Set 3E type 1 enhanced performance requirements.</p>			
Note 2:	Open loop transmit diversity requirements are set according to H-Set 3E type 1 enhanced performance requirements.			
Note 3:	<p>MIMO requirements for category 36, with <math>\hat{I}_{or}/I_{oc} = 6</math> and 10 dB are set according to H-Set 9E. MIMO requirements for category 36, with <math>\hat{I}_{or}/I_{oc} = 18</math> dB are set according to H-Set 11E.</p>			
Note 4:	For UE supporting the enhanced performance requirements type 3 for HS-DSCH the requirements for HS-SCCH Type 1 detection for single link are determined in Table 9.51A and for open loop transmit diversity in Table 9.54.			
Note 5:	For UE supporting MIMO for HS-DSCH the requirements for HS-SCCH Type 3 detection are determined in Tables 9.56, Table 9.57, 9.57a, 9.57b, 9.57c and 9.57d.			
Note 6:	For UE supporting the MIMO only with single-stream restriction the additional minimum requirements for HS-DSCH are given in Table 9.22G3, 9.22G4, 9.22H3 and 9.22H4 and for HS-SCCH type 3 in Table 9.57A3, 9.57A5 and 9.57A7.			
Note 7:	For UE supporting MIMO mode with four transmit antennas only with dual-stream restriction capability the additional minimum requirements for HS-DSCH are given in Table 9.22K2, 9.22K4 and for HS-SCCH type 4 in Table 9.57B5, 9.57B6.			



**Table 9.1AM: FRC for enhanced performance requirements type 3i for different 8C-HSDPA categories**

HS-DSCH category	Corresponding requirement			
	Single Link (Note 1)	Open Loop Diversity (Note 2)	Closed Loop Diversity	MIMO
Category 35	H-Set-10E, H-Set 6E, H-Set 8E, H-Set 3E	H-Set 3E	N/A	N/B
Category 36	H-Set-10E, H-Set 6E, H-Set 8E, H-Set 3E	H-Set 3E	N/A	H-Set 11E, H-Set 9E
<p>Note 1: Single link enhanced performance requirements type 3i for Categories 35, 36 with <math>\hat{I}_{or}/I_{oc}' = 0\text{dB}</math> are set according to H-Set 6E. Requirements in other conditions are according to type 3 enhanced performance requirements.</p> <p>Note 2: Open loop transmit diversity requirements are set according to H-Set 3 type1 enhanced performance requirements.</p> <p>Note 3: For UE supporting the enhanced performance requirements type 3i for HS-DSCH the requirements for HS-SCCH Type 1 detection for single link are determined in Table 9.51A and for open loop transmit diversity in Table 9.54</p> <p>Note 4: For UE supporting the MIMO only with single-stream restriction the additional minimum requirements for HS-DSCH are given in Table 9.22G3, 9.22G4, 9.22H3 and 9.22H4 and for HS-SCCH type 3 in Table 9.57A3, 9.57A5 and 9.57A7.</p> <p>Note 5: For UE supporting MIMO for HS-DSCH the requirements for HS-SCCH Type 3 detection are determined in Tables 9.56, Table 9.57, 9.57a, 9.57b, 9.57c and 9.57d.</p> <p>Note 6: For UE supporting MIMO mode with four transmit antennas only with dual-stream restriction capability the additional minimum requirements for HS-DSCH are given in Table 9.22K2, 9.22K4 and for HS-SCCH type 4 in Table 9.57B5, 9.57B6.</p>				

**Table 9.1AN: Applicability of the requirements for UE supporting NC-4C-HSDPA**

HS-DSCH categories supported by the UE	NC-4C-HSDPA configurations	Applicable category for performance requirement	Applicable requirements		
			FRC for enhanced performance requirements type 2	FRC for enhanced performance requirements type 3	FRC for enhanced performance requirements type 3i
21, 22, 23, 24, 25, 26, 27, 28 (Note 1)	I-1-5-1, IV-1-5-1	21, 22, 23, 24,	Table 9.1AE	Table 9.1AF	Table 9.1AG
29, 31		25, 26, 27, 28	NA	Table 9.1AF	Table 9.1AG
30, 32 (Note 1)		24	Table 9.1AE	Table 9.1AF	Table 9.1AG
29, 31		28	Table 9.1AE	Table 9.1AF	Table 9.1AG
30, 32 (Note 1)	I-2-5-1, IV-2-10-1, IV-2-20-1	29	Table 9.1AH	Table 9.1AI	Table 9.1AJ
31	IV-2-15-2, IV-2-25-2, I-3-10-1	30	NA	Table 9.1AI	Table 9.1AJ
32 (Note 1)		31	Table 9.1AH	Table 9.1AI	Table 9.1AJ
		32	NA	Table 9.1AI	Table 9.1AJ
<p>Note 1. MIMO requirements are applicable for UE supporting NC-4C-HSDPA if UE has signalled support for this combination via IE "Non-contiguous multi-cell with MIMO" in 25.331 [7].</p>					



**Table 9.1AO: FRC UEs supporting MIMO mode with four transmit antennas for DC-HSDPA/DB-DC-HSDPA and 4C-HSDPA categories**

HS-DSCH category	Corresponding requirement			
	Single Link	Open Loop Diversity	Closed Loop Diversity	MIMO mode with four transmit antennas
Category 37	Table 9.1AF, Table 9.1AG	Table 9.1AF, Table 9.1AG	N/A	H-Set 13A, H-Set 14A
Category 38	Table 9.1AI, Table 9.1AJ	Table 9.1AI, Table 9.1AJ	N/A	H-Set 13C, H-Set 14C
Note 1: For UE supporting MIMO mode with four transmit antennas for HS-DSCH the requirements for HS-SCCH Type 4 detection are determined in Tables 9.57B2, 9.57B3.				

During the Fixed Reference Channel tests the behaviour of the Node-B emulator in response to the ACK/NACK signalling field of the HS-DPCCH is specified in Table 9.1A:

**Table 9.1A: Node-B Emulator Behaviour in response to ACK/NACK/DTX**

HS-DPCCH ACK/NACK Field State	Node-B Emulator Behaviour
ACK	ACK: new transmission using 1 <sup>st</sup> redundancy and constellation version (RV)
NACK	NACK: retransmission using the next RV (up to the maximum permitted number of RV's)
DTX	DTX: retransmission using the RV previously transmitted to the same H-ARQ process

NOTE: Performance requirements in this section assume a sufficient power allocation to HS-SCCH\_1 so that probability of reporting DTX is very low.

## 9.2.1 Single Link performance

The receiver single link performance of the High Speed Physical Downlink Shared Channel (HS-DSCH) in different multi-path fading environments are determined by the information bit throughput R

### 9.2.1.1 Requirement QPSK, Fixed Reference Channel (FRC) H-Set 1/2/3/3A/3B/3C/3E

The requirements are specified in terms of a minimum information bit throughput R for the DL reference channels H-set 1/2/3/3A/3A/3B/3E (QPSK version) specified in Annex A.7.1.1, A.7.1.2 and A.7.1.3 respectively, with the addition of the parameters in Table 9.2 and the downlink physical channel setup according to table C.8.

Using this configuration the throughput shall meet or exceed the minimum requirements specified in table 9.3. Enhanced performance requirements type 1 specified in Table 9.3A are based on receiver diversity.



**Table 9.2: Test Parameters for Testing QPSK FRCs H-Set 1/H-Set 2/H-Set 3/H-Set 3A/H-Set 3B/H-Set 3C/3E**

Parameter	Unit	Test 1	Test 2	Test 3	Test 4
Phase reference		P-CPICH			
$I_{oc}$	dBm/3.84 MHz	-60			
Redundancy and constellation version coding sequence		{0,2,5,6}			
Maximum number of HARQ transmission		4			
Note:	The HS-SCCH-1 and HS-PDSCH shall be transmitted continuously with constant power. HS-SCCH-1 shall only use the identity of the UE under test for those TTI intended for the UE.				

**Table 9.3: Minimum requirement QPSK, Fixed Reference Channel (FRC) H-Set 1/2/3/3A/3B/3C/3E**

Test Number	Propagation Conditions	Reference value		
		HS-PDSCH $E_c / I_{or}$ (dB)	T-put $R$ (kbps) * $\hat{I}_{or} / I_{oc} = 0$ dB	T-put $R$ (kbps) * $\hat{I}_{or} / I_{oc} = 10$ dB
1	PA3	-6	65	309
		-3	N/A	423
2	PB3	-6	23	181
		-3	138	287
3	VA30	-6	22	190
		-3	142	295
4	VA120	-6	13	181
		-3	140	275

\* Notes: 1) The reference value R is for the Fixed Reference Channel (FRC) H-Set 1.  
2) For Fixed Reference Channel (FRC) H-Set 2 the reference values for R should be scaled (multiplied by 1.5 and rounding to the nearest integer t-put in kbps, where values of  $i+1/2$  are rounded up to  $i+1$ ,  $i$  integer).  
3) For Fixed Reference Channel (FRC) H-Set 3 the reference values for R should be scaled (multiplied by 3).  
4) For Fixed Reference Channel (FRC) H-Set 3A the reference values for R should be scaled (multiplied by 6).  
5) For Fixed Reference Channel (FRC) H-Set 3B the reference values for R should be scaled (multiplied by 9).  
6) For Fixed Reference Channel (FRC) H-Set 3C the reference values for R should be scaled (multiplied by 12).  
7) For Fixed Reference Channel (FRC) H-Set 3E the reference values for R should be scaled (multiplied by 24) .

**Table 9.3A: Enhanced requirement type 1 QPSK, Fixed Reference Channel (FRC) H-Set 1/2/3/3A/3B/3C/3E**

Test Number	Propagation Conditions	Reference value		
		HS-PDSCH $E_c / I_{or}$ (dB)	T-put $R$ (kbps) * $\hat{I}_{or} / I_{oc} = 0$ dB	T-put $R$ (kbps) * $\hat{I}_{or} / I_{oc} = 10$ dB
1	PA3	-12	N/A	247
		-9	N/A	379
		-6	195	N/A
		-3	329	N/A
2	PB3	-9	N/A	195
		-6	156	316
		-3	263	N/A
3	VA30	-9	N/A	212
		-6	171	329
		-3	273	N/A
4	VA120	-9	N/A	191
		-6	168	293
		-3	263	N/A



- \* Notes:
- 1) The reference value R is for the Fixed Reference Channel (FRC) H-Set 1.
  - 2) For Fixed Reference Channel (FRC) H-Set 2 the reference values for R should be scaled (multiplied by 1.5 and rounding to the nearest integer t-put in kbps, where values of  $i+1/2$  are rounded up to  $i+1$ , i integer).
  - 3) For Fixed Reference Channel (FRC) H-Set 3 the reference values for R should be scaled (multiplied by 3).
  - 4) For Fixed Reference Channel (FRC) H-Set 3A the reference values for R should be scaled (multiplied by 6).
  - 5) For Fixed Reference Channel (FRC) H-Set 3B the reference values for R should be scaled (multiplied by 9).
  - 6) For Fixed Reference Channel (FRC) H-Set 3C the reference values for R should be scaled (multiplied by 12).
  - 7) For Fixed Reference Channel (FRC) H-Set 3E the reference values for R should be scaled (multiplied by 24).

### 9.2.1.2 Requirement 16QAM, Fixed Reference Channel (FRC) H-Set 1/2/3

The requirements are specified in terms of a minimum information bit throughput R for the DL reference channels H-set 1/2/3 (16QAM version) specified in Annex A.7.1.1, A.7.1.2 and A.7.1.3 respectively, with the addition of the parameters in Table 9.4 and the downlink physical channel setup according to table C.8.

Using this configuration the throughput shall meet or exceed the minimum requirements specified in table 9.5. Enhanced performance requirements type 1 specified in Table 9.5A are based on receiver diversity.

**Table 9.4: Test Parameters for Testing 16QAM FRCs H-Set 1/H-Set 2/H-Set 3**

Parameter	Unit	Test 1	Test 2	Test 3	Test 4
Phase reference		P-CPICH			
$I_{oc}$	dBm/3.84 MHz	-60			
Redundancy and constellation version coding sequence		{6,2,1,5}			
Maximum number of HARQ transmission		4			
Note:	The HS-SCCH-1 and HS-PDSCH shall be transmitted continuously with constant power. HS-SCCH-1 shall only use the identity of the UE under test for those TTI intended for the UE.				

**Table 9.5: Minimum requirement 16QAM, Fixed Reference Channel (FRC) H-Set 1/2/3**

Test Number	Propagation Conditions	Reference value	
		HS-PDSCH $E_c / I_{or}$ (dB)	T-put $R$ (kbps) * $\hat{I}_{or} / I_{oc} = 10$ dB
1	PA3	-6	198
		-3	368
2	PB3	-6	34
		-3	219
3	VA30	-6	47
		-3	214
4	VA120	-6	28
		-3	167

\* Notes:

1)The reference value R is for the Fixed Reference Channel (FRC) H-Set 1.

2) For Fixed Reference Channel (FRC) H-Set 2 the reference values for R should be scaled (multiplied by 1.5 and rounding to the nearest integer t-put in kbps, where values of i+1/2 are rounded up to i+1, i integer).

3) For Fixed Reference Channel (FRC) H-Set 3 the reference values for R should be scaled (multiplied by 3).



**Table 9.5A: Enhanced requirement type 1 16QAM, Fixed Reference Channel (FRC) H-Set 1/2/3**

Test Number	Propagation Conditions	Reference value	
		HS-PDSCH $E_c / I_{or}$ (dB)	T-put $R$ (kbps) * $\hat{I}_{or} / I_{oc} = 10$ dB
1	PA3	-9	312
		-6	487
2	PB3	-6	275
		-3	408
3	VA30	-6	296
		-3	430
4	VA120	-6	271
		-3	392

\* Notes: 1)The reference value R is for the Fixed Reference Channel (FRC) H-Set 1.  
2) For Fixed Reference Channel (FRC) H-Set 2 the reference values for R should be scaled (multiplied by 1.5 and rounding to the nearest integer t-put in kbps, where values of i+1/2 are rounded up to i+1, i integer).  
3) For Fixed Reference Channel (FRC) H-Set 3 the reference values for R should be scaled (multiplied by 3).

### 9.2.1.3 Minimum requirement QPSK, Fixed Reference Channel (FRC) H-Set 4/5

The requirements are specified in terms of a minimum information bit throughput  $R$  for the DL reference channels H-set 4/5 specified in Annex A.7.1.4 and A.7.1.5 respectively, with the addition of the parameters in Table 9.6 and the downlink physical channel setup according to table C.8.

Using this configuration the throughput shall meet or exceed the minimum requirements specified in table 9.7 for H-Set 4 and table 9.8 for H-Set 5.

**Table 9.6: Test Parameters for Testing QPSK FRCs H-Set 4/H-Set 5**

Parameter	Unit	Test 1	Test 2	Test 3	Test 4
Phase reference		P-CPICH			
$I_{oc}$	dBm/3.84 MHz	-60			
Redundancy and constellation version coding sequence		{0,2,5,6}			
Maximum number of HARQ transmission		4			
Note: The HS-SCCH-1 and HS-PDSCH shall be transmitted continuously with constant power. HS-SCCH-1 shall only use the identity of the UE under test for those TTI intended for the UE.					

**Table 9.7: Minimum requirement QPSK, Fixed Reference Channel (FRC) H-Set 4**

Test Number	Propagation Conditions	Reference value		
		HS-PDSCH $E_c/I_{or}$ (dB)	T-put $R$ (kbps) $\hat{I}_{or}/I_{oc} = 0$ dB	T-put $R$ (kbps) $\hat{I}_{or}/I_{oc} = 10$ dB
1	PA3	-6	72	340
		-3	N/A	439
2	PB3	-6	24	186
		-3	142	299
3	VA30	-6	19	183
		-3	148	306
4	VA120	-6	11	170
		-3	144	284



**Table 9.8: Minimum requirement QPSK, Fixed Reference Channel (FRC) H-Set 5**

Test Number	Propagation Conditions	Reference value		
		HS-PDSCH $E_c/I_{or}$ (dB)	T-put $R$ (kbps) $\hat{I}_{or}/I_{oc} = 0$ dB	T-put $R$ (kbps) $\hat{I}_{or}/I_{oc} = 10$ dB
1	PA3	-6	98	464
		-3	N/A	635
2	PB3	-6	35	272
		-3	207	431
3	VA30	-6	33	285
		-3	213	443
4	VA120	-6	20	272
		-3	210	413

#### 9.2.1.4 Requirement QPSK, Fixed Reference Channel (FRC) H-Set 6/6A/6B/6C/6E

The requirements are specified in terms of a minimum information bit throughput  $R$  for the DL reference channel H-Set 6/6A/6B/6C/6E specified in Annex A.7.1.6 with the addition of the parameters in Table 9.8A and the downlink physical channel setup according to table C.8.

Using this configuration the throughput shall meet or exceed the minimum requirements specified in table 9.8B. Enhanced performance requirements type 1 as specified in Table 9.8B1 are based on receiver diversity. Enhanced performance requirements type 2 as specified in Table 9.8B2 are based on chip level equaliser. Enhanced performance requirements type 3 as specified in Table 9.8B3 and in Table 9.8B4 are based on receiver diversity and chip level equaliser. Enhanced performance requirements type 3i as specified in Table 9.8B5 are based on receiver diversity and interference-aware chip level equaliser.

**Table 9.8A: Test Parameters for Testing QPSK FRCs H-Set 6/6A/6B/6C/6E**

Parameter	Unit	Test 1	Test 2	Test 3	Test 4
Phase reference		P-CPICH			
$I_{oc}$	dBm/3.84 MHz	-60			
Redundancy and constellation version coding sequence		{0,2,5,6}			
Maximum number of HARQ transmission		4			
Note:	The HS-SCCH-1 and HS-PDSCH shall be transmitted continuously with constant power. HS-SCCH-1 shall only use the identity of the UE under test for those TTI intended for the UE.				

**Table 9.8B: Minimum requirement QPSK, Fixed Reference Channel (FRC) H-Set 6**

Test Number	Propagation Conditions	Reference value	
		HS-PDSCH $E_c/I_{or}$ (dB)	T-put $R$ (kbps) $\hat{I}_{or}/I_{oc} = 10$ dB
1	PA3	-6	1407
		-3	2090

**Table 9.8B1: Enhanced requirements type 1 QPSK, Fixed Reference Channel (FRC) H-Set 6**

Test Number	Propagation Conditions	Reference value	
		HS-PDSCH $E_c/I_{or}$ (dB)	T-put $R$ (kbps) $\hat{I}_{or}/I_{oc} = 10$ dB
1	PA3	-12	672
		-9	1305



**Table 9.8B2: Enhanced requirement type 2 QPSK, Fixed Reference Channel (FRC) H-Set 6/6A/6B/6C/6E**

Test Number	Propagation Conditions	Reference value	
		HS-PDSCH $E_c / I_{or}$ (dB)	T-put $R$ (kbps) * $\hat{I}_{or} / I_{oc} = 10$ dB
1	PA3	-6	1494
		-3	2153
2	PB3	-6	1038
		-3	1744
3	VA30	-6	1142
		-3	1782
4	VA120	-6	909
		-3	1467

\* Notes: 1)The reference value R is for the Fixed Reference Channel (FRC) H-Set 6.  
2) For Fixed Reference Channel (FRC) H-Set 6A the reference values for R should be scaled (multiplied by 2).  
3) For Fixed Reference Channel (FRC) H-Set 6B the reference values for R should be scaled (multiplied by 3).  
4) For Fixed Reference Channel (FRC) H-Set 6C the reference values for R should be scaled (multiplied by 4).  
5) For Fixed Reference Channel (FRC) H-Set 6E the reference values for R should be scaled (multiplied by 8).

**Table 9.8B3: Enhanced requirement type 3 QPSK at  $\hat{I}_{or} / I_{oc} = 10$  dB, Fixed Reference Channel (FRC) H-Set 6/6A/6B/6C/6E**

Test Number	Propagation Conditions	Reference value	
		HS-PDSCH $E_c / I_{or}$ (dB)	T-put $R$ (kbps) * $\hat{I}_{or} / I_{oc} = 10$ dB
1	PA3	-9	1554
		-6	2495
2	PB3	-9	1190
		-6	2098
3	VA30	-9	1229
		-6	2013
4	VA120	-9	1060
		-6	1674

\* Notes:

- 1) The reference value R is for the Fixed Reference Channel (FRC) H-Set 6.
- 2) For Fixed Reference Channel (FRC) H-Set 6A the reference values for R should be scaled (multiplied by 2).
- 3) For Fixed Reference Channel (FRC) H-Set 6B the reference values for R should be scaled (multiplied by 3).
- 4) For Fixed Reference Channel (FRC) H-Set 6C the reference values for R should be scaled (multiplied by 4).
- 5) For Fixed Reference Channel (FRC) H-Set 6E the reference values for R should be scaled (multiplied by 8).



**Table 9.8B4: Enhanced requirement type 3 QPSK at  $\hat{I}_{or}/I_{oc} = 5$  dB, Fixed Reference Channel (FRC) H-Set 6/6A/6B/6C/6E**

Test Number	Propagation Conditions	Reference value	
		HS-PDSCH $E_c / I_{or}$ (dB)	T-put $R$ (kbps) * $\hat{I}_{or} / I_{oc} = 5$ dB
5	PB3	-6	1248
		-3	2044
* Notes: 1)The reference value R is for the Fixed Reference Channel (FRC) H-Set 6. 2) For Fixed Reference Channel (FRC) H-Set 6A the reference values for R should be scaled (multiplied by 2.0). 3) For Fixed Reference Channel (FRC) H-Set 6B the reference values for R should be scaled (multiplied by 3.0). 4) For Fixed Reference Channel (FRC) H-Set 6C the reference values for R should be scaled (multiplied by 4.0). 5) For Fixed Reference Channel (FRC) H-Set 6E the reference values for R should be scaled (multiplied by 8.0).			

**Table 9.8B5: Enhanced requirement type 3i QPSK at  $\hat{I}_{or}/I_{oc} = 0$  dB, Fixed Reference Channel (FRC) H-Set 6/6A/6B/6C/6E**

Test Number	Propagation Conditions	Reference value	
		HS-PDSCH $E_c / I_{or}$ (dB)	T-put $R$ (kbps) * $\hat{I}_{or} / I_{oc}$ ' = 0 dB DIP1 = -2.75 dB DIP2 = -7.64 dB (Note 1)
1	PB3	-6	691
		-3	1359
2	VA30	-6	661
		-3	1327

\*Notes:

- 1)  $I_{oc}/I_{oc}$  " is computed based on the relations shown in C.5.3. (Information only  $I_{oc}/I_{oc}$  " = -5.27 dB).
- 2) The reference value R is for the Fixed Reference Channel (FRC) H-Set 6.
- 3) For Fixed Reference Channel (FRC) H-Set 6A the reference values for R should be scaled (multiplied by 2).
- 4) For Fixed Reference Channel (FRC) H-Set 6B the reference values for R should be scaled (multiplied by 3).
- 5) For Fixed Reference Channel (FRC) H-Set 6C the reference values for R should be scaled (multiplied by 4).
- 6) For Fixed Reference Channel (FRC) H-Set 6E the reference values for R should be scaled (multiplied by 8).

### 9.2.1.5 Requirement 16QAM, Fixed Reference Channel (FRC) H-Set 6/6A/6B/6C/6E

The requirements are specified in terms of a minimum information bit throughput  $R$  for the DL reference channel H-Set-6/6A/6B/6C/6E specified in Annex A.7.1.6 with the addition of the parameters in Table 9.8C and the downlink physical channel setup according to table C.8.

Using this configuration the throughput shall meet or exceed the minimum requirements specified in table 9.8D. Enhanced performance requirements type 1 as specified in Table 9.8D1 are based on receiver diversity. Enhanced performance requirements type 2 as specified in Table 9.8D2 are based on chip level equaliser. Enhanced performance requirements type 3 as specified in Table 9.8D3 and in Table 9.8D4 are based on receiver diversity and chip level equaliser.



**Table 9.8C: Test Parameters for Testing 16-QAM FRCs H-Set 6/6A/6B/6C/6E**

Parameter	Unit	Test 1	Test 2	Test 3	Test 4	Test 5
Phase reference		P-CPICH				
$I_{oc}$	dBm/3.84 MHz	-60				
Redundancy and constellation version coding sequence		{6,2,1,5}				
Maximum number of HARQ transmission		4				
Note:	The HS-SCCH-1 and HS-PDSCH shall be transmitted continuously with constant power. HS-SCCH-1 shall only use the identity of the UE under test for those TTI intended for the UE.					

**Table 9.8D: Minimum requirement 16QAM, Fixed Reference Channel (FRC) H-Set 6**

Test Number	Propagation Conditions	Reference value	
		HS-PDSCH $E_c / I_{or}$ (dB)	T-put $R$ (kbps) $\hat{I}_{or} / I_{oc} = 10$ dB
1	PA3	-6	887
		-3	1664

**Table 9.8D1: Enhanced requirements type 1 16QAM, Fixed Reference Channel (FRC) H-Set 6**

Test Number	Propagation Conditions	Reference value	
		HS-PDSCH $E_c / I_{or}$ (dB)	T-put $R$ (kbps) $\hat{I}_{or} / I_{oc} = 10$ dB
1	PA3	-9	912
		-6	1730

**Table 9.8D2: Enhanced requirement type 2 16QAM, Fixed Reference Channel (FRC) H-Set 6/6A/6B/6C/6E**

Test Number	Propagation Conditions	Reference value	
		HS-PDSCH $E_c / I_{or}$ (dB)	T-put $R$ (kbps) * $\hat{I}_{or} / I_{oc} = 10$ dB
1	PA3	-6	991
		-3	1808
2	PB3	-6	465
		-3	1370
3	VA30	-6	587
		-3	1488
4	VA120	-6	386
		-3	1291
* Notes: 1)The reference value R is for the Fixed Reference Channel (FRC) H-Set 6 2) For Fixed Reference Channel (FRC) H-Set 6A the reference values for R should be scaled (multiplied by 2) 3) For Fixed Reference Channel (FRC) H-Set 6B the reference values for R should be scaled (multiplied by 3) 4) For Fixed Reference Channel (FRC) H-Set 6C the reference values for R should be scaled (multiplied by 4) 5) For Fixed Reference Channel (FRC) H-Set 6E the reference values for R should be scaled (multiplied by 8)			



**Table 9.8D3: Enhanced requirement type 3 16QAM at  $\hat{I}_{or}/I_{oc} = 10$  dB, Fixed Reference Channel (FRC) H-Set 6/6A/6B/6C/6E**

Test Number	Propagation Conditions	Reference value	
		HS-PDSCH $E_c / I_{or}$ (dB)	T-put $R$ (kbps) * $\hat{I}_{or} / I_{oc} = 10$ dB
1	PA3	-6	1979
		-3	3032
2	PB3	-6	1619
		-3	2464
3	VA30	-6	1710
		-3	2490
4	VA120	-6	1437
		-3	2148

\* Notes:

- 1)The reference value R is for the Fixed Reference Channel (FRC) H-Set 6
- 2) For Fixed Reference Channel (FRC) H-Set 6A the reference values for R should be scaled (multiplied by 2)
- 3) For Fixed Reference Channel (FRC) H-Set 6B the reference values for R should be scaled (multiplied by 3)
- 4) For Fixed Reference Channel (FRC) H-Set 6C the reference values for R should be scaled (multiplied by 4)
- 5) For Fixed Reference Channel (FRC) H-Set 6E the reference values for R should be scaled (multiplied by 8)

**Table 9.8D4: Enhanced requirement type 3 16QAM at  $\hat{I}_{or}/I_{oc} = 5$  dB, Fixed Reference Channel (FRC) H-Set 6/6A/6B/6C/6E**

Test Number	Propagation Conditions	Reference value	
		HS-PDSCH $E_c / I_{or}$ (dB)	T-put $R$ (kbps) * $\hat{I}_{or} / I_{oc} = 5$ dB
5	PB3	-6	779
		-3	1688
* Notes: 1)The reference value R is for the Fixed Reference Channel (FRC) H-Set 6 2) For Fixed Reference Channel (FRC) H-Set 6A the reference values for R should be scaled (multiplied by 2) 3) For Fixed Reference Channel (FRC) H-Set 6B the reference values for R should be scaled (multiplied by 3) 4) For Fixed Reference Channel (FRC) H-Set 6C the reference values for R should be scaled (multiplied by 4) 5) For Fixed Reference Channel (FRC) H-Set 6E the reference values for R should be scaled (multiplied by 8)			

### 9.2.1.6 Requirement 64QAM, Fixed Reference Channel (FRC) H-Set 8/8A/8B/8C/8E

The requirements are specified in terms of a minimum information bit throughput  $R$  for the DL reference channel H Set-8/8A/8B/8C/8E specified in Annex A.7.1.7 with the addition of the parameters in Table 9.8E and the downlink physical channel setup according to table C.8.

Using this configuration the throughput shall meet or exceed the minimum requirements specified in table 9.8F2 and 9.8F3. Enhanced performance requirements type 2 as specified in Table 9.8F2 are based on chip level equaliser. Enhanced performance requirements type 3 as specified in Table 9.8F3 are based on receiver diversity and chip level equaliser.



**Table 9.8F1: Test Parameters for Testing 64QAM FRCs H-Set 8/8A/8B/8C/8E**

Parameter	Unit	Test 1
Phase reference		P-CPICH
$I_{oc}$	dBm/3.84 MHz	-60
$I_{otx} / I_{or}$	dB	-24.4
Redundancy and constellation version coding sequence		{6,2,1,5}
Maximum number of HARQ transmission		4
Note : The HS-SCCH-1 and HS-PDSCH shall be transmitted continuously with constant power. HS-SCCH-1 shall only use the identity of the UE under test for those TTI intended for the UE.		

**Table 9.8F2: Enhanced requirement type 2 64QAM, Fixed Reference Channel (FRC) H-Set 8/8A/8B/8C/8E**

Test Number	Propagation Conditions	Reference value	
		$\hat{I}_{or} / I_{oc}$ (dB)	T-put $R$ (kbps) * HS-PDSCH $E_c / I_{or} = -2$ dB
1	PA3	15	4507
		18	5736
* Notes: 1)The reference value R is for the Fixed Reference Channel (FRC) H-Set 8. 2) For Fixed Reference Channel (FRC) H-Set 8A the reference values for R should be scaled (multiplied by 2). 3) For Fixed Reference Channel (FRC) H-Set 8B the reference values for R should be scaled (multiplied by 3). 4) For Fixed Reference Channel (FRC) H-Set 8C the reference values for R should be scaled (multiplied by 4). 5) For Fixed Reference Channel (FRC) H-Set 8E the reference values for R should be scaled (multiplied by 8). 6) When determining $I_{or}/I_{oc}$ , the contribution from $I_{otx}$ is not included.			

**Table 9.8F3: Enhanced requirement type 3 64QAM, Fixed Reference Channel (FRC) H-Set 8/8A/8B/8C/8E**

Test Number	Propagation Conditions	Reference value	
		$\hat{I}_{or} / I_{oc}$ (dB)	T-put $R$ (kbps) * HS-PDSCH $E_c / I_{or} = -2$ dB
1	PA3	15	6412
		18	7638
* Notes: 1)The reference value R is for the Fixed Reference Channel (FRC) H-Set 8. 2) For Fixed Reference Channel (FRC) H-Set 8A the reference values for R should be scaled (multiplied by 2). 3) For Fixed Reference Channel (FRC) H-Set 8B the reference values for R should be scaled (multiplied by 3). 4) For Fixed Reference Channel (FRC) H-Set 8C the reference values for R should be scaled (multiplied by 4). 5) For Fixed Reference Channel (FRC) H-Set 8E the reference values for R should be scaled (multiplied by 8). 6) When determining Ior/Ioc, the contribution from $I_{otx}$ is not included.			



### 9.2.1.7 Requirement QPSK, Fixed Reference Channel (FRC) H-Set 10/10A/10B/10C/10E

The requirements are specified in terms of a minimum information bit throughput  $R$  for the DL reference channel H Set-10/10A/10B/10C/10E specified in Annex A.7.1.10 with the addition of the parameters in Table 9.8G and the downlink physical channel setup according to table C.8.

Using this configuration the throughput shall meet or exceed the minimum performance requirements as specified in table 9.8H and table 9.8H1. Enhanced performance requirements type 2 as specified in Table 9.8H are based on chip level equaliser. Enhanced performance requirements type 3 as specified in Table 9.8H1 are based on receiver diversity and chip level equaliser.

**Table 9.8G: Test Parameters for Testing QPSK FRCs H-Set 10/10A/10B/10C/10E**

Parameter	Unit	Test 1
Phase reference		P-CPICH
$I_{oc}$	dBm/3.84 MHz	-60
Redundancy and constellation version coding sequence		{0,2, 5, 6}
Maximum number of HARQ transmission		4
Note: The HS-SCCH-1 and HS-PDSCH shall be transmitted continuously with constant power. HS-SCCH-1 shall only use the identity of the UE under test for those TTI intended for the UE.		

**Table 9.8H: Enhanced requirement type 2 QPSK, Fixed Reference Channel (FRC) H-Set 10/10A/10B/10C/10E**

Test Number	Propagation Conditions	Reference value	
		HS-PDSCH $E_c / I_{or}$ (dB)	T-put $R$ (kbps) * $\hat{I}_{or} / I_{oc} = 4$ dB
1	VA3	-2	1397
* Notes: 1)The reference value $R$ is for the Fixed Reference Channel (FRC) H-Set 10. 2) For Fixed Reference Channel (FRC) H-Set 10A the reference values for $R$ should be scaled (multiplied by 2). 3) For Fixed Reference Channel (FRC) H-Set 10B the reference values for $R$ should be scaled (multiplied by 3). 4) For Fixed Reference Channel (FRC) H-Set 10C the reference values for $R$ should be scaled (multiplied by 4). 5) For Fixed Reference Channel (FRC) H-Set 10E the reference values for $R$ should be scaled (multiplied by 8).			

**Table 9.8H1: Enhanced requirement type 3 QPSK, Fixed Reference Channel (FRC) H-Set 10/10A/10B/10C/10E**

Test Number	Propagation Conditions	Reference value	
		HS-PDSCH $E_c / I_{or}$ (dB)	T-put $R$ (kbps) * $\hat{I}_{or} / I_{oc} = 4$ dB
1	VA3	-2	2621
* Notes: 1)The reference value $R$ is for the Fixed Reference Channel (FRC) H-Set 10. 2) For Fixed Reference Channel (FRC) H-Set 10A the reference values for should be scaled (multiplied by 2). 3) For Fixed Reference Channel (FRC) H-Set 10B the reference values for $R$ should be scaled (multiplied by 3). 4) For Fixed Reference Channel (FRC) H-Set 10C the reference values for $R$ should be scaled (multiplied by 4). 5) For Fixed Reference Channel (FRC) H-Set 10E the reference values for $R$ should be scaled (multiplied by 8).			



### 9.2.1.8 Requirement 16QAM, Fixed Reference Channel (FRC) H-Set 10/10A/10B/10C/10E

The requirements are specified in terms of a minimum information bit throughput  $R$  for the DL reference channel H Set-10/10A/10B/10C/10E specified in Annex A.7.1.10 with the addition of the parameters in Table 9.8I and the downlink physical channel setup according to table C.8.

Using this configuration the throughput shall meet or exceed the minimum performance requirements as specified in table 9.8J and table 9.8J1. Enhanced performance requirements type 2 as specified in Table 9.8J are based on chip level equaliser. Enhanced performance requirements type 3 as specified in Table 9.8J1 are based on receiver diversity and chip level equaliser.

**Table 9.8I: Test Parameters for Testing 16-QAM FRCs H-Set 10/10A/10B/10C/10E**

Parameter	Unit	Test 1
Phase reference		P-CPICH
$I_{oc}$	dBm/3.84 MHz	-60
Redundancy and constellation version coding sequence		{6, 2, 1, 5}
Maximum number of HARQ transmission		4
Note: The HS-SCCH-1 and HS-PDSCH shall be transmitted continuously with constant power. HS-SCCH-1 shall only use the identity of the UE under test for those TTI intended for the UE.		

**Table 9.8J: Enhanced requirement type 2 16QAM, Fixed Reference Channel (FRC) H-Set 10/10A/10B/10C/10E**

Test Number	Propagation Conditions	Reference value	
		HS-PDSCH $E_c / I_{or}$ (dB)	T-put $R$ (kbps) * $\hat{I}_{or} / I_{oc} = 8$ dB
1	VA3	-2	1726
* Notes: 1)The reference value $R$ is for the Fixed Reference Channel (FRC) H-Set 10. 2) For Fixed Reference Channel (FRC) H-Set 10A the reference values for $R$ should be scaled (multiplied by 2). 3) For Fixed Reference Channel (FRC) H-Set 10B the reference values for $R$ should be scaled (multiplied by 3). 4) For Fixed Reference Channel (FRC) H-Set 10C the reference values for $R$ should be scaled (multiplied by 4). 5) For Fixed Reference Channel (FRC) H-Set 10E the reference values for $R$ should be scaled (multiplied by 8).			

**Table 9.8J1: Enhanced requirement type 3 16QAM, Fixed Reference Channel (FRC) H-Set 10/10A/10B/10C/10E**

Test Number	Propagation Conditions	Reference value	
		HS-PDSCH $E_c / I_{or}$ (dB)	T-put $R$ (kbps) * $\hat{I}_{or} / I_{oc} = 8$ dB
1	VA3	-2	3396
* Notes: 1)The reference value $R$ is for the Fixed Reference Channel (FRC) H-Set 10. 2) For Fixed Reference Channel (FRC) H-Set 10A the reference values for should be scaled (multiplied by 2). 3) For Fixed Reference Channel (FRC) H-Set 10B the reference values for $R$ should be scaled (multiplied by 3). 4) For Fixed Reference Channel (FRC) H-Set 10C the reference values for $R$ should be scaled (multiplied by 4). 5) For Fixed Reference Channel (FRC) H-Set 10E the reference values for $R$ should be scaled (multiplied by 8).			



## 9.2.2 Open Loop Diversity performance

The receiver single open loop transmit diversity performance of the High Speed Physical Downlink Shared Channel (HS-DSCH) in multi-path fading environments are determined by the information bit throughput  $R$ .

### 9.2.2.1 Requirement QPSK, Fixed Reference Channel (FRC) H-Set 1/2/3/3A/3B/3C/3E

The requirements are specified in terms of a minimum information bit throughput  $R$  for the DL reference channels H-Set 1/2/3/3A/3B/3C/3E (QPSK version) specified in Annex A.7.1.1, A.7.1.2 and A.7.1.3 respectively, with the addition of the parameters in Table 9.9 and the downlink physical channel setup according to table C.9.

Using this configuration the throughput shall meet or exceed the minimum requirements specified in table 9.10. Enhanced performance requirements type 1 specified in Table 9.10A are based on receiver diversity.

**Table 9.9: Test Parameters for Testing QPSK FRCs H-Set 1/2/3/3A/3B/3C/3E**

Parameter	Unit	Test 1	Test 2	Test 3
Phase reference		P-CPICH		
$I_{oc}$	dBm/3.84 MHz	-60		
Redundancy and constellation version coding sequence		{0,2,5,6}		
Maximum number of HARQ transmission		4		
Note:	The HS-SCCH-1 and HS-PDSCH shall be transmitted continuously with constant power. HS-SCCH-1 shall only use the identity of the UE under test for those TTI intended for the UE.			

**Table 9.10: Minimum requirement QPSK, Fixed Reference Channel (FRC) H-Set 1/2/3/3A/3B/3C/3E**

Test Number	Propagation Conditions	Reference value		
		HS-PDSCH $E_c / I_{or}$ (dB)	T-put $R$ (kbps) * $\hat{I}_{or} / I_{oc} = 0$ dB	T-put $R$ (kbps) * $\hat{I}_{or} / I_{oc} = 10$ dB
1	PA3	-6	77	375
		-3	180	475
2	PB3	-6	20	183
		-3	154	274
3	VA30	-6	15	187
		-3	162	284

- \* Notes:
- 1) The reference value  $R$  is for the Fixed Reference Channel (FRC) H-Set 1.
  - 2) For Fixed Reference Channel (FRC) H-Set 2 the reference values for  $R$  should be scaled (multiplied by 1.5 and rounding to the nearest integer t-put in kbps, where values of  $i+1/2$  are rounded up to  $i+1$ ,  $i$  integer).
  - 3) For Fixed Reference Channel (FRC) H-Set 3 the reference values for  $R$  should be scaled (multiplied by 3).
  - 4) For Fixed Reference Channel (FRC) H-Set 3A the reference values for  $R$  should be scaled (multiplied by 6).
  - 5) For Fixed Reference Channel (FRC) H-Set 3B the reference values for  $R$  should be scaled (multiplied by 9).
  - 6) For Fixed Reference Channel (FRC) H-Set 3C the reference values for  $R$  should be scaled (multiplied by 12).
  - 7) For Fixed Reference Channel (FRC) H-Set 3E the reference values for  $R$  should be scaled (multiplied by 24).



**Table 9.10A: Enhanced requirement type 1 QPSK, Fixed Reference Channel (FRC) H-Set 1/2/3/3A/3B/3C/3E**

Test Number	Propagation Conditions	Reference value		
		HS-PDSCH $E_c / I_{or}$ (dB)	T-put $R$ (kbps) * $\hat{I}_{or} / I_{oc} = 0$ dB	T-put $R$ (kbps) * $\hat{I}_{or} / I_{oc} = 10$ dB
1	PA3	-12	N/A	268
		-9	N/A	407
		-6	197	N/A
		-3	333	N/A
2	PB3	-9	N/A	183
		-6	152	288
		-3	251	N/A
3	VA30	-9	N/A	197
		-6	164	307
		-3	261	N/A

\* Notes:

- 1) The reference value R is for the Fixed Reference Channel (FRC) H-Set 1.
- 2) For Fixed Reference Channel (FRC) H-Set 2 the reference values for R should be scaled (multiplied by 1.5 and rounding to the nearest integer t-put in kbps, where values of  $i+1/2$  are rounded up to  $i+1$ , i integer).
- 3) For Fixed Reference Channel (FRC) H-Set 3 the reference values for R should be scaled (multiplied by 3).
- 4) For Fixed Reference Channel (FRC) H-Set 3A the reference values for R should be scaled (multiplied by 6).
- 5) For Fixed Reference Channel (FRC) H-Set 3B the reference values for R should be scaled (multiplied by 9).
- 6) For Fixed Reference Channel (FRC) H-Set 3C the reference values for R should be scaled (multiplied by 12).
- 7) For Fixed Reference Channel (FRC) H-Set 3E the reference values for R should be scaled (multiplied by 24).

### 9.2.2.2 Requirement 16QAM, Fixed Reference Channel (FRC) H-Set 1/2/3/3A/3B/3C/3E

The requirements are specified in terms of a minimum information bit throughput R for the DL reference channels H-Set 1/2/3/3A/3B/3C/3E (16QAM version) specified in Annex A.7.1.1, A.7.1.2 and A.7.1.3 respectively, with the addition of the parameters in Table 9.11 and the downlink physical channel setup according to table C.9.

Using this configuration the throughput shall meet or exceed the minimum requirements specified in table 9.12. Enhanced performance requirements type 1 specified in Table 9.12A are based on receiver diversity.

**Table 9.11: Test Parameters for Testing 16QAM FRCs H-Set 1/2/3/3A/3B/3C/3E**

Parameter	Unit	Test 1	Test 2	Test 3
Phase reference		P-CPICH		
$I_{oc}$	dBm/3.84 MHz	-60		
Redundancy and constellation version coding sequence		{6,2,1,5}		
Maximum number of HARQ transmission		4		
Note: The HS-SCCH-1 and HS-PDSCH shall be transmitted continuously with constant power. HS-SCCH-1 shall only use the identity of the UE under test for those TTI intended for the UE.				



**Table 9.12: Minimum requirement 16QAM, Fixed Reference Channel (FRC) H-Set 1/2/3/3A/3B/3C/3E**

Test Number	Propagation Conditions	Reference value	
		HS-PDSCH $E_c / I_{or}$ (dB)	T-put $R$ (kbps) * $\hat{I}_{or} / I_{oc} = 10$ dB
1	PA3	-6	295
		-3	463
2	PB3	-6	24
		-3	243
3	VA30	-6	35
		-3	251

\* Notes: 1)The reference value  $R$  is for the Fixed Reference Channel (FRC) H-Set 1.  
2) For Fixed Reference Channel (FRC) H-Set 2 the reference values for  $R$  should be scaled (multiplied by 1.5 and rounding to the nearest integer t-put in kbps, where values of  $i+1/2$  are rounded up to  $i+1$ ,  $i$  integer).  
3) For Fixed Reference Channel (FRC) H-Set 3 the reference values for  $R$  should be scaled (multiplied by 3).  
4) For Fixed Reference Channel (FRC) H-Set 3A the reference values for  $R$  should be scaled (multiplied by 6).  
5) For Fixed Reference Channel (FRC) H-Set 3B the reference values for  $R$  should be scaled (multiplied by 9).  
6) For Fixed Reference Channel (FRC) H-Set 3C the reference values for  $R$  should be scaled (multiplied by 12).  
7) For Fixed Reference Channel (FRC) H-Set 3E the reference values for  $R$  should be scaled (multiplied by 24).

**Table 9.12A: Enhanced requirement type 1 16QAM, Fixed Reference Channel (FRC) H-Set 1/2/3/3A/3B/3C/3E**

Test Number	Propagation Conditions	Reference value	
		HS-PDSCH $E_c / I_{or}$ (dB)	T-put $R$ (kbps) * $\hat{I}_{or} / I_{oc} = 10$ dB
1	PA3	-9	340
		-6	513
2	PB3	-6	251
		-3	374
3	VA30	-6	280
		-3	398

\* Notes: 1)The reference value  $R$  is for the Fixed Reference Channel (FRC) H-Set 1.  
2) For Fixed Reference Channel (FRC) H-Set 2 the reference values for  $R$  should be scaled (multiplied by 1.5 and rounding to the nearest integer t-put in kbps, where values of  $i+1/2$  are rounded up to  $i+1$ ,  $i$  integer).  
3) For Fixed Reference Channel (FRC) H-Set 3 the reference values for  $R$  should be scaled (multiplied by 3).  
4) For Fixed Reference Channel (FRC) H-Set 3A the reference values for  $R$  should be scaled (multiplied by 6).  
5) For Fixed Reference Channel (FRC) H-Set 3B the reference values for  $R$  should be scaled (multiplied by 9).  
6) For Fixed Reference Channel (FRC) H-Set 3C the reference values for  $R$  should be scaled (multiplied by 12).  
7) For Fixed Reference Channel (FRC) H-Set 3E the reference values for  $R$  should be scaled (multiplied by 24).

### 9.2.2.3 Minimum requirement QPSK, Fixed Reference Channel (FRC) H-Set 4/5

The requirements are specified in terms of a minimum information bit throughput  $R$  for the DL reference channels H-Set 4/5 specified in Annex A.7.1.4 and A.7.1.5 respectively, with the addition of the parameters in Table 9.13 and the downlink physical channel setup according to table C.9.

Using this configuration the throughput shall meet or exceed the minimum requirements specified in table 9.14 for H-Set 4 and table 9.15 for H-Set 5.



**Table 9.13: Test Parameters for Testing QPSK FRCs H-Set 4/H-Set 5**

Parameter	Unit	Test 1	Test 2	Test 3	Test 4
Phase reference		P-CPICH			
$I_{oc}$	dBm/3.84 MHz	-60			
Redundancy and constellation version coding sequence		{0,2,5,6}			
Maximum number of HARQ transmission		4			
Note:	The HS-SCCH-1 and HS-PDSCH shall be transmitted continuously with constant power. HS-SCCH-1 shall only use the identity of the UE under test for those TTI intended for the UE.				

**Table 9.14: Minimum requirement QPSK, Fixed Reference Channel (FRC) H-Set 4**

Test Number	Propagation Conditions	Reference value		
		HS-PDSCH $E_c / I_{or}$ (dB)	T-put $R$ (kbps) * $\hat{I}_{or} / I_{oc} = 0$ dB	T-put $R$ (kbps) $\hat{I}_{or} / I_{oc} = 10$ dB
1	PA3	-6	70	369
		-3	171	471
2	PB3	-6	14	180
		-3	150	276
3	VA30	-6	11	184
		-3	156	285

**Table 9.15: Minimum requirement QPSK, Fixed Reference Channel (FRC) H-Set 5**

Test Number	Propagation Conditions	Reference value		
		HS-PDSCH $E_c / I_{or}$ (dB)	T-put $R$ (kbps) * $\hat{I}_{or} / I_{oc} = 0$ dB	T-put $R$ (kbps) $\hat{I}_{or} / I_{oc} = 10$ dB
1	PA3	-6	116	563
		-3	270	713
2	PB3	-6	30	275
		-3	231	411
3	VA30	-6	23	281
		-3	243	426

## 9.2.3 Closed Loop Diversity Performance

The closed loop transmit diversity (Mode 1) performance of the High Speed Physical Downlink Shared Channel (HS-DSCH) in multi-path fading environments are determined by the information bit throughput  $R$ .

### 9.2.3.1 Requirement QPSK, Fixed Reference Channel (FRC) H-Set 1/2/3

The requirements are specified in terms of a minimum information bit throughput  $R$  for the DL reference channels H-Set 1/2/3 (QPSK version) specified in Annex A.7.1.1, A.7.1.2 and A.7.1.3 respectively, with the addition of the parameters in Table 9.16 and the downlink physical channel setup according to table C.10.

Using this configuration the throughput shall meet or exceed the minimum requirements specified in table 9.17. Enhanced performance requirements type 1 specified in Table 9.17A are based on receiver diversity.



**Table 9.16: Test Parameters for Testing QPSK FRCs H-Set 1/H-Set 2/H-Set 3**

Parameter	Unit	Test 1	Test 2	Test 3
Phase reference		P-CPICH		
$I_{oc}$	dBm/3.84 MHz	-60		
DPCH frame offset ( $\tau_{DPCH,n}$ )	Chip	0		
Redundancy and constellation version coding sequence		{0,2,5,6}		
Maximum number of HARQ transmission		4		
Feedback Error Rate	%	4		
Closed loop timing adjustment mode		1		
Note:	The HS-SCCH-1 and HS-PDSCH shall be transmitted continuously with constant power. HS-SCCH-1 shall only use the identity of the UE under test for those TTI intended for the UE.			

**Table 9.17: Minimum requirement QPSK, Fixed Reference Channel (FRC) H-Set 1/2/3**

Test Number	Propagation Conditions	Reference value		
		HS-PDSCH $E_c / I_{or}$ (dB)	T-put $R$ (kbps) * $\hat{I}_{or} / I_{oc} = 0$ dB	T-put $R$ (kbps) * $\hat{I}_{or} / I_{oc} = 10$ dB
1	PA3	-6	118	399
		-3	225	458
2	PB3	-6	50	199
		-3	173	301
3	VA30	-6	47	204
		-3	172	305
* Notes: 1) The reference value R is for the Fixed Reference Channel (FRC) H-Set 1. 2) For Fixed Reference Channel (FRC) H-Set 2 the reference values for R should be scaled (multiplied by 1.5 and rounding to the nearest integer t-put in kbps, where values of i+1/2 are rounded up to i+1, i integer). 3) For Fixed Reference Channel (FRC) H-Set 3 the reference values for R should be scaled (multiplied by 3).				

**Table 9.17A: Enhanced requirement type 1 QPSK, Fixed Reference Channel (FRC) H-Set 1/2/3**

Test Number	Propagation Conditions	Reference value		
		HS-PDSCH $E_c / I_{or}$ (dB)	T-put $R$ (kbps) * $\hat{I}_{or} / I_{oc} = 0$ dB	T-put $R$ (kbps) * $\hat{I}_{or} / I_{oc} = 10$ dB
1	PA3	-12	N/A	297
		-9	N/A	410
		-6	242	N/A
		-3	369	N/A
2	PB3	-9	N/A	194
		-6	170	308
		-3	272	N/A
3	VA30	-9	N/A	204
		-6	172	315
		-3	270	N/A

\* Notes:

1) The reference value R is for the Fixed Reference Channel (FRC) H-Set 1.

2) For Fixed Reference Channel (FRC) H-Set 2 the reference values for R should be scaled (multiplied by 1.5 and rounding to the nearest integer t-put in kbps, where values of  $i+1/2$  are rounded up to  $i+1$ ,  $i$  integer).

3) For Fixed Reference Channel (FRC) H-Set 3 the reference values for R should be scaled (multiplied by 3).



### 9.2.3.2 Requirement 16QAM, Fixed Reference Channel (FRC) H-Set 1/2/3

The requirements are specified in terms of a minimum information bit throughput  $R$  for the DL reference channels H-set 1/2/3 (16QAM version) specified in Annex A.7.1.1, A.7.1.2 and A.7.1.3 respectively, with the addition of the parameters in Table 9.18 and the downlink physical channel setup according to table C.10.

Using this configuration the throughput shall meet or exceed the minimum requirements specified in table 9.19. Enhanced performance requirements type 1 specified in Table 9.19A are based on receiver diversity.

**Table 9.18: Test Parameters for Testing 16-QAM FRCs H-Set 1/H-Set 2/H-Set 3**

Parameter	Unit	Test 1	Test 2	Test 3
Phase reference		P-CPICH		
$I_{oc}$	dBm/3.84 MHz	-60		
DPCH frame offset ( $\tau_{DPCH,n}$ )	Chip	0		
Redundancy and constellation version coding sequence		{6,2,1,5}		
Maximum number of HARQ transmission		4		
Feedback Error Rate	%	4		
Closed loop timing adjustment mode		1		
Note: The HS-SCCH-1 and HS-PDSCH shall be transmitted continuously with constant power. HS-SCCH-1 shall only use the identity of the UE under test for those TTI intended for the UE.				

**Table 9.19: Minimum requirement 16QAM, Fixed Reference Channel (FRC) H-Set 1/2/3**

Test Number	Propagation Conditions	Reference value	
		HS-PDSCH $E_c / I_{or}$ (dB)	T-put $R$ (kbps) * $\hat{I}_{or} / I_{oc} = 10$ dB
1	PA3	-6	361
		-3	500
2	PB3	-6	74
		-3	255
3	VA30	-6	84
		-3	254

\* Notes:

1)The reference value R is for the Fixed Reference Channel (FRC) H-Set 1

2) For Fixed Reference Channel (FRC) H-Set 2 the reference values for R should be scaled (multiplied by 1.5 and rounding to the nearest integer t-put in kbps, where values of i+1/2 are rounded up to i+1, I integer)

3) For Fixed Reference Channel (FRC) H-Set 3 the reference values for R should be scaled (multiplied by 3 and rounding to the nearest integer t-put in kbps, where values of i+1/2 are rounded up to i+1, I integer)



**Table 9.19A: Enhanced requirement type 1 16QAM, Fixed Reference Channel (FRC) H-Set 1/2/3**

Test Number	Propagation Conditions	Reference value	
		HS-PDSCH $E_c / I_{or}$ (dB)	T-put $R$ (kbps) * $\hat{I}_{or} / I_{oc} = 10$ dB
1	PA3	-9	376
		-6	532
2	PB3	-6	267
		-3	393
3	VA30	-6	279
		-3	404

\* Notes: 1) The reference value  $R$  is for the Fixed Reference Channel (FRC) H-Set 1.  
2) For Fixed Reference Channel (FRC) H-Set 2 the reference values for  $R$  should be scaled (multiplied by 1.5 and rounding to the nearest integer t-put in kbps, where values of  $i+1/2$  are rounded up to  $i+1$ ,  $i$  integer).  
3) For Fixed Reference Channel (FRC) H-Set 3 the reference values for  $R$  should be scaled (multiplied by 3).

### 9.2.3.3 Minimum requirement QPSK, Fixed Reference Channel (FRC) H-Set 4/5

The requirements are specified in terms of a minimum information bit throughput  $R$  for the DL reference channels H-set 4/5 specified in Annex A.7.1.4 and A.7.1.5 respectively, with the addition of the parameters in Table 9.20 and the downlink physical channel setup according to table C.10.

Using this configuration the throughput shall meet or exceed the minimum requirements specified in table 9.21 for H-Set 4 and table 9.22 for H-Set 5.

**Table 9.20: Test Parameters for Testing QPSK FRCs H-Set 4/H-Set 5**

Parameter	Unit	Test 1	Test 2	Test 3
Phase reference		P-CPICH		
$I_{oc}$	dBm/3.84 MHz	-60		
DPCH frame offset ( $\tau_{DPCH,n}$ )	Chip	0		
Redundancy and constellation version coding sequence		{0,2,5,6}		
Maximum number of HARQ transmission		4		
Feedback Error Rate	%	4		
Closed loop timing adjustment mode		1		

Note: The HS-SCCH-1 and HS-PDSCH shall be transmitted continuously with constant power. HS-SCCH-1 shall only use the identity of the UE under test for those TTI intended for the UE.

**Table 9.21: Minimum requirement QPSK, Fixed Reference Channel (FRC) H-Set 4**

Test Number	Propagation Conditions	Reference value		
		HS-PDSCH $E_c / I_{or}$ (dB)	T-put $R$ (kbps) $\hat{I}_{or} / I_{oc} = 0$ dB	T-put $R$ (kbps) $\hat{I}_{or} / I_{oc} = 10$ dB
1	PA3	-6	114	398
		-3	223	457
2	PB3	-6	43	196
		-3	167	292
3	VA30	-6	40	199
		-3	170	305



**Table 9.22: Minimum requirement QPSK, Fixed Reference Channel (FRC) H-Set 5**

Test Number	Propagation Conditions	Reference value		
		HS-PDSCH $E_c/I_{or}$ (dB)	T-put $R$ (kbps) $\hat{I}_{or}/I_{oc} = 0$ dB	T-put $R$ (kbps) $\hat{I}_{or}/I_{oc} = 10$ dB
1	PA3	-6	177	599
		-3	338	687
2	PB3	-6	75	299
		-3	260	452
3	VA30	-6	71	306
		-3	258	458

#### 9.2.3.4 Requirement QPSK, Fixed Reference Channel (FRC) H-Set 6

The requirements are specified in terms of a minimum information bit throughput  $R$  for the DL reference channel H-Set 6 specified in Annex A.7.1.6 with the addition of the parameters in Table 9.22A and the downlink physical channel setup according to table C.10.

Using this configuration the throughput shall meet or exceed the requirements specified in table 9.22B. Enhanced performance requirements type 2 as specified in Table 9.22B are based on chip level equaliser.

**Table 9.22A: Test Parameters for Testing QPSK FRCs H-Set 6**

Parameter	Unit	Test 1
Phase reference		P-CPICH
$I_{oc}$	dBm/3.84 MHz	-60
DPCH frame offset ( $\tau_{DPCH,n}$ )	Chip	0
Redundancy and constellation version coding sequence		{0,2,5,6}
Maximum number of HARQ transmission		4
Feedback Error Rate	%	4
Closed loop timing adjustment mode		1
Note: The HS-SCCH-1 and HS-PDSCH shall be transmitted continuously with constant power. HS-SCCH-1 shall only use the identity of the UE under test for those TTI intended for the UE.		

**Table 9.22B: Enhanced requirement type 2 QPSK, Fixed Reference Channel (FRC) H-Set 6**

Test Number	Propagation Conditions	Reference value	
		HS-PDSCH $E_c/I_{or}$ (dB)	T-put $R$ (kbps) $\hat{I}_{or}/I_{oc} = 10$ dB
1	PB3	-3	1536

#### 9.2.3.5 Requirement 16QAM, Fixed Reference Channel (FRC) H-Set 6

The requirements are specified in terms of a minimum information bit throughput  $R$  for the DL reference channel H-Set-6 specified in Annex A.7.1.6 with the addition of the parameters in Table 9.22C and the downlink physical channel setup according to table C.10.

Using this configuration the throughput shall meet or exceed the requirements specified in table 9.22D. Enhanced performance requirements type 2 specified in Table 9.22D are based on chip level equaliser.



**Table 9.22C: Test Parameters for Testing 16-QAM FRCs H-Set 6**

Parameter	Unit	Test 1
Phase reference		P-CPICH
$I_{oc}$	dBm/3.84 MHz	-60
DPCH frame offset ( $\tau_{DPCH,n}$ )	Chip	0
Redundancy and constellation version coding sequence		{6,2,1,5}
Maximum number of HARQ transmission		4
Feedback Error Rate	%	4
Closed loop timing adjustment mode		1
Note: The HS-SCCH-1 and HS-PDSCH shall be transmitted continuously with constant power. HS-SCCH-1 shall only use the identity of the UE under test for those TTI intended for the UE.		

**Table 9.22D: Enhanced requirement type 2 16QAM, Fixed Reference Channel (FRC) H-Set 6**

Test Number	Propagation Conditions	Reference value	
		HS-PDSCH $E_c / I_{or}$ (dB)	T-put $R$ (kbps) $\hat{I}_{or} / I_{oc} = 10$ dB
1	PB3	-3	1154

## 9.2.4 MIMO Performance

The MIMO performance of the High Speed Physical Downlink Shared Channel (HS-DSCH) in multi-path fading environments is determined by the information bit throughput  $R$ .

### 9.2.4.1 Requirement Fixed Reference Channel (FRC) H-Set 9/9A/9B/9C/9E

The requirements are specified in terms of a minimum information bit throughput  $R$  for the DL reference channels H-Set 9/9A/9B/9C/9E specified in Annex A.7.1.9, with the addition of the parameters in Table 9.22E1 and the downlink physical channel setup according to Table C.9 and Table C.12D. Precoding weight set restriction shall not be enabled.

The primary precoding vector signalled on the HS-SCCH and applied on the associated HS-DSCH subframe shall correspond to the preferred primary precoding vector reported immediately before the start of the HS-SCCH subframe.

The determination of applied precoding vector for single transport block transmission shall be as follows: the reported preferred primary precoding vector shall be applied to the primary transport block.

The determination of applied precoding vector for two transport block transmission shall be as follows: If the CQI reported by the UE indicates a preference for a single transport block, the preferred primary precoding vector shall be applied to the primary transport block. If the CQI reported by the UE indicates a preference for two transport blocks, and the preferred primary precoding vector corresponds to the highest reported CQI value, the preferred primary precoding vector shall be applied to the primary transport block. If the CQI reported by the UE indicates a preference for two transport blocks, and the preferred primary precoding vector does not correspond to the highest reported CQI value, the preferred primary precoding vector shall be applied to the secondary transport block.

Using this configuration the throughput shall meet or exceed the minimum requirements specified in Table 9.22E2 with the downlink physical channel setup in Table C.9, and the minimum requirements specified in Table 9.22E3 with the downlink physical channel setup in Table C.12D.



**Table 9.22E1: Test Parameters for Testing MIMO FRC H-Set 9/9A/9B/9C/9E**

Parameter	Unit	Test 1	Test 2	Test 3	Test 4
$I_{oc}$	dBm/3.84 MHz	-60			
DPCH frame offset ( $\tau_{DPCH,n}$ )	Chip	0			
Redundancy and constellation version coding sequence		{0,3,2,1} for 16-QAM and QPSK			
Maximum number of HARQ transmission		4			
MIMO N_cqi_typeA/M_cqi ratio		1/1		1/2	
PCI/CQI reporting Error Rate	%	0		0	
Number of transport blocks		2		1	
Modulation		Primary Transport Block: 16QAM Secondary Transport Block: QPSK		Primary Transport Block: 16QAM Secondary Transport Block is not used.	

**Table 9.22E2: Minimum requirement MIMO, Fixed Reference Channel (FRC) H-Set 9/9A/9B/9C/9E with downlink physical channel setup in Table C.9**

Test Number	Propagation Conditions	Reference value	
		$\hat{I}_{or} / I_{oc}$ (dB)	T-put $R$ (kbps) * HS-PDSCH $E_c / I_{or} = -2$ dB
1	PA3	10	5563
2	VA3	10	4347
3	PA3	6	3933
4	VA3	6	3011
* Notes: 1) The reference value $R$ is for the Fixed Reference Channel (FRC) H-Set 9. 2) For Fixed Reference Channel (FRC) H-Set 9A the reference values for $R$ should be scaled (multiplied by 2). 3) For Fixed Reference Channel (FRC) H-Set 9B the reference values for $R$ should be scaled (multiplied by 3). 4) For Fixed Reference Channel (FRC) H-Set 9C the reference values for $R$ should be scaled (multiplied by 4). 5) For Fixed Reference Channel (FRC) H-Set 9E the reference values for $R$ should be scaled (multiplied by 8).			



**Table 9.22E3: Minimum requirement MIMO, Fixed Reference Channel (FRC) H-Set 9/9A/9B/9C/9E with downlink physical channel setup in Table C.12D**

Test Number	Propagation Conditions	Reference value	
		$\hat{I}_{or} / I_{oc}$ (dB)	T-put $R$ (kbps) * HS-PDSCH $E_c / I_{or} = -2$ dB
1	PA3	10	5394
2	VA3	10	4344
3	PA3	6	3742
4	VA3	6	2926
* Notes: 1)The reference value $R$ is for the Fixed Reference Channel (FRC) H-Set 9. 2) For Fixed Reference Channel (FRC) H-Set 9A the reference values for $R$ should be scaled (multiplied by 2). 3) For Fixed Reference Channel (FRC) H-Set 9B the reference values for $R$ should be scaled (multiplied by 3). 4) For Fixed Reference Channel (FRC) H-Set 9C the reference values for $R$ should be scaled (multiplied by 4). 5) For Fixed Reference Channel (FRC) H-Set 9E the reference values for $R$ should be scaled (multiplied by 8).			

#### 9.2.4.2 Requirement Fixed Reference Channel (FRC) H-Set 11/11A/11B/11C/11E

The requirements are specified in terms of a minimum information bit throughput  $R$  for the DL reference channels H-Set 11/11A/11B/11C/11E specified in Annex A.7.1.11, with the addition of the parameters in Table 9.22F1 and the downlink physical channel setup according to Table C.9 and Table C.12D. Precoding weight set restriction shall not be enabled.

The primary precoding vector signalled on the HS-SCCH and applied on the associated HS-DSCH subframe shall correspond to the preferred primary precoding vector reported immediately before the start of the HS-SCCH subframe.

The determination of applied precoding vector for two transport block transmission shall be as follows: If the CQI reported by the UE indicates a preference for a single transport block, the preferred primary precoding vector shall be applied to the primary transport block. If the CQI reported by the UE indicates a preference for two transport blocks, and the preferred primary precoding vector corresponds to the highest reported CQI value, the preferred primary precoding vector shall be applied to the primary transport block. If the CQI reported by the UE indicates a preference for two transport blocks, and the preferred primary precoding vector does not correspond to the highest reported CQI value, the preferred primary precoding vector shall be applied to the secondary transport block.

Using this configuration the throughput shall meet or exceed the minimum requirements specified in Table 9.22F2 with the downlink physical channel setup in Table C.9, and the minimum requirements specified in Table 9.22F3 with the downlink physical channel setup in Table C.12D.



**Table 9.22F1: Test Parameters for Testing MIMO FRC H-Set 11/11A/11B/11C/11E**

Parameter	Unit	Test 1
$I_{oc}$	dBm/3.84 MHz	-60
DPCCH frame offset ( $\tau_{DPCCH,n}$ )	Chip	0
Redundancy and constellation version coding sequence		{0,3,2,1} for 16QAM and 64QAM
Maximum number of HARQ transmission		4
MIMO N_cqi_typeA/M_cqi ratio		1/1
PCI/CQI reporting Error Rate	%	0
Number of transport blocks		2
Modulation		Primary Transport Block: 64QAM Secondary Transport Block: 16QAM

**Table 9.22F2: Minimum requirement MIMO, Fixed Reference Channel (FRC) H-Set 11/11A/11B/11C/11E with downlink physical channel setup in Table C.9**

Test Number	Propagation Conditions	Reference value	
		$\hat{I}_{or} / I_{oc}$ (dB)	T-put $R$ (kbps) * HS-PDSCH $E_c / I_{or} = -1.5$ dB
1	PA3	18	9980
* Notes: 1)The reference value R is for the Fixed Reference Channel (FRC) H-Set 11. 2) For Fixed Reference Channel (FRC) H-Set 11A the reference values for R should be scaled (multiplied by 2). 3) For Fixed Reference Channel (FRC) H-Set 11B the reference values for R should be scaled (multiplied by 3). 4) For Fixed Reference Channel (FRC) H-Set 11C the reference values for R should be scaled (multiplied by 4). 5) For Fixed Reference Channel (FRC) H-Set 11E the reference values for R should be scaled (multiplied by 8).			

**Table 9.22F3: Minimum requirement MIMO, Fixed Reference Channel (FRC) H-Set 11/11A/11B/11C/11E with downlink physical channel setup in Table C.12D**

Test Number	Propagation Conditions	Reference value	
		$\hat{I}_{or} / I_{oc}$ (dB)	T-put $R$ (kbps) * HS-PDSCH $E_c / I_{or} = -1.5$ dB
1	PA3	18	9880
* Notes: 1)The reference value R is for the Fixed Reference Channel (FRC) H-Set 11. 2) For Fixed Reference Channel (FRC) H-Set 11A the reference values for R should be scaled (multiplied by 2). 3) For Fixed Reference Channel (FRC) H-Set 11B the reference values for R should be scaled (multiplied by 3). 4) For Fixed Reference Channel (FRC) H-Set 11C the reference values for R should be scaled (multiplied by 4). 5) For Fixed Reference Channel (FRC) H-Set 11E the reference values for R should be scaled (multiplied by 8).			



## 9.2.4A MIMO only with single-stream restriction Performance

The MIMO only with single-stream performance of the High Speed Physical Downlink Shared Channel (HS-DSCH) in multi-path fading environments are determined by the information bit throughput R.

### 9.2.4A.1 Requirement QPSK, Fixed Reference Channel (FRC) H-Set 1/1A/1B/1C/1E

The requirements are specified in terms of a minimum information bit throughput R for the DL reference channels H-set 1/1A/1B/1C/1E (QPSK version) specified in Annex A.7.1.1, with the addition of the parameters in Table 9.22G1 and the downlink physical channel setup according to Table C.9 and Table C.12D. Precoding weight set restriction shall be enabled for the tests with the downlink physical channel setup according to Table C.12D, defined in Table 9.22G2A and Table 9.22G4. Precoding weight set restriction shall not be enabled for the tests with the downlink physical channel setup according to Table C.9, defined in Table 9.22G2 and Table 9.22G3.

The primary precoding vector signalled on the HS-SCCH and applied on the associated HS-DSCH subframe shall correspond to the preferred primary precoding vector reported immediately before the start of the HS-SCCH subframe.

The determination of applied precoding vector for single transport block transmission shall be as follows: the reported preferred primary precoding vector shall be applied to the primary transport block.

Using this configuration the throughput shall meet or exceed the minimum requirements specified in Table 9.22G2 with the downlink physical channel setup in Table C.9, and the minimum requirements specified in Table 9.22G2A with the downlink physical channel setup in Table C.12D. If UE supports enhanced performance requirements type 3, the throughput shall meet or exceed the minimum requirements specified in Table 9.22G3 with the downlink physical channel setup in Table C.9, and the minimum requirements specified in Table 9.22G4 with the downlink physical channel setup in Table C.12D. The performance requirements specified in Table 9.22G2 and Table 9.22G2A are based on chip level equaliser and the performance requirements specified in Table 9.22G3 and Table 9.22G4 are based on chip level equaliser with receiver diversity.

**Table 9.22G1: Test Parameters for Testing QPSK FRCs H-Set 1/1A/1B/1C/1E**

Parameter	Unit	Test 1	Test 2
$I_{oc}$	dBm/3.84 MHz	-60	
Redundancy and constellation version coding sequence		{0,3,2,1}	
Maximum number of HARQ transmission		4	
Note: The HS-SCCH-1 and HS-PDSCH shall be transmitted continuously with constant power. HS-SCCH-1 shall only use the identity of the UE under test for those TTI intended for the UE.			



**Table 9.22G2: Enhanced requirement type 2 QPSK, Fixed Reference Channel (FRC) H-Set 1/1A/1B/1C/1E with downlink physical channel setup in Table C.9**

Test Number	Propagation Conditions	Reference value	
		$\hat{I}_{or}/I_{oc}$ (dB)	T-put $R$ (kbps)* HS-PDSCH $E_c/I_{or} = -3$ dB
1	PA3	0	305
2	VA3	3	357
*Notes: 1) The reference value $R$ is for the Fixed Reference Channel (FRC) H-Set 1. 2) For Fixed Reference Channel (FRC) H-Set 1A the reference values for $R$ should be scaled (multiplied by 2). 3) For Fixed Reference Channel (FRC) H-Set 1B the reference values for $R$ should be scaled (multiplied by 3). 4) For Fixed Reference Channel (FRC) H-Set 1C the reference values for $R$ should be scaled (multiplied by 4). 5) For Fixed Reference Channel (FRC) H-Set 1E the reference values for $R$ should be scaled (multiplied by 8).			

**Table 9.22G2A: Enhanced requirement type 2 QPSK, Fixed Reference Channel (FRC) H-Set 1/1A/1B/1C/1E with downlink physical channel setup in Table C.12D**

Test Number	Propagation Conditions	Reference value	
		$\hat{I}_{or}/I_{oc}$ (dB)	T-put $R$ (kbps)* HS-PDSCH $E_c/I_{or} = -3$ dB
1	PA3	0	279
2	VA3	3	345
*Notes: 1) The reference value $R$ is for the Fixed Reference Channel (FRC) H-Set 1. 2) For Fixed Reference Channel (FRC) H-Set 1A the reference values for $R$ should be scaled (multiplied by 2). 3) For Fixed Reference Channel (FRC) H-Set 1B the reference values for $R$ should be scaled (multiplied by 3). 4) For Fixed Reference Channel (FRC) H-Set 1C the reference values for $R$ should be scaled (multiplied by 4). 5) For Fixed Reference Channel (FRC) H-Set 1E the reference values for $R$ should be scaled (multiplied by 8).			



**Table 9.22G3: Enhanced requirement type 3 QPSK, Fixed Reference Channel (FRC) H-Set 1/1A/1B/1C/1E with downlink physical channel setup in Table C.9**

Test Number	Propagation Conditions	Reference value	
		$\hat{I}_{or}/I_{oc}$ (dB)	T-put $R$ (kbps)* HS-PDSCH $E_c/I_{or} = -6$ dB
1	PA3	0	306
2	VA3	0	236
*Notes: 1) The reference value $R$ is for the Fixed Reference Channel (FRC) H-Set 1. 2) For Fixed Reference Channel (FRC) H-Set 1A the reference values for $R$ should be scaled (multiplied by 2). 3) For Fixed Reference Channel (FRC) H-Set 1B the reference values for $R$ should be scaled (multiplied by 3). 4) For Fixed Reference Channel (FRC) H-Set 1C the reference values for $R$ should be scaled (multiplied by 4). 5) For Fixed Reference Channel (FRC) H-Set 1E the reference values for $R$ should be scaled (multiplied by 8).			

**Table 9.22G4: Enhanced requirement type 3 QPSK, Fixed Reference Channel (FRC) H-Set 1/1A/1B/1C/1E with downlink physical channel setup in Table C.12D**

Test Number	Propagation Conditions	Reference value	
		$\hat{I}_{or}/I_{oc}$ (dB)	T-put $R$ (kbps)* HS-PDSCH $E_c/I_{or} = -6$ dB
1	PA3	0	285
2	VA3	0	230
*Notes: 1) The reference value $R$ is for the Fixed Reference Channel (FRC) H-Set 1. 2) For Fixed Reference Channel (FRC) H-Set 1A the reference values for $R$ should be scaled (multiplied by 2). 3) For Fixed Reference Channel (FRC) H-Set 1B the reference values for $R$ should be scaled (multiplied by 3). 4) For Fixed Reference Channel (FRC) H-Set 1C the reference values for $R$ should be scaled (multiplied by 4). 5) For Fixed Reference Channel (FRC) H-Set 1E the reference values for $R$ should be scaled (multiplied by 8).			

#### 9.2.4A.2 Requirement 16QAM, Fixed Reference Channel (FRC) H-Set 1/1A/1B/1C/1E

The requirements are specified in terms of a minimum information bit throughput  $R$  for the DL reference channels H-set 1/1A/1B/1C/1E (16QAM version) specified in Annex A.7.1.1, with the addition of the parameters in Table 9.22H1 and the downlink physical channel setup according to Table C.9 and Table C.12D. Precoding weight set restriction shall be enabled for the tests with the downlink physical channel setup according to Table C.12D, defined in Table 9.22H2A and 9.22H4. Precoding weight set restriction shall not be enabled for the tests with the downlink physical channel setup according to Table C.9, defined in Table 9.22H2 and Table 9.22H3.

The primary precoding vector signalled on the HS-SCCH and applied on the associated HS-DSCH subframe shall correspond to the preferred primary precoding vector reported immediately before the start of the HS-SCCH subframe.

The determination of applied precoding vector for single transport block transmission shall be as follows: the reported preferred primary precoding vector shall be applied to the primary transport block.

Using this configuration the throughput shall meet or exceed the minimum requirements specified in Table 9.22H2 with the downlink physical channel setup in Table C.9, and the minimum requirements specified in Table 9.22H2A with the downlink physical channel setup in Table C.12D. If UE supports enhanced performance requirements type 3, the throughput shall meet or exceed the minimum requirements specified in Table 9.22H3 with the downlink physical



channel setup in Table C.9, and the minimum requirements specified in Table 9.22H4 with the downlink physical channel setup in Table C.12D. The performance requirements specified in Table 9.22H2 and Table 9.22H2A are based on chip level equaliser and the performance requirements specified in Table 9.22H3 and Table 9.22H4 are based on chip level equaliser with receiver diversity.

**Table 9.22H1: Test Parameters for Testing 16QAM FRCs H-Set 1/1A/1B/1C/1E**

Parameter	Unit	Test 1	Test 2
$I_{oc}$	dBm/3.84 MHz	-60	
Redundancy and constellation version coding sequence		{0,3,2,1}	
Maximum number of HARQ transmission		4	
Note: The HS-SCCH-1 and HS-PDSCH shall be transmitted continuously with constant power. HS-SCCH-1 shall only use the identity of the UE under test for those TTI intended for the UE.			

**Table 9.22H2: Enhanced requirement type 2 16QAM, Fixed Reference Channel (FRC) H-Set 1/1A/1B/1C/1E with downlink physical channel setup in Table C.9**

Test Number	Propagation Conditions	Reference value	
		$\hat{I}_{or} / I_{oc}$ (dB)	T-put $R$ (kbps)* HS-PDSCH $E_c / I_{or} = -3$ dB
1	PA3	3	394
2	VA3	6	388
*Notes: 1) The reference value $R$ is for the Fixed Reference Channel (FRC) H-Set 1. 2) For Fixed Reference Channel (FRC) H-Set 1A the reference values for $R$ should be scaled (multiplied by 2). 3) For Fixed Reference Channel (FRC) H-Set 1B the reference values for $R$ should be scaled (multiplied by 3). 4) For Fixed Reference Channel (FRC) H-Set 1C the reference values for $R$ should be scaled (multiplied by 4). 5) For Fixed Reference Channel (FRC) H-Set 1E the reference values for $R$ should be scaled (multiplied by 8).			

**Table 9.22H2A: Enhanced requirement type 2 16QAM, Fixed Reference Channel (FRC) H-Set 1/1A/1B/1C/1E with downlink physical channel setup in Table C.12D**

Test Number	Propagation Conditions	Reference value	
		$\hat{I}_{or} / I_{oc}$ (dB)	T-put $R$ (kbps)* HS-PDSCH $E_c / I_{or} = -3$ dB
1	PA3	3	363
2	VA3	6	380
*Notes: 1) The reference value $R$ is for the Fixed Reference Channel (FRC) H-Set 1. 2) For Fixed Reference Channel (FRC) H-Set 1A the reference values for $R$ should be scaled (multiplied by 2). 3) For Fixed Reference Channel (FRC) H-Set 1B the reference values for $R$ should be scaled (multiplied by 3). 4) For Fixed Reference Channel (FRC) H-Set 1C the reference values for $R$ should be scaled (multiplied by 4). 5) For Fixed Reference Channel (FRC) H-Set 1E the reference values for $R$ should be scaled (multiplied by 8).			



**Table 9.22H3: Enhanced requirement type 3 16QAM, Fixed Reference Channel (FRC) H-Set 1/1A/1B/1C/1E with downlink physical channel setup in Table C.9**

Test Number	Propagation Conditions	Reference value	
		$\hat{I}_{or}/I_{oc}$ (dB)	T-put $R$ (kbps)* HS-PDSCH $E_c/I_{or} = -3$ dB
1	PA3	0	385
2	VA3	3	437
*Notes: 1) The reference value $R$ is for the Fixed Reference Channel (FRC) H-Set 1. 2) For Fixed Reference Channel (FRC) H-Set 1A the reference values for $R$ should be scaled (multiplied by 2). 3) For Fixed Reference Channel (FRC) H-Set 1B the reference values for $R$ should be scaled (multiplied by 3). 4) For Fixed Reference Channel (FRC) H-Set 1C the reference values for $R$ should be scaled (multiplied by 4). 5) For Fixed Reference Channel (FRC) H-Set 1E the reference values for $R$ should be scaled (multiplied by 8).			

**Table 9.22H4: Enhanced requirement type 3 16QAM, Fixed Reference Channel (FRC) H-Set 1/1A/1B/1C/1E with downlink physical channel setup in Table C.12D**

Test Number	Propagation Conditions	Reference value	
		$\hat{I}_{or}/I_{oc}$ (dB)	T-put $R$ (kbps)* HS-PDSCH $E_c/I_{or} = -3$ dB
1	PA3	0	365
2	VA3	3	433
*Notes: 1) The reference value $R$ is for the Fixed Reference Channel (FRC) H-Set 1. 2) For Fixed Reference Channel (FRC) H-Set 1A the reference values for $R$ should be scaled (multiplied by 2). 3) For Fixed Reference Channel (FRC) H-Set 1B the reference values for $R$ should be scaled (multiplied by 3). 4) For Fixed Reference Channel (FRC) H-Set 1C the reference values for $R$ should be scaled (multiplied by 4). 5) For Fixed Reference Channel (FRC) H-Set 1E the reference values for $R$ should be scaled (multiplied by 8).			

## 9.2.4B Four Transmit Antennas MIMO Performance

The four transmit antennas MIMO performance of the High Speed Physical Downlink Shared Channel (HS-DSCH) in multi-path fading environments is determined by the information bit throughput  $R$ .

### 9.2.4B.1 Requirement Fixed Reference Channel (FRC) H-Set 13A/13C

The requirements are specified in terms of a minimum information bit throughput  $R$  for the DL reference channels H-Set 13A/13C specified in Annex A.7.1.13, with the addition of the parameters in Table 9.22I1 and the downlink physical channel setup according to Table C.12F.

The precoding weights signalled on the HS-SCCH and applied on the associated HS-DSCH subframe shall correspond to the preferred precoding control index reported immediately before the start of the HS-SCCH subframe.

Using this configuration the throughput shall meet or exceed the minimum requirements specified in Table 9.22I2 with the downlink physical channel setup in Table C.12F.



**Table 9.22I1: Test Parameters for Testing MIMO mode with Four Transmit Antennas, FRC H-Set 13A/13C**

Parameter	Unit	Test 1	Test 2	Test 3	Test 4
$I_{oc}$	dBm/3.84 MHz	-60			
DPCH frame offset ( $\tau_{DPCH,n}$ )	Chip	0			
Redundancy and constellation version coding sequence		{0,3,2,1} for 16-QAM and QPSK			
Maximum number of HARQ transmission		4			
MIMO N_cqi_typeA/M_cqi ratio		1/1		1/1	
PCI/CQI reporting Error Rate	%	0		0	
Number of transport blocks		Up to 4		Up to 2	
Modulation		First and fourth Transport Block: 16QAM Secondary and third Transport Block: QPSK		Primary Transport Block: 16QAM Secondary Transport Block: QPSK.	

**Table 9.22I2: Minimum requirement for MIMO mode with four transmit antennas, Fixed Reference Channel (FRC) H-Set 13A/13C with downlink physical channel setup in Table C.12F**

Test Number	Propagation Conditions	Reference value		
		HS-PDSCH $E_c / I_{or}$ (dB)	$\hat{I}_{or} / I_{oc}$ (dB)	T-put $R$ (kbps) *
1	PA3	-1.9	15	16000
2	VA3	-1.9	12	8500
3	PA3	-2.26	8	7000
4	VA3	-1.9	10	6500
* Notes: 1) For Fixed Reference Channel (FRC) H-Set 13A the reference values for R should be scaled (multiplied by 2). 2) For Fixed Reference Channel (FRC) H-Set 13C the reference values for R should be scaled (multiplied by 4).				

### 9.2.4B.2 Requirement Fixed Reference Channel (FRC) H-Set 14A/14C

The requirements are specified in terms of a minimum information bit throughput  $R$  for the DL reference channels H-Set 14A/14C specified in Annex A.7.1.14, with the addition of the parameters in Table 9.22J1 and the downlink physical channel setup according to Table C.12F.

The precoding weights signalled on the HS-SCCH and applied on the associated HS-DSCH subframe shall correspond to the preferred precoding control index vector reported immediately before the start of the HS-SCCH subframe.

Using this configuration the throughput shall meet or exceed the minimum requirements specified in Table 9.22J2 with the downlink physical channel setup in Table C.12F.



**Table 9.22J1: Test Parameters for Testing MIMO mode with four transmit antennas, FRC H-Set 14A/14C**

Parameter	Unit	Test 1	Test 2
$I_{oc}$	dBm/3.84 MHz	-60	
DPCH frame offset ( $\tau_{DPCH,n}$ )	Chip	0	
Redundancy and constellation version coding sequence		{0,3,2,1} for 64QAM and 16-QAM	
Maximum number of HARQ transmission		4	
MIMO N_cqi_typeA/M_cqi ratio		1/1	1/1
PCI/CQI reporting Error Rate	%	0	0
Number of transport blocks		Up to 4	Up to 2
Modulation		First and fourth Transport Block: 64QAM Secondary and third Transport Block: 16QAM	Primary Transport Block: 64QAM Secondary Transport Block: 16QAM.

**Table 9.22J2: Minimum requirement MIMO mode with four transmit antennas, Fixed Reference Channel (FRC) H-Set 14A/14C with downlink physical channel setup in Table C.12F**

Test Number	Propagation Conditions	Reference value	
		$\hat{I}_{or}/I_{oc}$ (dB)	T-put R (kbps) * HS-PDSCH $E_c/I_{or} = -1.9$ dB
1	PA3	18	17500
2	PA3	15	13500
* Notes: 1) For Fixed Reference Channel (FRC) H-Set 14A the reference values for R should be scaled (multiplied by 2). 2) For Fixed Reference Channel (FRC) H-Set 14C the reference values for R should be scaled (multiplied by 4).			

## 9.2.4C MIMO Mode with Four Transmit Antennas Only With Dual-stream Restriction Performance

The performance of MIMO mode with four transmit antennas only with dual stream capability for High Speed Physical Downlink Shared Channel (HS-DSCH) in multi-path fading environments are determined by the information bit throughput R.

### 9.2.4C.1 Requirement Fixed Reference Channel (FRC) H-Set 9A/9C

The requirements are specified in terms of a minimum information bit throughput R for the DL reference channels H-set 9A/9C specified in Annex A.7.1.9, with the addition of the parameters in Table 9.22K1 and the downlink physical channel setup according to Table C.12F. Precoding weight set restriction shall be enabled for the tests with the downlink physical channel setup according to Table C.12F, defined in Table 9.22K2.

The precoding control index signalled on the HS-SCCH and applied on the associated HS-DSCH subframe shall correspond to the preferred precoding control index reported immediately before the start of the HS-SCCH subframe.



Using this configuration, if UE supports enhanced performance requirements type 3, the throughput shall meet or exceed the minimum requirements specified in Table 9.22K2 with the downlink physical channel setup in Table C.12F. The performance requirements specified in Table 9.22K2 are based on chip level equaliser with receiver diversity.

**Table 9.22K1: Test Parameters for Testing MIMO mode with four transmit antennas only with dual stream restriction, FRC H-Set 9A/9C**

Parameter	Unit	Test 1/Test 2
$I_{oc}$	dBm/3.84 MHz	-60
DPCH frame offset ( $\tau_{DPCH,n}$ )	Chip	0
Redundancy and constellation version coding sequence		{0,3,2,1} for 16QAM and QPSK
Maximum number of HARQ transmission		4
MIMO N_cqi_typeA/M_cqi ratio		1/1
PCI/CQI reporting Error Rate	%	0
Number of transport blocks		Up to 2
Modulation		Primary Transport Block: 16QAM Secondary Transport Block: QPSK.

**Table 9.22K2: Minimum requirement MIMO mode with four transmit antennas only with dual stream restriction capability, Fixed Reference Channel (FRC) H-Set 9A/9C with downlink physical channel setup in Table C.12F**

Test Number	Propagation Conditions	Reference value	
		$\hat{I}_{or} / I_{oc}$ (dB)	T-put $R$ (kbps) * HS-PDSCH $E_c / I_{or} = -1.9$ dB
1	PA3	12	8000
2	VA3	10	3000
* Notes: 1) For Fixed Reference Channel (FRC) H-Set 9A the reference values for $R$ should be scaled (multiplied by 2). 2) For Fixed Reference Channel (FRC) H-Set 9C the reference values for $R$ should be scaled (multiplied by 4).			

#### 9.2.4C.2 Requirement Fixed Reference Channel (FRC) H-Set 11A/11C

The requirements are specified in terms of a minimum information bit throughput  $R$  for the DL reference channels H-set 11A/11C specified in Annex A.7.1.11, with the addition of the parameters in Table 9.22K3 and the downlink physical channel setup according to Table C.12F. Precoding weight set restriction shall be enabled for the tests with the downlink physical channel setup according to Table C.12F, defined in Table 9.22K4.

The precoding control index signalled on the HS-SCCH and applied on the associated HS-DSCH subframe shall correspond to the preferred precoding control index reported immediately before the start of the HS-SCCH subframe.

Using this configuration, if UE supports enhanced performance requirements type 3, the throughput shall meet or exceed the minimum requirements specified in Table 9.22K4 with the downlink physical channel setup in Table C.12F. The performance requirements specified in Table 9.22K4 are based on chip level equaliser with receiver diversity.



**Table 9.22K3: Test Parameters for Testing MIMO mode with four transmit antennas only with dual stream restriction capability, FRC H-Set 11A/11C**

Parameter	Unit	Test 1
$I_{oc}$	dBm/3.84 MHz	-60
DPCH frame offset ( $\tau_{DPCH,n}$ )	Chip	0
Redundancy and constellation version coding sequence		{0,3,2,1} for 64QAM and 16QAM
Maximum number of HARQ transmission		4
MIMO N_cqi_typeA/M_cqi ratio		1/1
PCI/CQI reporting Error Rate	%	0
Number of transport blocks		Up to 2
Modulation		Primary Transport Block: 64QAM Secondary Transport Block: 16QAM.

**Table 9.22K4: Minimum requirement MIMO mode with four transmit antennas only with dual stream restriction capability, Fixed Reference Channel (FRC) H-Set 11A/11C with downlink physical channel setup in Table C.12F**

Test Number	Propagation Conditions	Reference value	
		$\hat{I}_{or} / I_{oc}$ (dB)	T-put $R$ (kbps) * HS-PDSCH $E_c / I_{or} = -1.9$ dB
1	PA3	18	12500
* Notes: 1) For Fixed Reference Channel (FRC) H-Set 11A the reference values for $R$ should be scaled (multiplied by 2). 2) For Fixed Reference Channel (FRC) H-Set 11C the reference values for $R$ should be scaled (multiplied by 4).			

## 9.2.5 Multiflow HSDPA performance

The Multiflow HSDPA performance in multi-path fading environments is determined by the information bit throughput  $R$ .

### 9.2.5.1 Requirement Fixed Reference Channel (FRC) H-Set 6 16QAM/QPSK

The requirements are specified in terms of a minimum information bit throughput  $R$  for the DL reference channels H-Set 6 16QAM (HS-DSCH serving cell) and QPSK (assisting HS-DSCH serving cell) specified in Annex A.7.1.6, with the addition of the parameters in Table 9.22H5 and the test set-up in Annex C.5.5.

Using this configuration the throughput shall meet or exceed the minimum requirements specified in table 9.22H6.



**Table 9.22H5: Test Parameters for Testing FRC H-Set 6 16QAM and QPSK**

Parameter	Unit	Test 1	Test 2	Test 3	Test 4
Phase reference		P-CPICH			
$I_{oc}$	dBm/3.84 MHz	-60			
Redundancy and constellation version coding sequence		{6,2,1,5} for H-Set 6 16QAM {0,2,5,6} for H-Set 6 QPSK			
Maximum number of HARQ transmission		4			
Note:	The HS-SCCH-1 and HS-PDSCH shall be transmitted continuously with constant power. HS-SCCH-1 shall only use the identity of the UE under test for those TTI intended for the UE.				

**Table 9.22H6: Minimum requirement QPSK, FRC H-Set 6 16QAM and QPSK**

Test Number	Number of additional interfering cell	Propagation Conditions	Reference value		
			HS-PDSCH $E_c/I_{or}$ (dB)	Serving HS-DSCH cell (H-Set 6, 16QAM)	Assisting serving HS-DSCH cell (H-Set 6, QPSK)
				T-put $R$ (kbps)	T-put $R$ (kbps)
				$I_{or,1}/I_{oc,1} = 1.83$ dB	$I_{or,2}/I_{oc,2} = -4.19$ dB
1	0	PA3	-3	1971	1408
2	0	PB3	-3	1706	1155
				$I_{or,1}/I_{oc,1} = 0$ dB	$I_{or,2}/I_{oc,2} = -4.42$ dB
3	1	PA3	-3	1324	1012
4	1	PB3	-3	1059	769
Notes: 1) When the number of configured cells is 3 in Multiflow mode, the serving HS-DSCH cell requirement is applicable to the secondary serving HS-DSCH cell. 2) When the number of configured cells is 4 in Multiflow mode, the serving HS-DSCH cell requirement is applicable to the secondary serving HS-DSCH cell and the assisting serving HS-DSCH cell requirement is applicable to the assisting secondary serving HS-DSCH cell. 3) $I_{oc,1}$ and $I_{oc,2}$ are defined in Annex C.5.5.1					

### 9.3 Reporting of Channel Quality Indicator

The propagation conditions for this subclause are defined in table B.1C for non-MIMO operation under fading conditions, in subclause B.2.6.1 for MIMO operation under single stream conditions, and in subclause B.2.6.2 for MIMO operation under dual stream conditions.

For the cases in this subclause where CQI reporting is evaluated under fading conditions or under MIMO single/dual stream conditions it is expected that the UE will not always detect the HS-SCCH, resulting in a DTX for the uplink ACK/NACK transmission. The downlink configuration for evaluating CQI performance does not use retransmission. Therefore any BLER calculations must exclude any packets where the UE may have attempted to combine data from more than one transmission due to having missed one or more new data indicators or initial transmissions in MIMO operation from lost HS-SCCH transmissions.

For the requirements for UEs supporting HS-DSCH categories 21, 22, 23, 24, 25, 26, 27, 28, 29, 30, 31, 32, 35 and 36, when the carriers are located in the same frequency band or the carriers belong to the same cell group in Multiflow mode, the spacing of the carrier frequencies of the two cells shall be 5 MHz.

For Multiflow HSDPA requirements in subclause 9.2.5, the serving HS-DSCH cell and the assisting serving HS-DSCH cell shall have the same carrier frequency, and the secondary serving HS-DSCH cell and the assisting secondary serving HS-DSCH cell shall have the same carrier frequency.



## 9.3.1 Single Link Performance

### 9.3.1.1 AWGN propagation conditions

The reporting accuracy of channel quality indicator (CQI) under AWGN environments is determined by the reporting variance and the BLER performance using the transport format indicated by the reported CQI median.

#### 9.3.1.1.1 Minimum Requirement – UE HS-DSCH categories 1-20

For the parameters specified in Table 9.23, and using the downlink physical channels specified in table C.8, the reported CQI value shall be in the range of  $\pm 2$  of the reported median more than 90% of the time. If the HS-PDSCH BLER using the transport format indicated by median CQI is less than or equal to 0.1, the BLER using the transport format indicated by the (median CQI +2) shall be greater than 0.1. If the HS-PDSCH BLER using the transport format indicated by the median CQI is greater than 0.1, the BLER using transport format indicated by (median CQI -1) shall be less than or equal to 0.1.

**Table 9.23: Test Parameter for CQI test in AWGN – single link**

Parameter	Unit	Test 1	Test 2	Test 3
$\hat{I}_{or} / I_{oc}$	dB	0	5	10
$I_{oc}$	dBm/3.84 MHz	-60		
Phase reference	-	P-CPICH		
HS-PDSCH $E_c / I_{or}$	dB	-3		
HS-SCCH_1 $E_c / I_{or}$	dB	-10		
DPCH $E_c / I_{or}$	dB	-10		
Maximum number of H-ARQ transmission	-	1		
Number of HS-SCCH set to be monitored	-	1		
CQI feedback cycle	ms	2		
CQI repetition factor	-	1		
HS-SCCH-1 signalling pattern	-	To incorporate inter-TTI=3 the six sub-frame HS-SCCH-1 signalling pattern shall be '...XOOXOO...', where 'X' indicates TTI in which the HS-SCCH-1 uses the identity of the UE under test, and 'O' indicates TTI in which the HS-SCCH-1 uses a different UE identity.		
Note 1: Measurement power offset 'T' is configured by RRC accordingly and as defined in [7].				
Note 2: TF for HS-PDSCH is configured according to the reported CQI statistics. TF based on median CQI, median CQI -1, median CQI+2 are used. Other physical channel parameters are configured according to the CQI mapping table described in TS25.214.				
Note 3: HS-PDSCH $E_c/I_{or}$ is decreased according to reference power adjustment $\Delta$ described in TS 25.214.				
Note 4: For any given transport format the power of the HS-SCCH and HS-PDSCH shall be transmitted continuously with constant power.				
Note 5: UEs from capability categories 13-20 shall be configured in non-64QAM/non-MIMO mode and use appropriate CQI tables according to TS 25.214.				

#### 9.3.1.1.2 Minimum Requirement – UE HS-DSCH categories 13,14,17,18, 19 and 20

For the parameters specified in Table 9.24, and using the downlink physical channels specified in table C.8, the reported CQI value shall be in the range of  $\pm 2$  of the reported median more than 90% of the time. If the HS-PDSCH BLER using the transport format indicated by median CQI is less than or equal to 0.1, the BLER using the transport format indicated by the (median CQI + 2) shall be greater than 0.1. If the HS-PDSCH BLER using the transport format



indicated by the median CQI is greater than 0.1, the BLER using transport format indicated by (median CQI -1) shall be less than or equal to 0.1.

**Table 9.24: Test Parameter for CQI test in AWGN – single link**

Parameter	Unit	Test 1
$\hat{I}_{or} / I_{oc}$	dB	15
$I_{oc}$	dBm/3.84 MHz	-60
Phase reference	-	P-CPICH
HS-PDSCH $E_c / I_{or}$	dB	-2
HS-SCCH_1 $E_c / I_{or}$	dB	-12
DPCH $E_c / I_{or}$	dB	-12
Maximum number of H-ARQ transmission	-	1
Number of HS-SCCH set to be monitored	-	1
CQI feedback cycle	ms	2
CQI repetition factor	-	1
HS-SCCH-1 signalling pattern	-	To incorporate inter-TTI=3 the six sub-frame HS-SCCH-1 signalling pattern shall be '...XOOXOO...', where 'X' indicates TTI in which the HS-SCCH-1 uses the identity of the UE under test, and 'O' indicates TTI in which the HS-SCCH-1 uses a different UE identity.
<p>Note 1: Measurement power offset 'I' is configured by RRC accordingly and as defined in [7].</p> <p>Note 2: TF for HS-PDSCH is configured according to the reported CQI statistics. TF based on median CQI, median CQI -1, median CQI+2 are used. Other physical channel parameters are configured according to the CQI mapping table described in TS25.214.</p> <p>Note 3: HS-PDSCH <math>E_c/I_{or}</math> is decreased according to reference power adjustment <math>\Delta</math> described in TS 25.214.</p> <p>Note 4: For any given transport format the power of the HS-SCCH and HS-PDSCH shall be transmitted continuously with constant power.</p> <p>Note 5: The UE shall be configured in 64QAM/non-MIMO mode and use appropriate CQI tables according to TS 25.214.</p>		

#### 9.3.1.1.3 Additional Requirements – UE HS-DSCH categories 21, 22, 23, 24, 25, 26, 27, 28, 29, 30, 31, 32, 35 and 36

For the parameters specified in Table 9.25, and using the downlink physical channels specified in table C.8, with a serving HS-DSCH cell and secondary serving HS-DSCH cell(s) configured, for each of the serving cells, the reported CQI value for the cell shall be in the range of +/-2 of the cell-specific reported median more than 90% of the time. If the HS-PDSCH BLER, for any of the cells, using the transport format indicated by cell-specific median CQI is less than or equal to 0.1, the BLER for this cell using the transport format indicated by the (cell-specific median CQI +2) shall be greater than 0.1. If the HS-PDSCH BLER, for any of the cells, using the transport format indicated by the cell-specific median CQI is greater than 0.1, the BLER using transport format indicated by (cell-specific median CQI -1) shall be less than or equal to 0.1.



**Table 9.25: Test Parameter for CQI test in AWGN – single link**

Parameter	Unit	Test 1
$\hat{I}_{or1} / I_{oc}$	dB	0
$\hat{I}_{or2} / I_{oc}$	dB	10
$I_{oc}$	dBm/3.84 MHz	-60
Phase reference	-	P-CPICH
HS-PDSCH $E_c / I_{or}$	dB	-3
HS-SCCH_1 $E_c / I_{or}$	dB	-10
DPCH $E_c / I_{or}$	dB	-10
Maximum number of H-ARQ transmission	-	1
Number of HS-SCCH set to be monitored	-	1
CQI feedback cycle	ms	2
CQI repetition factor	-	1
HS-SCCH-1 signalling pattern	-	To incorporate inter-TTI=3 the six sub-frame HS-SCCH-1 signalling pattern shall be '...XOOXOO...', where 'X' indicates TTI in which the HS-SCCH-1 uses the identity of the UE under test, and 'O' indicates TTI in which the HS-SCCH-1 uses a different UE identity.
<p>Note 1: Measurement power offset 'I' is configured by RRC accordingly and as defined in [7].</p> <p>Note 2: TF for HS-PDSCH is configured according to the reported CQI statistics. TF based on median CQI, median CQI -1, median CQI+2 are used. Other physical channel parameters are configured according to the CQI mapping table described in TS25.214.</p> <p>Note 3: HS-PDSCH <math>E_c/I_{or}</math> is decreased according to reference power adjustment <math>\Delta</math> described in TS 25.214.</p> <p>Note 4: For any given transport format the power of the HS-SCCH and HS-PDSCH shall be transmitted continuously with constant power.</p> <p>Note 5: The UE shall be configured in non 64QAM/MIMO mode and use appropriate CQI tables according to TS 25.214.</p>		

### 9.3.1.2 Fading propagation conditions

The reporting accuracy of the channel quality indicator (CQI) under fading environments is determined by the BLER performance using the transport format indicated by the reported CQI median.

The specified requirements may be subject to further simulations to verify assumptions.

#### 9.3.1.2.1 Minimum Requirement – UE HS-DSCH categories 1-20

For the parameters specified in Table 9.26, and using the downlink physical channels specified in table C.8, the requirements are specified in terms of maximum BLERs at particular reported CQIs when transmitting a fixed transport format given by the CQI median as shown in Table 9.27. The BLER at a particular reported CQI is obtained by associating a particular CQI reference measurement period with the HS-PDSCH subframe overlapping with the end of this CQI reference measurement period and calculating the fraction of erroneous HS-PDSCH subframes.



**Table 9.26: Test Parameters for CQI test in fading – single link**

Parameter	Unit	Test 1	Test 2
HS-PDSCH $E_c / I_{or}$	dB	-8	-4
$\hat{I}_{or} / I_{oc}$	dB	0	5
$I_{oc}$	dBm/3.84 MHz	-60	
Phase reference	-	P-CPICH	
HS-SCCH_1 $E_c / I_{or}$	dB	-8.5	
DPCH $E_c / I_{or}$	dB	-6	
Maximum number of H-ARQ transmission	-	1	
Number of HS-SCCH set to be monitored	-	1	
CQI feedback cycle	ms	2	
CQI repetition factor	-	1	
HS-SCCH-1 signalling pattern	-	To incorporate inter-TTI=3 the six sub-frame HS-SCCH-1 signalling pattern shall be '...XOOXOO...', where 'X' indicates TTI in which the HS-SCCH-1 uses the identity of the UE under test, and 'O' indicates TTI in which the HS-SCCH-1 uses a different UE identity.	
Propagation Channel		Case 8	
Note 1:	Measurement power offset 'T' is configured by RRC accordingly and as defined in [7] .		
Note 2:	TF for HS-PDSCH is configured according to the reported CQI statistics. TF based on median CQI is used. Other physical channel parameters are configured according to the CQI mapping table described in TS25.214.		
Note 3:	HS-PDSCH $E_c/I_{or}$ is decreased according to reference power adjustment $\Delta$ described in TS 25.214.		
Note 4:	For any given transport format the power of the HS-SCCH and HS-PDSCH shall be transmitted continuously with constant power.		
Note 5:	The UE shall be configured in non-64QAM/non-MIMO mode and use appropriate CQI tables according to TS 25.214.		

**Table 9.27: Minimum requirement for CQI test in fading – single link**

Reported CQI	Maximum BLER	
	Test 1	Test2
CQI median	60%	60%
CQI median + 3	15%	15%

#### 9.3.1.2.2 Minimum Requirement – UE HS-DSCH categories 13,14,17,18, 19 and 20

For the parameters specified in Table 9.27A, and using the downlink physical channels specified in table C.8, the requirements are specified in terms of maximum BLERs at particular reported CQIs when transmitting a fixed transport format given by the CQI median as shown in Table 9.27B. The BLER at a particular reported CQI is obtained by associating a particular CQI reference measurement period with the HS-PDSCH subframe overlapping with the end of this CQI reference measurement period and calculating the fraction of erroneous HS-PDSCH subframes.



**Table 9.27A: Test Parameters for CQI test in fading – single link**

Parameter	Unit	Test 1
HS-PDSCH $E_c/I_{or}$	dB	-2
$\hat{I}_{or}/I_{oc}$	dB	15
$I_{oc}$	dBm/3.84 MHz	-60
Phase reference	-	P-CPICH
HS-SCCH_1 $E_c/I_{or}$	dB	-12
DPCH $E_c/I_{or}$	dB	-12
Maximum number of H-ARQ transmission	-	1
Number of HS-SCCH set to be monitored	-	1
CQI feedback cycle	ms	2
CQI repetition factor	-	1
HS-SCCH-1 signalling pattern	-	To incorporate inter-TTI=3 the six sub-frame HS-SCCH-1 signalling pattern shall be '...XOOXOO...', where 'X' indicates TTI in which the HS-SCCH-1 uses the identity of the UE under test, and 'O' indicates TTI in which the HS-SCCH-1 uses a different UE identity.
Propagation Channel		Case 8
Note 1: Measurement power offset 'I' is configured by RRC accordingly and as defined in [7]. Note 2: TF for HS-PDSCH is configured according to the reported CQI statistics. TF based on median CQI is used. Other physical channel parameters are configured according to the CQI mapping table described in TS25.214. Note 3: HS-PDSCH $E_c/I_{or}$ is decreased according to reference power adjustment $\Delta$ described in TS 25.214. Note 4: For any given transport format the power of the HS-SCCH and HS-PDSCH shall be transmitted continuously with constant power. Note 5: The UE shall be configured in 64QAM/non-MIMO mode and use appropriate CQI tables according to TS 25.214.		

**Table 9.27B: Minimum requirement for CQI test in fading - single link**

Reported CQI	Maximum BLER
	Test 1
CQI median	60%
CQI median + 3	15%

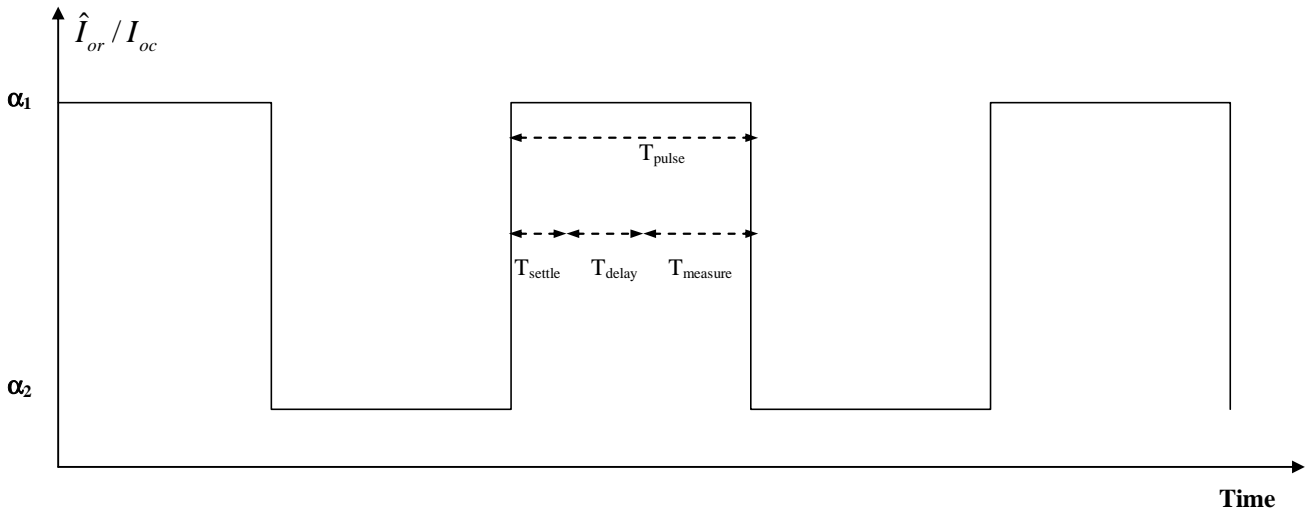
### 9.3.1.2.3 Additional Requirements – UE HS-DSCH categories 21, 22, 23, 24, 25, 26, 27, 28, 29, 30, 31, 32, 35 and 36

For the parameters specified in Table 9.26, and using the downlink physical channels specified in table C.8, with a serving HS-DSCH cell and secondary serving HS-DSCH cell(s) configured, for each of the serving cells, the requirements are specified in terms of maximum BLERs at particular reported CQIs for each serving cell when transmitting with a cell-specific fixed transport format given by the cell-specific CQI median as shown in Table 9.27. The BLER at a particular reported CQI for a specific serving cell is obtained by associating a particular CQI reference measurement period with the HS-PDSCH subframe transmitted from this serving cell overlapping with the end of this CQI reference measurement period and calculating the fraction of erroneous HS-PDSCH subframes.



### 9.3.1.3 Periodically varying radio conditions.

The reporting accuracy of the channel quality indicator (CQI) when subject to AWGN propagation conditions with periodically varying  $\hat{I}_{or}/I_{oc}$ , is determined by the reporting variance as measured during selected parts of a predetermined  $\hat{I}_{or}/I_{oc}$  pattern, as depicted in Figure 9.1.



**Figure 9.1 Test scenario for CQI reporting test under varying interference conditions.**  $\hat{I}_{or}/I_{oc}$  is varied between  $\alpha_1$  and  $\alpha_2$  according to a predetermined square wave pattern.

#### 9.3.1.3.1 Minimum Requirement – UE HS-DSCH categories 1-20

For the parameters specified in Table 9.27C, and using the downlink physical channels specified in table C.8, let  $M_1$  be defined as the median CQI that the UE reports in static propagation conditions, with  $I_{or}/I_{oc}$  set to  $\alpha_1$ , and  $M_2$  be the median CQI that the UE reports in static propagation conditions, with  $\hat{I}_{or}/I_{oc}$  set to  $\alpha_2$ . The minimum difference between  $M_1$  and  $M_2$  is required to be larger than 6.

For the parameters specified in Table 9.27C, and using the downlink physical channels specified in table C.8, 90% of the reported CQI values, during  $T_{measure}$  as depicted in Figure 9.1, shall be in the range of  $\pm 3$  of  $M_1$ , for the cases when  $T_{measure}$  occurs during time-periods where  $\hat{I}_{or}/I_{oc}$  is set to  $\alpha_1$ , and in the range of  $\pm 3$  of  $M_2$ , for the cases when  $T_{measure}$  occurs during time-periods where  $\hat{I}_{or}/I_{oc}$  is set to  $\alpha_2$ .

The measurement equipment is allowed to start the ramping of  $\hat{I}_{or}/I_{oc}$  13 slots before the start of the HS-DPCCH slot that contains the first CQI report in  $T_{measure}$ .

The measurement equipment shall have settled  $\hat{I}_{or}/I_{oc}$  to its nominal value 10 slots before the start of the HS-DPCCH slot that contains the first CQI report in  $T_{measure}$ .

An illustration of these timing relations is provided in Figure 9.2.



Table 9.27C: Test Parameter for CQI test in periodically varying radio conditions – single link

Parameter	Unit	Test 1
$\alpha_1$	dB	10
$\alpha_2$	dB	0
$I_{oc1}$	dBm/3.84 MHz	-60
$I_{oc2}$	dBm/3.84 MHz	-50
Phase reference	-	P-CPICH
$T_{measure}$	TTI	8
$T_{delay}$	TTI	3
$T_{settle}$	TTI	1
$T_{pulse}$	TTI	12
HS-PDSCH $E_c/I_{or}$	dB	-2
HS-SCCH_1 $E_c/I_{or}$	dB	-10
DPCH $E_c/I_{or}$	dB	-10
Maximum number of H-ARQ transmission	-	1
Number of HS-SCCH set to be monitored	-	1
CQI feedback cycle	ms	2
CQI repetition factor	-	1
HS-SCCH-1 signalling pattern	-	To incorporate inter-TTI=3 the six sub-frame HS-SCCH-1 signalling pattern shall be '...XOOXOO...', where 'X' indicates TTI in which the HS-SCCH-1 uses the identity of the UE under test, and 'O' indicates TTI in which the HS-SCCH-1 uses a different UE identity.
Note 1: Measurement power offset 'T' is configured by RRC accordingly and as defined in [7]. Note 2: The UE shall be configured in non-64QAM/non-MIMO mode and use appropriate CQI tables according to TS 25.214.		

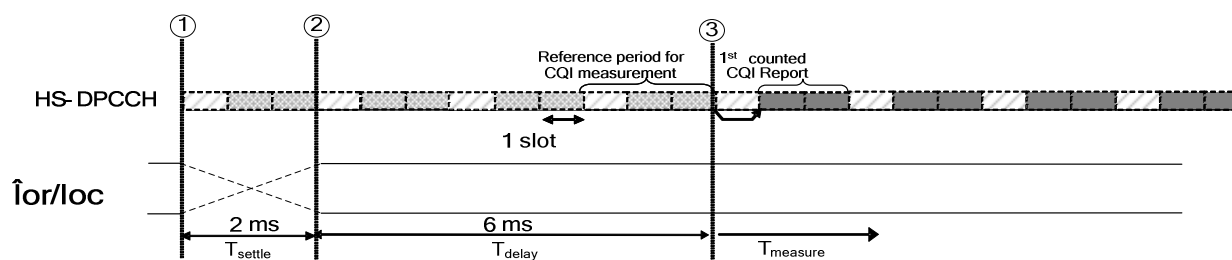


Figure 9.2 Timing relation between HS-DPCCH, DPCCH/DPDCH and  $\hat{I}_{or}/I_{oc}$  ramping. The measurement equipment starts ramping the  $\hat{I}_{or}/I_{oc}$  at point 1. The  $\hat{I}_{or}/I_{oc}$  should be settled to its nominal value at point 2. The first CQI report that is counted in the statistics of the requirement is transmitted in the uplink at point 3.



## 9.3.2 Open Loop Diversity Performance

### 9.3.2.1 AWGN propagation conditions

The reporting accuracy of channel quality indicator (CQI) under AWGN environments is determined by the reporting variance and the BLER performance using the transport format indicated by the reported CQI median.

#### 9.3.2.1.1 Minimum Requirement – UE HS-DSCH categories 1-20

For the parameters specified in Table 9.32, and using the downlink physical channels specified in table C.9, the reported CQI value shall be in the range of  $\pm 2$  of the reported median more than 90% of the time. If the HS-PDSCH (BLER) using the transport format indicated by median CQI is less than or equal to 0.1, the BLER using the transport format indicated by the (median CQI +2) shall be greater than 0.1. If the HS-PDSCH (BLER) using the transport format indicated by the median CQI is greater than 0.1, the BLER using transport format indicated by (median CQI -1) shall be less than or equal to 0.1.

**Table 9.32: Test Parameter for CQI test in AWGN – open loop diversity**

Parameter	Unit	Test 1	Test 2	Test 3
$\hat{I}_{or} / I_{oc}$	dB	0	5	10
$I_{oc}$	dBm/3.84 MHz	-60		
Phase reference	-	P-CPICH		
HS-PDSCH $E_c / I_{or}$	dB	-3		
HS-SCCH _1 $E_c / I_{or}$	dB	-10		
DPCH $E_c / I_{or}$	dB	-10		
Maximum number of H-ARQ transmission	-	1		
Number of HS-SCCH set to be monitored	-	1		
CQI feedback cycle	ms	2		
CQI repetition factor	-	1		
HS-SCCH-1 signalling pattern	-	To incorporate inter-TTI=3 the six sub-frame HS-SCCH-1 signalling pattern shall be '...XOOXOO...', where 'X' indicates TTI in which the HS-SCCH-1 uses the identity of the UE under test, and 'O' indicates TTI in which the HS-SCCH-1 uses a different UE identity.		
Note 1: Measurement power offset 'T' is configured by RRC accordingly and as defined in [7].				
Note 2: TF for HS-PDSCH is configured according to the reported CQI statistics. TF based on median CQI, median CQI -1, median CQI+2 are used. Other physical channel parameters are configured according to the CQI mapping table described in TS25.214.				
Note 3: HS-PDSCH $E_c/I_{or}$ is decreased according to reference power adjustment $\Delta$ described in TS 25.214.				
Note 4: For any given transport format the power of the HS-SCCH and HS-PDSCH shall be transmitted continuously with constant power.				
Note 5: The UE shall be configured in non-64QAM/non-MIMO mode and use appropriate CQI tables according to TS 25.214.				

#### 9.3.2.1.2 Additional Requirements – UE HS-DSCH categories 21, 22, 23, 24, 25, 26, 27, 28, 29, 30, 31, 32, 35 and 36

For the parameters specified in Table 9.33, and using the downlink physical channels specified in table C.9, with a serving HS-DSCH cell and secondary serving HS-DSCH cell(s) configured, for each of the serving cells, the reported CQI value for the cell shall be in the range of  $\pm 2$  of the cell-specific reported median more than 90% of the time. If the



HS-PDSCH BLER, for any of the cells, using the transport format indicated by cell-specific median CQI is less than or equal to 0.1, the BLER for this cell using the transport format indicated by the (cell-specific median CQI +2) shall be greater than 0.1. If the HS-PDSCH BLER, for any of the cells, using the transport format indicated by the cell-specific median CQI is greater than 0.1, the BLER using transport format indicated by (cell-specific median CQI -1) shall be less than or equal to 0.1.

**Table 9.33: Test Parameter for CQI test in AWGN – open loop diversity**

Parameter	Unit	Test 1
$\hat{I}_{or1} / I_{oc}$	dB	0
$\hat{I}_{or2} / I_{oc}$	dB	10
$I_{oc}$	dBm/3.84 MHz	-60
Phase reference	-	P-CPICH
HS-PDSCH $E_c / I_{or}$	dB	-3
HS-SCCH_1 $E_c / I_{or}$	dB	-10
DPCH $E_c / I_{or}$	dB	-10
Maximum number of H-ARQ transmission	-	1
Number of HS-SCCH set to be monitored	-	1
CQI feedback cycle	ms	2
CQI repetition factor	-	1
HS-SCCH-1 signalling pattern	-	To incorporate inter-TTI=3 the six sub-frame HS-SCCH-1 signalling pattern shall be '...XOOXOO...', where 'X' indicates TTI in which the HS-SCCH-1 uses the identity of the UE under test, and 'O' indicates TTI in which the HS-SCCH-1 uses a different UE identity.
<p>Note 1: Measurement power offset 'I' is configured by RRC accordingly and as defined in [7].</p> <p>Note 2: TF for HS-PDSCH is configured according to the reported CQI statistics. TF based on median CQI, median CQI -1, median CQI+2 are used. Other physical channel parameters are configured according to the CQI mapping table described in TS25.214.</p> <p>Note 3: HS-PDSCH <math>E_c/I_{or}</math> is decreased according to reference power adjustment <math>\Delta</math> described in TS 25.214.</p> <p>Note 4: For any given transport format the power of the HS-SCCH and HS-PDSCH shall be transmitted continuously with constant power.</p> <p>Note 5: The UE shall be configured in non-64QAM/non-MIMO mode and use appropriate CQI tables according to TS 25.214.</p>		

### 9.3.2.2 Fading propagation conditions

The reporting accuracy of the channel quality indicator (CQI) under fading environments is determined by the BLER performance using the transport format indicated by the reported CQI median.

The specified requirements may be subject to further simulations to verify assumptions.

#### 9.3.2.2.1 Minimum Requirement – UE HS-DSCH categories 1-20

For the parameters specified in Table 9.35, and using the downlink physical channels specified in table C.9, the requirements are specified in terms of maximum BLERs at particular reported CQIs when transmitting a fixed transport format given by the CQI median as shown in Table 9.36. The BLER at a particular reported CQI is obtained by associating a particular CQI reference measurement period with the HS-PDSCH subframe overlapping with the end of this CQI reference measurement period and calculating the fraction of erroneous HS-PDSCH subframes.



**Table 9.35: Test Parameters for CQI test in fading – open loop diversity**

Parameter	Unit	Test 1	Test 2
HS-PDSCH $E_c / I_{or}$	dB	-8	-4
$\hat{I}_{or} / I_{oc}$	dB	0	5
$I_{oc}$	dBm/3.84 MHz	-60	
Phase reference	-	P-CPICH	
HS-SCCH_1 $E_c / I_{or}$	dB	-8.5	
DPCH $E_c / I_{or}$	dB	-6	
Maximum number of H-ARQ transmission	-	1	
Number of HS-SCCH set to be monitored	-	1	
CQI feedback cycle	ms	2	
CQI repetition factor	-	1	
HS-SCCH-1 signalling pattern	-	To incorporate inter-TTI=3 the six sub-frame HS-SCCH-1 signalling pattern shall be '...XOOXOO...', where 'X' indicates TTI in which the HS-SCCH-1 uses the identity of the UE under test, and 'O' indicates TTI in which the HS-SCCH-1 uses a different UE identity.	
Propagation Channel		Case 8	
Note 1:	Measurement power offset 'T' is configured by RRC accordingly and as defined in [7].		
Note 2:	TF for HS-PDSCH is configured according to the reported CQI statistics. TF based on median CQI is used. Other physical channel parameters are configured according to the CQI mapping table described in TS25.214.		
Note 3:	HS-PDSCH $E_c/I_{or}$ is decreased according to reference power adjustment $\Delta$ described in TS 25.214.		
Note 4:	For any given transport format the power of the HS-SCCH and HS-PDSCH shall be transmitted continuously with constant power.		
Note 5:	The UE shall be configured in non-64QAM/non-MIMO mode and use appropriate CQI tables according to TS 25.214.		

**Table 9.36: Minimum requirement for CQI test in fading – open loop diversity**

Reported CQI	Maximum BLER	
	Test 1	Test2
CQI median	60%	60%
CQI median + 3	15%	15%

#### 9.3.2.2.2 Additional Requirements – UE HS-DSCH categories 21, 22, 23, 24, 25, 26, 27, 28, 29, 30, 31, 32, 35 and 36

For the parameters specified in Table 9.35 and using the downlink physical channels specified in table C.9, with a serving HS-DSCH cell and secondary serving HS-DSCH cell(s) configured, for each of the serving cells, the requirements are specified in terms of maximum BLERs at particular reported CQIs for each serving cell when transmitting with a cell-specific fixed transport format given by the cell-specific CQI median as shown in Table 9.36. The BLER at a particular reported CQI for a specific serving cell is obtained by associating a particular CQI reference measurement period with the HS-PDSCH subframe transmitted from this serving cell overlapping with the end of this CQI reference measurement period and calculating the fraction of erroneous HS-PDSCH subframes.

#### 9.3.2.3 Periodically varying radio conditions.

The reporting accuracy of the channel quality indicator (CQI) when subject to AWGN propagation conditions with periodically varying  $\hat{I}_{or} / I_{oc}$ , is determined by the reporting variance as measured during selected parts of a predetermined  $\hat{I}_{or} / I_{oc}$  pattern, as depicted in Figure 9.1.



#### 9.3.2.3.1 Minimum Requirement – UE HS-DSCH categories 1-20

For the parameters specified in Table 9.37, and using the downlink physical channels specified in table C.9, let  $M_1$  be defined as the median CQI that the UE reports in static propagation conditions, with  $I_{or}/I_{oc}$  set to  $\alpha_1$ , and  $M_2$  be the median CQI that the UE reports in static propagation conditions, with  $\hat{I}_{or}/I_{oc}$  set to  $\alpha_2$ . The minimum difference between  $M_1$  and  $M_2$  is required to be larger than 6.

For the parameters specified in Table 9.37, and using the downlink physical channels specified in table C.9, 90% of the reported CQI values, during  $T_{\text{measure}}$  as depicted in Figure 9.1, shall be in the range of  $\pm 3$  of  $M_1$ , for the cases when  $T_{\text{measure}}$  occurs during time-periods where  $\hat{I}_{or}/I_{oc}$  is set to  $\alpha_1$ , and in the range of  $\pm 3$  of  $M_2$ , for the cases when  $T_{\text{measure}}$  occurs during time-periods where  $\hat{I}_{or}/I_{oc}$  is set to  $\alpha_2$ .

The measurement equipment is allowed to start the ramping of  $\hat{I}_{or}/I_{oc}$  13 slots before the start of the HS-DPCCH slot that contains the first CQI report in  $T_{\text{measure}}$ .

The measurement equipment shall have settled  $\hat{I}_{or}/I_{oc}$  to its nominal value 10 slots before the start of the HS-DPCCH slot that contains the first CQI report in  $T_{\text{measure}}$ .

An illustration of these timing relations is provided in Figure 9.2.



**Table 9.37: Test Parameter for CQI test in periodically varying radio conditions – open loop diversity**

Parameter	Unit	Test 1
$\alpha_1$	dB	10
$\alpha_2$	dB	0
$I_{oc1}$	dBm/3.84 MHz	-60
$I_{oc2}$	dBm/3.84 MHz	-50
Phase reference	-	P-CPICH
$T_{measure}$	TTI	8
$T_{delay}$	TTI	3
$T_{settle}$	TTI	1
$T_{pulse}$	TTI	12
HS-PDSCH $E_c / I_{or}$	dB	-2
HS-SCCH_1 $E_c / I_{or}$	dB	-10
DPCH $E_c / I_{or}$	dB	-10
Maximum number of H-ARQ transmission	-	1
Number of HS-SCCH set to be monitored	-	1
CQI feedback cycle	ms	2
CQI repetition factor	-	1
HS-SCCH-1 signalling pattern	-	To incorporate inter-TTI=3 the six sub-frame HS-SCCH-1 signalling pattern shall be '...XOOXOO...', where 'X' indicates TTI in which the HS-SCCH-1 uses the identity of the UE under test, and 'O' indicates TTI in which the HS-SCCH-1 uses a different UE identity.
Note 1: Measurement power offset 'T' is configured by RRC accordingly and as defined in [7].		
Note 2: The UE shall be configured in non 64QAM/non-MIMO mode and use appropriate CQI tables according to TS 25.214.		

### 9.3.3 Closed Loop Diversity Performance

#### 9.3.3.1 AWGN propagation conditions

The reporting accuracy of channel quality indicator (CQI) under AWGN environments is determined by the reporting variance and the BLER performance using the transport format indicated by the reported CQI median.

##### 9.3.3.1.1 Minimum Requirement – UE HS-DSCH categories 1-20

For the parameters specified in Table 9.41, and using the downlink physical channels specified in table C.10, the reported CQI value shall be in the range of  $\pm 2$  of the reported median more than 90% of the time. If the HS-PDSCH (BLER) using the transport format indicated by median CQI is less than or equal to 0.1, the BLER using the transport format indicated by the (median CQI +2) shall be greater than 0.1. If the HS-PDSCH (BLER) using transport format indicated by the median CQI is greater than 0.1, the BLER using the transport format indicated by (median CQI -1) shall be less than or equal to 0.1.



**Table 9.41: Test Parameters for CQI in AWGN – closed loop diversity**

Parameter	Unit	Test 1	Test 2	Test 3
$\hat{I}_{or} / I_{oc}$	dB	0	5	10
$I_{oc}$	dBm/3.84 MHz	-60		
Phase reference	-	P-CPICH		
HS-PDSCH $E_c / I_{or}$	dB	-3		
HS-SCCH _1 $E_c / I_{or}$	dB	-10		
DPCH $E_c / I_{or}$	dB	-10		
Maximum number of H-ARQ transmission	-	1		
Number of HS-SCCH set to be monitored	-	1		
CQI feedback cycle	ms	2		
CQI repetition factor	-	1		
Feedback Error Rate	%	0		
Closed loop timing adjustment mode		1		
HS-SCCH-1 signalling pattern	-	To incorporate inter-TTI=3 the six sub-frame HS-SCCH-1 signalling pattern shall be '...XOOXOO...', where 'X' indicates TTI in which the HS-SCCH-1 uses the identity of the UE under test, and 'O' indicates TTI in which the HS-SCCH-1 uses a different UE identity.		
Note 1:	Measurement power offset 'T' is configured by RRC accordingly and as defined in [7].			
Note 2:	TF for HS-PDSCH is configured according to the reported CQI statistics. TF based on median CQI, median CQI -1, median CQI+2 are used. Other physical channel parameters are configured according to the CQI mapping table described in TS25.214.			
Note 3:	HS-PDSCH $E_c/I_{or}$ is decreased according to reference power adjustment $\Delta$ described in TS 25.214.			
Note 4:	For any given transport format the power of the HS-SCCH and HS-PDSCH shall be transmitted continuously with constant power.			
Note 5:	The UE shall be configured in non.64QAM/non-MIMO mode and use appropriate CQI tables according to TS 25.214.			

### 9.3.3.2 Fading propagation conditions

The reporting accuracy of the channel quality indicator (CQI) under fading environments is determined by the BLER performance using the transport format indicated by the reported CQI median.

The specified requirements may be subject to further simulations to verify assumptions.

#### 9.3.3.2.1 Minimum Requirement – UE HS-DSCH categories 1-20

For the parameters specified in Table 9.44, and using the downlink physical channels specified in table C.10, the requirements are specified in terms of maximum BLERs at particular reported CQIs when transmitting a fixed transport format given by the CQI median as shown in Table 9.45. The BLER at a particular reported CQI is obtained by associating a particular CQI reference measurement period with the HS-PDSCH subframe overlapping with the end of this CQI reference measurement period and calculating the fraction of erroneous HS-PDSCH subframes.



**Table 9.44: Test Parameters for CQI test in fading- closed loop diversity**

Parameter	Unit	Test 1	Test 2
HS-PDSCH $E_c / I_{or}$	dB	-8	-4
$\hat{I}_{or} / I_{oc}$	dB	0	5
$I_{oc}$	dBm/3.84 MHz	-60	
Phase reference	-	P-CPICH	
HS-SCCH_1 $E_c / I_{or}$	dB	-8.5	
DPCH $E_c / I_{or}$	dB	-6	
Maximum number of H-ARQ transmission	-	1	
Number of HS-SCCH set to be monitored	-	1	
CQI feedback cycle	ms	2	
CQI repetition factor	-	1	
Feedback Error Rate	%	0	
Closed loop timing adjustment mode		1	
HS-SCCH-1 signalling pattern	-	To incorporate inter-TTI=3 the six sub-frame HS-SCCH-1 signalling pattern shall be '...XOOXOO...', where 'X' indicates TTI in which the HS-SCCH-1 uses the identity of the UE under test, and 'O' indicates TTI in which the HS-SCCH-1 uses a different UE identity.	
Propagation Channel		Case 8	
Note 1:	Measurement power offset 'I' is configured by RRC accordingly and as defined in [7].		
Note 2:	TF for HS-PDSCH is configured according to the reported CQI statistics. TF based on median CQI is used. Other physical channel parameters are configured according to the CQI mapping table described in TS25.214.		
Note 3:	HS-PDSCH $E_c/I_{or}$ is decreased according to reference power adjustment $\Delta$ described in TS 25.214.		
Note 4:	For any given transport format the power of the HS-SCCH and HS-PDSCH shall be transmitted continuously with constant power.		
Note 5:	The UE shall be configured in non-64QAM/non-MIMO mode and use appropriate CQI tables according to TS 25.214.		

**Table 9.45: Minimum requirement for CQI test in fading – closed loop diversity**

Reported CQI	Maximum BLER	
	Test 1	Test2
CQI median	60%	60%
CQI median + 3	15%	15%

### 9.3.3.3 Periodically varying radio conditions.

The reporting accuracy of the channel quality indicator (CQI) when subject to AWGN propagation conditions with periodically varying  $\hat{I}_{or}/I_{oc}$ , is determined by the reporting variance as measured during selected parts of a predetermined  $\hat{I}_{or}/I_{oc}$  pattern, as depicted in Figure 9.1.

#### 9.3.3.3.1 Minimum Requirement – UE HS-DSCH categories 1-20

For the parameters specified in Table 9.45A, and using the downlink physical channels specified in table C.10, let  $M_1$  be defined as the median CQI that the UE reports in static propagation conditions, with  $I_{or}/I_{oc}$  set to  $\alpha_1$ , and  $M_2$  be the median CQI that the UE reports in static propagation conditions, with  $\hat{I}_{or}/I_{oc}$  set to  $\alpha_2$ . The minimum difference between  $M_1$  and  $M_2$  is required to be larger than 6.



For the parameters specified in Table 9.45A, and using the downlink physical channels specified in table C.10, 90% of the reported CQI values, during  $T_{\text{measure}}$  as depicted in Figure 9.1, shall be in the range of  $\pm 3$  of  $M1$ , for the cases when  $T_{\text{measure}}$  occurs during time-periods where  $\hat{I}_{or}/I_{oc}$  is set to  $\alpha_1$ , and in the range of  $\pm 3$  of  $M2$ , for the cases when  $T_{\text{measure}}$  occurs during time-periods where  $\hat{I}_{or}/I_{oc}$  is set to  $\alpha_2$ .

The measurement equipment is allowed to start the ramping of  $\hat{I}_{or}/I_{oc}$  13 slots before the start of the HS-DPCCH slot that contains the first CQI report in  $T_{\text{measure}}$ .

The measurement equipment shall have settled  $\hat{I}_{or}/I_{oc}$  to its nominal value 10 slots before the start of the HS-DPCCH slot that contains the first CQI report in  $T_{\text{measure}}$ .

An illustration of these timing relations is provided in Figure 9.2.

**Table 9.45A: Test Parameter for CQI test in periodically varying radio conditions – closed loop diversity**

Parameter	Unit	Test 1
$\alpha_1$	dB	10
$\alpha_2$	dB	0
$I_{oc1}$	dBm/3.84 MHz	-60
$I_{oc2}$	dBm/3.84 MHz	-50
Phase reference	-	P-CPICH
$T_{\text{measure}}$	TTI	8
$T_{\text{delay}}$	TTI	3
$T_{\text{settle}}$	TTI	1
$T_{\text{pulse}}$	TTI	12
HS-PDSCH $E_c/I_{or}$	dB	-2
HS-SCCH_1 $E_c/I_{or}$	dB	-10
DPCH $E_c/I_{or}$	dB	-10
Maximum number of H-ARQ transmission	-	1
Number of HS-SCCH set to be monitored	-	1
CQI feedback cycle	ms	2
CQI repetition factor	-	1
HS-SCCH-1 signalling pattern	-	To incorporate inter-TTI=3 the six sub-frame HS-SCCH-1 signalling pattern shall be '...XOOXOO...', where 'X' indicates TTI in which the HS-SCCH-1 uses the identity of the UE under test, and 'O' indicates TTI in which the HS-SCCH-1 uses a different UE identity.
Note 1: Measurement power offset 'I' is configured by RRC accordingly and as defined in [7].		
Note 2: The UE shall be configured in non-64QAM/non-MIMO mode and use appropriate CQI tables according to TS 25.214.		



## 9.3.4 MIMO Performance

### 9.3.4.1 MIMO Single Stream Fading Conditions

The minimum performance requirements of channel quality indicator (CQI) reporting under MIMO single stream conditions are defined based on a CQI Type A versus Type B reporting ratio of 1 / 2, i.e. the parameters  $N_{\text{cqi\_typeA}}$  and  $M_{\text{cqi}}$  (see [8]) are assumed to be set to 1 and 2, respectively. The propagation conditions assumed for minimum performance requirements of CQI reporting under MIMO single stream conditions are defined in subclause B.2.6.1. The precoding used at the transmitter is one randomly picked but fixed precoding vector for single transport block transmission out of the set of possible precoding vectors as defined in [8]. The same precoding vector shall be used to generate the resulting channel coefficients as described for MIMO single stream conditions in subclause B.2.6.1.

The reporting accuracy of CQI under MIMO single stream conditions is determined by the BLER performance when transmitting with a transport format indicated by the reported CQI median determined over all single transport block Type A CQI reports and all Type B CQI reports that were reported together with PCI reports matching the precoding vector embedded in the propagation channel as defined in subclause B.2.6.1.

#### 9.3.4.1.1 Minimum Requirement - UE HS-DSCH categories 15-20

For the parameters specified in Table 9.46, and using the downlink physical channels specified in Table C.9 and Table C.12D, the requirements are specified in terms of maximum BLERs at particular reported CQIs when transmitting a fixed transport format given by the CQI median as shown in Table 9.47. The CQI median shall be determined over all single transport block Type A CQI reports and all Type B CQI reports that were reported together with PCI reports matching the precoding vector embedded in the propagation channel as defined in subclause B.2.6.1. The BLER at a particular reported CQI is obtained by associating a particular CQI reference measurement period for all single transport block Type A CQI reports and all Type B CQI reports that were reported together with PCI reports matching the precoding vector embedded in the propagation channel as defined in subclause B.2.6.1 with the HS-PDSCH subframe overlapping with the end of this CQI reference measurement period and calculating the fraction of erroneous HS-PDSCH subframes to which the same CQI value was associated.



**Table 9.46: Test Parameters for CQI test in MIMO single stream fading conditions**

Parameter	Unit	Test 1	Test 2
HS-PDSCH $E_c / I_{or}$	dB	-2	-2.23 dB
$\hat{I}_{or} / I_{oc}$	dB	6	
$I_{OC}$	dBm/3.84 MHz	-60	
Phase reference	-	P-CPICH (Table C.9)	P-CPICH/S-CPICH (Table C.12D)
HS-SCCH_1 $E_c / I_{or}$	dB	-15 (using STTD)	-15 (without STTD)
DPCH $E_c / I_{or}$	dB	-10 (using STTD)	-10 (without STTD)
Precoding weight set restriction	-	Disabled	Enabled
Maximum number of H-ARQ transmission	-	1	
Number of HS-SCCH set to be monitored	-	1	
CQI feedback cycle	ms	2	
CQI repetition factor	-	1	
PCI/CQI reporting Error Rate	%	0	
HS-SCCH-1 signalling pattern	-	To incorporate inter-TTI=3 the six sub-frame HS-SCCH-1 signalling pattern shall be '...XOOXOO...', where 'X' indicates TTI in which the HS-SCCH-1 uses the identity of the UE under test, and 'O' indicates TTI in which the HS-SCCH-1 uses a different UE identity.	
Propagation Channel		MIMO single stream fading conditions	
Note 1:	Measurement power offset 'I' is configured by RRC accordingly and as defined in [7].		
Note 2:	TF for HS-PDSCH is configured according to the reported CQI statistics. TF based on median CQI over all single transport block Type A CQI reports and all Type B CQI reports that were reported together with PCI reports matching the precoding vector embedded in the propagation channel as defined in subclause B.2.6.1 is used. Other physical channel parameters are configured according to the CQI mapping table described in TS25.214. The precoding that shall be used in the transmitter is one randomly picked but fixed precoding vector for single transport block transmission out of the set of possible precoding vectors as defined in [8]. The same precoding vector shall be used to generate the resulting channel coefficients as described for MIMO single stream conditions in subclause B.2.6.1.		
Note 3:	HS-PDSCH $E_c/I_{or}$ is decreased according to reference power adjustment $\Delta$ described in TS 25.214.		
Note 4:	For any given transport format the power of the HS-SCCH and HS-PDSCH shall be transmitted continuously with constant power.		
Note 5:	The UE shall be configured in non-64QAM/MIMO mode and use appropriate CQI tables according to TS 25.214.		

**Table 9.47: Minimum requirement for CQI test in MIMO single stream conditions**

Reported CQI	Maximum BLER	
	Test 1	Test 2
CQI median	60%	60%
CQI median + 3	15%	15%

#### 9.3.4.1.2 Additional Requirement – UE HS-DSCH categories 25-28, 30, 32 and 36

With a serving HS-DSCH cell and secondary serving HS-DSCH cell(s) configured, using the parameters specified in Table 9.47A, and using the downlink physical channels specified in Table C.9 and Table C.12D, the requirements are specified in terms of maximum BLERs at particular reported CQIs when transmitting a fixed transport format given by the cell-specific CQI median as shown in Table 9.47B. The requirement is applicable for each cell individually, that is the median reported CQI, as well as corresponding BLERs, are to be separately determined for each cell and independently verified against the requirement in Table 9.47B. The cell-specific CQI median shall be determined over all single transport block Type A CQI reports and all Type B CQI reports that were reported together with PCI reports matching the precoding vector embedded in the propagation channel as defined in subclause B.2.6.1. The cell-specific BLER at a particular reported CQI is obtained by associating a particular CQI reference measurement period for all single transport block Type A CQI reports and all Type B CQI reports that were reported together with PCI reports matching the cell-specific precoding vector embedded in the propagation channel as defined in subclause B.2.6.1 with



the HS-PDSCH subframe overlapping with the end of this CQI reference measurement period and calculating the fraction of erroneous HS-PDSCH subframes to which the same CQI value was associated.

**Table 9.47A: Test Parameters for CQI test in MIMO single stream fading conditions**

Parameter	Unit	Test 1	Test 2
HS-PDSCH $E_c/I_{or}$	dB	-2	-2.23
$\hat{I}_{or1}/I_{oc}$	dB	6	
$\hat{I}_{or2}/I_{oc}$	dB	6	
$I_{oc}$	dBm/3.84 MHz	-60	
Phase reference	-	P-CPICH (Table C.9)	P-CPICH/S-CPICH (Table C.12D)
HS-SCCH_1 $E_c/I_{or}$	dB	-15 (using STTD)	-15 (without STTD)
DPCH $E_c/I_{or}$	dB	-10 (using STTD)	-10 (without STTD)
Precoding weight set restriction	-	Disabled	Enabled
Maximum number of H-ARQ transmission	-	1	
Number of HS-SCCH set to be monitored	-	1	
CQI feedback cycle	ms	2	
CQI repetition factor	-	1	
PCI/CQI reporting Error Rate	%	0	
HS-SCCH-1 signalling pattern	-	To incorporate inter-TTI=3 the six sub-frame HS-SCCH-1 signalling pattern shall be '...XOOXOO...', where 'X' indicates TTI in which the HS-SCCH-1 uses the identity of the UE under test, and 'O' indicates TTI in which the HS-SCCH-1 uses a different UE identity.	
Propagation Channel		MIMO single stream fading conditions	
Note 1:	Measurement power offset 'T' is configured by RRC accordingly and as defined in [7].		
Note 2:	TF for HS-PDSCH is configured according to the reported CQI statistics. TF based on median CQI over all single transport block Type A CQI reports and all Type B CQI reports that were reported together with PCI reports matching the precoding vector embedded in the propagation channel as defined in subclause B.2.6.1 is used. Other physical channel parameters are configured according to the CQI mapping table described in TS25.214. The precoding that shall be used in the transmitter is one randomly picked but fixed precoding vector for single transport block transmission out of the set of possible precoding vectors as defined in [8]. The same precoding vector shall be used to generate the resulting channel coefficients as described for MIMO single stream conditions in subclause B.2.6.1.		
Note 3:	HS-PDSCH $E_c/I_{or}$ is decreased according to reference power adjustment $\Delta$ described in TS 25.214.		
Note 4:	For any given transport format the power of the HS-SCCH and HS-PDSCH shall be transmitted continuously with constant power.		
Note 5:	The UE shall be configured in non-64QAM/MIMO mode and use appropriate CQI tables according to TS 25.214.		

**Table 9.47B: Minimum requirement for CQI test in MIMO single stream conditions**

Reported CQI	Maximum BLER	
	Test 1	Test 2
CQI median	60%	60%
CQI median + 3	15%	15%

#### 9.3.4.2 MIMO Dual Stream Fading Conditions

The minimum performance requirements of channel quality indicator (CQI) reporting under MIMO dual stream conditions are defined based on a Type A reporting fraction of 100%, i.e. the parameters  $N_{cqi\_typeA}$  and  $M_{cqi}$  (see [8]) are assumed to be both set to 1. The propagation conditions assumed for minimum performance requirements of CQI reporting under MIMO dual stream conditions are defined in subclause B.2.6.2. The precoding used at the transmitter is one randomly picked but fixed precoding matrix for dual transport block transmission out of the set of



possible precoding matrices as defined in [8]. The same precoding matrix shall be used to generate the resulting channel coefficients as described for MIMO dual stream conditions in subclause B.2.6.2.

The reporting accuracy of CQI under MIMO dual stream conditions is determined by the BLER performance of two streams of transport blocks using the transport formats indicated by the respective stream specific reported CQI median over all dual transport block CQI reports for each stream that were reported together with PCI reports matching the precoding matrix embedded in the propagation channel as defined in subclause B.2.6.2.

#### 9.3.4.2.1 Minimum Requirement – UE HS-DSCH categories 15-20

For the parameters specified in Table 9.48, and using the downlink physical channels specified in Table C.9 and Table C.12D, the requirements are specified in terms of maximum BLERs at particular reported CQIs for each stream when transmitting a fixed transport format per stream given by the stream specific CQI median as shown in Table 9.49. The stream specific CQI median shall be determined over all dual transport block CQI reports that were reported together with PCI reports matching the precoding matrix embedded in the propagation channel as defined in subclause B.2.6.2. When the reported preferred primary precoding vector is matching with the first column of the precoding matrix embedded in the propagation channel as defined in subclause B.2.6.2, the reported values  $CQI_1$  and  $CQI_2$  shall be used respectively to determine the median CQI values for stream #1 and stream #2 as depicted in Figure B.5 in subclause B.2.6.2. When the reported preferred primary precoding vector is matching with the second column of the precoding matrix embedded in the propagation channel as defined in subclause B.2.6.2, the reported values  $CQI_1$  and  $CQI_2$  shall be used to determine the median CQI values for stream #2 and stream #1, respectively. The stream specific BLER at a particular reported CQI is obtained by associating a particular CQI reference measurement period for all dual transport block CQI reports that were reported together with a PCI report that was matching the precoding matrix embedded in the propagation channel as defined in subclause B.2.6.2 with the two transport blocks of the HS-PDSCH subframe overlapping with the end of this CQI reference measurement period and calculating the fractions of erroneous HS-PDSCH subframes to which the same CQI values were associated.



**Table 9.48: Test Parameters for CQI test in MIMO dual stream fading conditions**

Parameter	Unit	Test 1	Test 2
HS-PDSCH $E_c / I_{or}$	dB	-2	-2.23
$\hat{I}_{or} / I_{oc}$	dB	10	
$I_{oc}$	dBm/3.84 MHz	-60	
Phase reference	-	P-CPICH (Table C.9)	P-CPICH/S-CPICH (Table C.12D)
HS-SCCH_1 $E_c / I_{or}$	dB	-15 (using STTD)	-15 (without STTD)
DPCH $E_c / I_{or}$	dB	-10 (using STTD)	-10 (without STTD)
Precoding weight set restriction	-	Disabled	Enabled
Maximum number of H-ARQ transmission	-	1	
Number of HS-SCCH set to be monitored	-	1	
CQI feedback cycle	ms	2	
CQI repetition factor	-	1	
PCI/CQI reporting Error Rate	%	0	
HS-SCCH-1 signalling pattern	-	To incorporate inter-TTI=3 the six sub-frame HS-SCCH-1 signalling pattern shall be '...XOOXOO...', where 'X' indicates TTI in which the HS-SCCH-1 uses the identity of the UE under test, and 'O' indicates TTI in which the HS-SCCH-1 uses a different UE identity.	
Propagation Channel		MIMO dual stream fading conditions	
Note 1:	Measurement power offset 'I' is configured by RRC accordingly and as defined in [7].		
Note 2:	TF for HS-PDSCH is configured for each stream according to the reported CQI statistics. TF for each stream is based on median CQI over all dual transport block CQI reports that are reported together with a PCI report that is matching the precoding matrix embedded in the propagation channel as defined in subclause B.2.6.2. Other physical channel parameters are configured according to the CQI mapping table described in TS25.214. The precoding that shall be used in the transmitter is one randomly picked but fixed precoding matrix for dual transport block transmission out of the set of possible precoding matrices as defined in [8]. The same precoding matrix shall be used to generate the resulting channel coefficients as described for MIMO dual stream conditions in subclause B.2.6.2.		
Note 3:	HS-PDSCH $E_c/I_{or}$ is decreased according to reference power adjustment $\Delta$ described in TS 25.214.		
Note 4:	For any given transport format the power of the HS-SCCH and HS-PDSCH shall be transmitted continuously with constant power.		
Note 5:	The UE shall be configured in non-64QAM/MIMO mode and use appropriate CQI tables according to TS 25.214.		

**Table 9.49: Minimum requirement for CQI test in MIMO dual stream conditions**

Reported CQI	Maximum BLER	
	Test 1	Test 2
CQI median	60%	60%
CQI median + 2	15%	15%

#### 9.3.4.2.2 Minimum Requirement – UE HS-DSCH categories 19-20

For the parameters specified in Table 9.49A, and using the downlink physical channels specified in table C.9 and Table C.12D, the requirements are specified in terms of maximum BLERs at particular reported CQIs for each stream when transmitting a fixed transport format per stream given by the stream specific CQI median as shown in Table 9.49B. The stream specific CQI median shall be determined over all dual transport block CQI reports that were reported together with PCI reports matching the precoding matrix embedded in the propagation channel as defined in subclause B.2.6.2. When the reported preferred primary precoding vector is matching with the first column of the precoding matrix embedded in the propagation channel as defined in subclause B.2.6.2, the reported values  $CQI_1$  and  $CQI_2$  shall be used respectively to determine the median CQI values for stream #1 and stream #2 as depicted in Figure B.5 in subclause B.2.6.2. When the reported preferred primary precoding vector is matching with the second column of the precoding matrix embedded in the propagation channel as defined in subclause B.2.6.2, the reported values  $CQI_1$  and  $CQI_2$  shall be used to determine the median CQI values for stream #2 and stream #1, respectively. The stream specific BLER at a



particular reported CQI is obtained by associating a particular CQI reference measurement period for all dual transport block CQI reports that were reported together with a PCI report that was matching the precoding matrix embedded in the propagation channel as defined in subclause B.2.6.2 with the two transport blocks of the HS-PDSCH subframe overlapping with the end of this CQI reference measurement period and calculating the fractions of erroneous HS-PDSCH subframes to which the same CQI values were associated.

**Table 9.49A: Test Parameters for CQI test in MIMO dual stream conditions**

Parameter	Unit	Test 1	Test 2
HS-PDSCH $E_c/I_{or}$	dB	-2	-2.23
$\hat{I}_{or}/I_{oc}$	dB	15	
$I_{oc}$	dBm/3.84 MHz	-60	
Phase reference	-	P-CPICH (Table C.9)	P-CPICH/S-CPICH (Table C.12D)
HS-SCCH_1 $E_c/I_{or}$	dB	-15 (using STTD)	-15 (without STTD)
DPCH $E_c/I_{or}$	dB	-10 (using STTD)	-10 (without STTD)
Precoding weight set restriction	-	Disabled	Enabled
Maximum number of H-ARQ transmission	-	1	
Number of HS-SCCH set to be monitored	-	1	
CQI feedback cycle	ms	2	
CQI repetition factor	-	1	
PCI/CQI reporting Error Rate	%	0	
HS-SCCH-1 signalling pattern	-	To incorporate inter-TTI=3 the six sub-frame HS-SCCH-1 signalling pattern shall be '...XOOXOO...', where 'X' indicates TTI in which the HS-SCCH-1 uses the identity of the UE under test, and 'O' indicates TTI in which the HS-SCCH-1 uses a different UE identity.	
Propagation Channel		MIMO dual stream conditions	
Note 1:	Measurement power offset 'T' is configured by RRC accordingly and as defined in [7].		
Note 2:	TF for HS-PDSCH is configured for each stream according to the reported CQI statistics. TF for each stream is based on median CQI over all dual transport block CQI reports that are reported together with a PCI report that is matching the precoding matrix embedded in the propagation channel as defined in subclause B.2.6.2. Other physical channel parameters are configured according to the CQI mapping table described in TS25.214. The precoding that shall be used in the transmitter is one randomly picked but fixed precoding matrix for dual transport block transmission out of the set of possible precoding matrices as defined in [8]. The same precoding matrix shall be used to generate the resulting channel coefficients as described for MIMO dual stream conditions in subclause B.2.6.2.		
Note 3:	HS-PDSCH $E_c/I_{or}$ is decreased according to reference power adjustment $\Delta$ described in TS 25.214.		
Note 4:	For any given transport format the power of the HS-SCCH and HS-PDSCH shall be transmitted continuously with constant power.		
Note 5:	The UE shall be configured in 64QAM/MIMO mode and use appropriate CQI tables according to TS 25.214.		

**Table 9.49B: Minimum requirement for CQI test in MIMO dual stream conditions**

Reported CQI	Maximum BLER	
	Test 1	Test 2
CQI median	60%	60%
CQI median + 2	15%	15%

#### 9.3.4.2.3 Additional Requirement – UE HS-DSCH categories 25-28, 30, 32 and 36

With a serving HS-DSCH cell and secondary serving HS-DSCH cell(s) configured, using the parameters specified in Table 9.49BA, and using the downlink physical channels specified in Table C.9 and Table C.12D, the requirements are specified in terms of maximum BLERs at particular reported CQIs for each stream when transmitting a fixed transport format per stream given by the stream specific CQI median as shown in Table 9.49BB. The requirement is applicable for each cell and stream individually, that is the median reported CQI, as well as corresponding BLERs, are to be



separately determined for each cell and stream, and independently verified against the requirement in Table 9.49BB. The stream and cell-specific CQI median shall be determined over all dual transport block CQI reports that were reported together with PCI reports matching the precoding matrix embedded in the propagation channel as defined in subclause B.2.6.2. When the reported preferred primary precoding vector is matching with the first column of the precoding matrix embedded in the propagation channel as defined in subclause B.2.6.2, the reported values  $CQI_1$  and  $CQI_2$  shall be used respectively to determine the median CQI values for stream #1 and stream #2 as depicted in Figure B.5 in subclause B.2.6.2. When the reported preferred primary precoding vector is matching with the second column of the precoding matrix embedded in the propagation channel as defined in subclause B.2.6.2, the reported values  $CQI_1$  and  $CQI_2$  shall be used to determine the median CQI values for stream #2 and stream #1, respectively. The stream and cell-specific BLER at a particular reported CQI is obtained by associating a particular CQI reference measurement period for all dual transport block CQI reports that were reported together with a PCI report that was matching the precoding matrix embedded in the propagation channel as defined in subclause B.2.6.2 with the two transport blocks of the HS-PDSCH subframe overlapping with the end of this CQI reference measurement period and calculating the fractions of erroneous HS-PDSCH subframes to which the same CQI values were associated.

**Table 9.49BA: Test Parameters for CQI test in MIMO dual stream conditions**

Parameter	Unit	Test 1	Test 2
HS-PDSCH $E_c / I_{or}$	dB	-2	-2.23
$\hat{I}_{or1} / I_{oc}$	dB	10	
$\hat{I}_{or2} / I_{oc}$	dB	10	
$I_{oc}$	dBm/3.84 MHz	-60	
Phase reference	-	P-CPICH (Table C.9)	P-CPICH/S-CPICH (Table C.12D)
HS-SCCH_1 $E_c / I_{or}$	dB	-15 (using STTD)	-15 (without STTD)
DPCH $E_c / I_{or}$	dB	-10 (using STTD)	-10 (without STTD)
Precoding weight set restriction	-	Disabled	Enabled
Maximum number of H-ARQ transmission	-	1	
Number of HS-SCCH set to be monitored	-	1	
CQI feedback cycle	ms	2	
CQI repetition factor	-	1	
PCI/CQI reporting Error Rate	%	0	
HS-SCCH-1 signalling pattern	-	To incorporate inter-TTI=3 the six sub-frame HS-SCCH-1 signalling pattern shall be '...XOOXOO...', where 'X' indicates TTI in which the HS-SCCH-1 uses the identity of the UE under test, and 'O' indicates TTI in which the HS-SCCH-1 uses a different UE identity.	
Propagation Channel		MIMO dual stream conditions	
Note 1:	Measurement power offset 'Γ' is configured by RRC accordingly and as defined in [7].		
Note 2:	TF for HS-PDSCH is configured for each stream according to the reported CQI statistics. TF for each stream is based on median CQI over all dual transport block CQI reports that are reported together with a PCI report that is matching the precoding matrix embedded in the propagation channel as defined in subclause B.2.6.2. Other physical channel parameters are configured according to the CQI mapping table described in TS25.214. The precoding that shall be used in the transmitter is one randomly picked but fixed precoding matrix for dual transport block transmission out of the set of possible precoding matrices as defined in [8]. The same precoding matrix shall be used to generate the resulting channel coefficients as described for MIMO dual stream conditions in subclause B.2.6.2.		
Note 3:	HS-PDSCH $E_c/I_{or}$ is decreased according to reference power adjustment Δ described in TS 25.214.		
Note 4:	For any given transport format the power of the HS-SCCH and HS-PDSCH shall be transmitted continuously with constant power.		
Note 5:	The UE shall be configured in non-64QAM/MIMO mode and use appropriate CQI tables according to TS 25.214.		



**Table 9.49BB: Minimum requirement for CQI test in MIMO dual stream conditions**

Reported CQI	Maximum BLER	
	Test 1	Test 2
CQI median	60%	60%
CQI median + 2	15%	15%

#### 9.3.4.2.4 Additional Requirement – UE HS-DSCH categories 27, 28, 30, 32 and 36

With a serving HS-DSCH cell and secondary serving HS-DSCH cell(s) configured, using the parameters specified in Table 9.49BC, and using the downlink physical channels specified in Table C.9 and Table C.12D, the requirements are specified in terms of maximum BLERs at particular reported CQIs for each stream when transmitting a fixed transport format per stream given by the stream specific CQI median as shown in Table 9.49BD. The requirement is applicable for each cell and stream individually, that is the median reported CQI, as well as corresponding BLERs, are to be separately determined for each cell and stream, and independently verified against the requirement in Table 9.49BB. The stream and cell-specific CQI median shall be determined over all dual transport block CQI reports that were reported together with PCI reports matching the precoding matrix embedded in the propagation channel as defined in subclause B.2.6.2. When the reported preferred primary precoding vector is matching with the first column of the precoding matrix embedded in the propagation channel as defined in subclause B.2.6.2, the reported values  $CQI_1$  and  $CQI_2$  shall be used respectively to determine the median CQI values for stream #1 and stream #2 as depicted in Figure B.5 in subclause B.2.6.2. When the reported preferred primary precoding vector is matching with the second column of the precoding matrix embedded in the propagation channel as defined in subclause B.2.6.2, the reported values  $CQI_1$  and  $CQI_2$  shall be used to determine the median CQI values for stream #2 and stream #1, respectively. The stream and cell-specific BLER at a particular reported CQI is obtained by associating a particular CQI reference measurement period for all dual transport block CQI reports that were reported together with a PCI report that was matching the precoding matrix embedded in the propagation channel as defined in subclause B.2.6.2 with the two transport blocks of the HS-PDSCH subframe overlapping with the end of this CQI reference measurement period and calculating the fractions of erroneous HS-PDSCH subframes to which the same CQI values were associated.



**Table 9.49BC: Test Parameters for CQI test in MIMO dual stream conditions**

Parameter	Unit	Test 1	Test 2
HS-PDSCH $E_c / I_{or}$	dB	-2	-2.23
$\hat{I}_{or1} / I_{oc}$	dB	15	
$\hat{I}_{or2} / I_{oc}$	dB	15	
$I_{oc}$	dBm/3.84 MHz	-60	
Phase reference	-	P-CPICH (Table C.9)	P-CPICH/S-CPICH (Table C.12D)
HS-SCCH_1 $E_c / I_{or}$	dB	-15 (using STTD)	-15 (without STTD)
DPCH $E_c / I_{or}$	dB	-10 (using STTD)	-10 (without STTD)
Precoding weight set restriction	-	Disabled	Enabled
Maximum number of H-ARQ transmission	-	1	
Number of HS-SCCH set to be monitored	-	1	
CQI feedback cycle	ms	2	
CQI repetition factor	-	1	
PCI/CQI reporting Error Rate	%	0	
HS-SCCH-1 signalling pattern	-	To incorporate inter-TTI=3 the six sub-frame HS-SCCH-1 signalling pattern shall be '...XOOXOO...', where 'X' indicates TTI in which the HS-SCCH-1 uses the identity of the UE under test, and 'O' indicates TTI in which the HS-SCCH-1 uses a different UE identity.	
Propagation Channel		MIMO dual stream conditions	
Note 1:	Measurement power offset 'I' is configured by RRC accordingly and as defined in [7].		
Note 2:	TF for HS-PDSCH is configured for each stream according to the reported CQI statistics. TF for each stream is based on median CQI over all dual transport block CQI reports that are reported together with a PCI report that is matching the precoding matrix embedded in the propagation channel as defined in subclause B.2.6.2. Other physical channel parameters are configured according to the CQI mapping table described in TS25.214. The precoding that shall be used in the transmitter is one randomly picked but fixed precoding matrix for dual transport block transmission out of the set of possible precoding matrices as defined in [8]. The same precoding matrix shall be used to generate the resulting channel coefficients as described for MIMO dual stream conditions in subclause B.2.6.2.		
Note 3:	HS-PDSCH $E_c/I_{or}$ is decreased according to reference power adjustment $\Delta$ described in TS 25.214		
Note 4:	For any given transport format the power of the HS-SCCH and HS-PDSCH shall be transmitted continuously with constant power.		
Note 5:	The UE shall be configured in 64QAM/MIMO mode and use appropriate CQI tables according to TS 25.214.		

**Table 9.49BD: Minimum requirement for CQI test in MIMO dual stream conditions**

Reported CQI	Maximum BLER	
	Test 1	Test 2
CQI median	60%	60%
CQI median + 2	15%	15%

### 9.3.4.3 MIMO Dual Stream Static Orthogonal Conditions

The minimum performance requirements of channel quality indicator (CQI) reporting under MIMO dual stream conditions are defined based on a Type A reporting fraction of 100%, i.e. the parameters  $N_{cqi\_typeA}$  and  $M_{cqi}$  (see [8]) are assumed to be both set to 1. The propagation conditions assumed for minimum performance requirements of CQI reporting under MIMO dual stream static orthogonal conditions are defined in subclause B.2.6.3.

The precoding matrix used in the transmitter shall be one randomly picked but fixed precoding matrix  $\mathbf{W}$  out of the set defined in equation EQ.B.2.6.2.



### 9.3.4.3.1 Minimum Requirement –UE HS-DSCH categories 15-20

For the parameters specified in Table 9.49C, and using the downlink physical channels specified in Table C.9 and Table C.12D, the reported CQI value, for each of the streams, shall be in the range of +/-2 of the reported stream specific CQI median more than 90% of the time. The stream specific CQI median shall be determined over all dual transport block CQI reports.

For each of the streams, if the HS-PDSCH BLER using the transport format indicated by the stream specific CQI median is less than or equal to 0.1, the BLER using the transport format indicated by the (stream specific CQI median + 2) shall be greater than 0.1. For each of the streams, if the HS-PDSCH BLER using the transport format indicated by the stream specific CQI median is greater than 0.1, the BLER using transport format indicated by (stream specific CQI median -1) shall be less than or equal to 0.1. The requirements are applicable to Test 1 and Test 2.

**Table 9.49C: Test Parameters for CQI test in MIMO dual stream static orthogonal conditions**

Parameter	Unit	Test 1	Test 2
HS-PDSCH $E_c / I_{or}$	dB	-2	-2.23
$\hat{I}_{or} / I_{oc}$	dB	10	
$I_{oc}$	dBm/3.84 MHz	-60	
Phase reference	-	P-CPICH (Table C.9)	P-CPICH/S-CPICH (Table C.12D)
HS-SCCH_1 $E_c / I_{or}$	dB	-15 (using STTD)	-15 (without STTD)
DPCH $E_c / I_{or}$	dB	-10 (using STTD)	-10 (without STTD)
Precoding weight set restriction	-	Disabled	Enabled
Maximum number of H-ARQ transmission	-	1	
Number of HS-SCCH set to be monitored	-	1	
CQI feedback cycle	ms	2	
CQI repetition factor	-	1	
PCI/CQI reporting Error Rate	%	0	
HS-SCCH-1 signalling pattern	-	To incorporate inter-TTI=3 the six sub-frame HS-SCCH-1 signalling pattern shall be '...XOOXOO...', where 'X' indicates TTI in which the HS-SCCH-1 uses the identity of the UE under test, and 'O' indicates TTI in which the HS-SCCH-1 uses a different UE identity.	
Propagation Channel		MIMO dual stream static orthogonal conditions	
Note 1:	Measurement power offset 'T' is configured by RRC accordingly and as defined in [7].		
Note 2:	HS-PDSCH $E_c/I_{or}$ is decreased according to reference power adjustment $\Delta$ described in TS 25.214		
Note 3:	For any given transport format the power of the HS-SCCH and HS-PDSCH shall be transmitted continuously with constant power.		
Note 4:	The UE shall be configured in non-64QAM/MIMO mode and use appropriate CQI tables according to TS 25.214.		

### 9.3.4.3.2 Minimum Requirement –UE HS-DSCH categories 19-20

For the parameters specified in Table 9.49D, and using the downlink physical channels specified in Table C.9 and Table C.12D, the reported CQI value, for each of the streams, shall be in the range of +/-2 of the reported stream specific CQI median more than 90% of the time. The stream specific CQI median shall be determined over all dual transport block CQI reports.

For each of the streams, if the HS-PDSCH BLER using the transport format indicated by the stream specific CQI median is less than or equal to 0.1, the BLER using the transport format indicated by the (stream specific CQI median + 2) shall be greater than 0.1. For each of the streams, if the HS-PDSCH BLER using the transport format indicated by the stream specific CQI median is greater than 0.1, the BLER using transport format indicated by (stream specific CQI median -1) shall be less than or equal to 0.1. The requirements are applicable to Test 1 and Test 2.



**Table 9.49D: Test Parameters for CQI test in MIMO dual stream static orthogonal conditions**

Parameter	Unit	Test 1	Test 2
HS-PDSCH $E_c / I_{or}$	dB	-2	-2.23
$\hat{I}_{or} / I_{oc}$	dB	15	
$I_{oc}$	dBm/3.84 MHz	-60	
Phase reference	-	P-CPICH (Table C.9)	P-CPICH/S-CPICH (Table C.12D)
HS-SCCH_1 $E_c / I_{or}$	dB	-15 (using STTD)	-15 (without STTD)
DPCH $E_c / I_{or}$	dB	-10 (using STTD)	-10 (without STTD)
Precoding weight set restriction	-	Disabled	Enabled
Maximum number of H-ARQ transmission	-	1	
Number of HS-SCCH set to be monitored	-	1	
CQI feedback cycle	ms	2	
CQI repetition factor	-	1	
PCI/CQI reporting Error Rate	%	0	
HS-SCCH-1 signalling pattern	-	To incorporate inter-TTI=3 the six sub-frame HS-SCCH-1 signalling pattern shall be '...XOOXOO...', where 'X' indicates TTI in which the HS-SCCH-1 uses the identity of the UE under test, and 'O' indicates TTI in which the HS-SCCH-1 uses a different UE identity.	
Propagation Channel		MIMO dual stream static orthogonal conditions	
Note 1:	Measurement power offset 'I' is configured by RRC accordingly and as defined in [7].		
Note 2:	HS-PDSCH $E_c/I_{or}$ is decreased according to reference power adjustment $\Delta$ described in TS 25.214		
Note 3:	For any given transport format the power of the HS-SCCH and HS-PDSCH shall be transmitted continuously with constant power.		
Note 4:	The UE shall be configured in 64QAM/MIMO mode and use appropriate CQI tables according to TS 25.214.		

#### 9.3.4.3.3 Additional Requirement – UE HS-DSCH categories 25-28, 30, 32 and 36

With a serving HS-DSCH cell and secondary serving HS-DSCH cell(s) configured, using the parameters specified in Table 9.49E, and using the downlink physical channels specified in Table C.9 and Table C.12D, the reported CQI value, for each of the streams, and cells shall be in the range of +/-2 of the reported stream specific CQI median more than 90% of the time. The requirement is applicable for each cell and stream individually, that is the median reported CQI, as well as corresponding BLERs, are to be separately determined for each cell and stream, and independently verified to fulfil the requirement. The stream and cell-specific CQI median shall be determined over all dual transport block CQI reports.

For each of the streams and cells, if the HS-PDSCH BLER using the transport format indicated by the stream and cell-specific CQI median is less than or equal to 0.1, the BLER using the transport format indicated by the (stream and cell-specific CQI median + 2) shall be greater than 0.1. For each of the streams and cells, if the HS-PDSCH BLER using the transport format indicated by the stream and cell-specific CQI median is greater than 0.1, the BLER using transport format indicated by (stream and cell-specific CQI median -1) shall be less than or equal to 0.1. The requirements are applicable to Test 1 and Test 2.



**Table 9.49E: Test Parameters for CQI test in MIMO dual stream static orthogonal conditions**

Parameter	Unit	Test 1	Test 2
HS-PDSCH $E_c / I_{or}$	dB	-2	-2.23
$\hat{I}_{or1} / I_{oc}$	dB	10	
$\hat{I}_{or2} / I_{oc}$	dB	10	
$I_{oc}$	dBm/3.84 MHz	-60	
Phase reference	-	P-CPICH (Table C.9)	P-CPICH/S-CPICH (Table C.12D)
HS-SCCH_1 $E_c / I_{or}$	dB	-15 (using STTD)	-15 (without STTD)
DPCH $E_c / I_{or}$	dB	-10 (using STTD)	-10 (without STTD)
Precoding weight set restriction	-	Disabled	Enabled
Maximum number of H-ARQ transmission	-	1	
Number of HS-SCCH set to be monitored	-	1	
CQI feedback cycle	ms	2	
CQI repetition factor	-	1	
PCI/CQI reporting Error Rate	%	0	
HS-SCCH-1 signalling pattern	-	To incorporate inter-TTI=3 the six sub-frame HS-SCCH-1 signalling pattern shall be '...XOOXOO...', where 'X' indicates TTI in which the HS-SCCH-1 uses the identity of the UE under test, and 'O' indicates TTI in which the HS-SCCH-1 uses a different UE identity.	
Propagation Channel		MIMO dual stream static orthogonal conditions	
Note 1:	Measurement power offset 'I' is configured by RRC accordingly and as defined in [7].		
Note 2:	Note 3: HS-PDSCH $E_c/I_{or}$ is decreased according to reference power adjustment $\Delta$ described in TS 25.214.		
Note 3:	For any given transport format the power of the HS-SCCH and HS-PDSCH shall be transmitted continuously with constant power.		
Note 4:	UEs from HS-DSCH categories 27-28 shall be configured in non-64QAM/MIMO and use appropriate CQI tables according to TS 25.214.		

#### 9.3.4.3.4 Additional Requirement – UE HS-DSCH categories 27, 28, 30, 32 and 36

With a serving HS-DSCH cell and secondary serving HS-DSCH cell(s) configured, using the parameters specified in Table 9.49F, and using the downlink physical channels specified in Table C.9 and Table C.12D, the reported CQI value, for each of the streams, and cells shall be in the range of +/-2 of the reported stream specific CQI median more than 90% of the time. The requirement is applicable for each cell and stream individually, that is the median reported CQI, as well as corresponding BLERs, are to be separately determined for each cell and stream, and independently verified to fulfil the requirement. The stream and cell-specific CQI median shall be determined over all dual transport block CQI reports.

For each of the streams and cells, if the HS-PDSCH BLER using the transport format indicated by the stream and cell-specific CQI median is less than or equal to 0.1, the BLER using the transport format indicated by the (stream and cell-specific CQI median + 2) shall be greater than 0.1. For each of the streams and cells, if the HS-PDSCH BLER using the transport format indicated by the stream and cell-specific CQI median is greater than 0.1, the BLER using transport format indicated by (stream and cell-specific CQI median -1) shall be less than or equal to 0.1. The requirements are applicable to Test 1 and Test 2.



**Table 9.49EF: Test Parameters for CQI test in MIMO dual stream static orthogonal conditions**

Parameter	Unit	Test 1	Test 2
HS-PDSCH $E_c/I_{or}$	dB	-2	-2.23
$\hat{I}_{or1}/I_{oc}$	dB	15	
$\hat{I}_{or2}/I_{oc}$	dB	15	
$I_{oc}$	dBm/3.84 MHz	-60	
Phase reference	-	P-CPICH (Table C.9)	P-CPICH/S-CPICH (Table C.12D)
HS-SCCH_1 $E_c/I_{or}$	dB	-15 (using STTD)	-15 (without STTD)
DPCH $E_c/I_{or}$	dB	-10 (using STTD)	-10 (without STTD)
Precoding weight set restriction	-	Disabled	Enabled
Maximum number of H-ARQ transmission	-	1	
Number of HS-SCCH set to be monitored	-	1	
CQI feedback cycle	ms	2	
CQI repetition factor	-	1	
PCI/CQI reporting Error Rate	%	0	
HS-SCCH-1 signalling pattern	-	To incorporate inter-TTI=3 the six sub-frame HS-SCCH-1 signalling pattern shall be '...XOOXOO...', where 'X' indicates TTI in which the HS-SCCH-1 uses the identity of the UE under test, and 'O' indicates TTI in which the HS-SCCH-1 uses a different UE identity.	
Propagation Channel		MIMO dual stream static orthogonal conditions	
Note 1:	Measurement power offset 'Γ' is configured by RRC accordingly and as defined in [7].		
Note 2:	Note 3: HS-PDSCH $E_c/I_{or}$ is decreased according to reference power adjustment Δ described in TS 25.214.		
Note 3:	For any given transport format the power of the HS-SCCH and HS-PDSCH shall be transmitted continuously with constant power.		
Note 4:	The UE shall be configured in 64QAM/MIMO mode and use appropriate CQI tables according to TS 25.214.		

## 9.3.5 MIMO only with single-stream restriction Performance

### 9.3.5.1 MIMO only with single-stream restriction Fading Conditions

The propagation conditions assumed for minimum performance requirements of CQI reporting under MIMO single stream conditions are defined in subclause B.2.6.1. The precoding used at the transmitter is one randomly picked but fixed precoding vector for single transport block transmission out of the set of possible precoding vectors as defined in [8]. The same precoding vector shall be used to generate the resulting channel coefficients as described for MIMO single stream conditions in subclause B.2.6.1.

The reporting accuracy of CQI under MIMO with single-stream restriction is determined by the BLER performance when transmitting with a transport format indicated by the reported CQI median determined over all CQI reports that were reported together with PCI reports matching the precoding vector embedded in the propagation channel as defined in subclause B.2.6.1.

#### 9.3.5.1.1 Minimum Requirement

For the parameters specified in Table 9.49E1, and using the downlink physical channels specified in Table C.9 and Table C.12D, the requirements are specified in terms of maximum BLERs at particular reported CQIs when transmitting a fixed transport format given by the CQI median as shown in Table 9.4E2. The CQI median shall be determined over all CQI reports that were reported together with PCI reports matching the precoding vector embedded in the propagation channel as defined in subclause B.2.6.1. The BLER at a particular reported CQI is obtained by associating a particular CQI reference measurement period for all Type B CQI reports that were reported together with PCI reports matching the precoding vector embedded in the propagation channel as defined in subclause B.2.6.1 with the



HS-PDSCH subframe overlapping with the end of this CQI reference measurement period and calculating the fraction of erroneous HS-PDSCH subframes to which the same CQI value was associated.

**Table 9.49E1: Test Parameters for CQI test in MIMO single stream fading conditions**

Parameter	Unit	Test 1	Test 2
HS-PDSCH $E_c/I_{or}$	dB	-2	-2.23
$\hat{I}_{or}/I_{oc}$	dB	6	
$I_{oc}$	dBm/3.84 MHz	-60	
Phase reference	-	P-CPICH (Table C.9)	P-CPICH/S-CPICH (Table C.12D)
HS-SCCH_1 $E_c/I_{or}$	dB	-15 (using STTD)	-15 (without STTD)
DPCH $E_c/I_{or}$	dB	-10 (using STTD)	-10 (without STTD)
Precoding weight set restriction	-	Disabled	Enabled
Maximum number of H-ARQ transmission	-	1	
Number of HS-SCCH set to be monitored	-	1	
CQI feedback cycle	ms	2	
CQI repetition factor	-	1	
PCI/CQI reporting Error Rate	%	0	
HS-SCCH-1 signalling pattern	-	To incorporate inter-TTI=3 the six sub-frame HS-SCCH-1 signalling pattern shall be '...XOOXOO...', where 'X' indicates TTI in which the HS-SCCH-1 uses the identity of the UE under test, and 'O' indicates TTI in which the HS-SCCH-1 uses a different UE identity.	
Propagation Channel		MIMO single stream fading conditions	
Note 1:	Measurement power offset 'I' is configured by RRC accordingly and as defined in [7].		
Note 2:	TF for HS-PDSCH is configured according to the reported CQI statistics. TF based on median CQI over all Type B CQI reports that were reported together with PCI reports matching the precoding vector embedded in the propagation channel as defined in subclause B.2.6.1 is used. Other physical channel parameters are configured according to the CQI mapping table described in TS25.214. The precoding that shall be used in the transmitter is one randomly picked but fixed precoding vector for single transport block transmission out of the set of possible precoding vectors as defined in [8]. The same precoding vector shall be used to generate the resulting channel coefficients as described for MIMO single stream conditions in subclause B.2.6.1.		
Note 3:	HS-PDSCH $E_c/I_{or}$ is decreased according to reference power adjustment $\Delta$ described in TS 25.214.		
Note 4:	For any given transport format the power of the HS-SCCH and HS-PDSCH shall be transmitted continuously with constant power.		

**Table 9.49E2: Minimum requirement for CQI test in MIMO single stream conditions**

Reported CQI	Maximum BLER	
	Test 1	Test 2
CQI median	60%	60%
CQI median + 3	15%	15%

## 9.3.6 Multiflow HSDPA performance

### 9.3.6.1 Fading propagation conditions

The reporting accuracy of the channel quality indicator (CQI) under fading environments is determined by the BLER performance using the transport format indicated by the reported CQI median.

The specified requirements may be subject to further simulations to verify assumptions.



### 9.3.6.1.1 Minimum Requirement

For the parameters specified in Table 9.49E3, and using the the test set-up in Annex C.5.5, the requirements are specified in terms of maximum BLERs at particular reported CQIs when transmitting a fixed transport format given by the CQI median as shown in Table 9.49E4. The BLER at a particular reported CQI is obtained by associating a particular CQI reference measurement period with the HS-PDSCH subframe of the time reference cell overlapping with the end of this CQI reference measurement period and calculating the fraction of erroneous HS-PDSCH subframes.

**Table 9.49E3: Test Parameters for CQI test in fading – Multiflow HSDPA**

Parameter	Unit	Test 1
HS-PDSCH $E_c/I_{or}$	dB	-3
$\hat{I}_{or}/I_{oc}$	dB	Specified in Annex C.5.5
$I_{oc}$	dBm/3.84 MHz	-60
Number of additional interfering cell		0
Phase reference	-	P-CPICH
Maximum number of H-ARQ transmission	-	1
Number of HS-SCCH set to be monitored	-	1
CQI feedback cycle	ms	2
CQI repetition factor	-	1
HS-SCCH-1 signalling pattern	-	The six sub-frame HS-SCCH-1 signalling pattern shall be '...XOOXOO...', where 'X' indicates TTI in which the HS-SCCH-1 uses the identity of the UE under test, and 'O' indicates TTI in which the HS-SCCH-1 uses a different UE identity. The HS-SCCH-1 shall be transmitted continuously with constant power.
Propagation Channel		Case 8
Note 1: Measurement power offset 'T' is configured by RRC accordingly and as defined in [7]. Note 2: TF for HS-PDSCH is configured according to the reported CQI statistics. TF based on median CQI is used. Other physical channel parameters are configured according to the CQI mapping table described in TS25.214. Note 3: HS-PDSCH $E_c/I_{or}$ is decreased according to reference power adjustment $\Delta$ described in TS 25.214. Note 4: For any given transport format the power of the HS-SCCH and HS-PDSCH shall be transmitted continuously with constant power. Note 5: The UE shall be configured in non-MIMO mode and use appropriate CQI tables according to TS 25.214.		

**Table 9.49E4: Minimum requirement for CQI test in fading – Multiflow HSDPA**

Reported CQI	Maximum BLER
	Test 1
CQI median	60%
CQI median + 3	15%

## 9.3.7 MIMO Performance with four transmit antennas

### 9.3.7.1 Four Streams Static Orthogonal Conditions

The minimum performance requirements of channel quality indicator (CQI) reporting under MIMO with four transmit antennas and four stream conditions are defined based on a Type A reporting fraction of 100%, i.e. the parameters  $N_{cqi\_typeA}$  and  $M_{cqi}$  (see [8]) are assumed to be both set to 1. The propagation conditions assumed for minimum performance requirements of CQI reporting are defined in subclause B.2.7.



The precoding matrix used in the transmitter shall be one randomly picked but fixed precoding matrix  $\mathbf{W}$  out of the set defined in Annex B.2.7.

#### 9.3.7.1.1 Minimum Requirement – UE HS-DSCH categories 37 and 38

With a serving HS-DSCH cell and secondary serving HS-DSCH cell(s) configured, using the parameters specified in Table 9.49E5, and using the downlink physical channels specified in C.12F, the reported CQI value, for each of the HARQ process, and cells shall be in the range of  $[\pm 2]$  of the reported stream specific CQI median more than 90% of the time. The requirement is applicable for each cell and for each HARQ process individually, that is the median reported CQI, as well as corresponding BLERs, are to be separately determined for each cell and HARQ process, and independently verified to fulfil the requirement. The HARQ process and cell-specific CQI median shall be determined over all four transport block reports.

For each HARQ process and cells, if the HS-PDSCH BLER averaged over the streams associated to the same HARQ-process identifier, using the transport format indicated by the HARQ process and cell-specific CQI median is less than or equal to  $[0.1]$ , the BLER using the transport format indicated by the HARQ process and cell-specific CQI median  $[\pm 2]$  shall be greater than  $[0.1]$ . For each of the HARQ process and cells, if the HS-PDSCH BLER using the transport format indicated by the stream and cell-specific CQI median is greater than  $[0.1]$ , the BLER using transport format indicated by the HARQ-process and cell-specific CQI median  $[-1]$  shall be less than or equal to  $[0.1]$ .



**Table 9.49E5: Test Parameters for CQI test for MIMO with four transmit antennas with four streams static orthogonal conditions**

Parameter	Unit	Test 1	Test 2
HS-PDSCH $E_c / I_{or}$	dB	-2.3	-2.3
$\hat{I}_{or1} / I_{oc}$	dB	13	18
$\hat{I}_{or2} / I_{oc}$	dB	13	18
$I_{oc}$	dBm/3.84 MHz	-60	-60
Phase reference	-	P-CPICH/S-CPICH (Table C.12F)	P-CPICH/S-CPICH (Table C.12F)
HS-SCCH_1 $E_c / I_{or}$	dB	-17.4 (without STTD)	-17.4 (without STTD)
DPCH $E_c / I_{or}$	dB	-10 (without STTD)	-10 (without STTD)
Precoding weight set restriction	-	Enabled	Enabled
Maximum number of H-ARQ transmission	-	1	1
Number of HS-SCCH set to be monitored	-	1	1
CQI feedback cycle	ms	2	2
CQI repetition factor	-	1	1
PCI/CQI reporting Error Rate	%	0	0
HS-SCCH-1 signalling pattern	-	To incorporate inter-TTI=3 the six sub-frame HS-SCCH-1 signalling pattern shall be '...XOOXOO...', where 'X' indicates TTI in which the HS-SCCH-1 uses the identity of the UE under test, and 'O' indicates TTI in which the HS-SCCH-1 uses a different UE identity.	To incorporate inter-TTI=3 the six sub-frame HS-SCCH-1 signalling pattern shall be '...XOOXOO...', where 'X' indicates TTI in which the HS-SCCH-1 uses the identity of the UE under test, and 'O' indicates TTI in which the HS-SCCH-1 uses a different UE identity.
Propagation Channel		Four branch MIMO four stream static orthogonal conditions, Annex B.2.7.1	Four branch MIMO four stream static orthogonal conditions, Annex B.2.7.1
Note 1: Measurement power offset 'I' is configured by RRC accordingly and as defined in [7].			
Note 2: HS-PDSCH $E_c/I_{or}$ is decreased according to reference power adjustment $\Delta$ described in TS 25.214.			
Note 3: For any given transport format the power of the HS-SCCH and HS-PDSCH shall be transmitted continuously with constant power.			

### 9.3.8 MIMO with Four Transmit Antennas only with Dual-Stream Restriction Performance

#### 9.3.8.1 MIMO with four transmit antennas only with dual-stream restriction fading conditions

The propagation conditions assumed for minimum performance requirements of CQI reporting under MIMO with four transmit antennas with dual stream conditions are defined in subclause B.2.7.2. The precoding used at the transmitter is one randomly picked but fixed precoding vector for dual transport block transmission out of the set of possible precoding vectors as defined in [8]. The same precoding vector shall be used to generate the resulting channel coefficients as described in subclause B.2.7.2.

The reporting accuracy of CQI under MIMO with four transmit antennas with dual-stream restriction is determined by the BLER performance when transmitting with a transport format indicated by the reported CQI median determined



over all CQI reports that were reported together with PCI reports matching the precoding matrix embedded in the propagation channel as defined in subclause B.2.7.2.

#### 9.3.8.1.1 Minimum Requirement

With a serving HS-DSCH cell and secondary serving HS-DSCH cell(s) configured, using the parameters specified in Table 9.49E6, and using the downlink physical channels specified in Table C.12F, the requirements are specified in terms of maximum BLERs at particular reported CQIs for each HARQ process when transmitting a fixed transport format per HARQ process given by the HARQ process specific CQI median as shown in Table 9.49E7. The requirement is applicable for each cell and stream individually, that is the median reported CQI, as well as corresponding BLERs, are to be separately determined for each cell and stream, and independently verified against the requirement in Table 9.49E7. The HARQ process and cell-specific CQI median shall be determined over all dual transport block CQI reports that were reported together with PCI reports matching the precoding matrix embedded in the propagation channel as defined in subclause B.2.7.2. The HARQ process and cell-specific BLER at a particular reported CQI is obtained by associating a particular CQI reference measurement period for all dual transport block CQI reports that were reported together with a PCI report that was matching the precoding matrix embedded in the propagation channel as defined in subclause B.2.7.2 with the two transport blocks of the HS-PDSCH subframe overlapping with the end of this CQI reference measurement period and calculating the fractions of erroneous HS-PDSCH subframes to which the same CQI values were associated.



**Table 9.49E6: Test Parameters for CQI test for MIMO with four transmit antennas only with dual streams conditions**

Parameter	Unit	Test 1
HS-PDSCH $E_c/I_{or}$	dB	-2.3
$\hat{I}_{or1}/I_{oc}$	dB	15
$\hat{I}_{or2}/I_{oc}$	dB	15
$I_{oc}$	dBm/3.84 MHz	-60
Phase reference	-	P-CPICH/S-CPICH (Table C.12F)
HS-SCCH_1 $E_c/I_{or}$	dB	-17.4 (without STTD)
DPCH $E_c/I_{or}$	dB	-10 (without STTD)
Precoding weight set restriction	-	Enabled
Maximum number of H-ARQ transmission	-	1
Number of HS-SCCH set to be monitored	-	1
CQI feedback cycle	Ms	2
CQI repetition factor	-	1
PCI/CQI reporting Error Rate	%	0
HS-SCCH-1 signalling pattern	-	To incorporate inter-TTI=3 the six sub-frame HS-SCCH-1 signalling pattern shall be '...XOOXOO...', where 'X' indicates TTI in which the HS-SCCH-1 uses the identity of the UE under test, and 'O' indicates TTI in which the HS-SCCH-1 uses a different UE identity.
Propagation Channel		Four branch MIMO dual stream fading conditions, Annex B.2.7.2
<p>Note 1: Measurement power offset 'T' is configured by RRC accordingly and as defined in [7].</p> <p>Note 2: TF for HS-PDSCH is configured for each stream according to the reported CQI statistics. TF for each stream is based on median CQI over all dual transport block CQI reports that are reported together with a PCI report that is matching the precoding matrix embedded in the propagation channel as defined in subclause B.2.7.2. Other physical channel parameters are configured according to the CQI mapping table described in TS25.214. The precoding that shall be used in the transmitter is one randomly picked but fixed precoding matrix for dual transport block transmission out of the set of possible precoding matrices as defined in [8]. The same precoding matrix shall be used to generate the resulting channel coefficients as described for MIMO dual stream conditions in subclause B.2.7.2.</p> <p>Note 3: HS-PDSCH <math>E_c/I_{or}</math> is decreased according to reference power adjustment <math>\Delta</math> described in TS 25.214</p> <p>Note 4: For any given transport format the power of the HS-SCCH and HS-PDSCH shall be transmitted continuously with constant power.</p> <p>Note 5: The UE shall be configured in 64QAM/MIMO mode and use appropriate CQI tables according to TS 25.214.</p>		

**Table 9.49E7: Minimum requirement for CQI test in MIMO dual stream conditions**

Reported CQI	Maximum BLER
	Test 1
CQI median	60%
CQI median [+ 2]	15%

## 9.4 HS-SCCH Detection Performance

The detection performance of the HS-SCCH is determined by the probability of event  $E_m$ , which is declared when the UE is signaled on HS-SCCH-1, but DTX is observed in the corresponding HS-DPCCH ACK/NACK field. The probability of event  $E_m$  is denoted  $P(E_m)$ .



### 9.4.1 HS-SCCH Type 1 Single Link Performance

For the test parameters specified in Table 9.50, for each value of HS-SCCH-1  $E_c/I_{or}$  specified in Table 9.51 and Table 9.51A the measured  $P(E_m)$  shall be less than or equal to the corresponding specified value of  $P(E_m)$ . Enhanced performance requirements type 1 specified in Table 9.51A are based on receiver diversity.

**Table 9.50: Test parameters for HS-SCCH detection – single link**

Parameter	Unit	Test 1	Test 2	Test 3
$I_{oc}$	dBm/3.84 MHz	-60		
Phase reference	-	P-CPICH		
P-CPICH $E_c/I_{or}$	dB	-10		
HS-SCCH UE Identity ( $x_{ue,1}, x_{ue,2}, \dots, x_{ue,16}$ )		HS-SCCH-1: 1010101010101010 (every third TTI only, UE under test addressed solely via HS-SCCH-1) HS-SCCH-2: 0001001010101010 HS-SCCH-3: 0001101010101010 HS-SCCH-4: 0001111110101010		
HS-DSCH TF of UE1		TF corresponding to CQI1		
HS-SCCH-1 transmission pattern		The HS-SCCH-1 shall be transmitted continuously with constant power.		
HS-PDSCH transmission pattern		The HS-PDSCH shall be transmitted continuously with constant power.		
HS-SCCH-1 TTI Signalling Pattern	-	The six sub-frame HS-SCCH-1 signalling pattern shall be '...XOOXOO...', where 'X' indicates TTI in which the HS-SCCH-1 uses the identity of the UE under test, and 'O' indicates TTI in which the HS-SCCH-1 uses a different UE identity.		

**Table 9.51: Minimum requirement for HS-SCCH detection – single link**

Test Number	Propagation Conditions	Reference value		
		HS-SCCH-1 $E_c/I_{or}$ (dB)	$\hat{I}_{or}/I_{oc}$ (dB)	$P(E_m)$
1	PA3	-9	0	0.05
2	PA3	-9.9	5	0.01
3	VA30	-10	0	0.01

**Table 9.51A: Enhanced requirement type 1 for HS-SCCH detection – single link**

Test Number	Propagation Conditions	Reference value		
		HS-SCCH-1 $E_c/I_{or}$ (dB)	$\hat{I}_{or}/I_{oc}$ (dB)	$P(E_m)$
1	PA3	-12.0	0	0.01
2	VA30	-15.6	0	0.01

### 9.4.2 HS-SCCH Type 1 Open Loop Diversity Performance

For the test parameters specified in Table 9.52, for each value of HS-SCCH-1  $E_c/I_{or}$  specified in Table 9.53 and Table 9.54 the measured  $P(E_m)$  shall be less than or equal to the corresponding specified value of  $P(E_m)$ . Enhanced performance requirements type 1 specified in Table 9.54 are based on receiver diversity.



**Table 9.52: Test parameters for HS-SCCH detection – open loop diversity**

Parameter	Unit	Test 1	Test 2	Test 3
$I_{oc}$	dBm/3.84 MHz	-60		
Phase reference	-	P-CPICH		
P-CPICH $E_c/I_{or}$	dB	-10		
HS-SCCH UE Identity ( $x_{ue,1}, x_{ue,2}, \dots, x_{ue,16}$ )		HS-SCCH-1: 1010101010101010 (every third TTI only, UE under test addressed solely via HS-SCCH-1) HS-SCCH-2: 0001001010101010 HS-SCCH-3: 0001101010101010 HS-SCCH-4: 0001111110101010		
HS-DSCH TF of UE1		TF corresponding to CQI1		
HS-SCCH-1 transmission pattern		The HS-SCCH-1 shall be transmitted continuously with constant power.		
HS-PDSCH transmission pattern		The HS-PDSCH shall be transmitted continuously with constant power.		
HS-SCCH-1 TTI Signalling Pattern	-	The six sub-frame HS-SCCH-1 signalling pattern shall be '...XOOXOO...', where 'X' indicates TTI in which the HS-SCCH-1 uses the identity of the UE under test, and 'O' indicates TTI in which the HS-SCCH-1 uses a different UE identity.		

**Table 9.53: Minimum requirement for HS-SCCH detection – open loop diversity**

Test Number	Propagation Conditions	Reference value		
		HS-SCCH-1 $E_c/I_{or}$ (dB)	$\hat{I}_{or}/I_{oc}$ (dB)	$P(E_m)$
1	PA3	-11.6	0	0.05
2	PA3	-13.4	5	0.01
3	VA30	-11.5	0	0.01

**Table 9.54: Enhanced requirement type 1 for HS-SCCH detection – open loop diversity**

Test Number	Propagation Conditions	Reference value		
		HS-SCCH-1 $E_c/I_{or}$ (dB)	$\hat{I}_{or}/I_{oc}$ (dB)	$P(E_m)$
1	PA3	-15.2	0	0.01
2	VA30	-16.4	0	0.01

### 9.4.3 HS-SCCH Type 3 Performance

For the test parameters specified in Table 9.55 with the downlink physical channel setup in Table C.12, for each value of HS-SCCH-1  $E_c/I_{or}$  specified in Table 9.56 and Table 9.57 the measured  $P(E_m)$  shall be less than or equal to the corresponding specified value of  $P(E_m)$ . The requirements in Table 9.56 and Table 9.57 assume STTD is enabled on HS-SCCH and DPCH. The requirements in Table 9.56 assume HS-SCCH Type 3 coding associated with single stream transmission on HS-DSCH. The requirements in Table 9.57 assume HS-SCCH Type 3 coding associated with dual stream transmission on HS-DSCH.

For the test parameters specified in Table 9.55 with the downlink physical channel setup in Table C.12E, for each value of HS-SCCH-1  $E_c/I_{or}$  specified in Table 9.57a, Table 9.57b, Table 9.57c and Table 9.57d, the measured  $P(E_m)$  shall be less than or equal to the corresponding specified value of  $P(E_m)$ . The requirements in Table 9.57a and Table 9.57b assume STTD is disabled on HS-SCCH and DPCH. The requirements in Table 9.57c and Table 9.57d assume STTD is enabled on HS-SCCH and DPCH. The requirements in Table 9.57a and Table 9.57c assume HS-SCCH Type 3 coding associated with single stream transmission on HS-DSCH. The requirements in Table 9.57b and Table 9.57d assume HS-SCCH Type 3 coding associated with dual stream transmission on HS-DSCH.

Minimum performance requirements specified in Table 9.56, 9.57, 9.57a, 9.57b, 9.57c and 9.57d are based on receiver diversity.



**Table 9.55: Test parameters for HS-SCCH Type 3 detection**

Parameter	Unit	Test 1	Test 2	Test 3	Test 4
$I_{oc}$	dBm/3.84 MHz	-60			
HS-SCCH UE Identity ( $x_{ue,1}, x_{ue,2}, \dots, x_{ue,16}$ )		HS-SCCH-1: 1010101010101010 (every third TTI only, UE under test addressed solely via HS-SCCH-1) HS-SCCH-2: 0001001010101010 HS-SCCH-3: 0001101010101010 HS-SCCH-4: 0001111110101010			
HS-DSCH TF of UE1		<u>In case one transport block is signalled on HS-SCCH:</u> One transport block with TF corresponding to CQI1 Precoding vector applied to HS-PDSCH shall cycle through the four possible options.  <u>In case two transport blocks are signalled on HS-SCCH:</u> Two transport blocks with the same size and same number of OVSF codes as used in the case of transmitting only one transport block. Precoding matrix applied to HS-PDSCH shall cycle through the four possible options.			
HS-SCCH-1 transmission pattern		The HS-SCCH-1 shall be transmitted continuously with constant power.			
HS-PDSCH transmission pattern		The HS-PDSCH shall be transmitted continuously with constant power.			
HS-SCCH-1 TTI Signalling Pattern	-	The six sub-frame HS-SCCH-1 signalling pattern shall be '...XOOXOO...', where 'X' indicates TTI in which the HS-SCCH-1 uses the identity of the UE under test, and 'O' indicates TTI in which the HS-SCCH-1 uses a different UE identity.			

**Table 9.56: Minimum requirement for HS-SCCH Type 3 detection, single transport block case with downlink physical channel setup in Table C.12**

Test Number	Propagation Conditions	Reference value		
		HS-SCCH-1 $E_c / I_{or}$ (dB)	$\hat{I}_{or} / I_{oc}$ (dB)	$P(E_m)$
1	PA3	-15.6	0	0.01
2	VA3	-16.8	0	0.01

**Table 9.57: Minimum requirement for HS-SCCH Type 3 detection, dual transport block case with downlink physical channel setup in Table C.12**

Test Number	Propagation Conditions	Reference value		
		HS-SCCH-1 $E_c / I_{or}$ (dB)	$\hat{I}_{or} / I_{oc}$ (dB)	$P(E_m)$
3	PA3	-14.7	0	0.01
4	VA3	-16.0	0	0.01

**Table 9.57a: Minimum requirement for HS-SCCH Type 3 detection, STTD disabled, single transport block case with downlink physical channel setup in Table C.12E**

Test Number	Propagation Conditions	Reference value		
		HS-SCCH-1 $E_c / I_{or}$ (dB)	$\hat{I}_{or} / I_{oc}$ (dB)	$P(E_m)$
1	PA3	-12.3	0	0.01
2	VA3	-14.9	0	0.01



**Table 9.57b: Minimum requirement for HS-SCCH Type 3 detection, STTD disabled, dual transport block case with downlink physical channel setup in Table C.12E**

Test Number	Propagation Conditions	Reference value		
		HS-SCCH-1 $E_c/I_{or}$ (dB)	$\hat{I}_{or}/I_{oc}$ (dB)	$P(E_m)$
3	PA3	-11.4	0	0.01
4	VA3	-14.2	0	0.01

**Table 9.57c: Minimum requirement for HS-SCCH Type 3 detection, STTD enabled, single transport block case with downlink physical channel setup in Table C.12E**

Test Number	Propagation Conditions	Reference value		
		HS-SCCH-1 $E_c/I_{or}$ (dB)	$\hat{I}_{or}/I_{oc}$ (dB)	$P(E_m)$
1	PA3	-15.3	0	0.01
2	VA3	-16.7	0	0.01

**Table 9.57d: Minimum requirement for HS-SCCH Type 3 detection, STTD enabled, dual transport block case with downlink physical channel setup in Table C.12E**

Test Number	Propagation Conditions	Reference value		
		HS-SCCH-1 $E_c/I_{or}$ (dB)	$\hat{I}_{or}/I_{oc}$ (dB)	$P(E_m)$
3	PA3	-14.4	0	0.01
4	VA3	-15.8	0	0.01

#### 9.4.4 HS-SCCH Type 3 Performance for MIMO only with single-stream restriction

For the test parameters specified in Table 9.57A1 with the downlink physical channel setup in Table C.12, for each value of HS-SCCH-1  $E_c/I_{or}$  specified in Table 9.57A2 and Table 9.57A3 the measured  $P(E_m)$  shall be less than or equal to the corresponding specified value of  $P(E_m)$ . The requirements in Table 9.57A2 and Table 9.57A3 assume STTD is enabled on HS-SCCH and DPCH. The requirements in Table 9.57A2 and Table 9.57A3 assume HS-SCCH Type 3 coding associated with single stream transmission on HS-DSCH. Performance requirements specified in Table 9.57A3 are based on receiver diversity.

For the test parameters specified in Table 9.57A1 with the downlink physical channel setup in Table C.12E, for each value of HS-SCCH-1  $E_c/I_{or}$  specified in Table 9.57A4, Table 9.57A5, Table 9.57A6 and Table 9.57A7, the measured  $P(E_m)$  shall be less than or equal to the corresponding specified value of  $P(E_m)$ . The requirements in Table 9.57A4 and Table 9.57A5 assume STTD is disabled on HS-SCCH and DPCH. The requirements in Table 9.57A6 and Table 9.57A7 assume STTD is enabled on HS-SCCH and DPCH. The requirements in Table 9.57A4, Table 9.57A5, Table 9.57A6 and Table 9.57A7 assume HS-SCCH Type 3 coding associated with single stream transmission on HS-DSCH. Performance requirements specified in Table 9.57A5 and Table 9.57A7 are based on receiver diversity.



**Table 9.57A1: Test parameters for HS-SCCH Type 3 detection**

Parameter	Unit	Test 1	Test 2
$I_{oc}$	dBm/3.84 MHz	-60	
Phase reference	-	P-CPICH	
P-CPICH $E_c/I_{or}$	dB	-10	
HS-SCCH UE Identity ( $x_{ue,1}, x_{ue,2}, \dots, x_{ue,16}$ )		HS-SCCH-1: 1010101010101010 (every third TTI only, UE under test addressed solely via HS-SCCH-1) HS-SCCH-2: 0001001010101010 HS-SCCH-3: 0001101010101010 HS-SCCH-4: 0001111110101010	
HS-DSCH TF of UE1		One transport block with TF corresponding to CQI1 Precoding vector applied to HS-PDSCH shall cycle through the four possible options.	
HS-SCCH-1 transmission pattern		The HS-SCCH-1 shall be transmitted continuously with constant power.	
HS-PDSCH transmission pattern		The HS-PDSCH shall be transmitted continuously with constant power.	
HS-SCCH-1 TTI Signalling Pattern	-	The six sub-frame HS-SCCH-1 signalling pattern shall be '...XOOXOO...', where 'X' indicates TTI in which the HS-SCCH-1 uses the identity of the UE under test, and 'O' indicates TTI in which the HS-SCCH-1 uses a different UE identity.	

**Table 9.57A2: Minimum requirement for HS-SCCH Type 3 detection, single transport block case with downlink physical channel setup in Table C.12**

Test Number	Propagation Conditions	Reference value		
		HS-SCCH-1 $E_c/I_{or}$ (dB)	$\hat{I}_{or}/I_{oc}$ (dB)	$P(E_m)$
1	PA3	-8.9	0	0.01
2	VA3	-11.0	0	0.01

**Table 9.57A3: Enhanced requirement type 1 for HS-SCCH Type 3 detection, single transport block case with downlink physical channel setup in Table C.12**

Test Number	Propagation Conditions	Reference value		
		HS-SCCH-1 $E_c/I_{or}$ (dB)	$\hat{I}_{or}/I_{oc}$ (dB)	$P(E_m)$
1	PA3	-15.6	0	0.01
2	VA3	-16.8	0	0.01

**Table 9.57A4: Minimum requirement for HS-SCCH Type 3 detection, STTD disabled, single transport block case with downlink physical channel setup in Table C.12E**

Test Number	Propagation Conditions	Reference value		
		HS-SCCH-1 $E_c/I_{or}$ (dB)	$\hat{I}_{or}/I_{oc}$ (dB)	$P(E_m)$
1	PA3	-11.0	3	0.05
2	VA3	-8.7	0	0.01



**Table 9.57A5: Enhanced requirement type 1 for HS-SCCH Type 3 detection, STTD disabled, single transport block case with downlink physical channel setup in Table C.12E**

Test Number	Propagation Conditions	Reference value		
		HS-SCCH-1 $E_c / I_{or}$ (dB)	$\hat{I}_{or} / I_{oc}$ (dB)	$P(E_m)$
1	PA3	-12.3	0	0.01
2	VA3	-14.9	0	0.01

**Table 9.57A6: Minimum requirement for HS-SCCH Type 3 detection, STTD enabled, single transport block case with downlink physical channel setup in Table C.12E**

Test Number	Propagation Conditions	Reference value		
		HS-SCCH-1 $E_c / I_{or}$ (dB)	$\hat{I}_{or} / I_{oc}$ (dB)	$P(E_m)$
1	PA3	-8.4	0	0.01
2	VA3	-11.1	0	0.01

**Table 9.57A7: Enhanced requirement type 1 for HS-SCCH Type 3 detection, STTD enabled, single transport block case with downlink physical channel setup in Table C.12E**

Test Number	Propagation Conditions	Reference value		
		HS-SCCH-1 $E_c / I_{or}$ (dB)	$\hat{I}_{or} / I_{oc}$ (dB)	$P(E_m)$
1	PA3	-15.3	0	0.01
2	VA3	-16.7	0	0.01

## 9.4.5 HS-SCCH Type 4 Performance

For the test parameters specified in Table 9.57B1 with the downlink physical channel setup in Table C.12G, for each value of HS-SCCH-1  $E_c / I_{or}$  specified in Table 9.57B2 and Table 9.57B3 the measured  $P(E_m)$  shall be less than or equal to the corresponding specified value of  $P(E_m)$ . The requirements in Table 9.57B2 and Table 9.57B3 assume STTD is disabled on HS-SCCH and DPCH. The requirements in Table 9.57B2 assume HS-SCCH Type 4 coding associated with single stream transmission on HS-DSCH. The requirements in Table 9.57B3 assume HS-SCCH Type 4 coding associated with four stream transmission on HS-DSCH.

Minimum performance requirements specified in Table 9.57B1, 9.57B2 are based on receiver diversity.



**Table 9.57B1: Test parameters for HS-SCCH Type 4 detection**

Parameter	Unit	Test 1	Test 2	Test 3	Test 4
$I_{oc}$	dBm/3.84 MHz	-60			
HS-SCCH UE Identity ( $x_{ue,1}, x_{ue,2}, \dots, x_{ue,16}$ )		HS-SCCH-1: 1010101010101010 (every third TTI only, UE under test addressed solely via HS-SCCH-1) HS-SCCH-2: 0001001010101010 HS-SCCH-3: 0001101010101010 HS-SCCH-4: 0001111101010101			
HS-DSCH TF of UE1		<u>In case one transport block is signalled on HS-SCCH:</u> One transport block with TF corresponding to CQI1 Precoding vector applied to HS-PDSCH shall cycle through all the possible options.  <u>In case four transport blocks are signalled on HS-SCCH:</u> Three/four transport blocks with the same size and same number of OVSF codes as used in the case of transmitting only one transport block. Precoding matrix applied to HS-PDSCH shall cycle through all the possible options. Note that 2, 3 or 4 transport blocks will have the same HS-SCCH structure.			
HS-SCCH-1 transmission pattern		The HS-SCCH-1 shall be transmitted continuously with constant power.			
HS-PDSCH transmission pattern		The HS-PDSCH shall be transmitted continuously with constant power.			
HS-SCCH-1 TTI Signalling Pattern	-	The six sub-frame HS-SCCH-1 signalling pattern shall be '...XOOXOO...', where 'X' indicates TTI in which the HS-SCCH-1 uses the identity of the UE under test, and 'O' indicates TTI in which the HS-SCCH-1 uses a different UE identity.			

**Table 9.57B2: Minimum requirement for HS-SCCH Type 4 detection, single transport block case with downlink physical channel setup in Table C.12G**

Test Number	Propagation Conditions	Reference value		
		HS-SCCH-1 $E_c/I_{or}$ (dB)	$\hat{I}_{or}/I_{oc}$ (dB)	$P(E_m)$
1	PA3	-18	0	0.01
2	VA3	-19	0	0.01

**Table 9.57B3: Minimum requirement for HS-SCCH Type 4 detection, four transport block case with downlink physical channel setup in Table C.12G**

Test Number	Propagation Conditions	Reference value		
		HS-SCCH-1 $E_c/I_{or}$ (dB)	$\hat{I}_{or}/I_{oc}$ (dB)	$P(E_m)$
3	PA3	-21	5	0.01
4	VA3	-20	5	0.01

## 9.4.6 HS-SCCH Type 4 Performance for MIMO mode with Four Transmit Antennas Only with Dual-stream Restriction

For the test parameters specified in Table 9.57B4 with the downlink physical channel setup in Table C.12G, for each value of HS-SCCH-1  $E_c/I_{or}$  specified in Table 9.57B5 and Table 9.57B6 the measured  $P(E_m)$  shall be less than or equal to the corresponding specified value of  $P(E_m)$ . The requirements in Table 9.57B5 and Table 9.57B6 assume STTD is disabled on HS-SCCH and DPCH. The requirements in Table 9.57B5 and Table 9.57B6 assume HS-SCCH Type 4



coding associated with dual stream transmission on HS-DSCH. Performance requirements specified in Table 9.57B5 and 9.57B6 are based on (dual branches) receiver diversity.

**Table 9.57B4: Test parameters for HS-SCCH Type 4 detection**

Parameter	Unit	Test 1	Test 2	Test 3	Test 4
$I_{oc}$	dBm/3.84 MHz	-60			
HS-SCCH UE Identity ( $x_{ue,1}, x_{ue,2}, \dots, x_{ue,16}$ )		HS-SCCH-1: 1010101010101010 (every third TTI only, UE under test addressed solely via HS-SCCH-1) HS-SCCH-2: 0001001010101010 HS-SCCH-3: 0001101010101010 HS-SCCH-4: 0001111101010101			
HS-DSCH TF of UE1		<u>In case one transport block is signalled on HS-SCCH:</u> One transport block with TF corresponding to CQI1 Precoding vector applied to HS-PDSCH shall cycle through all the possible options.  <u>Two transport blocks are signalled on HS-SCCH:</u> Two transport blocks with the same size and same number of OVSF codes as used in the case of transmitting only one transport block. Precoding matrix applied to HS-PDSCH shall cycle through all the possible options.			
HS-SCCH-1 transmission pattern		The HS-SCCH-1 shall be transmitted continuously with constant power.			
HS-PDSCH transmission pattern		The HS-PDSCH shall be transmitted continuously with constant power.			
HS-SCCH-1 TTI Signalling Pattern	-	The six sub-frame HS-SCCH-1 signalling pattern shall be '...XOOXOO...', where 'X' indicates TTI in which the HS-SCCH-1 uses the identity of the UE under test, and 'O' indicates TTI in which the HS-SCCH-1 uses a different UE identity.			

**Table 9.57B5: Enhanced requirement type 1 for HS-SCCH Type 4 detection, single transport block case with downlink physical channel setup in Table C.12G**

Test Number	Propagation Conditions	Reference value		
		HS-SCCH-1 $E_c / I_{or}$ (dB)	$\hat{I}_{or} / I_{oc}$ (dB)	$P(E_m)$
1	PA3	-17	5	0.01
2	VA3	-17.8	5	0.01

**Table 9.57B6: Enhanced requirement type 1 for HS-SCCH Type 4 detection, dual transport block case with downlink physical channel setup in Table C.12G**

Test Number	Propagation Conditions	Reference value		
		HS-SCCH-1 $E_c / I_{or}$ (dB)	$\hat{I}_{or} / I_{oc}$ (dB)	$P(E_m)$
1	PA3	-19	10	0.01
2	VA3	-18.5	10	0.01

## 9.5 HS-SCCH-less demodulation of HS-DSCH (Fixed Reference Channel)

The receiver performance of the High Speed Physical Downlink Shared Channel (HS-DSCH) with HS-SCCH-less operation in multi-path fading environment is determined by the information bit throughput R.

The propagation conditions for this subclause are defined in table B.1C.



During the Fixed Reference Channel tests the behaviour of the Node-B emulator in response to the ACK/NACK signalling field of the HS-DPCCH is specified in Table 9.1A.

Performance requirements in this section assume sufficient power allocation to HS-SCCH\_1, so that the probability of detection failure, when the HS-SCCH-1 uses the identity of the UE under test, is very low.

### 9.5.1 Requirement QPSK, Fixed Reference Channel (FRC) H-Set 7

The requirements are specified in terms of a minimum information bit throughput  $R$  for the DL reference channels H-set 7 specified in Annex A.7.1.7, with the addition of the parameters in Table 9.58 and the downlink physical channel setup according to table C.8.

Using this configuration the throughput shall meet or exceed the minimum requirements specified in table 9.59. Enhanced performance requirements type 1 specified in Table 9.60 are based on receiver diversity.

**Table 9.58: Test Parameters for Testing QPSK FRCs H-Set 7**

Parameter	Unit	Test 1
Phase reference	-	P-CPICH
$I_{oc}$	dBm/3.84 MHz	-60
Redundancy and constellation version coding sequence	-	{0,3}
Maximum number of HARQ transmission	-	2
NOTE: The HS-SCCH-1 and HS-PDSCH shall be transmitted continuously with constant power. HS-SCCH-1 shall only use the identity of the UE under test for redundancy version 3 transmissions intended for the UE.		

**Table 9.59: Minimum requirement, Fixed Reference Channel (FRC) H-Set 7**

Test Number	Propagation Conditions	Reference value		
		HS-PDSCH $E_c/I_{or}$ (dB)	$\hat{I}_{or}/I_{oc}$ (dB)	T-put $R$ (kbps)
1	Case 8	-6	0	19.9

**Table 9.60: Enhanced requirement type 1, Fixed Reference Channel (FRC) H-Set 7**

Test Number	Propagation Conditions	Reference value		
		HS-PDSCH $E_c/I_{or}$ (dB)	$\hat{I}_{or}/I_{oc}$ (dB)	T-put $R$ (kbps)
1	Case 8	-9	0	23.5

## 9.6 Requirements for HS-DSCH and HS-SCCH reception in CELL\_FACH state

The requirements determined in this section apply for UE being able to receive HS-DSCH and HS-SCCH in CELL\_FACH state.

### 9.6.1 HS-DSCH demodulation requirements (Single Link)

The receiver single link performance of the High Speed Physical Downlink Shared Channel (HS-DSCH) is determined by the RLC SDU error rate (RLC SDU ER).



### 9.6.1.1 Requirement QPSK, Fixed Reference Channel (FRC) H-Set 3

The requirements are specified in terms of a minimum RLC SDU error rate (RLC SDU ER) for the DL reference channel H-Set 3 (QPSK version) specified in A.7.1.3, with the addition of the parameters in Table 9.61 and the downlink physical channel setup according to Table C.12A. For the test parameters specified in Table 9.61, for the value of HS-DSCH-1  $E_c/I_{or}$  specified in Table 9.62 the measured RLC SDU ER shall be less than or equal to the corresponding specified value of RLC SDU ER.

**Table 9.61: Test Parameters for Testing QPSK FRCs H-Set 3**

Parameter	Unit	Test 1
Phase reference		P-CPICH
$I_{oc}$	dBm/3.84 MHz	-60
Redundancy and constellation version coding sequence		{0,2,5,6}
Number of HARQ transmission		4
NOTE: The HS-SCCH-1 and HS-PDSCH shall be transmitted continuously with constant power. HS-SCCH-1 shall only use the identity of the UE under test for those TTI intended for the UE.		
NOTE: The HS-PDSCH is transmitted using all four HARQ transmissions cycling through the different redundancy and constellation versions.		

**Table 9.62: Minimum requirement QPSK, Fixed Reference Channel (FRC) H-Set 3**

Test Number	Propagation Conditions	Reference value	
		HS-PDSCH $E_c/I_{or}$ (dB)	RLC SDU ER $\hat{I}_{or}/I_{oc} = 0$ dB
1	VA30	-6	0.82

## 9.6.2 HS-SCCH Detection Performance

The detection performance of the HS-SCCH is determined by RLC SDU error rate (RLC SDU ER).

### 9.6.2.1 HS-SCCH Type 1 Single Link Performance

For the test parameters specified in Table 9.63, for the value of HS-SCCH-1  $E_c/I_{or}$  specified in Table 9.64 the measured RLC SDU ER shall be less than or equal to the corresponding specified value of RLC SDU ER. The downlink physical channel setup according to Table C.12B.

**Table 9.63: Test parameters for HS-SCCH detection – single link**

Parameter	Unit	Test 1	Test 2	Test 3
$I_{oc}$	dBm/3.84 MHz	-60		
Phase reference	-	P-CPICH		
P-CPICH $E_c/I_{or}$	dB	-10		
HS-SCCH UE Identity ( $x_{ue,1}, x_{ue,2}, \dots, x_{ue,16}$ )		HS-SCCH-1: 1010101010101010 (UE under test addressed solely via HS-SCCH-1) HS-SCCH-2: 0001001010101010		
HS-DSCH TF of UE1		TF corresponding to CQI1		
HS-SCCH-1 transmission pattern		The HS-SCCH-1 shall be transmitted continuously with constant power.		
HS-PDSCH transmission pattern		The HS-PDSCH shall be transmitted continuously with constant power, without re-transmissions.		
HS-SCCH-1 TTI Signalling Pattern	-	The identity of the UE under test shall be used on every fourth TTI.		



**Table 9.64: Minimum requirement for HS-SCCH detection – single link**

Test Number	Propagation Conditions	Reference value		
		HS-SCCH-1 $E_c/I_{or}$ (dB)	$\hat{I}_{or}/I_{oc}$ (dB)	RLC SDU ER
3	VA30	-10	0	0.01

## 10 Performance requirement (E-DCH)

### 10.1 General

The performance requirements for the UE in this subclause are specified for the propagation conditions specified in Annex B.2.2 and the Downlink Physical channels specified in Annex C.3.2.

Unless otherwise stated the receiver characteristics are specified at the antenna connector of the UE. For UE(s) with an integral antenna only, a reference antenna with a gain of 0 dBi is assumed. UE with an integral antenna may be taken into account by converting these power levels into field strength requirements, assuming a 0 dBi gain antenna. For UEs with more than one receiver antenna connector the fading of the signals and the AWGN signals applied to each receiver antenna connector shall be uncorrelated. The levels of the test signal applied to each of the antenna connectors shall be as defined in the respective sections below. Enhanced performance requirements Type 1 are based on receiver diversity.

### 10.2 Detection of E-DCH HARQ ACK Indicator Channel (E-HICH)

#### 10.2.1 Single link performance

The receive characteristics of the E-DCH HARQ ACK Indicator Channel (E-HICH) in different multi-path fading environments are determined by the missed ACK and false ACK values.

##### 10.2.1.1 Performance requirement

For the parameters specified in Table 10.1 the average downlink E-HICH  $E_c/I_{or}$  power ratio shall be below the specified value for the missed ACK probabilities in Table 10.2 and 10.3 for minimum performance requirements and Table 10.2A and 10.3A for enhanced performance requirements Type 1. For the parameters specified in Table 10.1 the false ACK probability shall be below the specified value in Table 10.4 and 10.5.

**Table 10.1: Requirement scenario parameters for E-HICH – RLS containing the Serving E-DCH cell**

Parameter	Unit	Missed ACK	False ACK
$I_{oc}$	dBm/3.84 MHz	-60	
Phase reference	-	P-CPICH	
P-CPICH $E_c/I_{or}$	dB	-10	
E-HICH signalling pattern	-	100% ACK	100% DTX

**Table 10.2: Minimum requirement for Missed ACK when hybrid ARQ acknowledgement indicator is transmitted using 3 consecutive slots – RLS containing the Serving E-DCH cell**

Test Number	Propagation Conditions	Reference value		
		E-HICH $E_c/I_{or}$ (dB)	$\hat{I}_{or}/I_{oc}$ (dB)	Missed ACK probability
1	VA30	-28.3	0	0.01



**Table 10.2A: Enhanced performance requirement Type 1 for Missed ACK when hybrid ARQ acknowledgement indicator is transmitted using 3 consecutive slots – RLS containing the Serving E-DCH cell**

Test Number	Propagation Conditions	Reference value		
		E-HICH $E_c/I_{or}$ (dB)	$\hat{I}_{or}/I_{oc}$ (dB)	Missed ACK probability
1	VA30	-31.7	0	0.01

**Table 10.3: Minimum requirement for Missed ACK when hybrid ARQ acknowledgement indicator is transmitted using 12 consecutive slots – RLS containing the Serving E-DCH cell**

Test Number	Propagation Conditions	Reference value		
		E-HICH $E_c/I_{or}$ (dB)	$\hat{I}_{or}/I_{oc}$ (dB)	Missed ACK probability
2	VA30	-35.1	0	0.01

**Table 10.3A: Enhanced performance requirement Type 1 for Missed ACK when hybrid ARQ acknowledgement indicator is transmitted using 12 consecutive slots – RLS containing the Serving E-DCH cell**

Test Number	Propagation Conditions	Reference value		
		E-HICH $E_c/I_{or}$ (dB)	$\hat{I}_{or}/I_{oc}$ (dB)	Missed ACK probability
2	VA30	-38.3	0	0.01

**Table 10.4: Minimum requirement for False ACK when hybrid ARQ acknowledgement indicator is transmitted using 3 consecutive slots – RLS containing the Serving E-DCH cell**

Test Number	Propagation Conditions	Reference value	
		$\hat{I}_{or}/I_{oc}$ (dB)	False ACK probability
3	VA30	0	0.5

**Table 10.5: Minimum requirement for False ACK when hybrid ARQ acknowledgement indicator is transmitted using 12 consecutive slots – RLS containing the Serving E-DCH cell**

Test Number	Propagation Conditions	Reference value	
		$\hat{I}_{or}/I_{oc}$ (dB)	False ACK probability
4	VA30	0	0.5

## 10.2.2 Detection in Inter-Cell Handover conditions

The receive characteristics of the E-DCH HARQ ACK Indicator Channel (E-HICH) is determined during an inter-cell soft handover by the missed ACK and false ACK error probabilities. During the soft handover a UE receives signals from different cells. A UE has to be able to detect E-HICH signalling from different cells belonging to different RLS, containing and not containing the Serving E-DCH cell.

### 10.2.2.1 Performance requirement for RLS not containing the Serving E-DCH cell

For the parameters specified in Table 10.6 the average downlink E-HICH  $E_c/I_{or}$  power ratio of cell belonging to RLS not containing the Serving E-DCH cell shall be below the specified value for the missed ACK probabilities in Table 10.7 and 10.8 for minimum performance requirements and Table 10.7A and 10.8A for enhanced performance requirements Type 1. For the parameters specified in Table 10.6 the false ACK probability shall be below the specified value in Table 10.9 and 10.10.



**Table 10.6: Requirement scenario parameters for E-HICH – cell belonging to RLS not containing the Serving E-DCH cell**

Parameter	Unit	Missed ACK	False ACK
$I_{oc}$	dBm/3.84 MHz	-60	
Phase reference	-	P-CPICH	
P-CPICH $E_c/I_{or}$	dB	-10	
E-HICH signalling pattern for the Serving E-DCH cell	-	100% NACK (-1) <sup>1</sup>	100% NACK (-1) <sup>1</sup>
E-HICH signalling pattern for cell belonging to RLS not containing the Serving E-DCH cell		100% ACK (+1)	100% NACK (0)
Note 1 The Serving E-DCH cell E-HICH $E_c/I_{or}$ power level is set to -16 dB when hybrid ARQ acknowledgement indicator is transmitted using 3 consecutive slots and to -23 dB when hybrid ARQ acknowledgement indicator is transmitted using 12 consecutive slots.			

**Table 10.7: Minimum requirement for Missed ACK when hybrid ARQ acknowledgement indicator is transmitted using 3 consecutive slots – cell belonging to RLS not containing the Serving E-DCH cell**

Test Number	Propagation Conditions	Reference value		
		E-HICH $E_c/I_{or}$ (dB)	$\hat{I}_{or1}/I_{oc}$ and $\hat{I}_{or2}/I_{oc}$ (dB)	Missed ACK probability
1	VA30	-16.3	0	0.05

**Table 10.7A: Enhanced performance requirement Type 1 for Missed ACK when hybrid ARQ acknowledgement indicator is transmitted using 3 consecutive slots – cell belonging to RLS not containing the Serving E-DCH cell**

Test Number	Propagation Conditions	Reference value		
		E-HICH $E_c/I_{or}$ (dB)	$\hat{I}_{or1}/I_{oc}$ and $\hat{I}_{or2}/I_{oc}$ (dB)	Missed ACK probability
1	VA30	-20.6	0	0.05

**Table 10.8: Minimum requirement for Missed ACK when hybrid ARQ acknowledgement indicator is transmitted using 12 consecutive slots – cell belonging to RLS not containing the Serving E-DCH cell**

Test Number	Propagation Conditions	Reference value		
		E-HICH $E_c/I_{or}$ (dB)	$\hat{I}_{or1}/I_{oc}$ and $\hat{I}_{or2}/I_{oc}$ (dB)	Missed ACK probability
2	VA30	-23.6	0	0.05

**Table 10.8A: Enhanced performance requirement Type 1 for Missed ACK when hybrid ARQ acknowledgement indicator is transmitted using 12 consecutive slots – cell belonging to RLS not containing the Serving E-DCH cell**

Test Number	Propagation Conditions	Reference value		
		E-HICH $E_c/I_{or}$ (dB)	$\hat{I}_{or1}/I_{oc}$ and $\hat{I}_{or2}/I_{oc}$ (dB)	Missed ACK probability
2	VA30	-27.8	0	0.05



**Table 10.9: Requirement for False ACK when hybrid ARQ acknowledgement indicator is transmitted using 3 consecutive slots – cell belonging to RLS not containing the Serving E-DCH cell**

Test Number	Propagation Conditions	Reference value	
		$\hat{I}_{or1}/I_{oc}$ and $\hat{I}_{or2}/I_{oc}$ (dB)	False ACK probability
3	VA30	0	2E-4

**Table 10.10: Requirement for False ACK when hybrid ARQ acknowledgement indicator is transmitted using 12 consecutive slots – cell belonging to RLS not containing the Serving E-DCH cell**

Test Number	Propagation Conditions	Reference value	
		$\hat{I}_{or1}/I_{oc}$ and $\hat{I}_{or2}/I_{oc}$ (dB)	False ACK probability
4	VA30	0	2E-4

### 10.2.2.2 Performance requirement for RLS containing the serving E-DCH cell

For the parameters specified in Table 10.11 the average downlink E-HICH  $E_c/I_{or}$  power ratio of cell belonging to RLS containing the serving E-DCH cell shall be below the specified value for the missed ACK probabilities in Table 10.12 and 10.13 for minimum performance requirements and Table 10.12A and 10.13A for enhanced performance requirements Type 1. For the parameters specified in Table 10.11 the false ACK probability shall be below the specified value in Table 10.14 and 10.15.

**Table 10.11: Requirement scenario parameters for E-HICH – RLS containing the serving cell in SHO**

Parameter	Unit	Missed ACK	False ACK
$I_{oc}$	dBm/3.84 MHz	-60	
Phase reference	-	P-CPICH	
P-CPICH $E_c/I_{or}$	dB	-10	
E-HICH signalling pattern for Serving E-DCH cell	-	100% ACK (+1)	100% DTX (0)
E-HICH signalling pattern for cell belonging to RLS not containing the Serving E-DCH cell	-	100% NACK (0)	100% NACK (0)

**Table 10.12: Minimum requirement for Missed ACK when hybrid ARQ acknowledgement indicator is transmitted using 3 consecutive slots – RLS containing the Serving E-DCH cell**

Test Number	Propagation Conditions	Reference value		
		E-HICH $E_c/I_{or}$ (dB) for Serving E-DCH cell (ACK)	$\hat{I}_{or1}/I_{oc}$ and $\hat{I}_{or2}/I_{oc}$ (dB)	Missed ACK probability
1	VA30	-23.2	0	0.05

**Table 10.12A: Enhanced performance requirement Type 1 for Missed ACK when hybrid ARQ acknowledgement indicator is transmitted using 3 consecutive slots – RLS containing the Serving E-DCH cell**

Test Number	Propagation Conditions	Reference value		
		E-HICH $E_c/I_{or}$ (dB) for Serving E-DCH cell (ACK)	$\hat{I}_{or1}/I_{oc}$ and $\hat{I}_{or2}/I_{oc}$ (dB)	Missed ACK probability
1	VA30	-27.1	0	0.05



**Table 10.13: Minimum requirement for Missed ACK when hybrid ARQ acknowledgement indicator is transmitted using 12 consecutive slots – RLS containing the Serving E-DCH cell**

Test Number	Propagation Conditions	Reference value		
		E-HICH $E_c / I_{or}$ (dB) for Serving E-DCH cell (ACK)	$\hat{I}_{or1}/I_{oc}$ and $\hat{I}_{or2}/I_{oc}$ (dB)	Missed ACK probability
2	VA30	-29.7	0	0.05

**Table 10.13A: Enhanced performance requirement Type 1 for Missed ACK when hybrid ARQ acknowledgement indicator is transmitted using 12 consecutive slots – RLS containing the Serving E-DCH cell**

Test Number	Propagation Conditions	Reference value		
		E-HICH $E_c / I_{or}$ (dB) for Serving E-DCH cell (ACK)	$\hat{I}_{or1}/I_{oc}$ and $\hat{I}_{or2}/I_{oc}$ (dB)	Missed ACK probability
2	VA30	-33.4	0	0.05

**Table 10.14: Requirement for False ACK when hybrid ARQ acknowledgement indicator is transmitted using 3 consecutive slots – RLS containing the Serving E-DCH cell**

Test Number	Propagation Conditions	Reference value	
		$\hat{I}_{or1}/I_{oc}$ and $\hat{I}_{or2}/I_{oc}$ (dB)	False ACK probability
3	PA3	0	0.1
4	VA120	0	0.1

**Table 10.15: Requirement for False ACK when hybrid ARQ acknowledgement indicator is transmitted using 12 consecutive slots – RLS containing the Serving E-DCH cell**

Test Number	Propagation Conditions	Reference value	
		$\hat{I}_{or1}/I_{oc}$ and $\hat{I}_{or2}/I_{oc}$ (dB)	False ACK probability
5	PA3	0	0.1
6	VA120	0	0.1

## 10.3 Detection of E-DCH Relative Grant Channel (E-RGCH)

### 10.3.1 Single link performance

The receive characteristics of the E-DCH Relative Grant Channel (E-RGCH) in multi-path fading environment is determined by the missed UP/DOWN and missed HOLD.

#### 10.3.1.1 Performance requirement

For the parameters specified in Table 10.16 the average downlink E-RGCH  $E_c/I_{or}$  power ratio shall be below the specified value for the missed UP/DOWN probabilities in Table 10.17 and 10.18 for minimum performance requirements and Table 10.17A and 10.18A for enhanced performance requirements Type 1. For the parameters specified in Table 10.16 the missed HOLD probability shall be below the specified value in Table 10.19 and 10.20.



**Table 10.16: Requirement scenario parameters for E-RGCH – Serving E-DCH RLS**

Parameter	Unit	Missed UP/DOWN	Missed HOLD
$I_{oc}$	dBm/3.84 MHz	-60	
Phase reference	-	P-CPICH	
P-CPICH $E_c/I_{or}$	dB	-10	
E-RGCH signalling pattern	-	50% UP 50% DOWN	100% HOLD

**Table 10.17: Minimum requirement for Missed UP/DOWN when relative scheduling grant is transmitted using 3 consecutive slots – Serving E-DCH RLS**

Test Number	Propagation Conditions	Reference value		
		E-RGCH $E_c/I_{or}$ (dB)	$\hat{I}_{or}/I_{oc}$ (dB)	Missed UP/DOWN probability
1	VA30	-24.4	0	0.05/0.05

**Table 10.17A: Enhanced performance requirement Type 1 for Missed UP/DOWN when relative scheduling grant is transmitted using 3 consecutive slots – Serving E-DCH RLS**

Test Number	Propagation Conditions	Reference value		
		E-RGCH $E_c/I_{or}$ (dB)	$\hat{I}_{or}/I_{oc}$ (dB)	Missed UP/DOWN probability
1	VA30	-28.6	0	0.05/0.05

**Table 10.18: Minimum requirement for Missed UP/DOWN when relative scheduling grant is transmitted using 12 consecutive slots – Serving E-DCH RLS**

Test Number	Propagation Conditions	Reference value		
		E-RGCH $E_c/I_{or}$ (dB)	$\hat{I}_{or}/I_{oc}$ (dB)	Missed UP/DOWN probability
2	VA30	-31	0	0.05/0.05

**Table 10.18A: Enhanced performance requirement Type 1 for Missed UP/DOWN when relative scheduling grant is transmitted using 12 consecutive slots – Serving E-DCH RLS**

Test Number	Propagation Conditions	Reference value		
		E-RGCH $E_c/I_{or}$ (dB)	$\hat{I}_{or}/I_{oc}$ (dB)	Missed UP/DOWN probability
2	VA30	-35.0	0	0.05/0.05

**Table 10.19: Requirement for Missed HOLD when relative scheduling grant is transmitted using 3 consecutive slots – Serving E-DCH RLS**

Test Number	Propagation Conditions	Reference value	
		$\hat{I}_{or}/I_{oc}$ (dB)	Missed HOLD probability
3	VA30	0	0.1



**Table 10.20: Requirement for Missed HOLD when relative scheduling grant is transmitted using 12 consecutive slots – Serving E-DCH RLS**

Test Number	Propagation Conditions	Reference value	
		$\hat{I}_{or}/I_{oc}$ (dB)	Missed HOLD probability
4	VA30	0	0.1

### 10.3.2 Detection in Inter-Cell Handover conditions

The receive characteristics of the E-DCH Relative Grant Channel (E-RGCH) is determined during an inter-cell soft handover by the missed UP/DOWN and missed HOLD error probabilities. During the soft handover a UE receives signals from different cells. A UE has to be able to detect E-RGCH signalling from different cells, Serving E-DCH cell and Non-serving E-DCH RL.

#### 10.3.2.1 Performance requirement for Non-serving E-DCH RL

For the parameters specified in Table 10.21 the missed HOLD probability shall be below the specified value in Table 10.22. For the parameters specified in Table 10.21 the average downlink E-RGCH  $E_c/I_{or}$  power ratio shall be below the specified value for the missed DOWN probabilities in Table 10.23 for minimum performance requirements and Table 10.23A for enhanced performance requirements Type 1.

**Table 10.21: Requirement scenario parameters for E-RGCH – Non-serving E-DCH RL**

Parameter	Unit	Missed HOLD	Missed DOWN
$I_{oc}$	dBm/3.84 MHz	-60	
Phase reference	-	P-CPICH	
P-CPICH $E_c/I_{or}$	dB	-10	
E-RGCH signalling pattern for Serving E-DCH cell	-	100% UP <sup>1</sup>	100% UP <sup>1</sup>
E-AGCH information		Fixed SG <sup>2</sup>	Fixed SG <sup>2</sup>
E-RGCH signalling pattern for Non-serving E-DCH RL		100% HOLD	100% DOWN
Note 1 Serving E-DCH cell E-RGCH $E_c/I_{or}$ power level is set to -22 dB and relative scheduling grant is transmitted using 12 consecutive slots.			
Note 2 Serving E-DCH cell E-AGCH $E_c/I_{or}$ power level is set to -15 dB and E-AGCH TTI length is 10ms.			

**Table 10.22: Requirement for Missed HOLD when relative scheduling grant is transmitted using 15 consecutive slots – Non-serving E-DCH RL**

Test Number	Propagation Conditions	Reference value	
		$\hat{I}_{or1}/I_{oc}$ and $\hat{I}_{or2}/I_{oc}$ (dB)	Missed HOLD probability
1	VA30	0	0.005

**Table 10.23: Minimum requirement for Missed DOWN when relative scheduling grant is transmitted using 15 consecutive slots – Non-serving E-DCH RL**

Test Number	Propagation Conditions	Reference value		
		E-RGCH $E_c/I_{or}$ (dB)	$\hat{I}_{or1}/I_{oc}$ and $\hat{I}_{or2}/I_{oc}$ (dB)	Missed DOWN probability
2	VA30	-27.3	0	0.05



**Table 10.23A: Enhanced performance requirement Type 1 for Missed DOWN when relative scheduling grant is transmitted using 15 consecutive slots – Non-serving E-DCH RL**

Test Number	Propagation Conditions	Reference value		
		E-RGCH $E_c / I_{or}$ (dB)	$\hat{I}_{or1}/I_{oc}$ and $\hat{I}_{or2}/I_{oc}$ (dB)	Missed DOWN probability
2	VA30	-31.2	0	0.05

## 10.3A Determination of common E-RGCH radio links in CELL\_FACH state

### 10.3A.1 Introduction

The requirements defined in this section are applicable to a UE supporting Common E-RGCH based interference control [7].

Uplink interference from E-DCH transmission in CELL\_FACH can be controlled based on the UE monitoring an E-RGCH channel from the neighboring cells. The UE determines the set of cells from candidate set for common E-RGCH monitoring by comparing CPICH\_Ec/No of the neighbor cell within a threshold of the serving cell CPICH\_Ec/No according to the procedure specified in [7]. The UE starts monitoring common E-RGCH from common E-RGCH radio link (RL).

### 10.3A.2 Requirements

#### 10.3A.2.1 Determination when a cell for common E-RGCH RL has been already identified

This test case is targeting the scenario where UE has already been in CELL\_FACH state for a long enough time to identify candidate cells for common E-RGCH monitoring. The purpose of this test is to verify the amount of time for UE to determine common E-RGCH RL only without including a cell identification time, and to verify the missed down probability after determination.

The test parameters are given in Tables 10.23B and 10.23C below. The test consists of three successive time periods, with a time duration of T1, T2 and T3 respectively. During time duration T1, the UE shall not initiate PRACH preamble transmission for common E-DCH transmission. At the beginning of time duration T2, the UE shall initiate PRACH preamble transmission for common E-DCH transmission. During time duration T3, the common E-DCH resource shall be released.

**NOTE:** UE may not initiate PRACH preamble transmission for common E-DCH transmission exactly at the beginning of time duration T2.

Missed DOWN probability from Cell 2 shall be measured after 60 ms from initial PRACH preamble transmission until the end of time duration T2. Test shall be repeated to test common E-RGCH RL determination performance. The overall missed DOWN probability shall not exceed 5%. The overall missed down probability shall be measured over multiple repetitions of T2. If the UE fails to determine to monitor Cell 2 during a certain repetition of T1, T2, and T3, then the missed down probability for that repetition will be 100%.



**Table 10.23B: General test parameters for test 1**

Parameter	Unit	Value	Comment
Phase reference		P-CPICH	
Active cell		Cell 1	
Candidate cell for Common E-RGCH RL		Cell 2	
L3 filter coefficient		5 <sup>1</sup>	Applicable for event 1A
Reporting range	dB	4.5	Applicable for event 1A
Hysteresis	dB	0	Applicable for event 1A
Reporting deactivation threshold		0	Applicable for event 1A
Time to Trigger	Ms	0	Applicable for event 1A
$S_{intra search}$ for Cell 1	dB	Not sent	
$Q_{offset1_{s,n}}$ for Cell 2	dB	50	To prevent reselection to Cell 2 during the test
$Q_{offset2_{s,n}}$ for Cell 2	dB	50	To prevent reselection to Cell 2 during the test
E-RGCH signalling pattern for Cell 1		100% UP	Relative scheduling grant is transmitted using 12 consecutive slots.
E-RGCH signalling pattern for Cell 2		100% DOWN	Relative scheduling grant is transmitted using 12 consecutive slots.
E-AGCH information for Cell 1		Fixed SG	E-AGCH TTI length is 10 ms.
Common E-RGCH channel configuration list		24	
T1	S	1	UE shall identify Cell 2 during T1.
T2	S	3	
T3	S	1	
NOTE 1: L3 filter coefficient assumes the default filter input rate as 10 ms.			

**Table 10.23C: Cell specific test parameters for test 1**

Parameter	Unit	Cell 1			Cell 2		
		T1	T2	T3	T1	T2	T3
CPICH_Ec/lor	dB	-10			-10		
PCCPCH_Ec/lor	dB	-12			-12		
SCH_Ec/lor	dB	-12			-12		
PICH_Ec/lor	dB	-15			-15		
E-RGCH_Ec/lor	dB	-20			-35.3		
E-AGCH_Ec/lor	dB	-13			N/A		
OCNS		Note 1			Note 1		
$\hat{I}_{or}/I_{oc}$	dB	10	10	10	15	15	15
$I_{oc}$	dBm/3,84 MHz	-60					
CPICH_Ec/Io	dB	-16.3	-16.3	-16.3	-11.3	-11.3	-11.3
Propagation Condition		AWGN					
NOTE 1: The power of the OCNS channel that is added shall make the total power from the cell to be equal to $I_{or}$ .							
NOTE 2: Cell 2 PSC shall be changed from T1 in one test to T1 in the next test among Common E-RGCH channel configuration list.							

### 10.3A.2.2 Determination when a cell for common E-RGCH RL has not been identified

This test case is targeting the scenario where UE enters into CELL\_FACH and E-DCH resources are allocated immediately, before candidate cells for E-RGCH monitoring have been identified. The purpose of this test is to verify the amount of time for UE to determine common E-RGCH RL including the cell identification time for a candidate cell for common E-RGCH RL.

The test parameters are given in Tables 10.23D and 10.23E below. The test consists of two successive time periods, with a time duration of T1 and T2 respectively. At the beginning of time duration T1, the UE shall initiate PRACH preamble transmission for common E-DCH transmission. During time duration T2, the common E-DCH resource shall be released.



NOTE: UE may not initiate PRACH preamble transmission for common E-DCH transmission exactly at the beginning of time duration T1.

Missed DOWN probability from Cell 2 shall be measured after 120 ms from initial PRACH preamble transmission until the end of time duration T1. Test shall be repeated to test common E-RGCH RL determination performance. The overall missed DOWN probability shall not exceed 24%. The overall missed down probability shall be measured over multiple repetitions of T1. If the UE fails to determine to monitor Cell 2 during a certain repetition of T1 and T2, then the missed down probability for that repetition will be 100%.

**Table 10.23D: General test parameters for test 2**

Parameter	Unit	Value	Comment
Phase reference		P-CPICH	
Active cell		Cell 1	
Candidate cell for Common E-RGCH RL		Cell 2	
L3 filter coefficient		5 <sup>1</sup>	Applicable for event 1A
Reporting range	dB	4.5	Applicable for event 1A
Hysteresis	dB	0	Applicable for event 1A
Reporting deactivation threshold		0	Applicable for event 1A
Time to Trigger	ms	0	Applicable for event 1A
E-RGCH signalling pattern for Cell 1		100% UP	Relative scheduling grant is transmitted using 12 consecutive slots.
E-RGCH signalling pattern for Cell 2		100% DOWN	Relative scheduling grant is transmitted using 12 consecutive slots.
E-AGCH information for Cell 1		Fixed SG	E-AGCH TTI length is 10 ms.
Common E-RGCH channel configuration list		24	
T1	s	3	
T2	s	1	
NOTE 1: L3 filter coefficient assumes the default filter input rate as 10 ms.			

**Table 10.23E: Cell specific test parameters for test 2**

Parameter	Unit	Cell 1		Cell 2	
		T1	T2	T1	T2
CPICH_Ec/I <sub>or</sub>	dB	-10		-10	
PCCPCH_Ec/I <sub>or</sub>	dB	-12		-12	
SCH_Ec/I <sub>or</sub>	dB	-12		-12	
PICH_Ec/I <sub>or</sub>	dB	-15		-15	
E-RGCH_Ec/I <sub>or</sub>	dB	-22		-27.3	
E-AGCH_Ec/I <sub>or</sub>	dB	-15		N/A	
OCNS		Note 1		Note 1	
$\hat{I}_{or}/I_{oc}$	dB	0	0	2	-infinity
$I_{oc}$	dBm/3,84 MHz	-60			
CPICH_Ec/I <sub>o</sub>	dB	-15.5	-13	-13.5	-infinity
Propagation Condition		VA30			
NOTE 1: The power of the OCNS channel that is added shall make the total power from the cell to be equal to I <sub>or</sub> .					
NOTE 2: Cell 2 PSC shall be changed from T1 in one test to T1 in the next test among Common E-RGCH channel configuration list.					

## 10.4 Demodulation of E-DCH Absolute Grant Channel (E-AGCH)

### 10.4.1 Single link performance

The receive characteristics of the E-DCH Absolute Grant Channel (E-AGCH) in multi-path fading environment is determined by the missed detection probability.



### 10.4.1.1 Performance requirement

For the parameters specified in Table 10.24 the average downlink E-AGCH  $E_c/I_{or}$  power ratio shall be below the specified value for the missed detection probability in Table 10.25 for minimum performance requirements and Table 10.25A for enhanced performance requirements Type 1.

**Table 10.24: Test parameters for E-AGCH detection – single link**

Parameter	Unit	Missed detection
$I_{oc}$	dBm/3.84 MHz	-60
Phase reference	-	P-CPICH
P-CPICH $E_c/I_{or}$	dB	-10
E-AGCH information	-	Varying SG
E-AGCH TTI length	ms	10

**Table 10.25: Minimum requirement for E-AGCH detection – single link**

Test Number	Propagation Conditions	Reference value		
		E-AGCH $E_c/I_{or}$ (dB)	$\hat{I}_{or}/I_{oc}$ (dB)	Miss detection probability
1	VA30	-23.2	0	0.01

**Table 10.25A: Enhanced performance requirement Type 1 for E-AGCH detection – single link**

Test Number	Propagation Conditions	Reference value		
		E-AGCH $E_c/I_{or}$ (dB)	$\hat{I}_{or}/I_{oc}$ (dB)	Miss detection probability
1	VA30	-26.8	0	0.01

## 10.4A Demodulation of E-DCH Absolute Grant Channel (E-AGCH) with Time Multiplexed UE grants

This section specifies performance requirements when the UEs in a cell are scheduled grants in a time multiplexed fashion. The performance metric used to evaluate E-AGCH detection performance is the percentage of incorrect decisions by UE as a function of mis-detection rate ( $P_{MD}$ ) based on E-AGCH presence check, false alarm rate ( $P_{FA}$ ) based on E-AGCH presence check, and also the E-AGCH CRC check failure rate ( $P_{CRC}$ ).

### 10.4A.1 Single link performance

The receive characteristics of the E-DCH Absolute Grant Channel (E-AGCH) in multi-path fading environment is determined by the missed detection probability.

#### 10.4A.1.1 Performance requirement

For the parameters specified in Table 10.26 the average downlink E-AGCH  $E_c/I_{or}$  power ratio shall be below the specified value for the performance metric in Table 10.27, Table 10.28 and Table 10.30 for minimum performance requirements, and Table 10.29 and Table 10.31 for enhanced performance requirements Type 1.



**Table 10.26: Test parameters for E-AGCH detection – single link**

Parameter	Unit	Test 1	Test 2 and Test 3	Test 4 and Test 5
$I_{oc}$	dBm/3.84 MHz	-60		
Phase reference	-	P-CPICH		
P-CPICH $E_c/I_{or}$	dB	-10		
E-AGCH information	-	-	Varying SG	Varying SG
E-RNTI		NA	Set E-RNTI for a different UE	Set E-RNTI for UE under test
E-AGCH TTI length	ms	2		

**Table 10.27: Minimum requirement for E-AGCH detection when no E-AGCH is transmitted**

Test Number	Propagation Conditions	Reference value	
		$\hat{I}_{or}/I_{oc}$ (dB)	Performance Metric $P_{FA}$
1	AWGN	0	0.0015

**Table 10.28: Minimum requirement for E-AGCH detection when E-RNTI is not set for UE under test – single link**

Test Number	Propagation Conditions	Reference value		
		E-AGCH $E_c/I_{or}$ (dB)	$\hat{I}_{or}/I_{oc}$ (dB)	Performance Metric $P_{MD}$
2	AWGN	-21	0	0.001

**Table 10.29: Enhanced performance requirement Type 1 for E-AGCH detection when E-RNTI is not set for UE under test – single link**

Test Number	Propagation Conditions	Reference value		
		E-AGCH $E_c/I_{or}$ (dB)	$\hat{I}_{or}/I_{oc}$ (dB)	Performance Metric $P_{MD}$
3	AWGN	-24	0	0.001

**Table 10.30: Minimum requirement for E-AGCH detection when E-RNTI is set for UE under test – single link**

Test Number	Propagation Conditions	Reference value		
		E-AGCH $E_c/I_{or}$ (dB)	$\hat{I}_{or}/I_{oc}$ (dB)	Performance Metric $P_{MD} + (1 - P_{MD}) \cdot P_{CRC}$
4	AWGN	-21	0	0.01

**Table 10.31: Enhanced performance requirement Type 1 for E-AGCH detection when E-AGCH is for UE under test – single link**

Test Number	Propagation Conditions	Reference value		
		E-AGCH $E_c/I_{or}$ (dB)	$\hat{I}_{or}/I_{oc}$ (dB)	Performance Metric $P_{MD} + (1 - P_{MD}) \cdot P_{CRC}$
5	AWGN	-24	0	0.01

## 11 Performance requirement (MBMS)

Unless otherwise stated the receiver characteristics are specified at the antenna connector of the UE. For UE(s) with an integral antenna only, a reference antenna with a gain of 0 dBi is assumed. UE with an integral antenna may be taken



into account by converting these power levels into field strength requirements, assuming a 0 dBi gain antenna. For UEs with more than one receiver antenna connector the fading of the signals and the AWGN signals applied to each receiver antenna connector shall be uncorrelated. The levels of the test signal applied to each of the antenna connectors shall be as defined in the respective sections below.

## 11.1 Demodulation of MCCH

The receive characteristic of the MCCH is determined by the RLC SDU error rate (RLC SDU ER). The requirement is valid for all RRC states for which the UE has capabilities for MBMS.

### 11.1.1 Minimum requirement

For the parameters specified in Table 11.1 the average downlink S-CCPCH  $E_c/I_{or}$  power ratio shall be below the specified value for the RLC SDU ER shown in Table 11.2.

**Table 11.1: Parameters for MCCH detection**

Parameter	Unit	Test 1
Phase reference	-	P-CPICH
$I_{oc}$	dBm/3.84 MHz	-60
$\hat{I}_{or}/I_{oc}$	dB	-3
MCCH Data Rate		7.6 kbps
Propagation condition		VA3

**Table 11.2: Test requirements for MCCH detection**

Test Number	S-CCPCH $E_c/I_{or}$ (dB)	RLC SDU ER
1	-11.6	0.01

### 11.1.2 Minimum requirement for MBSFN

Requirement in this subclause is applicable to UEs that are capable of receiving MBSFN with at least two receive antenna connectors.

For the parameters specified in Table 11.1a the average downlink S-CCPCH  $E_c/I_{or}$  power ratio shall be below the specified value for the RLC SDU ER shown in Table 11.2a.

**Table 11.1a: Parameters for MCCH detection**

Parameter	Unit	Test 1
Phase reference	-	P-CPICH
$I_{oc}$	dBm/3.84 MHz	-60
$\hat{I}_{or}/I_{oc}$	dB	12
MCCH data rate	kbps	7.6
Propagation condition		MBSFN channel model ( see Appendix B)

**Table 11.2a: Test requirements for MCCH detection**

Test Number	S-CCPCH $E_c/I_{or}$ (dB)	RLC SDU ER
1	-24.9	0.01



## 11.2 Demodulation of MTCH

The receive characteristic of the MTCH is determined by RLC SDU error rate (RLC SDU ER). RLC SDU ER is specified for each individual data rate of the MTCH. The requirement is valid for all RRC states for which the UE has capabilities for MBMS.

### 11.2.1 Minimum requirement

For the parameters specified in Table 11.3 the average downlink S-CCPCH\_ $E_c/I_{or}$  power ratio shall be below the specified value for the RLC SDU ER shown in Table 11.4. If the UE supports optional enhanced performance requirements type1 for MBMS then for the parameters specified in Table 11.3 the average downlink S-CCPCH\_ $E_c/I_{or}$  power ratio shall be below the specified value for the RLC SDU ER shown in Table 11.4a.

**Table 11.3: Parameters for MTCH detection**

Parameter	Unit	Test 1	Test 2	Test 3
Phase reference	-	P-CPICH		
$I_{oc}$	dBm/3.84 MHz	-60		
$\hat{I}_{or}/I_{oc}$	dB	-3	-3	-3
MTCH Data Rate		128 kbps	256 kbps	128 kbps
Transmission Time Interval		40	40	80
Propagation condition		VA3		
Number of Radio Links p		3	3	3
Delay of Radio Link 2 compared with Radio Link 1		160ms	20 ms	20 ms
Delay of Radio Link 3 compared with Radio Link 1		1240ms	40.67 ms (1 TTI + 1 slot)	80.67 ms (1 TTI + 1 slot)

**Table 11.4: Test requirements for MTCH detection**

Test Number	S-CCPCH_ $E_c/I_{or}$ (dB)	RLC SDU ER
1	-4.9	0.1
2	-5.6	0.1
3	-8.5	0.1

**Table 11.4a: Test requirements for MTCH detection for UE supporting the enhanced performance requirements type1**

Test Number	S-CCPCH_ $E_c/I_{or}$ (dB)	RLC SDU ER
1	-7.7	0.1
2	-8.7	0.1
3	-11.5	0.1

### 11.2.2 Minimum requirement for MBSFN

Requirement in this subclause is applicable to UEs that are capable of receiving MBSFN with at least two receive antenna connectors.

For the parameters specified in Table 11.3a the average downlink S-CCPCH\_ $E_c/I_{or}$  power ratio shall be below the specified value for the RLC SDU ER shown in Table 11.4a.



**Table 11.3a: Parameters for MTCH detection**

Parameter	Unit	Test 1
Phase reference	-	P-CPICH
$I_{oc}$	dBm/3.84 MHz	-60
$\hat{I}_{or}/I_{oc}$	dB	12
MTCH Data Rate	kbps	512
Transmission Time Interval	ms	40
Propagation condition		MBSFN channel model (see Appendix B)

**Table 11.4a: Test requirements for MTCH detection**

Test Number	S-CCPCH_Ec/I <sub>or</sub> (dB)	RLC SDU ER
1	-5.8	0.1

## 11.3 Demodulation of MTCH and cell identification

MBMS combining is not controlled by a network but instead it is autonomously handled by a terminal. UE has to be able to receive MTCH and identify intra-frequency neighbour cells according to the requirements. The receive characteristic of the MTCH combined with cell identification is determined by RLC SDU error rate (RLC SDU ER).

### 11.3.1 Minimum requirement

For the parameters specified in Table 11.5 the average downlink S-CCPCH\_Ec/I<sub>or</sub> power ratio shall be below the specified value for the RLC SDU error rate shown in Table 11.6. The cell reselection parameters are given in clause A.9 in Table A.34. The different cells are assumed to be time aligned.

**Table 11.5: Parameters for MTCH demodulation requirements with cell identification**

Parameter	Unit	Test 1		
		Stage 1	Stage 2	Stage 2
Time in each stage	S	2	0.8	3
Phase reference	-	P-CPICH		
$I_{oc}$	dBm/3.84 MHz	-70	-73	-70
Cell1 $\hat{I}_{or1}/I_{oc}$	dB	-3	0	-3
Cell2 $\hat{I}_{or2}/I_{oc}$	dB	-3	0	-infinity
Cell3 $\hat{I}_{or3}/I_{oc}$	dB	-infinity	0	-3
Propagation condition		Case1		
MTCH Data Rate	Kbps	128		
Number of Radio Links		2	3	2

**Table 11.6: Requirements for MTCH detection**

Test Number	S-CCPCH_Ec/I <sub>or</sub> (dB)	RLC SDU ER
1	-5.6	0.05



## Annex A (normative): Measurement channels

### A.1 General

The measurement channels in this annex are defined to derive the requirements in clauses 6, 7 and 8. The measurement channels represent example configuration of radio access bearers for different data rates.

The measurement channel for 12.2 kbps shall be supported by any UE both in up- and downlink. Support for other measurement channels is depending on the UE Radio Access capabilities.

### A.2 UL reference measurement channel

#### A.2.1 UL reference measurement channel (12.2 kbps)

The parameters for the 12.2 kbps UL reference measurement channel are specified in Table A.1 and Table A.2. The channel coding for information is shown in figure A.1.

**Table A.1: UL reference measurement channel physical parameters (12.2 kbps)**

Parameter	Unit	Level
Information bit rate	kbps	12.2
DPDCH	kbps	60
DPCCH	kbps	15
DPCCH Slot Format #i	-	0
DPCCH/DPDCH power ratio	dB	-5.46
TFCI	-	On
Repetition	%	23
Note: Slot Format #2 is used for closed loop tests in subclause 8.6.2. Slot Format #2 and #5 are used for site selection diversity transmission tests in subclause 8.6.3		

**Table A.2: UL reference measurement channel, transport channel parameters (12.2 kbps)**

Parameters	DTCH	DCCH
Transport Channel Number	1	2
Transport Block Size	244	100
Transport Block Set Size	244	100
Transmission Time Interval	20 ms	40 ms
Type of Error Protection	Convolution Coding	Convolution Coding
Coding Rate	1/3	1/3
Rate Matching attribute	256	256
Size of CRC	16	12



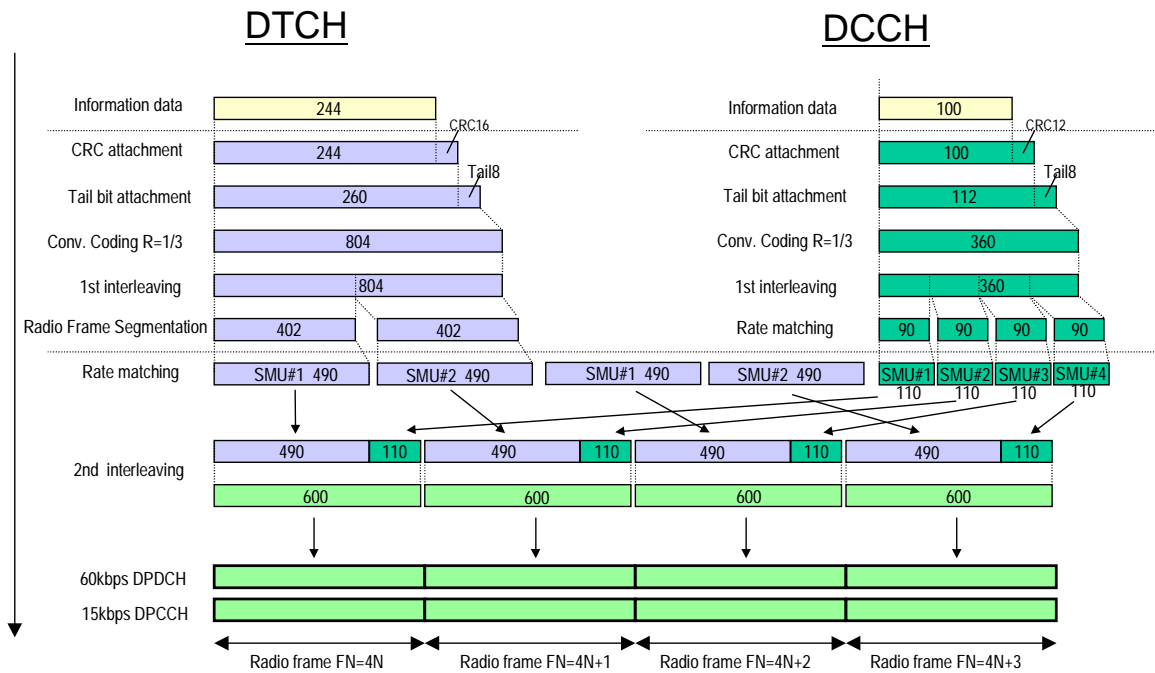


Figure A.1 (Informative): Channel coding of UL reference measurement channel (12.2 kbps)

## A.2.2 UL reference measurement channel (64 kbps)

The parameters for the 64 kbps UL reference measurement channel are specified in Table A.3 and Table A.4. The channel coding for information is shown in figure A.2. This measurement channel is not currently used in TS 25.101 but can be used for future requirements.

Table A.3: UL reference measurement channel (64 kbps)

Parameter	Unit	Level
Information bit rate	kbps	64
DPDCH	kbps	240
DPCCH	kbps	15
DPCCH Slot Format #i	-	0
DPCCH/DPDCH power ratio	dB	-9.54
TFCI	-	On
Repetition	%	18

Table A.4: UL reference measurement channel, transport channel parameters (64 kbps)

Parameter	DTCH	DCCH
Transport Channel Number	1	2
Transport Block Size	1280	100
Transport Block Set Size	1280	100
Transmission Time Interval	20 ms	40 ms
Type of Error Protection	Turbo Coding	Convolution Coding
Coding Rate	1/3	1/3
Rate Matching attribute	256	256
Size of CRC	16	12



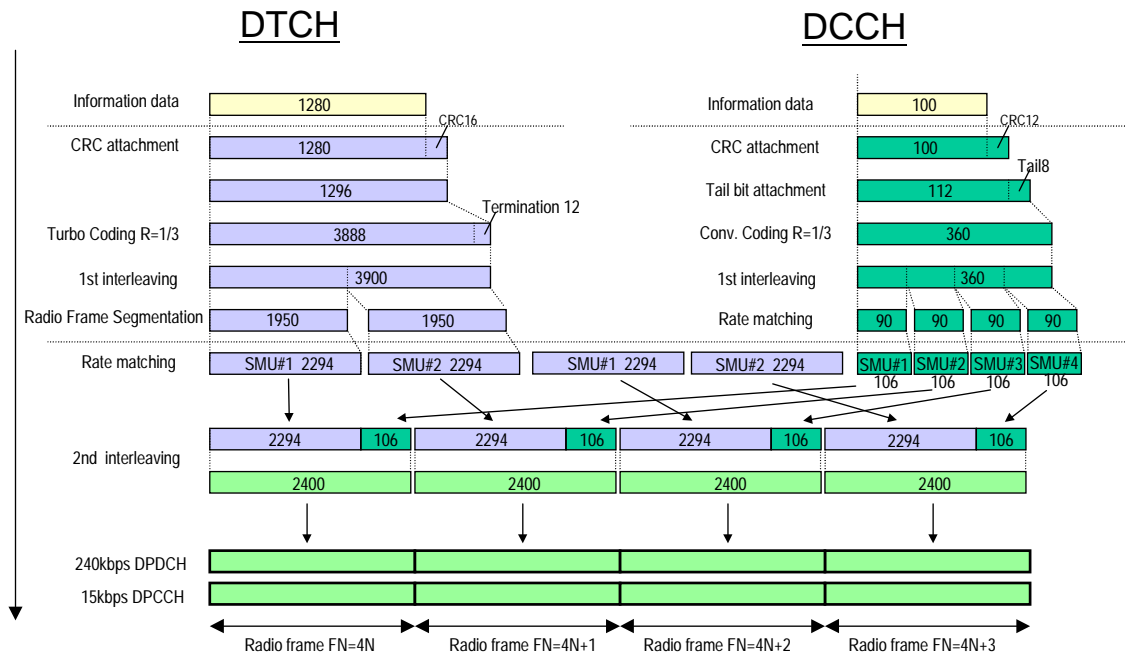


Figure A.2 (Informative): Channel coding of UL reference measurement channel (64 kbps)

### A.2.3 UL reference measurement channel (144 kbps)

The parameters for the 144 kbps UL reference measurement channel are specified in Table A.5 and Table A.6. The channel coding for information is shown in Figure A.3. This measurement channel is not currently used in the present document but can be used for future requirements.

Table A.5: UL reference measurement channel (144 kbps)

Parameter	Unit	Level
Information bit rate	kbps	144
DPDCH	kbps	480
DPCCH	kbps	15
DPCCH Slot Format #i	-	0
DPCCH/DPDCH power ratio	dB	-11.48
TFCI	-	On
Repetition	%	8

Table A.6: UL reference measurement channel, transport channel parameters (144kbps)

Parameters	DTCH	DCCH
Transport Channel Number	1	2
Transport Block Size	2880	100
Transport Block Set Size	2880	100
Transmission Time Interval	20 ms	40 ms
Type of Error Protection	Turbo Coding	Convolution Coding
Coding Rate	1/3	1/3
Rate Matching attribute	256	256
Size of CRC	16	12



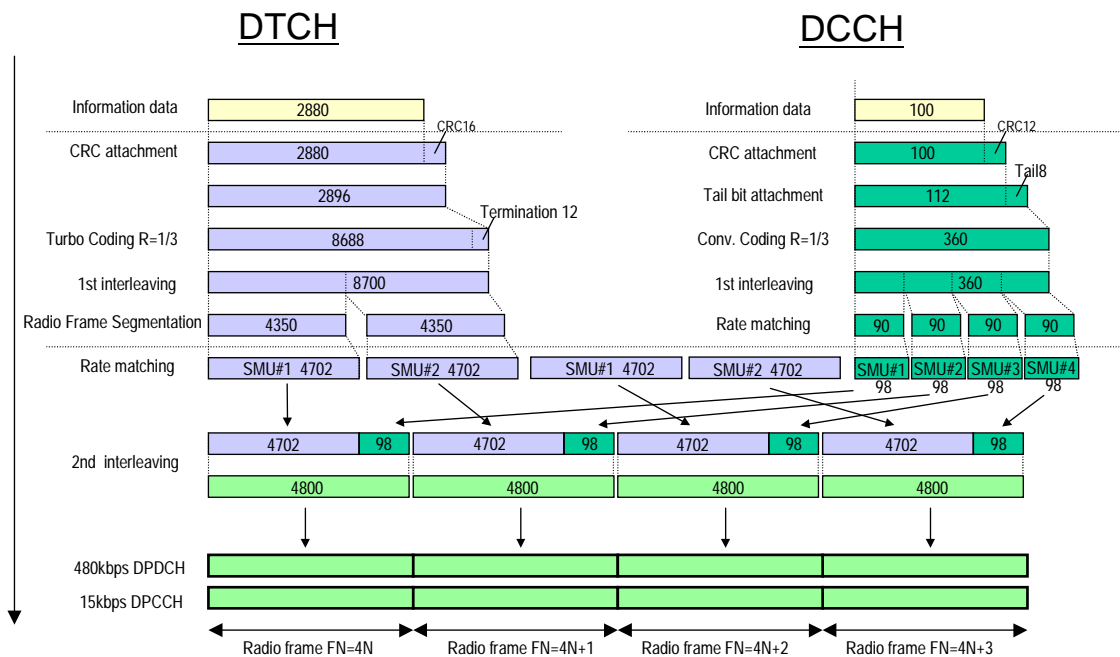


Figure A.3 (Informative): Channel coding of UL reference measurement channel (144 kbps)

### A.2.4 UL reference measurement channel (384 kbps)

The parameters for the 384 kbps UL reference measurement channel are specified in Table A.7 and Table A.8. The channel coding for information is shown in Figure A.4. This measurement channel is not currently used in TS 25.101 but can be used for future requirements.

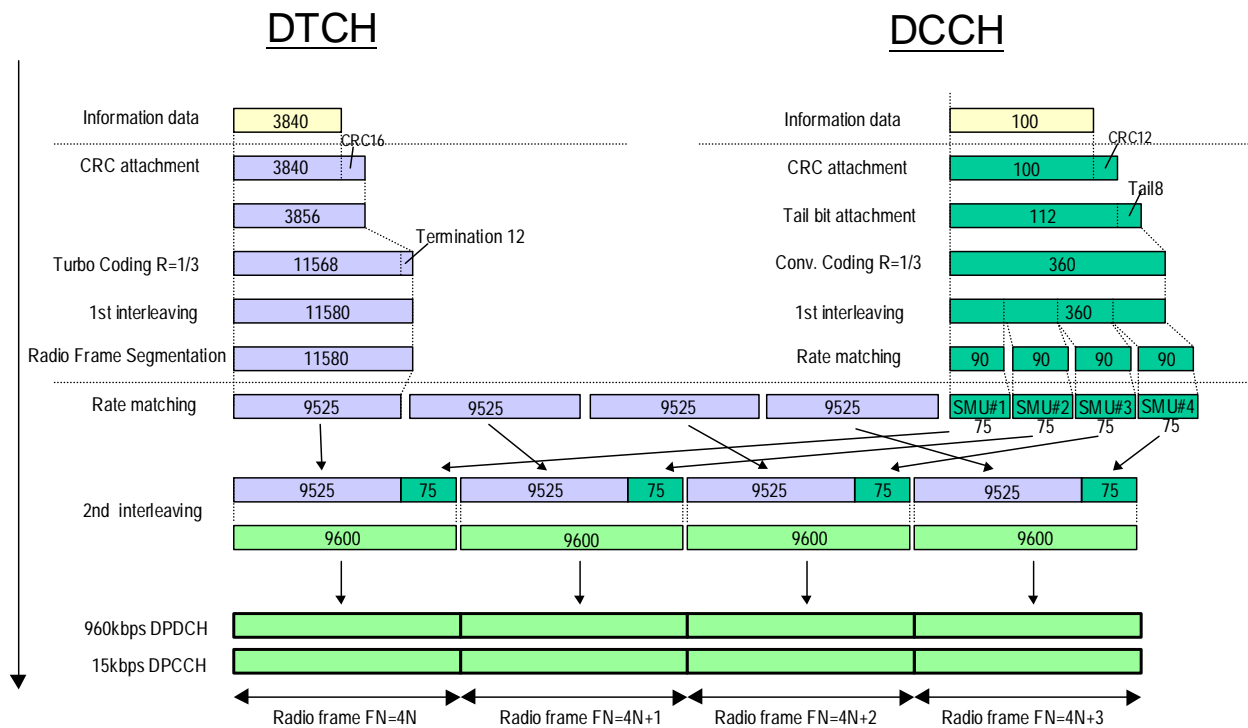
Table A.7: UL reference measurement channel (384 kbps)

Parameter	Unit	Level
Information bit rate	kbps	384
DPDCH	kbps	960
DPCCH	kbps	15
DPCCH Slot Format #1	-	0
DPCCH/DPDCH power ratio	dB	-11.48
TFCI	-	On
Puncturing	%	18

Table A.8: UL reference measurement channel, transport channel parameters (384 kbps)

Parameter	DTCH	DCCH
Transport Channel Number	1	2
Transport Block Size	3840	100
Transport Block Set Size	3840	100
Transmission Time Interval	10 ms	40 ms
Type of Error Protection	Turbo Coding	Convolution Coding
Coding Rate	1/3	1/3
Rate Matching attribute	256	256
Size of CRC	16	12





**Figure A.4 (Informative): Channel coding of UL reference measurement channel (384 kbps)**

## A.2.5 UL reference measurement channel (768 kbps)

The parameters for the UL measurement channel for 768 kbps are specified in Table A.9 and Table A.10.

**Table A.9: UL reference measurement channel, physical parameters (768 kbps)**

Parameter	Unit	Level
Information bit rate	kbps	2*384
DPDCH <sub>1</sub>	kbps	960
DPDCH <sub>2</sub>	kbps	960
DPCCH	kbps	15
DPCCH Slot Format #i	-	0
DPCCH/DPDCH power ratio	dB	-11.48
TFCI	-	On
Puncturing	%	18

**Table A.10: UL reference measurement channel, transport channel parameters (768 kbps)**

Parameter	DTCH	DCCH
Transport Channel Number	1	2
Transport Block Size	3840	100
Transport Block Set Size	7680	100
Transmission Time Interval	10 ms	40 ms
Type of Error Protection	Turbo Coding	Convolution Coding
Coding Rate	1/3	1/3
Rate Matching attribute	256	256
Size of CRC	16	12

## A.2.5A UL reference measurement channel (768 kbps)

The parameters for the UL measurement channel for 768 kbps are specified in Table A.9A and Table A.10A.



**Table A.9A: UL reference measurement channel, physical parameters (768 kbps)**

Parameter	Unit	Level
Information bit rate	kbps	2*384
DPDCH <sub>1</sub>	kbps	960
DPDCH <sub>2</sub>	kbps	960
DPCCH	kbps	15
DPCCH Slot Format #i	-	0
S-DPCCH	kbps	15
S-DPCCH Slot Format #i	-	1
DPCCH/DPDCH power ratio	dB	-11.48
TFCI	-	On
Puncturing	%	18

**Table A.10A: UL reference measurement channel, transport channel parameters (768 kbps)**

Parameter	DTCH	DCCH
Transport Channel Number	1	2
Transport Block Size	3840	100
Transport Block Set Size	7680	100
Transmission Time Interval	10 ms	40 ms
Type of Error Protection	Turbo Coding	Convolution Coding
Coding Rate	1/3	1/3
Rate Matching attribute	256	256
Size of CRC	16	12

## A.2.6 UL E-DCH reference measurement channel for DC-HSUPA using BPSK modulation

The parameters for the UL measurement channel for UE transmitter characteristics for DC-HSUPA are specified in Table A.10AA and Figure A.4AA. The power imbalance in Table A.10AA refers to the ratio of the DPCCH power of the primary uplink frequency to the DPCCH power of the secondary uplink frequency, expressed in dB.

**Table A.10AA: Settings for DC-HSUPA reference measurement channel using BPSK modulation**

Parameter	Unit	Value
Modulation		BPSK
Maximum. Inf. Bit Rate	kbps	60
TTI	ms	2
Number of HARQ Processes	Processes	8
Information Bit Payload ( $N_{INF}$ )	Bits	120
Binary Channel Bits per TTI ( $N_{BIN}$ ) (3840 / SF x TTI sum for all channels)	Bits	480
Coding Rate ( $N_{INF}/N_{BIN}$ )		0.25
Physical Channel Codes	SF for each	{ 16 }



	physical channel	
E-DPDCH/DPCCH power ratio	dB	4.08
E-DPCCH/DPCCH power ratio	dB	-9.54
HS-DPCCH/DPCCH power ratio	dB	-9.54
Power imbalance	dB	0
Note: HS-DPCCH is applicable only for the primary uplink frequency.		

Information Bit Payload	$N_{\text{INF}} = 120$	
CRC Addition	$N_{\text{INF}} = 120$	24
Code Block Segmentation	$120 + 24 = 144$	
Turbo Encoding ( $R=1/3$ )	$3 \times (N_{\text{INF}} + 24) = 432$	12
RV Selection	480	
Physical Channel Segmentation	480	

**Figure A.4AA: E-DPDCH coding rate for DC-HSUPA reference measurement channel using BPSK modulation**

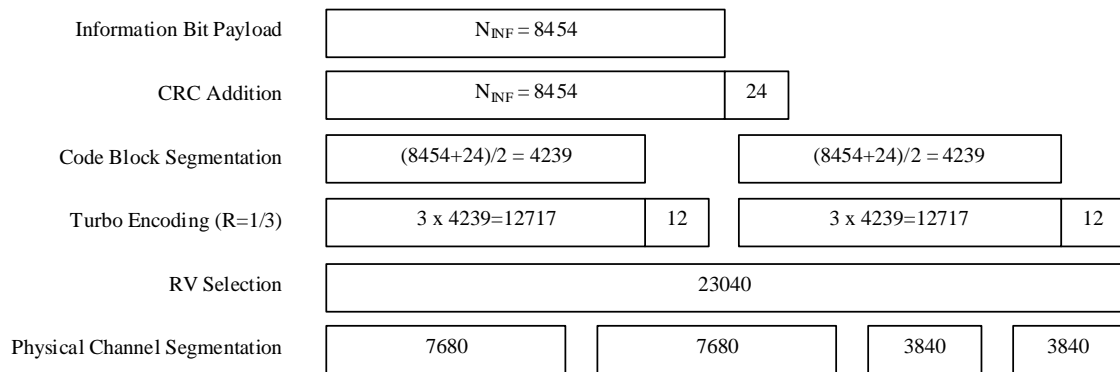
## A.2.7 UL E-DCH reference measurement channel for DC-HSUPA using 16QAM modulation

The parameters for the UL measurement channel for UE transmitter characteristics for DC-HSUPA using 16QAM modulation are specified in Table A.10AB and Figure A.4AB. The power imbalance in Table A.11 refers to the ratio of the DPCCH power of the primary uplink frequency to the DPCCH power of the secondary uplink frequency, expressed in dB.

**Table A.10AB: Settings for DC-HSUPA reference measurement channel using 16QAM modulation**

Parameter	Unit	Value
Modulation		16QAM
Maximum. Inf. Bit Rate	Kbps	4227.0
TTI	ms	2
Number of HARQ Processes	Processes	8
Information Bit Payload ( $N_{\text{INF}}$ )	Bits	8454
Binary Channel Bits per TTI ( $N_{\text{BIN}}$ ) ( $3840 / \text{SF} \times \text{TTI}$ sum for all channels)	Bits	23040
Coding Rate ( $N_{\text{INF}} / N_{\text{BIN}}$ )		0.367
Physical Channel Codes	SF for each physical channel	{2,2,4,4}
E-DPDCH/DPCCH power ratio, SF4 codes	dB	16.03
E-DPDCH/DPCCH power ratio, SF2 codes	dB	19.02
E-DPCCH/DPCCH power ratio	dB	8.07
HS-DPCCH/DPCCH power ratio	dB	2.05
Power imbalance	dB	0
Note: HS-DPCCH is applicable only for the primary uplink frequency.		





**Figure A.4AB: E-DPDCH coding rate for DC-HSUPA reference measurement channel using 16QAM modulation**

## A.2.8 Combinations of UL E-DCH reference measurement channel for DC-HSUPA tests

The combinations of BPSK and 16QAM reference measurement channels in Table A.10AC shall be used for verifying the UE maximum output power for DC-HSUPA, additional Spectrum emission mask for DC-HSUPA, and additional ACLR requirement for DC-HSUPA. The entry BPSK in Table A.10AC refers to the UL E-DCH reference measurement channel for DC-HSUPA using BPSK modulation, specified in subclause A.2.6, and the entry 16QAM refers to the UL E-DCH reference measurement channel for DC-HSUPA using 16QAM modulation, specified in subclause A.2.7. The power imbalance in subclause A.2.6 and A.2.7 have been adjusted as shown in Table A.10AC.

**Table A.10AC: Settings for DC-HSUPA reference measurement channels for UE maximum output power, spectrum emission mask and ACLR requirements**

Config #	Primary carrier	Secondary carrier	Power imbalance [dB]	Allowed MPR [dB]
1	BPSK	BPSK	-10	[0.5]
2	BPSK	BPSK	8	[1.0]
3	BPSK	BPSK	0	[1.5]
4	16QAM	16QAM	0	[TBD]

## A.3 DL reference measurement channel

### A.3.0 DL reference measurement channel (0 kbps)

The parameters for the 0 kbps DL reference measurement channel are specified in Table A.10A and Table A.10B. The channel coding is shown for information in figure A.4A.



Table A.10A: DL reference measurement channel physical parameters (0 kbps)

Parameter	Unit	Level
Information bit rate	kbps	0
DPCH	ksps	30
Slot Format #1	-	11
TFCI	-	On
Power offsets PO1, PO2 and PO3	dB	0
Puncturing	%	13.9

Table A.10B: DL reference measurement channel, transport channel parameters (0 kbps)

Parameter	DTCH	DCCH
Transport Channel Number	1	2
Transport Block Size	0	100
Transport Block Set Size	0	100
Transmission Time Interval	20 ms	40 ms
Type of Error Protection	Convolution Coding	Convolution Coding
Coding Rate	1/3	1/3
Rate Matching attribute	256	256
Size of CRC	16	12
Position of TrCH in radio frame	fixed	fixed

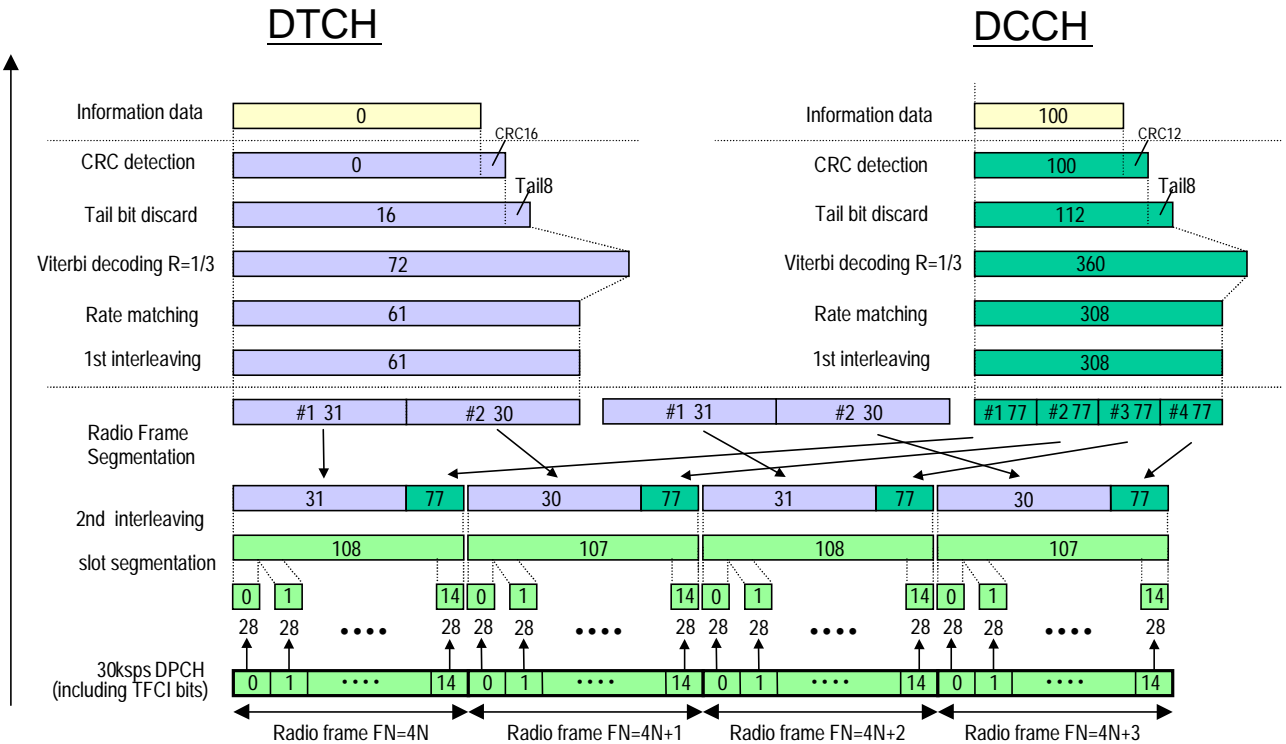


Figure A.4A (Informative): Channel coding of DL reference measurement channel (0 kbps)

A.3.1 DL reference measurement channel (12.2 kbps)

The parameters for the 12.2 Kbps DL reference measurement channel are specified in Table A.11 and Table A.12. The channel coding is shown for information in figure A.5.

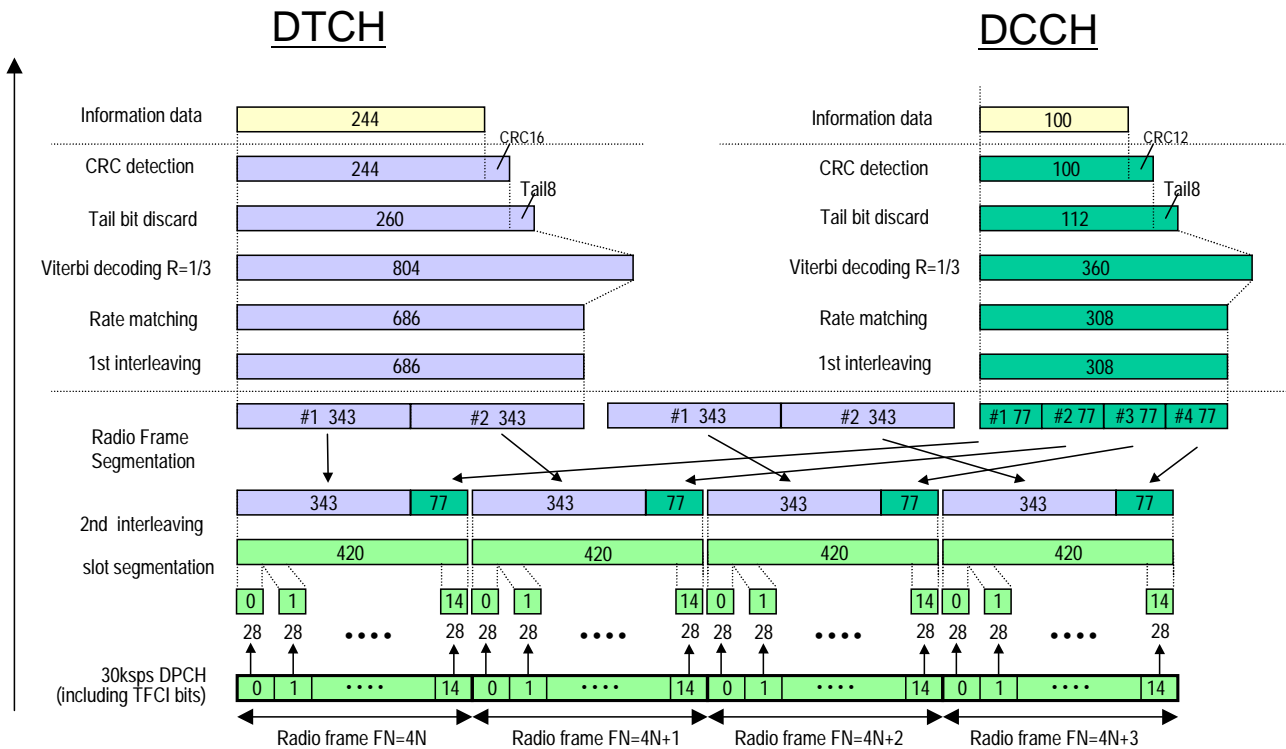


**Table A.11: DL reference measurement channel physical parameters (12.2 kbps)**

Parameter	Unit	Level
Information bit rate	kbps	12.2
DPCH	ksps	30
Slot Format #i	-	11
TFCI	-	On
Power offsets PO1, PO2 and PO3	dB	0
Puncturing	%	14.7

**Table A.12: DL reference measurement channel, transport channel parameters (12.2 kbps)**

Parameter	DTCH	DCCH
Transport Channel Number	1	2
Transport Block Size	244	100
Transport Block Set Size	244	100
Transmission Time Interval	20 ms	40 ms
Type of Error Protection	Convolution Coding	Convolution Coding
Coding Rate	1/3	1/3
Rate Matching attribute	256	256
Size of CRC	16	12
Position of TrCH in radio frame	fixed	fixed



**Figure A.5 (Informative): Channel coding of DL reference measurement channel (12.2 kbps)**

A.3.2 DL reference measurement channel (64 kbps)

The parameters for the DL reference measurement channel for 64 kbps are specified in Table A.13 and Table A.14. The channel coding is shown for information in Figure A.6.

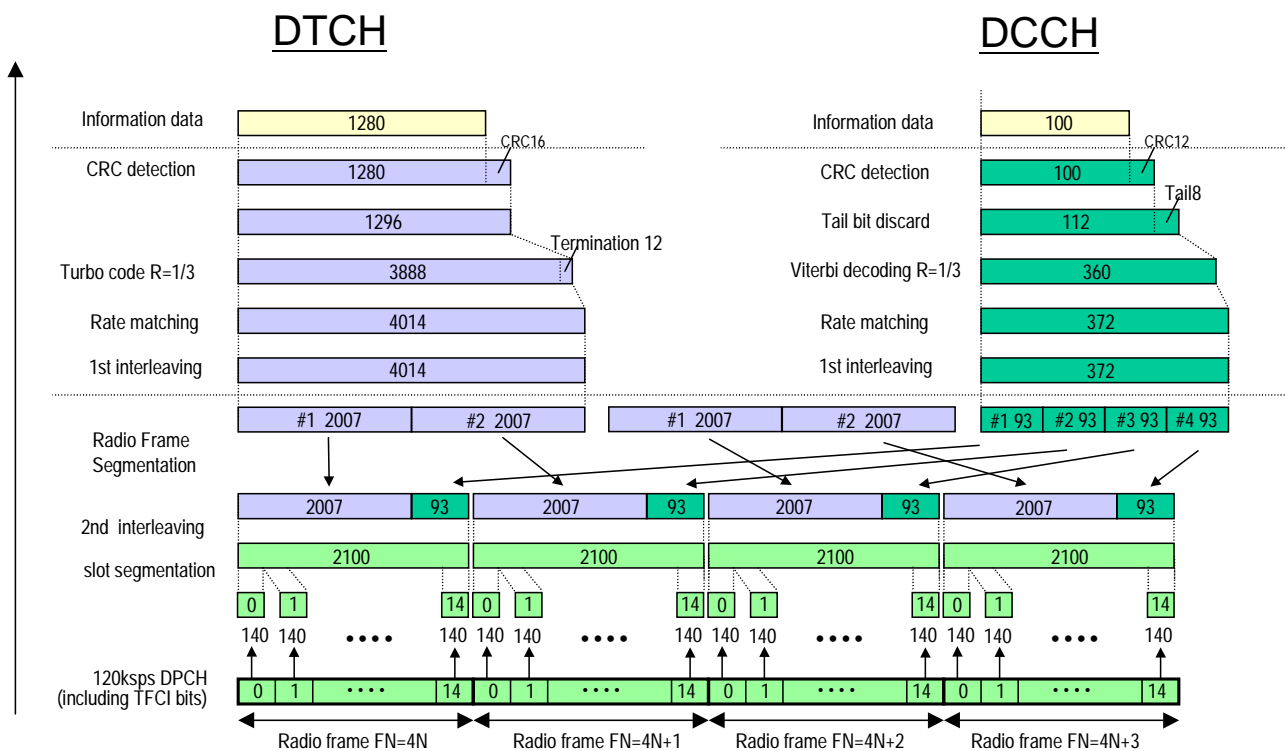


**Table A.13: DL reference measurement channel physical parameters (64 kbps)**

Parameter	Unit	Level
Information bit rate	kbps	64
DPCH	ksps	120
Slot Format #i	-	13
TFCI	-	On
Power offsets PO1, PO2 and PO3	dB	0
Repetition	%	2.9

**Table A.14: DL reference measurement channel, transport channel parameters (64 kbps)**

Parameter	DTCH	DCCH
Transport Channel Number	1	2
Transport Block Size	1280	100
Transport Block Set Size	1280	100
Transmission Time Interval	20 ms	40 ms
Type of Error Protection	Turbo Coding	Convolution Coding
Coding Rate	1/3	1/3
Rate Matching attribute	256	256
Size of CRC	16	12
Position of TrCH in radio frame	fixed	fixed

**Figure A.6 (Informative): Channel coding of DL reference measurement channel (64 kbps)**

### A.3.3 DL reference measurement channel (144 kbps)

The parameters for the DL measurement channel for 144 kbps are specified in Table A.15 and Table A.16. The channel coding is shown for information in Figure A.7.

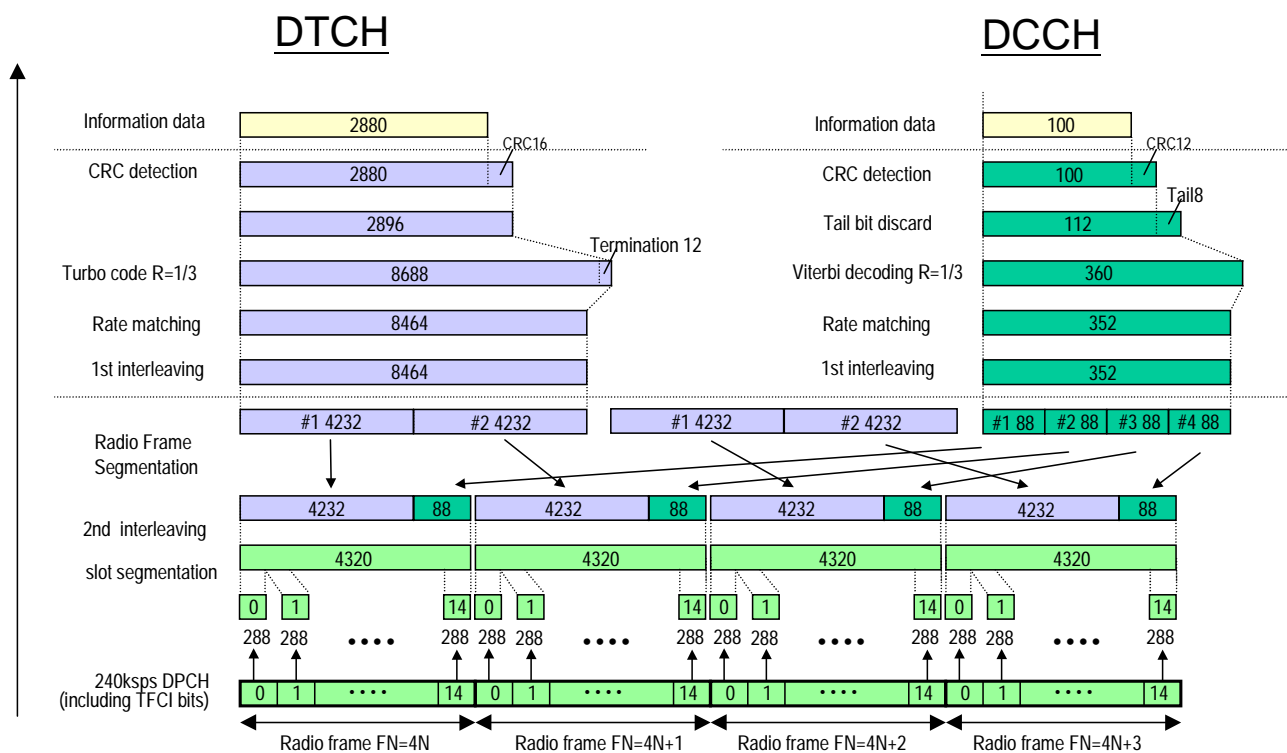


**Table A.15: DL reference measurement channel physical parameters (144 kbps)**

Parameter	Unit	Level
Information bit rate	kbps	144
DPCH	ksps	240
Slot Format #1	-	14
TFCI	-	On
Power offsets PO1, PO2 and PO3	dB	0
Puncturing	%	2.7

**Table A.16: DL reference measurement channel, transport channel parameters (144 kbps)**

Parameter	DTCH	DCCH
Transport Channel Number	1	2
Transport Block Size	2880	100
Transport Block Set Size	2880	100
Transmission Time Interval	20 ms	40 ms
Type of Error Protection	Turbo Coding	Convolution Coding
Coding Rate	1/3	1/3
Rate Matching attribute	256	256
Size of CRC	16	12
Position of TrCH in radio frame	fixed	fixed

**Figure A.7 (Informative): Channel coding of DL reference measurement channel (144 kbps)**

### A.3.4 DL reference measurement channel (384 kbps)

The parameters for the DL measurement channel for 384 kbps are specified in Table A.17 and Table A.18. The channel coding is shown for information in Figure A.8

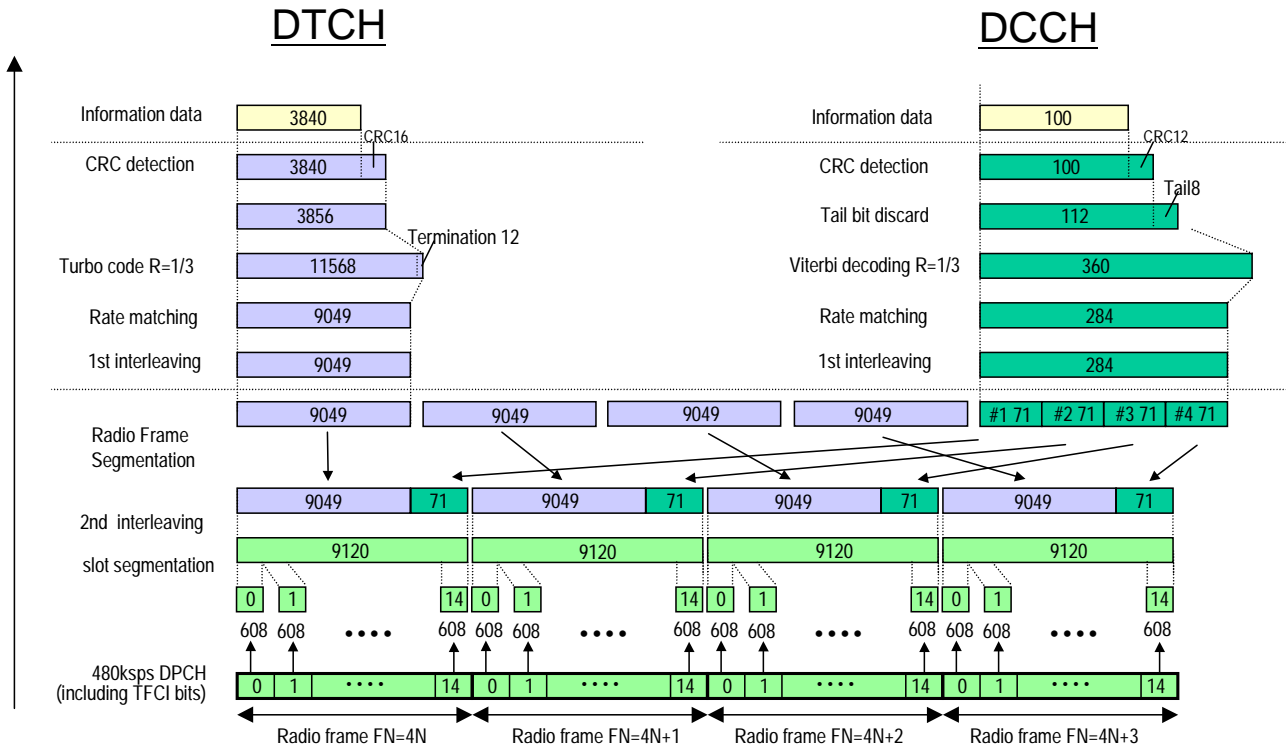


**Table A.17: DL reference measurement channel, physical parameters (384 kbps)**

Parameter	Unit	Level
Information bit rate	kbps	384
DPCH	ksps	480
Slot Format # i	-	15
TFCI		On
Power offsets PO1, PO2 and PO3	dB	0
Puncturing	%	22

**Table A.18: DL reference measurement channel, transport channel parameters (384 kbps)**

Parameter	DTCH	DCCH
Transport Channel Number	1	2
Transport Block Size	3840	100
Transport Block Set Size	3840	100
Transmission Time Interval	10 ms	40 ms
Type of Error Protection	Turbo Coding	Convolution Coding
Coding Rate	1/3	1/3
Rate Matching attribute	256	256
Size of CRC	16	12
Position of TrCH in radio frame	fixed	Fixed



**Figure A.8 (Informative): Channel coding of DL reference measurement channel (384 kbps)**

### A.3.5 DL reference measurement channel 2 (64 kbps)

The parameters for the DL reference measurement channel for 64 kbps are specified in Table A.18A and Table A.18B. The channel coding is shown for information in Figure A.8A.

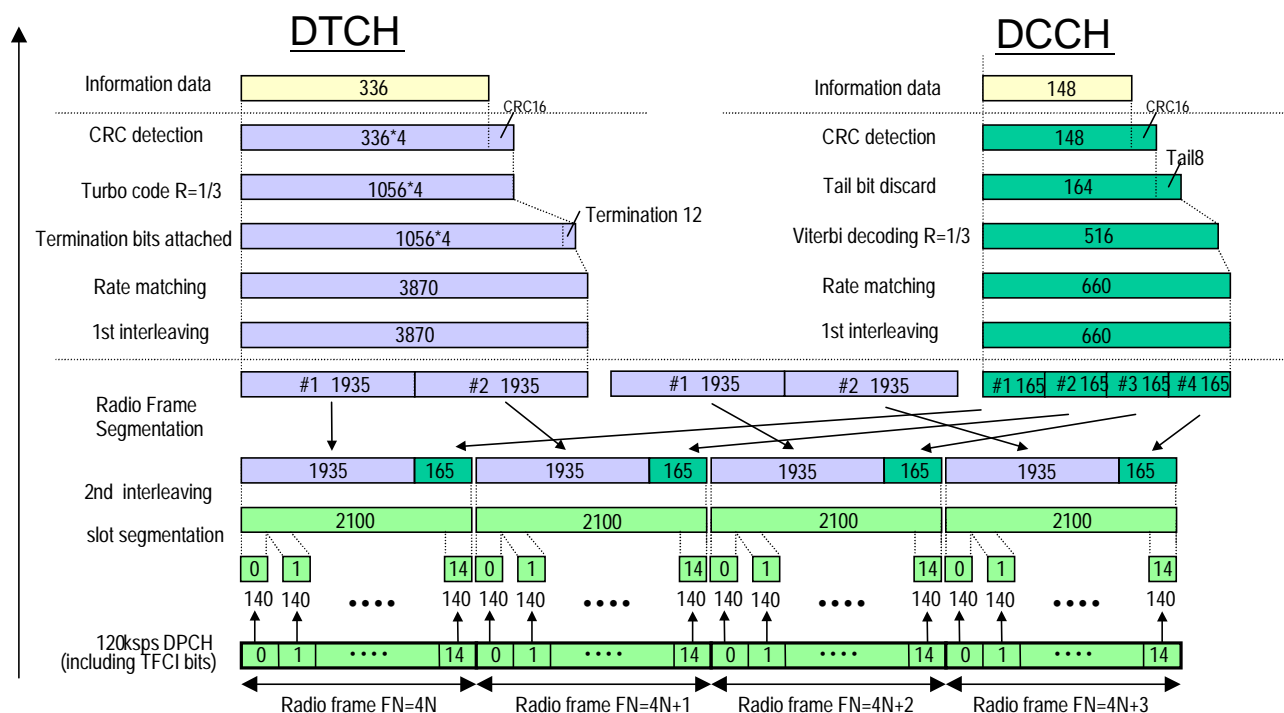


**Table A.18A: DL reference measurement channel physical parameters (64 kbps)**

Parameter	Unit	Level
Information bit rate (DTCH)	kbps	64
Information bit rate (DCCH)	kbps	3.4
DPCH	ksps	120
Slot Format #i	-	13
TFCI	-	On
Puncturing (DTCH)	%	8.6
Repetition (DCCH)	%	27.9

**Table A.18B: DL reference measurement channel, transport channel parameters (64 kbps)**

Parameter	DTCH	DCCH
Transport Channel Number	1	2
Transport Block Size	336	148
Transport Block Set Size	1344	148
Transport blocks per TTI	4	1
Transmission Time Interval	20 ms	40 ms
Type of Error Protection	Turbo Coding	Convolution Coding
Coding Rate	1/3	1/3
Rate Matching attribute	143	200
Size of CRC	16	16
Position of TrCH in radio frame	fixed	fixed

**Figure A.8A (Informative): Channel coding of DL reference measurement channel 2 (64 kbps)**

## A.3A DL reference measurement channel

### A.3A.0 DL reference measurement channel (0 kbps without DCCH)

The parameters for the 0 kbps DL reference measurement channel without DCCH are specified in Table A.10AA and Table A.10BA. The channel coding is shown for information in figure A.4AA.

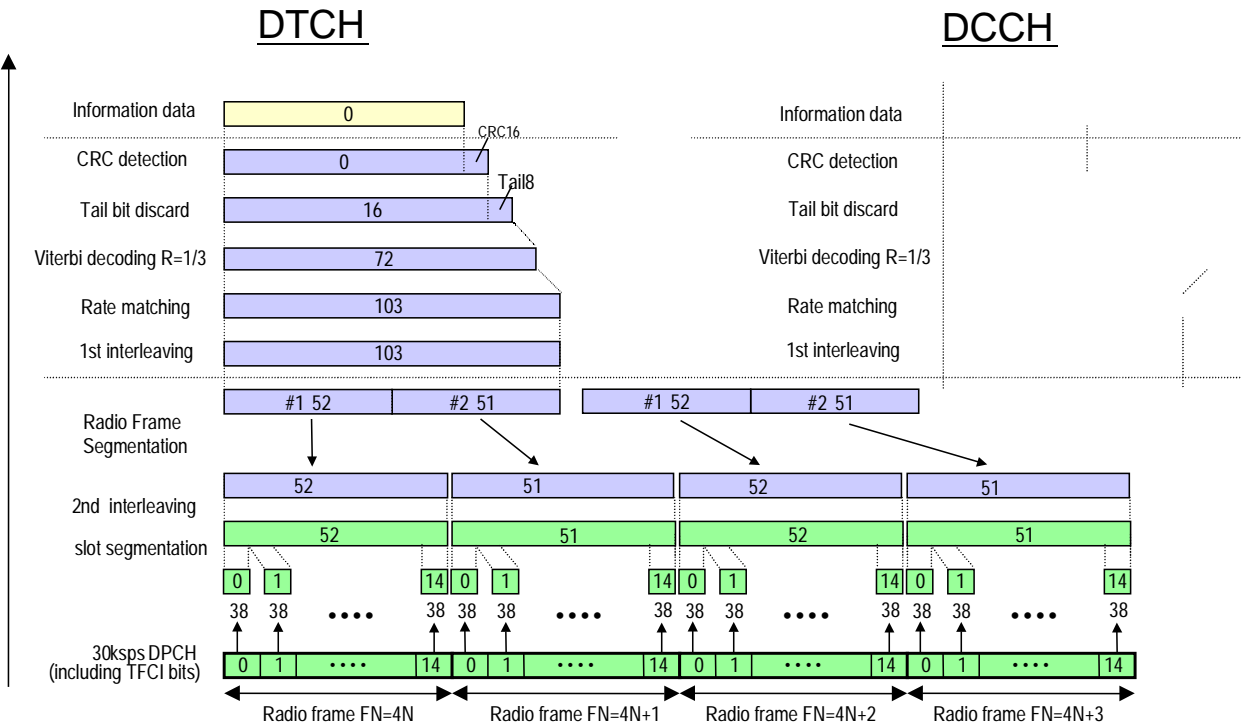


**Table A.18C: DL reference measurement channel physical parameters (0 kbps without DCCH)**

Parameter	Unit	Level
Information bit rate	Kbps	0
DPCH	Ksps	30
Slot Format #1	-	18
TFCI	-	Off
Power offsets PO1, PO2, PO3 and PO <sub>SRB</sub>	dB	0
Repetition	%	43.1

**Table A.18D: DL reference measurement channel, transport channel parameters (0 kbps without DCCH)**

Parameter	DTCH	DCCH
Transport Channel Number	1	2
Transport Block Size	0	0
Transport Block Set Size	0	0
Transmission Time Interval	20 ms	40 ms
Type of Error Protection	Convolution Coding	Convolution Coding
Coding Rate	1/3	1/3
Rate Matching attribute	256	0
Size of CRC	16	16
Position of TrCH in radio frame	Pseudo-flexible	Pseudo-flexible



**Figure A.8B (Informative): Channel coding of DL reference measurement channel (0 kbps without DCCH)**

### A.3A.1 DL reference measurement channel (0 kbps with DCCH)

The parameters for the 0 kbps DL reference measurement channel with DCCH are specified in Table A.11AA and Table A.11BA. The channel coding is shown for information in figure A.5AA.

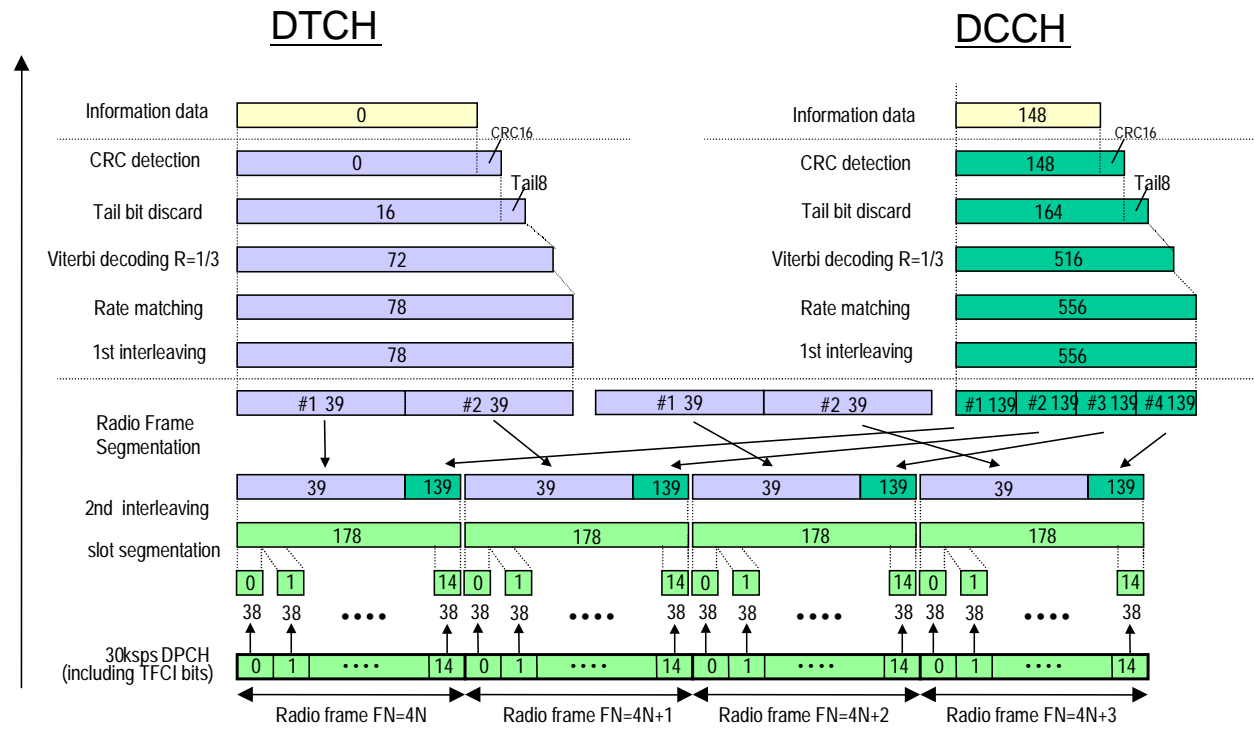


**Table A.18E: DL reference measurement channel physical parameters (0 kbps with DCCH)**

Parameter	Unit	Level
Information bit rate	kbps	0
DPCH	ksps	30
Slot Format #1	-	18
TFCI	-	Off
Power offsets PO1, PO2, PO3 and PO <sub>SRB</sub>	dB	0
Repetition	%	8.3

**Table A.18F: DL reference measurement channel, transport channel parameters (0 kbps with DCCH)**

Parameter	DTCH	DCCH
Transport Channel Number	1	2
Transport Block Size	0	148
Transport Block Set Size	0	148
Transmission Time Interval	20 ms	40 ms
Type of Error Protection	Convolution Coding	Convolution Coding
Coding Rate	1/3	1/3
Rate Matching attribute	256	256
Size of CRC	16	16
Position of TrCH in radio frame	Pseudo-flexible	Pseudo-flexible



**Figure A.8C (Informative): Channel coding of DL reference measurement channel (0 kbps with DCCH)**

### A.3A.2 DL reference measurement channel (12.2 kbps without DCCH)

The parameters for the 12.2 kbps DL reference measurement channel without DCCH are specified in Table A.12AA and Table A.12BA. The channel coding is shown for information in figure A.6AA.



Table A.18G: DL reference measurement channel physical parameters (12.2 kbps without DCCH)

Parameter	Unit	Level
Information bit rate	kbps	12.2
DPCH	ksps	30
Slot Format #i	-	18
TFCI	-	Off
Power offsets PO1, PO2, PO3 and PO <sub>SRB</sub>	dB	0
Repetition	%	41.8

Table A.18H: DL reference measurement channel, transport channel parameters (12.2 kbps without DCCH)

Parameter	DTCH	DCCH
Transport Channel Number	1	2
Transport Block Size	244	0
Transport Block Set Size	244	0
Transmission Time Interval	20 ms	40 ms
Type of Error Protection	Convolution Coding	Convolution Coding
Coding Rate	1/3	1/3
Rate Matching attribute	256	0
Size of CRC	16	16
Position of TrCH in radio frame	Pseudo-flexible	Pseudo-flexible

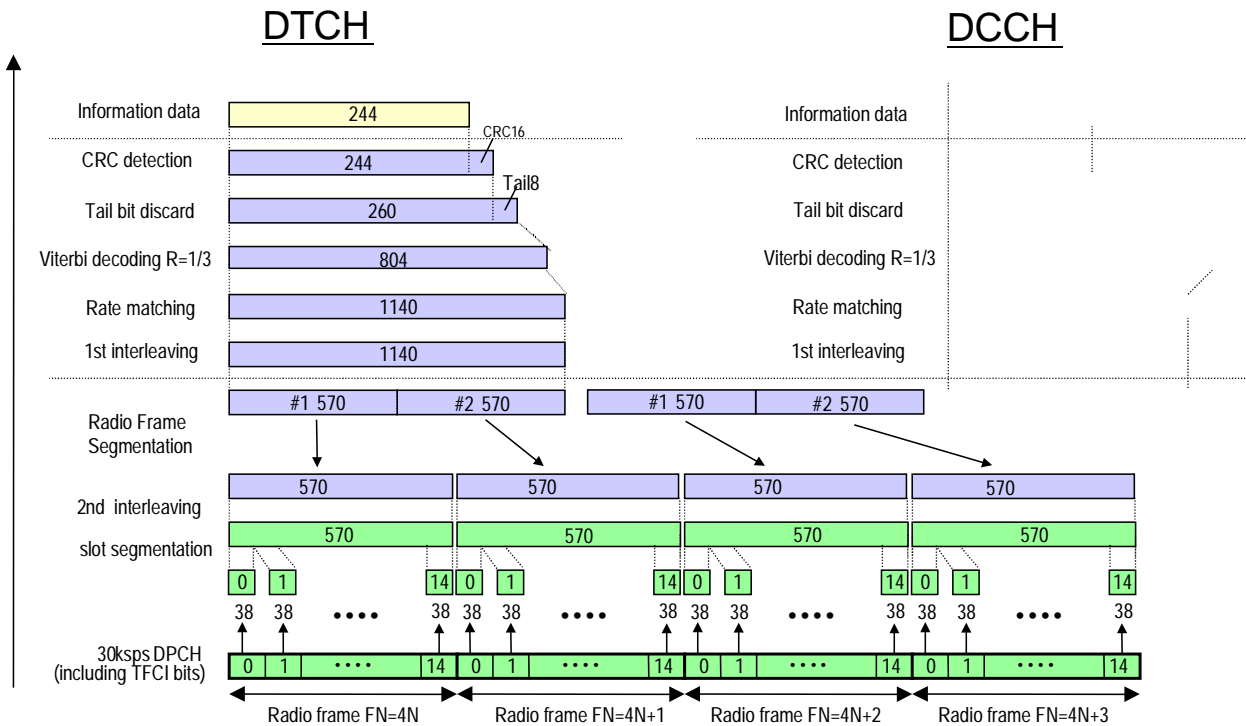


Figure A.8D (Informative): Channel coding of DL reference measurement channel (12.2 kbps without DCCH)

A.3A.3 DL reference measurement channel (12.2 kbps with DCCH)

The parameters for the 12.2 Kbps DL reference measurement channel with DCCH are specified in Table A.13AA and Table A.13BA. The channel coding is shown for information in figure A.7AA.

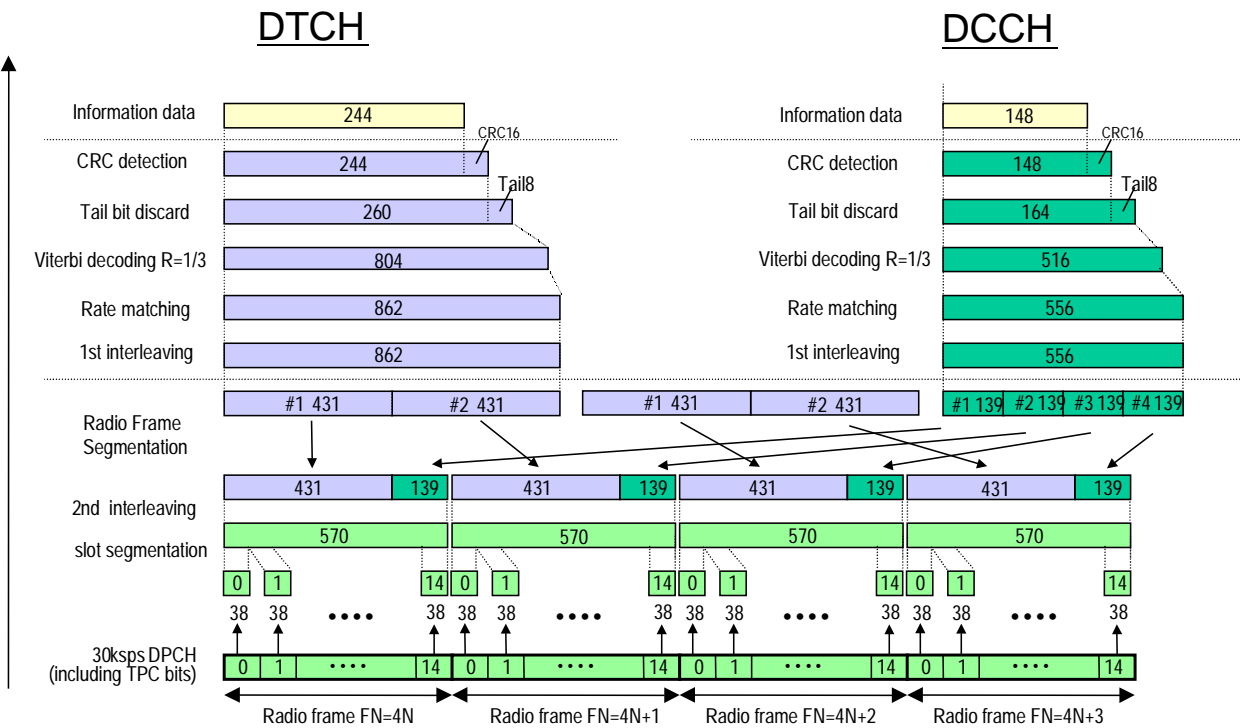


**Table A.18I: DL reference measurement channel physical parameters (12.2 kbps with DCCH)**

Parameter	Unit	Level
Information bit rate	kbps	12.2
DPCH	ksps	30
Slot Format #i	-	18
TFCI	-	Off
Power offsets PO1, PO2, PO3 and PO <sub>SRB</sub>	dB	0
Repetition	%	7.2

**Table A.18J: DL reference measurement channel, transport channel parameters (12.2 kbps with DCCH)**

Parameter	DTCH	DCCH
Transport Channel Number	1	2
Transport Block Size	244	148
Transport Block Set Size	244	148
Transmission Time Interval	20 ms	40 ms
Type of Error Protection	Convolution Coding	Convolution Coding
Coding Rate	1/3	1/3
Rate Matching attribute	256	256
Size of CRC	16	16
Position of TrCH in radio frame	Pseudo-flexible	Pseudo-flexible



**Figure A.8E (Informative): Channel coding of DL reference measurement channel (12.2 kbps with DCCH)**



## A.4 DL reference measurement channel for BTFD performance requirements

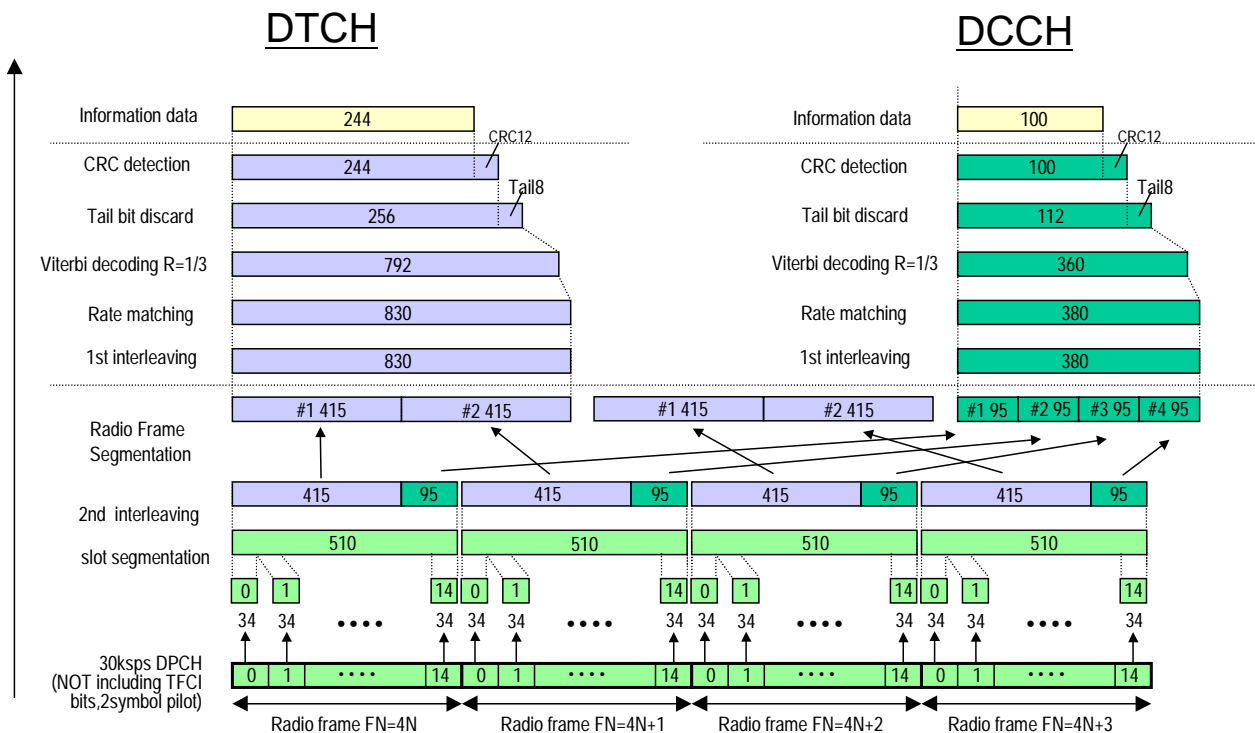
The parameters for DL reference measurement channel for BTFD are specified in Table A.19 and Table A.20. The channel coding for information is shown in figures A.9, A.10, and A.11.

**Table A.19: DL reference measurement channel physical parameters for BTFD**

Parameter	Unit	Rate 1	Rate 2	Rate 3
Information bit rate	kbps	12.2	7.95	1.95
DPCH	ksps	30		
Slot Format # i	-	8		
TFCI	-	Off		
Power offsets PO1, PO2 and PO3	dB	0		
Repetition	%	5		

**Table A.20: DL reference measurement channel, transport channel parameters for BTFD**

Parameter	DTCH			DCCH
	Rate 1	Rate 2	Rate 3	
Transport Channel Number	1			2
Transport Block Size	244	159	39	100
Transport Block Set Size	244	159	39	100
Transmission Time Interval	20 ms			40 ms
Type of Error Protection	Convolution Coding			Convolution Coding
Coding Rate	1/3			1/3
Rate Matching attribute	256			256
Size of CRC	12			12
Position of TrCH in radio frame	fixed			fixed



**Figure A.9 (Informative): Channel coding of DL reference measurement channel for BTFD (Rate 1)**



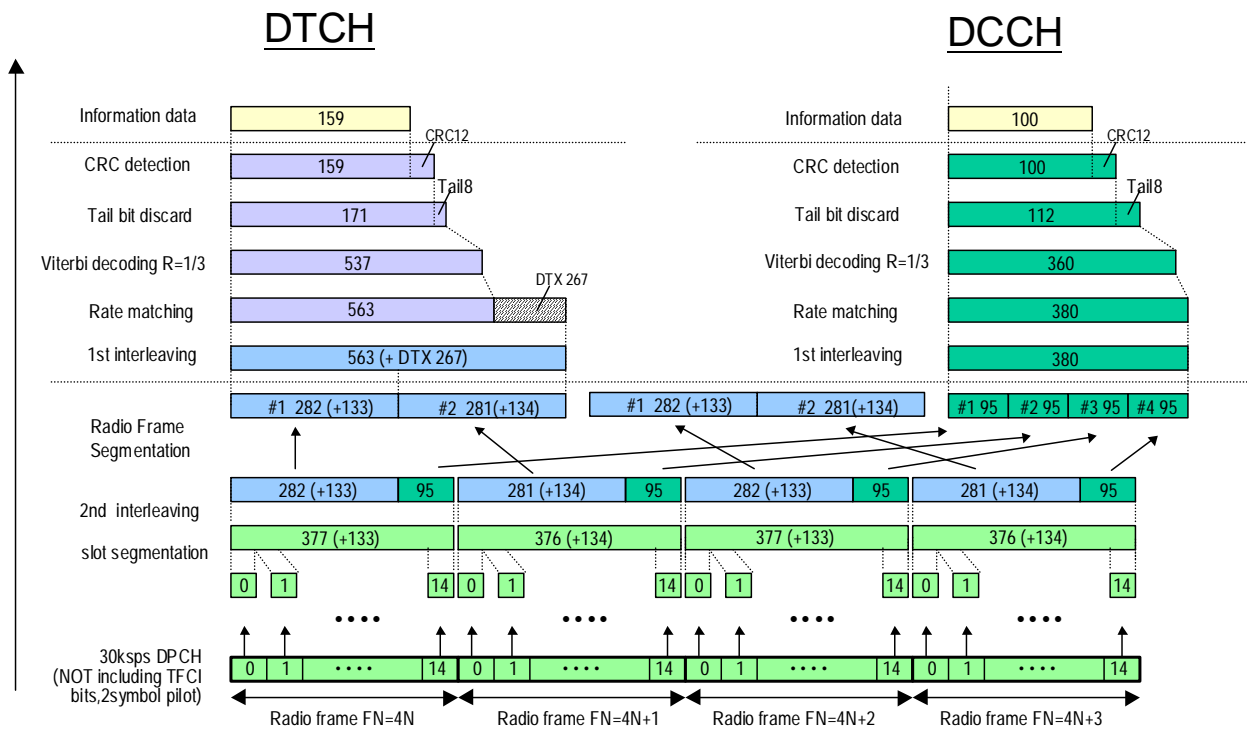


Figure A.10 (Informative): Channel coding of DL reference measurement channel for BTFD (Rate 2)

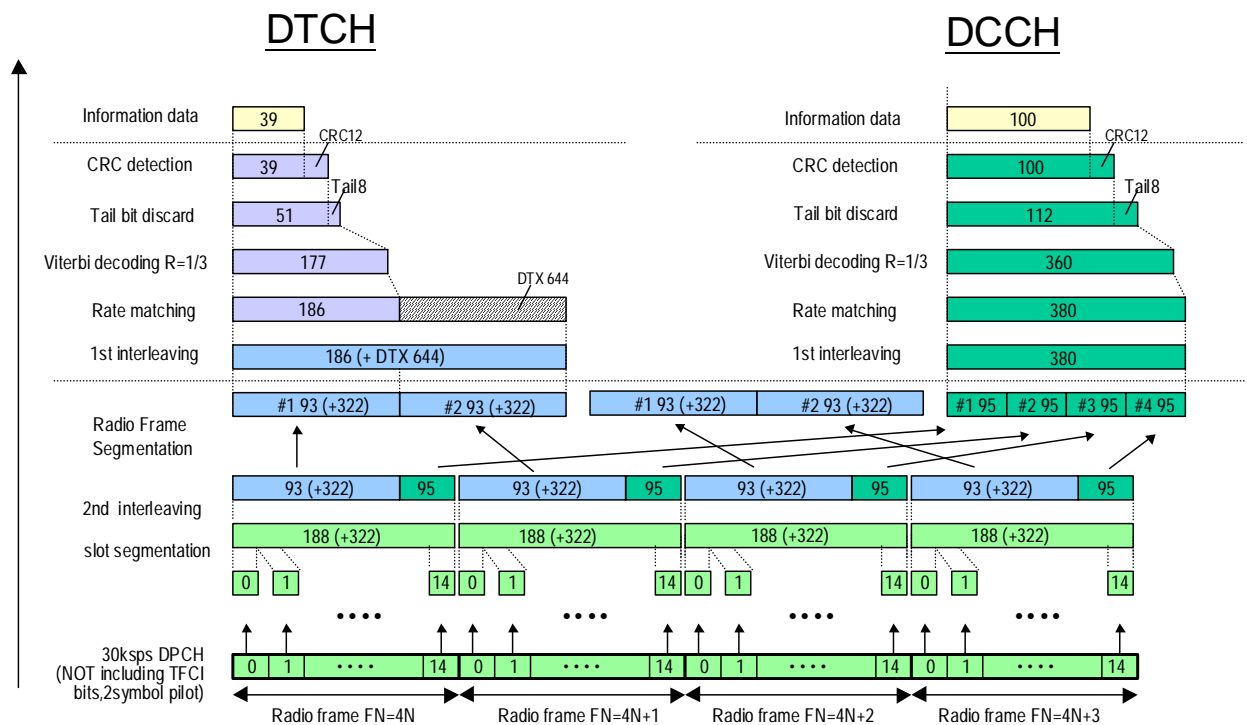


Figure A.11 (Informative): Channel coding of DL reference measurement channel for BTFD (Rate 3)



## A.4A Reference parameters for discontinuous UL DPCCH transmission

The parameters for the UE UL power control operation with discontinuous UL DPCCH transmission test is specified in Table A.20A. Same parameter values are used for 2ms and 10ms E-DCH TTI.

**Table A.20A: Parameters for the discontinuous UL DPCCH transmission**

Parameter	Unit	Level
Enabling_Delay	Radio frames	0
UE_DTX_cycle_1	Subframes	10
UE_DTX_cycle_2	Subframes	10
UE_DTX_DRX_offset	Subframes	0
Inactivity_threshold_for_UE_DTX_cycle2	E-DCH TTI	1
UE_DPCCH_burst_1	Subframes	1
UE_DPCCH_burst_2	Subframes	1
UE_DTX_long_preamble_length	Slots	2
CQI_Feedback_cycle, k	Milliseconds	0
CQI_DTX_TIMER	Subframes	0

**Table A.20B: (void)**

**Figure A.11A (void)**

## A.5 DL reference compressed mode parameters

Parameters described in Table A.21 are used in some test specified in TS 25.101 while parameters described in Table A.22 and Table A.22A are used in some tests specified in TS 25.133.

Parameters in Table A.21 are applicable when compressed mode by spreading factor reduction is used in downlink.

**Table A.21: Compressed mode reference pattern 1 parameters**

Parameter	Set 1	Set 2	Note
TGSN (Transmission Gap Starting Slot Number)	11	4	
TGL1 (Transmission Gap Length 1)	7	7	
TGL2 (Transmission Gap Length 2)	-	7	Only one gap in use.
TGD (Transmission Gap Distance)	0	15	Only one gap in use.
TGPL1 (Transmission Gap Pattern Length)	4	4	
TGPRC (Transmission Gap Pattern Repetition Count)	NA	NA	Defined by higher layers
TGCFN (Transmission Gap Connection Frame Number):	NA	0	Defined by higher layers
UL/DL compressed mode selection	DL & UL	DL & UL	2 configurations possible DL & UL / DL
UL compressed mode method	SF/2	SF/2	
DL compressed mode method	SF/2	SF/2	
Downlink frame type and Slot format	11B	11B	
Scrambling code change	No	No	
RPP ( Recovery period power control mode)	0	0	
ITP ( Initial transmission power control mode)	0	0	



**Table A.22: Compressed mode reference pattern 2 parameters**

Parameter	Set 1	Set 2	Set 4	Set 5	Note
TGSN (Transmission Gap Starting Slot Number)	4	4	8	10	
TGL1 (Transmission Gap Length 1)	7	7	14	10	
TGL2 (Transmission Gap Length 2)	-	-	-	-	Only one gap in use.
TGD (Transmission Gap Distance)	0	0	0	0	
TGPL1 (Transmission Gap Pattern Length)	3	12	4	8	
TGPRC (Transmission Gap Pattern Repetition Count)	NA	NA	NA	NA	Defined by higher layers
TGCFN (Transmission Gap Connection Frame Number):	NA	NA	NA	NA	Defined by higher layers
UL/DL compressed mode selection	DL & UL	DL & UL	DL & UL	DL & UL	2 configurations possible. DL & UL / DL
UL compressed mode method	SF/2	SF/2	SF/2	SF/2	
DL compressed mode method	SF/2	SF/2	SF/2	SF/2	
Downlink frame type and Slot format	11B	11B	11B	11B	
Scrambling code change	No	No	No	No	
RPP (Recovery period power control mode)	0	0	0	0	
ITP (Initial transmission power control mode)	0	0	0	0	

**Table A.22A: Compressed mode reference pattern 3 parameters**

Parameter	Set 1	Set 2	Set 3	Set 4	Note
TGSN (Transmission Gap Starting Slot Number)	8	8	8	8	
TGL1 (Transmission Gap Length 1)	14	14	14	14	
TGL2 (Transmission Gap Length 2)	-	-	-	-	Only one gap in use.
TGD (Transmission Gap Distance)	0	0	0	0	
TGPL1 (Transmission Gap Pattern Length)	8	24	24	24	
TGPRC (Transmission Gap Pattern Repetition Count)	NA	NA	NA	NA	Defined by higher layers
TGCFN (Transmission Gap Connection Frame Number):	0	4	12	20	
UL/DL compressed mode selection	DL & UL	DL & UL	DL & UL	DL & UL	2 configurations possible. DL & UL / DL
UL compressed mode method	SF/2	SF/2	SF/2	SF/2	
DL compressed mode method	SF/2	SF/2	SF/2	SF/2	
Downlink frame type and Slot format	11B	11B	11B	11B	
Scrambling code change	No	No	No	No	
RPP (Recovery period power control mode)	0	0	0	0	
ITP (Initial transmission power control mode)	0	0	0	0	



## A.6 DL reference parameters for PCH tests

The parameters for the PCH demodulation tests are specified in Table A.23 and Table A.24.

**Table A.23: Physical channel parameters for S-CCPCH**

Parameter	Unit	Level
Channel bit rate	kbps	60
Channel symbol rate	ksps	30
Slot Format #i	-	4
TFCI	-	OFF
Power offsets of TFCI and Pilot fields relative to data field	dB	0

**Table A.24: Transport channel parameters for S-CCPCH**

Parameter	PCH
Transport Channel Number	1
Transport Block Size	240
Transport Block Set Size	240
Transmission Time Interval	10 ms
Type of Error Protection	Convolution Coding
Coding Rate	$\frac{1}{2}$
Rate Matching attribute	256
Size of CRC	16
Position of TrCH in radio frame	fixed



A.7 DL reference channel parameters for HSDPA tests

A.7.1 Fixed Reference Channel (FRC)

A.7.1.1 Fixed Reference Channel Definition H-Set 1/1A/1B/1C/1E

Table A.25: Fixed Reference Channel H-Set 1/1A/1B/1C/1E

Parameter	Unit	Value	
Nominal Avg. Inf. Bit Rate	kbps	534	777
Inter-TTI Distance	TTI"s	3	3
Number of HARQ Processes	Processes	2	2
Information Bit Payload ( $N_{INF}$ )	Bits	3202	4664
Number Code Blocks	Blocks	1	1
Binary Channel Bits Per TTI	Bits	4800	7680
Total Available SML"s in UE	SML"s	19200	19200
Number of SML"s per HARQ Proc.	SML"s	9600	9600
Coding Rate		0.67	0.61
Number of Physical Channel Codes	Codes	5	4
Modulation		QPSK	16QAM
Note: The HS-DSCH shall be transmitted continuously with constant power but only every third TTI shall be allocated to the UE under test. The values in the table defines H-Set 1. H-Set 1A for DC-HSDPA and DB-DC-HSDPA is formed by applying H-Set 1 to each of the carriers available in DC-HSDPA and DB-DC-HSDPA mode. H-Set 1B and H-Set 1C for 4C-HSDPA are formed by applying H-Set 1 to each of the carriers available in 4C-HSDPA mode (3 carriers for H-Set 1B and 4 carriers for H-Set 1C). H-Set 1E for 8C-HSDPA is formed by applying H-Set 1 to each of the carriers available in 8C-HSDPA mode.			

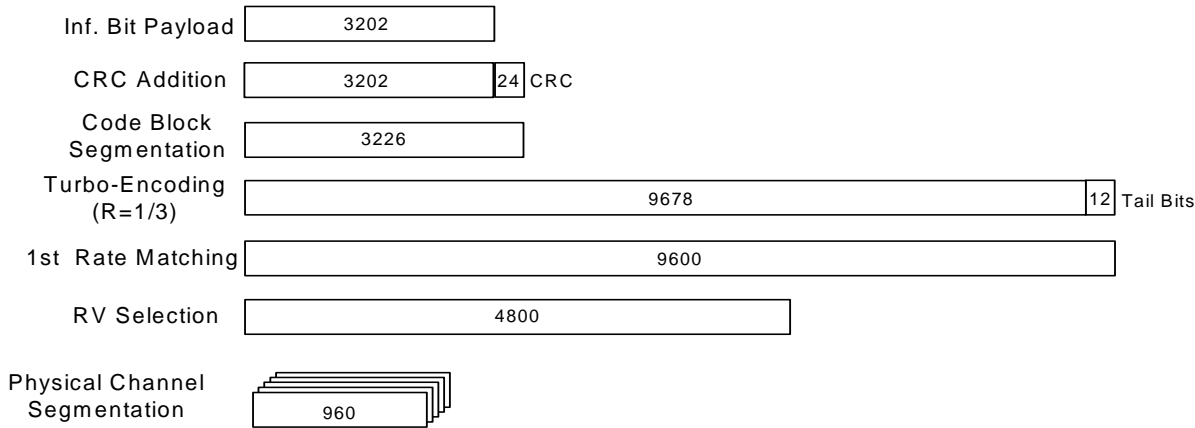


Figure A.12: Coding rate for Fixed reference Channel H-Set 1 (QPSK)



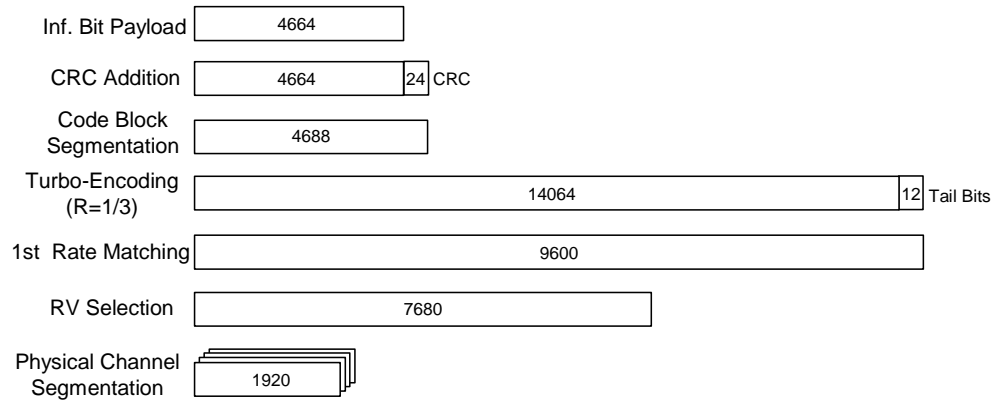


Figure A.13: Coding rate for Fixed reference Channel H-Set 1 (16 QAM)

A.7.1.2 Fixed Reference Channel Definition H-Set 2

Table A.26: Fixed Reference Channel H-Set 2

Parameter	Unit	Value	
Nominal Avg. Inf. Bit Rate	kbps	801	1166
Inter-TTI Distance	TTI"s	2	2
Number of HARQ Processes	Processes	3	3
Information Bit Payload ( $N_{INF}$ )	Bits	3202	4664
Number Code Blocks	Blocks	1	1
Binary Channel Bits Per TTI	Bits	4800	7680
Total Available SML"s in UE	SML"s	28800	28800
Number of SML"s per HARQ Proc.	SML"s	9600	9600
Coding Rate		0.67	0.61
Number of Physical Channel Codes	Codes	5	4
Modulation		QPSK	16QAM
Note: The HS-DSCH shall be transmitted continuously with constant power but only every second TTI shall be allocated to the UE under test.			

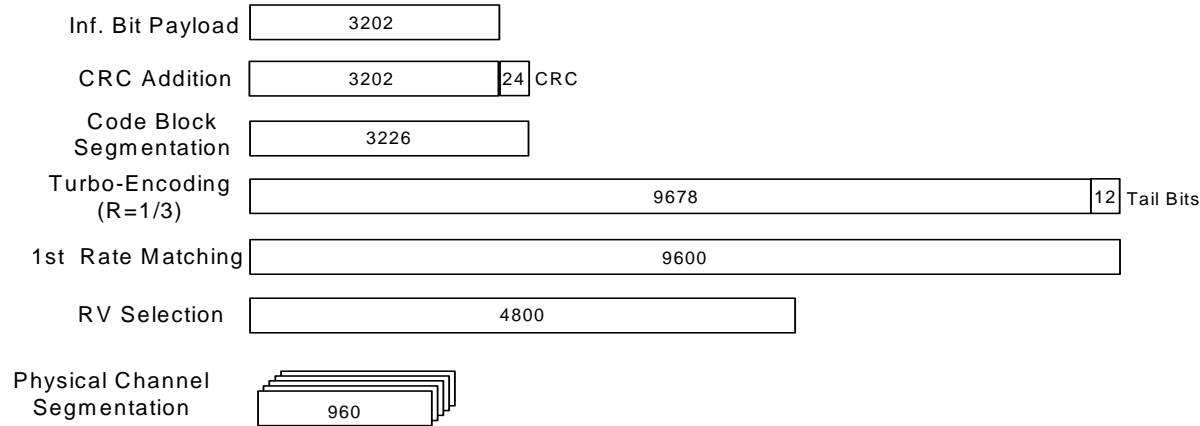


Figure A.14: Coding rate for Fixed Reference Channel H-Set 2 (QPSK)



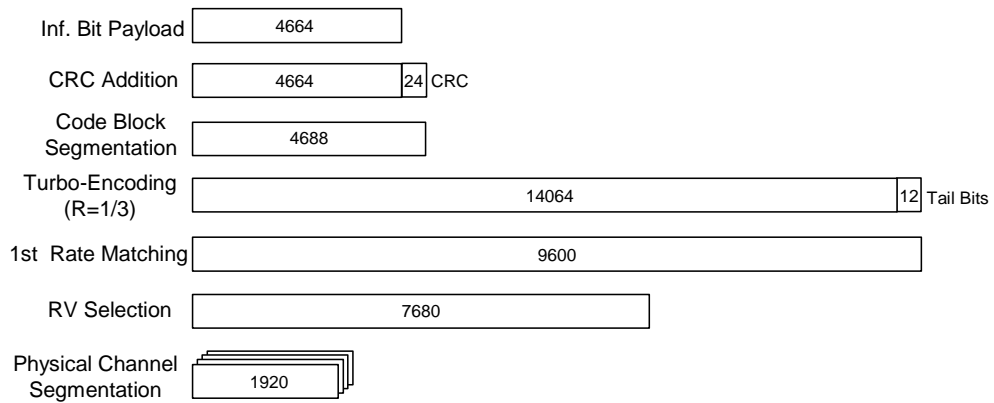


Figure A.15: Coding rate for Fixed Reference Channel H-Set 2 (16QAM)

### A.7.1.3 Fixed Reference Channel Definition H-Set 3/3A/3B/3C/3E

Table A.27: Fixed Reference Channel H-Set 3/3A/3B/3C/3E

Parameter	Unit	Value	
Nominal Avg. Inf. Bit Rate	kbps	1601	2332
Inter-TTI Distance	TTI"s	1	1
Number of HARQ Processes	Processes	6	6
Information Bit Payload ( $N_{INF}$ )	Bits	3202	4664
Number Code Blocks	Blocks	1	1
Binary Channel Bits Per TTI	Bits	4800	7680
Total Available SML"s, in UE	SML"s	57600	57600
Number of SML"s per HARQ Proc.	SML"s	9600	9600
Coding Rate		0.67	0.61
Number of Physical Channel Codes	Codes	5	4
Modulation		QPSK	16QAM
Note: The values in the table define H-Set 3. H-Set 3A for DC-HSDPA and DB-DC-HSDPA is formed by applying H-Set 3 to each of the carriers available in DC-HSDPA and DB-DC-HSDPA mode. H-Set 3B and H-Set 3C for 4C-HSDPA are formed by applying H-Set 3 to each of the carriers available in 4C-HSDPA mode (3 carriers for H-Set 3B and 4 carriers for H-Set 3C). H-Set 3E for 8C-HSDPA is formed by applying H-Set 3 to each of the carriers available in 8C-HSDPA mode.			

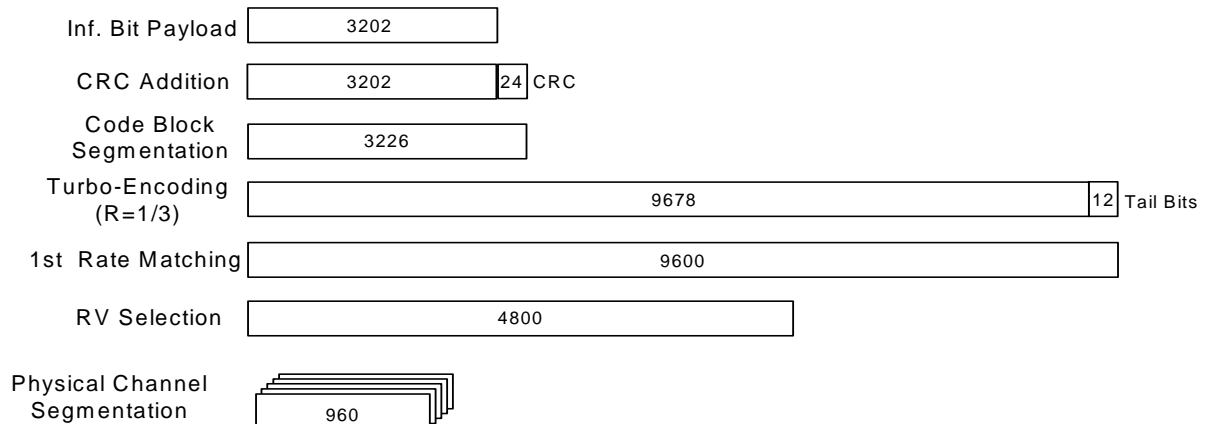
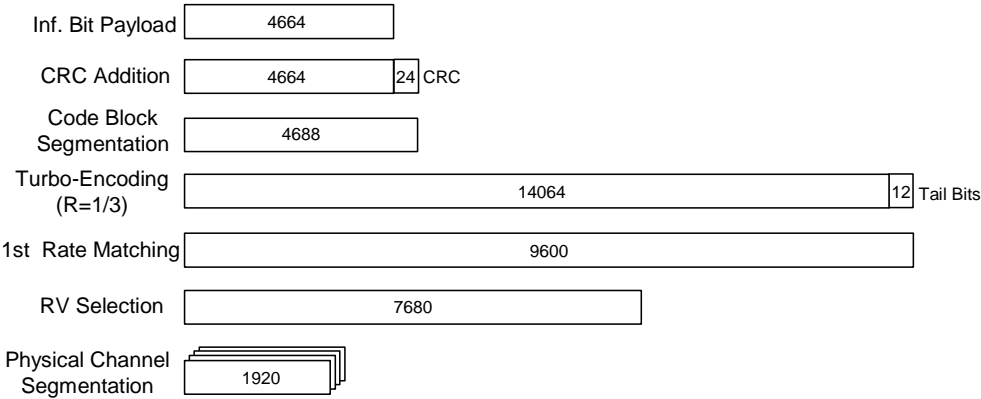


Figure A.16: Coding rate for Fixed reference Channel H-Set 3 (QPSK)



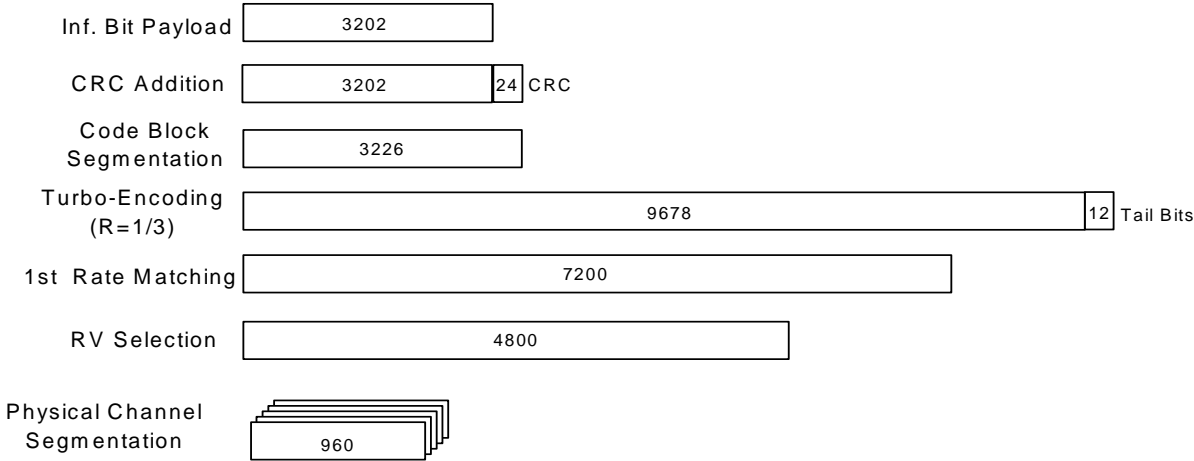


**Figure A.17: Coding rate for Fixed reference Channel H-Set 3 (16QAM)**

A.7.1.4 Fixed Reference Channel Definition H-Set 4

**Table A.28: Fixed Reference Channel H-Set 4**

Parameter	Unit	Value
Nominal Avg. Inf. Bit Rate	kbps	534
Inter-TTI Distance	TTI"s	2
Number of HARQ Processes	Processes	2
Information Bit Payload ( $N_{INF}$ )	Bits	3202
Number Code Blocks	Blocks	1
Binary Channel Bits Per TTI	Bits	4800
Total Available SML"s in UE	SML"s	14400
Number of SML"s per HARQ Proc.	SML"s	7200
Coding Rate		0.67
Number of Physical Channel Codes	Codes	5
Modulation		QPSK
Note: This FRC is used to verify the minimum inter-TTI distance for UE category 11. The HS-PDSCH shall be transmitted continuously with constant power. The six sub-frame HS-SCCH signalling pattern shall repeat as follows: ...OOXOXOOOXOXO..., where "X" marks TTI in which HS-SCCH uses the identity of the UE under test and "O" marks TTI, in which HS-SCCH uses a different identity.		



**Figure A.18: Coding rate for Fixed Reference Channel H-Set 4**



A.7.1.5 Fixed Reference Channel Definition H-Set 5

Table A.29: Fixed Reference Channel H-Set 5

Parameter	Unit	Value
Nominal Avg. Inf. Bit Rate	kbps	801
Inter-TTI Distance	TTI"s	1
Number of HARQ Processes	Processes	3
Information Bit Payload ( $N_{INF}$ )	Bits	3202
Number Code Blocks	Blocks	1
Binary Channel Bits Per TTI	Bits	4800
Total Available SML"s in UE	SML"s	28800
Number of SML"s per HARQ Proc.	SML"s	9600
Coding Rate		0.67
Number of Physical Channel Codes	Codes	5
Modulation		QPSK
Note: This FRC is used to verify the minimum inter-TTI distance for UE category 12. The HS-PDSCH shall be transmitted continuously with constant power. The six sub-frame HS-SCCH signalling pattern shall repeat as follows: ...OOXXXOOOXXXO..., where "X" marks TTI in which HS-SCCH uses the identity of the UE under test and "O" marks TTI, in which HS-SCCH uses a different identity.		

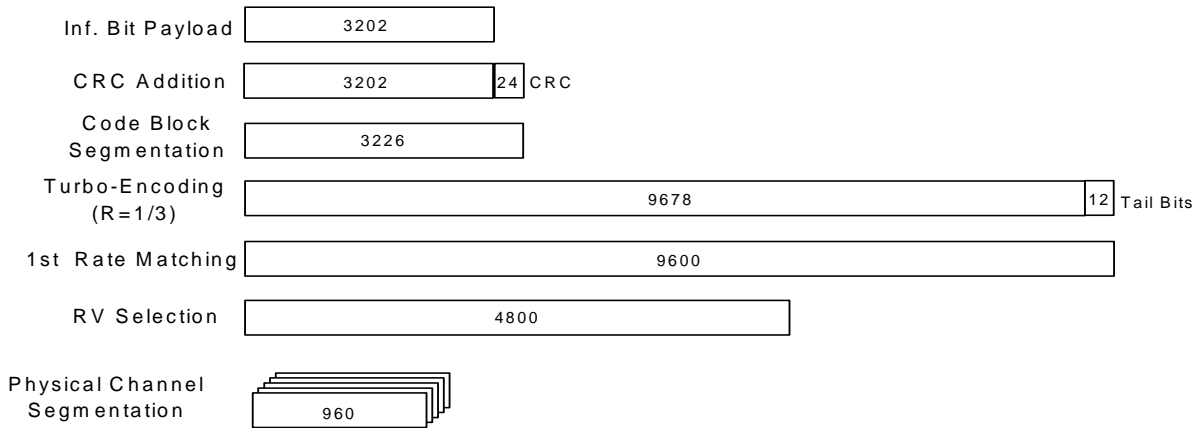


Figure A.19: Coding rate for Fixed Reference Channel H-Set 5



A.7.1.6 Fixed Reference Channel Definition H-Set 6/6A/6B/6C/6E

Table A.29A: Fixed Reference Channel H-Set 6/6A/6B/6C/6E

Parameter	Unit	Value	
Nominal Avg. Inf. Bit Rate	kbps	3219	4689
Inter-TTI Distance	TTI"s	1	1
Number of HARQ Processes	Processes	6	6
Information Bit Payload ( $N_{INF}$ )	Bits	6438	9377
Number Code Blocks	Blocks	2	2
Binary Channel Bits Per TTI	Bits	9600	15360
Total Available SML"s in UE	SML"s	115200	115200
Number of SML"s per HARQ Proc.	SML"s	19200	19200
Coding Rate		0.67	0.61
Number of Physical Channel Codes	Codes	10	8
Modulation		QPSK	16QAM
Note: The values in the table define H-Set 6. H-Set 6A for DC-HSDPA and DB-DC-HSDPA is formed by applying H-Set 6 to each of the carriers available in DC-HSDPA and DB-DC-HSDPA mode. H-Set 6B and H-Set 6C for 4C-HSDPA are formed by applying H-Set 6 to each of the carriers available in 4C-HSDPA mode (3 carriers for H-Set 6B and 4 carriers for H-Set 6C). H-Set 6E for 8C-HSDPA is formed by applying H-Set 6 to each of the carriers available in 8C-HSDPA mode.			

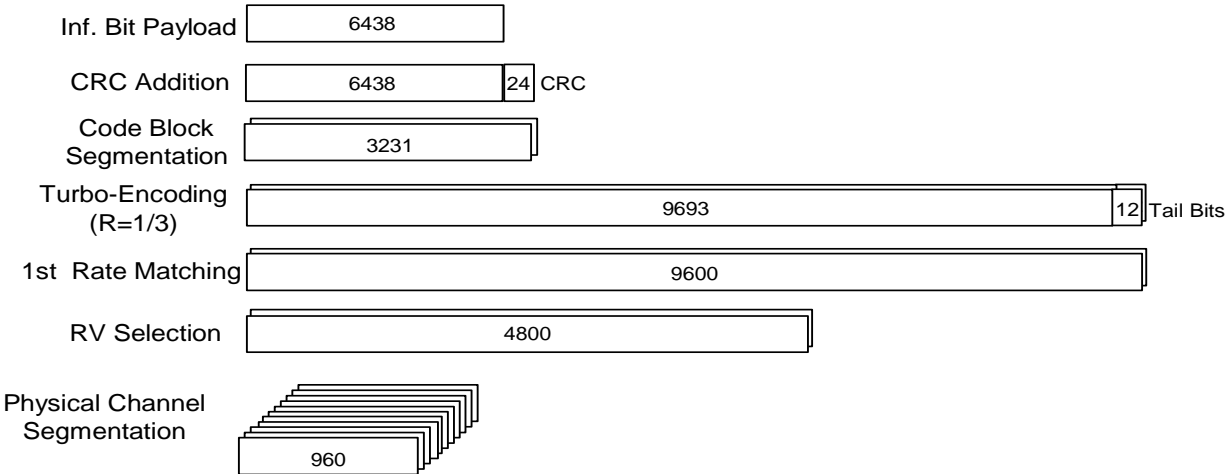


Figure A.20: Coding rate for Fixed reference Channel H-Set 6 (QPSK)



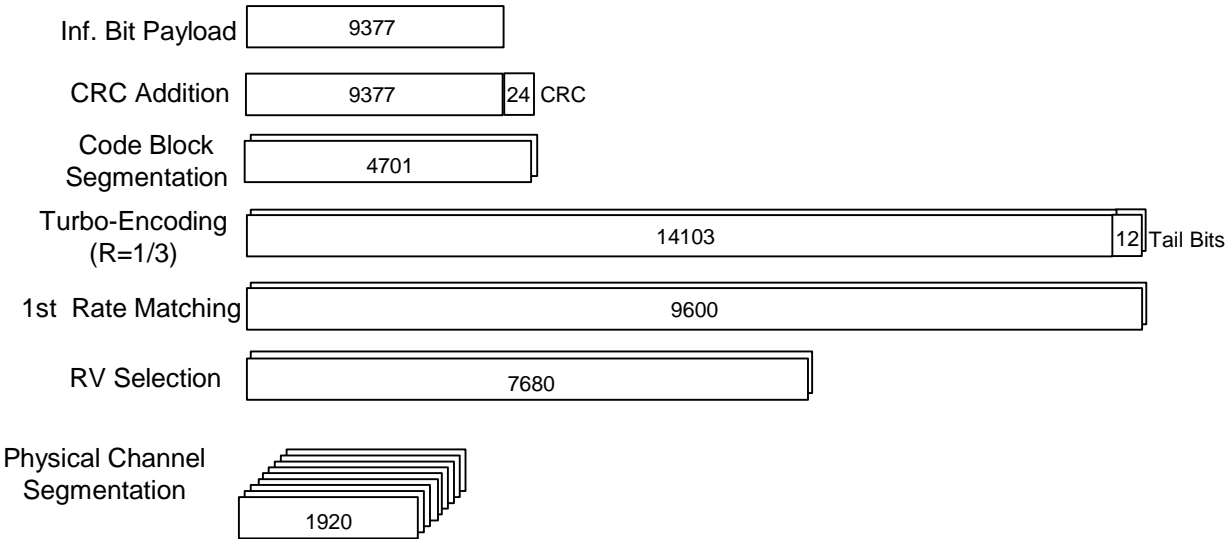


Figure A.21: Coding rate for Fixed reference Channel H-Set 6 (16 QAM)

A.7.1.7 Fixed Reference Channel Definition H-Set 7

Table A.29B: Fixed Reference Channel H-Set 7

Parameter	Unit	Value
Nominal Avg. Inf. Bit Rate	kbps	37.8
Inter-TTI Distance	TTI"s	8
Information Bit Payload ( $N_{INF}$ )	Bits	605
Number Code Blocks	Blocks	1
Binary Channel Bits Per TTI	Bits	960
Coding Rate		0.66
Number of Physical Channel Codes	Codes	1
Modulation		QPSK
Note: This FRC is used to verify CPC operation. The HS-DSCH shall be transmitted continuously with constant power but only every 8 <sup>th</sup> TTI shall be allocated to the UE under test.		

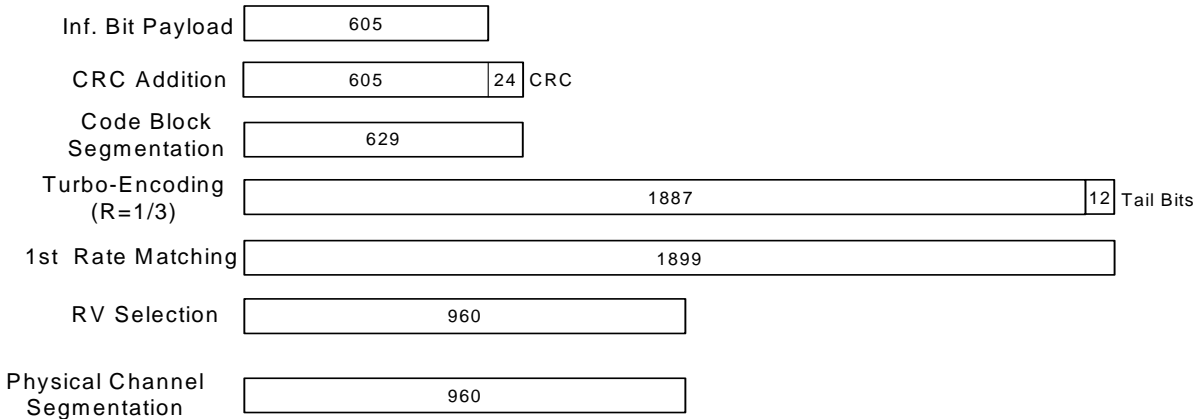


Figure A.22: Coding rate for Fixed Reference Channel H-Set 7 (QPSK)



A.7.1.8 Fixed Reference Channel Definition H-Set 8/8A/8B/8C/8E

Table A.29C: Fixed Reference Channel H-Set 8/8A/8B/8C/8E

Parameter	Unit	Value	
Nominal Avg. Inf. Bit Rate	kbps	13252	
Inter-TTI Distance	TTI"s	1	
Number of HARQ Processes	Processes	6	
Information Bit Payload ( $N_{INF}$ )	Bits	26504	
Number Code Blocks	Blocks	6	
Binary Channel Bits Per TTI	Bits	43200	
Total Available SML"s in UE	SML"s	259200	264000
Number of SML"s per HARQ Proc.	SML"s	43200	44000
Coding Rate		0.61	0.60
Number of Physical Channel Codes	Codes	15	
Modulation		64QAM	
Note 1:	The values in the table define H-Set 8. H-Set 8A for DC-HSDPA and DB-DC-HSDPA is formed by applying H-Set 8 to each of the carriers available in DC-HSDPA and DB-DC-HSDPA mode. H-Set 8B and H-Set 8C for 4C-HSDPA are formed by applying H-Set 8 to each of the carriers available in 4C-HSDPA mode (3 carriers for H-Set 8B and 4 carriers for H-Set 8C). H-Set 8E for 8C-HSDPA is formed by applying H-Set 8 to each of the carriers available in 8C-HSDPA mode.		
Note 2:	For H-Set 8, if 'Total number of soft channel bits' as per HS-DSCH categories is equal to 259200, set 'Number of SML"s per HARQ Proc.' as 43200 using an implicit UE IR Buffer Size Allocation. For H-Set 8, if 'Total number of soft channel bits' is larger than or equal to 264000, set 'Number of SML"s per HARQ Proc.' as 44000 using an explicit UE IR Buffer Size Allocation.		
Note 3:	For H-Set 8A/8B/8C/8E, set 'Number of SML"s per HARQ Proc.' as 43200 using an implicit UE IR Buffer Size Allocation.		

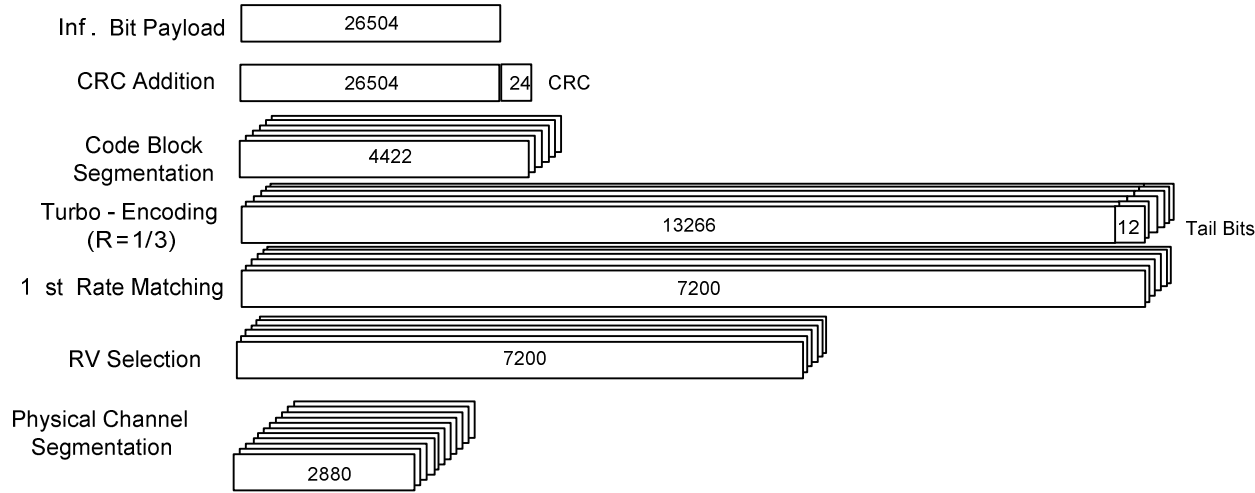


Figure A.23: Coding rate for Fixed reference Channel H-Set 8 (64 QAM)



A.7.1.9 Fixed Reference Channel Definition H-Set 9/9A/9B/9C/9E

Table A.29D: Fixed Reference Channel H-Set 9/9A/9B/9C/9E

Parameter	Unit	Value	
Transport block		Primary	Secondary
Combined Nominal Avg. Inf. Bit Rate		13652	
Nominal Avg. Inf. Bit Rate	kbps	8784	4868
Inter-TTI Distance	TTI"s	1	1
Number of HARQ Processes	Processes	6	6
Information Bit Payload ( $N_{INF}$ )	Bits	17568	9736
Number Code Blocks	Blocks	4	2
Binary Channel Bits Per TTI	Bits	28800	14400
Total available SML"s in UE	Bits	345600	
Number of SML"s per HARQ Proc.	SML"s	28800	28800
Coding Rate		0.61	0.68
Number of Physical Channel Codes	Codes	15	15
Modulation		16QAM	QPSK
Note: The values in the table define H-Set 9. H-Set 9A for DC-HSDPA and DB-DC-HSDPA is formed by applying H-Set 9 to each of the carriers available in DC-HSDPA and DB-DC-HSDPA mode. H-Set 9B and H-Set 9C for 4C-HSDPA are formed by applying H-Set 9 to each of the carriers available in 4C-HSDPA mode (3 carriers for H-Set 9B and 4 carriers for H-Set 9C). H-Set 9E for 8C-HSDPA is formed by applying H-Set 9 to each of the carriers available in 8C-HSDPA mode.			

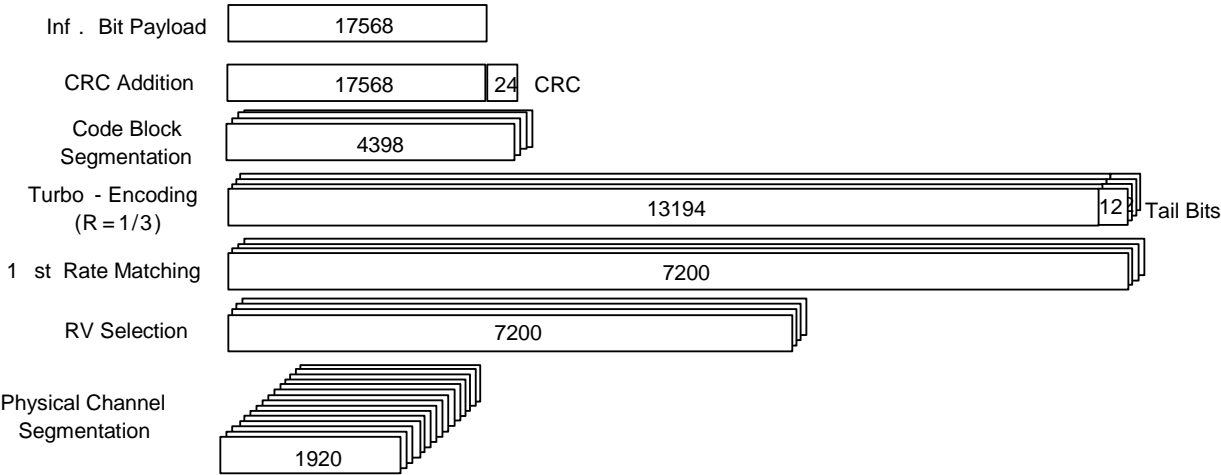


Figure A.24: Coding rate for Fixed Reference Channel H-Set 9 Primary Transport Block



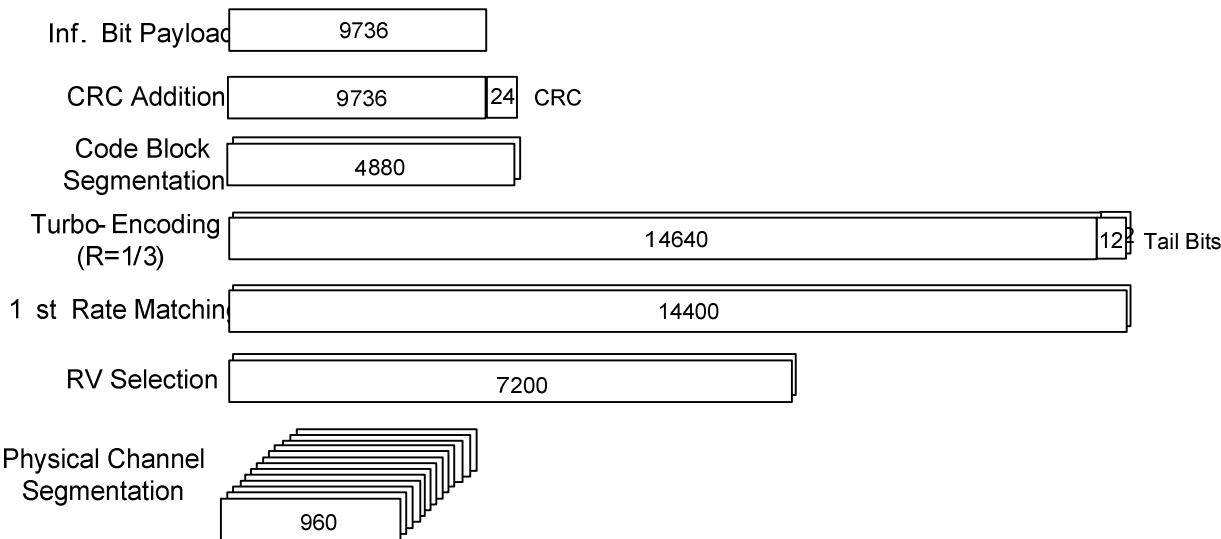


Figure A.25: Coding rate for Fixed Reference Channel H-Set 9 Secondary Transport Block

### A.7.1.10 Fixed Reference Channel Definition H-Set 10/10A/10B/10C/10E

Table A.29E: Fixed Reference Channel H-Set 10/10A/10B/10C/10E

Parameter	Unit	Value	
Nominal Avg. Inf. Bit Rate	Kbps	8774	4860
Inter-TTI Distance	TTI"s	1	1
Number of HARQ Processes	Processes	6	6
Information Bit Payload	Bits	17548	9719
Number Code Blocks	Blocks	4	2
Binary Channel Bits Per TTI	Bits	28800	14400
Number of SML"s per HARQ Proc.	SML"s	28800	28800
Coding Rate		0.6	0.67
Number of Physical Channel Codes	Codes	15	15
Modulation		16QAM	QPSK
Note: The values in the table define H-Set 10. H-Set 10A for DC-HSDPA and DB-DC-HSDPA is formed by applying H-Set 10 to each of the carriers available in DC-HSDPA and DB-DC-HSDPA mode. H-Set 10B and H-Set 10C for 4C-HSDPA are formed by applying H-Set 10 to each of the carriers available in 4C-HSDPA mode (3 carriers for H-Set 10B and 4 carriers for H-Set 10C). H-Set 10E for 8C-HSDPA is formed by applying H-Set 10 to each of the carriers available in 8C-HSDPA mode.			



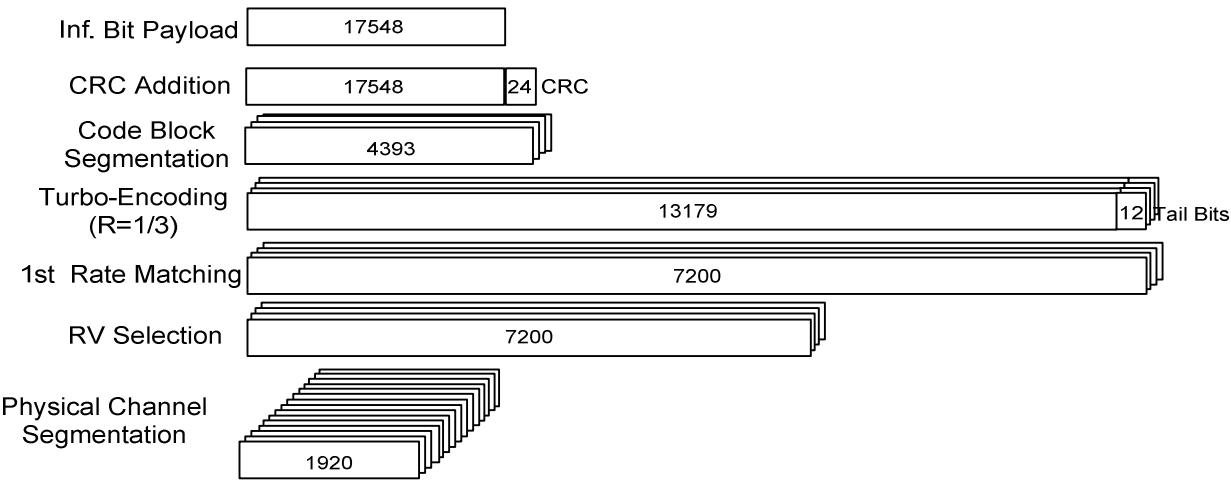


Figure A.24: Coding rate for Fixed Reference Channel H-Set 10 (16QAM)

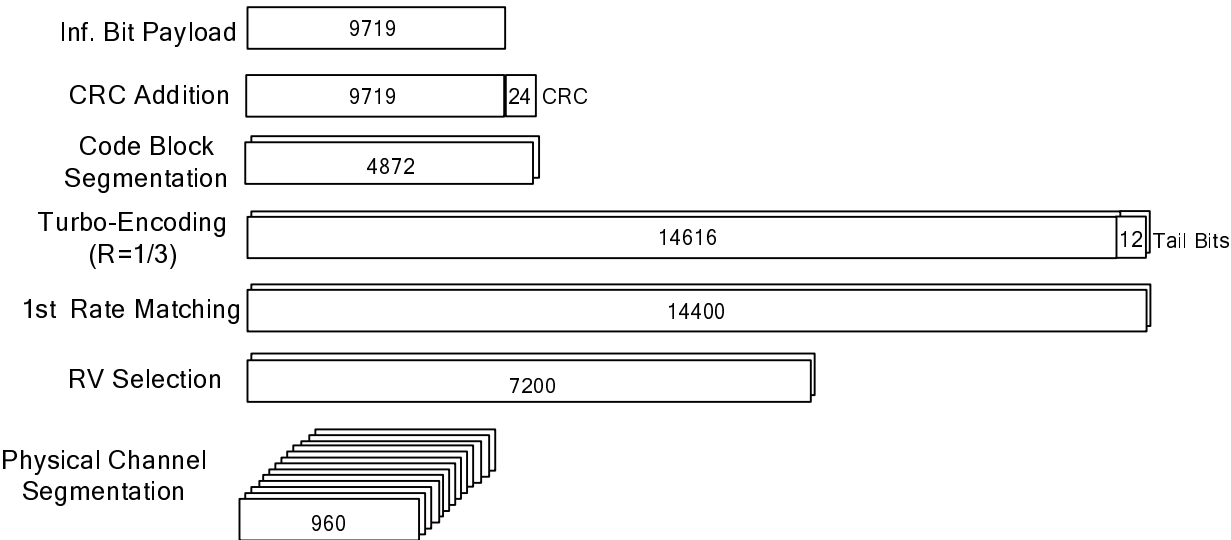


Figure A.25: Coding rate for Fixed Reference Channel H-Set 10 (QPSK)



A.7.1.11 Fixed Reference Channel Definition H-Set 11/11A/11B/11C/11E

Table A.29F: Fixed Reference Channel H-Set 11/11A/11B/11C/11E

Parameter	Unit	Value	
Transport block		Primary	Secondary
Combined Nominal Avg. Inf. Bit Rate		22074	
Nominal Avg. Inf. Bit Rate	kbps	13300	8774
Inter-TTI Distance	TTI"s	1	1
Number of HARQ Processes	Processes	6	6
Information Bit Payload ( $N_{INF}$ )	Bits	26504	17568
Number Code Blocks	Blocks	6	4
Binary Channel Bits Per TTI	Bits	43200	28800
Total available SML"s in UE	Bits	518400	
Number of SML"s per HARQ Proc.	SML"s	43200	43200
Coding Rate		0.61	0.6
Number of Physical Channel Codes	Codes	15	15
Modulation		64QAM	16QAM
Note: The values in the table define H-Set 11. H-Set 11A for DC-HSDPA and DB-DC-HSDPA is formed by applying H-Set 11 to each of the carriers available in DC-HSDPA and DB-DC-HSDPA mode. H-Set 11B and H-Set 11C for 4C-HSDPA are formed by applying H-Set 11 and H-Set 11C to each of the carriers available in 4C-HSDPA mode (3 carriers for H-Set 11B and 4 carriers for H-Set 11C). H-Set 11E for 8C-HSDPA is formed by applying H-Set 11 to each of the carriers available in 8C-HSDPA mode.			

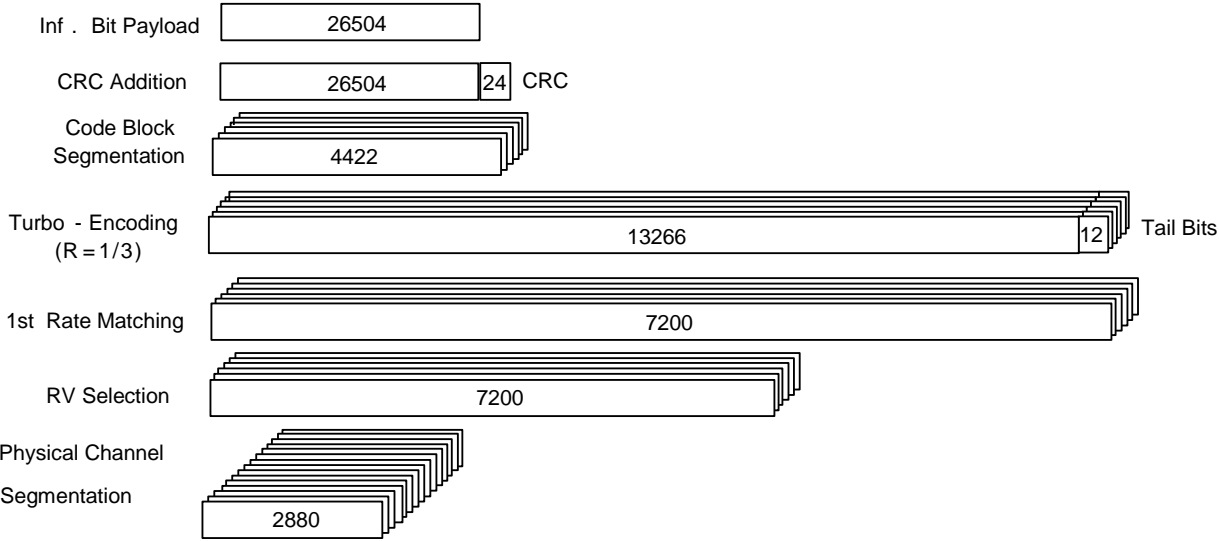


Figure A.26: Coding rate for Fixed Reference Channel H-Set 11 Primary Transport Block



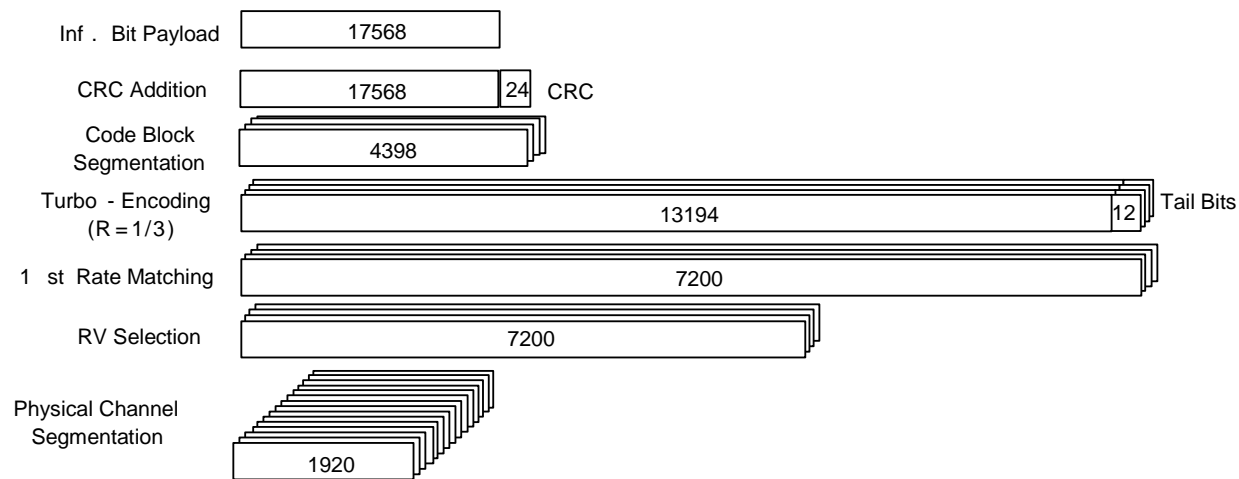
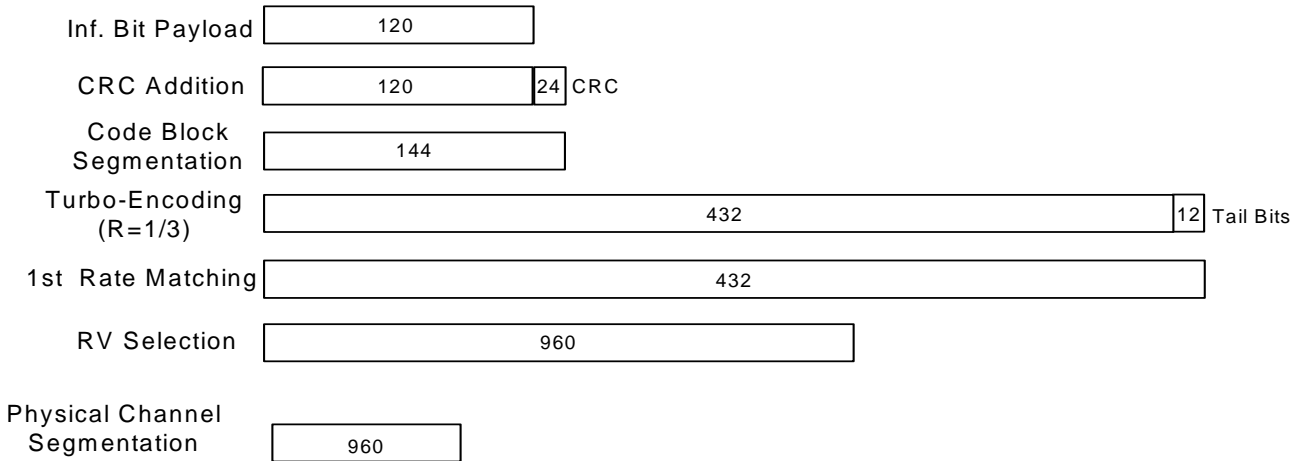


Figure A.27: Coding rate for Fixed Reference Channel H-Set 11 Secondary Transport Block

A.7.1.12 Fixed Reference Channel Definition H-Set 12

Table A.29G: Fixed Reference Channel H-Set 12

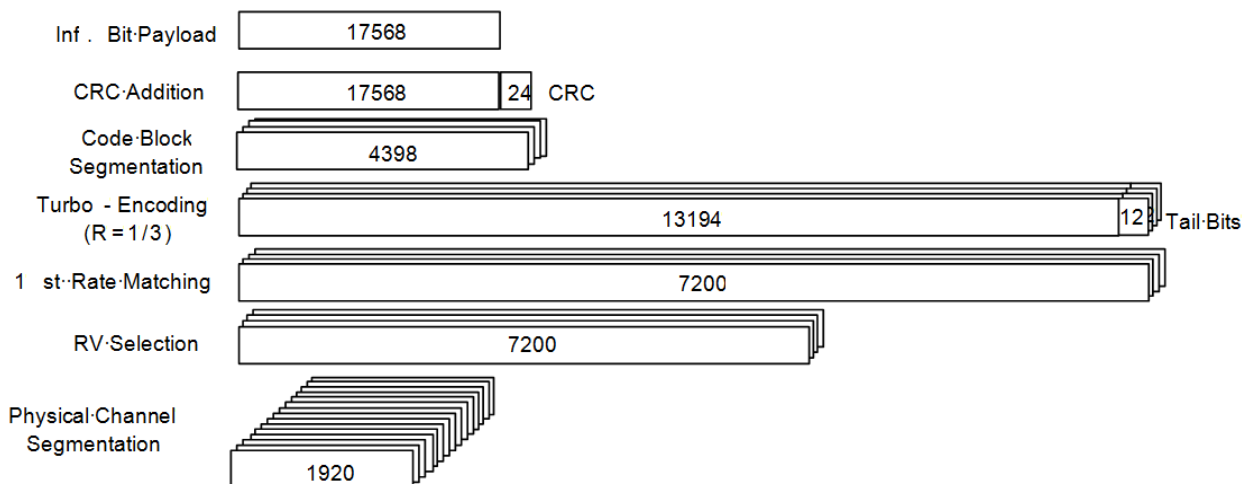
Parameter	Unit	Value
Nominal Avg. Inf. Bit Rate	kbps	60
Inter-TTI Distance	TTI"s	1
Number of HARQ Processes	Processes	6
Information Bit Payload ( $N_{INF}$ )	Bits	120
Number Code Blocks	Blocks	1
Binary Channel Bits Per TTI	Bits	960
Total Available SML"s in UE	SML"s	19200
Number of SML"s per HARQ Proc.	SML"s	3200
Coding Rate		0.15
Number of Physical Channel Codes	Codes	1
Modulation		QPSK
Note 1: The RMC is intended to be used for DC-HSDPA mode and both cells shall transmit with identical parameters as listed in the table.		
Note 2: Maximum number of transmission is limited to 1, i.e., retransmission is not allowed. The redundancy and constellation version 0 shall be used.		



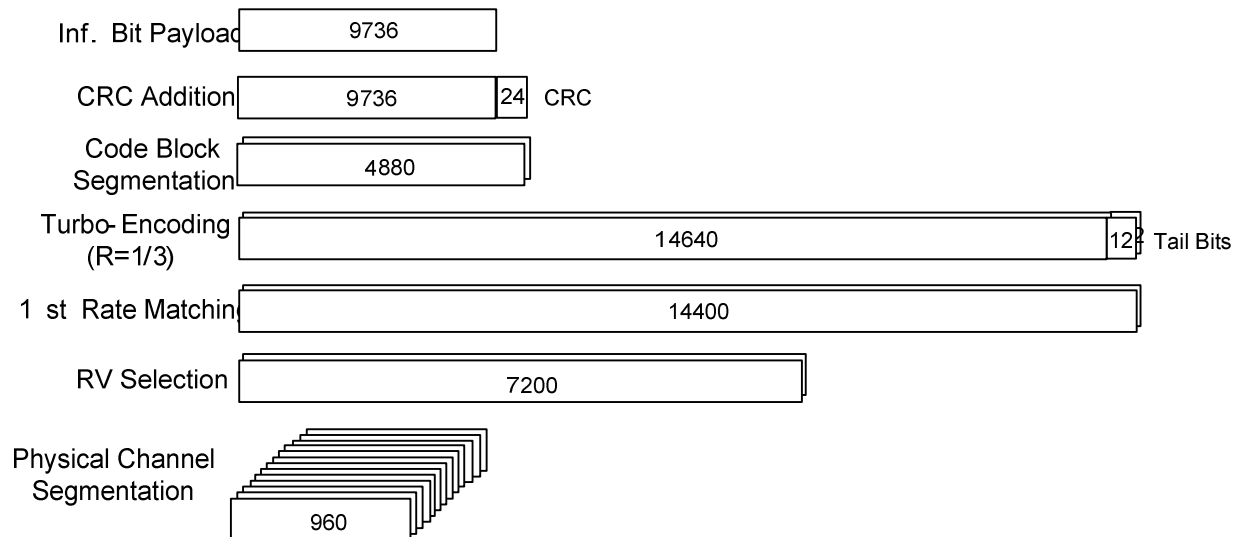


**Figure A.28: Coding rate for Fixed reference Channel H-Set 12 (QPSK)****A.7.1.13 Fixed Reference Channel Definition H-Set 13/13A/13C****Table A.29H: Fixed Reference Channel H-Set 13/13A/13C**

Parameter	Unit	Value			
Transport block		Primary	Second	Third	Fourth
Combined Nominal Avg. Inf. Bit Rate		27304			
Nominal Avg. Inf. Bit Rate	Kbps	8784	4868	4868	8784
Inter-TTI Distance	TTI"s	1	1	1	1
Number of HARQ Processes	Processes	6	6	6	6
Information Bit Payload ( $N_{INF}$ )	Bits	17568	9736	9736	17568
Number Code Blocks	Blocks	4	2	2	4
Binary Channel Bits Per TTI	Bits	28800	14400	14400	28800
Total available SML"s in UE	Bits	1036800			
Number of SML"s per HARQ Proc.	SML"s	43200	43200	43200	43200
Coding Rate		0.61	0.68	0.68	0.61
Number of Physical Channel Codes	Codes	15	15	15	15
Modulation		16QAM	QPSK	QPSK	16QAM
Note: The values in the table define H-Set 13. H-Set 13A for DC-HSDPA and DB-DC-HSDPA is formed by applying H-Set 13 to each of the carriers available in DC-HSDPA and DB-DC-HSDPA mode. H-Set 13C for 4C-HSDPA are formed by applying H-Set 13 to each of the carriers available in 4C-HSDPA mode.					

**Figure A.29: Coding rate for Fixed Reference Channel H-Set 13 Primary and Fourth Transport Block**





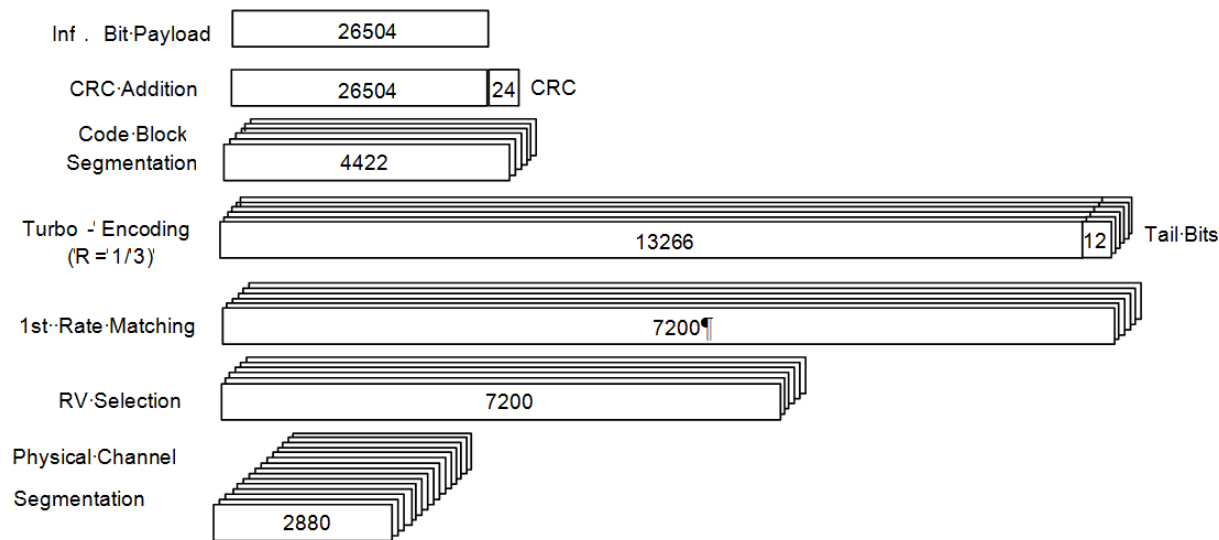
**Figure A.30: Coding rate for Fixed Reference Channel H-Set 13 Secondary and Third Transport Block**

#### A.7.1.14 Fixed Reference Channel Definition H-Set 14/14A/14C

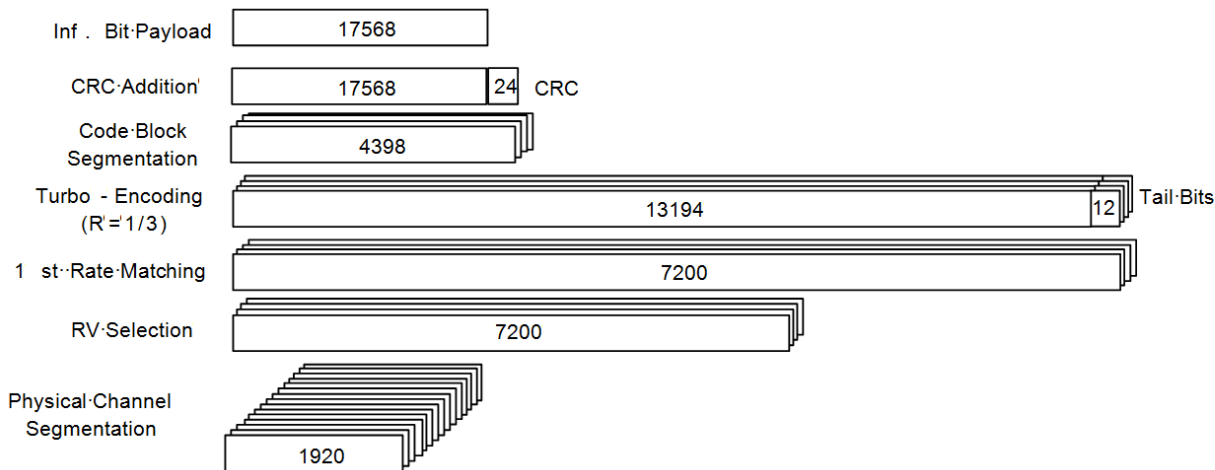
**Table A.29I: Fixed Reference Channel H-Set 14/14A/14C**

Parameter	Unit	Value			
		Primary	Second	Third	Fourth
Transport block		44148			
Combined Nominal Avg. Inf. Bit Rate		44148			
Nominal Avg. Inf. Bit Rate	Kbps	13300	8774	8774	13300
Inter-TTI Distance	TTI"s	1	1	1	1
Number of HARQ Processes	Processes	6	6	6	6
Information Bit Payload ( $N_{INF}$ )	Bits	26504	17568	17568	26504
Number Code Blocks	Blocks	6	4	4	6
Binary Channel Bits Per TTI	Bits	43200	28800	28800	43200
Total available SML"s in UE	Bits	1036800			
Number of SML"s per HARQ Proc.	SML"s	43200	43200	43200	43200
Coding Rate		0.61	0.6	0.6	0.61
Number of Physical Channel Codes	Codes	15	15	15	15
Modulation		64QAM	16QAM	16QAM	64QAM
Note: The values in the table define H-Set 14. H-Set 14A for DC-HSDPA and DB-DC-HSDPA is formed by applying H-Set 14 to each of the carriers available in DC-HSDPA and DB-DC-HSDPA mode. H-Set 14C for 4C-HSDPA are formed by applying H-Set 14 to each of the carriers available in 4C-HSDPA mode.					





**Figure A.31: Coding rate for Fixed Reference Channel H-Set 14 Primary and Fourth Transport Block**



**Figure A.32: Coding rate for Fixed Reference Channel H-Set 14 Secondary and Third Transport Block**

## A.8 DL reference parameters for MBMS tests

### A.8.1 MCCH

The parameters for the MCCH demodulation tests are specified in Table A.30 and Table A.31.

**Table A.30: Physical channel parameters for S-CCPCH**

Parameter	Unit	Level
Channel bit rate	kbps	30
Channel symbol rate	ksps	15
Slot Format #1	-	2
TFCI	-	ON
Power offsets of TFCI and Pilot fields relative to data field	dB	0



**Table A.31: Transport channel parameters for S-CCPCH**

Parameter	MCCH
<b>User Data Rate</b>	<b>7.6 kbps</b>
Transport Channel Number	1
Transport Block Size	72
Transport Block Set Size	72
RLC SDU block size	4088
Transmission Time Interval	10 ms
Repetition period	640 ms
Modification period	1280 ms
Type of Error Protection	Convolution Coding
Coding Rate	1/3
Rate Matching attribute	256
Size of CRC	16
Position of TrCH in radio frame	Flexible

## A.8.1 MTCH

The parameters for the MTCH demodulation tests are specified in Table A.32 and Table A.33.

**Table A.32: Physical channel parameters for S-CCPCH**

Parameter	Unit	Level	Level	Level
<b>User Data Rate</b>	<b>kbps</b>	<b>512</b>	<b>256</b>	<b>128</b>
Channel bit rate	kbps	1920	960	480
Channel symbol rate	ksps	480	480	240
Slot Format #i	-	23	14	12
TFCI	-	ON	ON	ON
Power offsets of TFCI and Pilot fields relative to data field	dB	0	0	0

**Table A.33: Transport channel parameters for S-CCPCH**

Parameter	MTCH			
<b>User Data Rate</b>	<b>512 kbps MBSFN</b>	<b>256 kbps</b>	<b>128 kbps 40 ms TTI</b>	<b>128 kbps, 80 ms TTI</b>
Transport Channel Number	1	1	1	1
Transport Block Size	2560	2536	2536	2536
Transport Block Set Size	20480	10144	5072	10144
Nr of transport blocks/TTI	8	4	2	4
RLC SDU block size	20336	10080	5024	10080
Transmission Time Interval	40 ms	40 ms	40 ms	80 ms
Minimum inter-TTI interval	1	1	1	1
Type of Error Protection	Turbo	Turbo	Turbo	Turbo
Rate Matching attribute	256	256	256	256
Size of CRC	16	16	16	16
Position of TrCH in radio frame	Flexible	Flexible	Flexible	Flexible

## A.9 DL reference parameters for combined MTCH demodulation and cell identification

Parameters for combined MTCH demodulation and cell identification requirements are defined in Table A.34.



**Table A.34: Cell reselection parameters**

Parameter	Unit	Value
Serving cell in the initial condition		Cell1
Neighbour cells		32 intra-frequency neighbour cells are indicated including Cell2 and Cell3
Cell_selection_and_reselection_quality_measure		CPICH $E_c/N_0$
Qqualmin	dB	-20
Qrxlevmin	dBm	-115
UE_TXPWR_MAX_RACH	dB	21
Qhyst2	dB	20 dB
Treselection	seconds	4
Sintrasearch	dB	not sent
IE 'FACH Measurement occasion info'		not sent



## Annex B (normative) : Propagation conditions

### B.1 (void)

### B.2 Propagation Conditions

#### B.2.1 Static propagation condition

The propagation for the static performance measurement is an Additive White Gaussian Noise (AWGN) environment. No fading and multi-paths exist for this propagation model.

#### B.2.2 Multi-path fading propagation conditions

Table B1 shows propagation conditions that are used for the performance measurements in multi-path fading environment. All taps have classical Doppler spectrum.

**Table B.1: Propagation Conditions for Multi path Fading Environments (Cases 1 to 6)**

Case 1		Case 2		Case 3		Case 4		Case 5 (Note 1)		Case 6	
Speed for Band I, II, III, IV, IX, X and XXV: 3 km/h		Speed for Band I, II, III, IV, IX, X and XXV: 3 km/h		Speed for Band I, II, III, IV, IX, X and XXV: 120 km/h		Speed for Band I, II, III, IV, IX, X and XXV: 3 km/h		Speed for Band I, II, III, IV, IX, X and XXV: 50 km/h		Speed for Band I, II, III, IV, IX, X and XXV: 250 km/h	
Speed for Band V, VI, VIII, XIX, XX and XXVI: 7 km/h		Speed for Band V, VI, VIII, XIX, XX and XXVI: 7 km/h		Speed for Band V, VI, VIII, XIX, XX and XXVI: 282 km/h (Note 2)		Speed for Band V, VI, VIII, XIX, XX and XXVI: 7 km/h		Speed for Band V, VI, VIII, XIX, XX and XXVI: 118 km/h		Speed for Band V, VI, VIII, XIX, XX and XXVI: 583 km/h (Note 2)	
Speed for Band VII: 2.3 km/h		Speed for Band VII: 2.3 km/h		Speed for Band VII: 92 km/h		Speed for Band VII: 2.3 km/h		Speed for Band VII: 38 km/h		Speed for Band VII: 192 km/h	
Speed for Band XI, XXI: 4.1 km/h		Speed for Band XI, XXI: 4.1 km/h		Speed for Band XI, XXI: 166 km/h		Speed for Band XI, XXI: 4.1 km/h		Speed for Band XI, XXI: 69 km/h		Speed for Band XI, XXI: 345 km/h (Note 2)	
Speed for Band XII, XIII, XIV 8 km/h		Speed for Band XII, XIII, XIV 8 km/h		Speed for Band XII, XIII, XIV 320 km/h		Speed for Band XII, XIII, XIV 8 km/h		Speed for Band XII, XIII, XIV 133 km/h		Speed for Band XII, XIII, XIV 668 km/h	
Speed for Band XXII: 1.7 km/h		Speed for Band XXII: 1.7 km/h		Speed for Band XXII: 69 km/h		Speed for Band XXII: 1.7 km/h		Speed for Band XXII: 29 km/h		Speed for Band XXII: 143 km/h	
Relative Delay [ns]	Relative mean Power [dB]	Relative Delay [ns]	Relative mean Power [dB]	Relative Delay [ns]	Relative mean Power [dB]	Relative Delay [ns]	Relative mean Power [dB]	Relative Delay [ns]	Relative mean Power [dB]	Relative Delay [ns]	Relative mean Power [dB]
0	0	0	0	0	0	0	0	0	0	0	0
976	-10	976	0	260	-3	976	0	976	-10	260	-3
		20000	0	521	-6					521	-6
				781	-9					781	-9

NOTE 1: Case 5 is only used in TS25.133.

NOTE 2: Speed above 250km/h is applicable to demodulation performance requirements only.



**Table B.1A (void)**

Table B.1B shows propagation conditions that are used for HSDPA performance measurements in multi-path fading environment. For HSDPA and DCH enhanced performance requirements, the fading of the signals and the AWGN signals provided in each receiver antenna port shall be independent. For DC-HSDPA requirements, the fading of the signals for each cell shall be independent.

**Table B.1B: Propagation Conditions for Multi-Path Fading Environments for HSDPA Performance Requirements**

ITU Pedestrian A Speed 3km/h (PA3)		ITU Pedestrian B Speed 3km/h (PB3)		ITU vehicular A Speed 30km/h (VA30)		ITU vehicular A Speed 120km/h (VA120)	
Speed for Band I, II, III, IV, IX, X and XXV 3 km/h		Speed for Band I, II, III, IV, IX, X and XXV 3 km/h		Speed for Band I, II, III, IV, IX, X and XXV 30 km/h		Speed for Band I, II, III, IV, IX, X and XXV 120 km/h	
Speed for Band V, VI, VIII, XIX, XX and XXVI 7 km/h		Speed for Band V, VI, VIII, XIX, XX and XXVI 7 km/h		Speed for Band V, VI, VIII, XIX, XX and XXVI 71 km/h		Speed for Band V, VI, VIII, XIX, XX and XXVI 282 km/h (Note 1)	
Speed for Band VII 2.3 km/h		Speed for Band VII 2.3 km/h		Speed for Band VII 23 km/h		Speed for Band VII 92 km/h	
Speed for Band XI, XXI, XXXII: 4.1 km/h		Speed for Band XI, XXI, XXXII: 4.1 km/h		Speed for Band XI, XXI, XXXII: 41 km/h		Speed for Band XI, XXI, XXXII: 166 km/h (Note 1)	
Speed for Band XII, XIII, XIV 8 km/h		Speed for Band XII, XIII, XIV 8 km/h		Speed for Band XII, XIII, XIV 80 km/h		Speed for Band XII, XIII, XIV 320 km/h	
Speed for Band XXII: 1.7 km/h		Speed for Band XXII: 1.7 km/h		Speed for Band XXII: 17 km/h		Speed for Band XXII: 69 km/h	
Relative Delay [ns]	Relative Mean Power [dB]	Relative Delay [ns]	Relative Mean Power [dB]	Relative Delay [ns]	Relative Mean Power [dB]	Relative Delay [ns]	Relative Mean Power [dB]
0	0	0	0	0	0	0	0
110	-9.7	200	-0.9	310	-1.0	310	-1.0
190	-19.2	800	-4.9	710	-9.0	710	-9.0
410	-22.8	1200	-8.0	1090	-10.0	1090	-10.0
		2300	-7.8	1730	-15.0	1730	-15.0
		3700	-23.9	2510	-20.0	2510	-20.0

NOTE 1: Speed above 120km/h is applicable to demodulation performance requirements only.

Table B.1C shows propagation conditions that are used for CQI test in multi-path fading and HS-SCCH-less demodulation of HS-DSCH. For HSDPA enhanced performance requirements, the fading of the signals and the AWGN signals provided in each receiver antenna port shall be independent. For DC-HSDPA requirements, the fading of the signals for each cell shall be independent.

**Table B.1C: Propagation Conditions for CQI test in multi-path fading and HS-SCCH-less demodulation of HS-DSCH**

Case 8, Speed for Band I, II, III, IV, IX, X and XXV: 30km/h Speed for Band V, VI, VIII, XIX, XX and XXVI: 71km/h Speed for Band VII: 23km/h Speed for Band XI, XXI, XXXII: 41km/h Speed for Band XII, XIII, XIV: 80 km/h Speed for Band XXII: 17 km/h	
Relative Delay [ns]	Relative mean Power [dB]
0	0
976	-10



Table B.1D shows propagation conditions that are used for MBMS demodulation performance measurements in multi-path fading environment.

**Table B.1D: Propagation Conditions for Multi-Path Fading Environments for MBMS Performance Requirements**

<b>ITU vehicular A Speed 3km/h (VA 3)</b>	
Speed for Band I, II, III, IV, IX, X and XXV 3 km/h	
Speed for Band V, VI, VIII, XIX, XX and XXVI: 7 km/h	
Speed for Band VII: 2.3 km/h	
Speed for Band XI, XXI: 4.1 km/h	
Speed for Band XII, XIII, XIV: 8 km/h	
Speed for Band XXII: 1.7 km/h	
<b>Relative Delay [ns]</b>	<b>Relative Mean Power [dB]</b>
0	0
310	-1.0
710	-9.0
1090	-10.0
1730	-15.0
2510	-20.0

Table B.1E shows propagation conditions that are used for MBSFN demodulation performance measurements in multi-path fading environment. All taps have classical Doppler spectrum.

The fading of the signals and the AWGN signals provided in each receiver antenna port shall be independent.



Table B.1E: Propagation Conditions for Multi-Path Fading Environments for MBSFN Demodulation Performance Requirements

MBSFN channel model	
Speed for Band I, II, III, IV, IX, X and XXV 3 km/h	
Speed for Band V, VI, VIII, XIX, XX and XXVI: 7 km/h	
Speed for Band VII: 2.3 km/h	
Speed for Band XI, XXI: 4.1 km/h	
Speed for Band XII, XIII and XIV 8 km/h	
Speed for Band XXII: 1.7 km/h	
Relative Delay [ns]	Relative Mean Power [dB]
0	0
310	-1
710	-9
1090	-10
1730	-15
2510	-20
12490	-10
12800	-11
13200	-19
13580	-20
14220	-25
15000	-30
27490	-20
27800	-21
28200	-29
28580	-30
29220	-35
30000	-40

B.2.3 Moving propagation conditions

The dynamic propagation conditions for the test of the baseband performance are non fading channel models with two taps. The moving propagation condition has two tap, one static, Path0, and one moving, Path1. The time difference between the two paths is according Equation (B.1). The taps have equal strengths and equal phases.

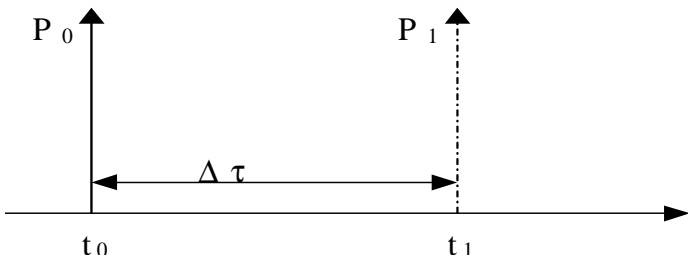


Figure B.1: The moving propagation conditions



$$\Delta\tau = B + \frac{A}{2}(1 + \sin(\Delta\omega \cdot t)) \quad (\text{B.1})$$

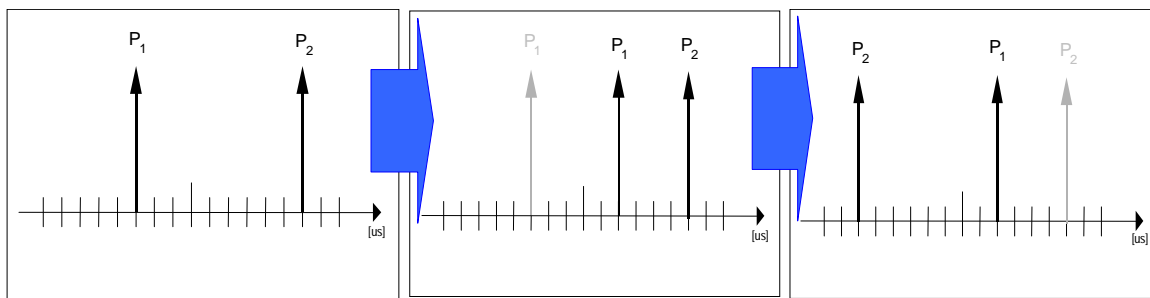
The parameters in the equation are shown in the following table.

**Table B.2**

Parameter	Value
A	5 $\mu\text{s}$
B	1 $\mu\text{s}$
$\Delta\omega$	$40 \cdot 10^{-3} \text{ s}^{-1}$

## B.2.4 Birth-Death propagation conditions

The dynamic propagation conditions for the test of the base band performance is a non fading propagation channel with two taps. The moving propagation condition has two taps, Path1 and Path2 which alternate between "birth" and "death". The positions the paths appear are randomly selected with an equal probability rate and is shown in Figure B.2.



**Figure B.2: Birth death propagation sequence**

1. Two paths, Path1 and Path2 are randomly selected from the group  $[-5, -4, -3, -2, -1, 0, 1, 2, 3, 4, 5] \mu\text{s}$ . The paths have equal magnitudes and equal phases.
2. After 191 ms, Path1 vanishes and reappears immediately at a new location randomly selected from the group  $[-5, -4, -3, -2, -1, 0, 1, 2, 3, 4, 5] \mu\text{s}$  but excludes the point Path 2. The magnitudes and the phases of the tap coefficients of Path 1 and Path 2 shall remain unaltered.
3. After an additional 191 ms, Path2 vanishes and reappears immediately at a new location randomly selected from the group  $[-5, -4, -3, -2, -1, 0, 1, 2, 3, 4, 5] \mu\text{s}$  but excludes the point Path 1. The magnitudes and the phases of the tap coefficients of Path 1 and Path 2 shall remain unaltered.

The sequence in 2) and 3) is repeated.

## B.2.5 High speed train condition

The high speed train condition for the test of the baseband performance is a non fading propagation channel with one tap. Doppler shift is given by

$$f_s(t) = f_d \cos \theta(t) \quad (\text{B.2})$$

where  $f_s(t)$  is the Doppler shift and  $f_d$  is the maximum Doppler frequency. The cosine of angle  $\theta(t)$  is given by



$$\cos \theta(t) = \frac{D_s/2 - vt}{\sqrt{D_{\min}^2 + (D_s/2 - vt)^2}}, \quad 0 \leq t \leq D_s/v \quad (\text{B.3})$$

$$\cos \theta(t) = \frac{-1.5D_s + vt}{\sqrt{D_{\min}^2 + (-1.5D_s + vt)^2}}, \quad D_s/v < t \leq 2D_s/v \quad (\text{B.4})$$

$$\cos \theta(t) = \cos \theta(t \bmod (2D_s/v)), \quad t > 2D_s/v \quad (\text{B.5})$$

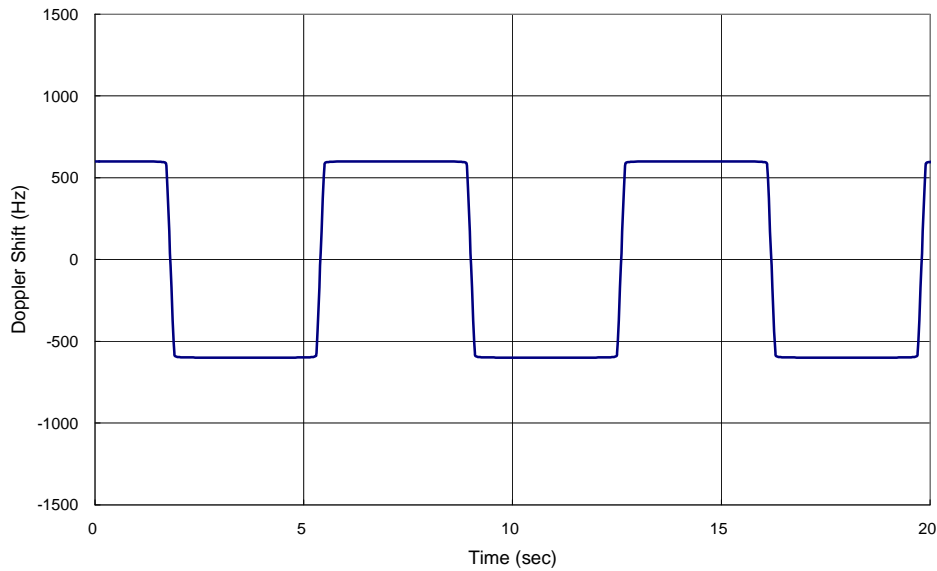
where  $D_s/2$  is the initial distance of the train from BS, and  $D_{\min}$  is BS-Railway track distance, both in meters;  $v$  is the velocity of the train in m/s,  $t$  is time in seconds.

Doppler shift and cosine angle is given by equation B.2 and B.3-B.5 respectively, where the required input parameters listed in table B.3 and the resulting Doppler shift shown in Figure B.3 are applied for all frequency bands.

**Table B.3**

Parameter	Value
$D_s$	300 m
$D_{\min}$	2 m
$v$	300 km/h
$f_d$	600 Hz

NOTE1: Parameters for HST conditions in table B.3 including  $f_d$  and Doppler shift trajectories presented on figure B.3 were derived for Band1.



**Figure B.3: Doppler shift trajectory**

## B.2.6 MIMO propagation conditions

MIMO propagation conditions are defined for a 2x2 antenna configuration. The resulting propagation channel shall be characterized by a complex 2x2 matrix termed



$$\mathbf{H} = \begin{pmatrix} h_{11} & h_{12} \\ h_{21} & h_{22} \end{pmatrix}.$$

The channel coefficients of  $\mathbf{H}$  shall be defined as a function of the possible precoding vectors or matrices. The possible precoding vectors for MIMO operation according to [8] shall be termed

$$\mathbf{w}^{(1)} = \begin{pmatrix} \frac{1}{\sqrt{2}} \\ \frac{1+j}{2} \end{pmatrix}, \quad \mathbf{w}^{(2)} = \begin{pmatrix} \frac{1}{\sqrt{2}} \\ \frac{1-j}{2} \end{pmatrix}, \quad \mathbf{w}^{(3)} = \begin{pmatrix} \frac{1}{\sqrt{2}} \\ \frac{-1+j}{2} \end{pmatrix}, \quad \mathbf{w}^{(4)} = \begin{pmatrix} \frac{1}{\sqrt{2}} \\ \frac{-1-j}{2} \end{pmatrix} \quad (\text{EQ.B.2.6.1})$$

In what follows. Furthermore the following possible precoding matrices shall be defined:

$$\mathbf{W}^{(1)} = \begin{pmatrix} \mathbf{w}^{(1)} & \mathbf{w}^{(4)} \end{pmatrix}, \quad \mathbf{W}^{(2)} = \begin{pmatrix} \mathbf{w}^{(2)} & \mathbf{w}^{(3)} \end{pmatrix}, \quad \mathbf{W}^{(3)} = \begin{pmatrix} \mathbf{w}^{(3)} & \mathbf{w}^{(2)} \end{pmatrix}, \quad \mathbf{W}^{(4)} = \begin{pmatrix} \mathbf{w}^{(4)} & \mathbf{w}^{(1)} \end{pmatrix} \quad (\text{EQ.B.2.6.2})$$

### B.2.6.1 MIMO Single Stream Fading Conditions

For MIMO single stream conditions, the resulting propagation channel shall be generated using two independent fading processes with classical Doppler and one randomly picked but fixed precoding vector  $\mathbf{W}$  out of the set defined in equation EQ.B.2.6.1. The two fading processes shall be generated according to the parameters in Table B.4

**Table B.4**

<b>MIMO Single Stream Conditions,</b> Speed for Band I, II, III, IV, IX, X and XXV: 3km/h Speed for Band V, VI, VIII, XIX, XX and XXVI: 7.1km/h Speed for Band VII: 2.3km/h Speed for Band XI, XXI: 4.1km/h Speed for Band XII, XIII and XIV: 8 km/h Speed for Band XXII: 1.7 km/h		
Relative Delay [ns]	Relative Mean Power [dB]	(Amplitude, phase) symbols
0	0	$(a_1, \varphi_1)$
0	0	$(a_2, \varphi_2)$

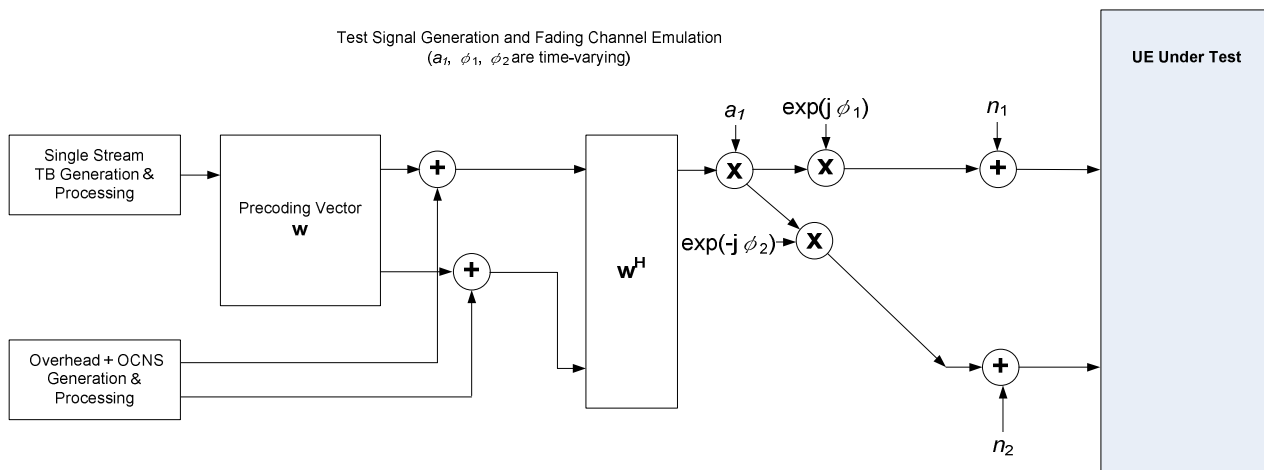
NOTE: The amplitude  $a_2$  is not used in tests under MIMO single stream conditions, only the phase  $\varphi_2$  will be used.

The channel coefficients of the resulting propagation channel under MIMO single stream conditions shall be given by

$$\mathbf{H} = \begin{pmatrix} h_{11} & h_{12} \\ h_{21} & h_{22} \end{pmatrix} = a_1 \cdot \begin{pmatrix} \exp(j \cdot \varphi_1) \\ \exp(-j \cdot \varphi_2) \end{pmatrix} \cdot \mathbf{W}^H$$

The generation of the resulting channel coefficients for MIMO single stream conditions and the association with the transmitter and receiver ports are depicted Figure B.4. Figure B.4 does not restrict test system implementation.





**Figure B.4: Test setup under MIMO Single Stream Fading Conditions**

### B.2.6.2 MIMO Dual Stream Fading Conditions

For MIMO dual stream conditions, the resulting propagation channel shall be generated using two independent fading processes with classical Doppler and one randomly picked but fixed precoding matrix  $\mathbf{W}$  out of the set defined in equation EQ.B.2.6.2. The two fading processes shall be generated according to the parameters in Table B.5

**Table B.5**

<b>MIMO Dual Stream Conditions,</b> Speed for Band I, II, III, IV, IX, X and XXV: 3km/h Speed for Band V, VI, VIII, XIX, XX and XXVI: 7.1km/h Speed for Band VII: 2.3km/h Speed for Band XI, XXI: 4.1km/h Speed for Band XII, XIII and XIV: 8 km/h Speed for Band XXII: 1.7 km/h		
Relative Delay [ns]	Relative Mean Power [dB]	(Amplitude, phase) symbols
0	0	$(a_1, \phi_1)$
0	-3	$(a_2, \phi_2)$

The channel coefficients of the resulting propagation channel under MIMO dual stream conditions shall be given by

$$\mathbf{H} = \begin{pmatrix} h_{11} & h_{12} \\ h_{21} & h_{22} \end{pmatrix} = \sqrt{\frac{2}{3}} \begin{pmatrix} \exp(j\phi_1) & \exp(j\phi_2) \\ \exp(-j\phi_2) & -\exp(-j\phi_1) \end{pmatrix} \cdot \begin{pmatrix} a_1 & 0 \\ 0 & a_2 \end{pmatrix} \cdot \mathbf{W}^H$$

The generation of the resulting channel coefficients for MIMO dual stream conditions and the association with the transmitter and receiver ports are depicted Figure B.5. Figure B.5 does not restrict test system implementation.



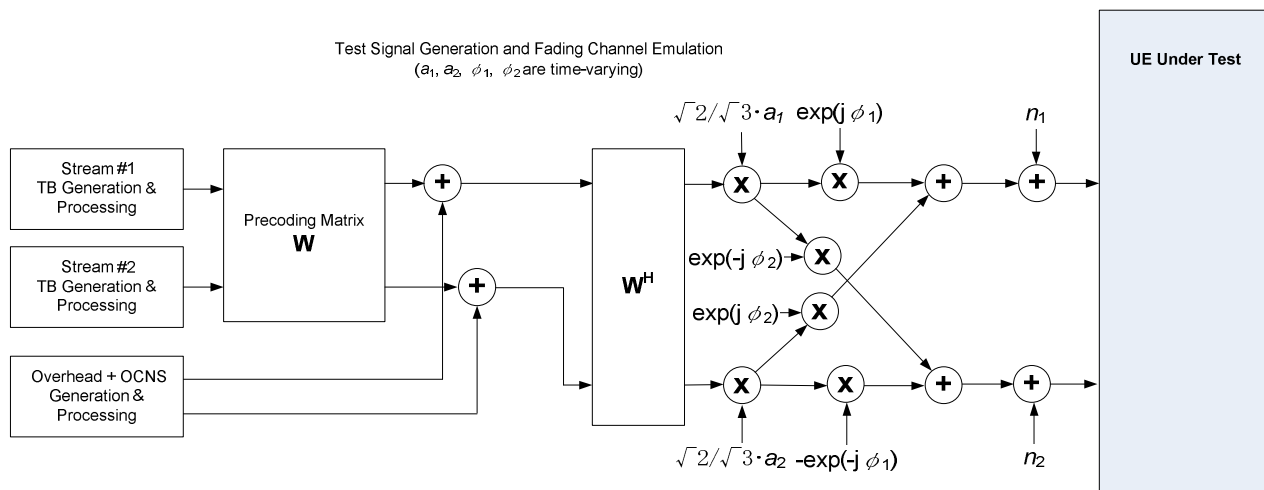


Figure B.5: Test setup under MIMO Dual Stream Fading Conditions

### B.2.6.3 MIMO Dual Stream Static Orthogonal Conditions

The channel coefficients of the resulting propagation channel under MIMO dual stream conditions shall be given by

$$\mathbf{H} = \begin{pmatrix} h_{11} & h_{12} \\ h_{21} & h_{22} \end{pmatrix} = \begin{pmatrix} 1 & 1 \\ 1 & -1 \end{pmatrix}$$

The generation of the resulting channel coefficients for MIMO dual stream conditions and the association with the transmitter and receiver ports are depicted Figure B.6. Figure B.6 does not restrict test system implementation.

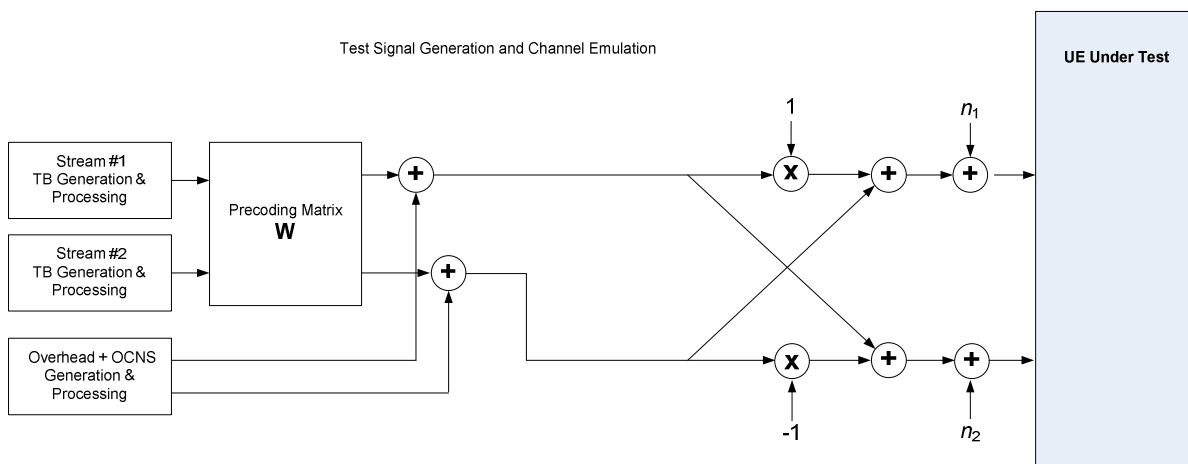


Figure B.6: Test setup under MIMO Dual Stream Static Orthogonal Conditions

## B.2.7 Propagation conditions for MIMO with four transmit antennas

The propagation conditions for MIMO with four transmit antennas are defined for a 4x4 antenna configuration. The resulting propagation channel shall be characterized by a complex 4x4 matrix termed



$$\mathbf{H} = \begin{pmatrix} h_{11} & h_{12} & h_{13} & h_{14} \\ h_{21} & h_{22} & h_{23} & h_{24} \\ h_{31} & h_{32} & h_{33} & h_{34} \\ h_{41} & h_{42} & h_{43} & h_{44} \end{pmatrix}.$$

The channel coefficients of  $\mathbf{H}$  shall be defined as a function of the possible precoding matrices. The possible precoding matrices for MIMO operation with four transmit antennas according to [8] are obtained by the quantity  $\mathbf{W} = \mathbf{W}_n^{\{s\}}$  which denotes the matrix defined by the columns given by the set  $\{s\}$  from the expression  $\mathbf{W}_n = \mathbf{I} - 2\mathbf{u}_n \mathbf{u}_n^H / \mathbf{u}_n^H \mathbf{u}_n$  where  $\mathbf{I}$  is the  $4 \times 4$  identity matrix and the vector  $\mathbf{u}_n$  is given in [8], Table 14B.7.

### B.2.7.1 MIMO with Four Transmit Antennas and Four Streams Static Orthogonal Conditions

The channel coefficients of the resulting propagation channel under MIMO with four transmit antennas and four stream conditions shall be given by

$$\mathbf{H} = \begin{pmatrix} h_{11} & h_{12} & h_{13} & h_{14} \\ h_{21} & h_{22} & h_{23} & h_{24} \\ h_{31} & h_{32} & h_{33} & h_{34} \\ h_{41} & h_{42} & h_{43} & h_{44} \end{pmatrix} = \begin{pmatrix} 1 & 1 & 1 & 1 \\ 1 & -1 & 1 & -1 \\ 1 & 1 & -1 & -1 \\ 1 & -1 & -1 & 1 \end{pmatrix}$$

The generation of the resulting channel coefficients for MIMO with four transmit antennas and four stream conditions and the association with the transmitter and receiver ports can be derived from Figure B.4 with the application of the above mentioned coefficients. Figure B.4 does not restrict test system implementation.

### B.2.7.2 MIMO with Four Transmit Antennas Only With Dual Stream Fading Conditions

For MIMO with four transmit antennas and dual stream conditions, the resulting propagation channel shall be generated using two independent fading processes with classical Doppler and one randomly picked but fixed precoding matrix

$\mathbf{W}$  out of the set defined in Section B.2.7 with two transport blocks. The two fading processes shall be generated according to the parameters in Table B.8

**Table B.8**

<b>MIMO Dual Stream Conditions,</b> Speed for Band I, II, III, IV, IX, X and XXV: 3km/h Speed for Band V, VI, VIII, XIX, XX and XXVI: 7.1km/h Speed for Band VII: 2.3km/h Speed for Band XI, XXI: 4.1km/h Speed for Band XII, XIII and XIV: 8 km/h Speed for Band XXII: 1.7 km/h		
Relative Delay [ns]	Relative Mean Power [dB]	(Amplitude, phase) symbols
0	0	$(a_1, \varphi_1)$
0	-3	$(a_2, \varphi_2)$

The channel coefficients of the resulting propagation channel under MIMO with four transmit antennas and dual stream conditions shall be given by

$$\mathbf{H} = \begin{pmatrix} h_{11} & h_{12} & h_{13} & h_{14} \\ h_{21} & h_{22} & h_{23} & h_{24} \end{pmatrix} = \sqrt{\frac{2}{3}} \begin{pmatrix} \exp(j\varphi_1) & \exp(j\varphi_2) \\ \exp(-j\varphi_2) & -\exp(-j\varphi_1) \end{pmatrix} \cdot \begin{pmatrix} a_1 & 0 \\ 0 & a_2 \end{pmatrix} \cdot \mathbf{W}^H$$



Where  $\mathbf{W}^H$  is a 2x4 matrix. The generation of the resulting channel coefficients for MIMO with four transmit antennas and dual stream conditions and the association with the transmitter and receiver ports can be derived from Figure B.5 with the appropriate changes to the matrix dimensions ( $\mathbf{W}$ ). Figure B.5 does not restrict test system implementation.



# Annex C (normative): Downlink Physical Channels

## C.1 General

This annex specifies the downlink physical channels that are needed for setting a connection and channels that are needed during a connection.

## C.2 Connection Set-up

Table C.1 describes the downlink Physical Channels that are required for connection set up.

**Table C.1: Downlink Physical Channels required for connection set-up**

Physical Channel
P-CPICH
P-CCPCH
SCH
S-CCPCH
PICH
AICH
DPCH

## C.3 During connection

The following clauses, describes the downlink Physical Channels that are transmitted during a connection i.e., when measurements are done. For these measurements the offset between DPCH and SCH shall be zero chips at Node B meaning that SCH is overlapping with the first symbols in DPCH in the beginning of DPCH slot structure.

### C.3.1 Measurement of Rx Characteristics

Table C.2 is applicable for measurements on the Receiver Characteristics (clause 7) with the exception of subclause 7.4 (Maximum input level).

**Table C.2: Downlink Physical Channels transmitted during a connection**

Physical Channel	Power ratio
P-CPICH	$P\text{-CPICH\_Ec} / DPCH\_Ec = 7 \text{ dB}$
P-CCPCH	$P\text{-CCPCH\_Ec} / DPCH\_Ec = 5 \text{ dB}$
SCH	$SCH\_Ec / DPCH\_Ec = 5 \text{ dB}$
PICH	$PICH\_Ec / DPCH\_Ec = 2 \text{ dB}$
DPCH	Test dependent power



## C.3.2 Measurement of Performance requirements

Table C.3 is applicable for measurements on the Performance requirements (clause 8), including subclause 7.4 (Maximum input level) and subclause 6.4.4 (Out-of-synchronization handling of output power).

**Table C.3: Downlink Physical Channels transmitted during a connection<sup>1</sup>**

Physical Channel	Power ratio	NOTE
P-CPICH	$P\text{-CPICH\_Ec/Ior} = -10 \text{ dB}$	Use of P-CPICH or S-CPICH as phase reference is specified for each requirement and is also set by higher layer signalling.
S-CPICH	$S\text{-CPICH\_Ec/Ior} = -10 \text{ dB}$	When S-CPICH is the phase reference in a test condition, the phase of S-CPICH shall be 180 degrees offset from the phase of P-CPICH. When S-CPICH is not the phase reference, it is not transmitted.
P-CCPCH	$P\text{-CCPCH\_Ec/Ior} = -12 \text{ dB}$	When BCH performance is tested the $P\text{-CCPCH\_Ec/Ior}$ is test dependent
SCH	$SCH\_Ec/Ior = -12 \text{ dB}$	This power shall be divided equally between Primary and Secondary Synchronous channels
PICH	$PICH\_Ec/Ior = -15 \text{ dB}$	
DPCH	Test dependent power	When S-CPICH is the phase reference in a test condition, the phase of DPCH shall be 180 degrees offset from the phase of P-CPICH. When BCH performance is tested the DPCH is not transmitted.
OCNS	Necessary power so that total transmit power spectral density of Node B (lor) adds to one <sup>1</sup>	OCNS interference consists of 16 dedicated data channels as specified in table C.6.

NOTE 1 For dynamic power correction required to compensate for the presence of transient channels, e.g. control channels, a subset of the DPCH channels may be used.



### C.3.3 Connection with open-loop transmit diversity mode

Table C.4 is applicable for measurements for subclause 8.6.1 (Demodulation of DCH in open loop transmit diversity mode).

**Table C.4: Downlink Physical Channels transmitted during a connection<sup>1</sup>**

Physical Channel	Power ratio	NOTE
P-CPICH (antenna 1)	P-CPICH_Ec1/lor = -13 dB	1. Total P-CPICH_Ec/lor = -10 dB
P-CPICH (antenna 2)	P-CPICH_Ec2/lor = -13 dB	
P-CCPCH (antenna 1)	P-CCPCH_Ec1/lor = -15 dB	1. STTD applied
P-CCPCH (antenna 2)	P-CCPCH_Ec2/lor = -15 dB	2. Total P-CCPCH_Ec/lor = -12 dB
SCH (antenna 1 / 2)	SCH_Ec/lor = -12 dB	1. TSTD applied. 2. This power shall be divided equally between Primary and Secondary Synchronous channels 3. When BCH performance is tested the P-CCPCH_Ec/lor is test dependent
PICH (antenna 1)	PICH_Ec1/lor = -18 dB	1. STTD applied 2. Total PICH_Ec/lor = -15 dB
PICH (antenna 2)	PICH_Ec2/lor = -18 dB	
DPCH	Test dependent power	1. STTD applied 2. Total power from both antennas
OCNS	Necessary power so that total transmit power spectral density of Node B (lor) adds to one <sup>1</sup>	1. This power shall be divided equally between antennas 2. OCNS interference consists of 16 dedicated data channels as specified in Table C.6.

Note 1: For dynamic power correction required to compensate for the presence of transient channels, e.g. control channels, a subset of the DPCH channels may be used.

### C.3.4 Connection with closed loop transmit diversity mode

Table C.5 is applicable for measurements for subclause 8.6.2 (Demodulation of DCH in closed loop transmit diversity mode).

**Table C.5: Downlink Physical Channels transmitted during a connection<sup>1</sup>**

Physical Channel	Power ratio	NOTE
P-CPICH (antenna 1)	P-CPICH_Ec1/lor = -13 dB	1. Total P-CPICH_Ec/lor = -10 dB
P-CPICH (antenna 2)	P-CPICH_Ec2/lor = -13 dB	
P-CCPCH (antenna 1)	P-CCPCH_Ec1/lor = -15 dB	1. STTD applied
P-CCPCH (antenna 2)	P-CCPCH_Ec2/lor = -15 dB	1. STTD applied, 2. total P-CCPCH_Ec/lor = -12 dB
SCH (antenna 1 / 2)	SCH_Ec/lor = -12 dB	1. TSTD applied
PICH (antenna 1)	PICH_Ec1/lor = -18 dB	1. STTD applied 2. STTD applied, total PICH_Ec/lor = -15 dB
PICH (antenna 2)	PICH_Ec2/lor = -18 dB	
DPCH	Test dependent power	1. Total power from both antennas
OCNS	Necessary power so that total transmit power spectral density of Node B (lor) adds to one (Notes 1 & 2)	1. This power shall be divided equally between antennas 2. OCNS interference consists of 16 dedicated data channels. As specified in Table C.6.
Note 1: For dynamic power correction required to compensate for the presence of transient channels, e.g. control channels, a subset of the DPCH channels may be used. Note 2: For the case of DPCH with transmit diversity, the OCNS power calculation shall be based on the addition of the power from Antenna 1 and Antenna 2, i.e. disregarding any phase relationship between the antennas.		



**Table C.6: DPCH Channelization Code and relative level settings for OCNS signal**

Channelization Code at SF=128	Relative Level setting (dB) (Note 1)	DPCH Data (see NOTE 3)
2	-1	The DPCH data for each channelization code shall be uncorrelated with each other and with any wanted signal over the period of any measurement. For OCNS with transmit diversity the DPCH data sent to each antenna shall be either STTD encoded or generated from uncorrelated sources.
11	-3	
17	-3	
23	-5	
31	-2	
38	-4	
47	-8	
55	-7	
62	-4	
69	-6	
78	-5	
85	-9	
94	-10	
125	-8	
113	-6	
119	0	
Note 1: The relative level setting specified in dB refers only to the relationship between the OCNS channels. The level of the OCNS channels relative to the Ior of the complete signal is a function of the power of the other channels in the signal with the intention that the power of the group of OCNS channels is used to make the total signal add up to 1.		
Note 2: The DPCH Channelization Codes and relative level settings are chosen to simulate a signal with realistic Peak to Average Ratio.		
Note 3: For MBSFN, the group of OCNS channels represent orthogonal S-CCPCH channels instead of DPCH. Transmit diversity is not applicable to MBSFN which excludes STTD.		

### C.3.5 (void)

**Table C.6A: (void)**

## C.4 W-CDMA Modulated Interferer

Table C.7 describes the downlink Channels that are transmitted as part of the W-CDMA modulated interferer.

**Table C.7: Spreading Code, Timing offsets and relative level settings for W-CDMA Modulated Interferer signal channels**

Channel Type	Spreading Factor	Channelization Code	Timing offset (x256T <sub>chip</sub> )	Power	NOTE
P-CCPCH	256	1	0	P-CCPCH_Ec/Ior = -10 dB	
SCH	256	-	0	SCH_Ec/Ior = -10 dB	The SCH power shall be divided equally between Primary and Secondary Synchronous channels
P-CPICH	256	0	0	P-CPICH_Ec/Ior = -10 dB	
PICH	256	16	16	PICH_Ec/Ior = -15 dB	
OCNS	See table C.6			Necessary power so that total transmit power spectral density of Node B (Ior) adds to one	OCNS interference consists of the dedicated data channels. As specified in Table C.6.



## C.5 HSDPA DL Physical channels

### C.5.1 Downlink Physical Channels connection set-up

Table C.8 is applicable for the measurements for tests in subclause 7.4.2, 9.2.1 and 9.3. Table C.9 is applicable for the measurements for tests in subclause 9.2.2 and 9.2.4. Table C.10 is applicable for the measurements for tests in subclause 9.2.3. Table C.11 is applicable for the measurements for tests in subclause 9.4.1. Table C.12 is applicable for the measurements in subclause 9.4.2. Table C.12A and C.12B are applicable to requirements in subclause 9.6. Table C.12D is applicable for the measurements in subclause 9.2.4 and 9.2.4A when explicitly mentioned. Table C.12E is applicable for the measurements in subclause 9.4.3 and 9.4.4 when explicitly mentioned. Table C.12F is applicable for the measurements in subclauses 9.2.4B and 9.2.4C. Table C.12G is applicable for the measurements in subclauses 9.4.5 and 9.4.6.

**Table C.8: Downlink physical channels for HSDPA/DC-HSDPA/DB-DC-HSDPA/4C-HSDPA receiver testing for Single Link performance.**

Physical Channel	Parameter	Value	Note
P-CPICH	P-CPICH_Ec/lor	-10dB	
P-CCPCH	P-CCPCH_Ec/lor	-12dB	Mean power level is shared with SCH.
SCH	SCH_Ec/lor	-12dB	Mean power level is shared with P-CCPCH – SCH includes P- and S-SCH, with power split between both. P-SCH code is S_dl,0 as per TS25.213 S-SCH pattern is scrambling code group 0
PICH	PICH_Ec/lor	-15dB	
DPCH	DPCH_Ec/lor	Test-specific only for serving HS-DSCH cell, omitted otherwise	12.2 kbps DL reference measurement channel as defined in Annex A.3.1
HS-SCCH-1	HS-SCCH_Ec/lor	Test-specific	Specifies fraction of Node-B radiated power transmitted when TTI is active (i.e. due to minimum inter-TTI interval).
HS-SCCH-2	HS-SCCH_Ec/lor	DTX"d	No signalling scheduled, or power radiated, on this HS-SCCH, but signalled to the UE as present.
HS-SCCH-3	HS-SCCH_Ec/lor	DTX"d	As HS-SCCH-2.
HS-SCCH-4	HS-SCCH_Ec/lor	DTX"d	No signalling scheduled, or power radiated, on this HS-SCCH, but signalled to the UE as present in HSDPA configuration.
HS-PDSCH	HS-PDSCH_Ec/lor	Test-specific	.
OCNS		Necessary power so that total transmit power spectral density of Node B (lor) adds to one	OCNS interference consists of a number of dedicated data channels as specified in table C.13 and C. 13A. Table C.13 specifies the OCNS setup for H-Set 1 to H-Set 6. Table C.13A specifies the OCNS setup for H-Set 8 and H-set 10.



**Table C.9: Downlink physical channels for HSDPA/DC-HSDPA/DB-DC-HSDPA/4C-HSDPA receiver testing for Open Loop Transmit Diversity and MIMO performance.**

Physical Channel	Parameter	Value	Note
P-CPICH (antenna 1)	P-CPICH_Ec1/lor	-13dB	1. Total P-CPICH_Ec/lor = -10dB
P-CPICH (antenna 2)	P-CPICH_Ec2/lor	-13dB	
P-CCPCH (antenna 1)	P-CCPCH_Ec1/lor	-15dB	1. STTD applied. 2. Total P-CCPCH Ec/lor is -12dB.
P-CCPCH (antenna 2)	P-CCPCH_Ec2/lor	-15dB	
SCH (antenna ½)	SCH_Ec/lor	-12dB	1. TSTD applied. 2. Power divided equally between primary and secondary SCH.
PICH (antenna 1)	PICH_Ec1/lor	-18dB	1. STTD applied. 2. Total PICH Ec/lor is -15dB.
PICH (antenna 2)	PICH_Ec2/lor	-18dB	
DPCH	DPCH_Ec/lor	Test-specific only for serving HS-DSCH cell, omitted otherwise	1. STTD applied.
HS-SCCH-1	HS-SCCH_Ec/lor	Test-specific	1. STTD applied. 2. Specifies fraction of Node-B radiated power transmitted when TTI is active (i.e. due to minimum inter-TTI interval).
HS-SCCH-2	HS-SCCH_Ec/lor	DTX"d	1. UE assumes STTD applied. 2. No signalling scheduled, or power radiated, on this HS-SCCH, but signalled to the UE as present.
HS-SCCH-3	HS-SCCH_Ec/lor	DTX"d	1. As HS-SCCH-2.
HS-SCCH-4	HS-SCCH_Ec/lor	DTX"d	1. UE assumes STTD applied. 2. No signalling scheduled, or power radiated, on this HS-SCCH, but signalled to the UE as present in HSDPA configuration.
HS-PDSCH	HS-PDSCH_Ec/lor	Test-specific	1. STTD applied for open loop transmit diversity tests, precoding used for MIMO tests
OCNS		Necessary power so that total transmit power spectral density of Node B (lor) adds to one (Note 1)	1. Balance of power $I_{or}$ of the Node-B is assigned to OCNS. 2. Power divided equally between antennas. 3. OCNS interference consists of a number of dedicated data channels as specified in table C.13 and C.13A. Table C.13 specifies the OCNS setup for H-Set 1 to H-set 6. Table C.13A specifies the OCNS setup for H-Set 9 and H-Set 11.

Note 1: For the case of DPCH with transmit diversity, the OCNS power calculation shall be based on the addition of the power from Antenna 1 and Antenna 2, i.e. disregarding any phase relationship between the antennas.



**Table C.10: Downlink physical channels for HSDPA receiver testing for Closed Loop.  
Transmit Diversity (Mode-1) performance.**

Physical Channel	Parameter	Value	Note
P-CPICH (antenna 1)	P-CPICH_Ec1/lor	-13dB	1. Total P-CPICH_Ec/lor = -10dB
P-CPICH (antenna 2)	P-CPICH_Ec2/lor	-13dB	
P-CCPCH (antenna 1)	P-CCPCH_Ec1/lor	-15dB	1. STTD applied. 2. Total P-CCPCH Ec/lor is -12dB.
P-CCPCH (antenna 2)	P-CCPCH_Ec2/lor	-15dB	
SCH (antenna ½)	SCH_Ec/lor	-12dB	1. TSTD applied. 2. Power divided equally between primary and secondary SCH.
PICH (antenna 1)	PICH_Ec1/lor	-18dB	1. STTD applied. 2. Total PICH Ec/lor is -15dB.
PICH (antenna 2)	PICH_Ec2/lor	-18dB	
DPCH	DPCH_Ec/lor	Test-specific	1. CL1 applied.
HS-SCCH-1	HS-SCCH_Ec/lor	Test-specific	1. STTD applied. 2. Specifies fraction of Node-B radiated power transmitted when TTI is active (i.e. due to minimum inter-TTI interval).
HS-SCCH-2	HS-SCCH_Ec/lor	DTX"d	1. UE assumes STDD] applied. 2. No signalling scheduled, or power radiated, on this HS-SCCH, but signalled to the UE as present.
HS-SCCH-3	HS-SCCH_Ec/lor	DTX"d	1. As HS-SCCH-2.
HS-SCCH-4	HS-SCCH_Ec/lor	DTX"d	2. As HS-SCCH-2.
HS-PDSCH	HS-PDSCH_Ec/lor	Test-specific	1. CL1 applied.
OCNS		Necessary power so that total transmit power spectral density of Node B (lor) adds to one (Note 1)	1. Balance of power $I_{or}$ of the Node-B is assigned to OCNS. 2. Power divided equally between antennas. 3. OCNS interference consists of 6 dedicated data channels as specified in table C.13.

Note 1: For the case of DPCH with transmit diversity, the OCNS power calculation shall be based on the addition of the power from Antenna 1 and Antenna 2, i.e. disregarding any phase relationship between the antennas.



**Table C.11: Downlink physical channels for HSDPA receiver testing for HS-SCCH detection performance**

Parameter	Units	Value	Comment
CPICH $E_c / I_{or}$	dB	-10	
P-CCPCH $E_c / I_{or}$	dB	-12	Mean power level is shared with SCH.
SCH $E_c / I_{or}$	dB	-12	Mean power level is shared with P-CCPCH – SCH includes P- and S-SCH, with power split between both. P-SCH code is S_dl,0 as per TS25.213 S-SCH pattern is scrambling code group 0
PICH $E_c / I_{or}$	dB	-15	
HS-PDSCH-1 $E_c / I_{or}$	dB	-10	HS-PDSCH associated with HS-SCCH-1. The HS-PDSCH shall be transmitted continuously with constant power.
HS-PDSCH-2 $E_c / I_{or}$	dB	DTX	HS-PDSCH associated with HS-SCCH-2
HS-PDSCH-3 $E_c / I_{or}$	dB	DTX	HS-PDSCH associated with HS-SCCH-3
HS-PDSCH-4 $E_c / I_{or}$	dB	DTX	HS-PDSCH associated with HS-SCCH-4
DPCH $E_c / I_{or}$	dB	-8	12.2 kbps DL reference measurement channel as defined in Annex A.3.1
HS-SCCH-1 $E_c / I_{or}$	dB	Test Specific	All HS-SCCH"s allocated equal $E_c / I_{or}$ . Specifies $E_c / I_{or}$ when TTI is active.
HS-SCCH-2 $E_c / I_{or}$	dB		
HS-SCCH-3 $E_c / I_{or}$	dB		
HS-SCCH-4 $E_c / I_{or}$	dB		
OCNS $E_c / I_{or}$	dB	Necessary power so that total transmit power spectral density of Node B (lor) adds to one (Note 1)	1. Balance of power $I_{or}$ of the Node-B is assigned to OCNS. 2. OCNS interference consists of 6 dedicated data channels as specified in table C.13.

Note 1: For the case of DPCH with transmit diversity, the OCNS power calculation shall be based on the addition of the power from Antenna 1 and Antenna 2, i.e. disregarding any phase relationship between the antennas.



**Table C.12: Downlink physical channels for HSDPA receiver testing for HS-SCCH detection performance in Open Loop Diversity**

Parameter	Units	Value	Comment
P-CPICH $E_c/I_{or}$ (antenna 1)	dB	-13	1. Total P-CPICH $E_c/I_{or} = -10\text{dB}$
P-CPICH $E_c/I_{or}$ (antenna 2)	dB	-13	
P-CCPCH $E_c/I_{or}$ (antenna 1)	dB	-15	1. STTD applied 2. Total P-CCPCH $E_c/I_{or} = -12\text{dB}$
P-CCPCH $E_c/I_{or}$ (antenna 2)	dB	-15	
SCH $E_c/I_{or}$ (antenna ½)	dB	-12	1. TSTD applied 2. Mean power level is shared with P-CCPCH – SCH includes P- and S-SCH, with power split between both. 3. P-SCH code is S_dl,0 as per TS25.213 4. S-SCH pattern is scrambling code group 0
PICH $E_c/I_{or}$ (antenna 1)	dB	-15	1. STTD applied 2. Total PICH $E_c/I_{or} = -12\text{dB}$
PICH $E_c/I_{or}$ (antenna 2)	dB	-15	
HS-PDSCH-1 $E_c/I_{or}$	dB	-10	1. STTD applied 2. HS-PDSCH assoc. with HS-SCCH-1
HS-PDSCH-2 $E_c/I_{or}$	dB	DTX	1. STTD applied 2. HS-PDSCH assoc. with HS-SCCH-2
HS-PDSCH-3 $E_c/I_{or}$	dB	DTX	1. STTD applied 2. HS-PDSCH assoc. with HS-SCCH-3
HS-PDSCH-4 $E_c/I_{or}$	dB	DTX	1. STTD applied 2. HS-PDSCH assoc. with HS-SCCH-4
DPCH $E_c/I_{or}$	dB	-8	1. STTD applied 2. 12.2 kbps DL reference measurement channel as defined in Annex A.3.1
HS-SCCH-1 $E_c/I_{or}$	dB	Test Specific	1. STTD applied 2. All HS-SCCH"s allocated equal $E_c/I_{or}$ . 3. Specifies $E_c/I_{or}$ when TTI is active.
HS-SCCH-2 $E_c/I_{or}$	dB		
HS-SCCH-3 $E_c/I_{or}$	dB		
HS-SCCH-4 $E_c/I_{or}$	dB		
OCNS $E_c/I_{or}$	dB	Remaining power at Node-B (including HS-SCCH power allocation when HS-SCCH"s inactive).	1. STTD applied 2. OCNS interference consists of 6 dedicated data channels as specified in table C.13. 3. Power divided equally between antennas



**Table C.12A: Downlink physical channels for HSDPA receiver testing for HS-DSCH reception in CELL\_FACH state.**

Physical Channel	Parameter	Value	Note
P-CPICH	P-CPICH_Ec/I <sub>or</sub>	-10dB	
P-CCPCH	P-CCPCH_Ec/I <sub>or</sub>	-12dB	Mean power level is shared with SCH.
SCH	SCH_Ec/I <sub>or</sub>	-12dB	Mean power level is shared with P-CCPCH – SCH includes P- and S-SCH, with power split between both. P-SCH code is S <sub>dl,0</sub> as per TS25.213 S-SCH pattern is scrambling code group 0
PICH	PICH_Ec/I <sub>or</sub>	-15dB	
HS-SCCH-1	HS-SCCH_Ec/I <sub>or</sub>	Test-specific	Specifies fraction of Node-B radiated power transmitted when TTI is active (i.e. due to minimum inter-TTI interval).
HS-SCCH-2	HS-SCCH_Ec/I <sub>or</sub>	DTX"d	No signalling scheduled, or power radiated, on this HS-SCCH, but signalled to the UE as present.
HS-SCCH-3	HS-SCCH_Ec/I <sub>or</sub>	DTX"d	As HS-SCCH-2.
HS-SCCH-4	HS-SCCH_Ec/I <sub>or</sub>	DTX"d	As HS-SCCH-2.
HS-PDSCH	HS-PDSCH_Ec/I <sub>or</sub>	Test-specific	.
OCNS		Necessary power so that total transmit power spectral density of Node B (I <sub>or</sub> ) adds to one	OCNS interference consists of a number of dedicated data channels as specified in table C.13.

**Table C.12B: Downlink physical channels for HSDPA receiver testing for HS-SCCH reception in CELL\_FACH state.**

Parameter	Units	Value	Comment
CPICH $E_c / I_{or}$	dB	-10	
P-CCPCH $E_c / I_{or}$	dB	-12	Mean power level is shared with SCH.
SCH $E_c / I_{or}$	dB	-12	Mean power level is shared with P-CCPCH – SCH includes P- and S-SCH, with power split between both. P-SCH code is S <sub>dl,0</sub> as per TS25.213 S-SCH pattern is scrambling code group 0
PICH $E_c / I_{or}$	dB	-15	
HS-PDSCH-1 $E_c / I_{or}$	dB	-3	HS-PDSCH associated with HS-SCCH-1. The HS-PDSCH shall be transmitted continuously with constant power.
HS-PDSCH-2 $E_c / I_{or}$	dB	DTX	HS-PDSCH associated with HS-SCCH-2
HS-PDSCH-3 $E_c / I_{or}$	dB	DTX	HS-PDSCH associated with HS-SCCH-3
HS-PDSCH-4 $E_c / I_{or}$	dB	DTX	HS-PDSCH associated with HS-SCCH-4
HS-SCCH-1 $E_c / I_{or}$	dB	Test Specific	All HS-SCCH"s allocated equal $E_c / I_{or}$ . Specifies $E_c / I_{or}$ when TTI is active.
HS-SCCH-2 $E_c / I_{or}$	dB		
HS-SCCH-3 $E_c / I_{or}$	dB	DTX	No signalling scheduled, or power radiated, on this HS-SCCH, but signalled to the UE as present.
HS-SCCH-4 $E_c / I_{or}$	dB		
OCNS $E_c / I_{or}$	dB	Necessary power so that total transmit power spectral density of Node B (I <sub>or</sub> ) adds to one (Note 1)	1. Balance of power $I_{or}$ of the Node-B is assigned to OCNS. 2. OCNS interference consists of 6 dedicated data channels as specified in table C.13.



**Table C.12C: Downlink physical channels for DC-HSDPA/DB-DC-HSDPA/4C-HSDPA Reference Measurement Channel testing**

Physical Channel	Parameter	Value	Note
P-CPICH	P-CPICH_Ec/Ior	-10dB	
P-CCPCH	P-CCPCH_Ec/Ior	-12dB	Mean power level is shared with SCH.
SCH	SCH_Ec/Ior	-12dB	Mean power level is shared with P-CCPCH – SCH includes P- and S-SCH, with power split between both. P-SCH code is S_dl,0 as per TS25.213 S-SCH pattern is scrambling code group 0
PICH	PICH_Ec/Ior	-15dB	
DPCH	DPCH_Ec/Ior	- 5 dB unless test-specific value is specified,  only for serving HS-DSCH cell, omitted otherwise	12.2 kbps DL reference measurement channel as defined in Annex A.3.1
HS-SCCH-1	HS-SCCH_Ec/Ior	-9dB unless test-specific value is specified	Specifies fraction of Node-B radiated power transmitted when TTI is active (i.e. due to minimum inter-TTI interval).
HS-SCCH-2	HS-SCCH_Ec/Ior	DTX"d	No signalling scheduled, or power radiated, on this HS-SCCH, but signalled to the UE as present.
HS-SCCH-3	HS-SCCH_Ec/Ior	DTX"d	As HS-SCCH-2.
HS-PDSCH	HS-PDSCH_Ec/Ior	Test-specific	.
OCNS		Necessary power so that total transmit power spectral density of Node B (Ior) adds to one	OCNS interference consists of a number of dedicated data channels as specified in table C.13 and C. 13A. Table C.13 specifies the OCNS setup for H-Set 1 to H-Set 6 and H-Set 12. Table C.13A specifies the OCNS setup for H-Set 8 and H-set 10.



**Table C.12D: Downlink physical channels for HSDPA/DC-HSDPA/DB-DC-HSDPA/4C-HSDPA receiver testing for MIMO performance with asymmetric P-CPICH/S-CPICH power settings.**

Physical Channel	Parameter	Value	Note
P-CPICH (antenna 1)	P-CPICH_Ec/lor	-10dB	Phase reference
S-CPICH (antenna 2)	S-CPICH_Ec/lor	-13dB	Phase reference
P-CCPCH	P-CCPCH_Ec/lor	-12dB	
SCH	SCH_Ec/lor	-12dB	
PICH	PICH_Ec/lor	-15dB	
DPCH	DPCH_Ec/lor	Test-specific	
HS-SCCH-1	HS-SCCH_Ec/lor	Test-specific	Specifies fraction of Node-B radiated power transmitted when TTI is active (i.e. due to minimum inter-TTI interval).
HS-SCCH-2	HS-SCCH_Ec/lor	DTX"d	No signalling scheduled, or power radiated, on this HS-SCCH, but signalled to the UE as present.
HS-SCCH-3	HS-SCCH_Ec/lor	DTX"d	As HS-SCCH-2.
HS-SCCH-4	HS-SCCH_Ec/lor	DTX"d	No signalling scheduled, or power radiated, on this HS-SCCH, but signalled to the UE as present in HSDPA configuration.
HS-PDSCH	HS-PDSCH_Ec/lor	Test-specific	Precoding used.
OCNS		Necessary power so that total transmit power spectral density of Node B (lor) adds to one	<ol style="list-style-type: none"> <li>1. Balance of power <math>I_{or}</math> of the Node-B is assigned to OCNS.</li> <li>2. OCNS interference consists of a number of dedicated data channels as specified in Table C.13 and C.13A. Table C.13 specifies the OCNS setup for H-Set 1 to H-set 6. Table C.13A specifies the OCNS setup for H-Set 9 and H-Set 11.</li> <li>3. OCNS transmitted only on antenna 1.</li> </ol>
Note: Transmit diversity (STTD or TSTD) is disabled on the associated physical channels (P-CPICH, PICH, SCH, HS-SCCH, DPCH).			



**Table C.12E: Downlink physical channels for HSDPA receiver testing for HS-SCCH detection performance with asymmetric P-CPICH/S-CPICH power settings.**

Physical Channel	Parameter	Value	Note
P-CPICH (antenna 1)	P-CPICH_Ec/lor	-10dB	Phase reference
S-CPICH (antenna 2)	S-CPICH_Ec/lor	-13dB	Phase reference
P-CCPCH	P-CCPCH_Ec/lor	-12dB	
SCH	SCH_Ec/lor	-12dB	
PICH	PICH_Ec/lor	-15dB	
DPCH	DPCH_Ec/lor	-8dB	1. STTD applicability is test-specific. 2. 12.2 kbps DL reference measurement channel as defined in Annex A.3.1
HS-SCCH-1	HS-SCCH_Ec/lor	Test-specific	1. STTD applicability is test specific. 2. Specifies fraction of Node-B radiated power transmitted when TTI is active (i.e. due to minimum inter-TTI interval). 2. All HS-SCCH"s allocated equal $E_c / I_{or}$ . 3. Specifies $E_c / I_{or}$ when TTI is active.
HS-SCCH-2	HS-SCCH_Ec/lor		
HS-SCCH-3	HS-SCCH_Ec/lor		
HS-SCCH-4	HS-SCCH_Ec/lor		
HS-PDSCH-1 $E_c / I_{or}$	HS-PDSCH_Ec/lor	Necessary power so that total transmit power spectral density of Node B (lor) adds to one	1. Precoding used. 2. Balance of power $I_{or}$ of the Node-B is assigned to HS-PDSCH.
HS-PDSCH-2 $E_c / I_{or}$	HS-PDSCH_Ec/lor	DTX	
HS-PDSCH-3 $E_c / I_{or}$	HS-PDSCH_Ec/lor	DTX	
HS-PDSCH-4 $E_c / I_{or}$	HS-PDSCH_Ec/lor	DTX	
OCNS		DTX	
Note 1: Transmit diversity (STTD or TSTD) is disabled on P-CCPCH, PICH and SCH.			
Note 2: OCNS is not present for this test. HS-PDSCH is used in order to model other UE MIMO traffic.			



**Table C.12F: Downlink physical channels for HSDPA/DC-HSDPA/DB-DC-HSDPA/4C-HSDPA receiver testing for MIMO mode with four transmit antennas performance with asymmetric P-CPICH/S-CPICH power settings.**

Physical Channel	Parameter	Value	Note
P-CPICH (antenna 1)	P-CPICH_Ec/Ior	-10dB	Phase reference
S-CPICH (antenna 2)	S-CPICH Ec/Ior	-13dB	Phase reference
S-CPICH (antenna 3)	S-CPICH Ec/Ior	-19dB	Phase reference
S-CPICH (antenna 4)	S-CPICH Ec/Ior	-19dB	Phase reference
P-CCPCH	P-CCPCH_Ec/Ior	-12dB	
SCH	SCH_Ec/Ior	-12dB	
PICH	PICH_Ec/Ior	-15dB	
DPCH	DPCH_Ec/Ior	Test-specific	
HS-SCCH-1	HS-SCCH_Ec/Ior	Test-specific	Specifies fraction of Node-B radiated power transmitted when TTI is active (i.e. due to minimum inter-TTI interval).
HS-SCCH-2	HS-SCCH_Ec/Ior	DTX"d	No signalling scheduled, or power radiated, on this HS-SCCH, but signalled to the UE as present.
HS-SCCH-3	HS-SCCH_Ec/Ior	DTX"d	As HS-SCCH-2.
HS-SCCH-4	HS-SCCH_Ec/Ior		Not configured
HS-PDSCH	HS-PDSCH_Ec/Ior	Test-specific	Precoding used.
OCNS		Necessary power so that total transmit power spectral density of Node B (Ior) adds to one	<ol style="list-style-type: none"> <li>1. Balance of power <math>I_{or}</math> of the Node-B is assigned to OCNS.</li> <li>2. OCNS interference consists of a number of dedicated data channels as specified in Table C.13B.</li> <li>3. OCNS transmitted only on antenna 1.</li> </ol>
Note 1: Transmit diversity (STTD or TSTD) is disabled on the associated physical channels (P-CPICH, PICH, SCH, HS-SCCH, DPCH).			



**Table C.12G: Downlink physical channels for HSDPA receiver testing for HS-SCCH type 4 detection performance with asymmetric P-CPICH/S-CPICH power settings.**

Physical Channel	Parameter	Value	Note
P-CPICH (antenna 1)	P-CPICH_Ec/lor	-10dB	Phase reference
S-CPICH (antenna 2)	S-CPICH Ec/lor	-13dB	Phase reference
S-CPICH (antenna 3)	S-CPICH Ec/lor	-19dB	Phase reference
S-CPICH (antenna 4)	S-CPICH Ec/lor	-19dB	Phase reference
P-CCPCH	P-CCPCH_Ec/lor	-12dB	
SCH	SCH_Ec/lor	-12dB	
PICH	PICH_Ec/lor	-15dB	
DPCH	DPCH_Ec/lor	-8dB	1. STTD disabled 2. 12.2 kbps DL reference measurement channel as defined in Annex A.3.1
HS-SCCH-1	HS-SCCH_Ec/lor	Test-specific	1. Specifies fraction of Node-B radiated power transmitted when TTI is active (i.e. due to minimum inter-TTI interval). 2. All HS-SCCH"s allocated equal $E_c / I_{or}$ . 3. Specifies $E_c / I_{or}$ when TTI is active.
HS-SCCH-2	HS-SCCH_Ec/lor		
HS-SCCH-3	HS-SCCH_Ec/lor		
HS-SCCH-4	HS-SCCH_Ec/lor		
HS-PDSCH-1 $E_c / I_{or}$	HS-PDSCH_Ec/lor	Necessary power so that total transmit power spectral density of Node B (lor) adds to one	1. Precoding used. 2. Balance of power $I_{or}$ of the Node-B is assigned to HS-PDSCH.
HS-PDSCH-2 $E_c / I_{or}$	HS-PDSCH_Ec/lor	DTX	
HS-PDSCH-3 $E_c / I_{or}$	HS-PDSCH_Ec/lor	DTX	
HS-PDSCH-4 $E_c / I_{or}$	HS-PDSCH_Ec/lor	DTX	
OCNS		DTX	
Note 1: Transmit diversity (STTD or TSTD) is disabled on P-CCPCH, PICH and SCH.			
Note 2: OCNS is not present for this test. HS-PDSCH is used in order to model other UE MIMO traffic.			

## C.5.2 OCNS Definition

The selected channelization codes and relative power levels for OCNS transmission during for HSDPA performance assessment for other than enhanced performance type 3i are defined in Table C.13. The selected codes are designed to have a single length-16 parent code. The test definition for the enhanced performance type 3i is defined in section C.5.3.

**Table C.13: OCNS definition for HSDPA receiver testing.**

Channelization Code at SF=128	Relative Level setting (dB) (Note 1)	DPCH Data
122	0	The DPCH data for each channelization code shall be uncorrelated with each other and with any wanted signal over the period of any measurement. For OCNS with transmit diversity the DPCH data sent to each antenna shall be either STTD encoded or generated from uncorrelated sources.
123	-2	
124	-2	
125	-4	
126	-1	
127	-3	



**Table C.13A: OCNS definition for HSDPA receiver testing, FRC H-Set 8, H-Set 9, H-Set 10 and H-Set 11.**

Channelization Code at SF=128	Relative Level setting (dB) (Note 1)	DPCH Data
4	0	The DPCH data for each channelization code shall be uncorrelated with each other and with any wanted signal over the period of any measurement. For OCNS with transmit diversity the DPCH data sent to each antenna shall be either STTD encoded or generated from uncorrelated sources.
5	-2	
6	-4	
7	-1	

**Table C.13B: OCNS definition for HSDPA receiver testing, FRC H-Set 13 and H-Set 14.**

Channelization Code at SF=128	DPCH Data
6	For OCNS with transmit diversity the DPCH data sent to each antenna shall be either STTD encoded or generated from uncorrelated sources.

Note 1: The relative level setting specified in dB refers only to the relationship between the OCNS channels. The level of the OCNS channels relative to the  $I_{or}$  of the complete signal is a function of the power of the other channels in the signal with the intention that the power of the group of OCNS channels is used to make the total signal add up to 1.

### C.5.3 Test Definition for Enhanced Performance Type 3i

This section defines additional test definition for enhanced performance type 3i including: number of interfering cells and their respective powers; transmitted code and power characteristics (OCNS) for serving and interfering cells; and frame offsets for interfering cells. For DC-HSDPA, DB-DC-HSDPA and 4C-HSDPA requirements, the number of interfering cells and their respective powers; transmitted code and power characteristics (OCNS) for serving and interfering cells; and frame offsets for interfering cells shall be the same for each carrier frequency. The transmitted OCNS and data signals shall be independent for each cell.

$DIP_i = \hat{I}_{or(i+1)} / I_{oc}'$  where  $\hat{I}_{orj}$  is the average received power spectral density from the  $j$ -th strongest interfering cell ( $\hat{I}_{or1}$  is assumed to be the power spectral density associated with the serving cell), and  $I_{oc}'$  is given by

$$I_{oc}' = \sum_{j=2}^3 \hat{I}_{orj} + I_{oc}$$

where  $I_{oc}$  is the average power spectral density of a band limited white noise source consistent

with the definition provided in section 3.2.

#### C.5.3.1 Transmitted code and power characteristics for serving cell

The downlink physical channel code allocations for the serving cell are specified in Table C.14. Ten HS-PDSCH codes have been reserved for the user of interest, based upon the use of QPSK with FRC H-Set 6. The other user codes are selected from 46 possible SF = 128 codes. Note not all 46 of these codes are used, and in addition only 16 codes are used at a given instance in time. Table C.15 summarizes the power allocations of different channels for the serving cell for 50% and 25% HS-PDSCH power allocation. Note the power allocations in the last row of Table C.15 are to be split between the HS-SCCH and the other users' channels in order to ensure proper operation of the HS-SCCH during testing.

Table C.16 summarizes the channelization codes to be used for the other users channels (OCNS) along with their respective relative power allocations in dB when HS-PDSCH is allocated 25% or 50% of the total power. As shown in



Table C.16, there are two groups of 16 codes, which are randomly selected with equal probability on a symbol-by-symbol basis. This random selection is done per code pair, where a code pair occupies the same row, as opposed to selecting all of the codes within group 1 or group 2. This random selection between these two groups is for purposes of modelling a simplified form of DTX. Note that the switching time for the symbols with SF = 64 would be the symbol timing associated with an SF 64 channel, and the switching time for the symbols with SF = 128 would be the symbol timing for SF = 128 channel. Thus, there would be two different symbol times dependent upon the SF. For SF = 64, symbol time ~ 16.67 microseconds, and for SF = 128, symbol time ~ 33.33 microseconds. Each of these users is also power controlled as described in section C.5.3.3.

The scrambling code of the serving cell is set to 0.

**Table C.14. Downlink physical channel code allocation.**

Channelization Code at SF=128	Note
0	P-CPICH, P-CCPCH and PICH on SF=256
1	
2...7	6 SF=128 codes free for OCNS
8...87	10 HS-PDSCH codes at SF=16
88...127	40 SF=128 codes free for OCNS

**Table C.15. Summary of modelling approach for the serving cell.**

	Serving cell	
Common channels	0.195 (-7.1dB) As specified in Table C.8	
HS-PDSCH transport format	H-Set 6	
HS-PDSCH power allocation [ $E_c/I_{or}$ ]	0.5 (-3 dB)	0.25 (-6 dB)
HS-SCCH + Other users" channels (OCNS)	0.3049 (-5.16 dB) Other users" channels set according to Table C.16	0.5551 (-2.56 dB) Other users" channels set according to Table C.16

Note: The values given in decibel are only for information.

**Table C.16. Channelization codes and relative power levels for 25% and 50% HS-PDSCH power allocations.**

Group 1 Channelization Code, Cch, SF,k	Group 2 Channelization Code, Cch, SF, k	Relative level setting for 25% and 50% allocation
--	---	--



$C_{ch,128,2}$	$C_{ch,128,108}$	-1.7
$C_{ch,128,3}$	$C_{ch,128,103}$	-2.7
$C_{ch,128,5}$	$C_{ch,128,109}$	-3.5
$C_{ch,128,6}$	$C_{ch,128,118}$	-0.8
$C_{ch,128,90}$	$C_{ch,128,4}$	-6.2
$C_{ch,128,94}$	$C_{ch,128,123}$	-4.6
$C_{ch,128,96}$	$C_{ch,128,111}$	-2.3
$C_{ch,128,98}$	$C_{ch,128,106}$	-4.1
$C_{ch,128,99}$	$C_{ch,128,100}$	-3.1
$C_{ch,128,101}$	$C_{ch,128,113}$	-5.1
$C_{ch,64,52}$	$C_{ch,64,44}$	0.0
$C_{ch,128,110}$	$C_{ch,128,124}$	-4.6
$C_{ch,128,114}$	$C_{ch,128,115}$	-4.8
$C_{ch,128,116}$	$C_{ch,128,126}$	-4.8
$C_{ch,64,60}$	$C_{ch,64,46}$	-1.1
$C_{ch,128,125}$	$C_{ch,128,95}$	-4.1

Note: The relative level settings specified in dB refer only to the relationship between the OCNS channels. For the serving cell, the sum of the powers of the OCNS channels plus the power allocated to the HS-SCCH must add up to the values specified in the last row of Table C.15. For the interfering cells, the sum of the powers of the OCNS channels must add up to the value shown in the last row of Table C.17.

### C.5.3.2 Transmitted code and power characteristics for interfering cells

The downlink physical channel code allocations for the interfering cells are same as for the serving cell as given in Table C.14. The modelling approach for the interfering cells is summarized in Table C.17. The modelling of the other users' dedicated channels is done in the same way as in the case of the serving cell except that the HSDPA power allocation is fixed at 50% and the total power allocated is not shared with the HS-SCCH. Thus, the two groups of channelization codes defined in Table C.16 apply, along with the specified relative power levels.

**Table C.17. Summary of modelling approach for the interfering cells.**

	<b>Interfering cell(s)</b>
Common channels	0.195 (-7.1dB) As specified in Table C.8
HS-PDSCH transport format	Selected randomly from Table C.18 Independent for each interferer.
HS-PDSCH power allocation [ $E_c/I_{0F}$ ]	0.5 (-3 dB)
Other users' channels	0.3049 (-5.16 dB) Set according to Table C.16 for 50% HS-PDSCH power allocation

Note: The values given in decibel are only for information.

The HS-PDSCH transmission for interfering cells is modelled to have randomly varying modulation and number of codes. The predefined modulation and number of codes are given in Table C.18, with the actual codes selected per the code allocation given in Table C.14. The transmission from each interfering cell is randomly and independently selected every HSDPA TTI among the four options given in Table C.18.

The scrambling codes of the interfering cells are set to 16 and 32, respectively. The frame offsets for the interfering cells are set to 1296 and 2576 chips relative to the serving cell. The scrambling code value of 16 and the frame offset value of 2576 corresponds to the first interfering cell.



**Table C.18. Predefined interferer transmission.**

#	Used modulation and number of HS-PDSCH codes
1	QPSK with 5 codes
2	16QAM with 5 codes
3	QPSK with 10 codes
4	16QAM, with 10 codes

### C.5.3.3 Model for power control sequence generation

In this section the modelling of power control for the other users' channels is described. There are two powers that are calculated for each user,  $I$  at each slot,  $n$ . The first is an interim power calculation, which develops a power  $P_n^i$  in dB.

The second is the actual applied transmit power,  $\hat{P}_n^i$  in the linear domain, which is normalized such that the total power for all users remains the same as that originally allocated. The interim power calculation is described first followed by the applied, normalized power calculation.

The interim power is varied randomly, either by increasing or decreasing it by 1 dB steps in each slot, i.e.

$$P_n^i = P_{n-1}^i + \Delta, \text{ where } \Delta \in \{-1, +1\} \quad (\text{EQ.C.5.3.3.1})$$

The probability of  $\Delta$  having a value of  $+1$  for the  $i^{\text{th}}$  user at time instant  $n$  can be determined as

$$\Pr_n^i(\Delta = +1) = 0.5 - (P_{n-1}^i - P_0^i) \frac{0.5}{L} \quad (\text{EQ.C.5.3.3.2})$$

where,  $P_{n-1}^i$  is the interim power at time instant  $n-1$  and  $P_0^i$  is the initial value given in Table C.16 after conversion to dB for each of the two possible HS-PDSCH power allocations.  $L$  is a scaling factor which can be used to determine the range to which the variation of power is confined. The value of  $L$  is set to 10, leading to a variance of  $\sim 5$  dB.

The applied, normalized power is given by

$$\hat{P}_n^i = \frac{P_{lin,n}^i}{\sum_i P_{lin,n}^i} \sum_i P_{lin,0}^i \quad (\text{EQ.C.5.3.3.3})$$

where  $P_{lin,n}^i$  is the interim power of the user  $I$  at time instant  $n$  in the linear domain, and  $P_{lin,0}^i$  is the initial value of the  $i^{\text{th}}$  user's power also in the linear domain. Each summation is over all 16 possible values for  $P_{lin,n}^i$  and  $P_{lin,0}^i$  where the latter summation is equal to either 0.5551 or 0.3049 for HS-PDSCH allocations of 25% and 50%, respectively, see Table C.16. The total instantaneous output power of the OCNS is now always equal to its allocated power. One other subtle point to note is that at each iteration of interim power generation using (EQ.C.5.3.3.1) that the value of  $P_{n-1}^i$  is set to  $P_n^i$  of the previous iteration as opposed to  $\hat{P}_n^i$  of the previous iteration. In summary, two sets of power control sequences are developed using (EQ.C.5.3.3.1) and (EQ.C.5.3.3.3), respectively, where the interim outputs developed by (C.1) are used to develop the applied, normalized values described by (EQ.C.5.3.3.3) and to which the actual channel powers are set.

## C.5.4 Simplified Multi Carrier HSDPA testing method

For DC-HSDPA, DB-DC-HSDPA or 4C-HSDPA tests which require more than 8 independent faders, the resulting propagation channel(s) shall be generated by considering a number of independent faders needed for one carrier and connecting them to the signal of randomly chosen carrier(s). The maximum number of channel faders on the test will be less than or equal to 8. The remaining carrier(s) shall be connected without a channel fader but with AWGN. The throughput shall be collected only for the carrier(s) connected to channel faders.



The test shall be repeated by choosing carrier(s) excluding already chosen carrier(s) until all the carrier(s) are tested under fading conditions. The sum of all the collected throughputs from each carrier shall be compared against the reference value in the requirements.

All supported carriers shall be configured and activated during the test.

## C.5.4A Simplified Multiflow HSDPA testing method

For Multiflow HSDPA tests which require more than 8 independent faders, the resulting propagation channel(s) shall be generated by considering a number of independent faders needed for one carrier frequency and connecting them to the signal of randomly chosen carrier(s). The maximum number of channel faders on the test will be less than or equal to 8. The remaining carrier(s) shall be connected without a channel fader but with AWGN. The throughput shall be collected only for the carrier(s) connected to channel faders.

The test shall be repeated by choosing carrier(s) excluding already chosen carrier(s) until all the carrier(s) are tested under fading conditions.

All supported carriers shall be configured and activated during the test.

## C.5.5 Test Definition for Multiflow HSDPA

This section defines additional test configuration for Multiflow HSDPA including: number of cells and their respective powers; transmitted code and power characteristics (OCNS) for the interfering cell; and frame offsets for assisting serving HS-DSCH cell and interfering cell.

### C.5.5.1 Test configuration when 2 cells are configured in Multiflow mode

The relative powers for the serving HS-DSCH cell (Cell 1), the assisting serving HS-DSCH cell (Cell 2) and additional interfering cell (Cell 3, if present) are shown in Table C.19. The scrambling code of the serving HS-DSCH cell is set to 0, that of the assisting serving HS-DSCH cell is set to 16, and that of the interfering cell is set to 32. The frame offsets of the assisting serving HS-DSCH cell is set to 2560 chips and that of the interfering cell is set to 1296 chips relative to the serving HS-DSCH cell. The downlink physical channel setup for the serving HS-DSCH cell and assisting serving HS-DSCH cell is shown in Table C.20 and Table C.21 respectively. The downlink physical channel setup for the additional interfering cell is shown in Table C.22.

**Table C.19: Relative power of the cells in Multiflow HSDPA test**

Number of additional interfering cell	$\hat{I}_{or1}/I_{oc}$	$\hat{I}_{or2}/I_{oc}$	$\hat{I}_{or3}/I_{oc}$	Cell 1 Geometry	Cell 2 Geometry
0	7.01	3.61	-inf	1.83	-4.19
1	5.27	2.52	-2.37	0.00	-4.42
Notes: 1) Cell 1 corresponds to the serving HS-DSCH cell, Cell 2 corresponds to the assisting serving HS-DSCH cell, and Cell 3 is the additional interfering cell.					
2) Cell 1 Geometry is defined by $\hat{I}_{or1}/I_{oc,1}$ , where $I_{oc,1} = (I_{oc} + \hat{I}_{or2} + \hat{I}_{or3})$ .					
3) Cell 2 Geometry is defined by $\hat{I}_{or2}/I_{oc,2}$ , where $I_{oc,2} = (I_{oc} + \hat{I}_{or1} + \hat{I}_{or3})$ .					

**Table C.20: Downlink physical channels for the serving/secondary serving HS-DSCH cell in HSDPA receiver testing of Multiflow HSDPA**

Physical Channel	Parameter	Value	Note
P-CPICH	P-CPICH_Ec/Ior	-10dB	
P-CCPCH	P-CCPCH_Ec/Ior	-12dB	Mean power level is shared with SCH.
SCH	SCH_Ec/Ior	-12dB	Mean power level is shared with P-CCPCH – SCH includes P- and S-SCH, with power split



			between both.
PICH	PICH_Ec/lor	-15dB	
DPCH	DPCH_Ec/lor	Necessary power so that total transmit power spectral density of Node B (lor) adds to one  Only for serving HS-DSCH cell, omitted otherwise	12.2 kbps DL reference measurement channel as defined in Annex A.3.1
HS-SCCH-1	HS-SCCH_Ec/lor	-8 dB for serving HS-DSCH cell, otherwise necessary power so that total transmit power spectral density of Node B (lor) adds to one	
HS-SCCH-2	HS-SCCH_Ec/lor	DTX"d	No signalling scheduled, or power radiated, on this HS-SCCH, but signalled to the UE as present.
HS-SCCH-3	HS-SCCH_Ec/lor	DTX"d	As HS-SCCH-2.
HS-PDSCH	HS-PDSCH_Ec/lor	Test-specific	

**Table C.21: Downlink physical channels for the assisting serving/secondary serving HS-DSCH cell in HSDPA receiver testing of Multiflow HSDPA**

Physical Channel	Parameter	Value	Note
P-CPICH	P-CPICH_Ec/lor	-10dB	
P-CCPCH	P-CCPCH_Ec/lor	-12dB	Mean power level is shared with SCH.
SCH	SCH_Ec/lor	-12dB	Mean power level is shared with P-CCPCH – SCH includes P- and S-SCH, with power split between both.
PICH	PICH_Ec/lor	-15dB	
DPCH	DPCH_Ec/lor	DTX"d	Omitted
HS-SCCH-1	HS-SCCH_Ec/lor	Necessary power so that total transmit power spectral density of Node B (lor) adds to one	
HS-SCCH-2	HS-SCCH_Ec/lor	DTX"d	No signalling scheduled, or power radiated, on this HS-SCCH, but signalled to the UE as present.
HS-SCCH-3	HS-SCCH_Ec/lor	DTX"d	As HS-SCCH-2.
HS-PDSCH	HS-PDSCH_Ec/lor	Test-specific	

**Table C.22: Downlink physical channels for the additional interfering cell in Multiflow HSDPA testing**

	Interfering cell
Common channels	0.195 (-7.1dB) Same as Table C.20



HS-SCCH_Ec/I <sub>or</sub>	-12 dB
HS-PDSCH transport format	Selected randomly from Table C.18
HS-PDSCH power allocation [E <sub>c</sub> /I <sub>or</sub> ]	Necessary power so that total transmit power spectral density of Node B (I <sub>or</sub> ) adds to one

### C.5.5.2 Test configuration when 3 cells are configured in Multiflow mode

When 3 cells are configured in Multiflow mode, the test configuration in C.5.5.1 shall be duplicated for each frequency according to Table C.20 and Table C.21. The downlink physical channel setup for the serving HS-DSCH cell, assisting serving HS-DSCH cell and the secondary serving HS-DSCH cell is shown in Table C.23. Cell 2 on the carrier of the secondary serving HS-DSCH cell becomes an interfering cell and does not participate in Multiflow mode. The downlink physical channel setup of Cell 2 on the carrier of the secondary serving HS-DSCH cell shall follow Table C.21.

**Table C.23: Test configuration when 3 cells are configured in Multiflow mode**

	Setting
Serving HS-DSCH cell	According to Table C.20
Assisting serving HS-DSCH cell	According to Table C.21
Secondary serving HS-DSCH cell	According to Table C.20

### C.5.5.3 Test configuration when 4 cells are configured in Multiflow mode

When 4 cells are configured in Multiflow mode, the test configuration in C.5.5.1 shall be duplicated for each frequency according to Table C.20 and Table C.21. The downlink physical channel setup for the serving HS-DSCH cell, assisting serving HS-DSCH cell, the secondary serving HS-DSCH cell and the assisting secondary serving HS-DSCH cell is shown in Table C.24.

**Table C.24: Test configuration when 4 cells are configured in Multiflow mode**

	Setting
Serving HS-DSCH cell	According to Table C.20
Assisting serving HS-DSCH cell	According to Table C.21
Secondary serving HS-DSCH cell	According to Table C.20
Assisting secondary serving HS-DSCH cell	According to Table C.21



## C.6 MBMS DL Physical channels

### C.6.1 Downlink Physical Channels connection set-up

Table C.14 is applicable for measurements on the Performance requirements in Clause 11.

**Table C.14: Downlink Physical Channels on each radiolink**

Physical Channel	Power ratio	NOTE
P-CPICH	$P\text{-CPICH\_Ec/lor} = -10 \text{ dB}$	Only P-CPICH is used as phase reference for S-CCPCH carrying MCCH or MTCH.
P-CCPCH	$P\text{-CCPCH\_Ec/lor} = -12 \text{ dB}$	
SCH	$SCH\_Ec/lor = -12 \text{ dB}$	This power shall be divided equally between Primary and Secondary Synchronous channels
PICH	$PICH\_Ec/lor = -15 \text{ dB}$	
S-CCPCH	$S\text{-CCPCH\_Ec/lor} = \text{test dependent}$	
DPCH	TBD	DPCH is enable only when UE has capability to receive MBMS in CELL_DCH state
OCNS	Necessary power so that total transmit power spectral density of Node B (lor) adds to one	OCNS interference consists of 16 dedicated data channels as specified in table C.6.

### C.6.2 Downlink Physical Channels connection set-up for MBSFN

**Table C.14a: Downlink Physical Channels for performance requirements**

Physical Channel	Power ratio	NOTE
P-CPICH	$P\text{-CPICH\_Ec/lor} = -10 \text{ dB}$	Only P-CPICH is used as phase reference for S-CCPCH carrying MCCH or MTCH.
P-CCPCH	$P\text{-CCPCH\_Ec/lor} = -12 \text{ dB}$	
SCH	$SCH\_Ec/lor = -12 \text{ dB}$	This power shall be divided equally between Primary and Secondary Synchronous channels
S-CCPCH	$S\text{-CCPCH\_Ec/lor} = \text{test dependent}$	
OCNS	Necessary power so that total transmit power spectral density of Node B (lor) adds to one	Same code channels as used for DPCH, see table C.6



## Annex D (normative) : Environmental conditions

### D.1 General

This normative annex specifies the environmental requirements of the UE. Within these limits the requirements of the present documents shall be fulfilled.

### D.2 Environmental requirements

The requirements in this clause apply to all types of UE(s).

#### D.2.1 Temperature

The UE shall fulfil all the requirements in the full temperature range of:

**Table D.1**

+15 °C to +35 °C	for normal conditions (with relative humidity of 25 % to 75 %)
-10 °C to +55 °C	for extreme conditions (see IEC publications 68-2-1 and 68-2-2)

Outside this temperature range the UE, if powered on, shall not make ineffective use of the radio frequency spectrum. In no case shall the UE exceed the transmitted levels as defined in TS 25.101 for extreme operation.

#### D.2.2 Voltage

The UE shall fulfil all the requirements in the full voltage range, i.e. the voltage range between the extreme voltages.

The manufacturer shall declare the lower and higher extreme voltages and the approximate shutdown voltage. For the equipment that can be operated from one or more of the power sources listed below, the lower extreme voltage shall not be higher, and the higher extreme voltage shall not be lower than that specified below.

**Table D.2**

Power source	Lower extreme voltage	Higher extreme voltage	Normal conditions voltage
AC mains	0,9 * nominal	1,1 * nominal	nominal
Regulated lead acid battery	0,9 * nominal	1,3 * nominal	1,1 * nominal
Non regulated batteries:			
Leclanché	0,85 * nominal	Nominal	Nominal
Lithium	0,95 * nominal	1,1 * nominal	1,1 * nominal
Mercury/nickel & cadmium	0,90 * nominal	Nominal	Nominal

Outside this voltage range the UE if powered on, shall not make ineffective use of the radio frequency spectrum. In no case shall the UE exceed the transmitted levels as defined in TS 25.101 for extreme operation. In particular, the UE shall inhibit all RF transmissions when the power supply voltage is below the manufacturer declared shutdown voltage.



## D.2.3 Vibration

The UE shall fulfil all the requirements when vibrated at the following frequency/amplitudes.

**Table D.3**

Frequency	ASD (Acceleration Spectral Density) random vibration
5 Hz to 20 Hz	0,96 m <sup>2</sup> /s <sup>3</sup>
20 Hz to 500 Hz	0,96 m <sup>2</sup> /s <sup>3</sup> at 20 Hz, thereafter -3 dB/Octave

Outside the specified frequency range the UE, if powered on, shall not make ineffective use of the radio frequency spectrum. In no case shall the UE exceed the transmitted levels as defined in TS 25.101 for extreme operation



## Annex E (informative): UARFCN numbers

### E.1 General

This Annex lists the UARFCN numbers used for the frequency bands implemented in the current specification.

### E.2 List of UARFCN used for UTRA FDD bands

The UARFCN numbering scheme detailed in clauses 5.4.3 and 5.4.4 of this specification is summarized for information in Table E.1. The table shows the UARFCN assigned to all UTRA FDD operating bands, starting with the lowest UARFCN and continuing up to the highest one assigned.

Each band may have two table entries, one for the 'general' numbers and one for the 'additional' ones, as specified in Table 5.2. The entries in Table E.1 are explained as follows:

**Band range:** The size of the frequency range for the UTRA FDD band specified in Table 5.0.

**Range res.:** The size of the frequency range corresponding to the UARFCN range that has been 'reserved' in 3GPP for possible future extensions of the band.

**Formula offset:** The offset parameter ( $F_{UL\_Offset}$  or  $F_{DL\_Offset}$ ) in the formula, used to calculate the UARFCN as specified in Clause 5.4.3.

**Assigned/reserved:** Indicates the significance of the UARFCN and corresponding frequencies listed as follows:

<b>Start res.</b>	Start of the UARFCN range reserved for the band.
<b>Min.</b>	The lowest UARFCN assigned to the band.
<b>Max.</b>	The highest UARFCN assigned to the band.
<b>End res.</b>	End of the UARFCN range reserved for the band.

$N_U, N_D$ : Uplink and downlink UARFCN.

$F_{UL}, F_{DL}$ : Corresponding uplink and downlink frequencies.

**(Add.):** Refers to the additional UARFCN (on the 100 kHz raster) as specified in Table 5.1A.

Note that bands V and VI are shown with common entries in Table E.1, since their UARFCN ranges are completely overlapping.



Table E.1: UARFCN used for the UTRA FDD bands

UTRA FDD Band	Band range [MHz]	Range res. [MHz]	Uplink UARFCN				Downlink UARFCN			
			Formula offset $F_{UL\_Offset}$ [MHz]	Assigned/Reserved	$N_U$	$F_{UL}$ [MHz]	Formula offset $F_{DL\_Offset}$ [MHz]	Assigned/Reserved	$N_D$	$F_{DL}$ [MHz]
II (Add.)	2x60	2x60	1850.1	Start res.	0	1850.1	1850.1	Start res.	400	1930.1
				Min.	12	1852.5		Min.	412	1932.5
				Max.	287	1907.5		Max.	687	1987.5
				End res.	299	1909.9		End res.	699	1989.9
XIX	2x15	2x15	770	Start res.	300	830.0	735	Start res.	700	875.0
				Min.	312	832.4		Min.	712	877.4
				Max.	363	842.6		Max.	763	887.6
				End res.	374	844.8		End res.	774	889.8
XIX (Add.)	2x15	2x15	755.1	Start res.	375	830.1	720.1	Start res.	775	875.1
				Min.	387	832.5		Min.	787	877.5
				Max.	437	842.5		Max.	837	887.5
				End res.	449	844.9		End res.	849	889.9
XXI	2x15	2x15	1358	Start res.	450	1448.0	1326	Start res.	850	1496.0
				Min.	462	1450.4		Min.	862	1498.4
				Max.	512	1460.4		Max.	912	1508.4
				End res.	524	1462.8		End res.	924	1510.8
V and VI (Add.)	2x25 (V) 2x10 (VI)	2x25	670.1	Start res.	770	824.1	670.1	Start res.	995	869.1
				Min. (V)	782	826.5		Min. (V)	1007	871.5
				Min. (VI)	812	832.5		Min. (VI)	1037	877.5
				Max. (VI)	837	837.5		Max. (VI)	1062	882.5
				Max. (V)	862	842.5		Max. (V)	1087	887.5
				End res.	894	848.9		End res.	1119	893.9
				End res.	894	848.9		End res.	1119	893.9
III	2x75	2x75	1525	Start res.	925	1710.0	1575	Start res.	1150	1805.0
				Min.	937	1712.4		Min.	1162	1807.4
				Max.	1288	1782.6		Max.	1513	1877.6
				End res.	1299	1784.8		End res.	1524	1879.8
IV	2x45	2x45	1450	Start res.	1300	1710.0	1805	Start res.	1525	2110.0
				Min.	1312	1712.4		Min.	1537	2112.4
				Max.	1513	1752.6		Max.	1738	2152.6
				End res.	1524	1754.8		End res.	1749	2154.8
IV (Add.)	2x45	2x45	1380.1	Start res.	1650	1710.1	1735.1	Start res.	1875	2110.1
				Min.	1662	1712.5		Min.	1887	2112.5
				Max.	1862	1752.5		Max.	2087	2152.5
				End res.	1874	1754.9		End res.	2099	2154.9
VII	2x70	2x70	2100	Start res.	2000	2500.0	2175	Start res.	2225	2620.0
				Min.	2012	2502.4		Min.	2237	2622.4
				Max.	2338	2567.6		Max.	2563	2687.6
				End res.	2349	2569.8		End res.	2574	2689.8
VII (Add.)	2x70	2x70	2030.1	Start res.	2350	2500.1	2105.1	Start res.	2575	2620.1
				Min.	2362	2502.5		Min.	2587	2622.5
				Max.	2687	2567.5		Max.	2912	2687.5
				End res.	2699	2569.9		End res.	2924	2689.9
VIII	2x35	2x35	340	Start res.	2700	880.0	340	Start res.	2925	925.0
				Min.	2712	882.4		Min.	2937	927.4
				Max.	2863	912.6		Max.	3088	957.6
				End res.	2874	914.8		End res.	3099	959.8
X	2x60	2x60	1135	Start res.	2875	1710.0	1490	Start res.	3100	2110.0
				Min.	2887	1712.4		Min.	3112	2112.4
				Max.	3163	1767.6		Max.	3388	2167.6
				End res.	3174	1769.8		End res.	3399	2169.8
X (Add.)	2x60	2x60	1075.1	Start res.	3175	1710.1	1430.1	Start res.	3400	2110.1
				Min.	3187	1712.5		Min.	3412	2112.5
				Max.	3462	1767.5		Max.	3687	2167.5
				End res.	3474	1769.9		End res.	3699	2169.9
XI	2x20	2x20	733	Start res.	3475	1428.0	736	Start res.	3700	1476.0
				Min.	3487	1430.4		Min.	3712	1478.4
				Max.	3562	1445.4		Max.	3787	1493.4
				End res.	3574	1447.8		End res.	3799	1495.8
XII	2x17	2x17	-22	Start res.	3605	699.0	-37	Start res.	3830	729.0



				Min.	3617	701.4		Min.	3842	731.4
				Max.	3678	713.6		Max.	3903	743.6
				End res.	3689	715.8		End res.	3914	745.8
XII (Add.)	2x17	2x17	-39.9	Start res.	3695	699.1	-54.9	Start res.	3920	729.1
				Min.	3707	701.5		Min.	3932	731.5
				Max.	3767	713.5		Max.	3992	743.5
				End res.	3779	715.9		End res.	4004	745.9
XIII	2x10	2x10	21	Start res.	3780	777.0	-55	Start res.	4005	746.0
				Min.	3792	779.4		Min.	4017	748.4
				Max.	3818	784.6		Max.	4043	753.6
				End res.	3829	786.8		End res.	4054	755.8
XIII (Add.)	2x10	2x10	11.1	Start res.	3830	777.1	-64.9	Start res.	4055	746.1
				Min.	3842	779.5		Min.	4067	748.5
				Max.	3867	784.5		Max.	4092	753.5
				End res.	3879	786.9		End res.	4104	755.9
XIV	2x10	2x10	12	Start res.	3880	788.0	-63	Start res.	4105	758.0
				Min.	3892	790.4		Min.	4117	760.4
				Max.	3918	795.6		Max.	4143	765.6
				End res.	3929	797.8		End res.	4154	767.8
XIV (Add.)	2x10	2x10	2.1	Start res.	3930	788.1	-72.9	Start res.	4155	758.1
				Min.	3942	790.5		Min.	4167	760.5
				Max.	3967	795.5		Max.	4192	765.5
				End res.	3979	797.9		End res.	4204	767.9
V and VI	2x25 (V) 2x10 (VI)	2x25	0	Start res.	4120	824.0	0	Start res.	4345	869.0
				Min. (V)	4132	826.4		Min. (V)	4357	871.4
				Min. (VI)	4162	832.4		Min. (VI)	4387	877.4
				Max. (VI)	4188	837.6		Max. (VI)	4413	882.6
				Max. (V)	4233	846.6		Max. (V)	4458	891.6
				End res.	4244	848.8		End res.	4469	893.8
XX	2x30	2x30	-23	Start res.	4275	832.0	-109	Start res.	4500	791.0
				Min.	4287	834.4		Min.	4512	793.4
				Max.	4413	859.6		Max.	4638	818.6
				End res.	4424	861.8		End res.	4649	820.8
XXII	80	80	2525	Start res.	4425	3410.0	2580	Start res.	4650	3510.0
				Min.	4437	3412.4		Min.	4662	3512.4
				Max.	4813	3487.6		Max.	5038	3587.6
				Stop res.	4824	3489.8		Stop res.	5049	3589.8
XXV	2x65	2x65	875	Start res.	4875	1850	910	Start res.	5100	1930
				Min.	4887	1852.4		Min.	5112	1932.4
				Max.	5188	1912.6		Max.	5413	1992.6
				End res.	5199	1914.8		End res.	5424	1994.8
XXV (Add.)	2x65	2x65	639.1	Start res.	6055	1850.1	674.1	Start res.	6280	1930.1
				Min.	6067	1852.5		Min.	6292	1932.5
				Max.	6367	1912.5		Max.	6592	1992.5
				End res.	6379	1914.9		End res.	6604	1994.9
XXVI	2x35	2x35	-291	Start res.	5525	814.0	-291	Start res.	5750	859.0
				Min.	5537	816.4		Min.	5762	861.4
				Max.	5688	846.6		Max.	5913	891.6
				End res.	5699	848.8		End res.	5924	893.8
XXVI (Add.)	2x35	2x35	-325.9	Start res.	5700	814.1	-325.9	Start res.	5925	859.1
				Min.	5712	816.5		Min.	5937	861.5
				Max.	5862	846.5		Max.	6087	891.5
				End res.	5874	848.9		End res.	6099	893.9
XXXII	44	44	N/A				131	Start res.	6605	1452.0
								Min.	6617	1454.4
								Max.	6813	1493.6
								End res.	6824	1495.8
XXXII (Add.)	44	44	N/A				87.1	Start res.	6825	1452.1
								Min.	6637	1454.5
								Max.	7012	1489.5
								End res.	7024	1491.9
IX	2x35	2x35	0	Start res.	8750	1750.0	0	Start res.	9225	1845.0
				Min.	8762	1752.4		Min.	9237	1847.4
				Max.	8912	1782.4		Max.	9387	1877.4
				End res.	8924	1784.8		End res.	9399	1879.8



II	2x60	2x60	0	Start res.	9250	1850.0	0	Start res.	9650	1930.0
				Min.	9262	1852.4		Min.	9662	1932.4
				Max.	9538	1907.6		Max.	9938	1987.6
				End res.	9549	1909.8		End res.	9949	1989.8
I	2x60	2x60	0	Start res.	9600	1920.0	0	Start res.	10550	2110.0
				Min.	9612	1922.4		Min.	10562	2112.4
				Max.	9888	1977.6		Max.	10838	2167.6
				End res.	9899	1979.8		End res.	10849	2169.8



## Annex F (informative): Change history

TSG	Doc	CR	R	Title	Cat	Curr	New	WI
RP-37				Rel-7 version created based on v7.9.0			8.0.0	
RP-37	RP-070658	0567		Introduction of UMTS1500 requirements (Rel-8)	B	7.9.0	8.0.0	RinImp8-UMTS1500
RP-37	RP-070654	0571	1	MBSFN FDD UE dem req	B	7.9.0	8.0.0	MBMSE-RANPhysFD D
RP-38	RP-070934	0578		Correction to UE Relative code domain power accuracy	A	8.0.0	8.1.0	RANimp-16QamUplink
RP-38	RP-070934	0580	1	Introduction of requirements for UE capable of receiving HS-DSCH and HS-SCCH in CELL_FACH state	A	8.0.0	8.1.0	RANImp-Enhstate
RP-38	RP-070936	0576		Editorial correction to the RV sequence of the MIMO FRC	A	8.0.0	8.1.0	MIMO-RF
RP-38	RP-070937	0575		Correction to extreme condition voltages for Lithium batteries in table D.2.2	A	8.0.0	8.1.0	TEI7
RP-39	RP-080121	0593		Correct reference to MIMO dual-stream channel model for MIMO CQI dual-stream requirements	A	8.1.0	8.2.0	MIMO-RF
RP-39	RP-080121	0594		HS-SCCH Type nominator	A	8.1.0	8.2.0	MIMO-RF
RP-39	RP-080121	0592	1	Nominal Peak Data Rate and redundancy versions in MIMO FRC Tests	A	8.1.0	8.2.0	MIMO-RF
RP-39	RP-080124	0583	2	Introduction of UMTS700EMC requirements	B	8.1.0	8.2.0	RinImp8-UMTS700
RP-39	RP-080165	0598		Addition of 15 code HSDPA demodulation requirements for 16QAM and QPSK	B	8.1.0	8.2.0	RinImp8-Hsdpa15codes
RP-39	RP-080166	0582	1	Specification of enhanced performance requirements type 3i for HSDPA based on receiver diversity and interference-aware chip level equaliser	B	8.1.0	8.2.0	RinImp8-2BIC
RP-39	RP-080167	0595		Correct reference to H-Set for 64-QAM max input test	A	8.1.0	8.2.0	RinImp
RP-40	RP-080326	0606		Correction of UMTS700 UE blocking and intermodulation values	F	8.2.0	8.3.0	RinImp8-UMTS700
RP-40	RP-080328	0608	2	Introduction of Cat 19-20 demodulation requirement and cleanup of HS-DSCH requirement applicability.	B	8.2.0	8.3.0	RANimp-64QamMimoHsdpa
RP-40	RP-080323	0600		Correction to MIMO propagation conditions	A	8.2.0	8.3.0	MIMO-RF
RP-40	RP-080323	0611		HS-DSCH transport Format used for HS-SCCH type 3 requirements	A	8.2.0	8.3.0	MIMO-RF
RP-40	RP-080321	0603		Correction to Rx Spurious Emissions	A	8.2.0	8.3.0	TEI6
RP-40	RP-080321	0601		Correction to Annex A.8.1	A	8.2.0	8.3.0	TEI6
RP-41	RP-080629	0618		Correction to F-DPCH TPC error rate requirement	A	8.3.0	8.4.0	TEI6
RP-41	RP-080629	0621	1	TS25.101: UTRA UE Power Class	A	8.3.0	8.4.0	TEI6
RP-41	RP-080631	0614	1	CQI reporting test for single link with varying lor/loc	F	8.3.0	8.4.0	TEI8
RP-41	RP-080631	0626	1	MIMO CQI reporting bias tests	F	8.3.0	8.4.0	TEI8
RP-41	RP-080631	0627		Clarification of HSDPA performance requirement applicability	F	8.3.0	8.4.0	TEI8
RP-41	RP-080625	624	1	CQI reporting test in fading conditions for 64QAM+MIMO	F	8.3.0	8.4.0	RANimp-64QamMimoHsdpa
RP-42	RP-080898	635	1	Introduction of fading CQI requirement at higher geometry for 64QAM operation	A	8.4.0	8.5.0	TEI7
RP-42	RP-080927	631	1	Clarification of HST propagation conditions	A	8.4.0	8.5.0	TEI7



RP-42	RP-080947	640	1	Introduction of E-AI requirements	B	8.4.0	8.5.0	RANImp-UplinkEnhState
RP-42	RP-080948	641		Introduction of CQI reporting test requirements for DC-HSDPA	B	8.4.0	8.5.0	RANImp-DCHSDPA
RP-42	RP-080948	639	3	Introduction of DC-HSDPA requirements	B	8.4.0	8.5.0	RANImp-DCHSDPA
RP-42	RP-080948	638	4	Introduction of FRC requirements for Dual cell HSDPA operation	B	8.4.0	8.5.0	RANImp-DCHSDPA
RP-42	RP-080942	636		CQI reporting test for STTD and CL1 with varying Ior/loc	F	8.4.0	8.5.0	TEI8
				Correction to version number shown in title line		8.5.0	8.5.1	
RP-043	RP-090168	644	1	Correction to requirement tables for 9.2.1 and 9.2.4.	A	8.5.1	8.6.0	TEI7
RP-043	RP-090168	648	1	Dual Cell HSDPA CQI Requirements in AWGN	F	8.5.1	8.6.0	RANImp-DCHSDPA
RP-043	RP-090168	658		Correction of HS-SCCH power in CQI tests	A	8.5.1	8.6.0	TEI7
RP-043	RP-090168	649	1	Correction to FRC requirements for DC HSDPA	F	8.5.1	8.6.0	RANImp-DCHSDPA
RP-043	RP-090168	651		25.101 CR Tx-Rx frequency separation for DC-HSDPA	F	8.5.1	8.6.0	RANImp-DCHSDPA
RP-043	RP-090168	653		25.101 CR clarification of CQI reporting requirement for DC-HSDPA	F	8.5.1	8.6.0	RANImp-DCHSDPA
RP-043	RP-090196	650	1	25.101 CR E-DCH phase discontinuity test requirement	F	8.5.1	8.6.0	TEI8
RP-043	RP-090196	654	1	Corrections of out of band blocking	F	8.5.1	8.6.0	TEI8
RP-044	RP-090539	660		Clarifications for CQI Reporting Requirements of HSDPA. (Technically Endorsed CR in R4-50bis - R4-091235)	A	8.6.0	8.7.0	TEI7
RP-044	RP-090539	662		Correction to MIMO Propagation Conditions. (Technically Endorsed CR in R4-50bis - R4-091433)	F	8.6.0	8.7.0	TEI7
RP-044	RP-090539	666	1	Correction to FRC H-Set 8 definition	A	8.6.0	8.7.0	TEI7
RP-044	RP-090546	667		Introduction of a new Compressed Mode pattern for E-UTRAN measurements	F	8.6.0	8.7.0	LTE-RF
RP-044	RP-090555	669		Removal of square brackets for DC-HSDPA Type 3i demodulation tests	F	8.6.0	8.7.0	TEI8
RP-044	RP-090559	661		Introduction of Extended UMTS800 requirements	B	8.7.0	9.0.0	RInImp9-UMTSLTE800
RP-45	RP-090820	673	1	Update of DC HSDPA CQI requirements	A	9.0.0	9.1.0	TEI8
RP-46	RP-091286	676	1	Introduction of Extended UMTS1500 requirements for TS25.101 (Technically endorsed at RAN 4 52bis in R4-093624)	B	9.1.0	9.2.0	UMTSLTE1500
RP-46	RP-091290	679	1	Combination of DC-HSDPA and MIMO, CQI requirements (Technically endorsed at RAN 4 52bis in R4-093831)	B	9.1.0	9.2.0	RANImp-DC_MIMO
RP-46	RP-091290	680	2	Combination of DC-HSDPA and MIMO, FRC requirements (Technically endorsed at RAN 4 52bis in R4-093832)	B	9.1.0	9.2.0	RANImp-DC_MIMO
RP-46	RP-091290	681	1	Combination of DC-HSDPA and MIMO, RF requirements (Technically endorsed at RAN 4 52bis in R4-093833)	B	9.1.0	9.2.0	RANImp-DC_MIMO
RP-46	RP-091288	682	1	RF transmitter requirements for DC-HSUPA (Technically endorsed at RAN 4 52bis in R4-094072)	B	9.1.0	9.2.0	RANImp-DC_HSUPA
RP-46	RP-091289	683		25.101 CR introduction of Dual Band DC-HSDPA (Technically Endorsed in R4-52, R4-093464)	B	9.1.0	9.2.0	RANImp-MultiBand_DC_HSDPA
RP-46	RP-091291	689	2	Introduction of requirements for TxAA fallback mode	B	9.1.0	9.2.0	RANImp-TxAA_nonMIMO
RP-46	RP-091296	690		Clarification of CQI reporting requirement applicability	A	9.1.0	9.2.0	TEI8
RP-46	RP-091372	694		RAN5 related changes to enhanced CELL_FACH test case	A	9.1.0	9.2.0	TEI7
RP-47	RP-100248	702		Correction of H-Set 11 requirement for type 3 and type 3i receivers	A	9.2.0	9.3.0	TEI8



RP-47	RP-100270	697		Correction of CQI requirements for DC_MIMO	F	9.2.0	9.3.0	RANimp-DC_MIMO
RP-47	RP-100271	703	1	HS-SCCH requirements for TxAA fallback extension	F	9.2.0	9.3.0	RANimp-TxAA_nonMIMO
RP-47	RP-100263	696		Introduction of UMTS in 800 MHz for Europe requirements in TS 25.101	B	9.2.0	9.3.0	UMTS LTE800 EU
RP-47	RP-100267	699	1	Tx-Rx frequency separation for DC-HSUPA	B	9.2.0	9.3.0	<b>RANimp-DC_HSUPA</b>
RP-47	RP-100267	698	2	Introduction of Rx core requirements for DC-HSUPA	B	9.2.0	9.3.0	RANimp-DC_HSUPA
RP-48	RP-100624	712		Editorial correction of note in varying geometry testcases	A	9.3.0	9.4.0	TEI8
RP-48	RP-100626	704	1	25.101 CR spurious emission requirements for DC-HSUPA in band XX	F	9.3.0	9.4.0	RANimp9-UMTS LTE800 EU
RP-48	RP-100631	714	1	Small correction to parameters for testing MIMO FRC H-Set11/11A	F	9.3.0	9.4.0	TEI9
RP-48	RP-100631	713		DC-MIMO-HSDPA; Removal of brackets from CQI Requirements	F	9.3.0	9.4.0	TEI9
RP-49	RP-100918	725		Corrections to CQI reporting requirements	A	9.4.0	9.5.0	TEI8
RP-49	RP-100921	728		Correction to Rx core requirements for DC-HSUPA	F	9.4.0	9.5.0	RANimp-DC_HSUPA
RP-49	RP-100921	722		Clarification of primary uplink frequency and secondary uplink frequency	F	9.4.0	9.5.0	4C_HSDPA-Core
RP-50	RP-101334	745		Correction to Band XII frequency range	A	9.5.0	9.6.0	TEI8
RP-50	RP-101339	742	1	Correction to Downlink Physical Channels in DC-HSDPA Tests	A	9.5.0	9.6.0	RANimp-DCHSDPA
RP-50	RP-101348	751	1	Correction to core requirements for DB-DC-HSDPA with bands II/IV combination	F	9.5.0	9.6.0	RANimp-MultiBand_DC_HSDPA
RP-50	RP-101348	747	2	Clarification on carrier spacing for DC-HSDPA with MIMO	F	9.5.0	9.6.0	RANimp-DC_MIMO
RP-50	RP-101353	733	2	Introduction of frequency bands for 4C-HSDPA	B	9.6.0	10.0.0	4C_HSDPA-Core
RP-50	RP-101353	750	1	25.101 CR Introduction of Tx Core Requirements for DB-DC-HSDPA and dual band 4C-HSDPA with bands II/IV combination	B	9.6.0	10.0.0	4C_HSDPA-Core
RP-50	RP-101353	737	1	25.101 CR introduction of Rx core requirements for 4C-HSDPA	B	9.6.0	10.0.0	4C_HSDPA-Core
RP-50	RP-101361	748		Protection of E-UTRA Band 24	B	9.6.0	10.0.0	L_Band_LTE_ATC_MSS-Core
				Correction of reference to table 7.1aB in section 7.3.1		10.0.0	10.0.1	
RP-51	RP-110354	0754	1	Introduction of Rx core requirements for DB-DC-HSDPA and dual band 4C-HSDPA	F	10.0.1	10.1.0	4C_HSDPA-Core
RP-51	RP-110345	0765	1	Correction to Downlink Physical Channels in DC-HSDPA receiver sensitivity	A	10.0.1	10.1.0	RANimp-DCHSDPA
RP-51	RP-110354	0766	1	Introduction of Tx core requirements for DB-DC-HSDPA and dual band 4C-HSDPA for I/VIII and I/V band combinations	F	10.0.1	10.1.0	4C_HSDPA-Core
RP-51	RP-110407	0768	1	HSDPA MIMO demodulation performance requirements due to asymmetric P-CPICH/S-CPICH power settings	B	10.0.1	10.1.0	MIMO_HSDPA-Perf
RP-51	RP-110345	0771	-	DC-HSUPA Rx core requirements for band XI and band XXI	A	10.0.1	10.1.0	RANimp-DC_HSUPA
RP-51	RP-110341	0776	-	Correction of UARFCN range for Band XII	A	10.0.1	10.1.0	TEI8
RP-51	RP-110336	0779	-	Correction of OOB interferer frequency ranges for Band XII	A	10.0.1	10.1.0	LTE-RF
RP-51	RP-110355	0783	-	25.101 CR: Correction of out of band blocking for DB-DC-HSDPA configuration 3 (Rel-10)	A	10.0.1	10.1.0	DB_DC_HSDPA-Core
RP-51	RP-110346	0785	2	25.101 CR Introduction of demodulation performance for DB-DC-HSDPA (rel-10)	F	10.0.1	10.1.0	TEI9, RANimp-MultiBand_DC_HSDPA
RP-51	RP-110355	0788	3	CR for the addition of the new band combinations and the TX core requirements for band I-XI and II-V	B	10.0.1	10.1.0	DB_DC_HSDPA-Core
RP-51	RP-110355	0789	3	CR for RX core requirements for band I-XI and II-V	B	10.0.1	10.1.0	DB_DC_HSDPA-Core
RP-51	RP-110341	0793	1	CR for the modification of the UE relative code domain power accuracy	A	10.0.1	10.1.0	TEI8
RP-52	RP-110798	797		CR for the introduction of TX core requirements for band I-XI and II-V	B	10.1.0	10.2.0	DB_DC_HSDPA-Core
RP-52	RP-110798	798		25.101 CR Introduction of Rx core requirements for Band combinations II-V and I-XI	B	10.1.0	10.2.0	DB_DC_HSDPA-Core
RP-52	RP-110801	799		HSDPA MIMO CQI reporting requirements due to asymmetric P-CPICH/S-CPICH power settings	B	10.1.0	10.2.0	MIMO_HSDPA-Perf



RP-52	RP-110801	811		HSDPA MIMO CQI reporting requirements due to asymmetric P-CPICH/S-CPICH power settings	B	10.1.0	10.2.0	MIMO_HSDPA-Perf
RP-52	RP-110812	812		UTRAN UE spurious emission requirements to protect E-UTRA band 23	B	10.1.0	10.2.0	S_Band_LTE_ATC_MSS-Core
RP-52	RP-110795	813		UTRAN UE spurious emission requirements to protect E-UTRA band 24	F	10.1.0	10.2.0	L_Band_LTE_ATC_MSS-Core
RP-52	RP-110796	816		Additional Spurious requirement extension due to EN spec change	F	10.1.0	10.2.0	TEI10
RP-52	RP-110801	807	1	Clarification on retransmission for MIMO workaround	B	10.1.0	10.2.0	MIMO_HSDPA-Perf
RP-52	RP-110804	805	3	Expanded 1900 MHz addition to 25.101	B	10.1.0	10.2.0	E1900-Core
RP-53	RP-111252	846		Correction of UE Relative code domain power accuracy requirements for TS 25.101 REL-10	A	10.2.0	10.3.0	TEI9
RP-53	RP-111253	843		Clarification of spectrum emission mask requirements	A	10.2.0	10.3.0	TEI9
RP-53	RP-111254	829		Clarification of ACLR requirements for DC-HSUPA	A	10.2.0	10.3.0	RANimp-DC_HSUPA
RP-53	RP-111255	838	1	Add Band XXII for LTE/UMTS 3500 (FDD) to TS 25.101	B	10.2.0	10.3.0	RInImp8-UMTSLTE3500
RP-53	RP-111262	837	1	Fixing UARFCN numbers in 25.101	F	10.2.0	10.3.0	TEI10
RP-53	RP-111264	830	1	UE core requirements for Band XXV	F	10.2.0	10.3.0	E1900
RP-53	RP-111270	818		Completion of UE demodulation performance requirements for 4C-HSDPA	B	10.2.0	10.3.0	4C_HSDPA-Perf
RP-53	RP-111270	819	1	Introduction of UE CQI reporting requirements for 4C-HSDPA	B	10.2.0	10.3.0	4C_HSDPA-Perf
RP-54	RP-111690	848		Non applicable UARFCN numbers	F	10.3.0	10.4.0	TEI10
RP-54	RP-111735	850		Alignment with TS 36.101 on 3500MHz	F	10.3.0	10.4.0	TEI10
RP-54	RP-111686	851		Introduction of missing ACS case 2 requirement for single band 4C-HSDPA	F	10.3.0	10.4.0	4C_HSDPA-core
RP-54	RP-111696	849		Introduction of single band 4C-HSDPA II-4	B	10.4.0	11.0.0	4C_HSDPA_Config-Core
RP-55	RP-120306	860	1	Introduction of Band 26/XXVI to TS 25.101	B	11.0.0	11.1.0	e850_UB-Core
RP-55	RP-120297	862		Correction of frequency range for spurious emission requirements	A	11.0.0	11.1.0	RInImp8-UMTSLTE3500
RP-56	RP-120775	866	-	Correction to H-Set 8	A	11.1.0	11.2.0	4C_HSDPA-Perf
RP-56	RP-120771	874	1	Introduction of Japanese Regulatory Requirements to W-CDMA Band VIII (R11)	A	11.1.0	11.2.0	TEI9
RP-56	RP-120786	876	2	Introduction of 8C-HSDPA operation in 25.101 and rx core requirements	B	11.1.0	11.2.0	8C-HSDPA-Core
RP-56	RP-120793	881	-	Introduction of Band 28	B	11.1.0	11.2.0	LTE_APAC700-Core
RP-56	RP-120779	883	-	Correction of TX power step size tolerance for HS-DPCCH	A	11.1.0	11.2.0	TEI10
RP-56	RP-120793	884	1	Introduction of Band 44	B	11.1.0	11.2.0	LTE_APAC700-Core
RP-56	RP-120763	888	-	Correction to numbers of HS-SCCH for DC-HSDPA	A	11.1.0	11.2.0	RANimp-DCHSDPA
RP-56	RP-120791	889	2	Introduction of E850_LB (Band 27) to TS 25.101	B	11.1.0	11.2.0	LTE_e850_LB-Core
RP-56	RP-120766	895	-	Correction of PHS protection requirements for TS 25.101	A	11.1.0	11.2.0	TEI8
RP-56	RP-120610	899	2	Introduction of non contiguous 4C-HSDPA core requirements definition	B	11.1.0	11.2.0	NC_4C_HSDPA-Core
RP-57	RP-121300	892a	-	Corrections of spurious emission band UE co-existence applicable in Japan	A	11.2.0	11.3.0	RInImp9-UMTSLTE800
RP-57	RP-121309	899a	1	Missing allowed de-sensitization for single band 4C-HSDPA	F	11.2.0	11.3.0	4C_HSDPA-Core
RP-57	RP-121299	905	1	Correction of DC-HSUPA core requirements	A	11.2.0	11.3.0	RANimp-DC_HSUPA
RP-57	RP-121314	906	1	Removal of [] in NC-4C-HSDPA core requirements	F	11.2.0	11.3.0	NC_4C_HSDPA-Core
RP-57	RP-121318	907	1	Performance requirements for 8C-HSDPA	B	11.2.0	11.3.0	8C_HSDPA-Perf



RP-57	RP-121312	909	-	DC-HSUPA for Band XXII	A	11.2.0	11.3.0	RInImp8-UMTS LTE3 500
RP-57	RP-121317	910	-	Modification of the MPR/CM for 8C-HSDPA	B	11.2.0	11.3.0	8C_HSDPA-Core
RP-57	RP-121340	911	-	Correction of the HS-DPCCH power step range	F	11.2.0	11.3.0	TEI11
RP-57	RP-121320	912	-	Tx requirements for I-2-VIII-2 and II-1-V-2	B	11.2.0	11.3.0	HSDPA_DB_MC-Core
RP-57	RP-121320	913	1	Missing requirements for I-2-VIII-2 and II-1-V-2	B	11.2.0	11.3.0	HSDPA_DB_MC-Core
RP-58	RP-121867	927		Japanese regulatory requirements for DC-HSUPA spurious emissions	A	11.3.0	11.4.0	TEI10
RP-58	RP-121856	931		Alignment of inconsistent Rx core requirements with dual uplinks	A	11.3.0	11.4.0	RANimp-DC_HSUPA
RP-58	RP-121908	933	1	Introduction of UL MIMO to TS 25.101	B	11.3.0	11.4.0	MIMO_64Q_AM_HSUPA-Core
RP-58	RP-121876	934	1	CR to TS 25.101 due to introduction of CLTD	B	11.3.0	11.4.0	HSPA_UL_TxDiv-CL-Core
RP-58	RP-121901	935		Introduction of Band 29	B	11.3.0	11.4.0	LTE_DL_FD D700-Core
RP-58	RP-121876	937		F-TPICH out of quality handling for UL CLTD and UL MIMO	B	11.3.0	11.4.0	HSPA_UL_TxDiv-CL-Core, MIMO_64Q_AM_HSUPA-Core
RP-58	RP-121877	918	1	CR to TS 25.101 due to introduction of OLTD	B	11.3.0	11.4.0	HSPA_UL_TxDiv-OL-Core
RP-58	RP-121848	923		Introducing the additional frequency bands of 5 MHz x 2 in 1.7 GHz in Japan to Band III	A	11.3.0	11.4.0	RInImp-UMTS1700
RP-58	RP-121867	925		<b>Cleaning of 25.101 Performance sections Rel-11 The CR was not implemented as it was not based on the latest version of the spec</b>	A	11.3.0	11.4.0	TEI10
RP-59	RP-130287	941	1	CR for Cleaning of 25.101 Rel-11	F	11.4.0	11.5.0	TEI11
RP-59	RP-130287	942	1	Band 41 requirements for operation in China and Japan	F	11.4.0	11.5.0	TEI11
RP-59	RP-130281	940	1	CR for Non contiguous Carrier aggregation UE demodulation performance	B	11.4.0	11.5.0	NC_4C_HSDPA-Perf
RP-59	RP-130271	939		Some corrections on requirements of ULTD for TS 25.101	F	11.4.0	11.5.0	HSPA_UL_TxDiv-OL-Core
RP-59	RP-130270	938	1	Removal of bracket from CR F-TPICH out of quality handling for UL CLTD and UL MIMO	F	11.4.0	11.5.0	HSPA_UL_TxDiv-CL-Core, MIMO_64Q_AM_HSUPA-Core
RP-60	RP-130762	948		Adding definition of UE maximum output power for DC-HSUPA	A	11.5.0	11.6.0	RANimp-DC_HSUPA
RP-60	RP-130762	951		Correction to center frequency offset for additional spectrum emissions mask	A	11.5.0	11.6.0	RANimp-DC_HSUPA
RP-60	RP-130768	952		Correction to Definitions list	F	11.5.0	11.6.0	8C_HSDPA-Core
RP-60	RP-130768	955	1	Co-existence with 2.6GHz bands	F	11.5.0	11.6.0	TEI11
RP-60	RP-130768	964		Introduction of F-TPICH demodulation performance requirements in F-TPICH out-of-quality handling requirements	F	11.5.0	11.6.0	HSPA_UL_TxDiv-CL-Core
RP-60	RP-130766	967		Carrier aggregation in multi-RAT UTRA and E-UTRA terminals	A	11.5.0	11.6.0	LTE_CA-Core
RP-60	RP-130764	973		Editorial CR for 25.101 rel-11	A	11.5.0	11.6.0	TEI10
RP-60	RP-130791	960		Introduction of Band 30	B	11.6.0	12.0.0	LTE_WCS_band-Core
RP-60	RP-130790	971		Protection of LTE 450 band	B	11.6.0	12.0.0	LTE450_Brazil-Core



RP-61	RP-131280	988		CM and MPR for DC-HSUPA with 16QAM	A	12.0.0	12.1.0	RANimp-DC_HSUPA
RP-61	RP-131304	989		Introduction of UE demodulation performance requirements for Multiflow HSDPA	A	12.0.0	12.1.0	HSDPA_MF TX-Perf
RP-61	RP-131304	990		Introduction of UE CQI reporting performance requirements for Multiflow HSDPA	A	12.0.0	12.1.0	HSDPA_MF TX-Perf
RP-62	RP-131925	1004		Missing update on reference input power adjustment for a dual band device	A	12.1.0	12.2.0	RANimp-DC_HSUPA
RP-62	RP-131933	1010		CSI testing for MIMO mode with 4 transmit antennas	A	12.1.0	12.2.0	4Tx_HSDPA-Perf
RP-62	RP-131932	1015		Introduction of UE requirements for determination of Common E-RGCH Radio Link(s) in Cell_FACH	A	12.1.0	12.2.0	Cell_FACH_enh-Perf
RP-62	RP-131967	1016		Band 41 deployment in Japan	F	12.1.0	12.2.0	TEI12
RP-62	RP-131933	992		HS-PDSCH performance requirements for MIMO mode with 4 transmit antennas	A	12.1.0	12.2.0	4Tx_HSDPA-Perf
RP-62	RP-131929	996		Clarification on the applicability of MIMO performance for a UE supporting NC-MC-HSDPA	A	12.1.0	12.2.0	NC_4C_HSDPA-Core
RP-63	RP-140375	1028		Editorial corrections to UE RF core requirements in TS 25.101	A	12.2.0	12.3.0	TEI11
RP-63	RP-140369	1018		Removing [] in 25.101 in the context of Four transmit antennas for HSDPA	A	12.2.0	12.3.0	4Tx_HSDPA-Perf
RP-64	RP-140926	1034	2	Introduction of Band XXXII and Band I+XXXII	B	12.3.0	12.4.0	LTE_UTRA_SDL_BandL-Core
RP-64	RP-140945	1033		Editorial correction of note in clause 4.4	D	12.3.0	12.4.0	TEI12
RP-65	RP-141543	1040		Addition of demodulation requirement for BCH mapped to S-CCPCH	B	12.4.0	12.5.0	UTRA_SIBenh-Perf
RP-65	RP-141529	1042		Maximum allowed UL TX power for Band XXVI coexistence with Public Safety	A	12.4.0	12.5.0	e850_UB-Core
RP-65	RP-141238	1043		CR on UMTS HetNet Enhancements	B	12.4.0	12.5.0	UTRA_hetnet_enh-core
RP-66	RP-142168	1054		UMTS HetNet Enhancements requirements for power control	B	12.5.0	12.6.0	UTRA_hetnet_enh-Perf
RP-66	RP-142167	1049	1	25.101 CR on performance requirements for UE DCH demodulation during handover due to introduction of DCH enhancements	B	12.5.0	12.6.0	UTRA_DCHenh-Perf
RP-66	RP-142167	1051	1	25.101 CR on performance requirements for UE DCH demodulation in static and multipath fading conditions due to introduction of DCH enhancements	B	12.5.0	12.6.0	UTRA_DCHenh-Perf
RP-66	RP-142170	1053	1	25.101 CR on E-AGCH performance requirements with TDM granting	B	12.5.0	12.6.0	EDCH_enh-Perf
RP-66	RP-142188	1059	1	TS25.101 removal of brackets (RF)	F	12.5.0	12.6.0	TEI12
RP-66	RP-142153	1055	1	UMTS HetNet Enhancements impact on cubic metric (MPR)	F	12.5.0	12.6.0	UTRA_hetnet_enh-Core
RP-66	RP-142167	1048	2	25.101 CR on new reference measurement channels due to introduction of DCH enhancements	B	12.5.0	12.6.0	UTRA_DCHenh-Perf
RP-66	RP-142167	1050	2	25.101 CR on performance requirements for downlink power control due to introduction of DCH enhancements	B	12.5.0	12.6.0	UTRA_DCHenh-Perf
RP-67	RP-150385	1060		TX UE spurious emissions alignment with 36.101	F	12.6.0	12.7.0	TEI12
RP-67	RP-150385	1061		RX UE spurious emissions simplification	F	12.6.0	12.7.0	TEI12
RP-67	RP-150385	1062		Removal of square brackets of cubic metric (MPR) for UMTS HetNet Enhancements	F	12.6.0	12.7.0	UTRA_hetnet_enh-Core
RP-68	RP-150957	1067		Receiver spurious emissions requirements for downlink-only bands (Band XXXII)	F	12.7.0	12.8.0	LTE_UTRA_SDL_BandL-Core
RP-69	RP-151483	1070	1	Correction on RX spurious emissions of Band VI and XIX	F	12.8.0	12.9.0	TEI12
RP-69	RP-151483	1071	1	UMTS UE co-existence requirements from the Japanese bands to the frequency range of 3400-3600 MHz	F	12.8.0	12.9.0	TEI12
RP-69	RP-151492	1073		Correction to table C.24 title	A	12.8.0	12.9.0	HSDPA_MFTX_enh-Core
RP-69	RP-151477	1075		Correction in the available channel list when DPCCH2 is configured	F	12.8.0	12.9.0	UTRA_HetNet_enh-Core
RP-69	RP-151483	1076		Correction of notes for UE additional TX/RX spurious emissions requirements	F	12.8.0	12.9.0	TEI12



# History

Document history		
V12.5.0	October 2014	Publication
V12.6.0	January 2015	Publication
V12.7.0	April 2015	Publication
V12.8.0	July 2015	Publication
V12.9.0	October 2015	Publication