

# ETSI TS 125 104 V15.3.0 (2018-07)



**Universal Mobile Telecommunications System (UMTS);  
Base Station (BS) radio transmission and reception (FDD)  
(3GPP TS 25.104 version 15.3.0 Release 15)**



---

Reference

RTS/TSGR-0425104vf30

---

Keywords

UMTS

**ETSI**

650 Route des Lucioles  
F-06921 Sophia Antipolis Cedex - FRANCE

Tel.: +33 4 92 94 42 00 Fax: +33 4 93 65 47 16

Siret N° 348 623 562 00017 - NAF 742 C  
Association à but non lucratif enregistrée à la  
Sous-Préfecture de Grasse (06) N° 7803/88

---

**Important notice**

The present document can be downloaded from:

<http://www.etsi.org/standards-search>

The present document may be made available in electronic versions and/or in print. The content of any electronic and/or print versions of the present document shall not be modified without the prior written authorization of ETSI. In case of any existing or perceived difference in contents between such versions and/or in print, the only prevailing document is the print of the Portable Document Format (PDF) version kept on a specific network drive within ETSI Secretariat.

Users of the present document should be aware that the document may be subject to revision or change of status.

Information on the current status of this and other ETSI documents is available at

<https://portal.etsi.org/TB/ETSIDeliverableStatus.aspx>

If you find errors in the present document, please send your comment to one of the following services:

<https://portal.etsi.org/People/CommiteeSupportStaff.aspx>

---

**Copyright Notification**

No part may be reproduced or utilized in any form or by any means, electronic or mechanical, including photocopying and microfilm except as authorized by written permission of ETSI.

The content of the PDF version shall not be modified without the written authorization of ETSI.

The copyright and the foregoing restriction extend to reproduction in all media.

© ETSI 2018.

All rights reserved.

**DECT™**, **PLUGTESTS™**, **UMTS™** and the ETSI logo are trademarks of ETSI registered for the benefit of its Members.

**3GPP™** and **LTE™** are trademarks of ETSI registered for the benefit of its Members and of the 3GPP Organizational Partners.

**oneM2M** logo is protected for the benefit of its Members.

**GSM®** and the GSM logo are trademarks registered and owned by the GSM Association.

---

# Intellectual Property Rights

## Essential patents

IPRs essential or potentially essential to normative deliverables may have been declared to ETSI. The information pertaining to these essential IPRs, if any, is publicly available for **ETSI members and non-members**, and can be found in ETSI SR 000 314: *"Intellectual Property Rights (IPRs); Essential, or potentially Essential, IPRs notified to ETSI in respect of ETSI standards"*, which is available from the ETSI Secretariat. Latest updates are available on the ETSI Web server (<https://ipr.etsi.org/>).

Pursuant to the ETSI IPR Policy, no investigation, including IPR searches, has been carried out by ETSI. No guarantee can be given as to the existence of other IPRs not referenced in ETSI SR 000 314 (or the updates on the ETSI Web server) which are, or may be, or may become, essential to the present document.

## Trademarks

The present document may include trademarks and/or tradenames which are asserted and/or registered by their owners. ETSI claims no ownership of these except for any which are indicated as being the property of ETSI, and conveys no right to use or reproduce any trademark and/or tradename. Mention of those trademarks in the present document does not constitute an endorsement by ETSI of products, services or organizations associated with those trademarks.

---

# Foreword

This Technical Specification (TS) has been produced by ETSI 3rd Generation Partnership Project (3GPP).

The present document may refer to technical specifications or reports using their 3GPP identities, UMTS identities or GSM identities. These should be interpreted as being references to the corresponding ETSI deliverables.

The cross reference between GSM, UMTS, 3GPP and ETSI identities can be found under <http://webapp.etsi.org/key/queryform.asp>.

---

# Modal verbs terminology

In the present document "**shall**", "**shall not**", "**should**", "**should not**", "**may**", "**need not**", "**will**", "**will not**", "**can**" and "**cannot**" are to be interpreted as described in clause 3.2 of the [ETSI Drafting Rules](#) (Verbal forms for the expression of provisions).

"**must**" and "**must not**" are **NOT** allowed in ETSI deliverables except when used in direct citation.

# Contents

Intellectual Property Rights .....	2
Foreword.....	2
Modal verbs terminology.....	2
Foreword.....	7
1 Scope .....	8
2 References .....	8
3 Definitions and abbreviations.....	8
3.1 Definitions .....	8
3.2 Abbreviations .....	11
3.3 Symbols.....	11
4 General .....	12
4.1 Relationship between Minimum Requirements and Test Requirements .....	12
4.2 Base station classes .....	12
4.3 Regional requirements.....	13
4.4 Environmental requirements for the BS equipment .....	15
4.5 Applicability of requirements.....	15
4.6 Requirements for contiguous and non-contiguous spectrum.....	15
4.7 Requirements for BS capable of multi-band operation .....	15
5 Frequency bands and channel arrangement.....	16
5.1 General .....	16
5.2 Frequency bands.....	16
5.3 Tx-Rx frequency separation .....	18
5.4 Channel arrangement.....	19
5.4.1 Channel spacing.....	19
5.4.2 Channel raster .....	20
5.4.3 Channel number .....	20
6 Transmitter characteristics .....	21
6.1 General .....	21
6.2 Base station output power .....	22
6.2.1 Base station maximum output power.....	22
6.2.1.1 Minimum requirement .....	22
6.3 Frequency error .....	23
6.3.1 Minimum requirement .....	23
6.4 Output power dynamics.....	23
6.4.1 Inner loop power control in the downlink.....	23
6.4.1.1 Power control steps .....	23
6.4.1.1.1 Minimum requirement.....	23
6.4.2 Power control dynamic range .....	24
6.4.2.1 Minimum requirements .....	24
6.4.3 Total power dynamic range .....	24
6.4.3.1 Minimum requirement .....	24
6.4.4 Primary CPICH power.....	24
6.4.4.1 Minimum requirement .....	24
6.4.4A Secondary CPICH power.....	24
6.4.4A.1 Minimum Requirement for MIMO mode .....	24
6.4.4A.2 Minimum Requirement for MIMO mode with four transmit antennas.....	25
6.4.4B Demodulation CPICH power for MIMO mode with four transmit antennas.....	25
6.4.4B.1 Minimum Requirement .....	25
6.4.5 IPDL time mask.....	25
6.4.5.1 Minimum Requirement .....	25
6.4.6 Home base station output power for adjacent channel protection.....	26
6.4.6.1 Minimum requirement .....	27
6.5 (void).....	27

6.6	Output RF spectrum emissions.....	27
6.6.1	Occupied bandwidth .....	27
6.6.1.1	Minimum requirement .....	27
6.6.2	Out of band emission.....	27
6.6.2.1	Spectrum emission mask.....	27
6.6.2.2	Adjacent Channel Leakage power Ratio (ACLR).....	33
6.6.2.2.1	Minimum requirement.....	33
6.6.2.2.2	Cumulative ACLR requirement in non-contiguous spectrum .....	34
6.6.3	Spurious emissions .....	35
6.6.3.1	Mandatory Requirements .....	35
6.6.3.1.1	Spurious emissions (Category A).....	35
6.6.3.1.2	Spurious emissions (Category B).....	36
6.6.3.2	Protection of the BS receiver of own or different BS .....	37
6.6.3.2.1	Minimum Requirement .....	37
6.6.3.3	Co-existence with other systems in the same geographical area.....	39
6.6.3.3.1	Minimum Requirements.....	39
6.6.3.4	Co-existence with co-located and co-sited base stations.....	44
6.6.3.4.1	Minimum Requirements .....	44
6.6.3.5	Co-existence with PHS .....	53
6.6.3.5.1	Minimum Requirement .....	53
6.6.3.6	Co-existence with services in adjacent frequency bands.....	53
6.6.3.6.1	Minimum requirement.....	54
6.6.3.7	(Void).....	54
6.6.3.8	Protection of Public Safety Operations .....	54
6.6.3.8.1	Minimum Requirement .....	54
6.6.3.9	Co-existence with Home BS operating in other bands.....	54
6.6.3.9.1	Minimum Requirements .....	55
6.7	Transmitter intermodulation.....	57
6.7.1	Minimum requirement .....	57
6.8	Transmit modulation .....	57
6.8.1	Transmit pulse shape filter.....	58
6.8.2	Error Vector Magnitude.....	58
6.8.2.1	Minimum requirement .....	58
6.8.3	Peak code Domain error .....	58
6.8.3.1	Minimum requirement .....	58
6.8.4	Time alignment error .....	58
6.8.4.1	Minimum Requirements.....	59
6.8.5	Relative Code Domain Error for 64QAM modulation.....	59
6.8.5.1	Minimum requirement .....	59
7	Receiver characteristics.....	59
7.1	General .....	59
7.2	Reference sensitivity level.....	60
7.2.1	Minimum requirement .....	60
7.2.2	Maximum Frequency Deviation for Receiver Performance .....	60
7.3	Dynamic range .....	60
7.3.1	Minimum requirement .....	60
7.4	Adjacent Channel Selectivity (ACS).....	60
7.4.1	Minimum requirement .....	61
7.4.2	Minimum requirement - Co-location with UTRA-TDD.....	61
7.5	Blocking characteristics .....	61
7.5.1	Minimum requirement .....	61
7.5.2	Minimum Requirement - Co-location with GSM, DCS, PCS, CDMA, UTRA and/or E-UTRA, UTRA TDD and/or E-UTRA TDD .....	72
7.5.3	Void .....	82
7.6	Intermodulation characteristics .....	82
7.6.1	Minimum requirement .....	83
7.7	Spurious emissions .....	84
7.7.1	Minimum requirement .....	85
8	Performance requirement .....	85
8.1	General .....	85

8.2	Demodulation in static propagation conditions .....	86
8.2.1	Demodulation of DCH.....	86
8.2.1.1	Minimum requirement .....	86
8.3	Demodulation of DCH in multipath fading conditions .....	87
8.3.1	Multipath fading Case 1.....	87
8.3.1.1	Minimum requirement .....	87
8.3.2	Multipath fading Case 2.....	87
8.3.2.1	Minimum requirement .....	87
8.3.3	Multipath fading Case 3.....	88
8.3.3.1	Minimum requirement .....	88
8.3.4	Multipath fading Case 4.....	88
8.3.4.1	Minimum requirement .....	89
8.4	Demodulation of DCH in moving propagation conditions.....	89
8.4.1	Minimum requirement .....	89
8.5	Demodulation of DCH in birth/death propagation conditions.....	89
8.5.1	Minimum requirement .....	90
8.5A	Demodulation of DCH in high speed train conditions .....	90
8.5A.1	General.....	90
8.5A.2	Minimum requirement .....	90
8.6	(void).....	90
8.7	Performance requirement for RACH.....	90
8.7.1	Performance requirement for RACH preamble detection.....	90
8.7.2	Demodulation of RACH message.....	91
8.7.2.1	Minimum requirements for Static Propagation Condition .....	91
8.7.2.2	Minimum requirements for Multipath Fading Case 3 .....	91
8.7.2.3	Minimum requirements for high speed train conditions .....	92
8.8	(void).....	92
8.9	(void).....	92
8.10	Performance of ACK/NACK detection for HS-DPCCH.....	92
8.10.1	ACK false alarm .....	92
8.10.2	ACK mis-detection .....	93
8.10A	Performance of ACK/NACK detection for 4C-HSDPA HS-DPCCH.....	93
8.10A.1	Performance requirements .....	93
8.10A.1.1	ACK false alarm.....	93
8.10A.1.2	ACK mis-detection.....	94
8.10A.2	Applicability of requirements .....	94
8.10B	Performance of ACK/NACK detection for 8C-HSDPA HS-DPCCH.....	95
8.11	Demodulation of E-DPDCH in multipath fading condition .....	95
8.11A	Demodulation of E-DPDCH and S-E-DPDCH in multipath fading condition for UL MIMO.....	96
8.12	Performance of signaling detection for E-DPCCH in multipath fading condition .....	97
<b>Annex A (normative): Measurement channels .....</b>		<b>98</b>
A.1	Summary of UL reference measurement channels.....	98
A.2	UL reference measurement channel for 12.2 kbps.....	99
A.3	UL reference measurement channel for 64 kbps.....	100
A.4	UL reference measurement channel for 144 kbps.....	101
A.5	UL reference measurement channel for 384 kbps.....	102
A.6	(void).....	102
A.7	Reference measurement channels for UL RACH .....	103
A.8	Reference measurement channel for HS-DPCCH.....	103
A.8A	Reference measurement channel for HS-DPCCH for 4C-HSDPA .....	104
A.9	Summary of E-DPDCH Fixed reference channels.....	105
A.10	E-DPDCH Fixed reference channel 1 (FRC1) .....	105
A.11	E-DPDCH Fixed reference channel 2 (FRC2) .....	106

A.12	E-DPDCH Fixed reference channel 3 (FRC3)	107
A.13	E-DPDCH Fixed reference channel 4 (FRC4)	108
A.14	E-DPDCH Fixed reference channel 5 (FRC5)	109
A.15	E-DPDCH Fixed reference channel 6 (FRC6)	110
A.16	E-DPDCH Fixed reference channel 7 (FRC7)	110
A.17	E-DPDCH Fixed reference channel 8 (FRC8)	111
A.18	E-DPDCH Fixed reference channel 9 (FRC9)	112
A.19	E-DPDCH Fixed reference channel 10 (FRC10)	113
<b>Annex B (normative):</b>	<b>Propagation conditions</b>	<b>115</b>
B.1	Static propagation condition	115
B.2	Multi-path fading propagation conditions	115
B.3	Moving propagation conditions	115
B.4	Birth-Death propagation conditions	116
B.4A	High speed train conditions	116
B.5	Multipath fading propagation conditions for E-DPDCH and E-DPCCH	119
<b>Annex C (normative):</b>	<b>Characteristics of the W-CDMA interference signal</b>	<b>120</b>
<b>Annex D (normative):</b>	<b>Regional requirement for protection of DTT</b>	<b>121</b>
<b>Annex E (informative):</b>	<b>Change History</b>	<b>122</b>
History		127

---

# Foreword

This Technical Specification has been produced by the 3GPP.

The contents of the present document are subject to continuing work within the TSG and may change following formal TSG approval. Should the TSG modify the contents of this TS, it will be re-released by the TSG with an identifying change of release date and an increase in version number as follows:

Version 3.y.z

where:

- x the first digit:
  - 1 presented to TSG for information;
  - 2 presented to TSG for approval;
  - 3 Indicates TSG approved document under change control.
- y the second digit is incremented for all changes of substance, i.e. technical enhancements, corrections, updates, etc.
- z the third digit is incremented when editorial only changes have been incorporated in the specification.



---

# 1 Scope

This document establishes the Base Station minimum RF characteristics of the FDD mode of UTRA.

---

## 2 References

The following documents contain provisions which, through reference in this text, constitute provisions of the present document.

- References are either specific (identified by date of publication, edition number, version number, etc.) or non-specific.
- For a specific reference, subsequent revisions do not apply.
- For a non-specific reference, the latest version applies. In the case of a reference to a 3GPP document (including a GSM document), a non-specific reference implicitly refers to the latest version of that document *in the same Release as the present document*.

- [1] ITU-R Recommendation SM.329, " Unwanted emissions in the spurious domain ".
- [2] (void)
- [3] ETSI ETR 273-1-2: "Electromagnetic compatibility and Radio spectrum Matters (ERM); Improvement of radiated methods of measurement (using test sites) and evaluation of the corresponding measurement uncertainties; Part 1: Uncertainties in the measurement of mobile radio equipment characteristics; Sub-part 2: Examples and annexes".
- [4] 3GPP TR 25.942 "RF System Scenarios".
- [5] 3GPP TS 45.004: "Digital cellular telecommunications system (Phase 2+); Modulation".
- [6] 3GPP TS 25.213: "Spreading and modulation (FDD)".
- [7] ITU-R recommendation SM.328: "Spectra and bandwidth of emissions".
- [8] 3GPP TS 36.104: " Evolved Universal Terrestrial Radio Access (E-UTRA); Base Station (BS) radio transmission and reception".
- [9] ECC/DEC/(09)03 " Harmonised conditions for MFCN in the band 790-862 MHz", 30 Oct. 2009
- [10] 3GPP TS 37.104: " E-UTRA, UTRA and GSM/EDGE; Multi-Standard Radio (MSR) Base Station (BS) radio transmission and reception".
- [11] 3GPP TS 25.331: " Radio Resource Control. Protocol Specification".
- [12] 3GPP TS 25.214: "Physical layer procedures (FDD) ".
- [13] CEPT ECC Decision (13)03, "The harmonised use of the frequency band 1452-1492 MHz for Mobile/Fixed Communications Networks Supplemental Downlink (MFCN SDL)".

---

## 3 Definitions and abbreviations

### 3.1 Definitions

For the purposes of the present document, the following definitions apply:

**Output power:** mean power of one carrier of the base station, delivered to a load with resistance equal to the nominal load impedance of the transmitter.

**Rated output power:** mean power level per carrier that the manufacturer has declared to be available at the antenna connector.

**Maximum output Power:** mean power level per carrier of the base station measured at the antenna connector in a specified reference condition.

**Mean power:** power (transmitted or received) in a bandwidth of at least  $(1 + \alpha)$  times the chip rate of the radio access mode.

NOTE 1:  $\alpha = 0,22$  is the roll-off factor of the WCDMA signal. The roll-off factor  $\alpha$  is defined in section 6.8

NOTE 2: The period of measurement shall be at least one timeslot unless otherwise stated.

**MIMO mode:** downlink MIMO configuration with two transmit antennas

**MIMO mode with four transmit antennas:** downlink MIMO configuration with four transmit antennas.

**Power control dynamic range:** difference between the maximum and the minimum transmit output power of a code channel for a specified reference condition.

**RRC filtered mean power:** mean power as measured through a root raised cosine filter with roll-off factor  $\alpha$  and a bandwidth equal to the chip rate of the radio access mode.

NOTE 1: The RRC filtered mean power of a perfectly modulated W-CDMA signal is 0.246 dB lower than the mean power of the same signal.

NOTE 2: The roll-off factor  $\alpha$  is defined in section 6.8.1.

**Code domain power:** part of the mean power which correlates with a particular (OVSF) code channel.

NOTE: The sum of all powers in the code domain equals the mean power in a bandwidth of  $(1 + \alpha)$  times the chip rate of the radio access mode.

**Total power dynamic range:** difference between the maximum and the minimum total transmit output power for a specified reference condition.

**Secondary serving HS-DSCH cell(s):** set of cells where the UE is configured to simultaneously monitor an HS-SCCH set and receive the HS-DSCH if it is scheduled in that cell.

NOTE: There can be up to 7 secondary serving HS-DSCH cells in addition to the serving HS-DSCH cell.

**Channel bandwidth:** RF bandwidth supporting a single UTRA RF carrier.

NOTE: the channel bandwidth is measured in MHz and is used as a reference for transmitter and receiver RF requirements.

**Channel edge:** lowest or highest frequency of the UTRA carrier, separated by the channel bandwidth.

**Base Station RF Bandwidth:** bandwidth in which a base station transmits and/or receives single or multiple carriers simultaneously within each supported operating band.

NOTE: In single carrier operation the channel bandwidth is equal to Base Station RF Bandwidth

**Base Station RF Bandwidth edge:** frequency of one of the edges of the Base Station RF Bandwidth.

**Contiguous spectrum:** spectrum consisting of a contiguous block of spectrum with no sub-block gap(s).

**Highest carrier:** carrier with the highest carrier centre frequency transmitted/received in the specified operating band(s).

**Non-contiguous spectrum:** spectrum consisting of two or more sub-blocks separated by sub-block gap(s).

**Radio Bandwidth:** frequency difference between the upper edge of the highest used carrier and the lower edge of the lowest used carrier.

**Sub-block:** one contiguous allocated block of spectrum for use by the same base station.

NOTE: There may be multiple instances of sub-blocks within an Base Station RF Bandwidth.

**Sub-block bandwidth:** RF bandwidth of one sub-block.

**Sub-block gap:** frequency gap between two consecutive sub-blocks within an Base Station RF Bandwidth, where the RF requirements in the gap are based on co-existence for un-coordinated operation.

**Lower sub-block edge:** frequency at the lower edge of one sub-block.

NOTE: It is used as a frequency reference point for both transmitter and receiver requirements.

**Lowest carrier:** carrier with the lowest carrier centre frequency transmitted/received in the specified operating band(s).

**Upper sub-block edge:** frequency at the higher edge of one sub-block.

NOTE: It is used as a frequency reference point for both transmitter and receiver requirements.

**Inter-band gap:** The frequency gap between two supported consecutive operating bands.

**Inter RF Bandwidth gap:** frequency gap between two consecutive Base Station RF Bandwidths that respectively correspond to two supported operating bands.

**Multi-band base station:** base station characterized by the ability of its transmitter and/or receiver to process two or more carriers in common active RF components simultaneously, where at least one carrier is configured at a different operating band (which is not a sub-band or superseding-band of another supported operating band) than the other carrier(s).

**Multi-band transmitter:** transmitter characterized by the ability to process two or more carriers in common active RF components simultaneously, where at least one carrier is configured at a different operating band (which is not a sub-band or superseding-band of another supported operating band) than the other carrier(s).

**Multi-band receiver:** receiver characterized by the ability to process two or more carriers in common active RF components simultaneously, where at least one carrier is configured at a different operating band (which is not a sub-band or superseding-band of another supported operating band) than the other carrier(s).

**Rated total output power:** the total power level that the manufacturer has declared to be available at the antenna connector.

**Sub-band:** A sub-band of an operating band contains a part of the uplink and downlink frequency range of the operating band.

**Superseding-band:** A superseding-band of an operating band includes the whole of the uplink and downlink frequency range of the operating band.

## 3.2 Abbreviations

For the purposes of the present document, the following abbreviations apply:

4C-HSDPA	Four-Carrier HSDPA. HSDPA operation configured on 3 or 4 DL carriers
8C-HSDPA	Eight-Carrier HSDPA. HSDPA operation configured for 5 to 8 DL carriers
16QAM	16 Quadrature Amplitude Modulation
ACIR	Adjacent Channel Interference Ratio
ACLR	Adjacent Channel Leakage power Ratio
ACS	Adjacent Channel Selectivity
BS	Base Station
BER	Bit Error Ratio
BLER	Block Error Ratio
CACLR	Cumulative ACLR
CPICH	Common Pilot Channel
CW	Continuous Wave (unmodulated signal)
DB-DC-HSDPA	Dual Band Dual Cell HSDPA
DB-DC-HSUPA	Dual Band Dual Cell HSUPA
DC-HSDPA	Dual Cell HSDPA
DC-HSUPA	Dual Cell HSUPA
DL	Down Link (forward link)
DTT	Digital Terrestrial Television
EIRP	Effective Isotropic Radiated Power
FDD	Frequency Division Duplexing
GSM	Global System for Mobile Communications
HSDPA	High Speed Downlink Packet Access
HSUPA	High Speed Uplink Packet Access
IE	Information Element
LA	Local Area
MIMO	Multiple Input Multiple Output
MR	Medium Range
NC-4C-HSDPA	Non-contiguous Four-Carrier HSDPA. HSDPA operation for two non-adjacent blocks within a single band configured on 2, 3 or 4 DL carriers.
P-CPICH	Primary CPICH
PHS	Personal Handyphone System
PPM	Parts Per Million
RAT	Radio Access Technology
RF	Radio Frequency
QPSK	Quadrature Phase Shift Keying
RSSI	Received Signal Strength Indicator
S-CPICH	Secondary CPICH
SIR	Signal to Interference ratio
TAE	Time Alignment Error
TDD	Time Division Duplexing
TPC	Transmit Power Control
UARFCN	UTRA Absolute Radio Frequency Channel Number
UE	User Equipment
UL	Up Link (reverse link)
WCDMA	Wideband Code Division Multiple Access
WA	Wide Area

## 3.3 Symbols

For the purposes of the present document, the following symbols apply:

$\alpha$	Roll-off factor
$E_b$	Average energy per information bit
$E_c$	Total energy per PN chip
$f$	Frequency $\Delta f$ Frequency offset of the measurement filter -3dB point, as defined in section 6.6.2.1
$\Delta f_{\max}$	The largest value of $\Delta f$ used for defining the requirement

$f_{\text{offset}}$	Frequency offset of the measurement filter centre frequency, as defined in section 6.6.2.1
$F_{\text{DL\_low}}$	The lowest frequency of the downlink operating band
$F_{\text{DL\_high}}$	The highest frequency of the downlink operating band
$F_{\text{DL\_Offset}}$	The offset parameter used to calculate the UARFCN for downlink
$F_{\text{UL\_low}}$	The lowest frequency of the uplink operating band
$F_{\text{UL\_high}}$	The highest frequency of the uplink operating band
$F_{\text{UL\_Offset}}$	The offset parameter used to calculate the UARFCN for uplink
$F_{\text{uw}}$	Frequency offset of unwanted signal
$P_{\text{EM,N}}$	Declared emission level for channel N
$P_{\text{EM,B32,ind}}$	Declared emission level in Band 32, ind=a, b, c, d, e
$P_{\text{out}}$	Output power
$P_{\text{rated,c}}$	Rated output power (per carrier)
$P_{\text{max,c}}$	Maximum output power (per carrier)
Rx	Receiver
Tx	Transmitter
$W_{\text{gap}}$	Sub-block gap or Inter RF Bandwidth gap size

---

## 4 General

### 4.1 Relationship between Minimum Requirements and Test Requirements

The Minimum Requirements given in this specification make no allowance for measurement uncertainty. The test specification 25.141 section 4 defines Test Tolerances. These Test Tolerances are individually calculated for each test. The Test Tolerances are used to relax the Minimum Requirements in this specification to create Test Requirements.

The measurement results returned by the Test System are compared - without any modification - against the Test Requirements as defined by the shared risk principle.

The Shared Risk principle is defined in ITU-R M.1545.

### 4.2 Base station classes

The requirements in this specification apply to Wide Area Base Stations, Medium Range Base Stations, Local Area Base Stations and Home Base Stations unless otherwise stated.

Wide Area Base Stations are characterised by requirements derived from Macro Cell scenarios with a BS to UE minimum coupling loss equal to 70 dB. The Wide Area Base Station class has the same requirements as the base station for General Purpose application in Release 99, 4 and 5.

Medium Range Base Stations are characterised by requirements derived from Micro Cell scenarios with a BS to UE minimum coupling loss equal to 53 dB.

Local Area Base Stations are characterised by requirements derived from Pico Cell scenarios with a BS to UE minimum coupling loss equal to 45 dB.

Home Base Stations are characterised by requirements derived from Femto Cell scenarios.

## 4.3 Regional requirements

Some requirements in TS 25.104 may only apply in certain regions. Table 4.1 lists all requirements that may be applied differently in different regions.

**Table 4.1: List of regional requirements**

Clause number	Requirement	Comments
5.2	Frequency bands	Some bands may be applied regionally.
5.3	Tx-Rx Frequency Separation	The requirement is applied according to what frequency bands in Clause 5.2 that are supported by the BS.
5.4	Channel arrangement	The requirement is applied according to what frequency bands in Clause 5.2 that are supported by the BS.
6.2.1	Base station maximum output power	In certain regions, the minimum requirement for normal conditions may apply also for some conditions outside the range of conditions defined as normal.
6.6.2.1	Spectrum emission mask	The mask specified may be mandatory in certain regions. In other regions this mask may not be applied. Additional spectrum protection requirements may apply regionally.
6.6.2.2.1	Adjacent Channel Leakage power Ratio	In Japan, the requirement depicted in the note of Table 6.7 shall be applied.
6.6.3.1.1	Spurious emissions (Category A)	These requirements shall be met in cases where Category A limits for spurious emissions, as defined in ITU-R Recommendation SM.329 [1], are applied.
6.6.3.1.2	Spurious emissions (Category B)	These requirements shall be met in cases where Category B limits for spurious emissions, as defined in ITU-R Recommendation SM.329 [1], are applied.
6.6.3.3	Co-existence with other systems in the same geographical area	These requirements may apply in geographic areas in which both UTRA FDD and GSM, DCS, PCS, CDMA, E-UTRA and/or UTRA BS operating in another frequency band are deployed.
6.6.3.4	Co-existence with co-located and co-sited base stations	These requirements may be applied for the protection of other BS receivers when GSM, DCS, PCS, CDMA, E-UTRA and/or UTRA BS operating in another frequency band are co-located with a UTRA FDD BS.
6.6.3.5	Co-existence with PHS	This requirement may be applied for the protection of PHS in geographic areas in which both PHS and UTRA FDD are deployed.
6.6.3.6	Co-existence with services in adjacent frequency bands	This requirement may be applied for the protection in bands adjacent to the downlink bands as defined in clause 5.2 in geographic areas in which both an adjacent band service and UTRA FDD are deployed.
6.6.3.8	Protection of public safety operations	This requirement shall be applied to BS operating in Bands XIII and XIV to ensure that appropriate interference protection is provided to 700 MHz public safety operations.
7.4.2	Adjacent Channel Selectivity Co-location with UTRA-TDD	This requirement may be applied for the protection of UTRA-FDD BS receivers when UTRA-FDD BS and UTRA-TDD BS are co-located.
7.5	Blocking characteristic	The requirement is applied according to what frequency bands in Clause 5.2 that are supported by the BS.
7.5.2	Blocking characteristics Co-location with GSM900, DCS 1800, PCS1900 and/or UTRA	This requirement may be applied for the protection of UTRA FDD BS receivers when UTRA FDD BS and GSM 900, DCS1800, PCS1900, GSM850 and/or UTRA BS (operating in different frequency bands) are co-located.
7.5.3	Blocking characteristics Co-location with UTRA TDD	This requirement may be applied for the protection of UTRA FDD BS receivers when UTRA FDD BS and UTRA TDD BS are co-located.
7.6	Intermodulation characteristics	The requirement is applied according to what frequency bands in Clause 5.2 that are supported by the BS.
7.7	Spurious emissions	The requirement is applied according to what frequency bands in Clause 5.2 that are supported by the BS.

	Base station classes*	Only requirements for Wide Area (General Purpose), Medium Range and Local Area Base Stations are applicable in Japan.
--	-----------------------	---

Note \*: Base station classes.; This regional requirement should be reviewed to check its necessity every TSG RAN meeting.

## 4.4 Environmental requirements for the BS equipment

The BS equipment shall fulfil all the requirements in the full range of environmental conditions for the relevant environmental class from the relevant IEC specifications listed below

60 721-3-3 "Stationary use at weather protected locations"

60 721-3-4 "Stationary use at non weather protected locations"

Normally it should be sufficient for all tests to be conducted using normal test conditions except where otherwise stated. For guidance on the use of test conditions to be used in order to show compliance refer to TS 25.141.

## 4.5 Applicability of requirements

For BS that is UTRA (single-RAT) capable only, the requirements in the present document are applicable and additional conformance to TS 37.104 [10] is optional. For a BS additionally conforming to TS 37.104 [10], conformance to some of the RF requirements in the present document can be demonstrated through the corresponding requirements in TS 37.104 [10] as listed in Table 4.2.

**Table 4.2: Alternative RF minimum requirements for a BS additionally conforming to TS 37.104 [10]**

RF requirement	Clause in the present document	Alternative clause in TS 37.104 [10]
Base station output power	6.2	6.2.1 6.2.2
Unwanted emissions		
Spectrum emission mask	6.6.2.1	6.6.2 (except for 6.6.2.3 and 6.6.2.4)
Transmitter spurious emissions	6.6.3 (except for 6.6.3.8)	6.6.1 (except for 6.6.1.1.3)
Transmitter intermodulation	6.7.1	6.7.1
Narrowband blocking	7.5.1	7.4.2
Blocking	7.5.1	7.4.1
Out-of-band blocking	7.5.1	7.5.1
Co-location with other base stations	7.5.2, 7.5.3	7.5.2
Receiver spurious emissions	7.7.1	7.6.1
Intermodulation	7.6.1	7.7.1
Narrowband intermodulation	7.6.1	7.7.2

## 4.6 Requirements for contiguous and non-contiguous spectrum

A spectrum allocation where the BS operates can either be contiguous or non-contiguous. Unless otherwise stated, the requirements in the present specification apply for BS configured for both contiguous spectrum operation and non-contiguous spectrum operation.

For BS operation in non-contiguous spectrum, some requirements apply also inside the sub-block gaps. For each such requirement, it is stated how the limits apply relative to the sub-block edges.

## 4.7 Requirements for BS capable of multi-band operation

For BS capable of multi-band operation, the RF requirements in clause 6 and 7 apply for each supported operating band unless otherwise stated. For some requirements it is explicitly stated that specific additions or exclusions to the requirement apply for BS capable of multi-band operation.

For BS capable of multi-band operation, various structures in terms of combinations of different transmitter and receiver implementations (multi-band or single band) with mapping of transceivers to one or more antenna port(s) in



different ways are possible. In the case where multiple bands are mapped on separate antenna connectors, the following applies:

- Single-band transmitter spurious emissions, spectrum emission mask, ACLR, transmitter intermodulation and receiver spurious emissions requirements apply to each antenna connector.
- If the BS is configured for single-band operation, single-band requirements shall apply to the antenna connector configured for single-band operation and no exclusions or provisions for multi-band capable BS are applicable. Single-band requirements are tested separately at the antenna connector configured for single-band operation, with all other antenna connectors terminated.

## 5 Frequency bands and channel arrangement

### 5.1 General

The information presented in this section is based on a chip rate of 3.84 Mcps.

NOTE 1: Other chip rates may be considered in future releases.

### 5.2 Frequency bands

- a) UTRA/FDD is designed to operate in the following paired bands:

**Table 5.0: Frequency bands**

Operating Band	UL Frequencies UE transmit, Node B receive	DL frequencies UE receive, Node B transmit
I	1920 - 1980 MHz	2110 -2170 MHz
II	1850 -1910 MHz	1930 -1990 MHz
III	1710-1785 MHz	1805-1880 MHz
IV	1710-1755 MHz	2110-2155 MHz
V	824 - 849MHz	869-894MHz
VI	830-840 MHz	875-885 MHz
VII	2500 - 2570 MHz	2620 - 2690 MHz
VIII	880 - 915 MHz	925 - 960 MHz
IX	1749.9 - 1784.9 MHz	1844.9 - 1879.9 MHz
X	1710-1770 MHz	2110-2170 MHz
XI	1427.9 - 1447.9 MHz	1475.9 - 1495.9 MHz
XII	699 - 716 MHz	729 - 746 MHz
XIII	777 - 787 MHz	746 - 756 MHz
XIV	788 - 798 MHz	758 - 768 MHz
XV	Reserved	Reserved
XVI	Reserved	Reserved
XVII	Reserved	Reserved
XVIII	Reserved	Reserved
XIX	830 – 845 MHz	875 -890 MHz
XX	832 - 862 MHz	791 - 821 MHz
XXI	1447.9 - 1462.9 MHz	1495.9 - 1510.9 MHz
XXII	3410 – 3490 MHz	3510 – 3590 MHz
XXV	1850 -1915 MHz	1930 -1995 MHz
XXVI	814-849 MHz	859-894 MHz
XXXII (NOTE 1)	N/A	1452 – 1496 MHz
NOTE 1: Restricted to UTRA operation when dual band is configured (e.g., DB-DC-HSDPA or dual band 4C-HSDPA). The down link frequenc(ies) of this band are paired with the uplink frequenc(ies) of the other FDD band (external) of the dual band configuration.		

- b) Deployment in other frequency bands is not precluded

- c) DB-DC-HSDPA is designed to operate in the following configurations:

Table 5.0aA: DB-DC-HSDPA configurations

DB-DC-HSDPA Configuration	UL Band	DL Bands
1	I or VIII	I and VIII
2	II or IV	II and IV
3	I or V	I and V
4	I or XI	I and XI
5	II or V	II and V
6	I	I and XXXII

d) Single band 4C-HSDPA is designed to operate in the following configurations:

Table 5.0aB Single band 4C-HSDPA configurations

Single band 4C-HSDPA Configuration	Operating Band	Number of DL carriers
I-3	I	3
II-3	II	3
II-4	II	4
NOTE: Single band 4C-HSDPA configuration is numbered as (X-M) where X denotes the operating band and M denotes the number of DL carriers.		

e) Dual band 4C-HSDPA is designed to operate in the following configurations:

Table 5.0aC Dual band 4C-HSDPA configurations

Dual band 4C-HSDPA Configuration	UL Band	DL Band A	Number of DL carriers in Band A	DL Band B	Number of DL carriers in Band B
I-2-VIII-1	I or VIII	I	2	VIII	1
I-3-VIII-1	I or VIII	I	3	VIII	1
II-1-IV-2	II or IV	II	1	IV	2
II-2-IV-1	II or IV	II	2	IV	1
II-2-IV-2	II or IV	II	2	IV	2
I-1-V-2	I or V	I	1	V	2
I-2-V-1	I or V	I	2	V	1
I-2-V-2	I or V	I	2	V	2
I-2-VIII-2	I or VIII	I	2	VIII	2
I-1-VIII-2	I or VIII	I	1	VIII	2
II-1-V-2	II or V	II	1	V	2
I-1-XXXII-2	I	I	1	XXXII	2
I-2-XXXII-1	I	I	2	XXXII	1
NOTE: Dual band 4C-HSDPA configuration is numbered as (X-M-Y-N) where X denotes the DL Band A, M denotes the number DL carriers in the DL Band A, Y denotes the DL Band B, and N denotes the number of DL carriers in the DL Band B					

f) Single band NC-4C-HSDPA is designed to operate in the following configurations:

Table 5.0aD Single band NC-4C-HSDPA configurations

Single band NC-4C-HSDPA Configuration	Operating Band	Number of DL carriers in one sub-block	Sub-block gap [MHz]	Number of DL carriers in the other sub-block
I-1-5-1	I	1	5	1
I-2-5-1	I	2	5	1
I-3-10-1	I	3	10	1
IV-1-5-1	IV	1	5	1
IV-2-10-1	IV	2	10	1
IV-2-15-2	IV	2	15	2
IV-2-20-1	IV	2	20	1
IV-2-25-2	IV	2	25	2

NOTE: Single band NC-4C-HSDPA configuration is numbered as (X-M-Y-N) where X denotes the operating band, M denotes the number of DL carriers in one sub-block, Y denotes the sub-block gap in MHz and N denotes the number of DL carriers in the other sub-block. M and N can be switched.

g) Single Band 8C-HSDPA is designed to operate in the following configurations:

Table 5.0aE Single Band 8C-HSDPA configurations

Single Band 8C-HSDPA Configuration	Operating Band	Number of DL carriers
I-8	I	8

NOTE: Single band 8C-HSDPA configuration is numbered as (X-M) where X denotes the operating band and M denotes the number of DL carriers.

h) DB-DC-HSUPA is designed to operate in the following configurations:

Table 5.0aF DB-DC-HSUPA configurations

Dual band HSUPA Configuration together with DB-DC-HSDPA/DB-4C-HSDPA	UL Band A/B	Number of UL carriers in Band A/B	DL Band A	Number of DL carriers in Band A	DL Band B	Number of DL carriers in Band B
I-1-VIII-1	I and VIII	1	I	1	VIII	1
I-2-VIII-1	I and VIII	1	I	2	VIII	1
I-2-VIII-2	I and VIII	1	I	2	VIII	2
I-1-VIII-2	I and VIII	1	I	1	VIII	2
I-3-VIII-1	I and VIII	1	I	3	VIII	1
I-1-V-1	I and V	1	I	1	V	1
I-1-V-2	I and V	1	I	1	V	2
I-2-V-1	I and V	1	I	2	V	1
I-2-V-2	I and V	1	I	2	V	2
II-1-V-1	II and V	1	II	1	V	1
II-1-V-2	II and V	1	II	1	V	2

## 5.3 Tx-Rx frequency separation

a) UTRA/FDD is designed to operate with the following TX-RX frequency separation:

**Table 5.0A: Tx-Rx frequency separation**

Operating Band	TX-RX frequency separation
I	190 MHz
II	80 MHz
III	95 MHz
IV	400 MHz
V	45 MHz
VI	45 MHz
VII	120 MHz
VIII	45 MHz
IX	95 MHz
X	400 MHz
XI	48 MHz
XII	30 MHz
XIII	31 MHz
XIV	30 MHz
XIX	45 MHz
XX	41 MHz
XXI	48 MHz
XXII	100 MHz
XXV	80 MHz
XXVI	45MHz

- b) UTRA/FDD can support both fixed and variable transmit to receive frequency separation.
- c) The use of other transmit to receive frequency separations in existing or other frequency bands shall not be precluded.
- d) When configured to operate in DC-HSDPA with a single UL frequency, the TX-RX frequency separation in Table 5.0A shall be applied for the serving HS-DSCH cell. For bands XII, XIII and XIV, the TX-RX frequency separation in Table 5.0A shall be the minimum spacing between the UL and either of the DL carriers.
- e) When configured to operate on dual cells in both the DL and UL, the TX-RX frequency separation in Table 5.0A shall be applied to the primary UL frequency and DL frequency of the serving HS-DSCH cell, and to the secondary UL frequency and the frequency of the secondary serving HS-DSCH cell respectively.
- f) When configured to operate on single/dual band 4C-HSDPA or single band 8C-HSDPA or single band NC-4C-HSDPA with a single UL frequency, the TX-RX frequency separation in Table 5.0A shall be applied for the DL frequency of the serving HS-DSCH cell. When configured to operate on single/dual band 4C-HSDPA or single band 8C-HSDPA or single band NC-4C-HSDPA with dual UL frequencies, the TX-RX frequency separation in Table 5.0A shall be applied to the primary UL frequency and DL frequency of the serving HS-DSCH cell, and to the secondary UL frequency and the frequency of the 1st secondary serving HS-DSCH cell respectively.
- g) For bands XII, XIII and XIV, the requirements in TS 25.104 are applicable only for a single uplink carrier frequency, however dual cell uplink operation may be considered in future releases.
- h) When configured to operate on dual band dual cell HSDPA or dual band 4C-HSDPA with dual band UL frequencies, the TX-RX frequency separation in Table 5.0A shall be applied to the primary UL frequency and DL frequency of the serving HS-DSCH cell, and to the secondary UL frequency and the frequency of the 1st secondary serving HS-DSCH cell respectively.

## 5.4 Channel arrangement

### 5.4.1 Channel spacing

The nominal channel spacing is 5 MHz, but this can be adjusted to optimise performance in a particular deployment scenario.

## 5.4.2 Channel raster

The channel raster is 200 kHz for all bands, which means that the centre frequency must be an integer multiple of 200 kHz. In addition a number of additional centre frequencies are specified according to table 5.1A, which means that the centre frequencies for these channels are shifted 100 kHz relative to the general raster.

## 5.4.3 Channel number

The carrier frequency is designated by the UTRA Absolute Radio Frequency Channel Number (UARFCN). For each operating Band, the UARFCN values are defined as follows:

Uplink:  $N_U = 5 * (F_{UL} - F_{UL\_Offset})$ , for the carrier frequency range  $F_{UL\_low} \leq F_{UL} \leq F_{UL\_high}$

Downlink:  $N_D = 5 * (F_{DL} - F_{DL\_Offset})$ , for the carrier frequency range  $F_{DL\_low} \leq F_{DL} \leq F_{DL\_high}$

For each operating Band,  $F_{UL\_Offset}$ ,  $F_{UL\_low}$ ,  $F_{UL\_high}$ ,  $F_{DL\_Offset}$ ,  $F_{DL\_low}$  and  $F_{DL\_high}$  are defined in Table 5.1 for the general UARFCN. For the additional UARFCN,  $F_{UL\_Offset}$ ,  $F_{DL\_Offset}$  and the specific  $F_{UL}$  and  $F_{DL}$  are defined in Table 5.1A.

**Table 5.1: UARFCN definition (general)**

Band	UPLINK (UL) UE transmit, Node B receive			DOWNLINK (DL) UE receive, Node B transmit		
	UARFCN formula offset $F_{UL\_Offset}$ [MHz]	Carrier frequency ( $F_{UL}$ ) range [MHz]		UARFCN formula offset $F_{DL\_Offset}$ [MHz]	Carrier frequency ( $F_{DL}$ ) range [MHz]	
		$F_{UL\_low}$	$F_{UL\_high}$		$F_{DL\_low}$	$F_{DL\_high}$
I	0	1922.4	1977.6	0	2112.4	2167.6
II	0	1852.4	1907.6	0	1932.4	1987.6
III	1525	1712.4	1782.6	1575	1807.4	1877.6
IV	1450	1712.4	1752.6	1805	2112.4	2152.6
V	0	826.4	846.6	0	871.4	891.6
VI	0	832.4	837.6	0	877.4	882.6
VII	2100	2502.4	2567.6	2175	2622.4	2687.6
VIII	340	882.4	912.6	340	927.4	957.6
IX	0	1752.4	1782.4	0	1847.4	1877.4
X	1135	1712.4	1767.6	1490	2112.4	2167.6
XI	733	1430.4	1445.4	736	1478.4	1493.4
XII	-22	701.4	713.6	-37	731.4	743.6
XIII	21	779.4	784.6	-55	748.4	753.6
XIV	12	790.4	795.6	-63	760.4	765.6
XIX	770	832.4	842.6	735	877.4	887.6
XX	-23	834.4	859.6	-109	793.4	818.6
XXI	1358	1450.4	1460.4	1326	1498.4	1508.4
XXII	2525	3412.4	3487.6	2580	3512.4	3587.6
XXV	875	1852.4	1912.6	910	1932.4	1992.6
XXVI	-291	816.4	846.6	-291	861.4	891.6
XXXII (NOTE 1)	-	N/A	N/A	131	1454.4	1493.6

NOTE 1: Restricted to UTRA operation when dual band is configured (e.g., DB-DC-HSDPA or dual band 4C-HSDPA)

Table 5.1A: UARFCN definition (additional channels)

Band	UPLINK (UL) UE transmit, Node B receive		DOWNLINK (DL) UE receive, Node B transmit	
	UARFCN formula offset F <sub>UL_Offset</sub> [MHz]	Carrier frequency [MHz] (F <sub>UL</sub> )	UARFCN formula offset F <sub>DL_Offset</sub> [MHz]	Carrier frequency [MHz] (F <sub>DL</sub> )
I	-	-	-	-
II	1850.1	1852.5, 1857.5, 1862.5, 1867.5, 1872.5, 1877.5, 1882.5, 1887.5, 1892.5, 1897.5, 1902.5, 1907.5	1850.1	1932.5, 1937.5, 1942.5, 1947.5, 1952.5, 1957.5, 1962.5, 1967.5, 1972.5, 1977.5, 1982.5, 1987.5
III	-	-	-	-
IV	1380.1	1712.5, 1717.5, 1722.5, 1727.5, 1732.5, 1737.5 1742.5, 1747.5, 1752.5	1735.1	2112.5, 2117.5, 2122.5, 2127.5, 2132.5, 2137.5, 2142.5, 2147.5, 2152.5
V	670.1	826.5, 827.5, 831.5, 832.5, 837.5, 842.5	670.1	871.5, 872.5, 876.5, 877.5, 882.5, 887.5
VI	670.1	832.5, 837.5	670.1	877.5, 882.5
VII	2030.1	2502.5, 2507.5, 2512.5, 2517.5, 2522.5, 2527.5, 2532.5, 2537.5, 2542.5, 2547.5, 2552.5, 2557.5, 2562.5, 2567.5	2105.1	2622.5, 2627.5, 2632.5, 2637.5, 2642.5, 2647.5, 2652.5, 2657.5, 2662.5, 2667.5, 2672.5, 2677.5, 2682.5, 2687.5
VIII	-	-	-	-
IX	-	-	-	-
X	1075.1	1712.5, 1717.5, 1722.5, 1727.5, 1732.5, 1737.5, 1742.5, 1747.5, 1752.5, 1757.5, 1762.5, 1767.5	1430.1	2112.5, 2117.5, 2122.5, 2127.5, 2132.5, 2137.5, 2142.5, 2147.5, 2152.5, 2157.5, 2162.5, 2167.5
XI	-	-	-	-
XII	-39.9	701.5, 706.5, 707.5, 712.5, 713.5	-54.9	731.5, 736.5, 737.5, 742.5, 743.5
XIII	11.1	779.5, 784.5	-64.9	748.5, 753.5
XIV	2.1	790.5, 795.5	-72.9	760.5, 765.5
XIX	755.1	832.5, 837.5, 842.5	720.1	877.5, 882.5, 887.5
XX	-	-	-	-
XXI	-	-	-	-
XXII	-	-	-	-
XXV	810.1	1852.5, 1857.5, 1862.5, 1867.5, 1872.5, 1877.5, 1882.5, 1887.5, 1892.5, 1897.5, 1902.5, 1907.5, 1912.5	845.1	1932.5, 1937.5, 1942.5, 1947.5, 1952.5, 1957.5, 1962.5, 1967.5, 1972.5, 1977.5, 1982.5, 1987.5, 1992.5
XXVI	-325.9	816.5, 821.5, 826.5, 827.5, 831.5, 832.5, 836.5, 837.5, 841.5, 842.5, 846.5	-325.9	861.5, 866.5, 871.5, 872.5, 876.5, 877.5, 881.5, 882.5, 886.5, 887.5, 891.5
XXXII (NOTE 1)	-	-	87.1	1454.5, 1459.5, 1464.5, 1469.5, 1474.5, 1479.5, 1484.5, 1489.5

NOTE 1: Restricted to UTRA operation when dual band is configured (e.g., DB-DC-HSDPA or dual band 4C-HSDPA)

## 6 Transmitter characteristics

### 6.1 General

Unless otherwise stated, the requirements in clause 6 are expressed for a single transmitter antenna connector. In case of transmit diversity, DB-DC-HSDPA or MIMO transmission, the requirements apply for each transmitter antenna connector.

A BS supporting DC-HSDPA and DB-DC-HSDPA transmits two cells simultaneously. A BS supporting DC-HSDPA transmits two cells simultaneously on adjacent carrier frequencies.

Unless otherwise stated, the transmitter characteristics are specified at the BS antenna connector (test port A) with a full complement of transceivers for the configuration in normal operating conditions. If any external apparatus such as a TX amplifier, a filter or the combination of such devices is used, requirements apply at the far end antenna connector (port B).

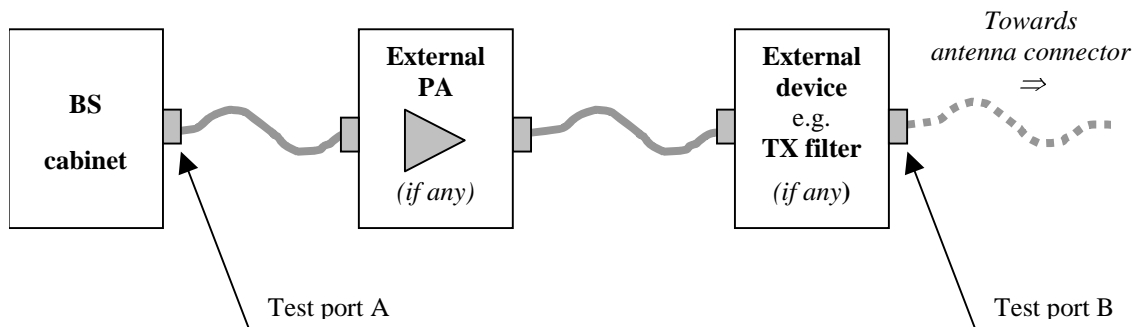

Figure 6.1: Transmitter test ports

## 6.2 Base station output power

Output power,  $P_{out}$ , of the base station is the mean power of one carrier delivered to a load with resistance equal to the nominal load impedance of the transmitter.

Rated output power,  $P_{rated,c}$ , of the base station is the mean power level per carrier that the manufacturer has declared to be available at the antenna connector.

### 6.2.1 Base station maximum output power

Maximum output power,  $P_{max,c}$ , of the base station is the mean power level per carrier measured at the antenna connector in specified reference condition.

The rated output power,  $P_{rated,c}$ , of the BS shall be as specified in Table 6.0A.

Table 6.0A: Base station rated output power

BS class	$P_{rated,c}$
Wide Area BS	- (note)
Medium Range BS	$\leq +38$ dBm
Local Area BS	$\leq +24$ dBm
Home BS	$\leq +20$ dBm (without transmit diversity or any MIMO mode) $\leq +17$ dBm (with transmit diversity or MIMO mode) $\leq +14$ dBm (with MIMO mode with four transmit antennas)
NOTE:	There is no upper limit required for the rated output power of the Wide Area Base Station like for the base station for General Purpose application in Release 99, 4, and 5.

#### 6.2.1.1 Minimum requirement

In normal conditions, the base station maximum output power,  $P_{max,c}$  shall remain within +2 dB and -2dB of the manufacturer's rated output power.

In extreme conditions, the base station maximum output power  $P_{max,c}$  shall remain within +2.5 dB and -2.5 dB of the manufacturer's rated output power.

In certain regions, the minimum requirement for normal conditions may apply also for some conditions outside the range of conditions defined as normal.

## 6.3 Frequency error

Frequency error is the measure of the difference between the actual BS transmit frequency and the assigned frequency. The same source shall be used for RF frequency and data clock generation.

### 6.3.1 Minimum requirement

The modulated carrier frequency of the BS shall be accurate to within the accuracy range given in Table 6.0 observed over a period of one timeslot.

**Table 6.0: Frequency error minimum requirement**

BS class	Accuracy
Wide Area BS	±0.05 ppm
Medium Range BS	±0.1 ppm
Local Area BS	±0.1 ppm
Home BS	±0.25 ppm

## 6.4 Output power dynamics

Power control is used to limit the interference level. The transmitter uses a quality-based power control on the downlink.

### 6.4.1 Inner loop power control in the downlink

Inner loop power control in the downlink is the ability of the BS transmitter to adjust the transmitter output power of a code channel in accordance with the corresponding TPC symbols received in the uplink.

#### 6.4.1.1 Power control steps

The power control step is the required step change in the code domain power of a code channel in response to the corresponding power control command. The combined output power change is the required total change in the DL transmitted power of a code channel in response to multiple consecutive power control commands corresponding to that code channel.

##### 6.4.1.1.1 Minimum requirement

The BS transmitter shall have the capability of setting the inner loop code domain power with a step sizes of 1dB mandatory and 0.5, 1.5, 2.0 dB optional

- The tolerance of the power control step due to inner loop power control shall be within the range shown in Table 6.1.
- The tolerance of the combined output power change due to inner loop power control shall be within the range shown in Table 6.2.

**Table 6.1: Transmitter power control step tolerance**

Power control commands in the down link	Transmitter power control step tolerance							
	2 dB step size		1.5 dB step size		1 dB step size		0.5 dB step size	
	Lower	Upper	Lower	Upper	Lower	Upper	Lower	Upper
Up (TPC command "1")	+1.0 dB	+3.0 dB	+0.75 dB	+2.25 dB	+0.5 dB	+1.5 dB	+0.25 dB	+0.75 dB
Down (TPC command "0")	-1.0 dB	-3.0 dB	-0.75 dB	-2.25 dB	-0.5 dB	-1.5 dB	-0.25 dB	-0.75 dB



**Table 6.2: Transmitter aggregated power control step range**

Power control commands in the down link	Transmitter aggregated power control step change after 10 consecutive equal commands (up or down)							
	2 dB step size		1.5 dB step size		1 dB step size		0.5 dB step size	
	Lower	Upper	Lower	Upper	Lower	Upper	Lower	Upper
Up (TPC command "1")	+16 dB	+24 dB	+12 dB	+18 dB	+8 dB	+12 dB	+4 dB	+6 dB
Down (TPC command "0")	-16 dB	-24 dB	-12 dB	-18 dB	-8 dB	-12 dB	-4 dB	-6 dB

## 6.4.2 Power control dynamic range

The power control dynamic range is the difference between the maximum and the minimum code domain power of a code channel for a specified reference condition. Transmit modulation quality shall be maintained within the whole dynamic range as specified in subclause 6.8.

### 6.4.2.1 Minimum requirements

Down link (DL) power control dynamic range:

Maximum code domain power: BS maximum output power - 3 dB or greater

Minimum code domain power: BS maximum output power - 28 dB or less

## 6.4.3 Total power dynamic range

The total power dynamic range is the difference between the maximum and the minimum output power for a specified reference condition.

NOTE: The upper limit of the dynamic range is the BS maximum output power. The lower limit of the dynamic range is the lowest minimum power from the BS when no traffic channels are activated.

### 6.4.3.1 Minimum requirement

The downlink (DL) total power dynamic range shall be 18 dB or greater.

## 6.4.4 Primary CPICH power

Primary CPICH (P-CPICH) power is the code domain power of the Primary Common Pilot Channel. P-CPICH power is indicated on the BCH..

### 6.4.4.1 Minimum requirement

The difference between the P-CPICH power transmitted at the antenna connector and the P-CPICH power indicated on the BCH shall be within  $\pm 2.1$  dB.

## 6.4.4A Secondary CPICH power

Secondary CPICH (S-CPICH) power is the code domain power of the Secondary Common Pilot Channel. S-CPICH power is equal to the sum of the P-CPICH power and the power offset, which are signalled to the UE. The power offset is signalled in the IE "Power Offset for S-CPICH for MIMO", for MIMO mode as defined in section 10.3.6.41b in TS 25.331 [11].

When the UE supports MIMO mode with four transmit antennas, the power offset of S-CPICH on antenna 2 is signalled in the IE "Power Offset for S-CPICH for MIMO mode with four transmit antennas on Antenna2" as defined in section 10.3.6.143 in TS 25.331 [11]. The power offset of S-CPICH on antenna 3 and 4 is signalled in the IE "Common Power Offset for S-CPICH for MIMO mode with four transmit antennas on Antenna3 and 4", as defined in section 10.3.6.143 in TS 25.331 [11].

### 6.4.4A.1 Minimum Requirement for MIMO mode

The difference between P-CPICH power transmitted at the first antenna connector and the S-CPICH power transmitted at the second antenna connector shall be within  $\pm 2$  dB of the IE "Power Offset for S-CPICH for MIMO".

Note: The accuracy level of the power offset for S-CPICH may affect both MIMO HS-DSCH demodulation and CQI reporting performance.

#### 6.4.4A.2 Minimum Requirement for MIMO mode with four transmit antennas

The difference between P-CPICH power transmitted at the first antenna connector and the S-CPICH power transmitted at the second antenna connector shall be within  $\pm 2$  dB of the IE "Power Offset for S-CPICH for MIMO mode with four transmit antennas on Antenna2".

The difference between P-CPICH power transmitted at the first antenna connector and the S-CPICH power transmitted at the third and four antenna connector shall be within  $\pm 2$  dB of the IE "Common Power Offset for S-CPICH for MIMO mode with four transmit antennas on Antenna3 and 4".

Note: The accuracy level of the power offset for S-CPICH transmitted on antennas 2, 3 and 4 may affect both MIMO HS-DSCH demodulation and CQI reporting performance.

#### 6.4.4B Demodulation CPICH power for MIMO mode with four transmit antennas

Demodulation CPICH (D-CPICH) power is the code domain power of the Demodulation Common Pilot Channel. D-CPICH power is equal to the sum of the P-CPICH power and the power offset, which are signalled to the UE. The power offset of D-CPICH on antenna 3 and 4 is signalled in the IE "Common Power Offset for D-CPICH for MIMO mode with four transmit antennas on Antenna3 and 4", as defined in section 10.3.6.143 in TS 25.331 [11].

##### 6.4.4B.1 Minimum Requirement

The difference between P-CPICH power transmitted at the first antenna connector and the D-CPICH power transmitted at the third and four antenna connector shall be within  $\pm 2$  dB of the IE "Common Power Offset for D-CPICH for MIMO mode with four transmit antennas on Antenna3 and 4".

Note 1: The accuracy level of the power offset for D-CPICH transmitted on antennas 2, 3 and 4 may affect both MIMO HS-DSCH demodulation and CQI reporting performance.

Note 2: At high geometry level PDSCH performance may be affected if D-CPICH is not scheduled.

#### 6.4.5 IPDL time mask

To support IPDL location method, the Node B shall interrupt all transmitted signals in the downlink (i.e. common and dedicated channels).

The IPDL time mask specifies the limits of the BS output power during these idle periods.

The requirement in this section shall apply to BS supporting IPDL.

##### 6.4.5.1 Minimum Requirement

The mean power measured over a period starting 27 chips after the beginning of the IPDL period and ending 27 chips before the expiration of the IPDL period shall be equal to or less than

$$\text{BS maximum output power} - 35 \text{ dB}$$

see also Figure 6.1A.

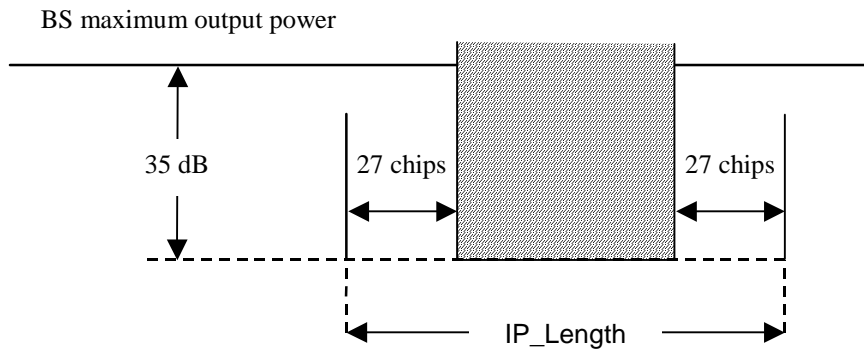

Figure 6.1A: IPDL Time Mask

The requirement applies to all output powers within the total power dynamic range as specified in subclause 6.4.3.

### 6.4.6 Home base station output power for adjacent channel protection

The Home BS shall be capable of adjusting the transmitter output power to minimize the interference level on the adjacent channels licensed to other operators in the same geographical area while optimize the Home BS coverage. These requirements are only applicable to Home BS. The requirements in this clause are applicable for AWGN radio propagation conditions.

The output power,  $P_{out}$ , of the Home BS shall be as specified in Table 6.3 under the following input conditions:

- $CPICH \hat{E}_c$ , measured in dBm, is the code power of the Primary CPICH on one of the adjacent channels present at the Home BS antenna connector for the CPICH received on the adjacent channels. If Tx diversity is applied on the Primary CPICH,  $CPICH \hat{E}_c$  shall be the sum in [W] of the code powers of the Primary CPICH transmitted from each antenna.
- $I_{oh}$ , measured in dBm, is the total received power density, including signals and interference but excluding the own Home BS signal, present at the Home BS antenna connector on the Home BS operating channel.

In case that both adjacent channels are licensed to other operators, the most stringent limit shall apply for  $P_{out}$ . In case the Home BS's operating channel and both adjacent channels are licensed to the same operator, the requirements of this clause do not apply.

The input conditions defined for the requirements in this section are specified at the antenna connector of the Home BS. For Home BS receivers with diversity, the requirements apply to each antenna connector separately, with the other one(s) terminated or disabled. The requirements are otherwise unchanged. For Home BS(s) without measurement capability, a reference antenna with a gain of 0 dBi is assumed for converting these power levels into field strength requirements.

Table 6.3: Home BS output power for adjacent operator channel protection

Input Conditions	Output power, $P_{out}$ (without transmit diversity or any MIMO mode)	Output power, $P_{out}$ (with transmit diversity or MIMO mode)	Output power, $P_{out}$ (with MIMO mode with four transmit antennas)
$I_{oh} > CPICH \hat{E}_c + 43 \text{ dB}$ And $CPICH \hat{E}_c \geq -105 \text{ dBm}$	$\leq 10 \text{ dBm}$	$\leq 7 \text{ dBm}$	$\leq 4 \text{ dBm}$
$I_{oh} \leq CPICH \hat{E}_c + 43 \text{ dB}$ and $CPICH \hat{E}_c \geq -105 \text{ dBm}$	$\leq \max(8 \text{ dBm}, \min(20 \text{ dBm},$ $CPICH \hat{E}_c + 100 \text{ dB}))$	$\leq \max(5 \text{ dBm}, \min(17 \text{ dBm},$ $CPICH \hat{E}_c + 97 \text{ dB}))$	$\leq \max(2 \text{ dBm}, \min(14$ $\text{dBm}, CPICH \hat{E}_c + 94 \text{ dB}))$

NOTE 1: The Home BS transmitter output power specified in Table 6.3 assumes a Home BS reference antenna gain of 0 dBi, an target outage zone of 47dB around the Home BS for an UE on the adjacent channel, with an allowance of 2 dB for measurement errors, an ACIR of 33 dB, an adjacent channel UE  $CPICH \hat{E}_c/I_o$  target of -18 dB and the same  $CPICH \hat{E}_c$  value at the adjacent channel UE as for the Home BS.

Note 2: For  $CPICH \hat{E}_c < -105 \text{ dBm}$ , the requirement in section 6.2.1 applies.

### 6.4.6.1 Minimum requirement

In normal operating conditions, the output power,  $P_{out}$ , of the Home BS shall be equal to or less than the value specified in Table 6.3 plus 2 dB.

In extreme operating conditions, the output power,  $P_{out}$ , of the Home BS shall be equal to or less than the value specified in Table 6.3 plus 2.5 dB.

## 6.5 (void)

## 6.6 Output RF spectrum emissions

### 6.6.1 Occupied bandwidth

The occupied bandwidth is the width of a frequency band such that, below the lower and above the upper frequency limits, the mean powers emitted are each equal to a specified percentage  $\beta/2$  of the total mean transmitted power. See also ITU-R Recommendation SM.328 [7].

The value of  $\beta/2$  shall be taken as 0,5%.

#### 6.6.1.1 Minimum requirement

The occupied channel bandwidth shall be less than 5 MHz based on a chip rate of 3.84 Mcps.

### 6.6.2 Out of band emission

Out of band emissions are unwanted emissions immediately outside the channel bandwidth resulting from the modulation process and non-linearity in the transmitter but excluding spurious emissions. This out of band emission requirement is specified both in terms of a spectrum emission mask and adjacent channel power ratio for the transmitter.

#### 6.6.2.1 Spectrum emission mask

The mask defined in Tables 6.3A to 6.6 below may be mandatory in certain regions. In other regions this mask may not be applied.

whatever the type of transmitter considered (single carrier or multi-carrier). In addition, for a BS operating in non-contiguous spectrum, the requirements apply inside any sub-block gap. In addition, for a BS capable of multi-band operation, the requirements apply inside any Inter RF Bandwidth gap. Emissions shall not exceed the maximum level specified in tables 6.3A to 6.6 for the appropriate BS rated output power, in the frequency range from  $\Delta f = 2.5$  MHz to  $\Delta f_{max}$  from the carrier frequency, where:

- $\Delta f$  is the separation between the carrier frequency and the nominal -3dB point of the measuring filter closest to the carrier frequency.
- $f_{offset}$  is the separation between the carrier frequency and the centre of the measuring filter.
- $f_{offset_{max}}$  is either 12.5 MHz or the offset to the UMTS Tx band edge as defined in section 5.2, whichever is the greater.
- $\Delta f_{max}$  is equal to  $f_{offset_{max}}$  minus half of the bandwidth of the measuring filter.

Inside any Inter RF Bandwidth gaps with  $W_{gap} < 20$  MHz for BS operating in multiple bands, emissions shall not exceed the cumulative sum of the minimum requirements specified at the Base Station RF Bandwidth edges on each side of the Inter RF Bandwidth gap. The minimum requirement for Base Station RF Bandwidth edge is specified in Tables 6.3A to 6.6E below, where in this case:

- $\Delta f$  is equal to 2.5MHz plus the separation between the Base Station RF Bandwidth edge frequency and the nominal -3dB point of the measuring filter closest to the Base Station RF Bandwidth edge.
- $f_{offset}$  is equal to 2.5MHz plus the separation between the Base Station RF Bandwidth edge frequency and the centre of the measuring filter.

- $f_{\text{offset}_{\text{max}}}$  is either 12.5 MHz or the offset to the UMTS Tx band edge as defined in section 5.2, whichever is the greater.
- $\Delta f_{\text{max}}$  is equal to  $f_{\text{offset}_{\text{max}}}$  minus half of the bandwidth of the measuring filter.

For BS capable of multi-band operation where multiple bands are mapped on the same antenna connector, the operating band unwanted emission limits apply also in a supported operating band without any carrier transmitted, in the case where there are carrier(s) transmitted in another supported operating band. In this case, no cumulative limit is applied in the inter-band gap between a supported downlink operating band with carrier(s) transmitted and a supported downlink operating band without any carrier transmitted and

- In case the inter-band gap between a downlink band with carrier(s) transmitted and a downlink band without any carrier transmitted is less than 20MHz,  $f_{\text{offset}_{\text{max}}}$  shall be the offset to the frequency 10 MHz outside the outermost edges of the two downlink operating bands and the operating band unwanted emission limit of the band where there are carriers transmitted, as defined in the tables of the present subclause, shall apply across both downlink bands.
- In other cases, the operating band unwanted emission limit of the band where there are carriers transmitted, as defined in the tables of the present subclause for the largest frequency offset ( $\Delta f_{\text{max}}$ ), shall apply from 10 MHz below the lowest frequency, up to 10 MHz above the highest frequency of the downlink operating band without any carrier transmitted.

Inside any sub-block gap for a BS operating in non-contiguous spectrum, emissions shall not exceed the cumulative sum of the minimum requirements specified for the adjacent sub blocks on each side of the sub block gap. The minimum requirement for each sub block is specified in Tables 6.3A to 6.6E below, where in this case:

- $\Delta f$  is equal to 2.5MHz plus the separation between the sub block edge frequency and the nominal -3 dB point of the measuring filter closest to the sub block edge.
- $f_{\text{offset}}$  is equal to 2.5MHz plus the separation between the sub block edge frequency and the centre of the measuring filter.
- $f_{\text{offset}_{\text{max}}}$  is equal to the sub block gap bandwidth minus half of the bandwidth of the measuring filter plus 2.5MHz.
- $\Delta f_{\text{max}}$  is equal to  $f_{\text{offset}_{\text{max}}}$  minus half of the bandwidth of the measuring filter.

For BS capable of multi-band operation where multiple bands are mapped on separate antenna connectors, the single-band requirements apply and the cumulative evaluation of the emission limit in the Inter RF Bandwidth gap are not applicable.

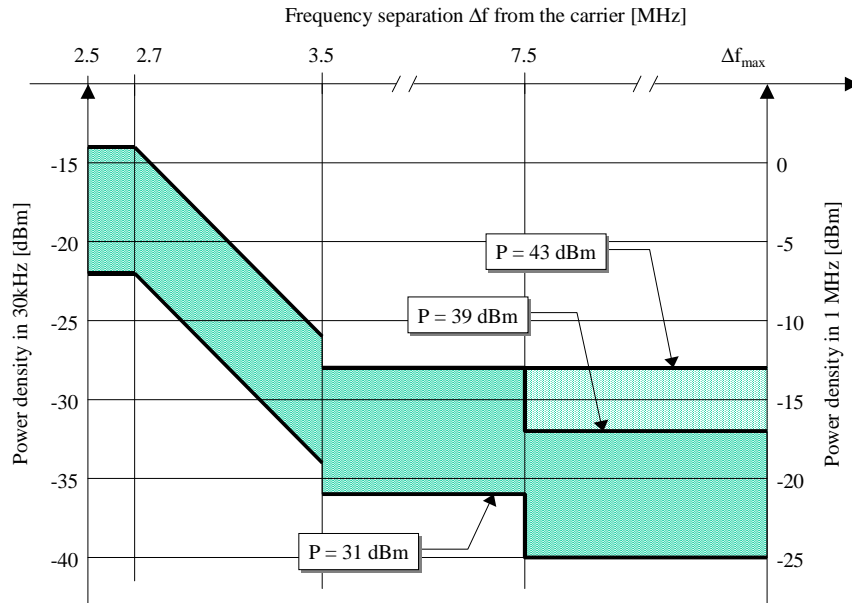

**Illustrative diagram of spectrum emission mask**

**Figure 6.2: Spectrum emission mask**

**Table 6.3A: Spectrum emission mask values, BS rated output power P ≥ 43 dBm**

Frequency offset of measurement filter -3dB point, Δf	Frequency offset of measurement filter centre frequency, f_offset	Minimum requirement (Note 1, 2)	Measurement bandwidth (Note 4)
2.5 MHz ≤ Δf < 2.7 MHz	2.515MHz ≤ f_offset < 2.715MHz	-14 dBm	30 kHz
2.7 MHz ≤ Δf < 3.5 MHz	2.715MHz ≤ f_offset < 3.515MHz	$-14dBm - 15 \cdot \left( \frac{f\_offset}{MHz} - 2.715 \right) dB$	30 kHz
(Note 3)	3.515MHz ≤ f_offset < 4.0MHz	-26 dBm	30 kHz
3.5 MHz ≤ Δf ≤ Δf_max	4.0MHz ≤ f_offset < f_offset_max	-13 dBm	1 MHz

NOTE 1: For BS supporting non-contiguous spectrum operation within any operating band, the minimum requirement within sub-block gaps is calculated as a cumulative sum of contributions from adjacent sub blocks on each side of the sub block gap, where the contribution from the far-end sub-block shall be scaled according to the measurement bandwidth of the near-end sub-block. Exception is Δf ≥ 12.5MHz from both adjacent sub blocks on each side of the sub-block gap, where the spurious emission requirements in subclause 6.6.3.1 shall be met.

NOTE 2: For BS supporting multi-band operation with Inter RF Bandwidth gap < 20MHz the minimum requirement within the Inter RF Bandwidth gaps is calculated as a cumulative sum of contributions from adjacent sub-blocks or RF Bandwidth on each side of the Inter RF Bandwidth gap, where the contribution from the far-end sub-block or RF Bandwidth shall be scaled according to the measurement bandwidth of the near-end sub-block or RF Bandwidth.

Table 6.4: Spectrum emission mask values, BS rated output power  $39 \leq P < 43$  dBm

Frequency offset of measurement filter -3dB point, $\Delta f$	Frequency offset of measurement filter centre frequency, $f_{\text{offset}}$	Minimum requirement (Note 1, 2)	Measurement bandwidth (Note 4)
$2.5 \text{ MHz} \leq \Delta f < 2.7 \text{ MHz}$	$2.515 \text{ MHz} \leq f_{\text{offset}} < 2.715 \text{ MHz}$	-14 dBm	30 kHz
$2.7 \text{ MHz} \leq \Delta f < 3.5 \text{ MHz}$	$2.715 \text{ MHz} \leq f_{\text{offset}} < 3.515 \text{ MHz}$	$-14 \text{ dBm} - 15 \cdot \left( \frac{f_{\text{offset}}}{\text{MHz}} - 2.715 \right) \text{ dB}$	30 kHz
(Note 3)	$3.515 \text{ MHz} \leq f_{\text{offset}} < 4.0 \text{ MHz}$	-26 dBm	30 kHz
$3.5 \text{ MHz} \leq \Delta f < 7.5 \text{ MHz}$	$4.0 \text{ MHz} \leq f_{\text{offset}} < 8.0 \text{ MHz}$	-13 dBm	1 MHz
$7.5 \text{ MHz} \leq \Delta f \leq \Delta f_{\text{max}}$	$8.0 \text{ MHz} \leq f_{\text{offset}} < f_{\text{offset}_{\text{max}}}$	$P - 56 \text{ dB}$	1 MHz
<p>NOTE 1: For BS supporting non-contiguous spectrum operation within any operating band, the minimum requirement within sub-block gaps is calculated as a cumulative sum of contributions from adjacent sub blocks on each side of the sub block gap, where the contribution from the far-end sub-block shall be scaled according to the measurement bandwidth of the near-end sub-block. Exception is <math>\Delta f \geq 12.5 \text{ MHz}</math> from both adjacent sub blocks on each side of the sub-block gap, where the spurious emission requirements in subclause 6.6.3.1 shall be met.</p> <p>NOTE 2: For BS supporting multi-band operation with Inter RF Bandwidth gap <math>&lt; 20 \text{ MHz}</math> the minimum requirement within the Inter RF Bandwidth gaps is calculated as a cumulative sum of contributions from adjacent sub-blocks or RF Bandwidth on each side of the Inter RF Bandwidth gap, where the contribution from the far-end sub-block or RF Bandwidth shall be scaled according to the measurement bandwidth of the near-end sub-block or RF Bandwidth.</p>			

Table 6.5: Spectrum emission mask values, BS rated output power  $31 \leq P < 39$  dBm

Frequency offset of measurement filter -3dB point, $\Delta f$	Frequency offset of measurement filter centre frequency, $f_{\text{offset}}$	Minimum requirement (Note 1, 2)	Measurement bandwidth (Note 4)
$2.5 \text{ MHz} \leq \Delta f < 2.7 \text{ MHz}$	$2.515 \text{ MHz} \leq f_{\text{offset}} < 2.715 \text{ MHz}$	$P - 53 \text{ dB}$	30 kHz
$2.7 \text{ MHz} \leq \Delta f < 3.5 \text{ MHz}$	$2.715 \text{ MHz} \leq f_{\text{offset}} < 3.515 \text{ MHz}$	$P - 53 \text{ dB} - 15 \cdot \left( \frac{f_{\text{offset}}}{\text{MHz}} - 2.715 \right) \text{ dB}$	30 kHz
(Note 3)	$3.515 \text{ MHz} \leq f_{\text{offset}} < 4.0 \text{ MHz}$	$P - 65 \text{ dB}$	30 kHz
$3.5 \text{ MHz} \leq \Delta f < 7.5 \text{ MHz}$	$4.0 \text{ MHz} \leq f_{\text{offset}} < 8.0 \text{ MHz}$	$P - 52 \text{ dB}$	1 MHz
$7.5 \text{ MHz} \leq \Delta f \leq \Delta f_{\text{max}}$	$8.0 \text{ MHz} \leq f_{\text{offset}} < f_{\text{offset}_{\text{max}}}$	$P - 56 \text{ dB}$	1 MHz
<p>Note 1: For BS supporting non-contiguous spectrum operation within any operating band, the minimum requirement within sub-block gaps is calculated as a cumulative sum of contributions from adjacent sub blocks on each side of the sub block gap, where the contribution from the far-end sub-block shall be scaled according to the measurement bandwidth of the near-end sub-block. Exception is <math>\Delta f \geq 12.5 \text{ MHz}</math> from both adjacent sub blocks on each side of the sub-block gap, where the spurious emission requirements in subclause 6.6.3.1 shall be met.</p> <p>Note 2: For BS supporting multi-band operation with Inter RF Bandwidth gap <math>&lt; 20 \text{ MHz}</math> the minimum requirement within the Inter RF Bandwidth gaps is calculated as a cumulative sum of contributions from adjacent sub-blocks or RF Bandwidth on each side of the Inter RF Bandwidth gap, where the contribution from the far-end sub-block or RF Bandwidth shall be scaled according to the measurement bandwidth of the near-end sub-block or RF Bandwidth.</p>			

**Table 6.6: Spectrum emission mask values, BS rated output power P < 31 dBm**

Frequency offset of measurement filter -3dB point, $\Delta f$	Frequency offset of measurement filter centre frequency, $f_{\text{offset}}$	Minimum requirement (Note 1, 2)	Measurement bandwidth (Note 4)
$2.5 \text{ MHz} \leq \Delta f < 2.7 \text{ MHz}$	$2.515 \text{ MHz} \leq f_{\text{offset}} < 2.715 \text{ MHz}$	-22 dBm	30 kHz
$2.7 \text{ MHz} \leq \Delta f < 3.5 \text{ MHz}$	$2.715 \text{ MHz} \leq f_{\text{offset}} < 3.515 \text{ MHz}$	$-22 \text{ dBm} - 15 \cdot \left( \frac{f_{\text{offset}}}{\text{MHz}} - 2.715 \right) \text{ dB}$	30 kHz
(Note 3)	$3.515 \text{ MHz} \leq f_{\text{offset}} < 4.0 \text{ MHz}$	-34 dBm	30 kHz
$3.5 \text{ MHz} \leq \Delta f < 7.5 \text{ MHz}$	$4.0 \text{ MHz} \leq f_{\text{offset}} < 8.0 \text{ MHz}$	-21 dBm	1 MHz
$7.5 \text{ MHz} \leq \Delta f \leq \Delta f_{\text{max}}$	$8.0 \text{ MHz} \leq f_{\text{offset}} < f_{\text{offset}_{\text{max}}}$	-25 dBm	1 MHz
<p>Note 1: For BS supporting non-contiguous spectrum operation within any operating band, the minimum requirement within sub-block gaps is calculated as a cumulative sum of contributions from adjacent sub blocks on each side of the sub block gap, where the contribution from the far-end sub-block shall be scaled according to the measurement bandwidth of the near-end sub-block. Exception is <math>\Delta f \geq 12.5 \text{ MHz}</math> from both adjacent sub blocks on each side of the sub-block gap, where the spurious emission requirements in subclause 6.6.3.1 shall be met.</p> <p>Note 2: For BS supporting multi-band operation with Inter RF Bandwidth gap &lt; 20MHz the minimum requirement within the Inter RF Bandwidth gaps is calculated as a cumulative sum of contributions from adjacent sub-blocks or RF Bandwidth on each side of the Inter RF Bandwidth gap, where the contribution from the far-end sub-block or RF Bandwidth shall be scaled according to the measurement bandwidth of the near-end sub-block or RF Bandwidth.</p>			

For operation in band II, IV, V, X, XII, XIII, XIV, XXV and XXVI the applicable additional requirements in Tables 6.6A, 6.6B or 6.6C apply in addition to the minimum requirements in Tables 6.3 to 6.6.

**Table 6.6A: Additional spectrum emission limits for Bands II, IV, X, XXV**

Frequency offset of measurement filter -3dB point, $\Delta f$	Frequency offset of measurement filter centre frequency, $f_{\text{offset}}$	Additional requirement	Measurement bandwidth (Note 4)
$2.5 \text{ MHz} \leq \Delta f < 3.5 \text{ MHz}$	$2.515 \text{ MHz} \leq f_{\text{offset}} < 3.515 \text{ MHz}$	-15 dBm	30 kHz
$3.5 \text{ MHz} \leq \Delta f \leq \Delta f_{\text{max}}$	$4.0 \text{ MHz} \leq f_{\text{offset}} < f_{\text{offset}_{\text{max}}}$	-13 dBm	1 MHz

**Table 6.6B: Additional spectrum emission limits for Bands V, XXVI**

Frequency offset of measurement filter -3dB point, $\Delta f$	Frequency offset of measurement filter centre frequency, $f_{\text{offset}}$	Additional requirement	Measurement bandwidth (Note 4)
$2.5 \text{ MHz} \leq \Delta f < 3.5 \text{ MHz}$	$2.515 \text{ MHz} \leq f_{\text{offset}} < 3.515 \text{ MHz}$	-15 dBm	30 kHz
$3.5 \text{ MHz} \leq \Delta f \leq \Delta f_{\text{max}}$	$3.55 \text{ MHz} \leq f_{\text{offset}} < f_{\text{offset}_{\text{max}}}$	-13 dBm	100 kHz

**Table 6.6C: Additional spectrum emission limits for Bands XII, XIII, XIV**

Frequency offset of measurement filter -3dB point, $\Delta f$	Frequency offset of measurement filter centre frequency, $f_{\text{offset}}$	Additional requirement	Measurement bandwidth (Note 4)
$2.5 \text{ MHz} \leq \Delta f < 2.6 \text{ MHz}$	$2.515 \text{ MHz} \leq f_{\text{offset}} < 2.615 \text{ MHz}$	-13 dBm	30 kHz
$2.6 \text{ MHz} \leq \Delta f \leq \Delta f_{\text{max}}$	$2.65 \text{ MHz} \leq f_{\text{offset}} < f_{\text{offset}_{\text{max}}}$	-13 dBm	100 kHz



For Home BS, the applicable additional requirements in Tables 6.6D or 6.6E apply in addition to the minimum requirements in Tables 6.3A to 6.6.

**Table 6.6D: Additional spectrum emission limit for Home BS, BS rated output power  $6 \leq P \leq 20$  dBm**

Frequency offset of measurement filter -3dB point, $\Delta f$	Frequency offset of measurement filter centre frequency, $f_{\text{offset}}$	Additional requirement	Measurement bandwidth (Note 4)
$12.5 \text{ MHz} \leq \Delta f \leq \Delta f_{\text{max}}$	$13 \text{ MHz} \leq f_{\text{offset}} < f_{\text{offset}_{\text{max}}}$	P - 56 dBm	1 MHz

**Table 6.6E: Additional spectrum emission limit for Home BS, BS rated output power  $P < 6$  dBm**

Frequency offset of measurement filter -3dB point, $\Delta f$	Frequency offset of measurement filter centre frequency, $f_{\text{offset}}$	Additional requirement	Measurement bandwidth (Note 4)
$12.5 \text{ MHz} \leq \Delta f \leq \Delta f_{\text{max}}$	$13 \text{ MHz} \leq f_{\text{offset}} < f_{\text{offset}_{\text{max}}}$	-50 dBm	1 MHz

In certain regions the following requirement may apply for protection of DTT. For UTRA BS operating in Band XX, the level of emissions in the band 470-790 MHz, measured in an 8MHz filter bandwidth on centre frequencies  $F_{\text{filter}}$  according to Table 6.6F, shall not exceed the maximum emission level  $P_{\text{EM},N}$  declared by the manufacturer.

**Table 6.6F: Declared emissions levels for protection of DTT**

Filter centre frequency, $F_{\text{filter}}$	Measurement bandwidth	Declared emission level [dBm]
$F_{\text{filter}} = 8 \cdot N + 306$ (MHz); $21 \leq N \leq 60$	8 MHz	$P_{\text{EM},N}$

NOTE: The regional requirement is defined in terms of EIRP (effective isotropic radiated power), which is dependent on both the BS emissions at the antenna connector and the deployment (including antenna gain and feeder loss). The requirement defined above provides the characteristics of the basestation needed to verify compliance with the regional requirement. Compliance with the regional requirement can be determined using the method outlined in Annex D.

In certain regions, the following requirements may apply to UTRA BS operating in Band XXXII within 1452-1492 MHz. The level of unwanted emissions, measured on centre frequencies  $f_{\text{offset}}$  with filter bandwidth, according to Table 6.6G shall neither exceed the maximum emission level  $P_{\text{EM},B32,a}$ ,  $P_{\text{EM},B32,b}$  nor  $P_{\text{EM},B32,c}$  declared by the manufacturer.

**Table 6.6G: Declared frequency band XXXII unwanted emission within 1452-1492 MHz**

Frequency offset of measurement filter centre frequency, $f_{\text{offset}}$	Declared emission level [dBm]	Measurement bandwidth
5 MHz	$P_{\text{EM},B32,a}$	5 MHz
10 MHz	$P_{\text{EM},B32,b}$	5 MHz
$15 \text{ MHz} \leq f_{\text{offset}} \leq f_{\text{offset}_{\text{max}, B32}}$	$P_{\text{EM},B32,c}$	5 MHz
NOTE: $f_{\text{offset}_{\text{max}, B32}}$ denotes the frequency difference between the lower channel carrier frequency and 1454.5 MHz, and the frequency difference between the upper channel carrier frequency and 1489.5 MHz for the set channel position.		

NOTE: The regional requirement, included in [13], is defined in terms of EIRP per antenna, which is dependent on both the BS emissions at the antenna connector and the deployment (including antenna gain and feeder loss). The requirement defined above provides the characteristics of the base station needed to verify compliance with the regional requirement. The assessment of the EIRP level is described in Annex H of TS36.104 [8].

In certain regions, the following requirement may apply to UTRA BS operating in Band XXXII within 1452-1492MHz for the protection of services in spectrum adjacent to the frequency range 1452-1492 MHz. The level of emissions,

measured on centre frequencies  $F_{\text{filter}}$  with filter bandwidth according to Table 6.6H shall neither exceed the maximum emission level  $P_{\text{EM,B32,d}}$  nor  $P_{\text{EM,B32,e}}$  declared by the manufacturer. This requirement applies in the frequency range 1429-1518MHz even though part of the range falls in the spurious domain.

**Table 6.6H: Frequency band XXXII declared emission outside 1452-1492 MHz**

Filter centre frequency, $F_{\text{filter}}$	Declared emission level [dBm]	Measurement bandwidth
$1429.5 \text{ MHz} \leq F_{\text{filter}} \leq 1448.5 \text{ MHz}$	$P_{\text{EM,B32,d}}$	1 MHz
$F_{\text{filter}} = 1450.5 \text{ MHz}$	$P_{\text{EM,B32,e}}$	3 MHz
$F_{\text{filter}} = 1493.5 \text{ MHz}$	$P_{\text{EM,B32,e}}$	3 MHz
$1495.5 \text{ MHz} \leq F_{\text{filter}} \leq 1517.5 \text{ MHz}$	$P_{\text{EM,B32,d}}$	1 MHz

NOTE: The regional requirement, included in [13], is defined in terms of EIRP, which is dependent on both the BS emissions at the antenna connector and the deployment (including antenna gain and feeder loss). The requirement defined above provides the characteristics of the base station needed to verify compliance with the regional requirement. The assessment of the EIRP level is described in Annex H of TS36.104 [8].

Notes for Tables 6.3A, 6.4, 6.5 & 6.6

NOTE 3: This frequency range ensures that the range of values of  $f_{\text{offset}}$  is continuous.

NOTE 4: As a general rule, the resolution bandwidth of the measuring equipment should be equal to the measurement bandwidth. However, to improve measurement accuracy, sensitivity and efficiency, the resolution bandwidth can be smaller than the measurement bandwidth. When the resolution bandwidth is smaller than the measurement bandwidth, the result should be integrated over the measurement bandwidth in order to obtain the equivalent noise bandwidth of the measurement bandwidth.

### 6.6.2.2 Adjacent Channel Leakage power Ratio (ACLR)

Adjacent Channel Leakage power Ratio (ACLR) is the ratio of the RRC filtered mean power centred on the assigned channel frequency to the RRC filtered mean power centred on an adjacent channel frequency.

The requirements shall apply outside the Base Station RF bandwidth or Radio Bandwidth whatever the type of transmitter considered (single carrier or multi-carrier) and for all transmission modes foreseen by the manufacturer's specification.

For a BS operating in non-contiguous spectrum, ACLR requirement also applies for the first adjacent channel, inside any sub-block gap with a gap size  $W_{\text{gap}} \geq 15 \text{ MHz}$ . The ACLR requirement for the second adjacent channel applies inside any sub-block gap with a gap size  $W_{\text{gap}} \geq 20 \text{ MHz}$ . The ACLR requirement in subclause 6.6.2.2.2 applies in sub block gaps for the frequency ranges defined in Table 6.7B.

For a BS operating in multiple bands, where multiple bands are mapped onto the same antenna connector, ACLR requirement also applies for the first adjacent channel, inside any Inter RF Bandwidth gap with a gap size  $W_{\text{gap}} \geq 15 \text{ MHz}$ . The ACLR requirement for the second adjacent channel applies inside any Inter RF Bandwidth gap with a gap size  $W_{\text{gap}} \geq 20 \text{ MHz}$ . The ACLR requirement in subclause 6.6.2.2.2 applies in Inter RF Bandwidth gaps for the frequency ranges defined in Table 6.7B.

#### 6.6.2.2.1 Minimum requirement

For Category A Wide Area BS, either the ACLR limits in the tables below or the absolute limit of -13dBm/MHz shall apply, whichever is less stringent.

For Category B Wide Area BS, either the ACLR limits in the tables below or the absolute limit of -15dBm/MHz shall apply, whichever is less stringent.

For Medium Range BS, either the ACLR limits in the tables below or the absolute limit of -25 dBm/MHz shall apply, whichever is less stringent.

For Local Area BS, either the ACLR limits in the tables below or the absolute limit of -32dBm/MHz shall apply, whichever is less stringent.

The ACLR shall be higher than the value specified in Table 6.7.

**Table 6.7: BS ACLR**

BS adjacent channel offset below the first or above the last carrier frequency used	ACLR limit
5 MHz	45 dB
10 MHz	50 dB
Note 1: In certain regions, the adjacent channel power (the RRC filtered mean power centred on an adjacent channel frequency) shall be less than or equal to -8.0 dBm/3.84 MHz (for Band I, III, IX, XI and XXI) or + 2.0dBm/3.84MHz (for Band VI, VIII and XIX) or as specified by the ACLR limit, whichever is the higher. This note is not applicable for Home BS. Note 2: For Home BS, the adjacent channel power (the RRC filtered mean power centred on an adjacent channel frequency) shall be less than or equal to -44.2 dBm/3.84MHz or as specified by the ACLR limit, whichever is the higher.	

For non-contiguous spectrum or multiple bands, the ACLR shall be higher than the value specified in Table 6.7A.

**Table 6.7A: BS ACLR in non-contiguous spectrum or multiple bands**

Sub-block or Inter RF Bandwidth gap size ( $W_{\text{gap}}$ ) where the limit applies	BS adjacent channel centre frequency offset below or above the sub-block edge or the Base Station RF Bandwidth edge (inside the gap)	Assumed adjacent channel carrier (informative)	Filter on the adjacent channel frequency and corresponding filter bandwidth	ACLR limit
$W_{\text{gap}} \geq 15$ MHz	2.5 MHz	3.84 Mcps UTRA	RRC (3.84 Mcps)	45 dB
$W_{\text{gap}} \geq 20$ MHz	7.5 MHz	3.84 Mcps UTRA	RRC (3.84 Mcps)	45 dB
NOTE: The RRC filter shall be equivalent to the transmit pulse shape filter defined in TS 25.104, with a chip rate as defined in this table.				

#### 6.6.2.2.2 Cumulative ACLR requirement in non-contiguous spectrum

The following requirement applies for the sub-block or Inter RF Bandwidth gap sizes listed in Table 6.7B,

- inside a sub-block gap within an operating band for a BS operating in non-contiguous spectrum;
- inside an Inter RF Bandwidth gap for a BS capable of multi-band operation, where multiple bands are mapped on the same antenna connector.

The Cumulative Adjacent Channel Leakage power Ratio (CACLR) in a sub-block gap or the Inter RF Bandwidth gap is the ratio of

- a) the sum of the filtered mean power centred on the assigned channel frequencies for the two carriers adjacent to each side of the sub-block gap or the Inter RF Bandwidth gap, and
- b) the filtered mean power centred on a frequency channel adjacent to one of the respective sub-block edges or Base Station RF Bandwidth edges.

The assumed filter for the adjacent channel frequency is defined in Table 6.7B and the filters on the assigned channels are defined in Table 6.7C.

For Wide Area Category A BS, either the CACLR limits in Table 6.7B or the absolute limit of -13dBm/MHz shall apply, whichever is less stringent.

For Wide Area Category B BS, either the CACLR limits in Table 6.7B or the absolute limit of -15dBm/MHz shall apply, whichever is less stringent.

For Medium Range BS, either the CACLR limits in Table 6.7B or the absolute limit of -25 dBm/MHz shall apply, whichever is less stringent.

For Local Area BS, either the CA CLR limits in Table 6.7B or the absolute limit of -32 dBm/MHz shall apply, whichever is less stringent.

The CA CLR for UTRA carriers located on either side of the sub-block gap or the Inter RF Bandwidth gap shall be higher than the value specified in Table 6.7B.

**Table 6.7B: Base Station CA CLR in non-contiguous spectrum or multiple bands**

Sub-block or Inter RF Bandwidth gap size ( $W_{\text{gap}}$ ) where the limit applies	BS adjacent channel centre frequency offset below or above the sub-block edge or the Base Station RF Bandwidth edge (inside the gap)	Assumed adjacent channel carrier (informative)	Filter on the adjacent channel frequency and corresponding filter bandwidth	CA CLR limit
$5 \text{ MHz} \leq W_{\text{gap}} < 15 \text{ MHz}$	2.5 MHz	3.84 Mcps UTRA	RRC (3.84 Mcps)	45 dB
$10 \text{ MHz} < W_{\text{gap}} < 20 \text{ MHz}$	7.5 MHz	3.84 Mcps UTRA	RRC (3.84 Mcps)	45 dB
NOTE: The RRC filter shall be equivalent to the transmit pulse shape filter defined in TS 25.104, with a chip rate as defined in this table.				

**Table 6.7C: Filter parameters for the assigned channel**

RAT of the carrier adjacent to the sub-block or Inter RF Bandwidth gap	Filter on the assigned channel frequency and corresponding filter bandwidth
UTRA FDD	RRC (3.84 Mcps)
NOTE: The RRC filter shall be equivalent to the transmit pulse shape filter defined in TS 25.104, with a chip rate as defined in this table.	

## 6.6.3 Spurious emissions

Spurious emissions are emissions which are caused by unwanted transmitter effects such as harmonics emission, parasitic emission, intermodulation products and frequency conversion products, but exclude out of band emissions. This is measured at the base station antenna connector.

The requirements shall apply whatever the type of transmitter considered (single carrier or multiple-carrier) and for all transmission modes foreseen by the manufacturer's specification.

The requirements (except 6.6.3.5 and 6.6.3.8 and specifically stated exceptions in Table 6.11) apply at frequencies within the specified frequency ranges, which are more than 12.5MHz below the first carrier frequency used or more than 12.5MHz above the last carrier frequency used.

For BS capable of multi-band operation where multiple bands are mapped on the same antenna connector, the requirements (except 6.6.3.5 and 6.6.3.8 and specifically stated exceptions in Table 6.11) apply at frequencies within the specified frequency ranges, excluding the frequency ranges which are less than or equal to 12.5MHz below the first carrier frequency used and less than or equal to 12.5MHz above the last carrier frequency used for each supported operating band. For BS capable of multi-band operation where multiple bands are mapped on separate antenna connectors, the single-band requirements apply and the multi-band exclusions and provisions are not applicable.

Unless otherwise stated, all requirements shall be measured as mean power (RMS).

### 6.6.3.1 Mandatory Requirements

The requirements of either subclause 6.6.3.1.1 or subclause 6.6.3.1.2 shall apply.

#### 6.6.3.1.1 Spurious emissions (Category A)

The following limits shall be met in cases where Category A limits for spurious emissions, as defined in ITU-R Recommendation SM.329 [1], are applied.

## 6.6.3.1.1.1 Minimum Requirement

The power of any spurious emission shall not exceed:

**Table 6.8: BS Mandatory spurious emissions limits, Category A**

Band	Maximum level	Measurement Bandwidth	Note
9kHz - 150kHz	-13 dBm	1 kHz	Note 1
150kHz - 30MHz		10 kHz	Note 1
30MHz - 1GHz		100 kHz	Note 1
1GHz - 12.75 GHz		1 MHz	Note 2
12.75 GHz - 5 <sup>th</sup> harmonic of the upper frequency edge of the DL operating band in GHz		1 MHz	Note 2, Note 3
NOTE 1: Bandwidth as in ITU-R SM.329 [1], s4.1			
NOTE 2: Upper frequency as in ITU-R SM.329 [1], s2.5 table 1			
NOTE 3: Applies only for Band XXII			

## 6.6.3.1.2 Spurious emissions (Category B)

The following limits shall be met in cases where Category B limits for spurious emissions, as defined in ITU-R Recommendation SM.329 [1], are applied.

## 6.6.3.1.2.1 Minimum Requirement

The power of any spurious emission shall not exceed:

**Table 6.9: BS Mandatory spurious emissions limits, operating band I, II, III, IV, VII, X, XXII, XXV, XXXII (Category B)**

Band	Maximum Level	Measurement Bandwidth	Note
9 kHz ↔ 150 kHz	-36 dBm	1 kHz	Note 1
150 kHz ↔ 30 MHz	-36 dBm	10 kHz	Note 1
30 MHz ↔ 1 GHz	-36 dBm	100 kHz	Note 1
1 GHz ↔ F <sub>low</sub> - 10 MHz	-30 dBm	1 MHz	Note 1
F <sub>low</sub> - 10 MHz ↔ F <sub>high</sub> + 10 MHz	-15 dBm	1 MHz	Note 2
F <sub>high</sub> + 10 MHz ↔ 12.75 GHz	-30 dBm	1 MHz	Note 3
12.75 GHz - 5 <sup>th</sup> harmonic of the upper frequency edge of the DL operating band in GHz	-30 dBm	1 MHz	Note 3, Note 4
NOTE 1: Bandwidth as in ITU-R Recommendation SM.329 [1], s4.1			
NOTE 2: Limit based on ITU-R Recommendation SM.329 [1], s4.3 and Annex 7			
NOTE 3: Bandwidth as in ITU-R Recommendation SM.329 [1], s4.1. Upper frequency as in ITU-R SM.329 [1], s2.5 table 1			
NOTE 4: Applies only for Band XXII			
Key:			
F <sub>low</sub> : The lowest downlink frequency of the operating band as defined in Table 5.0.			
F <sub>high</sub> : The highest downlink frequency of the operating band as defined in Table 5.0.			

**Table 6.9A: BS Mandatory spurious emissions limits, operating band V, VIII, XII, XIII, XIV, XX, XXVI (Category B)**

Band	Maximum Level	Measurement Bandwidth	Note
9 kHz ↔ 150 kHz	-36 dBm	1 kHz	Note 1
150 kHz ↔ 30 MHz	-36 dBm	10 kHz	Note 1
30 MHz ↔ $F_{low} - 10$ MHz	-36 dBm	100 kHz	Note 1
$F_{low} - 10$ MHz ↔ $F_{high} + 10$ MHz	-16 dBm	100 kHz	Note 2
$F_{high} + 10$ MHz ↔ 1 GHz	-36 dBm	100 kHz	Note 1
1GHz ↔ 12.75GHz	-30 dBm	1 MHz	Note 3
NOTE 1: Bandwidth as in ITU-R Recommendation SM.329 [1], s4.1			
NOTE 2: Limit based on ITU-R Recommendation SM.329 [1], s4.3 and Annex 7			
NOTE 3: Bandwidth as in ITU-R Recommendation SM.329 [1], s4.1. Upper frequency as in ITU-R SM.329 [1], s2.5 table 1			
Key:			
$F_{low}$ : The lowest downlink frequency of the operating band as defined in Table 5.0.			
$F_{high}$ : The highest downlink frequency of the operating band as defined in Table 5.0.			

**Table 6.9B: (void)****Table 6.9C: (void)****Table 6.9D: (void)****Table 6.9E: (void)****Table 6.9F: (void)****Table 6.9G: (void)**

### 6.6.3.2 Protection of the BS receiver of own or different BS

These limits shall be applied in order to prevent the receivers of the BSs being desensitised by emissions from a BS transmitter. This is measured at the transmit antenna port for any type of BS which has common or separate Tx/Rx antenna ports.

#### 6.6.3.2.1 Minimum Requirement

The power of any spurious emission shall not exceed:

**Table 6.10: Wide Area BS Spurious emissions limits for protection of the BS receiver**

Operating Band	Band	Maximum Level	Measurement Bandwidth	Note
I	1920 - 1980MHz	-96 dBm	100 kHz	
II	1850-1910 MHz	-96 dBm	100 kHz	
III	1710-1785 MHz	-96 dBm	100 kHz	
IV	1710-1755 MHz	-96 dBm	100 kHz	
V	824-849 MHz	-96 dBm	100 kHz	
VI, XIX	815-845 MHz	-96 dBm	100 kHz	
VII	2500-2570 MHz	-96 dBm	100 kHz	
VIII	880-915 MHz	-96 dBm	100 kHz	
IX	1749.9-1784.9 MHz	-96 dBm	100 kHz	
X	1710-1770 MHz	-96 dBm	100 kHz	
XI	1427.9 - 1447.9 MHz	-96 dBm	100 kHz	
XII	699 - 716 MHz	-96 dBm	100 kHz	
XIII	777 - 787 MHz	-96 dBm	100 kHz	
XIV	788 - 798 MHz	-96 dBm	100 kHz	
XX	832 - 862 MHz	-96 dBm	100 kHz	
XXI	1447.9 - 1462.9 MHz	-96 dBm	100 kHz	
XXII	3410 - 3490 MHz	-96 dBm	100 kHz	
XXV	1850-1915 MHz	-96 dBm	100 kHz	
XXVI	814-849 MHz	-96 dBm	100 kHz	

**Table 6.10A: Medium Range BS Spurious emissions limits for protection of the BS receiver**

Operating Band	Band	Maximum Level	Measurement Bandwidth	Note
I	1920 - 1980MHz	-86 dBm	100 kHz	
II	1850-1910 MHz	-86 dBm	100 kHz	
III	1710-1785 MHz	-86 dBm	100 kHz	
IV	1710-1755 MHz	-86 dBm	100 kHz	
V	824-849 MHz	-86 dBm	100 kHz	
VI, XIX	815-845 MHz	-86 dBm	100 kHz	
VII	2500-2570 MHz	-86 dBm	100 kHz	
VIII	880-915 MHz	-86 dBm	100 kHz	
IX	1749.9-1784.9 MHz	-86 dBm	100 kHz	
X	1710-1770 MHz	-86 dBm	100 kHz	
XI	1427.9 - 1447.9 MHz	-86 dBm	100 kHz	
XII	699 - 716 MHz	-86 dBm	100 kHz	
XIII	777 - 787 MHz	-86 dBm	100 kHz	
XIV	788 - 798 MHz	-86 dBm	100 kHz	
XX	832 - 862 MHz	-86 dBm	100 kHz	
XXI	1447.9 - 1462.9 MHz	-86 dBm	100 kHz	
XXII	3410 - 3490 MHz	-86 dBm	100 kHz	
XXV	1850-1915 MHz	-86 dBm	100 kHz	
XXVI	814-849 MHz	-86 dBm	100 kHz	

**Table 6.10B: Local Area BS Spurious emissions limits for protection of the BS receiver**

Operating Band	Band	Maximum Level	Measurement Bandwidth	Note
I	1920 - 1980MHz	-82 dBm	100 kHz	
II	1850-1910 MHz	-82 dBm	100 kHz	
III	1710-1785 MHz	-82 dBm	100 kHz	
IV	1710-1755 MHz	-82 dBm	100 kHz	
V	824-849 MHz	-82 dBm	100 kHz	
VI, XIX	815-845 MHz	-82 dBm	100 kHz	
VII	2500-2570 MHz	-82 dBm	100 kHz	
VIII	880-915 MHz	-82 dBm	100 kHz	
IX	1749.9-1784.9 MHz	-82 dBm	100 kHz	
X	1710-1770 MHz	-82 dBm	100 kHz	
XI	1427.9 - 1447.9 MHz	-82 dBm	100 kHz	
XII	699 - 716 MHz	-82 dBm	100 kHz	
XIII	777 - 787 MHz	-82 dBm	100 kHz	
XIV	788 - 798 MHz	-82 dBm	100 kHz	
XX	832 - 862 MHz	-82 dBm	100 kHz	
XXI	1447.9 - 1462.9 MHz	-82 dBm	100 kHz	
XXII	3410 - 3490 MHz	-82 dBm	100 kHz	
XXV	1850-1915 MHz	-82 dBm	100 kHz	
XXVI	814-849 MHz	-82 dBm	100 kHz	

**Table 6.10C: Home BS Spurious emissions limits for protection of the BS receiver**

Operating Band	Band	Maximum Level	Measurement Bandwidth	Note
I	1920 - 1980MHz	-82 dBm	100 kHz	
II	1850-1910 MHz	-82 dBm	100 kHz	
III	1710-1785 MHz	-82 dBm	100 kHz	
IV	1710-1755 MHz	-82 dBm	100 kHz	
V	824-849 MHz	-82 dBm	100 kHz	
VI, XIX	815-845 MHz	-82 dBm	100 kHz	
VII	2500-2570 MHz	-82 dBm	100 kHz	
VIII	880-915 MHz	-82 dBm	100 kHz	
IX	1749.9-1784.9 MHz	-82 dBm	100 kHz	
X	1710-1770 MHz	-82 dBm	100 kHz	
XI	1427.9 - 1447.9 MHz	-82 dBm	100 kHz	
XII	699 - 716 MHz	-82 dBm	100 kHz	
XIII	777 - 787 MHz	-82 dBm	100 kHz	
XIV	788 - 798 MHz	-82 dBm	100 kHz	
XX	832 - 862 MHz	-82 dBm	100 kHz	
XXI	1447.9 - 1462.9 MHz	-82 dBm	100 kHz	
XXII	3410 - 3490 MHz	-82 dBm	100 kHz	
XXV	1850-1915 MHz	-82 dBm	100 kHz	
XXVI	814-849 MHz	-82 dBm	100 kHz	

### 6.6.3.3 Co-existence with other systems in the same geographical area

These requirements may be applied for the protection of UE, MS and/or BS operating in other frequency bands in the same geographical area. The requirements may apply in geographic areas in which both a UTRA FDD BS and a system operating in another frequency band than the FDD operating band are deployed. The system operating in the other frequency band may be GSM, DCS, PCS, CDMA, E-UTRA and/or UTRA.

#### 6.6.3.3.1 Minimum Requirements

The power of any spurious emission shall not exceed the limits of Table 6.11 for a BS where requirements for co-existence with the system listed in the first column apply. For BS capable of multi-band operation, the exclusions and conditions in the Note column of Table 6.11 apply for each supported operating band. For BS capable of multi-band



operation where multiple bands are mapped on separate antenna connectors, the exclusions and conditions in the Note column of Table 6.11 apply for the operating band supported at that antenna connector.

**Table 6.11: BS Spurious emissions limits for UTRA FDD BS in geographic coverage area of systems operating in other frequency bands**

System type operating in the same geographical area	Band for co-existence requirement	Maximum Level	Measurement Bandwidth	Note
GSM900	921 - 960 MHz	-57 dBm	100 kHz	This requirement does not apply to UTRA FDD operating in band VIII
	876 - 915 MHz	-61 dBm	100 kHz	For the frequency range 880-915 MHz, this requirement does not apply to UTRA FDD operating in band VIII, since it is already covered by the requirement in sub-clause 6.6.3.2.
DCS1800	1805 - 1880 MHz	-47 dBm	100 kHz	This requirement does not apply to UTRA FDD operating in band III
	1710 - 1785 MHz	-61 dBm	100 kHz	This requirement does not apply to UTRA FDD operating in band III, since it is already covered by the requirement in sub-clause 6.6.3.2.
PCS1900	1930 - 1990 MHz	-47 dBm	100 kHz	This requirement does not apply to UTRA FDD BS operating in frequency band II or band XXV
	1850 - 1910 MHz	-61 dBm	100 kHz	This requirement does not apply to UTRA FDD BS operating in frequency band II or band XXV, since it is already covered by the requirement in sub-clause 6.6.3.2.
GSM850 or CDMA850	869 - 894 MHz	-57 dBm	100 kHz	This requirement does not apply to UTRA FDD BS operating in frequency band V or XXVI
	824 - 849 MHz	-61 dBm	100 kHz	This requirement does not apply to UTRA FDD BS operating in frequency band V or XXVI, since it is already covered by the requirement in sub-clause 6.6.3.2.
UTRA FDD Band I or E-UTRA Band 1	2110 - 2170 MHz	-52 dBm	1 MHz	This requirement does not apply to UTRA FDD BS operating in band I,
	1920 - 1980 MHz	-49 dBm	1 MHz	This requirement does not apply to UTRA FDD BS operating in band I, since it is already covered by the requirement in sub-clause 6.6.3.2.
UTRA FDD Band II or E-UTRA Band 2	1930 - 1990 MHz	-52 dBm	1 MHz	This requirement does not apply to UTRA FDD BS operating in band II or band XXV
	1850 - 1910 MHz	-49 dBm	1 MHz	This requirement does not apply to UTRA FDD BS operating in band II or band XXV, since it is already covered by the requirement in sub-clause 6.6.3.2.
UTRA FDD Band III or E-UTRA Band 3	1805 - 1880 MHz	-52 dBm	1 MHz	This requirement does not apply to UTRA FDD BS operating in band III or band IX
	1710 - 1785 MHz	-49 dBm	1 MHz	This requirement does not apply to UTRA FDD BS operating in band III, since it is already covered by the requirement in sub-clause 6.6.3.2. For UTRA BS operating in band IX, it applies for 1710 MHz to 1749.9 MHz and 1784.9 MHz to 1785 MHz, while the rest is covered in sub-clause 6.6.3.2.
UTRA FDD Band IV or E-UTRA Band 4	2110 - 2155 MHz	-52 dBm	1 MHz	This requirement does not apply to UTRA FDD BS operating in band IV or band X
	1710 - 1755 MHz	-49 dBm	1 MHz	This requirement does not apply to UTRA FDD BS operating in band IV or band X, since it is already covered by the requirement in sub-clause 6.6.3.2.
UTRA FDD Band V or E-UTRA Band 5	869 - 894 MHz	-52 dBm	1 MHz	This requirement does not apply to UTRA FDD BS operating in band V or XXVI
	824 - 849 MHz	-49 dBm	1 MHz	This requirement does not apply to UTRA FDD BS operating in band V or XXVI, since it is already covered by the requirement in sub-clause 6.6.3.2.
UTRA FDD Band VI or XIX, E-UTRA Band 6, 18 or 19	860 - 890 MHz	-52 dBm	1 MHz	This requirement does not apply to UTRA FDD BS operating in band VI or XIX
	815 - 845 MHz	-49 dBm	1 MHz	This requirement does not apply to UTRA FDD BS operating in band VI or XIX, since it is already covered by the requirement in sub-clause 6.6.3.2.
UTRA FDD Band VII or E-UTRA Band 7	2620 - 2690 MHz	-52 dBm	1 MHz	This requirement does not apply to UTRA FDD BS operating in band VII,
	2500 - 2570 MHz	-49 dBm	1 MHz	This requirement does not apply to UTRA FDD BS operating in band VII, since it is already covered by the requirement in sub-clause 6.6.3.2.
	925 - 960 MHz	-52 dBm	1 MHz	This requirement does not apply to UTRA FDD BS operating in band VIII.

UTRA FDD Band VIII or E-UTRA Band 8	880 - 915 MHz	-49 dBm	1 MHz	This requirement does not apply to UTRA FDD BS operating in band VIII, since it is already covered by the requirement in sub-clause 6.6.3.2.
UTRA FDD Band IX or E-UTRA Band 9	1844.9 - 1879.9 MHz	-52 dBm	1 MHz	This requirement does not apply to UTRA FDD BS operating in band III or band IX
	1749.9 - 1784.9 MHz	-49 dBm	1 MHz	This requirement does not apply to UTRA FDD BS operating in band III or band IX, since it is already covered by the requirement in sub-clause 6.6.3.2.
UTRA FDD Band X or E-UTRA Band 10	2110 - 2170 MHz	-52 dBm	1 MHz	This requirement does not apply to UTRA FDD BS operating in band IV or band X.
	1710 - 1770 MHz	-49 dBm	1 MHz	This requirement does not apply to UTRA FDD BS operating in band X, since it is already covered by the requirement in sub-clause 6.6.3.2. For UTRA FDD BS operating in Band IV, it applies for 1755 MHz to 1770 MHz, while the rest is covered in sub-clause 6.6.3.2.
UTRA FDD Band XI or XXI or E-UTRA Band 11 or 21	1475.9 - 1510.9 MHz	-52 dBm	1 MHz	This requirement does not apply to UTRA FDD BS operating in band XI , XXI or XXXII.
	1427.9 - 1447.9 MHz	-49 dBm	1 MHz	This requirement does not apply to UTRA FDD BS operating in band XI, since it is already covered by the requirement in sub-clause 6.6.3.2. For UTRA BS operating in band XXXII, this requirement applies for carriers allocated within 1475.9MHz and 1495.9MHz.
	1447.9 - 1462.9 MHz	-49 dBm	1 MHz	This requirement does not apply to UTRA FDD BS operating in band XXI, since it is already covered by the requirement in sub-clause 6.6.3.2. For UTRA BS operating in band XXXII, this requirement applies for carriers allocated within 1475.9MHz and 1495.9MHz.
UTRA FDD Band XII or E-UTRA Band 12	729 - 746 MHz	-52 dBm	1 MHz	This requirement does not apply to UTRA FDD BS operating in band XII
	699 - 716 MHz	-49 dBm	1 MHz	This requirement does not apply to UTRA FDD BS operating in band XII, since it is already covered by the requirement in sub-clause 6.6.3.2.
UTRA FDD Band XIII or E-UTRA Band 13	746 - 756 MHz	-52 dBm	1 MHz	This requirement does not apply to UTRA FDD BS operating in band XIII
	777 - 787 MHz	-49 dBm	1 MHz	This requirement does not apply to UTRA FDD BS operating in band XIII, since it is already covered by the requirement in sub-clause 6.6.3.2.
UTRA FDD Band XIV or E-UTRA Band 14	758 - 768 MHz	-52 dBm	1 MHz	This requirement does not apply to UTRA FDD BS operating in band XIV
	788 - 798 MHz	-49 dBm	1 MHz	This requirement does not apply to UTRA FDD BS operating in band XIV, since it is already covered by the requirement in sub-clause 6.6.3.2.
E-UTRA Band 17	734 - 746 MHz	-52 dBm	1 MHz	This requirement does not apply to UTRA FDD BS operating in band XII
	704 - 716 MHz	-49 dBm	1 MHz	This requirement does not apply to UTRA FDD BS operating in band XII, since it is already covered by the requirement in sub-clause 6.6.3.2.
UTRA FDD Band XX or E-UTRA Band 20	791 - 821 MHz	-52 dBm	1 MHz	This requirement does not apply to UTRA FDD BS operating in band XX
	832 - 862 MHz	-49 dBm	1 MHz	This requirement does not apply to UTRA FDD BS operating in band XX, since it is already covered by the requirement in sub-clause 6.6.3.2.
UTRA FDD Band XXII or E-UTRA Band 22	3510 -3590 MHz	-52	1 MHz	This requirement does not apply to UTRA FDD BS operating in band XXII.
	3410 -3490 MHz	-49	1 MHz	This requirement does not apply to UTRA FDD BS operating in band XXII, since it is already covered by the requirement in sub-clause 6.6.3.2.
	2010 – 2020 MHz	-49 dBm	1 MHz	
E-UTRA Band 24	1525 – 1559 MHz	-52 dBm	1 MHz	
	1626.5 – 1660.5 MHz	-49 dBm	1 MHz	
	1930 - 1995 MHz	-52 dBm	1 MHz	This requirement does not apply to UTRA FDD BS operating in band II or band XXV

UTRA FDD Band XXV or E-UTRA Band 25	1850 - 1915 MHz	-49 dBm	1 MHz	This requirement does not apply to UTRA FDD BS operating in band XXV, since it is already covered by the requirement in sub-clause 6.6.3.2. For UTRA FDD BS operating in Band II, it applies for 1910 MHz to 1915 MHz, while the rest is covered in sub-clause 6.6.3.2.
UTRA FDD Band XXVI or E-UTRA Band 26	859-894 MHz	-52 dBm	1 MHz	This requirement does not apply to UTRA FDD BS operating in band V or band XXVI
	814-849 MHz	-49 MHz	1 MHz	This requirement does not apply to UTRA FDD BS operating in band XXVI, since it is already covered by the requirements in sub-clause 6.6.3.2 For UTRA FDD BS operating in band V, it applies for 814MHz to 824MHz, while the rest is covered in sub-clause 6.6.3.2
E-UTRA Band 27	852 – 869 MHz	-52 dBm	1 MHz	This requirement does not apply to UTRA BS operating in Band V or XXVI.
	807 – 824 MHz	-49 dBm	1 MHz	For UTRA BS operating in Band XXVI, it applies for 807 MHz to 814 MHz, while the rest is covered in sub-clause 6.6.3.2.
E-UTRA Band 28	758 – 803 MHz	-52 dBm	1 MHz	
	703 – 748 MHz	-49 MHz	1 MHz	
E-UTRA Band 29	717 – 728 MHz	-52 dBm	1 MHz	
E-UTRA Band 30	2350 - 2360 MHz	-52 dBm	1 MHz	
	2305 - 2315 MHz	-49 dBm	1 MHz	
E-UTRA Band 31	462.5 -467.5 MHz	-52 dBm	1 MHz	
	452.5 -457.5 MHz	-49 dBm	1 MHz	
UTRA FDD Band XXXII or E-UTRA Band 32	1452 – 1496 MHz	-52 dBm	1 MHz	This requirement does not apply to UTRA BS operating in Band XI, XXI, or XXXII
UTRA TDD Band a) or E-UTRA Band 33	1900 – 1920 MHz	-52 dBm	1 MHz	
UTRA TDD Band a) or E-UTRA Band 34	2010 – 2025 MHz	-52 dBm	1 MHz	
UTRA TDD Band d) or E-UTRA Band 38	2570 – 2620 MHz	-52 dBm	1 MHz	
UTRA TDD Band f) or E-UTRA Band 39	1880 – 1920 MHz	-52 dBm	1 MHz	Applicable in China
UTRA TDD in Band e) or E-UTRA Band 40	2300 – 2400 MHz	-52 dBm	1 MHz	
E-UTRA Band 41	2496 - 2690 MHz	-52 dBm	1 MHz	
E-UTRA Band 42	3400 – 3600 MHz	-52 dBm	1 MHz	
E-UTRA Band 43	3600 – 3800 MHz	-52 dBm	1 MHz	
E-UTRA Band 44	703 - 803 MHz	-52 dBm	1 MHz	
E-UTRA Band 45	1447 - 1467 MHz	-52 dBm	1 MHz	
E-UTRA Band 46	5150 - 5925 MHz	-52 dBm	1 MHz	
E-UTRA Band 47	5855 - 5925 MHz	-52 dBm	1 MHz	
E-UTRA Band 48	3550 – 3700 MHz	-52 dBm	1 MHz	
E-UTRA Band 49	3550 – 3700 MHz	-52 dBm	1 MHz	
E-UTRA Band 50	1432 – 1517 MHz	-52 dBm	1 MHz	This requirement does not apply to UTRA BS operating in Band XI, XXI or XXXII
E-UTRA Band 51	1427 – 1432 MHz	-52 dBm	1 MHz	

E-UTRA Band 52	3300 – 3400 MHz	-52 dBm	1 MHz	
E-UTRA Band 65	2110 - 2200 MHz	-52 dBm	1 MHz	This requirement does not apply to UTRA BS operating in band I,
	1920 - 2010 MHz	-49 dBm	1 MHz	For UTRA BS operating in Band I, it applies for 1980 MHz to 2010 MHz, while the rest is covered in sub-clause 6.6.3.2
E-UTRA Band 66	2110 - 2200 MHz	-52 dBm	1 MHz	This requirement does not apply to UTRA BS operating in band IV or X .
	1710 - 1780 MHz	-49 dBm	1 MHz	For UTRA BS operating in Band IV, this requirement applies for 1755 MHz to 1780 MHz, while the rest is covered in sub-clause 6.6.3.2. For UTRA BS operating in Band X, this requirement applies for 1770 MHz to 1780 MHz, while the rest is covered in sub-clause 6.6.3.2.
E-UTRA Band 67	738 - 758 MHz	-52 dBm	1 MHz	
E-UTRA Band 68	753 -783 MHz	-52 dBm	1 MHz	
	698-728 MHz	-49 dBm	1 MHz	
E-UTRA Band 69	2570 - 2620 MHz	-52 dBm	1 MHz	
E-UTRA Band 70	1995 – 2020 MHz	-52 dBm	1 MHz	This requirement does not apply to UTRA BS operating in band II or XXV.
	1695 – 1710 MHz	-49 dBm	1 MHz	
E-UTRA Band 71	617 - 652 MHz	-52 dBm	1 MHz	
	663 – 698 MHz	-49 dBm	1 MHz	
E-UTRA Band 72	461 - 466 MHz	-52 dBm	1 MHz	
	451 - 456 MHz	-49 dBm	1 MHz	
E-UTRA Band 73	460 - 465 MHz	-52 dBm	1 MHz	
	450 - 455 MHz	-49 dBm	1 MHz	
E-UTRA Band 74	1475 – 1518 MHz	-52 dBm	1 MHz	This requirement does not apply to UTRA FDD BS operating in band XI, XXI or XXXII.
	1427 – 1470 MHz	-49 dBm	1MHz	
E-UTRA Band 75	1432 - 1517 MHz	-52 dBm	1 MHz	This requirement does not apply to UTRA BS operating in Band XI, XXI or XXXII.
E-UTRA Band 76	1427 - 1432 MHz	-52 dBm	1 MHz	
E-UTRA Band 85	728 - 746 MHz	-52 dBm	1 MHz	
	698 - 716 MHz	-49 dBm	1 MHz	

NOTE 1: The co-existence requirements do not apply for the 10 MHz frequency range immediately outside the downlink operating band (see Table 5.0). Emission limits for this excluded frequency range may be covered by local or regional requirements.

NOTE 2: The table above assumes that two operating bands, where the frequency ranges would be overlapping, are not deployed in the same geographical area. For such a case of operation with overlapping frequency arrangements in the same geographical area, special co-existence requirements may apply that are not covered by the 3GPP specifications.

NOTE 3: Void

#### 6.6.3.4 Co-existence with co-located and co-sited base stations

These requirements may be applied for the protection of other BS receivers when GSM, DCS, PCS, CDMA, E-UTRA and/or UTRA BS are co-located with a UTRA FDD BS.

The requirements in this chapter assume a 30 dB coupling loss between transmitter and receiver. If BSs of different classes are co-sited, the coupling loss should be increased by the value as stated in TR 25.942 [4] chapter 10.3 in Table 10.1 and Table 10.2.

##### 6.6.3.4.1 Minimum Requirements

The power of any spurious emission shall not exceed the limits of Table 6.12 for a Wide Area (WA) BS where requirements for co-location with a BS type listed in the first column apply. For BS capable of multi-band operation, the exclusions and conditions in the Note column of Table 6.12 apply for each supported operating band. For BS capable of

multi-band operation where multiple bands are mapped on separate antenna connectors, the exclusions and conditions in the Note column of Table 6.12 apply for the operating band supported at that antenna connector.

**Table 6.12: BS Spurious emissions limits for Wide Area BS co-located with another BS**

Type of co-located BS	Band for co-location requirement	Maximum Level	Measurement Bandwidth	Note
Macro GSM900	876 – 915 MHz	-98 dBm	100 kHz	
Macro DCS1800	1710 – 1785 MHz	-98 dBm	100 kHz	
Macro PCS1900	1850 – 1910 MHz	-98 dBm	100 kHz	
Macro GSM850 or CDMA850	824 – 849 MHz	-98 dBm	100 kHz	
WA UTRA FDD Band I or E-UTRA Band 1	1920 – 1980 MHz	-96 dBm	100 kHz	
WA UTRA FDD Band II or E-UTRA Band 2	1850 – 1910 MHz	-96 dBm	100 kHz	
WA UTRA FDD Band III or E-UTRA Band 3	1710 – 1785 MHz	-96 dBm	100 kHz	
WA UTRA FDD Band IV or E-UTRA Band 4	1710 – 1755 MHz	-96 dBm	100 kHz	
WA UTRA FDD Band V or E-UTRA Band 5	824 – 849 MHz	-96 dBm	100 kHz	
WA UTRA FDD Band VI or XIX, or E-UTRA Band 6, 18 or 19	815 – 845 MHz	-96 dBm	100 kHz	
WA UTRA FDD Band VII or E-UTRA Band 7	2500 – 2570 MHz	-96 dBm	100 kHz	
WA UTRA FDD Band VIII or E-UTRA Band 8	880 – 915 MHz	-96 dBm	100 kHz	
WA UTRA FDD Band IX or E-UTRA Band 9	1749.9 – 1784.9 MHz	-96 dBm	100 kHz	
WA UTRA FDD Band X or E-UTRA Band 10	1710 – 1770 MHz	-96 dBm	100 kHz	
WA UTRA FDD Band XI or E-UTRA Band 11	1427.9 – 1447.9 MHz	-96 dBm	100 kHz	
WA UTRA FDD Band XII or E-UTRA Band 12	699 – 716 MHz	-96 dBm	100 kHz	
WA UTRA FDD Band XIII or E-UTRA Band 13	777 – 787 MHz	-96 dBm	100 kHz	
WA UTRA FDD Band XIV or E-UTRA Band 14	788 – 798 MHz	-96 dBm	100 kHz	
WA E-UTRA Band 17	704 – 716 MHz	-96 dBm	100 kHz	
WA UTRA FDD Band XX or E-UTRA Band 20	832 – 862 MHz	-96 dBm	100 kHz	
WA UTRA FDD Band XXI or E-UTRA Band 21	1447.9 – 1462.9 MHz	-96 dBm	100 kHz	
WA UTRA FDD Band XXII or E-UTRA Band 22	3410 – 3490 MHz	-96 dBm	100 kHz	
WA E-UTRA Band 23	2000 - 2020 MHz	-96 dBm	100 kHz	
WA E-UTRA Band 24	1626.5 – 1660.5 MHz	-96 dBm	100 kHz	
WA UTRA FDD Band XXV or E-UTRA Band 25	1850 - 1915 MHz	-96 dBm	100 kHz	
WA UTRA FDD Band XXVI or E-UTRA Band 26	814-849 MHz	-96 dBm	100 kHz	
WA E-UTRA Band 27	807 - 824 MHz	-96 dBm	100 kHz	
WA E-UTRA Band 28	703 – 748 MHz	-96 dBm	100 kHz	
WA E-UTRA Band 30	2305 – 2315 MHz	-96 dBm	100 kHz	
WA E-UTRA Band 31	452.5 -457.5 MHz	-96 dBm	100 kHz	
WA UTRA TDD Band a) or E-UTRA Band 33	1900 – 1920 MHz	-86 dBm	1 MHz	
WA UTRA TDD Band a) or E-UTRA Band 34	2010 – 2025 MHz	-86 dBm	1 MHz	
WA UTRA TDD Band d) or E-UTRA Band 38	2570 – 2620 MHz	-86 dBm	1 MHz	
WA UTRA TDD Band f) or E-UTRA Band 39	1880 – 1920MHz	-86 dBm	1 MHz	Applicable in China
WA UTRA TDD Band e) or E-UTRA Band 40	2300 – 2400MHz	-86 dBm	1 MHz	
WA E-UTRA Band 41	2496 – 2690 MHz	-86 dBm	1 MHz	
WA E-UTRA Band 42	3400 – 3600 MHz	-86 dBm	1 MHz	
WA E-UTRA Band 43	3600 – 3800 MHz	-86 dBm	1 MHz	
WA E-UTRA Band 44	703 - 803 MHz	-86 dBm	1 MHz	

WA E-UTRA Band 45	1446 - 1467 MHz	-86 dBm	1 MHz	
WA E-UTRA Band 48	3550 – 3700 MHz	-86 dBm	1 MHz	
WA E-UTRA Band 50	1432 - 1517 MHz	-86 dBm	1 MHz	
WA E-UTRA Band 52	3300 – 3400 MHz	-86 dBm	1 MHz	
WA E-UTRA Band 65	1920 – 2110 MHz	-96 dBm	100 kHz	
WA E-UTRA Band 66	1710 – 1780 MHz	-96 dBm	100 kHz	
WA E-UTRA Band 68	698 - 728 MHz	-96 dBm	100 kHz	
WA E-UTRA Band 70	1695 – 1710 MHz	-96 dBm	100 kHz	
WA E-UTRA Band 71	663 - 698 MHz	-96 dBm	100 kHz	
WA E-UTRA Band 72	451 - 456 MHz	-96 dBm	100 kHz	
WA E-UTRA Band 73	450 - 455 MHz	-96 dBm	100 kHz	
WA E-UTRA Band 74	1427 – 1470 MHz	-96 dBm	100 kHz	
WA E-UTRA Band 85	698 – 716 MHz	-96 dBm	100 kHz	
<p>NOTE 1: The co-location requirements do not apply for the 10 MHz frequency range immediately outside the BS transmit frequency range of a downlink operating band (see Table 5.0). The current state-of-the-art technology does not allow a single generic solution for co-location with other system on adjacent frequencies for 30dB BS-BS minimum coupling loss. However, there are certain site-engineering solutions that can be used. These techniques are addressed in TR 25.942 [4].</p> <p>NOTE 2: The table above assumes that two operating bands, where the frequency ranges would be overlapping, are not deployed in the same geographical area. For such a case of operation with overlapping frequency arrangements in the same geographical area, special co-existence requirements may apply that are not covered by the 3GPP specifications.</p>				

The power of any spurious emission shall not exceed the limits of Table 6.13 for a Medium Range (MR) BS where requirements for co-location with a BS type listed in the first column apply. For BS capable of multi-band operation, the exclusions and conditions in the Note column of Table 6.13 apply for each supported operating band. For BS capable of multi-band operation where multiple bands are mapped on separate antenna connectors, the exclusions and conditions in the Note column of Table 6.13 apply for the operating band supported at that antenna connector.



**Table 6.13: BS Spurious emissions limits for Medium Range BS co-located with another BS**

Type of co-located BS	Band for co-location requirement	Maximum Level	Measurement Bandwidth	Note
Micro GSM900	876-915 MHz	-91 dBm	100 kHz	
Micro DCS1800	1710 - 1785 MHz	-96 dBm	100 kHz	
Micro PCS1900	1850 - 1910 MHz	-96 dBm	100 kHz	
Micro GSM850	824 - 849 MHz	-91 dBm	100 kHz	
MR UTRA FDD Band I or E-UTRA Band 1	1920 - 1980 MHz	-91 dBm	100 kHz	
MR UTRA FDD Band II or E-UTRA Band 2	1850 - 1910 MHz	-91 dBm	100 kHz	
MR UTRA FDD Band III or E-UTRA Band 3	1710 - 1785 MHz	-91 dBm	100 kHz	
MR UTRA FDD Band IV or E-UTRA Band 4	1710 - 1755 MHz	-91 dBm	100 kHz	
MR UTRA FDD Band V or E-UTRA Band 5	824 - 849 MHz	-91 dBm	100 kHz	
MR UTRA FDD Band VI or XIX, or E-UTRA Band 6, 18 or 19	815 - 845 MHz	-91 dBm	100 kHz	
MR UTRA FDD Band VII or E-UTRA Band 7	2500 - 2570 MHz	-91 dBm	100 kHz	
MR UTRA FDD Band VIII or E-UTRA Band 8	880 - 915 MHz	-91 dBm	100 kHz	
MR UTRA FDD Band IX or E-UTRA Band 9	1749.9 - 1784.9 MHz	-91 dBm	100 kHz	
MR UTRA FDD Band X or E-UTRA Band 10	1710 - 1770 MHz	-91 dBm	100 kHz	
MR UTRA FDD Band XI or E-UTRA Band 11	1427.9 - 1447.9 MHz	-91 dBm	100 kHz	
MR UTRA FDD Band XII or E-UTRA Band 12	699 - 716 MHz	-91 dBm	100 kHz	
MR UTRA FDD Band XIII or E-UTRA Band 13	777 - 787 MHz	-91 dBm	100 kHz	
MR UTRA FDD Band XIV or E-UTRA Band 14	788 - 798 MHz	-91 dBm	100 kHz	
MR E-UTRA Band 17	704 – 716 MHz	-91 dBm	100 KHz	
MR UTRA FDD Band XX or E-UTRA Band 20	832 - 862 MHz	-91 dBm	100 kHz	
MR UTRA FDD Band XXI or E-UTRA Band 21	1447.9 - 1462.9 MHz	-91 dBm	100 kHz	
MR UTRA FDD Band XXII or E-UTRA Band 22	3410 – 3490 MHz	-91 dBm	100 kHz	
MR E-UTRA Band 23	2000 - 2020 MHz	-91 dBm	100 KHz	
MR E-UTRA Band 24	1626.5 – 1660.5 MHz	-91 dBm	100 KHz	
MR UTRA FDD Band XXV or E-UTRA Band 25	1850 - 1915 MHz	-91 dBm	100 kHz	
MR UTRA FDD Band XXVI or E-UTRA Band 26	814.849 MHz	-91 dBm	100 kHz	
MR E-UTRA Band 27	807 - 824 MHz	-91 dBm	100 KHz	
MR E-UTRA Band 28	703 – 748 MHz	-91 dBm	100 KHz	
MR E-UTRA Band 30	2305 - 2315 MHz	-91 dBm	100 KHz	
MR E-UTRA Band 31	452.5 -457.5 MHz	-91 dBm	100 kHz	
MR E-UTRA Band 33	1900 – 1920 MHz	-91 dBm	100 KHz	
MR E-UTRA Band 34	2010 – 2025 MHz	-91 dBm	100 KHz	
MR E-UTRA Band 38	2570 – 2620 MHz	-91 dBm	100 KHz	
MR E-UTRA Band 39	1880 – 1920MHz	-91 dBm	100 KHz	
MR E-UTRA Band 40	2300 – 2400MHz	-91 dBm	100 KHz	
MR E-UTRA Band 41	2496 – 2690 MHz	-91 dBm	100 KHz	
MR E-UTRA Band 42	3400 – 3600 MHz	-91 dBm	100 KHz	
MR E-UTRA Band 43	3600 – 3800 MHz	-91 dBm	100 KHz	
MR E-UTRA Band 44	703 - 803 MHz	-91 dBm	100 KHz	
MR E-UTRA Band 45	1447 - 1467 MHz	-91 dBm	100 KHz	
MR E-UTRA Band 46	5150 – 5925 MHz	-91 dBm	100 kHz	
MR E-UTRA Band 48	3550 – 3700 MHz	-91 dBm	100 kHz	
MR E-UTRA Band 50	1432 - 1517 MHz	-91 dBm	100 KHz	
MR E-UTRA Band 52	3300 – 3400 MHz	-91 dBm	100 KHz	

MR E-UTRA Band 65	1920 – 2110 MHz	-91 dBm	100 kHz	
MR E-UTRA Band 66	1710 – 1780 MHz	-91 dBm	100 kHz	
MR E-UTRA Band 68	698 - 728 MHz	-91 dBm	100 kHz	
MR E-UTRA Band 70	1695 – 1710 MHz	-91 dBm	100 kHz	
MR E-UTRA Band 71	663 - 698 MHz	-91 dBm	100 kHz	
MR E-UTRA Band 72	451 - 456 MHz	-91 dBm	100 kHz	
MR E-UTRA Band 73	450 - 455 MHz	-91 dBm	100 kHz	
MR E-UTRA Band 74	1427 – 1470 MHz	-91 dBm	100 kHz	
MR E-UTRA Band 85	698 – 716 MHz	-91 dBm	100 kHz	
<p>NOTE 1: The co-location requirements do not apply for the 10 MHz frequency range immediately outside the BS transmit frequency range of a downlink operating band (see Table 5.0). The current state-of-the-art technology does not allow a single generic solution for co-location with other system on adjacent frequencies for 30dB BS-BS minimum coupling loss. However, there are certain site-engineering solutions that can be used. These techniques are addressed in TR 25.942 [4].</p> <p>NOTE 2: The table above assumes that two operating bands, where the frequency ranges would be overlapping, are not deployed in the same geographical area. For such a case of operation with overlapping frequency arrangements in the same geographical area, special co-existence requirements may apply that are not covered by the 3GPP specifications.</p> <p>NOTE 3: The requirements in this table do not apply to a Rel-10 or an earlier release UTRA MR BS, which is manufactured before 31 December 2015 and upgraded to support features in the present release, where the upgrade does not affect existing RF parts of the radio unit related to this requirement. For such a UTRA MR BS, the corresponding requirements in Rel-10 or the earlier release, which the BS was manufactured for, shall apply.</p>				

The power of any spurious emission shall not exceed the limits of Table 6.14 for a Local Area (LA) BS where requirements for co-location with a BS type listed in the first column apply. For BS capable of multi-band operation, the exclusions and conditions in the Note column of Table 6.14 apply for each supported operating band. For BS capable of multi-band operation where multiple bands are mapped on separate antenna connectors, the exclusions and conditions in the Note column of Table 6.14 apply for the operating band supported at that antenna connector.

**Table 6.14: BS Spurious emissions limits for Local Area BS co-located with another BS**

Type of co-located BS	Band for co-location requirement	Maximum Level	Measurement Bandwidth	Note
Pico GSM900	876-915 MHz	-70 dBm	100 kHz	
Pico DCS1800	1710 - 1785 MHz	-80 dBm	100 kHz	
Pico PCS1900	1850 - 1910 MHz	-80 dBm	100 kHz	
Pico GSM850	824 - 849 MHz	-70 dBm	100 kHz	
LA UTRA FDD Band I or E-UTRA Band 1	1920 - 1980 MHz	-88 dBm	100 kHz	
LA UTRA FDD Band II or E-UTRA Band 2	1850 - 1910 MHz	-88 dBm	100 kHz	
LA UTRA FDD Band III or E-UTRA Band 3	1710 - 1785 MHz	-88 dBm	100 kHz	
LA UTRA FDD Band IV or E-UTRA Band 4	1710 - 1755 MHz	-88 dBm	100 kHz	
LA UTRA FDD Band V or E-UTRA Band 5	824 - 849 MHz	-88 dBm	100 kHz	
LA UTRA FDD Band VI or XIX or E-UTRA Band 6, 18 or 19	815 - 845 MHz	-88 dBm	100 kHz	
LA UTRA FDD Band VII or E-UTRA Band 7	2500 - 2570 MHz	-88 dBm	100 kHz	
LA UTRA FDD Band VIII or E-UTRA Band 8	880 - 915 MHz	-88 dBm	100 kHz	
LA UTRA FDD Band IX or E-UTRA Band 9	1749.9 - 1784.9 MHz	-88 dBm	100 kHz	
LA UTRA FDD Band X or E-UTRA Band 10	1710 - 1770 MHz	-88 dBm	100 kHz	
LA UTRA FDD Band XI or E-UTRA Band 11	1427.9 - 1447.9 MHz	-88 dBm	100 kHz	
LA UTRA FDD Band XII or E-UTRA Band 12	699 - 716 MHz	-88 dBm	100 kHz	
LA UTRA FDD Band XIII or E-UTRA Band 13	777 - 787 MHz	-88 dBm	100 kHz	
LA UTRA FDD Band XIV or E-UTRA Band 14	788 - 798 MHz	-88 dBm	100 kHz	
LA E-UTRA Band 17	704 - 716 MHz	-88 dBm	100 kHz	
LA UTRA FDD Band XX or E-UTRA Band 20	832 - 862 MHz	-88 dBm	100 kHz	
LA UTRA FDD Band XXI or E-UTRA Band 21	1447.9 - 1462.9 MHz	-88 dBm	100 kHz	
LA UTRA FDD Band XXII or E-UTRA Band 22	3410 – 3490 MHz	-88 dBm	100 kHz	
LA E-UTRA Band 23	2000 - 2020 MHz	-88 dBm	100 kHz	
LA E-UTRA Band 24	1626.5 – 1660.5 MHz	-88 dBm	100 kHz	
LA UTRA FDD Band XXV or E-UTRA Band 25	1850 - 1915 MHz	-88 dBm	100 kHz	
LA UTRA FDD Band XXVI or E-UTRA Band 26	814-849 MHz	-88 dBm	100 kHz	•
LA E-UTRA Band 27	807 - 824 MHz	-88 dBm	100 kHz	•
LA E-UTRA Band 28	703 – 748 MHz	-88 dBm	100 kHz	
LA E-UTRA Band 30	2305 – 2315 MHz	-88 dBm	100 kHz	
LA E-UTRA Band 31	452.5 -457.5 MHz	-88 dBm	100 kHz	
LA UTRA TDD Band a) or E-UTRA Band 33	1900 - 1920 MHz	-78 dBm	1 MHz	
LA UTRA TDD Band a) or E-UTRA Band 34	2010 - 2025 MHz	-78 dBm	1 MHz	
LA UTRA TDD Band d) or E-UTRA Band 38	2570 - 2620 MHz	-78 dBm	1 MHz	
LA UTRA TDD Band f) or E-UTRA Band 39	1880 - 1920MHz	-78 dBm	1 MHz	Applicable in China
LA UTRA TDD Band e) or E-UTRA Band 40	2300 - 2400MHz	-78 dBm	1 MHz	
LA E-UTRA Band 41	2496 - 2690MHz	-78 dBm	1 MHz	
LA E-UTRA Band 42	3400 - 3600MHz	-78 dBm	1 MHz	
LA E-UTRA Band 43	3600 - 3800MHz	-78 dBm	1 MHz	

LA E-UTRA Band 44	703 - 803 MHz	-78 dBm	1 MHz	
LA E-UTRA Band 45	1447 - 1467 MHz	-78 dBm	1 MHz	
LA E-UTRA Band 46	5150 - 5925 MHz	-78 dBm	1 MHz	
LA E-UTRA Band 48	3550 - 3700 MHz	-78 dBm	1 MHz	
LA E-UTRA Band 49	3550 - 3700 MHz	-78 dBm	1 MHz	
LA E-UTRA Band 50	1432 - 1517 MHz	-78 dBm	1 MHz	
LA E-UTRA Band 51	1427 - 1432 MHz	-78 dBm	1 MHz	
LA E-UTRA Band 52	3300 - 3400MHz	-78 dBm	1 MHz	
LA E-UTRA Band 65	1920 – 2110 MHz	-88 dBm	100 kHz	
LA E-UTRA Band 66	1710 – 1780 MHz	-88 dBm	100 kHz	
LA E-UTRA Band 68	698 - 728 MHz	-88 dBm	100 kHz	
LA E-UTRA Band 70	1695 – 1710 MHz	-88 dBm	100 kHz	
LA E-UTRA Band 71	663 - 698 MHz	-88 dBm	100 kHz	
LA E-UTRA Band 72	451 - 456 MHz	-88 dBm	100 kHz	
LA E-UTRA Band 73	450 - 455 MHz	-88 dBm	100 kHz	
LA E-UTRA Band 74	1427 – 1470 MHz	-88 dBm	100 kHz	
LA E-UTRA Band 85	698 – 716 MHz	-88 dBm	100 kHz	

NOTE 1: The co-location requirements do not apply for the 10 MHz frequency range immediately outside the BS transmit frequency range of a downlink operating band (see Table 5.0). The current state-of-the-art technology does not allow a single generic solution for co-location with other system on adjacent frequencies for 30dB BS-BS minimum coupling loss. However, there are certain site-engineering solutions that can be used. These techniques are addressed in TR 25.942 [4].

NOTE 2: The table above assumes that two operating bands, where the frequency ranges would be overlapping, are not deployed in the same geographical area. For such a case of operation with overlapping frequency arrangements in the same geographical area, special co-existence requirements may apply that are not covered by the 3GPP specifications.

NOTE 3: The requirements in this table do not apply to a Rel-10 or an earlier release UTRA LA BS, which is manufactured before 31 December 2013 and upgraded to support features in the present release, where the upgrade does not affect existing RF parts of the radio unit related to this requirement. For such a UTRA LA BS, the corresponding requirements in Rel-10 or the earlier release, which the BS was manufactured for, shall apply.

### 6.6.3.5 Co-existence with PHS

This requirement may be applied for the protection of PHS in geographic areas in which both PHS and UTRA FDD are deployed. This requirement is also applicable at specified frequencies falling between 12.5MHz below the first carrier frequency used and 12.5MHz above the last carrier frequency used.

#### 6.6.3.5.1 Minimum Requirement

The power of any spurious emission shall not exceed:

**Table 6.15: BS Spurious emissions limits for BS in geographic coverage area of PHS**

Band	Maximum Level	Measurement Bandwidth	Note
1884.5 - 1915.7 MHz	-41 dBm	300 kHz	

### 6.6.3.6 Co-existence with services in adjacent frequency bands

This requirement may be applied for the protection in bands adjacent to bands I or VII as defined in clause 5.2, in geographic areas in which both an adjacent band service and UTRA FDD are deployed.

## 6.6.3.6.1 Minimum requirement

The power of any spurious emission shall not exceed:

**Table 6.16: BS spurious emissions limits for protection of adjacent band services**

Operating Band	Band	Maximum Level	Measurement Bandwidth	Note
I	2100-2105 MHz	$-30 + 3.4 \cdot (f - 2100 \text{ MHz}) \text{ dBm}$	1 MHz	
	2175-2180 MHz	$-30 + 3.4 \cdot (2180 \text{ MHz} - f) \text{ dBm}$	1 MHz	
VII	2610-2615 MHz	$-30 + 3.4 \cdot (f - 2610 \text{ MHz}) \text{ dBm}$	1 MHz	
	2695-2700 MHz	$-30 + 3.4 \cdot (2700 \text{ MHz} - f) \text{ dBm}$	1 MHz	

NOTE: This requirement for the frequency range 2610-2615 MHz may be applied to geographic areas in which both UTRA-TDD and UTRA-FDD are deployed.

## 6.6.3.7 (Void)

**Table 6.17: Void**

**Table 6.18: Void**

## 6.6.3.8 Protection of Public Safety Operations

## 6.6.3.8.1 Minimum Requirement

This requirement shall be applied to BS operating in Bands XIII and XIV to ensure that appropriate interference protection is provided to 700 MHz public safety operations. This requirement is also applicable at specified frequencies falling between 12.5 MHz below the first carrier frequency used and 12.5 MHz above the last carrier frequency used.

The power of any spurious emission shall not exceed:

**Table 6.19: BS spurious emissions limits**

Operating Band	Band	Maximum Level	Measurement Bandwidth	Note
XIII	763 - 775 MHz	-46 dBm	6.25 kHz	
XIII	793 - 805 MHz	-46 dBm	6.25 kHz	
XIV	769 - 775 MHz	-46 dBm	6.25 kHz	
XIV	799 - 805 MHz	-46 dBm	6.25 kHz	

This requirement shall be applied to BS operating in Bands XXVI to ensure that appropriate interference protection is provided to 800 MHz public safety operations. This requirement is also applicable at specified frequencies falling between 12.5 MHz below the first carrier frequency used and 12.5 MHz above the last carrier frequency used.

The power of any spurious emission shall not exceed:

**Table 6.19A: BS spurious emissions limits**

Operating Band	Band	Maximum Level	Measurement Bandwidth	Note
XXVI	851 - 859 MHz	-13 dBm	100 kHz	Applicable for offsets > 37.5kHz from the channel edge

## 6.6.3.9 Co-existence with Home BS operating in other bands

These requirements may be applied for the protection of Home BS receivers operating in other bands. These requirements are only applicable to Home BS.

### 6.6.3.9.1 Minimum Requirements

The power of any spurious emission shall not exceed the limits of Table 6.20 for a Home BS where requirements for co-existence with a Home BS type listed in the first column apply.

**Table 6.20: Home BS Spurious emissions limits for co-existence with Home BS operating in other bands**



Type of Home BS	Band for co-existence requirement	Maximum Level	Measurement Bandwidth	Note
UTRA FDD Band I or E-UTRA Band 1	1920 - 1980 MHz	-71 dBm	100 kHz	
UTRA FDD Band II or E-UTRA Band 2	1850 - 1910 MHz	-71 dBm	100 kHz	
UTRA FDD Band III or E-UTRA Band 3	1710 - 1785 MHz	-71 dBm	100 kHz	
UTRA FDD Band IV or E-UTRA Band 4	1710 - 1755 MHz	-71 dBm	100 kHz	
UTRA FDD Band V or E-UTRA Band 5	824 - 849 MHz	-71 dBm	100 kHz	
UTRA FDD Band VI or XIX or E-UTRA Band 6, 19	815 - 845 MHz	-71 dBm	100 kHz	
UTRA FDD Band VII or E-UTRA Band 7	2500 - 2570 MHz	-71 dBm	100 kHz	
UTRA FDD Band VIII or E-UTRA Band 8	880 - 915 MHz	-71 dBm	100 kHz	
UTRA FDD Band IX or E-UTRA Band 9	1749.9 - 1784.9 MHz	-71 dBm	100 kHz	
UTRA FDD Band X or E-UTRA Band 10	1710 - 1770 MHz	-71 dBm	100 kHz	
UTRA FDD Band XI or E-UTRA Band 11	1427.9 - 1447.9 MHz	-71 dBm	100 kHz	
UTRA FDD Band XII or E-UTRA Band 12	699 - 716 MHz	-71 dBm	100 kHz	
UTRA FDD Band XIII or E-UTRA Band 13	777 - 787 MHz	-71 dBm	100 kHz	
UTRA FDD Band XIV or E-UTRA Band 14	788 - 798 MHz	-71 dBm	100 kHz	
E-UTRA Band 17	704 - 716 MHz	-71 dBm	100 kHz	
UTRA FDD Band XX or E-UTRA Band 20	832 - 862 MHz	-71 dBm	100 kHz	
UTRA FDD Band XXI or E-UTRA Band 21	1447.9 - 1462.9 MHz	-71 dBm	100 kHz	
UTRA FDD Band XXII or E-UTRA Band 22	3410 - 3490 MHz	-71 dBm	100 kHz	
E-UTRA FDD Band 24	1626.5 – 1660.5 MHz	-71 dBm	100 kHz	
UTRA FDD Band XXV or E-UTRA Band 25	1850-1915 MHz	-71 dBm	100 kHz	
UTRA FDD Band XXVI or E-UTRA Band 26	814-849 MHz	-71dBm	100 kHz	
E-UTRA FDD Band 27	807 – 824 MHz	-71 dBm	100 kHz	
E-UTRA Band 28	703 – 748 MHz	-71dBm	100 kHz	
E-UTRA Band 30	2305 – 2315 MHz	-71dBm	100 kHz	
UTRA TDD Band a) or E-UTRA Band 33	1900 - 1920 MHz	-71 dBm	100 kHz	
UTRA TDD Band a) or E-UTRA Band 34	2010 - 2025 MHz	-71 dBm	100 kHz	
UTRA TDD Band d) or E-UTRA Band 38	2570 - 2620 MHz	-71 dBm	100 kHz	
UTRA TDD Band f) or E-UTRA Band 39	1880 - 1920 MHz	-71 dBm	100 kHz	
UTRA TDD Band e) E-UTRA Band 40	2300 - 2400 MHz	-71 dBm	100 kHz	
E-UTRA Band 41	2496 - 2690 MHz	-71 dBm	100 kHz	
E-UTRA Band 42	3400 -3600 MHz	-71 dBm	100 kHz	
E-UTRA Band 43	3600 -3800 MHz	-71 dBm	100 kHz	
E-UTRA Band 44	703 - 803 MHz	-71 dBm	100 kHz	
E-UTRA Band 48	3550 -3700 MHz	-71 dBm	100 kHz	
E-UTRA Band 50	1432 – 1517 MHz	-71 dBm	100 kHz	
E-UTRA Band 51	1427 – 1432 MHz	-71 dBm	100 kHz	
E-UTRA Band 52	3300 -3400 MHz	-71 dBm	100 kHz	
E-UTRA Band 65	1920 – 2110 MHz	-71 dBm	100 kHz	
E-UTRA Band 66	1710 – 1780 MHz	-71 dBm	100 kHz	
E-UTRA Band 68	698-728 MHz	-71 dBm	100 kHz	

E-UTRA Band 70	1695 - 1710 MHz	-71 dBm	100 kHz	
E-UTRA Band 71	663 – 698 MHz	-71 dBm	100 kHz	
E-UTRA Band 74	1427 – 1470 MHz	-71 dBm	100 kHz	
E-UTRA Band 85	698 – 716 MHz	-71 dBm	100 kHz	

## 6.7 Transmitter intermodulation

The transmitter intermodulation requirement is a measure of the capability of the transmitter to inhibit the generation of signals in its non-linear elements caused by presence of the wanted signal and an interfering signal reaching the transmitter via the antenna.

The transmitter intermodulation level is the power of the intermodulation products when a WCDMA interfering signal is injected into the antenna connector at a power level of 30 dB lower than the rated total output power in the operating band.

For BS capable of multi-band operation where multiple bands are mapped on separate antenna connectors, the single-band requirements apply regardless of the interfering signals position relative to the Inter RF Bandwidth gap.

For multi-carrier operation, the interfering signal offset is defined relative to the lower/upper edge of the wanted signal or edge of sub-block inside a gap. The interfering signal frequency offset shall be as in Table 6.21.

**Table 6.21: Interfering signal frequency offset**

Parameter	Value
Interfering signal centre frequency offset from the wanted signal centre frequency	-5 MHz -10 MHz -15 MHz +5 MHz +10 MHz +15 MHz
Interfering signal centre frequency offset from the lower/upper edge of the wanted signal or edge of sub-block inside a gap	-2.5 MHz -7.5 MHz -12.5 MHz +2.5 MHz +7.5 MHz +12.5 MHz
NOTE 1: Interference frequencies that are outside of any allocated frequency band for UTRA-FDD downlink specified in subclause 5.2 are excluded from the requirement, unless the interfering signal positions fall within the frequency range of adjacent downlink operating bands in the same geographical area.	
NOTE 2: NOTE 1 is not applied in Band I, III, VI, VIII, IX, XI, XIX, XXI, and XXXII operating within 1475.9-1495.9MHz, in certain regions.	

### 6.7.1 Minimum requirement

The transmitter intermodulation level shall not exceed the out of band emission or the spurious emission requirements of clauses 6.6.2 and 6.6.3 in the presence of a WCDMA interfering signal with a power level 30 dB lower than the rated total output power in the operating band.

For a BS operating in non-contiguous spectrum, the requirement is also applicable inside a sub-block gap for interfering signal offsets where the interfering signal falls completely within the sub-block gap. The interfering signal offset is defined relative to the sub-block edges.

For a BS capable of multi-band operation, the requirement is also applicable inside a Inter RF Bandwidth gap for interfering signal offsets where the interfering signal falls completely within the Inter RF Bandwidth gap.

## 6.8 Transmit modulation

Transmit modulation is specified in three parts, Frequency Error, Error Vector Magnitude and Peak Code Domain Error. These specifications are made with reference to a theoretical modulated waveform.

The theoretical modulated waveform is created by modulating a carrier at the assigned carrier frequency using the same data as was used to generate the measured waveform. The chip modulation rate for the theoretical waveform shall be

exactly 3.84 Mcps. The code powers of the theoretical waveform shall be the same as the measured waveform, rather than the nominal code powers used to generate the test signal.

### 6.8.1 Transmit pulse shape filter

The transmit pulse-shaping filter is a root-raised cosine (RRC) with roll-off  $\alpha = 0.22$  in the frequency domain. The impulse response of the chip impulse filter  $RC_0(t)$  is

$$RC_0(t) = \frac{\sin\left(\pi \frac{t}{T_c}(1-\alpha)\right) + 4\alpha \frac{t}{T_c} \cos\left(\pi \frac{t}{T_c}(1+\alpha)\right)}{\pi \frac{t}{T_c} \left(1 - \left(4\alpha \frac{t}{T_c}\right)^2\right)}$$

Where the roll-off factor  $\alpha = 0.22$  and the chip duration:

$$T_c = \frac{1}{\text{chiprate}} \approx 0.26042 \mu\text{s}$$

### 6.8.2 Error Vector Magnitude

The Error Vector Magnitude is a measure of the difference between the reference waveform and the measured waveform. This difference is called the error vector. Both waveforms pass through a matched Root Raised Cosine filter with bandwidth 3.84 MHz and roll-off  $\alpha = 0.22$ . Both waveforms are then further modified by selecting the frequency, absolute phase, absolute amplitude and chip clock timing so as to minimise the error vector. The EVM result is defined as the square root of the ratio of the mean error vector power to the mean reference power expressed as a %. The measurement interval is one timeslot as defined by the C-PICH (when present) otherwise the measurement interval is one timeslot starting with the beginning of the SCH. The requirement is valid over the total power dynamic range as specified in subclause 6.4.3.

#### 6.8.2.1 Minimum requirement

The Error Vector Magnitude shall not be worse than 17.5 % when the base station is transmitting a composite signal using only QPSK modulation.

The Error Vector Magnitude shall not be worse than 12.5 % when the base station is transmitting a composite signal that includes 16QAM modulation.

### 6.8.3 Peak code Domain error

The Peak Code Domain Error is computed by projecting the error vector (as defined in 6.8.2) onto the code domain at a specified spreading factor. The Code Domain Error for every code in the domain is defined as the ratio of the mean power of the projection onto that code, to the mean power of the composite reference waveform. This ratio is expressed in dB. The Peak Code Domain Error is defined as the maximum value for the Code Domain Error for all codes. The measurement interval is one timeslot as defined by the C-PICH (when present) otherwise the measurement interval is one timeslot starting with the beginning of the SCH.

#### 6.8.3.1 Minimum requirement

The peak code domain error shall not exceed -33 dB at spreading factor 256.

### 6.8.4 Time alignment error

This requirement applies to frame timing in Tx diversity, MIMO transmission, DC-HSDPA, DB-DC-HSDPA, 4C-HSDPA, NC-4C-HSDPA, 8C-HSDPA and their combinations.

Frames of the WCDMA signals present at the BS transmitter antenna port(s) are not perfectly aligned in time. In relation to each other, the RF signals present at the BS transmitter antenna port(s) experience certain timing differences.

For a specific set of signals/transmitter configuration/transmission mode, Time Alignment Error (TAE) is defined as the largest timing difference between any two signals.

### 6.8.4.1 Minimum Requirements

For MIMO or TX diversity transmissions, in each cell, TAE shall not exceed  $\frac{1}{4} T_c$ .

For transmission of multiple cells, with or without MIMO or TX diversity, in the same frequency band, TAE shall not exceed  $\frac{1}{2} T_c$ .

For transmission of multiple cells, with or without MIMO or TX diversity, in different frequency bands, TAE shall not exceed  $5 T_c$ .

### 6.8.5 Relative Code Domain Error for 64QAM modulation

The Relative Code Domain Error is computed by projecting the error vector (as defined in 6.8.2) onto the code domain at a specified spreading factor. Only the active code channels in the composite reference waveform are considered for this requirement. The Relative Code Domain Error for every active code is defined as the ratio of the mean power of the error projection onto that code, to the mean power of the active code in the composite reference waveform. This ratio is expressed in dB. The measurement interval is one frame.

The requirement for Relative Code Domain Error is only applicable for 64QAM modulated codes.

#### 6.8.5.1 Minimum requirement

The average Relative Code Domain Error for 64QAM modulated codes shall not exceed -21 dB at spreading factor 16.

## 7 Receiver characteristics

### 7.1 General

The requirements in clause 7 are expressed for a single receiver antenna connector. For receivers with antenna diversity, the requirements apply for each receiver antenna connector.

For ACS, blocking and intermodulation characteristics, the negative offsets of the interfering signal apply relative to the assigned channel frequency of the lowest carrier frequency used and positive offsets of the interfering signal apply relative to the assigned channel frequency of the highest carrier frequency used.

A BS supporting DC-HSUPA receives two cells simultaneously on adjacent carrier frequencies.

A BS supporting DB-DC-HSUPA receives two cells simultaneously in different operating bands.

Unless otherwise stated, the receiver characteristics are specified at the BS antenna connector (test port A) with a full complement of transceivers for the configuration in normal operating conditions. The requirements in clause 7 shall be met with the transmitter(s) on. If any external apparatus such as a RX amplifier, a filter or the combination of such devices is used, requirements apply at the far end antenna connector (port B).

NOTE: In normal operating conditions the BS is configured to transmit and receive at the same time. The transmitter may be off for some of the tests as specified in 25.141.

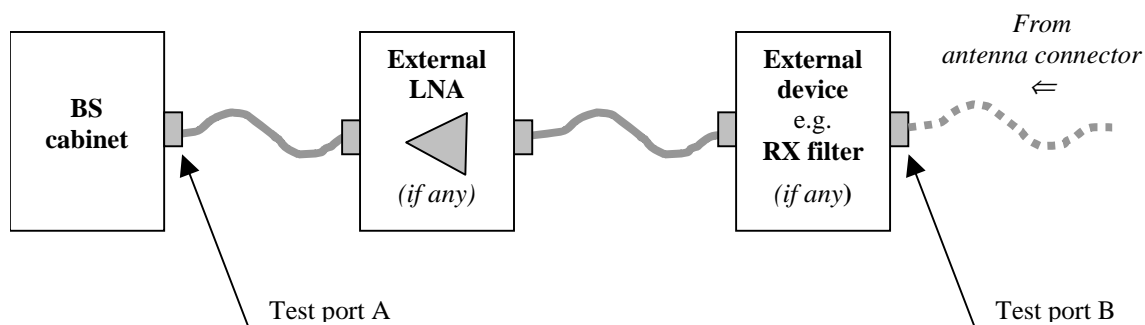

Figure 7.1: Receiver test ports

## 7.2 Reference sensitivity level

The reference sensitivity level is the minimum mean power received at the antenna connector at which the Bit Error Ratio (BER) shall not exceed the specific value indicated in section 7.2.1.

### 7.2.1 Minimum requirement

Using the reference measurement channel specification in Annex A, the reference sensitivity level and performance of the BS shall be as specified in Table 7.1.

**Table 7.1: BS reference sensitivity levels**

BS Class	Reference measurement channel data rate	BS reference sensitivity level (dBm)	BER
Wide Area BS	12.2 kbps	-121	BER shall not exceed 0.001
Medium Range BS	12.2 kbps	-111	BER shall not exceed 0.001
Local Area / Home BS	12.2 kbps	-107	BER shall not exceed 0.001

### 7.2.2 Maximum Frequency Deviation for Receiver Performance

The need for such a requirement is for further study.

## 7.3 Dynamic range

Receiver dynamic range is the receiver ability to handle a rise of interference in the reception frequency channel. The receiver shall fulfil a specified BER requirement for a specified sensitivity degradation of the wanted signal in the presence of an interfering AWGN signal in the same reception frequency channel.

### 7.3.1 Minimum requirement

The BER shall not exceed 0.001 for the parameters specified in Table 7.2.

**Table 7.2: Dynamic range**

Parameter	Level Wide Area BS	Level Medium Range BS	Level Local Area / Home BS	Level Home BS <sup>1</sup>	Unit
Reference measurement channel data rate	12.2	12.2	12.2	12.2	kbps
Wanted signal mean power	-91	-81	-77	-57	dBm
Interfering AWGN signal	-73	-63	-59	-39	dBm/3.84 MHz

Note 1: For Home BS, this additional requirement ensures the performance is met over a large dynamic range.

## 7.4 Adjacent Channel Selectivity (ACS)

Adjacent channel selectivity (ACS) is a measure of the receiver ability to receive a wanted signal at its assigned channel frequency in the presence of an adjacent channel signal at a given frequency offset from the center frequency of the assigned channel. ACS is the ratio of the receiver filter attenuation on the assigned channel frequency to the receiver filter attenuation on the adjacent channel(s).

The interference signal is offset from the wanted signal by the frequency offset  $F_{uw}$ . The interference signal shall be a W-CDMA signal as specified in Annex C.

For a BS operating in non-contiguous spectrum within any operating band, the requirement applies in addition inside any sub-block gap, in case the sub-block gap size is at least 5MHz. The interfering signal offset is defined relative to the lower/upper sub-block edge inside the sub-block gap and is equal to  $-2.5\text{MHz}/+2.5\text{MHz}$ , respectively.

For a BS capable of multi-band operation, the requirement applies in addition inside any Inter RF Bandwidth gap, in case the Inter RF Bandwidth gap size is at least 5MHz. The interfering signal offset is defined relative to lower/upper Base Station RF Bandwidth edges inside the Inter RF Bandwidth gap and is equal to  $-2.5\text{MHz}/+2.5\text{MHz}$ , respectively.

### 7.4.1 Minimum requirement

The BER shall not exceed 0.001 for the parameters specified in Table 7.3.

**Table 7.3: Adjacent channel selectivity**

Parameter	Level Wide Area BS	Level Medium Range BS	Level Local Area / Home BS	Level Home BS <sup>1</sup>	Unit
Data rate	12.2	12.2	12.2	12.2	kbps
Wanted signal mean power	-115	-105	-101	-91	dBm
Interfering signal mean power	-52	-42	-38	-28	dBm
Fuw offset (Modulated)	$\pm 5$	$\pm 5$	$\pm 5$	$\pm 5$	MHz
Note 1: For Home BS, this additional requirement ensures the performance is met over a large dynamic range.					

### 7.4.2 Minimum requirement - Co-location with UTRA-TDD

The current state-of-the-art technology does not allow a single generic solution for co-location with UTRA-TDD on adjacent frequencies for 30dB BS-BS minimum coupling loss.

Further information and analysis for this scenario can be found in TR 25.942 [4].

## 7.5 Blocking characteristics

The blocking characteristics are measure of the receiver ability to receive a wanted signal at its assigned channel frequency in the presence of an unwanted interferer on frequencies other than those of the adjacent channels. The interferences are either a WDCMA signal for in-band blocking or a CW signal for out-of-band blocking. The blocking performance requirement applies as specified in the tables 7.4 to 7.5B below, using a 1 MHz step size.

NOTE: The minimum requirements for Home BS when co-located with DECT and WiFi/WLAN are FFS.

### 7.5.1 Minimum requirement

The static reference performance as specified in clause 7.2.1 shall be met with a wanted and an interfering signal coupled to BS antenna input using the following parameters.

For a BS operating in non-contiguous spectrum within any operating band, the blocking requirement applies in addition inside any sub-block gap, in case the sub-block gap size is at least 15MHz. The interfering signal offset is defined relative to the lower/upper sub-block edge inside the sub-block gap and is equal to  $-7.5\text{MHz}/+7.5\text{MHz}$ , respectively.

For a BS operating in non-contiguous spectrum within any operating band, the narrowband blocking requirement applies in addition inside any sub-block gap, in case the sub-block gap size is at least 400kHz or 600kHz, depending on the operating band. The interfering signal offset is defined relative to the lower/upper sub-block edge inside the sub-block gap and is equal to  $-200\text{kHz}/+200\text{kHz}$  or  $-300\text{kHz}/+300\text{kHz}$ , respectively.

For a BS capable of multi-band operation, the requirement in the in-band blocking frequency range applies for each supported operating band. The requirement applies in addition inside any Inter RF Bandwidth gap, in case the Inter RF Bandwidth gap size is at least 15MHz. The interfering signal offset is defined relative to lower/upper Base Station RF bandwidth edges inside the Inter RF Bandwidth gap and is equal to  $-7.5\text{MHz}/+7.5\text{MHz}$ , respectively.

For a BS capable of multi-band operation, the requirement in the out-of-band blocking frequency ranges apply for each operating band, with the exception that the in-band blocking frequency ranges of all supported operating bands according to Tables 7.4, 7.4A and 7.4B shall be excluded from the out-of-band blocking requirement.

For a BS capable of multi-band operation, the narrowband blocking requirement applies in addition inside any Inter RF Bandwidth gap, in case the Inter RF Bandwidth gap size is at least 400kHz or 600kHz, depending on the operating band. The interfering signal offset is defined relative to lower/upper Base Station RF Bandwidth edges inside the Inter RF Bandwidth gap and is equal to -200kHz/+200kHz or -300kHz/+300kHz, respectively.

**Table 7.4: Blocking performance requirement for Wide Area BS**



Operating Band	Center Frequency of Interfering Signal	Interfering Signal mean power	Wanted Signal mean power	Minimum Offset of Interfering Signal	Type of Interfering Signal
I	1920 - 1980 MHz	-40 dBm	-115 dBm	$\pm 10$ MHz	WCDMA signal *
	1900 - 1920 MHz 1980 - 2000 MHz	-40 dBm	-115 dBm	$\pm 10$ MHz	WCDMA signal *
	1 MHz - 1900 MHz 2000 MHz - 12750 MHz	-15 dBm	-115 dBm	—	CW carrier
II	1850 - 1910 MHz	-40 dBm	-115 dBm	$\pm 10$ MHz	WCDMA signal *
	1830 - 1850 MHz 1910 - 1930 MHz	-40 dBm	-115 dBm	$\pm 10$ MHz	WCDMA signal *
	1 MHz - 1830 MHz 1930 MHz - 12750 MHz	-15 dBm	-115 dBm	—	CW carrier
III	1710 - 1785 MHz	-40 dBm	-115 dBm	$\pm 10$ MHz	WCDMA signal *
	1690 - 1710 MHz 1785 - 1805 MHz	-40 dBm	-115 dBm	$\pm 10$ MHz	WCDMA signal *
	1 MHz - 1690 MHz 1805 MHz - 12750 MHz	-15 dBm	-115 dBm	—	CW carrier
IV	1710 - 1755 MHz	-40 dBm	-115 dBm	$\pm 10$ MHz	WCDMA signal *
	1690 - 1710 MHz 1755 - 1775 MHz	-40 dBm	-115 dBm	$\pm 10$ MHz	WCDMA signal *
	1 MHz - 1690 MHz 1775 MHz - 12750 MHz	-15 dBm	-115 dBm	—	CW carrier
V	824-849 MHz	-40 dBm	-115 dBm	$\pm 10$ MHz	WCDMA signal *
	804-824 MHz 849-869 MHz	-40 dBm	-115 dBm	$\pm 10$ MHz	WCDMA signal *
	1 MHz - 804 MHz 869 MHz - 12750 MHz	-15 dBm	-115 dBm	—	CW carrier
VI	810 - 830 MHz 840 - 860 MHz	-40 dBm	-115 dBm	$\pm 10$ MHz	WCDMA signal *
	1 MHz - 810 MHz 860 MHz - 12750 MHz	-15 dBm	-115 dBm	—	CW carrier
VII	2500 - 2570 MHz	-40 dBm	-115 dBm	$\pm 10$ MHz	WCDMA signal *
	2480 - 2500 MHz 2570 - 2590 MHz	-40 dBm	-115 dBm	$\pm 10$ MHz	WCDMA signal *
	1 MHz - 2480 MHz 2590 MHz - 12750 MHz	-15 dBm	-115 dBm	—	CW carrier
VIII	880 - 915 MHz	-40 dBm	-115 dBm	$\pm 10$ MHz	WCDMA signal *
	860 - 880 MHz 915 - 925 MHz	-40 dBm	-115 dBm	$\pm 10$ MHz	WCDMA signal *
	1 MHz - 860 MHz 925 MHz - 12750 MHz	-15 dBm	-115 dBm	—	CW carrier
IX	1749.9 - 1784.9 MHz	-40 dBm	-115 dBm	$\pm 10$ MHz	WCDMA signal *
	1729.9 - 1749.9 MHz 1784.9 - 1804.9 MHz	-40 dBm	-115 dBm	$\pm 10$ MHz	WCDMA signal *
	1 MHz - 1729.9 MHz 1804.9 MHz - 12750 MHz	-15 dBm	-115 dBm	—	CW carrier
X	1710 - 1770 MHz	-40 dBm	-115 dBm	$\pm 10$ MHz	WCDMA signal *
	1690 - 1710 MHz 1770 - 1790 MHz	-40 dBm	-115 dBm	$\pm 10$ MHz	WCDMA signal *
	1 MHz - 1690 MHz 1790 MHz - 12750 MHz	-15 dBm	-115 dBm	—	CW carrier
XI	1427.9 - 1447.9 MHz	-40 dBm	-115 dBm	$\pm 10$ MHz	WCDMA signal *
	1407.9 - 1427.9 MHz 1447.9 - 1467.9 MHz	-40 dBm	-115 dBm	$\pm 10$ MHz	WCDMA signal *
	1 MHz - 1407.9 MHz 1467.9 MHz - 12750 MHz	-15 dBm	-115 dBm	—	CW carrier
XII	699 - 716 MHz	-40 dBm	-115 dBm	$\pm 10$ MHz	WCDMA signal *
	679 - 699 MHz 716 - 729 MHz	-40 dBm	-115 dBm	$\pm 10$ MHz	WCDMA signal *
	1 MHz - 679 MHz 729 MHz - 12750 MHz	-15 dBm	-115 dBm	—	CW carrier
XIII	777 - 787 MHz	-40 dBm	-115 dBm	$\pm 10$ MHz	WCDMA signal *

	757 - 777 MHz 787 - 807 MHz	-40 dBm	-115 dBm	$\pm 10$ MHz	WCDMA signal *
	1 - 757 MHz 807 MHz - 12750 MHz	-15 dBm	-115 dBm	—	CW carrier
XIV	788 - 798 MHz	-40 dBm	-115 dBm	$\pm 10$ MHz	WCDMA signal *
	768 - 788 MHz 798 - 818 MHz	-40 dBm	-115 dBm	$\pm 10$ MHz	WCDMA signal *
	1 - 768 MHz 818 MHz - 12750 MHz	-15 dBm	-115 dBm	—	CW carrier
XIX	830 - 845 MHz	-40 dBm	-115 dBm	$\pm 10$ MHz	WCDMA signal *
	810 - 830 MHz 845 - 865 MHz	-40 dBm	-115 dBm	$\pm 10$ MHz	WCDMA signal *
	1 MHz - 810 MHz 865 MHz - 12750 MHz	-15 dBm	-115 dBm	—	CW carrier
XX	832 - 862 MHz	-40 dBm	-115 dBm	$\pm 10$ MHz	WCDMA signal *
	821 - 832 MHz 862 - 882 MHz	-40 dBm	-115 dBm	$\pm 10$ MHz	WCDMA signal *
	1 MHz - 821 MHz 882 MHz - 12750 MHz	-15 dBm	-115 dBm	—	CW carrier
XXI	1447.9 - 1462.9 MHz	-40 dBm	-115 dBm	$\pm 10$ MHz	WCDMA signal *
	1427.9 - 1447.9 MHz 1462.9 - 1482.9 MHz	-40 dBm	-115 dBm	$\pm 10$ MHz	WCDMA signal *
	1 MHz - 1427.9 MHz 1482.9 MHz - 12750 MHz	-15 dBm	-115 dBm	—	CW carrier
XXII	3410 - 3490 MHz	-40 dBm	-115 dBm	$\pm 10$ MHz	WCDMA signal *
	3390 - 3410 MHz 3490 - 3510 MHz	-40 dBm	-115 dBm	$\pm 10$ MHz	WCDMA signal *
	1 MHz - 3390 MHz 3510 MHz - 12750 MHz	-15 dBm	-115 dBm	—	CW carrier
XXV	1850 - 1915 MHz	-40 dBm	-115 dBm	$\pm 10$ MHz	WCDMA signal *
	1830 - 1850 MHz 1915 - 1930 MHz	-40 dBm	-115 dBm	$\pm 10$ MHz	WCDMA signal *
	1 MHz - 1830 MHz 1930 MHz - 12750 MHz	-15 dBm	-115 dBm	—	CW carrier
XXVI	814-849 MHz	-40 dBm	-115 dBm	$\pm 10$ MHz	WCDMA signal *
	794-814 MHz 849-859 MHz	-40 dBm	-115 dBm	$\pm 10$ MHz	WCDMA signal *
NOTE *: The characteristics of the W-CDMA interference signal are specified in Annex C.					
NOTE **: For a BS capable of multiband operation, in case of interfering signal that is not in the in-band blocking frequency range of the operating band where the wanted signal is present, and not in an adjacent or overlapping band, the wanted Signal mean power is equal to -119.6 dBm.					

NOTE: Table 7.4 assumes that two operating bands, where the downlink frequencies (see Table 5.0) of one band would be within the in-band blocking region of the other band, are not deployed in the same geographical area.

**Table 7.4A: Blocking performance requirement for Medium range BS**

Operating Band	Center Frequency of Interfering Signal	Interfering Signal mean power	Wanted Signal mean power	Minimum Offset of Interfering Signal	Type of Interfering Signal
I	1920 - 1980 MHz	-35 dBm	-105 dBm	$\pm 10$ MHz	WCDMA signal *
	1900 - 1920 MHz 1980 - 2000 MHz	-35 dBm	-105 dBm	$\pm 10$ MHz	WCDMA signal *
	1 MHz - 1900 MHz 2000 MHz - 12750 MHz	-15 dBm	-105 dBm	—	CW carrier
II	1850 - 1910 MHz	-35 dBm	-105 dBm	$\pm 10$ MHz	WCDMA signal *
	1830 - 1850 MHz 1910 - 1930 MHz	-35 dBm	-105 dBm	$\pm 10$ MHz	WCDMA signal *
	1 MHz - 1830 MHz 1930 MHz - 12750 MHz	-15 dBm	-105 dBm	—	CW carrier
III	1710 - 1785 MHz	-35 dBm	-105 dBm	$\pm 10$ MHz	WCDMA signal *
	1690 - 1710 MHz 1785 - 1805 MHz	-35 dBm	-105 dBm	$\pm 10$ MHz	WCDMA signal *
	1 MHz - 1690 MHz 1805 MHz - 12750 MHz	-15 dBm	-105 dBm	—	CW carrier
IV	1710 - 1755 MHz	-35 dBm	-105 dBm	$\pm 10$ MHz	WCDMA signal *
	1690 - 1710 MHz 1755 - 1775 MHz	-35 dBm	-105 dBm	$\pm 10$ MHz	WCDMA signal *
	1 MHz - 1690 MHz 1775 MHz - 12750 MHz	-15 dBm	-105 dBm	—	CW carrier
V	824-849 MHz	-35 dBm	-105 dBm	$\pm 10$ MHz	WCDMA signal *
	804-824 MHz 849-869 MHz	-35 dBm	-105 dBm	$\pm 10$ MHz	WCDMA signal *
	1 MHz - 804 MHz 869 MHz - 12750 MHz	-15 dBm	-105 dBm	—	CW carrier
VI	810 - 830 MHz 840 - 860 MHz	-35 dBm	-105 dBm	$\pm 10$ MHz	WCDMA signal *
	1 MHz - 810 MHz 860 MHz - 12750 MHz	-15 dBm	-105 dBm	—	CW carrier
VII	2500 - 2570 MHz	-35 dBm	-105 dBm	$\pm 10$ MHz	WCDMA signal *
	2480 - 2500 MHz 2570 - 2590 MHz	-35 dBm	-105 dBm	$\pm 10$ MHz	WCDMA signal *
	1 MHz - 2480 MHz 2590 MHz - 12750 MHz	-15 dBm	-105 dBm	—	CW carrier
VIII	880 - 915 MHz	-35 dBm	-105 dBm	$\pm 10$ MHz	WCDMA signal *
	860 - 880 MHz 915 - 925 MHz	-35 dBm	-105 dBm	$\pm 10$ MHz	WCDMA signal *
	1 MHz - 860 MHz 925 MHz - 12750 MHz	-15 dBm	-105 dBm	—	CW carrier
IX	1749.9 - 1784.9 MHz	-35 dBm	-105 dBm	$\pm 10$ MHz	WCDMA signal *
	1729.9 - 1749.9 MHz 1784.9 - 1804.9 MHz	-35 dBm	-105 dBm	$\pm 10$ MHz	WCDMA signal *
	1 MHz - 1729.9 MHz 1804.9 MHz - 12750 MHz	-15 dBm	-105 dBm	—	CW carrier
X	1710 - 1770 MHz	-35 dBm	-105 dBm	$\pm 10$ MHz	WCDMA signal *
	1690 - 1710 MHz 1770 - 1790 MHz	-35 dBm	-105 dBm	$\pm 10$ MHz	WCDMA signal *
	1 MHz - 1690 MHz 1790 MHz - 12750 MHz	-15 dBm	-105 dBm	—	CW carrier
XI	1427.9 - 1447.9 MHz	-35 dBm	-105 dBm	$\pm 10$ MHz	WCDMA signal *
	1407.9 - 1427.9 MHz 1447.9 - 1467.9 MHz	-35 dBm	-105 dBm	$\pm 10$ MHz	WCDMA signal *
	1 MHz - 1407.9 MHz 1467.9 MHz - 12750 MHz	-15 dBm	-105 dBm	—	CW carrier
XII	699 - 716 MHz	-35dBm	-105 dBm	$\pm 10$ MHz	WCDMA signal *
	679 - 699 MHz 716 - 729 MHz	-35 dBm	-105 dBm	$\pm 10$ MHz	WCDMA signal *
	1 MHz - 678 MHz 728 MHz - 12750 MHz	-15 dBm	-105 dBm	—	CW carrier
XIII	777 - 787 MHz	-35 dBm	-105 dBm	$\pm 10$ MHz	WCDMA signal *

	757 - 777 MHz 787 - 807 MHz	-35 dBm	-105 dBm	$\pm 10$ MHz	WCDMA signal *
	1 - 757 MHz 807 MHz - 12750 MHz	-15 dBm	-105 dBm	—	CW carrier
XIV	788 - 798 MHz	-35 dBm	-105 dBm	$\pm 10$ MHz	WCDMA signal *
	768 - 788 MHz 798 - 818 MHz	-35 dBm	-105 dBm	$\pm 10$ MHz	WCDMA signal *
	1 - 768 MHz 818 MHz - 12750 MHz	-15 dBm	-105 dBm	—	CW carrier
XIX	830 - 845 MHz	-35 dBm	-105 dBm	$\pm 10$ MHz	WCDMA signal *
	810 - 830 MHz 845 - 865 MHz	-35 dBm	-105 dBm	$\pm 10$ MHz	WCDMA signal *
	1 MHz - 810 MHz 865 MHz - 12750 MHz	-15 dBm	-105 dBm	—	CW carrier
XX	832 - 862 MHz	-35 dBm	-105 dBm	$\pm 10$ MHz	WCDMA signal *
	821 - 832 MHz 862 - 882 MHz	-35 dBm	-105 dBm	$\pm 10$ MHz	WCDMA signal *
	1 MHz - 821 MHz 882 MHz - 12750 MHz	-15 dBm	-105 dBm	—	CW carrier
XXI	1447.9 - 1462.9 MHz	-35 dBm	-105 dBm	$\pm 10$ MHz	WCDMA signal *
	1427.9 - 1447.9 MHz 1462.9 - 1482.9 MHz	-35 dBm	-105 dBm	$\pm 10$ MHz	WCDMA signal *
	1 MHz - 1427.9 MHz 1482.9 MHz - 12750 MHz	-15 dBm	-105 dBm	—	CW carrier
XXII	3410 - 3490 MHz	-35 dBm	-105 dBm	$\pm 10$ MHz	WCDMA signal *
	3390 - 3410 MHz 3490 - 3510 MHz	-35 dBm	-105 dBm	$\pm 10$ MHz	WCDMA signal *
	1 MHz - 3390 MHz 3510 MHz - 12750 MHz	-15 dBm	-105 dBm	—	CW carrier
XXV	1850 - 1915 MHz	-35 dBm	-105 dBm	$\pm 10$ MHz	WCDMA signal *
	1830 - 1850 MHz 1915 - 1930 MHz	-35 dBm	-105 dBm	$\pm 10$ MHz	WCDMA signal *
	1 MHz - 1830 MHz 1930 MHz - 12750 MHz	-15 dBm	-105 dBm	—	CW carrier
XXVI	814-849 MHz	-35 dBm	-105 dBm	$\pm 10$ MHz	WCDMA signal *
	794-814 MHz 849-859 MHz	-35 dBm	-105 dBm	$\pm 10$ MHz	WCDMA signal *
NOTE *: The characteristics of the W-CDMA interference signal are specified in Annex C.					
NOTE **: For a BS capable of multiband operation, in case of interfering signal that is not in the in-band blocking frequency range of the operating band where the wanted signal is present, and not in an adjacent or overlapping band, the wanted Signal mean power is equal to -109.6 dBm.					

NOTE: Table 7.4A assumes that two operating bands, where the downlink frequencies (see Table 5.0) of one band would be within the in-band blocking region of the other band, are not deployed in the same geographical area.

**Table 7.4B: Blocking performance requirement for Local Area / Home BS**

Operating Band	Center Frequency of Interfering Signal	Interfering Signal mean power	Wanted Signal mean power	Minimum Offset of Interfering Signal	Type of Interfering Signal
I	1920 - 1980 MHz	-30 dBm	-101 dBm	$\pm 10$ MHz	WCDMA signal *
	1900 - 1920 MHz 1980 - 2000 MHz	-30 dBm	-101 dBm	$\pm 10$ MHz	WCDMA signal *
	1 MHz -1900 MHz 2000 MHz - 12750 MHz	-15 dBm	-101 dBm	—	CW carrier
II	1850 - 1910 MHz	-30 dBm	-101 dBm	$\pm 10$ MHz	WCDMA signal *
	1830 - 1850 MHz 1910 - 1930 MHz	-30 dBm	-101 dBm	$\pm 10$ MHz	WCDMA signal *
	1 MHz - 1830 MHz 1930 MHz - 12750 MHz	-15 dBm	-101 dBm	—	CW carrier
III	1710 - 1785 MHz	-30 dBm	-101 dBm	$\pm 10$ MHz	WCDMA signal *
	1690 - 1710 MHz 1785 - 1805 MHz	-30 dBm	-101 dBm	$\pm 10$ MHz	WCDMA signal *
	1 MHz - 1690 MHz 1805 MHz - 12750 MHz	-15 dBm	-101 dBm	—	CW carrier
IV	1710 - 1755 MHz	-30 dBm	-101 dBm	$\pm 10$ MHz	WCDMA signal *
	1690 - 1710 MHz 1755 - 1775 MHz	-30 dBm	-101 dBm	$\pm 10$ MHz	WCDMA signal *
	1 MHz - 1690 MHz 1775 MHz - 12750 MHz	-15 dBm	-101 dBm	—	CW carrier
V	824-849 MHz	-30 dBm	-101 dBm	$\pm 10$ MHz	WCDMA signal *
	804-824 MHz 849-869 MHz	-30 dBm	-101 dBm	$\pm 10$ MHz	WCDMA signal *
	1 MHz - 804 MHz 869 MHz - 12750 MHz	-15 dBm	-101 dBm	—	CW carrier
VI	810 - 830 MHz 840 - 860 MHz	-30 dBm	-101 dBm	$\pm 10$ MHz	WCDMA signal *
	1 MHz - 810 MHz 860 MHz - 12750 MHz	-15 dBm	-101 dBm	—	CW carrier
VII	2500 - 2570 MHz	-30 dBm	-101 dBm	$\pm 10$ MHz	WCDMA signal *
	2480 - 2500 MHz 2570 - 2590 MHz	-30 dBm	-101 dBm	$\pm 10$ MHz	WCDMA signal *
	1 MHz -2480 MHz 2590 MHz - 12750 MHz	-15 dBm	-101 dBm	—	CW carrier
VIII	880 - 915 MHz	-30 dBm	-101 dBm	$\pm 10$ MHz	WCDMA signal *
	860 - 880 MHz 915 - 925 MHz	-30 dBm	-101 dBm	$\pm 10$ MHz	WCDMA signal *
	1 MHz -860 MHz 925 MHz - 12750 MHz	-15 dBm	-101 dBm	—	CW carrier
IX	1749.9 - 1784.9 MHz	-30 dBm	-101 dBm	$\pm 10$ MHz	WCDMA signal *
	1729.9 - 1749.9 MHz 1784.9 - 1804.9 MHz	-30 dBm	-101 dBm	$\pm 10$ MHz	WCDMA signal *
	1 MHz - 1729.9 MHz 1804.9 MHz - 12750 MHz	-15 dBm	-101 dBm	—	CW carrier
X	1710 - 1770 MHz	-30 dBm	-101 dBm	$\pm 10$ MHz	WCDMA signal *
	1690 - 1710 MHz 1770 - 1790 MHz	-30 dBm	-101 dBm	$\pm 10$ MHz	WCDMA signal *
	1 MHz - 1690 MHz 1790 MHz - 12750 MHz	-15 dBm	-101 dBm	—	CW carrier
XI	1427.9 - 1447.9 MHz	-30 dBm	-101 dBm	$\pm 10$ MHz	WCDMA signal *
	1407.9 - 1427.9 MHz 1447.9 - 1467.9 MHz	-30 dBm	-101 dBm	$\pm 10$ MHz	WCDMA signal *
	1 MHz - 1407.9 MHz 1467.9 MHz - 12750 MHz	-15 dBm	-101 dBm	—	CW carrier
XII	699 - 716 MHz	-30 dBm	-101 dBm	$\pm 10$ MHz	WCDMA signal *
	679 - 699 MHz 716 - 729 MHz	-30 dBm	-101 dBm	$\pm 10$ MHz	WCDMA signal *
	1 MHz - 679 MHz 729 MHz - 12750 MHz	-15 dBm	-101 dBm	—	CW carrier
XIII	777 - 787 MHz	-30 dBm	-101 dBm	$\pm 10$ MHz	WCDMA signal *

	757 - 777 MHz 787 - 807 MHz	-30 dBm	-101 dBm	$\pm 10$ MHz	WCDMA signal *
	1 - 757 MHz 807 MHz - 12750 MHz	-15 dBm	-101 dBm	—	CW carrier
XIV	788 - 798 MHz	-30 dBm	-101 dBm	$\pm 10$ MHz	WCDMA signal *
	768 - 788 MHz 798 - 818 MHz	-30 dBm	-101 dBm	$\pm 10$ MHz	WCDMA signal *
	1 - 768 MHz 818 MHz - 12750 MHz	-15 dBm	-101 dBm	—	CW carrier
XIX	830 - 845 MHz	-30 dBm	-101 dBm	$\pm 10$ MHz	WCDMA signal *
	810 - 830 MHz 845 - 865 MHz	-30 dBm	-101 dBm	$\pm 10$ MHz	WCDMA signal *
	1 MHz - 810 MHz 865 MHz - 12750 MHz	-15 dBm	-101 dBm	—	CW carrier
XX	832 - 862 MHz	-30 dBm	-101 dBm	$\pm 10$ MHz	WCDMA signal *
	821 - 832 MHz 862 - 882 MHz	-30 dBm	-101 dBm	$\pm 10$ MHz	WCDMA signal *
	1 MHz - 821 MHz 882 MHz - 12750 MHz	-15 dBm	-101 dBm	—	CW carrier
XXI	1447.9 - 1462.9 MHz	-30 dBm	-101 dBm	$\pm 10$ MHz	WCDMA signal *
	1427.9 - 1447.9 MHz 1462.9 - 1482.9 MHz	-30 dBm	-101 dBm	$\pm 10$ MHz	WCDMA signal *
	1 MHz - 1427.9 MHz 1482.9 MHz - 12750 MHz	-15 dBm	-101 dBm	—	CW carrier
XXII	3410 - 3490 MHz	-30 dBm	-101 dBm	$\pm 10$ MHz	WCDMA signal *
	3390 - 3410 MHz 3490 - 3510 MHz	-30 dBm	-101 dBm	$\pm 10$ MHz	WCDMA signal *
	1 MHz - 3390 MHz 3510 MHz - 12750 MHz	-15 dBm	-101 dBm	—	CW carrier
XXV	1850 - 1915 MHz	-30 dBm	-101 dBm	$\pm 10$ MHz	WCDMA signal *
	1830 - 1850 MHz 1915 - 1930 MHz	-30 dBm	-101 dBm	$\pm 10$ MHz	WCDMA signal *
	1 MHz - 1830 MHz 1930 MHz - 12750 MHz	-15 dBm	-101 dBm	—	CW carrier
XXVI	814-849 MHz	-30 dBm	-101 dBm	$\pm 10$ MHz	WCDMA signal *
	794-814 MHz 849-859 MHz	-30 dBm	-101 dBm	$\pm 10$ MHz	WCDMA signal *
NOTE *: The characteristics of the W-CDMA interference signal are specified in Annex C.					
NOTE **: For a Local Area BS capable of multiband operation, in case of interfering signal that is not in the in-band blocking frequency range of the operating band where the wanted signal is present, and not in an adjacent or overlapping band, the wanted Signal mean power is equal to -105.6 dBm.					

NOTE: Table 7.4B assumes that two operating bands, where the downlink frequencies (see Table 5.0) of one band would be within the in-band blocking region of the other band, are not in the same geographical area.



**Table 7.5: Blocking performance requirement (narrowband) for Wide Area BS**

Operating Band	Center Frequency of Interfering Signal	Interfering Signal mean power	Wanted Signal mean power	Minimum Offset of Interfering Signal	Type of Interfering Signal
II	1850 - 1910 MHz	- 47 dBm	-115 dBm	±2.7 MHz	GMSK modulated*
III	1710 - 1785 MHz	- 47 dBm	-115 dBm	±2.8 MHz	GMSK modulated*
IV	1710 - 1755 MHz	- 47 dBm	-115 dBm	±2.7 MHz	GMSK modulated*
V	824 - 849 MHz	- 47 dBm	-115 dBm	±2.7 MHz	GMSK modulated*
VIII	880 - 915 MHz	- 47 dBm	-115 dBm	±2.8 MHz	GMSK modulated*
X	1710 - 1770 MHz	- 47 dBm	-115 dBm	±2.7 MHz	GMSK modulated*
XII	699 - 716 MHz	- 47 dBm	-115 dBm	±2.7 MHz	GMSK modulated*
XIII	777 - 787 MHz	- 47 dBm	-115 dBm	±2.7 MHz	GMSK modulated*
XIV	788 - 798 MHz	- 47 dBm	-115 dBm	±2.7 MHz	GMSK modulated*
XXV	1850 - 1915 MHz	- 47 dBm	-115 dBm	±2.7 MHz	GMSK modulated*
XXVI	814-849 MHz	-47 dBm	-115 dBm	±2.7 MHz	GMSK modulated*

NOTE \*: GMSK modulation as defined in TS 45.004 [5].

**Table 7.5A: Blocking performance requirement (narrowband) for Medium Range BS**

Operating Band	Center Frequency of Interfering Signal	Interfering Signal mean power	Wanted Signal mean power	Minimum Offset of Interfering Signal	Type of Interfering Signal
II	1850 - 1910 MHz	- 42 dBm	-105 dBm	±2.7 MHz	GMSK modulated*
III	1710 - 1785 MHz	- 42 dBm	-105 dBm	±2.8 MHz	GMSK modulated*
IV	1710 - 1755 MHz	- 42 dBm	-105 dBm	±2.7 MHz	GMSK modulated*
V	824 - 849 MHz	- 42 dBm	-105 dBm	±2.7 MHz	GMSK modulated*
VIII	880 - 915 MHz	- 42 dBm	-105 dBm	±2.8 MHz	GMSK modulated*
X	1710 - 1770 MHz	- 42 dBm	-105 dBm	±2.7 MHz	GMSK modulated*
XII	699 - 716 MHz	- 42 dBm	-105 dBm	±2.7 MHz	GMSK modulated*
XIII	777 - 787 MHz	- 42 dBm	-105 dBm	±2.7 MHz	GMSK modulated*
XIV	788 - 798 MHz	- 42 dBm	-105 dBm	±2.7 MHz	GMSK modulated*
XXV	1850 - 1915 MHz	- 42 dBm	-105 dBm	±2.7 MHz	GMSK modulated*
XXVI	814-849 MHz	- 42 dBm	-105 dBm	±2.7 MHz	GMSK modulated*

NOTE \*: GMSK modulation as defined in TS 45.004 [5].

**Table 7.5B: Blocking performance requirement (narrowband) for Local Area / Home BS**

Operating Band	Center Frequency of Interfering Signal	Interfering Signal mean power	Wanted Signal mean power	Minimum Offset of Interfering Signal	Type of Interfering Signal
II	1850 - 1910 MHz	- 37 dBm	-101 dBm	±2.7 MHz	GMSK modulated*
III	1710 - 1785 MHz	- 37 dBm	-101 dBm	±2.8 MHz	GMSK modulated*
IV	1710 - 1755 MHz	- 37 dBm	-101 dBm	±2.7 MHz	GMSK modulated*
V	824 - 849 MHz	- 37 dBm	-101 dBm	±2.7 MHz	GMSK modulated*
VIII	880 - 915 MHz	- 37 dBm	-101 dBm	±2.8 MHz	GMSK modulated*
X	1710 - 1770 MHz	- 37 dBm	-101 dBm	±2.7 MHz	GMSK modulated*
XII	699 - 716 MHz	- 37 dBm	-101 dBm	±2.7 MHz	GMSK modulated*
XIII	777 - 787 MHz	- 37 dBm	-101 dBm	±2.7 MHz	GMSK modulated*
XIV	788 - 798 MHz	- 37 dBm	-101 dBm	±2.7 MHz	GMSK modulated*
XXV	1850 - 1915 MHz	- 37 dBm	-101 dBm	±2.7 MHz	GMSK modulated*
XXVI	814-849 MHz	- 37 dBm	-101 dBm	±2.7 MHz	GMSK modulated*

NOTE \*: GMSK modulation as defined in TS 45.004 [5].

## 7.5.2 Minimum Requirement - Co-location with GSM, DCS, PCS, CDMA, UTRA and/or E-UTRA, UTRA TDD and/or E-UTRA TDD

This additional blocking requirement may be applied for the protection of FDD BS receivers when GSM, DCS, PCS, CDMA, UTRA BS and/or E-UTRA are co-located with a UTRA FDD BS.

The requirements in this chapter assume a 30 dB coupling loss between transmitter and receiver. If BSs of different classes are co-sited, the coupling loss should be increased by the value as stated in TR 25.942 [4] chapter 10.3 in Table 10.1 and Table 10.2.

For a Wide Area (WA) FDD BS, the static reference performance as specified in clause 7.2.1 shall be met with a wanted and an interfering signal coupled to BS antenna input using the parameters in Table 7.5C.

**Table 7.5C: Blocking performance requirement for Wide Area BS when co-located with BS in other bands.**

Co-located BS type	Center Frequency of Interfering Signal	Interfering Signal mean power	Wanted Signal mean power	Type of Interfering Signal
Macro GSM900	921 - 960 MHz	+16 dBm	-115 dBm	CW carrier
Macro DCS1800	1805 - 1880 MHz	+16 dBm	-115 dBm	CW carrier
Macro PCS1900	1930 - 1990 MHz	+16 dBm	-115 dBm	CW carrier
Macro GSM850 or CDMA850	869 - 894 MHz	+16 dBm	-115 dBm	CW carrier
WA UTRA-FDD Band I or E-UTRA Band 1	2110 - 2170 MHz	+16 dBm	-115 dBm	CW carrier
WA UTRA-FDD Band II or E-UTRA Band 2	1930 - 1990 MHz	+16 dBm	-115 dBm	CW carrier
WA UTRA-FDD Band III or E-UTRA Band 3	1805 - 1880 MHz	+16 dBm	-115 dBm	CW carrier
WA UTRA-FDD Band IV or E-UTRA Band 4	2110 - 2155 MHz	+16 dBm	-115 dBm	CW carrier
WA UTRA-FDD Band V or E-UTRA Band 5	869 - 894 MHz	+16 dBm	-115 dBm	CW carrier
WA UTRA-FDD Band VI or E-UTRA Band 6	875 - 885 MHz	+16 dBm	-115 dBm	CW carrier
WA UTRA-FDD Band VII or E-UTRA Band 7	2620 - 2690 MHz	+16 dBm	-115 dBm	CW carrier
WA UTRA-FDD Band VIII or E-UTRA Band 8	925 - 960 MHz	+16 dBm	-115 dBm	CW carrier
WA UTRA-FDD Band IX or E-UTRA Band 9	1844.9 - 1879.9 MHz	+16 dBm	-115 dBm	CW carrier
WA UTRA-FDD Band X or E-UTRA Band 10	2110 - 2170 MHz	+16 dBm	-115 dBm	CW carrier
WA UTRA-FDD Band XI or E-UTRA Band 11	1475.9 – 1495.9 MHz	+16 dBm	-115 dBm	CW carrier
WA UTRA-FDD Band XII or E-UTRA Band 12	729 - 746 MHz	+16 dBm	-115 dBm	CW carrier
WA UTRA-FDD Band XIII or E-UTRA Band 13	746 - 756 MHz	+16 dBm	-115 dBm	CW carrier
WA UTRA-FDD Band XIV or E-UTRA Band 14	758 - 768 MHz	+16 dBm	-115 dBm	CW carrier
WA E-UTRA Band 17	734 - 746 MHz	+16 dBm	-115 dBm	CW carrier
WA E-UTRA Band 18	860 – 875 MHz	+16 dBm	-115 dBm	CW carrier
WA UTRA-FDD Band XIX or E-UTRA Band 19	875 - 890 MHz	+16 dBm	-115 dBm	CW carrier
WA UTRA-FDD Band XX or E-UTRA Band 20	791 - 821 MHz	+16 dBm	-115 dBm	CW carrier
WA UTRA-FDD Band XXI or E-UTRA Band 21	1495.9 – 1510.9 MHz	+16 dBm	-115 dBm	CW carrier
WA UTRA-FDD Band XXII or E-UTRA Band 22	3510 - 3590 MHz	+16 dBm	-115 dBm	CW carrier
WA E-UTRA Band 23	2180 - 2200 MHz	+16 dBm	-115 dBm	CW carrier
WA E-UTRA Band 24	1525 – 1559 MHz	+16 dBm	-115 dBm	CW carrier
WA UTRA-FDD Band XXV or E-UTRA Band 25	1930 - 1995 MHz	+16 dBm	-115 dBm	CW carrier
WA UTRA-FDD Band XXVI or E-UTRA Band 26	859 - 894 MHz	+16 dBm	-115 dBm	CW carrier
WA E-UTRA Band 27	852 - 869 MHz	+16 dBm	-115 dBm	CW carrier
WA E-UTRA Band 28	758 – 803 MHz	+16 dBm	-115 dBm	CW carrier
WA E-UTRA Band 29	717 – 728 MHz	+16 dBm	-115 dBm	CW carrier
WA E-UTRA Band 30	2350 – 2360 MHz	+16 dBm	-115 dBm	CW carrier
WA E-UTRA Band 31	462.5 – 467.5 MHz	+16 dBm	-115 dBm	CW carrier
WA UTRA-FDD Band XXXII or E-UTRA Band 32	1452 – 1496 MHz (NOTE 3)	+ 16 dBm	-115 dBm	CW carrier
WA UTRA TDD Band a) or E-UTRA Band 33	1900 - 1920 MHz	+16 dBm	-115 dBm	CW carrier
WA UTRA TDD Band a) or E-UTRA Band 34	2010 - 2025 MHz	+16 dBm	-115 dBm	CW carrier
WA UTRA TDD Band d) or E-UTRA Band 38	2570 - 2620 MHz	+16 dBm	-115 dBm	CW carrier
WA UTRA TDD Band f) or E-UTRA Band 39	1880 - 1920 MHz	+16 dBm	-115 dBm	CW carrier

WA UTRA TDD Band e) E-UTRA Band 40	2300 - 2400 MHz	+16 dBm	-115 dBm	CW carrier
WA E-UTRA Band 41	2496 - 2690 MHz	+16 dBm	-115 dBm	CW carrier
WA E-UTRA Band 42	3400 - 3600 MHz	+16 dBm	-115 dBm	CW carrier
WA E-UTRA Band 43	3600 - 3800 MHz	+16 dBm	-115 dBm	CW carrier
WA E-UTRA Band 44	703 - 803 MHz	+16 dBm	-115 dBm	CW carrier
WA E-UTRA Band 45	1447 - 1467 MHz	+16 dBm	-115 dBm	CW carrier
WA E-UTRA Band 48	3550 - 3700 MHz	+16 dBm	-115 dBm	CW carrier
WA E-UTRA Band 50	1432 - 1517 MHz	+16 dBm	-115 dBm	CW carrier
WA E-UTRA Band 52	3300 - 3400 MHz	+16 dBm	-115 dBm	CW carrier
WA E-UTRA Band 65	2110 - 2200 MHz	+16 dBm	-115 dBm	CW carrier
WA E-UTRA Band 66	2110 - 2200 MHz	+16 dBm	-115 dBm	CW carrier
WA E-UTRA Band 67	738 - 758 MHz	+16 dBm	-115 dBm	CW carrier
WA E-UTRA Band 68	753 - 783 MHz	+16 dBm	-115 dBm	CW carrier
WA E-UTRA Band 69	2570 - 2620 MHz	+16 dBm	-115 dBm	CW carrier
WA E-UTRA Band 70	1995 - 2020 MHz	+16 dBm	-115 dBm	CW carrier
WA E-UTRA Band 71	617 - 652 MHz	+16 dBm	-115 dBm	CW carrier
WA E-UTRA Band 72	461 - 466 MHz	+16 dBm	-115 dBm	CW carrier
WA E-UTRA Band 73	460 - 465 MHz	+16 dBm	-115 dBm	CW carrier
WA E-UTRA Band 74	1475 – 1518 MHz	+16 dBm	-115 dBm	CW carrier
WA E-UTRA Band 75	1432 - 1517 MHz	+16 dBm	-115 dBm	CW carrier
WA E-UTRA Band 85	728 - 746 MHz	+16 dBm	-115 dBm	CW carrier
<p>NOTE 1: Except for a BS operating in Band XIII, these requirements do not apply when the interfering signal falls within any of the supported uplink operating band or in the 10 MHz immediately outside any of the supported uplink operating band. For a BS operating in band XIII the requirements do not apply when the interfering signal falls within the frequency range 768-797 MHz.</p> <p>NOTE 2: Some combinations of bands may not be possible to co-site based on the requirements above. The current state-of-the-art technology does not allow a single generic solution for co-location of UTRA FDD with UTRA TDD or E-UTRA TDD on adjacent frequencies for 30dB BS-BS minimum coupling loss. However, there are certain site-engineering solutions that can be used. These techniques are addressed in TR 25.942 [4].</p> <p>NOTE 3: For a BS operating in band XI or XXI, this requirement applies for interfering signal within the frequency range 1475.9-1495.9 MHz.</p>				

For a Medium Range (MR) FDD BS, the static reference performance as specified in clause 7.2.1 shall be met with a wanted and an interfering signal coupled to BS antenna input using the parameters in Table 7.5D.

**Table 7.5D: Blocking performance requirement for Medium Range BS when co-located with BS in other bands.**

Co-located BS type	Center Frequency of Interfering Signal	Interfering Signal mean power	Wanted Signal mean power	Type of Interfering Signal
Micro GSM900	921 - 960 MHz	-3 dBm	-105 dBm	CW carrier
Micro DCS1800	1805 - 1880 MHz	+5 dBm	-105 dBm	CW carrier
Micro PCS1900	1930 - 1990 MHz	+5 dBm	-105 dBm	CW carrier
Micro GSM850	869 - 894 MHz	-3 dBm	-105 dBm	CW carrier
MR UTRA-FDD Band I or E-UTRA Band 1	2110 - 2170 MHz	+8 dBm	-105 dBm	CW carrier
MR UTRA-FDD Band II or E-UTRA Band 2	1930 - 1990 MHz	+8 dBm	-105 dBm	CW carrier
MR UTRA-FDD Band III or E-UTRA Band 3	1805 - 1880 MHz	+8 dBm	-105 dBm	CW carrier
MR UTRA-FDD Band IV or E-UTRA Band 4	2110 - 2155 MHz	+8 dBm	-105 dBm	CW carrier
MR UTRA-FDD Band V or E-UTRA Band 5	869 - 894 MHz	+8 dBm	-105 dBm	CW carrier
MR UTRA-FDD Band VI or E-UTRA Band 6	875 - 885 MHz	+8 dBm	-105 dBm	CW carrier
MR UTRA-FDD Band VII or E-UTRA Band 7	2620 - 2690 MHz	+8 dBm	-105 dBm	CW carrier
MR UTRA-FDD Band VIII or E-UTRA Band 8	925 - 960 MHz	+8 dBm	-105 dBm	CW carrier
MR UTRA-FDD Band IX or E-UTRA Band 9	1844.9 - 1879.9 MHz	+8 dBm	-105 dBm	CW carrier
MR UTRA-FDD Band X or E-UTRA Band 10	2110 - 2170 MHz	+8 dBm	-105 dBm	CW carrier
MR UTRA-FDD Band XI or E-UTRA Band 11	1475.9 - 1495.9 MHz	+8 dBm	-105 dBm	CW carrier
MR UTRA-FDD Band XII or E-UTRA Band 12	729 - 746 MHz	+8 dBm	-105 dBm	CW carrier
MR UTRA-FDD Band XIII or E-UTRA Band 13	746 - 756 MHz	+8 dBm	-105 dBm	CW carrier
MR UTRA-FDD Band XIV or E-UTRA Band 14	758 - 768 MHz	+8 dBm	-105 dBm	CW carrier
MR E-UTRA Band 17	734 - 746 MHz	+8 dBm	-105 dBm	CW carrier
MR E-UTRA Band 18	860 - 875 MHz	+8 dBm	-105 dBm	CW carrier
MR UTRA-FDD Band XIX or E-UTRA Band 19	875 - 890 MHz	+8 dBm	-105 dBm	CW carrier
MR UTRA-FDD Band XX or E-UTRA Band 20	791 - 821 MHz	+8 dBm	-105 dBm	CW carrier
MR UTRA-FDD Band XXI or E-UTRA Band 21	1495.9 - 1510.9 MHz	+8 dBm	-105 dBm	CW carrier
MR UTRA-FDD Band XXII or E-UTRA Band 22	3510 - 3590 MHz	+8 dBm	-105 dBm	CW carrier
MR E-UTRA Band 23	2180 - 2200 MHz	+8 dBm	-105 dBm	CW carrier
MR E-UTRA Band 24	1525 - 1559 MHz	+8 dBm	-105 dBm	CW carrier
MR UTRA-FDD Band XXV or E-UTRA Band 25	1930 - 1995 MHz	+8 dBm	-105 dBm	CW carrier
MR UTRA-FDD Band XXVI or E-UTRA Band 26	859 - 894 MHz	+8 dBm	-105 dBm	CW carrier
MR E-UTRA Band 27	852 - 869 MHz	+8 dBm	-105 dBm	CW carrier
MR E-UTRA Band 28	758 - 803 MHz	+8 dBm	-105 dBm	CW carrier
MR E-UTRA Band 29	717 - 728 MHz	+8 dBm	-105 dBm	CW carrier
MR E-UTRA Band 30	2350 - 2360 MHz	+8 dBm	-105 dBm	CW carrier
MR E-UTRA Band 31	462.5 - 467.5 MHz	+8 dBm	-105 dBm	CW carrier
MR UTRA-FDD Band XXXII or E-UTRA Band 32	1452 - 1496 MHz (NOTE 3)	+8 dBm	-105 dBm	CW carrier
MR E-UTRA Band 33	1900 - 1920 MHz	+8 dBm	-105 dBm	CW carrier
MR E-UTRA Band 34	2010 - 2025 MHz	+8 dBm	-105 dBm	CW carrier
MR E-UTRA Band 38	2570 - 2620 MHz	+8 dBm	-105 dBm	CW carrier
MR E-UTRA Band 39	1880 - 1920 MHz	+8 dBm	-105 dBm	CW carrier
MR E-UTRA Band 40	2300 - 2400 MHz	+8 dBm	-105 dBm	CW carrier
MR E-UTRA Band 41	2496 - 2690 MHz	+8 dBm	-105 dBm	CW carrier
MR E-UTRA Band 42	3400 - 3600 MHz	+8 dBm	-105 dBm	CW carrier
MR E-UTRA Band 43	3600 - 3800 MHz	+8 dBm	-105 dBm	CW carrier

MR E-UTRA Band 44	703 - 803 MHz	+8 dBm	-105 dBm	CW carrier
MR E-UTRA Band 45	1447 - 1467 MHz	+8 dBm	-105 dBm	CW carrier
MR E-UTRA Band 46	5150 - 5925 MHz	+8 dBm	-105 dBm	CW carrier
MR E-UTRA Band 48	3550 - 3700 MHz	+8 dBm	-105 dBm	CW carrier
MR E-UTRA Band 50	1432 - 1517 MHz	+8 dBm	-105 dBm	CW carrier
MR E-UTRA Band 52	3300 - 3400 MHz	+8 dBm	-105 dBm	CW carrier
MR E-UTRA Band 65	2110 - 2200 MHz	+8 dBm	-105 dBm	CW carrier
MR E-UTRA Band 66	2110 - 2200 MHz	+8 dBm	-105 dBm	CW carrier
MR E-UTRA Band 67	738 - 758 MHz	+8 dBm	-105 dBm	CW carrier
MR E-UTRA Band 68	753 - 783 MHz	+8 dBm	-105 dBm	CW carrier
MR E-UTRA Band 69	2570 - 2620 MHz	+8 dBm	-105 dBm	CW carrier
MR E-UTRA Band 70	1995 - 2020 MHz	+8 dBm	-105 dBm	CW carrier
MR E-UTRA Band 71	617 - 652 MHz	+8 dBm	-105 dBm	CW carrier
MR E-UTRA Band 72	461 - 466 MHz	+8 dBm	-105 dBm	CW carrier
MR E-UTRA Band 73	460 - 465 MHz	+8 dBm	-105 dBm	CW carrier
MR E-UTRA Band 74	1475 - 1518 MHz	+8 dBm	-105 dBm	CW carrier
MR E-UTRA Band 75	1432 - 1517 MHz	+8 dBm	-105 dBm	CW carrier
MR E-UTRA Band 85	728 - 746 MHz	+8 dBm	-105 dBm	CW carrier
<p>NOTE 1: Except for a BS operating in Band XIII, these requirements do not apply when the interfering signal falls within any of the supported uplink operating band or in the 10 MHz immediately outside any of the supported uplink operating band. For a BS operating in band XIII the requirements do not apply when the interfering signal falls within the frequency range 768-797 MHz.</p> <p>NOTE 2: Some combinations of bands may not be possible to co-site based on the requirements above. The current state-of-the-art technology does not allow a single generic solution for co-location of UTRA FDD with UTRA TDD or E-UTRA TDD on adjacent frequencies for 30dB BS-BS minimum coupling loss. However, there are certain site-engineering solutions that can be used. These techniques are addressed in TR 25.942 [4].</p> <p>NOTE 3: For a BS operating in band XI or XXI, this requirement applies for interfering signal within the frequency range 1475.9-1495.9 MHz.</p>				

For a Local Area (LA) FDD BS, the static reference performance as specified in clause 7.2.1 shall be met with a wanted and an interfering signal coupled to BS antenna input using the parameters in Table 7.5E.



**Table 7.5E: Blocking performance requirement for Local Area BS when co-located with BS in other bands.**

Co-located BS type	Center Frequency of Interfering Signal	Interfering Signal mean power	Wanted Signal mean power	Type of Interfering Signal
Pico GSM900	921 - 960 MHz	-7 dBm	-101 dBm	CW carrier
Pico DCS1800	1805 - 1880 MHz	-4 dBm	-101 dBm	CW carrier
Pico PCS1900	1930 - 1990 MHz	-4 dBm	-101 dBm	CW carrier
Pico GSM850	869 - 894 MHz	-7dBm	-101 dBm	CW carrier
LA UTRA-FDD Band I or E-UTRA Band 1	2110 - 2170 MHz	-6 dBm	-101 dBm	CW carrier
LA UTRA-FDD Band II I or E-UTRA Band 2	1930 - 1990 MHz	-6 dBm	-101 dBm	CW carrier
LA UTRA-FDD Band III or E-UTRA Band 3	1805 - 1880 MHz	-6 dBm	-101 dBm	CW carrier
LA UTRA-FDD Band IV or E-UTRA Band 4	2110 - 2155 MHz	-6 dBm	-101 dBm	CW carrier
LA UTRA-FDD Band V or E-UTRA Band 5	869 - 894 MHz	-6 dBm	-101 dBm	CW carrier
LA UTRA-FDD Band VI or E-UTRA Band 6	875 - 885 MHz	-6 dBm	-101 dBm	CW carrier
LA UTRA-FDD Band VII or E-UTRA Band 7	2620 - 2690 MHz	-6 dBm	-101 dBm	CW carrier
LA UTRA-FDD Band VIII or E-UTRA Band 8	925 - 960 MHz	-6 dBm	-101 dBm	CW carrier
LA UTRA-FDD Band IX or E-UTRA Band 9	1844.9 - 1879.9 MHz	-6 dBm	-101 dBm	CW carrier
LA UTRA-FDD Band X or E-UTRA Band 10	2110 - 2170 MHz	-6 dBm	-101 dBm	CW carrier
LA UTRA-FDD Band XI or E-UTRA Band 11	1475.9 - 1495.9 MHz	-6 dBm	-101 dBm	CW carrier
LA UTRA-FDD Band XII or E-UTRA Band 12	729 - 746 MHz	-6 dBm	-101 dBm	CW carrier
LA UTRA-FDD Band XIII or E-UTRA Band 13	746 - 756 MHz	-6 dBm	-101 dBm	CW carrier
LA UTRA-FDD Band XIV or E-UTRA Band 14	758 - 768 MHz	-6 dBm	-101 dBm	CW carrier
LA E-UTRA Band 17	734 - 746 MHz	-6 dBm	-101 dBm	CW carrier
LA UTRA-FDD Band XIX or E-UTRA Band 19	875 - 890 MHz	-6 dBm	-101 dBm	CW carrier
LA UTRA-FDD Band XX or E-UTRA Band 20	791 - 821 MHz	-6 dBm	-101 dBm	CW carrier
LA UTRA-FDD Band XXI or E-UTRA Band 21	1495.9 - 1510.9 MHz	-6 dBm	-101 dBm	CW carrier
LA UTRA-FDD Band XXII or E-UTRA Band 22	3510 - 3590 MHz	-6 dBm	-101 dBm	CW carrier
LA E-UTRA Band 23	2180 - 2200 MHz	-6 dBm	-101 dBm	CW carrier
LA E-UTRA Band 24	1525 – 1559 MHz	-6 dBm	-101 dBm	CW carrier
LA UTRA-FDD Band XXV or E-UTRA Band 25	1930 - 1995 MHz	-6 dBm	-101 dBm	CW carrier
LA UTRA-FDD Band XXVI or E-UTRA Band 26	859 - 894 MHz	-6 dBm	-101 dBm	CW carrier
LA E-UTRA Band 27	852 - 869 MHz	-6 dBm	-101 dBm	CW carrier
LA E-UTRA Band 28	758 – 803 MHz	-6 dBm	-101 dBm	CW carrier
LA E-UTRA Band 29	717 – 728 MHz	-6 dBm	-101 dBm	CW carrier
LA E-UTRA Band 30	2350 – 2360 MHz	-6 dBm	-101 dBm	CW carrier
LA E-UTRA Band 31	462.5 – 467.5 MHz	-6 dBm	-101 dBm	CW carrier
LA UTRA_FDD Band XXXII or E-UTRA Band 32	1452 – 1496 MHz (NOTE 3)	-6 dBm	-101 dBm	CW carrier
LA UTRA TDD Band a) or E-UTRA Band 33	1900 - 1920 MHz	-6 dBm	-101 dBm	CW carrier
LA UTRA TDD Band a) or E-UTRA Band 34	2010 - 2025 MHz	-6 dBm	-101 dBm	CW carrier
LA UTRA TDD Band d) or E-UTRA Band 38	2570 - 2620 MHz	-4 dBm	-101 dBm	CW carrier
LA UTRA TDD Band f) or E-UTRA Band 39	1880 - 1920 MHz	-6 dBm	-101 dBm	CW carrier
LA UTRA TDD Band e) E-UTRA Band 40	2300 - 2400 MHz	-6 dBm	-101 dBm	CW carrier

LA E-UTRA Band 41	2496 - 2690 MHz	-6 dBm	-101 dBm	CW carrier
LA E-UTRA in Band 42	3400 - 3600 MHz	-6 dBm	-101 dBm	CW carrier
LA E-UTRA in Band 43	3600 – 3800 MHz	-6 dBm	-101 dBm	CW carrier
LA E-UTRA in Band 44	703 - 803 MHz	-6 dBm	-101 dBm	CW carrier
LA E-UTRA in Band 45	1447 - 1467 MHz	-6 dBm	-101 dBm	CW carrier
LA E-UTRA in Band 46	5150 - 5925 MHz	-6 dBm	-101 dBm	CW carrier
LA E-UTRA in Band 48	3550 - 3700 MHz	-6 dBm	-101 dBm	CW carrier
LA E-UTRA in Band 49	3550 - 3700 MHz	-6 dBm	-101 dBm	CW carrier
LA E-UTRA in Band 50	1432 - 1517 MHz	-6 dBm	-101 dBm	CW carrier
LA E-UTRA in Band 51	1427 - 1432 MHz	-6 dBm	-101 dBm	CW carrier
LA E-UTRA in Band 52	3300 - 3400 MHz	-6 dBm	-101 dBm	CW carrier
LA E-UTRA Band 65	2110 - 2200 MHz	-6 dBm	-101 dBm	CW carrier
LA E-UTRA Band 66	2110 - 2200 MHz	-6 dBm	-101 dBm	CW carrier
LA E-UTRA Band 67	738 - 758 MHz	-6 dBm	-101 dBm	CW carrier
LA E-UTRA Band 68	753 - 783 MHz	-6 dBm	-101 dBm	CW carrier
LA E-UTRA Band 69	2570 - 2620 MHz	-6 dBm	-101 dBm	CW carrier
LA E-UTRA Band 70	1995 – 2020 MHz	-6 dBm	-101 dBm	CW carrier
LA E-UTRA Band 71	617 - 652 MHz	-6 dBm	-101 dBm	CW carrier
LA E-UTRA Band 72	461 - 466 MHz	-6 dBm	-101 dBm	CW carrier
LA E-UTRA Band 73	460 - 465 MHz	-6 dBm	-101 dBm	CW carrier
LA E-UTRA Band 74	1475 – 1518 MHz	-6 dBm	-101 dBm	CW carrier
LA E-UTRA Band 75	1432 - 1517 MHz	-6 dBm	-101 dBm	CW carrier
LA E-UTRA Band 76	1427 - 1432 MHz	-6 dBm	-101 dBm	CW carrier
LA E-UTRA Band 85	728 - 746 MHz	-6 dBm	-101 dBm	CW carrier
NOTE 1: Except for a BS operating in Band XIII, these requirements do not apply when the interfering signal falls within any of the supported uplink operating band or in the 10 MHz immediately outside any of the supported uplink operating band. For a BS operating in band XIII the requirements do not apply when the interfering signal falls within the frequency range 768-797 MHz.				
NOTE 2: Some combinations of bands may not be possible to co-site based on the requirements above. The current state-of-the-art technology does not allow a single generic solution for co-location of UTRA FDD with UTRA TDD or E-UTRA TDD on adjacent frequencies for 30dB BS-BS minimum coupling loss. However, there are certain site-engineering solutions that can be used. These techniques are addressed in TR 25.942 [4].				
NOTE 3: For a BS operating in band XI or XXI, this requirement applies for interfering signal within the frequency range 1475.9-1495.9 MHz.				

### 7.5.3 Void

**Table 7.5F: Void**

**Table 7.5G: Void**

## 7.6 Intermodulation characteristics

Third and higher order mixing of the two interfering RF signals can produce an interfering signal in the band of the desired channel. Intermodulation response rejection is a measure of the capability of the receiver to receive a wanted signal on its assigned channel frequency in the presence of two or more interfering signals which have a specific frequency relationship to the wanted signal.

## 7.6.1 Minimum requirement

The static reference performance as specified in clause 7.2.1 shall be met for a Wide Area BS when the following signals are coupled to BS antenna input:

- A wanted signal at the assigned channel frequency with a mean power of -115 dBm.
- Two interfering signals with the following parameters.

For a BS operating in non-contiguous spectrum within any operating band, the narrowband intermodulation requirement applies in addition inside any sub-block gap, in case the sub-block gap size is at least 6.8MHz. The CW interfering signal offset is defined relative to the lower/upper sub-block edge inside the sub-block gap and is equal to -1MHz/+1MHz, respectively. The GMSK modulated interfering signal offset is defined relative to the lower/upper sub-block edge inside the sub-block gap and is equal to -3.4MHz/+3.4MHz, respectively.

For a BS capable of multi-band operation, the narrowband intermodulation requirement applies in addition inside any Inter RF Bandwidth gap, in case the Inter RF Bandwidth gap size is at least 6.8MHz. The CW interfering signal offset is defined relative to lower/upper Base Station RF Bandwidth edges inside the Inter RF Bandwidth gap and is equal to -1MHz/+1MHz, respectively. The GMSK modulated interfering signal offset is defined relative to lower/upper Base Station RF Bandwidth edges inside the Inter RF Bandwidth gap and is equal to -3.4MHz/+3.4MHz, respectively.

**Table 7.6: Intermodulation performance requirement (Wide Area BS)**

Operating band	Interfering Signal mean power	Offset	Type of Interfering Signal
All bands	- 48 dBm	±10 MHz	CW signal
	- 48 dBm	±20 MHz	WCDMA signal *
Note*: The characteristics of the W-CDMA interference signal are specified in Annex C.			

**Table 7.6A: Narrowband intermodulation performance requirement (Wide Area BS)**

Operating band	Interfering Signal mean power	Offset	Type of Interfering Signal
II, III, IV, V, VIII, X, XII, XIII, XIV, XXV, XXVI	- 47 dBm	±3.5 MHz	CW signal
	- 47 dBm	±5.9 MHz	GMSK modulated*
Note *: GMSK as defined in TS45.004.			

The static reference performance as specified in clause 7.2.1 shall be met for a Medium Range BS when the following signals are coupled to BS antenna input:

- A wanted signal at the assigned channel frequency with a mean power of -105 dBm.
- Two interfering signals with the following parameters.

For a BS operating in non-contiguous spectrum within any operating band, the narrowband intermodulation requirement applies in addition inside any sub-block gap, in case the sub-block gap size is at least 6.8MHz. The CW interfering signal offset is defined relative to the lower/upper sub-block edge inside the sub-block gap and is equal to -1MHz/+1MHz, respectively. The GMSK modulated interfering signal offset is defined relative to the lower/upper sub-block edge inside the sub-block gap and is equal to -3.4MHz/+3.4MHz, respectively.

For a BS capable of multi-band operation, the narrowband intermodulation requirement applies in addition inside any Inter RF Bandwidth gap, in case the Inter RF Bandwidth gap size is at least 6.8MHz. The CW interfering signal offset is defined relative to lower/upper Base Station RF Bandwidth edges inside the Inter RF Bandwidth gap and is equal to -1MHz/+1MHz, respectively. The GMSK modulated interfering signal offset is defined relative to lower/upper Base Station RF Bandwidth edges inside the Inter RF Bandwidth gap and is equal to -3.4MHz/+3.4MHz, respectively.

**Table 7.6B: Intermodulation performance requirement (Medium Range BS)**

Operating band	Interfering Signal mean power	Offset	Type of Interfering Signal
All bands	- 44 dBm	$\pm 10$ MHz	CW signal
	- 44 dBm	$\pm 20$ MHz	WCDMA signal *
Note*: The characteristics of the W-CDMA interference signal are specified in Annex C.			

**Table 7.6C: Narrowband intermodulation performance requirement (Medium Range BS)**

Operating band	Interfering Signal mean power	Offset	Type of Interfering Signal
II, III, IV, V, VIII, X, XII, XIII, XIV, XXV, XXVI	- 43 dBm	$\pm 3.5$ MHz	CW signal
	- 43 dBm	$\pm 5.9$ MHz	GMSK modulated*
Note*: GMSK as defined in TS45.004			

The static reference performance as specified in clause 7.2.1 shall be met for a Local Area /Home BS when the following signals are coupled to BS antenna input:

- A wanted signal at the assigned channel frequency with a mean power of -101 dBm.
- Two interfering signals with the following parameters.

For a BS operating in non-contiguous spectrum within any operating band, the narrowband intermodulation requirement applies in addition inside any sub-block gap, in case the sub-block gap size is at least 6.8MHz. The CW interfering signal offset is defined relative to the lower/upper sub-block edge inside the sub-block gap and is equal to -1MHz/+1MHz, respectively. The GMSK modulated interfering signal offset is defined relative to the lower/upper sub-block edge inside the sub-block gap and is equal to -3.4MHz/+3.4MHz, respectively.

For a BS capable of multi-band operation, the narrowband intermodulation requirement applies in addition inside any Inter RF Bandwidth gap, in case the Inter RF Bandwidth gap size is at least 6.8MHz. The CW interfering signal offset is defined relative to lower/upper Base Station RF Bandwidth edges inside the Inter RF Bandwidth gap and is equal to -1MHz/+1MHz, respectively. The GMSK modulated interfering signal offset is defined relative to lower/upper Base Station RF Bandwidth edges inside the Inter RF Bandwidth gap and is equal to -3.4MHz/+3.4MHz, respectively.

**Table 7.6D: Intermodulation performance requirement (Local Area / Home BS)**

Operating band	Interfering Signal mean power	Offset	Type of Interfering Signal
All bands	-38 dBm	$\pm 10$ MHz	CW signal
	-38 dBm	$\pm 20$ MHz	WCDMA signal *
Note*: The characteristics of the W-CDMA interference signal are specified in Annex C.			

**Table 7.6E: Narrowband intermodulation performance requirement (Local Area / Home BS)**

Operating band	Interfering Signal mean power	Offset	Type of Interfering Signal
II, III, IV, V, VIII, X, XII, XIII, XIV, XXV, XXVI	-37 dBm	$\pm 3.5$ MHz	CW signal
	-37 dBm	$\pm 5.9$ MHz	GMSK modulated*
Note *: GMSK as defined in TS45.004.			

## 7.7 Spurious emissions

The spurious emissions power is the power of emissions generated or amplified in a receiver that appear at the BS receiver antenna connector. The requirements apply to all BS with separate RX and TX antenna port. The test shall be performed when both TX and RX are on with the TX port terminated.

For all BS with common RX and TX antenna port the transmitter spurious emission as specified in section 6.6.3 is valid.

For BS capable of multi-band operation where multiple bands are mapped on separate antenna connectors, the single-band requirements apply and the excluded frequency range is only applicable for the operating band supported on each antenna connector.

## 7.7.1 Minimum requirement

The power of any spurious emission shall not exceed the limits of Table 7.7. For BS capable of multi-band operation, the exclusions and conditions in the Note column of Table 7.7 apply for each supported operating band. For BS capable of multi-band operation where multiple bands are mapped on separate antenna connectors, the single-band requirements apply and the excluded frequency range is only applicable for the operating band supported on each antenna connector.

**Table 7.7: General spurious emission minimum requirement**

Band	Maximum level	Measurement Bandwidth	Note
30MHz - 1 GHz	-57 dBm	100 kHz	With the exception of frequencies between 12.5 MHz below the first carrier frequency and 12.5 MHz above the last carrier frequency transmitted by the BS.
1 GHz - 12.75 GHz	-47 dBm	1 MHz	With the exception of frequencies between 12.5 MHz below the first carrier frequency and 12.5 MHz above the last carrier frequency transmitted by the BS.
12.75 GHz - 5 <sup>th</sup> harmonic of the upper frequency edge of the UL operating band in GHz	-47 dBm	1 MHz	NOTE 1: Applies only for Band XXII

In addition to the requirements in Table 7.7, the power of any spurious emission shall not exceed the levels specified for Protection of the BS receiver of own or different BS in subclause 6.6.3.2 and for Co-existence with other systems in the same geographical area in subclause 6.6.3.3 and 6.6.3.7.1. In addition, the co-existence requirements for co-located base stations specified in subclause 6.6.3.4 and 6.6.3.7.2 may also be applied.

**Table 7.7A: Void**

**Table 7.8: Void**

# 8 Performance requirement

## 8.1 General

Performance requirements for the BS are specified for the measurement channels defined in Annex A and the propagation conditions in Annex B. The requirements only apply to those measurement channels that are supported by the base station. For FRC8 in Annex 9 and Annex 17 the Non E-DPCCH boosting and E-DPCCH boosting requirement only apply for the option supported by the base station. The performance requirements for the high speed train conditions which scenarios defined in Annex B.4A are optional.

Unless stated otherwise, performance requirements apply for a single cell only. Performance requirements for a BS supporting DC-HSUPA or DB-DC-HSUPA are defined in terms of single carrier requirements. The requirements in clause 8 shall be met with the transmitter(s) on.

**NOTE:** In normal operating conditions the BS is configured to transmit and receive at the same time. The transmitter may be off for some of the tests as specified in 25.141.

For BS with dual receiver antenna diversity, only the BS performance requirements with Rx diversity apply, the required  $E_b/N_0$  shall be applied separately at each antenna port.

For BS without receiver antenna diversity, only the BS performance requirements without Rx diversity apply, the required  $E_b/N_0$  shall be applied at the BS Rx antenna port.

The  $E_b/N_0$  used in this section is defined as:

$$E_b / N_o = \frac{E_c}{N_o} \cdot \frac{L_{chip}}{L_{inf}}$$

Where:

$E_c$  is the received total energy of DPDCH, DPCCH, S-DPCCH, HS-DPCCH, E-DPDCH, S-E-DPDCH, E-DPCCH and S-E-DPCCH per PN chip per antenna from all paths.

$N_o$  is the total one-sided noise power spectral density due to all noise sources

$L_{chip}$  is the number of chips per frame

$L_{inf}$  is the number of information bits in DTCH excluding CRC bits per frame

**Table 8.1: Summary of Base Station performance targets**

Physical channel	Measurement channel	Static	Multi-path Case 1	Multi-path Case 2*	Multi-path Case 3*	Moving *	Birth / Death*
		Performance metric					
DCH	12.2 kbps	BLER<10 <sup>-2</sup>	BLER<10 <sup>-2</sup>	BLER<10 <sup>-2</sup>	BLER<10 <sup>-2</sup>	BLER<	BLER<
	64 kbps	BLER<10 <sup>-1</sup> ,10 <sup>-2</sup>	BLER<10 <sup>-1</sup> ,10 <sup>-2</sup>	BLER<10 <sup>-1</sup> ,10 <sup>-2</sup>	BLER<10 <sup>-1</sup> ,10 <sup>-2</sup> ,10 <sup>-3</sup>	BLER<	BLER<
	144 kbps	BLER<10 <sup>-1</sup> ,10 <sup>-2</sup>	BLER<10 <sup>-1</sup> ,10 <sup>-2</sup>	BLER<10 <sup>-1</sup> ,10 <sup>-2</sup>	BLER<10 <sup>-1</sup> ,10 <sup>-2</sup> ,10 <sup>-3</sup>	-	-
	384 kbps	BLER<10 <sup>-1</sup> ,10 <sup>-2</sup>	BLER<10 <sup>-1</sup> ,10 <sup>-2</sup>	BLER<10 <sup>-1</sup> ,10 <sup>-2</sup>	BLER<10 <sup>-1</sup> ,10 <sup>-2</sup> ,10 <sup>-3</sup>	-	-
* Not applicable for Home BS							

## 8.2 Demodulation in static propagation conditions

### 8.2.1 Demodulation of DCH

The performance requirement of DCH in static propagation conditions is determined by the maximum Block Error Ratio (BLER) allowed when the receiver input signal is at a specified  $E_b/N_0$  limit. The BLER is calculated for each of the measurement channels supported by the base station.

#### 8.2.1.1 Minimum requirement

The BLER shall not exceed the limit for the  $E_b/N_0$  specified in Table 8.2.

**Table 8.2: Performance requirements in AWGN channel**

Measurement channel	Received $E_b/N_0$ For BS with Rx diversity	Received $E_b/N_0$ For BS without Rx diversity	Required BLER
12.2 kbps	n.a.	n.a.	< 10 <sup>-1</sup>
	5.1 dB	8.3 dB	< 10 <sup>-2</sup>
64 kbps	1.5 dB	4.7 dB	< 10 <sup>-1</sup>
	1.7 dB	4.8 dB	< 10 <sup>-2</sup>
144 kbps	0.8 dB	3.8 dB	< 10 <sup>-1</sup>
	0.9 dB	4 dB	< 10 <sup>-2</sup>
384 kbps	0.9 dB	4 dB	< 10 <sup>-1</sup>
	1.0 dB	4.1 dB	< 10 <sup>-2</sup>

## 8.3 Demodulation of DCH in multipath fading conditions

### 8.3.1 Multipath fading Case 1

The performance requirement of DCH in multipath fading Case 1 is determined by the maximum Block Error Ratio (BLER) allowed when the receiver input signal is at a specified  $E_b/N_0$  limit. The BLER is calculated for each of the measurement channels supported by the base station.

#### 8.3.1.1 Minimum requirement

The BLER shall not exceed the limit for the  $E_b/N_0$  specified in Table 8.3.

**Table 8.3: Performance requirements in multipath Case 1 channel**

Measurement channel	Received $E_b/N_0$ For BS with Rx diversity	Received $E_b/N_0$ For BS without Rx diversity	Required BLER
12.2 kbps	n.a.	n.a.	$< 10^{-1}$
	11.9 dB	19.1 dB	$< 10^{-2}$
64 kbps	6.2 dB	11.6 dB	$< 10^{-1}$
	9.2 dB	15.9 dB	$< 10^{-2}$
144 kbps	5.4 dB	10.8 dB	$< 10^{-1}$
	8.4 dB	15 dB	$< 10^{-2}$
384 kbps	5.8 dB	11.2 dB	$< 10^{-1}$
	8.8 dB	15.5 dB	$< 10^{-2}$

### 8.3.2 Multipath fading Case 2

The performance requirement of DCH in multipath fading Case 2 is determined by the maximum Block Error Ratio (BLER) allowed when the receiver input signal is at a specified  $E_b/N_0$  limit. The BLER is calculated for each of the measurement channels supported by the base station.

This requirement shall not be applied to Home BS.

#### 8.3.2.1 Minimum requirement

The BLER shall not exceed the limit for the  $E_b/N_0$  specified in Table 8.4.

**Table 8.4: Performance requirements in multipath Case 2 channel**

Measurement channel	Received $E_b/N_0$ For BS with Rx Diversity	Received $E_b/N_0$ For BS without Rx Diversity	Required BLER
12.2 kbps	n.a.	n.a.	$< 10^{-1}$
	9.0 dB	15 dB	$< 10^{-2}$
64 kbps	4.3 dB	9.2 dB	$< 10^{-1}$
	6.4 dB	12.3 dB	$< 10^{-2}$
144 kbps	3.7 dB	8.2 dB	$< 10^{-1}$
	5.6 dB	11.5 dB	$< 10^{-2}$
384 kbps	4.1 dB	8.7 dB	$< 10^{-1}$
	6.1 dB	12.1 dB	$< 10^{-2}$



### 8.3.3 Multipath fading Case 3

The performance requirement of DCH in multipath fading Case 3 is determined by the maximum Block Error Ratio (BLER) allowed when the receiver input signal is at a specified  $E_b/N_0$  limit. The BLER is calculated for each of the measurement channels supported by the base station.

This requirement shall not be applied to Home BS.

#### 8.3.3.1 Minimum requirement

The BLER shall not exceed the limit for the  $E_b/N_0$  specified in Table 8.5.

**Table 8.5: Performance requirements in multipath Case 3 channel**

Measurement channel	Received $E_b/N_0$ For BS with Rx Diversity	Received $E_b/N_0$ For BS without Rx Diversity	Required BLER
12.2 kbps	n.a.	n.a.	$< 10^{-1}$
	7.2 dB	10.8 dB	$< 10^{-2}$
	8.0 dB	11.7 dB	$< 10^{-3}$
64 kbps	3.4 dB	7.1 dB	$< 10^{-1}$
	3.8 dB	7.7 dB	$< 10^{-2}$
	4.1 dB	8.5 dB	$< 10^{-3}$
144 kbps	2.8 dB	6 dB	$< 10^{-1}$
	3.2 dB	6.7 dB	$< 10^{-2}$
	3.6 dB	7.2 dB	$< 10^{-3}$
384 kbps	3.2 dB	6.5 dB	$< 10^{-1}$
	3.6 dB	7.2 dB	$< 10^{-2}$
	4.2 dB	7.9 dB	$< 10^{-3}$

### 8.3.4 Multipath fading Case 4

The performance requirement of DCH in multipath fading Case 4 in case of a Wide Area BS is determined by the maximum Block Error Ratio (BLER) allowed when the receiver input signal is at a specified  $E_b/N_0$  limit. The BLER is calculated for each of the measurement channels supported by the base station.

### 8.3.4.1 Minimum requirement

The BLER shall not exceed the limit for the  $E_b/N_0$  specified in Table 8.5A.

**Table 8.5A: Performance requirements in multipath Case 4 channel**

Measurement channel	Received $E_b/N_0$ For BS with Rx Diversity	Received $E_b/N_0$ For BS without Rx Diversity	Required BLER
12.2 kbps	n.a.	n.a.	$< 10^{-1}$
	10.2 dB	13.8 dB	$< 10^{-2}$
	11.0 dB	14.7 dB	$< 10^{-3}$
64 kbps	6.4 dB	10.1 dB	$< 10^{-1}$
	6.8 dB	10.7 dB	$< 10^{-2}$
	7.1 dB	11.5 dB	$< 10^{-3}$
144 kbps	5.8 dB	9 dB	$< 10^{-1}$
	6.2 dB	9.7 dB	$< 10^{-2}$
	6.6 dB	10.2 dB	$< 10^{-3}$
384 kbps	6.2 dB	9.5 dB	$< 10^{-1}$
	6.6 dB	10.2 dB	$< 10^{-2}$
	7.2 dB	10.9 dB	$< 10^{-3}$

## 8.4 Demodulation of DCH in moving propagation conditions

The performance requirement of DCH in moving propagation conditions is determined by the maximum Block Error Ratio (BLER) allowed when the receiver input signal is at a specified  $E_b/N_0$  limit. The BLER is calculated for each of the measurement channels supported by the base station.

This requirement shall not be applied to Home BS.

### 8.4.1 Minimum requirement

The BLER shall not exceed the limit for the  $E_b/N_0$  specified in Table 8.6.

**Table 8.6: Performance requirements in moving channel**

Measurement channel	Received $E_b/N_0$ For BS with Rx Diversity	Received $E_b/N_0$ For BS without Rx Diversity	Required BLER
12.2 kbps	n.a.	n.a.	$< 10^{-1}$
	5.7 dB	8.7 dB	$< 10^{-2}$
64 kbps	2.1 dB	5.3 dB	$< 10^{-1}$
	2.2 dB	5.5 dB	$< 10^{-2}$

## 8.5 Demodulation of DCH in birth/death propagation conditions

The performance requirement of DCH in birth/death propagation conditions is determined by the maximum Block Error Ratio (BLER) allowed when the receiver input signal is at a specified  $E_b/N_0$  limit. The BLER is calculated for each of the measurement channels supported by the base station.

This requirement shall not be applied to Home BS.

## 8.5.1 Minimum requirement

The BLER shall not exceed the limit for the  $E_b/N_0$  specified in Table 8.7.

**Table 8.7: Performance requirements in birth/death channel**

Measurement channel	Received $E_b/N_0$ For BS with Rx Diversity	Received $E_b/N_0$ For BS without Rx Diversity	Required BLER
12.2 kbps	n.a.	n.a.	$< 10^{-1}$
	7.7 dB	10.8 dB	$< 10^{-2}$
64 kbps	4.1 dB	7.4 dB	$< 10^{-1}$
	4.2 dB	7.5 dB	$< 10^{-2}$

## 8.5A Demodulation of DCH in high speed train conditions

### 8.5A.1 General

The performance requirement of DCH in high speed train conditions is determined by the maximum BLER allowed when the receiver input signal is at a specified  $E_b/N_0$  limit. The BLER is calculated for the measurement channel supported by the base station.

This requirement shall not be applied to Home BS.

### 8.5A.2 Minimum requirement

The BLER shall not exceed the limit for the  $E_b/N_0$  specified in Table 8.7A.

**Table 8.7A: Performance requirements in high speed train conditions**

Scenario	Measurement channel	Received $E_b/N_0$ For BS with Rx Diversity	Received $E_b/N_0$ For BS without Rx Diversity	Required BLER
1	12.2 kbps	6.5 dB	9.6 dB	$< 10^{-2}$
2	12.2 kbps	n.a.	8.8 dB	$< 10^{-2}$
3	12.2 kbps	n.a.	10.1 dB	$< 10^{-2}$

## 8.6 (void)

## 8.7 Performance requirement for RACH

Performance requirement for RACH consists of two parts: preamble detection and message demodulation. Requirements for these are in sections 8.7.1 and 8.7.2, respectively. Requirements are defined for three propagation conditions: static, fading case 3, and high speed train conditions. The propagation conditions are defined in annexes B.1, B.2, and B.4A.

### 8.7.1 Performance requirement for RACH preamble detection

Probability of false alarm,  $P_{fa}$  (=false detection of the preamble) when the preamble was not sent, shall be  $10^{-3}$  or less. The performance measure Required  $E_c/N_0$  at probability of detection,  $P_d$  of 0.99 and 0.999. Only 1 signature is used and it is known by the receiver. The requirement for preamble detection, when the preamble was sent is in table 8.9, 8.10, and 8.10A for static, case 3 fading, and high speed train conditions.

The requirements in Table 8.10 and Table 8.10A shall not be applied to Home BS.

**Table 8.9: Requirements for  $E_c/N_0$  of Pd in static propagation condition**

	$E_c/N_0$ for required Pd $\geq 0.99$	$E_c/N_0$ for required Pd $\geq 0.999$
<b>BS with Rx Diversity</b>	-20.5 dB	-20.1 dB
<b>BS without Rx Diversity</b>	-17.6 dB	-16.8 dB

**Table 8.10: Requirements of  $E_c/N_0$  of Pd in case 3 fading**

	$E_c/N_0$ for required Pd $\geq 0.99$	$E_c/N_0$ for required Pd $\geq 0.999$
<b>BS with Rx Diversity</b>	-15.5 dB	-13.4 dB
<b>BS without Rx Diversity</b>	-9.4 dB	-6.4 dB

**Table 8.10A: Requirements of  $E_c/N_0$  of Pd in high speed train conditions**

Scenario		$E_c/N_0$ for required Pd $\geq 0.99$	$E_c/N_0$ for required Pd $\geq 0.999$
1	<b>BS with Rx Diversity</b>	-18.1 dB	-17.9 dB
	<b>BS without Rx Diversity</b>	-15.2 dB	-14.8 dB
2	<b>BS with Rx Diversity</b>	n.a.	n.a.
	<b>BS without Rx Diversity</b>	-15.6 dB	-14.8 dB
3	<b>BS with Rx Diversity</b>	n.a.	n.a.
	<b>BS without Rx Diversity</b>	-15.3 dB	-15.1 dB

## 8.7.2 Demodulation of RACH message

The performance measure is required  $E_b/N_0$  for block error rate (BLER) of  $10^{-1}$  and  $10^{-2}$ . Both measurement channels have TTI=20 ms. Payloads are 168 and 360 bits. Channel coding is rate  $\frac{1}{2}$  convolutional coding.

The requirements in Table 8.12 and Table 8.12A shall not be applied to Home BS.

### 8.7.2.1 Minimum requirements for Static Propagation Condition

**Table 8.11: Required  $E_b/N_0$  for static propagation**

Transport Block size TB and TTI in frames	168 bits, TTI = 20 ms		360 bits, TTI = 20 ms	
	$E_b/N_0$ for required BLER $< 10^{-1}$	$E_b/N_0$ for required BLER $< 10^{-2}$	$E_b/N_0$ for required BLER $< 10^{-1}$	$E_b/N_0$ for required BLER $< 10^{-2}$
BS with Rx Diversity	4.1 dB	5.0 dB	3.9 dB	4.8 dB
BS without Rx Diversity	7.2 dB	8.1 dB	6.9 dB	7.8 dB

### 8.7.2.2 Minimum requirements for Multipath Fading Case 3

**Table 8.12: Required  $E_b/N_0$  for case 3 fading**

Transport Block size TB and TTI in frames	168 bits, TTI = 20 ms		360 bits, TTI = 20 ms	
	$E_b/N_0$ for required BLER $< 10^{-1}$	$E_b/N_0$ for required BLER $< 10^{-2}$	$E_b/N_0$ for required BLER $< 10^{-1}$	$E_b/N_0$ for required BLER $< 10^{-2}$
BS with Rx Diversity	7.4 dB	8.5 dB	7.3 dB	8.3 dB
BS without Rx Diversity	11.1 dB	12.4 dB	11.0 dB	12.1 dB

## 8.7.2.3 Minimum requirements for high speed train conditions

Table 8.12A: Required  $E_b/N_0$  for high speed train conditions

Transport Block size TB and TTI in frames		168 bits, TTI = 20 ms		360 bits, TTI = 20 ms	
Scenario		$E_b/N_0$ for required BLER < $10^{-1}$	$E_b/N_0$ for required BLER < $10^{-2}$	$E_b/N_0$ for required BLER < $10^{-1}$	$E_b/N_0$ for required BLER < $10^{-2}$
1	BS with Rx Diversity	5.1 dB	6.4 dB	5.3 dB	6.2 dB
	BS without Rx Diversity	8.1 dB	9.4 dB	8.3 dB	9.2 dB
2	BS with Rx Diversity	n.a.	n.a.	n.a.	n.a.
	BS without Rx Diversity	7.7 dB	8.6 dB	7.4 dB	8.3 dB
3	BS with Rx Diversity	n.a.	n.a.	n.a.	n.a.
	BS without Rx Diversity	8.2 dB	9.6 dB	8.4 dB	9.3 dB

## 8.8 (void)

Table 8.13: (void)

Table 8.14: (void)

## 8.9 (void)

Table 8.15: (void)

## 8.10 Performance of ACK/NACK detection for HS-DPCCH

Performance requirements of HS-DPCCH signaling detection consist of two parts; ACK false alarm and ACK mis-detection. Requirements for these are 8.10.1 and 8.10.2, respectively. Performance requirements are specified for the reference measurement channel of HS-DPCCH and four propagation conditions: static, multi-path fading case 1, case2 and case3. The reference measurement channel for HS-DPCCH is defined in Annex A.8. The propagation conditions are defined in Annex B.1 and B.2.

## 8.10.1 ACK false alarm

The probability of ACK false alarm,  $P(\text{DTX} \rightarrow \text{ACK})$  (= false ACK detection when DTX is transmitted) shall not exceed the required error ratio for the  $E_c/N_0$  specified in Table 8.16.

Table 8.16: Performance requirements for ACK false alarm

Propagation condition	Received $E_c/N_0$ (Test condition) For BS with Rx Diversity	Required error ratio
Static	-19.9 dB	< $10^{-2}$
Case 1	-13.1 dB	< $10^{-2}$
Case 2*	-16.0 dB	< $10^{-2}$
Case 3*	-17.8 dB	< $10^{-2}$
* Not applicable for Home BS		

## 8.10.2 ACK mis-detection

The probability of ACK mis-detection,  $P(\text{ACK} \rightarrow \text{NACK or DTX})$  (= mis-detected when ACK is transmitted) shall not exceed the required error ratio for the  $E_c/N_0$  specified in Table 8.17.

**Table 8.17: Performance requirements for ACK mis-detection**

Propagation condition	Received $E_c/N_0$ For BS with Rx Diversity	Required error ratio
Static	-17.3 dB	$< 10^{-2}$
Case 1	-10.7 dB	$< 10^{-2}$
Case 2*	-13.6 dB	$< 10^{-2}$
Case 3*	-12.1 dB	$< 10^{-2}$
* Not applicable for Home BS		

## 8.10A Performance of ACK/NACK detection for 4C-HSDPA HS-DPCCH

This requirement only applies to NodeB supporting 4C-HSDPA.

Performance requirements of HS-DPCCH signaling detection for 4C-HSDPA consist of two parts; ACK false alarm and ACK mis-detection. Requirements for these are 8.10A.1.1 and 8.10A.1.2, respectively. Performance requirements are specified for the reference measurement channel of HS-DPCCH and two propagation conditions: static and multi-path fading case 1. The reference measurement channel for HS-DPCCH is defined in Annex A.8A. The propagation conditions are defined in Annex B.1 and B.2.

Performance requirements of HS-DPCCH signaling detection for 4C-HSDPA apply also for HSDPA Multiflow operation on three/four cells on two frequencies without MIMO and HSDPA Multiflow operation on four cells on three frequencies without MIMO. If NodeB supports both 4C-HSDPA and HSDPA Multiflow operation on three/four cells on two frequencies without MIMO and/or HSDPA Multiflow operation on four cells on three frequencies without MIMO, performance of HS-DPCCH signaling detection shall be tested only once.

### 8.10A.1 Performance requirements

#### 8.10A.1.1 ACK false alarm

The probability of ACK false alarm for each stream,  $P(\text{DTX} \rightarrow \text{ACK})$  (=false ACK detection for a given stream in the detected HARQ message given that no HARQ message is transmitted) shall not exceed the required error ratio for the  $E_c/N_0$  specified in Table 8.17A.

**Table 8.17A: Performance requirements for ACK false alarm per stream**

Test Configuration <sup>1</sup>	Propagation condition	Received $E_c/N_0$ [dB] (Test condition) For BS with Rx Diversity	Required error ratio
4/4/4	Static	-16.7	$< 10^{-2}$
	Case 1	-11.4	$< 10^{-2}$
4/2/2	Static	-16.7	$< 10^{-2}$
	Case 1	-11.4	$< 10^{-2}$
3/3/3	Static	-17.0	$< 10^{-2}$
	Case 1	-11.4	$< 10^{-2}$
3/2/1	Static	-17.0	$< 10^{-2}$
	Case 1	-11.4	$< 10^{-2}$
3/3/0	Static	-17.4	$< 10^{-2}$
	Case 1	-12.5	$< 10^{-2}$

Note: Test configuration X/Y/Z denotes X number of carriers configured, Y number of active carriers, and Z number of carriers configured as MIMO out of Y carriers.

### 8.10A.1.2 ACK mis-detection

The probability of ACK mis-detection for each stream,  $P(\text{ACK} \rightarrow \text{NACK}, \text{DTX (no transmission)} \text{ or } \text{DTX codeword})$  (=an ACK for a given stream in a transmitted HARQ message is mis-detected as a NACK or DTX (no transmission) or DTX codeword in the received HARQ message) shall not exceed the required error ratio for the  $E_c/N_0$  specified in Table 8.17B. This requirement shall be conditioned on that the ACK false alarm requirement in Section 8.10A.1.1 above shall also be concurrently satisfied.

**Table 8.17B: Performance requirements for ACK mis-detection per stream conditioned on ACK false alarm per stream is less than 1%.**

Test Configuration <sup>1</sup>	Propagation condition	Received $E_c/N_0$ [dB] (Test condition) For BS with Rx Diversity	Required error ratio
4/4/4	Static	-13.9	$< 10^{-2}$
	Case 1	-8.7	$< 10^{-2}$
4/2/2	Static	-14.4	$< 10^{-2}$
	Case 1	-9.0	$< 10^{-2}$
3/3/3	Static	-14.2	$< 10^{-2}$
	Case 1	-8.6	$< 10^{-2}$
3/2/1	Static	-15.0	$< 10^{-2}$
	Case 1	-8.8	$< 10^{-2}$
3/3/0	Static	-15.4	$< 10^{-2}$
	Case 1	-10.5	$< 10^{-2}$

Note: Test configuration X/Y/Z denotes X number of carriers configured, Y number of active carriers, and Z number of carriers configured as MIMO out of Y carriers.

### 8.10A.2 Applicability of requirements

The requirements shown in Table 8.17A and Table 8.17B are applicable according to Table 8.17C. For each requirement, the requirement shall be tested with the highest number of configured, active and MIMO carriers that NodeB can support and the appropriate codebook subset is chosen for testing.

**Table 8.17C: Applicability of 4C-HSDPA HS-DPCCH requirements**

Number of Configured Carriers	Number of Active Carriers	Number of MIMO carriers	HS-DPCCH Spreading Factor	Codebook	Requirements Applicability <sup>1</sup>
4	4	0; 1; 2; 3; 4	SF128	Rel9 DC-MIMO codebook	4/4/4 requirements
3, 4	2	2	SF128	Rel9 DC-MIMO codebook Repeated across half-slots	4/2/2 requirements
3, 4	3	1; 2; 3	SF128	Rel9 DC-MIMO codebook	3/3/3 requirements <sup>2</sup>
4	3	0			
4	2	0; 1	SF128	Rel9 DC-MIMO codebook Repeated across half-slots	3/2/1 requirements <sup>2</sup>
3	2	1			
3	1; 2; 3	0	SF256	Rel10 TC-MIMO codebook	3/3/0 requirements

Note 1: X/Y/Z requirements refer to the requirements in Table 8.17A and Table 8.17B with test configuration X/Y/Z.  
Note 2: 3/3/3 and 3/2/1 requirements are applicable only when the NodeB does not support simultaneous 4 carrier operation.

## 8.10B Performance of ACK/NACK detection for 8C-HSDPA HS-DPCCH

This requirement only applies to NodeB supporting 8C-HSDPA.

In 8C-HSDPA two identical HS-DPCCH channels similar to the 4C-HSDPA HS-DPCCH are used and they are transmitted by means of I/Q multiplexing. One HS-DPCCH is serving carriers 1 to 4, while the other HS-DPCCH is serving carriers 5 to 8. The same performance requirements as for 4C-HSDPA HS-DPCCH, as defined in section 8.10A, shall apply for both I and Q HS-DPCCH channels.

Performance requirements are specified for the reference measurement channel of HS-DPCCH and two propagation conditions: static and multi-path fading case 1. The reference measurement channel for HS-DPCCH is defined in Annex A.8A. The propagation conditions are defined in Annex B.1 and B.2.

## 8.11 Demodulation of E-DPDCH in multipath fading condition

The performance requirement of the E-DPDCH in multi path fading condition is determined by the minimum throughput, R. For the test parameters specified in Table 8.18, the minimum requirements are specified in Table 8.19. For a BS supporting DC-HSUPA or DB-DC-HSUPA the requirements for FRC1, FRC2, FRC3 and FRC8 shall apply on each cell.

**Table 8.18: Test parameters for testing E-DPDCH**

Parameter	Unit	Test	
RSN		{0, 1, 2, 3}	
HARQ combining		IR	
Maximum number of HARQ transmission		4	
Power control		OFF	
DPCCH slot format		FRC8 or BS supporting DC-HSUPA or DB-DC-HSUPA	1
		otherwise	0
E-DPCCH # code words		1024, no optimization based on prior knowledge of valid code words.	
Physical channels to be turned on		DPCCH, E-DPDCH and E-DPCCH	



Table 8.19 Minimum Requirement for E-DPDCH

Fixed Reference Channel		Reference value, $E_c/N_0$ (dB), for $R \geq 30\%$ and $R \geq 70\%$ of maximum information bit rate									
		FRC1	FRC2	FRC3	FRC4	FRC5	FRC6	FRC7	FRC8		
Non E-DPCCH boosting	E-DPCCH Boosting										
Pedestrian A without RX diversity	30%	-2.4	0.8	2.4	-7.1	-4.4	-1.4	-15.0	NA	NA	
	70%	3.7	7.1	9.1	-0.6	2.1	5.2	-8.4	16.2	16.9	
Pedestrian A with RX diversity	30%	-6.2	-3.1	-1.4	-10.6	-8.0	-5.0	-18.3	NA	NA	
	70%	-1.0	2.2	4.1	-5.2	-2.6	0.2	-13.3	10.1	10.4	
Pedestrian B without RX diversity*	30%	-2.5	1.1	3.5	-7.5	-4.7	-1.3	-13.6	NA	NA	
	70%	3.9	NA	NA	-2.1	0.9	5.3	-10.1	NA	NA	
Pedestrian B with RX diversity*	30%	-6.1	-3.1	-1.0	-10.7	-8.1	-4.9	-18.0	NA	NA	
	70%	-0.3	3.9	8.2	-5.7	-2.9	0.7	-13.8	12.4	13.1	
Vehicular 30 without RX diversity*	30%	-2.5	1.0	3.2	-7.5	-4.6	-1.4	-14.3	NA	NA	
	70%	4.9	NA	NA	-1.7	1.4	5.8	-10.1	NA	NA	
Vehicular 30 with RX diversity*	30%	-6.1	-2.9	-0.9	-10.7	-8.0	-4.9	-17.6	NA	NA	
	70%	0.6	4.7	8.8	-5.4	-2.6	1.0	-13.7	13.3	13.6	
Vehicular 120 without RX diversity*	30%	-2.1	1.3	3.6	-7.3	-4.2	-1.2	-14.0	NA	NA	
	70%	5.1	NA	NA	-1.3	1.5	6.1	-10.1	NA	NA	
Vehicular 120 with RX diversity*	30%	-5.7	-2.6	-0.5	-10.4	-7.6	-4.3	-17.0	NA	NA	
	70%	0.7	5.0	9.5	-5.1	-2.3	1.2	-13.2	NA	NA	

\* Not applicable for Home BS

## 8.11A Demodulation of E-DPDCH and S-E-DPDCH in multipath fading condition for UL MIMO

The performance requirements of the E-DPDCH and S-E-DPDCH in multi path fading condition for UL MIMO are determined by the minimum throughput, R. For the test parameters specified in Table 8.19A, the minimum requirements are specified in Table 8.19B.

Table 8.19A: Test parameters for testing E-DPDCH and S-E-DPDCH for UL MIMO

Parameter	Test
RSN	{0, 1, 2, 3}
HARQ combining	IR
Maximum number of HARQ transmission	4
Power control	OFF
TX weight vector selection	A fixed precoding weight vector
Physical channels to be turned on	DPCCH, S-DPCCH, E-DPCCH, S-E-DPCCH, E-DPDCH and S-E-DPDCH

Table 8.19B: Minimum Requirements for E-DPDCH and S-E-DPDCH for UL MIMO

Fixed Reference Channel	Reference value, $E_c/N_0$ (dB), for $R \geq 70\%$ of maximum information bit rate			
	FRC9		FRC10	
Propagation conditions	E-DPDCH	S-E-DPDCH	E-DPDCH	S-E-DPDCH
Ped A, 3 km/h	9.1	9.1	17.8	17.8
Veh A, 3 km/h	10.4	10.4	N/A	N/A

## 8.12 Performance of signaling detection for E-DPCCH in multipath fading condition

The performance requirement of the E-DPCCH in multi path fading condition is determined by the false alarm rate and the missed detection rate. For the test parameters specified in Table 8.20, the minimum requirements are specified in Table 8.21 and 8.22.

**Table 8.20: Test parameters for testing E-DPCCH**

Parameter	Unit	Test
Power control		Off
E-DPCCH # code words		1024, no optimization based on prior knowledge of valid code words.
Physical channels to be turned on for missed detection test		DPCCH, E-DPCCH and E-DPCCH
Physical channels to be turned on for false alarm test		DPCCH

**Table 8.21: Performance requirements for E-DPCCH false alarm**

Propagation conditions	Received $E_c/N_0$		Required detection probability
	FRC1	FRC4	
Pedestrian A without RX diversity	-1.6 dB	-5.0 dB	$< 10^{-2}$
Pedestrian A with RX diversity	-11.2 dB	-12.3 dB	$< 10^{-2}$
Pedestrian B without RX diversity*	-13.8 dB	-15.2 dB	$< 10^{-2}$
Pedestrian B with RX diversity*	-16.4 dB	-17.6 dB	$< 10^{-2}$
Vehicular 30 without RX diversity*	-12.1 dB	-16.7 dB	$< 10^{-2}$
Vehicular 30 with RX diversity*	-15.7 dB	-18.6 dB	$< 10^{-2}$
Vehicular 120 without RX diversity*	-13.8 dB	-18.3 dB	$< 10^{-2}$
Vehicular 120 with RX diversity*	-17.1 dB	-19.6 dB	$< 10^{-2}$
* Not applicable for Home BS			

**Table 8.22: Performance requirements for E-DPCCH missed detection**

Propagation conditions	Received $E_c/N_0$		Required missed detection probability
	FRC1	FRC4	
Pedestrian A without RX diversity	13.7 dB	7.4 dB	$< 2 \cdot 10^{-3}$
Pedestrian A with RX diversity	1.2 dB	-2.8 dB	$< 2 \cdot 10^{-3}$
Pedestrian B without RX diversity*	1.5 dB	-2.8 dB	$< 2 \cdot 10^{-3}$
Pedestrian B with RX diversity*	-4.0 dB	-8.1 dB	$< 2 \cdot 10^{-3}$
Vehicular 30 without RX diversity*	3.2 dB	-4.3 dB	$< 2 \cdot 10^{-3}$
Vehicular 30 with RX diversity*	-3.3 dB	-9.1 dB	$< 2 \cdot 10^{-3}$
Vehicular 120 without RX diversity*	1.5 dB	-5.9 dB	$< 2 \cdot 10^{-3}$
Vehicular 120 with RX diversity*	-4.7 dB	-10.1 dB	$< 2 \cdot 10^{-3}$
* Not applicable for Home BS			

## Annex A (normative): Measurement channels

### A.1 Summary of UL reference measurement channels

The parameters for the UL reference measurement channels are specified in Table A.1 and the channel coding is detailed in figure A.2 through A.6 respectively. Note that for all cases, one DPCCH shall be attached to DPDCH(s).

**Table A.1: Reference measurement channels for UL DCH**

Parameter		DCH for DTCH / DCH for DCCH				Unit
DPDCH	Information bit rate	12.2/2.4	64/2.4	144/2.4	384/2.4	kbps
	Physical channel	60/15	240/15	480/15	960/15	kbps
	Spreading factor	64	16	8	4	
	Repetition rate	22/22	19/19	8/9	-18/-17	%
	Interleaving	20	40	40	40	ms
	Number of DPDCHs	1	1	1	1	
DPCCH	Dedicated pilot	6				bit/slot
	Power control	2				bit/slot
	TFCI	2				bit/slot
	Spreading factor	256				
Power ratio of DPCCH/DPDCH		-2.69	-5.46	-9.54	-9.54	dB
Amplitude ratio of DPCCH/DPDCH		0.7333	0.5333	0.3333	0.3333	

## A.2 UL reference measurement channel for 12.2 kbps

The parameters for the UL reference measurement channel for 12.2 kbps are specified in Table A.2 and the channel coding is detailed in Figure A.2.

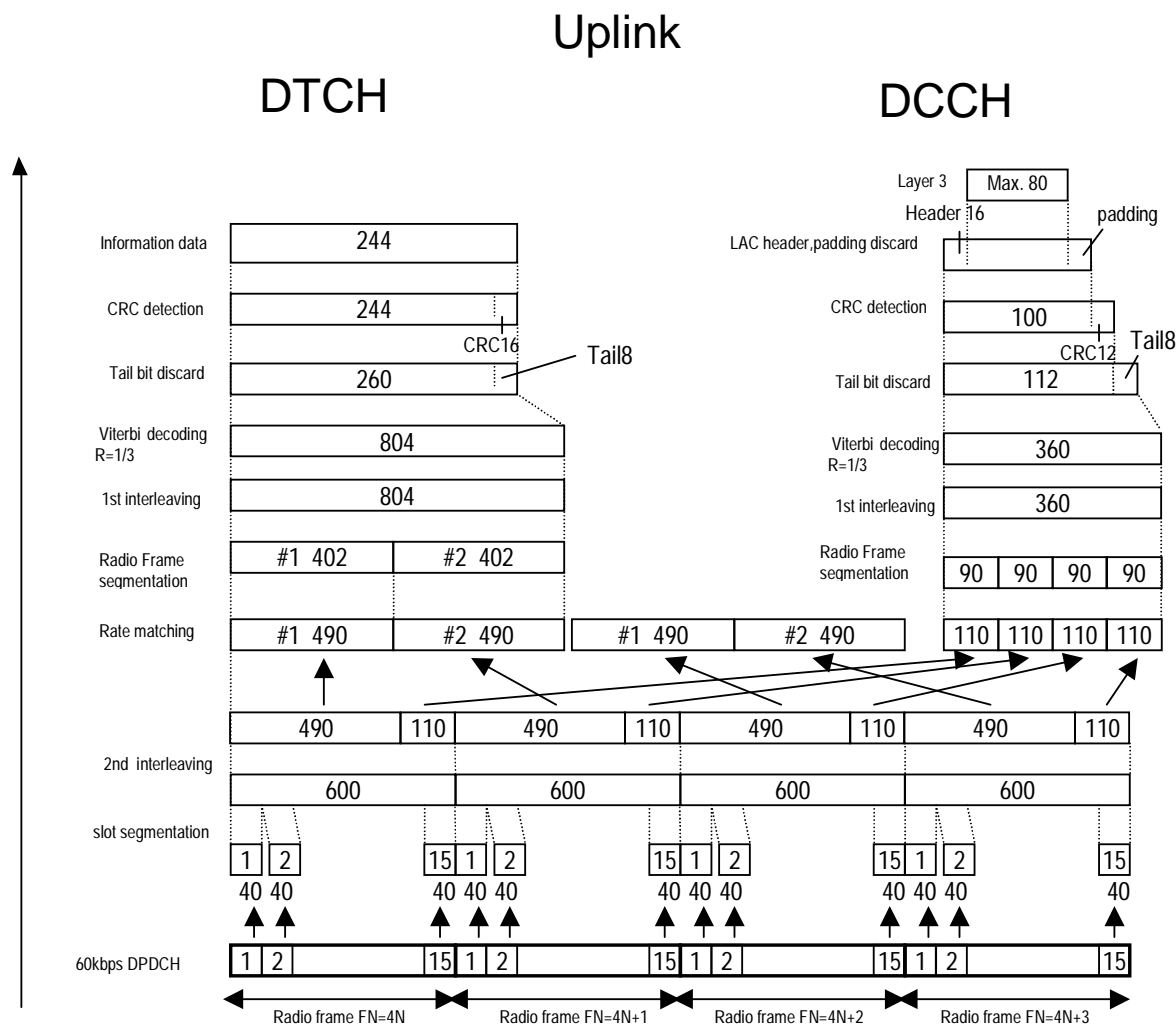

**Figure A.2: Channel coding for the UL reference measurement channel (12.2 kbps)**

**Table A.2: UL reference measurement channel (12.2 kbps)**

Parameter	Level	Unit
Information bit rate	12.2	kbps
DPCH	60	kbps
Power control	Off	
TFCI	On	
Repetition	22	%

# A.3 UL reference measurement channel for 64 kbps

The parameters for the UL reference measurement channel for 64 kbps are specified in Table A.3 and the channel coding is detailed in Figure A.3.

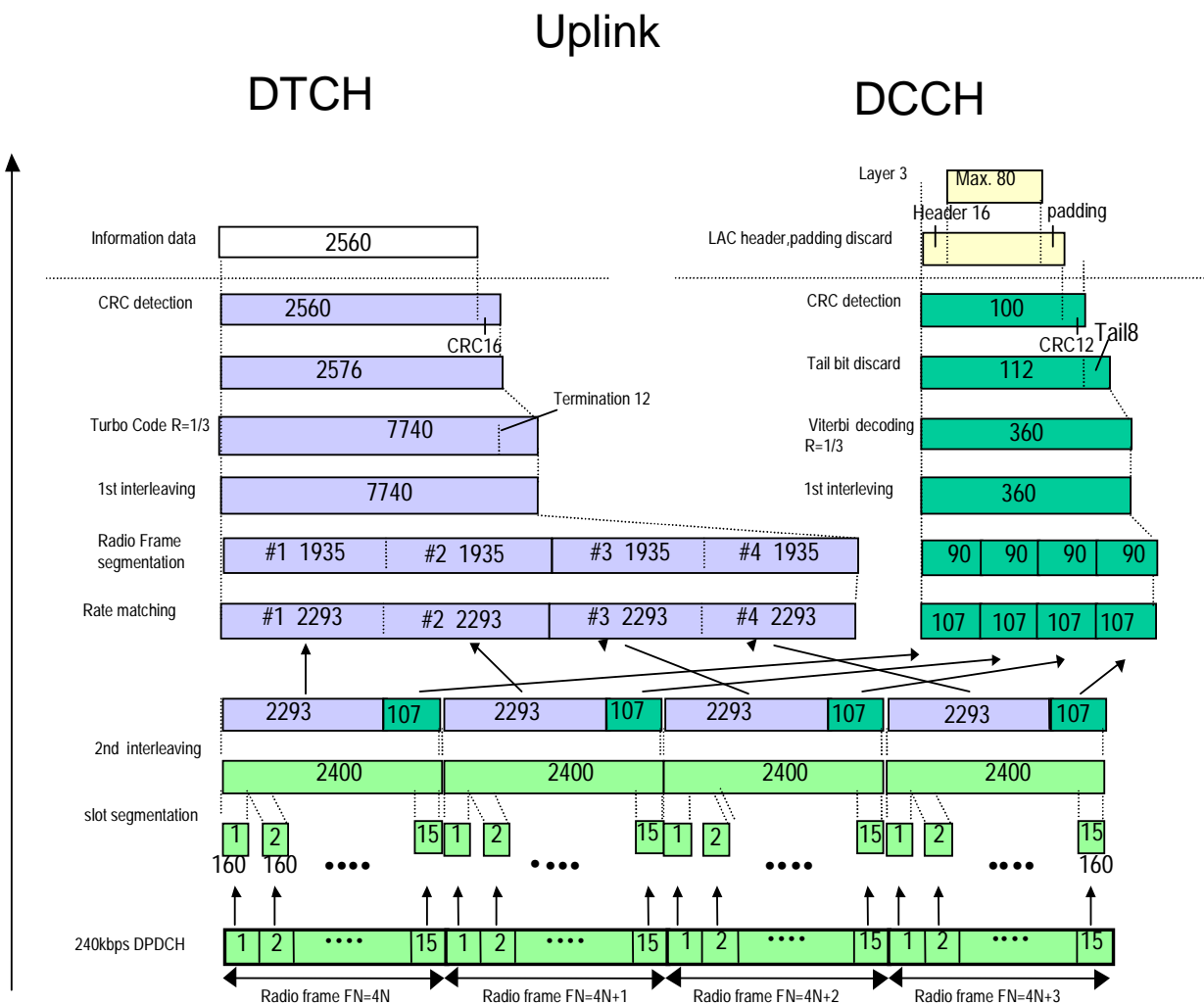

Figure A.3: Channel coding for the UL reference measurement channel (64 kbps)

Table A.3: UL reference measurement channel (64kbps)

Parameter	Level	Unit
Information bit rate	64	kbps
DPCH	240	kbps
Power control	Off	
TFCI	On	
Repetition	19	%

# A.4 UL reference measurement channel for 144 kbps

The parameters for the UL reference measurement channel for 144 kbps are specified in Table A.4 and the channel coding is detailed in Figure A.4.

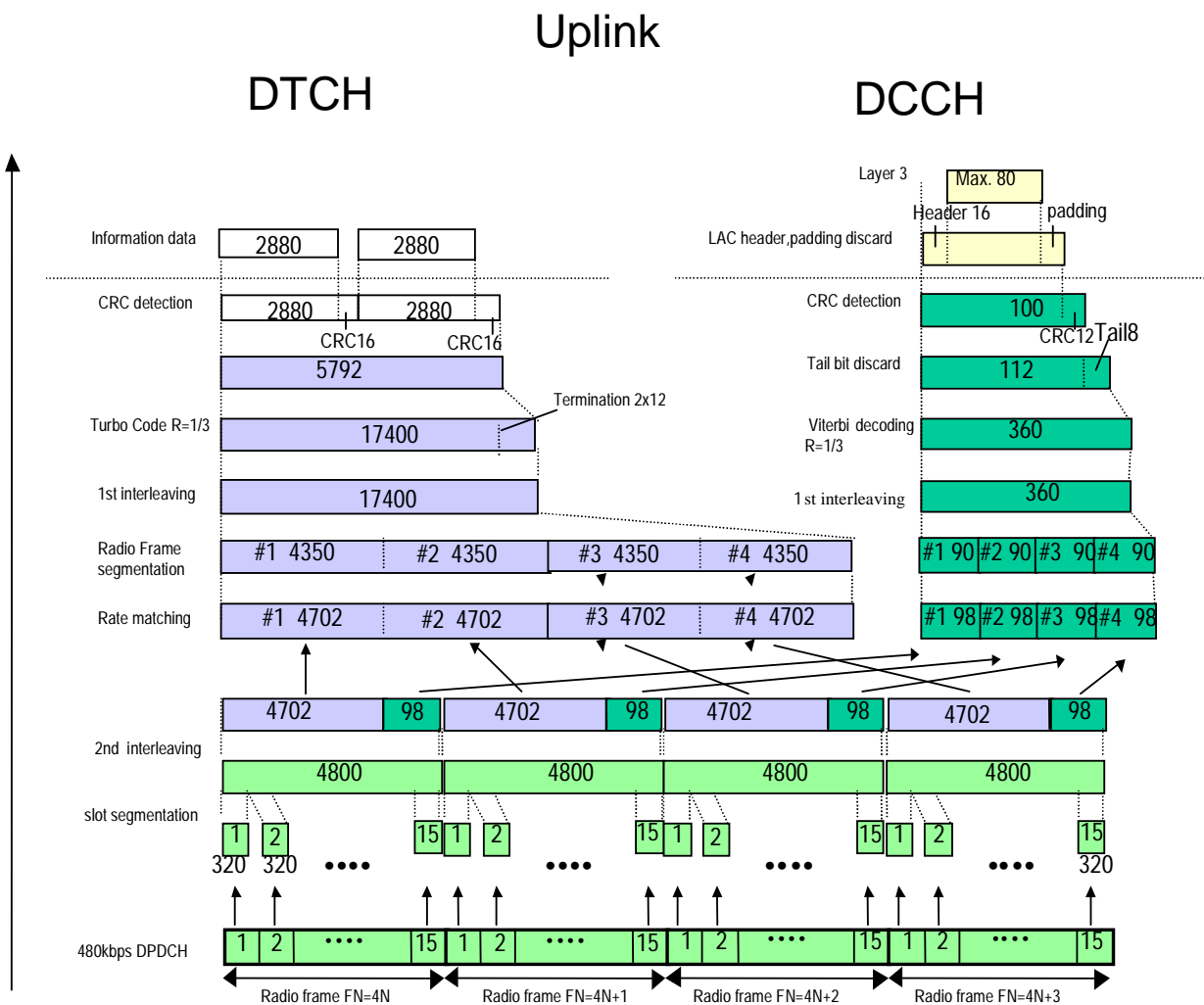

Figure A.4: Channel coding for the UL reference measurement channel (144 kbps)

Table A.4: UL reference measurement channel (144kbps)

Parameter	Level	Unit
Information bit rate	144	Kbps
DPCH	480	Kbps
Power control	Off	
TFCI	On	
Repetition	8	%

# A.5 UL reference measurement channel for 384 kbps

The parameters for the UL reference measurement channel for 384 kbps are specified in Table A.5 and the channel coding is detailed in Figure A.5.

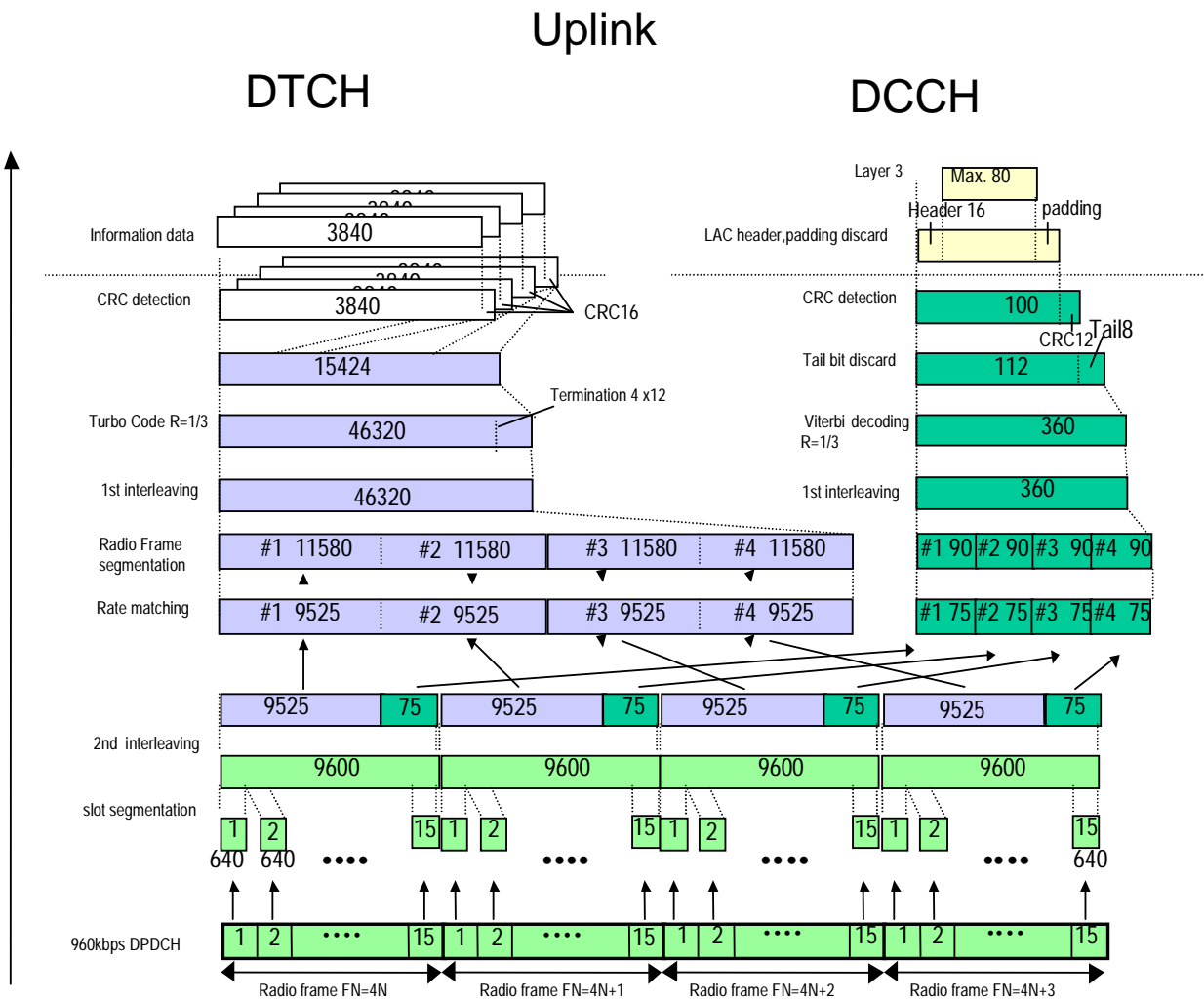

Figure A.5: Channel coding for the UL reference measurement channel (384 kbps)

Table A.5: UL reference measurement channel (384kbps)

Parameter	Level	Unit
Information bit rate	384	Kbps
DPCH	960	Kbps
Power control	Off	
TFCI	On	
Puncturing	18	%

# A.6 (void)

Figure A.6: (void)

Table A.6: (void)

## A.7 Reference measurement channels for UL RACH

The parameters for the UL RACH reference measurement channels are specified in Table A.7.

Table A.7: Reference measurement channels for UL RACH

Parameter			Unit
RACH	CRC	16	bits
	Channel Coding	Rate ½ conv. coding	
	TTI	20	ms
	TB size	168, 360	bits
	Rate Matching	Repetition	
	Number of diversity antennas	2	
	Preamble detection window size	256	chips
	Ratio of preamble power and total message power	0	dB
Power ratio of RACH Control/Data TB = 168		-2.69	dB
Power ratio of Control/Data TB = 360		-3.52	dB

## A.8 Reference measurement channel for HS-DPCCH

The parameters for the UL HS-DPCCH reference measurement channel are specified in Table A.8.

Table A.8: Reference measurement channel for HS-DPCCH

Parameter			Unit	
DPDCH	DTCH	Information bit rate	12.2	kbps
		Physical channel	60	kbps
		Repetition rate	22	%
	DCCH	Information bit rate	2.4	kbps
		Physical channel	15	kbps
		Repetition rate	22	%
	Spreading factor		64	
	Interleaving		20	ms
	Number of DPDCHs		1	
DPCCH	Dedicated pilot		6	bits/slot
	Power control		2	bits/slot
	TFCI		2	bits/slot
	Spreading factor		256	
Power ratio of DPCCH/DPDCH		-2.69	dB	
Amplitude ratio of DPCCH/DPDCH		0.7333		
Closed loop power control		OFF		
HS-DPCCH repetition		1		
HS-DPCCH power offset to DPCCH		0	dB	
HS-DPCCH timing offset to DPCCH		0	symbol	

DPDCH/DPCCH are same as 12.2kbps reference measurement channel specified in Annex A.2.



## A.8A Reference measurement channel for HS-DPCCH for 4C-HSDPA

The parameters for the UL 4C-HSDPA HS-DPCCH reference measurement channels are specified in Table A.8A. For RRC configuration, 0 dB shall be used for HS-DPCCH power offset to DPCCH in the test. In the reference measurement channels, HS-DPCCH power offset to DPCCH in Table A.8A shall be used for the waveform during the test as per the rule in Table 2b in Section 5.1.2.5A in TS 25.214 [12].

**Table A.8A: Reference measurement channels for 4C-HSDPA HS-DPCCH**

Test Configuration			Parameter					Unit
			4/4/4	4/4/2	3/3/3	3/2/1	3/3/0	
DPDCH	DTCH	Information bit rate	12.2					kbps
		Physical channel	60					kbps
		Repetition rate	22					%
	DCCH	Information bit rate	2.4					kbps
		Physical channel	15					kbps
		Repetition rate	22					%
	Spreading factor		64					
	Interleaving		20					Ms
Number of DPDCHs		1						
DPCCH	Dedicated pilot		6					bits/slot
	Power control		2					bits/slot
	TFCI		2					bits/slot
	Spreading factor		256					
Power ratio of DPCCH/DPDCH			-2.69					dB
Amplitude ratio of DPCCH/DPDCH			0.7333					
Closed loop power control			OFF					
HS-DPCCH repetition			1					
HS-DPCCH power offset to DPCCH			4.08	2.05	4.08	2.05	2.05	dB
HS-DPCCH timing offset to DPCCH			0					Symbol
HS-DPCCH spreading factor			128	128	128	128	256	
Secondary_Cell_Enabled			3	3	2	2	2	
Secondary_Cell_Active			3	1	2	1	2	
Number of MIMO carriers			4	2	3	1	0	
Codebook			Rel10 DC-MIMO codebook	Rel10 DC-MIMO codebook repeated	Rel10 DC-MIMO codebook	Rel10 DC-MIMO codebook repeated	Rel10 TC-MIMO codebook	
			Notes 2		Notes 3	Note 3		
<p>Note 1: Test configuration X/Y/Z denotes X number of carriers configured, Y number of active carriers, and Z number of carriers configured as MIMO out of Y carriers. However, the configuration during the test follows Table 8.17C.</p> <p>Note 2: If the NodeB is not capable of MIMO on all 4 active carriers, the maximum supportable number of MIMO carriers is configured.</p> <p>Note 3: Optional: Applies only if the NodeB is not capable of simultaneous 4 carrier operation.</p>								

## A.9 Summary of E-DPDCH Fixed reference channels

Table A.9

Fixed Ref Channel	TTI [ms]	N <sub>INF</sub>	SF <sub>1</sub>	SF <sub>2</sub>	SF <sub>3</sub>	SF <sub>4</sub>	N <sub>BIN</sub>	Coding rate	Max inf bit rate [kbps]
FRC1	2	2706	4	4	0	0	3840	0.705	1353.0
FRC2	2	5412	2	2	0	0	7680	0.705	2706.0
FRC3	2	8100	2	2	4	4	11520	0.703	4050.0
FRC4	10	5076	4	0	0	0	9600	0.529	507.6
FRC5	10	9780	4	4	0	0	19200	0.509	978.0
FRC6	10	19278	2	2	0	0	38400	0.502	1927.8
FRC7	10	690	16	0	0	0	2400	0.288	69.0
FRC8	2	16218	2	2	4	4	23040	0.704	8109.0
FRC9	2	16200	2	2	4	4	23040	0.703	8100.0
FRC10	2	32436	2	2	4	4	46080	0.704	16218.0

## A.10 E-DPDCH Fixed reference channel 1 (FRC1)

Table A.10

Parameter	Unit	Value
Maximum. Inf. Bit Rate	kbps	1353.0
TTI	ms	2
Number of HARQ Processes	Processes	8
Information Bit Payload (N <sub>INF</sub> )	Bits	2706
Binary Channel Bits per TTI (N <sub>BIN</sub> ) (3840 / SF x TTI sum for all channels)	Bits	3840
Coding Rate (N <sub>INF</sub> / N <sub>BIN</sub> )		0.705
Physical Channel Codes	SF for each physical channel	{4,4}
E-DPDCH testing: E-DPDCH/DPCCH power ratio  E-DPCCH/DPCCH power ratio	dB dB dB dB	Diversity: 8.94 Non-diversity: 12.04 Diversity: 2.05 Non-diversity: 6.02 E-DPDCH /DPCCH power ratio is calculated for a single E-DPDCH.
E-DPCCH missed detection testing: E-DPDCH/DPCCH power ratio  E-DPCCH/DPCCH power ratio	dB dB dB dB	Diversity: 8.94 Non-diversity: 12.04 Diversity: -1.94 Non-diversity: 0.00

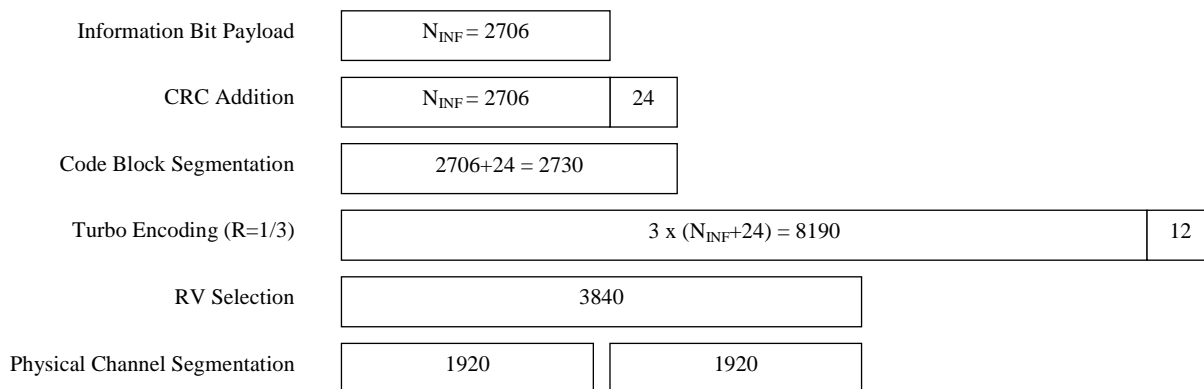

Figure A.10

# A.11 E-DPDCH Fixed reference channel 2 (FRC2)

Table A.11

Parameter	Unit	Value
Maximum. Inf. Bit Rate	kbps	2706.0
TTI	ms	2
Number of HARQ Processes	Processes	8
Information Bit Payload ( $N_{INF}$ )	Bits	5412
Binary Channel Bits per TTI ( $N_{BIN}$ ) (3840 / SF x TTI sum for all channels)	Bits	7680
Coding Rate ( $N_{INF} / N_{BIN}$ )		0.705
Physical Channel Codes	SF for each physical channel	{2,2}
E-DPDCH testing: E-DPDCH/DPCCH power ratio	dB	Diversity: 9.92
	dB	Non-diversity: 13.00
E-DPCCH/DPCCH power ratio	dB	Diversity: 4.08
	dB	Non-diversity: 6.02
		E-DPDCH /DPCCH power ratio is calculated for a single E-DPDCH.

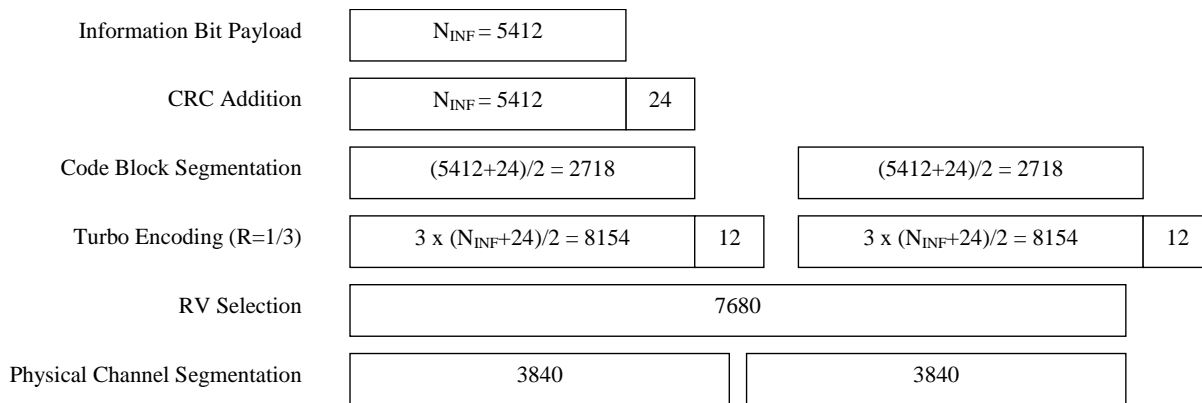

Figure A.11

## A.12 E-DPDCH Fixed reference channel 3 (FRC3)

Table A.12

Parameter	Unit	Value
Maximum. Inf. Bit Rate	kbps	4050.0
TTI	ms	2
Number of HARQ Processes	Processes	8
Information Bit Payload ( $N_{INF}$ )	Bits	8100
Binary Channel Bits per TTI ( $N_{BIN}$ ) (3840 / SF x TTI sum for all channels)	Bits	11520
Coding Rate ( $N_{INF} / N_{BIN}$ )		0.703
Physical Channel Codes	SF for each physical channel	{2,2,4,4}
E-DPDCH testing: E-DPDCH/DPCCH power ratio  E-DPCCH/DPCCH power ratio	dB dB dB dB	Diversity: 6.02 Non-diversity: 8.94 Diversity: 0.0 Non-diversity: 2.05  E-DPDCH/DPCCH power ratio is calculated for a single E-DPDCH with SF 4. The power of an E-DPDCH with SF2 is twice that of an E-DPDCH with SF4.

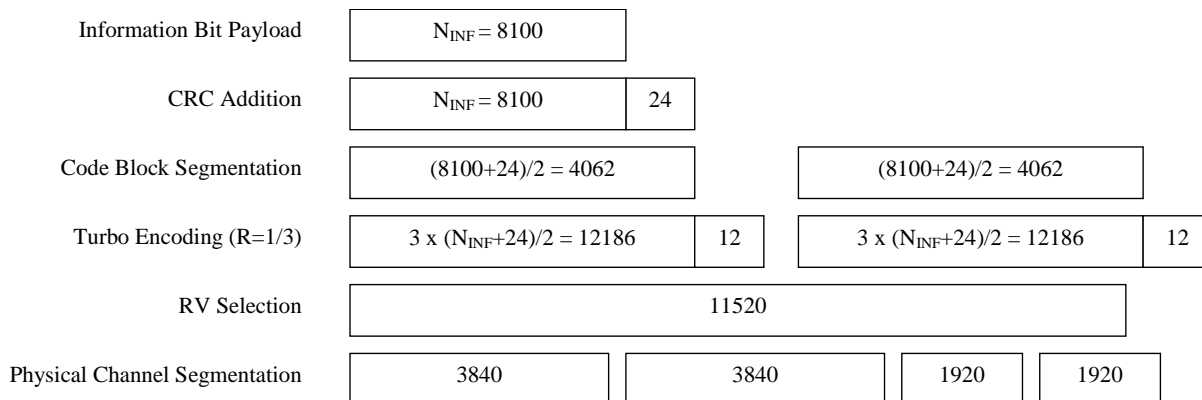

Figure A.12

# A.13 E-DPDCH Fixed reference channel 4 (FRC4)

Table A.13

Parameter	Unit	Value
Maximum. Inf. Bit Rate	kbps	507.6
TTI	ms	10
Number of HARQ Processes	Processes	4
Information Bit Payload ( $N_{INF}$ )	Bits	5076
Binary Channel Bits per TTI ( $N_{BIN}$ ) (3840 / SF x TTI sum for all channels)	Bits	9600
Coding Rate ( $N_{INF} / N_{BIN}$ )		0.529
Physical Channel Codes	SF for each physical channel	{4}
E-DPDCH testing: E-DPDCH/DPCCH power ratio	dB	Diversity: 8.94
E-DPCCH/DPCCH power ratio	dB	Non-diversity: 12.04
	dB	Diversity: -1.94
	dB	Non-diversity: 0.0
E-DPCCH missed detection testing: E-DPDCH/DPCCH power ratio	dB	Diversity: 8.94
	dB	Non-diversity: 12.04
E-DPCCH/DPCCH power ratio	dB	Diversity: -7.96
	dB	Non-diversity: -5.46

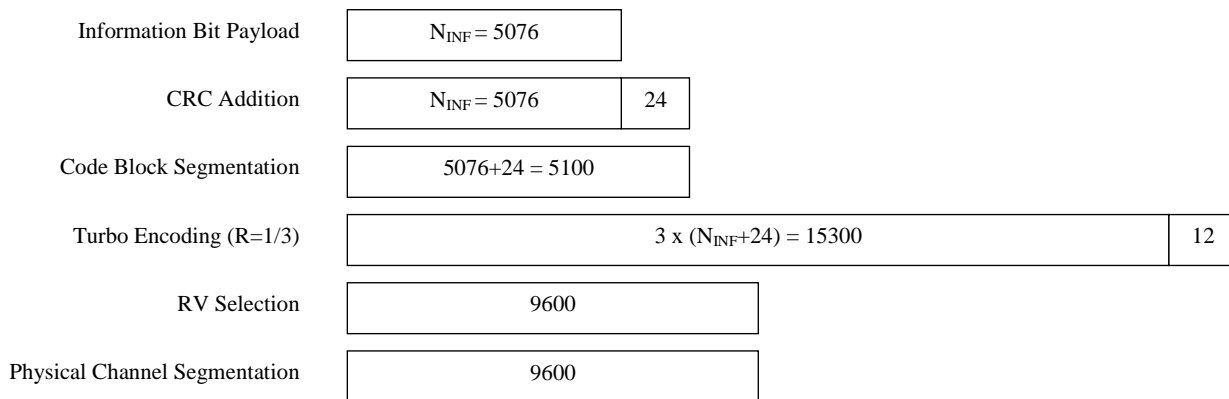

Figure A.13

# A.14 E-DPDCH Fixed reference channel 5 (FRC5)

Table A.14

Parameter	Unit	Value
Maximum. Inf. Bit Rate	kbps	978.0
TTI	ms	10
Number of HARQ Processes	Processes	4
Information Bit Payload ( $N_{INF}$ )	Bits	9780
Binary Channel Bits per TTI ( $N_{BIN}$ ) (3840 / SF x TTI sum for all channels)	Bits	19200
Coding Rate ( $N_{INF} / N_{BIN}$ )		0.509
Physical Channel Codes	SF for each physical channel	{4,4}
E-DPDCH testing: E-DPDCH/DPCCH power ratio E-DPCCH/DPCCH power ratio	dB dB dB dB	Diversity: 8.94 Non-diversity: 12.04 Diversity: -1.94 Non-diversity: 0.0  E-DPDCH /DPCCH power ratio is calculated for a single E-DPDCH.

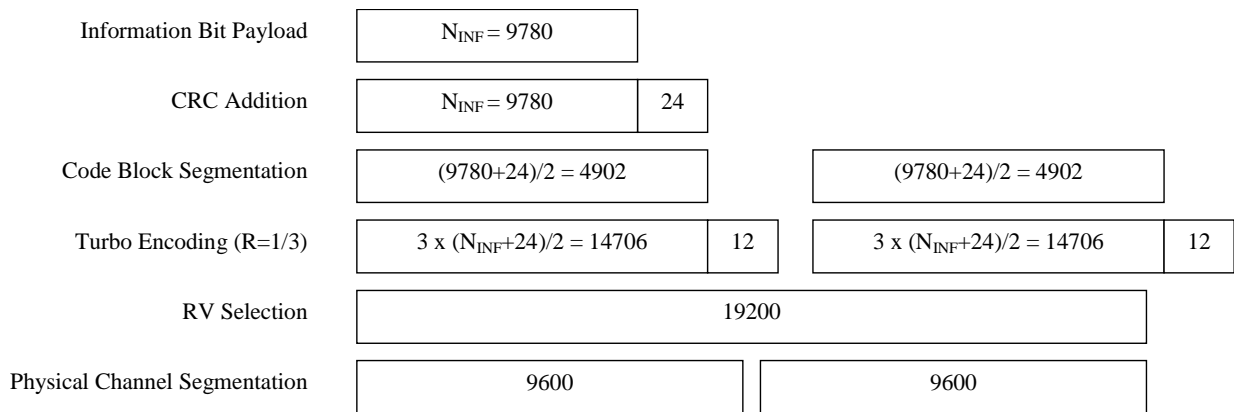

Figure A.14

## A.15 E-DPDCH Fixed reference channel 6 (FRC6)

Table A.15

Parameter	Unit	Value
Maximum. Inf. Bit Rate	kbps	1927.8
TTI	ms	10
Number of HARQ Processes	Processes	4
Information Bit Payload ( $N_{INF}$ )	Bits	19278
Binary Channel Bits per TTI ( $N_{BIN}$ ) (3840 / SF x TTI sum for all channels)	Bits	38400
Coding Rate ( $N_{INF} / N_{BIN}$ )		0.502
Physical Channel Codes	SF for each physical channel	{2,2}
E-DPDCH testing: E-DPDCH/DPCCH power ratio	dB	Diversity: 9.92 Non-diversity: 13.00
E-DPCCH/DPCCH power ratio	dB	Diversity: -5.46 Non-diversity: -1.94
		E-DPDCH /DPCCH power ratio is calculated for a single E-DPDCH.

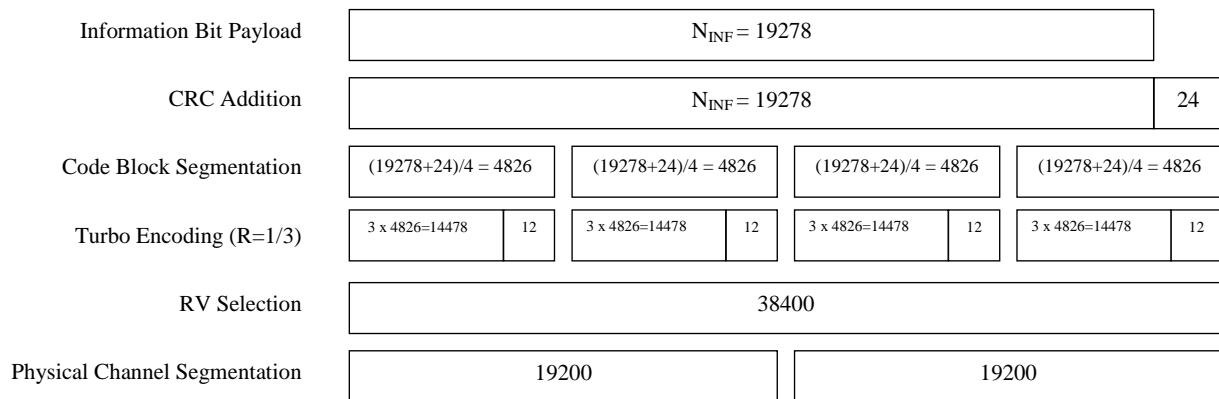

Figure A.15

## A.16 E-DPDCH Fixed reference channel 7 (FRC7)

Table A.16

Parameter	Unit	Value
Maximum. Inf. Bit Rate	kbps	69.0
TTI	ms	10
Number of HARQ Processes	Processes	4
Information Bit Payload ( $N_{INF}$ )	Bits	690
Binary Channel Bits per TTI ( $N_{BIN}$ ) (3840 / SF x TTI sum for all channels)	Bits	2400
Coding Rate ( $N_{INF} / N_{BIN}$ )		0.288
Physical Channel Codes	SF for each physical channel	{16}
E-DPDCH testing: E-DPDCH/DPCCH power ratio	dB	Diversity: 6.02 Non-diversity: 8.94
E-DPCCH/DPCCH power ratio	dB	Diversity: 0.0 Non-diversity: 4.08

Information Bit Payload	N <sub>INF</sub> = 690	
CRC Addition	N <sub>INF</sub> = 690	24
Code Block Segmentation	690+24 = 714	
Turbo Encoding (R=1/3)	3 x (N <sub>INF</sub> +24) = 2142	
RV Selection	2400	
Physical Channel Segmentation	2400	

Figure A.16

## A.17 E-DPDCH Fixed reference channel 8 (FRC8)

Table A.17

Parameter	Unit	Value
Modulation		16QAM
Maximum. Inf. Bit Rate	kbps	8109.0
TTI	ms	2
Number of HARQ Processes	Processes	8
Information Bit Payload (N <sub>INF</sub> )	Bits	16218
Binary Channel Bits per TTI (N <sub>BIN</sub> ) (3840 / SF x TTI sum for all channels)	Bits	23040
Coding Rate (N <sub>INF</sub> / N <sub>BIN</sub> )		0.704
Physical Channel Codes	SF for each physical channel	{2,2,4,4}
E-DPDCH testing:		<b>Non E-DPCCH boosting</b>
E-DPDCH/DPCCH power ratio	dB	Diversity: 4.09
E-DPCCH/DPCCH power ratio	dB	Non-diversity: 6.98
	dB	Diversity: -9.54
	dB	Non-diversity: -5.46
ΔT2TP	dB	<b>E-DPCCH Boosting</b>
E-DPDCH/DPCCH power ratio	dB	Diversity: 12
	dB	Non-diversity: 15
E-DPCCH/DPCCH power ratio	dB	Diversity: 19.99
	dB	Non-diversity: 22.00
	dB	Diversity: 16.03
	dB	Non-diversity: 14.09
		E-DPDCH/DPCCH power ratio is calculated for a single E-DPDCH with SF 4. The power of an E-DPDCH with SF2 is twice that of an E-DPDCH with SF4.



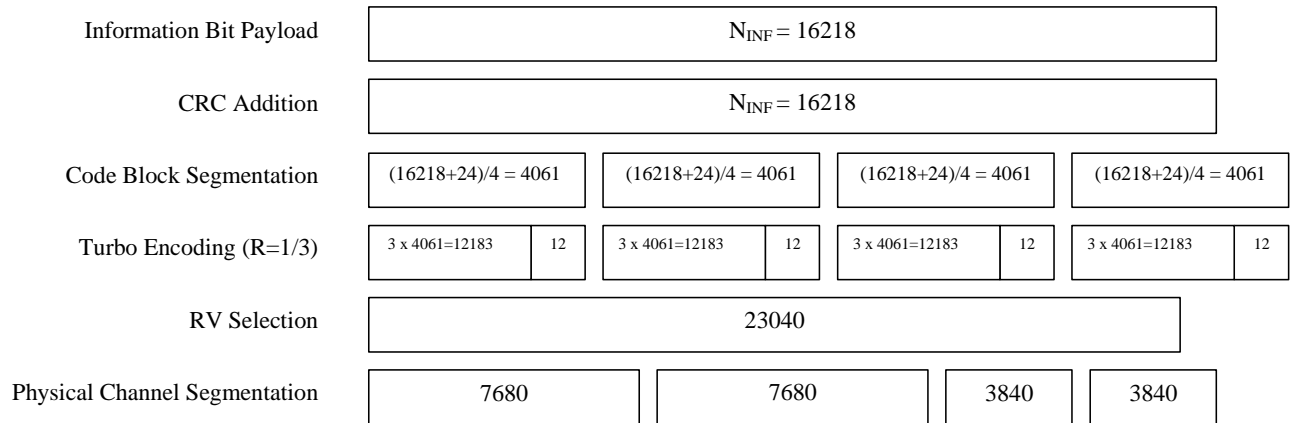

Figure A.17

## A.18 E-DPDCH Fixed reference channel 9 (FRC9)

Table A.18

Parameter	Unit	Value
Modulation		QPSK
Maximum. Inf. Bit Rate	kbps	8100
TTI	ms	2
Number of HARQ Processes	Processes	8
Information Bit Payload ( $N_{INF}$ )	Bits	16200
Binary Channel Bits per TTI ( $N_{BIN}$ ) (3840 / SF x TTI sum for all channels)	Bits	23040
Coding Rate ( $N_{INF} / N_{BIN}$ )		0.703
Physical Channel Codes	SF for each physical channel	{2,2,4,4}
E-DPDCH/DPCCH power ratio	dB	6.02
E-DPCCH/DPCCH power ratio	dB	-1.94
S-DPCCH/DPCCH power ratio	dB	-1.94
S-E-DPCCH/DPCCH power ratio	dB	0.00
S-E-DPDCH/DPCCH power ratio	dB	6.02
		E-DPDCH/DPCCH power ratio is calculated for a single E-DPDCH with SF 4. The power of an E-DPDCH with SF2 is twice that of an E-DPDCH with SF4.

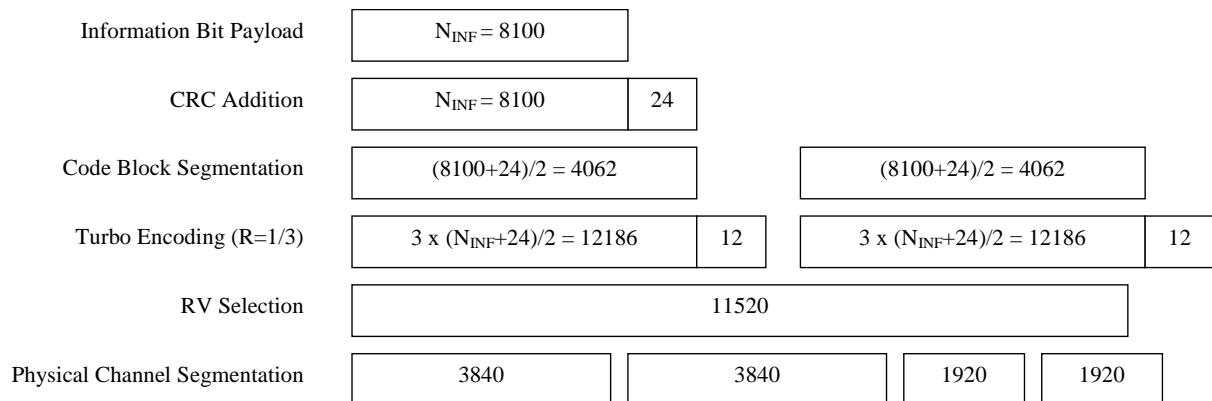

Figure A.18A. E-DPDCH

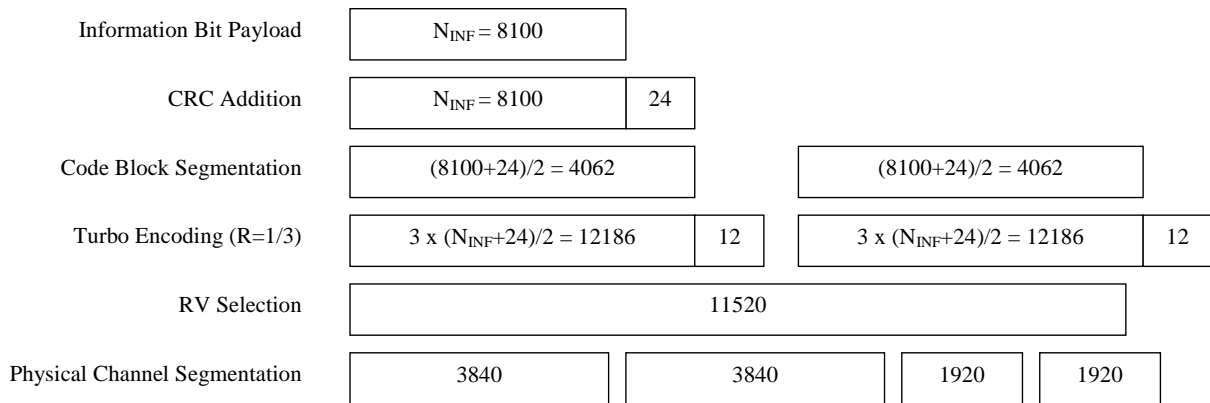

Figure A.18B. S-E-DPDCH

## A.19 E-DPDCH Fixed reference channel 10 (FRC10)

Table A.19

Parameter	Unit	Value
Modulation		16QAM
Maximum. Inf. Bit Rate	kbps	16218
TTI	ms	2
Number of HARQ Processes	Processes	8
Information Bit Payload ( $N_{INF}$ )	Bits	32436
Binary Channel Bits per TTI ( $N_{BIN}$ ) (3840 / SF x TTI sum for all channels)	Bits	46080
Coding Rate ( $N_{INF}/ N_{BIN}$ )		0.704
Physical Channel Codes	SF for each physical channel	{2,2,4,4}
E-DPDCH/DPCCH power ratio	dB	19.99
E-DPCCH/DPCCH power ratio	dB	16.03
S-DPCCH/DPCCH power ratio	dB	16.03
S-E-DPCCH/DPCCH power ratio	dB	6.02
S-E-DPDCH/DPCCH power ratio	dB	19.99
		E-DPDCH/DPCCH power ratio is calculated for a single E-DPDCH with SF 4. The power of an E-DPDCH with SF2 is twice that of an E-DPDCH with SF4.

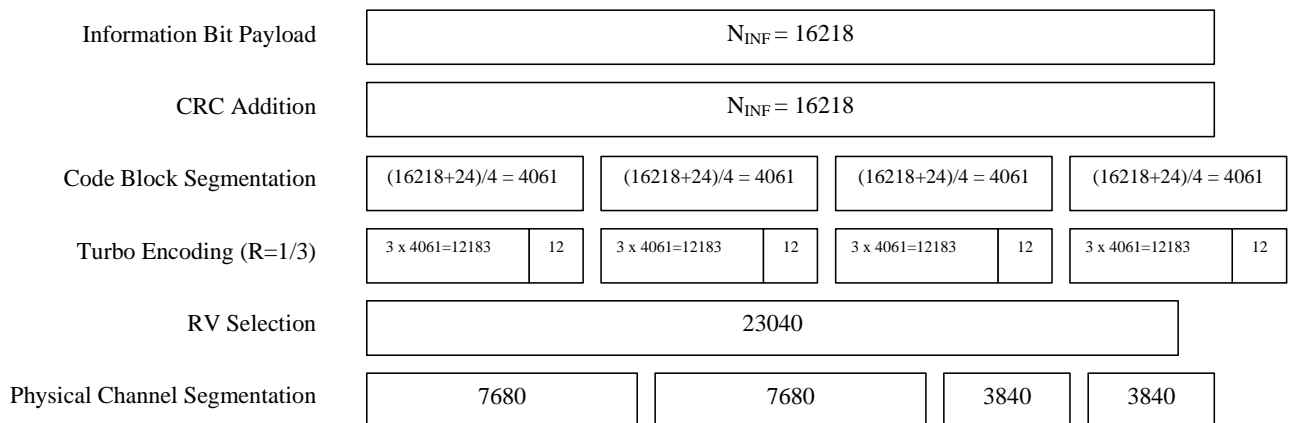

Figure A.19A. E-DPDCH

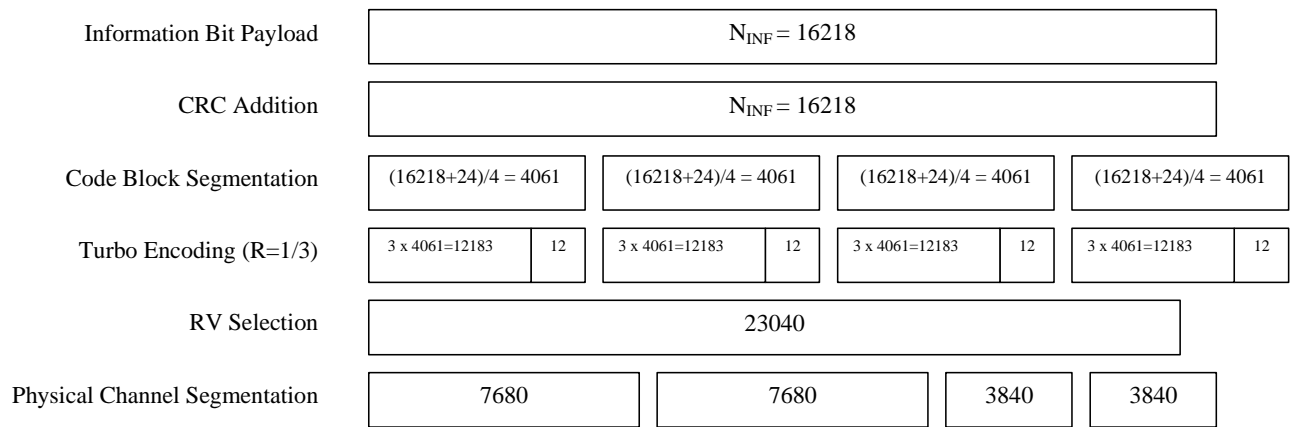

Figure A.19B. S-E-DPDCH

## Annex B (normative): Propagation conditions

### B.1 Static propagation condition

The propagation for the static performance measurement is an Additive White Gaussian Noise (AWGN) environment. No fading or multi-paths exist for this propagation model.

### B.2 Multi-path fading propagation conditions

Table B.1 shows propagation conditions that are used for the performance measurements in multi-path fading environment. All taps have classical Doppler spectrum, defined as:

$$(CLASS) \quad S(f) \propto 1/(1 - (f / f_D)^2)^{0.5} \quad \text{for } f \in [-f_D, f_D]$$

**Table B.1: Propagation Conditions for Multi-path Fading Environments**

Case 1		Case 2		Case 3		Case 4	
Speed for Band I, II, III, IV, IX, X, XXV 3 km/h		Speed for Band I, II, III, IV, IX, X, XXV 3 km/h		Speed for Band I, II, III, IV, IX, X, XXV 120 km/h		Speed for Band I, II, III, IV, IX, X, XXV 250 km/h	
Speed for Band V, VI, VIII, XIX, XX, XXVI 7 km/h		Speed for Band V, VI, VIII, XIX, XX, XXVI 7 km/h		Speed for Band V, VI, VIII, XIX, XX, XXVI 280 km/h		Speed for Band V, VI, VIII, XIX, XX, XXVI 583 km/h (Note 1)	
Speed for Band VII 2.3 km/h		Speed for Band VII 2.3 km/h		Speed for Band VII 92 km/h		Speed for Band VII 192 km/h	
Speed for Band XI, XXI 4.1 km/h		Speed for Band XI, XXI 4.1 km/h		Speed for Band XI, XXI 166 km/h		Speed for Band XI, XXI 345 km/h (Note 1)	
Speed for Band XII, XIII, XIV 8 km/h		Speed for Band XII, XIII, XIV 8 km/h		Speed for Band XII, XIII, XIV 320 km/h		Speed for Band XII, XIII, XIV 668 km/h	
Speed for Band XXII: 1.7 km/h		Speed for Band XXII: 1.7 km/h		Speed for Band XXII: 69 km/h		Speed for Band XXII: 143 km/h	
Relative Delay [ns]	Average Power [dB]	Relative Delay [ns]	Average Power [dB]	Relative Delay [ns]	Average Power [dB]	Relative Delay [ns]	Average Power [dB]
0	0	0	0	0	0	0	0
976	-10	976	0	260	-3	260	-3
		20000	0	521	-6	521	-6
				781	-9	781	-9

NOTE 1: Speed above 250km/h is applicable to demodulation performance requirements only.

### B.3 Moving propagation conditions

The dynamic propagation conditions for the test of the base band performance are non-fading channel models with two taps. The moving propagation condition has two tap, one static, Path0, and one moving, Path1. The time difference between the two paths is according Equation (B.1). The parameters for the equation are shown in Table B.2. The taps have equal strengths and equal phases.

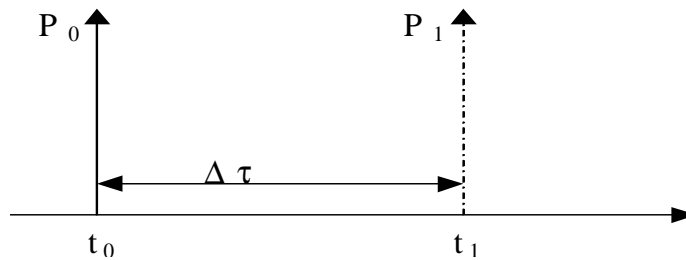

Figure B.1: The moving propagation conditions

$$\Delta\tau = B + \frac{A}{2}(1 + \sin(\Delta\omega \cdot t)) \tag{B.1}$$

Table B.2: Parameters for moving propagation

Parameter	Value
A	5 μs
B	1 μs
Δω	40·10 <sup>-3</sup> s <sup>-1</sup>

## B.4 Birth-Death propagation conditions

The dynamic propagation conditions for the test of the baseband performance is a non-fading propagation channel with two taps. The birth-death propagation conditions has two taps, Path1 and Path2 which alternate between 'birth' and 'death'. The positions the paths appear are randomly selected with an equal probability rate and are shown in Figure B.2. For BS with receiver diversity, the same path positions shall be applied to both receiver antenna connectors, and the path switching times shall be synchronized on the two receiver antenna connectors, but the AWGN signals applied to the two receiver antenna connectors shall be uncorrelated.

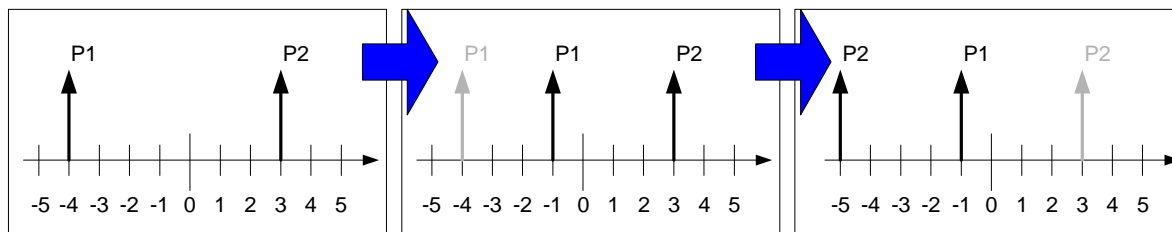

Figure B.2: Birth death propagation sequence

- Two paths, Path1 and Path2 are randomly selected from the group [-5, -4, -3, -2, -1, 0, 1, 2, 3, 4, 5] μs. The paths have equal magnitudes and equal phases.
- After 191 ms, Path1 vanishes and reappears immediately at a new location randomly selected from the group [-5, -4, -3, -2, -1, 0, 1, 2, 3, 4, 5] μs but excludes the point Path2. The magnitudes and the phases of the tap coefficients of Path 1 and Path 2 shall remain unaltered.
- After an additional 191 ms, Path2 vanishes and reappears immediately at a new location randomly selected from the group [-5, -4, -3, -2, -1, 0, 1, 2, 3, 4, 5] μs but excludes the point Path1. The magnitudes and the phases of the tap coefficients of Path 1 and Path 2 shall remain unaltered.
- The sequence in 2) and 3) is repeated.

### B.4A High speed train conditions

High speed train conditions are as follows:

Scenario 1: Open space

Scenario 2: Tunnel with leaky cable

Scenario 3: Tunnel for multi-antennas

The high speed train conditions for the test of the baseband performance are 2 non fading propagation channels (scenario 1 and 3) and 1 fading propagation channel (scenario 2) with one tap. For BS with Rx diversity defined in scenario 1, the Doppler shift variation is the same between antennas.

For scenario 1 and 3, Doppler shift is given by:

$$f_s(t) = f_d \cos \theta(t) \quad (\text{B.2})$$

where  $f_s(t)$  is the Doppler shift and  $f_d$  is the maximum Doppler frequency. The cosine of angle  $\theta(t)$  is given by

$$\cos \theta(t) = \frac{D_s/2 - vt}{\sqrt{D_{\min}^2 + (D_s/2 - vt)^2}}, \quad 0 \leq t \leq D_s/v \quad (\text{B.3})$$

$$\cos \theta(t) = \frac{-1.5D_s + vt}{\sqrt{D_{\min}^2 + (-1.5D_s + vt)^2}}, \quad D_s/v < t \leq 2D_s/v \quad (\text{B.4})$$

$$\cos \theta(t) = \cos \theta(t \bmod (2D_s/v)), \quad t > 2D_s/v \quad (\text{B.5})$$

where  $D_s/2$  is the initial distance of the train from BS, and  $D_{\min}$  is BS-Railway track distance, both in meters;  $v$  is the velocity of the train in m/s,  $t$  is time in seconds.

For scenario 2, Rician fading is considered where Rician factor,  $K$  is defined as the ratio between the dominant signal power and the variant of the other weaker signals.

Doppler shift and cosine angle is given by equation B.2 and B.3-B.5 respectively, where the required input parameters listed in table B.2A and the resulting Doppler shift shown in Figure B.3 and B.4 are applied for all frequency bands.

**Table B.2A: Parameters for high speed train conditions**

Parameter	Value		
	Scenario 1	Scenario 2	Scenario 3
$D_s$	1000 m	Infinity	300 m
$D_{min}$	50 m	-	2 m
$K$	-	10 dB	-
$v$	350 km/h	300 km/h	300 km/h
$f_d$	1340 Hz	1150 Hz	1150 Hz

NOTE1: Parameters for HST conditions in table B.2A including  $f_d$  and Doppler shift trajectories presented on figures B.3 and B.4 were derived for Band1.

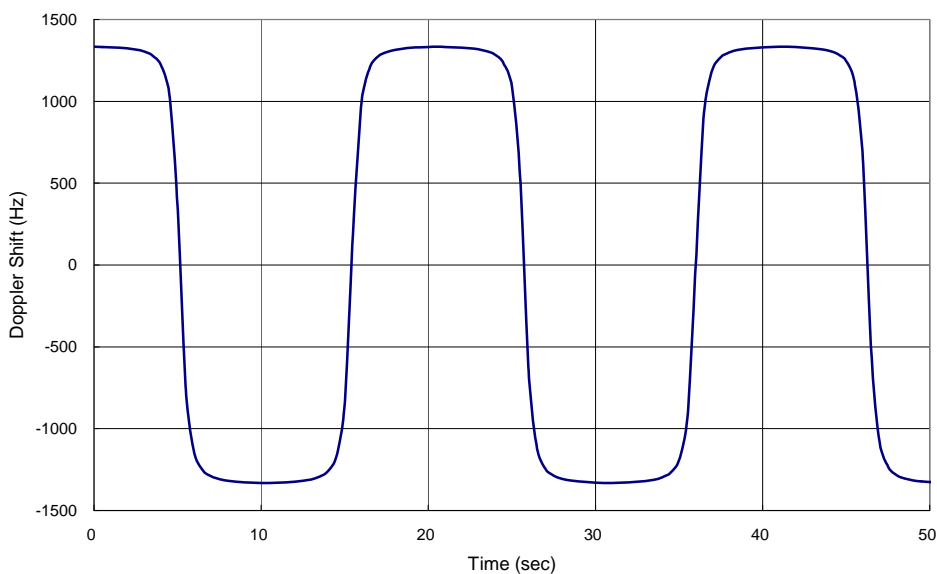

**Figure B.3: Doppler shift trajectory for scenario 1**

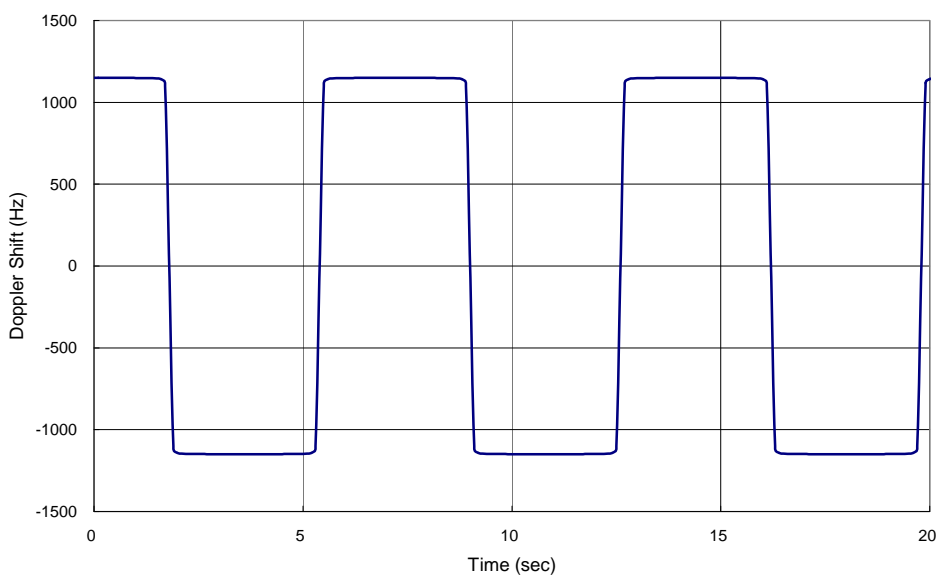

**Figure B.4: Doppler shift trajectory for scenario 3**

## B.5 Multipath fading propagation conditions for E-DPDCH and E-DPCCH

Table B.3 shows propagation conditions that are used for E-DPDCH and E-DPCCH performance measurements in multipath fading environment. For DC-HSUPA and DB-DC-HSUPA requirements, the fading of the signals for each cell shall be independent.

**Table B.3: Propagation Conditions for Multipath Fading Environments for E-DPDCH and E-DPCCH Performance Requirements**

ITU Pedestrian A Speed 3km/h (PA3)		ITU Pedestrian B Speed 3km/h (PB3)		ITU vehicular A Speed 30km/h (VA30)		ITU vehicular A Speed 120km/h (VA120)	
Speed for Band I, II, III, IV, IX, X, XXV 3 km/h		Speed for Band I, II, III, IV, IX, X, XXV 3 km/h		Speed for Band I, II, III, IV, IX, X, XXV 30 km/h		Speed for Band I, II, III, IV, IX, X, XXV 120 km/h	
Speed for Band V, VI, VIII, XIX, XX, XXVI 7 km/h		Speed for Band V, VI, VIII, XIX, XX, XXVI 7 km/h		Speed for Band V, VI, VIII, XIX, XX, XXVI 71 km/h		Speed for Band V, VI, VIII, XIX, XX, XXVI 282 km/h (Note 1)	
Speed for Band VII 2.3 km/h		Speed for Band VII 2.3 km/h		Speed for Band VII 23 km/h		Speed for Band VII 92 km/h	
Speed for Band XI, XXI 4.1 km/h		Speed for Band XI, XXI 4.1 km/h		Speed for Band XI, XXI 41 km/h		Speed for Band XI, XXI 166 km/h (Note 1)	
Speed for Band XII, XIII, XIV 8 km/h		Speed for Band XII, XIII, XIV 8 km/h		Speed for Band XII, XIII, XIV 80 km/h		Speed for Band XII, XIII, XIV 320 km/h	
Speed for Band XXII: 1.7 km/h		Speed for Band XXII: 1.7 km/h		Speed for Band XXII: 17.1 km/h		Speed for Band XXII: 69 km/h	
Relative Delay [ns]	Relative Mean Power [dB]	Relative Delay [ns]	Relative Mean Power [dB]	Relative Delay [ns]	Relative Mean Power [dB]	Relative Delay [ns]	Relative Mean Power [dB]
0	0	0	0	0	0	0	0
110	-9.7	200	-0.9	310	-1.0	310	-1.0
190	-19.2	800	-4.9	710	-9.0	710	-9.0
410	-22.8	1200	-8.0	1090	-10.0	1090	-10.0
		2300	-7.8	1730	-15.0	1730	-15.0
		3700	-23.9	2510	-20.0	2510	-20.0

NOTE 1: Speed above 120km/h is applicable to demodulation performance requirements only.



---

## Annex C (normative): Characteristics of the W-CDMA interference signal

The W-CDMA interference signal shall be a DPCH containing the DPCCH and one DPDCH. The data content for each channelization code shall be uncorrelated with each other and to the wanted signal and spread and modulated according to clause 4 of TS25.213 [6]. Further characteristics of DPDCH and DPCCH are specified in table C.1.

**Table C.1.: Characteristics of the W-CDMA interference signal**

Channel	Bit Rate	Spreading Factor	Channelization Code	Relative Power
DPDCH	240 kbps	16	4	0 dB
DPCCH	15 kbps	256	0	-5.46 dB
NOTE:	The DPDCH and DPCCH settings are chosen to simulate a signal with realistic Peak to Average Ratio.			

## Annex D (normative): Regional requirement for protection of DTT

The European Communications Committee (ECC) has adopted the “ECC Decision on harmonised conditions for Mobile/Fixed Communications Networks operating in the band 790-862 MHz” [9] applicable for BS operating in band XX. The decision defines a requirement for “Out-of-block BEM baseline requirements for ‘mobile/fixed communications network’ (MFCN) base stations within the spectrum allocated to the broadcasting (DTT) service”, where three different cases A, B, and C for protecting broadcasting DTT are defined. These cases can be applied on a per-channel and/or per-region basis, i.e. for the same channel different cases can be applied in different geographic areas (e.g. area related to DTT coverage) and different cases can be applied to different channels in the same geographic area.

For band XX, compliance with the regulatory requirements in Europe referenced above can be assessed based on the manufacturer’s declaration of  $P_{EM,N}$  specified in subclause 6.6.2.1, together with the deployment characteristics. Maximum output Power in 10 MHz ( $P_{10MHz}$ ) is also declared by the manufacturer. The parameters  $G_{ant}$  and  $N_{ant}$  are deployment specific parameters related to the deployment of the BS, where  $G_{ant}$  is the antenna gain and  $N_{ant}$  is the number of antennas.

For each channel (N) the EIRP level is calculated using:  $P_{EIRP,N} = P_{EM,N} + G_{ant} + 10 \cdot \log(N_{ant})$ . The regulatory requirement in [9] limits the EIRP level to the Maximum level in Table D-1 for the protection case(s) defined in the regulation.

**Table D-1: EIRP limits for protection of broadcasting (DTT) service**

Case	Measurement filter centre frequency	Condition on BS maximum aggregate EIRP / 10 MHz, $P_{EIRP\_10MHz}$ (Note)	Maximum Level $P_{EIRP,N,MAX}$	Measurement Bandwidth
A: for DTT frequencies where broadcasting is protected	$N \cdot 8 + 306$ MHz, $21 \leq N \leq 60$	$P_{EIRP\_10MHz} \geq 59$ dBm	0 dBm	8 MHz
	$N \cdot 8 + 306$ MHz, $21 \leq N \leq 60$	$36 \leq P_{EIRP\_10MHz} < 59$ dBm	$P_{EIRP\_10MHz} - 59$ dBm	8 MHz
	$N \cdot 8 + 306$ MHz, $21 \leq N \leq 60$	$P_{EIRP\_10MHz} < 36$ dBm	-23 dBm	8 MHz
B: for DTT frequencies where broadcasting is subject to an intermediate level of protection	$N \cdot 8 + 306$ MHz, $21 \leq N \leq 60$	$P_{EIRP\_10MHz} \geq 59$ dBm	10 dBm	8 MHz
	$N \cdot 8 + 306$ MHz, $21 \leq N \leq 60$	$36 \leq P_{EIRP\_10MHz} < 59$ dBm	$P_{EIRP\_10MHz} - 49$ dBm	8 MHz
	$N \cdot 8 + 306$ MHz, $21 \leq N \leq 60$	$P_{EIRP\_10MHz} < 36$ dBm	-13 dBm	8 MHz
C: for DTT frequencies where broadcasting is not protected	$N \cdot 8 + 306$ MHz, $21 \leq N \leq 60$	N.A.	22 dBm	8 MHz
NOTE: $P_{EIRP\_10MHz}$ (dBm) is defined by the expression $P_{EIRP\_10MHz} = P_{10MHz} + G_{ant} + 10 \cdot \log_{10}(N_{ant})$				

## Annex E (informative): Change History

Date	Meeting	TDoc	CR	Rev	Cat	Subject/Comment	New version
	37					Rel-8 version created based on v7.8.0	8.0.0
	37	RP-070658	0296		B	Introduction of UMTS1500 requirements (Rel-8)	8.0.0
	38	RP-070936	0299	1	A	Base station MIMO correction	8.1.0
	38	RP-070937	0301		A	Spurious emission limits for coexistence with CDMA850	8.1.0
	39	RP-080120	0307		A	Correction to RX spurious emissions	8.2.0
	39	RP-080124	0302	1	B	Introduction of UMTS700 requirements (Band XII, XIII and XIV) in TS 25.104	8.2.0
	40	RP-080326	0309	2	F	Correction on emission requirements for protection of public safety operations	8.3.0
	40	RP-080326	0308		F	Correction to SEM references	8.3.0
	41	RP-080633	312	1	F	Transmitter characteristics of 3G Home NodeB	8.4.0
	41	RP-080633	313	1	F	Receiver characteristics of 3G Home NodeB	8.4.0
						Editorial correction to Change History Table (previous two entries) [2008-10]	8.4.1
	42	RP-080927	315	1	A	Clarification of eNB HST propagation conditions (25.104, rel-8)	8.5.0
	42	RP-080945	318	1	B	HNB adjacent channel protection requirements	8.5.0
	42	RP-080945	321	1	F	Regional requirement on Home Node B applicability	8.5.0
	42	RP-080948	316		B	25.104 Modification due to DC-HSDPA	8.5.0
	43	RP-080192	322		F	Change bandwidth reference for ACLR limit for Home BS	8.6.0
	43	RP-090192	323		F	Clarification on 3G Home NodeB Transmit Power Conformance Testing for Adjacent Channel Protection	8.6.0
	43	RP-090195	324		F	25.104 CR Tx-Rx frequency separation for DC-HSDPA	8.6.0
	43	RP-090197	325		F	Co-existence requirement for the band 1880MHz	8.6.0
	44	RP-090553	328		F	Correction of local area base station coexistence spurious emission requirements	8.7.0
	44	RP-090605	326		F	Correction on Home BS Output Power Requirements for Adjacent Channel Protection	8.7.0
	44	RP-090559	327		B	Introduction of Extended UMTS800 requirements	9.0.0
	45	RP-090827	338	1	A	Correction of DPCCH slot format for FRC8	9.1.0
	RP-46	RP-091286	339		B	Introduction of Extended UMTS1500 requirements for TS25.104 (Technically endorsed at RAN 4 52bis in R4-093625)	9.2.0
	RP-46	RP-091276	341		A	Testing in case of Rx diversity, Tx diversity and MIMO (Technically endorsed at RAN 4 52bis in R4-093982)	9.2.0
	RP-46	RP-091289	342		B	Introduction of BS requirements for DB-DC-HSDPA (Technically Endorsed in R4-52, R4-092697)	9.2.0
	RP-46	RP-091288	343		B	Introduction of the BS requirements for DC-HSUPA (Technically Endorsed in R4-52, R4-093332)	9.2.0
	RP-46	RP-091277	345		A	Corrections on blocking performance requirement for Medium range BS for Band XII to Band XIV	9.2.0
	RP-46	RP-091277	347		A	Corrections on additional spectrum emission limits for Bands XII, XIII, XIV	9.2.0
	RP-46	RP-091296	348	1	F	Correction to the transmitter intermodulation	9.2.0
	RP-46	RP-091268	350	1	A	Protection of E-UTRA for UTRA BS	9.2.0
	RP-46	RP-091290	351	1	B	Definition and minimum requirement for time alignment error for DC-HSDPA-MIMO	9.2.0
	RP-46	RP-091296	356		A	Time alignment error definition correction for DC-HSDPA	9.2.0
	RP-47	RP-100272	360	1	F	Clarification of time alignment error requirements	9.3.0
	RP-47	RP-100263	361	1	B	Introduction of Band XX in 25.104	9.3.0
	RP-47	RP-100264	359		F	Corrections for Extended UMTS1500 requirements	9.3.0
	RP-47	RP-100267	365		B	Tx-Rx frequency separation for DC-HSUPA	9.3.0
	RP-48	RP-100625	371		F	Clarification of applicability of requirements for multi-carrier BS	9.4.0
	RP-48	RP-100626	366		F	Correction of blocking performance requirement when co-located with BS in other bands (Band 20)	9.4.0

	RP-48	RP-100631	370	1	F	Co-existence with services in adjacent frequency bands	9.4.0
	RP-49	RP-100921	374	1	C	Revision of Time Alignment Error requirement	9.5.0
	RP-49	RP-100918	373		A	Corrections on Home BS spurious emission limits for co-existence with Home BS operating in other bands	9.5.0
	RP-50	RP-101334	385	1	A	Band XII channel arrangement correction on 25.104	9.6.0
	RP-50	RP-101353	378	2	B	Introduction of frequency bands for 4C-HSDPA	10.0.0
	RP-50	RP-101353	382	1	B	Revision of Time Alignment Error requirement	10.0.0
	RP-50	RP-101361	379		B	Protection of E-UTRA Band 24	10.0.0
	RP-51	RP-110355	0383	1	B	DB-DC-HSDPA: New band combinations	10.1.0
	RP-51	RP-110352	0395	1	F	Correction of the test port description for TS 25.104 Rel-10	10.1.0
	RP-51	RP-110352	0396	1	F	UTRA BS Receiver spurious requirements for protection of other bands	10.1.0
	RP-51	RP-110352	0397	1	F	Harmonization of co-existence/co-location requirements between 25.104 and 36.104	10.1.0
	RP-52	RP-110812	401		B	Add 2GHz S-Band (Band 23) in 25.104	10.2.0
	RP-52	RP-110788	404		A	Modifications to Band 3 to allow LTE Band 3 operation in Japan (Rel-10 TS25.104 CR)	10.2.0
	RP-52	RP-110804	405		B	Add coexistence requirements for expanded 1900MHz band in 25.104	10.2.0
	RP-52	RP-110800	408		B	Introduction of S-CPICH power offset accuracy requirement	10.2.0
	RP-53	RP-111255	416		B	Add Band 42 and 43 for LTE 3500 (TDD) to TS 25.104	10.3.0
	RP-53	RP-111255	417		B	Add Band 22/XXII for LTE/UMTS 3500 (FDD) to TS 25.104	10.3.0
	RP-53	RP-111262	415		F	Co-existence requirements on TS 25.104	10.3.0
	RP-53	RP-111268	410	1	B	Updating BS Coexistence table for Band 23 in 25.104	10.3.0
	RP-53	RP-111270	411	1	B	Introduction of HS-DPCCH detection requirements for 4C-HSDPA	10.3.0
	RP-54	RP-111734	596		F	Clarification of general blocking requirements for co-existence in TS 25.104	10.4.0
	RP-54	RP-111687	598	2	F	TX ON or OFF CR 25.104	10.4.0
	RP-54	RP-111734	595		F	Band 42 and 43 for LTE 3500 (TDD) correction to TS 25.104	10.4.0
	RP-54	RP-111696	597	1	B	Introduction of new configuration for 4C-HSDPA	11.0.0
	RP-55	RP-120302	599	3	B	Introduction of non-contiguous operation for 4C-HSDPA	11.1.0
	RP-55	RP-120301	607		B	MC DB HSDPA: Introduction of configurations I-2-VIII-2 and II-1-V-2 in TS 25.104	11.1.0
	RP-55	RP-120305	611		B	Introduction of Band 26/XXVI to TS 25.104	11.1.0
	RP-55	RP-120297	612		A	Correction of frequency range for spurious emission requirements	11.1.0
	RP-55	RP-120338	0613		A	Addition of Band 23 HeNB specifications in 25.104	11.1.0
	RP-56	RP-120787	614	-	B	Corrections related to non-contiguous operation for 4C-HSDPA	11.2.0
	RP-56	RP-120786	615	1	B	8C-HSDPA: Introduction of BS Core Requirements in TS 25.104	11.2.0
	RP-56	RP-120783	617	1	A	Update to Regional Requirements table 25.104	11.2.0
	RP-56	RP-120771	621	-	A	Introduction of Japanese Regulatory Requirements to W-CDMA Band VIII (R11)	11.2.0
	RP-56	RP-120795	622	1	F	Co-location spurious emission requirement for LA BS in TS 25.104	11.2.0
	RP-56	RP-120793	623	1	B	Introduction of Band 28	11.2.0
	RP-56	RP-120793	624	-	B	Introduction of Band 44	11.2.0
	RP-56	RP-120791	625	1	B	Introduction of e850_LB (Band 27) to TS 25.104	11.2.0
	RP-56	RP-120766	629	-	A	Correction of PHS protection requirements for TS 25.104	11.2.0
	RP-57	RP-121314	630		F	Alignment of NC-4C-HSDPA configurations table	11.3.0
	RP-57	RP-121314	631	1	F	Correct f_offsetmax definition for a BS operating in non-contiguous spectrum in TS25.104	11.3.0
	RP-57	RP-121316	632		F	Update of B27 & B28 co-location spurious emission requirement for LA BS in 25.104	11.3.0

	RP-57	RP-121300	636		A	Modifications of frequency ranges on spurious emission requirements for Band 6, 18, 19	11.3.0
	RP-58	RP-121848	640		A	Introducing the additional frequency bands of 5 MHz x 2 in 1.7 GHz in Japan to Band III	11.4.0
	RP-58	RP-121868	642	1	B	Introduction of 4X4MIMO	11.4.0
	RP-58	RP-121901	643		B	Introduction of Band 29	11.4.0
	RP-58	RP-121905	644	1	B	Introduction of multi-band BS to TS 25.104	11.4.0
	RP-59	RP-130282	647		F	Introduction of MB requirements to MR/LA BS in TS 25.104	11.5.0
	RP-59	RP-130282	645	1	B	Introduction of remaining requirements for multi-band operation	11.5.0
	RP-60	RP-130768	649		B	Introduction of dual-band 4C-HSDPA configuration for Band I and VIII	11.6.0
	RP-60	RP-130768	650		F	Correction to Definitions list	11.6.0
	RP-60	RP-130800	651	1	B	Indication of HSDPA Multiflow BS performance requirements	11.6.0
	RP-60	RP-130769	652	1	B	Introduction of remaining requirements for multi-band operation	11.6.0
	RP-60	RP-130791	653	1	B	Introduction of Band 30	12.0.0
	RP-60	RP-130790	654	1	B	Introduction of LTE 450 into TS 25.104	12.0.0
	RP-61	RP-131289	657		A	Updates to requirements for BS capable of multi-band operation	12.1.0
	RP-61	RP-131293	660		A	Correction on TX-RX separation for TS25.104 (R12)	12.1.0
	RP-61	RP-131283	661		F	Co-location requirements for protection of E-UTRA Medium Range BS	12.1.0
	RP-61	RP-131288	663		A	Introduction of BS demodulation performance requirements for HSUPA MIMO	12.1.0
	RP-62	RP-131929	665		A	Correction of the terminology used for MIMO mode with 4 transmit antennas	12.2.0
	RP-62	RP-131930	670		A	Clarification for ACLR in TS25.104	12.2.0
	RP-62	RP-131934	672		A	CR for clarification for receiver requirement on MB-MSR BS	12.2.0
	RP-62	RP-131930	674		A	Corrections to requirements for multi-band operation	12.2.0
	RP-62	RP-131967	676	1	F	Alignment of Note related to BS Spurious emissions limits for co-location with another BS	12.2.0
	RP-64	RP-140913	683		A	CR for clarification for receiver requirement on MB-MSR BS	12.3.0
	RP-64	RP-140913	686		A	Clarification on definitions and ACLR requirement in TS25.104	12.3.0
	RP-64	RP-140926	687	1	B	Introduction of operating band XXXII in TS25.104	12.3.0
	RP-65	RP-141562	690		F	Update of definitions to support supplemental DL in TS25.104	12.4.0
	RP-66	RP-142146	693		A	Correction on transmitter intermodulation requirement related to multi-band operation	12.5.0
	RP-66	RP-142145	695		A	Absolute ACLR limit for UTRA	12.5.0
	RP-69	RP-151476	0706		A	BS Spec improvements: TS 25.104 Corrections	12.6.0
	RP-69	RP-151492	0704	1	B	CR with updates due to introduction of Rel-13 Multiflow enhancements	13.0.0
	RP-70	RP-152141	0712	1	B	Introduction of DB-DC-HSUPA for TS25.104	13.1.0
	RP-70	RP-152171	0717	-	B	Introduction of Band 65	13.1.0
	RP-70	RP-152132	0720	-	A	Tx IM requirement correction	13.1.0
	RP-70	RP-152157	0721	-	B	Introduction of E-UTRA Band 67 co-existence requirements	13.1.0
	RP-70	RP-152172	0722	-	B	Introduction of Band 66	13.1.0
	RP-70	RP-152173	0723	-	B	Introduction of 1447-1467MHz Band into 25.104	13.1.0
	RP-70	RP-152132	0726	-	A	BS Spec improvements: TS 25.104 Corrections	13.1.0
	RP-70	RP-152132	0729	-	A	Corrections on definition of f_offsetmax for BS operating in multiple bands or non-contiguous spectrum	13.1.0
	RP-70	RP-152132	0735	-	A	Correction of UEM requirement for multi-band base station	13.1.0
03/2016	RP-71	RP-160483	0736	1	B	Introduction of Band 68	13.2.0
03/2016	RP-71	RP-160490	0737	1	F	Introduction of Band 46 in 25.104	13.2.0

03/2016	RP-72	RP-161140	0743	1	F	Corrections on definition of multi-band definition and blocking	13.3.0
2016/06	RP-72	RP-161125	0742	-	B	Introduction of Band 70 to 25.104	14.0.0
2016/06	RP-72	RP-161124	0744	-	B	Introduction of Band 69 co-existence requirements	14.0.0
2016/12	RP-74	RP-162405	0745	-	B	Introduction of Band 48	14.1.0
2017/06	RP-76	RP-171282	0949	1	F	CR on BS for protection of V2X UE in TS 25.104	14.2.0
2017/09	RP-77	RP-171948	0951	2	B	Introduction of the FDD L-band (Band 74) into TS 25.104	15.0.0
2017/09	RP-77	RP-171952	0952	-	B	CR to 25.104: Introduction of Band 71	15.0.0
2017/09	RP-77	RP-171946	0953	-	B	CR to 25.104: Introduction of Band 72	15.0.0
2017/09	RP-77	RP-171950	0954	-	B	CR to 25.104: Introduction of Band 75 and 76	15.0.0
2017/09	RP-77	RP-171949	0956	1	B	Introduction of TDD L-band into TS 25.104	15.0.0
2017/12	RP-78	RP-172593	0957	-	B	Introduction of Band 73 into TS 25.104	15.1.0
2017/12	RP-78	RP-172594	0958	1	B	CR to 25.104: Introduction of Band 49	15.1.0
2018-03	RAN#79	RP-180279	0959	-	B	CR to 25.104: Introduction of Band 85	15.2.0
2018-03	RAN#79	RP-180278	0960	-	B	Introduction of TDD 3.3-3.4GHz band (band 52)	15.2.0
2018-06	RAN#80	RP-181100	0961	1	F	CR for 25.104: Clarification on spectrum emission mask	15.3.0

---

# History

<b>Document history</b>		
V15.3.0	July 2018	Publication