

ETSI TS 125 105 V3.16.0 (2008-04)

Technical Specification

**Universal Mobile Telecommunications System (UMTS);
Base Station (BS) radio transmission and reception (TDD)
(3GPP TS 25.105 version 3.16.0 Release 1999)**



Reference

RTS/TSGR-0425105v3g0

Keywords

UMTS

ETSI

650 Route des Lucioles
F-06921 Sophia Antipolis Cedex - FRANCE

Tel.: +33 4 92 94 42 00 Fax: +33 4 93 65 47 16

Siret N° 348 623 562 00017 - NAF 742 C
Association à but non lucratif enregistrée à la
Sous-Préfecture de Grasse (06) N° 7803/88

Important notice

Individual copies of the present document can be downloaded from:

<http://www.etsi.org>

The present document may be made available in more than one electronic version or in print. In any case of existing or perceived difference in contents between such versions, the reference version is the Portable Document Format (PDF). In case of dispute, the reference shall be the printing on ETSI printers of the PDF version kept on a specific network drive within ETSI Secretariat.

Users of the present document should be aware that the document may be subject to revision or change of status. Information on the current status of this and other ETSI documents is available at

<http://portal.etsi.org/tb/status/status.asp>

If you find errors in the present document, please send your comment to one of the following services:

http://portal.etsi.org/chaicor/ETSI_support.asp

Copyright Notification

No part may be reproduced except as authorized by written permission.
The copyright and the foregoing restriction extend to reproduction in all media.

© European Telecommunications Standards Institute 2008.
All rights reserved.

DECT™, PLUGTESTS™, UMTS™, TIPHON™, the TIPHON logo and the ETSI logo are Trade Marks of ETSI registered for the benefit of its Members.

3GPP™ is a Trade Mark of ETSI registered for the benefit of its Members and of the 3GPP Organizational Partners.

Intellectual Property Rights

IPRs essential or potentially essential to the present document may have been declared to ETSI. The information pertaining to these essential IPRs, if any, is publicly available for **ETSI members and non-members**, and can be found in ETSI SR 000 314: "*Intellectual Property Rights (IPRs); Essential, or potentially Essential, IPRs notified to ETSI in respect of ETSI standards*", which is available from the ETSI Secretariat. Latest updates are available on the ETSI Web server (<http://webapp.etsi.org/IPR/home.asp>).

Pursuant to the ETSI IPR Policy, no investigation, including IPR searches, has been carried out by ETSI. No guarantee can be given as to the existence of other IPRs not referenced in ETSI SR 000 314 (or the updates on the ETSI Web server) which are, or may be, or may become, essential to the present document.

Foreword

This Technical Specification (TS) has been produced by ETSI 3rd Generation Partnership Project (3GPP).

The present document may refer to technical specifications or reports using their 3GPP identities, UMTS identities or GSM identities. These should be interpreted as being references to the corresponding ETSI deliverables.

The cross reference between GSM, UMTS, 3GPP and ETSI identities can be found under <http://webapp.etsi.org/key/queryform.asp>.

Contents

| | |
|--|----|
| Intellectual Property Rights | 2 |
| Foreword..... | 2 |
| Foreword..... | 6 |
| 1 Scope | 7 |
| 2 References | 7 |
| 3 Definitions, symbols and abbreviations | 7 |
| 3.1 Definitions | 7 |
| 3.2 Symbols..... | 8 |
| 3.3 Abbreviations | 8 |
| 4 General | 9 |
| 4.1 Relationship between Minimum Requirements and Test Requirements | 9 |
| 4.2 Base station classes | 9 |
| 4.3 Regional requirements..... | 9 |
| 4.4 Environmental requirements for the BS equipment | 10 |
| 5 Frequency bands and channel arrangement..... | 11 |
| 5.1 General | 11 |
| 5.2 Frequency bands..... | 11 |
| 5.3 TX–RX frequency separation..... | 11 |
| 5.4 Channel arrangement..... | 11 |
| 5.4.1 Channel spacing..... | 11 |
| 5.4.2 Channel raster | 11 |
| 5.4.3 Channel number..... | 11 |
| 6 Transmitter characteristics | 12 |
| 6.1 General | 12 |
| 6.2 Base station output power | 12 |
| 6.2.1 Base station maximum output power..... | 12 |
| 6.2.1.1 Minimum Requirement | 12 |
| 6.3 Frequency stability | 13 |
| 6.3.1 Minimum Requirement..... | 13 |
| 6.4 Output power dynamics..... | 13 |
| 6.4.1 Inner loop power control..... | 13 |
| 6.4.2 Power control steps..... | 13 |
| 6.4.2.1 Minimum Requirement | 13 |
| 6.4.3 Power control dynamic range | 13 |
| 6.4.3.1 Minimum Requirement | 13 |
| 6.4.4 Minimum output power | 13 |
| 6.4.4.1 Minimum Requirement | 14 |
| 6.4.5 Primary CCPCH power | 14 |
| 6.5 Transmit ON/OFF power | 14 |
| 6.5.1 Transmit OFF power | 14 |
| 6.5.1.1 Minimum Requirement | 14 |
| 6.5.2 Transmit ON/OFF Time mask..... | 14 |
| 6.5.2.1 Minimum Requirement | 14 |
| 6.6 Output RF spectrum emissions..... | 15 |
| 6.6.1 Occupied bandwidth | 15 |
| 6.6.2 Out of band emission..... | 15 |
| 6.6.2.1 Spectrum emission mask..... | 15 |
| 6.6.2.2 Adjacent Channel Leakage power Ratio (ACLR)..... | 17 |
| 6.6.2.2.1 Minimum Requirement | 17 |
| 6.6.2.2.2 Requirement for operation in the same geographic area with FDD or unsynchronised TDD on adjacent channels..... | 18 |

| | | |
|-------------|--|----|
| 6.6.2.2.2.1 | Requirement for operation in the same geographic area with unsynchronised TDD on adjacent channels | 18 |
| 6.6.2.2.2.2 | Requirement for operation in the same geographic area with FDD on adjacent channels..... | 18 |
| 6.6.2.2.3 | Requirement in case of co-siting with unsynchronised TDD BS or FDD BS operating on an adjacent channel | 18 |
| 6.6.2.2.3.1 | Requirement in case of co-siting with unsynchronised TDD BS operating on an adjacent channel..... | 18 |
| 6.6.2.2.3.2 | Requirement in case of co-siting with FDD BS operating on an adjacent channel..... | 19 |
| 6.6.3 | Spurious emissions | 19 |
| 6.6.3.1 | Mandatory Requirements | 19 |
| 6.6.3.1.1 | Spurious emissions (Category A) | 19 |
| 6.6.3.1.1.1 | Minimum Requirement..... | 20 |
| 6.6.3.1.2 | Spurious emissions (Category B) | 20 |
| 6.6.3.1.2.1 | Minimum Requirement..... | 20 |
| 6.6.3.2 | Co-existence with GSM 900 | 20 |
| 6.6.3.2.1 | Operation in the same geographic area..... | 20 |
| 6.6.3.2.1.1 | Minimum Requirement..... | 20 |
| 6.6.3.2.2 | Co-located base stations | 21 |
| 6.6.3.2.2.1 | Minimum Requirement..... | 21 |
| 6.6.3.3 | Co-existence with DCS 1800 | 21 |
| 6.6.3.3.1 | Operation in the same geographic area..... | 21 |
| 6.6.3.3.1.1 | Minimum Requirement..... | 21 |
| 6.6.3.3.2 | Co-located base stations | 21 |
| 6.6.3.3.2.1 | Minimum Requirement..... | 21 |
| 6.6.3.4 | Co-existence with UTRA-FDD..... | 22 |
| 6.6.3.4.1 | Operation in the same geographic area..... | 22 |
| 6.6.3.4.1.1 | Minimum Requirement..... | 22 |
| 6.6.3.4.2 | Co-located base stations | 22 |
| 6.6.3.4.2.1 | Minimum Requirement..... | 22 |
| 6.6.3.5 | Co-existence with unsynchronised TDD..... | 23 |
| 6.6.3.5.1 | Operation in the same geographic area..... | 23 |
| 6.6.3.5.1.1 | Minimum Requirement..... | 23 |
| 6.6.3.5.2 | Co-located base stations | 23 |
| 6.6.3.5.2.1 | Minimum Requirement..... | 23 |
| 6.6.3.6 | Co-existence with PHS | 23 |
| 6.6.3.6.1 | Minimum Requirement | 23 |
| 6.7 | Transmit intermodulation | 24 |
| 6.7.1 | Minimum Requirement..... | 24 |
| 6.8 | Transmit modulation | 24 |
| 6.8.1 | Transmit pulse shape filter..... | 24 |
| 6.8.2 | Modulation Accuracy | 24 |
| 6.8.2.1 | Minimum Requirement | 24 |
| 6.8.3 | Peak Code Domain Error | 24 |
| 6.8.3.1 | Minimum Requirement | 25 |
| 7 | Receiver characteristics..... | 25 |
| 7.1 | General | 25 |
| 7.2 | Reference sensitivity level..... | 25 |
| 7.2.1 | Minimum Requirement..... | 25 |
| 7.3 | Dynamic range | 25 |
| 7.3.1 | Minimum requirement | 25 |
| 7.4 | Adjacent Channel Selectivity (ACS)..... | 25 |
| 7.4.1 | Minimum Requirement..... | 26 |
| 7.5 | Blocking characteristics | 26 |
| 7.5.1 | Co-location with GSM900 and/or DCS 1800..... | 27 |
| 7.6 | Intermodulation characteristics | 27 |
| 7.7 | Spurious emissions | 28 |
| 7.7.1 | Minimum Requirement..... | 28 |
| 8 | Performance requirement | 28 |
| 8.1 | General | 28 |
| 8.2 | Demodulation in static propagation conditions | 29 |

| | | |
|--|--|-----------|
| 8.2.1 | Demodulation of DCH..... | 29 |
| 8.2.1.1 | Minimum requirement | 29 |
| 8.3 | Demodulation of DCH in multipath fading conditions | 29 |
| 8.3.1 | Multipath fading Case 1 | 29 |
| 8.3.1.1 | Minimum requirement | 29 |
| 8.3.2 | Multipath fading Case 2..... | 30 |
| 8.3.2.1 | Minimum requirement | 30 |
| 8.3.3 | Multipath fading Case 3..... | 31 |
| 8.3.3.1 | Minimum requirement | 31 |
| Annex A (normative): Measurement Channels..... | | 32 |
| A.1 | General | 32 |
| A.2 | Reference measurement channel | 32 |
| A.2.1 | UL reference measurement channel (12.2 kbps) | 32 |
| A.2.2 | UL reference measurement channel (64 kbps) | 33 |
| A.2.3 | UL reference measurement channel (144 kbps) | 34 |
| A.2.4 | UL reference measurement channel (384 kbps) | 35 |
| A.2.5 | RACH reference measurement channel | 37 |
| A.2.5.1 | RACH mapped to 1 code SF16..... | 37 |
| A.2.5.2 | RACH mapped to 1 code SF8..... | 38 |
| Annex B (normative): Propagation conditions..... | | 39 |
| B.1 | Static propagation condition..... | 39 |
| B.2 | Multi-path fading propagation conditions..... | 39 |
| Annex C (informative): Change request history..... | | 40 |
| History | | 42 |

Foreword

This Technical Specification has been produced by the 3GPP.

The contents of the present document are subject to continuing work within the TSG and may change following formal TSG approval. Should the TSG modify the contents of this TS, it will be re-released by the TSG with an identifying change of release date and an increase in version number as follows:

Version 3.y.z

where:

- x the first digit:
 - 1 presented to TSG for information;
 - 2 presented to TSG for approval;
 - 3 Indicates TSG approved document under change control.
- y the second digit is incremented for all changes of substance, i.e. technical enhancements, corrections, updates, etc.
- z the third digit is incremented when editorial only changes have been incorporated in the specification.

1 Scope

This document establishes the minimum RF characteristics of the TDD mode of UTRA.

2 References

The following documents contain provisions which, through reference in this text, constitute provisions of the present document.

- References are either specific (identified by date of publication, edition number, version number, etc.) or non-specific.
- For a specific reference, subsequent revisions do not apply.
- For a non-specific reference, the latest version applies. In the case of a reference to a 3GPP document (including a GSM document), a non-specific reference implicitly refers to the latest version of that document *in the same Release as the present document*.

- [1] ITU-R Recommendation SM.329-8; "Spurious emissions".
- [2] ETSI ETR 273-1-2: "Electromagnetic compatibility and Radio spectrum Matters (ERM); Improvement of radiated methods of measurement (using test sites) and evaluation of the corresponding measurement uncertainties; Part 1: Uncertainties in the measurement of mobile radio equipment characteristics; Sub-part 2: Examples and annexes".
- [3] IEC 60721-3-3 (1994): "Classification of environmental conditions - Part 3: Classification of groups of environmental parameters and their severities - Section 3: Stationary use at weather protected locations".
- [4] IEC 60721-3-4 (1995): "Classification of environmental conditions - Part 3: Classification of groups of environmental parameters and their severities - Section 4: Stationary use at non-weather protected locations".
- [5] 3GPP TS 25.142: "Base station conformance testing (TDD)".

3 Definitions, symbols and abbreviations

3.1 Definitions

For the purposes of the present document, the following definitions apply.

Power Spectral Density: The units of Power Spectral Density (PSD) are extensively used in this document. PSD is a function of power versus frequency and when integrated across a given bandwidth, the function represents the mean power in such a bandwidth. When the mean power is normalised to (divided by) the chip-rate it represents the mean energy per chip. Some signals are directly defined in terms of energy per chip, (DPCH_Ec, Ec, and P-CCPCH_Ec) and others defined in terms of PSD (Io, Ioc, Ior and \hat{I}_{or}). There also exist quantities that are a ratio of energy per chip to PSD (DPCH_Ec/Ior, Ec/Ior etc.). This is the common practice of relating energy magnitudes in communication systems.

It can be seen that if both energy magnitudes in the ratio are divided by time, the ratio is converted from an energy ratio to a power ratio, which is more useful from a measurement point of view. It follows that an energy per chip of X dBm/3.84 MHz can be expressed as a mean power per chip of X dBm. Similarly, a signal PSD of Y dBm/3.84 MHz can be expressed as a signal power of Y dBm.

Mean power: When applied to a CDMA modulated signal this is the power (transmitted or received) in a bandwidth of at least $(1 + \alpha)$ times the chip rate of the radio access mode. The period of measurement shall be a transmit timeslot excluding the guard period unless otherwise stated.

NOTE: The roll-off factor α is defined in section 6.8.1.

RRC filtered mean power: The mean power as measured through a root raised cosine filter with roll-off factor α and a bandwidth equal to the chip rate of the radio access mode.

NOTE: The RRC filtered mean power of a perfectly modulated CDMA signal is 0.246 dB lower than the mean power of the same signal.

Code domain power: That part of the mean power which correlates with a particular (OVSF) code channel. The sum of all powers in the code domain equals the mean power in a bandwidth of $(1 + \alpha)$ times the chip rate of the radio access mode.

Output power: The mean power of one carrier of the base station, delivered to a load with resistance equal to the nominal load impedance of the transmitter.

Maximum output power: The mean power level per carrier of the base station measured at the antenna connector in a specified reference condition. The period of measurement shall be a transmit timeslot excluding the guard period.

Rated output power: Rated output power of the base station is the mean power level per carrier that the manufacturer has declared to be available at the antenna connector.

3.2 Symbols

(void)

3.3 Abbreviations

For the purposes of the present document, the following abbreviations apply:

| | |
|------------------------------|--|
| ACIR | Adjacent Channel Interference Ratio |
| ACLR | Adjacent Channel Leakage power Ratio |
| ACS | Adjacent Channel Selectivity |
| BER | Bit Error Rate |
| BS | Base Station |
| CW | Continuous wave (unmodulated signal) |
| DL | Down link (forward link) |
| DPCH _o | A mechanism used to simulate an individual intracell interferer in the cell with one code and a spreading factor of 16 |
| $\frac{DPCH_{o-Ec}}{I_{or}}$ | The ratio of the average transmit energy per PN chip for the DPCH _o to the total transmit power spectral density of all users in the cell in one timeslot as measured at the BS antenna connector |
| EIRP | Effective Isotropic Radiated Power |
| FDD | Frequency Division Duplexing |
| FER | Frame Error Rate |

| | |
|----------------|--|
| I_{oc} | The power spectral density (integrated in a noise bandwidth equal to the chip rate and normalized to the chip rate) of a band limited white noise source (simulating interference from other cells) as measured at the BS antenna connector. |
| \hat{I}_{or} | The received power spectral density (integrated in a bandwidth $(1+\alpha)$ times the chip rate and normalized to the chip rate) of all users in the cell in one timeslot as measured at the BS antenna connector |
| PPM | Parts Per Million |
| Pout | Output power. |
| PRAT | Rated Output power |
| RSSI | Received Signal Strength Indicator |
| SIR | Signal to Interference ratio |
| TDD | Time Division Duplexing |
| TPC | Transmit Power Control |
| UE | User Equipment |
| UL | Up link (reverse link) |
| UTRA | UMTS Terrestrial Radio Access |

4 General

4.1 Relationship between Minimum Requirements and Test Requirements

The Minimum Requirements given in this specification make no allowance for measurement uncertainty. The test specification 25.142 section 5.9.6 defines Test Tolerances. These Test Tolerances are individually calculated for each test. The Test Tolerances are used to relax the Minimum Requirements in this specification to create Test Requirements. The measurement results returned by the Test System are compared -without any modification- against the Test Requirements as defined by the shared risk principle.

The Shared Risk principle is defined in ETR 273 Part 1 sub-part 2 section 6.5.

4.2 Base station classes

The requirements in this specification apply to base station intended for general-purpose applications in co-ordinated network operation.

In the future further classes of base stations may be defined; the requirements for these may be different than for general-purpose applications.

4.3 Regional requirements

Some requirements in TS 25.105 may only apply in certain regions. Table 4.1 lists all requirements that may be applied differently in different regions.

Table 4.1: List of regional requirements.

| Clause number | Requirement | Comments |
|---------------|--|---|
| 5.2 | Frequency bands | Some bands may be applied regionally. |
| 6.2.1 | Base station maximum output power | In certain regions, the minimum requirement for normal conditions may apply also for some conditions outside the range of conditions defined as normal. |
| 6.6.2.1 | Spectrum emission mask | The mask specified may be mandatory in certain regions. In other regions this mask may not be applied. |
| 6.6.3.1.1 | Spurious emissions (Category A) | These requirements shall be met in cases where Category A limits for spurious emissions, as defined in ITU-R Recommendation SM.329-8 [1], are applied. |
| 6.6.3.1.2 | Spurious emissions (Category B) | These requirements shall be met in cases where Category B limits for spurious emissions, as defined in ITU-R Recommendation SM.329-8 [1], are applied. |
| 6.6.3.2.1 | Co-existence with GSM900 – Operation in the same geographic area | This requirement may be applied for the protection of GSM 900 MS and GSM 900 BTS in geographic areas in which both GSM 900 and UTRA are deployed. |
| 6.6.3.2.2 | Co-existence with GSM900 – Co-located base stations | This requirement may be applied for the protection of GSM 900 BTS receivers when GSM 900 BTS and UTRA BS are co-located. |
| 6.6.3.3.1 | Co-existence with DCS1800 – Operation in the same geographic area | This requirement may be applied for the protection of DCS 1800 MS and DCS 1800 BTS in geographic areas in which both DCS 1800 and UTRA are deployed. |
| 6.6.3.3.2 | Co-existence with DCS1800 – Co-located base stations | This requirement may be applied for the protection of DCS 1800 BTS receivers when DCS 1800 BTS and UTRA BS are co-located. |
| 6.6.3.4.1 | Co-existence with UTRA FDD – Operation in the same geographic area | This requirement may be applied to geographic areas in which both UTRA-TDD and UTRA-FDD are deployed. |
| 6.6.3.4.2 | Co-existence with UTRA FDD – Co-located base stations | This requirement may be applied for the protection of UTRA-FDD BS receivers when UTRA-TDD BS and UTRA FDD BS are co-located. |
| 6.6.3.6 | Co-existence with PHS | This requirement may be applied for the protection of PHS in geographic areas in which both PHS and UTRA TDD are deployed. |
| 7.5 | Blocking characteristic | The requirement is applied according to what frequency bands in Clause 5.2 that are supported by the BS. |
| 7.5.1 | Blocking characteristic Co-location with GSM900 and/or DCS 1800 | This requirement may be applied for the protection of UTRA TDD BS receivers when UTRA TDD BS and GSM 900/DCS1800 BS are co-located. |

4.4 Environmental requirements for the BS equipment

The BS equipment shall fulfil all the requirements in the full range of environmental conditions for the relevant environmental class from the relevant IEC specifications listed below:

IEC 60 721-3-3: "Stationary use at weather protected locations" [3]

IEC 60 721-3-4: "Stationary use at non weather protected locations" [4]

Normally it should be sufficient for all tests to be conducted using normal test conditions except where otherwise stated. For guidance on the use of test conditions to be used in order to show compliance refer to TS 25.142 [5].

5 Frequency bands and channel arrangement

5.1 General

The information presented in this section is based on a chip rate of 3.84 Mcps.

Note: Other chip rates may be considered in future releases.

5.2 Frequency bands

UTRA/TDD is designed to operate in the following bands;

- a)*** 1900 – 1920 MHz: Uplink and downlink transmission
2010 – 2025 MHz Uplink and downlink transmission
- b)* 1850 – 1910 MHz Uplink and downlink transmission
1930 – 1990 MHz Uplink and downlink transmission
- c)* 1910 – 1930 MHz Uplink and downlink transmission

* Used in ITU Region 2

*** In Japan, only the band 2010-2025MHz has been allocated for UTRA TDD operation.

Additional allocations in ITU region 2 are FFS.

Deployment in existing and other frequency bands is not precluded.

The co-existence of TDD and FDD in the same bands is still under study in WG4.

5.3 TX–RX frequency separation

No TX-RX frequency separation is required as Time Division Duplex (TDD) is employed. Each TDMA frame consists of 15 timeslots where each timeslot can be allocated to either transmit or receive.

5.4 Channel arrangement

5.4.1 Channel spacing

The nominal channel spacing is 5 MHz, but this can be adjusted to optimise performance in a particular deployment scenario.

5.4.2 Channel raster

The channel raster is 200 kHz, which means that the carrier frequency must be a multiple of 200 kHz.

5.4.3 Channel number

The carrier frequency is designated by the UTRA absolute radio frequency channel number (UARFCN). The value of the UARFCN in the IMT2000 band is defined as follows:

$$N_t = 5 * F \qquad 0.0 \leq F \leq 3276.6 \text{ MHz}$$

where F is the carrier frequency in MHz

6 Transmitter characteristics

6.1 General

Unless detailed the transmitter characteristic are specified at the antenna connector.

6.2 Base station output power

The rated output power of the base station is defined in section 3.1.

6.2.1 Base station maximum output power

The maximum output power of the base station is defined in section 3.1.

6.2.1.1 Minimum Requirement

In normal conditions, the base station maximum output power shall remain within +2 dB and –2 dB of the manufacturer"s rated output power.

In extreme conditions, the Base station maximum output power shall remain within +2.5 dB and –2.5 dB of the manufacturer"s rated output power.

In certain regions, the minimum requirement for normal conditions may apply also for some conditions outside the range of conditions defined as normal.

6.3 Frequency stability

Frequency stability is ability of the BS to transmit at the assigned carrier frequency. The BS shall use the same frequency source for both RF frequency generation and the chip clock.

6.3.1 Minimum Requirement

The modulated carrier frequency of the BS shall be accurate to within ± 0.05 PPM observed over a period of one timeslot for RF frequency generation.

6.4 Output power dynamics

Power control is used to limit the interference level. The transmitter uses a quality-based power control on the downlink.

6.4.1 Inner loop power control

Inner loop power control is the ability of the BS transmitter to adjust its code domain power in response to the UL received signal.

For inner loop correction on the Downlink Channel, the base station adjusts the code domain power of a power controlled CCTrCH in response to each valid power control bit received from the UE on the Uplink Traffic Channel based on the mapping of the TPC bits in uplink CCTrCH to downlink CCTrCH. Inner loop control is based on SIR measurements at the UE receiver and the corresponding TPC commands are generated by the UE.

6.4.2 Power control steps

The power control step is the step change in the DL code domain power in response to a TPC message from the UE.

6.4.2.1 Minimum Requirement

Down link (DL) power steps: 1, 2, 3 dB

The tolerance of the code domain power and the greatest average rate of change in code domain power due to the power control step shall be within the range shown in Table 6.1.

Table 6.1: power control step size tolerance

| Step size | Tolerance | Range of average rate of change in code domain power per 10 steps | |
|-----------|-----------|---|---------|
| | | minimum | maximum |
| 1dB | +/-0.5dB | +/-8dB | +/-12dB |
| 2dB | +/-0.75dB | +/-16dB | +/-24dB |
| 3dB | +/-1dB | +/-24dB | +/-36dB |

6.4.3 Power control dynamic range

The power control dynamic range is the difference between the maximum and the minimum code domain power of one power controlled code channel for a specified reference condition

6.4.3.1 Minimum Requirement

Down link (DL) power control dynamic range shall be greater than or equal to 30 dB

6.4.4 Minimum output power

The minimum controlled output power of the BS is when the power is set to a minimum value.

6.4.4.1 Minimum Requirement

Down link (DL) minimum output power shall be lower than or equal to:

$$\text{Maximum output power} - 30\text{dB}$$

6.4.5 Primary CCPCH power

Primary CCPCH power is the code domain power of the primary common control physical channel averaged over the transmit timeslot. Primary CCPCH power is signalled over the BCH.

The error between the BCH-broadcast value of the Primary CCPCH power and the Primary CCPCH power averaged over the timeslot shall not exceed the values in table 6.2. The error is a function of the output power averaged over the timeslot, P_{out} , and the manufacturer's rated output power, PRAT.

Table 6.2: Errors between Primary CCPCH power and the broadcast value

| Output power in slot, dB | PCCPCH power tolerance |
|---------------------------------|------------------------|
| $PRAT-3 < P_{out} \leq PRAT+2$ | +/- 2.5 dB |
| $PRAT-6 < P_{out} \leq PRAT-3$ | +/- 3.5 dB |
| $PRAT-13 < P_{out} \leq PRAT-6$ | +/- 5 dB |

6.5 Transmit ON/OFF power

6.5.1 Transmit OFF power

Transmit OFF power is defined as the RRC filtered mean power measured over one chip when the transmitter is off. The transmit OFF power state is when the BS does not transmit.

6.5.1.1 Minimum Requirement

The transmit OFF power shall be less than -79 dBm.

6.5.2 Transmit ON/OFF Time mask

The time mask transmit ON/OFF defines the ramping time allowed for the BS between transmit OFF power and transmit ON power.

6.5.2.1 Minimum Requirement

The transmit power level versus time should meet the mask specified in figure 6.1.

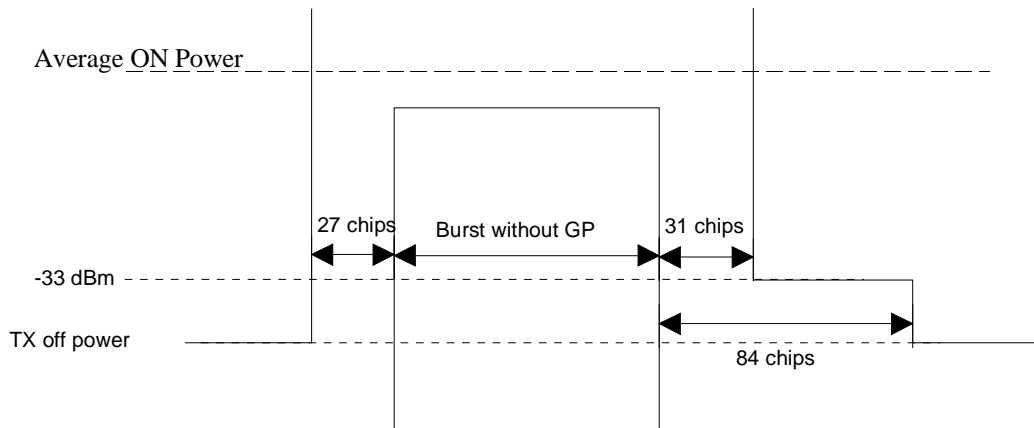

Figure 6.1: Transmit ON/OFF template

6.6 Output RF spectrum emissions

6.6.1 Occupied bandwidth

Occupied bandwidth is a measure of the bandwidth containing 99% of the total integrated power for transmitted spectrum and is centered on the assigned channel frequency. The occupied channel bandwidth is less than 5 MHz based on a chip rate of 3.84 Mcps.

6.6.2 Out of band emission

Out of band emissions are unwanted emissions immediately outside the channel bandwidth resulting from the modulation process and non-linearity in the transmitter but excluding spurious emissions. This out of band emission requirement is specified both in terms of a spectrum emission mask and adjacent channel power ratio for the transmitter.

6.6.2.1 Spectrum emission mask

The mask defined in Table 6.3 to 6.6 below may be mandatory in certain regions. In other regions this mask may not be applied.

For regions where this clause applies, the requirement shall be met by a base station transmitting on a single RF carrier configured in accordance with the manufacturer's specification. Emissions shall not exceed the maximum level specified in tables 6.3 to 6.6 for the appropriate BS maximum output power, in the frequency range from $\Delta f = 2.5$ MHz to Δf_{\max} from the carrier frequency, where:

- Δf is the separation between the carrier frequency and the nominal -3dB point of the measuring filter closest to the carrier frequency.
- f_{offset} is the separation between the carrier frequency and the center frequency of the measuring filter.

$f_{\text{offset}_{\max}}$ is either 12.5 MHz or the offset to the UMTS Tx band edge as defined in section 5.2, whichever is the greater.

- Δf_{\max} is equal to $f_{\text{offset}_{\max}}$ minus half of the bandwidth of the measurement filter.

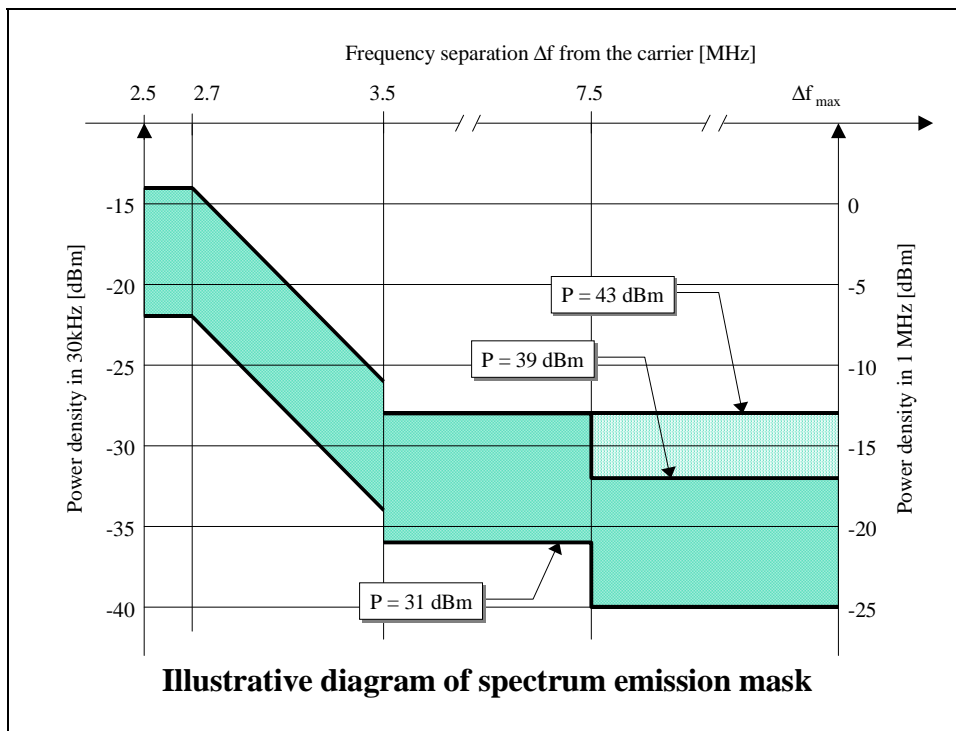

Figure 6.2

Table 6.3: Spectrum emission mask values, BS maximum output power P ≥ 43 dBm

| Frequency offset of measurement filter – 3dB point, Δf | Frequency offset of measurement filter centre frequency, f_offset | Maximum level | Measurement bandwidth |
|--|---|----------------------------------|-----------------------|
| 2.5 ≤ Δf < 2.7 MHz | 2.515MHz ≤ f_offset < 2.715MHz | -14 dBm | 30 kHz |
| 2.7 ≤ Δf < 3.5 MHz | 2.715MHz ≤ f_offset < 3.515MHz | - 14 - 15·(f_offset - 2.715) dBm | 30 kHz |
| (see note) | 3.515MHz ≤ f_offset < 4.0MHz | -26 dBm | 30 kHz |
| 3.5 ≤ Δf MHz | 4.0MHz ≤ f_offset < f_offset_max | -13 dBm | 1 MHz |

Table 6.4: Spectrum emission mask values, BS maximum output power 39 ≤ P < 43 dBm

| Frequency offset of measurement filter – 3dB point, Δf | Frequency offset of measurement filter centre frequency, f_offset | Maximum level | Measurement bandwidth |
|--|---|---------------------------------|-----------------------|
| 2.5 ≤ Δf < 2.7 MHz | 2.515MHz ≤ f_offset < 2.715MHz | -14 dBm | 30 kHz |
| 2.7 ≤ Δf < 3.5 MHz | 2.715MHz ≤ f_offset < 3.515MHz | -14 - 15·(f_offset - 2.715) dBm | 30 kHz |
| (see note) | 3.515MHz ≤ f_offset < 4.0MHz | -26 dBm | 30 kHz |
| 3.5 ≤ Δf < 7.5 MHz | 4.0MHz ≤ f_offset < 8.0MHz | -13 dBm | 1 MHz |
| 7.5 ≤ Δf MHz | 8.0MHz ≤ f_offset < f_offset_max | P - 56 dBm | 1 MHz |

Table 6.5: Spectrum emission mask values, BS maximum output power $31 \leq P < 39$ dBm

| Frequency offset of measurement filter – 3dB point, Δf | Frequency offset of measurement filter centre frequency, f_{offset} | Maximum level | Measurement bandwidth |
|--|--|------------------------------------|-----------------------|
| $2.5 \leq \Delta f < 2.7$ MHz | $2.515\text{MHz} \leq f_{\text{offset}} < 2.715\text{MHz}$ | P - 53 dBm | 30 kHz |
| $2.7 \leq \Delta f < 3.5$ MHz | $2.715\text{MHz} \leq f_{\text{offset}} < 3.515\text{MHz}$ | P - 53 - 15·(f_offset - 2.715) dBm | 30 kHz |
| (see note) | $3.515\text{MHz} \leq f_{\text{offset}} < 4.0\text{MHz}$ | P - 65 dBm | 30 kHz |
| $3.5 \leq \Delta f < 7.5$ MHz | $4.0\text{MHz} \leq f_{\text{offset}} < 8.0\text{MHz}$ | P - 52 dBm | 1 MHz |
| $7.5 \leq \Delta f$ MHz | $8.0\text{MHz} \leq f_{\text{offset}} < f_{\text{offset}_{\text{max}}}$ | P - 56 dBm | 1 MHz |

Table 6.6: Spectrum emission mask values, BS maximum output power $P < 31$ dBm

| Frequency offset of measurement filter – 3dB point, Δf | Frequency offset of measurement filter centre frequency, f_{offset} | Maximum level | Measurement bandwidth |
|--|--|---------------------------------|-----------------------|
| $2.5 \leq \Delta f < 2.7$ MHz | $2.515\text{MHz} \leq f_{\text{offset}} < 2.715\text{MHz}$ | -22 dBm | 30 kHz |
| $2.7 \leq \Delta f < 3.5$ MHz | $2.715\text{MHz} \leq f_{\text{offset}} < 3.515\text{MHz}$ | -22 - 15·(f_offset - 2.715) dBm | 30 kHz |
| (see note) | $3.515\text{MHz} \leq f_{\text{offset}} < 4.0\text{MHz}$ | -34 dBm | 30 kHz |
| $3.5 \leq \Delta f < 7.5$ MHz | $4.0\text{MHz} \leq f_{\text{offset}} < 8.0\text{MHz}$ | -21 dBm | 1 MHz |
| $7.5 \leq \Delta f$ MHz | $8.0\text{MHz} \leq f_{\text{offset}} < f_{\text{offset}_{\text{max}}}$ | -25 dBm | 1 MHz |

NOTE: This frequency range ensures that the range of values of f_{offset} is continuous.

6.6.2.2 Adjacent Channel Leakage power Ratio (ACLR)

Adjacent Channel Leakage power Ratio (ACLR) is the ratio of the RRC filtered mean power centered on the assigned channel frequency to the RRC filtered mean power centered on an adjacent channel frequency.

In some cases the requirement is expressed as adjacent channel leakage power, which is the maximum absolute emission level on the adjacent channel frequency measured with a filter that has a Root Raised Cosine (RRC) filter response with roll-off $\alpha=0,22$ and a bandwidth equal to the chip rate of the victim system.

The requirements shall apply for all configurations of BS (single carrier or multi-carrier), and for all operating modes foreseen by the manufacturer's specification.

6.6.2.2.1 Minimum Requirement

The ACLR of a single carrier BS or a multi-carrier BS with contiguous carrier frequencies shall be higher than the value specified in Table 6.7.

Table 6.7: BS ACLR

| BS adjacent channel offset below the first or above the last carrier frequency used | ACLR limit |
|---|------------|
| 5 MHz | 45 dB |
| 10 MHz | 55 dB |

If a BS provides multiple non-contiguous single carriers or multiple non-contiguous groups of contiguous single carriers, the above requirements shall be applied individually to the single carriers or group of single carriers.

6.6.2.2.2 Requirement for operation in the same geographic area with FDD or unsynchronised TDD on adjacent channels

6.6.2.2.2.1 Requirement for operation in the same geographic area with unsynchronised TDD on adjacent channels

In case the equipment is operated in the same geographic area with an unsynchronised TDD BS operating on the first or second adjacent frequency, the adjacent channel leakage power of a single carrier BS or a multi-carrier BS with contiguous carrier frequencies shall not exceed the limits specified in Table 6.8.

Table 6.8: Adjacent channel leakage power limits for operation in the same geographic area with unsynchronised TDD on adjacent channels

| BS adjacent channel offset below the first or above the last carrier frequency used | Maximum Level | Measurement Bandwidth |
|---|---------------|-----------------------|
| 5 MHz | -29 dBm | 3,84 MHz |
| 10 MHz | -29 dBm | 3,84 MHz |

NOTE: The requirement in Table 6.8 is based on a coupling loss of 74 dB between the unsynchronised TDD base stations. The scenario leading to this requirement is addressed in TR 25.942 [4].

If a BS provides multiple non-contiguous single carriers or multiple non-contiguous groups of contiguous single carriers, the above requirements shall be applied to those adjacent channels of the single carriers or group of single channels which are used by the TDD BS in the same geographic area.

6.6.2.2.2.2 Requirement for operation in the same geographic area with FDD on adjacent channels

In case the equipment is operated in the same geographic area with a FDD BS operating on the first or second adjacent channel, the adjacent channel leakage power shall not exceed the limits specified in Table 6.8A.

Table 6.8A: Adjacent channel leakage power limits for operation in the same geographic area with FDD on adjacent channels

| BS Adjacent Channel Offset | Maximum Level | Measurement Bandwidth |
|----------------------------|---------------|-----------------------|
| +/- 5 MHz | -36 dBm | 3,84 MHz |
| +/- 10 MHz | -36 dBm | 3,84 MHz |

NOTE: The requirement in Table 6.8A is based on a coupling loss of 74 dB between the FDD and TDD base stations. The scenario leading to this requirement is addressed in TR 25.942 [4].

If a BS provides multiple non-contiguous single carriers or multiple non-contiguous groups of contiguous single carriers, the above requirements shall be applied to those adjacent channels of the single carriers or group of single channels which are used by the FDD BS in the same geographic area.

6.6.2.2.3 Requirement in case of co-siting with unsynchronised TDD BS or FDD BS operating on an adjacent channel

6.6.2.2.3.1 Requirement in case of co-siting with unsynchronised TDD BS operating on an adjacent channel

In case the equipment is co-sited to an unsynchronised TDD BS operating on the first or second adjacent frequency, the adjacent channel leakage power of a single carrier BS or a multi-carrier BS with contiguous carrier frequencies shall not exceed the limits specified in Table 6.9.

Table 6.9: Adjacent channel leakage power limits in case of co-siting with unsynchronised TDD on adjacent channel

| BS adjacent channel offset below the first or above the last carrier frequency use | Maximum Level | Measurement Bandwidth |
|--|---------------|-----------------------|
| 5 MHz | -73 dBm | 3.84 MHz |
| 10 MHz | -73 dBm | 3.84 MHz |

NOTE: The requirements in Table 6.9 are based on a coupling loss of 30 dB between the unsynchronised TDD base stations.

If a BS provides multiple non-contiguous single carriers or multiple non-contiguous groups of contiguous single carriers, the above requirements shall be applied to those adjacent channels of the single carriers or group of single channels which are used by the co-sited TDD BS.

6.6.2.2.3.2 Requirement in case of co-siting with FDD BS operating on an adjacent channel

In case the equipment is co-sited to a FDD BS operating on the first or second adjacent channel, the adjacent channel leakage power shall not exceed the limits specified in Table 6.9A.

Table 6.9A: Adjacent channel leakage power limits in case of co-siting with FDD on adjacent channels

| BS Adjacent Channel Offset | Maximum Level | Measurement Bandwidth |
|----------------------------|---------------|-----------------------|
| +/- 5 MHz | -80 dBm | 3,84 MHz |
| +/- 10 MHz | -80 dBm | 3,84 MHz |

NOTE: The requirements in Table 6.9A are based on a coupling loss of 30 dB between the FDD and TDD base stations.

If a BS provides multiple non-contiguous single carriers or multiple non-contiguous groups of contiguous single carriers, the above requirements shall be applied to those adjacent channels of the single carriers or group of single channels which are used by the co-sited FDD BS.

6.6.3 Spurious emissions

Spurious emissions are emissions which are caused by unwanted transmitter effects such as harmonics emission, parasitic emission, intermodulation products and frequency conversion products, but exclude out of band emissions. This is measured at the base station RF output port.

The requirements shall apply whatever the type of transmitter considered (single carrier or multiple carrier). It applies for all transmission modes foreseen by the manufacturer's specification.

Either requirement (except 6.6.3.6) applies at frequencies within the specified frequency ranges which are more than 12.5 MHz under the first carrier frequency used or more than 12.5 MHz above the last carrier frequency used.

Unless otherwise stated, all requirements are measured as mean power.

6.6.3.1 Mandatory Requirements

The requirements of either subclause 6.6.3.1.1 or subclause 6.6.3.1.2 shall apply

6.6.3.1.1 Spurious emissions (Category A)

The following requirements shall be met in cases where Category A limits for spurious emissions, as defined in ITU-R Recommendation SM.329-8 [1], are applied.

6.6.3.1.1.1 Minimum Requirement

The power of any spurious emission shall not exceed:

Table 6.10: BS Mandatory spurious emissions limits, Category A

| Band | Minimum requirement | Measurement Bandwidth | Note |
|------------------|---------------------|-----------------------|--|
| 9kHz – 150kHz | -13 dBm | 1 kHz | Bandwidth as in ITU SM.329-8, s4.1 |
| 150kHz – 30MHz | | 10 kHz | Bandwidth as in ITU SM.329-8, s4.1 |
| 30MHz – 1GHz | | 100 kHz | Bandwidth as in ITU SM.329-8, s4.1 |
| 1GHz – 12.75 GHz | | 1 MHz | Upper frequency as in ITU SM.329-8, s2.5 table 1 |

6.6.3.1.2 Spurious emissions (Category B)

The following requirements shall be met in cases where Category B limits for spurious emissions, as defined in ITU-R Recommendation SM.329-8 [1], are applied.

6.6.3.1.2.1 Minimum Requirement

The power of any spurious emission shall not exceed:

Table 6.11: BS Mandatory spurious emissions limits, Category B

| Band | Maximum Level | Measurement Bandwidth | Note |
|-------------------------|---------------|-----------------------|--|
| 9kHz – 150kHz | -36 dBm | 1 kHz | Bandwidth as in ITU SM.329-8, s4.1 |
| 150kHz – 30MHz | - 36 dBm | 10 kHz | Bandwidth as in ITU SM.329-8, s4.1 |
| 30MHz – 1GHz | -36 dBm | 100 kHz | Bandwidth as in ITU SM.329-8, s4.1 |
| 1GHz ↔ Fl -10 MHz | -30 dBm | 1 MHz | Bandwidth as in ITU SM.329-8, s4.1 |
| Fl -10MHz ↔ Fu +10 MHz | -15 dBm | 1 MHz | Limit based on ITU-R SM.329-8, s4.3 and Annex 7 |
| Fu + 10 MHz ↔ 12,75 GHz | -30 dBm | 1 MHz | Bandwidth as in ITU-R SM.329-8, s4.3 and Annex 7. Upper frequency as in ITU-R SM.329-8, s2.5 table 1 |

Fl: Lower frequency of the band in which TDD operates

Fu: Upper frequency of the band in which TDD operates

6.6.3.2 Co-existence with GSM 900

6.6.3.2.1 Operation in the same geographic area

This requirement may be applied for the protection of GSM 900 MS and GSM 900 BTS receivers in geographic areas in which both GSM 900 and UTRA are deployed.

6.6.3.2.1.1 Minimum Requirement

The power of any spurious emission shall not exceed:

Table 6.12: BS Spurious emissions limits for BS in geographic coverage area of GSM 900 MS and GSM 900 BTS receiver

| Band | Maximum Level | Measurement Bandwidth | Note |
|--------------|---------------|-----------------------|------|
| 876 – 915MHz | -61 dBm | 100 kHz | |
| 921 – 960MHz | -57 dBm | 100 kHz | |

6.6.3.2.2 Co-located base stations

This requirement may be applied for the protection of GSM 900 BTS receivers when GSM 900 BTS and UTRA BS are co-located.

6.6.3.2.2.1 Minimum Requirement

The power of any spurious emission shall not exceed:

Table 6.13: BS Spurious emissions limits for protection of the GSM 900 BTS receiver

| Band | Maximum Level | Measurement Bandwidth | Note |
|---------------|---------------|-----------------------|------|
| 876 – 915 MHz | -98 dBm | 100 kHz | |

6.6.3.3 Co-existence with DCS 1800

6.6.3.3.1 Operation in the same geographic area

This requirement may be applied for the protection of DCS 1800 MS and DCS 1800 BTS receivers in geographic areas in which both DCS 1800 and UTRA are deployed.

6.6.3.3.1.1 Minimum Requirement

The power of any spurious emission shall not exceed:

Table 6.14: BS Spurious emissions limits for BS in geographic coverage area of DCS 1800 MS and DCS 1800 BTS receiver

| Band | Maximum Level | Measurement Bandwidth | Note |
|-----------------|---------------|-----------------------|------|
| 1710 – 1785 MHz | -61 dBm | 100 kHz | |
| 1805 – 1880MHz | -47 dBm | 100 kHz | |

6.6.3.3.2 Co-located base stations

This requirement may be applied for the protection of DCS 1800 BTS receivers when DCS 1800 BTS and UTRA BS are co-located.

6.6.3.3.2.1 Minimum Requirement

The power of any spurious emission shall not exceed:

Table 6.15: BS Spurious emissions limits for BS co-located with DCS 1800 BTS

| Band | Maximum Level | Measurement Bandwidth | Note |
|-----------------|---------------|-----------------------|------|
| 1710 – 1785 MHz | -98 dBm | 100 kHz | |

6.6.3.4 Co-existence with UTRA-FDD

6.6.3.4.1 Operation in the same geographic area

This requirement may be applied to geographic areas in which both UTRA-TDD and UTRA-FDD are deployed.

6.6.3.4.1.1 Minimum Requirement

For TDD base stations which use carrier frequencies within the band 2010 – 2025 MHz the requirements applies at all frequencies within the specified frequency bands in Table 6.16. For TDD base stations which use a carrier frequency within the band 1900 – 1920 MHz the requirements applies at frequencies within the specified frequency range which are more than 12,5 MHz above the last carrier used in the frequency band 1900 – 1920 MHz.

The power of any spurious emission shall not exceed:

Table 6.16: BS Spurious emissions limits for BS in geographic coverage area of UTRA-FDD

| Band | Maximum Level | Measurement Bandwidth | Note |
|---|---------------|-----------------------|------|
| 1920 – 1980 MHz | -43 dBm (*) | 3.84 MHz | |
| 2110 – 2170 MHz | -52 dBm | 1 MHz | |
| Note * The requirement shall be measured with the lowest center frequency of measurement at 1922,6 MHz or 15 MHz above the last TDD carrier used whichever is higher. | | | |

NOTE: The requirements in Table 6.16 are based on a coupling loss of 67 dB between the TDD and FDD base stations. The scenarios leading to these requirements are addressed in TR 25.942 [4].

6.6.3.4.2 Co-located base stations

This requirement may be applied for the protection of UTRA-FDD BS receivers when UTRA-TDD BS and UTRA FDD BS are co-located.

6.6.3.4.2.1 Minimum Requirement

For TDD base stations which use carrier frequencies within the band 2010 – 2025 MHz the requirements applies at all frequencies within the specified frequency bands in Table 6.17. For TDD base stations which use a carrier frequency within the band 1900 – 1920 MHz the requirements applies at frequencies within the specified frequency range which are more than 12,5 MHz above the last carrier used in the frequency band 1900 – 1920 MHz.

The power of any spurious emission shall not exceed:

Table 6.17: BS Spurious emissions limits for BS co-located with UTRA-FDD

| Band | Maximum Level | Measurement Bandwidth | Note |
|---|---------------|-----------------------|------|
| 1920 – 1980 MHz | -80 dBm (*) | 3.84 MHz | |
| 2110 – 2170 MHz | -52 dBm | 1 MHz | |
| Note * The requirement shall be measured with the lowest center frequency of measurement at 1922,6 MHz or 15 MHz above the last TDD carrier used whichever is higher. | | | |

NOTE: The requirements in Table 6.17 are based on a coupling loss of 30 dB between the TDD and FDD base stations.

6.6.3.5 Co-existence with unsynchronised TDD

6.6.3.5.1 Operation in the same geographic area

This requirement shall apply in case the equipment is operated in the same geographic area with unsynchronised TDD BS.

6.6.3.5.1.1 Minimum Requirement

The power of any spurious emission shall not exceed the limits specified in table 6.18.

Table 6.18: BS Spurious emissions limits for operation in same geographic area with unsynchronised TDD

| Band | Maximum Level | Measurement Bandwidth |
|-----------------|---------------|-----------------------|
| 1900 – 1920 MHz | –39 dBm | 3,84 MHz |
| 2010 – 2025 MHz | –39 dBm | 3,84 MHz |

NOTE: The requirements in Table 6.18 are based on a minimum coupling loss of 67 dB between unsynchronised TDD base stations. The scenarios leading to these requirements are addressed in TR25.942 [4].

6.6.3.5.2 Co-located base stations

This requirement shall apply in case of co-location with unsynchronised TDD BS.

6.6.3.5.2.1 Minimum Requirement

The power of any spurious emission in case of co-location shall not exceed the limits specified in table 6.19.

Table 6.19: BS Spurious emissions limits for co-location with unsynchronised TDD

| Band | Maximum Level | Measurement Bandwidth |
|-----------------|---------------|-----------------------|
| 1900 – 1920 MHz | –76 dBm | 3,84 MHz |
| 2010 – 2025 MHz | –76 dBm | 3,84 MHz |

NOTE: The requirements in Table 6.19 are based on a minimum coupling loss of 30 dB between unsynchronised TDD base stations.

6.6.3.6 Co-existence with PHS

This requirement may be applied for the protection of PHS in geographic areas in which both PHS and UTRA TDD are deployed. This requirement is also applicable at specified frequencies falling between 12.5MHz below the first carrier frequency used and 12.5MHz above the last carrier frequency used.

6.6.3.6.1 Minimum Requirement

The power of any spurious emission shall not exceed:

Table 6.24: BS Spurious emissions limits for BS in geographic coverage area of PHS

| Band | Maximum Level | Measurement Bandwidth | Note |
|---------------------|---------------|-----------------------|---|
| 1884.5 – 1919.6 MHz | –41 dBm | 300 kHz | Applicable for transmission in 2010-2025 MHz as defined in subclause 5.2 (a). |

6.7 Transmit intermodulation

The transmit intermodulation performance is a measure of the capability of the transmitter to inhibit the generation of signals in its non linear elements caused by presence of the wanted signal and an interfering signal reaching the transmitter via the antenna.

The transmit intermodulation level is the power of the intermodulation products when a CDMA modulated interference signal is injected into the antenna connector at a mean power level of 30 dB lower than that of the mean power of the subject signal. The frequency of the interference signal shall be ± 5 MHz, ± 10 MHz and ± 15 MHz offset from the subject signal.

6.7.1 Minimum Requirement

The Transmit intermodulation level shall not exceed the out of band or the spurious emission requirements of section 6.6.2 and 6.6.3.

6.8 Transmit modulation

6.8.1 Transmit pulse shape filter

The transmit pulse-shaping filter is a root-raised cosine (RRC) with roll-off $\alpha = 0.22$ in the frequency domain. The impulse response of the chip impulse filter $RC_0(t)$ is

$$RC_0(t) = \frac{\sin\left(\pi \frac{t}{T_c}(1-\alpha)\right) + 4\alpha \frac{t}{T_c} \cos\left(\pi \frac{t}{T_c}(1+\alpha)\right)}{\pi \frac{t}{T_c} \left(1 - \left(4\alpha \frac{t}{T_c}\right)^2\right)}$$

Where the roll-off factor $\alpha = 0.22$ and the chip duration:

$$T_c = \frac{1}{\text{chiprate}} \approx 0.26042 \mu\text{s}$$

6.8.2 Modulation Accuracy

The Error Vector Magnitude is a measure of the difference between the reference waveform and the measured waveform. This difference is called the error vector. Both waveforms pass through a matched Root Raised Cosine filter with bandwidth 3,84 MHz and roll-off $\alpha = 0.22$. Both waveforms are then further modified by selecting the frequency, absolute phase, absolute amplitude and chip clock timing so as to minimise the error vector. The EVM result is defined as the square root of the ratio of the mean error vector power to the mean reference power expressed as a %. The measurement interval is one timeslot. The requirement is valid over the total power dynamic range as specified in subclause 6.4.3. See Annex C of TS 25.142 for further details.

6.8.2.1 Minimum Requirement

The Modulation accuracy shall not be worse than 12.5 %.

6.8.3 Peak Code Domain Error

The code domain error is computed by projecting the error vector power onto the code domain at a specific spreading factor. The error power for each code is defined as the ratio to the mean power of the reference waveform expressed in dB. And the Peak Code Domain Error is defined as the maximum value for Code Domain Error. The measurement interval is one timeslot.

6.8.3.1 Minimum Requirement

The peak code domain error shall not exceed -28 dB at spreading factor 16.

7 Receiver characteristics

7.1 General

The requirements in this clause 7 assume that the receiver is not equipped with diversity. For receivers with diversity, the requirements apply to each antenna connector separately, with the other one(s) terminated or disabled. The requirements are otherwise unchanged.

7.2 Reference sensitivity level

The reference sensitivity level is the minimum mean power received at the antenna connector at which the BER shall not exceed the specific value indicated in section 7.2.1.

7.2.1 Minimum Requirement

Using the reference measurement channel specified in Annex A, the reference sensitivity level and performance of the BS shall be as specified in table 7.1

Table 7.1: BS reference sensitivity level

| Reference measurement channel data rate | BS reference sensitivity level | BER |
|---|--------------------------------|----------------------------|
| 12.2 kbps | -109 dBm | BER shall not exceed 0.001 |

7.3 Dynamic range

Receiver dynamic range is the receiver ability to handle a rise of interference in the reception frequency channel. The receiver shall fulfil a specified BER requirement for a specified sensitivity degradation of the wanted signal in the presence of an interfering AWGN signal in the same reception frequency channel.

7.3.1 Minimum requirement

The BER shall not exceed 0.001 for the parameters specified in Table 7.2.

Table 7.2: Dynamic Range

| Parameter | Level | Unit |
|---|-------|--------------|
| Reference measurement channel data rate | 12.2 | kbps |
| Wanted signal mean power | -79 | dBm |
| Interfering AWGN signal | -73 | dBm/3.84 MHz |

7.4 Adjacent Channel Selectivity (ACS)

Adjacent channel selectivity (ACS) is a measure of the receiver ability to receive a wanted signal at its assigned channel frequency in the presence of a single code CDMA modulated adjacent channel signal at a given frequency offset from the center frequency of the assigned channel. ACS is the ratio of the receiver filter attenuation on the assigned channel frequency to the receiver filter attenuation on the adjacent channel(s).

7.4.1 Minimum Requirement

The BER shall not exceed 0.001 for the parameters specified in table 7.3.

Table 7.3 : Adjacent channel selectivity

| Parameter | Level | Unit |
|---|-------|------|
| Reference measurement channel data rate | 12.2 | kbps |
| Wanted signal mean power | -103 | dBm |
| Interfering signal mean power | -52 | dBm |
| Fuw offset (Modulated) | 5 | MHz |

7.5 Blocking characteristics

The blocking characteristics is a measure of the receiver ability to receive a wanted signal at its assigned channel frequency in the presence of an unwanted interferer on frequencies other than those of the adjacent channels. The blocking performance requirement applies to interfering signals with center frequency within the ranges specified in the tables below, using a 1MHz step size.

The static reference performance as specified in clause 7.2.1 shall be met with a wanted and an interfering signal coupled to BS antenna input using the following parameters.

Table 7.4(a): Blocking requirements for operating bands defined in 5.2(a)

| Centre Frequency of Interfering Signal | Interfering Signal Mean Power | Wanted Signal Mean Power | Minimum Offset of Interfering Signal | Type of Interfering Signal |
|---|-------------------------------|--------------------------|--------------------------------------|----------------------------|
| 1900 – 1920 MHz, 2010 – 2025 MHz | -40 dBm | -103 dBm | 10 MHz | WCDMA signal with one code |
| 1880 – 1900 MHz, 1990 – 2010 MHz, 2025 – 2045 MHz | -40 dBm | -103 dBm | 10 MHz | WCDMA signal with one code |
| 1920 – 1980 MHz | -40 dBm | -103 dBm | 10 MHz | WCDMA signal with one code |
| 1 – 1880 MHz, 1980 – 1990 MHz, 2045 – 12750 MHz | -15 dBm | -103 dBm | — | CW carrier |

Table 7.4(b) : Blocking requirements for operating bands defined in 5.2(b)

| Centre Frequency of Interfering Signal | Interfering Signal Mean Power | Wanted Signal Mean Power | Minimum Offset of Interfering Signal | Type of Interfering Signal |
|--|-------------------------------|--------------------------|--------------------------------------|----------------------------|
| 1850 – 1990 MHz | -40 dBm | -103 dBm | 10 MHz | WCDMA signal with one code |
| 1830 – 1850 MHz, 1990 – 2010 MHz | -40 dBm | -103 dBm | 10 MHz | WCDMA signal with one code |
| 1 – 1830 MHz, 2010 – 12750 MHz | -15 dBm | -103 dBm | — | CW carrier |

Table 7.4(c) : Blocking requirements for operating bands defined in 5.2(c)

| Centre Frequency of Interfering Signal | Interfering Signal Mean Power | Wanted Signal Mean Power | Minimum Offset of Interfering Signal | Type of Interfering Signal |
|--|-------------------------------|--------------------------|--------------------------------------|----------------------------|
| 1910 – 1930 MHz | -40 dBm | -103 dBm | 10 MHz | WCDMA signal with one code |
| 1890 – 1910 MHz, 1930 – 1950 MHz | -40 dBm | -103 dBm | 10 MHz | WCDMA signal with one code |
| 1 – 1890 MHz, 1950 – 12750 MHz | -15 dBm | -103 dBm | — | CW carrier |

7.5.1 Co-location with GSM900 and/or DCS 1800

This additional blocking requirement may be applied for the protection of TDD BS receivers when GSM900 and/or DCS1800 BTS are co-located with UTRA TDD BS.

The blocking performance requirement applies to interfering signals with center frequency within the ranges specified in the tables below, using a 1MHz step size.

In case this additional blocking requirement is applied, the static reference performance as specified in clause 7.2.1 shall be met with a wanted and an interfering signal coupled to BS antenna input using the following parameters.

Table 7.4(d): Additional blocking requirements for operating bands defined in 5.2(a) when co-located with GSM900

| Centre Frequency of Interfering Signal | Interfering Signal Mean Power | Wanted Signal Mean Power | Minimum Offset of Interfering Signal | Type of Interfering Signal |
|--|-------------------------------|--------------------------|--------------------------------------|----------------------------|
| 921 – 960 MHz | +16 dBm | -103 dBm | — | CW carrier |

Table 7.4(e): Additional blocking requirements for operating bands defined in 5.2(a) when co-located with DCS1800

| Center Frequency of Interfering Signal | Interfering Signal Mean Power | Wanted Signal Mean Power | Minimum Offset of Interfering Signal | Type of Interfering Signal |
|--|-------------------------------|--------------------------|--------------------------------------|----------------------------|
| 1805 – 1880 MHz | +16 dBm | -103 dBm | — | CW carrier |

7.6 Intermodulation characteristics

Third and higher order mixing of the two interfering RF signals can produce an interfering signal in the band of the desired channel. Intermodulation response rejection is a measure of the capability of the receiver to receive a wanted signal on its assigned channel frequency in the presence of two or more interfering signals which have a specific frequency relationship to the wanted signal.

The static reference performance as specified in clause 7.2.1 should be met when the following signals are coupled to BS antenna input.

- A wanted signal at the assigned channel frequency, with mean power 6 dB above the static reference level.
- Two interfering signals with the following parameters.

Table 7.5 : Intermodulation requirement

| Interfering Signal Mean Power | Offset | Type of Interfering Signal |
|-------------------------------|--------|----------------------------|
| - 48 dBm | 10 MHz | CW signal |
| - 48 dBm | 20 MHz | WCDMA signal with one code |

7.7 Spurious emissions

The spurious emissions power is the power of emissions generated or amplified in a receiver that appear at the BS antenna connector. The requirements apply to all BS with separate RX and TX antenna port. The test shall be performed when both TX and RX are on with the TX port terminated.

For all BS with common RX and TX antenna port the transmitter spurious emission as specified in section 6.6.3 is valid.

7.7.1 Minimum Requirement

The power of any spurious emission shall not exceed:

Table 7.6 : Receiver spurious emission requirements

| Band | Maximum level | Measurement Bandwidth | Note |
|--|---------------|-----------------------|--|
| 30 MHz – 1 GHz | -57 dBm | 100 kHz | |
| 1 GHz – 1.9 GHz and 1.98 GHz – 2.01 GHz | -47 dBm | 1 MHz | With the exception of frequencies between 12.5MHz below the first carrier frequency and 12.5MHz above the last carrier frequency used by the BS. |
| 1.9 GHz – 1.98 GHz and 2.01 GHz – 2.025 GHz | -78 dBm | 3.84 MHz | With the exception of frequencies between 12.5MHz below the first carrier frequency and 12.5MHz above the last carrier frequency used by the BS. |
| 2.025 GHz – 12.75 GHz | -47 dBm | 1 MHz | With the exception of frequencies between 12.5MHz below the first carrier frequency and 12.5MHz above the last carrier frequency used by the BS. |

In addition to the requirements in table 7.6, the co-existence requirements for co-located base stations specified in subclause 6.6.3.2.2, 6.6.3.3.2 and 6.6.3.4.2 may also be applied.

8 Performance requirement

8.1 General

Performance requirements for the BS are specified for the measurement channels defined in Annex A and the propagation conditions in Annex B. The requirements only apply to those measurement channels that are supported by the base station.

The requirements only apply to a base station with dual receiver antenna diversity. The required \hat{I}_{or}/I_{oc} shall be applied separately at each antenna port.

Table 8.1: Summary of Base Station performance targets

| Physical channel | Measurement channel | Static | Multi-path Case 1 | Multi-path Case 2 | Multi-path Case 3 |
|------------------|---------------------|---------------------------|---------------------------|---------------------------|------------------------------------|
| | | Performance metric | | | |
| DCH | 12.2 kbps | BLER < 10^{-2} | BLER < 10^{-2} | BLER < 10^{-2} | BLER < 10^{-2} |
| | 64 kbps | BLER < $10^{-1}, 10^{-2}$ | BLER < $10^{-1}, 10^{-2}$ | BLER < $10^{-1}, 10^{-2}$ | BLER < $10^{-1}, 10^{-2}, 10^{-3}$ |
| | 144 kbps | BLER < $10^{-1}, 10^{-2}$ | BLER < $10^{-1}, 10^{-2}$ | BLER < $10^{-1}, 10^{-2}$ | BLER < $10^{-1}, 10^{-2}, 10^{-3}$ |
| | 384 kbps | BLER < $10^{-1}, 10^{-2}$ | BLER < $10^{-1}, 10^{-2}$ | BLER < $10^{-1}, 10^{-2}$ | BLER < $10^{-1}, 10^{-2}, 10^{-3}$ |

8.2 Demodulation in static propagation conditions

8.2.1 Demodulation of DCH

The performance requirement of DCH in static propagation conditions is determined by the maximum Block Error Rate (BLER) allowed when the receiver input signal is at a specified \hat{I}_{or}/I_{oc} limit. The BLER is calculated for each of the measurement channels supported by the base station.

8.2.1.1 Minimum requirement

For the parameters specified in Table 8.2 the BLER should not exceed the piece-wise linear BLER curve specified in Table 8.3. These requirements are applicable for TFCS size 16.

Table 8.2: Parameters in static propagation conditions

| Parameters | Unit | Test 1 | Test 2 | Test 3 | Test 4 |
|---|--------------|-------------------|-------------------|-------------------|--------|
| Number of DPCH _o | | 6 | 4 | 0 | 0 |
| $\frac{DPCH_o - E_c}{I_{or}}$ | dB | -9 | -9.5 | 0 | 0 |
| I_{oc} | dBm/3.84 MHz | -89 | | | |
| Cell Parameter* | | 0,1 | | | |
| DPCH Channelization Codes* | C(k,Q) | C(1,8) | C(1,4) C(5,16) | C(1,2) C(9,16) | C(1,2) |
| DPCH _o Channelization Codes* | C(k,Q) | C(i,16) 3 ≤ i ≤ 8 | C(i,16) 6 ≤ i ≤ 9 | - | - |
| Information Data Rate | kbps | 12.2 | 64 | 144 | 384 |

*Note: Refer to TS 25.223 for definition of channelization codes and cell parameter.

Table 8.3: Performance requirements in AWGN channel.

| Test Number | $\frac{\hat{I}_{or}}{I_{oc}}$ [dB] | BLER |
|-------------|------------------------------------|-----------|
| 1 | -2.0 | 10^{-2} |
| 2 | -0.4 | 10^{-1} |
| | -0.1 | 10^{-2} |
| 3 | -0.2 | 10^{-1} |
| | 0.1 | 10^{-2} |
| 4 | -0.8 | 10^{-1} |
| | -0.6 | 10^{-2} |

8.3 Demodulation of DCH in multipath fading conditions

8.3.1 Multipath fading Case 1

The performance requirement of DCH in multipath fading Case 1 is determined by the maximum Block Error Rate (BLER) allowed when the receiver input signal is at a specified \hat{I}_{or}/I_{oc} limit. The BLER is calculated for each of the measurement channels supported by the base station.

8.3.1.1 Minimum requirement

For the parameters specified in Table 8.4 the BLER should not exceed the piece-wise linear BLER curve specified in Table 8.5. These requirements are applicable for TFCS size 16.

Table 8.4: Parameters in multipath Case 1 channel

| Parameters | Unit | Test 1 | Test 2 | Test 3 | Test 4 |
|---|--------------|-------------------|-------------------|-------------------|--------|
| Number of DPCH _o | | 6 | 4 | 0 | 0 |
| $\frac{DPCH_o - E_c}{I_{or}}$ | dB | -9 | -9.5 | 0 | 0 |
| I_{oc} | dBm/3.84 MHz | -89 | | | |
| Cell Parameter* | | 0,1 | | | |
| DPCH Channelization Codes* | C(k,Q) | C(1,8) | C(1,4) C(5,16) | C(1,2) C(9,16) | C(1,2) |
| DPCH _o Channelization Codes* | C(k,Q) | C(i,16) 3 ≤ i ≤ 8 | C(i,16) 6 ≤ i ≤ 9 | - | - |
| Information Data Rate | kbps | 12.2 | 64 | 144 | 384 |

*Note: Refer to TS 25.223 for definition of channelization codes and cell parameter.

Table 8.5: Performance requirements in multipath Case 1 channel.

| Test Number | $\frac{\hat{I}_{or}}{I_{oc}}$ [dB] | BLER |
|-------------|------------------------------------|------------------|
| 1 | 6.5 | 10 ⁻² |
| 2 | 5.5 | 10 ⁻¹ |
| | 9.8 | 10 ⁻² |
| 3 | 5.5 | 10 ⁻¹ |
| | 9.8 | 10 ⁻² |
| 4 | 5.1 | 10 ⁻¹ |
| | 9.5 | 10 ⁻² |

8.3.2 Multipath fading Case 2

The performance requirement of DCH in multipath fading Case 2 is determined by the maximum Block Error Rate (BLER) allowed when the receiver input signal is at a specified \hat{I}_{or}/I_{oc} limit. The BLER is calculated for each of the measurement channels supported by the base station.

8.3.2.1 Minimum requirement

For the parameters specified in Table 8.6 the BLER should not exceed the piece-wise linear BLER curve specified in Table 8.7. These requirements are applicable for TFCS size 16.

Table 8.6: Parameters in multipath Case 2 channel

| Parameters | Unit | Test 1 | Test 2 | Test 3 | Test 4 |
|---|--------------|-------------------|-------------------|-------------------|--------|
| Number of DPCH _o | | 2 | 0 | 0 | 0 |
| $\frac{DPCH_o - E_c}{I_{or}}$ | dB | -6 | 0 | 0 | 0 |
| I_{oc} | dBm/3.84 MHz | -89 | | | |
| Cell Parameter* | | 0,1 | | | |
| DPCH Channelization Codes* | C(k,Q) | C(1,8) | C(1,4) C(5,16) | C(1,2) C(9,16) | C(1,2) |
| DPCH _o Channelization Codes* | C(k,Q) | C(i,16) 3 ≤ i ≤ 4 | - | - | - |
| Information Data Rate | kbps | 12.2 | 64 | 144 | 384 |

*Note: Refer to TS 25.223 for definition of channelization codes and cell parameter.

Table 8.7: Performance requirements in multipath Case 2 channel.

| Test Number | $\frac{\hat{I}_{or}}{I_{oc}}$ [dB] | BLER |
|-------------|------------------------------------|-----------|
| 1 | -0.4 | 10^{-2} |
| 2 | 0.2 | 10^{-1} |
| | 2.5 | 10^{-2} |
| 3 | 3.6 | 10^{-1} |
| | 6.0 | 10^{-2} |
| 4 | 2.8 | 10^{-1} |
| | 5.2 | 10^{-2} |

8.3.3 Multipath fading Case 3

The performance requirement of DCH in multipath fading Case 3 is determined by the maximum Block Error Rate (BLER) allowed when the receiver input signal is at a specified \hat{I}_{or}/I_{oc} limit. The BLER is calculated for each of the measurement channels supported by the base station.

8.3.3.1 Minimum requirement

For the parameters specified in Table 8.8 the BLER should not exceed the piece-wise linear BLER curve specified in Table 8.9. These requirements are applicable for TFCS size 16.

Table 8.8: Parameters in multipath Case 3 channel

| Parameters | Unit | Test 1 | Test 2 | Test 3 | Test 4 |
|---|--------------|-------------------|-------------------|-------------------|--------|
| Number of DPCH _o | | 2 | 0 | 0 | 0 |
| $\frac{DPCH_o - E_c}{I_{or}}$ | dB | -6 | 0 | 0 | 0 |
| I_{oc} | dBm/3.84 MHz | -89 | | | |
| Cell Parameter* | | 0,1 | | | |
| DPCH Channelization Codes* | C(k,Q) | C(1,8) | C(1,4) C(5,16) | C(1,2) C(9,16) | C(1,2) |
| DPCH _o Channelization Codes* | C(k,Q) | C(i,16) 3 ≤ i ≤ 4 | - | - | - |
| Information Data Rate | Kbps | 12.2 | 64 | 144 | 384 |

*Note: Refer to TS 25.223 for definition of channelization codes and cell parameter.

Table 8.9: Performance requirements in multipath Case 3 channel.

| Test Number | $\frac{\hat{I}_{or}}{I_{oc}}$ [dB] | BLER |
|-------------|------------------------------------|-----------|
| 1 | -0.1 | 10^{-2} |
| 2 | 0.8 | 10^{-1} |
| | 2.7 | 10^{-2} |
| | 4.2 | 10^{-3} |
| 3 | 4.5 | 10^{-1} |
| | 6.3 | 10^{-2} |
| | 8.0 | 10^{-3} |
| 4 | 3.6 | 10^{-1} |
| | 5.0 | 10^{-2} |
| | 6.3 | 10^{-3} |

Annex A (normative): Measurement Channels

A.1 General

A.2 Reference measurement channel

A.2.1 UL reference measurement channel (12.2 kbps)

Table A.1

| Parameter | Value |
|--|-------------|
| Information data rate | 12.2 kbps |
| RU's allocated | 2 RU |
| Midamble | 512 chips |
| Interleaving | 20 ms |
| Power control | 2 Bit/user |
| TFCI | 16 Bit/user |
| Inband signalling DCCH | 2 kbps |
| Puncturing level at Code rate 1/3 : DCH / DCCH | 10% / 0% |

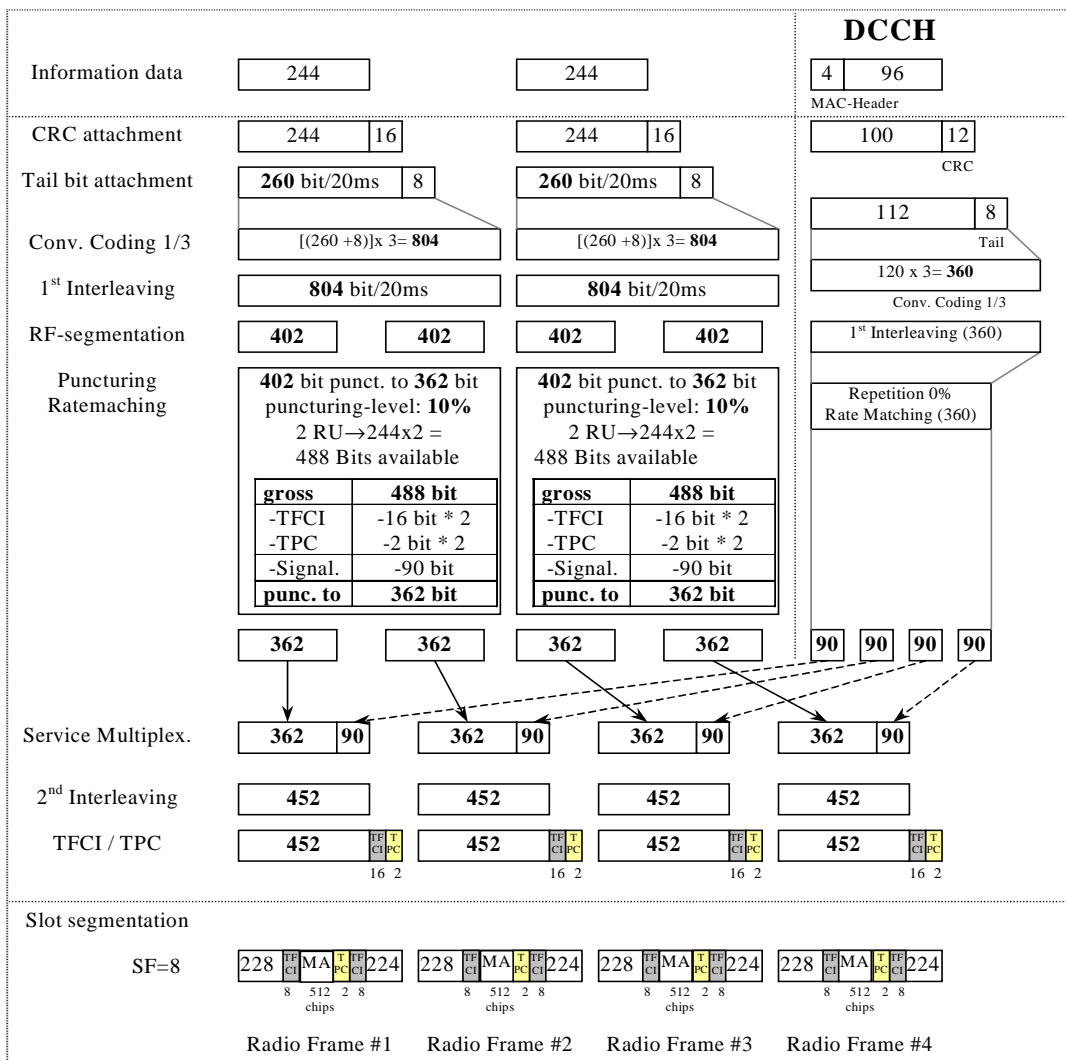

Figure A.1

A.2.2 UL reference measurement channel (64 kbps)

Table A.2

| Parameter | Value |
|--|----------------------|
| Information data rate | 64 kbps |
| RU's allocated | 1 SF4 + 1 SF16 = 5RU |
| Midamble | 512 chips |
| Interleaving | 20 ms |
| Power control | 2 Bit/user |
| TFCI | 16 Bit/user |
| Inband signalling DCCH | 2 kbps |
| Puncturing level at Code rate : 1/3 DCH / 1/2 DCCH | 43.8% / 13.3% |

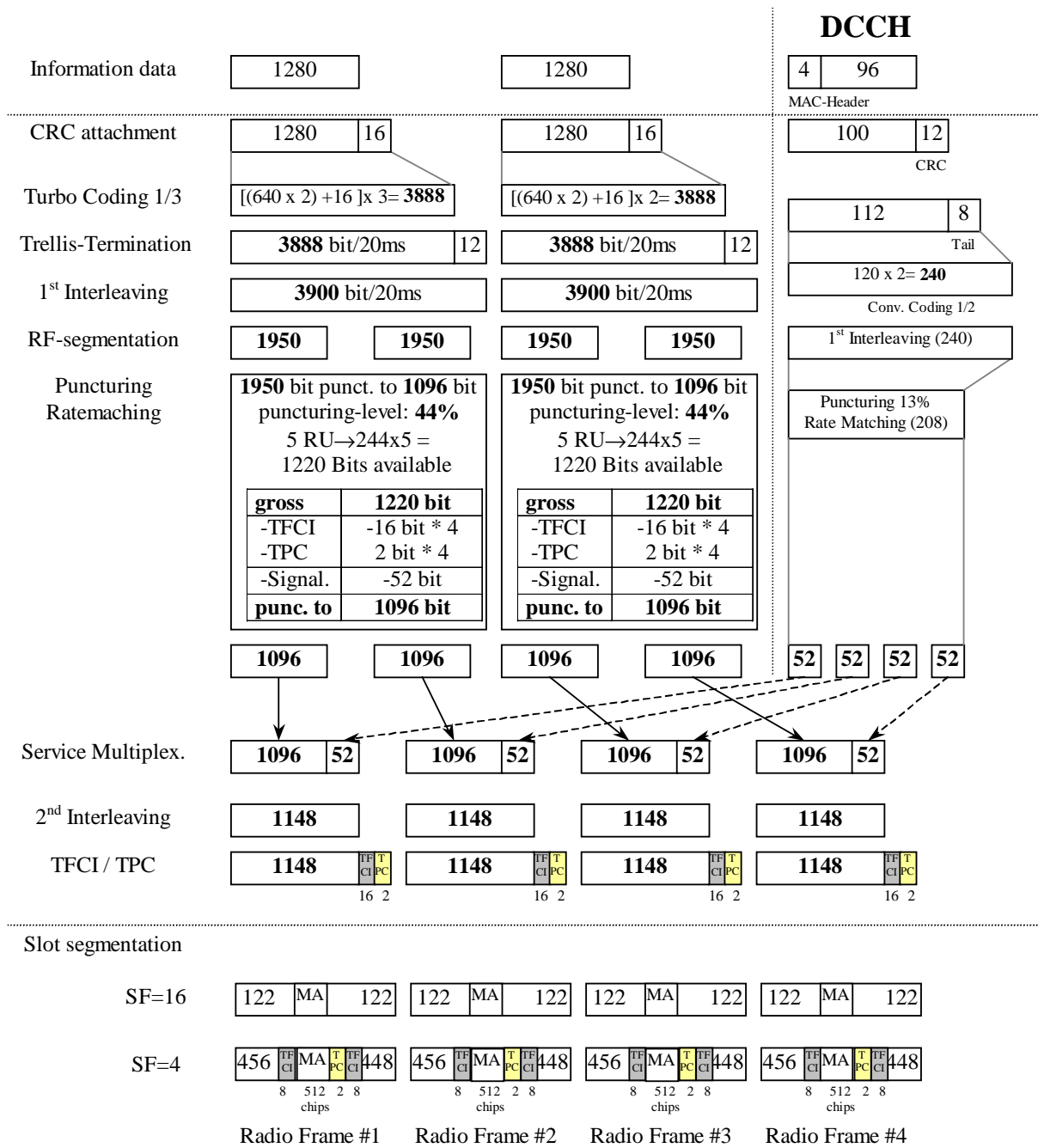

Figure A.2

A.2.3 UL reference measurement channel (144 kbps)

Table A.3

| Parameter | Value |
|--|----------------------|
| Information data rate | 144 kbps |
| RU's allocated | 1 SF2 + 1 SF16 = 9RU |
| Midamble | 256 chips |
| Interleaving | 20 ms |
| Power control | 2 Bit/user |
| TFCI | 16 Bit/user |
| Inband signalling DCCH | 2 kbps |
| Puncturing level at Code rate : 1/3 DCH / 1/2 DCCH | 47.3% / 20% |

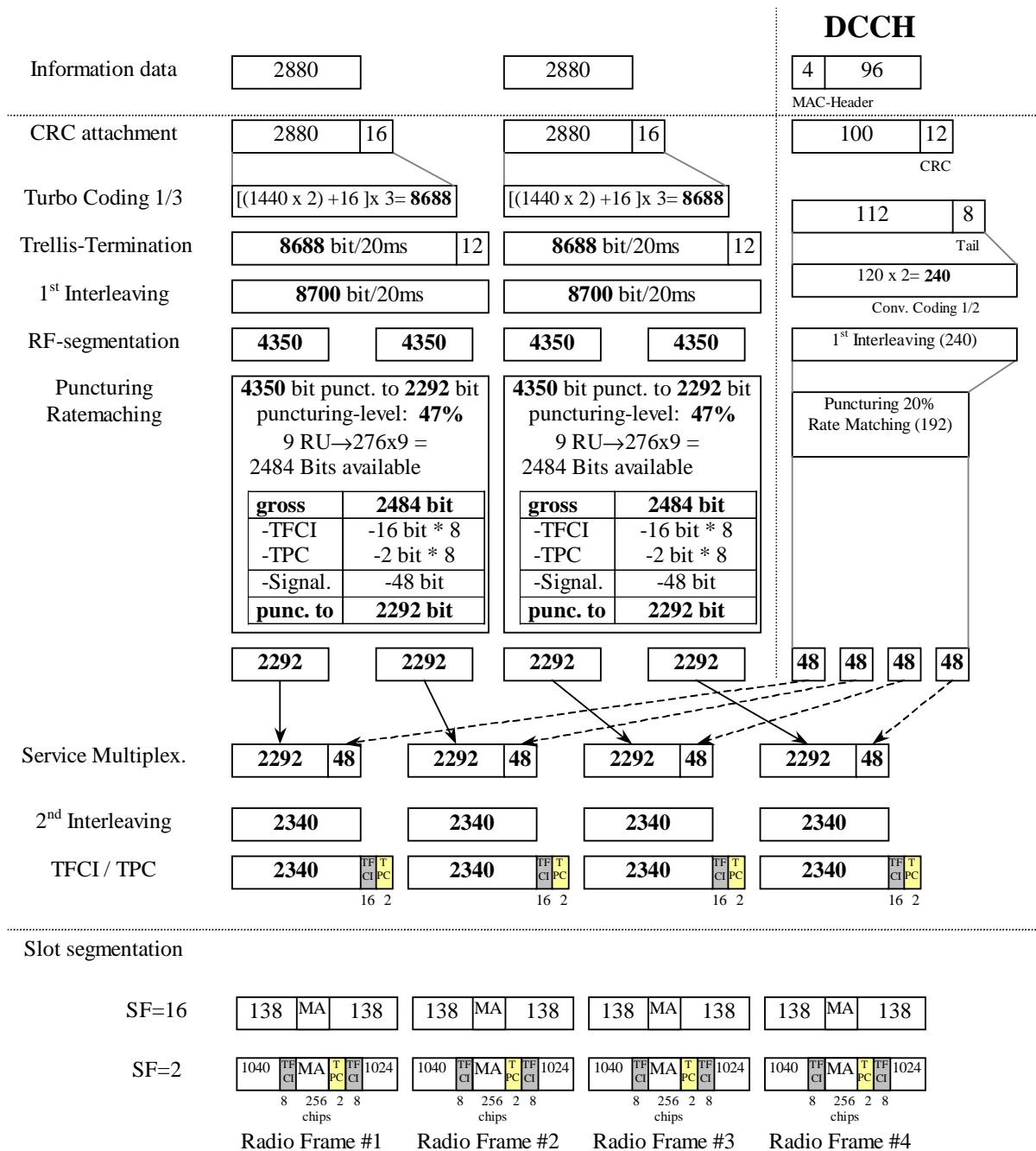

Figure A.3

A.2.4 UL reference measurement channel (384 kbps)

Table A.4

| Parameter | Value |
|--|---------------|
| Information data rate | 384 kbps |
| RU's allocated | 8*3TS = 24RU |
| Midamble | 256 chips |
| Interleaving | 20 ms |
| Power control | 2 Bit/user |
| TFCI | 16 Bit/user |
| Inband signalling DCCH | 2 kbps |
| Puncturing level at Code rate : 1/3 DCH / 1/2 DCCH | 43.4% / 15.3% |

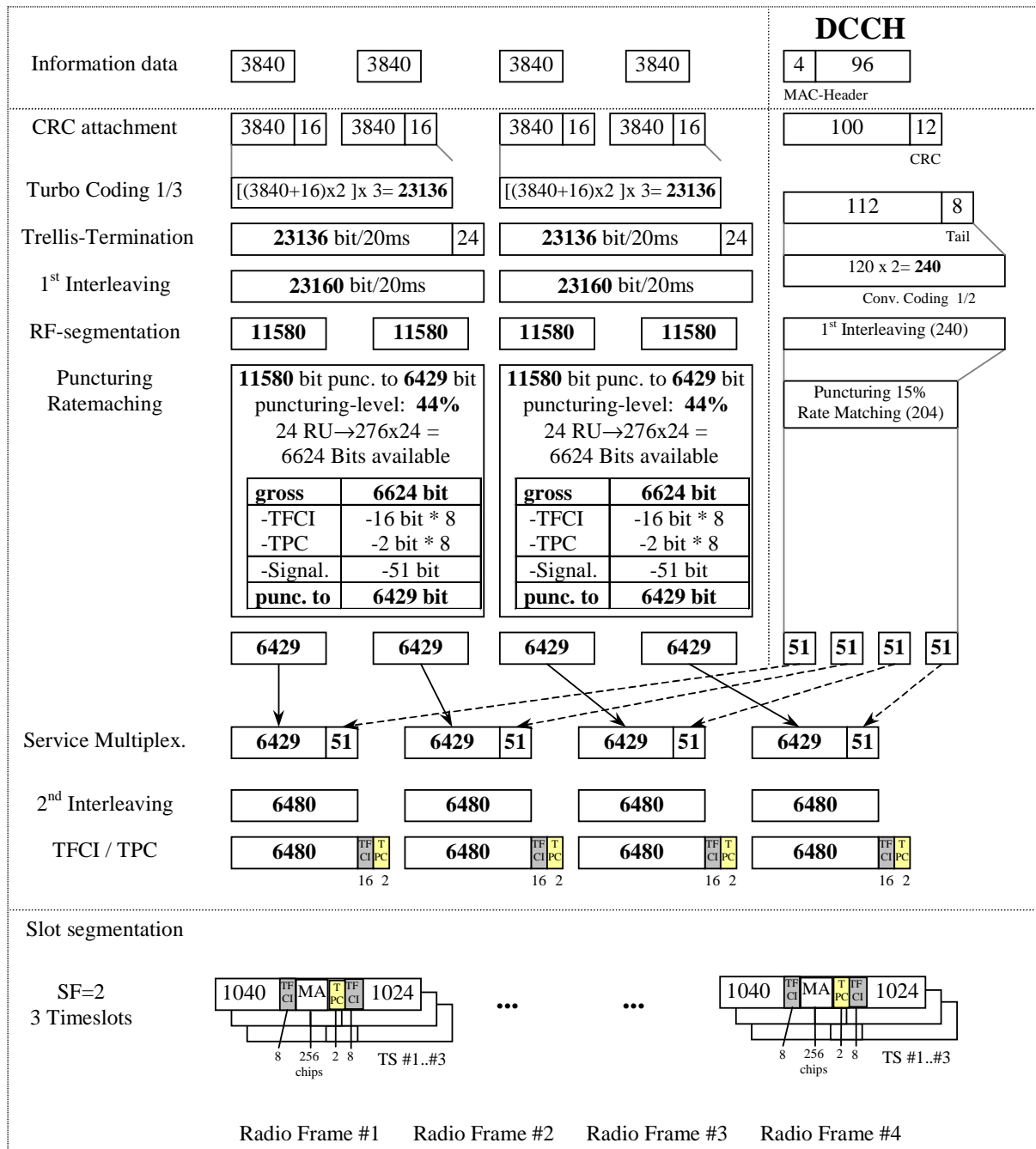

Figure A.4

A.2.5 RACH reference measurement channel

Table A.5

| Parameter | |
|---|---|
| Information data rate e.g. 2 TBs ($B_{RACH}=2$): SF16: 0% puncturing rate at CR=1/2 10% puncturing rate at CR=1/2 $N_{RACH} = \frac{232 + N_{RM} - 8}{B_{RACH}} - 8$ SF8: 0% puncturing rate at CR=1/2 10% puncturing rate at CR=1/2 $N_{RACH} = \frac{464 + N_{RM} - 8}{B_{RACH}} - 16$ | 46 bits per frame and TB 53 bits per frame and TB 96 bits per frame and TB 109 bits per frame and TB |
| RU's allocated | 1 RU |
| Midamble | 512 chips |
| Power control | 0 bit |
| TFCI | 0 bit |

N_{RACH} = number of bits per TB

B_{RACH} = number of TBs

A.2.5.1 RACH mapped to 1 code SF16

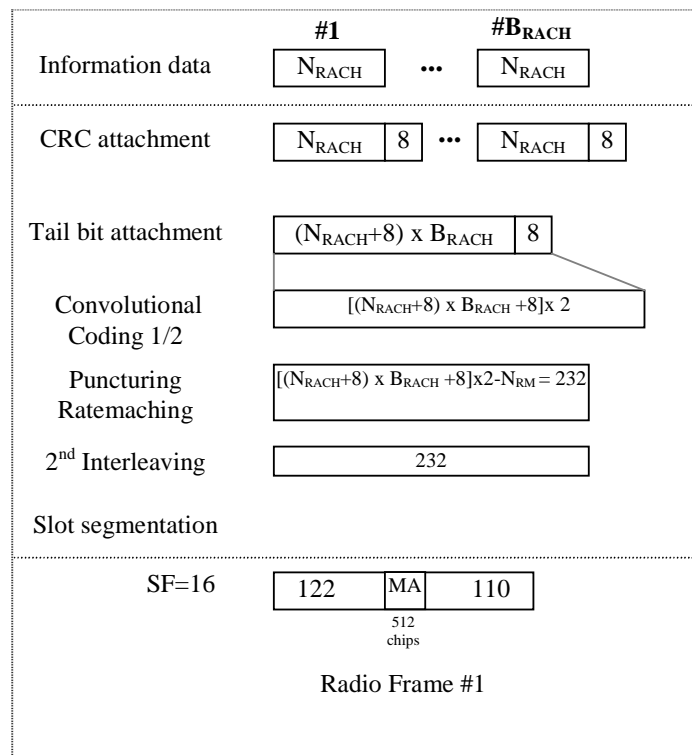

Figure A.5

A.2.5.2 RACH mapped to 1 code SF8

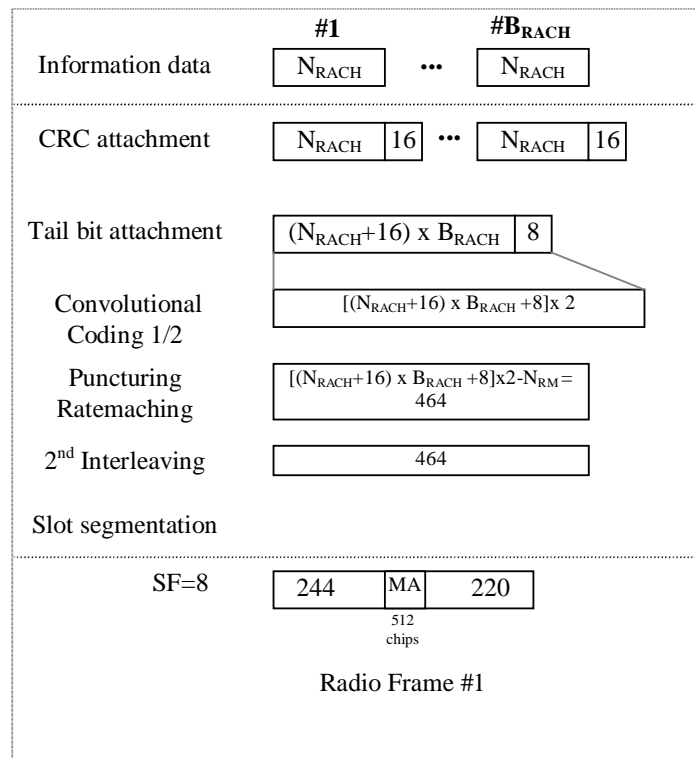

Figure A.6

Annex B (normative): Propagation conditions

B.1 Static propagation condition

The propagation for the static performance measurement is an Additive White Gaussian Noise (AWGN) environment. No fading and multi-paths exist for this propagation model.

B.2 Multi-path fading propagation conditions

Table B1 shows propagation conditions that are used for the performance measurements in multi-path fading environment. All taps have classical Doppler spectrum, defined as:

$$(CLASS) \quad S(f) \propto 1/(1 - (f / f_D)^2)^{0.5} \quad \text{for } f \in -f_D, f_D$$

Table B.1: Propagation Conditions for Multi path Fading Environments

| Case 1, speed 3km/h | | Case 2, speed 3 km/h | | Case 3, speed 120 km/h | |
|---------------------|--------------------------|----------------------|--------------------------|------------------------|--------------------------|
| Relative Delay [ns] | Relative Mean Power [dB] | Relative Delay [ns] | Relative Mean Power [dB] | Relative Delay [ns] | Relative Mean Power [dB] |
| 0 | 0 | 0 | 0 | 0 | 0 |
| 976 | -10 | 976 | 0 | 260 | -3 |
| | | 12000 | 0 | 521 | -6 |
| | | | | 781 | -9 |

Annex C (informative): Change request history

| TSG | Doc | CR | Rev | Subject | Cat | Curr | New | WI |
|-------|-----------|------|-----|---|-----|-------|-------|----|
| RP-06 | RP-99780 | 0002 | | Primary CCPCH Power for TDD-mode | C | 3.0.0 | 3.1.0 | |
| RP-06 | RP-99780 | 0003 | | BS Maximum input level (TDD) | C | 3.0.0 | 3.1.0 | |
| RP-06 | RP-99780 | 0001 | | Corrections to 25.105 version 3.0.0 | F | 3.0.0 | 3.1.0 | |
| RP-06 | RP-99779 | 0006 | | Open item list in Annex D of 25.105 v3.0.0 | D | 3.0.0 | 3.1.0 | |
| RP-06 | RP-99780 | 0004 | | Receiver spurious emissions for BS TDD | C | 3.0.0 | 3.1.0 | |
| RP-06 | RP-99780 | 0005 | | Power control in UTRA TDD | C | 3.0.0 | 3.1.0 | |
| RP-06 | RP-99780 | 0002 | 3 | TDD Base station power accuracy of PCCPCH (remove []) | C | 3.0.0 | 3.1.0 | |
| RP-06 | RP-99780 | 0007 | - | Change of propagation conditions recommendations | C | 3.0.0 | 3.1.0 | |
| RP-06 | RP-99780 | 0008 | | Timing Advance Requirements | F | 3.0.0 | 3.1.0 | |
| RP-06 | RP-99781 | 0009 | | Transmit Template | B | 3.0.0 | 3.1.0 | |
| RP-06 | RP-99781 | 0010 | | Performance Requirements | B | 3.0.0 | 3.1.0 | |
| RP-06 | RP-99780 | 0011 | | Corrections for BS TDD Blocking Characteristics | F | 3.0.0 | 3.1.0 | |
| RP-06 | RP-99780 | 0012 | | Corrections to 25.105 v.3.0.0 (change ME to BTS) | F | 3.0.0 | 3.1.0 | |
| RP-06 | RP-99780 | 0013 | | Synchronization Requirement | C | 3.0.0 | 3.1.0 | |
| RP-06 | RP-99780 | 0014 | | Update of ITU Region 2 Specific Specifications and proposed universal channel numbering | C | 3.0.0 | 3.1.0 | |
| RP-06 | RP-99780 | 0015 | | Clarification of Antenna Diversity receiver requirements | F | 3.0.0 | 3.1.0 | |
| RP-06 | RP-99780 | 0016 | | Spurious Emission in 25.105 | F | 3.0.0 | 3.1.0 | |
| RP-06 | RP-99780 | 0017 | | ACLR | C | 3.0.0 | 3.1.0 | |
| RP-06 | RP-99781 | 0018 | | BS TDD Spurious Emission Requirements for Co-Existence UTRA-FDD/ UTRA-TDD | B | 3.0.0 | 3.1.0 | |
| RP-07 | R4-000283 | 0019 | 1 | Corrections for BS TDD Blocking Requirements | F | 3.1.0 | 3.2.0 | |
| RP-07 | R4-000088 | 0020 | | Revised Spurious Emission Requirements | F | 3.1.0 | 3.2.0 | |
| RP-07 | R4-000100 | 0021 | | Corrections of spurious emissions aligning to GSM for UTRA | F | 3.1.0 | 3.2.0 | |
| RP-07 | R4-000109 | 0022 | | Editorial corrections | D | 3.1.0 | 3.2.0 | |
| RP-07 | R4-000111 | 0023 | | Spurious emission correction | F | 3.1.0 | 3.2.0 | |
| RP-07 | R4-000112 | 0024 | | Protection outside a licensee's frequency block | F | 3.1.0 | 3.2.0 | |
| RP-07 | R4-000199 | 0025 | | Definition of Rated Output Power and Pmax | F | 3.1.0 | 3.2.0 | |
| RP-07 | R4-000200 | 0026 | | Primary CCPCH Power | F | 3.1.0 | 3.2.0 | |
| RP-07 | R4-000216 | 0027 | | BS Transmit OFF power | F | 3.1.0 | 3.2.0 | |
| RP-07 | R4-000223 | 0028 | | Corrected reference sensitivity value for the TDD BS | F | 3.1.0 | 3.2.0 | |
| RP-07 | R4-000259 | 0029 | | ACLR | F | 3.1.0 | 3.2.0 | |
| RP-07 | R4-000255 | 0030 | | Spectrum emission mask | F | 3.1.0 | 3.2.0 | |
| RP-07 | R4-000135 | 0031 | | Clock Accuracy | C | 3.1.0 | 3.2.0 | |
| RP-08 | RP-000207 | 0032 | | Reference Measurement Channels | F | 3.2.0 | 3.3.0 | |
| RP-08 | RP-000207 | 0033 | | Regional requirements in TS 25.105 | F | 3.2.0 | 3.3.0 | |
| RP-08 | RP-000207 | 0034 | | Clarification of receiver dynamic range. | F | 3.2.0 | 3.3.0 | |
| RP-08 | RP-000207 | 0035 | | Input power level for performance requirements | F | 3.2.0 | 3.3.0 | |
| RP-08 | RP-000207 | 0036 | | Modification to the handling of UE TDD Measurement Uncertainty | F | 3.2.0 | 3.3.0 | |
| RP-08 | RP-000207 | 0037 | | Clarification of the specification on Peak Code Domain Error (PCDE) | F | 3.2.0 | 3.3.0 | |
| RP-08 | RP-000207 | 0038 | | Correction for emission mask measurement (TDD) | F | 3.2.0 | 3.3.0 | |
| RP-09 | RP-000397 | 0039 | | Maximum frequency deviation for receiver performance. | F | 3.3.0 | 3.4.0 | |
| RP-09 | RP-000397 | 0040 | | Corrections to spectrum mask | F | 3.3.0 | 3.4.0 | |
| RP-09 | RP-000397 | 0041 | | Handling of measurement uncertainties in base station radio conformance testing (TDD) | F | 3.3.0 | 3.4.0 | |
| RP-09 | RP-000397 | 0042 | | Performance requirements with TFCl decoding | F | 3.3.0 | 3.4.0 | |

| | | | | | | | | |
|-------|-----------|------|---|--|---|--------|--------|-----|
| RP-09 | RP-000397 | 0043 | | Inner Loop Power Control | F | 3.3.0 | 3.4.0 | |
| RP-09 | RP-000397 | 0044 | | BS Transmit ON/OFF time mask for TDD-mode | F | 3.3.0 | 3.4.0 | |
| RP-09 | RP-000397 | 0045 | | Definition of period for frequency error | F | 3.3.0 | 3.4.0 | |
| RP-10 | RP-000397 | 0046 | | Correction for 25.105 concerning the channel number calculation. | F | 3.4.0 | 3.5.0 | |
| RP-10 | RP-000397 | 0047 | | Correction to reference measurement channels | F | 3.4.0 | 3.5.0 | |
| RP-11 | RP-010088 | 0048 | | Receiver Blocking requirement for co-existence with GSM/DCS and co-located base stations. | F | 3.5.0 | 3.6.0 | |
| RP-11 | RP-010088 | 0049 | | Relationship between Minimum Requirements and Test Tolerances. | F | 3.5.0 | 3.6.0 | |
| RP-11 | RP-010088 | 0050 | | Correction of reference to SM.329-8 in TS25.105 | F | 3.5.0 | 3.6.0 | |
| RP-11 | RP-010088 | 0051 | | BS EVM definition | F | 3.5.0 | 3.6.0 | |
| RP-12 | RP-010350 | 0054 | | inclusion of environmental requirements | F | 3.6.0 | 3.7.0 | |
| RP-12 | RP-010350 | 0056 | | Application of blocking requirement | F | 3.6.0 | 3.7.0 | |
| RP-12 | RP-010350 | 0058 | | CR for BS Performance Requirements | F | 3.6.0 | 3.7.0 | |
| RP-12 | RP-010350 | 0062 | | Correction to upper frequency of transmitter Spurious emission limits | F | 3.6.0 | 3.7.0 | |
| RP-13 | RP-010617 | 0066 | | BS Performance Requirements (3.84Mcps TDD) | F | 3.7.0 | 3.8.0 | |
| RP-13 | RP-010617 | 0068 | | Receiver spurious emissions for co-located base stations | F | 3.7.0 | 3.8.0 | |
| RP-13 | RP-010617 | 0070 | | Power and ACLR definition corrections | F | 3.7.0 | 3.8.0 | |
| RP-13 | RP-010617 | 0072 | | Clarification in Spectrum emission mask section | F | 3.7.0 | 3.8.0 | |
| RP-13 | RP-010617 | 0074 | | PC dynamic range and minimum TP requirements correction. | F | 3.7.0 | 3.8.0 | |
| RP-13 | RP-010617 | 0076 | | Correction of frequency range for receiver spurious emissions | F | 3.7.0 | 3.8.0 | |
| RP-13 | RP-010617 | 0078 | | Definition of "classical Doppler spectrum" | F | 3.7.0 | 3.8.0 | |
| RP-13 | RP-010617 | 0080 | | BS Performance Requirements for 12.2 kbps, 64 kbps, 144 kbps and 384 kbps, Case 1, addition of Figure Note for Table 8.4 | F | 3.7.0 | 3.8.0 | |
| RP-14 | RP-010780 | 0086 | | Table label correction from BLER Required Eb/No to BLER | F | 3.8.0 | 3.9.0 | |
| RP-15 | RP-020017 | 0088 | | UL reference measurement channel (12.2 kbps) puncturing rate correction | F | 3.9.0 | 3.10.0 | |
| RP-15 | RP-020017 | 0099 | 1 | Consideration of multi-carrier operation in ACLR requirements | F | 3.9.0 | 3.10.0 | |
| RP-15 | RP-020017 | 0102 | | Single and multi carrier in spurious emissions requirements | F | 3.9.0 | 3.10.0 | |
| RP-16 | RP-020281 | 0111 | | Correction of power terms and definitions | F | 3.10.0 | 3.11.0 | |
| RP-16 | RP-020281 | 0117 | | ACLR and spurious emission requirements for coexistence | F | 3.10.0 | 3.11.0 | |
| RP-18 | RP-020779 | 0131 | | Spurious emission requirements for unsynchronized TDD operation | F | 3.11.0 | 3.12.0 | |
| RP-18 | RP-020804 | 0135 | 1 | Corrections to 3.84 Mcps TDD reference measurement channels | F | 3.11.0 | 3.12.0 | |
| RP-19 | RP-030030 | 0145 | | TDD-GSM co-existence in the same geographic area | F | 3.12.0 | 3.13.0 | |
| RP-33 | RP-060517 | 0183 | | Clarification of Tx spurious emission level from 3.84 Mcps TDD BS into PHS band | F | 3.13.0 | 3.14.0 | TEI |
| RP-33 | RP-060518 | 0190 | 1 | Clarification on the deployment of UTRA TDD in Japan | F | 3.13.0 | 3.14.0 | TEI |
| RP-33 | RP-070369 | 0206 | | Modifying category B spurious emission limits for UTRA TDD BS | F | 3.14.0 | 3.15.0 | TEI |
| RP-39 | RP-080117 | 0221 | | Update NOTE in Category B BS spurious emissions | F | 3.15.0 | 3.16.0 | TEI |

History

| Document history | | |
|-------------------------|---------------|-------------|
| V3.1.0 | January 2000 | Publication |
| V3.2.0 | March 2000 | Publication |
| V3.3.0 | June 2000 | Publication |
| V3.4.0 | October 2000 | Publication |
| V3.5.0 | December 2000 | Publication |
| V3.6.0 | May 2001 | Publication |
| V3.7.0 | July 2001 | Publication |
| V3.8.0 | October 2001 | Publication |
| V3.9.0 | December 2001 | Publication |
| V3.10.0 | March 2002 | Publication |
| V3.11.0 | June 2002 | Publication |
| V3.12.0 | December 2002 | Publication |
| V3.13.0 | March 2003 | Publication |
| V3.14.0 | October 2006 | Publication |
| V3.15.0 | June 2007 | Publication |
| V3.16.0 | April 2008 | Publication |