

ETSI TS 125 105 V4.10.0 (2007-06)

Technical Specification

**Universal Mobile Telecommunications System (UMTS);
Base Station (BS) radio transmission and reception (TDD)
(3GPP TS 25.105 version 4.10.0 Release 4)**



Reference

RTS/TSGR-0425105v4a0

Keywords

UMTS

ETSI

650 Route des Lucioles
F-06921 Sophia Antipolis Cedex - FRANCE

Tel.: +33 4 92 94 42 00 Fax: +33 4 93 65 47 16

Siret N° 348 623 562 00017 - NAF 742 C
Association à but non lucratif enregistrée à la
Sous-Préfecture de Grasse (06) N° 7803/88

Important notice

Individual copies of the present document can be downloaded from:

<http://www.etsi.org>

The present document may be made available in more than one electronic version or in print. In any case of existing or perceived difference in contents between such versions, the reference version is the Portable Document Format (PDF). In case of dispute, the reference shall be the printing on ETSI printers of the PDF version kept on a specific network drive within ETSI Secretariat.

Users of the present document should be aware that the document may be subject to revision or change of status. Information on the current status of this and other ETSI documents is available at

<http://portal.etsi.org/tb/status/status.asp>

If you find errors in the present document, please send your comment to one of the following services:

http://portal.etsi.org/chaicor/ETSI_support.asp

Copyright Notification

No part may be reproduced except as authorized by written permission.
The copyright and the foregoing restriction extend to reproduction in all media.

© European Telecommunications Standards Institute 2007.
All rights reserved.

DECTTM, **PLUGTESTS**TM and **UMTS**TM are Trade Marks of ETSI registered for the benefit of its Members.
TIPHONTM and the **TIPHON logo** are Trade Marks currently being registered by ETSI for the benefit of its Members.
3GPPTM is a Trade Mark of ETSI registered for the benefit of its Members and of the 3GPP Organizational Partners.

Intellectual Property Rights

IPRs essential or potentially essential to the present document may have been declared to ETSI. The information pertaining to these essential IPRs, if any, is publicly available for **ETSI members and non-members**, and can be found in ETSI SR 000 314: *"Intellectual Property Rights (IPRs); Essential, or potentially Essential, IPRs notified to ETSI in respect of ETSI standards"*, which is available from the ETSI Secretariat. Latest updates are available on the ETSI Web server (<http://webapp.etsi.org/IPR/home.asp>).

Pursuant to the ETSI IPR Policy, no investigation, including IPR searches, has been carried out by ETSI. No guarantee can be given as to the existence of other IPRs not referenced in ETSI SR 000 314 (or the updates on the ETSI Web server) which are, or may be, or may become, essential to the present document.

Foreword

This Technical Specification (TS) has been produced by ETSI 3rd Generation Partnership Project (3GPP).

The present document may refer to technical specifications or reports using their 3GPP identities, UMTS identities or GSM identities. These should be interpreted as being references to the corresponding ETSI deliverables.

The cross reference between GSM, UMTS, 3GPP and ETSI identities can be found under <http://webapp.etsi.org/key/queryform.asp>.

Contents

Intellectual Property Rights	2
Foreword.....	2
Foreword.....	7
1 Scope	8
2 References	8
3 Definitions, symbols and abbreviations	8
3.1 Definitions	8
3.2 Symbols.....	9
3.3 Abbreviations	9
4 General	10
4.1 Relationship between Minimum Requirements and Test Requirements	10
4.2 Base station classes	10
4.3 Regional requirements.....	10
4.4 Environmental requirements for the BS equipment	11
5 Frequency bands and channel arrangement.....	12
5.1 General	12
5.2 Frequency bands.....	12
5.3 TX–RX frequency separation.....	12
5.3.1 3,84 Mcps TDD Option	12
5.3.2 1,28 Mcps TDD Option	12
5.4 Channel arrangement.....	13
5.4.1 Channel spacing.....	13
5.4.1.1 3,84 Mcps TDD Option.....	13
5.4.1.2 1,28 Mcps TDD Option.....	13
5.4.2 Channel raster	13
5.4.3 Channel number	13
6 Transmitter characteristics	13
6.1 General	13
6.2 Base station output power	14
6.2.1 Base station maximum output power.....	14
6.2.1.1 Minimum Requirement	14
6.3 Frequency stability	14
6.3.1 Minimum Requirement.....	14
6.3.1.1 3,84 Mcps TDD Option.....	14
6.3.1.2 1,28 Mcps TDD Option.....	14
6.4 Output power dynamics.....	15
6.4.1 Inner loop power control.....	15
6.4.2 Power control steps.....	15
6.4.2.1 Minimum Requirement	15
6.4.3 Power control dynamic range	15
6.4.3.1 Minimum Requirement	15
6.4.4 Minimum output power	15
6.4.4.1 Minimum Requirement	15
6.4.5 Primary CCPCH power	15
6.4.6 Differential accuracy of Primary CCPCH power.....	16
6.4.6.1 Minimum Requirement for Differential accuracy of PCCPCH power	16
6.5 Transmit ON/OFF power	16
6.5.1 Transmit OFF power.....	16
6.5.1.1 Minimum Requirement	16
6.5.1.1.1 3,84 Mcps TDD Option.....	16
6.5.1.1.2 1,28 Mcps TDD Option.....	16
6.5.2 Transmit ON/OFF Time mask	16

6.5.2.1	Minimum Requirement	16
6.5.2.1.1	3,84 Mcps TDD Option	16
6.5.2.1.2	1,28 Mcps TDD Option	17
6.6	Output RF spectrum emissions	17
6.6.1	Occupied bandwidth	17
6.6.1.1	3,84 Mcps TDD Option	17
6.6.1.2	1,28 Mcps TDD Option	17
6.6.2	Out of band emission	18
6.6.2.1	Spectrum emission mask	18
6.6.2.1.1	3,84 Mcps TDD Option	18
6.6.2.1.2	1,28 Mcps TDD Option	19
6.6.2.2	Adjacent Channel Leakage power Ratio (ACLR)	21
6.6.2.2.1	Minimum Requirement	21
6.6.2.2.1.1	3,84 Mcps TDD Option	21
6.6.2.2.1.2	1,28 Mcps TDD Option	22
6.6.2.2.2	Additional requirement for operation in the same geographic area with FDD or unsynchronised TDD on adjacent channels	22
6.6.2.2.2.1	3,84 Mcps TDD Option	22
6.6.2.2.2.1.1	Additional requirement for operation in the same geographic area with unsynchronised TDD on adjacent channels	22
6.6.2.2.2.1.2	Additional requirement for operation in the same geographic area with FDD on adjacent channels	22
6.6.2.2.2.2	1,28 Mcps TDD Option	23
6.6.2.2.2.2.1	Additional requirement for operation in the same geographic area with unsynchronised TDD on adjacent channels	23
6.6.2.2.2.2.2	Additional requirement for operation in the same geographic area with FDD on adjacent channels	23
6.6.2.2.3	Additional requirement in case of co-siting with unsynchronised TDD BS or FDD BS operating on an adjacent channel	24
6.6.2.2.3.1	3,84 Mcps TDD Option	24
6.6.2.2.3.1.1	Additional requirement in case of co-siting with unsynchronised TDD BS operating on an adjacent channel	24
6.6.2.2.3.1.2	Additional requirement in case of co-siting with FDD BS operating on an adjacent channel	24
6.6.2.2.3.2	1,28 Mcps TDD Option	24
6.6.2.2.3.2.1	Additional requirement in case of co-siting with unsynchronised TDD BS operating on an adjacent channel	24
6.6.2.2.3.2.2	Additional requirement in case of co-siting with FDD BS operating on an adjacent channel	25
6.6.3	Spurious emissions	25
6.6.3.1	Mandatory Requirements	25
6.6.3.1.1	Spurious emissions (Category A)	25
6.6.3.1.1.1	Minimum Requirement	26
6.6.3.1.1.1.1	3,84 Mcps TDD Option	26
6.6.3.1.1.1.2	1,28 Mcps TDD Option	26
6.6.3.1.2	Spurious emissions (Category B)	26
6.6.3.1.2.1	Minimum Requirement	26
6.6.3.1.2.1.1	3,84 Mcps TDD Option	26
6.6.3.1.2.1.2	1,28 Mcps TDD Option	27
6.6.3.2	Co-existence with GSM 900	28
6.6.3.2.1	Operation in the same geographic area	28
6.6.3.2.1.1	Minimum Requirement	28
6.6.3.2.2	Co-located base stations	28
6.6.3.2.2.1	Minimum Requirement	28
6.6.3.3	Co-existence with DCS 1800	28
6.6.3.3.1	Operation in the same geographic area	28
6.6.3.3.1.1	Minimum Requirement	28
6.6.3.3.2	Co-located base stations	29
6.6.3.3.2.1	Minimum Requirement	29
6.6.3.4	Co-existence with UTRA-FDD	29
6.6.3.4.1	Operation in the same geographic area	29
6.6.3.4.1.1	Minimum Requirement	29

6.6.3.4.2	Co-located base stations	29
6.6.3.4.2.1	Minimum Requirement	29
6.6.3.5	Co-existence with unsynchronised TDD	30
6.6.3.5.1	Operation in the same geographic area	30
6.6.3.5.1.1	Minimum Requirement	30
6.6.3.5.1.1.1	3,84 Mcps TDD option	30
6.6.3.5.1.1.2	1,28 Mcps TDD option	30
6.6.3.5.2	Co-located base stations	31
6.6.3.5.2.1	Minimum Requirement	31
6.6.3.5.2.1.1	3,84 Mcps TDD option	31
6.6.3.5.2.1.2	1,28 Mcps TDD option	31
6.6.3.6	Co-existence with PHS	31
6.6.3.6.1	Minimum Requirement	32
6.6.3.6.1.1	3,84 Mcps TDD option	32
6.7	Transmit intermodulation	32
6.7.1	Minimum Requirement	32
6.7.1.1	3,84 Mcps TDD Option	32
6.7.1.2	1,28 Mcps TDD Option	32
6.8	Transmit modulation	32
6.8.1	Transmit pulse shape filter	32
6.8.2	Modulation Accuracy	33
6.8.2.1	Minimum Requirement	33
6.8.3	Peak Code Domain Error	33
6.8.3.1	Minimum Requirement	33
7	Receiver characteristics	33
7.1	General	33
7.2	Reference sensitivity level	33
7.2.1	Minimum Requirement	34
7.2.1.1	3,84 Mcps TDD Option	34
7.2.1.2	1,28 Mcps TDD Option	34
7.3	Dynamic range	34
7.3.1	Minimum requirement	34
7.3.1.1	3,84 Mcps TDD Option	34
7.3.1.2	1,28 Mcps TDD Option:	34
7.4	Adjacent Channel Selectivity (ACS)	35
7.4.1	Minimum Requirement	35
7.4.1.1	3,84 Mcps TDD Option	35
7.4.1.2	1,28 Mcps TDD Option	35
7.5	Blocking characteristics	35
7.5.0	Minimum requirement	35
7.5.0.1	3,84 Mcps TDD Option	36
7.5.0.2	1,28 Mcps TDD Option	36
7.5.1	Co-location with GSM900 and/or DCS 1800	37
7.5.1.1	3,84 Mcps TDD Option	37
7.5.1.2	1,28 Mcps TDD Option	38
7.6	Intermodulation characteristics	38
7.6.1	Minimum requirement	38
7.6.1.1	3,84 Mcps TDD Option	38
7.6.1.2	1,28 Mcps TDD Option	38
7.7	Spurious emissions	39
7.7.1	Minimum Requirement	39
7.7.1.1	3,84 Mcps TDD Option	39
7.7.1.2	1,28 Mcps TDD Option	39
8	Performance requirement	40
8.1	General	40
8.2	Demodulation in static propagation conditions	40
8.2.1	Demodulation of DCH	40
8.2.1.1	Minimum requirement	40
8.2.1.1.1	3,84 Mcps TDD Option	40
8.2.1.1.2	1,28 Mcps TDD Option	41

8.3	Demodulation of DCH in multipath fading conditions	41
8.3.1	Multipath fading Case 1	41
8.3.1.1	Minimum requirement	42
8.3.1.1.1	3,84 Mcps TDD Option	42
8.3.1.1.2	1,28 Mcps TDD Option	42
8.3.2	Multipath fading Case 2	43
8.3.2.1	Minimum requirement	43
8.3.2.1.1	3,84 Mcps TDD Option	43
8.3.2.1.2	1,28 Mcps TDD Option	43
8.3.3	Multipath fading Case 3	44
8.3.3.1	Minimum requirement	44
8.3.3.1.1	3,84 Mcps TDD Option	44
8.3.3.1.2	1,28 Mcps TDD Option	45
Annex A (normative): Measurement Channels		46
A.1	General	46
A.2	Reference measurement channel	46
A.2.1	UL reference measurement channel (12.2 kbps)	46
A.2.1.1	3,84 Mcps TDD Option	46
A.2.1.2	1,28 Mcps TDD Option	47
A.2.2	UL reference measurement channel (64 kbps)	48
A.2.2.1	3,84 Mcps TDD Option	48
A.2.2.2	1,28 Mcps TDD Option	50
A.2.3	UL reference measurement channel (144 kbps)	51
A.2.3.1	3,84 Mcps TDD Option	51
A.2.3.2	1,28 Mcps TDD Option	53
A.2.4	UL reference measurement channel (384 kbps)	54
A.2.4.1	3,84 Mcps TDD Option	54
A.2.4.2	1,28 Mcps TDD Option	56
A.2.5	RACH reference measurement channel	57
A.2.5.0	General	57
A.2.5.0.1	3,84 Mcps TDD Option	57
A.2.5.0.2	1,28 Mcps TDD Option	57
A.2.5.1	RACH mapped to 1 code SF16	58
A.2.5.1.1	3,84 Mcps TDD Option	58
A.2.5.1.2	1,28 Mcps TDD Option	59
A.2.5.2	RACH mapped to 1 code SF8	59
A.2.5.2.1	3,84 Mcps TDD Option	59
A.2.5.2.2	1,28 Mcps TDD Option	60
A.2.5.3	RACH mapped to 1 code SF4 (1,28 Mcps option only)	60
Annex B (normative): Propagation conditions		61
B.1	Static propagation condition	61
B.2	Multi-path fading propagation conditions	61
B.2.1	3,84 Mcps TDD Option	61
B.2.2	1,28 Mcps TDD Option	61
Annex C (informative): Change request history		62
History	64

Foreword

This Technical Specification has been produced by the 3GPP.

The contents of the present document are subject to continuing work within the TSG and may change following formal TSG approval. Should the TSG modify the contents of this TS, it will be re-released by the TSG with an identifying change of release date and an increase in version number as follows:

Version 3.y.z

where:

- x the first digit:
 - 1 presented to TSG for information;
 - 2 presented to TSG for approval;
 - 3 Indicates TSG approved document under change control.
- y the second digit is incremented for all changes of substance, i.e. technical enhancements, corrections, updates, etc.
- z the third digit is incremented when editorial only changes have been incorporated in the specification.

1 Scope

This document establishes the minimum RF characteristics of both options of the TDD mode of UTRA. The two options are the 3.84Mcps and 1.28Mcps options respectively. The requirements are listed in different subsections only if the parameters deviate.

2 References

The following documents contain provisions which, through reference in this text, constitute provisions of the present document.

- References are either specific (identified by date of publication, edition number, version number, etc.) or non-specific.
- For a specific reference, subsequent revisions do not apply.
- For a non-specific reference, the latest version applies. In the case of a reference to a 3GPP document (including a GSM document), a non-specific reference implicitly refers to the latest version of that document *in the same Release as the present document*.

- [1] ITU-R Recommendation SM.329-9 "Spurious emissions".
- [2] ETSI ETR 273-1-2: "Electromagnetic compatibility and Radio spectrum Matters (ERM); Improvement of radiated methods of measurement (using test sites) and evaluation of the corresponding measurement uncertainties; Part 1: Uncertainties in the measurement of mobile radio equipment characteristics; Sub-part 2: Examples and annexes".
- [3] IEC 60721-3-3 (1994): "Classification of environmental conditions - Part 3: Classification of groups of environmental parameters and their severities - Section 3: Stationary use at weather protected locations".
- [4] IEC 60721-3-4 (1995): "Classification of environmental conditions - Part 3: Classification of groups of environmental parameters and their severities - Section 4: Stationary use at non-weather protected locations".
- [5] 3GPP TS 25.142: "Base station conformance testing (TDD)".

3 Definitions, symbols and abbreviations

3.1 Definitions

For the purposes of the present document, the following definitions apply.

Power Spectral Density: The units of Power Spectral Density (PSD) are extensively used in this document. PSD is a function of power versus frequency and when integrated across a given bandwidth, the function represents the mean power in such a bandwidth. When the mean power is normalised to (divided by) the chip-rate it represents the mean energy per chip. Some signals are directly defined in terms of energy per chip, (DPCH_Ec, Ec, and P-CCPCH_Ec) and others defined in terms of PSD (Io, Ioc, Ior and \hat{I}_{or}). There also exist quantities that are a ratio of energy per chip to PSD (DPCH_Ec/Ior, Ec/Ior etc.). This is the common practice of relating energy magnitudes in communication systems.

It can be seen that if both energy magnitudes in the ratio are divided by time, the ratio is converted from an energy ratio to a power ratio, which is more useful from a measurement point of view. It follows that an energy per chip of X dBm/3.84 MHz (3.84 Mcps TDD option) or X dBm/1.28 MHz (1.28 Mcps TDD option) can be expressed as a mean power per chip of X dBm. Similarly, a signal PSD of Y dBm/3.84 MHz (3.84 Mcps TDD option) or Y dBm/1.28 MHz (1.28 Mcps TDD option) can be expressed as a signal power of Y dBm.

Mean power: When applied to a CDMA modulated signal this is the power (transmitted or received) in a bandwidth of at least $(1 + \alpha)$ times the chip rate of the radio access mode. The period of measurement shall be a transmit timeslot excluding the guard period unless otherwise stated.

NOTE: The roll-off factor α is defined in section 6.8.1.

RRC filtered mean power: The mean power as measured through a root raised cosine filter with roll-off factor α and a bandwidth equal to the chip rate of the radio access mode.

NOTE: The RRC filtered mean power of a perfectly modulated CDMA signal is 0.246 dB lower than the mean power of the same signal.

Code domain power: That part of the mean power which correlates with a particular (OVSF) code channel. The sum of all powers in the code domain equals the mean power in a bandwidth of $(1 + \alpha)$ times the chip rate of the radio access mode.

Output power: The mean power of one carrier of the base station, delivered to a load with resistance equal to the nominal load impedance of the transmitter.

Maximum output power: The mean power level per carrier of the base station measured at the antenna connector in a specified reference condition. The period of measurement shall be a transmit timeslot excluding the guard period.

Rated output power: Rated output power of the base station is the mean power level per carrier that the manufacturer has declared to be available at the antenna connector.

Total power dynamic range: The difference between the maximum and the minimum output power of the base station for a specified reference condition.

3.2 Symbols

(void)

3.3 Abbreviations

For the purposes of the present document, the following abbreviations apply:

ACIR	Adjacent Channel Interference Ratio
ACLR	Adjacent Channel Leakage power Ratio
ACS	Adjacent Channel Selectivity
BER	Bit Error Rate
BS	Base Station
CW	Continuous wave (unmodulated signal)
DL	Down link (forward link)
DPCH _o	A mechanism used to simulate an individual intracell interferer in the cell with one code and a spreading factor of 16

$\frac{DPCH_{o} - E_c}{I_{or}}$ The ratio of the average transmit energy per PN chip for the DPCH_o to the total transmit power spectral density of all users in the cell in one timeslot as measured at the BS antenna connector

EIRP	Effective Isotropic Radiated Power
FDD	Frequency Division Duplexing
FER	Frame Error Rate
I_{oc}	The power spectral density (integrated in a noise bandwidth equal to the chip rate and normalized to the chip rate) of a band limited white noise source (simulating interference from other cells) as measured at the BS antenna connector.
\hat{I}_{or}	The received power spectral density (integrated in a bandwidth $(1+\alpha)$ times the chip rate and normalized to the chip rate) of all users in the cell in one timeslot as measured at the BS antenna connector
PPM	Parts Per Million
P_{out}	Output power.
PRAT	Rated Output power
RSSI	Received Signal Strength Indicator
SIR	Signal to Interference ratio
TDD	Time Division Duplexing
TPC	Transmit Power Control
UE	User Equipment
UL	Up link (reverse link)
UTRA	UMTS Terrestrial Radio Access

4 General

4.1 Relationship between Minimum Requirements and Test Requirements

The Minimum Requirements given in this specification make no allowance for measurement uncertainty. The test specification 25.142 section 5.9.6 defines Test Tolerances. These Test Tolerances are individually calculated for each test. The Test Tolerances are used to relax the Minimum Requirements in this specification to create Test Requirements. The measurement results returned by the Test System are compared -without any modification- against the Test Requirements as defined by the shared risk principle.

The Shared Risk principle is defined in ETR 273 Part 1 sub-part 2 section 6.5.

4.2 Base station classes

The requirements in this specification apply to base station intended for general-purpose applications in co-ordinated network operation.

In the future further classes of base stations may be defined; the requirements for these may be different than for general-purpose applications.

4.3 Regional requirements

Some requirements in TS 25.105 may only apply in certain regions. Table 4.1 lists all requirements that may be applied differently in different regions.

Table 4.1: List of regional requirements.

Clause number	Requirement	Comments
5.1	General	Only 3.84Mcps TDD is currently applicable in Japan.
5.2	Frequency bands	Some bands may be applied regionally.
6.2.1	Base station maximum output power	In certain regions, the minimum requirement for normal conditions may apply also for some conditions outside the range of conditions defined as normal.
6.6.2.1	Spectrum emission mask	The mask specified may be mandatory in certain regions. In other regions this mask may not be applied.
6.6.3.1.1	Spurious emissions (Category A)	These requirements shall be met in cases where Category A limits for spurious emissions, as defined in ITU-R Recommendation SM.329-9 [1], are applied.
6.6.3.1.2	Spurious emissions (Category B)	These requirements shall be met in cases where Category B limits for spurious emissions, as defined in ITU-R Recommendation SM.329-9 [1], are applied.
6.6.3.2.1	Co-existence with GSM900 – Operation in the same geographic area	This requirement may be applied for the protection of GSM 900 MS and GSM 900 BTS in geographic areas in which both GSM 900 and UTRA are deployed.
6.6.3.2.2	Co-existence with GSM900 – Co-located base stations	This requirement may be applied for the protection of GSM 900 BTS receivers when GSM 900 BTS and UTRA BS are co-located.
6.6.3.3.1	Co-existence with DCS1800 – Operation in the same geographic area	This requirement may be applied for the protection of DCS 1800 MS and DCS 1800 BTS in geographic areas in which both DCS 1800 and UTRA are deployed.
6.6.3.3.2	Co-existence with DCS1800 – Co-located base stations	This requirement may be applied for the protection of DCS 1800 BTS receivers when DCS 1800 BTS and UTRA BS are co-located.
6.6.3.4.1	Co-existence with UTRA FDD – Operation in the same geographic area	This requirement may be applied to geographic areas in which both UTRA-TDD and UTRA-FDD are deployed.
6.6.3.4.2	Co-existence with UTRA FDD – Co-located base stations	This requirement may be applied for the protection of UTRA-FDD BS receivers when UTRA-TDD BS and UTRA FDD BS are co-located.
6.6.3.6	Co-existence with PHS	This requirement may be applied for the protection of PHS in geographic areas in which both PHS and 3.84 Mcps UTRA TDD are deployed.
7.5	Blocking characteristic	The requirement is applied according to what frequency bands in Clause 5.2 that are supported by the BS.
7.5.1	Blocking characteristic Co-location with GSM900 and/or DCS 1800	This requirement may be applied for the protection of UTRA TDD BS receivers when UTRA TDD BS and GSM 900/DCS1800 BS are co-located.

4.4 Environmental requirements for the BS equipment

The BS equipment shall fulfil all the requirements in the full range of environmental conditions for the relevant environmental class from the relevant IEC specifications listed below:

IEC 60 721-3-3 “Stationary use at weather protected locations” [3]

IEC 60 721-3-4 “Stationary use at non weather protected locations” [4]

Normally it should be sufficient for all tests to be conducted using normal test conditions except where otherwise stated. For guidance on the use of test conditions to be used in order to show compliance refer to TS 25.142 [5].

5 Frequency bands and channel arrangement

5.1 General

The information presented in this section is based on the chip rates of 3.84 Mcps and 1.28 Mcps.

Note: Other chip rates may be considered in future releases.

5.2 Frequency bands

UTRA/TDD is designed to operate in the following bands;

- a)*** 1900 – 1920 MHz: Uplink and downlink transmission
2010 – 2025 MHz Uplink and downlink transmission
- b)* 1850 – 1910 MHz Uplink and downlink transmission
1930 – 1990 MHz Uplink and downlink transmission
- c)* 1910 – 1930 MHz Uplink and downlink transmission

* Used in ITU Region 2

*** In Japan, only the band 2010-2025MHz has been allocated for UTRA TDD operation.

Additional allocations in ITU region 2 are FFS.

Deployment in existing and other frequency bands is not precluded.

The co-existence of TDD and FDD in the same bands is still under study in WG4.

5.3 TX–RX frequency separation

5.3.1 3,84 Mcps TDD Option

No TX-RX frequency separation is required as Time Division Duplex (TDD) is employed. Each TDMA frame consists of 15 timeslots where each timeslot can be allocated to either transmit or receive.

5.3.2 1,28 Mcps TDD Option

No TX-RX frequency separation is required as Time Division Duplex (TDD) is employed. Each subframe consists of 7 main timeslots where all main timeslots (at least the first one) before the single switching point are allocated DL and all main timeslots (at least the last one) after the single switching point are allocated UL.

5.4 Channel arrangement

5.4.1 Channel spacing

5.4.1.1 3,84 Mcps TDD Option

The nominal channel spacing is 5 MHz, but this can be adjusted to optimise performance in a particular deployment scenario.

5.4.1.2 1,28 Mcps TDD Option

The channel spacing is 1.6MHz, but this can be adjusted to optimise performance in a particular deployment scenario.

5.4.2 Channel raster

The channel raster is 200 kHz, which means that the carrier frequency must be a multiple of 200 kHz.

5.4.3 Channel number

The carrier frequency is designated by the UTRA absolute radio frequency channel number (UARFCN). The value of the UARFCN in the IMT2000 band is defined as follows:

$$N_t = 5 * F \qquad 0.0 \leq F \leq 3276.6 \text{ MHz}$$

where F is the carrier frequency in MHz

6 Transmitter characteristics

6.1 General

Unless otherwise stated the transmitter characteristics are specified at the antenna connector (test port A) with a full complement of transceivers for the configuration in normal operating conditions. If any external apparatus such as a TX amplifier, a filter or the combination of such devices is used, requirements apply at the far end antenna connector. (port B).

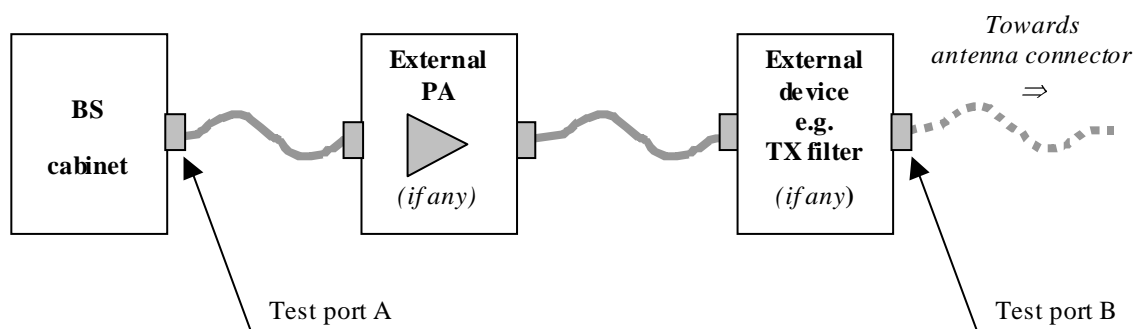

Figure 6.0: Transmitter test ports

6.2 Base station output power

The rated output power of the base station is defined in section 3.1.

6.2.1 Base station maximum output power

The maximum output power of the base station is defined in section 3.1.

6.2.1.1 Minimum Requirement

In normal conditions, the base station maximum output power shall remain within +2 dB and –2 dB of the manufacturer's rated output power.

In extreme conditions, the Base station maximum output power shall remain within +2.5 dB and –2.5 dB of the manufacturer's rated output power.

In certain regions, the minimum requirement for normal conditions may apply also for some conditions outside the range of conditions defined as normal.

6.3 Frequency stability

Frequency stability is ability of the BS to transmit at the assigned carrier frequency. The BS shall use the same frequency source for both RF frequency generation and the chip clock.

6.3.1 Minimum Requirement

6.3.1.1 3,84 Mcps TDD Option

The modulated carrier frequency of the BS shall be accurate to within ± 0.05 PPM observed over a period of one timeslot for RF frequency generation.

6.3.1.2 1,28 Mcps TDD Option

The modulated carrier frequency of the BS shall be accurate to within ± 0.05 PPM observed over a period of one timeslot for RF frequency generation.

6.4 Output power dynamics

Power control is used to limit the interference level. The transmitter uses a quality-based power control on the downlink.

6.4.1 Inner loop power control

Inner loop power control is the ability of the BS transmitter to adjust its code domain power in response to the UL received signal.

For inner loop correction on the Downlink Channel, the base station adjusts the code domain power of a power controlled CCTrCH in response to each valid power control bit received from the UE on the Uplink Traffic Channel based on the mapping of the TPC bits in uplink CCTrCH to downlink CCTrCH. Inner loop control is based on SIR measurements at the UE receiver and the corresponding TPC commands are generated by the UE.

6.4.2 Power control steps

The power control step is the step change in the DL code domain power in response to a TPC message from the UE.

6.4.2.1 Minimum Requirement

Down link (DL) power steps: 1, 2, 3 dB

The tolerance of the code domain power and the greatest average rate of change in code domain power due to the power control step shall be within the range shown in Table 6.1.

Table 6.1: power control step size tolerance

Step size	Tolerance	Range of average rate of change in code domain power per 10 steps	
		minimum	maximum
1dB	+/-0.5dB	+/-8dB	+/-12dB
2dB	+/-0.75dB	+/-16dB	+/-24dB
3dB	+/-1dB	+/-24dB	+/-36dB

6.4.3 Power control dynamic range

The power control dynamic range is the difference between the maximum and the minimum code domain power of one power controlled code channel for a specified reference condition

6.4.3.1 Minimum Requirement

Down link (DL) power control dynamic range shall be greater or equal to 30 dB

6.4.4 Minimum output power

The minimum controlled output power of the BS is when the power is set to a minimum value.

6.4.4.1 Minimum Requirement

Down link (DL) minimum output power shall be lower than or equal to:

$$\text{Maximum output power} - 30\text{dB}$$

6.4.5 Primary CCPCH power

Primary CCPCH power is the code domain power of the primary common control physical channel averaged over the transmit timeslot. Primary CCPCH power is signalled over the BCH.

The error between the BCH-broadcast value of the Primary CCPCH power and the Primary CCPCH power averaged over the timeslot shall not exceed the values in table 6.2. The error is a function of the output power averaged over the timeslot, P_{out} , and the manufacturer's rated output power, PRAT.

Table 6.2: Errors between Primary CCPCH power and the broadcast value

Output power in slot, dB	PCCPCH power tolerance
$PRAT-3 < P_{out} \leq PRAT+2$	+/- 2.5 dB
$PRAT-6 < P_{out} \leq PRAT-3$	+/- 3.5 dB
$PRAT-13 < P_{out} \leq PRAT-6$	+/- 5 dB

6.4.6 Differential accuracy of Primary CCPCH power

The differential accuracy of the Primary CCPCH power is the relative transmitted power accuracy of PCCPCH in consecutive frames when the nominal PCCPCH power is not changed.

6.4.6.1 Minimum Requirement for Differential accuracy of PCCPCH power

Differential accuracy of PCCPCH power: +/- 0.5 dB

6.5 Transmit ON/OFF power

6.5.1 Transmit OFF power

Transmit OFF power is defined as the RRC filtered mean power measured over one chip when the transmitter is off. The transmit OFF power state is when the BS does not transmit.

6.5.1.1 Minimum Requirement

6.5.1.1.1 3,84 Mcps TDD Option

The transmit OFF power shall be less than -79 dBm.

6.5.1.1.2 1,28 Mcps TDD Option

The requirement of transmit OFF power shall be less than -82 dBm.

6.5.2 Transmit ON/OFF Time mask

The time mask transmit ON/OFF defines the ramping time allowed for the BS between transmit OFF power and transmit ON power.

6.5.2.1 Minimum Requirement

6.5.2.1.1 3,84 Mcps TDD Option

The transmit power level versus time should meet the mask specified in figure 6.1.

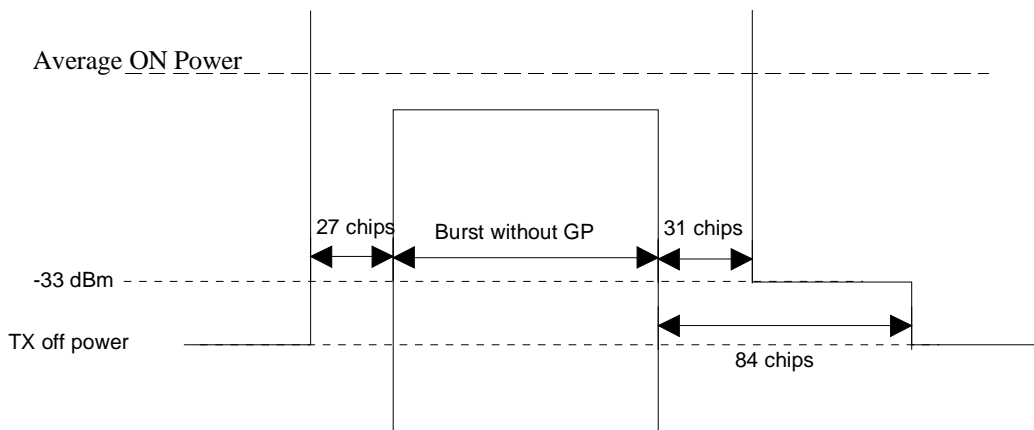

Figure 6.1: Transmit ON/OFF template

6.5.2.1.2 1,28 Mcps TDD Option

The transmit power level versus time should meet the mask specified in figure6.1A.

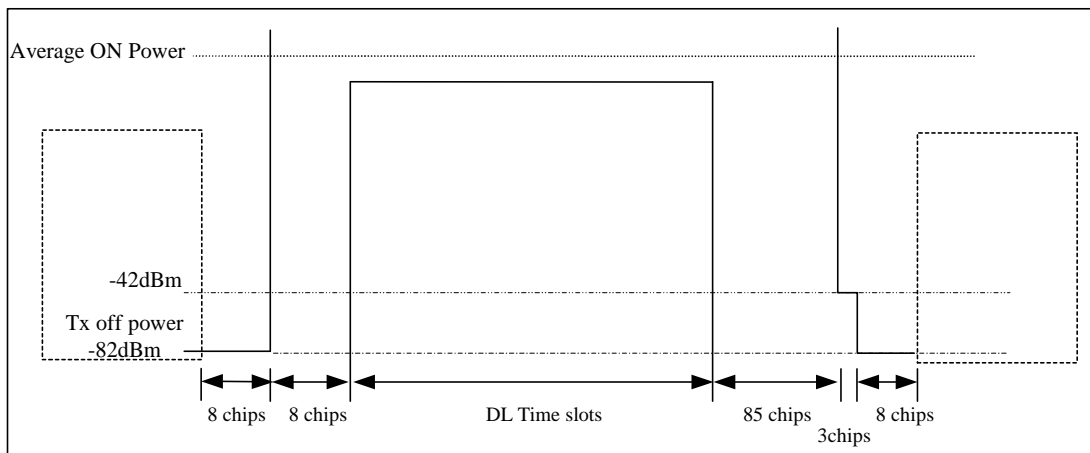

Figure 6.1A: Transmit ON/OFF template

6.6 Output RF spectrum emissions

6.6.1 Occupied bandwidth

6.6.1.1 3,84 Mcps TDD Option

Occupied bandwidth is a measure of the bandwidth containing 99% of the total integrated power for transmitted spectrum and is centered on the assigned channel frequency. The occupied channel bandwidth is less than 5 MHz based on a chip rate of 3.84 Mcps.

6.6.1.2 1,28 Mcps TDD Option

Occupied bandwidth is a measure of the bandwidth containing 99% of the total integrated power for transmitted spectrum and is centered on the assigned channel frequency. The occupied channel bandwidth is about 1.6 MHz based on a chip rate of 1.28 Mcps.

6.6.2 Out of band emission

Out of band emissions are unwanted emissions immediately outside the channel bandwidth resulting from the modulation process and non-linearity in the transmitter but excluding spurious emissions. This out of band emission requirement is specified both in terms of a spectrum emission mask and adjacent channel power ratio for the transmitter.

6.6.2.1 Spectrum emission mask

6.6.2.1.1 3,84 Mcps TDD Option

The mask defined in Table 6.3 to 6.6 below may be mandatory in certain regions. In other regions this mask may not be applied.

For regions where this clause applies, the requirement shall be met by a base station transmitting on a single RF carrier configured in accordance with the manufacturer's specification. Emissions shall not exceed the maximum level specified in tables 6.3 to 6.6 for the appropriate BS maximum output power, in the frequency range from $\Delta f = 2.5$ MHz to Δf_{max} from the carrier frequency, where:

- Δf is the separation between the carrier frequency and the nominal -3dB point of the measuring filter closest to the carrier frequency.
- f_{offset} is the separation between the carrier frequency and the center frequency of the measuring filter.-
 $f_{offset_{max}}$ is either 12.5 MHz or the offset to the UMTS Tx band edge as defined in section 5.2, whichever is the greater.
- Δf_{max} is equal to $f_{offset_{max}}$ minus half of the bandwidth of the measurement filter.

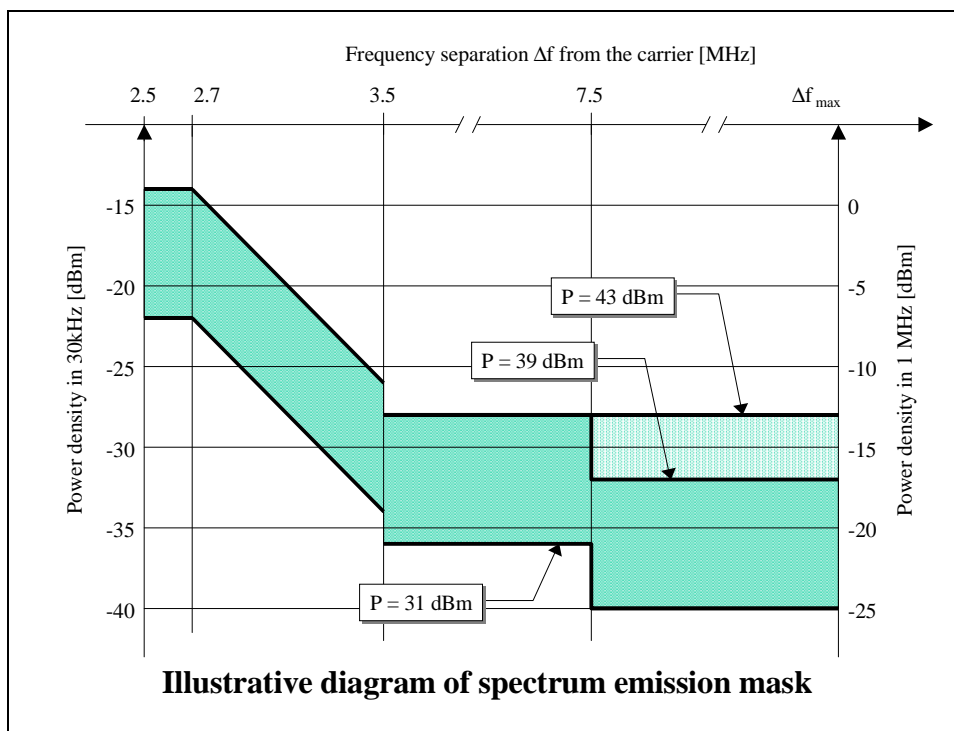

Figure 6.2

Table 6.3: Spectrum emission mask values, BS maximum output power $P \geq 43$ dBm

Frequency offset of measurement filter –3dB point, Δf	Frequency offset of measurement filter centre frequency, f_{offset}	Maximum level	Measurement bandwidth
$2.5 \leq \Delta f < 2.7$ MHz	$2.515\text{MHz} \leq f_{\text{offset}} < 2.715\text{MHz}$	-14 dBm	30 kHz
$2.7 \leq \Delta f < 3.5$ MHz	$2.715\text{MHz} \leq f_{\text{offset}} < 3.515\text{MHz}$	$-14 - 15 \cdot (f_{\text{offset}} - 2.715)$ dBm	30 kHz
(see note)	$3.515\text{MHz} \leq f_{\text{offset}} < 4.0\text{MHz}$	-26 dBm	30 kHz
$3.5 \leq \Delta f$ MHz	$4.0\text{MHz} \leq f_{\text{offset}} < f_{\text{offset}_{\text{max}}}$	-13 dBm	1 MHz

Table 6.4: Spectrum emission mask values, BS maximum output power $39 \leq P < 43$ dBm

Frequency offset of measurement filter –3dB point, Δf	Frequency offset of measurement filter centre frequency, f_{offset}	Maximum level	Measurement bandwidth
$2.5 \leq \Delta f < 2.7$ MHz	$2.515\text{MHz} \leq f_{\text{offset}} < 2.715\text{MHz}$	-14 dBm	30 kHz
$2.7 \leq \Delta f < 3.5$ MHz	$2.715\text{MHz} \leq f_{\text{offset}} < 3.515\text{MHz}$	$-14 - 15 \cdot (f_{\text{offset}} - 2.715)$ dBm	30 kHz
(see note)	$3.515\text{MHz} \leq f_{\text{offset}} < 4.0\text{MHz}$	-26 dBm	30 kHz
$3.5 \leq \Delta f < 7.5$ MHz	$4.0\text{MHz} \leq f_{\text{offset}} < 8.0\text{MHz}$	-13 dBm	1 MHz
$7.5 \leq \Delta f$ MHz	$8.0\text{MHz} \leq f_{\text{offset}} < f_{\text{offset}_{\text{max}}}$	$P - 56$ dBm	1 MHz

Table 6.5: Spectrum emission mask values, BS maximum output power $31 \leq P < 39$ dBm

Frequency offset of measurement filter –3dB point, Δf	Frequency offset of measurement filter centre frequency, f_{offset}	Maximum level	Measurement bandwidth
$2.5 \leq \Delta f < 2.7$ MHz	$2.515\text{MHz} \leq f_{\text{offset}} < 2.715\text{MHz}$	$P - 53$ dBm	30 kHz
$2.7 \leq \Delta f < 3.5$ MHz	$2.715\text{MHz} \leq f_{\text{offset}} < 3.515\text{MHz}$	$P - 53 - 15 \cdot (f_{\text{offset}} - 2.715)$ dBm	30 kHz
(see note)	$3.515\text{MHz} \leq f_{\text{offset}} < 4.0\text{MHz}$	$P - 65$ dBm	30 kHz
$3.5 \leq \Delta f < 7.5$ MHz	$4.0\text{MHz} \leq f_{\text{offset}} < 8.0\text{MHz}$	$P - 52$ dBm	1 MHz
$7.5 \leq \Delta f$ MHz	$8.0\text{MHz} \leq f_{\text{offset}} < f_{\text{offset}_{\text{max}}}$	$P - 56$ dBm	1 MHz

Table 6.6: Spectrum emission mask values, BS maximum output power $P < 31$ dBm

Frequency offset of measurement filter –3dB point, Δf	Frequency offset of measurement filter centre frequency, f_{offset}	Maximum level	Measurement bandwidth
$2.5 \leq \Delta f < 2.7$ MHz	$2.515\text{MHz} \leq f_{\text{offset}} < 2.715\text{MHz}$	-22 dBm	30 kHz
$2.7 \leq \Delta f < 3.5$ MHz	$2.715\text{MHz} \leq f_{\text{offset}} < 3.515\text{MHz}$	$-22 - 15 \cdot (f_{\text{offset}} - 2.715)$ dBm	30 kHz
(see note)	$3.515\text{MHz} \leq f_{\text{offset}} < 4.0\text{MHz}$	-34 dBm	30 kHz
$3.5 \leq \Delta f < 7.5$ MHz	$4.0\text{MHz} \leq f_{\text{offset}} < 8.0\text{MHz}$	-21 dBm	1 MHz
$7.5 \leq \Delta f$ MHz	$8.0\text{MHz} \leq f_{\text{offset}} < f_{\text{offset}_{\text{max}}}$	-25 dBm	1 MHz

NOTE: This frequency range ensures that the range of values of f_{offset} is continuous.

6.6.2.1.2 1,28 Mcps TDD Option

The mask defined in Table 6.3A to 6.6A may be mandatory in certain regions. In other regions this mask may not be applied.

For regions where this clause applies, the requirement shall be met by a base station transmitting on a single RF carrier configured in accordance with the manufacturer's specification. Emissions shall not exceed the maximum level specified in table 6.3A to 6.6A for the appropriate BS maximum output power, in the frequency range from $\Delta f = 0.8$ MHz to Δf_{max} from the carrier frequency, where:

- Δf is the separation between the carrier frequency and the nominal -3dB point of the measuring filter closest to the carrier frequency.
- f_{offset} is the separation between the carrier frequency and the center frequency of the measuring filter.-
 $f_{\text{offset}_{\text{max}}}$ is either 4 MHz or the offset to the UMTS Tx band edge as defined in section 5.2, whichever is the greater.
- Δf_{max} is equal to $f_{\text{offset}_{\text{max}}}$ minus half of the bandwidth of the measurement filter.

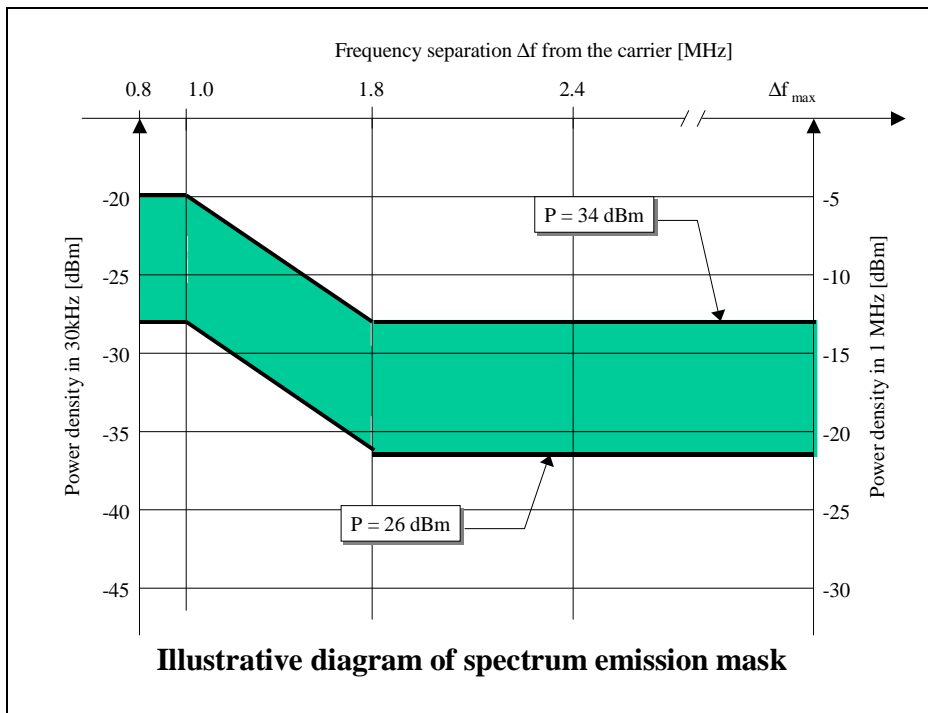

Figure 6.2A

Table 6.3A: Spectrum emission mask values, BS maximum output power $P \geq 34$ dBm

Frequency offset of measurement filter -3dB point, Δf	Frequency offset of measurement filter centre frequency, f_{offset}	Maximum level	Measurement bandwidth
$0.8 \text{ MHz} \leq \Delta f < 1.0 \text{ MHz}$	$0.815\text{MHz} \leq f_{\text{offset}} < 1.015\text{MHz}$	-20 dBm	30 kHz
$1.0 \text{ MHz} \leq \Delta f < 1.8 \text{ MHz}$	$1.015\text{MHz} \leq f_{\text{offset}} < 1.815\text{MHz}$	$-20\text{dBm} - 10 \cdot \left(\frac{f_{\text{offset}}}{\text{MHz}} - 1,015 \right) \text{dB}$	30 kHz
See note	$1.815\text{MHz} \leq f_{\text{offset}} < 2.3\text{MHz}$	-28 dBm	30 kHz
$1.8 \text{ MHz} \leq \Delta f \leq \Delta f_{\text{max}}$	$2.3\text{MHz} \leq f_{\text{offset}} < f_{\text{offset}_{\text{max}}}$	-13 dBm	1 MHz

Table 6.4A: Spectrum emission mask values, BS maximum output power $26 \leq P < 34$ dBm

Frequency offset of measurement filter -3dB point, Δf	Frequency offset of measurement filter centre frequency, f_{offset}	Maximum level	Measurement bandwidth
$0.8 \text{ MHz} \leq \Delta f < 1.0 \text{ MHz}$	$0.815\text{MHz} \leq f_{\text{offset}} < 1.015\text{MHz}$	P-54 dB	30 kHz
$1.0 \text{ MHz} \leq \Delta f < 1.8 \text{ MHz}$	$1.015\text{MHz} \leq f_{\text{offset}} < 1.815\text{MHz}$	$P - 54\text{dB} - 10 \cdot \left(\frac{f_{\text{offset}}}{\text{MHz}} - 1,015 \right) \text{dB}$	30 kHz
See note	$1.815 \text{ MHz} \leq f_{\text{offset}} < 2.3 \text{ MHz}$	P-62 dB	30 kHz
$1.8 \text{ MHz} \leq \Delta f \leq \Delta f_{\text{max}}$	$2.3 \text{ MHz} \leq f_{\text{offset}} < f_{\text{offset}_{\text{max}}}$	P - 47 dB	1 MHz

Table 6.5A: Spectrum emission mask values, BS maximum output power $P < 26$ dBm

Frequency offset of measurement filter -3dB point, Δf	Frequency offset of measurement filter centre frequency, f_{offset}	Maximum level	Measurement bandwidth
$0.8 \text{ MHz} \leq \Delta f < 1.0 \text{ MHz}$	$0.815\text{MHz} \leq f_{\text{offset}} < 1.015\text{MHz}$	-28 dBm	30 kHz
$1.0 \text{ MHz} \leq \Delta f < 1.8 \text{ MHz}$	$1.015\text{MHz} \leq f_{\text{offset}} < 1.815\text{MHz}$	$-28\text{dBm} - 10 \cdot \left(\frac{f_{\text{offset}}}{\text{MHz}} - 1,015 \right) \text{dB}$	30 kHz
See note	$1.815\text{MHz} \leq f_{\text{offset}} < 2.3\text{MHz}$	-36 dBm	30 kHz
$1.8 \text{ MHz} \leq \Delta f \leq \Delta f_{\text{max}}$	$2.3\text{MHz} \leq f_{\text{offset}} < f_{\text{offset}_{\text{max}}}$	-21 dBm	1 MHz

NOTE: This frequency range ensures that the range of values of f_{offset} is continuous.

6.6.2.2 Adjacent Channel Leakage power Ratio (ACLR)

Adjacent Channel Leakage power Ratio (ACLR) is the ratio of the RRC filtered mean power centered on the assigned channel frequency to the RRC filtered mean power centered on an adjacent channel frequency. The requirements shall apply for all configurations of BS (single carrier or multi-carrier), and for all operating modes foreseen by the manufacturer's specification.

In some cases the requirement is expressed as adjacent channel leakage power, which is the RRC filtered mean power for the given bandwidth of the victim system at the defined adjacent channel offset. The requirement depends on the deployment scenario. Three different deployment scenarios have been defined as given below.

6.6.2.2.1 Minimum Requirement

6.6.2.2.1.1 3,84 Mcps TDD Option

The ACLR of a single carrier BS or a multi-carrier BS with contiguous carrier frequencies shall be higher than the value specified in Table 6.7.

Table 6.7: BS ACLR

BS adjacent channel offset below the first or above the last carrier frequency used	ACLR limit
5 MHz	45 dB
10 MHz	55 dB

If a BS provides multiple non-contiguous single carriers or multiple non-contiguous groups of contiguous single carriers, the above requirements shall be applied individually to the single carriers or group of single carriers.

6.6.2.2.1.2 1,28 Mcps TDD Option

For the 1.28Mcps chip rate option, the ACLR of a single carrier BS or a multi-carrier BS with contiguous carrier frequencies shall be better than the value specified in Table 6.7A

Table 6.7A: BS ACLR (1.28Mcps chip rate)

BS adjacent channel offset below the first or above the last carrier frequency used	ACLR limit
1.6 MHz	40 dB
3.2 MHz	45 dB

If a BS provides multiple non-contiguous single carriers or multiple non-contiguous groups of contiguous single carriers, the above requirements shall be applied individually to the single carriers or group of single carriers.

6.6.2.2.2 Additional requirement for operation in the same geographic area with FDD or unsynchronised TDD on adjacent channels

6.6.2.2.2.1 3,84 Mcps TDD Option

6.6.2.2.2.1.1 Additional requirement for operation in the same geographic area with unsynchronised TDD on adjacent channels

In case the equipment is operated in the same geographic area with an unsynchronised TDD BS operating on the first or second adjacent frequency, the adjacent channel leakage power of a single carrier BS or a multi-carrier BS with contiguous carrier frequencies shall not exceed the limits specified in Table 6.8.

Table 6.8: Adjacent channel leakage power limits for operation in the same geographic area with unsynchronised TDD on adjacent channels

BS adjacent channel offset below the first or above the last carrier frequency used	Maximum Level	Measurement Bandwidth
5 MHz	- 29 dBm	3,84 MHz
10 MHz	- 29 dBm	3,84 MHz

NOTE: The requirement in Table 6.8 are based on a coupling loss of 74 dB between the unsynchronised TDD base stations . The scenarios leading to these requirements are addressed in TR 25.942 [4].

If a BS provides multiple non-contiguous single carriers or multiple non-contiguous groups of contiguous single carriers, the above requirements shall be applied to those adjacent channels of the single carriers or group of single channels which are used by the TDD BS in the same geographic area.

6.6.2.2.2.1.2 Additional requirement for operation in the same geographic area with FDD on adjacent channels

In case the equipment is operated in the same geographic area with a FDD BS operating on the first or second adjacent channel , the adjacent channel leakage power shall not exceed the limits specified in Table 6.8AA.

Table 6.8AA: Adjacent channel leakage power limits for operation in the same geographic area with FDD on adjacent channels

BS Adjacent Channel Offset	Maximum Level	Measurement Bandwidth
± 5 MHz	- 36 dBm	3,84 MHz
± 10 MHz	- 36 dBm	3,84 MHz

NOTE: The requirements in Table 6.8AA are based on a coupling loss of 74 dB between the FDD and TDD base stations. The scenarios leading to these requirements are addressed in TR 25.942 [4].

If a BS provides multiple non-contiguous single carriers or multiple non-contiguous groups of contiguous single carriers, the above requirements shall be applied to those adjacent channels of the single carriers or group of single channels which are used by the FDD BS in the same geographic area.

6.6.2.2.2.2 1,28 Mcps TDD Option

6.6.2.2.2.2.1 Additional requirement for operation in the same geographic area with unsynchronised TDD on adjacent channels

In case the equipment is operated in the same geographic area with an unsynchronised TDD BS operating on an adjacent channel, the requirement is specified in terms of adjacent channel leakage power. In geographic areas where only UTRA 1.28 Mcps TDD option is deployed, the adjacent channel leakage power limits shall not exceed the limits specified in Table 6.8A, otherwise the limits in Table 6.8B shall apply.

Table 6.8A: Adjacent channel leakage limits for operation in the same geographic area with unsynchronised 1.28 Mcps TDD on adjacent channels

BS Adjacent Channel Offset	Maximum Level	Measurement Bandwidth
± 1,6 MHz	-29 dBm	1,28 MHz
± 3,2 MHz	-29 dBm	1,28 MHz

Table 6.8B: Adjacent Channel leakage power limits for operation in the same geographic area with unsynchronised TDD on adjacent channels

BS Adjacent Channel Offset	Maximum Level	Measurement Bandwidth
± 3,4 MHz	-29 dBm	3,84 MHz

NOTE: The requirement in Table 6.8A and 6.8B are based on a coupling loss of 74 dB between the unsynchronised TDD base stations. The scenarios leading to these requirements are addressed in TR25.942 [4].

6.6.2.2.2.2.2 Additional requirement for operation in the same geographic area with FDD on adjacent channels

In case the equipment is operated in the same geographic area with a FDD BS operating on an adjacent channel, the adjacent channel leakage power shall not exceed the limits specified in Table 6.8C. This requirement is only applicable if the equipment is intended to operate in frequency bands specified in 5.2 a) and the highest carrier frequency used is in the range 1916,2 – 1920 MHz.

Table 6.8C: Adjacent channel leakage power limits for operation in the same geographic area with FDD on adjacent channels

Center Frequency for Measurement	Maximum Level	Measurement Bandwidth
1922,6 MHz	-36 dBm	3,84 MHz

NOTE: The requirement in Table 6.8C is based on a relaxed coupling loss of 74 dB between the TDD and FDD base stations. The scenarios leading to these requirements are addressed in TR 25.942 [4].

6.6.2.2.3 Additional requirement in case of co-siting with unsynchronised TDD BS or FDD BS operating on an adjacent channel

6.6.2.2.3.1 3,84 Mcps TDD Option

6.6.2.2.3.1.1 Additional requirement in case of co-siting with unsynchronised TDD BS operating on an adjacent channel

In case the equipment is co-sited to an unsynchronised TDD BS operating on the first or second adjacent frequency, the adjacent channel leakage power of a single carrier BS or a multi-carrier BS with contiguous carrier frequencies shall not exceed the limits specified in Table 6.9.

Table 6.9: Adjacent channel leakage power limits in case of co-siting with unsynchronised TDD on adjacent channel

BS adjacent channel offset below the first or above the last carrier frequency used	Maximum Level	Measurement Bandwidth
5 MHz	-73 dBm	3.84 MHz
10 MHz	-73 dBm	3.84 MHz

Note: The requirements in Table 6.9 are based on a minimum coupling loss of 30 dB between unsynchronised TDD base stations.

If a BS provides multiple non-contiguous single carriers or multiple non-contiguous groups of contiguous single carriers, the above requirements shall be applied to those adjacent channels of the single carriers or group of single channels which are used by the co-sited TDD BS.

6.6.2.2.3.1.2 Additional requirement in case of co-siting with FDD BS operating on an adjacent channel

In case the equipment is co-sited to a FDD BS operating on the first or second adjacent channel, the adjacent channel leakage power shall not exceed the limits specified in Table 6.9AA.

Table 6.9AA: Adjacent channel leakage power limits in case of co-siting with FDD on an adjacent channel

BS Adjacent Channel Offset	Maximum Level	Measurement Bandwidth
± 5 MHz	-80 dBm	3,84 MHz
± 10 MHz	-80 dBm	3,84 MHz

NOTE: The requirements in Table 6.9AA are based on a minimum coupling loss of 30 dB between base stations.

If a BS provides multiple non-contiguous single carriers or multiple non-contiguous groups of contiguous single carriers, the above requirements shall be applied to those adjacent channels of the single carriers or group of single channels which are used by the co-sited FDD BS.

6.6.2.2.3.2 1,28 Mcps TDD Option

6.6.2.2.3.2.1 Additional requirement in case of co-siting with unsynchronised TDD BS operating on an adjacent channel

In case the equipment is co-sited to an unsynchronised TDD BS operating on an adjacent frequency band, the requirement is specified in terms of adjacent channel leakage power. In geographic areas where only UTRA 1.28 Mcps TDD option is deployed, the adjacent channel leakage power shall not exceed the limits specified in Table 6.9A, otherwise the limits in Table 6.9B shall apply.

Table 6.9A: Adjacent channel leakage power limits in case of co-siting with unsynchronised 1.28 Mcps TDD on an adjacent channel

BS Adjacent Channel Offset	Maximum Level	Measurement Bandwidth
± 1,6 MHz	-73 dBm	1,28 MHz
± 3,2 MHz	-73 dBm	1,28 MHz

Table 6.9B: Adjacent Channel leakage power limits for operation in the same geographic area with unsynchronised TDD on an adjacent channel

BS Adjacent Channel Offset	Maximum Level	Measurement Bandwidth
± 3,4 MHz	-73 dBm	3,84 MHz

NOTE: The requirements in Table 6.9A and 6.9B are based on a minimum coupling loss of 30 dB between unsynchronised TDD base stations.

6.6.2.2.3.2.2 Additional requirement in case of co-siting with FDD BS operating on an adjacent channel

In case the equipment is co-sited to a FDD BS operating on an adjacent channel, the adjacent channel leakage power shall not exceed the limits specified in Table 6.9C. This requirement is only applicable if the equipment is intended to operate in frequency bands specified in 5.2 a) and the highest carrier frequency used is in the range 1916,2 – 1920 MHz.

Table 6.9C: Adjacent channel leakage power in case of co-siting with UTRA FDD on an adjacent channel

Center Frequency for Measurement	Maximum Level	Measurement Bandwidth
1922,6 MHz	-80 dBm	3,84 MHz

NOTE: The requirements in Table 6.9C are based on a minimum coupling loss of 30 dB between base stations.

6.6.3 Spurious emissions

Spurious emissions are emissions which are caused by unwanted transmitter effects such as harmonics emission, parasitic emission, intermodulation products and frequency conversion products, but exclude out of band emissions. This is measured at the base station RF output port.

The requirements shall apply whatever the type of transmitter considered (single carrier or multi carrier). It applies for all transmission modes foreseen by the manufacturer's.

For 3.84 Mcps TDD option, either requirement (except 6.6.3.6) applies at frequencies within the specified frequency ranges which are more than 12.5 MHz under the first carrier frequency used or more than 12.5 MHz above the last carrier frequency used.

For 1.28 Mcps TDD option, either requirement applies at frequencies within the specified frequency ranges which are more than 4 MHz under the first carrier frequency used or more than 4 MHz above the last carrier frequency used.

Unless otherwise stated, all requirements are measured as mean power.

6.6.3.1 Mandatory Requirements

The requirements of either subclause 6.6.3.1.1 or subclause 6.6.3.1.2 shall apply.

6.6.3.1.1 Spurious emissions (Category A)

The following requirements shall be met in cases where Category A limits for spurious emissions, as defined in ITU-R Recommendation SM.329-9 [1], are applied.

6.6.3.1.1.1 Minimum Requirement

6.6.3.1.1.1.1 3,84 Mcps TDD Option

The power of any spurious emission shall not exceed:

Table 6.10: BS Mandatory spurious emissions limits, Category A

Band	Minimum requirement	Measurement Bandwidth	Note
9kHz – 150kHz	-13 dBm	1 kHz	Bandwidth as in ITU SM.329-9, s4.1
150kHz – 30MHz		10 kHz	Bandwidth as in ITU SM.329-9, s4.1
30MHz – 1GHz		100 kHz	Bandwidth as in ITU SM.329-9, s4.1
1GHz – 12.75 GHz		1 MHz	Upper frequency as in ITU SM.329-9, s2.5 table 1

6.6.3.1.1.1.2 1,28 Mcps TDD Option

The power of any spurious emission shall not exceed:

Table 6.10A: BS Mandatory spurious emissions limits, Category A

Band	Minimum requirement	Measurement Bandwidth	Note
9kHz – 150kHz	-13 dBm	1 kHz	Bandwidth as in ITU SM.329-9, s4.1
150kHz – 30MHz		10 kHz	Bandwidth as in ITU SM.329-9, s4.1
30MHz – 1GHz		100 kHz	Bandwidth as in ITU SM.329-9, s4.1
1GHz – 12.75 GHz		1 MHz	Upper frequency as in ITU SM.329-9, s2.5 table 1

NOTE: only the measurement bands are different according to the occupied bandwidth.

6.6.3.1.2 Spurious emissions (Category B)

The following requirements shall be met in cases where Category B limits for spurious emissions, as defined in ITU-R Recommendation SM.329-8 [1], are applied.

6.6.3.1.2.1 Minimum Requirement

6.6.3.1.2.1.1 3,84 Mcps TDD Option

The power of any spurious emission shall not exceed:

Table 6.11: BS Mandatory spurious emissions limits, Category B

Band	Maximum Level	Measurement Bandwidth	Notes
9kHz – 150kHz	-36 dBm	1 kHz	Note 1
150kHz – 30MHz	- 36 dBm	10 kHz	Note 1
30MHz – 1GHz	-36 dBm	100 kHz	Note 1
1GHz ↔ FI -10 MHz	-30 dBm	1 MHz	Note 1
FI -10MHz ↔ Fu +10 MHz	-15 dBm	1 MHz	Note 2
Fu + 10 MHz ↔ 12,75 GHz	-30 dBm	1 MHz	Note 3
NOTE 1: Bandwidth as in ITU SM.329 [1], s4.1 NOTE 2: Specification in accordance with ITU-R SM.329 [1], s4.3 and Annex 7 NOTE 3: Bandwidth as in ITU-R SM.329 [1], s4.3 and Annex 7. Upper frequency as in ITU-R SM.329 [1], s2.5 table 1			

Fl: Lower frequency of the band in which TDD operates

Fu: Upper frequency of the band in which TDD operates

6.6.3.1.2.1.2 1,28 Mcps TDD Option

The power of any spurious emission shall not exceed:

Table 6.11A: BS Mandatory spurious emissions limits, Category B

Band	Maximum Level	Measurement Bandwidth	Note
9kHz – 150kHz	-36 dBm	1 kHz	Bandwidth as in ITU SM.329-9, s4.1
150kHz – 30MHz	- 36 dBm	10 kHz	Bandwidth as in ITU SM.329-9, s4.1
30MHz – 1GHz	-36 dBm	100 kHz	Bandwidth as in ITU SM.329-9, s4.1
1GHz ↔ Fc1-19.2 MHz or FI –10 MHz <i>whichever is the higher</i>	-30 dBm	1 MHz	Bandwidth as in ITU SM.329-9, s4.1
Fc1 – 19.2 MHz or FI -10MHz <i>whichever is the higher</i> ↔ Fc1 - 16 MHz or FI –10 MHz <i>whichever is the higher</i>	-25 dBm	1 MHz	Specification in accordance with ITU-R SM.329-9, s4.1
Fc1 - 16 MHz or FI –10 MHz <i>whichever is the higher</i> ↔ Fc2 + 16 MHz or Fu +10 MHz <i>whichever is the lower</i>	-15 dBm	1 MHz	Specification in accordance with ITU-R SM.329-9, s4.1
Fc2 + 16 MHz or Fu + 10MHz <i>whichever is the lower</i> ↔ Fc2 +19.2 MHz or Fu + 10MHz <i>whichever is the lower</i>	-25 dBm	1 MHz	Specification in accordance with ITU-R SM.329-9, s4.1
Fc2 + 19.2 MHz or Fu +10 MHz <i>whichever is the lower</i> ↔ 12,5 GHz	-30 dBm	1 MHz	Bandwidth as in ITU-R SM.329-9, s4.1. Upper frequency as in ITU-R SM.329-9, s2.5 table 1

Fc1: Center frequency of emission of the first carrier transmitted by the BS

Fc2: Center frequency of emission of the last carrier transmitted by the BS

F_l : Lower frequency of the band in which TDD operates

F_u : Upper frequency of the band in which TDD operates

6.6.3.2 Co-existence with GSM 900

6.6.3.2.1 Operation in the same geographic area

This requirement may be applied for the protection of GSM 900 MS and GSM 900 BTS receivers in geographic areas in which both GSM 900 and UTRA are deployed.

6.6.3.2.1.1 Minimum Requirement

The power of any spurious emission shall not exceed:

Table 6.12: BS Spurious emissions limits for BS in geographic coverage area of GSM 900 MS and GSM 900 BTS receiver

Band	Maximum Level	Measurement Bandwidth	Note
876 – 915 MHz	-61 dBm	100 kHz	
921 – 960MHz	-57 dBm	100 kHz	

6.6.3.2.2 Co-located base stations

This requirement may be applied for the protection of GSM 900 BTS receivers when GSM 900 BTS and UTRA BS are co-located.

6.6.3.2.2.1 Minimum Requirement

The power of any spurious emission shall not exceed:

Table 6.13: BS Spurious emissions limits for protection of the GSM 900 BTS receiver

Band	Maximum Level	Measurement Bandwidth	Note
876 – 915 MHz	-98 dBm	100 kHz	

6.6.3.3 Co-existence with DCS 1800

6.6.3.3.1 Operation in the same geographic area

This requirement may be applied for the protection of DCS 1800 MS and DCS 1800 BTS receivers in geographic areas in which both DCS 1800 and UTRA are deployed.

6.6.3.3.1.1 Minimum Requirement

The power of any spurious emission shall not exceed:

Table 6.14: BS Spurious emissions limits for BS in geographic coverage area of DCS 1800 MS and DCS 1800 BTS receiver

Band	Maximum Level	Measurement Bandwidth	Note
1710 – 1785 MHz	-61 dBm	100 kHz	
1805 – 1880MHz	-47 dBm	100 kHz	

6.6.3.3.2 Co-located base stations

This requirement may be applied for the protection of DCS 1800 BTS receivers when DCS 1800 BTS and UTRA BS are co-located.

6.6.3.3.2.1 Minimum Requirement

The power of any spurious emission shall not exceed:

Table 6.15: BS Spurious emissions limits for BS co-located with DCS 1800 BTS

Band	Maximum Level	Measurement Bandwidth	Note
1710 – 1785 MHz	-98 dBm	100 kHz	

6.6.3.4 Co-existence with UTRA-FDD

6.6.3.4.1 Operation in the same geographic area

This requirement may be applied to geographic areas in which both UTRA-TDD and UTRA-FDD are deployed.

6.6.3.4.1.1 Minimum Requirement

For TDD base stations which use carrier frequencies within the band 2010 – 2025 MHz the requirements applies at all frequencies within the specified frequency bands in table 6.16. For 3.84 Mcps TDD option base stations which use a carrier frequency within the band 1900-1920 MHz, the requirement applies at frequencies within the specified frequency range which are more than 12,5 MHz above the last carrier used in the frequency band 1900-1920 MHz. For 1.28 Mcps TDD option base stations which use carrier frequencies within the band 1900-1920 MHz, the requirement applies at frequencies within the specified frequency range which are more than 4 MHz above the last carrier used in the frequency band 1900-1920 MHz.

The power of any spurious emission shall not exceed:

Table 6.16: BS Spurious emissions limits for BS in geographic coverage area of UTRA-FDD

Band	Maximum Level	Measurement Bandwidth
1920 – 1980 MHz	-43 dBm (*)	3,84 MHz
2110 – 2170 MHz	-52 dBm	1 MHz
NOTE*	For 3.84 Mcps TDD option base stations, the requirement shall be measured RRC filtered mean power with the lowest center frequency of measurement at 1922.6 MHz or 15 MHz above the last TDD carrier used, whichever is higher. For 1.28 Mcps TDD option base stations, the requirement shall be measured RRC filtered mean power with the lowest center frequency of measurement at 1922.6 MHz or 6.6 MHz above the last TDD carrier used, whichever is higher.	

NOTE: The requirements in Table 6.16 are based on a coupling loss of 67dB between the TDD and FDD base stations. The scenarios leading to these requirements are addressed in TR 25.942 [4].

6.6.3.4.2 Co-located base stations

This requirement may be applied for the protection of UTRA-FDD BS receivers when UTRA-TDD BS and UTRA FDD BS are co-located.

6.6.3.4.2.1 Minimum Requirement

For TDD base stations which use carrier frequencies within the band 2010 – 2025 MHz the requirements applies at all frequencies within the specified frequency bands in table 6.17. For 3.84 Mcps TDD option base stations which use a carrier frequency within the band 1900-1920 MHz, the requirement applies at frequencies within the specified frequency range which are more than 12,5 MHz above the last carrier used in the frequency band 1900-1920 MHz. For

1.28 Mcps TDD option base stations which use carrier frequencies within the band 1900-1920 MHz, the requirement applies at frequencies within the specified frequency range which are more than 4 MHz above the last carrier used in the frequency band 1900-1920 MHz.

The power of any spurious emission shall not exceed:

Table 6.17: BS Spurious emissions limits for BS co-located with UTRA-FDD

Band	Maximum Level	Measurement Bandwidth
1920 – 1980 MHz	-80 dBm (*)	3,84 MHz
2110 – 2170 MHz	-52 dBm	1 MHz
NOTE * For 3.84 Mcps TDD option base stations, the requirement shall be measured RRC filtered mean power with the lowest center frequency of measurement at 1922.6 MHz or 15 MHz above the last TDD carrier used, whichever is higher. For 1.28 Mcps TDD option base stations, the requirement shall be measured RRC filtered mean power with the lowest center frequency of measurement at 1922.6 MHz or 6.6 MHz above the last TDD carrier used, whichever is higher.		

NOTE: The requirements in Table 6.17 are based on a minimum coupling loss of 30 dB between base stations.

6.6.3.5 Co-existence with unsynchronised TDD

6.6.3.5.1 Operation in the same geographic area

This requirement shall apply in case the equipment is operated in the same geographic area with unsynchronised TDD BS.

6.6.3.5.1.1 Minimum Requirement

6.6.3.5.1.1.1 3,84 Mcps TDD option

The RRC filtered mean power of any spurious emission shall not exceed the limits specified in table 6.18.

Table 6.18: BS Spurious emissions limits for operation in same geographic area with unsynchronised TDD

Band	Maximum Level	Measurement Bandwidth
1900 – 1920 MHz	-39 dBm	3,84 MHz
2010 – 2025 MHz	-39 dBm	3,84 MHz

NOTE: The requirements in Table 6.18 are based on a minimum coupling loss of 67 dB between unsynchronised TDD base stations. The scenarios leading to these requirements are addressed in TR25.942 [4].

6.6.3.5.1.1.2 1,28 Mcps TDD option

In geographic areas where only 1,28 Mcps TDD is deployed, the RRC filtered mean power of any spurious emission shall not exceed the limits specified in table 6.19, otherwise the limits in table 6.20 shall apply.

Table 6.19: BS Spurious emissions limits for operation in same geographic area with unsynchronised 1,28 Mcps TDD

Band	Maximum Level	Measurement Bandwidth
1900 – 1920 MHz	-39 dBm	1,28 MHz
2010 – 2025 MHz	-39 dBm	1,28 MHz

Table 6.20: BS Spurious emissions limits for operation in same geographic area with unsynchronised TDD

Band	Maximum Level	Measurement Bandwidth
1900 – 1920 MHz	–39 dBm	3,84 MHz
2010 – 2025 MHz	–39 dBm	3,84 MHz

NOTE: The requirements in Table 6.19 and 6.20 are based on a minimum coupling loss of 67 dB between unsynchronised TDD base stations. The scenarios leading to these requirements are addressed in TR25.942 [4].

6.6.3.5.2 Co-located base stations

This requirement shall apply in case of co-location with unsynchronised TDD BS.

6.6.3.5.2.1 Minimum Requirement

6.6.3.5.2.1.1 3,84 Mcps TDD option

The RRC filtered mean power of any spurious emission in case of co-location shall not exceed the limits specified in table 6.21.

Table 6.21: BS Spurious emissions limits for co-location with unsynchronised TDD

Band	Maximum Level	Measurement Bandwidth
1900 – 1920 MHz	–76 dBm	3,84 MHz
2010 – 2025 MHz	–76 dBm	3,84 MHz

NOTE: The requirements in Table 6.21 are based on a minimum coupling loss of 30 dB between unsynchronised TDD base stations.

6.6.3.5.2.1.2 1,28 Mcps TDD option

In geographic areas where only 1,28 Mcps TDD is deployed, the RRC filtered mean power of any spurious emission in case of co-location shall not exceed the limits specified in table 6.22, otherwise the limits in table 6.23 shall apply.

Table 6.22: BS Spurious emissions limits for co-location with unsynchronised 1,28 Mcps TDD

Band	Maximum Level	Measurement Bandwidth
1900 – 1920 MHz	–76 dBm	1,28 MHz
2010 – 2025 MHz	–76 dBm	1,28 MHz

Table 6.23: BS Spurious emissions limits for co-location with unsynchronised TDD

Band	Maximum Level	Measurement Bandwidth
1900 – 1920 MHz	–76 dBm	3,84 MHz
2010 – 2025 MHz	–76 dBm	3,84 MHz

NOTE: The requirements in Table 6.22 and 6.23 are based on a minimum coupling loss of 30 dB between unsynchronised TDD base stations.

6.6.3.6 Co-existence with PHS

This requirement may be applied for the protection of PHS in geographic areas in which both PHS and UTRA TDD are deployed. For 3.84 Mcps TDD option, this requirement is also applicable at specified frequencies falling between 12.5MHz below the first carrier frequency used and 12.5MHz above the last carrier frequency used.

6.6.3.6.1 Minimum Requirement

6.6.3.6.1.1 3,84 Mcps TDD option

The power of any spurious emission shall not exceed:

Table 6.24: BS Spurious emissions limits for BS in geographic coverage area of PHS (3.84 Mcps TDD option)

Band	Maximum Level	Measurement Bandwidth	Note
1884.5 – 1919.6 MHz	-41 dBm	300 kHz	Applicable for transmission in 2010-2025 MHz as defined in subclause 5.2 (a).

6.7 Transmit intermodulation

The transmit intermodulation performance is a measure of the capability of the transmitter to inhibit the generation of signals in its non linear elements caused by presence of the wanted signal and an interfering signal reaching the transmitter via the antenna.

The transmit intermodulation level is the power of the intermodulation products when a CDMA modulated interference signal is injected into the antenna connector at a mean power level of 30 dB lower than that of the mean power of the subject signal.

6.7.1 Minimum Requirement

6.7.1.1 3,84 Mcps TDD Option

The frequency of the interference signal shall be ± 5 MHz, ± 10 MHz and ± 15 MHz offset from the subject signal. The Transmit intermodulation level shall not exceed the out of band or the spurious emission requirements of section 6.6.2 and 6.6.3.

6.7.1.2 1,28 Mcps TDD Option

The frequency of the interference signal shall be ± 1.6 MHz, ± 3.2 MHz and ± 4.8 MHz offset from the subject signal. The Transmit intermodulation level shall not exceed the out of band or the spurious emission requirements of section 6.6.2 and 6.6.3.

6.8 Transmit modulation

6.8.1 Transmit pulse shape filter

The transmit pulse-shaping filter is a root-raised cosine (RRC) with roll-off $\alpha = 0.22$ in the frequency domain. The impulse response of the chip impulse filter $RC_0(t)$ is

$$RC_0(t) = \frac{\sin\left(\pi \frac{t}{T_c}(1-\alpha)\right) + 4\alpha \frac{t}{T_c} \cos\left(\pi \frac{t}{T_c}(1+\alpha)\right)}{\pi \frac{t}{T_c} \left(1 - \left(4\alpha \frac{t}{T_c}\right)^2\right)}$$

Where the roll-off factor $\alpha = 0.22$ and T_c is the chip duration.

6.8.2 Modulation Accuracy

The Error Vector Magnitude is a measure of the difference between the reference waveform and the measured waveform. This difference is called the error vector. Both waveforms pass through a matched Root Raised Cosine filter with bandwidth corresponding to the considered chip rate and roll-off $\alpha = 0,22$. Both waveforms are then further modified by selecting the frequency, absolute phase, absolute amplitude and chip clock timing so as to minimise the error vector. The EVM result is defined as the square root of the ratio of the mean error vector power to the mean reference power expressed as a %. The measurement interval is one timeslot. The requirement is valid over the total power dynamic range as specified in subclause 3.1. See Annex C of TS 25.142 for further details.

6.8.2.1 Minimum Requirement

The Modulation accuracy shall not be worse than 12.5 %.

6.8.3 Peak Code Domain Error

The code domain error is computed by projecting the error vector power onto the code domain at a specific spreading factor. The error power for each code is defined as the ratio to the mean power of the reference waveform expressed in dB. And the Peak Code Domain Error is defined as the maximum value for Code Domain Error. The measurement interval is one timeslot.

6.8.3.1 Minimum Requirement

The peak code domain error shall not exceed -28 dB at spreading factor 16.

7 Receiver characteristics

7.1 General

The requirements in this clause 7 assume that the receiver is not equipped with diversity. For receivers with diversity, the requirements apply to each antenna connector separately, with the other one(s) terminated or disabled. The requirements are otherwise unchanged.

Unless otherwise stated, the receiver characteristics are specified at the BS antenna connector (test port A) with a full complement of transceivers for the configuration in normal operating conditions. If any external apparatus such as a RX amplifier, a filter or the combination of such devices is used, requirements apply at the far end antenna connector (port B).

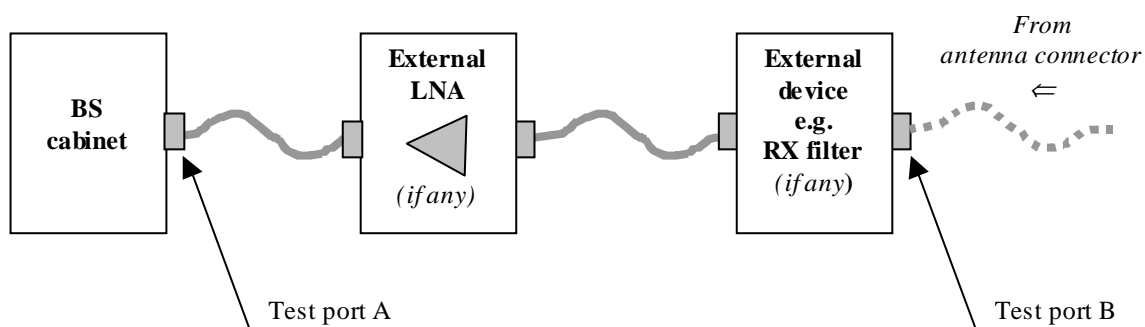

Figure 7.1: Receiver test ports

7.2 Reference sensitivity level

The reference sensitivity level is the minimum mean power received at the antenna connector at which the BER shall not exceed the specific value indicated in section 7.2.1.

7.2.1 Minimum Requirement

7.2.1.1 3,84 Mcps TDD Option

Using the reference measurement channel specified in Annex A, the reference sensitivity level and performance of the BS shall be as specified in table 7.1.

Table 7.1: BS reference sensitivity level

Reference measurement channel data rate	BS reference sensitivity level	BER
12.2 kbps	-109 dBm	BER shall not exceed 0.001

7.2.1.2 1,28 Mcps TDD Option

Using the reference measurement channel specified in Annex A, the reference sensitivity level and performance of the BS shall be as specified in table 7.1A.

Table 7.1A: BS reference sensitivity level

Reference measurement channel data rate	BS reference sensitivity level	BER
12.2 kbps	-110 dBm	BER shall not exceed 0.001

7.3 Dynamic range

Receiver dynamic range is the receiver ability to handle a rise of interference in the reception frequency channel. The receiver shall fulfil a specified BER requirement for a specified sensitivity degradation of the wanted signal in the presence of an interfering AWGN signal in the same reception frequency channel.

7.3.1 Minimum requirement

7.3.1.1 3,84 Mcps TDD Option

The BER shall not exceed 0.001 for the parameters specified in Table 7.2.

Table 7.2: Dynamic Range

Parameter	Level	Unit
Reference measurement channel data rate	12.2	kbps
Wanted signal mean power	-79	dBm
Interfering AWGN signal	-73	dBm/3.84 MHz

7.3.1.2 1,28 Mcps TDD Option:

The BER shall not exceed 0.001 for the parameters specified in Table 7.2A.

Table 7.2A: Dynamic Range

Parameter	Level	Unit
Reference measurement channel data rate	12.2	kbps
Wanted signal mean power	-80	dBm
Interfering AWGN signal	-76dBm	dBm/1.28 MHz

7.4 Adjacent Channel Selectivity (ACS)

Adjacent channel selectivity (ACS) is a measure of the receiver ability to receive a wanted signal at its assigned channel frequency in the presence of a single code CDMA modulated adjacent channel signal at a given frequency offset from the center frequency of the assigned channel. ACS is the ratio of the receiver filter attenuation on the assigned channel frequency to the receiver filter attenuation on the adjacent channel(s).

7.4.1 Minimum Requirement

7.4.1.1 3,84 Mcps TDD Option

The BER shall not exceed 0.001 for the parameters specified in table 7.3.

Table 7.3: Adjacent channel selectivity

Parameter	Level	Unit
Reference measurement channel data rate	12.2	kbps
Wanted signal mean power	-103	dBm
Interfering signal	-52	dBm
Fuw offset (Modulated)	5	MHz

7.4.1.2 1,28 Mcps TDD Option

The BER shall not exceed 0.001 for the parameters specified in table 7.3A.

Table 7.3A: Adjacent channel selectivity

Parameter	Level	Unit
Reference measurement channel data rate	12.2	kbps
Wanted signal mean power	-104	dBm
Interfering signal mean power	-55	dBm
Fuw offset (Modulated)	1.6	MHz

7.5 Blocking characteristics

The blocking characteristics is a measure of the receiver ability to receive a wanted signal at its assigned channel frequency in the presence of an unwanted interferer on frequencies other than those of the adjacent channels. The blocking performance requirement applies to interfering signals with center frequency within the ranges specified in the tables below, using a 1MHz step size.

7.5.0 Minimum requirement

The static reference performance as specified in clause 7.2.1 shall be met with a wanted and an interfering signal coupled to BS antenna input using the following parameters.

7.5.0.1 3,84 Mcps TDD Option

Table 7.4(a): Blocking requirements for operating bands defined in 5.2(a)

Centre Frequency of Interfering Signal	Interfering Signal Mean Power	Wanted Signal Mean Power	Minimum Offset of Interfering Signal	Type of Interfering Signal
1900 – 1920 MHz, 2010 – 2025 MHz	-40 dBm	-103 dBm	10 MHz	WCDMA signal with one code
1880 – 1900 MHz, 1990 – 2010 MHz, 2025 – 2045 MHz	-40 dBm	-103 dBm	10 MHz	WCDMA signal with one code
1920 – 1980 MHz	-40 dBm	-103 dBm	10 MHz	WCDMA signal with one code
1 – 1880 MHz, 1980 – 1990 MHz, 2045 – 12750 MHz	-15 dBm	-103 dBm	—	CW carrier

Table 7.4(b) : Blocking requirements for operating bands defined in 5.2(b)

Centre Frequency of Interfering Signal	Interfering Signal Mean Power	Wanted Signal Mean Power	Minimum Offset of Interfering Signal	Type of Interfering Signal
1850 – 1990 MHz	-40 dBm	-103 dBm	10 MHz	WCDMA signal with one code
1830 – 1850 MHz, 1990 – 2010 MHz	-40 dBm	-103 dBm	10 MHz	WCDMA signal with one code
1 – 1830 MHz, 2010 – 12750 MHz	-15 dBm	-103 dBm	—	CW carrier

Table 7.4(c) : Blocking requirements for operating bands defined in 5.2(c)

Centre Frequency of Interfering Signal	Interfering Signal Mean Power	Wanted Signal Mean Power	Minimum Offset of Interfering Signal	Type of Interfering Signal
1910 – 1930 MHz	-40 dBm	-103 dBm	10 MHz	WCDMA signal with one code
1890 – 1910 MHz, 1930 – 1950 MHz	-40 dBm	-103 dBm	10 MHz	WCDMA signal with one code
1 – 1890 MHz, 1950 – 12750 MHz	-15 dBm	-103 dBm	—	CW carrier

7.5.0.2 1,28 Mcps TDD Option

Table 7.4A(a): Blocking requirements for operating bands defined in 5.2(a)

Center Frequency of Interfering Signal	Interfering Signal Mean Power	Wanted Signal Mean Power	Minimum Offset of Interfering Signal	Type of Interfering Signal
1900 – 1920 MHz, 2010 – 2025 MHz	-40 dBm	-104 dBm	3.2MHz	Narrow band CDMA signal with one code
1880 – 1900 MHz, 1990 – 2010 MHz, 2025 – 2045 MHz	-40dBm	-104 dBm	3.2MHz	Narrow band CDMA signal with one code
1920 – 1980 MHz	-40dBm	-104 dBm	3.2MHz	Narrow band CDMA signal with one code
1 – 1880 MHz, 1980 – 1990 MHz, 2045 – 12750 MHz	-15dBm	-104 dBm	—	CW carrier

Table 7.4A(b): Blocking requirements for operating bands defined in 5.2(b)

Center Frequency of Interfering Signal	Interfering Signal Mean Power	Wanted Signal Mean Power	Minimum Offset of Interfering Signal	Type of Interfering Signal
1850 – 1990 MHz	-40dBm	-104 dBm	3.2MHz	Narrow band CDMA signal with one code
1830 – 1850 MHz, 1990 – 2010 MHz	-40 dBm	-104 dBm	3.2MHz	Narrow band CDMA signal with one code
1 – 1830 MHz, 2010 – 12750 MHz	-15 dBm	-104 dBm	—	CW carrier

Table 7.4A(c): Blocking requirements for operating bands defined in 5.2(c)

Center Frequency of Interfering Signal	Interfering Signal Mean Power	Wanted Signal Mean Power	Minimum Offset of Interfering Signal	Type of Interfering Signal
1910 – 1930 MHz	-40dBm	-104 dBm	3.2MHz	Narrow band CDMA signal with one code
1890 – 1910 MHz, 1930 – 1950 MHz	-40dBm	-104 dBm	3.2 MHz	Narrow band CDMA signal with one code
1 – 1890 MHz, 1950 – 12750 MHz	-15 dBm	-104 dBm	—	CW carrier

7.5.1 Co-location with GSM900 and/or DCS 1800

This additional blocking requirement may be applied for the protection of TDD BS receivers when GSM900 and/or DCS1800 BTS are co-located with UTRA TDD BS.

The blocking performance requirement applies to interfering signals with center frequency within the ranges specified in the tables below, using a 1MHz step size.

In case this additional blocking requirement is applied, the static reference performance as specified in clause 7.2.1 shall be met with a wanted and an interfering signal coupled to BS antenna input using the following parameters.

7.5.1.1 3,84 Mcps TDD Option

Table 7.4 (d): Additional blocking requirements for operating bands defined in 5.2(a) when co-located with GSM900

Centre Frequency of Interfering Signal	Interfering Signal Mean Power	Wanted Signal Mean Power	Minimum Offset of Interfering Signal	Type of Interfering Signal
921 – 960 MHz	+16 dBm	-103 dBm	—	CW carrier

Table 7.4 (e): Additional blocking requirements for operating bands defined in 5.2(a) when co-located with DCS1800

Center Frequency of Interfering Signal	Interfering Signal Mean Power	Wanted Signal Mean Power	Minimum Offset of Interfering Signal	Type of Interfering Signal
1805 - 1880 MHz	+16 dBm	-103 dBm	—	CW carrier

7.5.1.2 1,28 Mcps TDD Option

Table 7.4A (d): Additional blocking requirements for operating bands defined in 5.2(a) when co-located with GSM900

Centre Frequency of Interfering Signal	Interfering Signal Mean Power	Wanted Signal Mean Power	Minimum Offset of Interfering Signal	Type of Interfering Signal
921 – 960 MHz	+16 dBm	-104 dBm	—	CW carrier

Table 7.4A (e): Additional blocking requirements for operating bands defined in 5.2(a) when co-located with DCS1800

Center Frequency of Interfering Signal	Interfering Signal Mean Power	Wanted Signal Mean Power	Minimum Offset of Interfering Signal	Type of Interfering Signal
1805 – 1880 MHz	+16 dBm	-104 dBm	—	CW carrier

7.6 Intermodulation characteristics

Third and higher order mixing of the two interfering RF signals can produce an interfering signal in the band of the desired channel. Intermodulation response rejection is a measure of the capability of the receiver to receive a wanted signal on its assigned channel frequency in the presence of two or more interfering signals which have a specific frequency relationship to the wanted signal.

7.6.1 Minimum requirement

The static reference performance as specified in clause 7.2.1 should be met when the following signals are coupled to BS antenna input.

- A wanted signal at the assigned channel frequency, with mean power 6 dB above the static reference level.
- Two interfering signals with the following parameters.

7.6.1.1 3,84 Mcps TDD Option

Table 7.5: Intermodulation requirement

Interfering Signal Mean Power	Offset	Type of Interfering Signal
- 48 dBm	10 MHz	CW signal
- 48 dBm	20 MHz	WCDMA signal with one code

7.6.1.2 1,28 Mcps TDD Option

Table 7.5A: Intermodulation requirement

Interfering Signal Mean Power	Offset	Type of Interfering Signal
- 48 dBm	3.2 MHz	CW signal
- 48 dBm	6.4 MHz	1,28 Mcps TDD Option signal with one code

7.7 Spurious emissions

The spurious emissions power is the power of emissions generated or amplified in a receiver that appear at the BS antenna connector. The requirements apply to all BS with separate RX and TX antenna port. The test shall be performed when both TX and RX are on with the TX port terminated.

For all BS with common RX and TX antenna port the transmitter spurious emission as specified in section 6.6.3 is valid.

7.7.1 Minimum Requirement

7.7.1.1 3,84 Mcps TDD Option

The power of any spurious emission shall not exceed:

Table 7.6: Receiver spurious emission requirements

Band	Maximum level	Measurement Bandwidth	Note
30 MHz – 1 GHz	-57 dBm	100 kHz	
1 GHz – 1.9 GHz and 1.98 GHz – 2.01 GHz	-47 dBm	1 MHz	With the exception of frequencies between 12.5MHz below the first carrier frequency and 12.5MHz above the last carrier frequency used by the BS.
1.9 GHz – 1.98 GHz and 2.01 GHz – 2.025 GHz	-78 dBm	3.84 MHz	With the exception of frequencies between 12.5MHz below the first carrier frequency and 12.5MHz above the last carrier frequency used by the BS.
2.025 GHz – 12.75 GHz	-47 dBm	1 MHz	With the exception of frequencies between 12.5MHz below the first carrier frequency and 12.5MHz above the last carrier frequency used by the BS.

In addition to the requirements in table 7.6, the co-existence requirements for co-located base stations specified in subclause 6.6.3.2.2, 6.6.3.3.2 and 6.6.3.4.2 may also be applied.

7.7.1.2 1,28 Mcps TDD Option

The power of any spurious emission shall not exceed:

Table 7.6A: Receiver spurious emission requirements

Band	Maximum level	Measurement Bandwidth	Note
30 MHz – 1 GHz	-57 dBm	100 kHz	
1 GHz – 1.9 GHz and 1.98 GHz – 2.01 GHz	-47 dBm	1 MHz	With the exception of frequencies between 4MHz below the first carrier frequency and 4MHz above the last carrier frequency used by the BS.
1.9 GHz – 1.98 GHz and 2.01 GHz – 2.025 GHz	-83 dBm	1.28 MHz	With the exception of frequencies between 4MHz below the first carrier frequency and 4MHz above the last carrier frequency used by the BS.
2.025 GHz – 12.75 GHz	-47 dBm	1 MHz	With the exception of frequencies between 4MHz below the first carrier frequency and 4MHz above the last carrier frequency used by the BS.

In addition to the requirements in table 7.6A, the co-existence requirements for co-located base stations specified in subclause 6.6.3.2.2, 6.6.3.3.2 and 6.6.3.4.2 may also be applied.

8 Performance requirement

8.1 General

Performance requirements for the BS are specified for the measurement channels defined in Annex A and the propagation conditions in Annex B. The requirements only apply to those measurement channels that are supported by the base station.

The requirements only apply to a base station with dual receiver antenna diversity. The required \hat{I}_{or}/I_{oc} shall be applied separately at each antenna port.

Table 8.1: Summary of Base Station performance targets

Physical channel	Measurement channel	Static	Multi-path Case 1	Multi-path Case 2	Multi-path Case 3
		Performance metric			
DCH	12.2 kbps	BLER<10 ⁻²	BLER<10 ⁻²	BLER<10 ⁻²	BLER<10 ⁻²
	64 kbps	BLER<10 ⁻¹ , 10 ⁻²	BLER<10 ⁻¹ , 10 ⁻²	BLER<10 ⁻¹ , 10 ⁻²	BLER<10 ⁻¹ , 10 ⁻² , 10 ⁻³
	144 kbps	BLER<10 ⁻¹ , 10 ⁻²	BLER<10 ⁻¹ , 10 ⁻²	BLER<10 ⁻¹ , 10 ⁻²	BLER<10 ⁻¹ , 10 ⁻² , 10 ⁻³
	384 kbps	BLER<10 ⁻¹ , 10 ⁻²	BLER<10 ⁻¹ , 10 ⁻²	BLER<10 ⁻¹ , 10 ⁻²	BLER<10 ⁻¹ , 10 ⁻² , 10 ⁻³

8.2 Demodulation in static propagation conditions

8.2.1 Demodulation of DCH

The performance requirement of DCH in static propagation conditions is determined by the maximum Block Error Rate (BLER) allowed when the receiver input signal is at a specified \hat{I}_{or}/I_{oc} limit. The BLER is calculated for each of the measurement channels supported by the base station.

8.2.1.1 Minimum requirement

8.2.1.1.1 3,84 Mcps TDD Option

For the parameters specified in Table 8.2 the BLER should not exceed the piece-wise linear BLER curve specified in Table 8.3. These requirements are applicable for TFCS size 16.

Table 8.2: Parameters in static propagation conditions

Parameters	Unit	Test 1	Test 2	Test 3	Test 4
Number of DPCH _o		6	4	0	0
$\frac{DPCH_o - E_c}{I_{or}}$	dB	-9	-9.5	0	0
I_{oc}	dBm/3.84 MHz	-89			
Cell Parameter*		0,1			
DPCH Channelization Codes*	C(k,Q)	C(1,8)	C(1,4) C(5,16)	C(1,2) C(9,16)	C(1,2)
DPCH _o Channelization Codes*	C(k,Q)	C(i,16) 3 ≤ i ≤ 8	C(i,16) 6 ≤ i ≤ 9	-	-
Information Data Rate	kbps	12.2	64	144	384

*Note: Refer to TS 25.223 for definition of channelization codes and cell parameter.

Table 8.3: Performance requirements in AWGN channel.

Test Number	$\frac{\hat{I}_{or}}{I_{oc}}$ [dB]	BLER
1	-2.0	10^{-2}
2	-0.4	10^{-1}
	-0.1	10^{-2}
3	-0.2	10^{-1}
	0.1	10^{-2}
4	-0.8	10^{-1}
	-0.6	10^{-2}

8.2.1.1.2 1,28 Mcps TDD Option

For the parameters specified in Table8.2A the BLER should not exceed the piece-wise linear BLER curve specified in Table8.3A. These requirements are applicable for TFCS size 16.

Table 8.2A: Parameters in static propagation conditions

Parameters	Unit	Test 1	Test 2	Test 3	Test 4
Number of DPCH _o		4	1	1	0
Spread factor of DPCH _o		8	8	8	-
Scrambling code and basic midamble code number*		0	0	0	0
DPCH Channelization Codes*	C(k,Q)	C(1,8)	C(1,2)	C(1,2)	C(1,2) C(5,8)
DPCH _o Channelization Codes*	C(k,Q)	C(i,8) 2 ≤ i ≤ 5	C(5,8)	C(5,8)	-
$\frac{DPCH_o - E_c}{I_{or}}$	dB	-7	-7	-7	0
I_{oc}	dBm/ 1.28MHz	-91			
Information Data Rate	Kbps	12.2	64	144	384

*Note: Refer to TS 25.223 for definition of channelization codes, scrambling code and basic midamble code.

Table 8.3A: Performance requirements in AWGN channel.

Test Number	$\frac{\hat{I}_{or}}{I_{oc}}$ [dB]	BLER
1	0.5	10^{-2}
2	-1.1	10^{-1}
	-0.7	10^{-2}
3	-0.5	10^{-1}
	-0.3	10^{-2}
4	0.1	10^{-1}
	0.4	10^{-2}

8.3 Demodulation of DCH in multipath fading conditions

8.3.1 Multipath fading Case 1

The performance requirement of DCH in multipath fading Case 1 is determined by the maximum Block Error Rate (BLER) allowed when the receiver input signal is at a specified \hat{I}_{or}/I_{oc} limit. The BLER is calculated for each of the measurement channels supported by the base station.

8.3.1.1 Minimum requirement

8.3.1.1.1 3,84 Mcps TDD Option

For the parameters specified in Table 8.4 the BLER should not exceed the piece-wise linear BLER curve specified in Table 8.5. These requirements are applicable for TFCS size 16.

Table 8.4: Parameters in multipath Case 1 channel

Parameters	Unit	Test 1	Test 2	Test 3	Test 4
Number of DPCH _o		6	4	0	0
$\frac{DPCH_o - E_c}{I_{or}}$	dB	-9	-9.5	0	0
I_{oc}	dBm/3.84 MHz	-89			
Cell Parameter*		0,1			
DPCH Channelization Codes*	C(k,Q)	C(1,8)	C(1,4) C(5,16)	C(1,2) C(9,16)	C(1,2)
DPCH _o Channelization Codes*	C(k,Q)	C(i,16) 3 ≤ i ≤ 8	C(i,16) 6 ≤ i ≤ 9	-	-
Information Data Rate	kbps	12.2	64	144	384

*Note: Refer to TS 25.223 for definition of channelization codes and cell parameter.

Table 8.5: Performance requirements in multipath Case 1 channel.

Test Number	$\frac{\hat{I}_{or}}{I_{oc}}$ [dB]	BLER
1	6.5	10 ⁻²
2	5.5	10 ⁻¹
	9.8	10 ⁻²
3	5.5	10 ⁻¹
	9.8	10 ⁻²
4	5.1	10 ⁻¹
	9.5	10 ⁻²

8.3.1.1.2 1,28 Mcps TDD Option

For the parameters specified in Table 8.4A the BLER should not exceed the piece-wise linear BLER curve specified in Table 8.5A. These requirements are applicable for TFCS size 16.

Table 8.4A: Parameters in multipath Case 1 channel

Parameters	Unit	Test 1	Test 2	Test 3	Test 4
Number of DPCH _o		4	1	1	0
Spread factor of DPCH _o		8	8	8	-
Scrambling code and basic midamble code number*		0	0	0	0
DPCH Channelization Codes*	C(k,Q)	C(1,8)	C(1,2)	C(1,2)	C(1,2) C(5,8)
DPCH _o Channelization Codes*	C(k,Q)	C(i,8) 2 ≤ i ≤ 5	C(5,8)	C(5,8)	-
$\frac{DPCH_o - E_c}{I_{or}}$	dB	-7	-7	-7	0
I_{oc}	dBm/1.28 MHz	-91			
Information Data Rate	Kbps	12.2	64	144	384

*Note: Refer to TS 25.223 for definition of channelization codes, scrambling code and basic midamble code.

Table 8.5A: Performance requirements in multipath Case 1 channel.

Test Number	$\frac{\hat{I}_{or}}{I_{oc}}$ [dB]	BLER
1	10.7	10^{-2}
2	5.3	10^{-1}
	9.6	10^{-2}
3	5.7	10^{-1}
	10.3	10^{-2}
4	6.0	10^{-1}
	10.3	10^{-2}

8.3.2 Multipath fading Case 2

The performance requirement of DCH in multipath fading Case 2 is determined by the maximum Block Error Rate (BLER) allowed when the receiver input signal is at a specified \hat{I}_{or}/I_{oc} limit. The BLER is calculated for each of the measurement channels supported by the base station.

8.3.2.1 Minimum requirement

8.3.2.1.1 3,84 Mcps TDD Option

For the parameters specified in Table 8.6 the BLER should not exceed the piece-wise linear BLER curve specified in Table 8.7. These requirements are applicable for TFCS size 16.

Table 8.6: Parameters in multipath Case 2 channel

Parameters	Unit	Test 1	Test 2	Test 3	Test 4
Number of DPCH _o		2	0	0	0
$\frac{DPCH_o - E_c}{I_{or}}$	dB	-6	0	0	0
I_{oc}	dBm/3.84 MHz	-89			
Cell Parameter*		0,1			
DPCH Channelization Codes*	C(k,Q)	C(1,8)	C(1,4) C(5,16)	C(1,2) C(9,16)	C(1,2)
DPCH _o Channelization Codes*	C(k,Q)	C(i,16) 3 ≤ i ≤ 4	-	-	-
Information Data Rate	kbps	12.2	64	144	384

*Note: Refer to TS 25.223 for definition of channelization codes and cell parameter.

Table 8.7: Performance requirements in multipath Case 2 channel.

Test Number	$\frac{\hat{I}_{or}}{I_{oc}}$ [dB]	BLER
1	-0.4	10^{-2}
2	0.2	10^{-1}
	2.5	10^{-2}
3	3.6	10^{-1}
	6.0	10^{-2}
4	2.8	10^{-1}
	5.2	10^{-2}

8.3.2.1.2 1,28 Mcps TDD Option

For the parameters specified in Table 8.6A the BLER should not exceed the piece-wise linear BLER curve specified in Table 8.7A. These requirements are applicable for TFCS size 16.

Table 8.6A: Parameters in multipath Case 2 channel

Parameters	Unit	Test 1	Test 2	Test 3	Test 4
Number of DPCH _o		4	1	1	0
Spread factor of DPCH _o		8	8	8	-
Scrambling code and basic midamble code number*		0	0	0	0
DPCH Channelization Codes*	C(k,Q)	C(1,8)	C(1,2)	C(1,2)	C(1,2) C(5,8)
DPCH _o Channelization Codes*	C(k,Q)	C(i,8) 2 ≤ i ≤ 5	C(5,8)	C(5,8)	-
$\frac{DPCH_{o} - E_c}{I_{or}}$	dB	-7	-7	-7	0
I _{oc}	dBm/1.28 MHz	-91			
Information Data Rate	Kbps	12.2	64	144	384

*Note: Refer to TS 25.223 for definition of channelization codes, scrambling code and basic midamble code.

Table 8.7A: Performance requirements in multipath Case 2 channel.

Test Number	$\frac{\hat{I}_{or}}{I_{oc}}$ [dB]	BLER
1	6.7	10 ⁻²
2	3.5	10 ⁻¹
	5.9	10 ⁻²
3	4.0	10 ⁻¹
	6.4	10 ⁻²
4	4.4	10 ⁻¹
	6.3	10 ⁻²

8.3.3 Multipath fading Case 3

The performance requirement of DCH in multipath fading Case 3 is determined by the maximum Block Error Rate (BLER) allowed when the receiver input signal is at a specified \hat{I}_{or}/I_{oc} limit. The BLER is calculated for each of the measurement channels supported by the base station.

8.3.3.1 Minimum requirement

8.3.3.1.1 3,84 Mcps TDD Option

For the parameters specified in Table 8.8 the BLER should not exceed the piece-wise linear BLER curve specified in Table 8.9. These requirements are applicable for TFCS size 16.

Table 8.8: Parameters in multipath Case 3 channel

Parameters	Unit	Test 1	Test 2	Test 3	Test 4
Number of DPCH _o		2	0	0	0
$\frac{DPCH_{o} - E_c}{I_{or}}$	dB	-6	0	0	0
I _{oc}	dBm/3.84 MHz	-89			
Cell Parameter*		0,1			
DPCH Channelization Codes*	C(k,Q)	C(1,8)	C(1,4) C(5,16)	C(1,2) C(9,16)	C(1,2)
DPCH _o Channelization Codes*	C(k,Q)	C(i,16) 3 ≤ i ≤ 4	-	-	-
Information Data Rate	Kbps	12.2	64	144	384

*Note: Refer to TS 25.223 for definition of channelization codes and cell parameter.

Table 8.9: Performance requirements in multipath Case 3 channel.

Test Number	$\frac{\hat{I}_{or}}{I_{oc}}$ [dB]	BLER
1	-0.1	10^{-2}
2	0.8	10^{-1}
	2.7	10^{-2}
	4.2	10^{-3}
3	4.5	10^{-1}
	6.3	10^{-2}
	8.0	10^{-3}
4	3.6	10^{-1}
	5.0	10^{-2}
	6.3	10^{-3}

8.3.3.1.2 1,28 Mcps TDD Option

For the parameters specified in Table 8.8A the BLER should not exceed the piece-wise linear BLER curve specified in Table 8.9A. These requirements are applicable for TFCS size 16.

Table 8.8A: Parameters in multipath Case 3 channel

Parameters	Unit	Test 1	Test 2	Test 3	Test 4
Number of DPCH _o		4	1	1	0
Spread factor of DPCH _o		8	8	8	-
Scrambling code and basic midamble code number*		0	0	0	0
DPCH Channelization Codes*	C(k,Q)	C(1,8)	C(1,2)	C(1,2)	C(1,2) C(5,8)
DPCH _o Channelization Codes*	C(k,Q)	C(i,8) 2 ≤ i ≤ 5	C(5,8)	C(5,8)	-
$\frac{DPCH_o - E_c}{I_{or}}$	dB	-7	-7	-7	0
I_{oc}	dBm/1.28 MHz	-91			
Information Data Rate	Kbps	12.2	64	144	384

*Note: Refer to TS 25.223 for definition of channelization codes, scrambling code and basic midamble code.

Table 8.9A: Performance requirements in multipath Case 3 channel.

Test Number	$\frac{\hat{I}_{or}}{I_{oc}}$ [dB]	BLER
1	5.9	10^{-2}
2	3.2	10^{-1}
	4.8	10^{-2}
	6.1	10^{-3}
3	3.7	10^{-1}
	5.0	10^{-2}
	6.1	10^{-3}
4	4.1	10^{-1}
	5.1	10^{-2}
	5.9	10^{-3}

Annex A (normative): Measurement Channels

A.1 General

(void)

A.2 Reference measurement channel

A.2.1 UL reference measurement channel (12.2 kbps)

A.2.1.1 3,84 Mcps TDD Option

Table A.1

Parameter	Value
Information data rate	12.2 kbps
RU's allocated	2 RU
Midamble	512 chips
Interleaving	20 ms
Power control	2 Bit/user
TFCI	16 Bit/user
Inband signalling DCCH	2 kbps
Puncturing level at Code rate 1/3 : DCH of the DTCH / DCH of the DCCH	10% / 0%

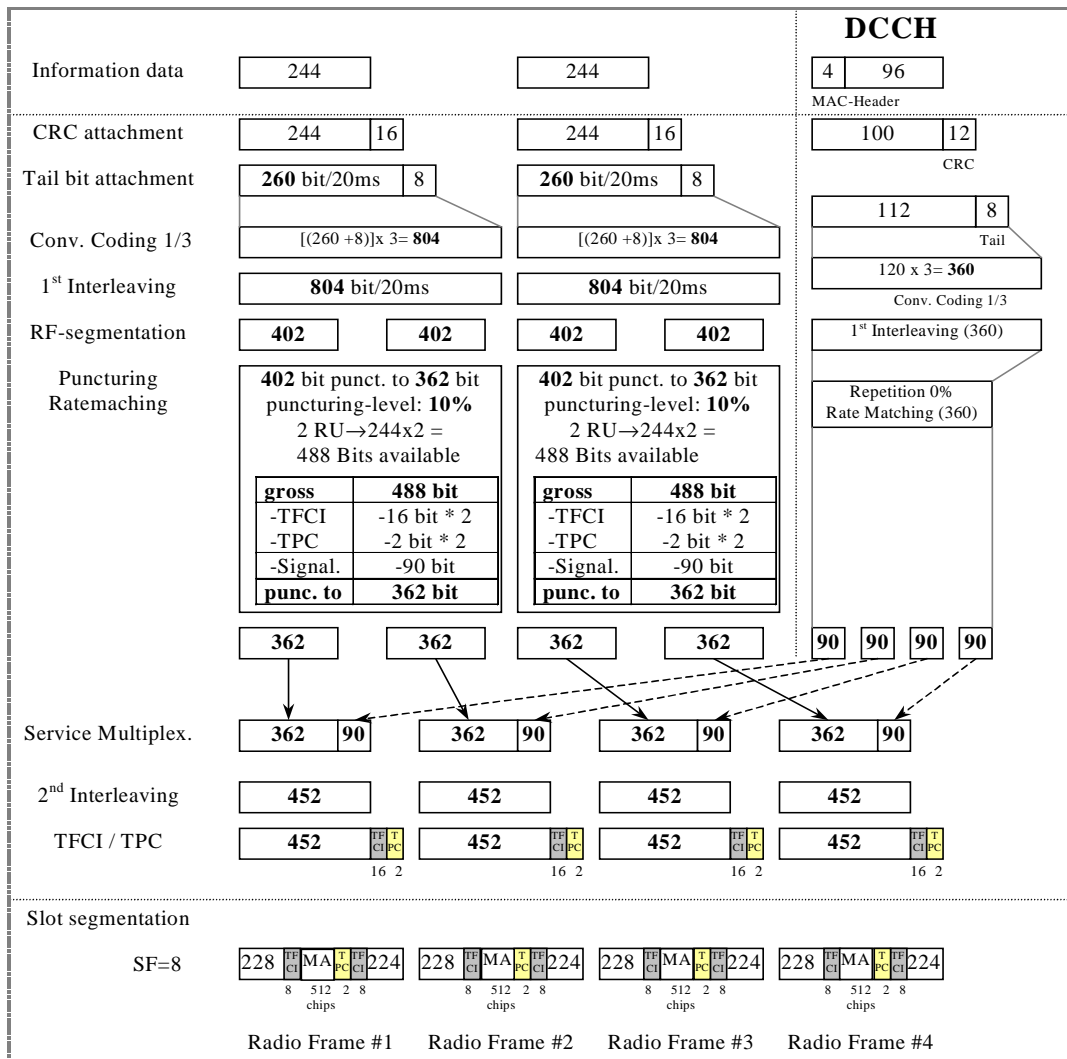

Figure A.1

A.2.1.2 1,28 Mcps TDD Option

Table A.1A

Parameter	Value
Information data rate	12.2 kbps
RU's allocated	1TS (1*SF8) = 2RU/5ms
Midamble	144
Interleaving	20 ms
Power control (TPC)	4 Bit/user/10ms
TFCI	16 Bit/user/10ms
Synchronisation Shift (SS)	4 Bit/user/10ms
Inband signalling DCCH	2.4 kbps
Puncturing level at Code rate 1/3: DCH of the DTCH / DCH of the DCCH	33% / 33%

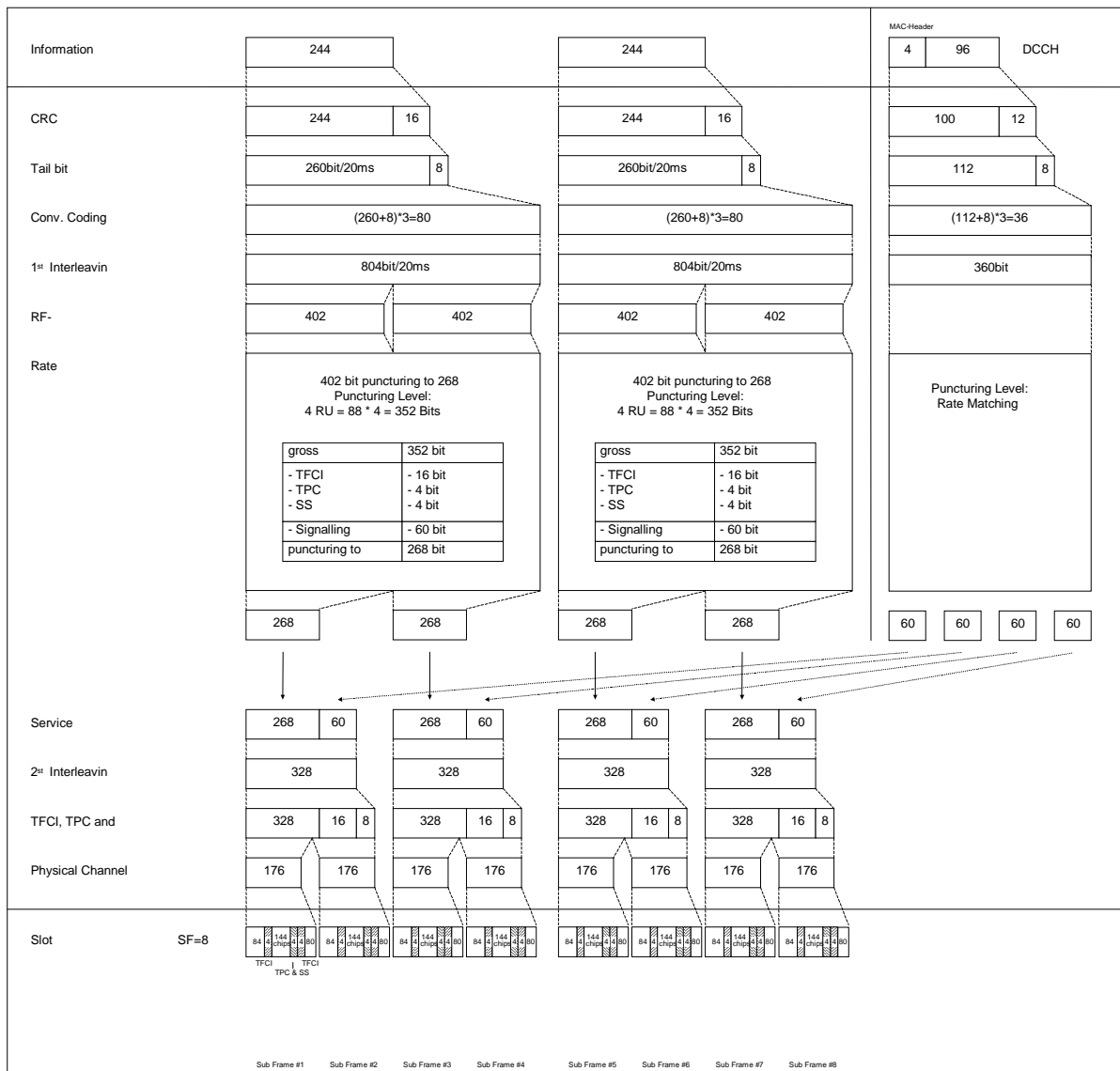

Figure A.1A

A.2.2 UL reference measurement channel (64 kbps)

A.2.2.1 3,84 Mcps TDD Option

Table A.2

Parameter	Value
Information data rate	64 kbps
RU's allocated	1 SF4 + 1 SF16 = 5RU
Midamble	512 chips
Interleaving	20 ms
Power control	2 Bit/user
TFCI	16 Bit/user
Inband signalling DCCH	2 kbps
Puncturing level at Code rate : 1/3 DCH of the DTCH / 1/2 DCH of the DCCH	43.8% / 13.3%

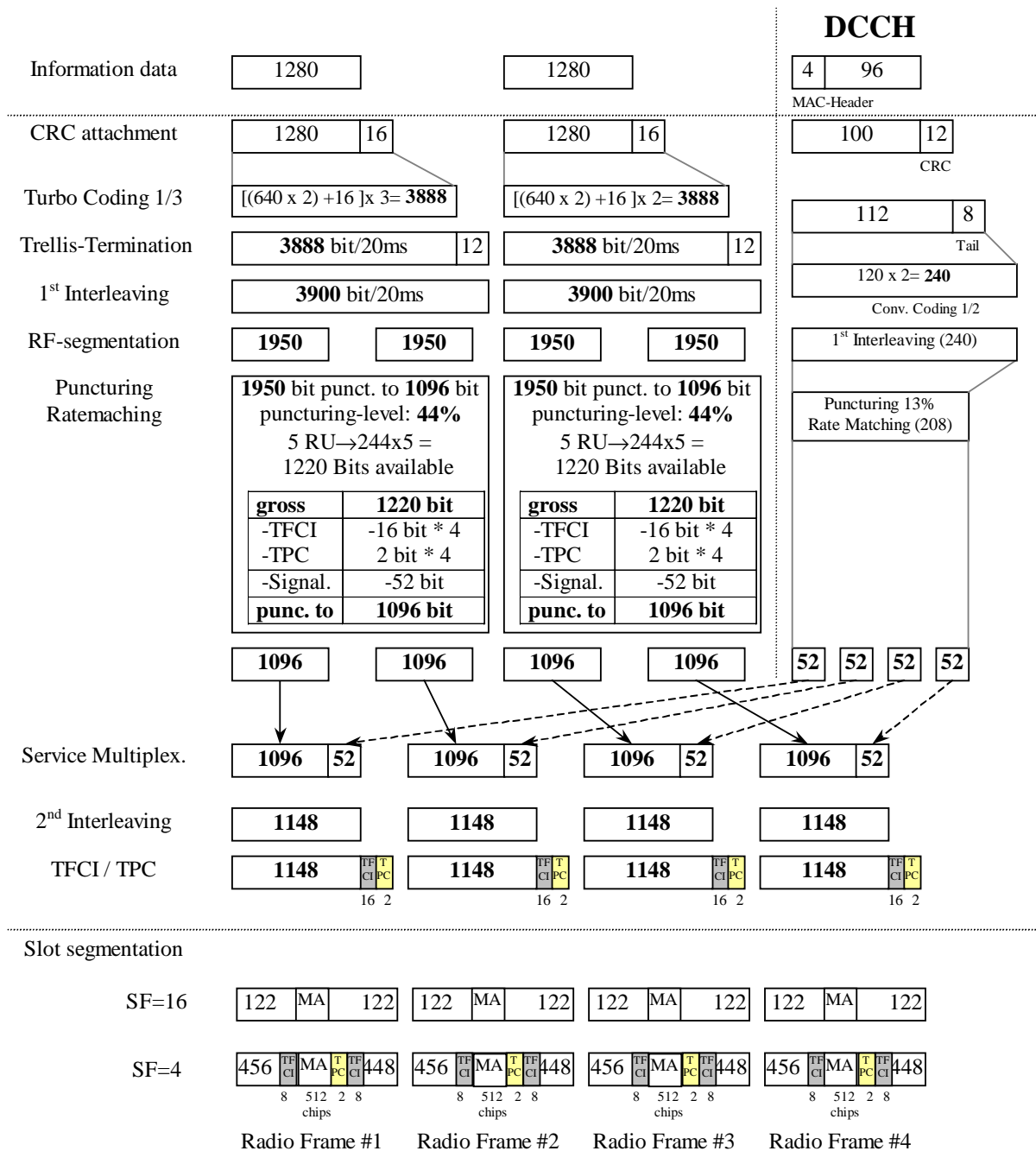

Figure A.2

A.2.2.2 1,28 Mcps TDD Option

Table A.2A

Parameter	Value
Information data rate	64 kbps
RU's allocated	1TS (1*SF2) = 8RU/5ms
Midamble	144
Interleaving	20 ms
Power control (TPC)	4 Bit/user/10ms
TFCI	16 Bit/user/10ms
Synchronisation Shift (SS)	4 Bit/user/10ms
Inband signalling DCCH	2.4 kbps
Puncturing level at Code rate: 1/3 DCH of the DTCH / 1/2 DCH of the DCCH	32% / 0

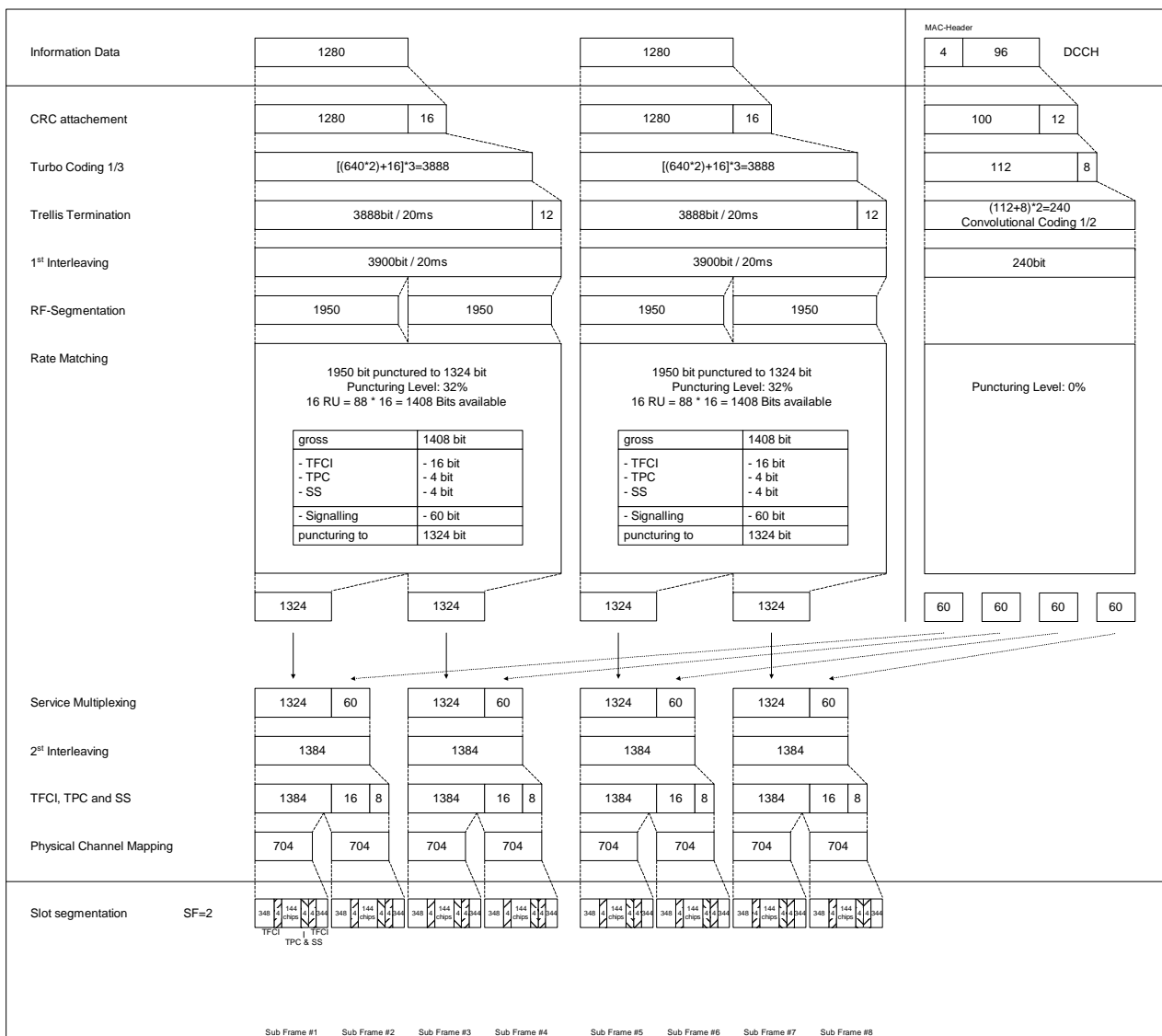

Figure A.2A

A.2.3 UL reference measurement channel (144 kbps)

A.2.3.1 3,84 Mcps TDD Option

Table A.3

Parameter	Value
Information data rate	144 kbps
RU's allocated	1 SF2 + 1 SF16 = 9RU
Midamble	256 chips
Interleaving	20 ms
Power control	2 Bit/user
TFCI	16 Bit/user
Inband signalling DCCH	2 kbps
Puncturing level at Code rate : 1/3 DCH of the DTCH / 1/2 DCH of the DCCH	47.3% / 20%

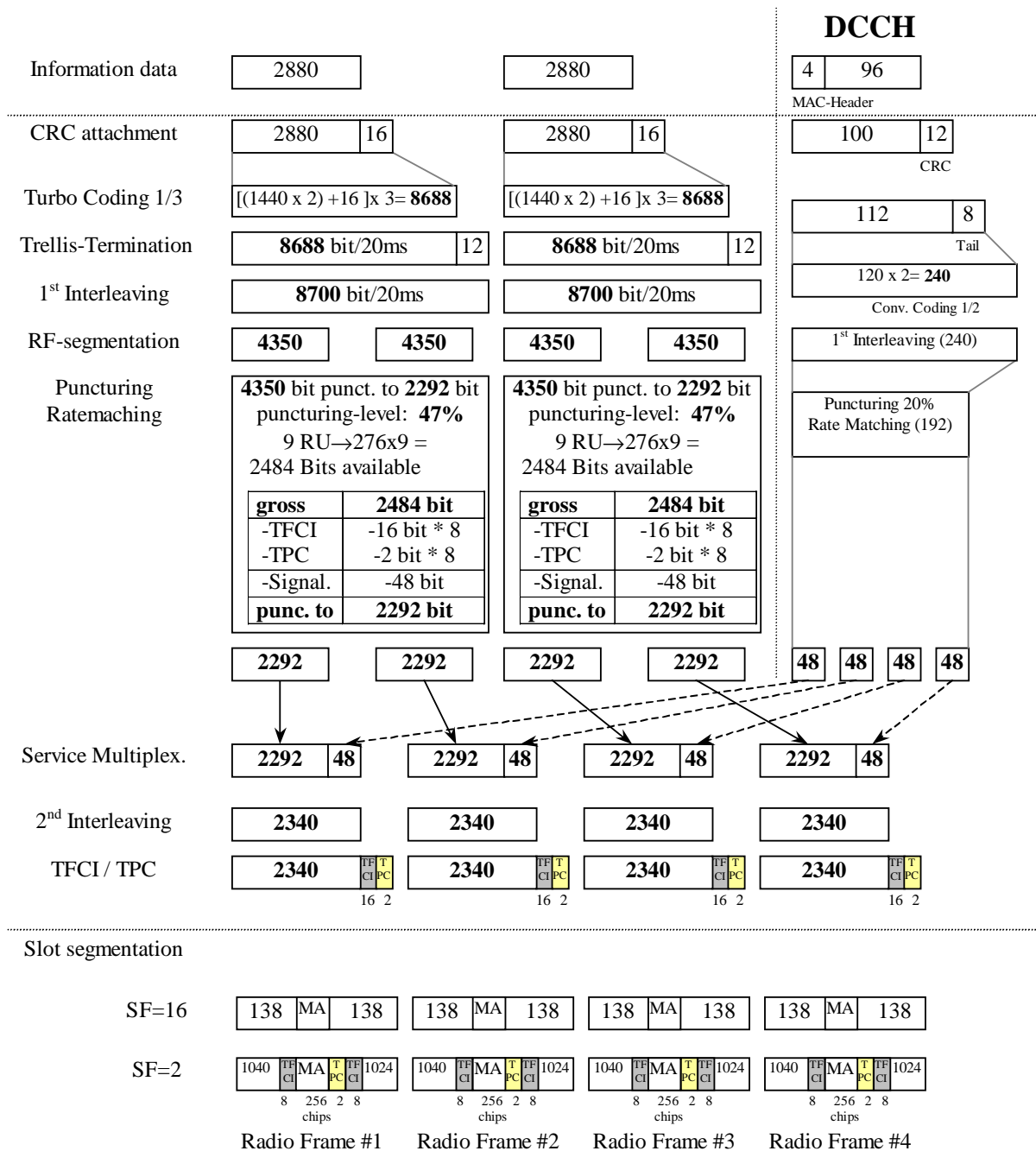

Figure A.3

A.2.3.2 1,28 Mcps TDD Option

Table A.3A

Parameter	Value
Information data rate	144 kbps
RU's allocated	2TS (1*SF2) = 16RU/5ms
Midamble	144
Interleaving	20 ms
Power control (TPC)	8 Bit/user/10ms
TFCI	32 Bit/user/10ms
Synchronisation Shift (SS)	8 Bit/user/10ms
Inband signalling DCCH	2.4 kbps
Puncturing level at Code rate: 1/3 DCH of the DTCH / 1/2 DCH of the DCCH	38% / 7%

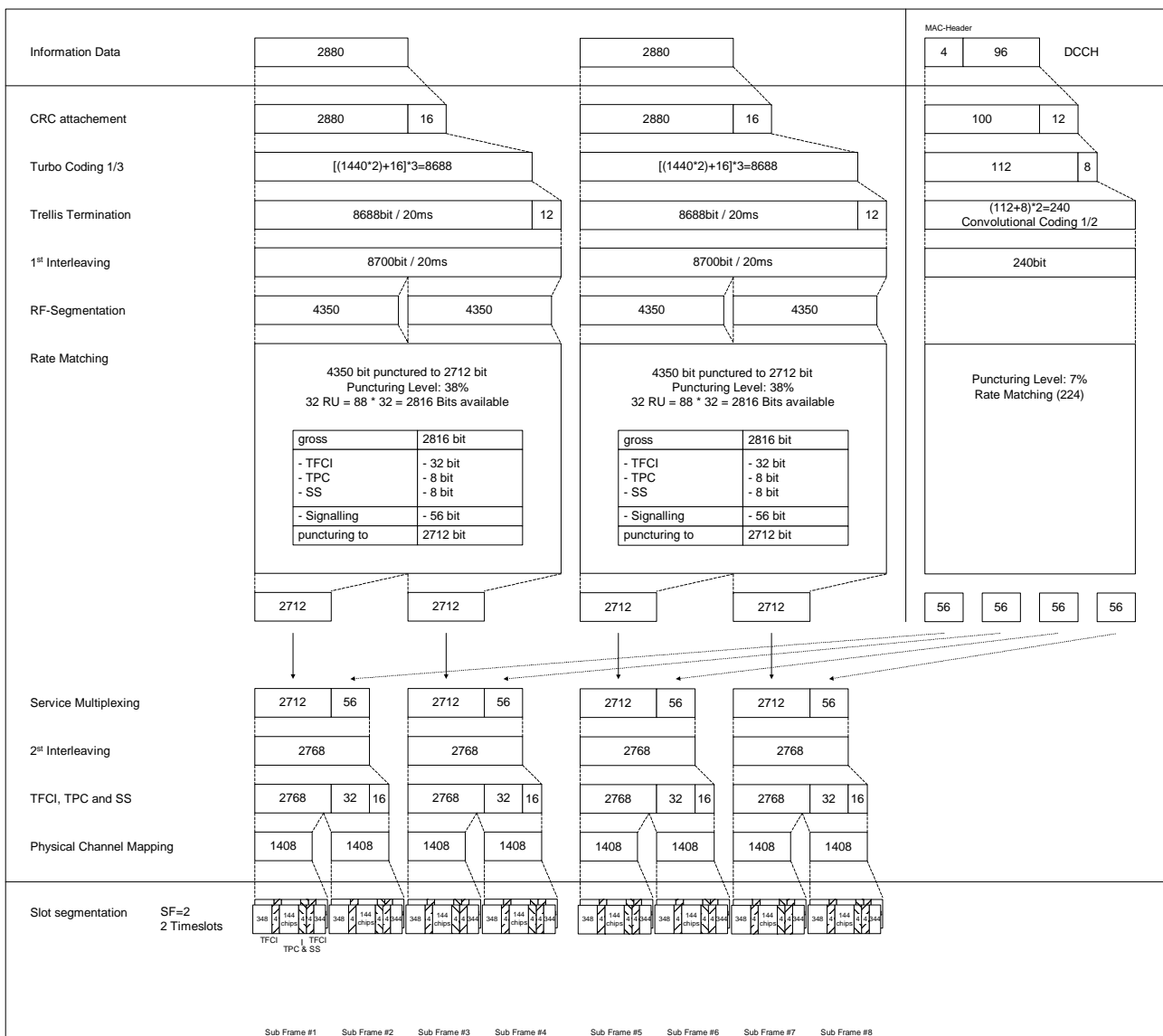

Figure A.3A

A.2.4 UL reference measurement channel (384 kbps)

A.2.4.1 3,84 Mcps TDD Option

Table A.4

Parameter	Value
Information data rate	384 kbps
RU's allocated	8*3TS = 24RU
Midamble	256 chips
Interleaving	20 ms
Power control	2 Bit/user
TFCI	16 Bit/user
Inband signalling DCCH	2 kbps
Puncturing level at Code rate : 1/3 DCH of the DTCH / 1/2 DCH of the DCCH	43.4% / 15.3%

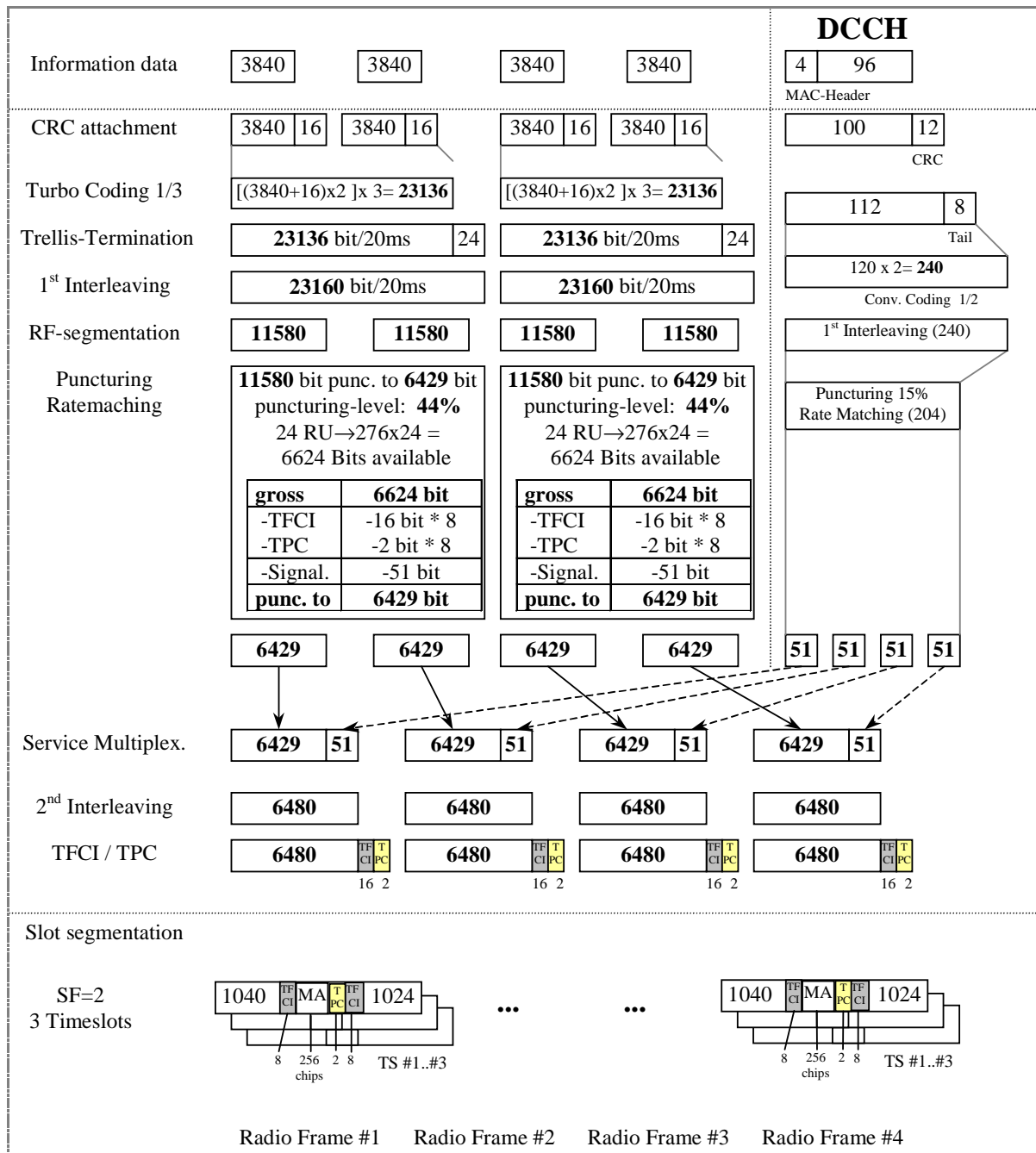

Figure A.4

A.2.4.2 1,28 Mcps TDD Option

Table A.4A

Parameter	Value
Information data rate	384 kbps
RU's allocated	4TS (1*SF2 + 1*SF8) = 40RU/5ms
Midamble	144
Interleaving	20 ms
Power control (TPC)	16 Bit/user/10ms
TFCI	64 Bit/user/10ms
Synchronisation Shift (SS)	16 Bit/user/10ms
Inband signalling DCCH	max 2.0 kbps
Puncturing level at Code rate: 1/3 DCH of the DTCH / 1/2 DCH of the DCCH	41% / 12%

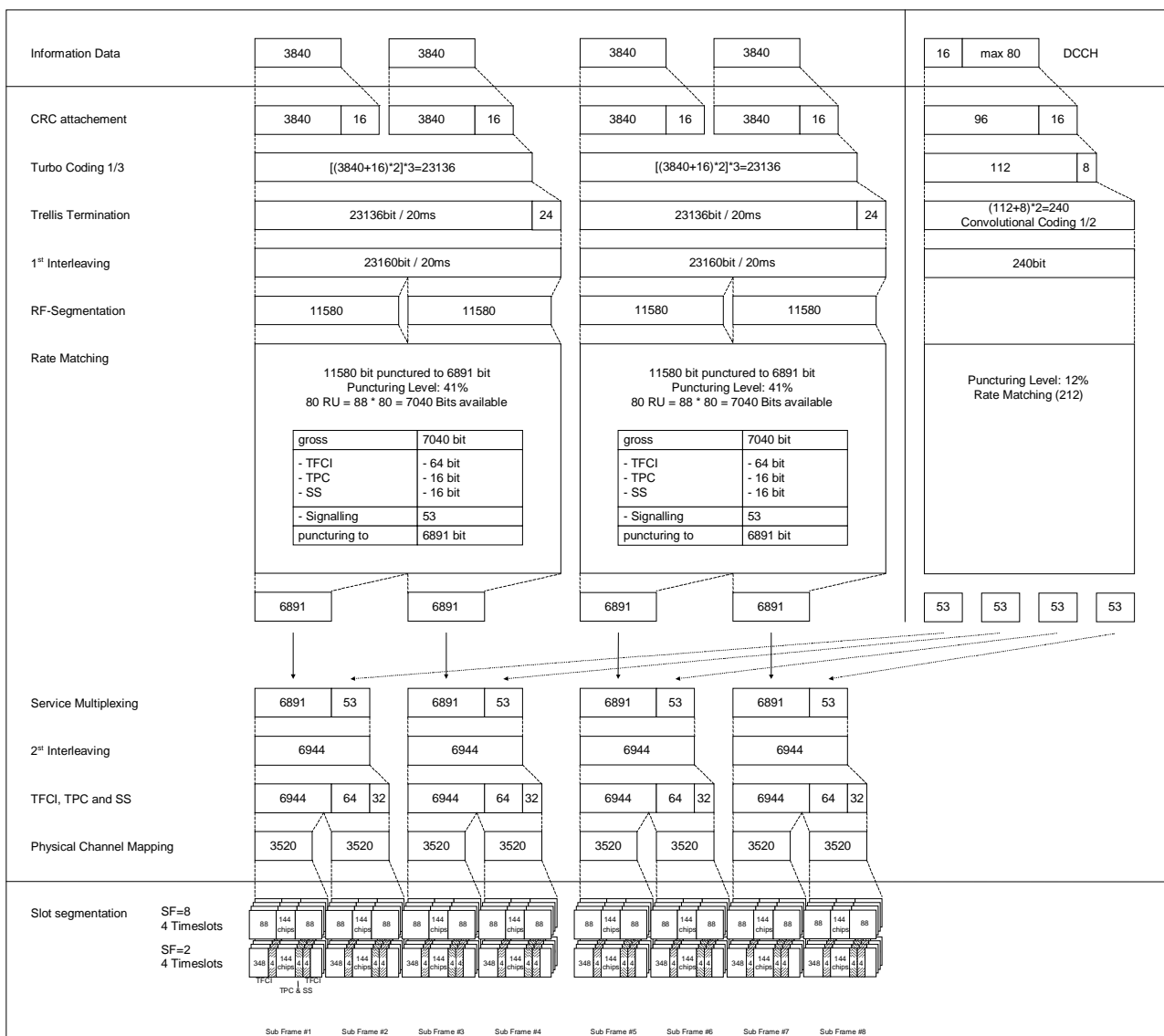

Figure A.4A

A.2.5 RACH reference measurement channel

A.2.5.0 General

A.2.5.0.1 3,84 Mcps TDD Option

Table A.5

Parameter	Value
Information data rate e.g. 2 TBs ($B_{RACH}=2$): SF16: 0% puncturing rate at CR=1/2 10% puncturing rate at CR=1/2 $N_{RACH} = \frac{\frac{232 + N_{RM}}{2} - 8}{B_{RACH}} - 8$ SF8: 0% puncturing rate at CR=1/2 10% puncturing rate at CR=1/2 $N_{RACH} = \frac{\frac{464 + N_{RM}}{2} - 8}{B_{RACH}} - 16$	46 bits per frame and TB 53 bits per frame and TB 96 bits per frame and TB 109 bits per frame and TB
RU's allocated	1 RU
Midamble	512 chips
Power control	0 bit
TFCI	0 bit

N_{RACH} = number of bits per TB

B_{RACH} = number of TBs

A.2.5.0.2 1,28 Mcps TDD Option

Table A.5A

Parameter	Value
Information data rate: $N_{RACH} = \frac{88 * \frac{16}{SF} \left(\frac{N_{RM}}{100} + 1 \right) - 8}{B_{RACH}} - 16$ SF16 (RU's allocated:1): 0% puncturing rate at CR=1/2 ~10% puncturing rate at CR=1/2 SF8 (RU's allocated:2): 0% puncturing rate at CR=1/2 ~10% puncturing rate at CR=1/2 SF4 (RU's allocated:4): 0% puncturing rate at CR=1/2 ~10% puncturing rate at CR=1/2	$B_{RACH}=1$ CRC length = 16 Tail Bits = 8 20 bits per frame and TB 24 bits per frame and TB 64 bits per frame and TB 73 bits per frame and TB 152 bits per frame and TB 170 bits per frame and TB
TTI	5msec
Midamble	144 chips
Power control	0 bit
TFCI	0 bit

N_{RACH} = number of bits per TB

B_{RACH} = number of TBs

N_{RM} = puncturing rate

A.2.5.1 RACH mapped to 1 code SF16

A.2.5.1.1 3,84 Mcps TDD Option

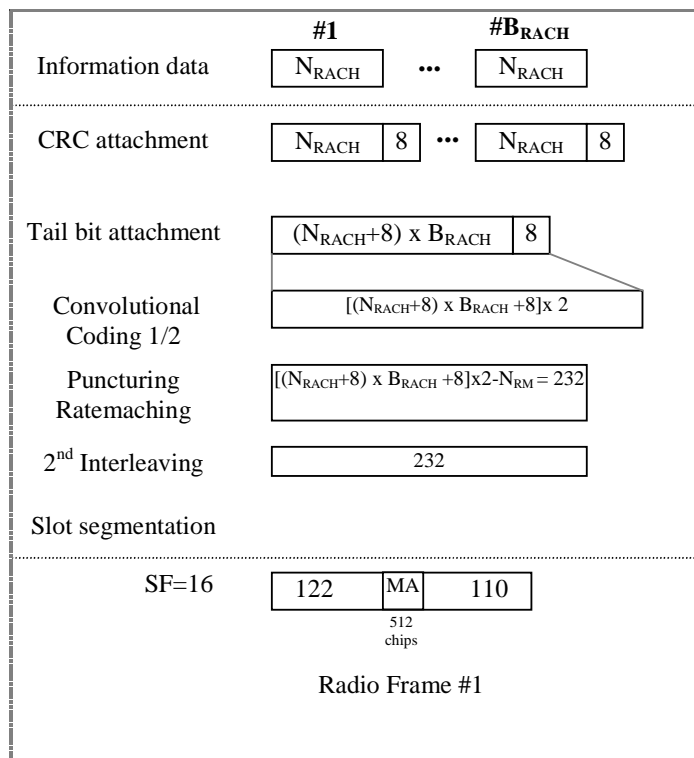

Figure A.5

A.2.5.1.2 1,28 Mcps TDD Option

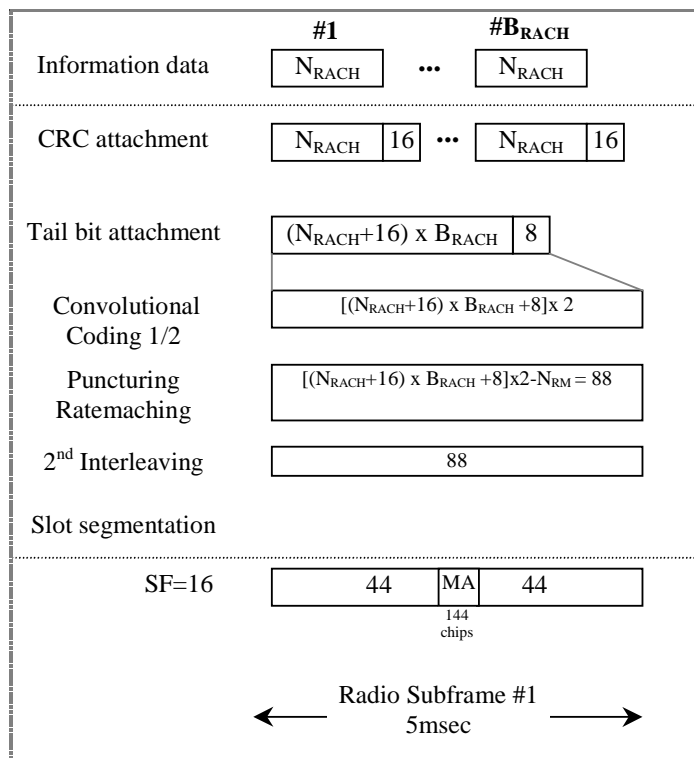

Figure A.5A

A.2.5.2 RACH mapped to 1 code SF8

A.2.5.2.1 3,84 Mcps TDD Option

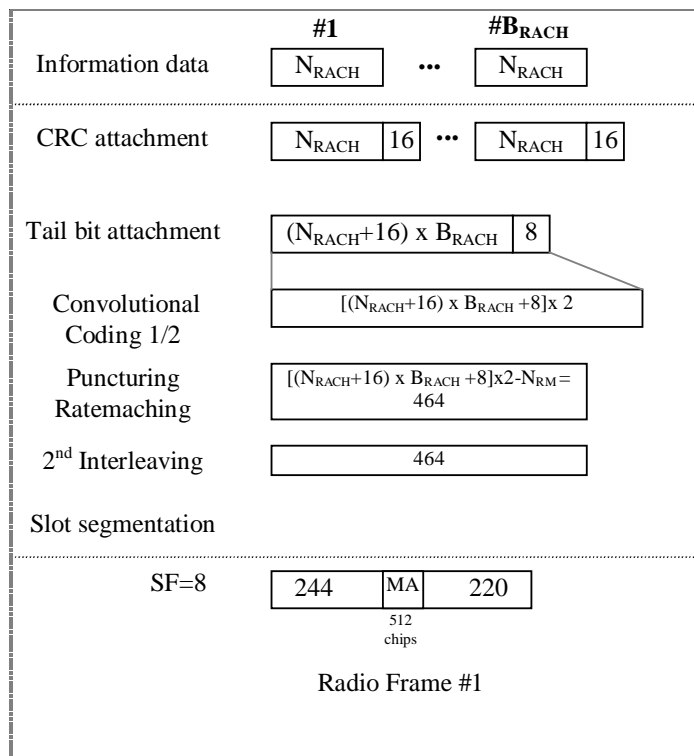

Figure A.6

A.2.5.2.2 1,28 Mcps TDD Option

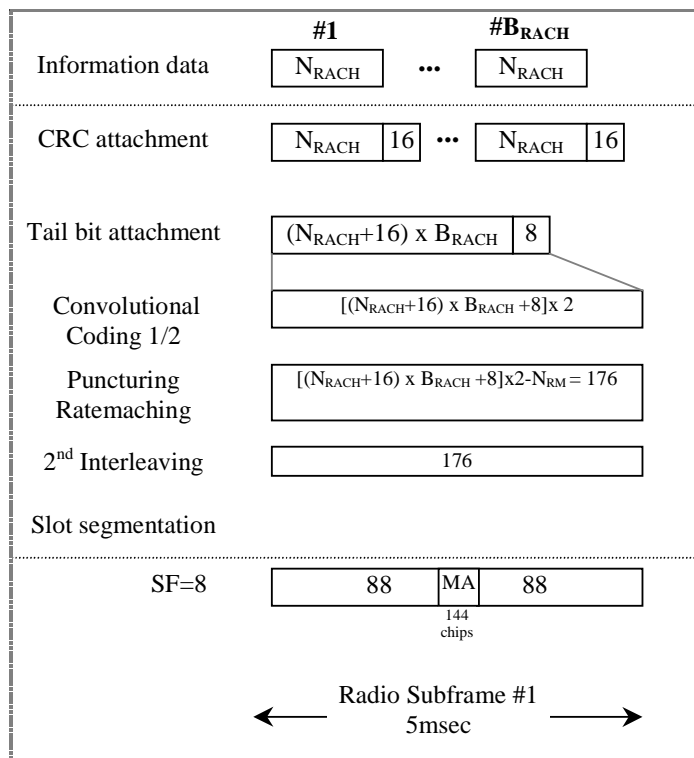

Figure A.6A

A.2.5.3 RACH mapped to 1 code SF4 (1,28 Mcps option only)

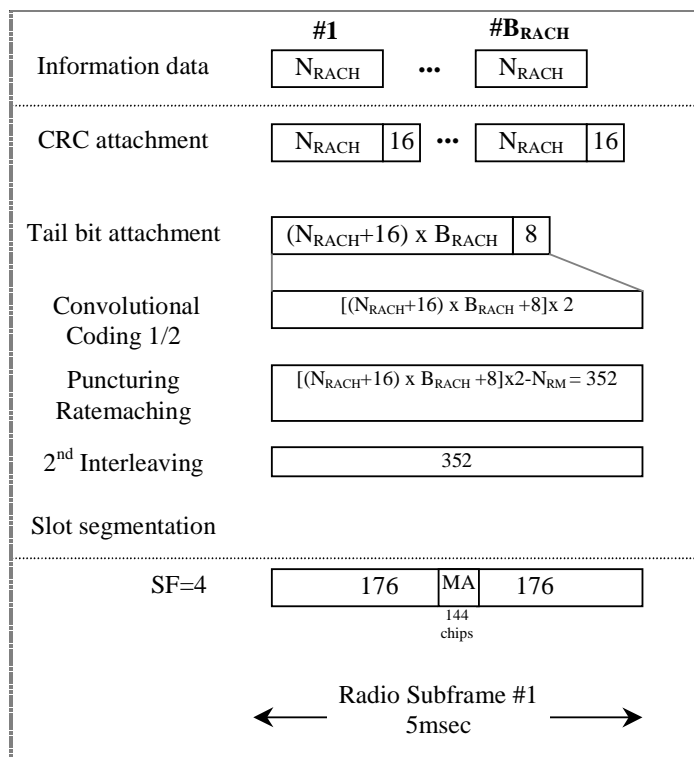

Figure A.7A

Annex B (normative): Propagation conditions

B.1 Static propagation condition

The propagation for the static performance measurement is an Additive White Gaussian Noise (AWGN) environment. No fading and multi-paths exist for this propagation model.

B.2 Multi-path fading propagation conditions

B.2.1 3,84 Mcps TDD Option

Table B1 shows propagation conditions that are used for the performance measurements in multi-path fading environment. All taps have classical Doppler spectrum, defined as:

$$(CLASS) \quad S(f) \propto 1/(1 - (f / f_D)^2)^{0.5} \quad \text{for } f \in -f_D, f_D$$

Table B.1: Propagation Conditions for Multi path Fading Environments

Case 1, speed 3km/h		Case 2, speed 3 km/h		Case 3, 120 km/h	
Relative Delay [ns]	Relative Mean Power [dB]	Relative Delay [ns]	Relative Mean Power [dB]	Relative Delay [ns]	Relative Mean Power [dB]
0	0	0	0	0	0
976	-10	976	0	260	-3
		12000	0	521	-6
				781	-9

B.2.2 1,28 Mcps TDD Option

TableB2 shows propagation conditions that are used for the performance measurements in multi-path fading environment. All taps have classical Doppler spectrum, defined as:

$$(CLASS) \quad S(f) \propto 1/(1 - (f / f_D)^2)^{0.5} \quad \text{for } f \in -f_D, f_D$$

TableB.2: Propagation Conditions for Multi-Path Fading Environments

Case 1, speed 3km/h		Case 2, speed 3km/h		Case 3, speed 120km/h	
Relative Delay [ns]	Relative Mean Power [dB]	Relative Delay [ns]	Relative Mean Power [dB]	Relative Delay [ns]	Relative Mean Power [dB]
0	0	0	0	0	0
2928	-10	2928	0	781	-3
		12000	0	1563	-6
				2344	-9

Annex C (informative): Change request history

Table C.1: Change History

TSG	Doc	CR	R	Subject	Cat	Curr	New	WI
RP-11				Rel-4 version generated based on v3.6.0				
RP-11	RP-010097	0052		UTRA (BS) TDD; Radio transmission and Reception	B	3.6.0	4.0.0	
RP-12	RP-010361	0053		Differential accuracy of P-CCPCH power	B	4.0.0	4.1.0	
RP-12	RP-010350	0055		inclusion of environmental requirements	A	4.0.0	4.1.0	
RP-12	RP-010350	0057		Application of blocking requirement	A	4.0.0	4.1.0	
RP-12	RP-010350	0059		CR for BS Performance Requirements	A	4.0.0	4.1.0	
RP-12	RP-010361	0060		Clarification of transmit intermodulation requirements	F	4.0.0	4.1.0	
RP-12	RP-010361	0061		BS EVM definition correction	F	4.0.0	4.1.0	
RP-12	RP-010350	0063		Correction to upper frequency of transmitter spurious emission limits	A	4.0.0	4.1.0	
RP-12	RP-010361	0064		Application of blocking requirement for 1.28 Mcps TDD	F	4.0.0	4.1.0	
RP-12	RP-010361	0065		Correction to upper frequency of transmitter spurious emission limits for 1.28 Mcps TDD	F	4.0.0	4.1.0	
RP-13	RP-010617	0067		BS Performance Requirements (3.84Mcps TDD)	A	4.1.0	4.2.0	
RP-13	RP-010617	0069		Receiver spurious emissions for co-located base stations	A	4.1.0	4.2.0	
RP-13	RP-010617	0071		Power and ACLR definition corrections.	A	4.1.0	4.2.0	
RP-13	RP-010617	0073		Clarification in Spectrum emission mask section	A	4.1.0	4.2.0	
RP-13	RP-010617	0075		PC dynamic range and minimum TP requirements correction.	A	4.1.0	4.2.0	
RP-13	RP-010617	0077		Correction of frequency range for receiver spurious emissions	A	4.1.0	4.2.0	
RP-13	RP-010617	0079		Definition of "classical Doppler spectrum"	A	4.1.0	4.2.0	
RP-13	RP-010627	0081		BS Performance Requirements (1.28Mcps TDD)	F	4.1.0	4.2.0	
RP-13	RP-010627	0082		Power definition correction for 1.28 Mcps TDD option.	F	4.1.0	4.2.0	
RP-13	RP-010627	0083		Receiver spurious emissions for co-located base stations for 1.28 Mcps TDD option	F	4.1.0	4.2.0	
RP-13	RP-010627	0084		Correction of frequency range for receiver spurious emissions (1.28 Mcps TDD option)	F	4.1.0	4.2.0	
RP-13	RP-010627	0085		Clarification in Spectrum emission mask section (1.28 Mcps section)	F	4.1.0	4.2.0	
RP-14	RP-010780	0087		Table label correction from BLER Required Eb/No to BLER	A	4.2.0	4.3.0	
RP-15	RP-020017	0089		UL reference measurement channel (12.2 kbps) puncturing rate correction	A	4.3.0	4.4.0	
RP-15	RP-020027	0097	1	Amendment for BS ACLR2 of 1.28 Mcps TDD option	F	4.3.0	4.4.0	
RP-15	RP-020027	0098	1	Amendment for BS Spectrum Emission Mask of 1.28Mcps TDD option	F	4.3.0	4.4.0	
RP-15	RP-020017	0100	1	Consideration of multi-carrier operation in ACLR requirements	A	4.3.0	4.4.0	
RP-15	RP-020027	0101	1	Consideration of multi-carrier operation in ACLR requirements for 1.28 Mcps TDD option	F	4.3.0	4.4.0	
RP-15	RP-020017	0103		Single and multi carrier in spurious emissions requirements	A	4.3.0	4.4.0	
RP-15	RP-020027	0104		Single and multi carrier in spurious emissions requirements for 1.28 Mcps TDD option	F	4.3.0	4.4.0	
RP-15	RP-020027	0106		Addition of channelization code, scrambling code and midamble code parameter for BS performance requirements (1.28Mcps TDD)	F	4.3.0	4.4.0	
RP-16	RP-020291	0109		The amendment for BS Category B spurious emission band adjacent to allocated bands for LCR-TDD	F	4.4.0	4.5.0	
RP-16	RP-020281	0112		Correction of power terms and definitions	A	4.4.0	4.5.0	
RP-16	RP-020291	0114		Correction of power terms and definitions	F	4.4.0	4.5.0	
RP-16	RP-020281	0118		ACLR and spurious emission requirements for coexistence for 3.84 Mcps and 1.28 Mcps TDD	F	4.4.0	4.5.0	
RP-18	RP-020784	0128	1	Introduction of Rel-5 clarifications and small corrections in Rel-4	F	4.5.0	4.6.0	
RP-18	RP-020784	0129		Name correction of logical and transport channels	F	4.5.0	4.6.0	
RP-18	RP-020779	0132		Spurious emission requirements for unsynchronized TDD operation	F	4.5.0	4.6.0	

RP-18	RP-020804	0136		Corrections to 3.84 Mcps TDD reference measurement channels	A	4.5.0	4.6.0	
RP-18	RP-020804	0138	1	Corrections to 1.28 Mcps TDD reference measurement channels	F	4.5.0	4.6.0	
RP-19	RP-030030	0146		TDD-GSM co-existence in the same geographic area	A	4.6.0	4.7.0	
RP-19	RP-030035	0148		Correction to external equipment definition	F	4.6.0	4.7.0	
RP-24	RP-040189	0152		Clarification of measurement filter of spurious emission considering coexistence issue	F	4.7.0	4.8.0	
RP-33	RP-060517	0184		Clarification of Tx spurious emission level from 3.84 Mcps TDD BS into PHS band	F	4.8.0	4.9.0	TEI
RP-33	RP-060518	0191	1	Clarification on the deployment of UTRA TDD in Japan	F	4.8.0	4.9.0	TEI
RP-36	RP-070369	0208		Modifying category B spurious emission limits for UTRA TDD BS	F	4.9.0	4.10.0	TEI

History

Document history		
V4.0.0	March 2001	Publication
V4.1.0	June 2001	Publication
V4.2.0	September 2001	Publication
V4.3.0	December 2001	Publication
V4.4.0	March 2002	Publication
V4.5.0	June 2002	Publication
V4.6.0	December 2002	Publication
V4.7.0	March 2003	Publication
V4.8.0	June 2004	Publication
V4.9.0	October 2006	Publication
V4.10.0	June 2007	Publication