

ETSI TS 125 211 V4.0.0 (2001-03)

Technical Specification

Universal Mobile Telecommunications System (UMTS); Physical channels and mapping of transport channels onto physical channels (FDD) (3GPP TS 25.211 version 4.0.0 Release 4)



Reference

RTS/TSGR-0125211Uv4

Keywords

UMTS

ETSI

650 Route des Lucioles
F-06921 Sophia Antipolis Cedex - FRANCE

Tel.: +33 4 92 94 42 00 Fax: +33 4 93 65 47 16

Siret N° 348 623 562 00017 - NAF 742 C
Association à but non lucratif enregistrée à la
Sous-Préfecture de Grasse (06) N° 7803/88

Important notice

Individual copies of the present document can be downloaded from:

<http://www.etsi.org>

The present document may be made available in more than one electronic version or in print. In any case of existing or perceived difference in contents between such versions, the reference version is the Portable Document Format (PDF). In case of dispute, the reference shall be the printing on ETSI printers of the PDF version kept on a specific network drive within ETSI Secretariat.

Users of the present document should be aware that the document may be subject to revision or change of status. Information on the current status of this and other ETSI documents is available at <http://www.etsi.org/tb/status/>

If you find errors in the present document, send your comment to:
editor@etsi.fr

Copyright Notification

No part may be reproduced except as authorized by written permission.
The copyright and the foregoing restriction extend to reproduction in all media.

© European Telecommunications Standards Institute 2001.

All rights reserved.

Intellectual Property Rights

IPRs essential or potentially essential to the present document may have been declared to ETSI. The information pertaining to these essential IPRs, if any, is publicly available for **ETSI members and non-members**, and can be found in ETSI SR 000 314: "*Intellectual Property Rights (IPRs); Essential, or potentially Essential, IPRs notified to ETSI in respect of ETSI standards*", which is available from the ETSI Secretariat. Latest updates are available on the ETSI Web server (<http://www.etsi.org/ipr>).

Pursuant to the ETSI IPR Policy, no investigation, including IPR searches, has been carried out by ETSI. No guarantee can be given as to the existence of other IPRs not referenced in ETSI SR 000 314 (or the updates on the ETSI Web server) which are, or may be, or may become, essential to the present document.

Foreword

This Technical Specification (TS) has been produced by the ETSI 3rd Generation Partnership Project (3GPP).

The present document may refer to technical specifications or reports using their 3GPP identities, UMTS identities or GSM identities. These should be interpreted as being references to the corresponding ETSI deliverables.

The cross reference between GSM, UMTS, 3GPP and ETSI identities can be found under www.etsi.org/key.

Contents

Foreword.....	5
1 Scope	6
2 References	6
3 Abbreviations	6
4 Services offered to higher layers	7
4.1 Transport channels	7
4.1.1 Dedicated transport channels.....	8
4.1.1.1 DCH - Dedicated Channel.....	8
4.1.2 Common transport channels	8
4.1.2.1 BCH - Broadcast Channel.....	8
4.1.2.2 FACH - Forward Access Channel	8
4.1.2.3 PCH - Paging Channel.....	8
4.1.2.4 RACH - Random Access Channel.....	8
4.1.2.5 CPCH - Common Packet Channel.....	8
4.1.2.6 DSCH - Downlink Shared Channel.....	8
4.2 Indicators.....	8
5 Physical channels and physical signals	9
5.1 Physical signals	9
5.2 Uplink physical channels	9
5.2.1 Dedicated uplink physical channels.....	9
5.2.2 Common uplink physical channels	12
5.2.2.1 Physical Random Access Channel (PRACH).....	12
5.2.2.1.1 Overall structure of random-access transmission.....	12
5.2.2.1.2 RACH preamble part	13
5.2.2.1.3 RACH message part.....	13
5.2.2.2 Physical Common Packet Channel (PCPCH).....	14
5.2.2.2.1 CPCH transmission.....	15
5.2.2.2.2 CPCH access preamble part.....	15
5.2.2.2.3 CPCH collision detection preamble part.....	15
5.2.2.2.4 CPCH power control preamble part.....	15
5.2.2.2.5 CPCH message part	15
5.3 Downlink physical channels.....	16
5.3.1 Downlink transmit diversity	16
5.3.1.1 Open loop transmit diversity	17
5.3.1.1.1 Space time block coding based transmit antenna diversity (STTD)	17
5.3.1.1.2 Time Switched Transmit Diversity for SCH (TSTD)	17
5.3.1.2 Closed loop transmit diversity	17
5.3.2 Dedicated downlink physical channels.....	17
5.3.2.1 STTD for DPCH.....	21
5.3.2.2 Dedicated channel pilots with closed loop mode transmit diversity.....	22
5.3.2.3 DL-DPCCH for CPCH	23
5.3.3 Common downlink physical channels	24
5.3.3.1 Common Pilot Channel (CPICH)	24
5.3.3.1.1 Primary Common Pilot Channel (P-CPICH)	24
5.3.3.1.2 Secondary Common Pilot Channel (S-CPICH)	25
5.3.3.2 Downlink phase reference	25
5.3.3.3 Primary Common Control Physical Channel (P-CCPCH)	25
5.3.3.3.1 Primary CCPCH structure with STTD encoding	26
5.3.3.4 Secondary Common Control Physical Channel (S-CCPCH)	26
5.3.3.4.1 Secondary CCPCH structure with STTD encoding	28
5.3.3.5 Synchronisation Channel (SCH)	28
5.3.3.5.1 SCH transmitted by TSTD.....	29
5.3.3.6 Physical Downlink Shared Channel (PDSCH).....	29
5.3.3.7 Acquisition Indicator Channel (AICH)	30

5.3.3.8	CPCCH Access Preamble Acquisition Indicator Channel (AP-AICH).....	32
5.3.3.9	CPCCH Collision Detection/Channel Assignment Indicator Channel (CD/CA-ICH).....	32
5.3.3.10	Paging Indicator Channel (PICH).....	34
5.3.3.11	CPCCH Status Indicator Channel (CSICH)	35
5.3.3.11.1	CSICH Information Structure when Channel Assignment is not active	36
5.3.3.11.2	PCPCH Availability when Channel Assignment is active.....	36
6	Mapping and association of physical channels.....	38
6.1	Mapping of transport channels onto physical channels.....	38
6.2	Association of physical channels and physical signals	39
7	Timing relationship between physical channels.....	39
7.1	General.....	39
7.2	PICH/S-CCPCH timing relation	40
7.3	PRACH/AICH timing relation.....	41
7.4	PCPCH/AICH timing relation.....	42
7.5	DPCH/PDSCH timing.....	43
7.6	DPCCH/DPDCH timing relations.....	43
7.6.1	Uplink.....	43
7.6.2	Downlink.....	43
7.6.3	Uplink/downlink timing at UE	43
Annex A (informative): Change history		44

Foreword

This Technical Specification (TS) has been produced by the 3rd Generation Partnership Project (3GPP).

The contents of the present document are subject to continuing work within the TSG and may change following formal TSG approval. Should the TSG modify the contents of the present document, it will be re-released by the TSG with an identifying change of release date and an increase in version number as follows:

Version x.y.z

where:

- x the first digit:
 - 1 presented to TSG for information;
 - 2 presented to TSG for approval;
 - 3 or greater indicates TSG approved document under change control.
- y the second digit is incremented for all changes of substance, i.e. technical enhancements, corrections, updates, etc.
- z the third digit is incremented when editorial only changes have been incorporated in the document.

1 Scope

The present document describes the characteristics of the Layer 1 transport channels and physical channels in the FDD mode of UTRA. The main objectives of the document are to be a part of the full description of the UTRA Layer 1, and to serve as a basis for the drafting of the actual technical specification (TS).

2 References

The following documents contain provisions which, through reference in this text, constitute provisions of the present document.

- References are either specific (identified by date of publication, edition number, version number, etc.) or non-specific.
- For a specific reference, subsequent revisions do not apply.
- For a non-specific reference, the latest version applies. In the case of a reference to a 3GPP document (including a GSM document), a non-specific reference implicitly refers to the latest version of that document *in the same Release as the present document*.

- [1] 3GPP TS 25.201: "Physical layer - general description".
- [2] 3GPP TS 25.211: "Physical channels and mapping of transport channels onto physical channels (FDD)".
- [3] 3GPP TS 25.212: "Multiplexing and channel coding (FDD)".
- [4] 3GPP TS 25.213: "Spreading and modulation (FDD)".
- [5] 3GPP TS 25.214: "Physical layer procedures (FDD)".
- [6] 3GPP TS 25.221: "Transport channels and physical channels (TDD)".
- [7] 3GPP TS 25.222: "Multiplexing and channel coding (TDD)".
- [8] 3GPP TS 25.223: "Spreading and modulation (TDD)".
- [9] 3GPP TS 25.224: "Physical layer procedures (TDD)".
- [10] 3GPP TS 25.215: "Physical layer - Measurements (FDD)".
- [11] 3GPP TS 25.301: "Radio Interface Protocol Architecture".
- [12] 3GPP TS 25.302: "Services Provided by the Physical Layer".
- [13] 3GPP TS 25.401: "UTRAN Overall Description".
- [14] 3GPP TS 25.133: "Requirements for Support of Radio Resource Management (FDD)".
- [15] 3G TS 25.427: "UTRAN Overall Description :UTRA Iub/Iur Interface User Plane Protocol for DCH data streams".

3 Abbreviations

For the purposes of the present document, the following abbreviations apply:

AI	Acquisition Indicator
AICH	Acquisition Indicator Channel
AP	Access Preamble
AP-AICH	Access Preamble Acquisition Indicator Channel

API	Access Preamble Indicator
BCH	Broadcast Channel
CA	Channel Assignment
CAI	Channel Assignment Indicator
CCC	CPCH Control Command
CCPCH	Common Control Physical Channel
CCTrCH	Coded Composite Transport Channel
CD	Collision Detection
CD/CA-ICH	Collision Detection/Channel Assignment Indicator Channel
CDI	Collision Detection Indicator
CPCH	Common Packet Channel
CPICH	Common Pilot Channel
CSICH	CPCH Status Indicator Channel
DCH	Dedicated Channel
DPCCH	Dedicated Physical Control Channel
DPCH	Dedicated Physical Channel
DPDCH	Dedicated Physical Data Channel
DSCH	Downlink Shared Channel
DSMA-CD	Digital Sense Multiple Access - Collision Detection
DTX	Discontinuous Transmission
FACH	Forward Access Channel
FBI	Feedback Information
FSW	Frame Synchronization Word
ICH	Indicator Channel
MUI	Mobile User Identifier
PCH	Paging Channel
P-CCPCH	Primary Common Control Physical Channel
PCPCH	Physical Common Packet Channel
PDSCH	Physical Downlink Shared Channel
PICH	Page Indicator Channel
PRACH	Physical Random Access Channel
PSC	Primary Synchronisation Code
RACH	Random Access Channel
RNC	Radio Network Controller
S-CCPCH	Secondary Common Control Physical Channel
SCH	Synchronisation Channel
SF	Spreading Factor
SFN	System Frame Number
SI	Status Indicator
SSC	Secondary Synchronisation Code
STTD	Space Time Transmit Diversity
TFCI	Transport Format Combination Indicator
TSTD	Time Switched Transmit Diversity
TPC	Transmit Power Control
UE	User Equipment
UTRAN	UMTS Terrestrial Radio Access Network

4 Services offered to higher layers

4.1 Transport channels

Transport channels are services offered by Layer 1 to the higher layers. General concepts about transport channels are described in [12].

A transport channel is defined by how and with what characteristics data is transferred over the air interface. A general classification of transport channels is into two groups:

- Dedicated channels, using inherent addressing of UE;

- Common channels, using explicit addressing of UE if addressing is needed.

4.1.1 Dedicated transport channels

There exists only one type of dedicated transport channel, the Dedicated Channel (DCH).

4.1.1.1 DCH - Dedicated Channel

The Dedicated Channel (DCH) is a downlink or uplink transport channel. The DCH is transmitted over the entire cell or over only a part of the cell using e.g. beam-forming antennas.

4.1.2 Common transport channels

There are six types of common transport channels: BCH, FACH, PCH, RACH, CPCH and DSCH.

4.1.2.1 BCH - Broadcast Channel

The Broadcast Channel (BCH) is a downlink transport channel that is used to broadcast system- and cell-specific information. The BCH is always transmitted over the entire cell and has a single transport format.

4.1.2.2 FACH - Forward Access Channel

The Forward Access Channel (FACH) is a downlink transport channel. The FACH is transmitted over the entire cell or over only a part of the cell using e.g. beam-forming antennas. The FACH can be transmitted using slow power control.

4.1.2.3 PCH - Paging Channel

The Paging Channel (PCH) is a downlink transport channel. The PCH is always transmitted over the entire cell. The transmission of the PCH is associated with the transmission of physical-layer generated Paging Indicators, to support efficient sleep-mode procedures.

4.1.2.4 RACH - Random Access Channel

The Random Access Channel (RACH) is an uplink transport channel. The RACH is always received from the entire cell. The RACH is characterized by a collision risk and by being transmitted using open loop power control.

4.1.2.5 CPCH - Common Packet Channel

The Common Packet Channel (CPCH) is an uplink transport channel. CPCH is associated with a dedicated channel on the downlink which provides power control and CPCH Control Commands (e.g. Emergency Stop) for the uplink CPCH. The CPCH is characterised by initial collision risk and by being transmitted using inner loop power control.

4.1.2.6 DSCH - Downlink Shared Channel

The Downlink Shared Channel (DSCH) is a downlink transport channel shared by several UEs. The DSCH is associated with one or several downlink DCH. The DSCH is transmitted over the entire cell or over only a part of the cell using e.g. beam-forming antennas.

4.2 Indicators

Indicators are means of fast low-level signalling entities which are transmitted without using information blocks sent over transport channels. The meaning of indicators is specific to the type of indicator.

The indicators defined in the current version of the specifications are: Acquisition Indicator (AI), Access Preamble Indicator (API), Channel Assignment Indicator (CAI), Collision Detection Indicator (CDI), Page Indicator (PI) and Status Indicator (SI).

Indicators may be either boolean (two-valued) or three-valued. Their mapping to indicator channels is channel specific.

Indicators are transmitted on those physical channels that are indicator channels (ICH).

5 Physical channels and physical signals

Physical channels are defined by a specific carrier frequency, scrambling code, channelization code (optional), time start & stop (giving a duration) and, on the uplink, relative phase (0 or $\pi/2$). Scrambling and channelization codes are specified in [4]. Time durations are defined by start and stop instants, measured in integer multiples of chips. Suitable multiples of chips also used in specification are:

Radio frame: A radio frame is a processing duration which consists of 15 slots. The length of a radio frame corresponds to 38400 chips.

Slot: A slot is a duration which consists of fields containing bits. The length of a slot corresponds to 2560 chips.

The default time duration for a physical channel is continuous from the instant when it is started to the instant when it is stopped. Physical channels that are not continuous will be explicitly described.

Transport channels are described (in more abstract higher layer models of the physical layer) as being capable of being mapped to physical channels. Within the physical layer itself the exact mapping is from a composite coded transport channel (CCTrCH) to the data part of a physical channel. In addition to data parts there also exist channel control parts and physical signals.

5.1 Physical signals

Physical signals are entities with the same basic on-air attributes as physical channels but do not have transport channels or indicators mapped to them. Physical signals may be associated with physical channels in order to support the function of physical channels.

5.2 Uplink physical channels

5.2.1 Dedicated uplink physical channels

There are two types of uplink dedicated physical channels, the uplink Dedicated Physical Data Channel (uplink DPDCH) and the uplink Dedicated Physical Control Channel (uplink DPCCH).

The DPDCH and the DPCCH are I/Q code multiplexed within each radio frame (see [4]).

The uplink DPDCH is used to carry the DCH transport channel. There may be zero, one, or several uplink DPDCHs on each radio link.

The uplink DPCCH is used to carry control information generated at Layer 1. The Layer 1 control information consists of known pilot bits to support channel estimation for coherent detection, transmit power-control (TPC) commands, feedback information (FBI), and an optional transport-format combination indicator (TFCI). The transport-format combination indicator informs the receiver about the instantaneous transport format combination of the transport channels mapped to the simultaneously transmitted uplink DPDCH radio frame. There is one and only one uplink DPCCH on each radio link.

Figure 1 shows the frame structure of the uplink dedicated physical channels. Each radio frame of length 10 ms is split into 15 slots, each of length $T_{\text{slot}} = 2560$ chips, corresponding to one power-control period.

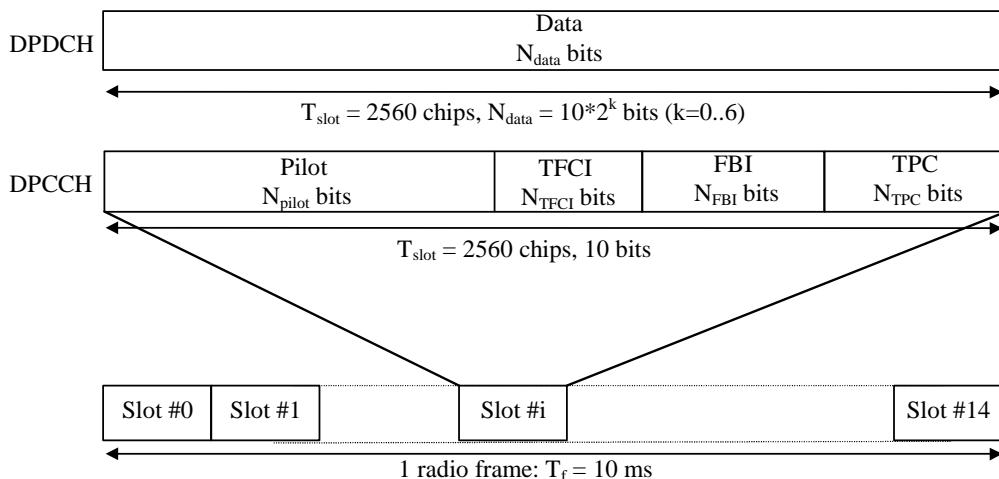

Figure 1: Frame structure for uplink DPDCH/DPCCH

The parameter k in figure 1 determines the number of bits per uplink DPDCH slot. It is related to the spreading factor SF of the DPDCH as $SF = 256/2^k$. The DPDCH spreading factor may range from 256 down to 4. The spreading factor of the uplink DPCCH is always equal to 256, i.e. there are 10 bits per uplink DPCCH slot.

The exact number of bits of the uplink DPDCH and the different uplink DPCCH fields (N_{pilot} , N_{TFCI} , N_{FBI} , and N_{TPC}) is given by table 1 and table 2. What slot format to use is configured by higher layers and can also be reconfigured by higher layers.

The channel bit and symbol rates given in table 1 and table 2 are the rates immediately before spreading. The pilot patterns are given in table 3 and table 4, the TPC bit pattern is given in table 5.

The FBI bits are used to support techniques requiring feedback from the UE to the UTRAN Access Point, including closed loop mode transmit diversity and site selection diversity transmission (SSDT). The structure of the FBI field is shown in figure 2 and described below.

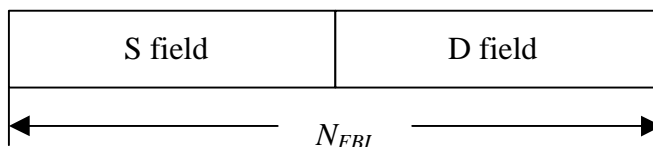

Figure 2: Details of FBI field

The S field is used for SSDT signalling, while the D field is used for closed loop mode transmit diversity signalling. The S field consists of 0, 1 or 2 bits. The D field consists of 0 or 1 bit. The total FBI field size N_{FBI} is given by table 2. If total FBI field is not filled with S field or D field, FBI field shall be filled with "1". When N_{FBI} is 2bits, S field is 0bit and D field is 1bit, left side field shall be filled with "1" and right side field shall be D field. Simultaneous use of SSDT power control and closed loop mode transmit diversity requires that the S field consists of 1 bit. The use of the FBI fields is described in detail in [5].

Table 1: DPDCH fields

Slot Format #i	Channel Bit Rate (kbps)	Channel Symbol Rate (ksps)	SF	Bits/Frame	Bits/Slot	N_{data}
0	15	15	256	150	10	10
1	30	30	128	300	20	20
2	60	60	64	600	40	40
3	120	120	32	1200	80	80
4	240	240	16	2400	160	160
5	480	480	8	4800	320	320
6	960	960	4	9600	640	640

There are two types of uplink dedicated physical channels; those that include TFCI (e.g. for several simultaneous services) and those that do not include TFCI (e.g. for fixed-rate services). These types are reflected by the duplicated

rows of table 2. It is the UTRAN that determines if a TFCI should be transmitted and it is mandatory for all UEs to support the use of TFCI in the uplink. The mapping of TFCI bits onto slots is described in [3].

In compressed mode, DPCCH slot formats with TFCI fields are changed. There are two possible compressed slot formats for each normal slot format. They are labelled A and B and the selection between them is dependent on the number of slots that are transmitted in each frame in compressed mode.

Table 2: DPCCH fields

Slot Form at #i	Channel Bit Rate (kbps)	Channel Symbol Rate (ksps)	SF	Bits/ Frame	Bits/ Slot	N _{pilot}	N _{TPC}	N _{TFCI}	N _{FBI}	Transmitted slots per radio frame
0	15	15	256	150	10	6	2	2	0	15
0A	15	15	256	150	10	5	2	3	0	10-14
0B	15	15	256	150	10	4	2	4	0	8-9
1	15	15	256	150	10	8	2	0	0	8-15
2	15	15	256	150	10	5	2	2	1	15
2A	15	15	256	150	10	4	2	3	1	10-14
2B	15	15	256	150	10	3	2	4	1	8-9
3	15	15	256	150	10	7	2	0	1	8-15
4	15	15	256	150	10	6	2	0	2	8-15
5	15	15	256	150	10	5	1	2	2	15
5A	15	15	256	150	10	4	1	3	2	10-14
5B	15	15	256	150	10	3	1	4	2	8-9

The pilot bit patterns are described in table 3 and table 4. The shadowed column part of pilot bit pattern is defined as FSW and FSWs can be used to confirm frame synchronization. (The value of the pilot bit pattern other than FSWs shall be "1".)

Table 3: Pilot bit patterns for uplink DPCCH with N_{pilot} = 3, 4, 5 and 6

Bit #	N _{pilot} = 3			N _{pilot} = 4				N _{pilot} = 5					N _{pilot} = 6					
	0	1	2	0	1	2	3	0	1	2	3	4	0	1	2	3	4	5
Slot #0	1	1	1	1	1	1	1	1	1	1	1	0	1	1	1	1	1	0
1	0	0	1	1	0	0	1	0	0	1	1	0	1	0	0	1	1	0
2	0	1	1	1	0	1	1	0	1	1	0	1	1	0	1	1	0	1
3	0	0	1	1	0	0	1	0	0	1	0	0	1	0	0	1	0	0
4	1	0	1	1	1	0	1	1	0	1	0	1	1	1	0	1	0	1
5	1	1	1	1	1	1	1	1	1	1	1	0	1	1	1	1	1	0
6	1	1	1	1	1	1	1	1	1	1	0	0	1	1	1	1	0	0
7	1	0	1	1	1	0	1	1	0	1	0	0	1	1	0	1	0	0
8	0	1	1	1	0	1	1	0	1	1	1	0	1	0	1	1	1	0
9	1	1	1	1	1	1	1	1	1	1	1	1	1	1	1	1	1	1
10	0	1	1	1	0	1	1	0	1	1	0	1	1	0	1	1	0	1
11	1	0	1	1	1	0	1	1	0	1	1	1	1	1	0	1	1	1
12	1	0	1	1	1	0	1	1	0	1	0	0	1	1	0	1	0	0
13	0	0	1	1	0	0	1	0	0	1	1	1	1	0	0	1	1	1
14	0	0	1	1	0	0	1	0	0	1	1	1	1	0	0	1	1	1

Table 4: Pilot bit patterns for uplink DPCCH with $N_{\text{pilot}} = 7$ and 8

Bit #	$N_{\text{pilot}} = 7$							$N_{\text{pilot}} = 8$							
	0	1	2	3	4	5	6	0	1	2	3	4	5	6	7
Slot #0	1	1	1	1	1	0	1	1	1	1	1	1	1	1	0
1	1	0	0	1	1	0	1	1	0	1	0	1	1	1	0
2	1	0	1	1	0	1	1	1	0	1	1	1	0	1	1
3	1	0	0	1	0	0	1	1	0	1	0	1	0	1	0
4	1	1	0	1	0	1	1	1	1	1	0	1	0	1	1
5	1	1	1	1	1	0	1	1	1	1	1	1	1	1	0
6	1	1	1	1	0	0	1	1	1	1	1	1	0	1	0
7	1	1	0	1	0	0	1	1	1	1	0	1	0	1	0
8	1	0	1	1	1	0	1	1	0	1	1	1	1	1	0
9	1	1	1	1	1	1	1	1	1	1	1	1	1	1	1
10	1	0	1	1	0	1	1	1	0	1	1	1	0	1	1
11	1	1	0	1	1	1	1	1	1	1	0	1	1	1	1
12	1	1	0	1	0	0	1	1	1	1	0	1	0	1	0
13	1	0	0	1	1	1	1	1	0	1	0	1	1	1	1
14	1	0	0	1	1	1	1	1	0	1	0	1	1	1	1

The relationship between the TPC bit pattern and transmitter power control command is presented in table 5.

Table 5: TPC Bit Pattern

TPC Bit Pattern		Transmitter power control command
$N_{\text{TPC}} = 1$	$N_{\text{TPC}} = 2$	
1	11	1
0	00	0

Multi-code operation is possible for the uplink dedicated physical channels. When multi-code transmission is used, several parallel DPDCH are transmitted using different channelization codes, see [4]. However, there is only one DPCCH per radio link.

A period of uplink DPCCH transmission prior to the start of the uplink DPDCH transmission (uplink DPCCH power control preamble) shall be used for initialisation of a DCH. The length of the power control preamble is a higher layer parameter, N_{pcp} , signalled by the network [5]. The UL DPCCH shall take the same slot format in the power control preamble as afterwards, as given in table 2. When $N_{\text{pcp}} > 0$ the pilot patterns of table 3 and table 4 shall be used. The timing of the power control preamble is described in [5], subclause 4.3.2.2. The TFCI field is filled with "0" bits.

5.2.2 Common uplink physical channels

5.2.2.1 Physical Random Access Channel (PRACH)

The Physical Random Access Channel (PRACH) is used to carry the RACH.

5.2.2.1.1 Overall structure of random-access transmission

The random-access transmission is based on a Slotted ALOHA approach with fast acquisition indication. The UE can start the random-access transmission at the beginning of a number of well-defined time intervals, denoted *access slots*. There are 15 access slots per two frames and they are spaced 5120 chips apart, see figure 3. The timing of the access slots and the acquisition indication is described in subclause 7.3. Information on what access slots are available for random-access transmission is given by higher layers.

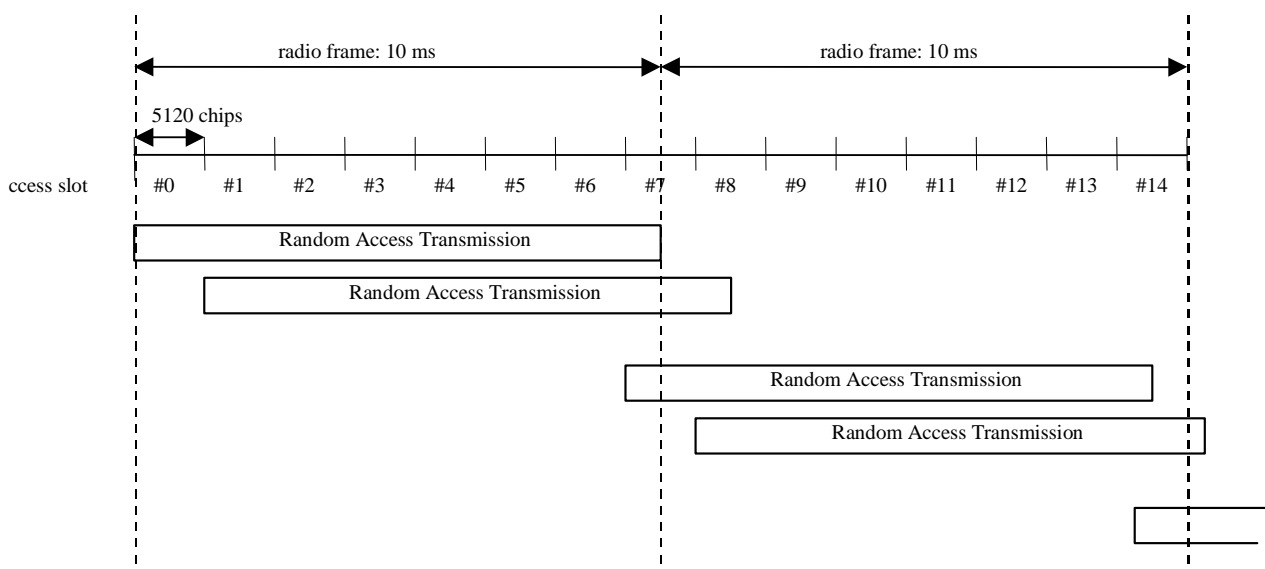

Figure 3: RACH access slot numbers and their spacing

The structure of the random-access transmission is shown in figure 4. The random-access transmission consists of one or several *preambles* of length 4096 chips and a *message* of length 10 ms or 20 ms.

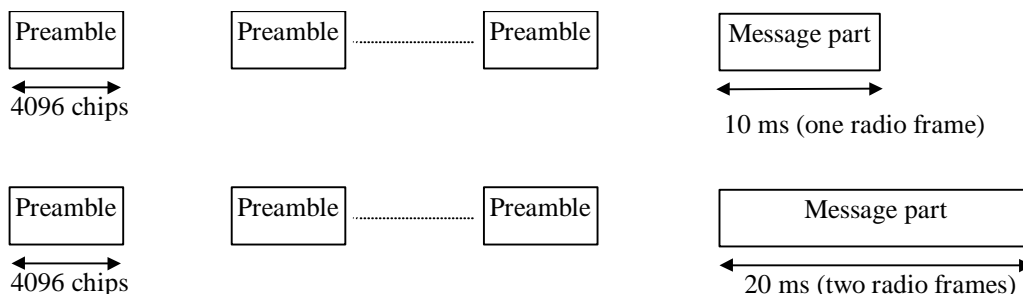

Figure 4: Structure of the random-access transmission

5.2.2.1.2 RACH preamble part

Each preamble is of length 4096 chips and consists of 256 repetitions of a signature of length 16 chips. There are a maximum of 16 available signatures, see [4] for more details.

5.2.2.1.3 RACH message part

Figure 5 shows the structure of the random-access message part radio frame. The 10 ms message part radio frame is split into 15 slots, each of length $T_{slot} = 2560$ chips. Each slot consists of two parts, a data part to which the RACH transport channel is mapped and a control part that carries Layer 1 control information. The data and control parts are transmitted in parallel. A 10 ms message part consists of one message part radio frame, while a 20 ms message part consists of two consecutive 10 ms message part radio frames. The message part length is equal to the Transmission Time Interval of the RACH Transport channel in use. This TTI length is configured by higher layers.

The data part consists of $10 \cdot 2^k$ bits, where $k=0,1,2,3$. This corresponds to a spreading factor of 256, 128, 64, and 32 respectively for the message data part.

The control part consists of 8 known pilot bits to support channel estimation for coherent detection and 2 TFCI bits. This corresponds to a spreading factor of 256 for the message control part. The pilot bit pattern is described in table 8. The total number of TFCI bits in the random-access message is $15 \cdot 2 = 30$. The TFCI of a radio frame indicates the transport format of the RACH transport channel mapped to the simultaneously transmitted message part radio frame. In case of a 20 ms PRACH message part, the TFCI is repeated in the second radio frame.

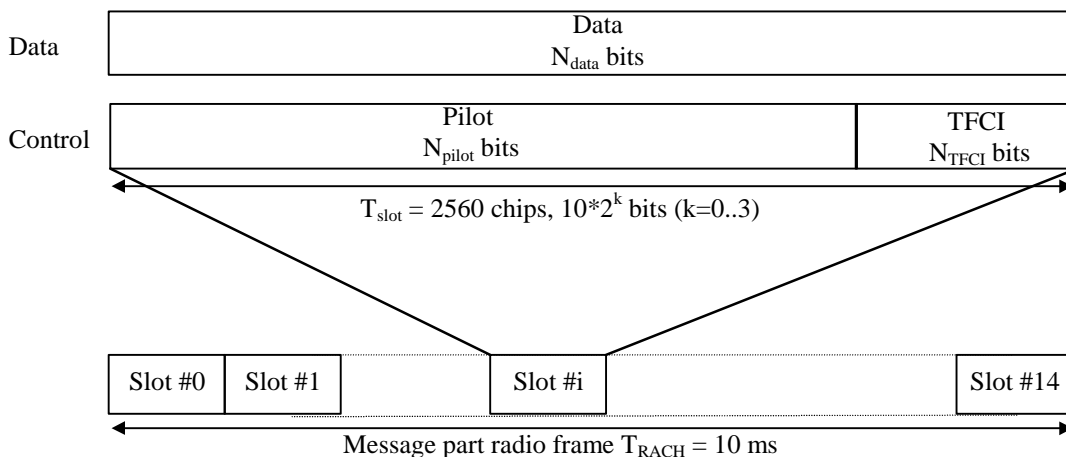

Figure 5: Structure of the random-access message part radio frame

Table 6: Random-access message data fields

Slot Format #i	Channel Bit Rate (kbps)	Channel Symbol Rate (ksps)	SF	Bits/ Frame	Bits/ Slot	N_{data}
0	15	15	256	150	10	10
1	30	30	128	300	20	20
2	60	60	64	600	40	40
3	120	120	32	1200	80	80

Table 7: Random-access message control fields

Slot Format #i	Channel Bit Rate (kbps)	Channel Symbol Rate (ksps)	SF	Bits/ Frame	Bits/ Slot	N_{pilot}	N_{TFCI}
0	15	15	256	150	10	8	2

Table 8: Pilot bit patterns for RACH message part with $N_{pilot} = 8$

Bit #	$N_{pilot} = 8$							
	0	1	2	3	4	5	6	7
Slot #0	1	1	1	1	1	1	1	0
1	1	0	1	0	1	1	1	0
2	1	0	1	1	1	0	1	1
3	1	0	1	0	1	0	1	0
4	1	1	1	0	1	0	1	1
5	1	1	1	1	1	1	1	0
6	1	1	1	1	1	0	1	0
7	1	1	1	0	1	0	1	0
8	1	0	1	1	1	1	1	0
9	1	1	1	1	1	1	1	1
10	1	0	1	1	1	0	1	1
11	1	1	1	0	1	1	1	1
12	1	1	1	0	1	0	1	0
13	1	0	1	0	1	1	1	1
14	1	0	1	0	1	1	1	1

5.2.2.2 Physical Common Packet Channel (PCPCH)

The Physical Common Packet Channel (PCPCH) is used to carry the CPCH.

5.2.2.2.1 CPCH transmission

The CPCH transmission is based on DSMA-CD approach with fast acquisition indication. The UE can start transmission at the beginning of a number of well-defined time-intervals, relative to the frame boundary of the received BCH of the current cell. The access slot timing and structure is identical to RACH in subclause 5.2.2.1.1. The structure of the CPCH access transmission is shown in figure 6. The CPCH access transmission consists of one or several Access Preambles [A-P] of length 4096 chips, one Collision Detection Preamble (CD-P) of length 4096 chips, a CPCH Power Control Preamble (PC-P) which is either 0 slots or 8 slots in length, and a message of variable length $N \times 10$ ms.

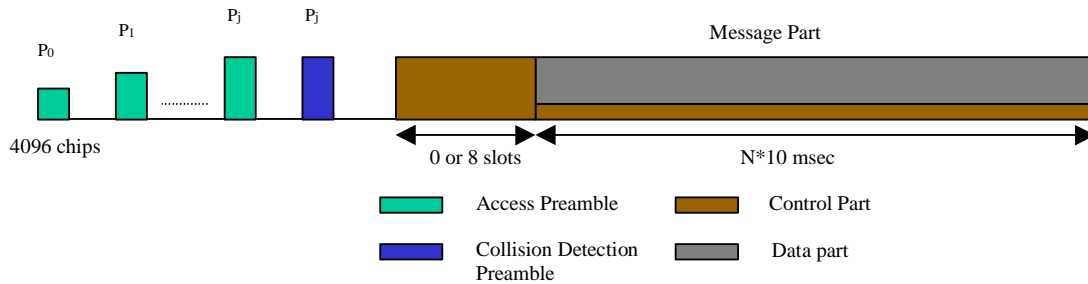

Figure 6: Structure of the CPCH access transmission

5.2.2.2.2 CPCH access preamble part

Similar to 5.2.2.1.2 (RACH preamble part). The RACH preamble signature sequences are used. The number of sequences used could be less than the ones used in the RACH preamble. The scrambling code could either be chosen to be a different code segment of the Gold code used to form the scrambling code of the RACH preambles (see [4] for more details) or could be the same scrambling code in case the signature set is shared.

5.2.2.2.3 CPCH collision detection preamble part

Similar to 5.2.2.1.2 (RACH preamble part). The RACH preamble signature sequences are used. The scrambling code is chosen to be a different code segment of the Gold code used to form the scrambling code for the RACH and CPCH preambles (see [4] for more details).

5.2.2.2.4 CPCH power control preamble part

The power control preamble segment is called the CPCH Power Control Preamble (PC-P) part. The slot format for CPCH PC-P part shall be the same as for the following message part in Table 9 in subclause 5.2.2.2.5. The Power Control Preamble length is a higher layer parameter, $L_{pc-preamble}$ (see [5], section 6.2), which shall take the value 0 or 8 slots. When $L_{pc-preamble} > 0$, the pilot bit patterns from slot #(15- $L_{pc-preamble}$) to slot #14 of table 3 and 4 in subclause 5.2.1 shall be used for CPCH PC-P pilot bit patterns. The TFCI field is filled with "1" bits.

5.2.2.2.5 CPCH message part

Figure 1 in subclause 5.2.1 shows the structure of the CPCH message part. Each message consists of up to N_{Max_frames} 10 ms frames. N_{Max_frames} is a higher layer parameter. Each 10 ms frame is split into 15 slots, each of length $T_{slot} = 2560$ chips. Each slot consists of two parts, a data part that carries higher layer information and a control part that carries Layer 1 control information. The data and control parts are transmitted in parallel.

The entries of table 1 in subclause 5.2.1 apply to the data part of the CPCH message part. The spreading factor for the control part of the CPCH message part shall be 256. Table 9 defines the slot format of the control part of CPCH message part. The pilot bit patterns of table 3 and 4 in subclause 5.2.1 shall be used for pilot bit patterns of the CPCH message part.

Table 9: Slot format of the control part of CPCH message part

Slot Format #i	Channel Bit Rate (kbps)	Channel Symbol Rate (ksps)	SF	Bits/ Frame	Bits/ Slot	N _{pilot}	N _{TPC}	N _{TFCI}	N _{FBI}
0	15	15	256	150	10	6	2	2	0
1	15	15	256	150	10	5	2	2	1
2	15	15	256	150	10	5	1	2	2

Figure 7 shows the frame structure of the uplink common packet physical channel. Each frame of length 10 ms is split into 15 slots, each of length $T_{slot} = 2560$ chips, corresponding to one power-control period.

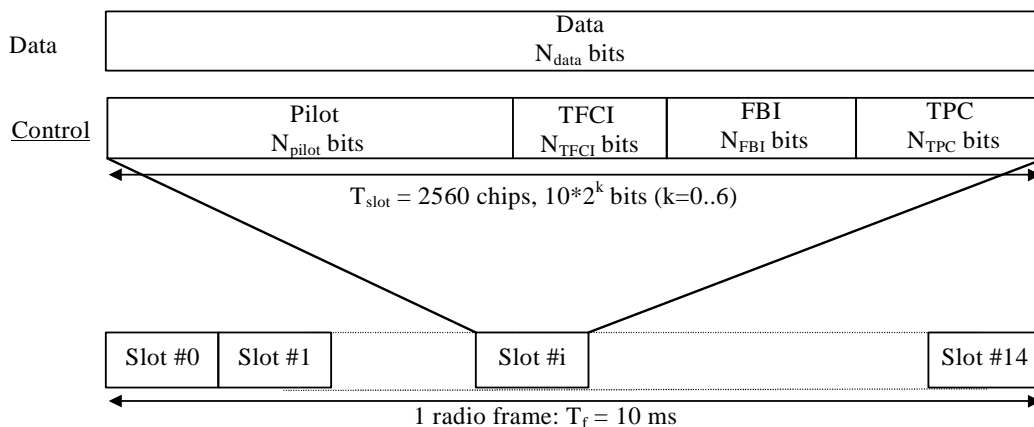

Figure 7: Frame structure for uplink Data and Control Parts Associated with PCPCH

The data part consists of $10 * 2^k$ bits, where $k = 0, 1, 2, 3, 4, 5, 6$, corresponding to spreading factors of 256, 128, 64, 32, 16, 8, 4 respectively.

5.3 Downlink physical channels

5.3.1 Downlink transmit diversity

Table 10 summarizes the possible application of open and closed loop transmit diversity modes on different downlink physical channel types. Simultaneous use of STTD and closed loop modes on the same physical channel is not allowed. In addition, if Tx diversity is applied on any of the downlink physical channels it shall also be applied on P-CCPCH and SCH. Regarding CPICH transmission in case of transmit diversity, see subclause 5.3.3.1.

Furthermore, the transmit diversity mode used for a PDSCH frame shall be the same as the transmit diversity mode used for the DPCH associated with this PDSCH frame. During the duration of the PDSCH frame, and within the slot prior to the PDSCH frame, the transmit diversity mode (open loop or closed loop) on the associated DPCH may not change. However, changing from closed loop mode 1 to mode 2 or vice versa, is allowed.

Table 10: Application of Tx diversity modes on downlink physical channel types
"X" – can be applied, "-" – not applied

Physical channel type	Open loop mode		Closed loop Mode
	TSTD	STTD	
P-CCPCH	-	X	-
SCH	X	-	-
S-CCPCH	-	X	-
DPCH	-	X	X
PICH	-	X	-
PDSCH	-	X	X
AICH	-	X	-
CSICH	-	X	-

5.3.1.1 Open loop transmit diversity

5.3.1.1.1 Space time block coding based transmit antenna diversity (STTD)

The open loop downlink transmit diversity employs a space time block coding based transmit diversity (STTD). The STTD encoding is optional in UTRAN. STTD support is mandatory at the UE. STTD encoding is applied on blocks of 4 consecutive channel bits. A block diagram of a generic STTD encoder for channel bits b_0, b_1, b_2, b_3 is shown in the figure 8 below. Channel coding, rate matching and interleaving is done as in the non-diversity mode. The bit b_i is real valued $\{0\}$ for DTX bits and $\{1, -1\}$ for all other channel bits.

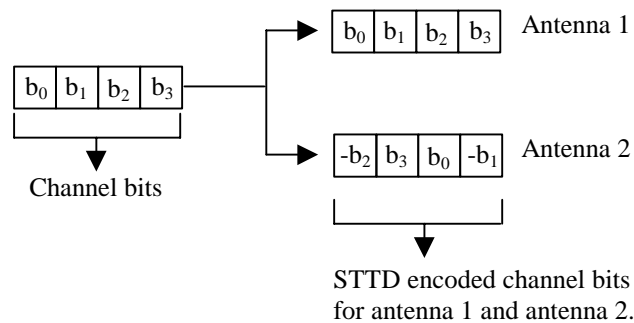

Figure 8: Generic block diagram of the STTD encoder

5.3.1.1.2 Time Switched Transmit Diversity for SCH (TSTD)

Transmit diversity, in the form of Time Switched Transmit Diversity (TSTD), can be applied to the SCH. TSTD for the SCH is optional in UTRAN, while TSTD support is mandatory in the UE. TSTD for the SCH is described in subclause 5.3.3.4.1.

5.3.1.2 Closed loop transmit diversity

Closed loop transmit diversity is described in [5]. Both closed loop transmit diversity modes shall be supported at the UE and may be supported in the UTRAN.

5.3.2 Dedicated downlink physical channels

There is only one type of downlink dedicated physical channel, the Downlink Dedicated Physical Channel (downlink DPCH).

Within one downlink DPCH, dedicated data generated at Layer 2 and above, i.e. the dedicated transport channel (DCH), is transmitted in time-multiplex with control information generated at Layer 1 (known pilot bits, TPC commands, and an optional TFCI). The downlink DPCH can thus be seen as a time multiplex of a downlink DPDCH and a downlink DPCCH, compare subclause 5.2.1.

Figure 9 shows the frame structure of the downlink DPCH. Each frame of length 10 ms is split into 15 slots, each of length $T_{\text{slot}} = 2560$ chips, corresponding to one power-control period.

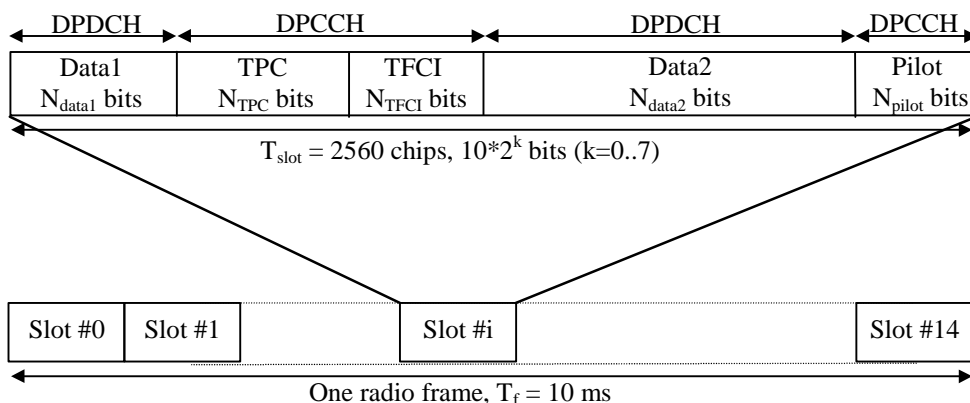

Figure 9: Frame structure for downlink DPCH

The parameter k in figure 9 determines the total number of bits per downlink DPCH slot. It is related to the spreading factor SF of the physical channel as $SF = 512/2^k$. The spreading factor may thus range from 512 down to 4.

The exact number of bits of the different downlink DPCH fields (N_{pilot} , N_{TPC} , N_{TFCI} , N_{data1} and N_{data2}) is given in table 11. What slot format to use is configured by higher layers and can also be reconfigured by higher layers.

There are basically two types of downlink Dedicated Physical Channels; those that include TFCI (e.g. for several simultaneous services) and those that do not include TFCI (e.g. for fixed-rate services). These types are reflected by the duplicated rows of table 11. It is the UTRAN that determines if a TFCI should be transmitted and it is mandatory for all UEs to support the use of TFCI in the downlink. The mapping of TFCI bits onto slots is described in [3].

In compressed mode, a different slot format is used compared to normal mode. There are two possible compressed slot formats that are labelled A and B. Format B is used for compressed mode by spreading factor reduction and format A is used for all other transmission time reduction methods. The channel bit and symbol rates given in table 11 are the rates immediately before spreading.

Table 11: DPDCH and DPCCH fields

Slot Format #i	Channel Bit Rate (kbps)	Channel Symbol Rate (ksps)	SF	Bits/Slot	DPDCH Bits/Slot		DPCCH Bits/Slot			Transmitted slots per radio frame N _{Tr}
					N _{Data1}	N _{Data2}	N _{TPC}	N _{TFCI}	N _{Pilot}	
0	15	7.5	512	10	0	4	2	0	4	15
0A	15	7.5	512	10	0	4	2	0	4	8-14
0B	30	15	256	20	0	8	4	0	8	8-14
1	15	7.5	512	10	0	2	2	2	4	15
1B	30	15	256	20	0	4	4	4	8	8-14
2	30	15	256	20	2	14	2	0	2	15
2A	30	15	256	20	2	14	2	0	2	8-14
2B	60	30	128	40	4	28	4	0	4	8-14
3	30	15	256	20	2	12	2	2	2	15
3A	30	15	256	20	2	10	2	4	2	8-14
3B	60	30	128	40	4	24	4	4	4	8-14
4	30	15	256	20	2	12	2	0	4	15
4A	30	15	256	20	2	12	2	0	4	8-14
4B	60	30	128	40	4	24	4	0	8	8-14
5	30	15	256	20	2	10	2	2	4	15
5A	30	15	256	20	2	8	2	4	4	8-14
5B	60	30	128	40	4	20	4	4	8	8-14
6	30	15	256	20	2	8	2	0	8	15
6A	30	15	256	20	2	8	2	0	8	8-14
6B	60	30	128	40	4	16	4	0	16	8-14
7	30	15	256	20	2	6	2	2	8	15
7A	30	15	256	20	2	4	2	4	8	8-14
7B	60	30	128	40	4	12	4	4	16	8-14
8	60	30	128	40	6	28	2	0	4	15
8A	60	30	128	40	6	28	2	0	4	8-14
8B	120	60	64	80	12	56	4	0	8	8-14
9	60	30	128	40	6	26	2	2	4	15
9A	60	30	128	40	6	24	2	4	4	8-14
9B	120	60	64	80	12	52	4	4	8	8-14
10	60	30	128	40	6	24	2	0	8	15
10A	60	30	128	40	6	24	2	0	8	8-14
10B	120	60	64	80	12	48	4	0	16	8-14
11	60	30	128	40	6	22	2	2	8	15
11A	60	30	128	40	6	20	2	4	8	8-14
11B	120	60	64	80	12	44	4	4	16	8-14
12	120	60	64	80	12	48	4	8*	8	15
12A	120	60	64	80	12	40	4	16*	8	8-14
12B	240	120	32	160	24	96	8	16*	16	8-14
13	240	120	32	160	28	112	4	8*	8	15
13A	240	120	32	160	28	104	4	16*	8	8-14
13B	480	240	16	320	56	224	8	16*	16	8-14
14	480	240	16	320	56	232	8	8*	16	15
14A	480	240	16	320	56	224	8	16*	16	8-14
14B	960	480	8	640	112	464	16	16*	32	8-14
15	960	480	8	640	120	488	8	8*	16	15
15A	960	480	8	640	120	480	8	16*	16	8-14
15B	1920	960	4	1280	240	976	16	16*	32	8-14
16	1920	960	4	1280	248	1000	8	8*	16	15
16A	1920	960	4	1280	248	992	8	16*	16	8-14

* If TFCI bits are not used, then DTX shall be used in TFCI field.

NOTE 1: Compressed mode is only supported through spreading factor reduction for SF=512 with TFCI.

NOTE 2: Compressed mode by spreading factor reduction is not supported for SF=4.

NOTE 3: If the Node B receives an invalid combination of data frames for downlink transmission, the procedure specified in [15], sub-clause 5.1.2, may require the use of DTX in both the DPDCH and the TFCI field of the DPCCH.

The pilot bit patterns are described in table 12. The shadowed column part of pilot bit pattern is defined as FSW and FSWs can be used to confirm frame synchronization. (The value of the pilot bit pattern other than FSWs shall be "11".) In table 12, the transmission order is from left to right.

In downlink compressed mode through spreading factor reduction, the number of bits in the TPC and Pilot fields are doubled. Symbol repetition is used to fill up the fields. Denote the bits in one of these fields in normal mode by $x_1, x_2, x_3, \dots, x_X$. In compressed mode the following bit sequence is sent in corresponding field: $x_1, x_2, x_1, x_2, x_3, x_4, x_3, x_4, \dots, x_X$.

Table 12: Pilot bit patterns for downlink DPCCH with $N_{pilot} = 2, 4, 8$ and 16

Symbol #	$N_{pilot} = 2$	$N_{pilot} = 4$ (*1)		$N_{pilot} = 8$ (*2)				$N_{pilot} = 16$ (*3)							
	0	0	1	0	1	2	3	0	1	2	3	4	5	6	7
Slot #0	11	11	11	11	11	11	10	11	11	11	10	11	11	11	10
1	00	11	00	11	00	11	10	11	00	11	10	11	11	11	00
2	01	11	01	11	01	11	01	11	01	11	01	11	10	11	00
3	00	11	00	11	00	11	00	11	00	11	00	11	01	11	10
4	10	11	10	11	10	11	01	11	10	11	01	11	11	11	11
5	11	11	11	11	11	11	10	11	11	11	10	11	01	11	01
6	11	11	11	11	11	11	00	11	11	11	00	11	10	11	11
7	10	11	10	11	10	11	00	11	10	11	00	11	10	11	00
8	01	11	01	11	01	11	10	11	01	11	10	11	00	11	11
9	11	11	11	11	11	11	11	11	11	11	11	11	00	11	11
10	01	11	01	11	01	11	01	11	01	11	01	11	11	11	10
11	10	11	10	11	10	11	11	11	10	11	11	11	00	11	10
12	10	11	10	11	10	11	00	11	10	11	00	11	01	11	01
13	00	11	00	11	00	11	11	11	00	11	11	11	00	11	00
14	00	11	00	11	00	11	11	11	00	11	11	11	10	11	01

NOTE *1: This pattern is used except slot formats 2B and 3B.

NOTE *2: This pattern is used except slot formats 0B, 1B, 4B, 5B, 8B, and 9B.

NOTE *3: This pattern is used except slot formats 6B, 7B, 10B, 11B, 12B, and 13B.

NOTE: For slot format nB where $n = 0, \dots, 15$, the pilot bit pattern corresponding to $N_{pilot}/2$ is to be used and symbol repetition shall be applied.

The relationship between the TPC symbol and the transmitter power control command is presented in table 13.

Table 13: TPC Bit Pattern

TPC Bit Pattern			Transmitter power control command
$N_{TPC} = 2$	$N_{TPC} = 4$	$N_{TPC} = 8$	
11	1111	11111111	1
00	0000	00000000	0

Multicode transmission may be employed in the downlink, i.e. the CCTrCH (see [3]) is mapped onto several parallel downlink DPCHs using the same spreading factor. In this case, the Layer 1 control information is transmitted only on the first downlink DPCH. DTX bits are transmitted during the corresponding time period for the additional downlink DPCHs, see figure 10.

In case there are several CCTrCHs mapped to different DPCHs transmitted to the same UE different spreading factors can be used on DPCHs to which different CCTrCHs are mapped. Also in this case, Layer 1 control information is only transmitted on the first DPCH while DTX bits are transmitted during the corresponding time period for the additional DPCHs.

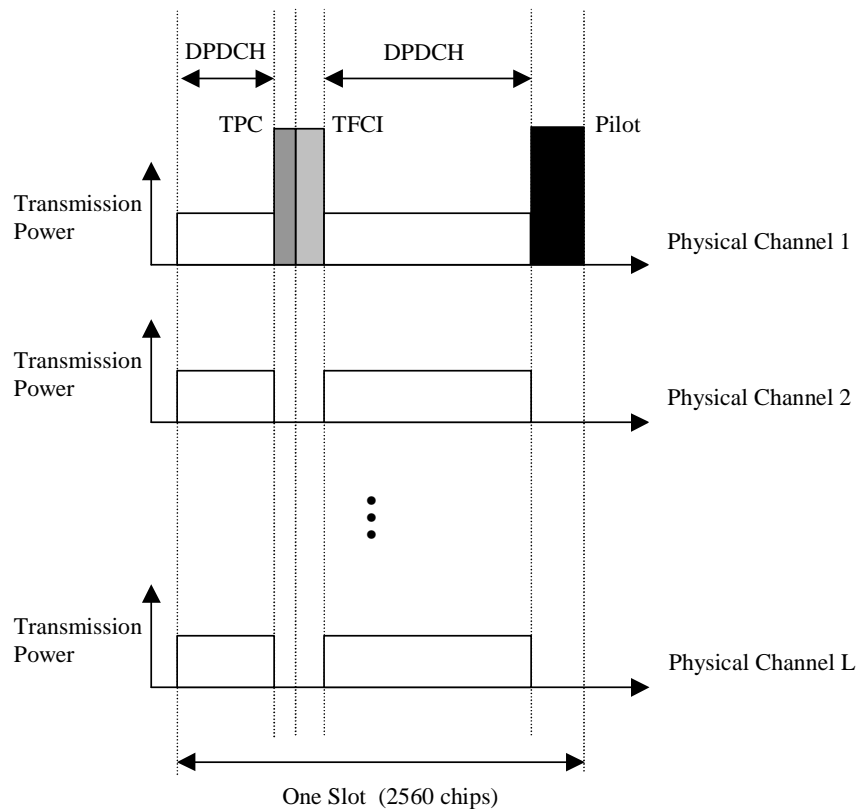

Figure 10: Downlink slot format in case of multi-code transmission

5.3.2.1 STTD for DPCH

The pilot bit pattern for the DPCH channel transmitted on antenna 2 is given in table 14.

- For $N_{\text{pilot}} = 8, 16$ the shadowed part indicates pilot bits that are obtained by STTD encoding the corresponding (shadowed) bits in Table 12. The non-shadowed pilot bit pattern is orthogonal to the corresponding (non-shadowed) pilot bit pattern in table 12.
- For $N_{\text{pilot}} = 4$, the diversity antenna pilot bit pattern is obtained by STTD encoding both the shadowed and non-shadowed pilot bits in table 12.
- For $N_{\text{pilot}} = 2$, the diversity antenna pilot pattern is obtained by STTD encoding the two pilot bits in table 12 with the last two bits (data or DTX) of the second data field (data2) of the slot. Thus for $N_{\text{pilot}} = 2$ case, the last two bits of the second data field (data 2) after STTD encoding, follow the diversity antenna pilot bits in Table 14.

STTD encoding for the DPDCH, TPC, and TFCI fields is done as described in subclause 5.3.1.1.1. For the SF=512 DPCH, the first two bits in each slot, i.e. TPC bits, are not STTD encoded and the same bits are transmitted with equal power from the two antennas. The remaining four bits are STTD encoded.

For compressed mode through spreading factor reduction and for $N_{\text{pilot}} > 4$, symbol repetition shall be applied to the pilot bit patterns of table 14, in the same manner as described in 5.3.2. For slot formats 2B and 3B, i.e. compressed mode through spreading factor reduction and $N_{\text{pilot}} = 4$, the pilot bits transmitted on antenna 2 are STTD encoded, and thus the pilot bit pattern is as shown in the most right set of table 14.

Table 14: Pilot bit patterns of downlink DPCCH for antenna 2 using STTD

Symbol #	$N_{pilot} = 2$ (*1)		$N_{pilot} = 4$ (*2)		$N_{pilot} = 8$ (*3)			$N_{pilot} = 16$ (*4)							$N_{pilot} = 4$ (*5)		
	0	1	0	1	0	1	2	3	0	1	2	3	4	5	6	7	0
Slot #0	01	01	10	11	00	00	10	11	00	00	10	11	00	00	10	01	10
1	10	10	10	11	00	00	01	11	00	00	01	11	10	00	10	10	01
2	11	11	10	11	11	00	00	11	11	00	00	11	10	00	11	11	00
3	10	10	10	11	10	00	01	11	10	00	01	11	00	00	00	10	01
4	00	00	10	11	11	00	11	11	11	00	11	11	01	00	10	00	11
5	01	01	10	11	00	00	10	11	00	00	10	11	11	00	00	01	10
6	01	01	10	11	10	00	10	11	10	00	10	11	01	00	11	01	10
7	00	00	10	11	10	00	11	11	10	00	11	11	10	00	11	00	11
8	11	11	10	11	00	00	00	11	00	00	00	11	01	00	01	11	00
9	01	01	10	11	01	00	10	11	01	00	10	11	01	00	01	01	10
10	11	11	10	11	11	00	00	11	11	00	00	11	00	00	10	11	00
11	00	00	10	11	01	00	11	11	01	00	11	11	00	00	01	00	11
12	00	00	10	11	10	00	11	11	10	00	11	11	11	00	00	00	11
13	10	10	10	11	01	00	01	11	01	00	01	11	10	00	01	10	01
14	10	10	10	11	01	00	01	11	01	00	01	11	11	00	11	10	01

NOTE *1: The pilot bits precede the last two bits of the data2 field.

NOTE *2: This pattern is used except slot formats 2B and 3B.

NOTE *3: This pattern is used except slot formats 0B, 1B, 4B, 5B, 8B, and 9B.

NOTE *4: This pattern is used except slot formats 6B, 7B, 10B, 11B, 12B, and 13B.

NOTE *5: This pattern is used for slot formats 2B and 3B.

NOTE: For slot format nB where $n = 0, 1, 4, 5, 6, \dots, 15$, the pilot bit pattern corresponding to $N_{pilot}/2$ is to be used and symbol repetition shall be applied.

5.3.2.2 Dedicated channel pilots with closed loop mode transmit diversity

In closed loop mode 1 orthogonal pilot patterns are used between the transmit antennas. Pilot patterns defined in the table 12 will be used on antenna 1 and pilot patterns defined in the table 14 on antenna 2. This is illustrated in the figure 11 a which indicates the difference in the pilot patterns with different shading.

In closed loop mode 2 same pilot pattern is used on both of the antennas (see figure 11 b). The pattern to be used is according to the table 12.

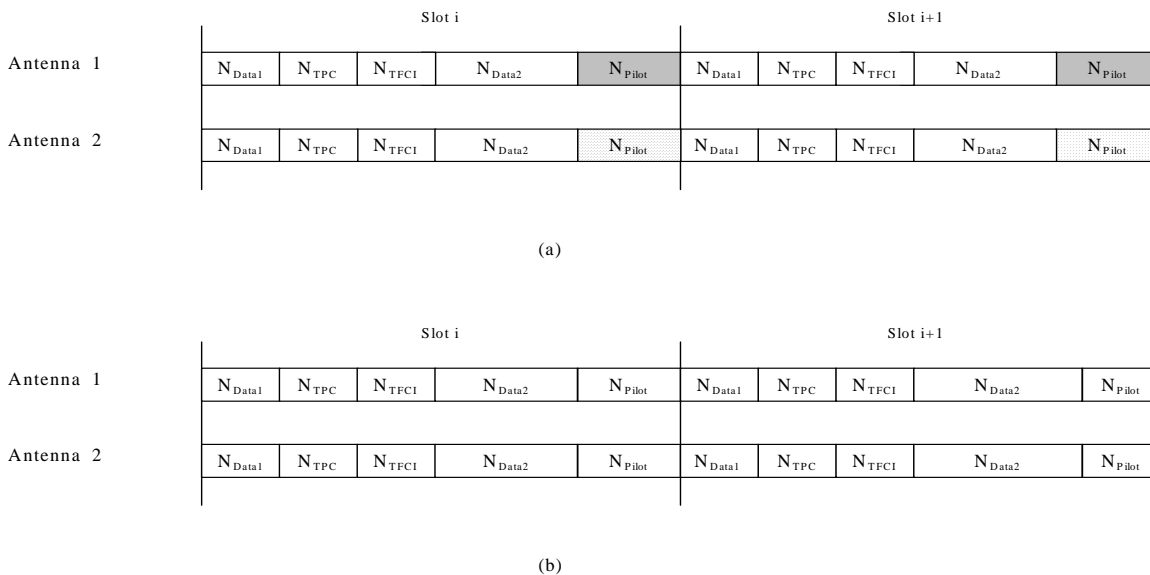

Figure 11: Slot structures for downlink dedicated physical channel diversity transmission.
Structure (a) is used in closed loop mode 1.
Structure (b) is used in closed loop mode 2.
Different shading of the pilots indicate orthogonality of the patterns

5.3.2.3 DL-DPCCH for CPCH

The downlink DPCCH for CPCH is a special case of downlink dedicated physical channel of the slot format #0 in table 11. The spreading factor for the DL-DPCCH is 512. Figure 12 shows the frame structure of DL-DPCCH for CPCH.

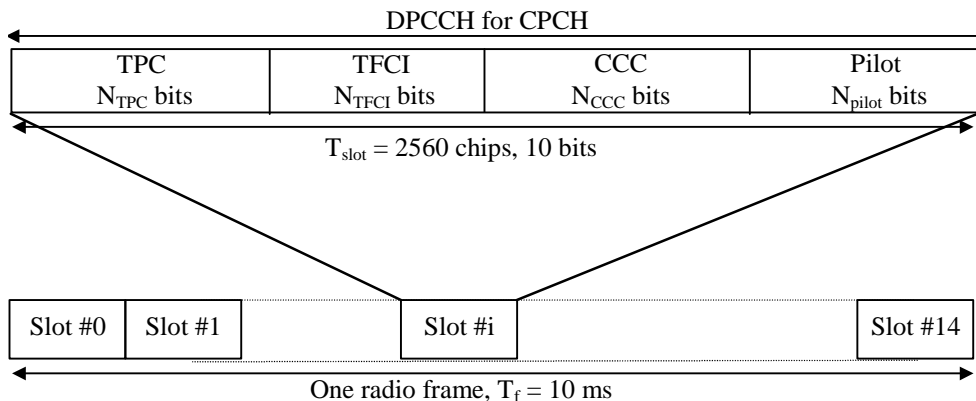

Figure 12: Frame structure for downlink DPCCH for CPCH

DL-DPCCH for CPCH consists of known pilot bits, TFCI, TPC commands and CPCH Control Commands (CCC). CPCH control commands are used to support CPCH signalling. There are two types of CPCH control commands: Layer 1 control command such as Start of Message Indicator, and higher layer control command such as Emergency Stop command. The exact number of bits of DL DPCCH fields (N_{pilot} , N_{TFCI} , N_{CCC} and N_{TPC}) is determined in table 15. The pilot bit pattern for $N_{pilot}=4$ of table 12 is used for DPCCH for CPCH.

Table 15: DPCCH fields for CPCH message transmission

Slot Format #i	Channel Bit Rate (kbps)	Channel Symbol Rate (ksp/s)	SF	Bits/Slot	DPCCH Bits/Slot				Transmitted slots per radio frame N_{Tr}
					N_{TPC}	N_{TFCI}	N_{CCC}	N_{Pilot}	
0	15	7.5	512	10	2	0	4	4	15

The DL DPCCCH power control preamble for CPCH shall take the same slot format as afterwards, as given in Table 15. The length of the power control preamble is a higher-layer parameter, $L_{pc-preamble}$ (see [5], section 6.2), signalled by the network. When $L_{pc-preamble} > 0$, the pilot patterns from slot $\#(15 - N_{pcp})$ to slot $\#14$ of table 12 shall be used for the power control preamble pilot patterns. The TFCI field is filled with "1" bits.

CCC field in figure 12 is used for the transmission of CPCH control command. On CPCH control command transmission request from higher layer, a certain pattern is mapped onto CCC field, otherwise nothing is transmitted in CCC field. There is one to one mapping between the CPCH control command and the pattern. In case of Emergency Stop of CPCH transmission, [1111] pattern is mapped onto CCC field. The Emergency Stop command shall not be transmitted during the first $N_{Start_Message}$ frames of DL DPCCCH after Power Control preamble.

Start of Message Indicator shall be transmitted during the first $N_{Start_Message}$ frames of DL DPCCCH after Power Control preamble. [1010] pattern is mapped onto CCC field for Start of Message Indicator. The value of $N_{Start_Message}$ shall be provided by higher layers.

5.3.3 Common downlink physical channels

5.3.3.1 Common Pilot Channel (CPICH)

The CPICH is a fixed rate (30 kbps, SF=256) downlink physical channel that carries a pre-defined bit/symbol sequence. Figure 13 shows the frame structure of the CPICH.

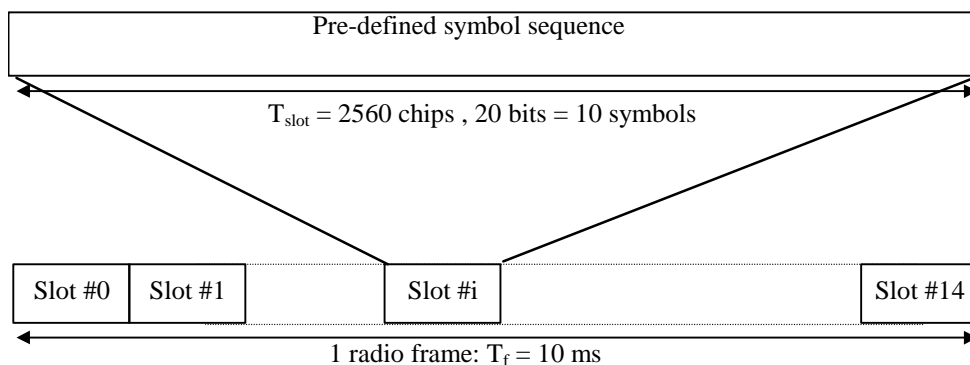

Figure 13: Frame structure for Common Pilot Channel

In case transmit diversity (open or closed loop) is used on any downlink channel in the cell, the CPICH shall be transmitted from both antennas using the same channelization and scrambling code. In this case, the pre-defined symbol sequence of the CPICH is different for Antenna 1 and Antenna 2, see figure 14. In case of no transmit diversity, the symbol sequence of Antenna 1 in figure 14 is used.

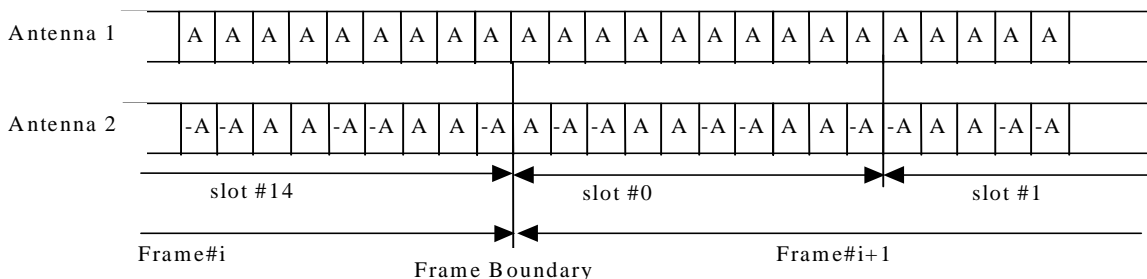

Figure 14: Modulation pattern for Common Pilot Channel (with $A = 1+j$)

There are two types of Common pilot channels, the Primary and Secondary CPICH. They differ in their use and the limitations placed on their physical features.

5.3.3.1.1 Primary Common Pilot Channel (P-CPICH)

The Primary Common Pilot Channel (P-CPICH) has the following characteristics:

- The same channelization code is always used for the P-CPICH, see [4];
- The P-CPICH is scrambled by the primary scrambling code, see [4];
- There is one and only one P-CPICH per cell;
- The P-CPICH is broadcast over the entire cell.

The Primary CPICH is a phase reference for the following downlink channels: SCH, Primary CCPCH, AICH, PICH AP-AICH, CD/CA-ICH, CSICH, and the S-CCPCH. By default, the Primary CPICH is also a phase reference for downlink DPCH. The UE is informed by higher layer signalling if the P-CPICH is not a phase reference for a downlink DPCH.

The Primary CPICH is always a phase reference for a downlink physical channel using closed loop TX diversity.

5.3.3.1.2 Secondary Common Pilot Channel (S-CPICH)

A Secondary Common Pilot Channel (S-CPICH) has the following characteristics:

- An arbitrary channelization code of SF=256 is used for the S-CPICH, see [4];
- A S-CPICH is scrambled by either the primary or a secondary scrambling code, see [4];
- There may be zero, one, or several S-CPICH per cell;
- A S-CPICH may be transmitted over the entire cell or only over a part of the cell;

A Secondary CPICH may be a phase reference for a downlink DPCH. If this is the case, the UE is informed about this by higher-layer signalling.

The Secondary CPICH can be a phase reference for a downlink physical channel using open loop TX diversity, instead of the Primary CPICH being a phase reference.

Note that it is possible that neither the P-CPICH nor any S-CPICH is a phase reference for a downlink DPCH.

5.3.3.2 Downlink phase reference

Table 16 summarizes the possible phase references usable on different downlink physical channel types.

Table 16: Application of phase references on downlink physical channel types
"X" – can be applied, "-" – not applied

Physical channel type	Primary-CPICH	Secondary-CPICH	Dedicated pilot
P-CCPCH	X	-	-
SCH	X	-	-
S-CCPCH	X	-	-
DPCH	X	X	X
PICH	X	-	-
PDSCH*	X	X	X
AICH	X	-	-
CSICH	X	-	-

Note * The same phase reference as with the associated DPCH shall be used.

5.3.3.3 Primary Common Control Physical Channel (P-CCPCH)

The Primary CCPCH is a fixed rate (30 kbps, SF=256) downlink physical channels used to carry the BCH transport channel.

Figure 15 shows the frame structure of the Primary CCPCH. The frame structure differs from the downlink DPCH in that no TPC commands, no TFCI and no pilot bits are transmitted. The Primary CCPCH is not transmitted during the first 256 chips of each slot. Instead, Primary SCH and Secondary SCH are transmitted during this period (see subclause 5.3.3.4).

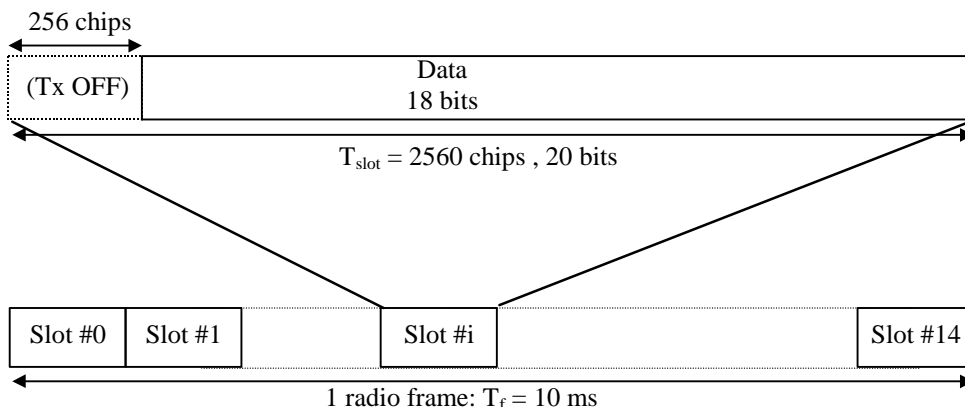

Figure 15: Frame structure for Primary Common Control Physical Channel

5.3.3.3.1 Primary CCPCH structure with STTD encoding

In case the diversity antenna is present in UTRAN and the P-CCPCH is to be transmitted using open loop transmit diversity, the data bits of the P-CCPCH are STTD encoded as given in subclause 5.3.1.1.1. The last two data bits in even numbered slots are STTD encoded together with the first two data bits in the following slot, except for slot #14 where the two last data bits are not STTD encoded and instead transmitted with equal power from both the antennas, see figure 16. Higher layers signal whether STTD encoding is used for the P-CCPCH or not. In addition the presence/absence of STTD encoding on P-CCPCH is indicated by modulating the SCH, see 5.3.3.4. During power on and hand over between cells the UE can determine the presence of STTD encoding on the P-CCPCH, by either receiving the higher layer message, by demodulating the SCH channel, or by a combination of the above two schemes.

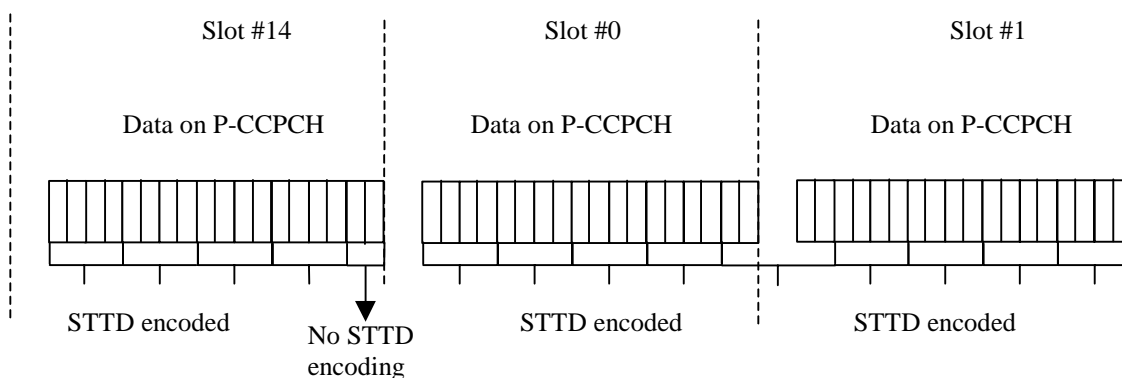

Figure 16: STTD encoding for the data bits of the P-CCPCH

5.3.3.4 Secondary Common Control Physical Channel (S-CCPCH)

The Secondary CCPCH is used to carry the FACH and PCH. There are two types of Secondary CCPCH: those that include TFCI and those that do not include TFCI. It is the UTRAN that determines if a TFCI should be transmitted, hence making it mandatory for all UEs to support the use of TFCI. The set of possible rates for the Secondary CCPCH is the same as for the downlink DPCH, see subclause 5.3.2. The frame structure of the Secondary CCPCH is shown in figure 17.

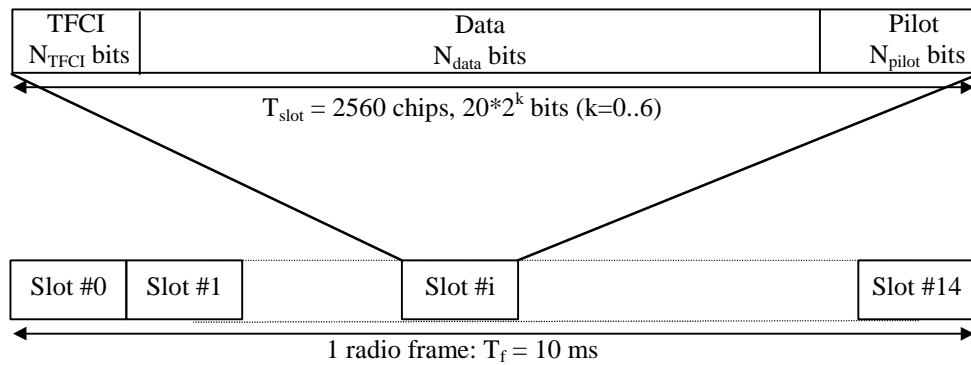

Figure 17: Frame structure for Secondary Common Control Physical Channel

The parameter k in figure 17 determines the total number of bits per downlink Secondary CCPCH slot. It is related to the spreading factor SF of the physical channel as $SF = 256/2^k$. The spreading factor range is from 256 down to 4.

The values for the number of bits per field are given in table 17. The channel bit and symbol rates given in table 17 are the rates immediately before spreading. The pilot patterns are given in table 18.

The FACH and PCH can be mapped to the same or to separate Secondary CCPCHs. If FACH and PCH are mapped to the same Secondary CCPCH, they can be mapped to the same frame. The main difference between a CCPCH and a downlink dedicated physical channel is that a CCPCH is not inner-loop power controlled. The main difference between the Primary and Secondary CCPCH is that the transport channel mapped to the Primary CCPCH (BCH) can only have a fixed predefined transport format combination, while the Secondary CCPCH support multiple transport format combinations using TFCI. Furthermore, a Primary CCPCH is transmitted over the entire cell while a Secondary CCPCH may be transmitted in a narrow lobe in the same way as a dedicated physical channel (only valid for a Secondary CCPCH carrying the FACH).

Table 17: Secondary CCPCH fields

Slot Format #i	Channel Bit Rate (kbps)	Channel Symbol Rate (ksps)	SF	Bits/ Frame	Bits/ Slot	N_{data}	N_{pilot}	N_{TFCI}
0	30	15	256	300	20	20	0	0
1	30	15	256	300	20	12	8	0
2	30	15	256	300	20	18	0	2
3	30	15	256	300	20	10	8	2
4	60	30	128	600	40	40	0	0
5	60	30	128	600	40	32	8	0
6	60	30	128	600	40	38	0	2
7	60	30	128	600	40	30	8	2
8	120	60	64	1200	80	72	0	8*
9	120	60	64	1200	80	64	8	8*
10	240	120	32	2400	160	152	0	8*
11	240	120	32	2400	160	144	8	8*
12	480	240	16	4800	320	312	0	8*
13	480	240	16	4800	320	296	16	8*
14	960	480	8	9600	640	632	0	8*
15	960	480	8	9600	640	616	16	8*
16	1920	960	4	19200	1280	1272	0	8*
17	1920	960	4	19200	1280	1256	16	8*

* If TFCI bits are not used, then DTX shall be used in TFCI field.

The pilot symbol pattern is described in table 18. The shadowed part can be used as frame synchronization words. (The symbol pattern of pilot symbols other than the frame synchronization word shall be "11"). In table 18, the transmission order is from left to right. (Each two-bit pair represents an I/Q pair of QPSK modulation.)

Table 18: Pilot Symbol Pattern

Symbol #	N _{pilot} = 8				N _{pilot} = 16							
	0	1	2	3	0	1	2	3	4	5	6	7
Slot #0	11	11	11	10	11	11	11	10	11	11	11	10
1	11	00	11	10	11	00	11	10	11	11	11	00
2	11	01	11	01	11	01	11	01	11	10	11	00
3	11	00	11	00	11	00	11	00	11	01	11	10
4	11	10	11	01	11	10	11	01	11	11	11	11
5	11	11	11	10	11	11	11	10	11	01	11	01
6	11	11	11	00	11	11	11	00	11	10	11	11
7	11	10	11	00	11	10	11	00	11	10	11	00
8	11	01	11	10	11	01	11	10	11	00	11	11
9	11	11	11	11	11	11	11	11	11	00	11	11
10	11	01	11	01	11	01	11	01	11	11	11	10
11	11	10	11	11	11	10	11	11	11	00	11	10
12	11	10	11	00	11	10	11	00	11	01	11	01
13	11	00	11	11	11	00	11	11	11	00	11	00
14	11	00	11	11	11	00	11	11	11	10	11	01

For slot formats using TFCI, the TFCI value in each radio frame corresponds to a certain transport format combination of the FACHs and/or PCHs currently in use. This correspondence is (re-)negotiated at each FACH/PCH addition/removal. The mapping of the TFCI bits onto slots is described in [3].

5.3.3.4.1 Secondary CCPCH structure with STTD encoding

In case the diversity antenna is present in UTRAN and the S-CCPCH is to be transmitted using open loop transmit diversity, the data symbols of the S-CCPCH are STTD encoded as given in subclause 5.3.1.1.1. The pilot symbol pattern for antenna 2 for the S-CCPCH is given in table 19 below.

Table 19: Pilot symbol pattern for antenna 2 when STTD encoding is used on the S-CCPCH

Symbol #	N _{pilot} = 8				N _{pilot} = 16							
	0	1	2	3	0	1	2	3	4	5	6	7
Slot #0	11	00	00	10	11	00	00	10	11	00	00	10
1	11	00	00	01	11	00	00	01	11	10	00	10
2	11	11	00	00	11	11	00	00	11	10	00	11
3	11	10	00	01	11	10	00	01	11	00	00	00
4	11	11	00	11	11	11	00	11	11	01	00	10
5	11	00	00	10	11	00	00	10	11	11	00	00
6	11	10	00	10	11	10	00	10	11	01	00	11
7	11	10	00	11	11	10	00	11	11	10	00	11
8	11	00	00	00	11	00	00	00	11	01	00	01
9	11	01	00	10	11	01	00	10	11	01	00	01
10	11	11	00	00	11	11	00	00	11	00	00	10
11	11	01	00	11	11	01	00	11	11	00	00	01
12	11	10	00	11	11	10	00	11	11	11	00	00
13	11	01	00	01	11	01	00	01	11	10	00	01
14	11	01	00	01	11	01	00	01	11	11	00	11

5.3.3.5 Synchronisation Channel (SCH)

The Synchronisation Channel (SCH) is a downlink signal used for cell search. The SCH consists of two sub channels, the Primary and Secondary SCH. The 10 ms radio frames of the Primary and Secondary SCH are divided into 15 slots, each of length 2560 chips. Figure 18 illustrates the structure of the SCH radio frame.

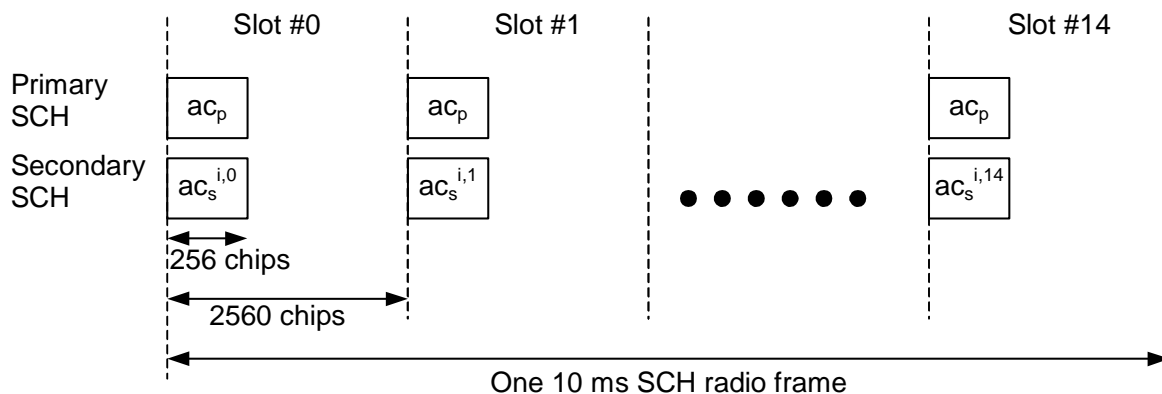

Figure 18: Structure of Synchronisation Channel (SCH)

The Primary SCH consists of a modulated code of length 256 chips, the Primary Synchronisation Code (PSC) denoted c_p in figure 18, transmitted once every slot. The PSC is the same for every cell in the system.

The Secondary SCH consists of repeatedly transmitting a length 15 sequence of modulated codes of length 256 chips, the Secondary Synchronisation Codes (SSC), transmitted in parallel with the Primary SCH. The SSC is denoted $c_s^{i,k}$ in figure 18, where $i = 0, 1, \dots, 63$ is the number of the scrambling code group, and $k = 0, 1, \dots, 14$ is the slot number. Each SSC is chosen from a set of 16 different codes of length 256. This sequence on the Secondary SCH indicates which of the code groups the cell's downlink scrambling code belongs to.

The primary and secondary synchronization codes are modulated by the symbol a shown in figure 18, which indicates the presence/ absence of STTD encoding on the P-CCPCH and is given by the following table:

P-CCPCH STTD encoded	$a = +1$
P-CCPCH not STTD encoded	$a = -1$

5.3.3.5.1 SCH transmitted by TSTD

Figure 19 illustrates the structure of the SCH transmitted by the TSTD scheme. In even numbered slots both PSC and SSC are transmitted on antenna 1, and in odd numbered slots both PSC and SSC are transmitted on antenna 2.

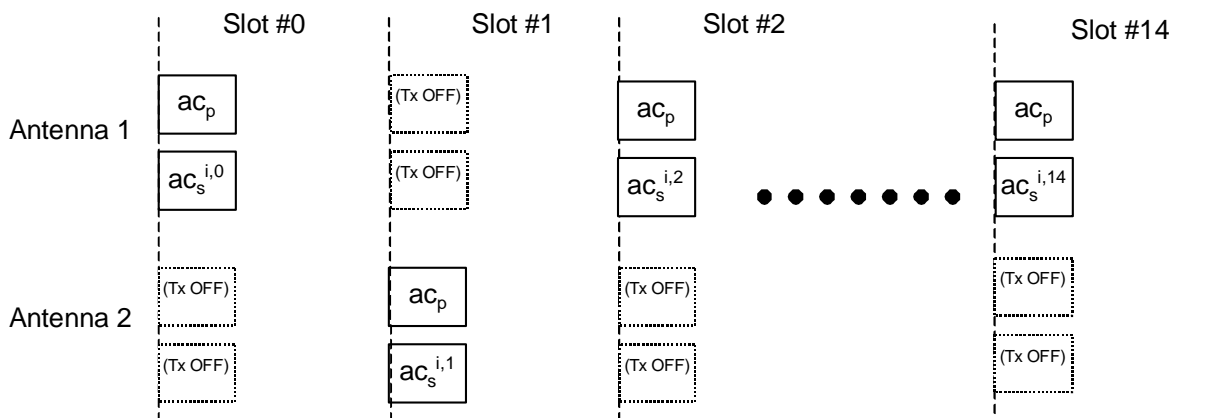

Figure 19: Structure of SCH transmitted by TSTD scheme

5.3.3.6 Physical Downlink Shared Channel (PDSCH)

The Physical Downlink Shared Channel (PDSCH) is used to carry the Downlink Shared Channel (DSCH).

A PDSCH corresponds to a channelisation code below or at a PDSCH root channelisation code. A PDSCH is allocated on a radio frame basis to a single UE. Within one radio frame, UTRAN may allocate different PDSCHs under the same PDSCH root channelisation code to different UEs based on code multiplexing. Within the same radio frame, multiple

parallel PDSCHs, with the same spreading factor, may be allocated to a single UE. This is a special case of multicode transmission. All the PDSCHs under the same PDSCH root channelisation code are operated with radio frame synchronisation.

PDSCHs allocated to the same UE on different radio frames may have different spreading factors.

The frame and slot structure of the PDSCH are shown on figure 20.

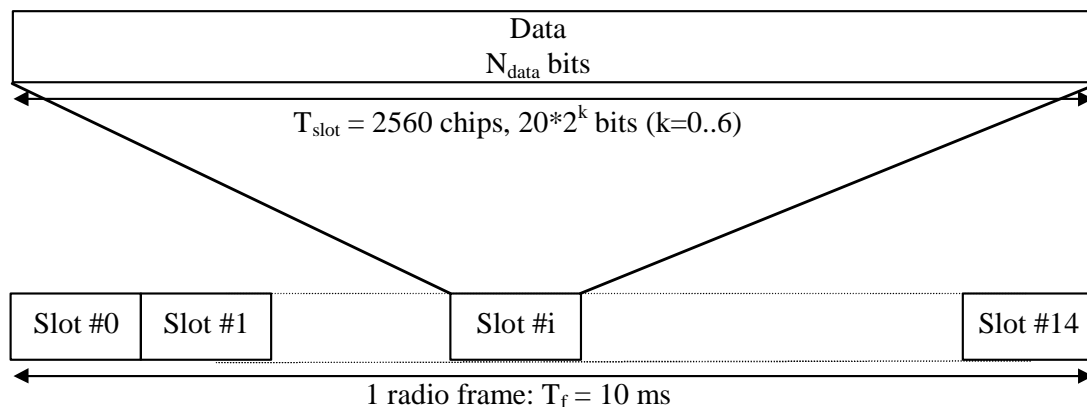

Figure 20: Frame structure for the PDSCH

For each radio frame, each PDSCH is associated with one downlink DPCH. The PDSCH and associated DPCH do not necessarily have the same spreading factors and are not necessarily frame aligned.

All relevant Layer 1 control information is transmitted on the DPCCCH part of the associated DPCH, i.e. the PDSCH does not carry Layer 1 information. To indicate for UE that there is data to decode on the DSCH, the TFCI field of the associated DPCH shall be used.

The TFCI informs the UE of the instantaneous transport format parameters related to the PDSCH as well as the channelisation code of the PDSCH.

The channel bit rates and symbol rates for PDSCH are given in table 20.

For PDSCH the allowed spreading factors may vary from 256 to 4.

Table 20: PDSCH fields

Slot format #i	Channel Bit Rate (kbps)	Channel Symbol Rate (ksps)	SF	Bits/ Frame	Bits/ Slot	N _{data}
0	30	15	256	300	20	20
1	60	30	128	600	40	40
2	120	60	64	1200	80	80
3	240	120	32	2400	160	160
4	480	240	16	4800	320	320
5	960	480	8	9600	640	640
6	1920	960	4	19200	1280	1280

When open loop transmit diversity is employed for the PDSCH, STTD encoding is used on the data bits as described in subclause 5.3.1.1.1.

5.3.3.7 Acquisition Indicator Channel (AICH)

The Acquisition Indicator channel (AICH) is a fixed rate (SF=256) physical channel used to carry Acquisition Indicators (AI). Acquisition Indicator AI_s corresponds to signature s on the PRACH.

Figure 21 illustrates the structure of the AICH. The AICH consists of a repeated sequence of 15 consecutive *access slots* (AS), each of length 5120 chips. Each access slot consists of two parts, an *Acquisition-Indicator* (AI) part consisting of 32 real-valued symbols a_0, \dots, a_{31} and a part of duration 1024 chips with no transmission that is not

5.3.3.8 CPCH Access Preamble Acquisition Indicator Channel (AP-AICH)

The Access Preamble Acquisition Indicator channel (AP-AICH) is a fixed rate (SF=256) physical channel used to carry AP acquisition indicators (API) of CPCH. AP acquisition indicator API_s corresponds to AP signature s transmitted by UE.

AP-AICH and AICH may use the same or different channelisation codes. The phase reference for the AP-AICH is the Primary CPICH. Figure 22 illustrates the structure of AP-AICH. The AP-AICH has a part of duration 4096 chips where the AP acquisition indicator (API) is transmitted, followed by a part of duration 1024 chips with no transmission that is not formally part of the AP-AICH. The part of the slot with no transmission is reserved for possible use by CSICH or possible future use by other physical channels.

The spreading factor (SF) used for channelisation of the AP-AICH is 256.

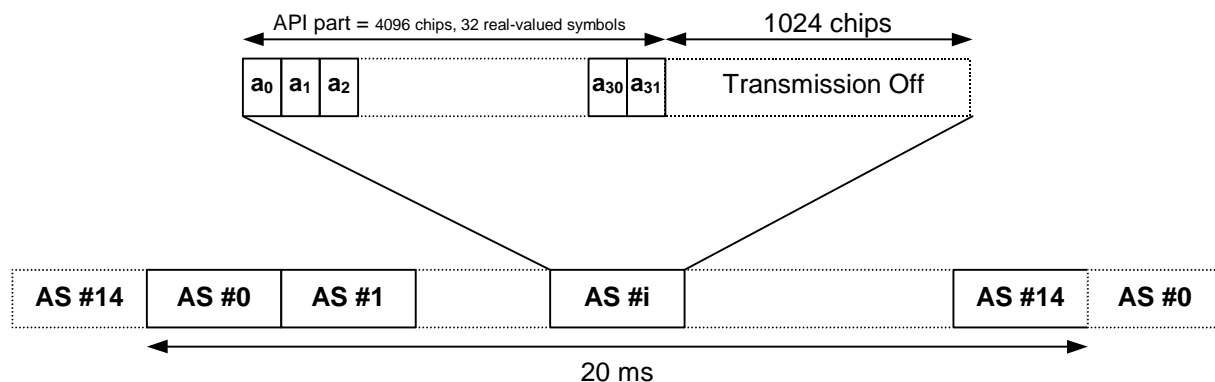

Figure 22: Structure of AP Acquisition Indicator Channel (AP-AICH)

The real-valued symbols a_0, a_1, \dots, a_{31} in figure 22 are given by

$$a_j = \sum_{s=0}^{15} API_s \times b_{s,j}$$

where API_s , taking the values +1, -1, and 0, is the AP acquisition indicator corresponding to Access Preamble signature s transmitted by UE and the sequence $b_{s,0}, \dots, b_{s,31}$ is given in Table 21. If the signature s is not a member of the set of UL Access Preamble signatures for the corresponding PCPCH (cf [5]) then API_s shall be set to 0.

The use of acquisition indicators is described in [5]. If an AP acquisition indicator is set to +1, it represents a positive acknowledgement. If an AP acquisition indicator is set to -1, it represents a negative acknowledgement.

The real-valued symbols, a_j , are spread and modulated in the same fashion as bits when represented in { +1, -1 } form.

In case STTD-based open-loop transmit diversity is applied to AP-AICH, STTD encoding according to subclause 5.3.1.1.1 is applied to each sequence $b_{s,0}, b_{s,1}, \dots, b_{s,31}$ separately before the sequences are combined into AP-AICH symbols a_0, \dots, a_{31} .

5.3.3.9 CPCH Collision Detection/Channel Assignment Indicator Channel (CD/CA-ICH)

The Collision Detection Channel Assignment Indicator channel (CD/CA-ICH) is a fixed rate (SF=256) physical channel used to carry CD Indicator (CDI) only if the CA is not active, or CD Indicator/CA Indicator (CDI/CAI) at the same time if the CA is active. The structure of CD/CA-ICH is shown in figure 23. CD/CA-ICH and AP-AICH may use the same or different channelisation codes.

The CD/CA-ICH has a part of duration of 4096 chips where the CDI/CAI is transmitted, followed by a part of duration 1024 chips with no transmission that is not formally part of the CD/CA-ICH. The part of the slot with no transmission is reserved for possible use by CSICH or possible future use by other physical channels.

The spreading factor (SF) used for channelisation of the CD/CA-ICH is 256.

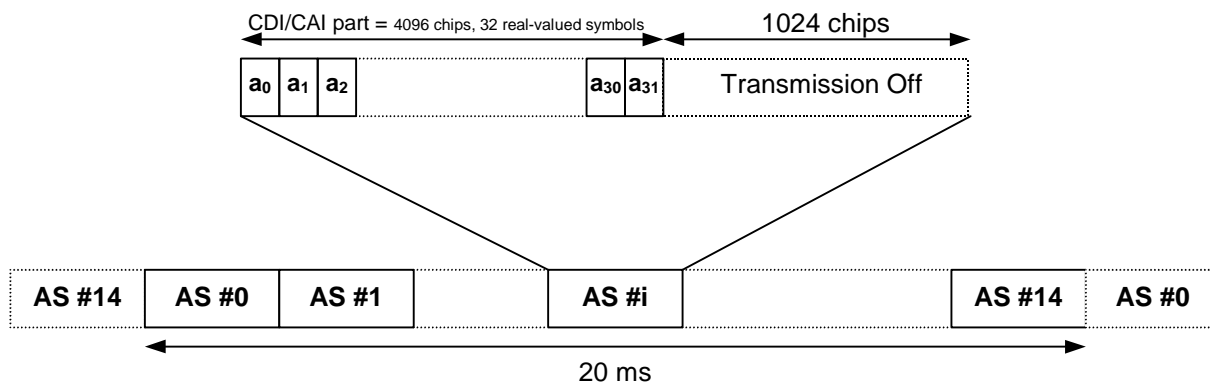

Figure 23: Structure of CD/CA Indicator Channel (CD/CA-ICH)

In case STTD-based open-loop transmit diversity is applied to CD/CA-ICH, STTD encoding according to subclause 5.3.1.1.1 is applied to each sequence $b_{s,0}, b_{s,1}, \dots, b_{s,31}$ separately before the sequences are combined into CD/CA-ICH symbols a_0, \dots, a_{31} .

In case CA is not active, the real-valued symbols a_0, a_1, \dots, a_{31} in figure 23 are given by

$$a_j = \sum_{s=0}^{15} \text{CDI}_s \times b_{s,j}$$

where CDI_s , taking the values +1, and 0, is the CD indicator corresponding to CD preamble signature s transmitted by UE and the sequence $b_{s,0}, \dots, b_{s,31}$ is given in table 21. If the signature s is not a member of the set of CD Preamble signatures for the corresponding PCPCH (cf [5]), then CDI_s shall be set to 0.

The real-valued symbols, a_j , are spread and modulated in the same fashion as bits when represented in $\{ +1, -1 \}$ form.

In case CA is active, the real-valued symbols a_0, a_1, \dots, a_{31} in figure 23 are given by

$$a_j = \sum_{i=0}^{15} \text{CDI}_i \times b_{s_i,j} + \sum_{k=0}^{15} \text{CAI}_k \times b_{s_k,j}$$

where the subscript s_i, s_k depend on the indexes i, k according to table 22, respectively, and indicate the signature number s in table 21. The sequence $b_{s,0}, \dots, b_{s,31}$ is given in table 21. CDI_i , taking the values +1/0 or -1/0, is the CD indicator corresponding to the CD preamble i transmitted by the UE, and CAI_k , taking the values +1/0 or -1/0, is the CA indicator corresponding to the assigned channel index k as given in table 22. If the signature s_i is not a member of the set of CD Preamble signatures for the corresponding PCPCH (cf [5]), then CDI_s shall be set to 0. Similarly, if the signature s_k is not a member of the set of CD Preamble signatures for the corresponding PCPCH (cf [5]), then CDI_s shall be set to 0.

Table 22. Generation of CDI_i/CAI_k

UE transmitted CD Preamble i	CDI_i	signature s_i	Channel Assignment Index k	CAI_k	signature s_k
0	+1/0	1	0	+1/0	0
1	-1/0		1	-1/0	
2	+1/0	3	2	+1/0	8
3	-1/0		3	-1/0	
4	+1/0	5	4	+1/0	4
5	-1/0		5	-1/0	
6	+1/0	7	6	+1/0	12
7	-1/0		7	-1/0	
8	+1/0	9	8	+1/0	2
9	-1/0		9	-1/0	
10	+1/0	11	10	+1/0	10
11	-1/0		11	-1/0	
12	+1/0	13	12	+1/0	6
13	-1/0		13	-1/0	
14	+1/0	15	14	+1/0	14
15	-1/0		15	-1/0	

5.3.3.10 Paging Indicator Channel (PICH)

The Paging Indicator Channel (PICH) is a fixed rate (SF=256) physical channel used to carry the paging indicators. The PICH is always associated with an S-CCPCH to which a PCH transport channel is mapped.

Figure 24 illustrates the frame structure of the PICH. One PICH radio frame of length 10 ms consists of 300 bits (b_0, b_1, \dots, b_{299}). Of these, 288 bits (b_0, b_1, \dots, b_{287}) are used to carry paging indicators. The remaining 12 bits are not formally part of the PICH and shall not be transmitted. The part of the frame with no transmission is reserved for possible future use.

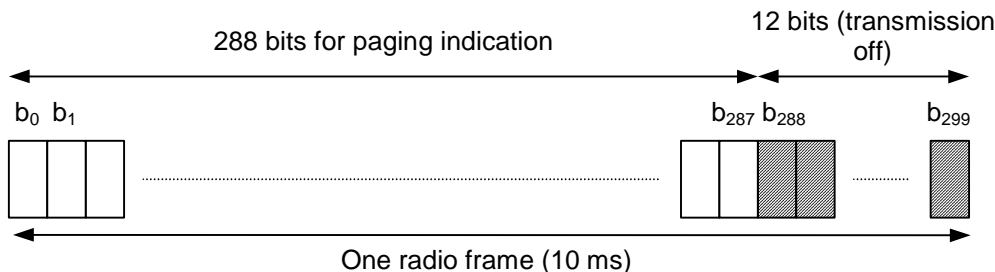

Figure 24: Structure of Paging Indicator Channel (PICH)

In each PICH frame, N_p paging indicators $\{P_0, \dots, P_{N_p-1}\}$ are transmitted, where $N_p=18, 36, 72, \text{ or } 144$.

The PI calculated by higher layers for use for a certain UE, is associated to the paging indicator P_q , where q is computed as a function of the PI computed by higher layers, the SFN of the P-CCPCH radio frame during which the start of the PICH radio frame occurs, and the number of paging indicators per frame (N_p):

$$q = \left(PI + \left[\left((18 \times (SFN + \lfloor SFN/8 \rfloor) + \lfloor SFN/64 \rfloor + \lfloor SFN/512 \rfloor) \right) \bmod 144 \right] \times \frac{N_p}{144} \right) \bmod N_p$$

Further, the PI calculated by higher layers is associated with the value of the paging indicator P_q . If a paging indicator in a certain frame is set to "1" it is an indication that UEs associated with this paging indicator and PI should read the corresponding frame of the associated S-CCPCH.

The PI bitmap in the PCH data frames over Iub contains indication values for all higher layer PI values possible. Each bit in the bitmap indicates if the paging indicator associated with that particular PI shall be set to 0 or 1. Hence, the calculation in the formula above is to be performed in Node B to make the association between PI and P_q .

The mapping from $\{P_0, \dots, P_{N_p-1}\}$ to the PICH bits $\{b_0, \dots, b_{287}\}$ are according to table 23.

Table 23: Mapping of paging indicators P_q to PICH bits

Number of paging indicators per frame (N_p)	$P_q = 1$	$P_q = 0$
$N_p=18$	$\{b_{16q}, \dots, b_{16q+15}\} = \{-1, -1, \dots, -1\}$	$\{b_{16q}, \dots, b_{16q+15}\} = \{+1, +1, \dots, +1\}$
$N_p=36$	$\{b_{8q}, \dots, b_{8q+7}\} = \{-1, -1, \dots, -1\}$	$\{b_{8q}, \dots, b_{8q+7}\} = \{+1, +1, \dots, +1\}$
$N_p=72$	$\{b_{4q}, \dots, b_{4q+3}\} = \{-1, -1, \dots, -1\}$	$\{b_{4q}, \dots, b_{4q+3}\} = \{+1, +1, \dots, +1\}$
$N_p=144$	$\{b_{2q}, b_{2q+1}\} = \{-1, -1\}$	$\{b_{2q}, b_{2q+1}\} = \{+1, +1\}$

When transmit diversity is employed for the PICH, STTD encoding is used on the PICH bits as described in subclause 5.3.1.1.1.

5.3.3.11 CPCH Status Indicator Channel (CSICH)

The CPCH Status Indicator Channel (CSICH) is a fixed rate (SF=256) physical channel used to carry CPCH status information.

A CSICH is always associated with a physical channel used for transmission of CPCH AP-AICH and uses the same channelization and scrambling codes. Figure 25 illustrates the frame structure of the CSICH. The CSICH frame consists of 15 consecutive access slots (AS) each of length 40 bits. Each access slot consists of two parts, a part of duration 4096 chips with no transmission that is not formally part of the CSICH, and a Status Indicator (SI) part consisting of 8 bits b_{8i}, \dots, b_{8i+7} , where i is the access slot number. The part of the slot with no transmission is reserved for use by AICH, AP-AICH or CD/CA-ICH. The modulation used by the CSICH is the same as for the PICH. The phase reference for the CSICH is the Primary CPICH.

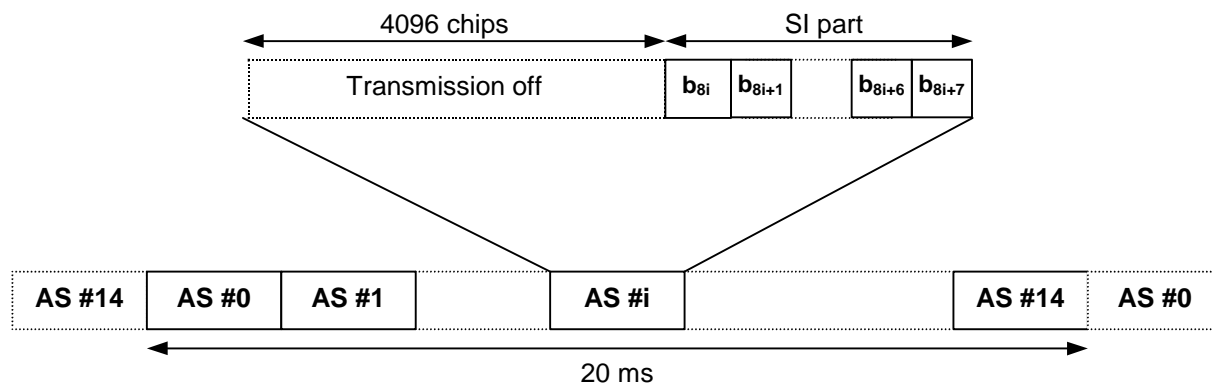

Figure 25: Structure of CPCH Status Indicator Channel (CSICH)

N Status Indicators $\{SI_0, \dots, SI_{N-1}\}$ shall be transmitted in each CSICH frame. The mapping from $\{SI_0, \dots, SI_{N-1}\}$ to the CSICH bits $\{b_0, \dots, b_{119}\}$ is according to table 24. The Status Indicators shall be transmitted in all the access slots of the CSICH frame, even if some signatures and/or access slots are shared between CPCH and RACH.

Table 24: Mapping of Status Indicators (SI) to CSICH bits

Number of SI per frame (N)	SI _n = 1	SI _n = 0
N=1	{b ₀ , ..., b ₁₁₉ } = {-1,-1,...,-1}	{b ₀ , ..., b ₁₁₉ } = {+1,+1,...,+1}
N=3	{b _{40n} , ..., b _{40n+39} } = {-1,-1,...,-1}	{b _{40n} , ..., b _{40n+39} } = {+1,+1,...,+1}
N=5	{b _{24n} , ..., b _{24n+23} } = {-1,-1,...,-1}	{b _{24n} , ..., b _{24n+23} } = {+1,+1,...,+1}
N=15	{b _{8n} , ..., b _{8n+7} } = {-1,-1,...,-1}	{b _{8n} , ..., b _{8n+7} } = {+1,+1,...,+1}
N=30	{b _{4n} , ..., b _{4n+3} } = {-1, -1, -1, -1}	{b _{4n} , ..., b _{4n+3} } = {+1, +1, +1, +1}
N=60	{b _{2n} , b _{2n+1} } = {-1,-1}	{b _{2n} , b _{2n+1} } = {+1,+1}

When transmit diversity is employed for the CSICH, STTD encoding is used on the CSICH bits as described in subclause 5.3.1.1.1.

The CPCH Status Indicator mode (CSICH mode) defines the structure of the information carried on the CSICH. At the UTRAN the value of the CPCH Status Indicator mode is set by higher layers. There are two CSICH modes depending on whether Channel Assignment is active or not. The CSICH mode defines the number of status indicators per frame and the content of each status indicator. Layer 1 transmits the CSICH information according to the CSICH mode and the structures defined in the following paragraphs.

5.3.3.11.1 CSICH Information Structure when Channel Assignment is not active

In this mode, CPCH Status Indication conveys the PCPCH Channel Availability value which is a 1 to 16 bit value which indicates the availability of each of the 1 to 16 defined PCPCHs in the CPCH set. PCPCHs are numbered from PCPCH0 through PCPCH15. There is one bit of the PCPCH Resource Availability (PRA) value for each defined PCPCH channel. If there are 2 PCPCHs defined in the CPCH set, then there are 2 bits in the PRA value. And likewise for other numbers of defined PCPCH channels up to 16 maximum CPCH channels per set when Channel Assignment is not active.

The number of SIs (Status Indicators) per frame is a function of the number of defined PCPCH channels.

Number of defined PCPCHs(=K)	Number of SIs per frame(=N)
1, 2, 3	3
4,5	5
6,7,8,9,10,11,12,13,14,15	15
16	30

The value of the SI shall indicate the PRA value for one of the defined PCPCHs, where PRA(n)=1 indicates that the PCPCH is available, and PRA(n)=0 indicates that the PCPCH_n is not available. SI(0) shall indicate PRA(0) for PCPCH0, SI(1) shall indicate PRA(1) for PCPCH1, etc., for each defined PCPCH. When the number of SIs per frame exceeds the number of defined PCPCHs (K), the SIs which exceed K shall be set to repeat the PRA values for the defined PCPCHs. In general ,

$$SI(n) = PRA(n \text{ mod } (K)),$$

where PRA(i) is availability of PCPCH_i,

and n ranges from 0 to N-1.

5.3.3.11.2 PCPCH Availability when Channel Assignment is active

In this mode, CPCH Status Indication conveys two pieces of information. One is the Minimum Available Spreading Factor (MASF) value and the other is the PCPCH Resource Availability (PRA) value.

- MASF is a 3 bit number with bits MASF(0) through MASF(2) where MASF(0) is the MSB of the MASF value and MASF(2) is the LSB of the MASF value.

The following table defines MASF(0), MASF(1) and MASF(2) values to convey the MASF. All spreading factors greater than MASF are available

Minimum Available Spreading Factor (MASF)	MASF(0)	MASF(1)	MASF(2)
N/A (No available CPCH resources)	0	0	0
256	0	0	1
128	0	1	0
64	0	1	1
32	1	0	0
16	1	0	1
08	1	1	0
04	1	1	1

The number of SIs (Status Indicators) per frame, N is a function of the number of defined PCPCH channels, K.

Number of defined PCPCHs(K)	Number of SIs per frame(N)
1, 2,	5
3,4,5,6,7,8,9,10,11,12	15
13,14,15,16,17,18,19,20,21,22,23,24,25,26,27	30
28....57	60

PRA(n)=1 indicates that the PCPCHn is available, and PRA(n)=0 indicates that the PCPCHn is not available. PRA value for each PCPCH channel defined in a CPCH set shall be assigned to one SI (Status Indicator), and 3-bit MASF value shall be assigned to SIs as shown in Figure 26.

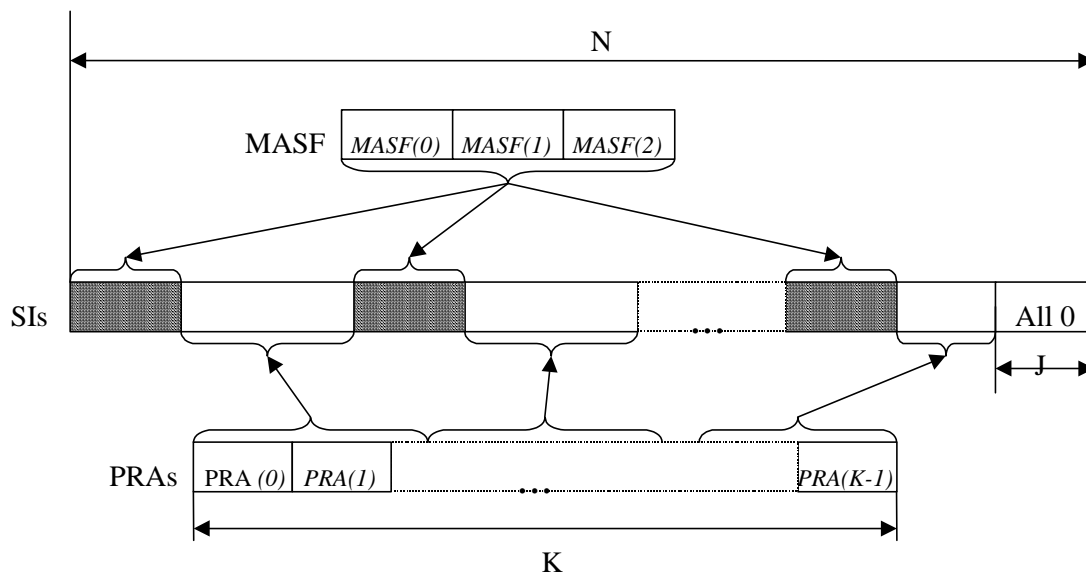

Figure 26: Mapping of MASF and PRAs to SIs in CSICH

The number of repetition that 3-bit MASF values shall be repeated is

$$T = \lfloor (N - K) / 3 \rfloor$$

where $\lfloor x \rfloor$ is largest integer less than or equal to x. Each MASF value it, MASF(n), shall be mapped to SI as follows.

$$SI_{l(t+4)+i} = MASF(i), \quad 0 \leq i \leq 2 \quad l = 0, 1, \dots, s-1$$

$$SI_{s+l(t+3)+i} = MASF(i), \quad 0 \leq i \leq 2 \quad l = s, s+1, \dots, T-1$$

where

$$t = \lfloor K / T \rfloor$$

and

$$s = K - t \cdot T$$

Each PRA value bit, PRA(n), shall be mapped to SI as follows.

$$SI_{l(t+4)+j+3} = PRA(l + l \cdot t + j), \quad 0 \leq j \leq t \quad l = 0, 1, \dots, s-1$$

$$SI_{s+l(t+3)+j+3} = PRA(s + l \cdot t + j), \quad 0 \leq j \leq t-1 \quad l = s, s+1, \dots, T-1$$

The remaining

$$J = N - (3T + K)$$

SIs shall be set to 0.

6 Mapping and association of physical channels

6.1 Mapping of transport channels onto physical channels

Figure 27 summarises the mapping of transport channels onto physical channels.

<u>Transport Channels</u>	<u>Physical Channels</u>
DCH	Dedicated Physical Data Channel (DPDCH) Dedicated Physical Control Channel (DPCCCH)
RACH	Physical Random Access Channel (PRACH)
CPCH	Physical Common Packet Channel (PCPCH) Common Pilot Channel (CPICH)
BCH	Primary Common Control Physical Channel (P-CCPCH)
FACH	Secondary Common Control Physical Channel (S-CCPCH)
PCH	
	Synchronisation Channel (SCH)
DSCH	Physical Downlink Shared Channel (PDSCH) Acquisition Indicator Channel (AICH) Access Preamble Acquisition Indicator Channel (AP-AICH) Paging Indicator Channel (PICH) CPCH Status Indicator Channel (CSICH) Collision-Detection/Channel-Assignment Indicator Channel (CD/CA-ICH)

Figure 27: Transport-channel to physical-channel mapping

The DCHs are coded and multiplexed as described in [3], and the resulting data stream is mapped sequentially (first-in-first-mapped) directly to the physical channel(s). The mapping of BCH and FACH/PCH is equally straightforward,

where the data stream after coding and interleaving is mapped sequentially to the Primary and Secondary CCPCH respectively. Also for the RACH, the coded and interleaved bits are sequentially mapped to the physical channel, in this case the message part of the PRACH.

6.2 Association of physical channels and physical signals

Figure 28 illustrates the association between physical channels and physical signals.

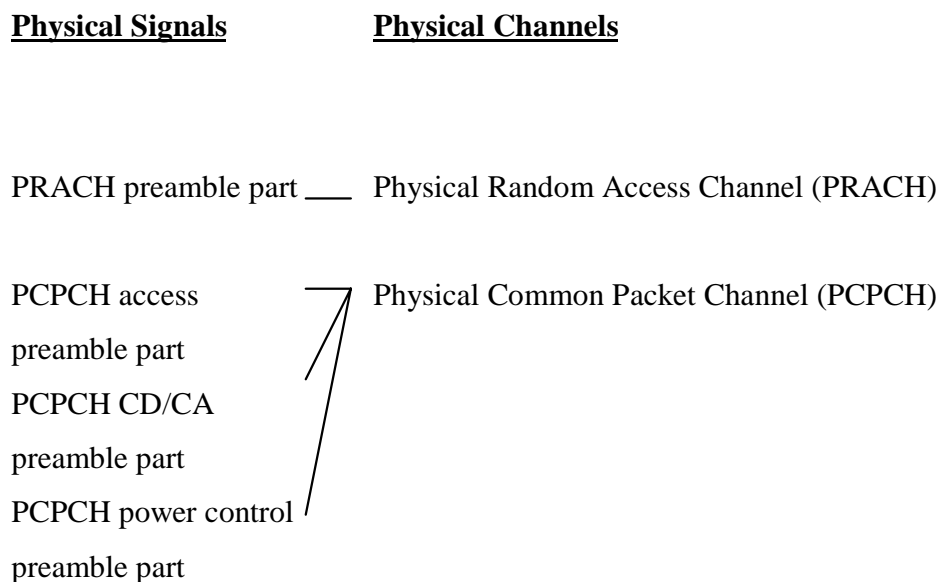

Figure 28: Physical channel and physical signal association

7 Timing relationship between physical channels

7.1 General

The P-CCPCH, on which the cell SFN is transmitted, is used as timing reference for all the physical channels, directly for downlink and indirectly for uplink.

Figure 29 below describes the frame timing of the downlink physical channels. For the AICH the access slot timing is included. Transmission timing for uplink physical channels is given by the received timing of downlink physical channels, as described in the following subclauses.

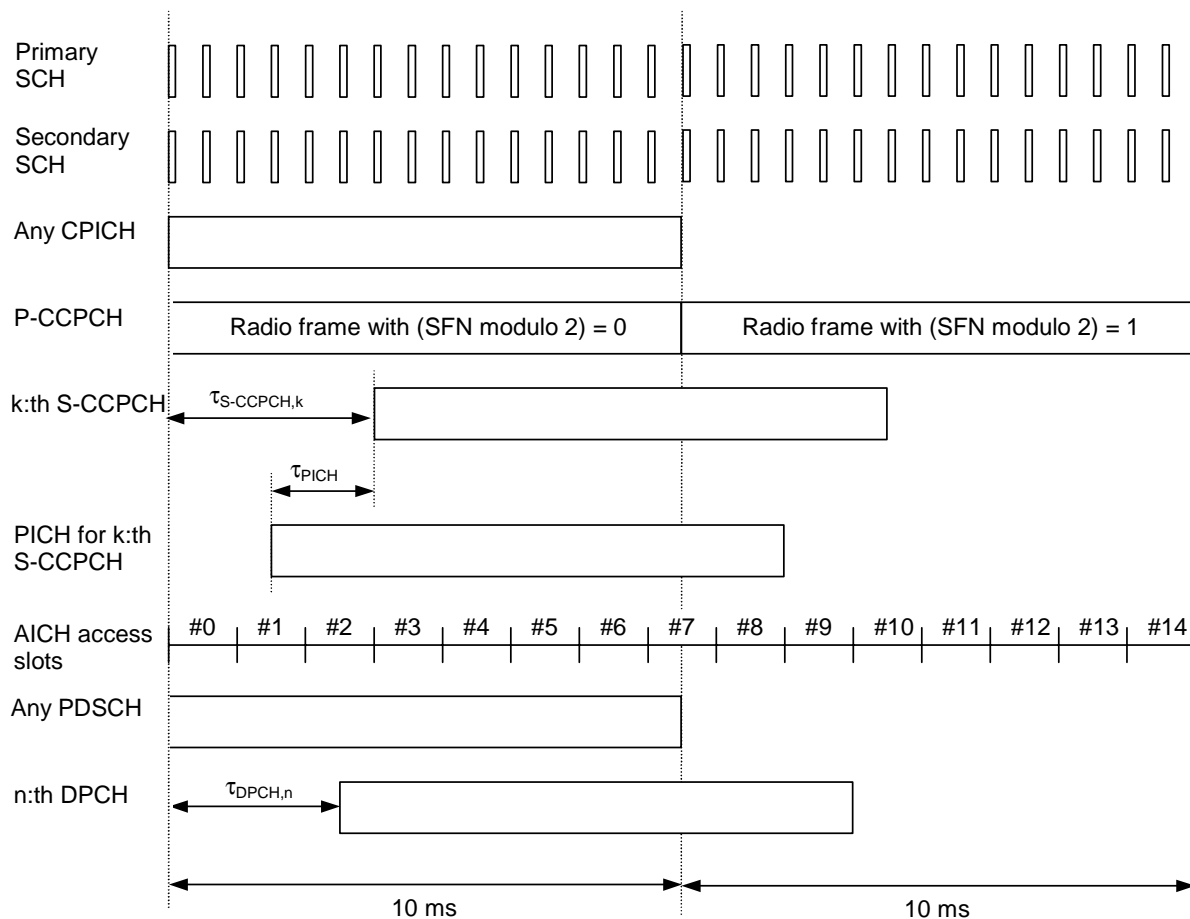

Figure 29: Radio frame timing and access slot timing of downlink physical channels

The following applies:

- SCH (primary and secondary), CPICH (primary and secondary), P-CCPCH, and PDSCH have identical frame timings.
- The S-CCPCH timing may be different for different S-CCPCHs, but the offset from the P-CCPCH frame timing is a multiple of 256 chips, i.e. $\tau_{S-CCPCH,k} = T_k \times 256 \text{ chip}$, $T_k \in \{0, 1, \dots, 149\}$.
- The PICH timing is $\tau_{PICH} = 7680$ chips prior to its corresponding S-CCPCH frame timing, i.e. the timing of the S-CCPCH carrying the PCH transport channel with the corresponding paging information, see also subclause 7.2.
- AICH access slots #0 starts the same time as P-CCPCH frames with $(SFN \bmod 2) = 0$. The AICH/PRACH and AICH/PCPCH timing is described in subclauses 7.3 and 7.4 respectively.
- The relative timing of associated PDSCH and DPCH is described in subclause 7.5.
- The DPCH timing may be different for different DPCHs, but the offset from the P-CCPCH frame timing is a multiple of 256 chips, i.e. $\tau_{DPCH,n} = T_n \times 256 \text{ chip}$, $T_n \in \{0, 1, \dots, 149\}$. The DPCH (DPCCH/DPDCH) timing relation with uplink DPCCH/DPDCHs is described in subclause 7.6.

7.2 PICH/S-CCPCH timing relation

Figure 30 illustrates the timing between a PICH frame and its associated single S-CCPCH frame, i.e. the S-CCPCH frame that carries the paging information related to the paging indicators in the PICH frame. A paging indicator set in a

PICH frame means that the paging message is transmitted on the PCH in the S-CCPCH frame starting τ_{PICH} chips after the transmitted PICH frame. τ_{PICH} is defined in subclause 7.1.

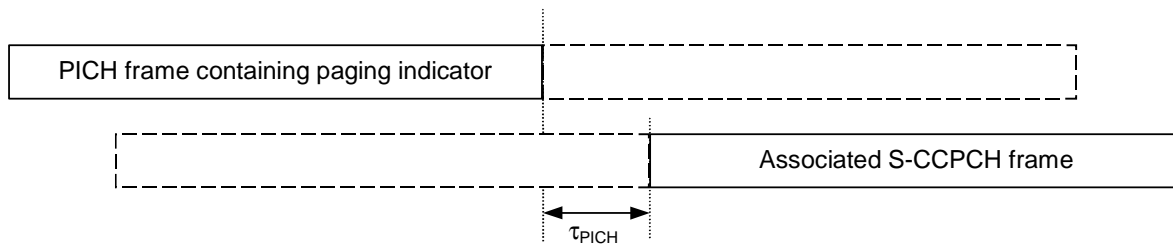

Figure 30: Timing relation between PICH frame and associated S-CCPCH frame

7.3 PRACH/AICH timing relation

The downlink AICH is divided into downlink access slots, each access slot is of length 5120 chips. The downlink access slots are time aligned with the P-CCPCH as described in subclause 7.1.

The uplink PRACH is divided into uplink access slots, each access slot is of length 5120 chips. Uplink access slot number n is transmitted from the UE τ_{p-a} chips prior to the reception of downlink access slot number n , $n = 0, 1, \dots, 14$.

Transmission of downlink acquisition indicators may only start at the beginning of a downlink access slot. Similarly, transmission of uplink RACH preambles and RACH message parts may only start at the beginning of an uplink access slot.

The PRACH/AICH timing relation is shown in figure 31.

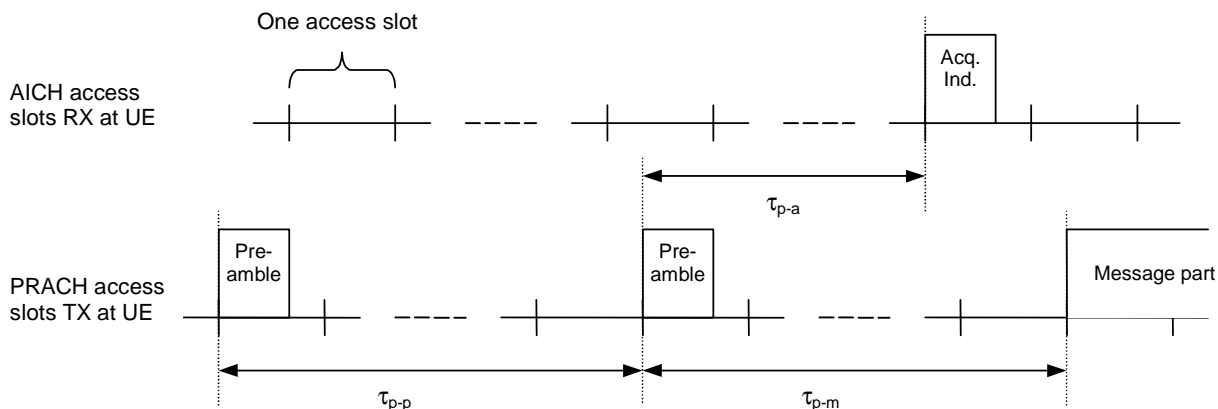

Figure 31: Timing relation between PRACH and AICH as seen at the UE

The preamble-to-preamble distance τ_{p-p} shall be larger than or equal to the minimum preamble-to-preamble distance $\tau_{p-p,min}$, i.e. $\tau_{p-p} \geq \tau_{p-p,min}$.

In addition to $\tau_{p-p,min}$, the preamble-to-AI distance τ_{p-a} and preamble-to-message distance τ_{p-m} are defined as follows:

- when AICH_Transmission_Timing is set to 0, then

$$\tau_{p-p,min} = 15360 \text{ chips (3 access slots)}$$

$$\tau_{p-a} = 7680 \text{ chips}$$

$$\tau_{p-m} = 15360 \text{ chips (3 access slots)}$$

- when AICH_Transmission_Timing is set to 1, then

$$\tau_{p-p,min} = 20480 \text{ chips (4 access slots)}$$

$$\tau_{p-a} = 12800 \text{ chips}$$

$$\tau_{p-m} = 20480 \text{ chips (4 access slots)}$$

The parameter AICH_Transmission_Timing is signalled by higher layers.

7.4 PCPCH/AICH timing relation

The uplink PCPCH is divided into uplink access slots, each access slot is of length 5120 chips. Uplink access slot number n is transmitted from the UE τ_{p-a1} chips prior to the reception of downlink access slot number n , $n=0, 1, \dots, 14$.

The timing relationship between preambles, AICH, and the message is the same as PRACH/AICH. Note that the collision resolution preambles follow the access preambles in PCPCH/AICH. However, the timing relationships between CD-Preamble and CD/CA-ICH is identical to RACH Preamble and AICH. The timing relationship between CD/CA-ICH and the Power Control Preamble in CPCH is identical to AICH to message in RACH. The T_{cpch} timing parameter is identical to the PRACH/AICH transmission timing parameter. When T_{cpch} is set to zero or one, the following PCPCH/AICH timing values apply.

Note that a1 corresponds to AP-AICH and a2 corresponds to CD/CA-ICH.

τ_{p-p} = Time to next available access slot, between Access Preambles.

$$\text{Minimum time} = 15360 \text{ chips} + 5120 \text{ chips} \times T_{cpch}$$

$$\text{Maximum time} = 5120 \text{ chips} \times 12 = 61440 \text{ chips}$$

Actual time is time to next slot (which meets minimum time criterion) in allocated access slot subchannel group.

τ_{p-a1} = Time between Access Preamble and AP-AICH has two alternative values: 7680 chips or 12800 chips, depending on T_{cpch}

τ_{a1-cdp} = Time between receipt of AP-AICH and transmission of the CD Preamble τ_{a1-cdp} has a minimum value of $\tau_{a1-cdp, \min} = 7680$ chips.

τ_{p-cdp} = Time between the last AP and CD Preamble. τ_{p-cdp} has a minimum value of $\tau_{p-cdp, \min}$ which is either 3 or 4 access slots, depending on T_{cpch}

τ_{cdp-a2} = Time between the CD Preamble and the CD/CA-ICH has two alternative values: 7680 chips or 12800 chips, depending on T_{cpch}

$\tau_{cdp-pcp}$ = Time between CD Preamble and the start of the Power Control Preamble is either 3 or 4 access slots, depending on T_{cpch} .

The time between the start of the reception of DL-DPCCH slot at UE and the Power Control Preamble is T_0 chips, where T_0 is as in subclause 7.6.3.

The message transmission shall start 0 or 8 slots after the start of the power control preamble depending on the length of the power control preamble.

Figure 32 illustrates the PCPCH/AICH timing relationship when T_{cpch} is set to 0 and all access slot subchannels are available for PCPCH.

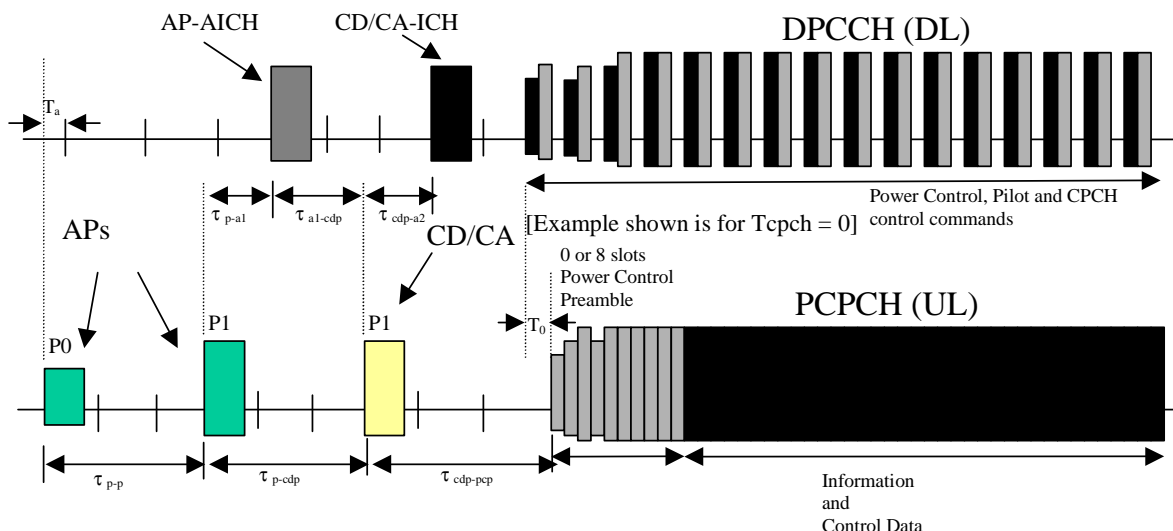

Figure 32: Timing of PCPCH and AICH transmission as seen by the UE, with $T_{cpch} = 0$

7.5 DPCH/PDSCH timing

The relative timing between a DPCH frame and the associated PDSCH frame is shown in figure 33.

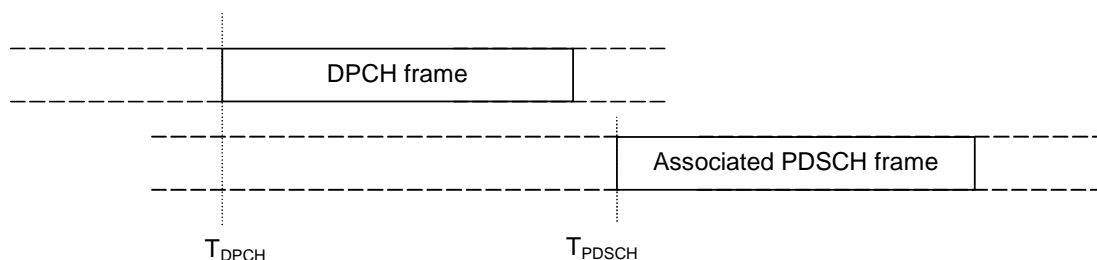

Figure 33: Timing relation between DPCH frame and associated PDSCH frame

The start of a DPCH frame is denoted T_{DPCH} and the start of the associated PDSCH frame is denoted T_{PDSCH} . Any DPCH frame is associated to one PDSCH frame through the relation $46080 \text{ chips} \leq T_{PDSCH} - T_{DPCH} < 84480 \text{ chips}$, i.e. the associated PDSCH frame starts anywhere between three slot after the end of the DPCH frame up to 18 slots behind the end of the DPCH frame.

7.6 DPCCH/DPDCH timing relations

7.6.1 Uplink

In uplink the DPCCH and all the DPDCHs transmitted from one UE have the same frame timing.

7.6.2 Downlink

In downlink, the DPCCH and all the DPDCHs carrying CCTrCHs of dedicated type to one UE have the same frame timing.

7.6.3 Uplink/downlink timing at UE

At the UE, the uplink DPCCH/DPDCH frame transmission takes place approximately T_0 chips after the reception of the first detected path (in time) of the corresponding downlink DPCCH/DPDCH frame. T_0 is a constant defined to be 1024 chips. The first detected path (in time) is defined implicitly by the relevant tests in [14]. More information about the uplink/downlink timing relation and meaning of T_0 can be found in [5].

Annex A (informative): Change history

Change history							
Date	TSG #	TSG Doc.	CR	Rev	Subject/Comment	Old	New
	RAN_05	RP-99587	-		Approved at TSG RAN #5 and placed under Change Control	-	3.0.0
14/01/00	RAN_06	RP-99676	001	1	Removal of superframe notation	3.0.0	3.1.0
14/01/00	RAN_06	RP-99677	002	-	Use of CPICH in case of open loop Tx	3.0.0	3.1.0
14/01/00	RAN_06	RP-99677	003	2	CPCH power control preamble length	3.0.0	3.1.0
14/01/00	RAN_06	RP-99684	005	1	Editorial corrections	3.0.0	3.1.0
14/01/00	RAN_06	RP-99676	006	-	Change to the description of TSTD for SCH	3.0.0	3.1.0
14/01/00	RAN_06	RP-99678	007	1	Introduction of compressed mode by higher layer scheduling	3.0.0	3.1.0
14/01/00	RAN_06	RP-99676	008	1	Modifications to STTD text	3.0.0	3.1.0
14/01/00	RAN_06	RP-99684	009	1	20 ms RACH message length	3.0.0	3.1.0
14/01/00	RAN_06	RP-99676	010	-	Update to AICH description	3.0.0	3.1.0
14/01/00	RAN_06	RP-99678	011	1	Sliding paging indicators	3.0.0	3.1.0
14/01/00	RAN_06	RP-99677	016	-	TAB structure and timing relation for USTS	3.0.0	3.1.0
14/01/00	RAN_06	RP-99677	017	-	Timing for initialisation procedures	3.0.0	3.1.0
14/01/00	RAN_06	RP-99677	022	-	Modification of the STTD encoding scheme on DL DPCH with SF 512	3.0.0	3.1.0
14/01/00	-	-	-	-	Change history was added by the editor	3.1.0	3.1.1
31/03/00	RAN_07	RP-000060	013	6	Addition of a downlink channel indicating CPCH status	3.1.1	3.2.0
31/03/00	RAN_07	RP-000060	023	6	CPCH-related editorial changes, technical changes and additions to 25.211 and some clarifications to 7.4 PCPCH/AICH timing relation.	3.1.1	3.2.0
31/03/00	RAN_07	RP-000060	024	1	Additional description of TX diversity for PDSCH	3.1.1	3.2.0
31/03/00	RAN_07	RP-000060	025	1	Consistent numbering of scrambling code groups	3.1.1	3.2.0
31/03/00	RAN_07	RP-000060	026	-	Minor corrections to timing section	3.1.1	3.2.0
31/03/00	RAN_07	RP-000060	028	1	Timing of PDSCH	3.1.1	3.2.0
31/03/00	RAN_07	RP-000060	029	1	Modifications to STTD text	3.1.1	3.2.0
31/03/00	RAN_07	RP-000060	031	4	CD/CA-ICH for dual mode CPCH	3.1.1	3.2.0
31/03/00	RAN_07	RP-000060	033	-	Clarification of frame synchronization word and its usage	3.1.1	3.2.0
31/03/00	RAN_07	RP-000060	034	1	Editorial updates to 25.211	3.1.1	3.2.0
31/03/00	RAN_07	RP-000060	036	-	PDSCH multi-code transmission	3.1.1	3.2.0
31/03/00	RAN_07	RP-000060	037	-	Clarification of pilot bit patterns for CPCH and slot formats for CPCH PC-P and message part	3.1.1	3.2.0
31/03/00	RAN_07	RP-000060	039	-	Further restrictions on the application of the Tx diversity modes in DL	3.1.1	3.2.0
31/03/00	RAN_07	RP-000060	040	-	Clarification of downlink pilot bit patterns	3.1.1	3.2.0
31/03/00	RAN_07	RP-000060	041	-	Clarification of DCH initialisation	3.1.1	3.2.0
31/03/00	RAN_07	RP-000060	044	2	Emergency Stop of CPCH transmission and Start of Message Indicator	3.1.1	3.2.0
31/03/00	RAN_07	RP-000060	046	-	Clean up of USTS related specifications	3.1.1	3.2.0
26/06/00	RAN_08	RP-000265	047	4	Clarifications to power control preamble sections	3.2.0	3.3.0
26/06/00	RAN_08	RP-000265	048	-	Propagation delay for PCPCH	3.2.0	3.3.0
26/06/00	RAN_08	RP-000265	049	1	PICH undefined bits and AICH, AP-ICH, CD/CA-ICH non-transmitted chips	3.2.0	3.3.0
26/06/00	RAN_08	RP-000265	051	1	Bit value notation change for PICH and CSICH	3.2.0	3.3.0
26/06/00	RAN_08	RP-000265	053	1	Revision of notes in sections 5.3.2 and 5.3.2.1	3.2.0	3.3.0
26/06/00	RAN_08	RP-000265	054	5	Slot format clarification for CPCH	3.2.0	3.3.0
26/06/00	RAN_08	RP-000265	055	3	Physical channel nomenclature in FDD	3.2.0	3.3.0
26/06/00	RAN_08	RP-000265	056	3	Clarification for the PDSCH channelisation code association with DPCH in 25.211	3.2.0	3.3.0
26/06/00	RAN_08	RP-000265	057	2	Clarification for the PDSCH channelisation code association with DPCH in 25.211	3.2.0	3.3.0
26/06/00	RAN_08	RP-000265	058	-	Clarification of spreading factor for AICH	3.2.0	3.3.0
26/06/00	RAN_08	RP-000265	060	-	Explicit mention of slot format reconfiguration also for uplink	3.2.0	3.3.0
23/09/00	RAN_09	RP-000340	065	-	Correction of reference	3.3.0	3.4.0
23/09/00	RAN_09	RP-000340	066	4	Clarification of paging indicator mapping	3.3.0	3.4.0
23/09/00	RAN_09	RP-000340	068	-	Editorial modification of the 25.211 about the CD/CA-ICH	3.3.0	3.4.0
23/09/00	RAN_09	RP-000340	070	1	Support of closed loop transmit diversity modes	3.3.0	3.4.0
23/09/00	RAN_09	RP-000340	071	-	DPCH initialisation procedure	3.3.0	3.4.0
23/09/00	RAN_09	RP-000340	072	3	Correction on indicators	3.3.0	3.4.0
23/09/00	RAN_09	RP-000340	074	-	Correction of STTD for DPCH	3.3.0	3.4.0
23/09/00	RAN_09	RP-000340	075	-	Clarification of first significant path	3.3.0	3.4.0
23/09/00	RAN_09	RP-000340	076	-	Clarification of SCH transmitted by TSTD	3.3.0	3.4.0
23/09/00	RAN_09	RP-000340	077	1	Clarification of FBI field	3.3.0	3.4.0
15/12/00	RAN_10	RP-000537	079	2	Clarification of downlink phase reference	3.4.0	3.5.0
15/12/00	RAN_10	RP-000537	083	1	DL Transmission in the case of invalid data frames	3.4.0	3.5.0

15/12/00	RAN_10	RP-000537	084	-	Clarification of figure 28	3.4.0	3.5.0
15/12/00	RAN_10	RP-000537	087	-	RACH message part length	3.4.0	3.5.0
15/12/00	RAN_10	RP-000537	088	-	Clarifications on power control preambles	3.4.0	3.5.0
15/12/00	RAN_10	RP-000537	089	1	Proposed CR to 25.211 for transfer of CSICH Information from Layer 3 Specification	3.4.0	3.5.0
15/12/00	RAN_10	RP-000537	090	-	PCPCH/DL-DPCCH Timing Relationship	3.4.0	3.5.0
16/03/01	RAN_11	-	-	-	Approved as Release 4 specification (v4.0.0) at TSG RAN #11	3.5.0	4.0.0
16/03/01	RAN_11	RP-010058	091	-	DSCH reading indication	3.5.0	4.0.0
16/03/01	RAN_11	RP-010058	092	1	Clarification of the S-CCPCH frame carrying paging information	3.5.0	4.0.0
16/03/01	RAN_11	RP-010255	095	3	Phase Reference for Secondary CCPCH carrying FACH	3.5.0	4.0.0
16/03/01	RAN_11	RP-010058	096	-	Uplink power control preamble	3.5.0	4.0.0

History

Document history		
V4.0.0	March 2001	Publication