

# ETSI TS 125 211 V8.3.0 (2009-01)

---

*Technical Specification*

## **Universal Mobile Telecommunications System (UMTS); Physical channels and mapping of transport channels onto physical channels (FDD) (3GPP TS 25.211 version 8.3.0 Release 8)**



---

Reference

RTS/TSGR-0125211v830

---

Keywords

UMTS

**ETSI**

650 Route des Lucioles  
F-06921 Sophia Antipolis Cedex - FRANCE

Tel.: +33 4 92 94 42 00 Fax: +33 4 93 65 47 16

Siret N° 348 623 562 00017 - NAF 742 C  
Association à but non lucratif enregistrée à la  
Sous-Préfecture de Grasse (06) N° 7803/88

---

**Important notice**

Individual copies of the present document can be downloaded from:

<http://www.etsi.org>

The present document may be made available in more than one electronic version or in print. In any case of existing or perceived difference in contents between such versions, the reference version is the Portable Document Format (PDF). In case of dispute, the reference shall be the printing on ETSI printers of the PDF version kept on a specific network drive within ETSI Secretariat.

Users of the present document should be aware that the document may be subject to revision or change of status. Information on the current status of this and other ETSI documents is available at

<http://portal.etsi.org/tb/status/status.asp>

If you find errors in the present document, please send your comment to one of the following services:

[http://portal.etsi.org/chaicor/ETSI\\_support.asp](http://portal.etsi.org/chaicor/ETSI_support.asp)

---

**Copyright Notification**

No part may be reproduced except as authorized by written permission.  
The copyright and the foregoing restriction extend to reproduction in all media.

© European Telecommunications Standards Institute 2009.  
All rights reserved.

**DECT**<sup>TM</sup>, **PLUGTESTS**<sup>TM</sup>, **UMTS**<sup>TM</sup>, **TIPHON**<sup>TM</sup>, the TIPHON logo and the ETSI logo are Trade Marks of ETSI registered for the benefit of its Members.

**3GPP**<sup>TM</sup> is a Trade Mark of ETSI registered for the benefit of its Members and of the 3GPP Organizational Partners.

**LTE**<sup>TM</sup> is a Trade Mark of ETSI currently being registered

for the benefit of its Members and of the 3GPP Organizational Partners.

**GSM**<sup>®</sup> and the GSM logo are Trade Marks registered and owned by the GSM Association.

---

## Intellectual Property Rights

IPRs essential or potentially essential to the present document may have been declared to ETSI. The information pertaining to these essential IPRs, if any, is publicly available for **ETSI members and non-members**, and can be found in ETSI SR 000 314: "*Intellectual Property Rights (IPRs); Essential, or potentially Essential, IPRs notified to ETSI in respect of ETSI standards*", which is available from the ETSI Secretariat. Latest updates are available on the ETSI Web server (<http://webapp.etsi.org/IPR/home.asp>).

Pursuant to the ETSI IPR Policy, no investigation, including IPR searches, has been carried out by ETSI. No guarantee can be given as to the existence of other IPRs not referenced in ETSI SR 000 314 (or the updates on the ETSI Web server) which are, or may be, or may become, essential to the present document.

---

## Foreword

This Technical Specification (TS) has been produced by ETSI 3rd Generation Partnership Project (3GPP).

The present document may refer to technical specifications or reports using their 3GPP identities, UMTS identities or GSM identities. These should be interpreted as being references to the corresponding ETSI deliverables.

The cross reference between GSM, UMTS, 3GPP and ETSI identities can be found under <http://webapp.etsi.org/key/queryform.asp>.

# Contents

Intellectual Property Rights .....	2
Foreword.....	2
Foreword.....	5
1 Scope .....	6
2 References .....	6
3 Symbols and abbreviations.....	7
3.1 Symbols.....	7
3.2 Abbreviations .....	7
4 Services offered to higher layers .....	8
4.1 Transport channels .....	8
4.1.1 Dedicated transport channels .....	8
4.1.1.1 DCH - Dedicated Channel .....	8
4.1.1.2 E-DCH – Enhanced Dedicated Channel .....	8
4.1.2 Common transport channels .....	8
4.1.2.1 BCH - Broadcast Channel.....	8
4.1.2.2 FACH - Forward Access Channel.....	8
4.1.2.3 PCH - Paging Channel .....	8
4.1.2.4 RACH - Random Access Channel .....	9
4.1.2.5 Void.....	9
4.1.2.6 Void.....	9
4.1.2.7 HS-DSCH – High Speed Downlink Shared Channel.....	9
4.1.2.7A E-DCH - Enhanced Dedicated Channel .....	9
4.2 Indicators.....	9
5 Physical channels and physical signals .....	9
5.1 Physical signals .....	10
5.2 Uplink physical channels.....	10
5.2.1 Dedicated uplink physical channels.....	10
5.2.1.1 DPCCH and DPDCH .....	10
5.2.1.2 HS-DPCCH.....	13
5.2.1.3 E-DPCCH and E-DPDCH.....	13
5.2.2 Common uplink physical channels .....	15
5.2.2.1 Physical Random Access Channel (PRACH) .....	15
5.2.2.1.1 Overall structure of random-access transmission .....	15
5.2.2.1.2 RACH preamble part.....	15
5.2.2.1.3 RACH message part .....	16
5.2.2.2 Void.....	17
5.3 Downlink physical channels.....	17
5.3.1 Downlink transmit diversity .....	17
5.3.1.1 Open loop transmit diversity .....	18
5.3.1.1.1 Space time block coding based transmit antenna diversity (STTD).....	18
5.3.1.1.2 Time Switched Transmit Diversity for SCH (TSTD).....	20
5.3.1.2 Closed loop transmit diversity.....	20
5.3.2 Dedicated downlink physical channels .....	20
5.3.2.1 STTD for DPCH and F-DPCH.....	24
5.3.2.2 Dedicated channel pilots with closed loop mode transmit diversity .....	25
5.3.2.3 Void.....	26
5.3.2.4 E-DCH Relative Grant Channel.....	26
5.3.2.5 E-DCH Hybrid ARQ Indicator Channel .....	28
5.3.2.6 Fractional Dedicated Physical Channel (F-DPCH).....	28
5.3.3 Common downlink physical channels .....	29
5.3.3.1 Common Pilot Channel (CPICH).....	29
5.3.3.1.1 Primary Common Pilot Channel (P-CPICH).....	30
5.3.3.1.2 Secondary Common Pilot Channel (S-CPICH).....	30

5.3.3.2	Downlink phase reference .....	30
5.3.3.3	Primary Common Control Physical Channel (P-CCPCH) .....	32
5.3.3.3.1	Primary CCPCH structure with STTD encoding .....	32
5.3.3.4	Secondary Common Control Physical Channel (S-CCPCH) .....	33
5.3.3.4.1	Secondary CCPCH structure with STTD encoding .....	35
5.3.3.5	Synchronisation Channel (SCH) .....	35
5.3.3.5.1	SCH transmitted by TSTD .....	36
5.3.3.6	Void .....	36
5.3.3.7	Acquisition Indicator Channel (AICH) .....	36
5.3.3.8	Void .....	40
5.3.3.9	Void .....	40
5.3.3.10	Paging Indicator Channel (PICH) .....	40
5.3.3.11	Void .....	41
5.3.3.12	Shared Control Channel (HS-SCCH) .....	41
5.3.3.13	High Speed Physical Downlink Shared Channel (HS-PDSCH) .....	41
5.3.3.14	E-DCH Absolute Grant Channel (E-AGCH) .....	42
5.3.3.15	MBMS Indicator Channel (MICH) .....	42
6	Mapping and association of physical channels .....	43
6.1	Mapping of transport channels onto physical channels .....	43
6.2	Association of physical channels and physical signals .....	44
7	Timing relationship between physical channels .....	45
7.1	General .....	45
7.2	PICH/S-CCPCH timing relation .....	46
7.2A	PICH/HS-SCCH timing relation .....	46
7.3	PRACH/AICH timing relation .....	47
7.3A	UL/DL timing relation for Enhanced Uplink in CELL_FACH state and IDLE mode .....	48
7.4	Void .....	49
7.5	Void .....	49
7.6	DPCCH/DPDCH timing relations .....	49
7.6.1	Uplink .....	49
7.6.2	Downlink .....	49
7.6.3	Uplink/downlink timing at UE .....	49
7.7	Uplink DPCCH/HS-DPCCH/HS-PDSCH timing at the UE .....	49
7.8	HS-SCCH/HS-PDSCH timing .....	50
7.9	MICH/S-CCPCH timing relation .....	50
7.10	E-HICH/P-CCPCH/DPCH timing relation .....	51
7.11	E-RGCH/P-CCPCH/DPCH timing relation .....	51
7.12	E-AGCH/P-CCPCH timing relation .....	52
7.13	E-DPDCH/E-DPCCH/DPCH timing relation .....	52
<b>Annex A (informative):</b>	<b>Change history .....</b>	<b>53</b>
History .....		57

---

# Foreword

This Technical Specification (TS) has been produced by the 3<sup>rd</sup> Generation Partnership Project (3GPP).

The contents of the present document are subject to continuing work within the TSG and may change following formal TSG approval. Should the TSG modify the contents of the present document, it will be re-released by the TSG with an identifying change of release date and an increase in version number as follows:

Version x.y.z

where:

- x the first digit:
  - 1 presented to TSG for information;
  - 2 presented to TSG for approval;
  - 3 or greater indicates TSG approved document under change control.
- y the second digit is incremented for all changes of substance, i.e. technical enhancements, corrections, updates, etc.
- z the third digit is incremented when editorial only changes have been incorporated in the document.

---

# 1 Scope

The present document describes the characteristics of the Layer 1 transport channels and physical channels in the FDD mode of UTRA. The main objectives of the document are to be a part of the full description of the UTRA Layer 1, and to serve as a basis for the drafting of the actual technical specification (TS).

---

# 2 References

The following documents contain provisions which, through reference in this text, constitute provisions of the present document.

- References are either specific (identified by date of publication, edition number, version number, etc.) or non-specific.
- For a specific reference, subsequent revisions do not apply.
- For a non-specific reference, the latest version applies. In the case of a reference to a 3GPP document (including a GSM document), a non-specific reference implicitly refers to the latest version of that document *in the same Release as the present document*.

- [1] 3GPP TS 25.201: "Physical layer - general description".
- [2] 3GPP TS 25.211: "Physical channels and mapping of transport channels onto physical channels (FDD)".
- [3] 3GPP TS 25.212: "Multiplexing and channel coding (FDD)".
- [4] 3GPP TS 25.213: "Spreading and modulation (FDD)".
- [5] 3GPP TS 25.214: "Physical layer procedures (FDD)".
- [6] 3GPP TS 25.221: "Transport channels and physical channels (TDD)".
- [7] 3GPP TS 25.222: "Multiplexing and channel coding (TDD)".
- [8] 3GPP TS 25.223: "Spreading and modulation (TDD)".
- [9] 3GPP TS 25.224: "Physical layer procedures (TDD)".
- [10] 3GPP TS 25.215: "Physical layer - Measurements (FDD)".
- [11] 3GPP TS 25.301: "Radio Interface Protocol Architecture".
- [12] 3GPP TS 25.302: "Services Provided by the Physical Layer".
- [13] 3GPP TS 25.401: "UTRAN Overall Description".
- [14] 3GPP TS 25.133: "Requirements for Support of Radio Resource Management (FDD)".
- [15] 3G TS 25.427: "UTRAN Overall Description :UTRA Iub/Iur Interface User Plane Protocol for DCH data streams".
- [16] 3GPP TS 25.435: "UTRAN Iub Interface User Plane Protocols for Common Transport Channel Data Streams".

## 3 Symbols and abbreviations

### 3.1 Symbols

$N_{data1}$	The number of data bits per downlink slot in Data1 field.
$N_{data2}$	The number of data bits per downlink slot in Data2 field. If the slot format does not contain a Data2 field, $N_{data2} = 0$ .

### 3.2 Abbreviations

For the purposes of the present document, the following abbreviations apply:

16QAM	16 Quadrature Amplitude Modulation
4PAM	4 Pulse-Amplitude Modulation
64QAM	64 Quadrature Amplitude Modulation
AI	Acquisition Indicator
AICH	Acquisition Indicator Channel
BCH	Broadcast Channel
CCPCH	Common Control Physical Channel
CCTrCH	Coded Composite Transport Channel
CPICH	Common Pilot Channel
CQI	Channel Quality Indicator
DCH	Dedicated Channel
DPCCH	Dedicated Physical Control Channel
DPCH	Dedicated Physical Channel
DPDCH	Dedicated Physical Data Channel
DTX	Discontinuous Transmission
E-AGCH	E-DCH Absolute Grant Channel
E-DCH	Enhanced Dedicated Channel
E-DPCCH	E-DCH Dedicated Physical Control Channel
E-DPDCH	E-DCH Dedicated Physical Data Channel
E-HICH	E-DCH Hybrid ARQ Indicator Channel
E-RGCH	E-DCH Relative Grant Channel
FACH	Forward Access Channel
FBI	Feedback Information
F-DPCH	Fractional Dedicated Physical Channel
FSW	Frame Synchronization Word
HS-DPCCH	Dedicated Physical Control Channel (uplink) for HS-DSCH
HS-DSCH	High Speed Downlink Shared Channel
HS-PDSCH	High Speed Physical Downlink Shared Channel
HS-SCCH	Shared Control Channel for HS-DSCH
ICH	Indicator Channel
MBSFN	MBMS over a Single Frequency Network
MICH	MBMS Indicator Channel
MIMO	Multiple Input Multiple Output
MUI	Mobile User Identifier
NI	MBMS Notification Indicator
PCH	Paging Channel
P-CCPCH	Primary Common Control Physical Channel
PICH	Page Indicator Channel
PRACH	Physical Random Access Channel
PSC	Primary Synchronisation Code
RACH	Random Access Channel
RNC	Radio Network Controller
S-CCPCH	Secondary Common Control Physical Channel
SCH	Synchronisation Channel
SF	Spreading Factor
SFN	System Frame Number
SSC	Secondary Synchronisation Code
STTD	Space Time Transmit Diversity



TFCI	Transport Format Combination Indicator
TSTD	Time Switched Transmit Diversity
TPC	Transmit Power Control
UE	User Equipment
UTRAN	UMTS Terrestrial Radio Access Network

---

## 4 Services offered to higher layers

### 4.1 Transport channels

Transport channels are services offered by Layer 1 to the higher layers. General concepts about transport channels are described in [12].

A transport channel is defined by how and with what characteristics data is transferred over the air interface. A general classification of transport channels is into two groups:

- Dedicated channels, using inherent addressing of UE;
- Common channels, using explicit addressing of UE if addressing is needed.

#### 4.1.1 Dedicated transport channels

There exists two types of dedicated transport channel, the Dedicated Channel (DCH) and the Enhanced Dedicated Channel (E-DCH).

##### 4.1.1.1 DCH - Dedicated Channel

The Dedicated Channel (DCH) is a downlink or uplink transport channel. The DCH is transmitted over the entire cell or over only a part of the cell using e.g. beam-forming antennas.

##### 4.1.1.2 E-DCH – Enhanced Dedicated Channel

The Enhanced Dedicated Channel (E-DCH) is an uplink transport channel in CELL DCH.

#### 4.1.2 Common transport channels

There are six types of common transport channels: BCH, FACH, PCH, RACH, HS-DSCH and E-DCH.

##### 4.1.2.1 BCH - Broadcast Channel

The Broadcast Channel (BCH) is a downlink transport channel that is used to broadcast system- and cell-specific information. The BCH is always transmitted over the entire cell and has a single transport format.

##### 4.1.2.2 FACH - Forward Access Channel

The Forward Access Channel (FACH) is a downlink transport channel. The FACH is transmitted over the entire cell. The FACH can be transmitted using power setting described in [16].

##### 4.1.2.3 PCH - Paging Channel

The Paging Channel (PCH) is a downlink transport channel. The PCH is always transmitted over the entire cell. The transmission of the PCH is associated with the transmission of physical-layer generated Paging Indicators, to support efficient sleep-mode procedures.

#### 4.1.2.4 RACH - Random Access Channel

The Random Access Channel (RACH) is an uplink transport channel. The RACH is always received from the entire cell. The RACH is characterized by a collision risk and by being transmitted using open loop power control.

#### 4.1.2.5 Void

#### 4.1.2.6 Void

#### 4.1.2.7 HS-DSCH – High Speed Downlink Shared Channel

The High Speed Downlink Shared Channel is a downlink transport channel shared by several UEs. The HS-DSCH can be associated with one downlink DPCH, and one or several Shared Control Channels (HS-SCCH). The HS-DSCH is transmitted over the entire cell or over only part of the cell using e.g. beam-forming antennas.

#### 4.1.2.7A E-DCH - Enhanced Dedicated Channel

The Enhanced Dedicated Channel (E-DCH) is an uplink transport channel in CELL\_FACH state and IDLE mode.

## 4.2 Indicators

Indicators are means of fast low-level signalling entities which are transmitted without using information blocks sent over transport channels. The meaning of indicators is specific to the type of indicator.

The indicators defined in the current version of the specifications are: Acquisition Indicator (AI), Page Indicator (PI) and MBMS Notification Indicator (NI).

Indicators may be either boolean (two-valued) or three-valued. Their mapping to indicator channels is channel specific.

Indicators are transmitted on those physical channels that are indicator channels (ICH).

---

## 5 Physical channels and physical signals

Physical channels are defined by a specific carrier frequency, scrambling code, channelization code (optional), time start & stop (giving a duration) and, on the uplink, relative phase (0 or  $\pi/2$ ). The downlink E-HICH and E-RGCH are each further defined by a specific orthogonal signature sequence. Scrambling and channelization codes are specified in [4]. Time durations are defined by start and stop instants, measured in integer multiples of chips. Suitable multiples of chips also used in specification are:

Radio frame:	A radio frame is a processing duration which consists of 15 slots. The length of a radio frame corresponds to 38400 chips.
Slot:	A slot is a duration which consists of fields containing bits. The length of a slot corresponds to 2560 chips.
Sub-frame:	A sub-frame is the basic time interval for E-DCH and HS-DSCH transmission and E-DCH and HS-DSCH-related signalling at the physical layer. The length of a sub-frame corresponds to 3 slots (7680 chips).

The default time duration for a physical channel is continuous from the instant when it is started to the instant when it is stopped. Physical channels that are not continuous will be explicitly described.

Transport channels are described (in more abstract higher layer models of the physical layer) as being capable of being mapped to physical channels. Within the physical layer itself the exact mapping is from a composite coded transport channel (CCTrCH) to the data part of a physical channel. In addition to data parts there also exist channel control parts and physical signals.

## 5.1 Physical signals

Physical signals are entities with the same basic on-air attributes as physical channels but do not have transport channels or indicators mapped to them. Physical signals may be associated with physical channels in order to support the function of physical channels.

## 5.2 Uplink physical channels

### 5.2.1 Dedicated uplink physical channels

There are five types of uplink dedicated physical channels, the uplink Dedicated Physical Data Channel (uplink DPDCH), the uplink Dedicated Physical Control Channel (uplink DPCCH), the uplink E-DCH Dedicated Physical Data Channel (uplink E-DPDCH), the uplink E-DCH Dedicated Physical Control Channel (uplink E-DPCCH) and the uplink Dedicated Control Channel associated with HS-DSCH transmission (uplink HS-DPCCH).

The DPDCH, the DPCCH, the E-DPDCH, the E-DPCCH and the HS-DPCCH are I/Q code multiplexed (see [4]).

#### 5.2.1.1 DPCCH and DPDCH

The uplink DPDCH is used to carry the DCH transport channel. There may be zero, one, or several uplink DPDCHs on each radio link.

The uplink DPCCH is used to carry control information generated at Layer 1. The Layer 1 control information consists of known pilot bits to support channel estimation for coherent detection, transmit power-control (TPC) commands, feedback information (FBI), and an optional transport-format combination indicator (TFCI). The transport-format combination indicator informs the receiver about the instantaneous transport format combination of the transport channels mapped to the simultaneously transmitted uplink DPDCH radio frame. There is one and only one uplink DPCCH on each radio link.

Figure 1 shows the frame structure of the uplink DPDCH and the uplink DPCCH. Each radio frame of length 10 ms is split into 5 subframes, each of 3 slots, each of length  $T_{slot} = 2560$  chips, corresponding to one power-control period. The DPDCH and DPCCH are always frame aligned with each other.

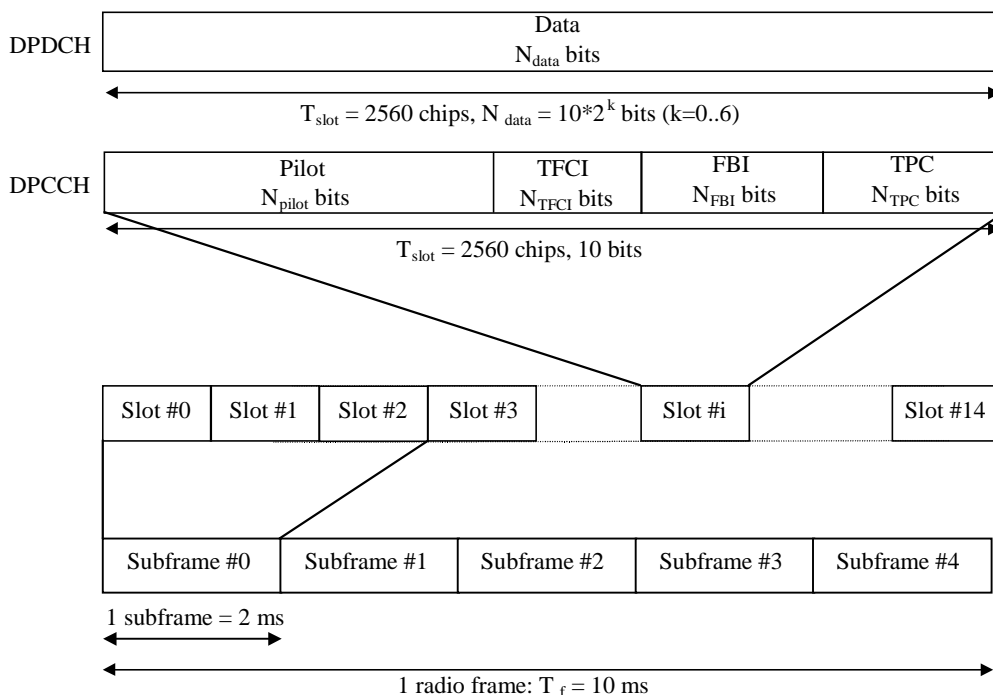

Figure 1: Frame structure for uplink DPDCH/DPCCH

The parameter  $k$  in figure 1 determines the number of bits per uplink DPDCH slot. It is related to the spreading factor SF of the DPDCH as  $SF = 256/2^k$ . The DPDCH spreading factor may range from 256 down to 4. The spreading factor of the uplink DPCCH is always equal to 256, i.e. there are 10 bits per uplink DPCCH slot.

The exact number of bits of the uplink DPDCH and the different uplink DPCCH fields ( $N_{\text{pilot}}$ ,  $N_{\text{TFCI}}$ ,  $N_{\text{FBI}}$ , and  $N_{\text{TPC}}$ ) is given by table 1 and table 2. What slot format to use is configured by higher layers and can also be reconfigured by higher layers.

The channel bit and symbol rates given in table 1 and table 2 are the rates immediately before spreading. The pilot patterns are given in table 3 and table 4, the TPC bit pattern is given in table 5.

The FBI bits are used to support techniques requiring feedback from the UE to the UTRAN Access Point for operation of closed loop mode transmit diversity. The use of the FBI bits is described in detail in [5].

**Table 1: DPDCH fields**

Slot Format #i	Channel Bit Rate (kbps)	Channel Symbol Rate (ksps)	SF	Bits/Frame	Bits/Slot	$N_{\text{data}}$
0	15	15	256	150	10	10
1	30	30	128	300	20	20
2	60	60	64	600	40	40
3	120	120	32	1200	80	80
4	240	240	16	2400	160	160
5	480	480	8	4800	320	320
6	960	960	4	9600	640	640

There are two types of uplink dedicated physical channels; those that include TFCI (e.g. for several simultaneous services) and those that do not include TFCI (e.g. for fixed-rate services). These types are reflected by the duplicated rows of table 2. It is the UTRAN that determines if a TFCI should be transmitted and it is mandatory for all UEs to support the use of TFCI in the uplink. The mapping of TFCI bits onto slots is described in [3].

In compressed mode, DPCCH slot formats with TFCI fields are changed. There are two possible compressed slot formats for each normal slot format. They are labelled A and B and the selection between them is dependent on the number of slots that are transmitted in each frame in compressed mode.

If UL\_DTX\_Active is TRUE (see [5]), the number of transmitted slots per radio frame may be less than the number shown in Table 2.

**Table 2: DPCCH fields**

Slot Form at #i	Channel Bit Rate (kbps)	Channel Symbol Rate (ksps)	SF	Bits/Frame	Bits/Slot	$N_{\text{pilot}}$	$N_{\text{TPC}}$	$N_{\text{TFCI}}$	$N_{\text{FBI}}$	Transmitted slots per radio frame
0	15	15	256	150	10	6	2	2	0	15
0A	15	15	256	150	10	5	2	3	0	10-14
0B	15	15	256	150	10	4	2	4	0	8-9
1	15	15	256	150	10	8	2	0	0	8-15
2	15	15	256	150	10	5	2	2	1	15
2A	15	15	256	150	10	4	2	3	1	10-14
2B	15	15	256	150	10	3	2	4	1	8-9
3	15	15	256	150	10	7	2	0	1	8-15
4	15	15	256	150	10	6	4	0	0	8-15

The pilot bit patterns are described in table 3 and table 4. The shadowed column part of pilot bit pattern is defined as FSW and FSWs can be used to confirm frame synchronization. (The value of the pilot bit pattern other than FSWs shall be "1".)

**Table 3: Pilot bit patterns for uplink DPCCH with  $N_{\text{pilot}} = 3, 4, 5$  and 6**

Bit #	$N_{\text{pilot}} = 3$			$N_{\text{pilot}} = 4$				$N_{\text{pilot}} = 5$					$N_{\text{pilot}} = 6$					
	0	1	2	0	1	2	3	0	1	2	3	4	0	1	2	3	4	5
Slot #0	1	1	1	1	1	1	1	1	1	1	1	0	1	1	1	1	1	0
1	0	0	1	1	0	0	1	0	0	1	1	0	1	0	0	1	1	0
2	0	1	1	1	0	1	1	0	1	1	0	1	1	0	1	1	0	1
3	0	0	1	1	0	0	1	0	0	1	0	0	1	0	0	1	0	0
4	1	0	1	1	1	0	1	1	0	1	0	1	1	1	0	1	0	1
5	1	1	1	1	1	1	1	1	1	1	1	0	1	1	1	1	1	0
6	1	1	1	1	1	1	1	1	1	1	0	0	1	1	1	1	0	0
7	1	0	1	1	1	0	1	1	0	1	0	0	1	1	0	1	0	0
8	0	1	1	1	0	1	1	0	1	1	1	0	1	0	1	1	1	0
9	1	1	1	1	1	1	1	1	1	1	1	1	1	1	1	1	1	1
10	0	1	1	1	0	1	1	0	1	1	0	1	1	0	1	1	0	1
11	1	0	1	1	1	0	1	1	0	1	1	1	1	1	0	1	1	1
12	1	0	1	1	1	0	1	1	0	1	0	0	1	1	0	1	0	0
13	0	0	1	1	0	0	1	0	0	1	1	1	1	0	0	1	1	1
14	0	0	1	1	0	0	1	0	0	1	1	1	1	0	0	1	1	1

**Table 4: Pilot bit patterns for uplink DPCCH with  $N_{\text{pilot}} = 7$  and 8**

Bit #	$N_{\text{pilot}} = 7$							$N_{\text{pilot}} = 8$							
	0	1	2	3	4	5	6	0	1	2	3	4	5	6	7
Slot #0	1	1	1	1	1	0	1	1	1	1	1	1	1	1	0
1	1	0	0	1	1	0	1	1	0	1	0	1	1	1	0
2	1	0	1	1	0	1	1	1	0	1	1	1	0	1	1
3	1	0	0	1	0	0	1	1	0	1	0	1	0	1	0
4	1	1	0	1	0	1	1	1	1	1	0	1	0	1	1
5	1	1	1	1	1	0	1	1	1	1	1	1	1	1	0
6	1	1	1	1	0	0	1	1	1	1	1	1	0	1	0
7	1	1	0	1	0	0	1	1	1	1	0	1	0	1	0
8	1	0	1	1	1	0	1	1	0	1	1	1	1	1	0
9	1	1	1	1	1	1	1	1	1	1	1	1	1	1	1
10	1	0	1	1	0	1	1	1	0	1	1	1	0	1	1
11	1	1	0	1	1	1	1	1	1	1	0	1	1	1	1
12	1	1	0	1	0	0	1	1	1	1	0	1	0	1	0
13	1	0	0	1	1	1	1	1	0	1	0	1	1	1	1
14	1	0	0	1	1	1	1	1	0	1	0	1	1	1	1

The relationship between the TPC bit pattern and transmitter power control command is presented in table 5.

**Table 5: TPC Bit Pattern**

TPC Bit Pattern		Transmitter power control command
$N_{\text{TPC}} = 2$	$N_{\text{TPC}} = 4$	
11	1111	1
00	0000	0

Multi-code operation is possible for the uplink dedicated physical channels. When multi-code transmission is used, several parallel DPDCH are transmitted using different channelization codes, see [4]. However, there is only one DPCCH per radio link.

A period of uplink DPCCH transmission prior to the start of the uplink DPDCH transmission (uplink DPCCH power control preamble) shall be used for initialisation of a DCH. The length of the power control preamble is a higher layer parameter,  $N_{\text{pcp}}$ , signalled by the network [5]. The UL DPCCH shall take the same slot format in the power control preamble as afterwards, as given in table 2. When  $N_{\text{pcp}} > 0$  the pilot patterns of table 3 and table 4 shall be used. The timing of the power control preamble is described in [5], subclause 4.3.2.3. The TFCI field is filled with "0" bits.

### 5.2.1.2 HS-DPCCH

Figure 2A illustrates the frame structure of the HS-DPCCH. The HS-DPCCH carries uplink feedback signalling related to downlink HS-DSCH transmission. The HS-DSCH-related feedback signalling consists of Hybrid-ARQ Acknowledgement (HARQ-ACK) and Channel-Quality Indication (CQI) and in case the UE is configured in MIMO mode of Precoding Control Indication (PCI) as well [3]. Each sub frame of length 2 ms ( $3 \times 2560$  chips) consists of 3 slots, each of length 2560 chips. The HARQ-ACK is carried in the first slot of the HS-DPCCH sub-frame. The CQI, and in case the UE is configured in MIMO mode also the PCI, are carried in the second and third slot of a HS-DPCCH sub-frame. There is at most one HS-DPCCH on each radio link. The HS-DPCCH can only exist together with an uplink DPCCH. The timing of the HS-DPCCH relative to the uplink DPCCH is shown in section 7.7.

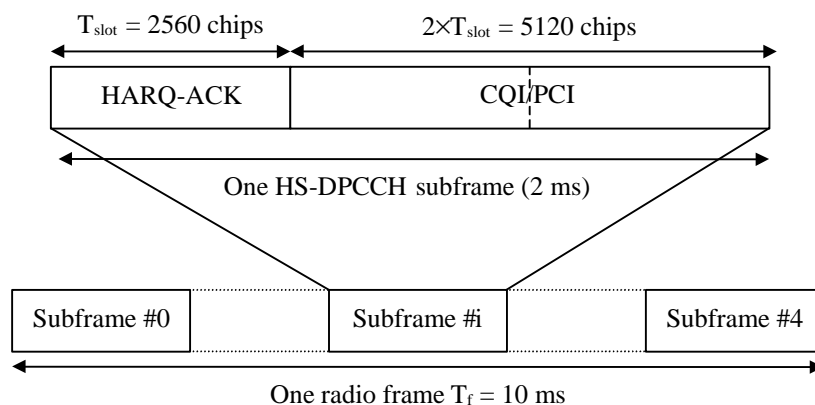

**Figure 2A: Frame structure for uplink HS-DPCCH**

The spreading factor of the HS-DPCCH is 256 i.e. there are 10 bits per uplink HS-DPCCH slot. The slot format for uplink HS-DPCCH is defined in Table 5A.

**Table 5A: HS-DPCCH fields**

Slot Format #i	Channel Bit Rate (kbps)	Channel Symbol Rate (ksp/s)	SF	Bits/ Subframe	Bits/ Slot	Transmitted slots per Subframe
0	15	15	256	30	10	3

### 5.2.1.3 E-DPCCH and E-DPDCH

The E-DPDCH is used to carry the E-DCH transport channel. There may be zero, one, or several E-DPDCH on each radio link.

The E-DPCCH is a physical channel used to transmit control information associated with the E-DCH. There is at most one E-DPCCH on each radio link.

E-DPDCH and E-DPCCH are always transmitted simultaneously, except for the following cases when E-DPCCH is transmitted without E-DPDCH:

- when E-DPDCH but not E-DPCCH is DTXed due to power scaling as described in [5] section 5.1.2.6, or
- during the  $n_{dtx}$  E-DPDCH idle slots if  $n_{max} > n_{rx1}$  as described in [3] section 4.4.5.2.

E-DPCCH shall not be transmitted in a slot unless DPCCH is also transmitted in the same slot.

Figure 2B shows the E-DPDCH and E-DPCCH (sub)frame structure. Each radio frame is divided in 5 subframes, each of length 2 ms; the first subframe starts at the start of each radio frame and the 5<sup>th</sup> subframe ends at the end of each radio frame.

An E-DPDCH may use BPSK or 4PAM modulation symbols. In figure 2B, M is the number of bits per modulation symbol i.e. M=1 for BPSK and M=2 for 4PAM.

The E-DPDCH slot formats, corresponding rates and number of bits are specified in Table 5B. The E-DPCCH slot format is listed in Table 5C.

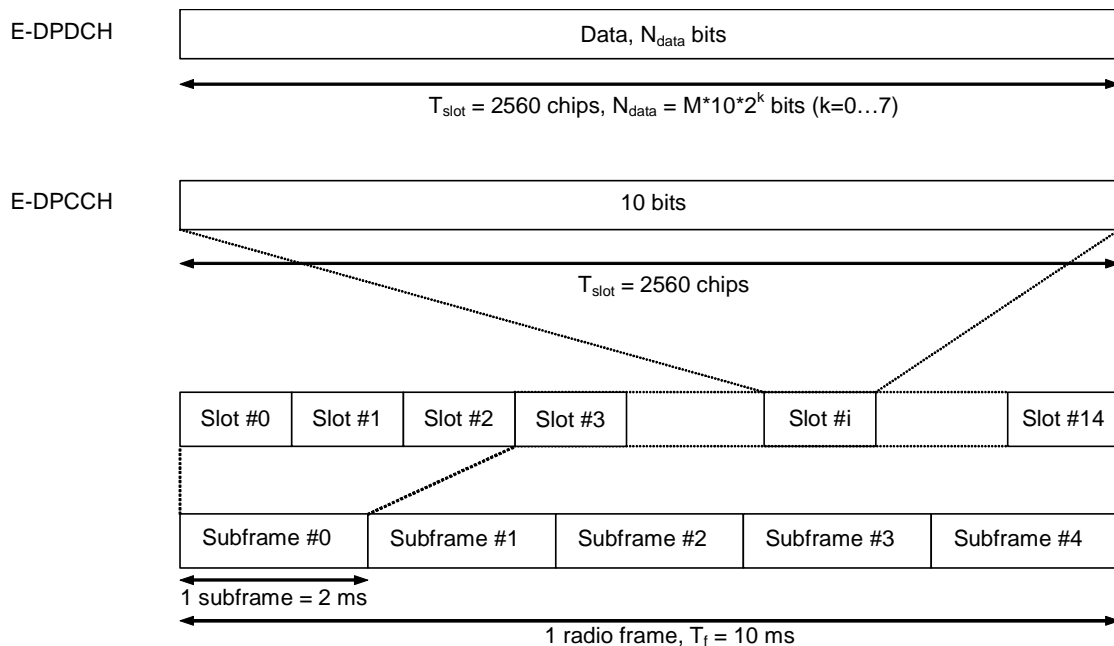

Figure 2B: E-DPDCH frame structure

Table 5B: E-DPDCH slot formats

Slot Format #i	Channel Bit Rate (kbps)	Bits/Symbol M	SF	Bits/Frame	Bits/Subframe	Bits/Slot N <sub>data</sub>
0	15	1	256	150	30	10
1	30	1	128	300	60	20
2	60	1	64	600	120	40
3	120	1	32	1200	240	80
4	240	1	16	2400	480	160
5	480	1	8	4800	960	320
6	960	1	4	9600	1920	640
7	1920	1	2	19200	3840	1280
8	1920	2	4	19200	3840	1280
9	3840	2	2	38400	7680	2560

Table 5C: E-DPCCH slot formats

Slot Format #i	Channel Bit Rate (kbps)	SF	Bits/Frame	Bits/Subframe	Bits/Slot N <sub>data</sub>
0	15	256	150	30	10

## 5.2.2 Common uplink physical channels

### 5.2.2.1 Physical Random Access Channel (PRACH)

The Physical Random Access Channel (PRACH) is used to carry the RACH.

#### 5.2.2.1.1 Overall structure of random-access transmission

The random-access transmission is based on a Slotted ALOHA approach with fast acquisition indication. The UE can start the random-access transmission at the beginning of a number of well-defined time intervals, denoted *access slots*. There are 15 access slots per two frames and they are spaced 5120 chips apart, see figure 3. The timing of the access slots and the acquisition indication is described in subclause 7.3. Information on what access slots are available for random-access transmission is given by higher layers.

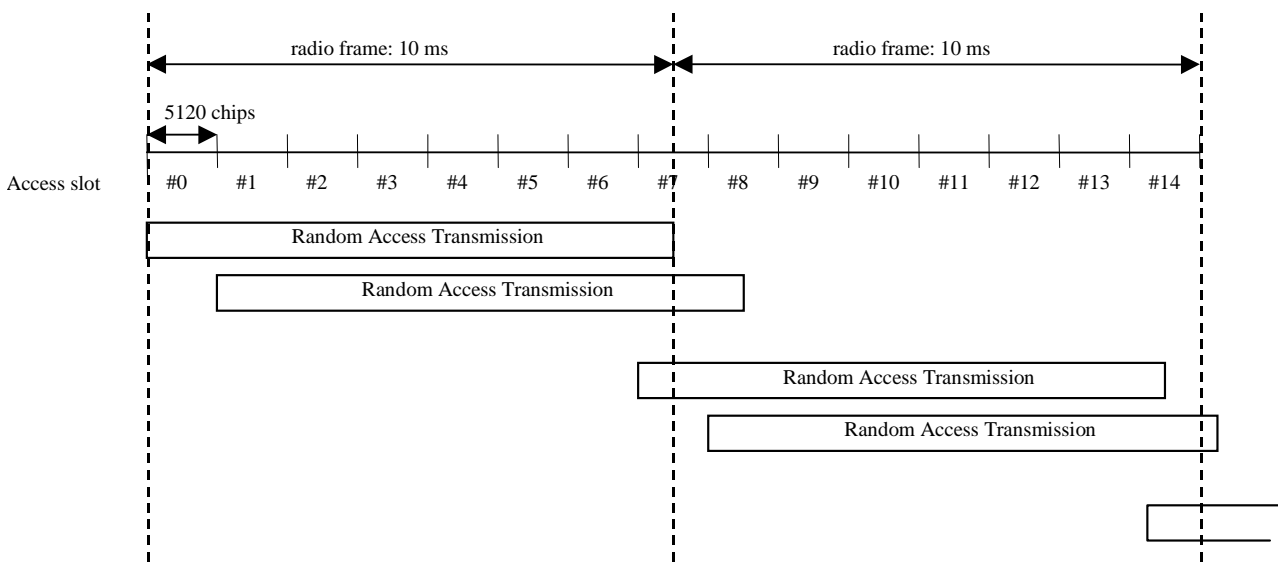

**Figure 3: RACH access slot numbers and their spacing**

The structure of the random-access transmission is shown in figure 4. The random-access transmission consists of one or several *preambles* of length 4096 chips and a *message* of length 10 ms or 20 ms.

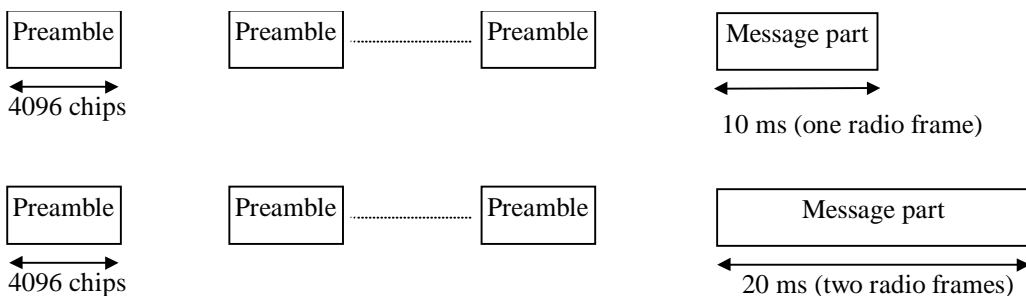

**Figure 4: Structure of the random-access transmission**

#### 5.2.2.1.2 RACH preamble part

Each preamble is of length 4096 chips and consists of 256 repetitions of a signature of length 16 chips. There are a maximum of 16 available signatures, see [4] for more details.



5.2.2.1.3 RACH message part

Figure 5 shows the structure of the random-access message part radio frame. The 10 ms message part radio frame is split into 15 slots, each of length  $T_{slot} = 2560$  chips. Each slot consists of two parts, a data part to which the RACH transport channel is mapped and a control part that carries Layer 1 control information. The data and control parts are transmitted in parallel. A 10 ms message part consists of one message part radio frame, while a 20 ms message part consists of two consecutive 10 ms message part radio frames. The message part length is equal to the Transmission Time Interval of the RACH Transport channel in use. This TTI length is configured by higher layers.

The data part consists of  $10 \cdot 2^k$  bits, where  $k=0,1,2,3$ . This corresponds to a spreading factor of 256, 128, 64, and 32 respectively for the message data part.

The control part consists of 8 known pilot bits to support channel estimation for coherent detection and 2 TFCI bits. This corresponds to a spreading factor of 256 for the message control part. The pilot bit pattern is described in table 8. The total number of TFCI bits in the random-access message is  $15 \cdot 2 = 30$ . The TFCI of a radio frame indicates the transport format of the RACH transport channel mapped to the simultaneously transmitted message part radio frame. In case of a 20 ms PRACH message part, the TFCI is repeated in the second radio frame.

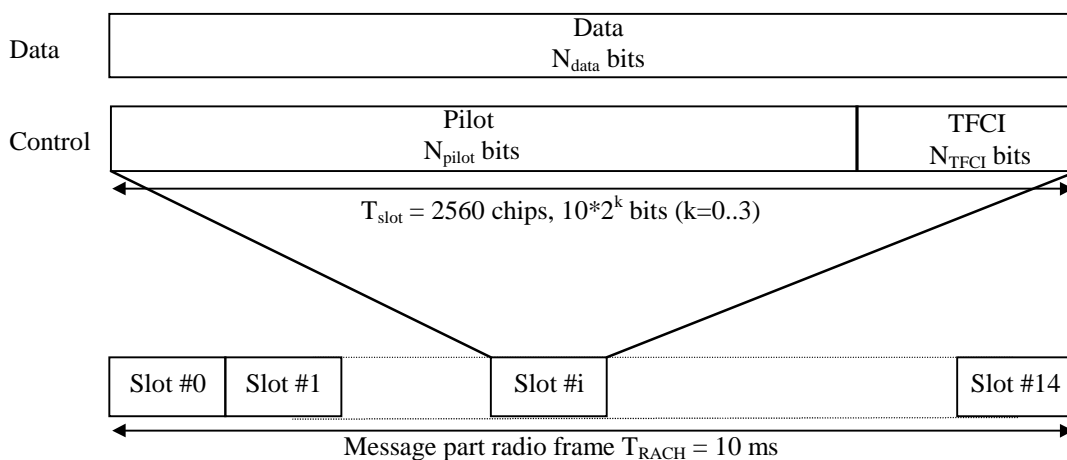

Figure 5: Structure of the random-access message part radio frame

Table 6: Random-access message data fields

Slot Format #i	Channel Bit Rate (kbps)	Channel Symbol Rate (ksps)	SF	Bits/ Frame	Bits/ Slot	$N_{data}$
0	15	15	256	150	10	10
1	30	30	128	300	20	20
2	60	60	64	600	40	40
3	120	120	32	1200	80	80

Table 7: Random-access message control fields

Slot Format #i	Channel Bit Rate (kbps)	Channel Symbol Rate (ksps)	SF	Bits/ Frame	Bits/ Slot	$N_{pilot}$	$N_{TFCI}$
0	15	15	256	150	10	8	2

**Table 8: Pilot bit patterns for RACH message part with  $N_{\text{pilot}} = 8$** 

Bit #	$N_{\text{pilot}} = 8$							
	0	1	2	3	4	5	6	7
Slot #0	1	1	1	1	1	1	1	0
1	1	0	1	0	1	1	1	0
2	1	0	1	1	1	0	1	1
3	1	0	1	0	1	0	1	0
4	1	1	1	0	1	0	1	1
5	1	1	1	1	1	1	1	0
6	1	1	1	1	1	0	1	0
7	1	1	1	0	1	0	1	0
8	1	0	1	1	1	1	1	0
9	1	1	1	1	1	1	1	1
10	1	0	1	1	1	0	1	1
11	1	1	1	0	1	1	1	1
12	1	1	1	0	1	0	1	0
13	1	0	1	0	1	1	1	1
14	1	0	1	0	1	1	1	1

### 5.2.2.2 Void

## 5.3 Downlink physical channels

### 5.3.1 Downlink transmit diversity

Table 10 summarises the possible application of open and closed loop transmit diversity modes on different downlink physical channel types. Simultaneous use of STTD and closed loop modes on the same physical channel is not allowed. In addition, if Tx diversity is applied on any of the downlink physical channels allocated to UE(s) that are not configured in MIMO mode Tx diversity shall also be applied on P-CCPCH and SCH. If Tx diversity is applied on SCH it shall also be applied on P-CCPCH and vice versa. Regarding CPICH transmission in case of transmit diversity used on SCH and P-CCPCH, see subclause 5.3.3.1.

With respect to the usage of Tx diversity for DPCH on different radio links within an active set, the following rules apply:

- Different Tx diversity modes (STTD and closed loop) shall not be used on the radio links within one active set.
- No Tx diversity on one or more radio links shall not prevent UTRAN to use Tx diversity on other radio links within the same active set.
- If STTD is activated on one or several radio links in the active set, the UE shall operate STTD on only those radio links where STTD has been activated. Higher layers inform the UE about the usage of STTD on the individual radio links in the active set.
- If closed loop TX diversity is activated on one or several radio links in the active set, the UE shall operate closed loop TX diversity on only those radio links where closed loop TX diversity has been activated. Higher layers inform the UE about the usage of closed loop TX diversity on the individual radio links in the active set.

Furthermore, if the UE is not configured in MIMO mode the following restrictions apply:

- If a DPCH is associated with an HS-PDSCH subframe, the transmit diversity mode used for the HS-PDSCH subframe shall be the same as the transmit diversity mode used for the DPCH associated with this HS-PDSCH subframe.
- If an F-DPCH is associated with an HS-PDSCH subframe, the transmit diversity mode used for the HS-PDSCH subframe shall be the same as the transmit diversity mode signalled for the F-DPCH associated with this HS-PDSCH subframe.
- If neither DPCH nor F-DPCH is associated with an HS-PDSCH subframe the transmit diversity mode used for the HS-PDSCH subframe shall be the STTD if the P-CCPCH in the cell is using transmit diversity. Otherwise, no transmit diversity is used for the HS-PDSCH subframe.

If the UE is configured in MIMO mode then a DPCH or F-DPCH associated with an HS-PDSCH subframe can be either in transmit diversity mode or in no transmit diversity mode.

Regardless of whether or not the UE is configured in MIMO mode,

- If the DPCH associated with an HS-SCCH subframe is using either open or closed loop transmit diversity on the radio link transmitted from the HS-DSCH serving cell, the HS-SCCH subframe from this cell shall be transmitted using STTD, otherwise no transmit diversity shall be used for this HS-SCCH subframe.
- If a F-DPCH for which STTD is signalled is associated with an HS-SCCH subframe, the HS-SCCH subframe shall be transmitted using STTD, otherwise no transmit diversity shall be used for this HS-SCCH subframe.
- If neither DPCH nor F-DPCH is associated with an HS-SCCH subframe the transmit diversity mode used for the HS-SCCH subframe shall be the STTD if the P-CCPCH in the cell is using transmit diversity. Otherwise, no transmit diversity is used for the HS-SCCH subframe.

The transmit diversity mode on the associated DPCH or F-DPCH may not change during a HS-SCCH and or HS-PDSCH subframe and within the slot prior to the HS-SCCH subframe. This includes any change between no Tx diversity and either open loop or closed loop mode.

If the UE is receiving a DPCH on which transmit diversity is used from a cell, or if the UE is receiving a F-DPCH for which STTD is signalled from a cell, the UE shall assume that the E-AGCH, E-RGCH, and E-HICH from the same cell are transmitted using STTD.

**Table 10: Application of Tx diversity modes on downlink physical channel types**  
"X" – can be applied, "-" – not applied

Physical channel type	Open loop mode		Closed loop mode
	TSTD	STTD	Mode 1
P-CCPCH	–	X	–
SCH	X	–	–
S-CCPCH	–	X	–
DPCH	–	X	X
F-DPCH	–	X	–
PICH	–	X	–
MICH	–	X	–
HS-PDSCH (UE not in MIMO mode, UE configured without a secondary serving HS-DSCH cell)	–	X	X
HS-PDSCH (UE not in MIMO mode, UE configured with a secondary serving HS-DSCH cell)	–	X	–
HS-PDSCH (UE in MIMO mode)	–	–	–
HS-SCCH	–	X	–
E-AGCH	–	X	–
E-RGCH	–	X	–
E-HICH	–	X	–
AICH	–	X	–

### 5.3.1.1 Open loop transmit diversity

#### 5.3.1.1.1 Space time block coding based transmit antenna diversity (STTD)

The open loop downlink transmit diversity employs a space time block coding based transmit diversity (STTD).

The STTD encoding is optional in UTRAN. STTD support is mandatory at the UE.

A block diagram of a generic STTD encoder is shown in the figure 8, figure 8A and figure 8B below. Channel coding, rate matching and interleaving are done as in the non-diversity mode. For QPSK, the STTD encoder operates on 4

symbols  $b_0, b_1, b_2, b_3$  as shown in figure 8. For AICH, E-RGCH, E-HICH the  $b_i$  are real valued signals, and  $\bar{b}_i$  is defined as  $-b_i$ . For channels other than AICH, E-RGCH, E-HICH the  $b_i$  are 3-valued digits, taking the values 0, 1, "DTX", and  $\bar{b}_i$  is defined as follows: if  $b_i = 0$  then  $\bar{b}_i = 1$ , if  $b_i = 1$  then  $\bar{b}_i = 0$ , otherwise  $\bar{b}_i = b_i$ .

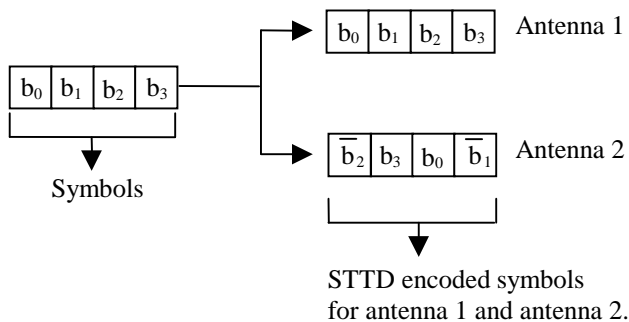

Figure 8: Generic block diagram of the STTD encoder for QPSK

For 16QAM, STTD operates on blocks of 8 consecutive symbols  $b_0, b_1, b_2, b_3, b_4, b_5, b_6, b_7$  as shown in figure 8A below.

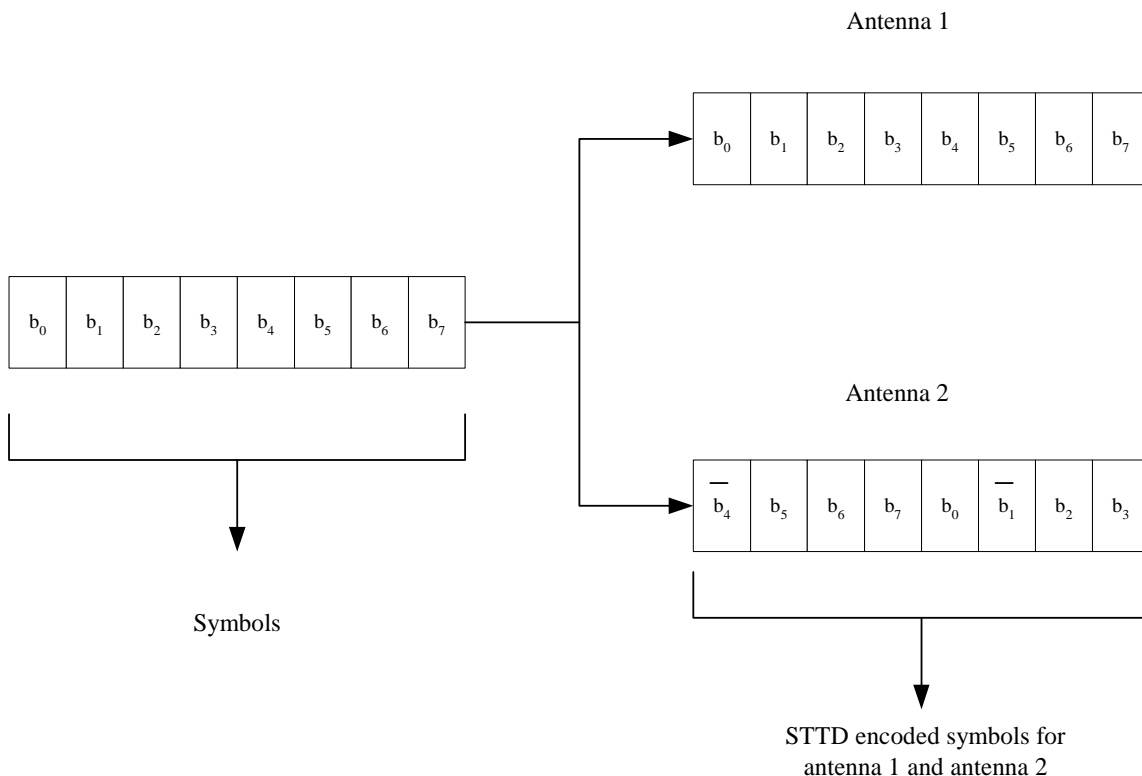
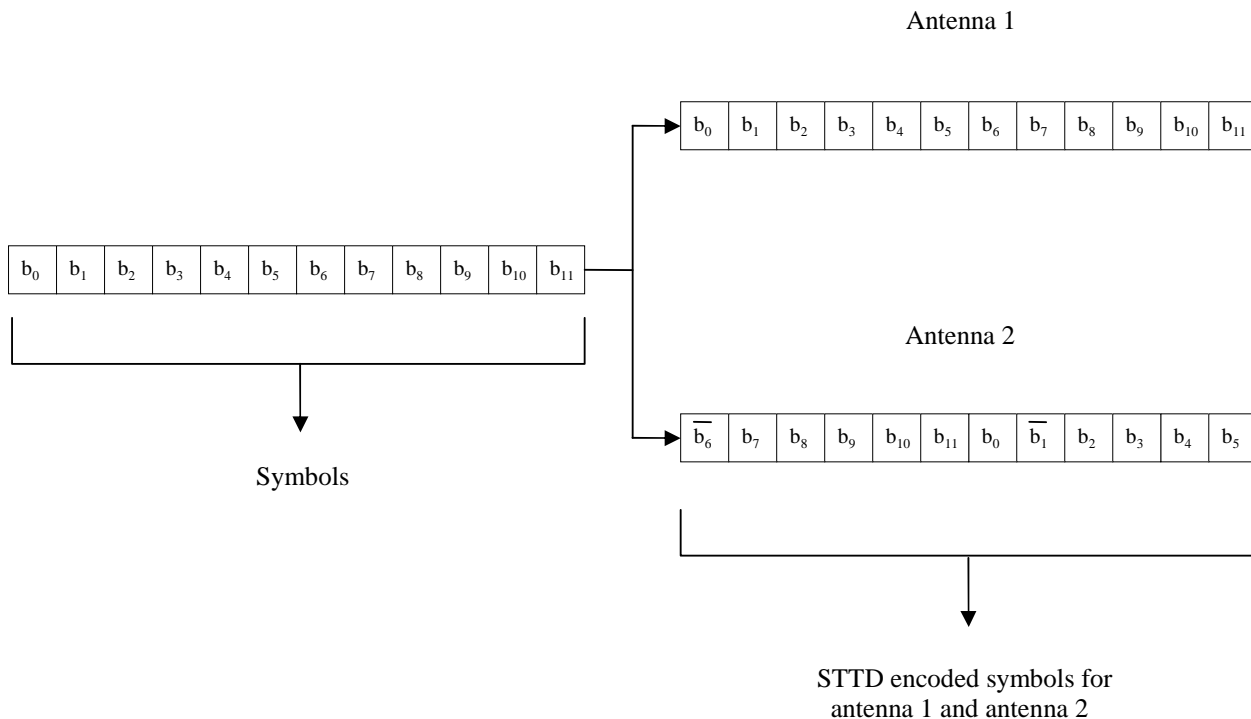

Figure 8A: Generic block diagram of the STTD encoder for 16QAM

For 64QAM, STTD operates on blocks of 12 consecutive symbols  $b_0, b_1, b_2, b_3, b_4, b_5, b_6, b_7, b_8, b_9, b_{10}, b_{11}$  as shown in figure 8B below.



**Figure 8B: Generic block diagram of the STTD encoder for 64QAM**

5.3.1.1.2 Time Switched Transmit Diversity for SCH (TSTD)

Transmit diversity, in the form of Time Switched Transmit Diversity (TSTD), can be applied to the SCH. TSTD for the SCH is optional in UTRAN, while TSTD support is mandatory in the UE. TSTD for the SCH is described in subclause 5.3.3.5.1.

5.3.1.2 Closed loop transmit diversity

Closed loop transmit diversity is described in [5]. Closed loop transmit diversity mode 1 shall be supported at the UE and may be supported in the UTRAN.

5.3.2 Dedicated downlink physical channels

There are four types of downlink dedicated physical channels, the Downlink Dedicated Physical Channel (downlink DPCH), the Fractional Dedicated Physical Channel (F-DPCH), the E-DCH Relative Grant Channel (E-RGCH), and the E-DCH Hybrid ARQ Indicator Channel (E-HICH).

The F-DPCH is described in subclause 5.3.2.6.

Within one downlink DPCH, dedicated data generated at Layer 2 and above, i.e. the dedicated transport channel (DCH), is transmitted in time-multiplex with control information generated at Layer 1 (known pilot bits, TPC commands, and an optional TFCI). The downlink DPCH can thus be seen as a time multiplex of a downlink DPDCH and a downlink DPCCH, compare subclause 5.2.1.

Figure 9 shows the frame structure of the downlink DPCH. Each frame of length 10 ms is split into 15 slots, each of length  $T_{slot} = 2560$  chips, corresponding to one power-control period.

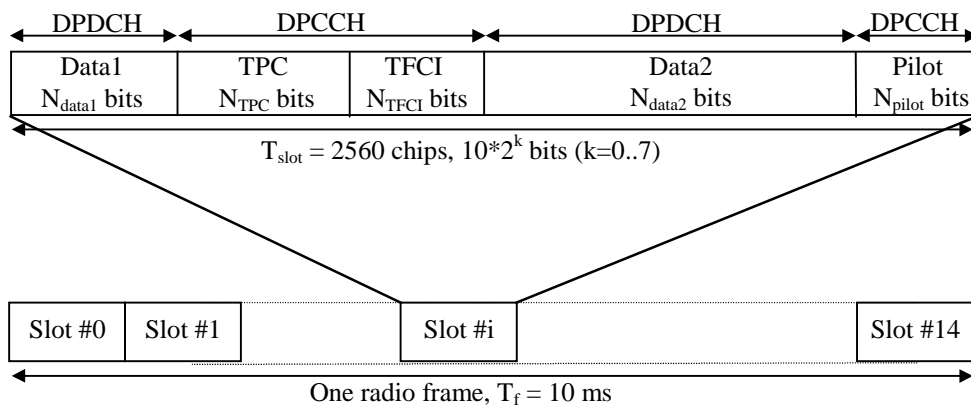

**Figure 9: Frame structure for downlink DPCH**

The parameter k in figure 9 determines the total number of bits per downlink DPCH slot. It is related to the spreading factor SF of the physical channel as  $SF = 512/2^k$ . The spreading factor may thus range from 512 down to 4.

The exact number of bits of the different downlink DPCH fields (N<sub>pilot</sub>, N<sub>TPC</sub>, N<sub>TFCI</sub>, N<sub>data1</sub> and N<sub>data2</sub>) is given in table 11. What slot format to use is configured by higher layers and can also be reconfigured by higher layers.

There are basically two types of downlink Dedicated Physical Channels; those that include TFCI (e.g. for several simultaneous services) and those that do not include TFCI (e.g. for fixed-rate services). These types are reflected by the duplicated rows of table 11. It is the UTRAN that determines if a TFCI should be transmitted and it is mandatory for all UEs to support the use of TFCI in the downlink. The mapping of TFCI bits onto slots is described in [3].

In compressed frames, a different slot format is used compared to normal mode. There are two possible compressed slot formats that are labelled A and B. Slot format B shall be used in frames compressed by spreading factor reduction and slot format A shall be used in frames compressed by higher layer scheduling. The channel bit and symbol rates given in table 11 are the rates immediately before spreading.

Table 11: DPDCH and DPCCH fields

Slot Format #i	Channel Bit Rate (kbps)	Channel Symbol Rate (ksps)	SF	Bits/Slot	DPDCH Bits/Slot		DPCCH Bits/Slot			Transmitted slots per radio frame $N_{Tr}$
					$N_{Data1}$	$N_{Data2}$	$N_{TPC}$	$N_{TFCI}$	$N_{Pilot}$	
0	15	7.5	512	10	0	4	2	0	4	15
0A	15	7.5	512	10	0	4	2	0	4	8-14
0B	30	15	256	20	0	8	4	0	8	8-14
1	15	7.5	512	10	0	2	2	2	4	15
1B	30	15	256	20	0	4	4	4	8	8-14
2	30	15	256	20	2	14	2	0	2	15
2A	30	15	256	20	2	14	2	0	2	8-14
2B	60	30	128	40	4	28	4	0	4	8-14
3	30	15	256	20	2	12	2	2	2	15
3A	30	15	256	20	2	10	2	4	2	8-14
3B	60	30	128	40	4	24	4	4	4	8-14
4	30	15	256	20	2	12	2	0	4	15
4A	30	15	256	20	2	12	2	0	4	8-14
4B	60	30	128	40	4	24	4	0	8	8-14
5	30	15	256	20	2	10	2	2	4	15
5A	30	15	256	20	2	8	2	4	4	8-14
5B	60	30	128	40	4	20	4	4	8	8-14
6	30	15	256	20	2	8	2	0	8	15
6A	30	15	256	20	2	8	2	0	8	8-14
6B	60	30	128	40	4	16	4	0	16	8-14
7	30	15	256	20	2	6	2	2	8	15
7A	30	15	256	20	2	4	2	4	8	8-14
7B	60	30	128	40	4	12	4	4	16	8-14
8	60	30	128	40	6	28	2	0	4	15
8A	60	30	128	40	6	28	2	0	4	8-14
8B	120	60	64	80	12	56	4	0	8	8-14
9	60	30	128	40	6	26	2	2	4	15
9A	60	30	128	40	6	24	2	4	4	8-14
9B	120	60	64	80	12	52	4	4	8	8-14
10	60	30	128	40	6	24	2	0	8	15
10A	60	30	128	40	6	24	2	0	8	8-14
10B	120	60	64	80	12	48	4	0	16	8-14
11	60	30	128	40	6	22	2	2	8	15
11A	60	30	128	40	6	20	2	4	8	8-14
11B	120	60	64	80	12	44	4	4	16	8-14
12	120	60	64	80	12	48	4	8*	8	15
12A	120	60	64	80	12	40	4	16*	8	8-14
12B	240	120	32	160	24	96	8	16*	16	8-14
13	240	120	32	160	28	112	4	8*	8	15
13A	240	120	32	160	28	104	4	16*	8	8-14
13B	480	240	16	320	56	224	8	16*	16	8-14
14	480	240	16	320	56	232	8	8*	16	15
14A	480	240	16	320	56	224	8	16*	16	8-14
14B	960	480	8	640	112	464	16	16*	32	8-14
15	960	480	8	640	120	488	8	8*	16	15
15A	960	480	8	640	120	480	8	16*	16	8-14
15B	1920	960	4	1280	240	976	16	16*	32	8-14
16	1920	960	4	1280	248	1000	8	8*	16	15
16A	1920	960	4	1280	248	992	8	16*	16	8-14

\* If TFCI bits are not used, then DTX shall be used in TFCI field.

NOTE 1: Compressed mode is only supported through spreading factor reduction for SF=512 with TFCI.

NOTE 2: Compressed mode by spreading factor reduction is not supported for SF=4.

NOTE 3: If the Node B receives an invalid combination of data frames for downlink transmission, the procedure specified in [15], sub-clause 5.1.2, may require the use of DTX in both the DPDCH and the TFCI field of the DPCCH.

The pilot bit patterns are described in table 12. The shadowed column part of pilot bit pattern is defined as FSW and FSWs can be used to confirm frame synchronization. (The value of the pilot bit pattern other than FSWs shall be "11".) In table 12, the transmission order is from left to right.

In downlink compressed mode through spreading factor reduction, the number of bits in the TPC and Pilot fields are doubled. Symbol repetition is used to fill up the fields. Denote the bits in one of these fields in normal mode by  $x_1, x_2, x_3, \dots, x_X$ . In compressed mode the following bit sequence is sent in corresponding field:  $x_1, x_2, x_1, x_2, x_3, x_4, x_3, x_4, \dots, x_X$ .

**Table 12: Pilot bit patterns for downlink DPCCH with  $N_{pilot} = 2, 4, 8$  and 16**

Symbol #	$N_{pilot} = 2$	$N_{pilot} = 4$ (*1)		$N_{pilot} = 8$ (*2)				$N_{pilot} = 16$ (*3)							
	0	0	1	0	1	2	3	0	1	2	3	4	5	6	7
Slot #0	11	11	11	11	11	11	10	11	11	11	10	11	11	11	10
1	00	11	00	11	00	11	10	11	00	11	10	11	11	11	00
2	01	11	01	11	01	11	01	11	01	11	01	11	10	11	00
3	00	11	00	11	00	11	00	11	00	11	00	11	01	11	10
4	10	11	10	11	10	11	01	11	10	11	01	11	11	11	11
5	11	11	11	11	11	11	10	11	11	11	10	11	01	11	01
6	11	11	11	11	11	11	00	11	11	11	00	11	10	11	11
7	10	11	10	11	10	11	00	11	10	11	00	11	10	11	00
8	01	11	01	11	01	11	10	11	01	11	10	11	00	11	11
9	11	11	11	11	11	11	11	11	11	11	11	11	00	11	11
10	01	11	01	11	01	11	01	11	01	11	01	11	11	11	10
11	10	11	10	11	10	11	11	11	10	11	11	11	00	11	10
12	10	11	10	11	10	11	00	11	10	11	00	11	01	11	01
13	00	11	00	11	00	11	11	11	00	11	11	11	00	11	00
14	00	11	00	11	00	11	11	11	00	11	11	11	10	11	01

NOTE \*1: This pattern is used except slot formats 2B and 3B.

NOTE \*2: This pattern is used except slot formats 0B, 1B, 4B, 5B, 8B, and 9B.

NOTE \*3: This pattern is used except slot formats 6B, 7B, 10B, 11B, 12B, and 13B.

NOTE: For slot format  $nB$  where  $n = 0, \dots, 15$ , the pilot bit pattern corresponding to  $N_{pilot}/2$  is to be used and symbol repetition shall be applied.

The relationship between the TPC symbol and the transmitter power control command is presented in table 13.

**Table 13: TPC Bit Pattern**

TPC Bit Pattern			Transmitter power control command
$N_{TPC} = 2$	$N_{TPC} = 4$	$N_{TPC} = 8$	
11	1111	11111111	1
00	0000	00000000	0

Multicode transmission may be employed in the downlink, i.e. the CCTrCH (see [3]) is mapped onto several parallel downlink DPCHs using the same spreading factor. In this case, the Layer 1 control information is transmitted only on the first downlink DPCH. DTX bits are transmitted during the corresponding time period for the additional downlink DPCHs, see figure 10.

In case there are several CCTrCHs mapped to different DPCHs transmitted to the same UE different spreading factors can be used on DPCHs to which different CCTrCHs are mapped. Also in this case, Layer 1 control information is only transmitted on the first DPCH while DTX bits are transmitted during the corresponding time period for the additional DPCHs.

Note : support of multiple CCTrCHs of dedicated type is not part of the current release.



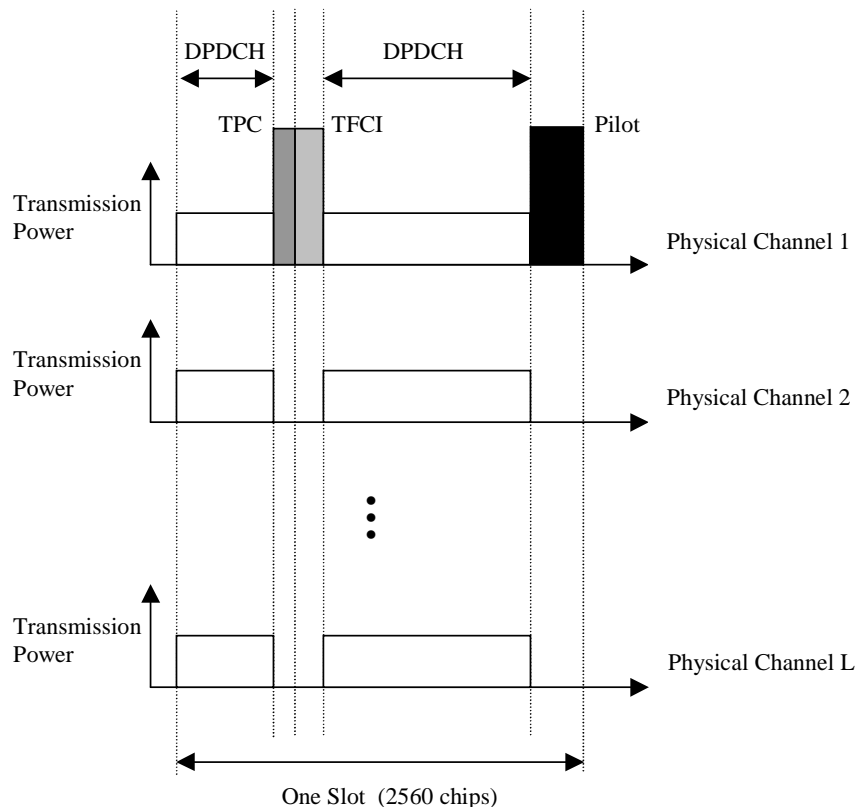

**Figure 10: Downlink slot format in case of multi-code transmission**

### 5.3.2.1 STTD for DPCH and F-DPCH

The pilot bit pattern for the DPCH channel transmitted on antenna 2 is given in table 14.

- For  $N_{\text{pilot}} = 8, 16$  the shadowed part indicates pilot bits that are obtained by STTD encoding the corresponding (shadowed) bits in Table 12. The non-shadowed pilot bit pattern is orthogonal to the corresponding (non-shadowed) pilot bit pattern in table 12.
- For  $N_{\text{pilot}} = 4$ , the diversity antenna pilot bit pattern is obtained by STTD encoding both the shadowed and non-shadowed pilot bits in table 12.
- For  $N_{\text{pilot}} = 2$ , the diversity antenna pilot pattern is obtained by STTD encoding the two pilot bits in table 12 with the last two bits (data or DTX) of the second data field (data2) of the slot. Thus for  $N_{\text{pilot}} = 2$  case, the last two bits of the second data field (data 2) after STTD encoding, follow the diversity antenna pilot bits in Table 14.

STTD encoding for the DPDCH, TPC, and TFCI fields is done as described in subclause 5.3.1.1.1. For the SF=512 DPCH, the first two bits in each slot, i.e. TPC bits, are not STTD encoded and the same bits are transmitted with equal power from the two antennas. The remaining four bits are STTD encoded.

For F-DPCH, the TPC bits are not STTD encoded and the same bits are transmitted with equal power from the two antennas.

For compressed mode through spreading factor reduction and for  $N_{\text{pilot}} > 4$ , symbol repetition shall be applied to the pilot bit patterns of table 14, in the same manner as described in 5.3.2. For slot formats 2B and 3B, i.e. compressed mode through spreading factor reduction and  $N_{\text{pilot}} = 4$ , the pilot bits transmitted on antenna 2 are STTD encoded, and thus the pilot bit pattern is as shown in the most right set of table 14.

**Table 14: Pilot bit patterns of downlink DPCCH for antenna 2 using STTD**

Symbol #	$N_{pilot} = 2$ (*1)		$N_{pilot} = 4$ (*2)		$N_{pilot} = 8$ (*3)				$N_{pilot} = 16$ (*4)								$N_{pilot} = 4$ (*5)	
	0	1	0	1	0	1	2	3	0	1	2	3	4	5	6	7	0	1
Slot #0	01	01	10	11	00	00	10	11	00	00	10	11	00	00	10	10	01	10
1	10	10	10	11	00	00	01	11	00	00	01	11	10	00	10	10	10	01
2	11	11	10	11	11	00	00	11	11	00	00	11	10	00	11	11	00	00
3	10	10	10	11	10	00	01	11	10	00	01	11	00	00	00	10	01	00
4	00	00	10	11	11	00	11	11	11	00	11	11	01	00	10	00	11	00
5	01	01	10	11	00	00	10	11	00	00	10	11	11	00	00	01	10	00
6	01	01	10	11	10	00	10	11	10	00	10	11	01	00	11	01	10	00
7	00	00	10	11	10	00	11	11	10	00	11	11	10	00	11	00	11	00
8	11	11	10	11	00	00	00	11	00	00	00	11	01	00	01	11	00	00
9	01	01	10	11	01	00	10	11	01	00	10	11	01	00	01	01	10	00
10	11	11	10	11	11	00	00	11	11	00	00	11	00	00	10	11	00	00
11	00	00	10	11	01	00	11	11	01	00	11	11	00	00	01	00	11	00
12	00	00	10	11	10	00	11	11	10	00	11	11	11	00	00	00	11	00
13	10	10	10	11	01	00	01	11	01	00	01	11	10	00	01	10	01	00
14	10	10	10	11	01	00	01	11	01	00	01	11	11	00	11	10	01	00

NOTE \*1: The pilot bits precede the last two bits of the data2 field.

NOTE \*2: This pattern is used except slot formats 2B and 3B.

NOTE \*3: This pattern is used except slot formats 0B, 1B, 4B, 5B, 8B, and 9B.

NOTE \*4: This pattern is used except slot formats 6B, 7B, 10B, 11B, 12B, and 13B.

NOTE \*5: This pattern is used for slot formats 2B and 3B.

NOTE: For slot format  $nB$  where  $n = 0, 1, 4, 5, 6, \dots, 15$ , the pilot bit pattern corresponding to  $N_{pilot}/2$  is to be used and symbol repetition shall be applied.

### 5.3.2.2 Dedicated channel pilots with closed loop mode transmit diversity

In closed loop mode 1 orthogonal pilot patterns are used between the transmit antennas. Closed loop mode 1 shall not be used with DPCCH slot formats for which  $N_{pilot}=2$ . Pilot patterns defined in the table 12 will be used on antenna 1 and pilot patterns defined in the table 15 on antenna 2. This is illustrated in the figure 11 a which indicates the difference in the pilot patterns with different shading.

**Table 15: Pilot bit patterns of downlink DPCCH for antenna 2 using closed loop mode 1**

Symbol #	$N_{pilot} = 4$		$N_{pilot} = 8$ (*1)				$N_{pilot} = 16$ (*2)							
	0	1	0	1	2	3	0	1	2	3	4	5	6	7
Slot #0	01	10	11	00	00	10	11	00	00	10	11	00	00	10
1	10	10	11	00	00	01	11	00	00	01	11	10	00	10
2	11	10	11	11	00	00	11	11	00	00	11	10	00	11
3	10	10	11	10	00	01	11	10	00	01	11	00	00	00
4	00	10	11	11	00	11	11	11	00	11	11	01	00	10
5	01	10	11	00	00	10	11	00	00	10	11	11	00	00
6	01	10	11	10	00	10	11	10	00	10	11	01	00	11
7	00	10	11	10	00	11	11	10	00	11	11	10	00	11
8	11	10	11	00	00	00	11	00	00	00	11	01	00	01
9	01	10	11	01	00	10	11	01	00	10	11	01	00	01
10	11	10	11	11	00	00	11	11	00	00	11	00	00	10
11	00	10	11	01	00	11	11	01	00	11	11	00	00	01
12	00	10	11	10	00	11	11	10	00	11	11	11	00	00
13	10	10	11	01	00	01	11	01	00	01	11	10	00	01
14	10	10	11	01	00	01	11	01	00	01	11	11	00	11

NOTE \*1: This pattern is used except slot formats 0B, 1B, 4B, 5B, 8B, and 9B.

NOTE \*2: This pattern is used except slot formats 6B, 7B, 10B, 11B, 12B, and 13B.

NOTE: For slot format  $nB$  where  $n = 0, 1, 4, 5, 6, \dots, 15$ , the pilot bit pattern corresponding to  $N_{pilot}/2$  is to be used and symbol repetition shall be applied.

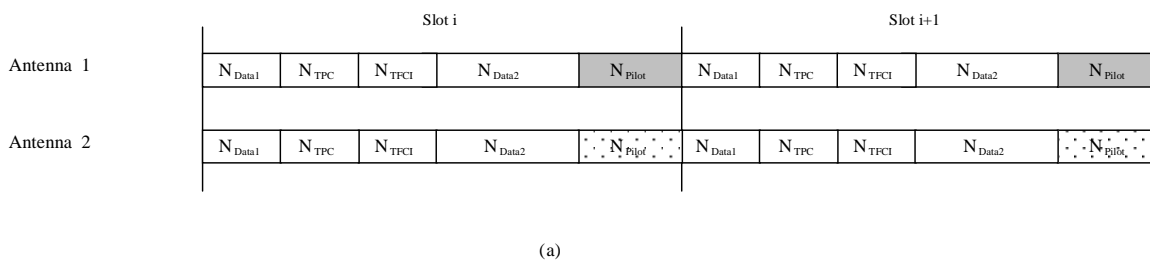

**Figure 11: Slot structures for downlink dedicated physical channel diversity transmission. Structure (a) is used in closed loop mode 1. Different shading of the pilots indicate orthogonality of the patterns**

5.3.2.3 Void

5.3.2.4 E-DCH Relative Grant Channel

The E-DCH Relative Grant Channel (E-RGCH) is a fixed rate (SF=128) dedicated downlink physical channel carrying the uplink E-DCH relative grants. Figure 12A illustrates the structure of the E-RGCH. A relative grant is transmitted using 3, 12 or 15 consecutive slots and in each slot a sequence of 40 ternary values is transmitted. The 3 and 12 slot duration shall be used on an E-RGCH transmitted to UEs for which the cell transmitting the E-RGCH is in the E-DCH serving radio link set and for which the E-DCH TTI is respectively 2 and 10 ms. The 15 slot duration shall be used on an E-RGCH transmitted to UEs for which the cell transmitting the E-RGCH is not in the E-DCH serving radio link set.

The sequence  $b_{i,0}, b_{i,1}, \dots, b_{i,39}$  transmitted in slot  $i$  in Figure 12A is given by  $b_{i,j} = a C_{ss,40,m(i),j}$ . In a serving E-DCH radio link set, the relative grant  $a$  is set to +1, 0, or -1 and in a radio link not belonging to the serving E-DCH radio link set, the relative grant  $a$  is set to 0 or -1. The orthogonal signature sequences  $C_{ss,40,m(i)}$  is given by Table 16A and the index  $m(i)$  in slot  $i$  is given by Table 16B. The E-RGCH signature sequence index  $l$  in Table 16B is given by higher layers.

In case STTD-based open loop transmit diversity is applied for E-RGCH, STTD encoding according to subclause 5.3.1.1.1 is applied to the sequence  $b_{i,j}$ .

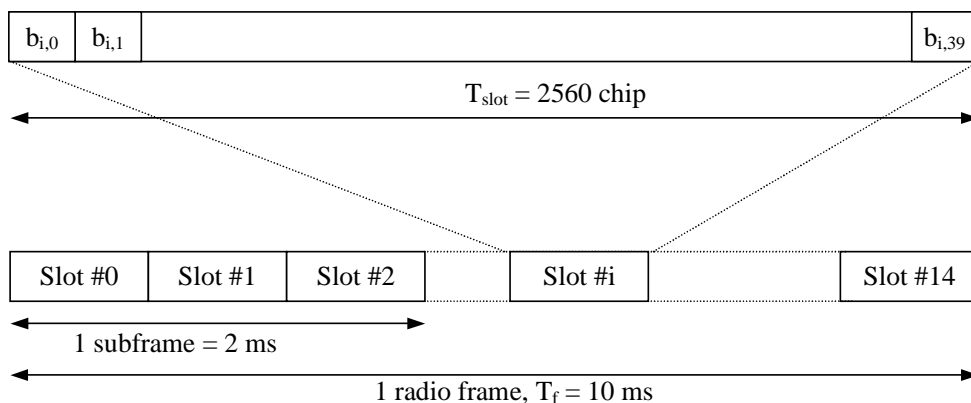

**Figure 12A: E-RGCH and E-HICH structure**



12	12	29	30
13	13	11	23
14	14	24	22
15	15	28	21
16	16	35	19
17	17	21	36
18	18	37	2
19	19	23	11
20	20	39	9
21	21	22	3
22	22	9	15
23	23	36	20
24	24	0	26
25	25	5	24
26	26	7	8
27	27	27	17
28	28	32	29
29	29	15	38
30	30	30	12
31	31	26	7
32	32	20	37
33	33	1	35
34	34	14	0
35	35	33	31
36	36	25	28
37	37	10	27
38	38	31	4
39	39	38	6

### 5.3.2.5 E-DCH Hybrid ARQ Indicator Channel

The E-DCH Hybrid ARQ Indicator Channel (E-HICH) is a fixed rate (SF=128) dedicated downlink physical channel carrying the uplink E-DCH hybrid ARQ acknowledgement indicator. Figure 12A illustrates the structure of the E-HICH. A hybrid ARQ acknowledgement indicator is transmitted using 3 or 12 consecutive slots and in each slot a sequence of 40 binary values is transmitted. The 3 and 12 slot duration shall be used for UEs which E-DCH TTI is set to respectively 2 ms and 10 ms.

The sequence  $b_{i,0}, b_{i,1}, \dots, b_{i,39}$  transmitted in slot  $i$  in Figure 12A is given by  $b_{i,j} = a C_{ss,40,m(i),j}$ . In a radio link set containing the serving E-DCH radio link set, the hybrid ARQ acknowledgement indicator  $a$  is set to +1 or -1, and in a radio link set not containing the serving E-DCH radio link set the hybrid ARQ indicator  $a$  is set to +1 or 0. The orthogonal signature sequences  $C_{ss,40,m(i)}$  is given by Table 16A and the index  $m(i)$  in slot  $i$  is given by Table 16B. The E-HICH signature sequence index  $l$  is given by higher layers.

In case STTD-based open loop transmit diversity is applied for E-HICH, STTD encoding according to subclause 5.3.1.1.1 is applied to the sequence  $b_{i,j}$

### 5.3.2.6 Fractional Dedicated Physical Channel (F-DPCH)

The F-DPCH carries control information generated at layer 1 (TPC commands). It is a special case of downlink DPCH.

Figure 12B shows the frame structure of the F-DPCH. Each frame of length 10ms is split into 15 slots, each of length  $T_{slot} = 2560$  chips, corresponding to one power-control period.

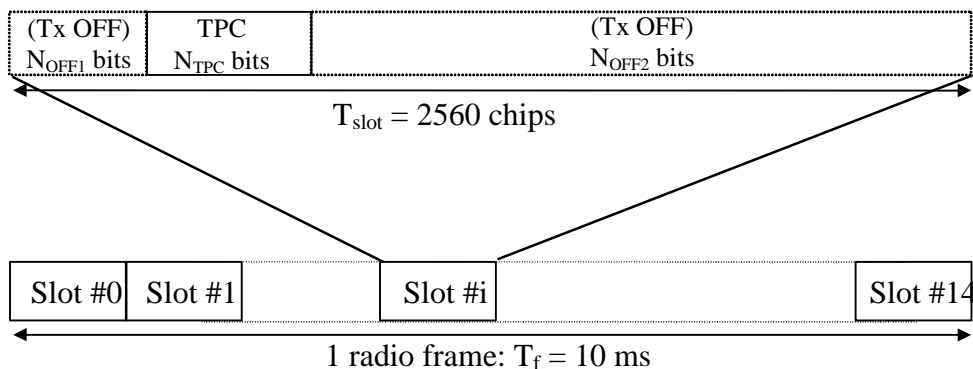

**Figure 12B: Frame structure for F-DPCH**

The exact number of bits of the OFF periods and of the F-DPCH fields ( $N_{TPC}$ ) is described in table 16C. Each slot format corresponds to a different set of OFF periods within the F-DPCH slot.

**Table 16C: F-DPCH fields**

Slot Format #i	Channel Bit Rate (kbps)	Channel Symbol Rate (ksps)	SF	Bits/ Slot	$N_{OFF1}$ Bits/Slot	$N_{TPC}$ Bits/Slot	$N_{OFF2}$ Bits/Slot
0	3	1.5	256	20	2	2	16
1	3	1.5	256	20	4	2	14
2	3	1.5	256	20	6	2	12
3	3	1.5	256	20	8	2	10
4	3	1.5	256	20	10	2	8
5	3	1.5	256	20	12	2	6
6	3	1.5	256	20	14	2	4
7	3	1.5	256	20	16	2	2
8	3	1.5	256	20	18	2	0
9	3	1.5	256	20	0	2	18

In compressed frames, F-DPCH is not transmitted in downlink transmission gaps given by transmission gap pattern sequences signalled by higher layers.

The relationship between the TPC symbol and the transmitter power control command is according to table 13.

### 5.3.3 Common downlink physical channels

#### 5.3.3.1 Common Pilot Channel (CPICH)

The CPICH is a fixed rate (30 kbps, SF=256) downlink physical channel that carries a pre-defined bit sequence. Figure 13 shows the frame structure of the CPICH.

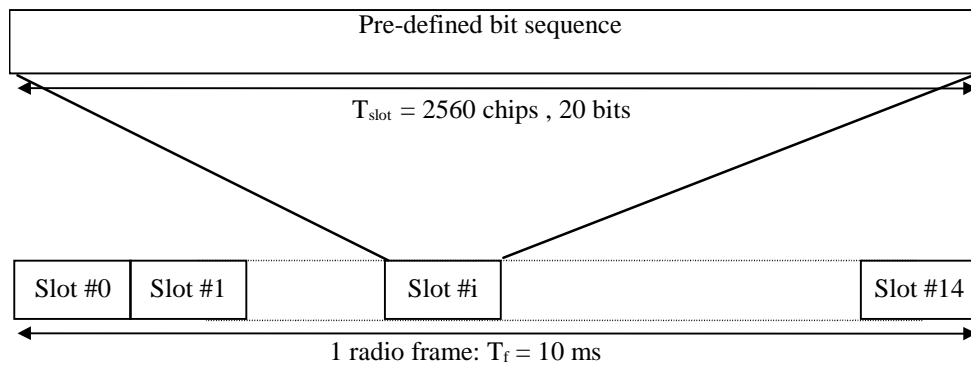

**Figure 13: Frame structure for Common Pilot Channel**

In case transmit diversity is used on P-CCPCH and SCH, the CPICH shall be transmitted from both antennas using the same channelization and scrambling code. In this case, the pre-defined bit sequence of the CPICH is different for Antenna 1 and Antenna 2, see figure 14. In case of no transmit diversity, the bit sequence of Antenna 1 in figure 14 is used.

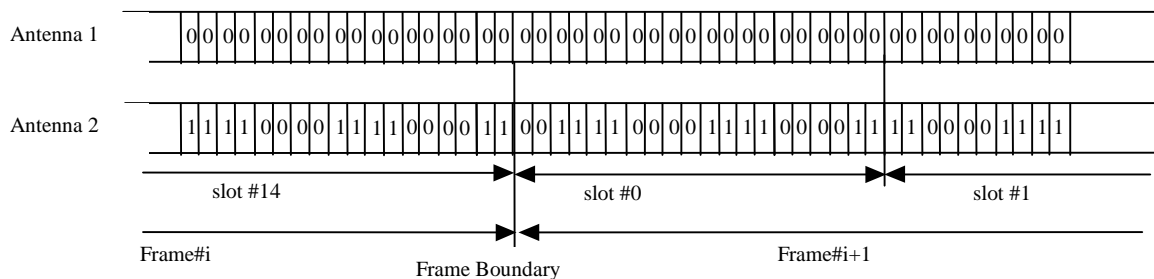

**Figure 14: Modulation pattern for Common Pilot Channel**

There are two types of Common pilot channels, the Primary and Secondary CPICH. They differ in their use and the limitations placed on their physical features.

**5.3.3.1.1 Primary Common Pilot Channel (P-CPICH)**

The Primary Common Pilot Channel (P-CPICH) has the following characteristics:

- The same channelization code is always used for the P-CPICH, see [4];
- The P-CPICH is scrambled by the primary scrambling code, see [4];
- There is one and only one P-CPICH per cell;
- The P-CPICH is broadcast over the entire cell.

**5.3.3.1.2 Secondary Common Pilot Channel (S-CPICH)**

A Secondary Common Pilot Channel (S-CPICH) has the following characteristics:

- An arbitrary channelization code of SF=256 is used for the S-CPICH, see [4];
- An S-CPICH is scrambled by either the primary or a secondary scrambling code, see [4];
- There may be zero, one, or several S-CPICH per cell;
- An S-CPICH may be transmitted over the entire cell or only over a part of the cell;

**5.3.3.2 Downlink phase reference**

Table 17 specifies the channels which the UE may use as a phase reference for each downlink physical channel type; it also specifies whether the channels which the UE may use as a phase reference for a channel of a particular type shall

be assumed to be the same as the ones which the UE may use as a phase reference for the associated DPCH or F-DPCH, if configured.

For the DPCH or F-DPCH and the associated downlink physical channels the following always applies:

- The UE may use the DPCH pilot bits as a phase reference.
- In addition, the UE may use either the primary CPICH or a secondary CPICH as a phase reference.
  - By default (i.e. without any indication by higher layers) the UE may use the primary CPICH as a phase reference.
  - When a UE is not configured in MIMO mode: The UE is informed by higher layers when it may use a secondary CPICH as a phase reference. In this case the UE shall not use the primary CPICH as a phase reference. Indication that a secondary CPICH may be a phase reference is also applicable when open loop or closed loop TX diversity is enabled for a downlink physical channel.
  - When the UE is configured in MIMO mode: The UE is informed by higher layers when it may use a secondary CPICH as a phase reference for a second transmit antenna in addition to the primary CPICH which will be transmitted from the first antenna. If no secondary CPICH is signalled as phase reference, it may use the Antenna 1 and Antenna 2 primary CPICH as phase references.

**Table 17: Phase references for downlink physical channel types**  
**"X" – Applicable, "-" – Not applicable**

Physical channel type	DPCH Dedicated pilot (never as the sole phase reference)	Primary-CPICH	Secondary-CPICH	Same as associated DPCH or F-DPCH
P-CCPCH	-	X	-	-
SCH	-	X	-	-
S-CCPCH	-	X	-	-
DPCH*	X	X	X	-
F-DPCH*	-	X	X	-
PICH	-	X	-	-
MICH	-	X	-	-
HS-PDSCH* (UE not in MIMO mode and associated DPCH or F-DPCH is configured)	-	-	-	X
HS-PDSCH* (UE in MIMO mode)	-	X	X	-
HS-PDSCH (if no associated DPCH or F-DPCH is configured)	-	X	-	-
HS-SCCH* (if associated DPCH or F-DPCH is configured)	-	-	-	X
HS-SCCH (if no associated DPCH or F-DPCH is configured)	-	X	-	-
E-AGCH*	-	-	-	X
E-RGCH*	-	-	-	X
E-HICH*	-	-	-	X
AICH	-	X	-	-

Note \*: A secondary CPICH should not be configured as a phase reference for DPCH or F-DPCH when a UE simultaneously receives S-CCPCHs on different radio links and DPCH or F-DPCH. The UE behavior is undefined if this configuration is used. The support for simultaneous reception of S-CCPCHs on different radio links and DPCH or F-DPCH is optional in the UE.

Dedicated pilot bits are never the sole phase reference for any physical channel, but the UE may always use dedicated pilot bits as a phase reference for DPCH.



Furthermore, during a DPCH or F-DPCH frame overlapping with any part of an associated HS-DSCH or HS-SCCH subframe, the phase reference on this DPCH or F-DPCH shall not change.

### 5.3.3.3 Primary Common Control Physical Channel (P-CCPCH)

The Primary CCPCH is a fixed rate (30 kbps, SF=256) downlink physical channels used to carry the BCH transport channel.

Figure 15 shows the frame structure of the Primary CCPCH. The frame structure differs from the downlink DPCH in that no TPC commands, no TFCI and no pilot bits are transmitted. The Primary CCPCH is not transmitted during the first 256 chips of each slot. Instead, Primary SCH and Secondary SCH are transmitted during this period (see subclause 5.3.3.5).

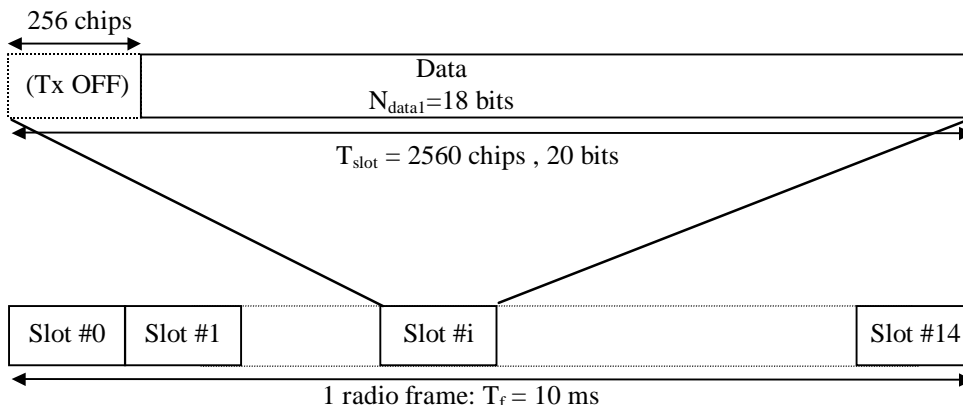

Figure 15: Frame structure for Primary Common Control Physical Channel

#### 5.3.3.3.1 Primary CCPCH structure with STTD encoding

In case the diversity antenna is present in UTRAN and the P-CCPCH is to be transmitted using open loop transmit diversity, the data bits of the P-CCPCH are STTD encoded as given in subclause 5.3.1.1.1. The last two data bits in even numbered slots are STTD encoded together with the first two data bits in the following slot, except for slot #14 where the two last data bits are not STTD encoded and instead transmitted with equal power from both the antennas, see figure 16. Higher layers signal whether STTD encoding is used for the P-CCPCH or not. In addition to the presence/absence of STTD encoding on P-CCPCH is indicated by modulating the SCH, see 5.3.3.4. During power on and hand over between cells the UE can determine the presence of STTD encoding on the P-CCPCH, by either receiving the higher layer message, by demodulating the SCH channel, or by a combination of the above two schemes.

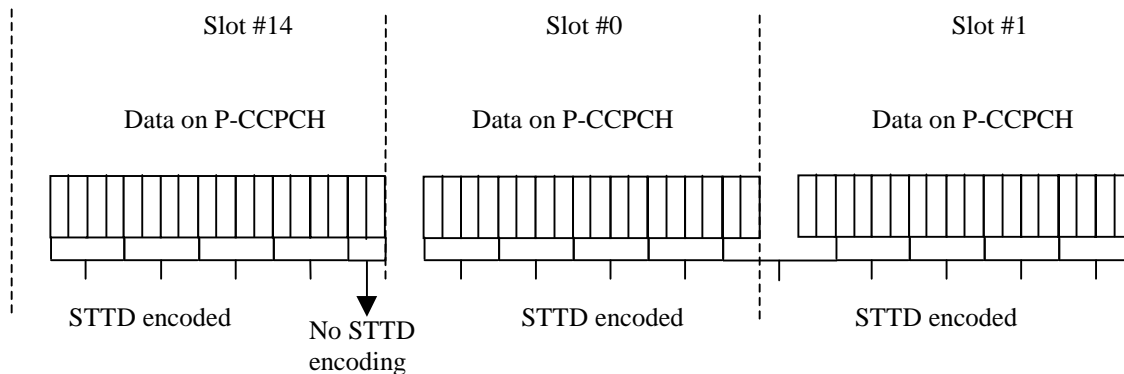
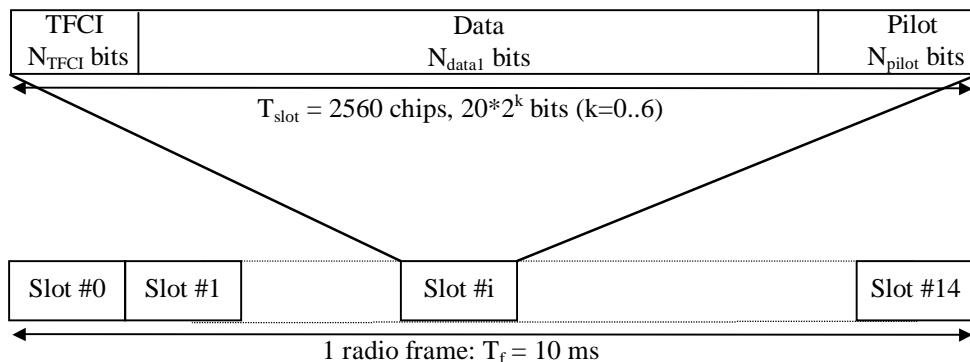

Figure 16: STTD encoding for the data bits of the P-CCPCH

### 5.3.3.4 Secondary Common Control Physical Channel (S-CCPCH)

The Secondary CCPCH is used to carry the FACH and PCH. There are two types of Secondary CCPCH: those that include TFCI and those that do not include TFCI. It is the UTRAN that determines if a TFCI should be transmitted, hence making it mandatory for all UEs to support the use of TFCI. The set of possible rates for the Secondary CCPCH is the same as for the downlink DPCH, see subclause 5.3.2. The frame structure of the Secondary CCPCH is shown in figure 17.



**Figure 17: Frame structure for Secondary Common Control Physical Channel**

The parameter  $k$  in figure 17 determines the total number of bits per downlink Secondary CCPCH slot. It is related to the spreading factor  $SF$  of the physical channel as  $SF = 256/2^k$ . The spreading factor range is from 256 down to 4.

The values for the number of bits per field are given in Table 18. The channel bit and symbol rates given in Table 18 are the rates immediately before spreading. The slot formats applicable to QPSK with pilot bits are not supported in this release. The pilot patterns for the slot formats applicable to QPSK are given in Table 19. DTX shall be used in the pilot field of the 16QAM slot formats, i.e. no pilot bits are used in this release.

The FACH and PCH can be mapped to the same or to separate Secondary CCPCHs. If FACH and PCH are mapped to the same Secondary CCPCH, they can be mapped to the same frame. The main difference between a CCPCH and a downlink dedicated physical channel is that a CCPCH is not inner-loop power controlled. The main difference between the Primary and Secondary CCPCH is that the transport channel mapped to the Primary CCPCH (BCH) can only have a fixed predefined transport format combination, while the Secondary CCPCH support multiple transport format combinations using TFCI.

Table 18: Secondary CCPCH fields

Slot Format #i	Channel Bit Rate (kbps)	Channel Symbol Rate (ksp/s)	SF	Bits/ Frame	Bits/ Slot	N <sub>data1</sub>	N <sub>pilot</sub>	N <sub>TFCI</sub>
0	30	15	256	300	20	20	0	0
1	30	15	256	300	20	12	8	0
2	30	15	256	300	20	18	0	2
3	30	15	256	300	20	10	8	2
4	60	30	128	600	40	40	0	0
5	60	30	128	600	40	32	8	0
6	60	30	128	600	40	38	0	2
7	60	30	128	600	40	30	8	2
8	120	60	64	1200	80	72	0	8*
9	120	60	64	1200	80	64	8	8*
10	240	120	32	2400	160	152	0	8*
11	240	120	32	2400	160	144	8	8*
12	480	240	16	4800	320	312	0	8*
13	480	240	16	4800	320	296	16	8*
14	960	480	8	9600	640	632	0	8*
15	960	480	8	9600	640	616	16	8*
16	1920	960	4	19200	1280	1272	0	8*
17	1920	960	4	19200	1280	1256	16	8*
18***	60	15	256	600	40	36	0	4
19***	120	30	128	1200	80	76	0	4
20***	240	60	64	2400	160	144	0	16*
21***	480	120	32	4800	320	272	32**	16*
22***	960	240	16	9600	640	560	64**	16*
23***	1920	480	8	19200	1280	1136	128**	16*

\* If TFCI bits are not used, then DTX shall be used in TFCI field.

\*\* If pilot bits are not used, then DTX shall be used in pilot field.

\*\*\* Slot formats applicable to 16QAM. See subclause 4.3.5.1.1 in [3] for mapping TFCI bits on 16QAM slot formats.

NOTE 1: The slot formats 18 to 23 in Table 18 are only applicable for MBSFN operations with 16QAM.

NOTE 2: The modulation used in MBSFN operations is signalled by higher layers.

The pilot symbol pattern described in Table 19 is not supported in this release. The shadowed part can be used as frame synchronization words. (The symbol pattern of pilot symbols other than the frame synchronization word shall be "11"). In Table 19, the transmission order is from left to right. (Each two-bit pair represents an I/Q pair of QPSK modulation.)

Table 19: Pilot Symbol Pattern

Symbol #	N <sub>pilot</sub> = 8				N <sub>pilot</sub> = 16							
	0	1	2	3	0	1	2	3	4	5	6	7
Slot #0	11	11	11	10	11	11	11	10	11	11	11	10
1	11	00	11	10	11	00	11	10	11	11	11	00
2	11	01	11	01	11	01	11	01	11	10	11	00
3	11	00	11	00	11	00	11	00	11	01	11	10
4	11	10	11	01	11	10	11	01	11	11	11	11
5	11	11	11	10	11	11	11	10	11	01	11	01
6	11	11	11	00	11	11	11	00	11	10	11	11
7	11	10	11	00	11	10	11	00	11	10	11	00
8	11	01	11	10	11	01	11	10	11	00	11	11
9	11	11	11	11	11	11	11	11	11	00	11	11
10	11	01	11	01	11	01	11	01	11	11	11	10
11	11	10	11	11	11	10	11	11	11	00	11	10
12	11	10	11	00	11	10	11	00	11	01	11	01
13	11	00	11	11	11	00	11	11	11	00	11	00
14	11	00	11	11	11	00	11	11	11	10	11	01

For slot formats using TFCI, the TFCI value in each radio frame corresponds to a certain transport format combination of the FACHs and/or PCHs currently in use. This correspondence is (re-)negotiated at each FACH/PCH addition / removal. The mapping of the TFCI bits onto slots is described in [3].

5.3.3.4.1 Secondary CCPCH structure with STTD encoding

In case the diversity antenna is present in UTRAN and the S-CCPCH is to be transmitted using open loop transmit diversity, the data and TFCI bits of the S-CCPCH are STTD encoded as given in subclause 5.3.1.1.1. The pilot symbol pattern for antenna 2 for the S-CCPCH given in Table 20 is not supported in this release.

Table 20: Pilot symbol pattern for antenna 2 when STTD encoding is used on the S-CCPCH

Symbol #	Npilot = 8				Npilot = 16							
	0	1	2	3	0	1	2	3	4	5	6	7
Slot #0	11	00	00	10	11	00	00	10	11	00	00	10
1	11	00	00	01	11	00	00	01	11	10	00	10
2	11	11	00	00	11	11	00	00	11	10	00	11
3	11	10	00	01	11	10	00	01	11	00	00	00
4	11	11	00	11	11	11	00	11	11	01	00	10
5	11	00	00	10	11	00	00	10	11	11	00	00
6	11	10	00	10	11	10	00	10	11	01	00	11
7	11	10	00	11	11	10	00	11	11	10	00	11
8	11	00	00	00	11	00	00	00	11	01	00	01
9	11	01	00	10	11	01	00	10	11	01	00	01
10	11	11	00	00	11	11	00	00	11	00	00	10
11	11	01	00	11	11	01	00	11	11	00	00	01
12	11	10	00	11	11	10	00	11	11	11	00	00
13	11	01	00	01	11	01	00	01	11	10	00	01
14	11	01	00	01	11	01	00	01	11	11	00	11

5.3.3.5 Synchronisation Channel (SCH)

The Synchronisation Channel (SCH) is a downlink signal used for cell search. The SCH consists of two sub channels, the Primary and Secondary SCH. The 10 ms radio frames of the Primary and Secondary SCH are divided into 15 slots, each of length 2560 chips. Figure 18 illustrates the structure of the SCH radio frame.

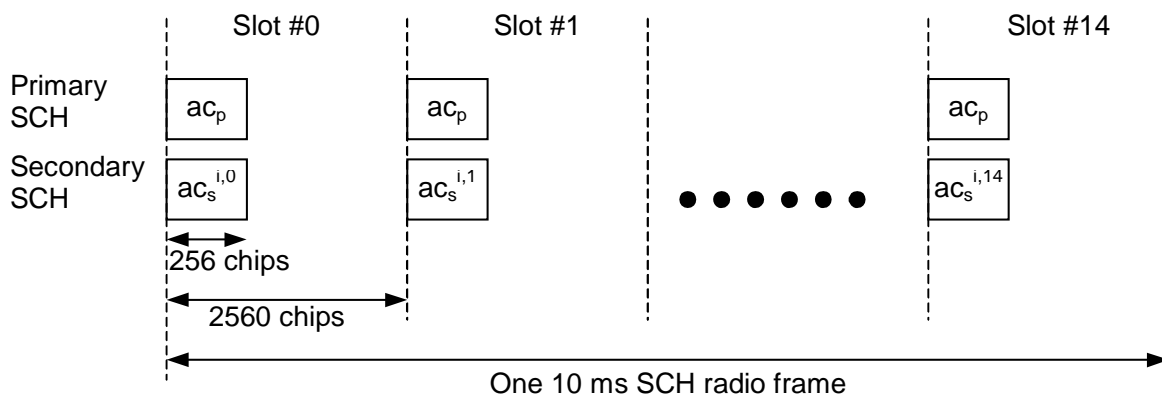

Figure 18: Structure of Synchronisation Channel (SCH)

The Primary SCH consists of a modulated code of length 256 chips, the Primary Synchronisation Code (PSC) denoted  $c_p$  in figure 18, transmitted once every slot. The PSC is the same for every cell in the system.

The Secondary SCH consists of repeatedly transmitting a length 15 sequence of modulated codes of length 256 chips, the Secondary Synchronisation Codes (SSC), transmitted in parallel with the Primary SCH. The SSC is denoted  $c_s^{i,k}$  in figure 18, where  $i = 0, 1, \dots, 63$  is the number of the scrambling code group, and  $k = 0, 1, \dots, 14$  is the slot number. Each SSC is chosen from a set of 16 different codes of length 256. This sequence on the Secondary SCH indicates which of the code groups the cell's downlink scrambling code belongs to.

The primary and secondary synchronization codes are modulated by the symbol  $a$  shown in figure 18, which indicates the presence/ absence of STTD encoding on the P-CCPCH and is given by the following table:

P-CCPCH STTD encoded	$a = +1$
P-CCPCH not STTD encoded	$a = -1$

5.3.3.5.1 SCH transmitted by TSTD

Figure 19 illustrates the structure of the SCH transmitted by the TSTD scheme. In even numbered slots both PSC and SSC are transmitted on antenna 1, and in odd numbered slots both PSC and SSC are transmitted on antenna 2.

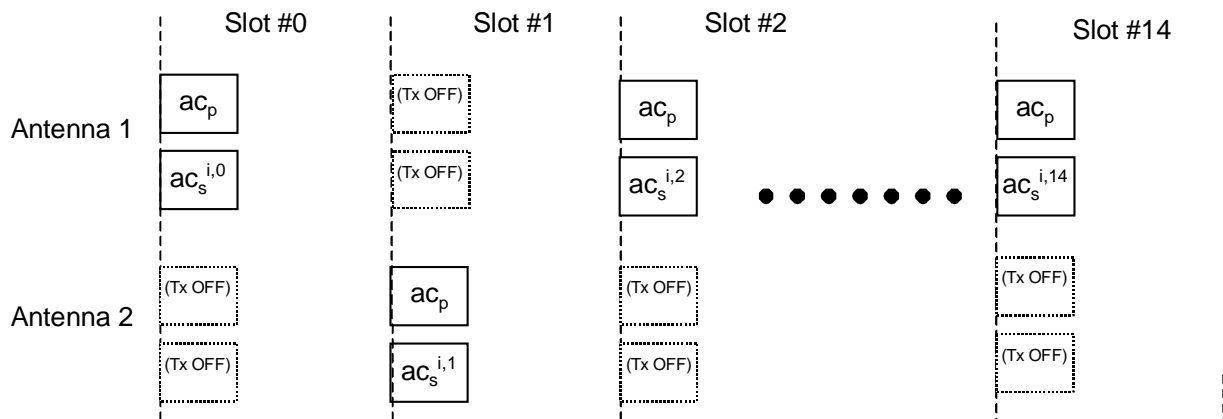

Figure 19: Structure of SCH transmitted by TSTD scheme

5.3.3.6 Void

5.3.3.7 Acquisition Indicator Channel (AICH)

The Acquisition Indicator channel (AICH) is a fixed rate ( $SF=256$ ) physical channel used to carry Acquisition Indicators (AI) and Extended Acquisition Indicators (EAI). Acquisition Indicator  $AI_s$  corresponds to signature  $s$  on the PRACH. Extended Acquisition Indicators represent a set of values corresponding to a set of E-DCH resource configurations.

Figure 21 illustrates the structure of the AICH. The AICH consists of a repeated sequence of 15 consecutive *access slots* (AS), each of length 5120 chips. Each access slot consists of two parts, an *Acquisition-Indicator* (AI) part consisting of 32 real-valued signals  $a_0, \dots, a_{31}$  and a part of duration 1024 chips with no transmission that is not formally part of the AICH. The part of the slot with no transmission is reserved for possible future use by other physical channels.

The spreading factor (SF) used for channelisation of the AICH is 256.

The phase reference for the AICH is the Primary CPICH.

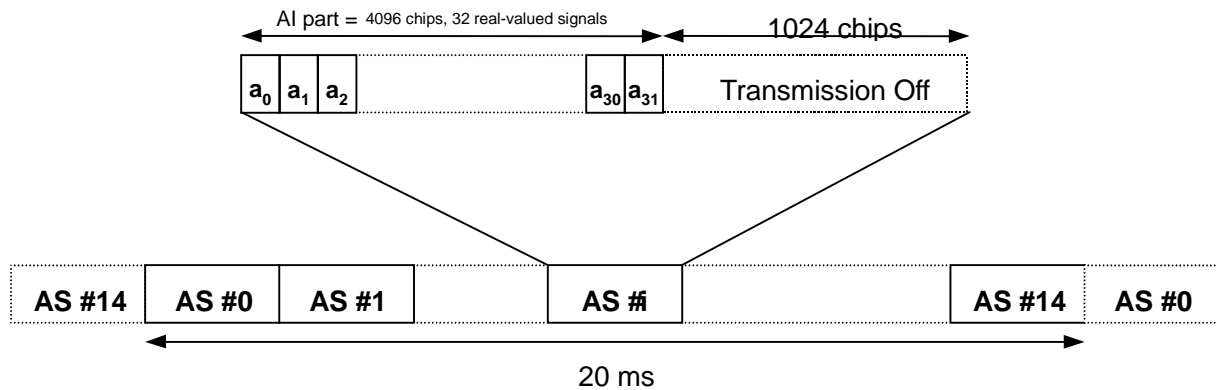

Figure 21: Structure of Acquisition Indicator Channel (AICH)

The real-valued signals  $a_0, a_1, \dots, a_{31}$  in figure 21 are given by

$$a_j = \left( \sum_{s=0}^{15} AI_s b_{s,j} \right) + \gamma EAI_{s'} c_{s',j}$$

where  $AI_s$ , taking the values +1, -1, and 0, is the acquisition indicator corresponding to signature  $s$  and the sequence  $b_{s,0}, \dots, b_{s,31}$  is given by Table 22,  $EAI_{s'}$ , taking the values +1, -1, and 0, is the extended acquisition indicator corresponding to signature  $s'$  and the sequence  $c_{s',0}, \dots, c_{s',31}$  is given by Table 22B, and  $\gamma$  is the relative amplitude weighting factor corresponding to the square root of the ratio of the relative transmit power of the EAI and the relative transmit power of the AI, as signalled by higher layers. If the signature  $s$  is not a member of the set of available signatures for all the Access Service Class (ASC) for the corresponding PRACH (cf [5]) then  $AI_s$  shall be set to 0.

The use of acquisition indicators is described in [5]. The meaning of acquisition indicators depends on whether a UE sends an access preamble signature corresponding to a PRACH message or corresponding to an E-DCH transmission. Furthermore, if a UE sends an access preamble signature corresponding to an E-DCH transmission, the meaning of the acquisition indicator depends on whether EAI is configured or not. The following rules apply for one PRACH preamble scrambling code. If multiple PRACH preamble scrambling codes are defined in a cell, then for each of them the following rules are used independently.

- If the UE sends an access preamble signature corresponding to a PRACH message, then;
  - if an Acquisition Indicator is set to +1, it represents a positive acknowledgement,
  - if an Acquisition Indicator is set to -1, it represents a negative acknowledgement.
- If the UE sends an access preamble signature corresponding to an E-DCH transmission, then;
  - if the corresponding Acquisition Indicator is set to +1, it represents a positive acknowledgement and the associated default E-DCH resource configuration is allocated to the UE,
  - if the corresponding Acquisition Indicator is set to -1 and EAI is not configured, then it represents a negative acknowledgement,
  - if the corresponding Acquisition Indicator is set to -1 and EAI is configured, then the UE detects which one of the Extended Acquisition Indicator signatures is present.

The association between the AI and the default E-DCH resource index is such that

$$X = \text{SigInd} \bmod Y,$$

where  $X$  is the Default E-DCH resource index,  $Y$  is the total number of E-DCH resources configured in the cell for Enhanced Uplink in CELL\_FACH state and IDLE mode, and SigInd is the Nth PRACH preamble signature corresponding to the AI that is configured available in the cell and corresponding to E-DCH transmission for Enhanced Uplink in CELL\_FACH state and IDLE mode, counting from zero and taking into account only the PRACH preamble signature indices that are configured available in the cell and corresponding to E-DCH transmission for Enhanced Uplink in CELL\_FACH state and IDLE mode.

The use of Extended Acquisition Indicators is described in [5]. If  $s''=0$  and an  $EAI_0$  is set to +1, it represents a negative acknowledgement. The mapping between the non-zero  $EAI_s''$  and the E-DCH resource configuration index is presented in Table 22A where X is the index of the default E-DCH resource as defined above and Y is the total number of E-DCH resources configured in the cell.

The real-valued signals,  $a_s$ , are spread and modulated in the same fashion as bits when represented in  $\{+1, -1\}$  form.

In case STTD-based open-loop transmit diversity is applied to AICH, STTD encoding according to subclause 5.3.1.1.1 is applied to each sequence  $b_{s,0}, b_{s,1}, \dots, b_{s,31}$  separately before the sequences are combined into AICH signals  $a_0, \dots, a_{31}$ .

**Table 22: AI signature patterns**

s	$b_{s,0}, b_{s,1}, \dots, b_{s,31}$																																						
0	1	1	1	1	1	1	1	1	1	1	1	1	1	1	1	1	1	1	1	1	1	1	1	1	1	1	1	1	1	1	1	1	1	1	1	1			
1	1	1	-1	-1	1	1	-1	-1	1	1	-1	-1	1	1	-1	-1	1	1	-1	-1	1	1	-1	-1	1	1	-1	-1	1	1	-1	-1	1	1	-1	-1	1	1	
2	1	1	1	1	-1	-1	-1	-1	1	1	1	1	1	1	-1	-1	-1	-1	1	1	1	1	-1	-1	-1	-1	1	1	1	1	-1	-1	-1	-1	1	1	-1	-1	
3	1	1	-1	-1	-1	-1	1	1	1	1	1	-1	-1	-1	-1	1	1	1	1	-1	-1	-1	-1	1	1	1	1	-1	-1	-1	-1	1	1	1	1	-1	-1	-1	-1
4	1	1	1	1	1	1	1	1	-1	-1	-1	-1	-1	-1	-1	1	1	1	1	1	1	1	1	1	1	1	1	1	1	1	1	1	1	1	1	1	1	1	1
5	1	1	-1	-1	1	1	-1	-1	-1	-1	1	1	-1	-1	1	1	1	1	-1	-1	1	1	-1	-1	1	1	-1	-1	-1	-1	1	1	1	1	-1	-1	1	1	
6	1	1	1	1	-1	-1	-1	-1	-1	-1	-1	-1	1	1	1	1	1	1	1	-1	-1	-1	-1	-1	-1	-1	-1	-1	-1	-1	-1	-1	-1	-1	-1	-1	-1	-1	
7	1	1	-1	-1	-1	-1	1	1	-1	-1	1	1	1	1	-1	-1	1	1	-1	-1	-1	-1	-1	-1	1	1	-1	-1	1	1	1	1	1	1	1	1	-1	-1	
8	1	1	1	1	1	1	1	1	1	1	1	1	1	1	1	1	1	1	-1	-1	-1	-1	-1	-1	-1	-1	-1	-1	-1	-1	-1	-1	-1	-1	-1	-1	-1	-1	-1
9	1	1	-1	-1	1	1	-1	-1	1	1	-1	-1	1	1	-1	-1	-1	-1	1	1	-1	-1	1	1	-1	-1	-1	-1	1	1	-1	-1	1	1	-1	-1	1	1	
10	1	1	1	1	-1	-1	-1	1	1	1	1	-1	-1	-1	-1	-1	-1	-1	1	1	1	1	-1	-1	-1	-1	-1	-1	-1	-1	-1	-1	-1	-1	-1	-1	-1	-1	-1
11	1	1	-1	-1	-1	-1	1	1	1	1	-1	-1	-1	-1	1	1	1	1	-1	-1	-1	-1	1	1	-1	-1	-1	-1	1	1	1	1	1	1	1	1	1	-1	-1
12	1	1	1	1	1	1	1	1	-1	-1	-1	-1	-1	-1	-1	-1	-1	-1	-1	-1	-1	-1	-1	-1	-1	-1	-1	-1	-1	-1	-1	-1	-1	-1	-1	-1	-1	-1	-1
13	1	1	-1	-1	1	1	-1	-1	-1	-1	1	1	-1	-1	1	1	-1	-1	1	1	-1	-1	1	1	-1	-1	1	1	1	1	1	1	1	1	1	1	1	-1	-1
14	1	1	1	1	-1	-1	-1	-1	-1	-1	-1	-1	-1	-1	-1	-1	-1	-1	-1	-1	-1	-1	-1	-1	-1	-1	-1	-1	-1	-1	-1	-1	-1	-1	-1	-1	-1	-1	-1
15	1	1	-1	-1	-1	-1	1	1	-1	-1	1	1	1	1	-1	-1	-1	-1	1	1	1	1	-1	-1	1	1	-1	-1	1	1	-1	-1	-1	-1	-1	-1	-1	-1	-1

**Table 22A: EAI and resource configuration mapping**

EAI <sub>s''</sub>	Signature s''	E-DCH Resource configuration index
+1	0	NACK
-1		$(X + 1) \bmod Y$
+1	1	$(X + 2) \bmod Y$
-1		$(X + 3) \bmod Y$
+1	2	$(X + 4) \bmod Y$
-1		$(X + 5) \bmod Y$
+1	3	$(X + 6) \bmod Y$
-1		$(X + 7) \bmod Y$
+1	4	$(X + 8) \bmod Y$
-1		$(X + 9) \bmod Y$
+1	5	$(X + 10) \bmod Y$
-1		$(X + 11) \bmod Y$
+1	6	$(X + 12) \bmod Y$
-1		$(X + 13) \bmod Y$
+1	7	$(X + 14) \bmod Y$
-1		$(X + 15) \bmod Y$
+1	8	$(X + 16) \bmod Y$
-1		$(X + 17) \bmod Y$
+1	9	$(X + 18) \bmod Y$
-1		$(X + 19) \bmod Y$
+1	10	$(X + 20) \bmod Y$
-1		$(X + 21) \bmod Y$
+1	11	$(X + 22) \bmod Y$
-1		$(X + 23) \bmod Y$
+1	12	$(X + 24) \bmod Y$
-1		$(X + 25) \bmod Y$
+1	13	$(X + 26) \bmod Y$
-1		$(X + 27) \bmod Y$
+1	14	$(X + 28) \bmod Y$
-1		$(X + 29) \bmod Y$
+1	15	$(X + 30) \bmod Y$
-1		$(X + 31) \bmod Y$

**Table 22B: EAI signature patterns**

s''	C <sub>s'',0</sub> , C <sub>s'',1</sub> ..., C <sub>s'',31</sub>
0	1 -1 1 -1 1 -1 1 -1 1 -1 1 -1 1 -1 1 -1 1 -1 1 -1 1 -1 1 -1 1 -1 1 -1 1 -1 1 -1
1	1 -1 -1 1 1 -1 -1 1 1 -1 -1 1 1 -1 -1 1 1 -1 -1 1 1 -1 -1 1 1 -1 -1 1 1 -1 -1 1
2	1 -1 1 -1 -1 1 -1 1 1 -1 1 -1 -1 1 -1 1 1 -1 1 -1 -1 1 -1 1 1 -1 1 -1 -1 1 -1 1
3	1 -1 -1 1 -1 1 1 -1 1 -1 -1 1 -1 1 1 -1 1 -1 -1 1 -1 1 1 -1 1 -1 -1 1 -1 1 1 -1
4	1 -1 1 -1 1 -1 1 -1 -1 1 -1 1 -1 1 -1 1 1 -1 1 -1 1 -1 1 -1 -1 1 -1 1 -1 1 -1 1
5	1 -1 -1 1 1 -1 -1 1 -1 1 1 -1 -1 1 -1 1 -1 -1 1 1 -1 -1 1 -1 1 -1 1 -1 -1 1 1 -1
6	1 -1 1 -1 -1 1 -1 1 -1 1 -1 1 1 -1 1 -1 1 -1 1 -1 -1 1 -1 1 -1 1 -1 1 -1 1 1 -1
7	1 -1 -1 1 -1 1 1 -1 -1 1 1 -1 1 -1 -1 1 1 -1 -1 1 -1 1 1 -1 -1 1 1 -1 1 -1 -1 1
8	1 -1 1 -1 1 -1 1 -1 1 -1 1 -1 1 -1 1 -1 -1 1 -1 1 -1 1 -1 1 -1 1 -1 1 -1 1 -1 1
9	1 -1 -1 1 1 -1 -1 1 1 -1 -1 1 1 -1 -1 1 -1 1 1 -1 -1 1 1 -1 -1 1 1 -1 -1 1 1 -1
10	1 -1 1 -1 -1 1 -1 1 1 -1 1 -1 -1 1 -1 1 -1 1 1 -1 1 -1 -1 1 -1 1 1 -1 1 1 -1 1
11	1 -1 -1 1 -1 1 1 -1 1 -1 -1 1 -1 1 1 -1 -1 1 1 -1 1 -1 -1 1 -1 1 1 -1 1 -1 -1 1
12	1 -1 1 -1 1 -1 1 -1 -1 1 -1 1 -1 1 -1 1 -1 1 -1 1 -1 1 1 -1 1 -1 1 -1 1 -1 1 -1
13	1 -1 -1 1 1 -1 -1 1 -1 1 1 -1 -1 1 1 -1 -1 1 1 -1 -1 1 1 -1 1 -1 -1 1 1 -1 -1 1
14	1 -1 1 -1 -1 1 -1 1 -1 1 -1 1 1 -1 1 -1 -1 1 -1 1 1 -1 1 -1 1 -1 1 -1 -1 1 -1 1
15	1 -1 -1 1 -1 1 1 -1 -1 1 1 -1 1 -1 -1 1 -1 1 1 -1 1 -1 -1 1 1 -1 -1 1 -1 1 1 -1



5.3.3.8 Void

5.3.3.9 Void

5.3.3.10 Paging Indicator Channel (PICH)

The Paging Indicator Channel (PICH) is a fixed rate (SF=256) physical channel used to carry the paging indicators. The PICH is associated either with an S-CCPCH to which a PCH transport channel is mapped, or with a HS-SCCH associated with the HS-PDSCH(s) to which a HS-DSCH transport channel carrying paging messages is mapped.

Figure 24 illustrates the frame structure of the PICH. One PICH radio frame of length 10 ms consists of 300 bits ( $b_0, b_1, \dots, b_{299}$ ). Of these, 288 bits ( $b_0, b_1, \dots, b_{287}$ ) are used to carry paging indicators. The remaining 12 bits are not formally part of the PICH and shall not be transmitted (DTX). The part of the frame with no transmission is reserved for possible future use.

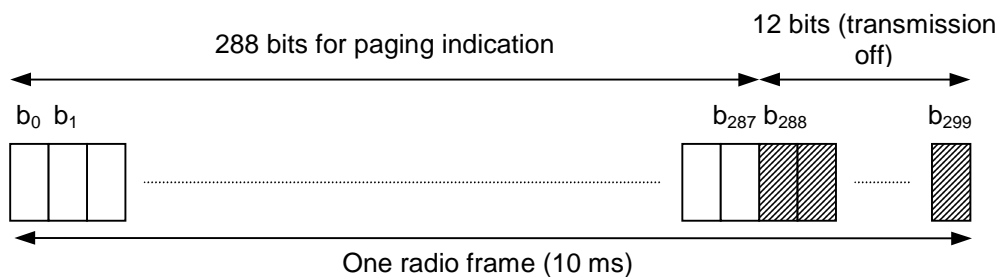

Figure 24: Structure of Paging Indicator Channel (PICH)

In each PICH frame,  $N_p$  paging indicators  $\{P_0, \dots, P_{N_p-1}\}$  are transmitted, where  $N_p=18, 36, 72,$  or  $144$ .

The PI calculated by higher layers for use for a certain UE, is associated to the paging indicator  $P_q$ , where  $q$  is computed as a function of the PI computed by higher layers, the SFN of the P-CCPCH radio frame during which the start of the PICH radio frame occurs, and the number of paging indicators per frame ( $N_p$ ):

$$q = \left( PI + \left[ \left( (18 \times (SFN + \lfloor SFN / 8 \rfloor) + \lfloor SFN / 64 \rfloor) + \lfloor SFN / 512 \rfloor \right) \bmod 144 \right] \times \frac{N_p}{144} \right) \bmod N_p$$

Further, the PI calculated by higher layers is associated with the value of the paging indicator  $P_q$ . If a paging indicator in a certain frame is set to "1" it is an indication that UEs associated with this paging indicator and PI should read either the corresponding frame of the associated S-CCPCH, or the corresponding subframes of the associated HS-SCCH

The PI bitmap in the PCH data frames over  $I_{ub}$  contains indication values for all higher layer PI values possible. Each bit in the bitmap indicates if the paging indicator associated with that particular PI shall be set to 0 or 1. Hence, the calculation in the formula above is to be performed in Node B to make the association between PI and  $P_q$ .

The mapping from  $\{P_0, \dots, P_{N_p-1}\}$  to the PICH bits  $\{b_0, \dots, b_{287}\}$  are according to Table 24.

Table 24: Mapping of paging indicators  $P_q$  to PICH bits

Number of paging indicators per frame ( $N_p$ )	$P_q = 1$	$P_q = 0$
$N_p=18$	$\{b_{16q}, \dots, b_{16q+15}\} = \{1, 1, \dots, 1\}$	$\{b_{16q}, \dots, b_{16q+15}\} = \{0, 0, \dots, 0\}$
$N_p=36$	$\{b_{8q}, \dots, b_{8q+7}\} = \{1, 1, \dots, 1\}$	$\{b_{8q}, \dots, b_{8q+7}\} = \{0, 0, \dots, 0\}$
$N_p=72$	$\{b_{4q}, \dots, b_{4q+3}\} = \{1, 1, \dots, 1\}$	$\{b_{4q}, \dots, b_{4q+3}\} = \{0, 0, \dots, 0\}$
$N_p=144$	$\{b_{2q}, b_{2q+1}\} = \{1, 1\}$	$\{b_{2q}, b_{2q+1}\} = \{0, 0\}$

When transmit diversity is employed for the PICH, STTD encoding is used on the PICH bits as described in subclause 5.3.1.1.1.

## 5.3.3.11 Void

## 5.3.3.12 Shared Control Channel (HS-SCCH)

The HS-SCCH is a fixed rate (60 kbps, SF=128) downlink physical channel used to carry downlink signalling related to HS-DSCH transmission. Figure 26A illustrates the sub-frame structure of the HS-SCCH.

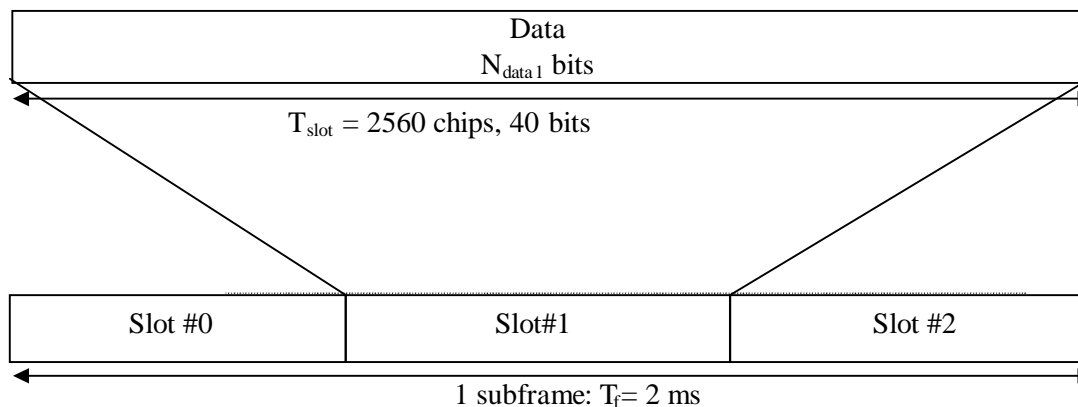

**Figure 26A: Subframe structure for the HS-SCCH**

## 5.3.3.13 High Speed Physical Downlink Shared Channel (HS-PDSCH)

The High Speed Physical Downlink Shared Channel (HS-PDSCH) is used to carry the High Speed Downlink Shared Channel (HS-DSCH).

A HS-PDSCH corresponds to one channelization code of fixed spreading factor SF=16 from the set of channelization codes reserved for HS-DSCH transmission. Multi-code transmission is allowed, which translates to UE being assigned multiple channelisation codes in the same HS-PDSCH subframe, depending on its UE capability.

The subframe and slot structure of HS-PDSCH are shown in figure 26B.

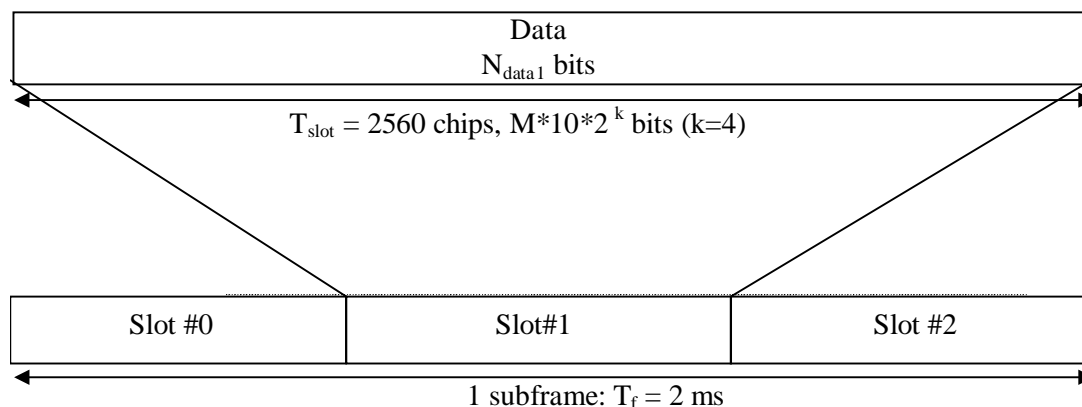

**Figure 26B: Subframe structure for the HS-PDSCH**

An HS-PDSCH may use QPSK, 16QAM or 64QAM modulation symbols. In figure 26B, M is the number of bits per modulation symbols i.e. M=2 for QPSK, M=4 for 16QAM and M=6 for 64QAM. The slot formats are shown in table 26.

Table 26: HS-DSCH fields

Slot format #i	Channel Bit Rate (kbps)	Channel Symbol Rate (ksps)	SF	Bits/ HS-DSCH subframe	Bits/ Slot	Ndata
0(QPSK)	480	240	16	960	320	320
1(16QAM)	960	240	16	1920	640	640
2(64QAM)	1440	240	16	2880	960	960

All relevant Layer 1 information is transmitted in the associated HS-SCCH i.e. the HS-PDSCH does not carry any Layer 1 information.

5.3.3.14 E-DCH Absolute Grant Channel (E-AGCH)

The E-DCH Absolute Grant Channel (E-AGCH) is a fixed rate (30 kbps, SF=256) downlink physical channel carrying the uplink E-DCH absolute grant. Figure 26C illustrates the frame and sub-frame structure of the E-AGCH.

An E-DCH absolute grant shall be transmitted over one E-AGCH sub-frame or one E-AGCH frame. The transmission over one E-AGCH sub-frame and over one E-AGCH frame shall be used for UEs for which E-DCH TTI is set to respectively 2 ms and 10 ms.

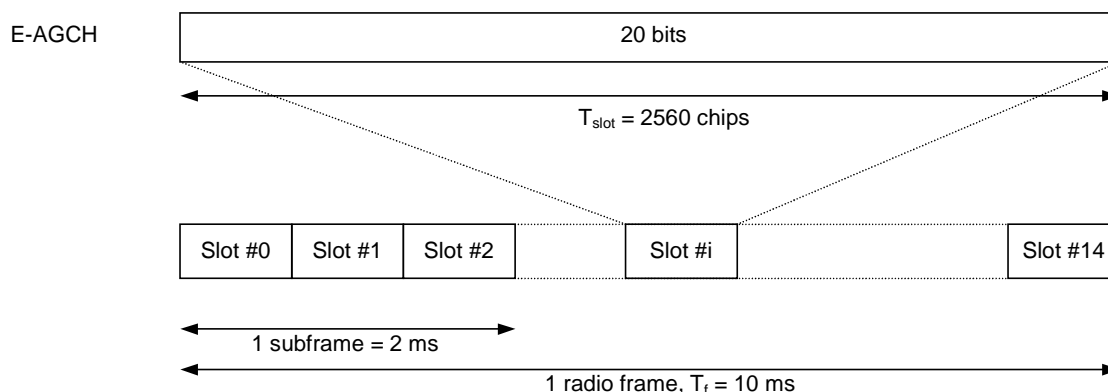

Figure 26C: Sub-frame structure for the E-AGCH

5.3.3.15 MBMS Indicator Channel (MICH)

The MBMS Indicator Channel (MICH) is a fixed rate (SF=256) physical channel used to carry the MBMS notification indicators. The MICH is always associated with an S-CCPCH to which a FACH transport channel is mapped.

Figure 26D illustrates the frame structure of the MICH. One MICH radio frame of length 10 ms consists of 300 bits ( $b_0, b_1, \dots, b_{299}$ ). Of these, 288 bits ( $b_0, b_1, \dots, b_{287}$ ) are used to carry notification indicators. The remaining 12 bits are not formally part of the MICH and shall not be transmitted (DTX).

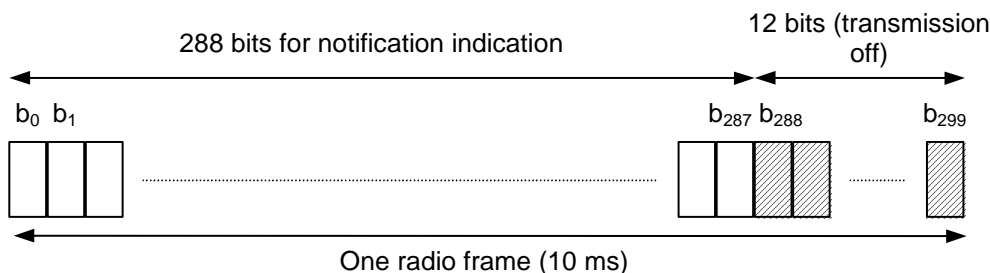

Figure 26D: Structure of MBMS Indicator Channel (MICH)

In each MICH frame,  $N_n$  notification indicators  $\{N_0, \dots, N_{N_n-1}\}$  are transmitted, where  $N_n=18, 36, 72, \text{ or } 144$ .

The NI calculated by higher layers is associated to the index  $q$  of the notification indicator  $N_q$ , where  $q$  is computed as a function of the NI computed by higher layers, the SFN of the P-CCPCH radio frame during which the start of the MICH radio frame occurs, and the number of notification indicators per frame ( $N_n$ ):

$$q = \left\lfloor \left( (C \times (NI \oplus ((C \times SFN) \bmod G))) \bmod G \right) \times \frac{N_n}{G} \right\rfloor$$

where  $G = 2^{16}$ ,  $C = 25033$  and NI is the 16 bit Notification Indicator calculated by higher layers.

The set of NI signalled over Iub indicates all higher layer NI values for which the associated notification indicator on MICH shall be set to 1 during the corresponding modification period. Hence, the calculation in the formula above shall be performed in the Node B every MICH frame for each NI signalled over Iub to make the association between NI and  $q$  and set the related  $N_q$  to 1. All other notification indicators on MICH shall be set to 0.

The mapping from  $\{N_0, \dots, N_{N_n-1}\}$  to the MICH bits  $\{b_0, \dots, b_{287}\}$  are according to table 27.

**Table 27: Mapping of notification indicators  $N_q$  to MICH bits**

Number of notification indicators per frame ( $N_n$ )	$N_q = 1$	$N_q = 0$
$N_n=18$	$\{b_{16q}, \dots, b_{16q+15}\} = \{1, 1, \dots, 1\}$	$\{b_{16q}, \dots, b_{16q+15}\} = \{0, 0, \dots, 0\}$
$N_n=36$	$\{b_{8q}, \dots, b_{8q+7}\} = \{1, 1, \dots, 1\}$	$\{b_{8q}, \dots, b_{8q+7}\} = \{0, 0, \dots, 0\}$
$N_n=72$	$\{b_{4q}, \dots, b_{4q+3}\} = \{1, 1, \dots, 1\}$	$\{b_{4q}, \dots, b_{4q+3}\} = \{0, 0, \dots, 0\}$
$N_n=144$	$\{b_{2q}, b_{2q+1}\} = \{1, 1\}$	$\{b_{2q}, b_{2q+1}\} = \{0, 0\}$

When transmit diversity is employed for the MICH, STTD encoding is used on the MICH bits as described in subclause 5.3.1.1.1.

## 6 Mapping and association of physical channels

### 6.1 Mapping of transport channels onto physical channels

Figure 27 summarises the mapping of transport channels onto physical channels.

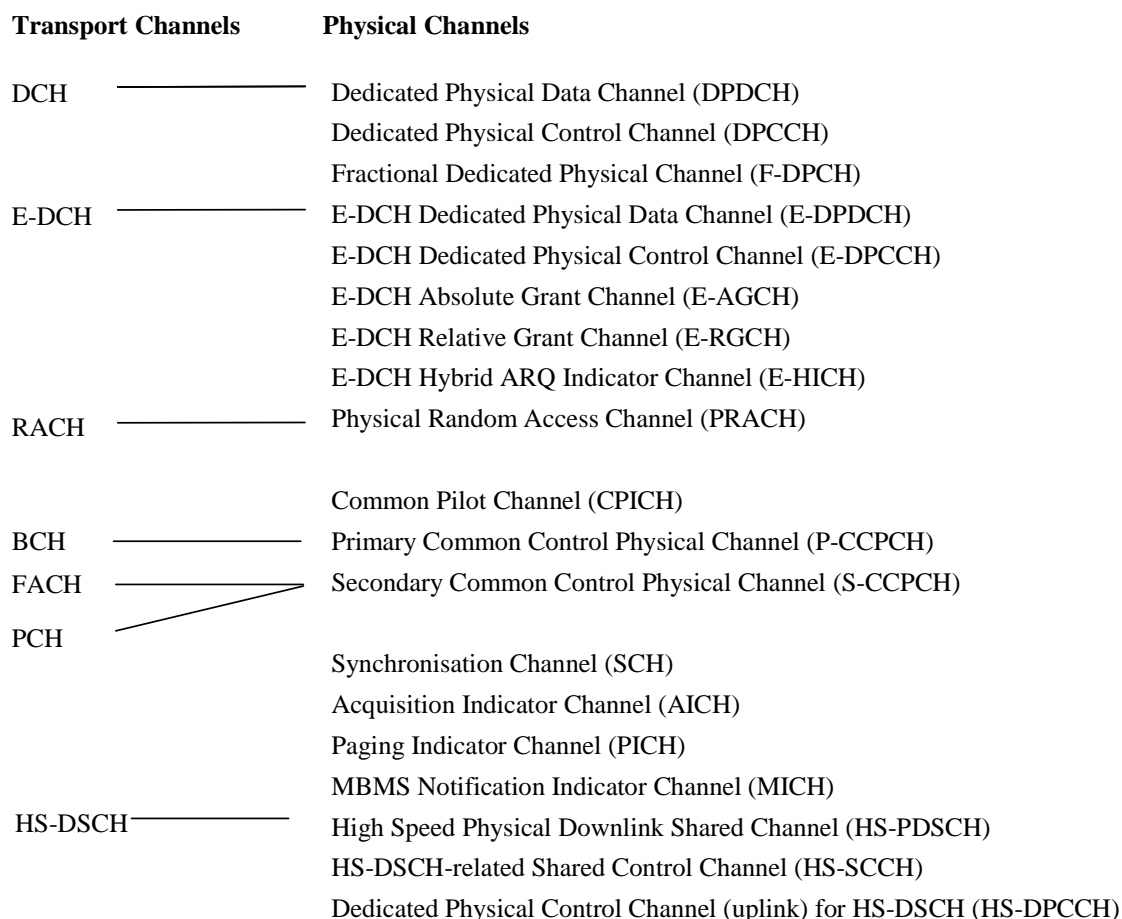

**Figure 27: Transport-channel to physical-channel mapping**

The DCHs are coded and multiplexed as described in [3], and the resulting data stream is mapped sequentially (first-in-first-mapped) directly to the physical channel(s). The mapping of BCH and FACH/PCH is equally straightforward, where the data stream after coding and interleaving is mapped sequentially to the Primary and Secondary CCPCH respectively. Also for the RACH, the coded and interleaved bits are sequentially mapped to the physical channel, in this case the message part of the PRACH. The E-DCH is coded as described in [3], and the resulting data stream is mapped sequentially (first-in-first-mapped) directly to the physical channel(s).

## 6.2 Association of physical channels and physical signals

Figure 28 illustrates the association between physical channels and physical signals.

Physical Signals

Physical Channels

PRACH preamble part \_\_\_\_ Physical Random Access Channel (PRACH)

Figure 28: Physical channel and physical signal association

## 7 Timing relationship between physical channels

### 7.1 General

The P-CCPCH, on which the cell SFN is transmitted, is used as timing reference for all the physical channels, directly for downlink and indirectly for uplink.

Figure 29 describes the frame timing of some of the downlink physical channels; the timing of the remaining downlink physical channels and of the uplink physical channels is specified in the remaining subclauses. For the AICH the access slot timing is included. Transmission timing for uplink physical channels is given by the received timing of downlink physical channels.

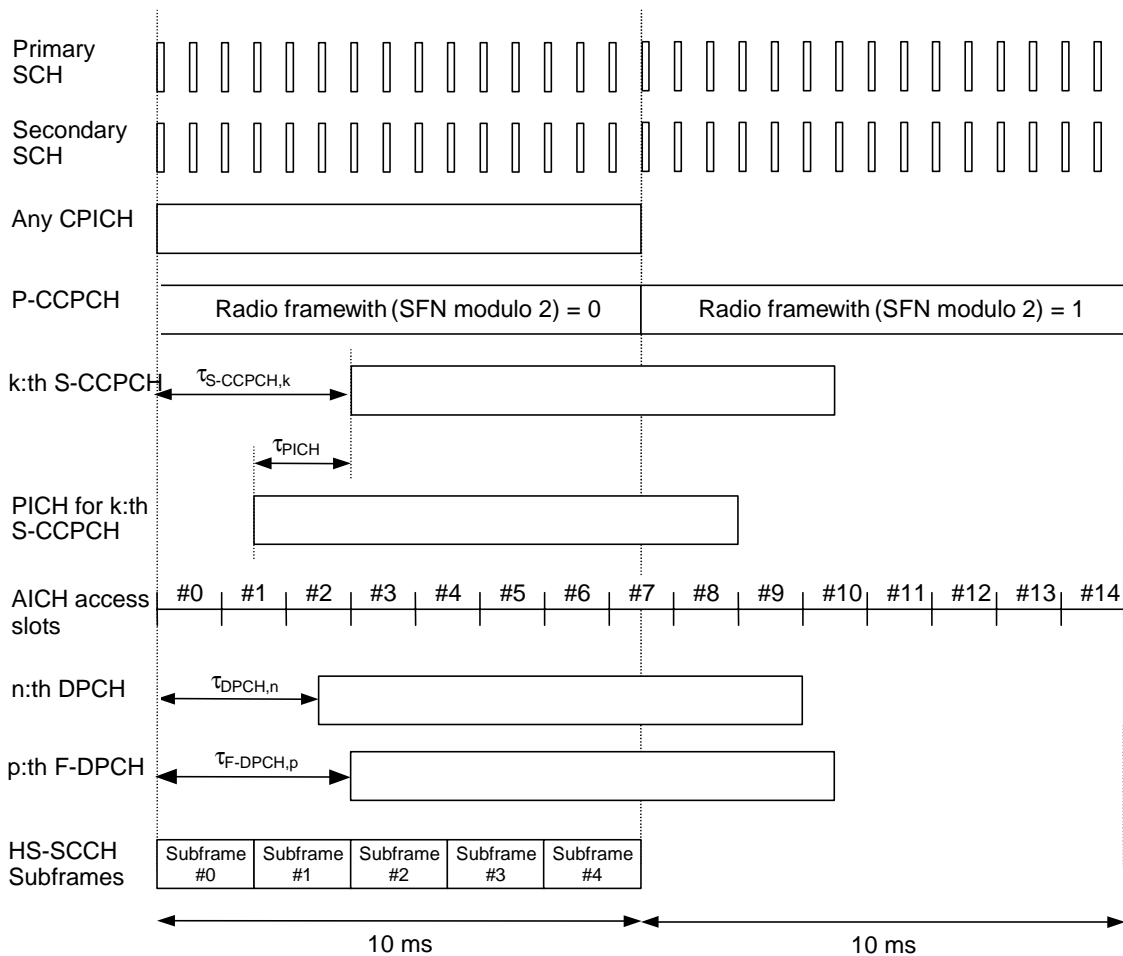

Figure 29: Radio frame timing and access slot timing of downlink physical channels

The following applies:

- SCH (primary and secondary), CPICH (primary and secondary) and P-CCPCH have identical frame timings.
- The S-CCPCH timing may be different for different S-CCPCHs, but the offset from the P-CCPCH frame timing is a multiple of 256 chips, i.e.  $\tau_{S-CCPCH,k} = T_k \times 256$  chip,  $T_k \in \{0, 1, \dots, 149\}$ . For MBSFN operations using slot formats 21 to 23 in table 18, the offset shall be set in accordance with  $\tau_{S-CCPCH,k} = 256 + \lfloor T_k/10 \rfloor \times 2560$  chip.
- If the PICH is associated to the S-CCPCH, the PICH timing is  $\tau_{PICH} = 7680$  chips prior to its corresponding S-CCPCH frame timing, i.e. the timing of the S-CCPCH carrying the PCH transport channel with the corresponding paging information, see also subclause 7.2. If the PICH is associated to the HS-SCCH, the PICH frame timing is the same as the HS-SCCH frame timing.
- AICH access slots #0 starts the same time as P-CCPCH frames with (SFN modulo 2) = 0. The AICH/PRACH timing is described in subclauses 7.3 and 7.4 respectively.
- The DPCH timing may be different for different DPCHs, but the offset from the P-CCPCH frame timing is a multiple of 256 chips, i.e.  $\tau_{DPCH,n} = T_n \times 256$  chip,  $T_n \in \{0, 1, \dots, 149\}$ . The DPCH (DPCCH/DPDCH) timing relation with uplink DPCCH/DPDCHs is described in subclause 7.6.
- The F-DPCH timing may be different for different F-DPCHs, but the offset from the P-CCPCH frame timing is a multiple of 256 chips, i.e.  $\tau_{F-DPCH,p} = T_p \times 256$  chip,  $T_p \in \{0, 1, \dots, 149\}$ . The F-DPCH timing relation with uplink DPCCH/DPDCHs is described in subclause 7.6.
- The start of HS-SCCH subframe #0 is aligned with the start of the P-CCPCH frames. The relative timing between a HS-PDSCH and the corresponding HS-SCCH is described in subclause 7.8.
- The E-HICH, E-RGCH and E-AGCH downlink timing are respectively specified in subclause 7.10, 7.11 and 7.12. The E-DPCCH and E-DPDCH uplink timing are specified in subclause 7.13.
- For a secondary serving HS-DSCH cell, the nominal radio frame timing for CPICH and timing reference are the same as the radio frame timing for CPICH and timing reference for the serving HS-DSCH cell.

## 7.2 PICH/S-CCPCH timing relation

Figure 30 illustrates the timing between a PICH frame and its associated single S-CCPCH frame, i.e. the S-CCPCH frame that carries the paging information related to the paging indicators in the PICH frame. A paging indicator set in a PICH frame means that the paging message is transmitted on the PCH in the S-CCPCH frame starting  $\tau_{PICH}$  chips after the transmitted PICH frame.  $\tau_{PICH}$  is defined in subclause 7.1.

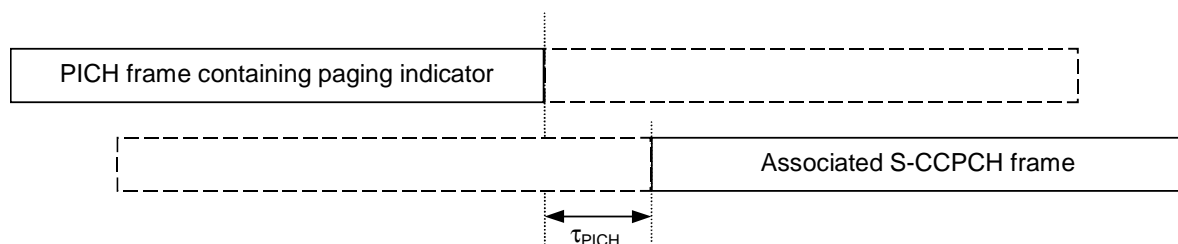

Figure 30: Timing relation between PICH frame and associated S-CCPCH frame

### 7.2A PICH/HS-SCCH timing relation

Figure 30a illustrates the timing between a PICH frame and its set of 5 associated HS-SCCH subframes. The first associated subframe of the associated HS-SCCH starts  $\tau_{PICH}$  chips after the transmitted PICH frame and is the HS-SCCH subframe number 1 as defined in subclause 7.1. A paging indicator set in a PICH frame means that one or more HS-DSCH subframes may be transmitted to the UE on the HS-PDSCH(s) associated with the HS-SCCH subframes associated with the PICH.  $\tau_{PICH}$  is defined in subclause 7.1.

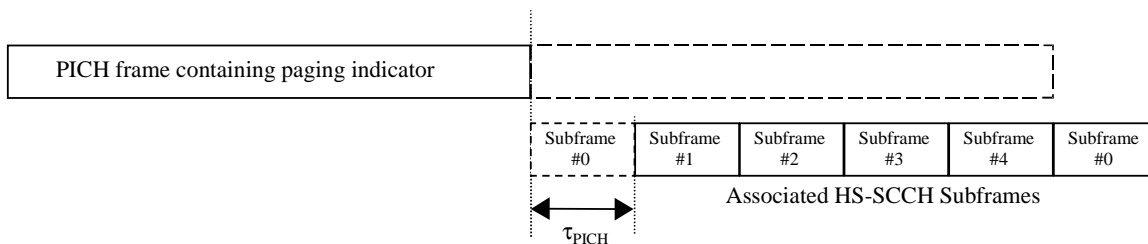

Figure 30a: Timing relation between PICH frame and associated HS-SCCH subframes

### 7.3 PRACH/AICH timing relation

The downlink AICH is divided into downlink access slots, each access slot is of length 5120 chips. The downlink access slots are time aligned with the P-CCPCH as described in subclause 7.1.

The uplink PRACH is divided into uplink access slots, each access slot is of length 5120 chips. Uplink access slot number  $n$  is transmitted from the UE  $\tau_{p-a}$  chips prior to the reception of downlink access slot number  $n$ ,  $n = 0, 1, \dots, 14$ .

Transmission of downlink acquisition indicators may only start at the beginning of a downlink access slot. Similarly, transmission of uplink RACH preambles and RACH message parts may only start at the beginning of an uplink access slot.

The PRACH/AICH timing relation is shown in figure 31.

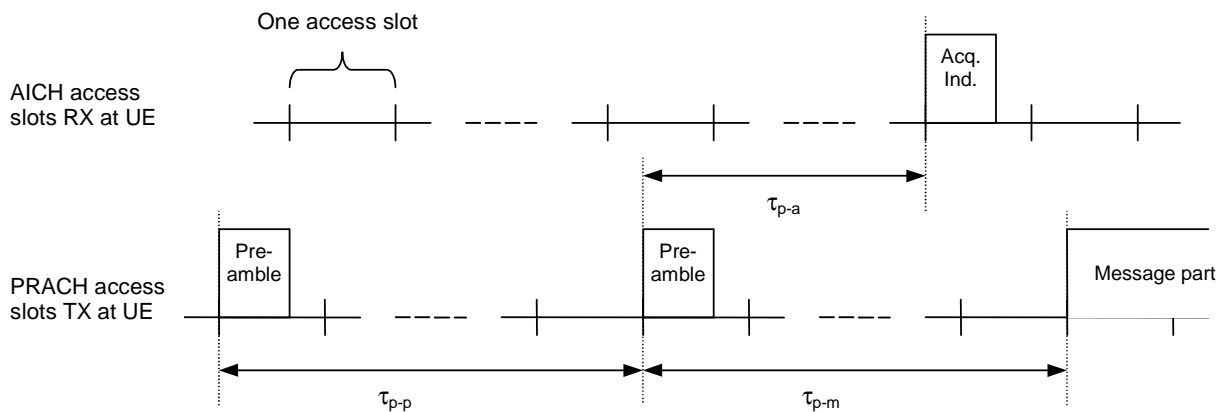

Figure 31: Timing relation between PRACH and AICH as seen at the UE

The preamble-to-preamble distance  $\tau_{p-p}$  shall be larger than or equal to the minimum preamble-to-preamble distance  $\tau_{p-p,min}$ , i.e.  $\tau_{p-p} \geq \tau_{p-p,min}$ .



In addition to  $\tau_{p-p,\min}$ , the preamble-to-AI distance  $\tau_{p-a}$  and preamble-to-message distance  $\tau_{p-m}$  are defined as follows:

- when AICH\_Transmission\_Timing is set to 0, then

$$\tau_{p-p,\min} = 15360 \text{ chips (3 access slots)}$$

$$\tau_{p-a} = 7680 \text{ chips}$$

$$\tau_{p-m} = 15360 \text{ chips (3 access slots)}$$

- when AICH\_Transmission\_Timing is set to 1, then

$$\tau_{p-p,\min} = 20480 \text{ chips (4 access slots)}$$

$$\tau_{p-a} = 12800 \text{ chips}$$

$$\tau_{p-m} = 20480 \text{ chips (4 access slots)}$$

The parameter AICH\_Transmission\_Timing is signalled by higher layers.

### 7.3A UL/DL timing relation for Enhanced Uplink in CELL\_FACH state and IDLE mode

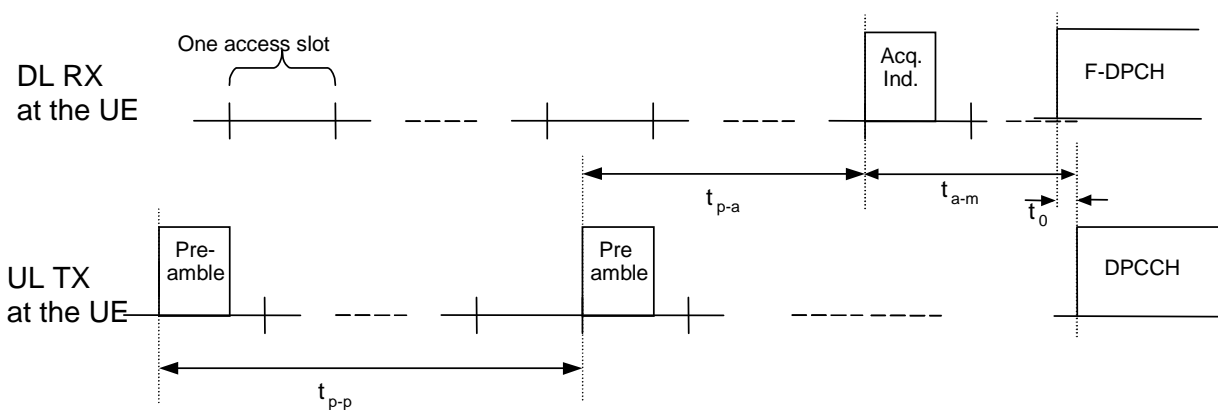

**Figure 31A: UL/DL timing relation for Enhanced Uplink in CELL\_FACH state and IDLE mode as seen at the UE**

The PRACH preamble and Acquisition indication timings  $\tau_{p-p}$  and  $\tau_{p-a}$  are as defined in section 7.3.

$$\tau_{F-DPCH} = [(5120 * \text{AICH access slot \# with the AI}) + 10240 + 256 * S_{\text{offset}}] \bmod 38400$$

$$\tau_{a-m} = 10240 + 256 * S_{\text{offset}} + \tau_0 \text{ chips, where}$$

$S_{\text{offset}}$  = a symbol offset, configured by higher layers,  $\{0, \dots, 9\}$ .

$\tau_0$  = 1024 chips defining the DL to UL frame timing difference.

## 7.4 Void

## 7.5 Void

## 7.6 DPCCH/DPDCH timing relations

### 7.6.1 Uplink

In uplink the DPCCH and all the DPDCHs transmitted from one UE have the same frame timing.

### 7.6.2 Downlink

In downlink, the DPCCH and all the DPDCHs carrying CCTrCHs of dedicated type to one UE have the same frame timing.

Note: support of multiple CCTrCHs of dedicated type is not part of the current release.

### 7.6.3 Uplink/downlink timing at UE

At the UE, the uplink DPCCH/DPDCH frame transmission takes place approximately  $T_0$  chips after the reception of the first detected path (in time) of the corresponding downlink DPCCH/DPDCH or F-DPCH frame.  $T_0$  is a constant defined to be 1024 chips. The first detected path (in time) is defined implicitly by the relevant tests in [14]. More information about the uplink/downlink timing relation and meaning of  $T_0$  can be found in [5].

## 7.7 Uplink DPCCH/HS-DPCCH/HS-PDSCH timing at the UE

Figure 34 shows the timing offset between the uplink DPCH, the HS-PDSCH and the HS-DPCCH at the UE. An HS-DPCCH sub-frame starts  $m \times 256$  chips after the start of an uplink DPCH frame that corresponds to the DL DPCH or F-DPCH frame from the HS-DSCH serving cell containing the beginning of the related HS-PDSCH subframe with  $m$  calculated as

$$m = (T_{TX\_diff} / 256) + 101$$

where  $T_{TX\_diff}$  is the difference in chips ( $T_{TX\_diff} = 0, 256, \dots, 38144$ ), between

- the transmit timing of the start of the related HS-PDSCH subframe (see sub-clauses 7.8 and 7.1)

and

- the transmit timing of the start of the downlink DPCH or F-DPCH frame from the HS-DSCH serving cell that contains the beginning of the HS-PDSCH subframe (see sub-clause 7.1).

At any one time,  $m$  therefore takes one of a set of five possible values according to the transmission timing of HS-DSCH sub-frame timings relative to the DPCH or F-DPCH frame boundary. The UE and Node B shall only update the set of values of  $m$  in connection to UTRAN reconfiguration of downlink timing.

More information about uplink timing adjustments can be found in [5].

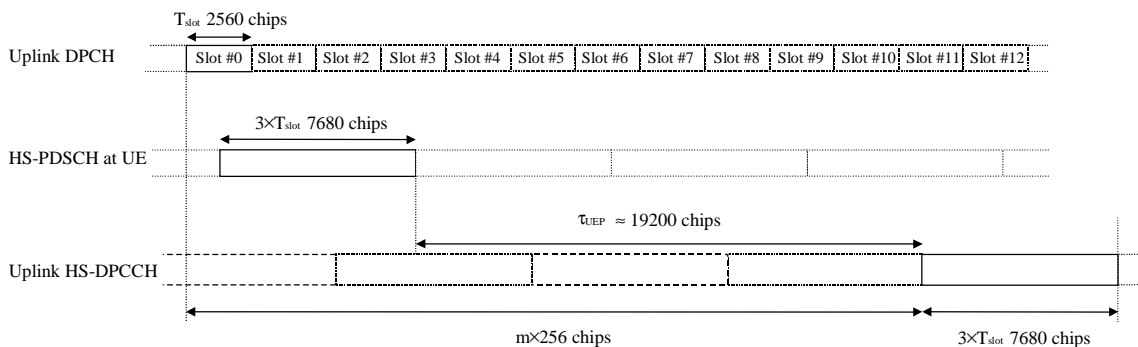

Figure 34: Timing structure at the UE for HS-DPCCH control signalling

### 7.8 HS-SCCH/HS-PDSCH timing

Figure 35 shows the relative timing between the HS-SCCH and the associated HS-PDSCH for one HS-DSCH sub-frame. The HS-PDSCH starts  $\tau_{HS-PDSCH} = 2 \times T_{slot} = 5120$  chips after the start of the HS-SCCH.

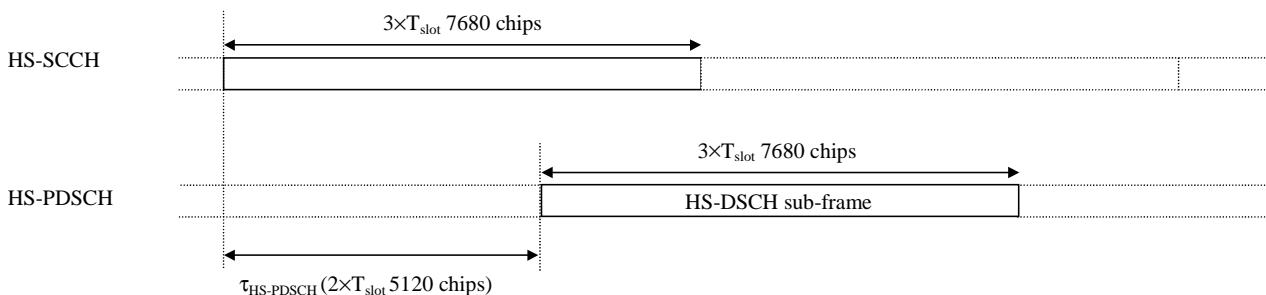

Figure 35: Timing relation between the HS-SCCH and the associated HS-PDSCH.

### 7.9 MICH/S-CCPCH timing relation

Figure 36 illustrates the timing between the MICH frame boundaries and the frame boundaries of the associated S-CCPCH, i.e. the S-CCPCH that carries the MBMS control information related to the notification indicators in the MICH frame. The MICH transmission timing shall be such that the end of radio frame boundary occurs  $\tau_{MICH}$  chips before the associated S-CCPCH start of radio frame boundary.  $\tau_{MICH}$  is equal to 7680 chips.

The MICH frames during which the Node B shall set specific notification indicators and the S-CCPCH frames during which the Node B shall transmit the corresponding MBMS control data is defined by higher layers.

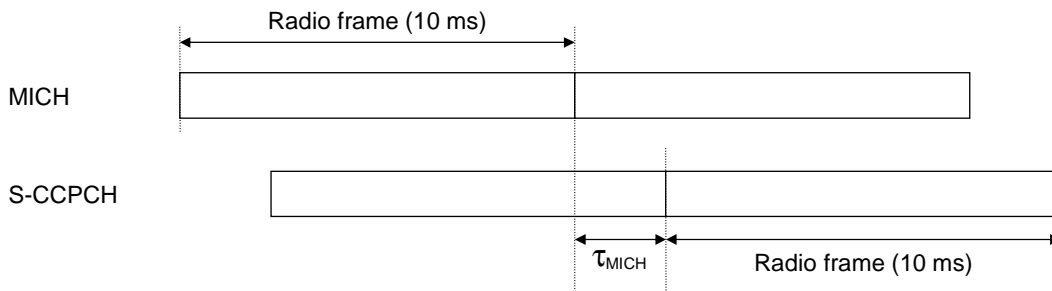

Figure 36: Timing relation between MICH frame and associated S-CCPCH frame

## 7.10 E-HICH/P-CCPCH/DPCH timing relation

The timing of the E-HICH relative to the P-CCPCH is illustrated in figure 37.

When the E-DCH TTI is 10 ms the E-HICH frame offset relative to P-CCPCH shall be  $\tau_{E-HICH,n}$  chips with

$$\tau_{E-HICH,n} = 5120 + 7680 \times \left\lfloor \frac{(\tau_{DPCH,n}/256) - 70}{30} \right\rfloor$$

When the E-DCH TTI is 2 ms the E-HICH frame offset relative to P-CCPCH shall be  $\tau_{E-HICH,n}$  chips with

$$\tau_{E-HICH,n} = 5120 + 7680 \times \left\lfloor \frac{(\tau_{DPCH,n}/256) + 50}{30} \right\rfloor$$

When a downlink F-DPCH is configured,  $\tau_{DPCH,n} = \tau_{F-DPCH,n}$ .

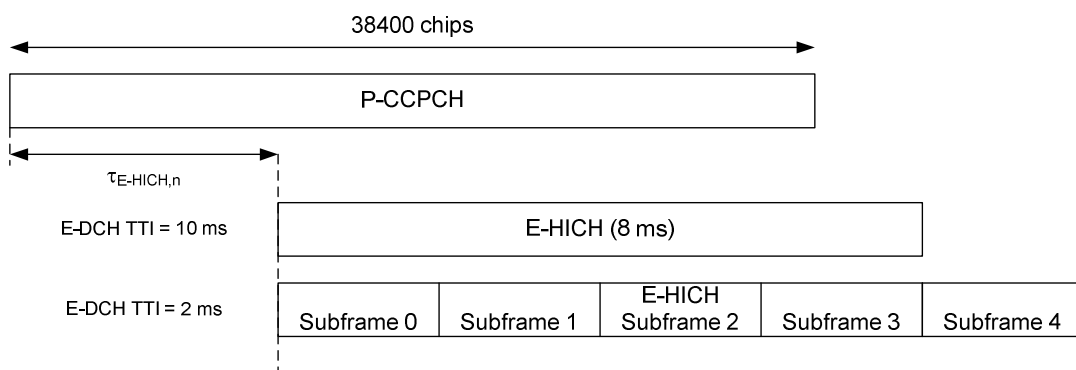

Figure 37: E-HICH timing

## 7.11 E-RGCH/P-CCPCH/DPCH timing relation

The timing of the E-RGCH relative to the P-CCPCH is illustrated in figure 38.

When transmitted to a UE for which the cell transmitting the E-RGCH is in the E-DCH serving radio link set, the E-RGCH frame offset shall be as follows:

- if the E-DCH TTI is 10 ms, the E-RGCH frame offset relative to P-CCPCH shall be  $\tau_{E-RGCH,n}$  chips with

$$\tau_{E-RGCH,n} = 5120 + 7680 \times \left\lfloor \frac{(\tau_{DPCH,n}/256) - 70}{30} \right\rfloor$$

- if the E-DCH TTI is 2 ms the E-RGCH frame offset relative to P-CCPCH shall be  $\tau_{E-RGCH,n}$  chips with

$$\tau_{E-RGCH,n} = 5120 + 7680 \times \left\lfloor \frac{(\tau_{DPCH,n}/256) + 50}{30} \right\rfloor$$

When a downlink F-DPCH is configured,  $\tau_{DPCH,n} = \tau_{F-DPCH,n}$ .

When transmitted to a UE for which the cell transmitting the E-RGCH is not in the E-DCH serving radio link set, the E-RGCH frame offset relative to P-CCPCH shall be  $\tau_{E-RGCH} = 5120$  chips.

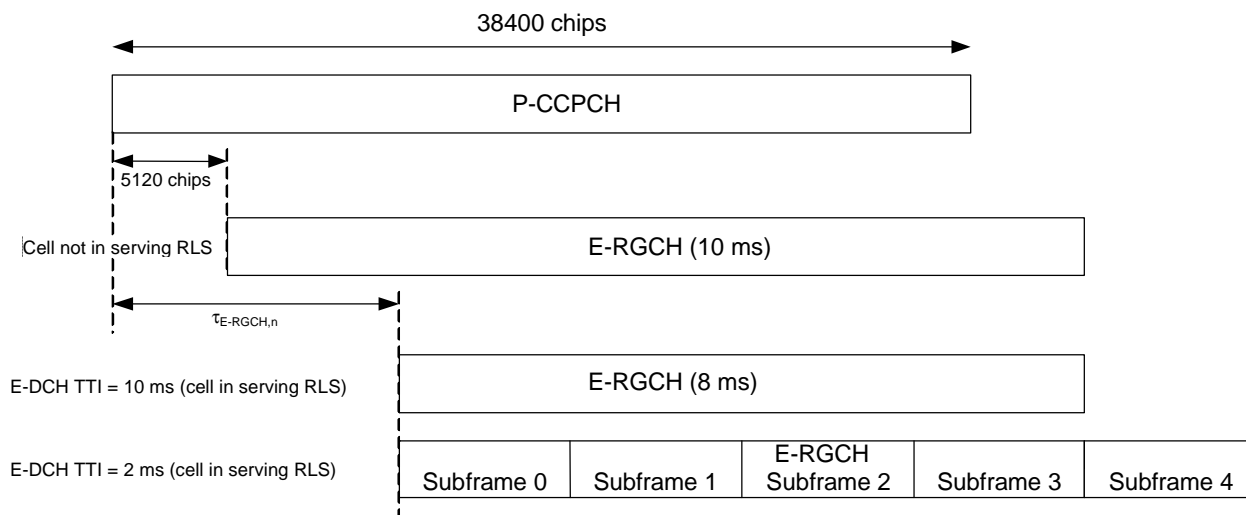

Figure 38: E-RGCH timing

### 7.12 E-AGCH/P-CCPCH timing relation

The E-AGCH frame offset relative to P-CCPCH shall be  $\tau_{E-AGCH} = 5120$  chips as illustrated in figure 39.

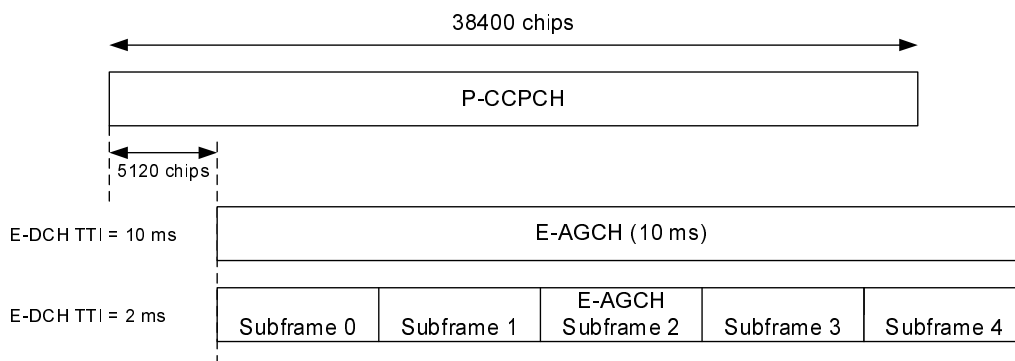

Figure 39: E-AGCH timing

### 7.13 E-DPDCH/E-DPCCH/DPCCH timing relation

The frame timing of the E-DPCCH and all E-DPDCHs transmitted from one UE shall be the same as the uplink DPCCH frame timing.

## Annex A (informative): Change history

Change history							
Date	TSG #	TSG Doc.	CR	Rev	Subject/Comment	Old	New
	RAN_05	RP-99587	-		Approved at TSG RAN #5 and placed under Change Control	-	3.0.0
14/01/00	RAN_06	RP-99676	001	1	Removal of superframe notation	3.0.0	3.1.0
14/01/00	RAN_06	RP-99677	002	-	Use of CPICH in case of open loop Tx	3.0.0	3.1.0
14/01/00	RAN_06	RP-99677	003	2	CPCH power control preamble length	3.0.0	3.1.0
14/01/00	RAN_06	RP-99684	005	1	Editorial corrections	3.0.0	3.1.0
14/01/00	RAN_06	RP-99676	006	-	Change to the description of TSTD for SCH	3.0.0	3.1.0
14/01/00	RAN_06	RP-99678	007	1	Introduction of compressed mode by higher layer scheduling	3.0.0	3.1.0
14/01/00	RAN_06	RP-99676	008	1	Modifications to STTD text	3.0.0	3.1.0
14/01/00	RAN_06	RP-99684	009	1	20 ms RACH message length	3.0.0	3.1.0
14/01/00	RAN_06	RP-99676	010	-	Update to AICH description	3.0.0	3.1.0
14/01/00	RAN_06	RP-99678	011	1	Sliding paging indicators	3.0.0	3.1.0
14/01/00	RAN_06	RP-99677	016	-	TAB structure and timing relation for USTS	3.0.0	3.1.0
14/01/00	RAN_06	RP-99677	017	-	Timing for initialisation procedures	3.0.0	3.1.0
14/01/00	RAN_06	RP-99677	022	-	Modification of the STTD encoding scheme on DL DPCH with SF 512	3.0.0	3.1.0
14/01/00	-	-	-	-	Change history was added by the editor	3.1.0	3.1.1
31/03/00	RAN_07	RP-000060	013	6	Addition of a downlink channel indicating CPCH status	3.1.1	3.2.0
31/03/00	RAN_07	RP-000060	023	6	CPCH-related editorial changes, technical changes and additions to 25.211 and some clarifications to 7.4 PCPCH/AICH timing relation.	3.1.1	3.2.0
31/03/00	RAN_07	RP-000060	024	1	Additional description of TX diversity for PDSCH	3.1.1	3.2.0
31/03/00	RAN_07	RP-000060	025	1	Consistent numbering of scrambling code groups	3.1.1	3.2.0
31/03/00	RAN_07	RP-000060	026	-	Minor corrections to timing section	3.1.1	3.2.0
31/03/00	RAN_07	RP-000060	028	1	Timing of PDSCH	3.1.1	3.2.0
31/03/00	RAN_07	RP-000060	029	1	Modifications to STTD text	3.1.1	3.2.0
31/03/00	RAN_07	RP-000060	031	4	CD/CA-ICH for dual mode CPCH	3.1.1	3.2.0
31/03/00	RAN_07	RP-000060	033	-	Clarification of frame synchronization word and its usage	3.1.1	3.2.0
31/03/00	RAN_07	RP-000060	034	1	Editorial updates to 25.211	3.1.1	3.2.0
31/03/00	RAN_07	RP-000060	036	-	PDSCH multi-code transmission	3.1.1	3.2.0
31/03/00	RAN_07	RP-000060	037	-	Clarification of pilot bit patterns for CPCH and slot formats for CPCH PC-P and message part	3.1.1	3.2.0
31/03/00	RAN_07	RP-000060	039	-	Further restrictions on the application of the Tx diversity modes in DL	3.1.1	3.2.0
31/03/00	RAN_07	RP-000060	040	-	Clarification of downlink pilot bit patterns	3.1.1	3.2.0
31/03/00	RAN_07	RP-000060	041	-	Clarification of DCH initialisation	3.1.1	3.2.0
31/03/00	RAN_07	RP-000060	044	2	Emergency Stop of CPCH transmission and Start of Message Indicator	3.1.1	3.2.0
31/03/00	RAN_07	RP-000060	046	-	Clean up of USTS related specifications	3.1.1	3.2.0
26/06/00	RAN_08	RP-000265	047	4	Clarifications to power control preamble sections	3.2.0	3.3.0
26/06/00	RAN_08	RP-000265	048	-	Propagation delay for PCPCH	3.2.0	3.3.0
26/06/00	RAN_08	RP-000265	049	1	PICH undefined bits and AICH, AP-ICH, CD/CA-ICH non-transmitted chips	3.2.0	3.3.0
26/06/00	RAN_08	RP-000265	051	1	Bit value notation change for PICH and CSICH	3.2.0	3.3.0
26/06/00	RAN_08	RP-000265	053	1	Revision of notes in sections 5.3.2 and 5.3.2.1	3.2.0	3.3.0
26/06/00	RAN_08	RP-000265	054	5	Slot format clarification for CPCH	3.2.0	3.3.0
26/06/00	RAN_08	RP-000265	055	3	Physical channel nomenclature in FDD	3.2.0	3.3.0
26/06/00	RAN_08	RP-000265	056	3	Clarification for the PDSCH channelisation code association with DPCH in 25.211	3.2.0	3.3.0
26/06/00	RAN_08	RP-000265	057	2	Clarification for the PDSCH channelisation code association with DPCH in 25.211	3.2.0	3.3.0
26/06/00	RAN_08	RP-000265	058	-	Clarification of spreading factor for AICH	3.2.0	3.3.0
26/06/00	RAN_08	RP-000265	060	-	Explicit mention of slot format reconfiguration also for uplink	3.2.0	3.3.0
23/09/00	RAN_09	RP-000340	065	-	Correction of reference	3.3.0	3.4.0
23/09/00	RAN_09	RP-000340	066	4	Clarification of paging indicator mapping	3.3.0	3.4.0
23/09/00	RAN_09	RP-000340	068	-	Editorial modification of the 25.211 about the CD/CA-ICH	3.3.0	3.4.0
23/09/00	RAN_09	RP-000340	070	1	Support of closed loop transmit diversity modes	3.3.0	3.4.0
23/09/00	RAN_09	RP-000340	071	-	DPCH initialisation procedure	3.3.0	3.4.0
23/09/00	RAN_09	RP-000340	072	3	Correction on indicators	3.3.0	3.4.0
23/09/00	RAN_09	RP-000340	074	-	Correction of STTD for DPCH	3.3.0	3.4.0
23/09/00	RAN_09	RP-000340	075	-	Clarification of first significant path	3.3.0	3.4.0
23/09/00	RAN_09	RP-000340	076	-	Clarification of SCH transmitted by TSTD	3.3.0	3.4.0
23/09/00	RAN_09	RP-000340	077	1	Clarification of FBI field	3.3.0	3.4.0
15/12/00	RAN_10	RP-000537	079	2	Clarification of downlink phase reference	3.4.0	3.5.0

Change history							
Date	TSG #	TSG Doc.	CR	Rev	Subject/Comment	Old	New
15/12/00	RAN_10	RP-000537	083	1	DL Transmission in the case of invalid data frames	3.4.0	3.5.0
15/12/00	RAN_10	RP-000537	084	-	Clarification of figure 28	3.4.0	3.5.0
15/12/00	RAN_10	RP-000537	087	-	RACH message part length	3.4.0	3.5.0
15/12/00	RAN_10	RP-000537	088	-	Clarifications on power control preambles	3.4.0	3.5.0
15/12/00	RAN_10	RP-000537	089	1	Proposed CR to 25.211 for transfer of CSICH Information from Layer 3 Specification	3.4.0	3.5.0
15/12/00	RAN_10	RP-000537	090	-	PCPCH/DL-DPCCH Timing Relationship	3.4.0	3.5.0

Change history							
Date	TSG #	TSG Doc.	CR	Rev	Subject/Comment	Old	New
16/03/01	RAN_11	-	-	-	Approved as Release 4 specification (v4.0.0) at TSG RAN #11	3.5.0	4.0.0
16/03/01	RAN_11	RP-010058	091	-	DSCH reading indication	3.5.0	4.0.0
16/03/01	RAN_11	RP-010058	092	1	Clarification of the S-CCPCH frame carrying paging information	3.5.0	4.0.0
16/03/01	RAN_11	RP-010255	095	3	Phase Reference for Secondary CCPCH carrying FACH	3.5.0	4.0.0
16/03/01	RAN_11	RP-010058	096	-	Uplink power control preamble	3.5.0	4.0.0
15/06/01	RAN_12	RP-010331	098	-	Downlink Phase Reference for DL-DPCCH for CPCH	4.0.0	4.1.0
15/06/01	RAN_12	RP-010331	100	-	Removal of out-of-date reference to FACH beamforming	4.0.0	4.1.0
15/06/01	RAN_12	RP-010331	102	-	Correction of compressed mode by puncturing	4.0.0	4.1.0
15/06/01	RAN_12	RP-010331	104	-	Correction of the representation of slot format	4.0.0	4.1.0
15/06/01	RAN_12	RP-010331	106	1	Clarification of PDSCH definition	4.0.0	4.1.0
21/09/01	RAN_13	RP-010518	111	2	Correction to DPCH/PDSCH timing	4.1.0	4.2.0
21/09/01	RAN_13	RP-010518	121	1	Clarification of the usage of Tx diversity modes in Soft HOV	4.1.0	4.2.0
21/09/01	RAN_13	RP-010709	114	2	Removal of another reference to FACH beamforming	4.1.0	4.2.0
21/09/01	RAN_13	RP-010518	118	1	Clarification of STTD	4.1.0	4.2.0
14/12/01	RAN_14	RP-010904	116	2	Clarification of the pilot bits on CPCH message part and S-CCPCH	4.2.0	4.3.0
14/12/01	RAN_14	RP-010736	123	-	Addition of pilot bit patterns table of downlink DPCCH for antenna 2 using closed loop mode 1	4.2.0	4.3.0
14/12/01	RAN_14	RP-010736	125	-	Slot format for the CPCH	4.2.0	4.3.0
14/12/01	RAN_14	RP-010736	127	1	Clarification of Tx diversity with PDSCH, AP-AICH, CD/CA-ICH and DL-DPCCH associated to CPCH	4.2.0	4.3.0
14/12/01	RAN_14	RP-010736	129	1	Interaction between DSCH scheduling and phase reference modification	4.2.0	4.3.0
14/12/01	RAN_14	RP-010736	131	-	Support of multiple CCTrChs of dedicated type	4.2.0	4.3.0
14/12/01	RAN_14	RP-010736	133	-	Removal of slow power control from TS 25.211	4.2.0	4.3.0
14/12/01	RAN_14	RP-010932	135	-	Restriction to simultaneous use of SSTD and closed loop mode TX diversity	4.2.0	4.3.0
08/03/02	RAN_15	RP-020046	139	1	Clarification of different diversity modes used in the same active set	4.3.0	4.4.0
08/03/02	RAN_15	RP-020058	146	-	Specification of HS-DSCH for Release 5 in 25.211	4.3.0	5.0.0
07/06/02	RAN_16	RP-020307	149	1	SCCPCH structure with STTD encoding	5.0.0	5.1.0
07/06/02	RAN_16	RP-020307	153	-	Downlink bit mapping	5.0.0	5.1.0
07/06/02	RAN_16	RP-020437	147	4	Specification of TX diversity for HSDPA	5.0.0	5.1.0
07/06/02	RAN_16	RP-020316	150	1	Adding section on HS-SCCH/HS-PDSCH timing relation	5.0.0	5.1.0
07/06/02	RAN_16	RP-020316	155	-	HSDPA subframe definition	5.0.0	5.1.0
07/06/02	RAN_16	RP-020316	157	1	Clarification for uplink HS-DPCCH/HS-PDSCH timing	5.0.0	5.1.0
14/09/02	RAN_17	RP-020591	161	1	Phase reference for HSDPA	5.1.0	5.2.0
14/09/02	RAN_17	RP-020571	164	-	Reversal of unwanted corrections resulting from CR 25.211-122	5.1.0	5.2.0
14/09/02	RAN_17	RP-020581	168	1	Numbering corrections	5.1.0	5.2.0
14/09/02	RAN_17	RP-020590	169	-	TX diversity on radio links in the active set	5.1.0	5.2.0
14/09/02	RAN_17	RP-020588	170	1	HS-DPCCH timing correction	5.1.0	5.2.0
14/09/02	RAN_17	RP-020587	171	-	Inclusion of closed loop transmit diversity for HSDPA	5.1.0	5.2.0
14/09/02	RAN_17	RP-020581	172	-	Physical channel mapping	5.1.0	5.2.0
20/12/02	RAN_18	RP-020845	173	-	Correction of the number of transport channels in clause 4.1	5.2.0	5.3.0
20/12/02	RAN_18	RP-020845	175	-	HSDPA Tx diversity of closed loop transmit diversity mode 2 use with HS-PDSCH/HS-SCCH	5.2.0	5.3.0
21/06/03	RAN_20	RP-030271	178	-	Alignment of the terminology, "subframe"	5.3.0	5.4.0
21/06/03	RAN_20	RP-030271	179	-	Correction of AICH description	5.3.0	5.4.0
21/06/03	RAN_20	RP-030271	180	-	Correction of description of TTX_diff	5.3.0	5.4.0
21/09/03	RAN_21	RP-030462	186	1	Removal of the combination of TxAA Mode 1 with HS-SCCH	5.4.0	5.5.0
13/01/04	RAN_22	-	-	-	Created for M.1457 update	5.5.0	6.0.0
09/06/04	RAN_24	RP-040231	189	1	Re-Introduction of S-CPICH in combination with Closed Loop Tx Diversity	6.0.0	6.1.0
09/06/04	RAN_24	RP-040231	190	-	Clarification of NTFCl field of DL-DPCCH power preamble for CPCH	6.0.0	6.1.0
07/09/04	RAN_25	RP-040317	192	-	Correction for the slot range of DL DPCCH power control preamble for CPCH	6.1.0	6.2.0
13/12/04	RAN_26	RP-040449	195	1	Introduction of E-DCH	6.2.0	6.3.0
13/12/04	RAN_26	RP-040450	193	1	Introduction of MICH	6.2.0	6.3.0
14/03/05	RAN_27	RP-050043	197	1	E-HICH/E-RGCH Signature Sequences	6.3.0	6.4.0
14/03/05	RAN_27	RP-050043	198	1	E-HICH/E-RGCH Signature Sequence Hopping	6.3.0	6.4.0
14/03/05	RAN_27	RP-050090	202	2	E-HICH/E-RGCH/E-AGCH timing	6.3.0	6.4.0
14/03/05	RAN_27	RP-050088	200	1	Introduction of F-DPCH without pilot field	6.3.0	6.4.0
16/06/05	RAN_28	RP-050357	203	2	Correction of text on E-RGCH duration	6.4.0	6.5.0
16/06/05	RAN_28	RP-050250	205	1	Feature Clean Up: Removal of 'CPCH'	6.4.0	6.5.0
16/06/05	RAN_28	RP-050248	207	-	Feature Clean Up: Removal of DSCH (FDD mode)	6.4.0	6.5.0
16/06/05	RAN_28	RP-050252	210	1	Clarification on E-AGCH transmission interval	6.4.0	6.5.0
16/06/05	RAN_28	RP-050256	211	2	Clarification on phase reference for downlink channels	6.4.0	6.5.0
16/06/05	RAN_28	RP-050252	212	1	Clarification on E-DCH timing	6.4.0	6.5.0
16/06/05	RAN_28	RP-050244	214	-	Feature Clean Up: Removal of 'SSTD'	6.4.0	6.5.0
16/06/05	RAN_28	RP-050247	217	-	Feature clean up: Removal of the 'TX diversity closed loop mode 2'	6.4.0	6.5.0



Change history							
Date	TSG #	TSG Doc.	CR	Rev	Subject/Comment	Old	New
16/06/05	RAN_28	RP-050249	219	-	Feature clean up: Removal of the 'compressed mode by puncturing'	6.4.0	6.5.0
16/06/05	RAN_28	RP-050246	221	-	Feature Clean Up: Removal of dedicated pilot as sole phase reference	6.4.0	6.5.0
26/09/05	RAN_29	RP-050450	0222	-	SF max for E-DPDCH	6.5.0	6.6.0
26/09/05	RAN_29	RP-050450	0223	1	DPCCH, E-DPCCH, E-DPDCH combinations	6.5.0	6.6.0
26/09/05	RAN_29	RP-050543	0244	-	Correcting the accidental removal of F-DPCH, MICH, E-AGCH, E-RGCH and E-HICH from Tx Diversity applicability table	6.5.0	6.6.0
12/12/05	RAN_30	RP-050726	0224	-	Clean up due to removal of $N_{TPC}=1$	6.6.0	6.7.0
12/12/05	RAN_30	RP-050727	0225	2	Combination of DPCCH and E-DCH	6.6.0	6.7.0
12/12/05	RAN_30	RP-050725	0227	-	Clean up due to removal of CSICH	6.6.0	6.7.0
20/03/06	RAN_31	-	-	-	Creation of Release 7 specification (v7.0.0) at RAN#31	6.7.0	7.0.0
07/03/07	RAN_35	RP-070114	0238	-	Transmit diversity operation in MIMO mode	7.0.0	7.1.0
07/03/07	RAN_35	RP-070115	0230	2	Support of CPC feature	7.0.0	7.1.0
07/03/07	RAN_35	RP-070115	0231	-	Support of CPC feature: addition of subframe numbering	7.0.0	7.1.0
07/03/07	RAN_35	RP-070116	0234	2	Introduction of 64QAM for HSDPA	7.0.0	7.1.0
30/05/07	RAN_36	RP-070388	0235	2	Introduction of 16QAM for HSUPA	7.1.0	7.2.0
30/05/07	RAN_36	RP-070384	0237	3	Support for DL only SFN operation for MBMS FDD	7.1.0	7.2.0
30/05/07	RAN_36	RP-070390	0239	3	Introduction of PICH to HS-SCCH timing relation and Tx diversity definition for HS-DSCH without associated DL dedicated channel	7.1.0	7.2.0
30/05/07	RAN_36	RP-070387	0240	-	Definition of abbreviation 'MIMO'	7.1.0	7.2.0
30/05/07	RAN_36	RP-070389	0241	-	Clarification for CPC feature	7.1.0	7.2.0
11/09/07	RAN_37	RP-070639	0246	1	Clarification on MICH	7.2.0	7.3.0
11/09/07	RAN_37	RP-070649	0232	3	Enhanced F-DPCH	7.2.0	7.3.0
11/09/07	RAN_37	RP-070643	0242	1	PICH associated HS-SCCH for Enhanced CELL_FACH	7.2.0	7.3.0
11/09/07	RAN_37	RP-070641	0243	-	Clarification for CPC feature	7.2.0	7.3.0
11/09/07	RAN_37	RP-070646	0245	-	Clarifications on the use of S-CCPCH pilot bits for MBSFN FDD feature	7.2.0	7.3.0
27/11/07	RAN_38	RP-070940	0250	-	Correction to E-DPCCH transmission	7.3.0	7.4.0
27/11/07	RAN_38	RP-070941	0248	-	Correction to transmit diversity specification in MIMO mode	7.3.0	7.4.0
27/11/07	RAN_38	RP-070941	0251	1	Mention PCI as part of HS-DPCCH structure	7.3.0	7.4.0
04/03/08	RAN_39	RP-080142	0252	-	Correction to tie use of transmit diversity on SCH and P-CCPCH	7.4.0	7.5.0
04/03/08	RAN_39	-	-	-	Release 8 version created further to RAN_39 decision	7.5.0	8.0.0
28/05/08	RAN_40	RP-080351	0255	1	Correction to E-DCH control channel timing	8.0.0	8.1.0
10/09/08	RAN_41	RP-080672	0256	2	Introduction of the Enhanced Uplink for CELL_FACH state	8.1.0	8.2.0
03/12/08	RAN_42	RP-080989	257	3	Introduction of Dual-Cell HSDPA Operation on Adjacent Carriers	8.2.0	8.3.0
03/12/08	RAN_42	RP-080986	259	1	Removal of a reference to E-AICH	8.2.0	8.3.0

---

## History

<b>Document history</b>		
V8.1.0	October 2008	Publication
V8.2.0	October 2008	Publication
V8.3.0	January 2009	Publication