

ETSI TS 125 212 V3.5.0 (2000-12)

Technical Specification

**Universal Mobile Telecommunications System (UMTS);
Multiplexing and channel coding (FDD)
(3GPP TS 25.212 version 3.5.0 Release 1999)**



Reference

RTS/TSGR-0125212UR4

Keywords

UMTS

ETSI

650 Route des Lucioles
F-06921 Sophia Antipolis Cedex - FRANCE

Tel.: +33 4 92 94 42 00 Fax: +33 4 93 65 47 16

Siret N° 348 623 562 00017 - NAF 742 C
Association à but non lucratif enregistrée à la
Sous-Préfecture de Grasse (06) N° 7803/88

Important notice

Individual copies of the present document can be downloaded from:

<http://www.etsi.org>

The present document may be made available in more than one electronic version or in print. In any case of existing or perceived difference in contents between such versions, the reference version is the Portable Document Format (PDF). In case of dispute, the reference shall be the printing on ETSI printers of the PDF version kept on a specific network drive within ETSI Secretariat.

Users of the present document should be aware that the document may be subject to revision or change of status. Information on the current status of this and other ETSI documents is available at <http://www.etsi.org/tb/status/>

If you find errors in the present document, send your comment to:
editor@etsi.fr

Copyright Notification

No part may be reproduced except as authorized by written permission.
The copyright and the foregoing restriction extend to reproduction in all media.

© European Telecommunications Standards Institute 2000.

All rights reserved.

Intellectual Property Rights

IPRs essential or potentially essential to the present document may have been declared to ETSI. The information pertaining to these essential IPRs, if any, is publicly available for **ETSI members and non-members**, and can be found in ETSI SR 000 314: "*Intellectual Property Rights (IPRs); Essential, or potentially Essential, IPRs notified to ETSI in respect of ETSI standards*", which is available from the ETSI Secretariat. Latest updates are available on the ETSI Web server (<http://www.etsi.org/ipr>).

Pursuant to the ETSI IPR Policy, no investigation, including IPR searches, has been carried out by ETSI. No guarantee can be given as to the existence of other IPRs not referenced in ETSI SR 000 314 (or the updates on the ETSI Web server) which are, or may be, or may become, essential to the present document.

Foreword

This Technical Specification (TS) has been produced by the ETSI 3rd Generation Partnership Project (3GPP).

The present document may refer to technical specifications or reports using their 3GPP identities, UMTS identities or GSM identities. These should be interpreted as being references to the corresponding ETSI deliverables.

The cross reference between GSM, UMTS, 3GPP and ETSI identities can be found under www.etsi.org/key.

Contents

Foreword.....	5
1 Scope.....	6
2 References.....	6
3 Definitions, symbols and abbreviations.....	6
3.1 Definitions.....	6
3.2 Symbols.....	7
3.3 Abbreviations.....	7
4 Multiplexing, channel coding and interleaving.....	8
4.1 General.....	8
4.2 Transport-channel coding/multiplexing.....	8
4.2.1 CRC attachment.....	12
4.2.1.1 CRC Calculation.....	12
4.2.1.2 Relation between input and output of the CRC attachment block.....	12
4.2.2 Transport block concatenation and code block segmentation.....	13
4.2.2.1 Concatenation of transport blocks.....	13
4.2.2.2 Code block segmentation.....	13
4.2.3 Channel coding.....	14
4.2.3.1 Convolutional coding.....	15
4.2.3.2 Turbo coding.....	15
4.2.3.2.1 Turbo coder.....	15
4.2.3.2.2 Trellis termination for Turbo coder.....	16
4.2.3.2.3 Turbo code internal interleaver.....	16
4.2.3.3 Concatenation of encoded blocks.....	20
4.2.4 Radio frame size equalisation.....	20
4.2.5 1 st interleaving.....	20
4.2.5.1 Insertion of marked bits in the sequence to be input in first interleaver.....	20
4.2.5.2 1 st interleaver operation.....	21
4.2.5.3 Relation between input and output of 1 st interleaving in uplink.....	22
4.2.5.4 Relation between input and output of 1 st interleaving in downlink.....	22
4.2.6 Radio frame segmentation.....	23
4.2.6.1 Relation between input and output of the radio frame segmentation block in uplink.....	23
4.2.6.2 Relation between input and output of the radio frame segmentation block in downlink.....	23
4.2.7 Rate matching.....	23
4.2.7.1 Determination of rate matching parameters in uplink.....	25
4.2.7.1.1 Determination of SF and number of PhCHs needed.....	25
4.2.7.2 Determination of rate matching parameters in downlink.....	28
4.2.7.2.1 Determination of rate matching parameters for fixed positions of TrCHs.....	29
4.2.7.2.2 Determination of rate matching parameters for flexible positions of TrCHs.....	32
4.2.7.3 Bit separation and collection in uplink.....	34
4.2.7.3.1 Bit separation.....	36
4.2.7.3.2 Bit collection.....	37
4.2.7.4 Bit separation and collection in downlink.....	37
4.2.7.4.1 Bit separation.....	38
4.2.7.4.2 Bit collection.....	39
4.2.7.5 Rate matching pattern determination.....	39
4.2.8 TrCH multiplexing.....	40
4.2.9 Insertion of discontinuous transmission (DTX) indication bits.....	41
4.2.9.1 1 st insertion of DTX indication bits.....	41
4.2.9.2 2 nd insertion of DTX indication bits.....	41
4.2.10 Physical channel segmentation.....	42
4.2.10.1 Relation between input and output of the physical segmentation block in uplink.....	43
4.2.10.2 Relation between input and output of the physical segmentation block in downlink.....	43
4.2.11 2 nd interleaving.....	43
4.2.12 Physical channel mapping.....	44
4.2.12.1 Uplink.....	44

4.2.12.2	Downlink	44
4.2.13	Restrictions on different types of CCTrCHs	45
4.2.13.1	Uplink Dedicated channel (DCH).....	45
4.2.13.2	Random Access Channel (RACH).....	45
4.2.13.3	Common Packet Channel (CPCH).....	45
4.2.13.4	Downlink Dedicated Channel (DCH).....	46
4.2.13.5	Downlink Shared Channel (DSCH) associated with a DCH	46
4.2.13.6	Broadcast channel (BCH)	46
4.2.13.7	Forward access and paging channels (FACH and PCH)	46
4.2.14	Multiplexing of different transport channels into one CCTrCH, and mapping of one CCTrCH onto physical channels	46
4.2.14.1	Allowed CCTrCH combinations for one UE.....	47
4.2.14.1.1	Allowed CCTrCH combinations on the uplink.....	47
4.2.14.1.2	Allowed CCTrCH combinations on the downlink.....	47
4.3	Transport format detection.....	47
4.3.1	Blind transport format detection.....	48
4.3.2	Transport format detection based on TFCI.....	48
4.3.3	Coding of Transport-Format-Combination Indicator (TFCI).....	48
4.3.4	Operation of Transport-Format-Combination Indicator (TFCI) in Split Mode	49
4.3.5	Mapping of TFCI words	50
4.3.5.1	Mapping of TFCI word in normal mode	50
4.3.5.2	Mapping of TFCI word in compressed mode.....	51
4.3.5.2.1	Uplink compressed mode.....	51
4.3.5.2.2	Downlink compressed mode.....	51
4.4	Compressed mode	52
4.4.1	Frame structure in the uplink.....	52
4.4.2	Frame structure types in the downlink	52
4.4.3	Transmission time reduction method	53
4.4.3.1	Compressed mode by puncturing	53
4.4.3.2	Compressed mode by reducing the spreading factor by 2	53
4.4.3.3	Compressed mode by higher layer scheduling	53
4.4.4	Transmission gap position.....	53
Annex A (informative): Blind transport format detection		56
A.1	Blind transport format detection using fixed positions	56
A.1.1	Blind transport format detection using received power ratio	56
A.1.2	Blind transport format detection using CRC	56
Annex B (informative): Compressed mode idle lengths.....		59
B.1	Idle lengths for DL, UL and DL+UL compressed mode	59
Annex C (informative): Change history		61

Foreword

This Technical Specification (TS) has been produced by the 3rd Generation Partnership Project (3GPP).

The contents of the present document are subject to continuing work within the TSG and may change following formal TSG approval. Should the TSG modify the contents of the present document, it will be re-released by the TSG with an identifying change of release date and an increase in version number as follows:

Version x.y.z

where:

- x the first digit:
 - 1 presented to TSG for information;
 - 2 presented to TSG for approval;
 - 3 or greater indicates TSG approved document under change control.
- y the second digit is incremented for all changes of substance, i.e. technical enhancements, corrections, updates, etc.
- z the third digit is incremented when editorial only changes have been incorporated in the document.

1 Scope

The present document describes the characteristics of the Layer 1 multiplexing and channel coding in the FDD mode of UTRA.

2 References

The following documents contain provisions which, through reference in this text, constitute provisions of the present document.

- References are either specific (identified by date of publication, edition number, version number, etc.) or non-specific.
- For a specific reference, subsequent revisions do not apply.
- For a non-specific reference, the latest version applies.

- [1] 3GPP TS 25.201: "Physical layer – General Description".
 - [2] 3GPP TS 25.211: "Physical channels and mapping of transport channels onto physical channels (FDD)".
 - [3] 3GPP TS 25.213: "Spreading and modulation (FDD)".
 - [4] 3GPP TS 25.214: "Physical layer procedures (FDD)".
 - [5] 3GPP TS 25.215: "Physical layer – Measurements (FDD)".
 - [6] 3GPP TS 25.221: "Physical channels and mapping of transport channels onto physical channels (TDD)".
 - [7] 3GPP TS 25.222: "Multiplexing and channel coding (TDD)".
 - [8] 3GPP TS 25.223: "Spreading and modulation (TDD)".
 - [9] 3GPP TS 25.224: "Physical layer procedures (TDD)".
 - [10] 3GPP TS 25.225: "Physical layer – Measurements (TDD)".
 - [11] 3GPP TS 25.302: "Services Provided by the Physical Layer".
 - [12] 3GPP TS 25.402: "Synchronisation in UTRAN, Stage 2".
-

3 Definitions, symbols and abbreviations

3.1 Definitions

For the purposes of the present document, the following terms and definitions apply:

TG: Transmission Gap is consecutive empty slots that have been obtained with a transmission time reduction method. The transmission gap can be contained in one or two consecutive radio frames.

TGL: Transmission Gap Length is the number of consecutive empty slots that have been obtained with a transmission time reduction method. $0 \leq TGL \leq 14$. The CFNs of the radio frames containing the first empty slot of the transmission gaps, the CFNs of the radio frames containing the last empty slot, the respective positions N_{first} and N_{last} within these frames of the first and last empty slots of the transmission gaps, and the transmission gap lengths can be calculated with the compressed mode parameters described in [5].

TrCH number: Transport channel number represents a TrCH ID assigned to L1 by L2. Transport channels are multiplexed to the CCTrCH in the ascending order of these IDs.

3.2 Symbols

For the purposes of the present document, the following symbols apply:

$\lceil x \rceil$	round towards ∞ , i.e. integer such that $x \leq \lceil x \rceil < x+1$
$\lfloor x \rfloor$	round towards $-\infty$, i.e. integer such that $x-1 < \lfloor x \rfloor \leq x$
$ x $	absolute value of x
$\text{sgn}(x)$	signum function, i.e. $\text{sgn}(x) = \begin{cases} 1; & x \geq 0 \\ -1; & x < 0 \end{cases}$
N_{first}	The first slot in the TG , located in the first compressed radio frame if the TG spans two frames.
N_{last}	The last slot in the TG , located in the second compressed radio frame if the TG spans two frames.
N_{tr}	Number of transmitted slots in a radio frame.

Unless otherwise is explicitly stated when the symbol is used, the meaning of the following symbols is:

i	TrCH number
j	TFC number
k	Bit number
l	TF number
m	Transport block number
n_i	Radio frame number of TrCH i .
p	PhCH number
r	Code block number
I	Number of TrCHs in a CCTrCH.
C_i	Number of code blocks in one TTI of TrCH i .
F_i	Number of radio frames in one TTI of TrCH i .
M_i	Number of transport blocks in one TTI of TrCH i .
$N_{data,j}$	Number of data bits that are available for the CCTrCH in a radio frame with TFC j .
$N_{data,j}^{cm}$	Number of data bits that are available for the CCTrCH in a compressed radio frame with TFC j .
P	Number of PhCHs used for one CCTrCH.
PL	Puncturing Limit for the uplink. Signalled from higher layers
RM_i	Rate Matching attribute for TrCH i . Signalled from higher layers.

Temporary variables, i.e. variables used in several (sub)clauses with different meaning.

x, X
 y, Y
 z, Z

3.3 Abbreviations

For the purposes of the present document, the following abbreviations apply:

ARQ	Automatic Repeat Request
BCH	Broadcast Channel
BER	Bit Error Rate
BLER	Block Error Rate
BS	Base Station
CCPCH	Common Control Physical Channel
CCTrCH	Coded Composite Transport Channel
CFN	Connection Frame Number
CRC	Cyclic Redundancy Check
DCH	Dedicated Channel
DL	Downlink (Forward link)
DPCCH	Dedicated Physical Control Channel
DPCH	Dedicated Physical Channel

DPDCH	Dedicated Physical Data Channel
DS-CDMA	Direct-Sequence Code Division Multiple Access
DSCH	Downlink Shared Channel
DTX	Discontinuous Transmission
FACH	Forward Access Channel
FDD	Frequency Division Duplex
FER	Frame Error Rate
GF	Galois Field
MAC	Medium Access Control
Mcps	Mega Chip Per Second
MS	Mobile Station
OVSF	Orthogonal Variable Spreading Factor (codes)
PCCC	Parallel Concatenated Convolutional Code
PCH	Paging Channel
PhCH	Physical Channel
PRACH	Physical Random Access Channel
RACH	Random Access Channel
RSC	Recursive Systematic Convolutional Coder
RX	Receive
SCH	Synchronisation Channel
SF	Spreading Factor
SFN	System Frame Number
SIR	Signal-to-Interference Ratio
SNR	Signal to Noise Ratio
TF	Transport Format
TFC	Transport Format Combination
TFCI	Transport Format Combination Indicator
TPC	Transmit Power Control
TrCH	Transport Channel
TTI	Transmission Time Interval
TX	Transmit
UL	Uplink (Reverse link)

4 Multiplexing, channel coding and interleaving

4.1 General

Data stream from/to MAC and higher layers (Transport block / Transport block set) is encoded/decoded to offer transport services over the radio transmission link. Channel coding scheme is a combination of error detection, error correcting, rate matching, interleaving and transport channels mapping onto/splitting from physical channels.

4.2 Transport-channel coding/multiplexing

Data arrives to the coding/multiplexing unit in form of transport block sets once every transmission time interval. The transmission time interval is transport-channel specific from the set {10 ms, 20 ms, 40 ms, 80 ms}.

The following coding/multiplexing steps can be identified:

- add CRC to each transport block (see subclause 4.2.1);
- transport block concatenation and code block segmentation (see subclause 4.2.2);
- channel coding (see subclause 4.2.3);
- radio frame equalisation (see subclause 4.2.4);
- rate matching (see subclause 4.2.7);
- insertion of discontinuous transmission (DTX) indication bits (see subclause 4.2.9);

- interleaving (two steps, see subclauses 4.2.5 and 4.2.11);
- radio frame segmentation (see subclause 4.2.6);
- multiplexing of transport channels (see subclause 4.2.8);
- physical channel segmentation (see subclause 4.2.10);
- mapping to physical channels (see subclause 4.2.12).

The coding/multiplexing steps for uplink and downlink are shown in figure 1 and figure 2 respectively.

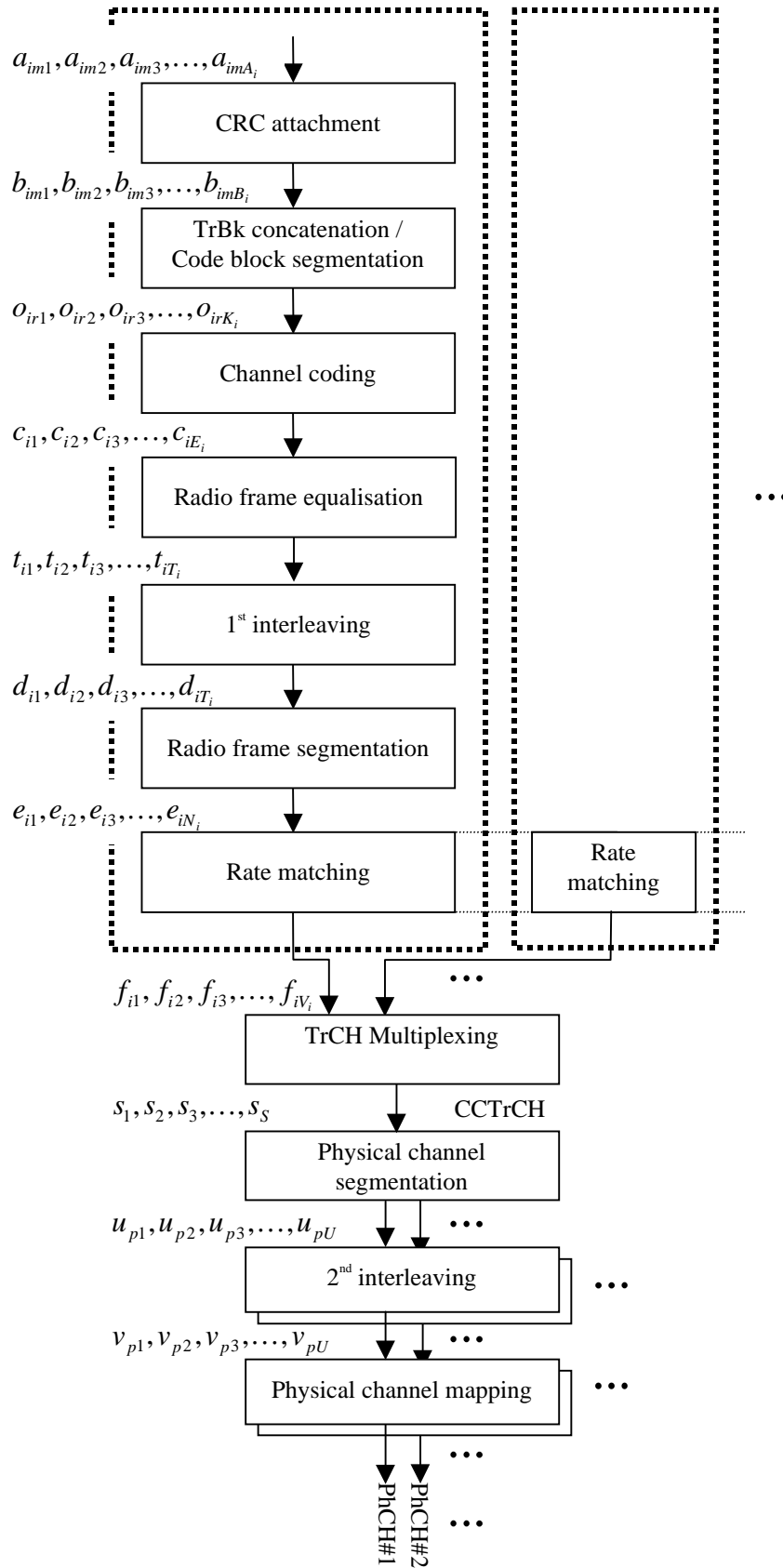

Figure 1: Transport channel multiplexing structure for uplink

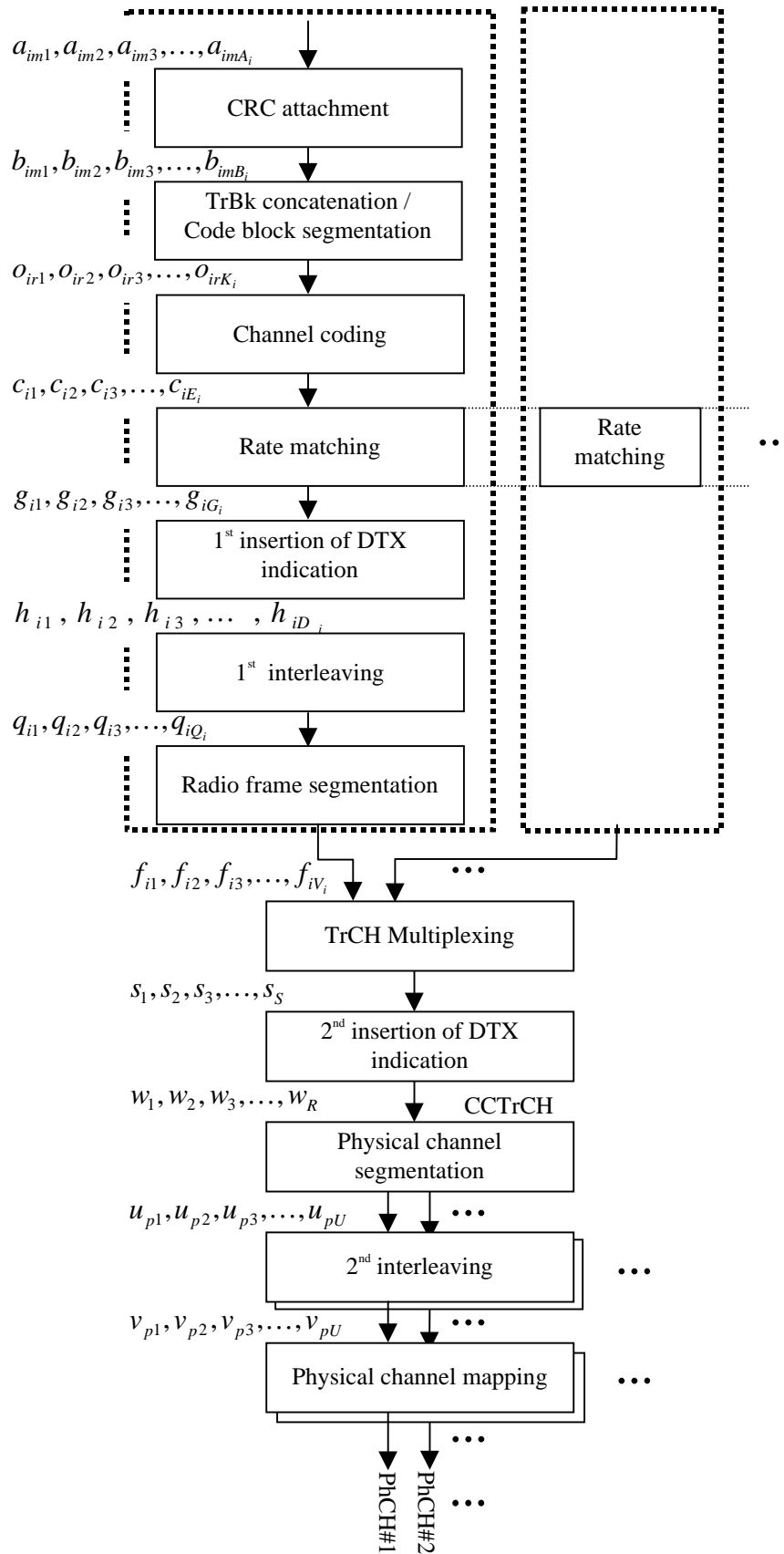

Figure 2: Transport channel multiplexing structure for downlink

The single output data stream from the TrCH multiplexing, including DTX indication bits in downlink, is denoted *Coded Composite Transport Channel (CCTrCH)*. A CCTrCH can be mapped to one or several physical channels.

4.2.1 CRC attachment

Error detection is provided on transport blocks through a Cyclic Redundancy Check (CRC). The size of the CRC is 24, 16, 12, 8 or 0 bits and it is signalled from higher layers what CRC size that should be used for each TrCH.

4.2.1.1 CRC Calculation

The entire transport block is used to calculate the CRC parity bits for each transport block. The parity bits are generated by one of the following cyclic generator polynomials:

- $g_{\text{CRC24}}(D) = D^{24} + D^{23} + D^6 + D^5 + D + 1$;
- $g_{\text{CRC16}}(D) = D^{16} + D^{12} + D^5 + 1$;
- $g_{\text{CRC12}}(D) = D^{12} + D^{11} + D^3 + D^2 + D + 1$;
- $g_{\text{CRC8}}(D) = D^8 + D^7 + D^4 + D^3 + D + 1$.

Denote the bits in a transport block delivered to layer 1 by $a_{im1}, a_{im2}, a_{im3}, \dots, a_{imA_i}$, and the parity bits by $p_{im1}, p_{im2}, p_{im3}, \dots, p_{imL_i}$. A_i is the size of a transport block of TrCH i , m is the transport block number, and L_i is the number of parity bits. L_i can take the values 24, 16, 12, 8, or 0 depending on what is signalled from higher layers.

The encoding is performed in a systematic form, which means that in GF(2), the polynomial:

$$a_{im1}D^{A_i+23} + a_{im2}D^{A_i+22} + \dots + a_{imA_i}D^{24} + p_{im1}D^{23} + p_{im2}D^{22} + \dots + p_{im23}D^1 + p_{im24}$$

yields a remainder equal to 0 when divided by $g_{\text{CRC24}}(D)$, polynomial:

$$a_{im1}D^{A_i+15} + a_{im2}D^{A_i+14} + \dots + a_{imA_i}D^{16} + p_{im1}D^{15} + p_{im2}D^{14} + \dots + p_{im15}D^1 + p_{im16}$$

yields a remainder equal to 0 when divided by $g_{\text{CRC16}}(D)$, polynomial:

$$a_{im1}D^{A_i+11} + a_{im2}D^{A_i+10} + \dots + a_{imA_i}D^{12} + p_{im1}D^{11} + p_{im2}D^{10} + \dots + p_{im11}D^1 + p_{im12}$$

yields a remainder equal to 0 when divided by $g_{\text{CRC12}}(D)$ and polynomial:

$$a_{im1}D^{A_i+7} + a_{im2}D^{A_i+6} + \dots + a_{imA_i}D^8 + p_{im1}D^7 + p_{im2}D^6 + \dots + p_{im7}D^1 + p_{im8}$$

yields a remainder equal to 0 when divided by $g_{\text{CRC8}}(D)$.

If no transport blocks are input to the CRC calculation ($M_i = 0$), no CRC attachment shall be done. If transport blocks are input to the CRC calculation ($M_i \neq 0$) and the size of a transport block is zero ($A_i = 0$), CRC shall be attached, i.e. all parity bits equal to zero.

4.2.1.2 Relation between input and output of the CRC attachment block

The bits after CRC attachment are denoted by $b_{im1}, b_{im2}, b_{im3}, \dots, b_{imB_i}$, where $B_i = A_i + L_i$. The relation between a_{imk} and b_{imk} is:

$$b_{imk} = a_{imk} \quad k = 1, 2, 3, \dots, A_i$$

$$b_{imk} = p_{im(L_i+1-(k-A_i))} \quad k = A_i + 1, A_i + 2, A_i + 3, \dots, A_i + L_i$$

4.2.2 Transport block concatenation and code block segmentation

All transport blocks in a TTI are serially concatenated. If the number of bits in a TTI is larger than Z , the maximum size of a code block in question, then code block segmentation is performed after the concatenation of the transport blocks. The maximum size of the code blocks depends on whether convolutional coding, turbo coding or no coding is used for the TrCH.

4.2.2.1 Concatenation of transport blocks

The bits input to the transport block concatenation are denoted by $b_{im1}, b_{im2}, b_{im3}, \dots, b_{imB_i}$ where i is the TrCH number, m is the transport block number, and B_i is the number of bits in each block (including CRC). The number of transport blocks on TrCH i is denoted by M_i . The bits after concatenation are denoted by $x_{i1}, x_{i2}, x_{i3}, \dots, x_{iX_i}$, where i is the TrCH number and $X_i = M_i B_i$. They are defined by the following relations:

$$x_{ik} = b_{i1k} \quad k = 1, 2, \dots, B_i$$

$$x_{ik} = b_{i,2,(k-B_i)} \quad k = B_i + 1, B_i + 2, \dots, 2B_i$$

$$x_{ik} = b_{i,3,(k-2B_i)} \quad k = 2B_i + 1, 2B_i + 2, \dots, 3B_i$$

...

$$x_{ik} = b_{i,M_i,(k-(M_i-1)B_i)} \quad k = (M_i - 1)B_i + 1, (M_i - 1)B_i + 2, \dots, M_i B_i$$

4.2.2.2 Code block segmentation

Segmentation of the bit sequence from transport block concatenation is performed if $X_i > Z$. The code blocks after segmentation are of the same size. The number of code blocks on TrCH i is denoted by C_i . If the number of bits input to the segmentation, X_i , is not a multiple of C_i , filler bits are added to the beginning of the first block. If turbo coding is selected and $X_i < 40$, filler bits are added to the beginning of the code block. The filler bits are transmitted and they are always set to 0. The maximum code block sizes are:

- convolutional coding: $Z = 504$;
- turbo coding: $Z = 5114$;
- no channel coding: $Z = \text{unlimited}$.

The bits output from code block segmentation, for $C_i \neq 0$, are denoted by $o_{ir1}, o_{ir2}, o_{ir3}, \dots, o_{irK_i}$, where i is the TrCH number, r is the code block number, and K_i is the number of bits per code block.

Number of code blocks:

$$C_i = \begin{cases} \lceil X_i / Z \rceil & \text{when } Z \neq \text{unlimited} \\ 0 & \text{when } Z = \text{unlimited} \text{ and } X_i = 0 \\ 1 & \text{when } Z = \text{unlimited} \text{ and } X_i \neq 0 \end{cases}$$

Number of bits in each code block (applicable for $C_i \neq 0$ only):

if $X_i < 40$ and Turbo coding is used, then

$$K_i = 40$$

else

$$K_i = \lceil X_i / C_i \rceil$$

end if

Number of filler bits: $Y_i = C_i K_i - X_i$

for $k = 1$ to Y_i -- Insertion of filler bits

$$o_{ilk} = 0$$

end for

for $k = Y_i + 1$ to K_i

$$o_{ilk} = x_{i,(k-Y_i)}$$

end for

$r = 2$ -- Segmentation

while $r \leq C_i$

for $k = 1$ to K_i

$$O_{irk} = x_{i,(k+(r-1)K_i-Y_i)}^I$$

end for

$r = r + 1$

end while

4.2.3 Channel coding

Code blocks are delivered to the channel coding block. They are denoted by $O_{ir1}, O_{ir2}, O_{ir3}, \dots, O_{irK_i}$, where i is the TrCH number, r is the code block number, and K_i is the number of bits in each code block. The number of code blocks on TrCH i is denoted by C_i . After encoding the bits are denoted by $y_{ir1}, y_{ir2}, y_{ir3}, \dots, y_{irY_i}$, where Y_i is the number of encoded bits. The relation between O_{irk} and y_{irk} and between K_i and Y_i is dependent on the channel coding scheme.

The following channel coding schemes can be applied to TrCHs:

- convolutional coding;
- turbo coding;
- no coding.

Usage of coding scheme and coding rate for the different types of TrCH is shown in table 1.

The values of Y_i in connection with each coding scheme:

- convolutional coding with rate 1/2: $Y_i = 2 * K_i + 16$; rate 1/3: $Y_i = 3 * K_i + 24$;
- turbo coding with rate 1/3: $Y_i = 3 * K_i + 12$;
- no coding: $Y_i = K_i$.

Table 1: Usage of channel coding scheme and coding rate

Type of TrCH	Coding scheme	Coding rate
BCH	Convolutional coding	1/2
PCH		
RACH		
CPCH, DCH, DSCH, FACH	Turbo coding	1/3, 1/2
	No coding	1/3

4.2.3.1 Convolutional coding

Convolutional codes with constraint length 9 and coding rates 1/3 and 1/2 are defined.

The configuration of the convolutional coder is presented in figure 3.

Output from the rate 1/3 convolutional coder shall be done in the order output0, output1, output2, output0, output1, output 2, output 0, ..., output2. Output from the rate 1/2 convolutional coder shall be done in the order output 0, output 1, output 0, output 1, output 0, ..., output 1.

8 tail bits with binary value 0 shall be added to the end of the code block before encoding.

The initial value of the shift register of the coder shall be "all 0" when starting to encode the input bits.

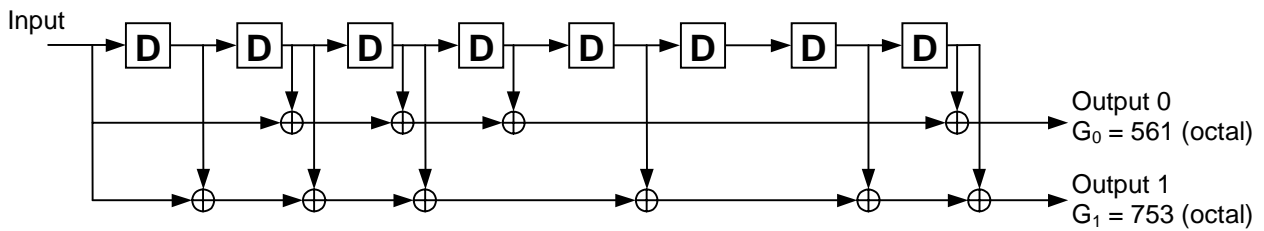

(a) Rate 1/2 convolutional coder

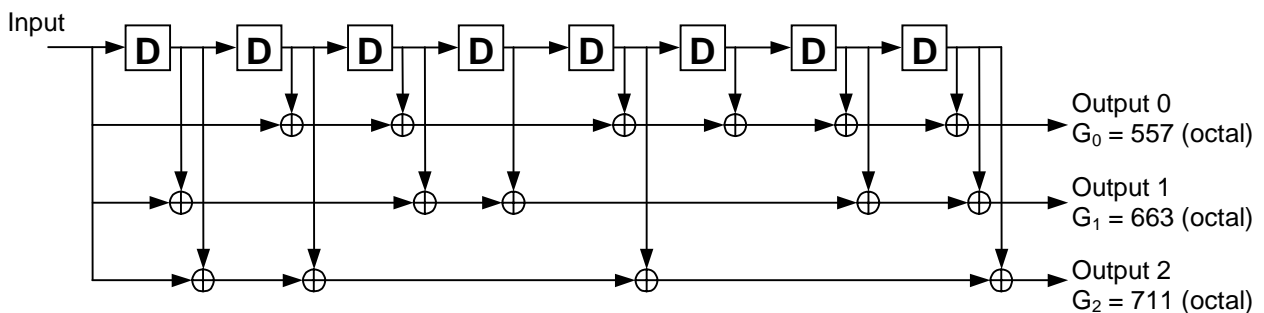

(b) Rate 1/3 convolutional coder

Figure 3: Rate 1/2 and rate 1/3 convolutional coders

4.2.3.2 Turbo coding

4.2.3.2.1 Turbo coder

The scheme of Turbo coder is a Parallel Concatenated Convolutional Code (PCCC) with two 8-state constituent encoders and one Turbo code internal interleaver. The coding rate of Turbo coder is 1/3. The structure of Turbo coder is illustrated in figure 4.

The transfer function of the 8-state constituent code for PCCC is:

$$G(D) = \left[1, \frac{g_1(D)}{g_0(D)} \right],$$

where

$$g_0(D) = 1 + D^2 + D^3,$$

$$g_1(D) = 1 + D + D^3.$$

The initial value of the shift registers of the 8-state constituent encoders shall be all zeros when starting to encode the input bits.

Output from the Turbo coder is

$$x_1, z_1, z'_1, x_2, z_2, z'_2, \dots, x_K, z_K, z'_K,$$

where x_1, x_2, \dots, x_K are the bits input to the Turbo coder i.e. both first 8-state constituent encoder and Turbo code internal interleaver, and K is the number of bits, and z_1, z_2, \dots, z_K and z'_1, z'_2, \dots, z'_K are the bits output from first and second 8-state constituent encoders, respectively.

The bits output from Turbo code internal interleaver are denoted by x'_1, x'_2, \dots, x'_K , and these bits are to be input to the second 8-state constituent encoder.

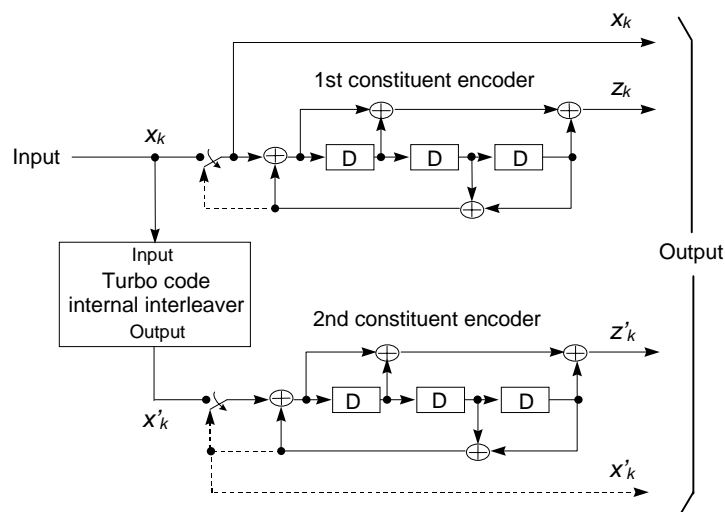

Figure 4: Structure of rate 1/3 Turbo coder (dotted lines apply for trellis termination only)

4.2.3.2.2 Trellis termination for Turbo coder

Trellis termination is performed by taking the tail bits from the shift register feedback after all information bits are encoded. Tail bits are padded after the encoding of information bits.

The first three tail bits shall be used to terminate the first constituent encoder (upper switch of figure 4 in lower position) while the second constituent encoder is disabled. The last three tail bits shall be used to terminate the second constituent encoder (lower switch of figure 4 in lower position) while the first constituent encoder is disabled.

The transmitted bits for trellis termination shall then be:

$$x_{K+1}, z_{K+1}, x_{K+2}, z_{K+2}, x_{K+3}, z_{K+3}, x'_{K+1}, z'_{K+1}, x'_{K+2}, z'_{K+2}, x'_{K+3}, z'_{K+3}.$$

4.2.3.2.3 Turbo code internal interleaver

The Turbo code internal interleaver consists of bits-input to a rectangular matrix with padding, intra-row and inter-row permutations of the rectangular matrix, and bits-output from the rectangular matrix with pruning. The bits input to the Turbo code internal interleaver are denoted by $x_1, x_2, x_3, \dots, x_K$, where K is the integer number of the bits and takes one value of $40 \leq K \leq 5114$. The relation between the bits input to the Turbo code internal interleaver and the bits input to the channel coding is defined by $x_k = o_{irk}$ and $K = K_i$.

The following subclause specific symbols are used in subclauses 4.2.3.2.3.1 to 4.2.3.2.3.3:

- K Number of bits input to Turbo code internal interleaver
- R Number of rows of rectangular matrix

C	Number of columns of rectangular matrix
p	Prime number
v	Primitive root
$\langle s(j) \rangle_{j \in \{0,1,\dots,p-2\}}$	Base sequence for intra-row permutation
q_i	Minimum prime integers
r_i	Permuted prime integers
$\langle T(i) \rangle_{i \in \{0,1,\dots,R-1\}}$	Inter-row permutation pattern
$\langle U_i(j) \rangle_{j \in \{0,1,\dots,C-1\}}$	Intra-row permutation pattern of i -th row
i	Index of row number of rectangular matrix
j	Index of column number of rectangular matrix
k	Index of bit sequence

4.2.3.2.3.1 Bits-input to rectangular matrix with padding

The bit sequence $x_1, x_2, x_3, \dots, x_K$ input to the Turbo code internal interleaver is written into the rectangular matrix as follows.

(1) Determine the number of rows of the rectangular matrix, R , such that:

$$R = \begin{cases} 5, & \text{if } (40 \leq K \leq 159) \\ 10, & \text{if } ((160 \leq K \leq 200) \text{ or } (481 \leq K \leq 530)) \\ 20, & \text{if } (K = \text{any other value}) \end{cases} .$$

The rows of rectangular matrix are numbered $0, 1, \dots, R - 1$ from top to bottom.

(2) Determine the prime number to be used in the intra-permutation, p , and the number of columns of rectangular matrix, C , such that:

if $(481 \leq K \leq 530)$ then

$$p = 53 \text{ and } C = p.$$

else

Find minimum prime number p from table 2 such that

$$K \leq R \times (p + 1),$$

and determine C such that

$$C = \begin{cases} p - 1 & \text{if } K \leq R \times (p - 1) \\ p & \text{if } R \times (p - 1) < K \leq R \times p \\ p + 1 & \text{if } R \times p < K \end{cases} .$$

end if

The columns of rectangular matrix are numbered $0, 1, \dots, C - 1$ from left to right.

Table 2: List of prime number p and associated primitive root v

p	v	p	v	p	v	p	v	p	v
7	3	47	5	101	2	157	5	223	3
11	2	53	2	103	5	163	2	227	2
13	2	59	2	107	2	167	5	229	6
17	3	61	2	109	6	173	2	233	3
19	2	67	2	113	3	179	2	239	7
23	5	71	7	127	3	181	2	241	7
29	2	73	5	131	2	191	19	251	6
31	3	79	3	137	3	193	5	257	3
37	2	83	2	139	2	197	2		
41	6	89	3	149	2	199	3		
43	3	97	5	151	6	211	2		

- (3) Write the input bit sequence $x_1, x_2, x_3, \dots, x_K$ into the $R \times C$ rectangular matrix row by row starting with bit y_1 in column 0 of row 0:

$$\begin{bmatrix} y_1 & y_2 & y_3 & \cdots & y_C \\ y_{(C+1)} & y_{(C+2)} & y_{(C+3)} & \cdots & y_{2C} \\ \vdots & \vdots & \vdots & \cdots & \vdots \\ y_{((R-1)C+1)} & y_{((R-1)C+2)} & y_{((R-1)C+3)} & \cdots & y_{R \times C} \end{bmatrix}$$

where $y_k = x_k$ for $k = 1, 2, \dots, K$ and if $R \times C > K$, the dummy bits are padded such that $y_k = 0$ or 1 for $k = K + 1, K + 2, \dots, R \times C$. These dummy bits are pruned away from the output of the rectangular matrix after intra-row and inter-row permutations.

4.2.3.2.3.2 Intra-row and inter-row permutations

After the bits-input to the $R \times C$ rectangular matrix, the intra-row and inter-row permutations for the $R \times C$ rectangular matrix are performed stepwise by using the following algorithm with steps (1) – (6):

- (1) Select a primitive root v from table 2 in section 4.2.3.2.3.1, which is indicated on the right side of the prime number p .

- (2) Construct the base sequence $\langle s(j) \rangle_{j \in \{0, 1, \dots, p-2\}}$ for intra-row permutation as:

$$s(j) = (v \times s(j-1)) \bmod p, \quad j = 1, 2, \dots, (p-2), \text{ and } s(0) = 1.$$

- (3) Assign $q_0 = 1$ to be the first prime integer in the sequence $\langle q_i \rangle_{i \in \{0, 1, \dots, R-1\}}$, and determine the prime integer q_i in the sequence $\langle q_i \rangle_{i \in \{0, 1, \dots, R-1\}}$ to be a least prime integer such that $\text{g.c.d}(q_i, p-1) = 1$, $q_i > 6$, and $q_i > q_{(i-1)}$ for each $i = 1, 2, \dots, R-1$. Here g.c.d. is greatest common divisor.

- (4) Permute the sequence $\langle q_i \rangle_{i \in \{0, 1, \dots, R-1\}}$ to make the sequence $\langle r_i \rangle_{i \in \{0, 1, \dots, R-1\}}$ such that

$$r_{T(i)} = q_i, \quad i = 0, 1, \dots, R-1,$$

where $\langle T(i) \rangle_{i \in \{0, 1, \dots, R-1\}}$ is the inter-row permutation pattern defined as the one of the four kind of patterns, which are shown in table 3, depending on the number of input bits K .

Table 3: Inter-row permutation patterns for Turbo code internal interleaver

Number of input bits K	Number of rows R	Inter-row permutation patterns $\langle T(0), T(1), \dots, T(R-1) \rangle$
$(40 \leq K \leq 159)$	5	$\langle 4, 3, 2, 1, 0 \rangle$
$(160 \leq K \leq 200)$ or $(481 \leq K \leq 530)$	10	$\langle 9, 8, 7, 6, 5, 4, 3, 2, 1, 0 \rangle$

$(2281 \leq K \leq 2480)$ or $(3161 \leq K \leq 3210)$	20	<19, 9, 14, 4, 0, 2, 5, 7, 12, 18, 16, 13, 17, 15, 3, 1, 6, 11, 8, 10>
$K = \text{any other value}$	20	<19, 9, 14, 4, 0, 2, 5, 7, 12, 18, 10, 8, 13, 17, 3, 1, 16, 6, 15, 11>

(5) Perform the i -th ($i = 0, 1, \dots, R - 1$) intra-row permutation as:

if ($C = p$) then

$$U_i(j) = s((j \times r_i) \bmod (p - 1)), \quad j = 0, 1, \dots, (p - 2), \text{ and } U_i(p - 1) = 0,$$

where $U_i(j)$ is the original bit position of j -th permuted bit of i -th row.

end if

if ($C = p + 1$) then

$$U_i(j) = s((j \times r_i) \bmod (p - 1)), \quad j = 0, 1, \dots, (p - 2). \quad U_i(p - 1) = 0, \text{ and } U_i(p) = p,$$

where $U_i(j)$ is the original bit position of j -th permuted bit of i -th row, and

if ($K = R \times C$) then

Exchange $U_{R-1}(p)$ with $U_{R-1}(0)$.

end if

end if

if ($C = p - 1$) then

$$U_i(j) = s((j \times r_i) \bmod (p - 1)) - 1, \quad j = 0, 1, \dots, (p - 2),$$

where $U_i(j)$ is the original bit position of j -th permuted bit of i -th row.

end if

(6) Perform the inter-row permutation for the rectangular matrix based on the pattern $\langle T(i) \rangle_{i \in \{0, 1, \dots, R-1\}}$,

where $T(i)$ is the original row position of the i -th permuted row.

4.2.3.2.3.3 Bits-output from rectangular matrix with pruning

After intra-row and inter-row permutations, the bits of the permuted rectangular matrix are denoted by y'_k :

$$\begin{bmatrix} y'_1 & y'_{(R+1)} & y'_{(2R+1)} & \cdots & y'_{((C-1)R+1)} \\ y'_2 & y'_{(R+2)} & y'_{(2R+2)} & \cdots & y'_{((C-1)R+2)} \\ \vdots & \vdots & \vdots & \cdots & \vdots \\ y'_R & y'_{2R} & y'_{3R} & \cdots & y'_{C \times R} \end{bmatrix}$$

The output of the Turbo code internal interleaver is the bit sequence read out column by column from the intra-row and inter-row permuted $R \times C$ rectangular matrix starting with bit y'_1 in row 0 of column 0 and ending with bit y'_{CR} in row $R - 1$ of column $C - 1$. The output is pruned by deleting dummy bits that were padded to the input of the rectangular matrix before intra-row and inter row permutations, i.e. bits y'_k that corresponds to bits y_k with $k > K$ are removed from the output. The bits output from Turbo code internal interleaver are denoted by x'_1, x'_2, \dots, x'_K , where x'_1 corresponds to the bit y'_k with smallest index k after pruning, x'_2 to the bit y'_k with second smallest index k after pruning, and so on. The number of bits output from Turbo code internal interleaver is K and the total number of pruned bits is:

$$R \times C - K.$$

4.2.3.3 Concatenation of encoded blocks

After the channel coding for each code block, if C_i is greater than 1, the encoded blocks are serially concatenated so that the block with lowest index r is output first from the channel coding block, otherwise the encoded block is output from channel coding block as it is. The bits output are denoted by $c_{i1}, c_{i2}, c_{i3}, \dots, c_{iE_i}$, where i is the TrCH number and $E_i = C_i Y_i$. The output bits are defined by the following relations:

$$c_{ik} = y_{i1k} \quad k = 1, 2, \dots, Y_i$$

$$c_{ik} = y_{i,2,(k-Y_i)} \quad k = Y_i + 1, Y_i + 2, \dots, 2Y_i$$

$$c_{ik} = y_{i,3,(k-2Y_i)} \quad k = 2Y_i + 1, 2Y_i + 2, \dots, 3Y_i$$

...

$$c_{ik} = y_{i,C_i,(k-(C_i-1)Y_i)} \quad k = (C_i - 1)Y_i + 1, (C_i - 1)Y_i + 2, \dots, C_i Y_i$$

If no code blocks are input to the channel coding ($C_i = 0$), no bits shall be output from the channel coding, i.e. $E_i = 0$.

4.2.4 Radio frame size equalisation

Radio frame size equalisation is padding the input bit sequence in order to ensure that the output can be segmented in F_i data segments of same size as described in subclause 4.2.7. Radio frame size equalisation is only performed in the UL (In normal mode and in compressed modes by SF reduction and by higher layer scheduling, DL rate matching output block length is always an integer multiple of F_i . In compressed mode by puncturing, first interleaver input block length after p-bits insertion is always an integer multiple of F_i).

The input bit sequence to the radio frame size equalisation is denoted by $c_{i1}, c_{i2}, c_{i3}, \dots, c_{iE_i}$, where i is TrCH number and E_i the number of bits. The output bit sequence is denoted by $t_{i1}, t_{i2}, t_{i3}, \dots, t_{iT_i}$, where T_i is the number of bits. The output bit sequence is derived as follows:

- $t_{ik} = c_{ik}$, for $k = 1 \dots E_i$; and
- $t_{ik} = \{0, 1\}$ for $k = E_i + 1 \dots T_i$, if $E_i < T_i$;

where

- $T_i = F_i * N_i$; and
- $N_i = \lceil E_i / F_i \rceil$ is the number of bits per segment after size equalisation.

4.2.5 1st interleaving

In Compressed Mode by puncturing, bits marked with a fourth value on top of $\{0, 1, \delta\}$ and noted p, are introduced in the radio frames to be compressed, in positions corresponding to the first bits of the radio frames. They will be removed in a later stage of the multiplexing chain to create the actual gap. Additional puncturing has been performed in the rate matching step, over the TTI containing the compressed radio frame, to create room for these p-bits. The following subclause describes this feature.

4.2.5.1 Insertion of marked bits in the sequence to be input in first interleaver

In normal mode, compressed mode by higher layer scheduling, and compressed mode by spreading factor reduction:

$$x_{i,k} = z_{i,k} \text{ and } X_i = Z_i$$

In case the TTI contains a radio frame that is compressed by puncturing and fixed positions are used, sequence $x_{i,k}$ which will be input to first interleaver for TrCH i and TTI m within largest TTI, is built from bits $z_{i,k}$, $k=1, \dots, Z_i$, plus $Np_{i,\max}^{TTI,m}$ bits marked p and $X_i = Z_i + Np_{i,\max}^{TTI,m}$, as is described thereafter.

$Np_{i,\max}^{TTI,m}$ is defined in the Rate Matching subclause 4.2.7.

$P1_{F_i}(x)$ defines the inter column permutation function for a TTI of length $F_i \times 10$ ms, as defined in Table 3 in section 4.2.5.2. $P1_{F_i}(x)$ is the Bit Reversal function of x on $\log_2(F_i)$ bits.

NOTE 1: $C[x]$, $x=0$ to F_i-1 , the number of bits p which have to be inserted in each of the F_i segments of the TTI, where x is the column number before permutation, i.e. in each column of the first interleaver. $C[P1_{F_i}(x)]$ is equal to $Np_{i,\max}^{m \times F_i + x}$ for x equal 0 to F_i-1 for fixed positions. It is noted $Np_{i,\max}^{m \times F_i + x}$ in the following initialisation step.

NOTE 2: $cbi[x]$, $x=0$ to F_i-1 , the counter of the number of bits p inserted in each of the F_i segments of the TTI, i.e. in each column of the first interleaver x is the column number before permutation.

col = 0

while col < F_i **do** -- here col is the column number after column permutation

$C[P1_{F_i}(\text{col})] = Np_{i,\max}^{m \times F_i + \text{col}}$ -- initialisation of number of bits p to be inserted in each of the F_i segments of the TTI number m

$cbi[P1_{F_i}(\text{col})] = 0$ -- initialisation of counter of number of bits p inserted in each of the F_i segments of the TTI

col = col + 1

end do

n = 0, m = 0

while n < X_i **do** -- from here col is the column number before column permutation

col = n mod F_i

if $cbi[\text{col}] < C[\text{col}]$ **do**

$x_{i,n} = p$ -- insert one p bit

$cbi[\text{col}] = cbi[\text{col}] + 1$ -- update counter of number of bits p inserted

else -- no more p bit to insert in this segment

$x_{i,n} = z_{i,m}$

m = m + 1

endif

n = n + 1

end do

4.2.5.2 1st interleaver operation

The 1st interleaving is a block interleaver with inter-column permutations. The input bit sequence to the block interleaver is denoted by $x_{i,1}, x_{i,2}, x_{i,3}, \dots, x_{i,X_i}$, where i is TrCH number and X_i the number of bits. Here X_i is guaranteed to be an integer multiple of the number of radio frames in the TTI. The output bit sequence from the block interleaver is derived as follows:

(1) Select the number of columns $C1$ from table 4 depending on the TTI. The columns are numbered 0, 1, ..., $C1 - 1$ from left to right.

(2) Determine the number of rows of the matrix, $R1$ defined as

$$R1 = X_i / C1.$$

The rows of the matrix are numbered 0, 1, ..., $R1 - 1$ from top to bottom.

(3) Write the input bit sequence into the $R1 \times C1$ matrix row by row starting with bit $x_{i,1}$ in column 0 of row 0 and ending with bit $x_{i,(R1 \times C1)}$ in column $C1 - 1$ of row $R1 - 1$:

$$\begin{bmatrix} x_{i,1} & x_{i,2} & x_{i,3} & \dots & x_{i,C1} \\ x_{i,(C1+1)} & x_{i,(C1+2)} & x_{i,(C1+3)} & \dots & x_{i,(2 \times C1)} \\ \vdots & \vdots & \vdots & \dots & \vdots \\ x_{i,((R1-1) \times C1+1)} & x_{i,((R1-1) \times C1+2)} & x_{i,((R1-1) \times C1+3)} & \dots & x_{i,(R1 \times C1)} \end{bmatrix}$$

(4) Perform the inter-column permutation for the matrix based on the pattern $\langle P1_{C1}(j) \rangle_{j \in \{0,1,\dots,C1-1\}}$ shown in table 4, where $P1_{C1}(j)$ is the original column position of the j -th permuted column. After permutation of the columns, the bits are denoted by y_{ik} :

$$\begin{bmatrix} y_{i,1} & y_{i,(R1+1)} & y_{i,(2 \times R1+1)} & \dots & y_{i,((C1-1) \times R1+1)} \\ y_{i,2} & y_{i,(R1+2)} & y_{i,(2 \times R1+2)} & \dots & y_{i,((C1-1) \times R1+2)} \\ \vdots & \vdots & \vdots & \dots & \vdots \\ y_{i,R1} & y_{i,(2 \times R1)} & y_{i,(3 \times R1)} & \dots & y_{i,(C1 \times R1)} \end{bmatrix}$$

(5) Read the output bit sequence $y_{i,1}, y_{i,2}, y_{i,3}, \dots, y_{i,(C1 \times R1)}$ of the block interleaver column by column from the inter-column permuted $R1 \times C1$ matrix. Bit $y_{i,1}$ corresponds to row 0 of column 0 and bit $y_{i,(R1 \times C1)}$ corresponds to row $R1 - 1$ of column $C1 - 1$.

Table 4 Inter-column permutation patterns for 1st interleaving

TTI	Number of columns $C1$	Inter-column permutation patterns $\langle P1_{C1}(0), P1_{C1}(1), \dots, P1_{C1}(C1-1) \rangle$
10 ms	1	$\langle 0 \rangle$
20 ms	2	$\langle 0, 1 \rangle$
40 ms	4	$\langle 0, 2, 1, 3 \rangle$
80 ms	8	$\langle 0, 4, 2, 6, 1, 5, 3, 7 \rangle$

4.2.5.3 Relation between input and output of 1st interleaving in uplink

The bits input to the 1st interleaving are denoted by $t_{i,1}, t_{i,2}, t_{i,3}, \dots, t_{i,T_i}$, where i is the TrCH number and T_i the number of bits. Hence, $z_{i,k} = t_{i,k}$ and $Z_i = T_i$.

The bits output from the 1st interleaving are denoted by $d_{i,1}, d_{i,2}, d_{i,3}, \dots, d_{i,T_i}$, and $d_{i,k} = y_{i,k}$.

4.2.5.4 Relation between input and output of 1st interleaving in downlink

If fixed positions of the TrCHs in a radio frame is used then the bits input to the 1st interleaving are denoted by $h_{i,1}, h_{i,2}, h_{i,3}, \dots, h_{i,D_i}$, where i is the TrCH number. Hence, $z_{i,k} = h_{i,k}$ and $Z_i = D_i$.

If flexible positions of the TrCHs in a radio frame is used then the bits input to the 1st interleaving are denoted by $g_{i1}, g_{i2}, g_{i3}, \dots, g_{iG_i}$, where i is the TrCH number. Hence, $z_{ik} = g_{ik}$ and $Z_i = G_i$.

The bits output from the 1st interleaving are denoted by $q_{i1}, q_{i2}, q_{i3}, \dots, q_{iQ_i}$, where i is the TrCH number and Q_i is the number of bits. Hence, $q_{ik} = y_{ik}$, $Q_i = F_i H_i$ if fixed positions are used, and $Q_i = G_i$ if flexible positions are used.

4.2.6 Radio frame segmentation

When the transmission time interval is longer than 10 ms, the input bit sequence is segmented and mapped onto consecutive F_i radio frames. Following rate matching in the DL and radio frame size equalisation in the UL the input bit sequence length is guaranteed to be an integer multiple of F_i .

The input bit sequence is denoted by $x_{i1}, x_{i2}, x_{i3}, \dots, x_{iX_i}$ where i is the TrCH number and X_i is the number bits. The F_i output bit sequences per TTI are denoted by $y_{i,n_i1}, y_{i,n_i2}, y_{i,n_i3}, \dots, y_{i,n_iY_i}$ where n_i is the radio frame number in current TTI and Y_i is the number of bits per radio frame for TrCH i . The output sequences are defined as follows:

$$y_{i,n_i k} = x_{i,((n_i-1)Y_i)+k}, n_i = 1 \dots F_i, k = 1 \dots Y_i$$

where

$$Y_i = (X_i / F_i) \text{ is the number of bits per segment.}$$

The n_i -th segment is mapped to the n_i -th radio frame of the transmission time interval.

4.2.6.1 Relation between input and output of the radio frame segmentation block in uplink

The input bit sequence to the radio frame segmentation is denoted by $d_{i1}, d_{i2}, d_{i3}, \dots, d_{iT_i}$, where i is the TrCH number and T_i the number of bits. Hence, $x_{ik} = d_{ik}$ and $X_i = T_i$.

The output bit sequence corresponding to radio frame n_i is denoted by $e_{i1}, e_{i2}, e_{i3}, \dots, e_{iN_i}$, where i is the TrCH number and N_i is the number of bits. Hence, $e_{i,k} = y_{i,n_i k}$ and $N_i = Y_i$.

4.2.6.2 Relation between input and output of the radio frame segmentation block in downlink

The bits input to the radio frame segmentation are denoted by $q_{i1}, q_{i2}, q_{i3}, \dots, q_{iQ_i}$, where i is the TrCH number and Q_i the number of bits. Hence, $x_{ik} = q_{ik}$ and $X_i = Q_i$.

The output bit sequence corresponding to radio frame n_i is denoted by $f_{i1}, f_{i2}, f_{i3}, \dots, f_{iV_i}$, where i is the TrCH number and V_i is the number of bits. Hence, $f_{i,k} = y_{i,n_i k}$ and $V_i = Y_i$.

4.2.7 Rate matching

Rate matching means that bits on a transport channel are repeated or punctured. Higher layers assign a rate-matching attribute for each transport channel. This attribute is semi-static and can only be changed through higher layer signalling. The rate-matching attribute is used when the number of bits to be repeated or punctured is calculated.

The number of bits on a transport channel can vary between different transmission time intervals. In the downlink the transmission is interrupted if the number of bits is lower than maximum. When the number of bits between different transmission time intervals in uplink is changed, bits are repeated or punctured to ensure that the total bit rate after TrCH multiplexing is identical to the total channel bit rate of the allocated dedicated physical channels.

If no bits are input to the rate matching for all TrCHs within a CCTrCH, the rate matching shall output no bits for all TrCHs within the CCTrCH and no uplink DPDCH will be selected in the case of uplink rate matching.

Notation used in subclause 4.2.7 and subclauses:

- $N_{i,j}$: For uplink: Number of bits in a radio frame before rate matching on TrCH i with transport format combination j .
For downlink: An intermediate calculation variable (not an integer but a multiple of 1/8).
- $N_{i,l}^{TTI}$: Number of bits in a transmission time interval before rate matching on TrCH i with transport format l .
Used in downlink only.
- $\Delta N_{i,j}$: For uplink: If positive - number of bits that should be repeated in each radio frame on TrCH i with transport format combination j .
If negative - number of bits that should be punctured in each radio frame on TrCH i with transport format combination j .
For downlink: An intermediate calculation variable (not an integer but a multiple of 1/8).
- $\Delta N_{i,l}^{TTI}$: If positive - number of bits to be repeated in each transmission time interval on TrCH i with transport format l .
If negative - number of bits to be punctured in each transmission time interval on TrCH i with transport format l .
Used in downlink only.
- $Np_{i,l}^{TTI,m}$, $m=0$ to $(F_{max}/F_i) - 1$: Positive or null: number of bits to be removed in TTI number m within the largest TTI, to create the required gaps in the compressed radio frames of this TTI, in case of compressed mode by puncturing, for TrCH i with transport format l . In case of fixed positions and compressed mode by puncturing, this value is noted $Np_{i,max}^{TTI,m}$ since it is calculated for all TrCH with their maximum number of bits; thus it is the same for all TFCs
Used in downlink only.
- $Np_{i,l}^n$, $n=0$ to $F_{max} - 1$: Positive or null: number of bits, in radio frame number n within the largest TTI, corresponding to the gap for compressed mode in this radio frame, for TrCH i with transport format l . The value will be null for the radio frames not overlapping with a transmission gap. In case of fixed positions and compressed mode by puncturing, this value is noted $Np_{i,max}^n$ since it is calculated for all TrCHs with their maximum number of bits; thus it is the same for all TFCs
Used in downlink only.
- $N_{TGL}[k]$, $k=0$ to $F_{max}-1$: Positive or null: number of bits in each radio frame corresponding to the gap for compressed mode for the CCTrCH.
- RM_i : Semi-static rate matching attribute for transport channel i . RM_i is provided by higher layers or takes a value as indicated in section 4.2.13.
- PL : Puncturing limit for uplink. This value limits the amount of puncturing that can be applied in order to avoid multicode or to enable the use of a higher spreading factor. Signalled from higher layers. The allowed puncturing in % is actually equal to $(1-PL)*100$.
- $N_{data,j}$: Total number of bits that are available for the CCTrCH in a radio frame with transport format combination j .
- I : Number of TrCHs in the CCTrCH.
- $Z_{i,j}$: Intermediate calculation variable.

- F_i : Number of radio frames in the transmission time interval of TrCH i .
- F_{\max} : Maximum number of radio frames in a transmission time interval used in the CCTrCH :
- $$F_{\max} = \max_{1 \leq i \leq I} F_i$$
- n_i : Radio frame number in the transmission time interval of TrCH i ($0 \leq n_i < F_i$).
- q : Average puncturing or repetition distance (normalised to only show the remaining rate matching on top of an integer number of repetitions). Used in uplink only.
- $P1_F(n_i)$: The column permutation function of the 1st interleaver, $P1_F(x)$ is the original position of column with number x after permutation. $P1$ is defined on table 4 of section 4.2.5.2 (note that the $P1_F$ is self-inverse). Used for rate matching in uplink only.
- $S[n]$: The shift of the puncturing or repetition pattern for radio frame n_i when $n = P1_{F_i}(n_i)$. Used in uplink only.
- $TF_i(j)$: Transport format of TrCH i for the transport format combination j .
- $TFS(i)$: The set of transport format indexes l for TrCH i .
- $TFCs$: The set of transport format combination indexes j .
- e_{ini} : Initial value of variable e in the rate matching pattern determination algorithm of subclause 4.2.7.5.
- e_{plus} : Increment of variable e in the rate matching pattern determination algorithm of subclause 4.2.7.5.
- e_{minus} : Decrement of variable e in the rate matching pattern determination algorithm of subclause 4.2.7.5.
- b : Indicates systematic and parity bits
- $b=1$: Systematic bit. x_k in subclause 4.2.3.2.1.
- $b=2$: 1st parity bit (from the upper Turbo constituent encoder). z_k in subclause 4.2.3.2.1.
- $b=3$: 2nd parity bit (from the lower Turbo constituent encoder). z'_k in subclause 4.2.3.2.1.

The * (star) notation is used to replace an index x when the indexed variable X_x does not depend on the index x . In the left wing of an assignment the meaning is that " $X_* = Y$ " is equivalent to "**for all x do $X_x = Y$** ". In the right wing of an assignment, the meaning is that " $Y = X_*$ " is equivalent to "**take any x and do $Y = X_x$** ".

The following relations, defined for all TFC j , are used when calculating the rate matching parameters:

$$Z_{0,j} = 0$$

$$Z_{i,j} = \left\lfloor \frac{\left(\left(\sum_{m=1}^i RM_m \times N_{m,j} \right) \times N_{data,j} \right)}{\sum_{m=1}^I RM_m \times N_{m,j}} \right\rfloor \text{ for all } i = 1 \dots I \quad (1)$$

$$\Delta N_{i,j} = Z_{i,j} - Z_{i-1,j} - N_{i,j} \text{ for all } i = 1 \dots I$$

4.2.7.1 Determination of rate matching parameters in uplink

4.2.7.1.1 Determination of SF and number of PhCHs needed

In uplink, puncturing can be applied to match the CCTrCH bit rate to the PhCH bit rate. The bit rate of the PhCH(s) is limited by the UE capability and restrictions imposed by UTRAN, through limitations on the PhCH spreading factor. The maximum amount of puncturing that can be applied is 1-PL, PL is signalled from higher layers. The number of

available bits in the radio frames of one PhCH for all possible spreading factors is given in [2]. Denote these values by N_{256} , N_{128} , N_{64} , N_{32} , N_{16} , N_8 , and N_4 , where the index refers to the spreading factor. The possible number of bits available to the CCTrCH on all PhCHs, N_{data} , then are $\{ N_{256}, N_{128}, N_{64}, N_{32}, N_{16}, N_8, N_4, 2 \times N_4, 3 \times N_4, 4 \times N_4, 5 \times N_4, 6 \times N_4 \}$.

For a RACH CCTrCH SET0 represents the set of N_{data} values allowed by the UTRAN, as set by the minimum SF provided by higher layers. SET0 may be a sub-set of $\{ N_{256}, N_{128}, N_{64}, N_{32} \}$. SET0 does not take into account the UE's capability.

For other CCTrCHs, SET0 denotes the set of N_{data} values allowed by the UTRAN and supported by the UE, as part of the UE's capability. SET0 can be a subset of $\{ N_{256}, N_{128}, N_{64}, N_{32}, N_{16}, N_8, N_4, 2 \times N_4, 3 \times N_4, 4 \times N_4, 5 \times N_4, 6 \times N_4 \}$. $N_{data,j}$ for the transport format combination j is determined by executing the following algorithm:

$$\text{SET1} = \{ N_{data} \text{ in SET0 such that } \left(\min_{1 \leq y \leq I} \{ RM_y \} \right) \times N_{data} - \sum_{x=1}^I RM_x \times N_{x,j} \text{ is non negative} \}$$

If SET1 is not empty and the smallest element of SET1 requires just one PhCH then

$$N_{data,j} = \min \text{SET1}$$

else

$$\text{SET2} = \{ N_{data} \text{ in SET0 such that } \left(\min_{1 \leq y \leq I} \{ RM_y \} \right) \times N_{data} - PL \times \sum_{x=1}^I RM_x \times N_{x,j} \text{ is non negative} \}$$

Sort SET2 in ascending order

$$N_{data} = \min \text{SET2}$$

While N_{data} is not the max of SET2 and the follower of N_{data} requires no additional PhCH do

$$N_{data} = \text{follower of } N_{data} \text{ in SET2}$$

End while

$$N_{data,j} = N_{data}$$

End if

For a RACH CCTrCH, if $N_{data,j}$ is not part of the UE's capability then the TFC j cannot be used.

4.2.7.1.2 Determination of parameters needed for calculating the rate matching pattern

The number of bits to be repeated or punctured, $\Delta N_{i,j}$, within one radio frame for each TrCH i is calculated with equation 1 for all possible transport format combinations j and selected every radio frame. $N_{data,j}$ is given from subclause 4.2.7.1.1.

In a compressed radio frame, $N_{data,j}$ is replaced by $N_{data,j}^{cm}$ in Equation 1. $N_{data,j}^{cm}$ is given as follows:

In a radio frame compressed by higher layer scheduling, $N_{data,j}^{cm}$ is obtained by executing the algorithm in subclause

4.2.7.1.1 but with the number of bits in one radio frame of one PhCH reduced to $\frac{N_{tr}}{15}$ of the value in normal mode.

N_{tr} is the number of transmitted slots in a compressed radio frame and is defined by the following relation:

$$N_{tr} = \begin{cases} 15 - TGL, & \text{if } N_{first} + TGL \leq 15 \\ N_{first}, & \text{in first frame if } N_{first} + TGL > 15 \\ 30 - TGL - N_{first}, & \text{in second frame if } N_{first} + TGL > 15 \end{cases}$$

N_{first} and TGL are defined in subclause 4.4.

In a radio frame compressed by spreading factor reduction, $N_{data,j}^{cm} = 2 \times (N_{data,j} - N_{TGL})$, where

$$N_{TGL} = \frac{15 - N_{tr}}{15} \times N_{data,j}$$

If $\Delta N_{ij} = 0$ then the output data of the rate matching is the same as the input data and the rate matching algorithm of subclause 4.2.7.5 does not need to be executed.

If $\Delta N_{ij} \neq 0$ the parameters listed in subclauses 4.2.7.1.2.1 and 4.2.7.1.2.2 shall be used for determining e_{minus} , e_{plus} , and e_{minus} (regardless if the radio frame is compressed or not).

4.2.7.1.2.1 Uncoded and convolutionally encoded TrCHs

$R = \Delta N_{ij} \bmod N_{ij}$ -- note: in this context $\Delta N_{ij} \bmod N_{ij}$ is in the range of 0 to $N_{ij}-1$ i.e. $-1 \bmod 10 = 9$.

if $R \neq 0$ and $2 \times R \leq N_{ij}$

$$\text{then } q = \lceil N_{ij} / R \rceil$$

else

$$q = \lceil N_{ij} / (R - N_{ij}) \rceil$$

endif

-- note: q is a signed quantity.

if q is even

$$\text{then } q' = q + \gcd(|q|, F_i) / F_i \text{ -- where } \gcd(|q|, F_i) \text{ means greatest common divisor of } |q| \text{ and } F_i$$

-- note that q' is not an integer, but a multiple of $1/8$

else

$$q' = q$$

endif

for $x = 0$ to $F_i - 1$

$$S[\lfloor x \times q' \rfloor \bmod F_i] = (\lfloor x \times q' \rfloor \text{ div } F_i)$$

end for

$$\Delta N_i = \Delta N_{ij}$$

$$a = 2$$

For each radio frame, the rate-matching pattern is calculated with the algorithm in subclause 4.2.7.5, where :

$$X_i = N_{i,j}, \text{ and}$$

$$e_{minus} = (a \times S[\text{P1}_{F_i}(n_i)] \times |\Delta N_i| + 1) \bmod (a \cdot N_{ij}).$$

$$e_{plus} = a \times N_{ij}$$

$$e_{minus} = a \times |\Delta N_i|$$

puncturing for $\Delta N < 0$, repetition otherwise.

4.2.7.1.2.2 Turbo encoded TrCHs

If repetition is to be performed on turbo encoded TrCHs, i.e. $\Delta N_{ij} > 0$, the parameters in subclause 4.2.7.1.2.1 are used.

If puncturing is to be performed, the parameters below shall be used. Index b is used to indicate systematic ($b=1$), 1st parity ($b=2$), and 2nd parity bit ($b=3$).

$a=2$ when $b=2$

$a=1$ when $b=3$

$$\Delta N_i = \begin{cases} \lfloor \Delta N_{i,j} / 2 \rfloor, & b = 2 \\ \lfloor \Delta N_{i,j} / 2 \rfloor, & b = 3 \end{cases}$$

If ΔN_i is calculated as 0 for $b=2$ or $b=3$, then the following procedure and the rate matching algorithm of subclause 4.2.7.5 don't need to be performed for the corresponding parity bit stream.

$$X_i = \lfloor N_{i,j} / 3 \rfloor,$$

$$q = \lfloor X_i / |\Delta N_i| \rfloor$$

if($q \leq 2$)

for $r=0$ to F_i-1

$$S[(3 \times r + b - 1) \bmod F_i] = r \bmod 2;$$

end for

else

if q is even

then $q' = q - \text{gcd}(q, F_i) / F_i$ -- where $\text{gcd}(q, F_i)$ means greatest common divisor of q and F_i
-- note that q' is not an integer, but a multiple of $1/8$

else $q' = q$

endif

for $x=0$ to $F_i - 1$

$$r = \lceil x \times q' \rceil \bmod F_i;$$

$$S[(3 \times r + b - 1) \bmod F_i] = \lceil x \times q' \rceil \text{div } F_i;$$

endfor

endif

For each radio frame, the rate-matching pattern is calculated with the algorithm in subclause 4.2.7.5, where:

X_i is as above:

$$e_{\text{ini}} = (a \times S[P1_{F_i}(n_i)] \times |\Delta N_i| + X_i) \bmod (a \times X_i), \text{ if } e_{\text{ini}} = 0 \text{ then } e_{\text{ini}} = a \times X_i$$

$$e_{\text{plus}} = a \times X_i$$

$$e_{\text{minus}} = a \times |\Delta N_i|$$

4.2.7.2 Determination of rate matching parameters in downlink

For downlink $N_{\text{data},j}$ does not depend on the transport format combination j . $N_{\text{data},*}$ is given by the channelization code(s) assigned by higher layers. Denote the number of physical channels used for the CCTrCH by P . $N_{\text{data},*}$ is the number of bits available to the CCTrCH in one radio frame and defined as $N_{\text{data},*} = P \times 15 \times (N_{\text{data}1} + N_{\text{data}2})$, where $N_{\text{data}1}$ and $N_{\text{data}2}$ are defined in [2]. Note that contrary to the uplink, the same rate matching patterns are used in TTIs containing no compressed radio frames and in TTIs containing radio frames compressed by spreading factor reduction or higher layer scheduling.

In the following, the total amount of puncturing or repetition for the TTI is calculated.

Additional calculations for TTIs containing radio frames compressed by puncturing in case fixed positions are used, are performed to determine this total amount of rate matching needed.

For compressed mode by puncturing, in TTIs where some compressed radio frames occur, the puncturing is increased or the repetition is decreased compared to what is calculated according to the rate matching parameters provided by higher layers. This allows to cope with reduction of available data bits on the physical channel(s) if the slot format for the compressed frame(s) contains fewer data bits than for the normal frames(s), and to create room for later insertion of marked bits, noted p-bits, which will identify the positions of the gaps in the compressed radio frames.

The amount of additional puncturing corresponds to the number of bits to create the gap in the TTI for TrCH i , plus the difference between the number of data bits available in normal frames and in compressed frames, due to slot format change. In case of fixed positions, it is calculated in addition to the amount of rate matching indicated by higher layers.

It is noted $Np_{i,\max}^{TTI,m}$.

In fixed positions case, to obtain the total rate matching $\Delta N_{i,\max}^{TTI,cm,m}$ to be performed on the TTI m , $Np_{i,\max}^{TTI,m}$ is subtracted from $\Delta N_{i,\max}^{TTI,m}$ (calculated based on higher layers RM parameters as for normal rate matching). This allows to create room for the $Np_{i,\max}^{TTI,m}$ bits p to be inserted later. If the result is null, i.e. the amount of repetition matches exactly the amount of additional puncturing needed, then no rate matching is necessary.

In case of compressed mode by puncturing and fixed positions, for some calculations, $N'_{data,*}$ is used for radio frames with gap instead of $N_{data,*}$, where $N'_{data,*} = P \times 15 \times (N'_{data1} + N'_{data2})$. N'_{data1} and N'_{data2} are the number of bits in the data fields of the slot format used for the current compressed mode, i.e. slot format A or B as defined in [2] corresponding to the Spreading Factor and the number of transmitted slots in use.

The number of bits corresponding to the gap for TrCH i , in each radio frame of its TTI is calculated using the number of bits to remove on all Physical Channels $N_{TGL}[k]$, where k is the radio frame number in the largest TTI.

For each radio frame k of the largest TTI that is overlapping with a transmission gap, $N_{TGL}[k]$ is given by the relation:

$$N_{TGL} = \begin{cases} \frac{TGL}{15} \times N'_{data,*}, & \text{if } N_{first} + TGL \leq 15 \\ \frac{15 - N_{first}}{15} \times N'_{data,*}, & \text{in first radio frame of the gap if } N_{first} + TGL > 15 \\ \frac{TGL - (15 - N_{first})}{15} \times N'_{data,*}, & \text{in second radio frame of the gap if } N_{first} + TGL > 15 \end{cases}$$

N_{first} and TGL are defined in subclause 4.4.

Note that $N_{TGL}[k] = 0$ if radio frame k is not overlapping with a transmission gap.

4.2.7.2.1 Determination of rate matching parameters for fixed positions of TrCHs

4.2.7.2.1.1 Calculation of $\Delta N_{i,\max}$ for normal mode and compressed mode by spreading factor reduction

First an intermediate calculation variable $N_{i,*}$ is calculated for all transport channels i by the following formula:

$$N_{i,*} = \frac{1}{F_i} \times \left(\max_{l \in TFS(i)} N_{i,l}^{TTI} \right)$$

In order to compute the $\Delta N_{i,l}^{TTI}$ parameters for all TrCH i and all TF l , we first compute an intermediate parameter $\Delta N_{i,\max}$ by the following formula, where $\Delta N_{i,*}$ is derived from $N_{i,*}$ by the formula given at subclause 4.2.7:

$$\Delta N_{i,\max} = F_i \times \Delta N_{i,*}$$

If $\Delta N_{i,\max} = 0$ then, for TrCH i , the output data of the rate matching is the same as the input data and the rate matching algorithm of subclause 4.2.7.5 does not need to be executed. In this case we have :

$$\forall l \in TFS(i) \Delta N_{i,l}^{TTI} = 0$$

If $\Delta N_{i,\max} \neq 0$ the parameters listed in subclauses 4.2.7.2.1.3 and 4.2.7.2.1.4 shall be used for determining e_{minus} , e_{plus} , and e_{minus} , and $\Delta N_{i,l}^{TTI}$.

4.2.7.2.1.2 Calculations for compressed mode by puncturing

Calculations of $\Delta N_{i,\max}^{TTI,m}$ for all TTI m within largest TTI, for all TrCH i

First an intermediate calculation variable $N_{i,*}$ is calculated for all transport channels i by the following formula:

$$N_{i,*} = \frac{1}{F_i} \times \left(\max_{l \in TFS(i)} N_{i,l}^{TTI} \right)$$

Then an intermediate calculation variable $\Delta N_{i,*}$ is derived from $N_{i,*}$ by the formula given at subclause 4.2.7, for all TrCH i .

In order to compute the $\Delta N_{i,l}^{TTI,m}$ parameters for all TrCH i , all TF l and all TTI with number m in the largest TTI, we first compute an intermediate parameter $\Delta N_{i,\max}^m$ by the following formula :

$$\Delta N_{i,\max}^m = F_i \times \Delta N_{i,*}$$

Calculations of $Np_{i,\max}^n$ and $Np_{i,\max}^{TTI,m}$

Let $Np_{i,\max}^n$ be the number of bits to eliminate on TrCH i to create the gap for compressed mode and to cope for the reduction of the number of available data bits in the compressed frame if the changed slot format contains fewer data bits than for normal frame, in each radio frame n of the TTI, calculated for the Transport Format Combination of TrCH i , in which the number of bits of TrCH i is at its maximum.

$Np_{i,\max}^n$ is calculated for each radio frame n of the TTI in the following way.

Intermediate variables Z_i for $i = 1$ to I are calculated using the formula (1) in 4.2.7, by replacing $N_{\text{data},j}$ by $(N_{TGL}[n] + (N_{\text{data},*} - N'_{\text{data},*}))$.

Then $Np_{i,\max}^n = (Z_i - Z_{i-1})$ for $i = 1$ to I

The total number of bits $Np_{i,\max}^{TTI,m}$ corresponding to the gaps for compressed mode for TrCH i in the TTI is calculated as:

$$Np_{i,\max}^{TTI,m} = \sum_{n=m \times F_i}^{n=(m+1) \times F_i - 1} Np_{i,\max}^n$$

The amount of rate matching $\Delta N_{i,\max}^{TTI,cm,m}$ for the highest TrCH bit rate is then computed by the following formula :

$$\Delta N_{i,\max}^{TTI,cm,m} = \Delta N_{i,\max}^m - Np_{i,\max}^{TTI,m}$$

If $\Delta N_{i,\max}^{TTI,cm,m} = 0$, then, for TrCH i , the output data of the rate matching is the same as the input data and the rate matching algorithm of subclause 4.2.7.5 does not need to be executed.

If $\Delta N_{i,\max}^{TTI,cm,m} \neq 0$, then, for TrCH i , the rate matching algorithm of subclause 4.2.7.5 needs to be executed, and the parameters listed in subclauses 4.2.7.2.1.3 and 4.2.7.2.1.4 shall be used for determining e_{ini} , e_{plus} , and e_{minus} , and $\Delta N_{i,l}^{TTI,m}$.

4.2.7.2.1.3 Determination of rate matching parameters for uncoded and convolutionally encoded TrCHs

$$\Delta N_i = \Delta N_{i,\max}$$

For compressed mode by puncturing, ΔN_i is defined as: $\Delta N_i = \Delta N_{i,\max}^{TTI,cm,m}$, instead of the previous relation.

$$a=2$$

$$N_{max} = \max_{l \in TFS(i)} N_{il}^{TTI}$$

For each transmission time interval of TrCH i with TF l , the rate-matching pattern is calculated with the algorithm in subclause 4.2.7.5. The following parameters are used as input:

$$X_i = N_{il}^{TTI}$$

$$e_{ini} = 1$$

$$e_{plus} = a \times N_{max}$$

$$e_{minus} = a \times |\Delta N_i|$$

Puncturing if $\Delta N_i < 0$, repetition otherwise. The values of $\Delta N_{i,l}^{TTI}$ may be computed by counting repetitions or puncturing when the algorithm of subclause 4.2.7.5 is run. The resulting values of $\Delta N_{i,l}^{TTI}$ can be represented with following expression.

$$\Delta N_{i,l}^{TTI} = \left\lceil \frac{|\Delta N_i| \times X_i}{N_{max}} \right\rceil \times \text{sgn}(\Delta N_i)$$

For compressed mode by puncturing, the above formula produces $\Delta N_{i,l}^{TTI,m}$ instead of $\Delta N_{i,l}^{TTI}$.

4.2.7.2.1.4 Determination of rate matching parameters for Turbo encoded TrCHs

If repetition is to be performed on turbo encoded TrCHs, i.e. $\Delta N_{i,\max} > 0$, the parameters in subclause 4.2.7.2.1.3 are used.

If puncturing is to be performed, the parameters below shall be used. Index b is used to indicate systematic ($b=1$), 1st parity ($b=2$), and 2nd parity bit ($b=3$).

$$a=2 \text{ when } b=2$$

$$a=1 \text{ when } b=3$$

The bits indicated by $b=1$ shall not be punctured.

$$\Delta N_i^b = \begin{cases} \left\lfloor \frac{\Delta N_{i,\max}}{2} \right\rfloor, & \text{for } b=2 \\ \left\lceil \frac{\Delta N_{i,\max}}{2} \right\rceil, & \text{for } b=3 \end{cases}$$

In Compressed Mode by puncturing, the following relations are used instead of the previous ones:

$$\Delta N_i^b = \left\lfloor \frac{\Delta N_{i,\max}^{TTI,cm,m}}{2} \right\rfloor, \text{ for } b=2$$

$$\Delta N_{i,l}^b = \left\lceil \frac{\Delta N_{i,\max}^{TTI,cm,m}}{2} \right\rceil, \text{ for } b=3$$

$$N_{\max} = \max_{l \in TFS(i)} (N_{il}^{TTI} / 3)$$

For each transmission time interval of TrCH i with TF l , the rate-matching pattern is calculated with the algorithm in subclause 4.2.7.5. The following parameters are used as input:

$$X_i = N_{il}^{TTI} / 3$$

$$e_{ini} = N_{\max}$$

$$e_{plus} = a \times N_{\max}$$

$$e_{minus} = a \times |\Delta N_i^b|$$

The values of $\Delta N_{i,l}^{TTI}$ may be computed by counting puncturing when the algorithm of subclause 4.2.7.5 is run. The resulting values of $\Delta N_{i,l}^{TTI}$ can be represented with following expression.

$$\Delta N_{i,l}^{TTI} = - \left\lfloor \frac{|\Delta N_i^2| \times X_i}{N_{\max}} + 0.5 \right\rfloor - \left\lfloor \frac{|\Delta N_i^3| \times X_i}{N_{\max}} \right\rfloor$$

In the above equation, the first term of the right hand side represents the amount of puncturing for $b=2$ and the second term represents the amount of puncturing for $b=3$.

For compressed mode by puncturing, the above formula produces $\Delta N_{i,l}^{TTI,m}$ instead of $\Delta N_{i,l}^{TTI}$.

4.2.7.2.2 Determination of rate matching parameters for flexible positions of TrCHs

4.2.7.2.2.1 Calculations for normal mode, compressed mode by higher layer scheduling, and compressed mode by spreading factor reduction

First an intermediate calculation variable N_{ij} is calculated for all transport channels i and all transport format combinations j by the following formula:

$$N_{i,j} = \frac{1}{F_i} \times N_{i,TF_i(j)}^{TTI}$$

Then rate matching ratios RF_i are calculated for each the transport channel i in order to minimise the number of DTX bits when the bit rate of the CCTrCH is maximum. The RF_i ratios are defined by the following formula:

$$RF_i = \frac{N_{data,*}}{\max_{j \in TFCS} \sum_{i=1}^{i=I} (RM_i \times N_{i,j})} \times RM_i$$

The computation of $\Delta N_{i,l}^{TTI}$ parameters is then performed in two phases. In a first phase, tentative temporary values of $\Delta N_{i,l}^{TTI}$ are computed, and in the second phase they are checked and corrected. The first phase, by use of the RF_i ratios, ensures that the number of DTX indication bits inserted is minimum when the CCTrCH bit rate is maximum, but it does not ensure that the maximum CCTrCH bit rate is not greater than $N_{data,*}$ per 10ms. The latter condition is ensured through the checking and possible corrections carried out in the second phase.

At the end of the second phase, the latest value of $\Delta N_{i,l}^{TTI}$ is the definitive value.

The first phase defines the tentative temporary $\Delta N_{i,l}^{TTI}$ for all transport channel i and any of its transport format l by use of the following formula:

$$\Delta N_{i,l}^{TTI} = F_i \times \left[\frac{RF_i \times N_{i,l}^{TTI}}{F_i} \right] - N_{i,l}^{TTI} = F_i \times \left[\frac{N_{data,*} \times RM_i \times N_{i,l}^{TTI}}{F_i \times \max_{j \in TFCS} \sum_{i=1}^I (RM_i \times N_{i,j})} \right] - N_{i,l}^{TTI}$$

The second phase is defined by the following algorithm:

for all j in $TFCS$ in ascending order of TFCI do -- for all TFC

$$D = \sum_{i=1}^{i=I} \frac{N_{i,TF_i(j)}^{TTI} + \Delta N_{i,TF_i(j)}^{TTI}}{F_i} \quad \text{-- CCTrCH bit rate (bits per 10ms) for TFC } j$$

if $D > N_{data,*}$ then

for $i = 1$ to I do -- for all TrCH

$$\Delta N = F_i \times \Delta N_{i,j} \quad \text{-- } \Delta N_{i,j} \text{ is derived from } N_{i,j} \text{ by the formula given at subclause 4.2.7.}$$

if $\Delta N_{i,TF_i(j)}^{TTI} > \Delta N$ then

$$\Delta N_{i,TF_i(j)}^{TTI} = \Delta N$$

end-if

end-for

end-if

end-for

If $\Delta N_{i,l}^{TTI} = 0$ then, for TrCH i at TF l , the output data of the rate matching is the same as the input data and the rate matching algorithm of subclause 4.2.7.5 does not need to be executed.

If $\Delta N_{i,l}^{TTI} \neq 0$ the parameters listed in subclauses 4.2.7.2.2.2 and 4.2.7.2.2.3 shall be used for determining e_{minus} , e_{plus} , and e_{minus} .

4.2.7.2.2.2 Determination of rate matching parameters for uncoded and convolutionally encoded TrCHs

$$\Delta N_i = \Delta N_{il}^{TTI}$$

$$a=2$$

For each transmission time interval of TrCH i with TF l , the rate-matching pattern is calculated with the algorithm in subclause 4.2.7.5. The following parameters are used as input:

$$X_i = N_{il}^{TTI}$$

$$e_{ini} = 1$$

$$e_{plus} = a \times N_{il}^{TTI}$$

$$e_{minus} = a \times |\Delta N_i|$$

puncturing for $\Delta N_i < 0$, repetition otherwise.

4.2.7.2.2.3 Determination of rate matching parameters for Turbo encoded TrCHs

If repetition is to be performed on turbo encoded TrCHs, i.e. $\Delta N_{il}^{TTI} > 0$, the parameters in subclause 4.2.7.2.2.2 are used.

If puncturing is to be performed, the parameters below shall be used. Index b is used to indicate systematic ($b=1$), 1st parity ($b=2$), and 2nd parity bit ($b=3$).

$$a=2 \text{ when } b=2$$

$$a=1 \text{ when } b=3$$

The bits indicated by $b=1$ shall not be punctured.

$$\Delta N_i = \begin{cases} \left\lfloor \Delta N_{il}^{TTI} / 2 \right\rfloor, & b = 2 \\ \left\lfloor \Delta N_{il}^{TTI} / 2 \right\rfloor, & b = 3 \end{cases}$$

For each transmission time interval of TrCH i with TF l , the rate-matching pattern is calculated with the algorithm in subclause 4.2.7.5. The following parameters are used as input:

$$X_i = N_{il}^{TTI} / 3,$$

$$e_{ini} = X_i,$$

$$e_{plus} = a \times X_i$$

$$e_{minus} = a \times |\Delta N_i|$$

4.2.7.3 Bit separation and collection in uplink

The systematic bits of turbo encoded TrCHs shall not be punctured, the other bits may be punctured. The systematic bits, first parity bits, and second parity bits in the bit sequence input to the rate matching block are therefore separated into three sequences.

The first sequence contains:

- All of the systematic bits that are from turbo encoded TrCHs.

- From 0 to 2 first and/or second parity bits that are from turbo encoded TrCHs. These bits come into the first sequence when the total number of bits in a block after radio frame segmentation is not a multiple of three.
- Some of the systematic, first parity and second parity bits that are for trellis termination.

The second sequence contains:

- All of the first parity bits that are from turbo encoded TrCHs, except those that go into the first sequence when the total number of bits is not a multiple of three.
- Some of the systematic, first parity and second parity bits that are for trellis termination.

The third sequence contains:

- All of the second parity bits that are from turbo encoded TrCHs, except those that go into the first sequence when the total number of bits is not a multiple of three.
- Some of the systematic, first parity and second parity bits that are for trellis termination.

The second and third sequences shall be of equal length, whereas the first sequence can contain from 0 to 2 more bits. Puncturing is applied only to the second and third sequences. The bit separation function is transparent for uncoded TrCHs, convolutionally encoded TrCHs, and for turbo encoded TrCHs with repetition. The bit separation and bit collection are illustrated in figures 5 and 6.

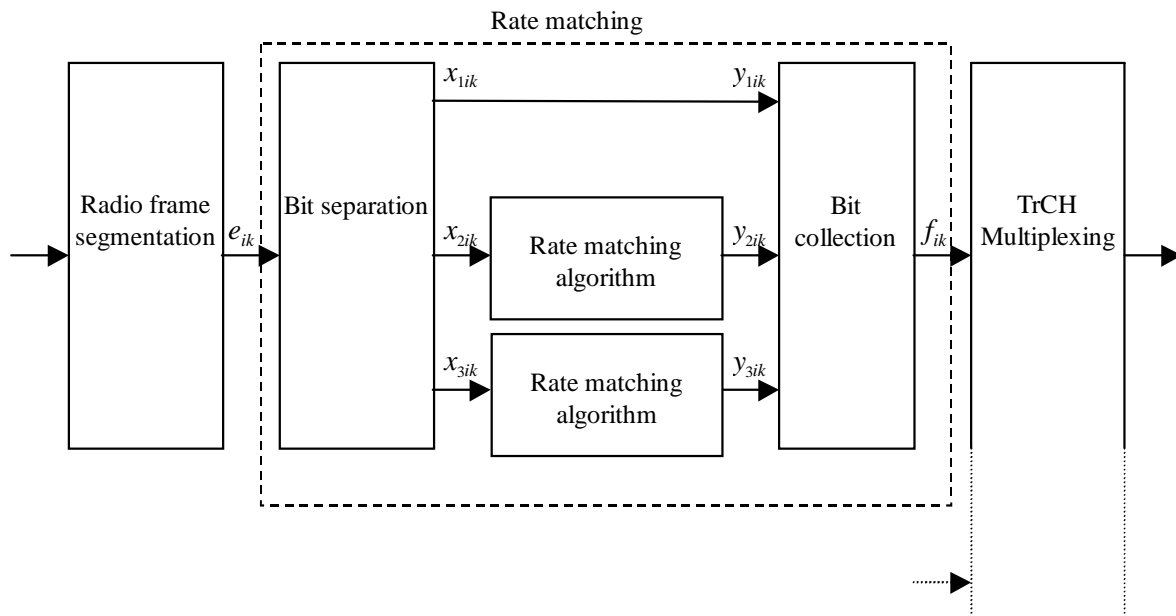

Figure 5: Puncturing of turbo encoded TrCHs in uplink

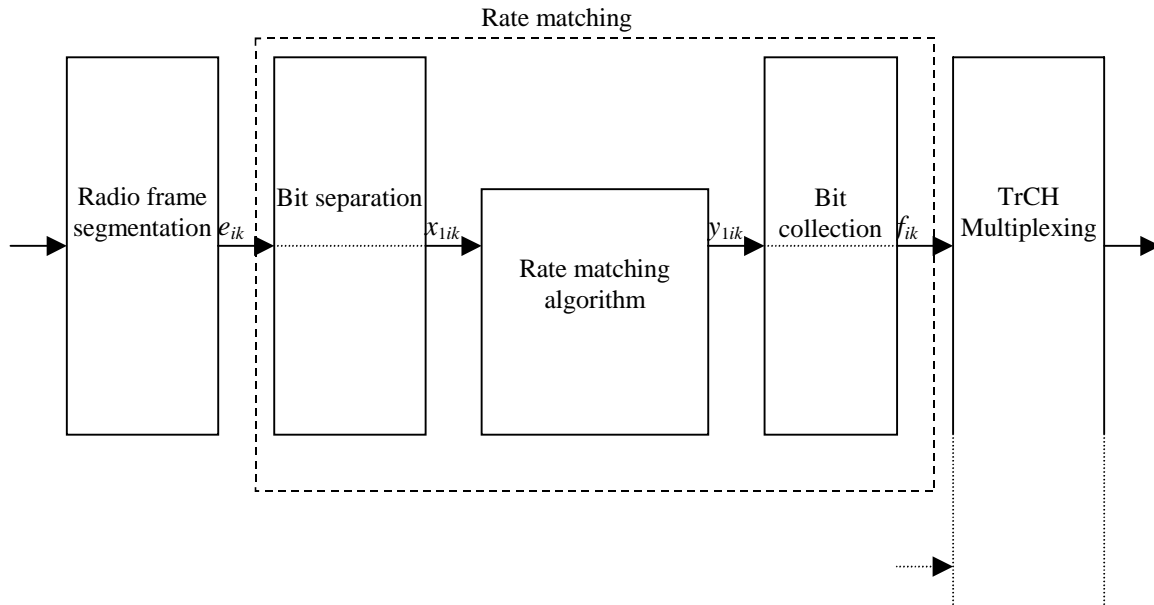

Figure 6: Rate matching for uncoded TrCHs, convolutionally encoded TrCHs, and for turbo encoded TrCHs with repetition in uplink

The bit separation is dependent on the 1st interleaving and offsets are used to define the separation for different TTIs. b indicates the three sequences defined in this section, with $b=1$ indicating the first sequence, $b = 2$ the second one, and $b = 3$ the third one. The offsets α_b for these sequences are listed in table 5.

Table 5: TTI dependent offset needed for bit separation

TTI (ms)	α_1	α_2	α_3
10, 40	0	1	2
20, 80	0	2	1

The bit separation is different for different radio frames in the TTI. A second offset is therefore needed. The radio frame number for TrCH i is denoted by n_i , and the offset by β_{n_i} .

Table 6: Radio frame dependent offset needed for bit separation

TTI (ms)	β_0	β_1	β_2	β_3	β_4	β_5	β_6	β_7
10	0	NA	NA	NA	NA	NA	NA	NA
20	0	1	NA	NA	NA	NA	NA	NA
40	0	1	2	0	NA	NA	NA	NA
80	0	1	2	0	1	2	0	1

4.2.7.3.1 Bit separation

The bits input to the rate matching are denoted by $e_{i1}, e_{i2}, e_{i3}, \dots, e_{iN_i}$, where i is the TrCH number and N_i is the number of bits input to the rate matching block. Note that the transport format combination number j for simplicity has been left out in the bit numbering, i.e. $N_i=N_{ij}$. The bits after separation are denoted by $x_{bi1}, x_{bi2}, x_{bi3}, \dots, x_{biX_i}$. For turbo encoded TrCHs with puncturing, b indicates the three sequences defined in section 4.2.7.3, with $b=1$ indicating the first sequence, and so forth. For all other cases b is defined to be 1. X_i is the number of bits in each separated bit sequence. The relation between e_{ik} and x_{bik} is given below.

For turbo encoded TrCHs with puncturing:

$$x_{1,i,k} = e_{i,3(k-1)+1+(\alpha_1+\beta_{n_i}) \bmod 3} \quad k = 1, 2, 3, \dots, X_i \quad X_i = \lfloor N_i / 3 \rfloor$$

$$x_{1,i,\lfloor N_i/3 \rfloor+k} = e_{i,3\lfloor N_i/3 \rfloor+k} \quad k = 1, \dots, N_i \bmod 3 \quad \text{Note: When } (N_i \bmod 3) = 0 \text{ this row is not needed.}$$

$$x_{2,i,k} = e_{i,3(k-1)+1+(\alpha_2+\beta_{n_i}) \bmod 3} \quad k = 1, 2, 3, \dots, X_i \quad X_i = \lfloor N_i/3 \rfloor$$

$$x_{3,i,k} = e_{i,3(k-1)+1+(\alpha_3+\beta_{n_i}) \bmod 3} \quad k = 1, 2, 3, \dots, X_i \quad X_i = \lfloor N_i/3 \rfloor$$

For uncoded TrCHs, convolutionally encoded TrCHs, and turbo encoded TrCHs with repetition:

$$x_{1,i,k} = e_{i,k} \quad k = 1, 2, 3, \dots, X_i \quad X_i = N_i$$

4.2.7.3.2 Bit collection

The bits x_{bik} are input to the rate matching algorithm described in subclause 4.2.7.5. The bits output from the rate matching algorithm are denoted $y_{bi1}, y_{bi2}, y_{bi3}, \dots, y_{biY_i}$.

Bit collection is the inverse function of the separation. The bits after collection are denoted by $z_{bi1}, z_{bi2}, z_{bi3}, \dots, z_{biY_i}$. After bit collection, the bits indicated as punctured are removed and the bits are then denoted by $f_{i1}, f_{i2}, f_{i3}, \dots, f_{iV_i}$, where i is the TrCH number and $V_i = N_i + \Delta N_i$. The relations between y_{bik} , z_{bik} , and f_{ik} are given below.

For turbo encoded TrCHs with puncturing ($Y_i = X_i$):

$$z_{i,3(k-1)+1+(\alpha_1+\beta_{n_i}) \bmod 3} = y_{1,i,k} \quad k = 1, 2, 3, \dots, Y_i$$

$$z_{i,3\lfloor N_i/3 \rfloor+k} = y_{1,i,\lfloor N_i/3 \rfloor+k} \quad k = 1, \dots, N_i \bmod 3 \quad \text{Note: When } (N_i \bmod 3) = 0 \text{ this row is not needed.}$$

$$z_{i,3(k-1)+1+(\alpha_2+\beta_{n_i}) \bmod 3} = y_{2,i,k} \quad k = 1, 2, 3, \dots, Y_i$$

$$z_{i,3(k-1)+1+(\alpha_3+\beta_{n_i}) \bmod 3} = y_{3,i,k} \quad k = 1, 2, 3, \dots, Y_i$$

After the bit collection, bits $z_{i,k}$ with value δ , where $\delta \notin \{0, 1\}$, are removed from the bit sequence. Bit $f_{i,1}$ corresponds to the bit $z_{i,k}$ with smallest index k after puncturing, bit $f_{i,2}$ corresponds to the bit $z_{i,k}$ with second smallest index k after puncturing, and so on.

For uncoded TrCHs, convolutionally encoded TrCHs, and turbo encoded TrCHs with repetition:

$$z_{i,k} = y_{1,i,k} \quad k = 1, 2, 3, \dots, Y_i$$

When repetition is used, $f_{i,k} = z_{i,k}$ and $Y_i = V_i$.

When puncturing is used, $Y_i = X_i$ and bits $z_{i,k}$ with value δ , where $\delta \notin \{0, 1\}$, are removed from the bit sequence. Bit $f_{i,1}$ corresponds to the bit $z_{i,k}$ with smallest index k after puncturing, bit $f_{i,2}$ corresponds to the bit $z_{i,k}$ with second smallest index k after puncturing, and so on.

4.2.7.4 Bit separation and collection in downlink

The systematic bits of turbo encoded TrCHs shall not be punctured, the other bits may be punctured.

The systematic bits, first parity bits and second parity bits in the bit sequence input to the rate matching block are therefore separated into three sequences of equal lengths.

The first sequence contains :

- All of the systematic bits that are from turbo encoded TrCHs.
- Some of the systematic, first parity and second parity bits that are for trellis termination.

The second sequence contains:

- All of the first parity bits that are from turbo encoded TrCHs.
- Some of the systematic, first parity and second parity bits that are for trellis termination.

The third sequence contains:

- All of the second parity bits that are from turbo encoded TrCHs.
- Some of the systematic, first parity and second parity bits that are for trellis termination.

Puncturing is applied only to the second and third sequences.

The bit separation function is transparent for uncoded TrCHs, convolutionally encoded TrCHs, and for turbo encoded TrCHs with repetition. The bit separation and bit collection are illustrated in figures 7 and 8.

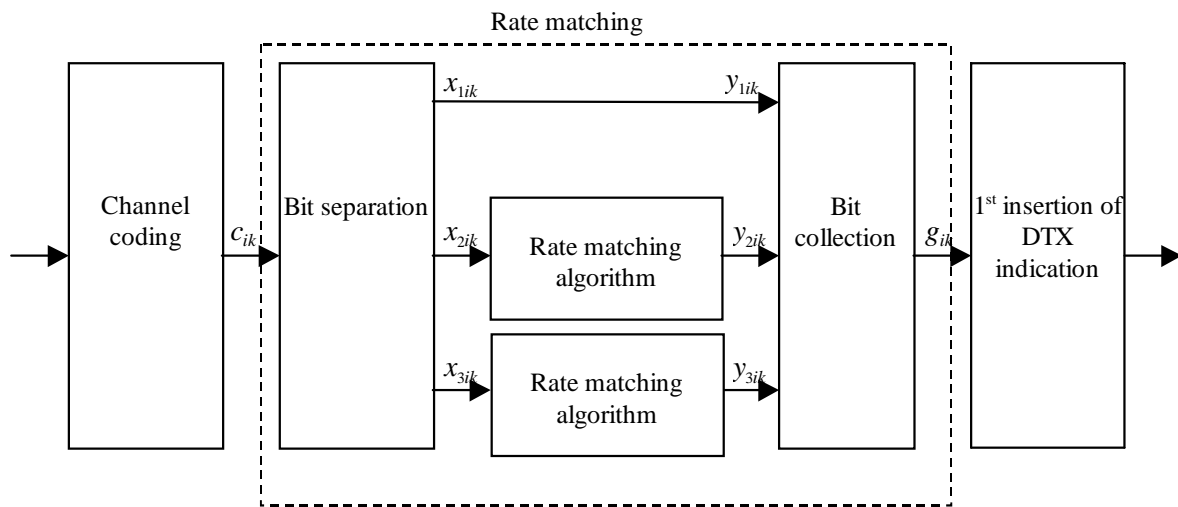

Figure 7: Puncturing of turbo encoded TrCHs in downlink

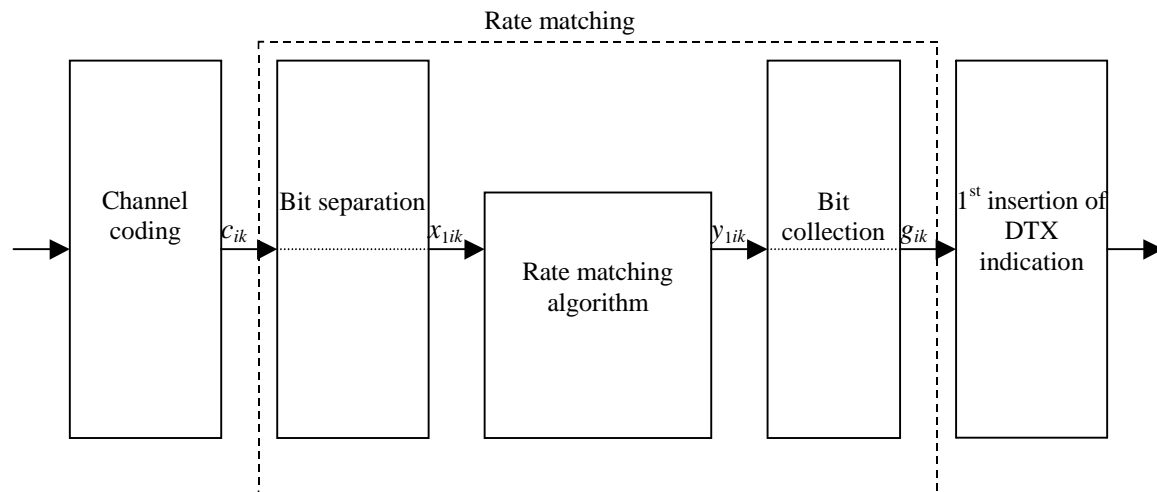

Figure 8: Rate matching for uncoded TrCHs, convolutionally encoded TrCHs, and for turbo encoded TrCHs with repetition in downlink

4.2.7.4.1 Bit separation

The bits input to the rate matching are denoted by $C_{i1}, C_{i2}, C_{i3}, \dots, C_{iE_i}$, where i is the TrCH number and E_i is the number of bits input to the rate matching block. Note that E_i is a multiple of 3 for turbo encoded TrCHs and that the transport format l for simplicity has been left out in the bit numbering, i.e. $E_i = N_{il}^{TTI}$. The bits after separation are

denoted by $x_{bi1}, x_{bi2}, x_{bi3}, \dots, x_{biX_i}$. For turbo encoded TrCHs with puncturing, b indicates the three sequences defined in section 4.2.7.4, with $b=1$ indicating the first sequence, and so forth. For all other cases b is defined to be 1. X_i is the number of bits in each separated bit sequence. The relation between c_{ik} and x_{bik} is given below.

For turbo encoded TrCHs with puncturing:

$$x_{1,i,k} = c_{i,3(k-1)+1} \quad k = 1, 2, 3, \dots, X_i \quad X_i = E_i/3$$

$$x_{2,i,k} = c_{i,3(k-1)+2} \quad k = 1, 2, 3, \dots, X_i \quad X_i = E_i/3$$

$$x_{3,i,k} = c_{i,3(k-1)+3} \quad k = 1, 2, 3, \dots, X_i \quad X_i = E_i/3$$

For uncoded TrCHs, convolutionally encoded TrCHs, and turbo encoded TrCHs with repetition:

$$x_{1,i,k} = c_{i,k} \quad k = 1, 2, 3, \dots, X_i \quad X_i = E_i$$

4.2.7.4.2 Bit collection

The bits x_{bik} are input to the rate matching algorithm described in subclause 4.2.7.5. The bits output from the rate matching algorithm are denoted $y_{bi1}, y_{bi2}, y_{bi3}, \dots, y_{biY_i}$.

Bit collection is the inverse function of the separation. The bits after collection are denoted by $z_{bi1}, z_{bi2}, z_{bi3}, \dots, z_{biY_i}$. After bit collection, the bits indicated as punctured are removed and the bits are then denoted by $g_{i1}, g_{i2}, g_{i3}, \dots, g_{iG_i}$, where i is the TrCH number and $G_i = N_{il}^{TTI} + \Delta N_{il}^{TTI}$. The relations between y_{bik} , z_{bik} , and g_{ik} are given below.

For turbo encoded TrCHs with puncturing ($Y_i=X_i$):

$$z_{i,3(k-1)+1} = y_{1,i,k} \quad k = 1, 2, 3, \dots, Y_i$$

$$z_{i,3(k-1)+2} = y_{2,i,k} \quad k = 1, 2, 3, \dots, Y_i$$

$$z_{i,3(k-1)+3} = y_{3,i,k} \quad k = 1, 2, 3, \dots, Y_i$$

After the bit collection, bits $z_{i,k}$ with value δ , where $\delta \notin \{0, 1\}$, are removed from the bit sequence. Bit $g_{i,1}$ corresponds to the bit $z_{i,k}$ with smallest index k after puncturing, bit $g_{i,2}$ corresponds to the bit $z_{i,k}$ with second smallest index k after puncturing, and so on.

For uncoded TrCHs, convolutionally encoded TrCHs, and turbo encoded TrCHs with repetition:

$$z_{i,k} = y_{1,i,k} \quad k = 1, 2, 3, \dots, Y_i$$

When repetition is used, $g_{i,k}=z_{i,k}$ and $Y_i=G_i$.

When puncturing is used, $Y_i=X_i$ and bits $z_{i,k}$ with value δ , where $\delta \notin \{0, 1\}$, are removed from the bit sequence. Bit $g_{i,1}$ corresponds to the bit $z_{i,k}$ with smallest index k after puncturing, bit $g_{i,2}$ corresponds to the bit $z_{i,k}$ with second smallest index k after puncturing, and so on.

4.2.7.5 Rate matching pattern determination

Denote the bits before rate matching by:

$x_{i1}, x_{i2}, x_{i3}, \dots, x_{iX_i}$, where i is the TrCH number and the sequence is defined in 4.2.7.3 for uplink or in 4.2.7.4 for downlink. Parameters X_i , e_{ini} , e_{plus} , and e_{minus} are given in 4.2.7.1 for uplink or in 4.2.7.2 for downlink.

The rate matching rule is as follows:

if puncturing is to be performed

$e = e_{ini}$ -- initial error between current and desired puncturing ratio

$m = 1$ -- index of current bit

do while $m \leq X_i$

$e = e - e_{minus}$ -- update error

if $e \leq 0$ then -- check if bit number m should be punctured

 set bit $x_{i,m}$ to δ where $\delta \in \{0, 1\}$

$e = e + e_{plus}$ -- update error

end if

$m = m + 1$ -- next bit

end do

else

$e = e_{ini}$ -- initial error between current and desired puncturing ratio

$m = 1$ -- index of current bit

do while $m \leq X_i$

$e = e - e_{minus}$ -- update error

do while $e \leq 0$ -- check if bit number m should be repeated

 repeat bit $x_{i,m}$

$e = e + e_{plus}$ -- update error

end do

$m = m + 1$ -- next bit

end do

end if

A repeated bit is placed directly after the original one.

4.2.8 TrCH multiplexing

Every 10 ms, one radio frame from each TrCH is delivered to the TrCH multiplexing. These radio frames are serially multiplexed into a coded composite transport channel (CCTrCH).

The bits input to the TrCH multiplexing are denoted by $f_{i1}, f_{i2}, f_{i3}, \dots, f_{iV_i}$, where i is the TrCH number and V_i is the number of bits in the radio frame of TrCH i . The number of TrCHs is denoted by I . The bits output from TrCH multiplexing are denoted by $s_1, s_2, s_3, \dots, s_S$, where S is the number of bits, i.e. $S = \sum_i V_i$. The TrCH multiplexing is defined by the following relations:

$$s_k = f_{1k} \quad k = 1, 2, \dots, V_1$$

$$s_k = f_{2,(k-V_1)} \quad k = V_1+1, V_1+2, \dots, V_1+V_2$$

$$s_k = f_{3,(k-(V_1+V_2))} \quad k = (V_1+V_2)+1, (V_1+V_2)+2, \dots, (V_1+V_2)+V_3$$

...

$$s_k = f_{I, (k - (V_1 + V_2 + \dots + V_{I-1}))} \quad k = (V_1 + V_2 + \dots + V_{I-1}) + 1, (V_1 + V_2 + \dots + V_{I-1}) + 2, \dots, (V_1 + V_2 + \dots + V_{I-1}) + V_I$$

4.2.9 Insertion of discontinuous transmission (DTX) indication bits

In the downlink, DTX is used to fill up the radio frame with bits. The insertion point of DTX indication bits depends on whether fixed or flexible positions of the TrCHs in the radio frame are used. It is up to the UTRAN to decide for each CTrCH whether fixed or flexible positions are used during the connection. DTX indication bits only indicate when the transmission should be turned off, they are not transmitted.

4.2.9.1 1st insertion of DTX indication bits

This step of inserting DTX indication bits is used only if the positions of the TrCHs in the radio frame are fixed. With fixed position scheme a fixed number of bits is reserved for each TrCH in the radio frame.

The bits from rate matching are denoted by $g_{i1}, g_{i2}, g_{i3}, \dots, g_{iG_i}$, where G_i is the number of bits in one TTI of TrCH i . Denote the number of bits in one radio frame of TrCH i by H_i . Denote D_i the number of bits output of the first DTX insertion block.

In TTIs containing no compressed frames or frames compressed by spreading factor reduction, H_i is constant and corresponds to the maximum number of bits from TrCH i in one radio frame for any transport format of TrCH i and $D_i = F_i \times H_i$.

In TTIs containing frames compressed by puncturing, additional puncturing is performed in the rate matching block. The empty positions resulting from the additional puncturing are used to insert p-bits in the first interleaving block, the DTX insertion is therefore limited to allow for later insertion of p-bits. Thus DTX bits are inserted until the total number of bits is D_i where $D_i = F_i \times H_i - Np^{TTI, m}_{i, max}$ and $H_i = N_{i*} + \Delta N_{i*}$.

The bits output from the DTX insertion are denoted by $h_{i1}, h_{i2}, h_{i3}, \dots, h_{iD_i}$. Note that these bits are three valued. They are defined by the following relations:

$$h_{ik} = g_{ik} \quad k = 1, 2, 3, \dots, G_i$$

$$h_{ik} = \delta \quad k = G_i + 1, G_i + 2, G_i + 3, \dots, D_i$$

where DTX indication bits are denoted by δ . Here $g_{ik} \in \{0, 1\}$ and $\delta \in \{0, 1\}$.

4.2.9.2 2nd insertion of DTX indication bits

The DTX indication bits inserted in this step shall be placed at the end of the radio frame. Note that the DTX will be distributed over all slots after 2nd interleaving.

The bits input to the DTX insertion block are denoted by $s_1, s_2, s_3, \dots, s_S$, where S is the number of bits from TrCH multiplexing. The number of PhCHs is denoted by P and the number of bits in one radio frame, including DTX indication bits, for each PhCH by R .

In non-compressed frames, $R = \frac{N_{data,*}}{P} = 15 \times (N_{data1} + N_{data2})$, where N_{data1} and N_{data2} are defined in [2].

For compressed frames, $N'_{data,*}$ is defined as $N'_{data,*} = P \times 15 \times (N'_{data1} + N'_{data2})$. N'_{data1} and N'_{data2} are the number of bits in the data fields of the slot format used for the current compressed frame, i.e. slot format A or B as defined in [2] corresponding to the spreading factor and the number of transmitted slots in use.

In frames compressed by puncturing and when fixed positions are used, no DTX shall be inserted, since the exact room for the gap is already reserved thanks to the earlier insertion of the p-bits.

In frames compressed by higher layer scheduling, additional DTX with respect to normal mode shall be inserted if the transmission time reduction does not exactly create a transmission gap of the desired TGL .

The number of bits available to the CCTrCH in one radio frame compressed by spreading factor reduction or by higher layer scheduling is denoted by $N_{data,*}^{cm}$ and $R = \frac{N_{data,*}^{cm}}{P}$.

For frames compressed by spreading factor reduction $N_{data,*}^{cm} = \frac{N'_{data,*}}{2}$.

For frames compressed by higher layer scheduling the exact value of $N_{data,*}^{cm}$ is dependent on the TGL which is signalled from higher layers. It can be calculated as $N_{data,*}^{cm} = N'_{data,*} - N_{TGL}$.

N_{TGL} is the number of bits that are located within the transmission gap and defined as:

$$N_{TGL} = \begin{cases} \frac{TGL}{15} \times N'_{data,*}, & \text{if } N_{first} + TGL \leq 15 \\ \frac{15 - N_{first}}{15} \times N'_{data,*}, & \text{in first frame if } N_{first} + TGL > 15 \\ \frac{TGL - (15 - N_{first})}{15} \times N'_{data,*}, & \text{in second frame if } N_{first} + TGL > 15 \end{cases}$$

N_{first} and TGL are defined in subclause 4.4.

The bits output from the DTX insertion block are denoted by $w_1, w_2, w_3, \dots, w_{(PR)}$. Note that these bits are four valued in case of compressed mode by puncturing, and three valued otherwise. They are defined by the following relations:

$$w_k = s_k \quad k = 1, 2, 3, \dots, S$$

$$w_k = \delta \quad k = S+1, S+2, S+3, \dots, P \cdot R$$

where DTX indication bits are denoted by δ . Here $s_k \in \{0, 1, p\}$ and $\delta \in \{0, 1\}$.

4.2.10 Physical channel segmentation

When more than one PhCH is used, physical channel segmentation divides the bits among the different PhCHs. The bits input to the physical channel segmentation are denoted by $x_1, x_2, x_3, \dots, x_X$, where X is the number of bits input to the physical channel segmentation block. The number of PhCHs is denoted by P .

The bits after physical channel segmentation are denoted $u_{p1}, u_{p2}, u_{p3}, \dots, u_{pU}$, where p is PhCH number and U is the number of bits in one radio frame for each PhCH, i.e. $U = (X - N_{TGL} - (N_{data,*} - N'_{data,*})) / P$ for compressed mode by puncturing, and $U = \frac{X}{P}$ otherwise. The relation between x_k and u_{pk} is given below.

For all modes, some bits of the input flow are mapped to each code until the number of bits on the code is U . For modes other than compressed mode by puncturing, all bits of the input flow are taken to be mapped to the codes. For compressed mode by puncturing, only the bits of the input flow not corresponding to bits p are taken to be mapped to the codes, each bit p is removed to ensure creation the gap required by the compressed mode, as described below.

Bits on first PhCH after physical channel segmentation:

$$u_{1,k} = x_{f(k)} \quad k = 1, 2, \dots, U$$

Bits on second PhCH after physical channel segmentation:

$$u_{2,k} = x_{f(k+U)} \quad k = 1, 2, \dots, U$$

...

Bits on the P^{th} PhCH after physical channel segmentation:

$$u_{P,k} = x_{f(k+(P-1) \times U)} \quad k = 1, 2, \dots, U$$

where f is such that :

- for modes other than compressed mode by puncturing, $x_{f(k)} = x_k$, i.e. $f(k) = k$, for all k .
- for compressed mode by puncturing, bit $u_{1,1}$ corresponds to the bit x_k with smallest index k when the bits p are not counted, bit $u_{1,2}$ corresponds to the bit x_k with second smallest index k when the bits p are not counted, and so on for bits $u_{1,3}, \dots, u_{1,U}, u_{2,1}, u_{2,2}, \dots, u_{2,U}, \dots, u_{P,1}, u_{P,2}, \dots, u_{P,U}$.

4.2.10.1 Relation between input and output of the physical segmentation block in uplink

The bits input to the physical segmentation are denoted by $s_1, s_2, s_3, \dots, s_S$. Hence, $x_k = s_k$ and $Y = S$.

4.2.10.2 Relation between input and output of the physical segmentation block in downlink

The bits input to the physical segmentation are denoted by $w_1, w_2, w_3, \dots, w_{(PU)}$. Hence, $x_k = w_k$ and $Y = PU$.

4.2.11 2^{nd} interleaving

The 2^{nd} interleaving is a block interleaver and consists of bits input to a matrix with padding, the inter-column permutation for the matrix and bits output from the matrix with pruning. The bits input to the block interleaver are denoted by $u_{p,1}, u_{p,2}, u_{p,3}, \dots, u_{p,U}$, where p is PhCH number and U is the number of bits in one radio frame for one PhCH. The output bit sequence from the block interleaver is derived as follows:

- (1) Assign $C2 = 30$ to be the number of columns of the matrix. The columns of the matrix are numbered $0, 1, 2, \dots, C2 - 1$ from left to right.
- (2) Determine the number of rows of the matrix, $R2$, by finding minimum integer $R2$ such that:

$$U \leq R2 \times C2.$$

The rows of rectangular matrix are numbered $0, 1, 2, \dots, R2 - 1$ from top to bottom.

- (3) Write the input bit sequence $u_{p,1}, u_{p,2}, u_{p,3}, \dots, u_{p,U}$ into the $R2 \times C2$ matrix row by row starting with bit $y_{p,1}$ in column 0 of row 0:

$$\begin{bmatrix} y_{p,1} & y_{p,2} & y_{p,3} & \cdots & y_{p,C2} \\ y_{p,(C2+1)} & y_{p,(C2+2)} & y_{p,(C2+3)} & \cdots & y_{p,(2 \times C2)} \\ \vdots & \vdots & \vdots & \dots & \vdots \\ y_{p,((R2-1) \times C2+1)} & y_{p,((R2-1) \times C2+2)} & y_{p,((R2-1) \times C2+3)} & \cdots & y_{p,(R2 \times C2)} \end{bmatrix}$$

where $y_{p,k} = u_{p,k}$ for $k = 1, 2, \dots, U$ and if $R2 \times C2 > U$, the dummy bits are padded such that $y_{p,k} = 0$ or 1 for $k = U + 1, U + 2, \dots, R2 \times C2$. These dummy bits are pruned away from the output of the matrix after the inter-column permutation.

- (4) Perform the inter-column permutation for the matrix based on the pattern $\langle P2(j) \rangle_{j \in \{0,1,\dots,C2-1\}}$ that is shown in table 7, where $P2(j)$ is the original column position of the j -th permuted column. After permutation of the columns, the bits are denoted by $y'_{p,k}$.

$$\begin{bmatrix} y'_{p,1} & y'_{p,(R2+1)} & y'_{p,(2 \times R2+1)} & \cdots & y'_{p,((C2-1) \times R2+1)} \\ y'_{p,2} & y'_{p,(R2+2)} & y'_{p,(2 \times R2+2)} & \cdots & y'_{p,((C2-1) \times R2+2)} \\ \vdots & \vdots & \vdots & \cdots & \vdots \\ y'_{p,R2} & y'_{p,(2 \times R2)} & y'_{p,(3 \times R2)} & \cdots & y'_{p,(C2 \times R2)} \end{bmatrix}$$

- (5) The output of the block interleaver is the bit sequence read out column by column from the inter-column permuted $R2 \times C2$ matrix. The output is pruned by deleting dummy bits that were padded to the input of the matrix before the inter-column permutation, i.e. bits $y'_{p,k}$ that corresponds to bits $y_{p,k}$ with $k > U$ are removed from the output. The bits after 2nd interleaving are denoted by $v_{p,1}, v_{p,2}, \dots, v_{p,U}$, where $v_{p,1}$ corresponds to the bit $y'_{p,k}$ with smallest index k after pruning, $v_{p,2}$ to the bit $y'_{p,k}$ with second smallest index k after pruning, and so on.

Table 7 Inter-column permutation pattern for 2nd interleaving

Number of columns C2	Inter-column permutation pattern < P2(0), P2(1), ..., P2(C2-1) >
30	<0, 20, 10, 5, 15, 25, 3, 13, 23, 8, 18, 28, 1, 11, 21, 6, 16, 26, 4, 14, 24, 19, 9, 29, 12, 2, 7, 22, 27, 17>

4.2.12 Physical channel mapping

The PhCH for both uplink and downlink is defined in [2]. The bits input to the physical channel mapping are denoted by $v_{p1}, v_{p2}, \dots, v_{pU}$, where p is the PhCH number and U is the number of bits in one radio frame for one PhCH. The bits v_{pk} are mapped to the PhCHs so that the bits for each PhCH are transmitted over the air in ascending order with respect to k .

In compressed mode, no bits are mapped to certain slots of the PhCH(s). If $N_{first} + TGL \leq 15$, no bits are mapped to slots N_{first} to N_{last} . If $N_{first} + TGL > 15$, i.e. the transmission gap spans two consecutive radio frames, the mapping is as follows:

- In the first radio frame, no bits are mapped to slots $N_{first}, N_{first}+1, N_{first}+2, \dots, 14$.
- In the second radio frame, no bits are mapped to the slots $0, 1, 2, \dots, N_{last}$.

TGL , N_{first} , and N_{last} are defined in subclause 4.4.

4.2.12.1 Uplink

In uplink, the PhCHs used during a radio frame are either completely filled with bits that are transmitted over the air or not used at all. The only exception is when the UE is in compressed mode. The transmission can then be turned off during consecutive slots of the radio frame.

4.2.12.2 Downlink

In downlink, the PhCHs do not need to be completely filled with bits that are transmitted over the air. Bits $v_{pk} \notin \{0, 1\}$ are not transmitted.

During compressed mode by reducing the spreading factor by 2, the data bits are always mapped into 7.5 slots within a compressed frame. No bits are mapped to the DPDCH field as follows:

If $N_{first} + TGL \leq 15$, i.e. the transmission gap spans one radio frame,

if $N_{first} + 7 \leq 14$

no bits are mapped to slots $N_{first}, N_{first} + 1, N_{first} + 2, \dots, N_{first} + 6$

no bits are mapped to the first $(N_{Data1} + N_{Data2})/2$ bit positions of slot $N_{first} + 7$

else

no bits are mapped to slots $N_{first}, N_{first} + 1, N_{first} + 2, \dots, 14$

no bits are mapped to slots $N_{first} - 1, N_{first} - 2, N_{first} - 3, \dots, 8$

no bits are mapped to the last $(N_{Data1} + N_{Data2})/2$ bit positions of slot 7

end if

If $N_{first} + TGL > 15$, i.e. the transmission gap spans two consecutive radio frames,

In the first radio frame, no bits are mapped to last $(N_{Data1} + N_{Data2})/2$ bit positions in slot 7 as well as to slots 8, 9, 10, ..., 14.

In the second radio frame, no bits are mapped to slots 0, 1, 2, ..., 6 as well as to first $(N_{Data1} + N_{Data2})/2$ bit positions in slot 7.

N_{Data1} and N_{Data2} are defined in [2].

4.2.13 Restrictions on different types of CCTrCHs

Restrictions on the different types of CCTrCHs are described in general terms in TS 25.302[11]. In this subclause those restrictions are given with layer 1 notation.

4.2.13.1 Uplink Dedicated channel (DCH)

The maximum value of the number of TrCHs I in a CCTrCH, the maximum value of the number of transport blocks M_i on each transport channel, and the maximum value of the number of DPDCHs P are given from the UE capability class.

4.2.13.2 Random Access Channel (RACH)

- There can only be one TrCH in each RACH CCTrCH, i.e. $I=1$, $s_k = f_{1k}$ and $S = V_1$.
- The maximum value of the number of transport blocks M_1 on the transport channel is given from the UE capability class.
- The transmission time interval is either 10 ms or 20 ms.
- Only one PRACH is used, i.e. $P=1$, $u_{1k} = s_k$, and $U = S$.
- The Static rate matching parameter RM_1 is not provided by higher layer signalling on the System information as the other transport channel parameters. Any value may be used as there is one transport channel in the CCTrCH, hence one transport channel per Transport Format Combination and no need to do any balancing between multiple transport channels.

4.2.13.3 Common Packet Channel (CPCH)

- There can only be one TrCH in each CPCH CCTrCH, i.e. $I=1$, $s_k = f_{1k}$ and $S = V_1$.
- The maximum value of the number of transport blocks M_1 on the transport channel is given from the UE capability class.
- Only one PCPCH is used, i.e. $P=1$, $u_{1k} = s_k$, and $U = S$.

4.2.13.4 Downlink Dedicated Channel (DCH)

The maximum value of the number of TrCHs I in a CCTrCH, the maximum value of the number of transport blocks M_i on each transport channel, and the maximum value of the number of DPDCHs P are given from the UE capability class.

4.2.13.5 Downlink Shared Channel (DSCH) associated with a DCH

- The spreading factor is indicated with the TFCI or with higher layer signalling on DCH.
- The maximum value of the number of TrCHs I in a CCTrCH, the maximum value of the number of transport blocks M_i on the transport channel and the maximum value of the number of PDSCHs P are given from the UE capability class.

4.2.13.6 Broadcast channel (BCH)

- There can only be one TrCH in the BCH CCTrCH, i.e. $I=1$, $s_k = f_{1k}$, and $S = V_1$.
- There can only be one transport block in each transmission time interval, i.e. $M_1 = 1$.
- All transport format attributes have predefined values which are provided in [11] apart from the rate matching RM_1 .
- The Static rate matching parameter RM_1 is not provided by higher layer signalling neither fixed. Any value may be used as there is one transport channel in the CCTrCH, hence one transport channel per Transport Format Combination and no need to do any balancing between multiple transport channels.
- Only one primary CCPCCH is used, i.e. $P=1$.

4.2.13.7 Forward access and paging channels (FACH and PCH)

- The maximum value of the number of TrCHs I in a CCTrCH and the maximum value of the number of transport blocks M_i on each transport channel are given from the UE capability class.
- The transmission time interval for TrCHs of PCH type is always 10 ms.
- Only one secondary CCPCCH is used per CCTrCH, i.e. $P=1$.

4.2.14 Multiplexing of different transport channels into one CCTrCH, and mapping of one CCTrCH onto physical channels

The following rules shall apply to the different transport channels which are part of the same CCTrCH:

- 1) Transport channels multiplexed into one CCTrCH shall have co-ordinated timings. When the TFCS of a CCTrCH is changed because one or more transport channels are added to the CCTrCH or reconfigured within the CCTrCH, or removed from the CCTrCH, the change may only be made at the start of a radio frame with CFN fulfilling the relation

$$\text{CFN mod } F_{\max} = 0,$$

where F_{\max} denotes the maximum number of radio frames within the transmission time intervals of all transport channels which are multiplexed into the same CCTrCH, including any transport channels i which are added, reconfigured or have been removed, and CFN denotes the connection frame number of the first radio frame of the changed CCTrCH.

After addition or reconfiguration of a transport channel i within a CCTrCH, the TTI of transport channel i may only start in radio frames with CFN fulfilling the relation:

$$\text{CFN mod } F_i = 0.$$

- 2) Only transport channels with the same active set can be mapped onto the same CCTrCH.
- 3) Different CCTrCHs cannot be mapped onto the same PhCH.

- 4) One CCTrCH shall be mapped onto one or several PhCHs. These physical channels shall all have the same SF.
- 5) Dedicated Transport channels and common transport channels cannot be multiplexed into the same CCTrCH.
- 6) For the common transport channels, only the FACH and PCH may belong to the same CCTrCH.

There are hence two types of CCTrCH:

- 1) CCTrCH of dedicated type, corresponding to the result of coding and multiplexing of one or several DCHs.
- 2) CCTrCH of common type, corresponding to the result of the coding and multiplexing of a common channel, RACH in the uplink, DSCH ,BCH, or FACH/PCH for the downlink.

4.2.14.1 Allowed CCTrCH combinations for one UE

4.2.14.1.1 Allowed CCTrCH combinations on the uplink

A maximum of one CCTrCH is allowed for one UE on the uplink. It can be either:

- 1) one CCTrCH of dedicated type;
- 2) one CCTrCH of common type.

4.2.14.1.2 Allowed CCTrCH combinations on the downlink

The following CCTrCH combinations for one UE are allowed:

- x CCTrCH of dedicated type + y CCTrCH of common type. The allowed combination of CCTrCHs of dedicated and common type are given from UE radio access capabilities. There can be a maximum on one CCTrCH of common type for DSCH and a maximum of one CCTrCH of common type for FACH. With one CCTrCH of common type for DSCH, there shall be only one CCTrCH of dedicated type.

NOTE 1: There is only one DPCCCH in the uplink, hence one TPC bits flow on the uplink to control possibly the different DPDCHs on the downlink, part of the same or several CCTrCHs.

NOTE 2: There is only one DPCCCH in the downlink, even with multiple CCTrCHs. With multiple CCTrCHs, the DPCCCH is transmitted on one of the physical channels of that CCTrCH which has the smallest SF among the multiple CCTrCHs. Thus there is only one TPC command flow and only one TFCI word in downlink even with multiple CCTrCHs.

4.3 Transport format detection

If the transport format set of a TrCH i contains more than one transport format, the transport format can be detected according to one of the following methods:

- TFCI based detection: This method is applicable when the transport format combination is signalled using the TFCI field;
- explicit blind detection: This method typically consists of detecting the TF of TrCH i by use of channel decoding and CRC check;
- guided detection: This method is applicable when there is at least one other TrCH i' , hereafter called guiding TrCH, such that:
 - the guiding TrCH has the same TTI duration as the TrCH under consideration, i.e. $F_T = F_i$;
 - different TFs of the TrCH under consideration correspond to different TFs of the guiding TrCH;
 - explicit blind detection is used on the guiding TrCH.

If the transport format set for a TrCH i contains one transport format only, no transport format detection needs to be performed for this TrCH.

For uplink, blind transport format detection is a network controlled option. For downlink, the UE shall be capable of performing blind transport format detection, if certain restrictions on the configured transport channels are fulfilled.

For a DPCH associated with a PDSCH, the DPCCCH shall include TFCI.

4.3.1 Blind transport format detection

When no TFCI is available then explicit blind detection or guided detection shall be performed on all TrCHs within the CCTrCH that have more than one transport format. The UE shall only be required to support blind transport format detection if all of the following restrictions are fulfilled:

1. only one CCTrCH is received by the UE;
2. the number of CCTrCH bits received per radio frame is 600 or less;
3. the number of transport format combinations of the CCTrCH is 64 or less;
4. fixed positions of the transport channels is used on the CCTrCH to be detectable;
5. convolutional coding is used on all explicitly detectable TrCHs;
6. CRC with non-zero length is appended to all transport blocks on all explicitly detectable TrCHs;
7. at least one transport block shall be transmitted per TTI on each explicitly detectable TrCH;
8. the number of explicitly detectable TrCHs is 3 or less;
9. for all explicitly detectable TrCHs i , the number of code blocks in one TTI (C_i) shall not exceed 1;
10. the sum of the transport format set sizes of all explicitly detectable TrCHs, is 16 or less. The transport format set size is defined as the number of transport formats within the transport format set;
11. there is at least one TrCH that can be used as the guiding transport channel for all transport channels using guided detection.

Examples of blind transport format detection methods are given in annex A.

4.3.2 Transport format detection based on TFCI

If a TFCI is available, then TFCI based detection shall be applicable to all TrCHs within the CCTrCH. The TFCI informs the receiver about the transport format combination of the CCTrCHs. As soon as the TFCI is detected, the transport format combination, and hence the transport formats of the individual transport channels are known.

4.3.3 Coding of Transport-Format-Combination Indicator (TFCI)

The TFCI is encoded using a (32, 10) sub-code of the second order Reed-Muller code. The coding procedure is as shown in figure 9.

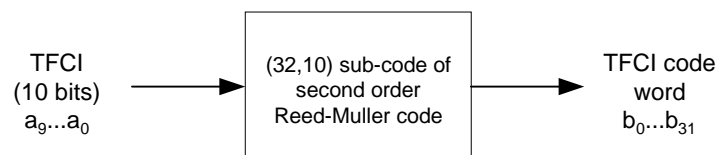

Figure 9: Channel coding of TFCI information bits

If the TFCI consist of less than 10 bits, it is padded with zeros to 10 bits, by setting the most significant bits to zero. The length of the TFCI code word is 32 bits.

The code words of the (32,10) sub-code of second order Reed-Muller code are linear combination of 10 basis sequences. The basis sequences are as in the following table 8.

Table 8: Basis sequences for (32,10) TFCI code

<i>i</i>	$M_{i,0}$	$M_{i,1}$	$M_{i,2}$	$M_{i,3}$	$M_{i,4}$	$M_{i,5}$	$M_{i,6}$	$M_{i,7}$	$M_{i,8}$	$M_{i,9}$
0	1	0	0	0	0	1	0	0	0	0
1	0	1	0	0	0	1	1	0	0	0
2	1	1	0	0	0	1	0	0	0	1
3	0	0	1	0	0	1	1	0	1	1
4	1	0	1	0	0	1	0	0	0	1
5	0	1	1	0	0	1	0	0	1	0
6	1	1	1	0	0	1	0	1	0	0
7	0	0	0	1	0	1	0	1	1	0
8	1	0	0	1	0	1	1	1	1	0
9	0	1	0	1	0	1	1	0	1	1
10	1	1	0	1	0	1	0	0	1	1
11	0	0	1	1	0	1	0	1	1	0
12	1	0	1	1	0	1	0	1	0	1
13	0	1	1	1	0	1	1	0	0	1
14	1	1	1	1	0	1	1	1	1	1
15	1	0	0	0	1	1	1	1	0	0
16	0	1	0	0	1	1	1	1	0	1
17	1	1	0	0	1	1	1	0	1	0
18	0	0	1	0	1	1	0	1	1	1
19	1	0	1	0	1	1	0	1	0	1
20	0	1	1	0	1	1	0	0	1	1
21	1	1	1	0	1	1	0	1	1	1
22	0	0	0	1	1	1	0	1	0	0
23	1	0	0	1	1	1	1	1	0	1
24	0	1	0	1	1	1	1	0	1	0
25	1	1	0	1	1	1	1	0	0	1
26	0	0	1	1	1	1	0	0	1	0
27	1	0	1	1	1	1	1	1	0	0
28	0	1	1	1	1	1	1	1	1	0
29	1	1	1	1	1	1	1	1	1	1
30	0	0	0	0	0	1	0	0	0	0
31	0	0	0	0	1	1	1	0	0	0

The TFCI information bits $a_0, a_1, a_2, a_3, a_4, a_5, a_6, a_7, a_8, a_9$ (where a_0 is LSB and a_9 is MSB) shall correspond to the TFC index (expressed in unsigned binary form) defined by the RRC layer to reference the TFC of the CCTrCH in the associated DPCH radio frame.

The output code word bits b_i are given by:

$$b_i = \sum_{n=0}^9 (a_n \times M_{i,n}) \bmod 2$$

where $i = 0, \dots, 31$.

The output bits are denoted by $b_k, k = 0, 1, 2, \dots, 31$.

In downlink, when the SF < 128 the encoded TFCI code words are repeated yielding 8 encoded TFCI bits per slot in normal mode and 16 encoded TFCI bits per slot in compressed mode. Mapping of repeated bits to slots is explained in subclause 4.3.5.

4.3.4 Operation of Transport-Format-Combination Indicator (TFCI) in Split Mode

If one of the DCH is associated with a DSCH, the TFCI code word may be split in such a way that the code word relevant for TFCI activity indication is not transmitted from every cell. The use of such a functionality shall be indicated by higher layer signalling.

The TFCI is encoded using a (16, 5) bi-orthogonal (or first order Reed-Muller) code. The coding procedure is as shown in figure 10.

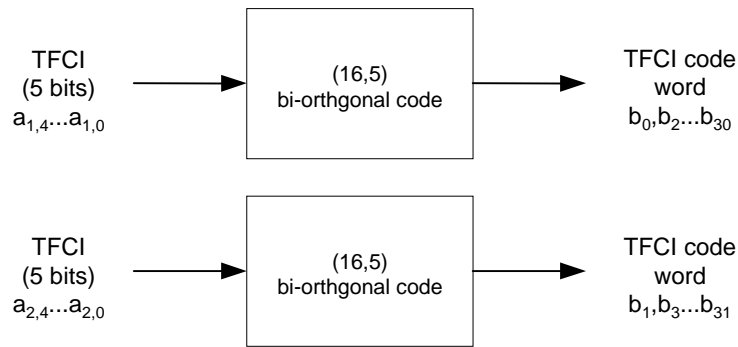

Figure 10: Channel coding of split mode TFCI information bits

The code words of the (16,5) bi-orthogonal code are linear combinations of 5 basis sequences as defined in table 9.

Table 9: Basis sequences for (16,5) TFCI code

i	M _{i,0}	M _{i,1}	M _{i,2}	M _{i,3}	M _{i,4}
0	1	0	0	0	1
1	0	1	0	0	1
2	1	1	0	0	1
3	0	0	1	0	1
4	1	0	1	0	1
5	0	1	1	0	1
6	1	1	1	0	1
7	0	0	0	1	1
8	1	0	0	1	1
9	0	1	0	1	1
10	1	1	0	1	1
11	0	0	1	1	1
12	1	0	1	1	1
13	0	1	1	1	1
14	1	1	1	1	1
15	0	0	0	0	1

The first set of TFCI information bits ($a_{1,0}, a_{1,1}, a_{1,2}, a_{1,3}, a_{1,4}$ where $a_{1,0}$ is LSB and $a_{1,4}$ is MSB) shall correspond to the TFC index (expressed in unsigned binary form) defined by the RRC layer to reference the TFC of the DCH CCTrCH in the associated DPCH radio frame.

The second set of TFCI information bits ($a_{2,0}, a_{2,1}, a_{2,2}, a_{2,3}, a_{2,4}$ where $a_{2,0}$ is LSB and $a_{2,4}$ is MSB) shall correspond to the TFC index (expressed in unsigned binary form) defined by the RRC layer to reference the TFC of the associated DSCH CCTrCH in the corresponding PDSCH radio frame.

The output code word bits b_k are given by:

$$b_{2i} = \sum_{n=0}^4 (a_{1,n} \times M_{i,n}) \bmod 2; \quad b_{2i+1} = \sum_{n=0}^4 (a_{2,n} \times M_{i,n}) \bmod 2$$

where $i = 0, \dots, 15$.

The output bits are denoted by $b_k, k = 0, 1, 2, \dots, 31$.

4.3.5 Mapping of TFCI words

4.3.5.1 Mapping of TFCI word in normal mode

The bits of the code word are directly mapped to the slots of the radio frame. Within a slot the bit with lower index is transmitted before the bit with higher index. The coded bits b_k , are mapped to the transmitted TFCI bits d_k , according to the following formula:

$$d_k = b_{k \bmod 32}$$

For uplink physical channels regardless of the SF and downlink physical channels, if $SF \geq 128$, $k = 0, 1, 2, \dots, 29$. Note that this means that bits b_{30} and b_{31} are not transmitted.

For downlink physical channels whose $SF < 128$, $k = 0, 1, 2, \dots, 119$. Note that this means that bits b_0 to b_{23} are transmitted four times and bits b_{24} to b_{31} are transmitted three times.

4.3.5.2 Mapping of TFCI word in compressed mode

The mapping of the TFCI bits in compressed mode is different for uplink, downlink with $SF \geq 128$ and downlink with $SF < 128$.

4.3.5.2.1 Uplink compressed mode

For uplink compressed mode, the slot format is changed so that no TFCI coded bits are lost. The different slot formats in compressed mode do not match the exact number of TFCI coded bits for all possible TGLs. Repetition of the TFCI bits is therefore used.

Denote the number of bits available in the TFCI fields of one compressed radio frame by D and the number of bits in the TFCI field in a slot by N_{TFCI} . The parameter E is used to determine the number of the first TFCI bit to be repeated.

$E = N_{\text{first}} N_{\text{TFCI}}$, if the start of the transmission gap is allocated to the current frame.

$E = 0$, if the start of the transmission gap is allocated to the previous frame and the end of the transmission gap is allocated to the current frame.

The TFCI coded bits b_k are mapped to the bits in the TFCI fields d_k . The following relations define the mapping for each compressed frame.

$$d_k = b_k$$

where $k = 0, 1, 2, \dots, \min(31, D-1)$.

If $D > 32$, the remaining positions are filled by repetition (in reversed order):

$$d_{D-k-1} = b_{(E+k) \bmod 32}$$

where $k = 0, \dots, D-33$.

4.3.5.2.2 Downlink compressed mode

For downlink compressed mode, the slot format is changed so that no TFCI coded bits are lost. The different slot formats in compressed mode do not match the exact number of TFCI bits for all possible TGLs. DTX is therefore used if the number of bits available in the TFCI fields in one compressed frame exceeds the number of TFCI bits given from the slot format. The block of bits in the TFCI fields where DTX is used starts on the first TFCI field after the transmission gap. If there are more bits available in the TFCI fields before the transmission gap than TFCI bits, DTX is also used on the bits in the last TFCI fields before the transmission gap.

Denote the number of bits available in the TFCI fields of one compressed radio frame by D and the number of bits in the TFCI field in a slot by N_{TFCI} . The parameter E is used to determine the position of the first bit in the TFCI field on which DTX is used.

$E = N_{\text{first}} N_{\text{TFCI}}$, if the start of the transmission gap is allocated to the current frame.

$E = 0$, if the start of the transmission gap is allocated to the previous frame and the end of the transmission gap is allocated to the current frame.

Denote the total number of TFCI bits to be transmitted by F . $F = 32$ for slot formats nA or nB , where $n = 0, 1, \dots, 11$ (see table 11 in [2]). Otherwise, $F = 128$. The TFCI coded bits b_k are mapped to the bits in the TFCI fields d_k . The following relations define the mapping for each compressed frame.

If $E > 0$,

$$d_k = b_{k \bmod 32}$$

where $k = 0, 1, 2, \dots, \min(E, F)-1$.

If $E < F$,

$$d_{k+D-F} = b_{k \bmod 32}$$

where $k = E, \dots, F - 1$.

DTX is used on d_k where $k = \min(E, F), \dots, \min(E, F) + D - F - 1$.

4.4 Compressed mode

In compressed frames, TGL slots from N_{first} to N_{last} are not used for transmission of data. As illustrated in figure 11, the instantaneous transmit power is increased in the compressed frame in order to keep the quality (BER, FER, etc.) unaffected by the reduced processing gain. The amount of power increase depends on the transmission time reduction method (see subclause 4.4.3). What frames are compressed, are decided by the network. When in compressed mode, compressed frames can occur periodically, as illustrated in figure 11, or requested on demand. The rate and type of compressed frames is variable and depends on the environment and the measurement requirements.

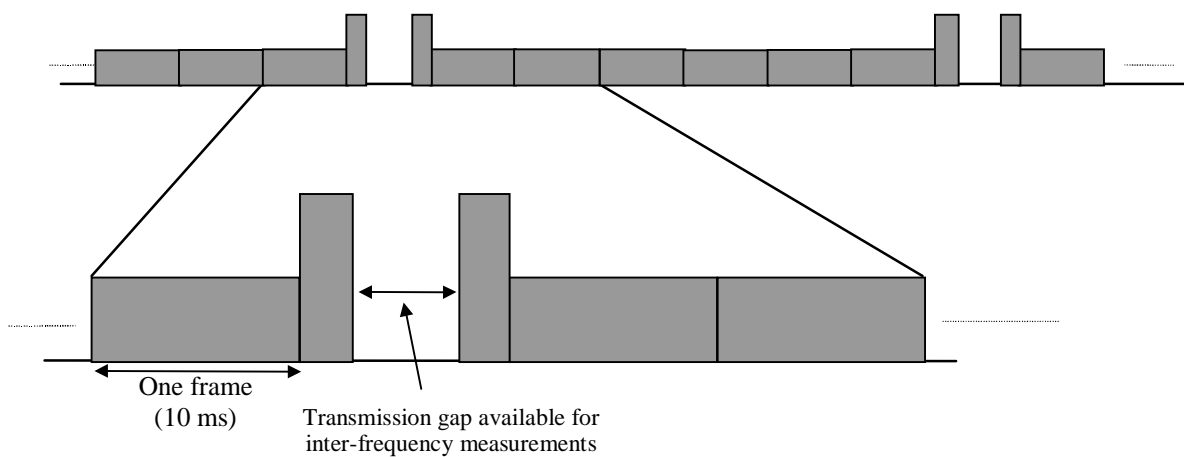

Figure 11: Compressed mode transmission

4.4.1 Frame structure in the uplink

The frame structure for uplink compressed frames is illustrated in figure 12.

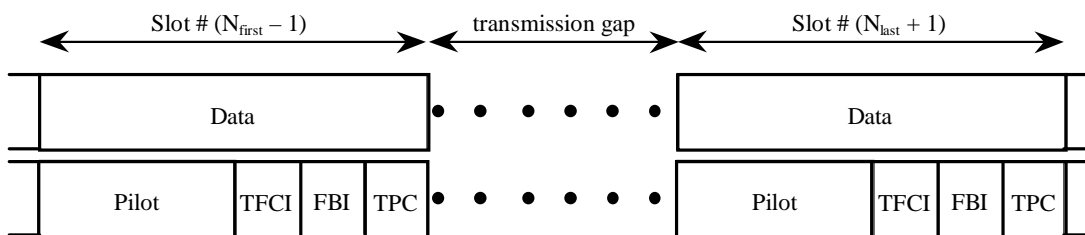

Figure 12: Frame structure in uplink compressed transmission

4.4.2 Frame structure types in the downlink

There are two different types of frame structures defined for downlink compressed frames. Type A maximises the transmission gap length and type B is optimised for power control. The frame structure type A or B is set by higher layers independent from the downlink slot format type A or B.

- With frame structure of type A, the pilot field of the last slot in the transmission gap is transmitted. Transmission is turned off during the rest of the transmission gap (figure 13(a)).

- With frame structure of type B, the TPC field of the first slot in the transmission gap and the pilot field of the last slot in the transmission gap is transmitted. Transmission is turned off during the rest of the transmission gap (figure 13(b)).

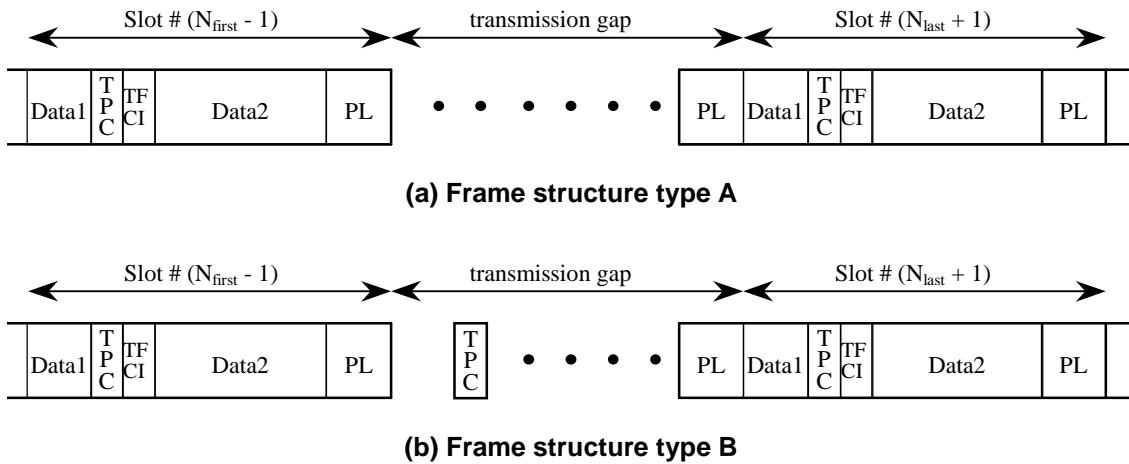

Figure 13: Frame structure types in downlink compressed transmission

4.4.3 Transmission time reduction method

When in compressed mode, the information normally transmitted during a 10 ms frame is compressed in time. The mechanisms provided for achieving this are puncturing, reduction of the spreading factor by a factor of two, and higher layer scheduling. In the downlink, all methods are supported while compressed mode by puncturing is not used in the uplink. The maximum idle length is defined to be 7 slots per one 10 ms frame. The slot formats that are used in compressed frames are listed in [2].

4.4.3.1 Compressed mode by puncturing

Rate matching is applied for creating a transmission gap in one or two frames. The algorithm for rate matching as described in subclause 4.2.7 is used.

4.4.3.2 Compressed mode by reducing the spreading factor by 2

The spreading factor (SF) can be reduced by 2 during one compressed radio frame to enable the transmission of the information bits in the remaining time slots of the compressed frame.

On the downlink, UTRAN can also order the UE to use a different scrambling code in a compressed frame than in a non-compressed frame. If the UE is ordered to use a different scrambling code in a compressed frame, then there is a one-to-one mapping between the scrambling code used in the non-compressed frame and the one used in the compressed frame, as described in [3] subclause 5.2.1.

4.4.3.3 Compressed mode by higher layer scheduling

Compressed frames can be obtained by higher layer scheduling. Higher layers then set restrictions so that only a subset of the allowed TFCs are used in a compressed frame. The maximum number of bits that will be delivered to the physical layer during the compressed radio frame is then known and a transmission gap can be generated. Note that in the downlink, the TFCI field is expanded on the expense of the data fields and this shall be taken into account by higher layers when setting the restrictions on the TFCs. Compressed mode by higher layer scheduling shall not be used with fixed starting positions of the TrCHs in the radio frame.

4.4.4 Transmission gap position

Transmission gaps can be placed at different positions as shown in figures 14 and 15 for each purpose such as interfrequency power measurement, acquisition of control channel of other system/carrier, and actual handover operation.

When using single frame method, the transmission gap is located within the compressed frame depending on the transmission gap length (TGL) as shown in figure 14 (1). When using double frame method, the transmission gap is located on the center of two connected frames as shown in figure 14 (2).

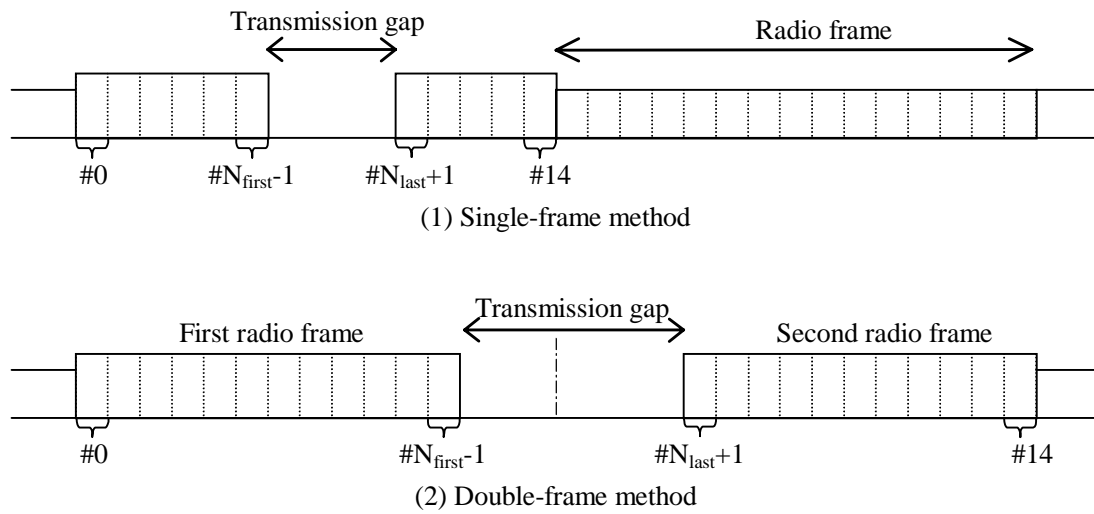

Figure 14: Transmission gap position

Parameters of the transmission gap positions are calculated as follows.

TGL is the number of consecutive idle slots during the compressed mode transmission gap:

$$TGL = 3, 4, 5, 7, 10, 14$$

N_{first} specifies the starting slot of the consecutive idle slots,

$$N_{\text{first}} = 0, 1, 2, 3, \dots, 14.$$

N_{last} shows the number of the final idle slot and is calculated as follows;

$$\text{If } N_{\text{first}} + TGL \leq 15, \text{ then } N_{\text{last}} = N_{\text{first}} + TGL - 1 \text{ (in the same frame)},$$

$$\text{If } N_{\text{first}} + TGL > 15, \text{ then } N_{\text{last}} = (N_{\text{first}} + TGL - 1) \bmod 15 \text{ (in the next frame)}.$$

When the transmission gap spans two consecutive radio frames, N_{first} and TGL must be chosen so that at least 8 slots in each radio frame are transmitted.

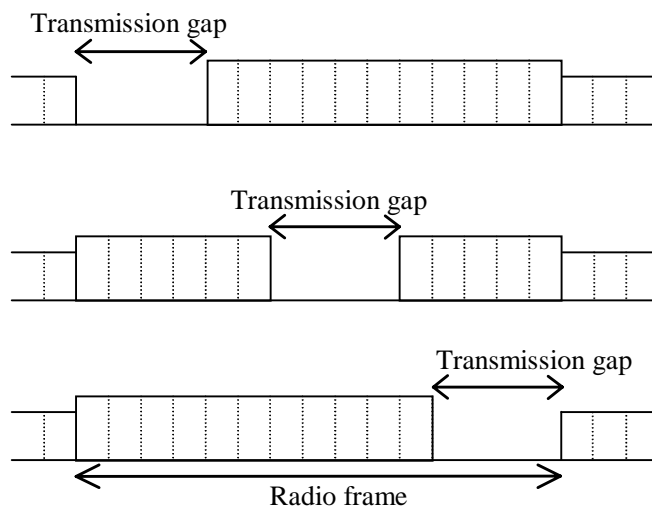

(1) Single-frame method

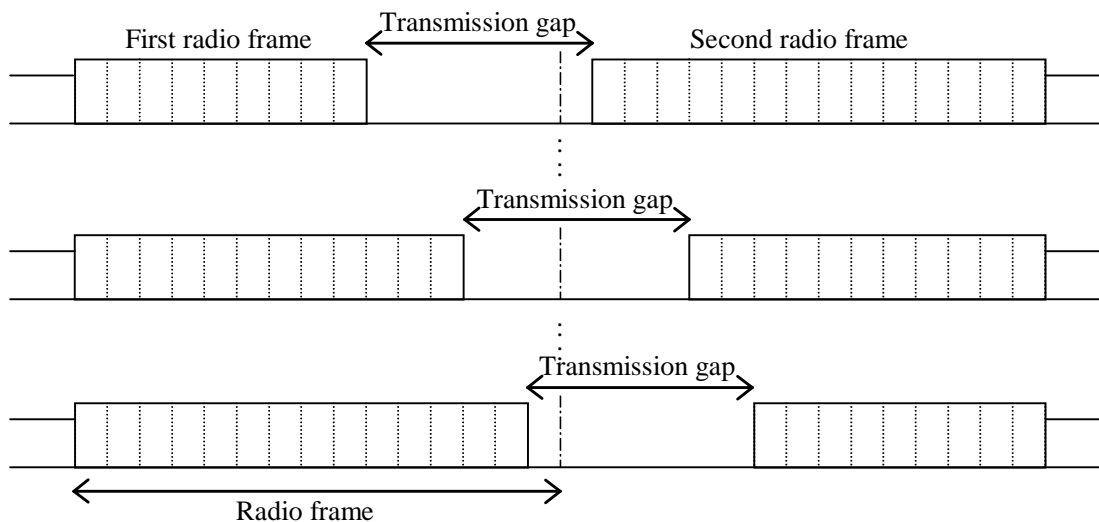

(2) Double-frame method

Figure 15: Transmission gap positions with different N_{first}

Annex A (informative): Blind transport format detection

A.1 Blind transport format detection using fixed positions

A.1.1 Blind transport format detection using received power ratio

For the dual transport format case (the possible data rates are 0 and full rate, and CRC is only transmitted for full rate), blind transport format detection using received power ratio can be used.

The transport format detection is then done using average received power ratio of DPDCH to DPCCH. Define the following:

- P_c : Received power per bit of DPCCH calculated from all pilot and TPC bits per slot over a radio frame;
- P_d : Received power per bit of DPDCH calculated from X bits per slot over a radio frame;
- X : the number of DPDCH bits per slot when transport format corresponds to full rate;
- T : Threshold of average received power ratio of DPDCH to DPCCH for transport format detection.

The decision rule can then be formulated as:

If $P_d/P_c > T$ then:

- full rate transport format detected;

else

- zero rate transport format detected.

A.1.2 Blind transport format detection using CRC

For the multiple transport format case (the possible data rates are 0, ..., (full rate)/ r , ..., full rate, and CRC is transmitted for all transport formats), blind transport format detection using CRC can be used.

At the transmitter, the data stream with variable number of bits from higher layers is block-encoded using a cyclic redundancy check (CRC) and then convolutionally encoded. CRC parity bits are attached just after the data stream with variable number of bits as shown in figure A.1.

The receiver knows only the possible transport formats (or the possible end bit position $\{n_{\text{end}}\}$) by Layer-3 negotiation. The receiver performs Viterbi-decoding on the soft decision sample sequence. The correct trellis path of the Viterbi-decoder ends at the zero state at the correct end bit position.

The blind transport format detection method using CRC traces back the surviving trellis path ending at the zero state (hypothetical trellis path) at each possible end bit position to recover the data sequence. For each recovered data sequence error-detection is performed by checking the CRC, and if there is no error, the recovered sequence is declared to be correct.

The following variable is defined:

$$s(n_{\text{end}}) = -10 \log \left(\frac{a_0(n_{\text{end}}) - a_{\min}(n_{\text{end}})}{a_{\max}(n_{\text{end}}) - a_{\min}(n_{\text{end}})} \right) \text{ [dB]} \quad (\text{Eq. 1})$$

where $a_{\max}(n_{\text{end}})$ and $a_{\min}(n_{\text{end}})$ are the maximum and minimum path-metric values among all survivors at end bit position n_{end} , and $a_0(n_{\text{end}})$ is the path-metric value at zero state.

In order to reduce the probability of false detection (this happens if the selected path is wrong but the CRC misses the error detection), a path selection threshold D is introduced. The threshold D determines whether the hypothetical trellis path connected to the zero state should be traced back or not at each end bit position n_{end} . If the hypothetical trellis path connected to the zero state that satisfies:

$$s(n_{\text{end}}) \leq D \quad (\text{Eq. 2})$$

is found, the path is traced back to recover the frame data, where D is the path selection threshold and a design parameter.

If more than one end bit positions satisfying Eq. 2 is found, the end bit position which has minimum value of $s(n_{\text{end}})$ is declared to be correct. If no path satisfying Eq. 2 is found even after all possible end bit positions have been exhausted, the received frame data is declared to be in error.

Figure A-2 shows the procedure of blind transport format detection using CRC.

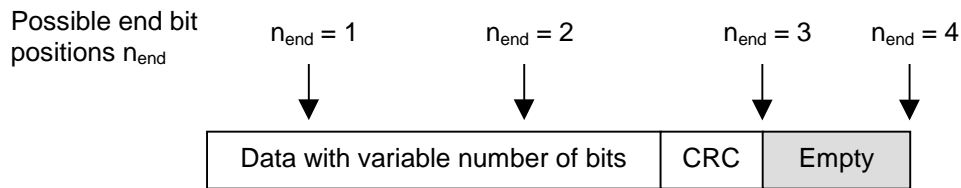

**Figure A.1: An example of data with variable number of bits.
Four possible transport formats, and transmitted end bit position $n_{\text{end}} = 3$**

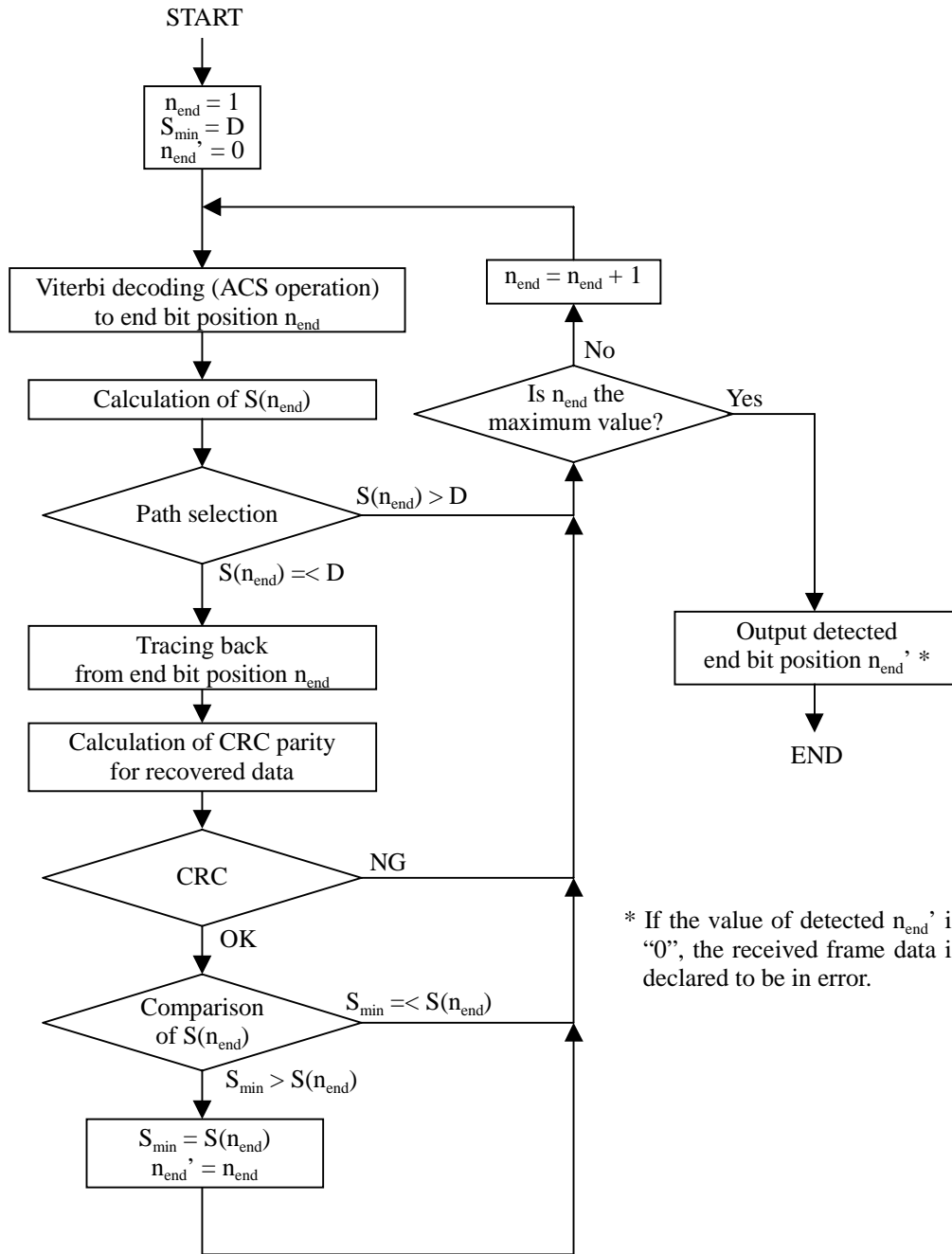

* If the value of detected n_{end}' is "0", the received frame data is declared to be in error.

Figure A.2: Basic processing flow of blind transport format detection

Annex B (informative): Compressed mode idle lengths

The tables 9-11 show the resulting idle lengths for different transmission gap lengths, UL/DL modes and DL frame types. The idle lengths given are calculated purely from the slot and frame structures and the UL/DL offset. They do not contain margins for e.g. synthesizer switching.

B.1 Idle lengths for DL, UL and DL+UL compressed mode

Table 9: Parameters for DL compressed mode

TGL	DL Frame Type	Spreading Factor	Idle length [ms]	Transmission time Reduction method	Idle frame Combining
3	A	512 – 4	1.73 – 1.99	Puncturing, Spreading factor division by 2 or Higher layer scheduling	(S) (D) =(1,2) or (2,1)
	B		1.60 – 1.86		(S)
4	A		2.40 – 2.66		(D) =(1,3), (2,2) or (3,1)
	B		2.27 – 2.53		(S)
5	A		3.07 – 3.33		(D) = (1,4), (2,3), (3, 2) or (4,1)
	B		2.93 – 3.19		(S)
7	A		4.40 – 4.66		(D)=(1,6), (2,5), (3,4), (4,3), (5,2) or (6,1)
	B		4.27 – 4.53		(S)
10	A		6.40 – 6.66		(D)=(3,7), (4,6), (5,5), (6,4) or (7,3)
	B		6.27 – 6.53		(D) =(7,7)
14	A		9.07 – 9.33		
	B		8.93 – 9.19		

Table 10: Parameters for UL compressed mode

TGL	Spreading Factor	Idle length [ms]	Transmission time Reduction method	Idle frame Combining
3	256 – 4	2.00	Spreading factor division by 2 or Higher layer scheduling	(S) (D) =(1,2) or (2,1)
4		2.67		(S) (D) =(1,3), (2,2) or (3,1)
5		3.33		(S) (D) = (1,4), (2,3), (3, 2) or (4,1)
7		4.67		(S) (D)=(1,6), (2,5), (3,4), (4,3), (5,2) or (6,1)
10		6.67		(D)=(3,7), (4,6), (5,5), (6,4) or (7,3)
14		9.33		(D) =(7,7)

Table 11: Parameters for combined UL/DL compressed mode

TGL	DL Frame Type	Spreading Factor	Idle length [ms]	Transmission time Reduction method	Idle frame Combining
3	A or B	DL: 512 – 4	1.47 – 1.73	DL: Puncturing, Spreading factor division by 2 or Higher layer scheduling UL: Spreading factor division by 2 or Higher layer scheduling	(S) (D) =(1,2) or (2,1)
4			2.13 – 2.39		(S) (D) =(1,3), (2,2) or (3,1)
5		UL: 256 – 4	2.80 – 3.06		(S) (D) = (1,4), (2,3), (3, 2) or (4,1)
7			4.13 – 4.39		(S) (D)=(1,6), (2,5), (3,4), (4,3), (5,2) or (6,1)
10			6.13 – 6.39		(D)=(3,7), (4,6), (5,5), (6,4) or (7,3)
14			8.80 – 9.06		(D) =(7,7)

(S): Single-frame method as shown in figure 14 (1).

(D): Double-frame method as shown in figure 14 (2). (x,y) indicates x: the number of idle slots in the first frame, y: the number of idle slots in the second frame.

NOTE: Compressed mode by spreading factor reduction is not supported when SF=4 is used in normal mode

Annex C (informative): Change history

Change history							
Date	TSG #	TSG Doc.	CR	Rev	Subject/Comment	Old	New
	RAN_05	RP-99588	-		Approved at TSG RAN #5 and placed under Change Control	-	3.0.0
14/01/00	RAN_06	RP-99680	001	3	Correction of rate matching parameters for repetition after 1st interleaving in 25.212	3.0.0	3.1.0
14/01/00	RAN_06	RP-99680	004	-	Changing the initial offset value for convolutional code rate matching	3.0.0	3.1.0
14/01/00	RAN_06	RP-99681	005	1	Introduction of compressed mode by higher layer scheduling	3.0.0	3.1.0
14/01/00	RAN_06	RP-99679	008	-	Editorial corrections to TS 25.212	3.0.0	3.1.0
14/01/00	RAN_06	RP-99680	009	-	Removal of SFN multiplexing	3.0.0	3.1.0
14/01/00	RAN_06	RP-99680	010	1	Clarification of bit separation and collection	3.0.0	3.1.0
14/01/00	RAN_06	RP-99680	011	2	Connection between TTI and CFN	3.0.0	3.1.0
14/01/00	RAN_06	RP-99680	012	2	Zero length transport blocks	3.0.0	3.1.0
14/01/00	RAN_06	RP-99679	014	-	Update of channel coding sections	3.0.0	3.1.0
14/01/00	RAN_06	RP-99680	016	-	Removal of TrCH restriction in DSCH CTrCH	3.0.0	3.1.0
14/01/00	RAN_06	RP-99681	017	-	20 ms RACH message length	3.0.0	3.1.0
14/01/00	RAN_06	RP-99680	018	-	Minimum SF in UL	3.0.0	3.1.0
14/01/00	RAN_06	RP-99680	024	-	Rate matching parameter determination in DL and fixed positions	3.0.0	3.1.0
14/01/00	RAN_06	RP-99680	026	1	Corrections to TS 25.212	3.0.0	3.1.0
14/01/00	RAN_06	RP-99679	027	-	Modification of BTFD description in 25.212 Annex	3.0.0	3.1.0
14/01/00	RAN_06	RP-99681	028	-	TFCI coding and mapping including compressed mode	3.0.0	3.1.0
14/01/00	-	-	-	-	Change history was added by the editor	3.1.0	3.1.1
31/03/00	RAN_07	RP-000061	025	2	CR for parity bit attachment to 0 bit transport block	3.1.1	3.2.0
31/03/00	RAN_07	RP-000061	029	1	Limitations of blind transport format detection	3.1.1	3.2.0
31/03/00	RAN_07	RP-000061	034	1	Clarification of fixed position rate matching	3.1.1	3.2.0
31/03/00	RAN_07	RP-000061	035	1	Clarification of DL compressed mode	3.1.1	3.2.0
31/03/00	RAN_07	RP-000061	036	-	Reconfiguration of TFCS	3.1.1	3.2.0
31/03/00	RAN_07	RP-000061	037	1	Removal of fixed gap position in 25.212	3.1.1	3.2.0
31/03/00	RAN_07	RP-000061	038	2	Definition clarification for TS 25.212	3.1.1	3.2.0
31/03/00	RAN_07	RP-000061	039	1	Clarification on TFCI coding input	3.1.1	3.2.0
31/03/00	RAN_07	RP-000061	041	2	Correction of UL compressed mode by higher layer scheduling	3.1.1	3.2.0
31/03/00	RAN_07	RP-000061	042	5	Downlink Compressed Mode by puncturing	3.1.1	3.2.0
31/03/00	RAN_07	RP-000061	044	-	Modification of Turbo code internal interleaver	3.1.1	3.2.0
31/03/00	RAN_07	RP-000061	045	-	Editorial corrections	3.1.1	3.2.0
31/03/00	RAN_07	RP-000061	046	-	SF/2 method: DTX insertion after 2nd interleaver	3.1.1	3.2.0
31/03/00	RAN_07	RP-000061	047	1	TFCI coding for FDD	3.1.1	3.2.0
31/03/00	RAN_07	RP-000061	048	-	Mapping of TFCI in downlink compressed mode	3.1.1	3.2.0
31/03/00	RAN_07	RP-000061	049	-	Editorial changes to Annex A	3.1.1	3.2.0
31/03/00	RAN_07	RP-000061	050	-	Removal of rate matching attribute setting for RACH	3.1.1	3.2.0
31/03/00	RAN_07	RP-000061	052	-	Padding Function for Turbo coding of small blocks	3.1.1	3.2.0
31/03/00	RAN_07	RP-000061	055	2	Clarifications relating to DSCH	3.1.1	3.2.0
31/03/00	RAN_07	RP-000061	056	-	Editorial modification of uplink shifting parameter calculation for turbo code puncturing	3.1.1	3.2.0
31/03/00	RAN_07	RP-000062	059	1	Revision: Editorial correction to the calculation of Rate Matching parameters	3.1.1	3.2.0
31/03/00	RAN_07	RP-000062	060	1	Editorial changes of channel coding section	3.1.1	3.2.0
31/03/00	RAN_07	RP-000062	061	-	Removal of DL compressed mode by higher layer scheduling with fixed positions	3.1.1	3.2.0
26/06/00	RAN_08	RP-000266	066	1	Section 4.4.5 and table 9 is moved to informative annex	3.2.0	3.3.0
26/06/00	RAN_08	RP-000266	068	-	Editorial modifications of 25.212	3.2.0	3.3.0
26/06/00	RAN_08	RP-000266	069	-	Removal of BTFD for flexible positions in Release 99	3.2.0	3.3.0
26/06/00	RAN_08	RP-000266	070	1	Editorial modifications	3.2.0	3.3.0
26/06/00	RAN_08	RP-000266	071	1	Corrections and editorial modifications of 25.212 for 2nd insertion of DTX bits for CM	3.2.0	3.3.0
26/06/00	RAN_08	RP-000266	072	4	Corrections to 25.212 (Rate Matching, p-bit insertion, PhCH segmentation)	3.2.0	3.3.0
26/06/00	RAN_08	RP-000266	073	-	Editorial correction in 25.212 coding/multiplexing	3.2.0	3.3.0
26/06/00	RAN_08	RP-000266	074	2	Bit separation of the Turbo encoded data	3.2.0	3.3.0
26/06/00	RAN_08	RP-000266	076	1	Revision of code block segmentation description	3.2.0	3.3.0
26/06/00	RAN_08	RP-000266	077	-	Clarifications for TFCI coding	3.2.0	3.3.0
26/06/00	RAN_08	RP-000266	078	2	Clarifying the rate matching parameter setting for the RACH and BCH	3.2.0	3.3.0
26/06/00	RAN_08	RP-000266	080	-	Clarification on BTFD utilisation (single CTrCH)	3.2.0	3.3.0
26/06/00	RAN_08	RP-000266	081	-	Correction of order of checking TFC during flexible position RM	3.2.0	3.3.0

Change history							
Date	TSG #	TSG Doc.	CR	Rev	Subject/Comment	Old	New
					parameter determination		
26/06/00	RAN_08	RP-000266	082	-	Editorial corrections in channel coding section	3.2.0	3.3.0
26/06/00	RAN_08	RP-000266	083	-	Correction for bit separation and bit collection	3.2.0	3.3.0
26/06/00	RAN_08	RP-000266	084	1	Correction on the spreading factor selection for the RACH	3.2.0	3.3.0
23/09/00	RAN_09	RP-000341	079	-	Clarification of compressed mode terminology	3.3.0	3.4.0
23/09/00	RAN_09	RP-000341	085	1	Editorial corrections in Turbo code internal interleaver section	3.3.0	3.4.0
23/09/00	RAN_09	RP-000341	086	1	Clarification on DL slot format for compressed mode by SF/2	3.3.0	3.4.0
23/09/00	RAN_09	RP-000341	087	-	Corrections	3.3.0	3.4.0
23/09/00	RAN_09	RP-000341	088	1	Clarifications to TS 25.212	3.3.0	3.4.0
23/09/00	RAN_09	RP-000341	089	-	Correction regarding DSCH	3.3.0	3.4.0
23/09/00	RAN_09	RP-000341	090	-	Correction regarding CPCH	3.3.0	3.4.0
23/09/00	RAN_09	RP-000341	092	1	Bit separation and collection for rate matching	3.3.0	3.4.0
23/09/00	RAN_09	RP-000341	093	-	Puncturing Limit definition in WG1 specification	3.3.0	3.4.0
15/12/00	RAN_10	RP-000538	094	2	Correction of BTFD limitations	3.4.0	3.5.0
15/12/00	RAN_10	RP-000538	096	-	Compressed mode by puncturing	3.4.0	3.5.0
15/12/00	RAN_10	RP-000538	097	-	Clarification on the Ci formula	3.4.0	3.5.0
15/12/00	RAN_10	RP-000538	099	-	Editorial modification in RM section	3.4.0	3.5.0
15/12/00	RAN_10	RP-000538	100	1	Editorial corrections in TS 25.212	3.4.0	3.5.0
15/12/00	RAN_10	RP-000538	101	-	Correction to code block segmentation	3.4.0	3.5.0

History

Document history		
V3.1.1	January 2000	Publication
V3.2.0	March 2000	Publication
V3.3.0	June 2000	Publication
V3.4.0	September 2000	Publication
V3.5.0	December 2000	Publication