

ETSI TS 125 221 V5.1.0 (2002-06)

Technical Specification

**Universal Mobile Telecommunications System (UMTS);
Physical channels and mapping of transport channels
onto physical channels (TDD)
(3GPP TS 25.221 version 5.1.0 Release 5)**



Reference

RTS/TSGR-0125221v510

Keywords

UMTS

ETSI

650 Route des Lucioles
F-06921 Sophia Antipolis Cedex - FRANCE

Tel.: +33 4 92 94 42 00 Fax: +33 4 93 65 47 16

Siret N° 348 623 562 00017 - NAF 742 C
Association à but non lucratif enregistrée à la
Sous-Préfecture de Grasse (06) N° 7803/88

Important notice

Individual copies of the present document can be downloaded from:

<http://www.etsi.org>

The present document may be made available in more than one electronic version or in print. In any case of existing or perceived difference in contents between such versions, the reference version is the Portable Document Format (PDF). In case of dispute, the reference shall be the printing on ETSI printers of the PDF version kept on a specific network drive within ETSI Secretariat.

Users of the present document should be aware that the document may be subject to revision or change of status. Information on the current status of this and other ETSI documents is available at

<http://portal.etsi.org/tb/status/status.asp>

If you find errors in the present document, send your comment to:

editor@etsi.fr

Copyright Notification

No part may be reproduced except as authorized by written permission.
The copyright and the foregoing restriction extend to reproduction in all media.

© European Telecommunications Standards Institute 2002.
All rights reserved.

DECTTM, **PLUGTESTS**TM and **UMTS**TM are Trade Marks of ETSI registered for the benefit of its Members.
TIPHONTM and the **TIPHON logo** are Trade Marks currently being registered by ETSI for the benefit of its Members.
3GPPTM is a Trade Mark of ETSI registered for the benefit of its Members and of the 3GPP Organizational Partners.

Intellectual Property Rights

IPRs essential or potentially essential to the present document may have been declared to ETSI. The information pertaining to these essential IPRs, if any, is publicly available for **ETSI members and non-members**, and can be found in ETSI SR 000 314: "*Intellectual Property Rights (IPRs); Essential, or potentially Essential, IPRs notified to ETSI in respect of ETSI standards*", which is available from the ETSI Secretariat. Latest updates are available on the ETSI Web server (<http://webapp.etsi.org/IPR/home.asp>).

Pursuant to the ETSI IPR Policy, no investigation, including IPR searches, has been carried out by ETSI. No guarantee can be given as to the existence of other IPRs not referenced in ETSI SR 000 314 (or the updates on the ETSI Web server) which are, or may be, or may become, essential to the present document.

Foreword

This Technical Specification (TS) has been produced by ETSI 3rd Generation Partnership Project (3GPP).

The present document may refer to technical specifications or reports using their 3GPP identities, UMTS identities or GSM identities. These should be interpreted as being references to the corresponding ETSI deliverables.

The cross reference between GSM, UMTS, 3GPP and ETSI identities can be found under www.etsi.org/key .

Contents

Intellectual Property Rights	2
Foreword.....	2
Foreword.....	8
1 Scope	9
2 References	9
3 Abbreviations	9
4 Services offered to higher layers	11
4.1 Transport channels	11
4.1.1 Dedicated transport channels	11
4.1.2 Common transport channels	11
4.1.2.1 BCH - Broadcast Channel	11
4.1.2.2 FACH – Forward Access Channel	11
4.1.2.3 PCH – Paging Channel.....	11
4.1.2.4 RACH – Random Access Channel.....	11
4.1.2.5 USCH – Uplink Shared Channel.....	11
4.1.2.6 DSCH – Downlink Shared Channel.....	11
4.1.2.7 HS-DSCH – High Speed Downlink Shared Channel.....	12
4.2 Indicators	12
5 Physical channels for the 3.84 Mcps option.....	12
5.1 Frame structure.....	12
5.2 Dedicated physical channel (DPCH).....	13
5.2.1 Spreading	14
5.2.1.1 Spreading for Downlink Physical Channels.....	14
5.2.1.2 Spreading for Uplink Physical Channels.....	14
5.2.2 Burst Types	14
5.2.2.1 Burst Type 1	14
5.2.2.2 Burst Type 2.....	15
5.2.2.3 Burst Type 3.....	15
5.2.2.4 Transmission of TFCI	16
5.2.2.5 Transmission of TPC.....	17
5.2.2.6 Timeslot formats	18
5.2.2.6.1 Downlink timeslot formats	18
5.2.2.6.2 Uplink timeslot formats.....	18
5.2.3 Training sequences for spread bursts	20
5.2.4 Beamforming	22
5.3 Common physical channels	22
5.3.1 Primary common control physical channel (P-CCPCH).....	22
5.3.1.1 P-CCPCH Spreading	22
5.3.1.2 P-CCPCH Burst Types.....	23
5.3.1.3 P-CCPCH Training sequences	23
5.3.2 Secondary common control physical channel (S-CCPCH).....	23
5.3.2.1 S-CCPCH Spreading	23
5.3.2.2 S-CCPCH Burst Types.....	23
5.3.2.3 S-CCPCH Training sequences	23
5.3.3 The physical random access channel (PRACH)	23
5.3.3.1 PRACH Spreading	23
5.3.3.2 PRACH Burst Type.....	23
5.3.3.3 PRACH Training sequences.....	23
5.3.3.4 PRACH timeslot formats	24
5.3.3.5 Association between Training Sequences and Channelisation Codes.....	24
5.3.4 The synchronisation channel (SCH)	25
5.3.5 Physical Uplink Shared Channel (PUSCH).....	26
5.3.5.1 PUSCH Spreading.....	26

5.3.5.2	PUSCH Burst Types	27
5.3.5.3	PUSCH Training Sequences	27
5.3.5.4	UE Selection	27
5.3.6	Physical Downlink Shared Channel (PDSCH)	27
5.3.6.1	PDSCH Spreading	27
5.3.6.2	PDSCH Burst Types	27
5.3.6.3	PDSCH Training Sequences	27
5.3.6.4	UE Selection	27
5.3.7	The Paging Indicator Channel (PICH)	27
5.3.7.1	Mapping of Paging Indicators to the PICH bits	27
5.3.7.2	Structure of the PICH over multiple radio frames	28
5.3.7.3	PICH Training sequences	29
5.3.8	The physical node B synchronisation channel (PNBSCH)	29
5.3.9	High Speed Physical Downlink Shared Channel (HS-PDSCH)	29
5.3.9.1	HS-PDSCH Spreading	29
5.3.9.2	HS-PDSCH Burst Types	29
5.3.9.3	HS-PDSCH Training Sequences	29
5.3.9.4	UE Selection	29
5.3.9.5	HS-PDSCH timeslot formats	29
5.3.10	Shared Control Channel for HS-DSCH (HS-SCCH)	30
5.3.10.1	HS-SCCH Spreading	30
5.3.10.2	HS-SCCH Burst Types	30
5.3.10.3	HS-SCCH Training Sequences	30
5.3.10.4	HS-SCCH timeslot formats	30
5.3.11	Shared Information Channel for HS-DSCH (HS-SICH)	30
5.3.11.1	HS-SICH Spreading	30
5.3.11.2	HS-SICH Burst Types	30
5.3.11.3	HS-SICH Training Sequences	30
5.3.11.4	HS-SICH timeslot formats	31
5.4	Transmit Diversity for DL Physical Channels	31
5.5	Beacon characteristics of physical channels	31
5.5.1	Location of beacon channels	31
5.5.2	Physical characteristics of beacon channels	31
5.6	Midamble Allocation for Physical Channels	32
5.6.1	Midamble Allocation for DL Physical Channels	32
5.6.1.1	Midamble Allocation by signalling from higher layers	32
5.6.1.2	Midamble Allocation by layer 1	32
5.6.1.2.1	Default midamble	32
5.6.1.2.2	Common Midamble	33
5.6.2	Midamble Allocation for UL Physical Channels	33
5.7	Midamble Transmit Power	33
6	Physical channels for the 1.28 Mcps option	34
6.1	Frame structure	35
6.2	Dedicated physical channel (DPCH)	36
6.2.1	Spreading	36
6.2.2	Burst Format	36
6.2.2.1	Transmission of TFCI	37
6.2.2.2	Transmission of TPC	37
6.2.2.3	Transmission of SS	40
6.2.2.4	Timeslot formats	42
6.2.2.4.1	Timeslot formats for QPSK	43
6.2.2.4.2	Time slot formats for 8PSK	46
6.2.3	Training sequences for spread bursts	46
6.2.4	Beamforming	48
6.3	Common physical channels	48
6.3.1	Primary common control physical channel (P-CCPCH)	48
6.3.1.1	P-CCPCH Spreading	48
6.3.1.2	P-CCPCH Burst Format	48
6.3.1.3	P-CCPCH Training sequences	48
6.3.2	Secondary common control physical channel (S-CCPCH)	48
6.3.2.1	S-CCPCH Spreading	49

6.3.2.2	S-CCPCH Burst Format	49
6.3.2.3	S-CCPCH Training sequences	49
6.3.3	Fast Physical Access CHannel (FPACH)	49
6.3.3.1	FPACH burst.....	49
6.3.3.1.1	Signature Reference Number.....	49
6.3.3.1.2	Relative Sub-Frame Number	49
6.3.3.1.3	Received starting position of the UpPCH (UpPCH _{pos}).....	49
6.3.3.1.4	Transmit Power Level Command for the RACH message.....	50
6.3.3.2	FPACH Spreading.....	50
6.3.3.2	FPACH Burst Format.....	50
6.3.3.3	FPACH Training sequences	50
6.3.3.4	FPACH timeslot formats.....	50
6.3.4	The physical random access channel (PRACH)	50
6.3.4.1	PRACH Spreading	50
6.3.4.2	PRACH Burst Format	50
6.3.4.3	PRACH Training sequences.....	50
6.3.4.4	PRACH timeslot formats	50
6.3.4.5	Association between Training Sequences and Channelisation Codes.....	50
6.3.5	The synchronisation channels (DwPCH, UpPCH)	51
6.3.6	Physical Uplink Shared Channel (PUSCH).....	51
6.3.7	Physical Downlink Shared Channel (PDSCH)	51
6.3.8	The Page Indicator Channel (PICH)	52
6.3.8.1	Mapping of Paging Indicators to the PICH bits	52
6.3.8.2	Structure of the PICH over multiple radio frames.....	52
6.3.9	High Speed Physical Downlink Shared Channel (HS-PDSCH)	52
6.3.9.1	HS-PDSCH Spreading	52
6.3.9.2	HS-PDSCH Burst Types	52
6.3.9.3	HS-PDSCH Training Sequences	52
6.3.9.4	UE Selection	53
6.3.9.5	HS-PDSCH timeslot formats	53
6.3.10	Shared Control Channel for HS-DSCH (HS-SCCH).....	53
6.3.10.1	HS-SCCH Spreading.....	53
6.3.10.2	HS-SCCH Burst Types	53
6.3.10.3	HS-SCCH Training Sequences	53
6.3.10.4	HS-SCCH timeslot formats.....	53
6.3.11	Shared Information Channel for HS-DSCH (HS-SICH)	53
6.3.11.1	HS-SICH Spreading	53
6.3.11.2	HS-SICH Burst Types.....	54
6.3.11.3	HS-SICH Training Sequences.....	54
6.3.11.4	HS-SICH timeslot formats	54
6.4	Transmit Diversity for DL Physical Channels.....	54
6.5	Beacon characteristics of physical channels.....	54
6.5.1	Location of beacon channels.....	54
6.5.2	Physical characteristics of the beacon function	54
6.6	Midamble Allocation for Physical Channels.....	55
6.6.1	Midamble Allocation for DL Physical Channels	55
6.6.1.1	Midamble Allocation by signalling from higher layers.....	55
6.6.1.2	Midamble Allocation by layer 1.....	55
6.6.1.2.1	Default midamble	55
6.6.1.2.2	Common Midamble.....	55
6.6.2	Midamble Allocation for UL Physical Channels	55
6.7	Midamble Transmit Power	55
7	Mapping of transport channels to physical channels for the 3.84 Mcps option	56
7.1	Dedicated Transport Channels	56
7.2	Common Transport Channels.....	57
7.2.1	The Broadcast Channel (BCH).....	57
7.2.2	The Paging Channel (PCH)	57
7.2.2.1	PCH/PICH Association.....	57
7.2.3	The Forward Channel (FACH).....	57
7.2.4	The Random Access Channel (RACH)	57
7.2.5	The Uplink Shared Channel (USCH).....	57

7.2.6	The Downlink Shared Channel (DSCH).....	58
7.2.7	The High Speed Downlink Shared Channel (HS-DSCH).....	58
7.2.7.1	HS-DSCH/HS-SCCH Association and Timing.....	58
7.2.7.2	HS-SCCH/HS-DSCH/HS-SICH Association and Timing.....	58
8	Mapping of transport channels to physical channels for the 1.28 Mcps option	59
8.1	Dedicated Transport Channels	59
8.2	Common Transport Channels.....	60
8.2.1	The Broadcast Channel (BCH).....	60
8.2.2	The Paging Channel (PCH)	60
8.2.3	The Forward Channel (FACH).....	60
8.2.4	The Random Access Channel (RACH)	60
8.2.5	The Uplink Shared Channel (USCH).....	60
8.2.6	The Downlink Shared Channel (DSCH).....	61
8.2.7	The High Speed Downlink Shared Channel (HS-DSCH).....	61
8.2.7.1	HS-DSCH/HS-SCCH Association and Timing.....	61
8.2.7.2	HS-SCCH/HS-DSCH/HS-SICH Association and Timing.....	61
Annex A (normative): Basic Midamble Codes for the 3.84 Mcps option.....		63
A.1	Basic Midamble Codes for Burst Type 1 and 3	63
A.2	Basic Midamble Codes for Burst Type 2	68
A.3	Association between Midambles and Channelisation Codes	71
A.3.1	Association for Burst Type 1/3 and $K_{Cell}=16$ Midambles	71
A.3.2	Association for Burst Type 1/3 and $K_{Cell}=8$ Midambles.....	72
A.3.3	Association for Burst Type 1/3 and $K_{Cell}=4$ Midambles.....	72
A.3.4	Association for Burst Type 2 and $K_{Cell}=6$ Midambles	73
A.3.5	Association for Burst Type 2 and $K_{Cell}=3$ Midambles.....	73
Annex B (normative): Basic Midamble Codes for the 1.28 Mcps option.....		75
B.1	Basic Midamble Codes.....	75
B.2	Association between Midambles and Channelisation Codes	78
B.2.1	Association for $K=16$ Midambles	78
B.2.2	Association for $K=14$ Midambles	79
B.2.3	Association for $K=12$ Midambles	79
B.2.4	Association for $K=10$ Midambles	80
B.2.5	Association for $K=8$ Midambles	80
B.2.6	Association for $K=6$ Midambles	81
B.2.7	Association for $K=4$ Midambles	81
B.2.8	Association for $K=2$ Midambles	82
Annex C (normative): Signalling of the number of channelisation codes for the DL common midamble case for 3.84Mcps TDD		83
C.1	Mapping scheme for Burst Type 1 and $K_{Cell}=16$ Midambles	83
C.2	Mapping scheme for Burst Type 1 and $K_{Cell}=8$ Midambles	83
C.3	Mapping scheme for Burst Type 1 and $K_{Cell}=4$ Midambles	84
C.4	Mapping scheme for beacon timeslots and $K_{Cell}=16$ Midambles	84
C.5	Mapping scheme for beacon timeslots and $K_{Cell}=8$ Midambles	85
C.6	Mapping scheme for beacon timeslots and $K_{Cell}=4$ Midambles	85
C.7	Mapping scheme for Burst Type 2 and $K_{Cell}=6$ Midambles	85
C.8	Mapping scheme for Burst Type 2 and $K_{Cell}=3$ Midambles	86
Annex D (normative): Signalling of the number of channelisation codes for the DL common midamble case for 1.28Mcps TDD		87
D.1	Mapping scheme for $K=16$ Midambles.....	87

D.2	Mapping scheme for K=14 Midambles.....	87
D.3	Mapping scheme for K=12 Midambles.....	88
D.4	Mapping scheme for K=10 Midambles.....	88
D.5	Mapping scheme for K=8 Midambles.....	88
D.6	Mapping scheme for K=6 Midambles.....	88
D.7	Mapping scheme for K=4 Midambles.....	89
D.8	Mapping scheme for K=2 Midambles.....	89
Annex E (informative):	CCPCH Multiframe Structure for the 3.84 Mcps option.....	90
Annex F (informative):	CCPCH Multiframe Structure for the 1.28 Mcps option.....	92
Annex G (informative):	Examples of the association of DL TPC commands to UL uplink time slots for 1.28 Mcps TDD.....	93
Annex H (informative):	Examples of the association of DL SS commands to UL uplink time slots.....	94
Annex I (informative):	Change history	95
History		97

Foreword

This Technical Specification (TS) has been produced by the 3rd Generation Partnership Project (3GPP).

The contents of the present document are subject to continuing work within the TSG and may change following formal TSG approval. Should the TSG modify the contents of the present document, it will be re-released by the TSG with an identifying change of release date and an increase in version number as follows:

Version x.y.z

where:

- x the first digit:
 - 1 presented to TSG for information;
 - 2 presented to TSG for approval;
 - 3 or greater indicates TSG approved document under change control.
- y the second digit is incremented for all changes of substance, i.e. technical enhancements, corrections, updates, etc.
- z the third digit is incremented when editorial only changes have been incorporated in the document.

1 Scope

The present document describes the characteristics of the physical channels and the mapping of the transport channels to physical channels in the TDD mode of UTRA.

2 References

The following documents contain provisions which, through reference in this text, constitute provisions of the present document.

- References are either specific (identified by date of publication, edition number, version number, etc.) or non-specific.
- For a specific reference, subsequent revisions do not apply.
- For a non-specific reference, the latest version applies.

- [1] 3GPP TS 25.201: "Physical layer - general description".
- [2] 3GPP TS 25.211: "Physical channels and mapping of transport channels onto physical channels (FDD)".
- [3] 3GPP TS 25.212: "Multiplexing and channel coding (FDD)".
- [4] 3GPP TS 25.213: "Spreading and modulation (FDD)".
- [5] 3GPP TS 25.214: "Physical layer procedures (FDD)".
- [6] 3GPP TS 25.215: "Physical layer – Measurements (FDD)".
- [7] 3GPP TS 25.222: "Multiplexing and channel coding (TDD)".
- [8] 3GPP TS 25.223: "Spreading and modulation (TDD)".
- [9] 3GPP TS 25.224: "Physical layer procedures (TDD)".
- [10] 3GPP TS 25.225: "Physical layer – Measurements (TDD)".
- [11] 3GPP TS 25.301: "Radio Interface Protocol Architecture".
- [12] 3GPP TS 25.302: "Services Provided by the Physical Layer".
- [13] 3GPP TS 25.401: "UTRAN Overall Description".
- [14] 3GPP TS 25.402: "Synchronisation in UTRAN, Stage 2".
- [15] 3GPP TS 25.304: " UE Procedures in Idle Mode and Procedures for Cell Reselection in Connected Mode".
- [16] 3GPP TS 25.427: "UTRAN Iur and Iub interface user plane protocols for DCH data streams".
- [17] 3GPP TS 25.435: "UTRAN I_{ub} Interface User Plane Protocols for Common Transport Channel Data Streams".
- [18] 3GPP TS 25.308: High Speed Downlink Packet Access (HSDPA); Overall description; Stage 2

3 Abbreviations

For the purposes of the present document, the following abbreviations apply:

16QAM 16 Quadrature Amplitude Modulation

BCH	Broadcast Channel
CCPCH	Common Control Physical Channel
CCTrCH	Coded Composite Transport Channel
CDMA	Code Division Multiple Access
CQI	Channel Quality Indicator
DCH	Dedicated Channel
DL	Downlink
DPCH	Dedicated Physical Channel
DRX	Discontinuous Reception
DSCH	Downlink Shared Channel
DTX	Discontinuous Transmission
DwPCH	Downlink Pilot Channel
DwPTS	Downlink Pilot Time Slot
FACH	Forward Access Channel
FDD	Frequency Division Duplex
FEC	Forward Error Correction
GP	Guard Period
GSM	Global System for Mobile Communication
HARQ	Hybrid ARQ
HS-DSCH	High Speed Downlink Shared Channel
HS-PDSCH	High Speed Physical Downlink Shared Channel
HS-SCCH	Shared Control Channel for HS-DSCH
HS-SICH	Shared Information Channel for HS-DSCH
MIB	Master Information Block
NRT	Non-Real Time
OVSF	Orthogonal Variable Spreading Factor
P-CCPCH	Primary CCPCH
PCH	Paging Channel
PDSCH	Physical Downlink Shared Channel
PI	Paging Indicator (value calculated by higher layers)
PICH	Page Indicator Channel
P_q	Paging Indicator (indicator set by physical layer)
PRACH	Physical Random Access Channel
PUSCH	Physical Uplink Shared Channel
RACH	Random Access Channel
RF	Radio Frame
RT	Real Time
S-CCPCH	Secondary CCPCH
SCH	Synchronisation Channel
SCTD	Space Code Transmit Diversity
SF	Spreading Factor
SFN	Cell System Frame Number
SS	Synchronisation Shift
TCH	Traffic Channel
TDD	Time Division Duplex
TDMA	Time Division Multiple Access
TFC	Transport Format Combination
TFCI	Transport Format Combination Indicator
TFI	Transport Format Indicator
TPC	Transmitter Power Control
TrCH	Transport Channel
TSTD	Time Switched Transmit Diversity
TTI	Transmission Time Interval
UE	User Equipment
UL	Uplink
UMTS	Universal Mobil Telecommunications System
UpPTS	Uplink Pilot Time Slot
UpPCH	Uplink Pilot Channel
USCH	Uplink Shared Channel
UTRAN	UMTS Terrestrial Radio Access Network

4 Services offered to higher layers

4.1 Transport channels

Transport channels are the services offered by layer 1 to the higher layers. A transport channel is defined by how and with what characteristics data is transferred over the air interface. A general classification of transport channels is into two groups:

- Dedicated Channels, using inherent addressing of UE
- Common Channels, using explicit addressing of UE if addressing is needed

General concepts about transport channels are described in [12].

4.1.1 Dedicated transport channels

The Dedicated Channel (DCH) is an up- or downlink transport channel that is used to carry user or control information between the UTRAN and a UE.

4.1.2 Common transport channels

There are six types of transport channels: BCH, FACH, PCH, RACH, USCH, DSCH

4.1.2.1 BCH - Broadcast Channel

The Broadcast Channel (BCH) is a downlink transport channel that is used to broadcast system- and cell-specific information.

4.1.2.2 FACH – Forward Access Channel

The Forward Access Channel (FACH) is a downlink transport channel that is used to carry control information to a mobile station when the system knows the location cell of the mobile station. The FACH may also carry short user packets.

4.1.2.3 PCH – Paging Channel

The Paging Channel (PCH) is a downlink transport channel that is used to carry control information to a mobile station when the system does not know the location cell of the mobile station.

4.1.2.4 RACH – Random Access Channel

The Random Access Channel (RACH) is an up link transport channel that is used to carry control information from mobile station. The RACH may also carry short user packets.

4.1.2.5 USCH – Uplink Shared Channel

The uplink shared channel (USCH) is an uplink transport channel shared by several UEs carrying dedicated control or traffic data.

4.1.2.6 DSCH – Downlink Shared Channel

The downlink shared channel (DSCH) is a downlink transport channel shared by several UEs carrying dedicated control or traffic data.

4.1.2.7 HS-DSCH – High Speed Downlink Shared Channel

The High Speed Downlink Shared Channel (HS-DSCH) is a downlink transport channel shared by several UEs. The HS-DSCH is associated with one downlink DPCH, and one or several Shared Control Channels (HS-SCCH). The HS-DSCH is transmitted over the entire cell or over only part of the cell using e.g. beam-forming antennas.

4.2 Indicators

Indicators are means of fast low-level signalling entities which are transmitted without using information blocks sent over transport channels. The meaning of indicators is implicit to the receiver.

The indicator(s) defined in the current version of the specifications are: Paging Indicator.

5 Physical channels for the 3.84 Mcps option

All physical channels take three-layer structure with respect to timeslots, radio frames and system frame numbering (SFN), see [14]. Depending on the resource allocation, the configuration of radio frames or timeslots becomes different. All physical channels need a guard period in every timeslot. The time slots are used in the sense of a TDMA component to separate different user signals in the time domain. The physical channel signal format is presented in figure 1.

A physical channel in TDD is a burst, which is transmitted in a particular timeslot within allocated Radio Frames. The allocation can be continuous, i.e. the time slot in every frame is allocated to the physical channel or discontinuous, i.e. the time slot in a subset of all frames is allocated only. A burst is the combination of two data parts, a midamble part and a guard period. The duration of a burst is one time slot. Several bursts can be transmitted at the same time from one transmitter. In this case, the data parts must use different OVFSF channelisation codes, but the same scrambling code. The midamble parts are either identically or differently shifted versions of a cell-specific basic midamble code, see section 5.2.3.

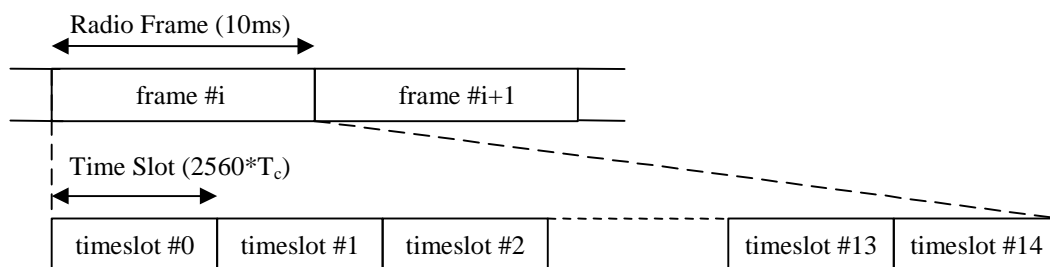

Figure 1: Physical channel signal format

The data part of the burst is spread with a combination of channelisation code and scrambling code. The channelisation code is a OVFSF code, that can have a spreading factor of 1, 2, 4, 8, or 16. The data rate of the physical channel is depending on the used spreading factor of the used OVFSF code.

The midamble part of the burst can contain two different types of midambles: a short one of length 256 chips, or a long one of 512 chips. The data rate of the physical channel is depending on the used midamble length.

So a physical channel is defined by frequency, timeslot, channelisation code, burst type and Radio Frame allocation. The scrambling code and the basic midamble code are broadcast and may be constant within a cell. When a physical channel is established, a start frame is given. The physical channels can either be of infinite duration, or a duration for the allocation can be defined.

5.1 Frame structure

The TDMA frame has a duration of 10 ms and is subdivided into 15 time slots (TS) of $2560 \cdot T_c$ duration each. A time slot corresponds to 2560 chips. The physical content of the time slots are the bursts of corresponding length as described in subclause 5.2.2.

Each 10 ms frame consists of 15 time slots, each allocated to either the uplink or the downlink (figure 2). With such a flexibility, the TDD mode can be adapted to different environments and deployment scenarios. In any configuration at least one time slot has to be allocated for the downlink and at least one time slot has to be allocated for the uplink.

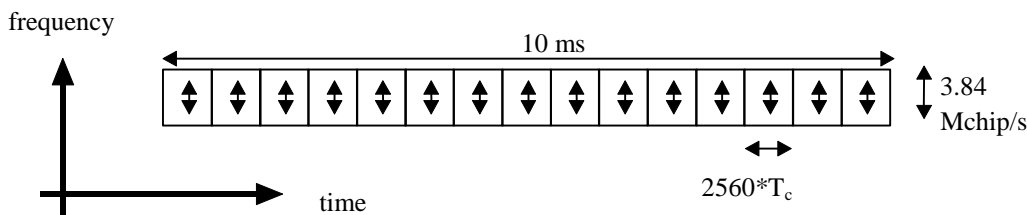

Figure 2: The TDD frame structure

Examples for multiple and single switching point configurations as well as for symmetric and asymmetric UL/DL allocations are given in figure 3.

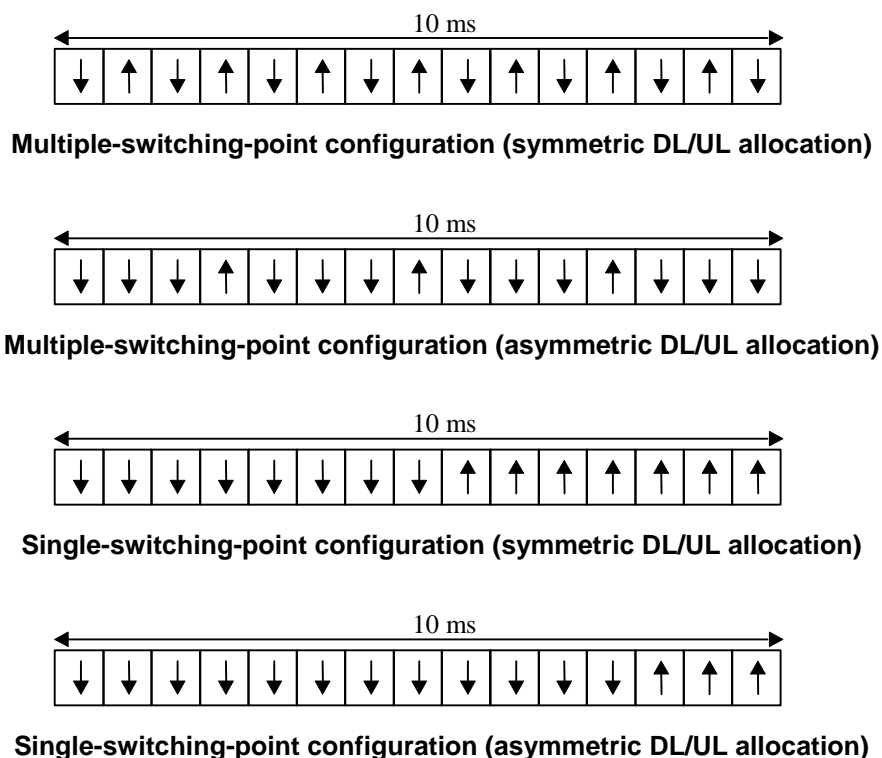

Figure 3: TDD frame structure examples

5.2 Dedicated physical channel (DPCH)

The DCH as described in subclause 4.1.1 is mapped onto the dedicated physical channel.

5.2.1 Spreading

Spreading is applied to the data part of the physical channels and consists of two operations. The first is the channelisation operation, which transforms every data symbol into a number of chips, thus increasing the bandwidth of the signal. The number of chips per data symbol is called the Spreading Factor (SF). The second operation is the scrambling operation, where a scrambling code is applied to the spread signal. Details on channelisation and scrambling operation can be found in [8].

5.2.1.1 Spreading for Downlink Physical Channels

Downlink physical channels shall use SF =16. Multiple parallel physical channels can be used to support higher data rates. These parallel physical channels shall be transmitted using different channelisation codes, see [8]. These codes with SF =16 are generated as described in [8].

Operation with a single code with spreading factor 1 is possible for the downlink physical channels.

5.2.1.2 Spreading for Uplink Physical Channels

The range of spreading factor that may be used for uplink physical channels shall range from 16 down to 1. For each physical channel an individual minimum spreading factor SF_{min} is transmitted by means of the higher layers. There are two options that are indicated by UTRAN:

1. The UE shall use the spreading factor SF_{min} , independent of the current TFC.
2. The UE shall autonomously increase the spreading factor depending on the current TFC.

If the UE autonomously changes the SF, it shall always vary the channelisation code along the branch with the higher code numbering of the allowed OVFSF sub tree, as depicted in [8].

For multicode transmission a UE shall use a maximum of two physical channels per timeslot simultaneously. These two parallel physical channels shall be transmitted using different channelisation codes, see [8].

5.2.2 Burst Types

Three types of bursts for dedicated physical channels are defined. All of them consist of two data symbol fields, a midamble and a guard period, the lengths of which are different for the individual burst types. Thus, the number of data symbols in a burst depends on the SF and the burst type, as depicted in table 1.

Table 1: Number of data symbols (N) for burst type 1, 2, and 3

Spreading factor (SF)	Burst Type 1	Burst Type 2	Burst Type 3
1	1952	2208	1856
2	976	1104	928
4	488	552	464
8	244	276	232
16	122	138	116

The support of all three burst types is mandatory for the UE. The three different bursts defined here are well suited for different applications, as described in the following sections.

5.2.2.1 Burst Type 1

The burst type 1 can be used for uplink and downlink. Due to its longer midamble field this burst type supports the construction of a larger number of training sequences, see 5.2.3. The maximum number of training sequences depend on the cell configuration, see annex A. For the burst type 1 this number may be 4, 8, or 16.

The data fields of the burst type 1 are 976 chips long. The corresponding number of symbols depends on the spreading factor, as indicated in table 1 above. The midamble of burst type 1 has a length of 512 chips. The guard period for the burst type 1 is 96 chip periods long. The burst type 1 is shown in Figure 4. The contents of the burst fields are described in table 2.

Table 2: The contents of the burst type 1 fields

Chip number (CN)	Length of field in chips	Length of field in symbols		Contents of field
0-975	976	Cf table 1		Data symbols
976-1487	512	-		Midamble
1488-2463	976	Cf table 1		Data symbols
2464-2559	96	-		Guard period

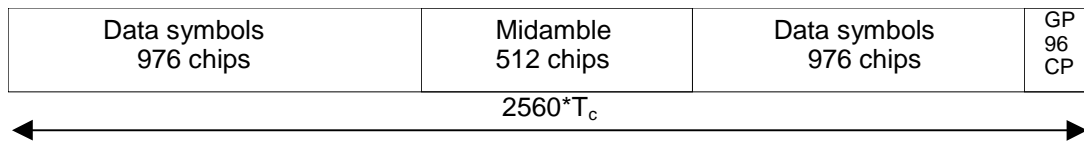

Figure 4: Burst structure of the burst type 1. GP denotes the guard period and CP the chip periods

5.2.2.2 Burst Type 2

The burst type 2 can be used for uplink and downlink. It offers a longer data field than burst type 1 on the cost of a shorter midamble. Due to the shorter midamble field the burst type 2 supports a maximum number of training sequences of 3 or 6 only, depending on the cell configuration, see annex A.

The data fields of the burst type 2 are 1104 chips long. The corresponding number of symbols depends on the spreading factor, as indicated in table 1 above. The guard period for the burst type 2 is 96 chip periods long. The burst type 2 is shown in Figure 5. The contents of the burst fields are described in table 3.

Table 3: The contents of the burst type 2 fields

Chip number (CN)	Length of field in chips	Length of field in symbols		Contents of field
0-1103	1104	cf table 1		Data symbols
1104-1359	256	-		Midamble
1360-2463	1104	cf table 1		Data symbols
2464-2559	96	-		Guard period

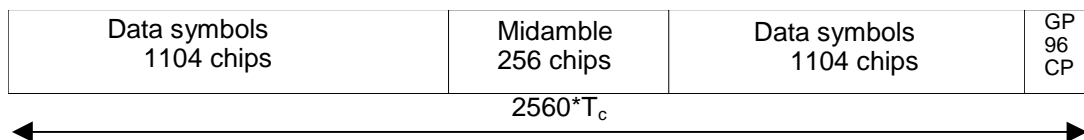

Figure 5: Burst structure of the burst type 2. GP denotes the guard period and CP the chip periods

5.2.2.3 Burst Type 3

The burst type 3 is used for uplink only. Due to the longer guard period it is suitable for initial access or access to a new cell after handover. It offers the same number of training sequences as burst type 1.

The data fields of the burst type 3 have a length of 976 chips and 880 chips, respectively. The corresponding number of symbols depends on the spreading factor, as indicated in table 1 above. The midamble of burst type 3 has a length of 512 chips. The guard period for the burst type 3 is 192 chip periods long. The burst type 3 is shown in Figure 6. The contents of the burst fields are described in table 4.

Table 4: The contents of the burst type 3 fields

Chip number (CN)	Length of field in chips	Length of field in symbols	Contents of field
0-975	976	Cf table 1	Data symbols
976-1487	512	-	Midamble
1488-2367	880	Cf table 1	Data symbols
2368-2559	192	-	Guard period

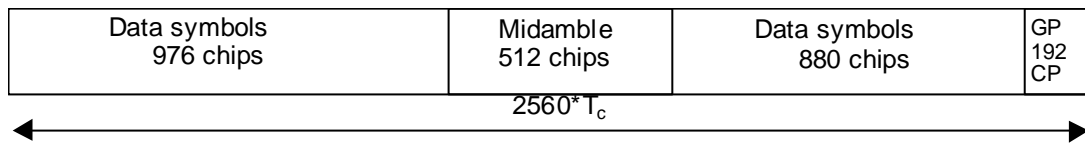

Figure 6: Burst structure of the burst type 3. GP denotes the guard period and CP the chip periods

5.2.2.4 Transmission of TFCI

All burst types 1, 2 and 3 provide the possibility for transmission of TFCI.

The transmission of TFCI is negotiated at call setup and can be re-negotiated during the call. For each CCTrCH it is indicated by higher layer signalling, which TFCI format is applied. Additionally for each allocated timeslot it is signalled individually whether that timeslot carries the TFCI or not. The TFCI is always present in the first timeslot in a radio frame for each CCTrCH. If a time slot contains the TFCI, then it is always transmitted using the first allocated channelisation code in the timeslot, according to the order in the higher layer allocation message.

The transmission of TFCI is done in the data parts of the respective physical channel. In DL the TFCI code word bits and data bits are subject to the same spreading procedure as depicted in [8]. In UL, independent of the SF that is applied to the data symbols in the burst, the data in the TFCI field are always spread with SF=16 using the channelisation code in the branch with the highest code numbering of the allowed OVSF sub tree, as depicted in [8]. Hence the midamble structure and length is not changed. The TFCI code word is to be transmitted directly adjacent to the midamble, possibly after the TPC. Figure 7 shows the position of the TFCI code word in a traffic burst in downlink. Figure 8 shows the position of the TFCI code word in a traffic burst in uplink.

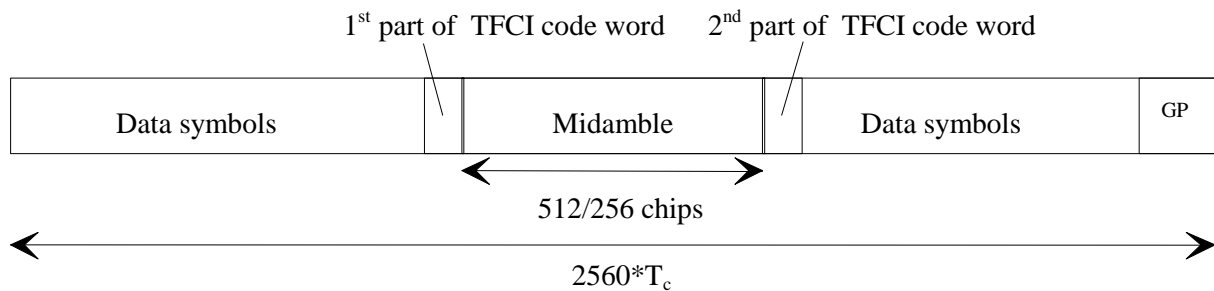

Figure 7: Position of the TFCI code word in the traffic burst in case of downlink

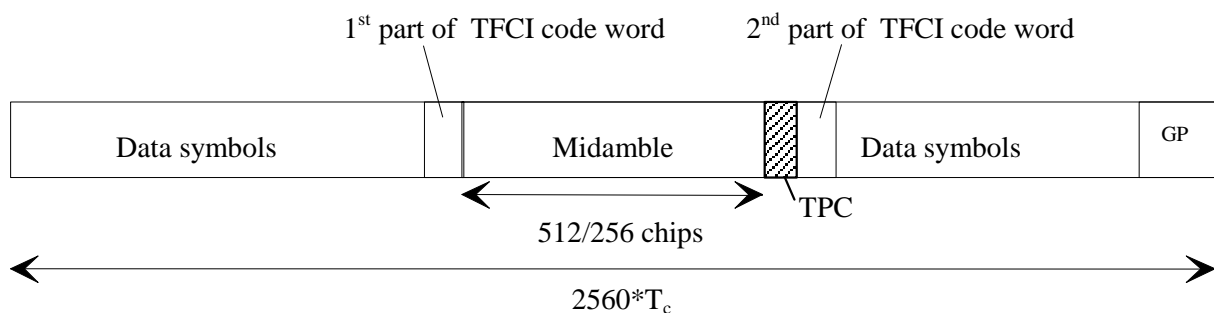

Figure 8: Position of the TFCI code word in the traffic burst in case of uplink

Two examples of TFCI transmission in the case of multiple DPCHs used for a connection are given in the Figure 9 and Figure 10 below. Combinations of the two schemes shown are also applicable.

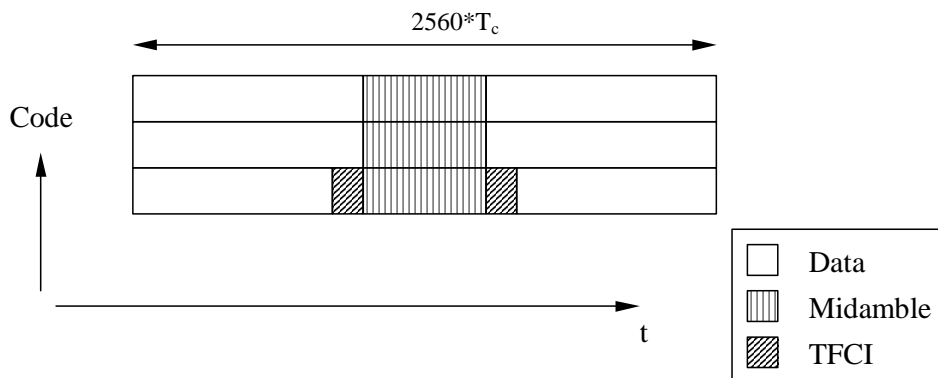

Figure 9: Example of TFCI transmission with physical channels multiplexed in code domain

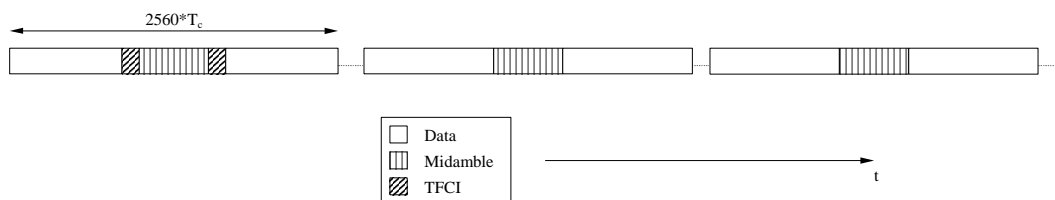

Figure 10: Example of TFCI transmission with physical channels multiplexed in time domain

In case the Node B receives an invalid TFI combination on the DPCHs mapped to one CCTrCH the procedure described in [16] shall be applied. According to this procedure DTX shall be applied to all DPCHs to which the CCTrCH is mapped to.

5.2.2.5 Transmission of TPC

All burst types 1, 2 and 3 for dedicated channels provide the possibility for transmission of TPC in uplink.

The transmission of TPC is done in the data parts of the traffic burst. Independent of the SF that is applied to the data symbols in the burst, the data in the TPC field are always spread with SF=16 using the channelisation code in the branch with the highest code numbering of the allowed OVSF sub tree, as depicted in [8]. Hence the midamble structure and length is not changed. The TPC information is to be transmitted directly after the midamble. Figure 11 shows the position of the TPC in a traffic burst.

For every user the TPC information shall be transmitted at least once per transmitted frame. If a TFCI is applied for a CCTrCH, TPC shall be transmitted with the same channelization codes and in the same timeslots as the TFCI. If no TFCI is applied for a CCTrCH, TPC shall be transmitted using the first allocated channelisation code and the first allocated timeslot, according to the order in the higher layer allocation message.

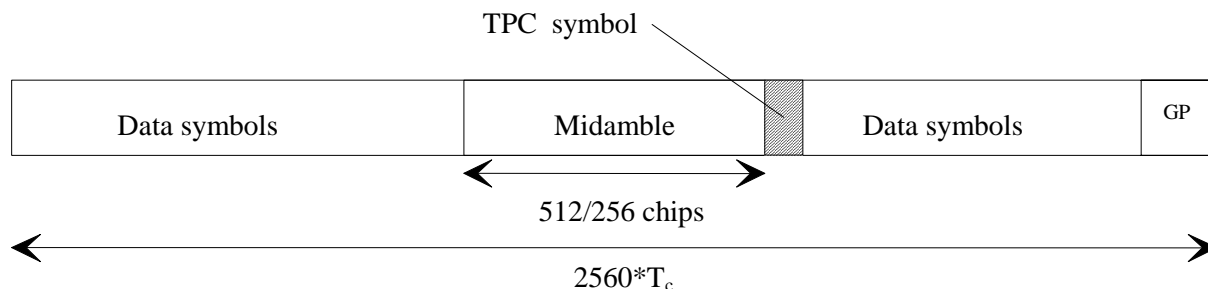

Figure 11: Position of TPC information in the traffic burst

The length of the TPC command is one symbol. The relationship between the TPC symbol and the TPC command is shown in table 4a.

Table 4a: TPC bit pattern

TPC Bits	TPC command	Meaning
00	'Down'	Decrease Tx Power
11	'Up'	Increase Tx Power

5.2.2.6 Timeslot formats

5.2.2.6.1 Downlink timeslot formats

The downlink timeslot format depends on the spreading factor, midamble length and on the number of the TFCI code word bits, as depicted in the table 5a.

Table 5a: Time slot formats for the Downlink

Slot Format #	Spreading Factor	Midamble length (chips)	N _{TFCI} code word (bits)	Bits/slot	N _{Data/Slot} (bits)	N _{data/data field} (bits)
0	16	512	0	244	244	122
1	16	512	4	244	240	120
2	16	512	8	244	236	118
3	16	512	16	244	228	114
4	16	512	32	244	212	106
5	16	256	0	276	276	138
6	16	256	4	276	272	136
7	16	256	8	276	268	134
8	16	256	16	276	260	130
9	16	256	32	276	244	122
10	1	512	0	3904	3904	1952
11	1	512	4	3904	3900	1950
12	1	512	8	3904	3896	1948
13	1	512	16	3904	3888	1944
14	1	512	32	3904	3872	1936
15	1	256	0	4416	4416	2208
16	1	256	4	4416	4412	2206
17	1	256	8	4416	4408	2204
18	1	256	16	4416	4400	2200
19	1	256	32	4416	4384	2192

5.2.2.6.2 Uplink timeslot formats

The uplink timeslot format depends on the spreading factor, midamble length, guard period length and on the number of the TFCI code word bits. Due to TPC, different amount of bits are mapped to the two data fields. The timeslot formats are depicted in the table 5b.

Table 5b: Timeslot formats for the Uplink

Slot Format #	Spreading Factor	Midamble length (chips)	Guard Period (chips)	N _{TCI} code word (bits)	N _{TPC} (bits)	Bits/slot	N _{Data/Slot} (bits)	N _{data/data field(1)} (bits)	N _{data/data field(2)} (bits)
0	16	512	96	0	0	244	244	122	122
1	16	512	96	0	2	244	242	122	120
2	16	512	96	4	2	244	238	120	118
3	16	512	96	8	2	244	234	118	116
4	16	512	96	16	2	244	226	114	112
5	16	512	96	32	2	244	210	106	104
6	16	256	96	0	0	276	276	138	138
7	16	256	96	0	2	276	274	138	136
8	16	256	96	4	2	276	270	136	134
9	16	256	96	8	2	276	266	134	132
10	16	256	96	16	2	276	258	130	128
11	16	256	96	32	2	276	242	122	120
12	8	512	96	0	0	488	488	244	244
13	8	512	96	0	2	486	484	244	240
14	8	512	96	4	2	482	476	240	236
15	8	512	96	8	2	478	468	236	232
16	8	512	96	16	2	470	452	228	224
17	8	512	96	32	2	454	420	212	208
18	8	256	96	0	0	552	552	276	276
19	8	256	96	0	2	550	548	276	272
20	8	256	96	4	2	546	540	272	268
21	8	256	96	8	2	542	532	268	264
22	8	256	96	16	2	534	516	260	256
23	8	256	96	32	2	518	484	244	240
24	4	512	96	0	0	976	976	488	488
25	4	512	96	0	2	970	968	488	480
26	4	512	96	4	2	958	952	480	472
27	4	512	96	8	2	946	936	472	464
28	4	512	96	16	2	922	904	456	448
29	4	512	96	32	2	874	840	424	416
30	4	256	96	0	0	1104	1104	552	552
31	4	256	96	0	2	1098	1096	552	544
32	4	256	96	4	2	1086	1080	544	536
33	4	256	96	8	2	1074	1064	536	528
34	4	256	96	16	2	1050	1032	520	512
35	4	256	96	32	2	1002	968	488	480
36	2	512	96	0	0	1952	1952	976	976
37	2	512	96	0	2	1938	1936	976	960
38	2	512	96	4	2	1910	1904	960	944
39	2	512	96	8	2	1882	1872	944	928
40	2	512	96	16	2	1826	1808	912	896
41	2	512	96	32	2	1714	1680	848	832
42	2	256	96	0	0	2208	2208	1104	1104
43	2	256	96	0	2	2194	2192	1104	1088
44	2	256	96	4	2	2166	2160	1088	1072
45	2	256	96	8	2	2138	2128	1072	1056
46	2	256	96	16	2	2082	2064	1040	1024
47	2	256	96	32	2	1970	1936	976	960

Slot Format #	Spreading Factor	Midamble length (chips)	Guard Period (chips)	N _{TFCI} code word (bits)	N _{TPC} (bits)	Bits/slot	N _{Data/Slot} (bits)	N _{data/data field(1)} (bits)	N _{data/data field(2)} (bits)
48	1	512	96	0	0	3904	3904	1952	1952
49	1	512	96	0	2	3874	3872	1952	1920
50	1	512	96	4	2	3814	3808	1920	1888
51	1	512	96	8	2	3754	3744	1888	1856
52	1	512	96	16	2	3634	3616	1824	1792
53	1	512	96	32	2	3394	3360	1696	1664
54	1	256	96	0	0	4416	4416	2208	2208
55	1	256	96	0	2	4386	4384	2208	2176
56	1	256	96	4	2	4326	4320	2176	2144
57	1	256	96	8	2	4266	4256	2144	2112
58	1	256	96	16	2	4146	4128	2080	2048
59	1	256	96	32	2	3906	3872	1952	1920
60	16	512	192	0	0	232	232	122	110
61	16	512	192	0	2	232	230	122	108
62	16	512	192	4	2	232	226	120	106
63	16	512	192	8	2	232	222	118	104
64	16	512	192	16	2	232	214	114	100
65	16	512	192	32	2	232	198	106	92
66	8	512	192	0	0	464	464	244	220
67	8	512	192	0	2	462	460	244	216
68	8	512	192	4	2	458	452	240	212
69	8	512	192	8	2	454	444	236	208
70	8	512	192	16	2	446	428	228	200
71	8	512	192	32	2	430	396	212	184
72	4	512	192	0	0	928	928	488	440
73	4	512	192	0	2	922	920	488	432
74	4	512	192	4	2	910	904	480	424
75	4	512	192	8	2	898	888	472	416
76	4	512	192	16	2	874	856	456	400
77	4	512	192	32	2	826	792	424	368
78	2	512	192	0	0	1856	1856	976	880
79	2	512	192	0	2	1842	1840	976	864
80	2	512	192	4	2	1814	1808	960	848
81	2	512	192	8	2	1786	1776	944	832
82	2	512	192	16	2	1730	1712	912	800
83	2	512	192	32	2	1618	1584	848	736
84	1	512	192	0	0	3712	3712	1952	1760
85	1	512	192	0	2	3682	3680	1952	1728
86	1	512	192	4	2	3622	3616	1920	1696
87	1	512	192	8	2	3562	3552	1888	1664
88	1	512	192	16	2	3442	3424	1824	1600
89	1	512	192	32	2	3202	3168	1696	1472

5.2.3 Training sequences for spread bursts

In this subclause, the training sequences for usage as midambles in burst type 1, 2 and 3 (see subclause 5.2.2) are defined. The training sequences, i.e. midambles, of different users active in the same cell and same time slot are cyclically shifted versions of one cell-specific single basic midamble code. The applicable basic midamble codes are

given in Annex A.1 and A.2. As different basic midamble codes are required for different burst formats, the Annex A.1 shows the basic midamble codes \mathbf{m}_{pL} for burst type 1 and 3, and Annex and A.2 shows \mathbf{m}_{pS} for burst type 2. It should be noted that burst type 2 must not be mixed with burst type 1 or 3 in the same timeslot of one cell.

The basic midamble codes in Annex A.1 and A.2 are listed in hexadecimal notation. The binary form of the basic midamble code shall be derived according to table 6 below.

Table 6: Mapping of 4 binary elements m_i on a single hexadecimal digit

4 binary elements m_i	Mapped on hexadecimal digit
-1 -1 -1 -1	0
-1 -1 -1 1	1
-1 -1 1 -1	2
-1 -1 1 1	3
-1 1 -1 -1	4
-1 1 -1 1	5
-1 1 1 -1	6
-1 1 1 1	7
1 -1 -1 -1	8
1 -1 -1 1	9
1 -1 1 -1	A
1 -1 1 1	B
1 1 -1 -1	C
1 1 -1 1	D
1 1 1 -1	E
1 1 1 1	F

For each particular basic midamble code, its binary representation can be written as a vector \mathbf{m}_p :

$$\mathbf{m}_p = (m_1, m_2, \dots, m_p) \quad (1)$$

According to Annex A.1, the size of this vector \mathbf{m}_p is $P=456$ for burst type 1 and 3. Annex A.2 is setting $P=192$ for burst type 2. As QPSK modulation is used, the training sequences are transformed into a complex form, denoted as the complex vector $\underline{\mathbf{m}}_p$:

$$\underline{\mathbf{m}}_p = (\underline{m}_1, \underline{m}_2, \dots, \underline{m}_p) \quad (2)$$

The elements \underline{m}_i of $\underline{\mathbf{m}}_p$ are derived from elements m_i of \mathbf{m}_p using equation (3):

$$\underline{m}_i = (j)^i \cdot m_i \text{ for all } i = 1, \dots, P \quad (3)$$

Hence, the elements \underline{m}_i of the complex basic midamble code are alternating real and imaginary.

To derive the required training sequences (different shifts), this vector $\underline{\mathbf{m}}_p$ is periodically extended to the size:

$$i_{\max} = L_m + (K'-1)W + \lfloor P/K \rfloor \quad (4)$$

Notes on equation (4):

- L_m : Midamble length
- K' : Maximum number of different midamble shifts in a cell, when no intermediate shifts are used. This value depends on the midamble length.
- K : Maximum number of different midamble shifts in a cell, when intermediate shifts are used, $K=2K'$. This value depends on the midamble length.
- W : Shift between the midambles, when the number of midambles is K' .

- $\lfloor x \rfloor$ denotes the largest integer smaller or equal to x

Allowed values for L_m , K' and W are given in Annex A.1 and A.2.

So we obtain a new vector $\underline{\mathbf{m}}$ containing the periodic basic midamble sequence:

$$\underline{\mathbf{m}} = (m_1, m_2, \dots, m_{i_{\max}}) = (m_1, m_2, \dots, m_{L_m + (K'-1)W + \lfloor P/K \rfloor}) \quad (5)$$

The first P elements of this vector $\underline{\mathbf{m}}$ are the same ones as in vector $\underline{\mathbf{m}}_P$, the following elements repeat the beginning:

$$m_i = m_{i-P} \text{ for the subset } i = (P+1), \dots, i_{\max} \quad (6)$$

Using this periodic basic midamble sequence $\underline{\mathbf{m}}$ for each shift k a midamble $\underline{\mathbf{m}}^{(k)}$ of length L_m is derived, which can be written as a shift specific vector:

$$\underline{\mathbf{m}}^{(k)} = (m_1^{(k)}, m_2^{(k)}, \dots, m_{L_m}^{(k)}) \quad (7)$$

The L_m midamble elements $m_i^{(k)}$ are generated for each midamble of the first K' shifts ($k = 1, \dots, K'$) based on:

$$m_i^{(k)} = m_{i+(K'-k)W} \text{ with } i = 1, \dots, L_m \text{ and } k = 1, \dots, K' \quad (8)$$

The elements of midambles for the second K' shifts ($k = (K'+1), \dots, K = (K'+1), \dots, 2K'$) are generated based on a slight modification of this formula introducing intermediate shifts:

$$m_i^{(k)} = m_{i+(K-k-1)W + \lfloor P/K \rfloor} \text{ with } i = 1, \dots, L_m \text{ and } k = K'+1, \dots, K-1 \quad (9)$$

$$m_i^{(k)} = m_{i+(K'-1)W + \lfloor P/K \rfloor} \text{ with } i = 1, \dots, L_m \text{ and } k = K \quad (10)$$

The number K_{Cell} of midambles that is supported in each cell can be smaller than K , depending on the cell size and the possible delay spreads, see annex A. The number K_{Cell} is signalled by higher layers. The midamble sequences derived according to equations (7) to (10) have complex values and are not subject to channelisation or scrambling process, i.e. the elements $m_i^{(k)}$ represent complex chips for usage in the pulse shaping process at modulation.

The term 'a midamble code set' or 'a midamble code family' denotes K specific midamble codes $\underline{\mathbf{m}}^{(k)}$; $k=1, \dots, K$, based on a single basic midamble code $\underline{\mathbf{m}}_P$ according to (1).

5.2.4 Beamforming

When DL beamforming is used, at least that user to which beamforming is applied and which has a dedicated channel shall get one individual midamble according to subclause 5.2.3, even in DL.

5.3 Common physical channels

5.3.1 Primary common control physical channel (P-CCPCH)

The BCH as described in subclause 4.1.2 is mapped onto the Primary Common Control Physical Channel (P-CCPCH). The position (time slot / code) of the P-CCPCH is known from the Physical Synchronisation Channel (PSCH), see subclause 5.3.4.

5.3.1.1 P-CCPCH Spreading

The P-CCPCH uses fixed spreading with a spreading factor $SF = 16$ as described in subclause 5.2.1.1. The P-CCPCH always uses channelisation code $C_{Q=16}^{(k=1)}$.

5.3.1.2 P-CCPCH Burst Types

The burst type 1 as described in subclause 5.2.2 is used for the P-CCPCH. No TFCI is applied for the P-CCPCH.

5.3.1.3 P-CCPCH Training sequences

The training sequences, i.e. midambles, as described in subclause 5.2.3 are used for the P-CCPCH. For those timeslots in which the P-CCPCH is transmitted, the midambles $m^{(1)}$ and $m^{(2)}$ are reserved for P-CCPCH in order to support Space Code transmit Diversity (SCTD) and the beacon function, see 5.4 and 5.5. The use of midambles depends on whether SCTD is applied to the P-CCPCH:

- If no antenna diversity is applied to P-CCPCH, $m^{(1)}$ is used and $m^{(2)}$ is left unused. The maximum number K_{Cell} of midambles in a cell may be 4, 8 or 16.
- If SCTD antenna diversity is applied to P-CCPCH, $m^{(1)}$ is used for the first antenna and $m^{(2)}$ is used for the diversity antenna. The maximum number K_{Cell} of midambles in a cell may be 8 or 16. The case of 4 midambles is not allowed for SCTD.

5.3.2 Secondary common control physical channel (S-CCPCH)

PCH and FACH as described in subclause 4.1.2 are mapped onto one or more secondary common control physical channels (S-CCPCH). In this way the capacity of PCH and FACH can be adapted to the different requirements.

5.3.2.1 S-CCPCH Spreading

The S-CCPCH uses fixed spreading with a spreading factor $SF = 16$ as described in subclause 5.2.1.1.

5.3.2.2 S-CCPCH Burst Types

The burst types 1 or 2 as described in subclause 5.2.2 are used for the S-CCPCHs. TFCI may be applied for S-CCPCHs.

5.3.2.3 S-CCPCH Training sequences

The training sequences, i.e. midambles, as described in subclause 5.2.3 are used for the S-CCPCH.

5.3.3 The physical random access channel (PRACH)

The RACH as described in subclause 4.1.2 is mapped onto one uplink physical random access channel (PRACH).

5.3.3.1 PRACH Spreading

The uplink PRACH uses either spreading factor $SF=16$ or $SF=8$ as described in subclause 5.2.1.2. The set of admissible spreading codes for use on the PRACH and the associated spreading factors are broadcast on the BCH (within the RACH configuration parameters on the BCH).

5.3.3.2 PRACH Burst Type

The UEs send uplink access bursts of type 3 randomly in the PRACH. TFCI and TPC are not applied for the PRACH.

5.3.3.3 PRACH Training sequences

The training sequences, i.e. midambles, of different users active in the same time slot are time shifted versions of a single periodic basic code. The basic midamble codes for burst type 3 are shown in Annex A. The necessary time shifts are obtained by choosing either *all* $k=1,2,3,\dots,K'$ (for cells with small radius) or *uneven* $k=1,3,5,\dots\leq K'$ (for cells with large radius). Different cells use different periodic basic codes, i.e. different midamble sets.

For cells with large radius additional midambles may be derived from the time-inverted Basic Midamble Sequence. Thus, the second Basic Midamble Code m_2 is the time inverted version of Basic Midamble Code m_1 .

In this way, a joint channel estimation for the channel impulse responses of all active users within one time slot can be performed by a maximum of two cyclic correlations (in cells with small radius, a single cyclic correlator suffices). The different user specific channel impulse response estimates are obtained sequentially in time at the output of the cyclic correlators.

5.3.3.4 PRACH timeslot formats

For the PRACH the timeslot format is only spreading factor dependent. The timeslot formats 60 and 66 of table 5b are applicable for the PRACH.

5.3.3.5 Association between Training Sequences and Channelisation Codes

For the PRACH there exists a fixed association between the training sequence and the channelisation code. The generic rule to define this association is based on the order of the channelisation codes $c_Q^{(k)}$ given by k and the order of the midambles $m_j^{(k)}$ given by k , firstly, and j , secondly, with the constraint that the midamble for a spreading factor Q is the same as in the upper branch for the spreading factor $2Q$. The index $j=1$ or 2 indicates whether the original Basic Midamble Sequence ($j=1$) or the time-inverted Basic Midamble Sequence is used ($j=2$).

- For the case that all k are allowed and only one periodic basic code m_1 is available for the RACH, the association depicted in figure 12 is straightforward.
- For the case that only odd k are allowed the principle of the association is shown in figure 13. This association is applied for one and two basic periodic codes.

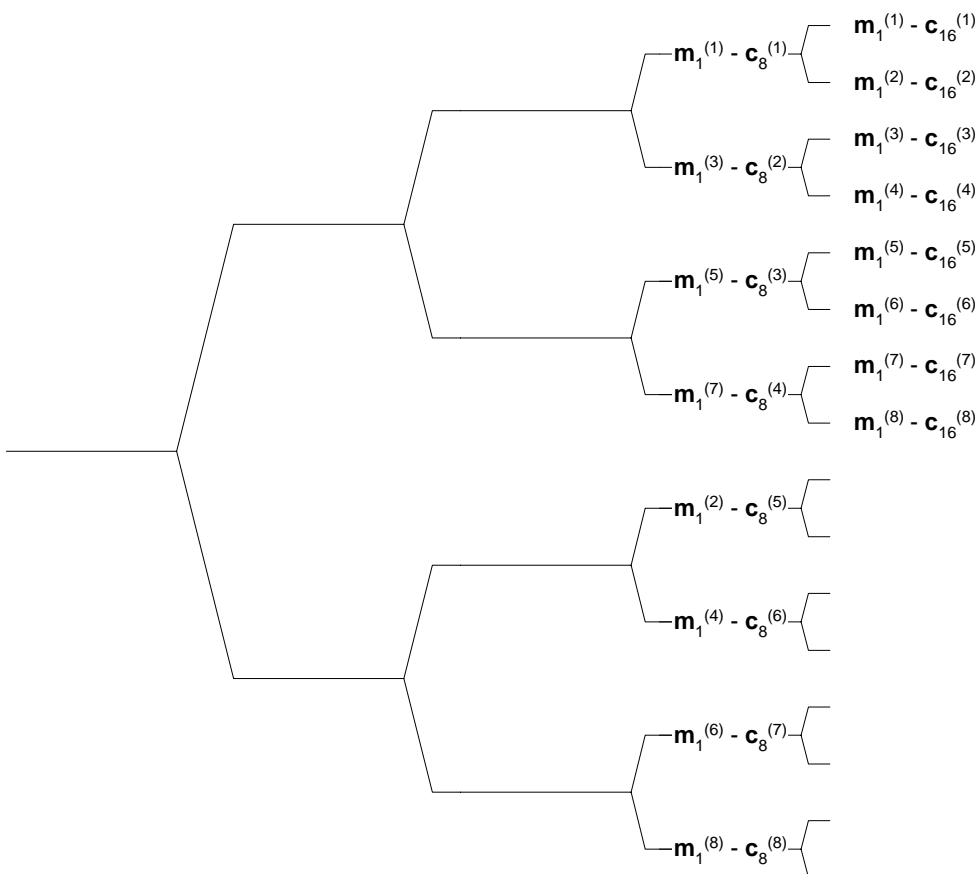

Figure 12: Association of Midambles to Channelisation Codes in the OVSF tree for all k

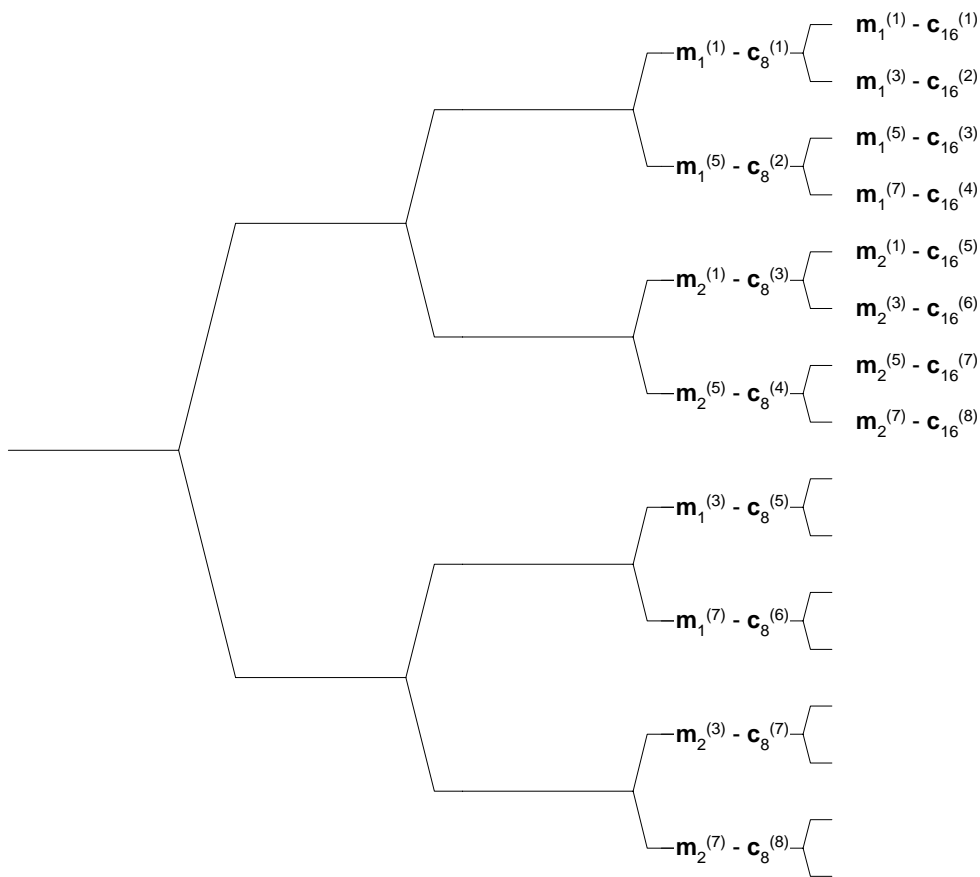

Figure 13: Association of Midambles to Channelisation Codes in the OVSF tree for odd *k*

5.3.4 The synchronisation channel (SCH)

In TDD mode code group of a cell can be derived from the synchronisation channel. In order not to limit the uplink/downlink asymmetry the SCH is mapped on one or two downlink slots per frame only.

There are two cases of SCH and P-CCPCH allocation as follows:

- Case 1) SCH and P-CCPCH allocated in TS#*k*, *k*=0...14
- Case 2) SCH allocated in two TS: TS#*k* and TS#*k*+8, *k*=0...6; P-CCPCH allocated in TS#*k*.

The position of SCH (value of *k*) in frame can change on a long term basis in any case.

Due to this SCH scheme, the position of P-CCPCH is known from the SCH.

Figure 14 is an example for transmission of SCH, *k*=0, of Case 2.

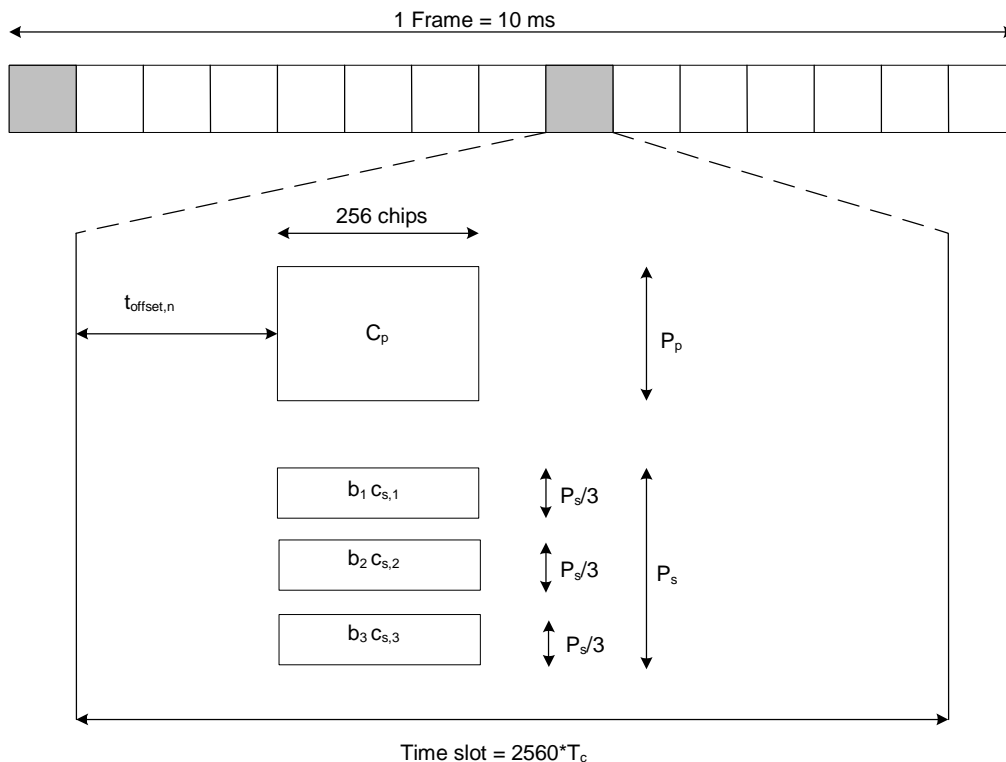

$$b_i \in \{\pm 1, \pm j\}, C_{s,i} \in \{C_0, C_1, C_3, C_4, C_5, C_6, C_8, C_{10}, C_{12}, C_{13}, C_{14}, C_{15}\}, i=1,2,3; \text{ see [8]}$$

Figure 14: Scheme for Synchronisation channel SCH consisting of one primary sequence Cp and 3 parallel secondary sequences Cs,i in slot k and k+8 (example for k=0 in Case 2)

As depicted in figure 14, the SCH consists of a primary and three secondary code sequences each 256 chips long. The primary and secondary code sequences are defined in [8] clause 8 'Synchronisation codes for the 3.84 Mcps option'.

Due to mobile to mobile interference, it is mandatory for public TDD systems to keep synchronisation between base stations. As a consequence of this, a capture effect concerning SCH can arise. The time offset $t_{offset,n}$ enables the system to overcome the capture effect.

The time offset $t_{offset,n}$ is one of 32 values, depending on the code group of the cell, n, cf. 'table 6 Mapping scheme for Cell Parameters, Code Groups, Scrambling Codes, Midambles and t_{offset} ' in [8]. Note that the cell parameter will change from frame to frame, cf. 'Table 7 Alignment of cell parameter cycling and system frame number' in [8], but the cell will belong to only one code group and thus have one time offset $t_{offset,n}$. The exact value for $t_{offset,n}$, regarding column 'Associated t_{offset} ' in table 6 in [8] is given by:

$$t_{offset,n} = \begin{cases} n \cdot 48 \cdot T_c & n < 16 \\ (720 + n \cdot 48) T_c & n \geq 16 \end{cases}; \quad n = 0, \dots, 31$$

5.3.5 Physical Uplink Shared Channel (PUSCH)

The USCH as described in subclause 4.1.2 is mapped onto one or more physical uplink shared channels (PUSCH). Timing advance, as described in [9], subclause 4.3, is applied to the PUSCH.

5.3.5.1 PUSCH Spreading

The spreading factors that can be applied to the PUSCH are SF = 1, 2, 4, 8, 16 as described in subclause 5.2.1.2.

5.3.5.2 PUSCH Burst Types

Burst types 1, 2 or 3 as described in subclause 5.2.2 can be used for PUSCH. TFCI and TPC can be transmitted on the PUSCH.

5.3.5.3 PUSCH Training Sequences

The training sequences as described in subclause 5.2.3 are used for the PUSCH.

5.3.5.4 UE Selection

The UE that shall transmit on the PUSCH is selected by higher layer signalling.

5.3.6 Physical Downlink Shared Channel (PDSCH)

The DSCH as described in subclause 4.1.2 is mapped onto one or more physical downlink shared channels (PDSCH).

5.3.6.1 PDSCH Spreading

The PDSCH uses either spreading factor $SF = 16$ or $SF = 1$ as described in subclause 5.2.1.1.

5.3.6.2 PDSCH Burst Types

Burst types 1 or 2 as described in subclause 5.2.2 can be used for PDSCH. TFCI can be transmitted on the PDSCH.

5.3.6.3 PDSCH Training Sequences

The training sequences as described in subclause 5.2.3 are used for the PDSCH.

5.3.6.4 UE Selection

To indicate to the UE that there is data to decode on the DSCH, three signalling methods are available:

- 1) using the TFCI field of the associated channel or PDSCH;
- 2) using on the DSCH user specific midamble derived from the set of midambles used for that cell;
- 3) using higher layer signalling.

When the midamble based method is used, the UE specific midamble allocation method shall be employed (see subclause 5.6), and the UE shall decode the PDSCH if the PDSCH was transmitted with the midamble assigned to the UE by UTRAN. For this method no other physical channels may use the same time slot as the PDSCH and only one UE may share the PDSCH time slot within one TTI.

Note: From the above mentioned signalling methods, only the higher layer signalling method is supported by higher layers in this release.

5.3.7 The Paging Indicator Channel (PICH)

The Paging Indicator Channel (PICH) is a physical channel used to carry the paging indicators.

5.3.7.1 Mapping of Paging Indicators to the PICH bits

Figure 15 depicts the structure of a PICH burst and the numbering of the bits within the burst. The same burst type is used for the PICH in every cell. N_{PIB} bits in a normal burst of type 1 or 2 are used to carry the paging indicators, where N_{PIB} depends on the burst type: $N_{PIB}=240$ for burst type 1 and $N_{PIB}=272$ for burst type 2. The bits $s_{N_{PIB}+1}, \dots, s_{N_{PIB}+4}$ adjacent to the midamble are reserved for possible future use.

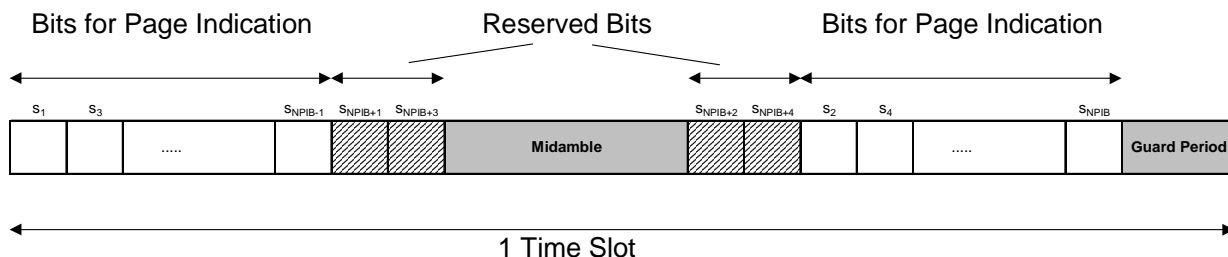

Figure 15: Transmission and numbering of paging indicator carrying bits in a PICH burst

Each paging indicator P_q in one time slot is mapped to the bits $\{s_{2L_{PI} \cdot q+1}, \dots, s_{2L_{PI} \cdot (q+1)}\}$ within this time slot. Thus, due to the interleaved transmission of the bits half of the symbols used for each paging indicator are transmitted in the first data part, and the other half of the symbols are transmitted in the second data part, as exemplary shown in figure 16 for a paging indicator length L_{PI} of 4 symbols.

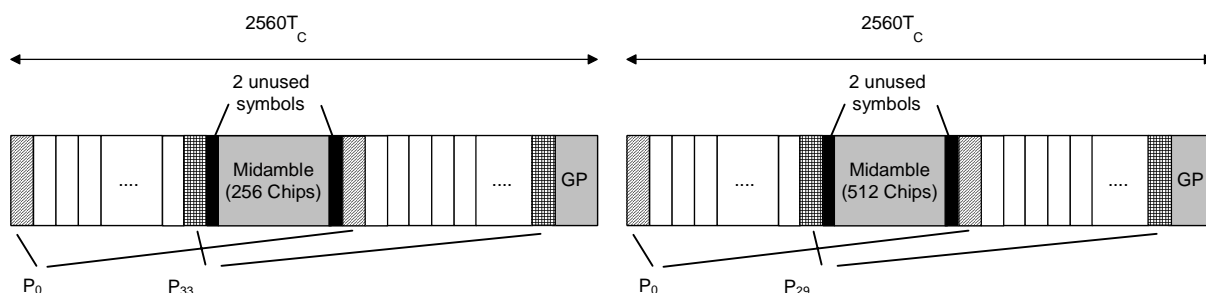

Figure 16: Example of mapping of paging indicators on PICH bits for $L_{PI}=4$

The setting of the paging indicators and the corresponding PICH bits (including the reserved ones) is described in [7].

N_{PI} paging indicators of length $L_{PI}=2$, $L_{PI}=4$ or $L_{PI}=8$ symbols are transmitted in each radio frame that contains the PICH. The number of paging indicators N_{PI} per radio frame is given by the paging indicator length and the burst type, which are both known by higher layer signalling. In table 7 this number is shown for the different possibilities of burst types and paging indicator lengths.

Table 7: Number N_{PI} of paging indicators per time slot for the different burst types and paging indicator lengths L_{PI}

	$L_{PI}=2$	$L_{PI}=4$	$L_{PI}=8$
Burst Type 1	$N_{PI}=60$	$N_{PI}=30$	$N_{PI}=15$
Burst Type 2	$N_{PI}=68$	$N_{PI}=34$	$N_{PI}=17$

5.3.7.2 Structure of the PICH over multiple radio frames

As shown in figure 17, the paging indicators of N_{PICH} consecutive frames form a PICH block, N_{PICH} is configured by higher layers. Thus, $N_P=N_{PICH} \cdot N_{PI}$ paging indicators are transmitted in each PICH block.

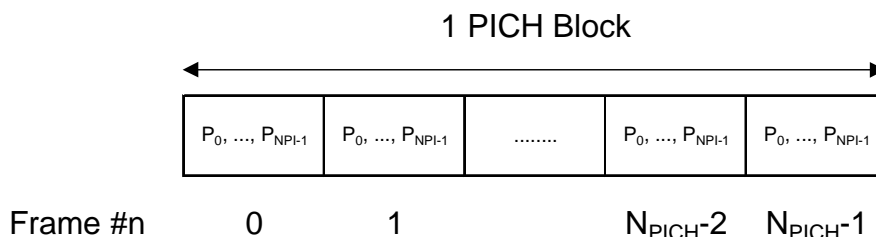

Figure 17: Structure of a PICH block

The value PI (PI = 0, ..., N_P-1) calculated by higher layers for use for a certain UE, see [15], is associated to the paging indicator P_q in the n th frame of one PICH block, where q is given by

$$q = \text{PI mod } N_{PI}$$

and n is given by

$$n = \text{PI div } N_{PI}$$

The PI bitmap in the PCH data frames over I_{ub} contains indication values for all possible higher layer PI values, see [17]. Each bit in the bitmap indicates if the paging indicator P_q associated with that particular PI shall be set to 0 or 1. Hence, the calculation in the formulas above is to be performed in Node B to make the association between PI and P_q .

5.3.7.3 PICH Training sequences

The training sequences, i.e. midambles for the PICH, are generated as described in subclause 5.2.3. The allocation of midambles depends on whether SCTD is applied to the PICH.

- If no antenna diversity is applied to the PICH the midambles can be allocated as described in subclause 5.6.
- If SCTD antenna diversity is applied to the PICH the allocation of midambles shall be as described in [9].

5.3.8 The physical node B synchronisation channel (PNBSCH)

In case cell sync bursts are used for Node B synchronisation the PNBSCH shall be used for the transmission of the cell sync burst [8]. The PNBSCH shall be mapped on the same timeslot as the PRACH acc. to a higher layer schedule. The cell sync burst shall be transmitted at the beginning of a timeslot. In case of Node B synchronisation via the air interface the transmission of a RACH may be prohibited on higher layer command in specified frames and timeslots.

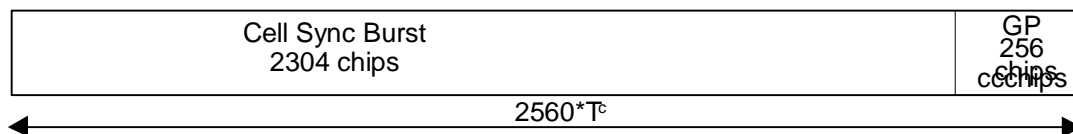

5.3.9 High Speed Physical Downlink Shared Channel (HS-PDSCH)

The HS-DSCH as described in subclause 4.1.2 is mapped onto one or more high speed physical downlink shared channels (HS-PDSCH).

5.3.9.1 HS-PDSCH Spreading

The HS-PDSCH shall use either spreading factor $SF = 16$ or $SF=1$, as described in 5.2.1.1.

5.3.9.2 HS-PDSCH Burst Types

Burst types 1 or 2 as described in subclause 5.2.2 can be used for PDSCH. TFCI shall not be transmitted on the HS-PDSCH. The TF of the HS-DSCH is derived from the associated HS-SCCH.

5.3.9.3 HS-PDSCH Training Sequences

The training sequences as described in subclause 5.2.3 are used for the HS-PDSCH.

5.3.9.4 UE Selection

To indicate to the UE that there is data to decode on the HS-DSCH, the UE id on the associated HS-SCCH shall be used.

5.3.9.5 HS-PDSCH timeslot formats

An HS-PDSCH may use QPSK or 16QAM modulation symbols. The time slot formats are shown in table 8.

Table 8: Time slot formats for the HS-PDSCH

Slot Format #	Spreading Factor	Midamble length (chips)	N_{TFCI} code word (bits)	Bits/slot	$N_{\text{Data/Slot}}$ (bits)	$N_{\text{data/data field}}$ (bits)
0 (QPSK)	16	512	0	244	244	122
1 (16QAM)	16	512	0	488	488	244
2 (QPSK)	16	256	0	276	276	138
3 (16QAM)	16	256	0	552	552	276
4 (QPSK)	1	512	0	3904	3904	1952
5 (16QAM)	1	512	0	7808	7808	3904
6 (QPSK)	1	256	0	4416	4416	2208
7(16QAM)	1	256	0	8832	8832	4416

5.3.10 Shared Control Channel for HS-DSCH (HS-SCCH)

The HS-SCCH is a DL physical channel that carries higher layer control information for HS-DSCH. The physical layer will process this information according to [7] and will transmit the resulting bits on the HS-SCCH the structure of which is described below.

5.3.10.1 HS-SCCH Spreading

The HS-SCCH shall use spreading factor $SF = 16$, as described in 5.2.1.1.

5.3.10.2 HS-SCCH Burst Types

Burst type 1 as described in subclause 5.2.2 can be used for HS-SCCH. TFCI shall not be transmitted on the HS-SCCH.

5.3.10.3 HS-SCCH Training Sequences

The training sequences as described in subclause 5.2.3 are used for the HS-SCCH.

5.3.10.4 HS-SCCH timeslot formats

The HS-SCCH always uses time slot format #0 from table 5a, see section 5.2.2.6.1.

5.3.11 Shared Information Channel for HS-DSCH (HS-SICH)

The HS-SICH is a UL physical channel that carries higher layer control information and the Channel Quality Indicator CQI for HS-DSCH. The physical layer will process this information according to [7] and will transmit the resulting bits on the HS-SICH the structure of which is described below.

5.3.11.1 HS-SICH Spreading

The HS-SICH shall use spreading factor $SF = 16$, as described in 5.2.1.2.

5.3.11.2 HS-SICH Burst Types

Burst types 1 or 2 as described in subclause 5.2.2 can be used for HS-SICH. TFCI shall not be transmitted on the HS-SICH, however, the HS-SICH shall carry TPC information.

5.3.11.3 HS-SICH Training Sequences

The training sequences as described in subclause 5.2.3 are used for the HS-SICH.

5.3.11.4 HS-SICH timeslot formats

The HS-SICH may use time slot format #1 or #7 from table 5b, see section 5.2.2.6.2.

5.4 Transmit Diversity for DL Physical Channels

Table 9 summarizes the different transmit diversity schemes for different downlink physical channel types that are described in [9].

Table 9: Application of Tx diversity schemes on downlink physical channel types
"X" – can be applied, "-" – must not be applied

Physical channel type	Open loop Tx Diversity		Closed loop Tx Diversity
	TSTD	SCTD	
P-CCPCH	–	X	–
SCH	X	–	–
DPCH	–	–	X
PDSCH	–	–	X
PICH	–	X	–
HS-SCCH	-	-	X
HS-PDSCH	-	-	X

5.5 Beacon characteristics of physical channels

For the purpose of measurements, physical channels at particular locations (time slot, code) shall have particular physical characteristics, called beacon characteristics. Physical channels with beacon characteristics are called beacon channels. The locations of the beacon channels are called beacon locations. The ensemble of beacon channels shall provide the beacon function, i.e. a reference power level at the beacon locations, regularly existing in each radio frame. Thus, beacon channels must be present in each radio frame, the only exception is when idle periods are used to support time difference measurements for location services [9]. Then it may be possible that the beacon channels occur in the same frame and time slot as the idle periods. In this case, the beacon channels will not be transmitted in that particular frame and time slot.

5.5.1 Location of beacon channels

The beacon locations are determined by the SCH and depend on the SCH allocation case, see subclause 5.3.4:

Case 1) The beacon function shall be provided by the physical channels that are allocated to channelisation code $c_{Q=16}^{(k=1)}$ and to TS#k, k=0,...,14.

Case 2) The beacon function shall be provided by the physical channels that are allocated to channelisation code $c_{Q=16}^{(k=1)}$ and to TS#k and TS#k+8, k=0,...,6.

Note that by this definition the P-CCPCH always has beacon characteristics.

5.5.2 Physical characteristics of beacon channels

The beacon channels shall have the following physical characteristics. They:

- are transmitted with reference power;
- are transmitted without beamforming;
- use burst type 1;
- use midamble $m^{(1)}$ and $m^{(2)}$ exclusively in this time slot; and
- midambles $m^{(9)}$ and $m^{(10)}$ are always left unused in this time slot, if 16 midambles are allowed in that cell.

Note that in the time slot where the P-CCPCH is transmitted only the midambles $m^{(1)}$ to $m^{(8)}$ shall be used, see 5.6.1. Thus, midambles $m^{(9)}$ and $m^{(10)}$ are always left unused in this time slot.

The reference power corresponds to the sum of the power allocated to both midambles $m^{(1)}$ and $m^{(2)}$. Two possibilities exist:

- If no SCTD antenna diversity is applied to the P-CCPCH and PICH all the reference power of any beacon channel is allocated to $m^{(1)}$.
- If SCTD antenna diversity is applied to the P-CCPCH and PICH for any beacon channel midambles $m^{(1)}$ and $m^{(2)}$ are each allocated half of the reference power. Midamble $m^{(1)}$ is used for the first antenna and $m^{(2)}$ is used for the diversity antenna. SCTD is applied to the P-CCPCH and PICH, see [9]; for all other beacon channels identical spread data sequences are transmitted on both antennas.

5.6 Midamble Allocation for Physical Channels

Midambles are part of the physical channel configuration which is performed by higher layers. Three different midamble allocation schemes exist:

- UE specific midamble allocation: A UE specific midamble for DL or UL is explicitly assigned by higher layers.
- Default midamble allocation: The midamble for DL or UL is allocated by layer 1 depending on the associated channelisation code.
- Common midamble allocation: The midamble for the DL is allocated by layer 1 depending on the number of channelisation codes currently being present in the DL time slot.

If a midamble is not explicitly assigned and the use of the common midamble allocation scheme is not signalled by higher layers, the midamble shall be allocated by layer 1, based on the default midamble allocation scheme. This default midamble allocation scheme is given by a fixed association between midambles and channelisation codes, see clause A.3, and shall be applied individually to all channelisation codes within one time slot. Different associations apply for different burst types and cell configurations with respect to the maximum number of midambles.

5.6.1 Midamble Allocation for DL Physical Channels

Beacon channels shall always use the reserved midambles $m^{(1)}$ and $m^{(2)}$, see 5.5. For DL physical channels that are located in the same time slot as the P-CCPCH, midambles shall be allocated based on the default midamble allocation scheme, using the association for burst type 1 and $K_{\text{Cell}}=8$ midambles. For all other DL physical channels, the midamble is explicitly assigned by higher layers or allocated by layer 1.

5.6.1.1 Midamble Allocation by signalling from higher layers

UE specific midambles may be signalled by higher layers to UE's as a part of the physical channel configuration, if:

- multiple UEs use the physical channels in one DL time slot; and
- beamforming is applied to all of these DL physical channels; and
- no closed loop TxDiversity is applied to any of these DL physical channels;

or

- PDSCH physical layer signalling based on the midamble is used.

5.6.1.2 Midamble Allocation by layer 1

5.6.1.2.1 Default midamble

If a midamble is not explicitly assigned and the use of the common midamble allocation scheme is not signalled by higher layers, the UE shall derive the midambles from the allocated channelisation codes and shall use an individual midamble for each channelisation code group containing one primary and a set of secondary channelisation codes. The

association between midambles and channelisation code groups is given in annex A.3. All the secondary channelisation codes within a set use the same midamble as the primary channelisation code to which they are associated.

Higher layers shall allocate the channelisation codes in a particular order. Primary channelisation codes shall be allocated prior to associated secondary channelisation codes. If midambles are reserved for the beacon channels, all primary and secondary channelisation codes that are associated with the reserved midambles shall not be used.

Channelisation codes of one channelisation code group shall not be allocated to different UE's.

In the case that secondary channelisation codes are used, secondary channelisation codes of one set shall be allocated in ascending order, with respect to their numbering.

The UE shall assume different channel estimates for each of the individual midambles.

The default midamble allocation shall not apply for those downlink channels that are intended for a UE which will be the only UE assigned to a given time slot or slots for the duration of the assigned channel's existence (as in the case of high rate services).

5.6.1.2.2 Common Midamble

The use of the common midamble allocation scheme is signalled to the UE by higher layers as a part of the physical channel configuration. A common midamble may be assigned by layer 1 to all physical channels in one DL time slot, if:

- a single UE uses all physical channels in one DL time slot (as in the case of high rate service);

or

- multiple UEs use the physical channels in one DL time slot; and
- no beamforming is applied to any of these DL physical channels; and
- no closed loop TxDiversity is applied to any of these DL physical channels; and
- midambles are not used for PDSCH physical layer signalling.

The number of channelisation codes currently employed in the DL time slot is associated with the use of a particular common midamble. Different associations apply for different burst types and cell configurations with respect to the maximum number of midambles, see annex C.

5.6.2 Midamble Allocation for UL Physical Channels

If the midamble is explicitly assigned by higher layers, an individual midamble shall be assigned to all UE's in one UL time slot.

If no midamble is explicitly assigned by higher layers, the UE shall derive the midamble from the channelisation code that is used for the data part (except for TFCI/TPC) of the burst. The associations between midamble and channelisation code are the same as for DL physical channels.

5.7 Midamble Transmit Power

There shall be no offset between the sum of the powers allocated to all midambles in a timeslot and the sum of the powers allocated to the data symbol fields. The transmit power within a timeslot is hence constant.

The midamble transmit power of beacon channels is equal to the reference power. If SCTD is used for the P-CCPCH, the reference power is equally divided between the midambles $m^{(1)}$ and $m^{(2)}$.

The midamble transmit power of all other physical channels depends on the midamble allocation scheme used. The following rules apply

- In case of Default Midamble Allocation, every midamble is transmitted with the same power as the associated codes.

- In case of Common Midamble Allocation in the downlink, the transmit power of this common midamble is such that there is no power offset between the data parts and the midamble part of the overall transmit signal within one time slot.
- In case of UE Specific Midamble Allocation, the transmit power of the UE specific midamble is such that there is no power offset between the data parts and the midamble part of every user within one time slot.

The following figure 18 depicts the midamble powers for the different channel types and midamble allocation schemes.

Note 1: In figure 18, the codes $c(1)$ to $c(16)$ represent the set of usable codes and not the set of used codes.

Note 2: The common midamble allocation and the midamble allocation by higher layers are not applicable in those beacon time slots, in which the P-CCPCH is located, see section 5.6.1.

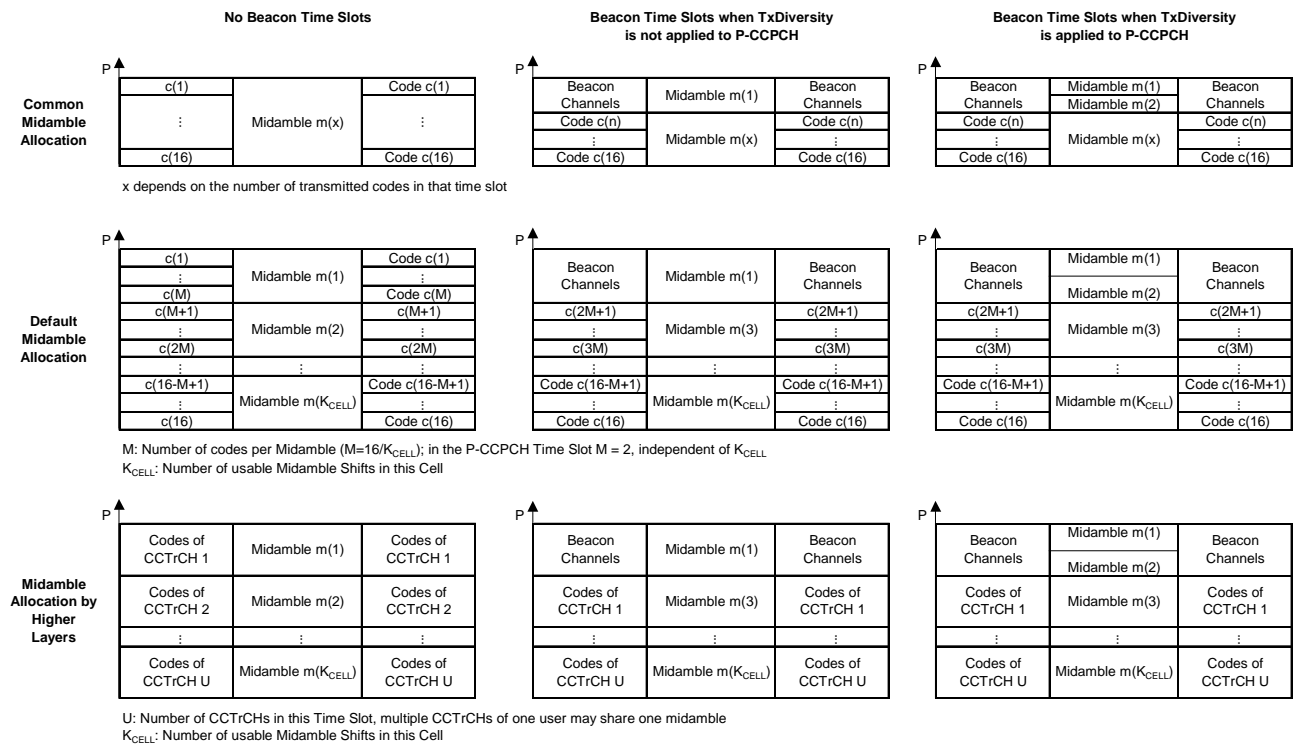

Figure 18: Midamble powers for the different midamble allocation schemes

6 Physical channels for the 1.28 Mcps option

All physical channels take three-layer structure with respect to timeslots, radio frames and system frame numbering (SFN), see [14]. Depending on the resource allocation, the configuration of radio frames or timeslots becomes different. All physical channels need guard symbols in every timeslot. The time slots are used in the sense of a TDMA component to separate different user signals in the time and the code domain. The physical channel signal format for 1.28Mcps TDD is presented in figure 19.

A physical channel in TDD is a burst, which is transmitted in a particular timeslot within allocated Radio Frames. The allocation can be continuous, i.e. the time slot in every frame is allocated to the physical channel or discontinuous, i.e. the time slot in a subset of all frames is allocated only. A burst is the combination of a data part, a midamble and a guard period. The duration of a burst is one time slot. Several bursts can be transmitted at the same time from one transmitter. In this case, the data part must use different OVFSF channelisation codes, but the same scrambling code. The midamble part has to use the same basic midamble code, but can use different midambles.

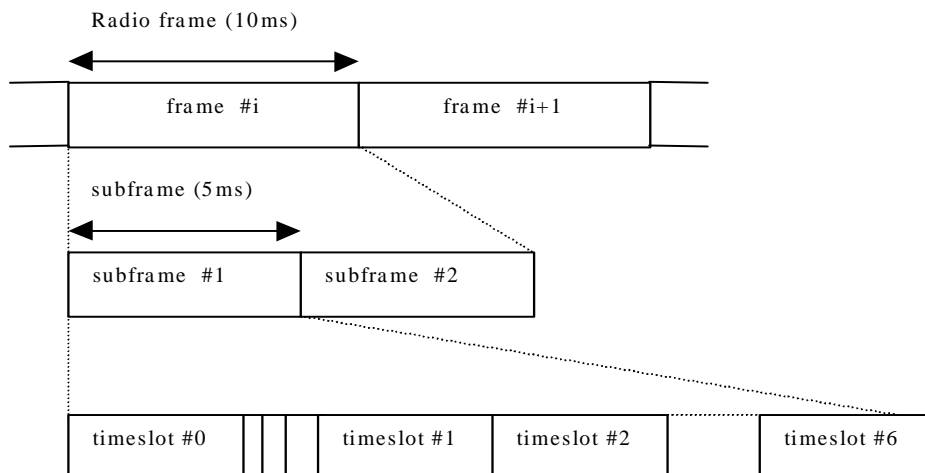

Figure 19: Physical channel signal format for 1.28Mcps TDD option

The data part of the burst is spread with a combination of channelisation code and scrambling code. The channelisation code is a OVFSF code, that can have a spreading factor of 1, 2, 4, 8, or 16. The data rate of the physical channel is depending on the used spreading factor of the used OVFSF code.

So a physical channel is defined by frequency, timeslot, channelisation code, burst type and Radio Frame allocation. The scrambling code and the basic midamble code are broadcast and may be constant within a cell. When a physical channel is established, a start frame is given. The physical channels can either be of infinite duration, or a duration for the allocation can be defined.

6.1 Frame structure

The TDMA frame has a duration of 10 ms and is divided into 2 sub-frames of 5ms. The frame structure for each sub-frame in the 10ms frame length is the same.

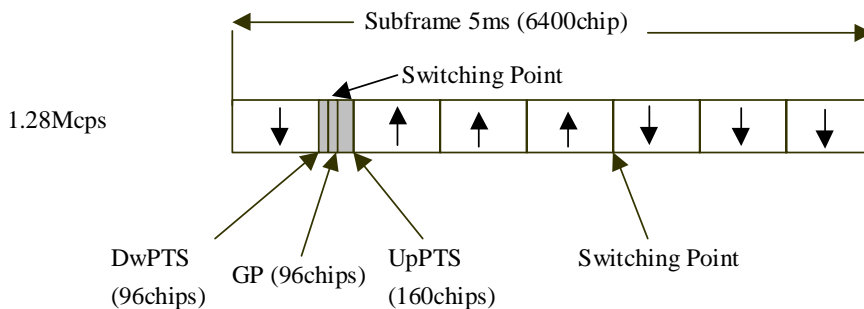

Figure 20: Structure of the sub-frame for 1.28Mcps TDD option

- Time slot#n (n from 0 to 6): the nth traffic time slot, 864 chips duration;
- DwPTS: downlink pilot time slot, 96 chips duration;
- UpPTS: uplink pilot time slot, 160 chips duration;
- GP: main guard period for TDD operation, 96 chips duration;

In Figure 20, the total number of traffic time slots for uplink and downlink is 7, and the length for each traffic time slot is 864 chips duration. Among the 7 traffic time slots, time slot#0 is always allocated as downlink while time slot#1 is always allocated as uplink. The time slots for the uplink and the downlink are separated by switching points. Between

the downlink time slots and uplink time slots, the special period is the switching point to separate the uplink and downlink. In each sub-frame of 5ms for 1.28Mcps option, there are two switching points (uplink to downlink and vice versa).

Using the above frame structure, the 1.28Mcps TDD option can operate on both symmetric and asymmetric mode by properly configuring the number of downlink and uplink time slots. In any configuration at least one time slot (time slot#0) has to be allocated for the downlink and at least one time slot has to be allocated for the uplink (time slot#1).

Examples for symmetric and asymmetric UL/DL allocations are given in figure 21.

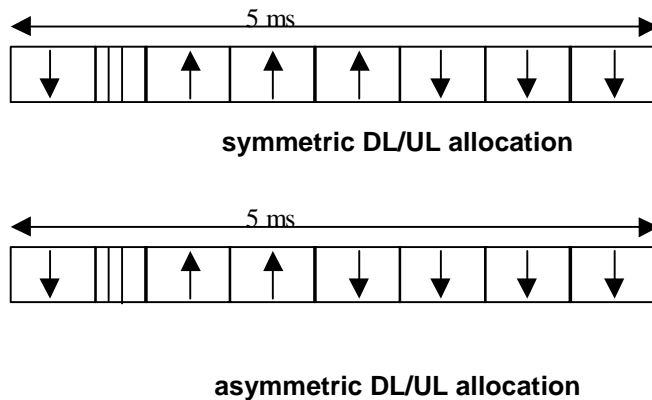

Figure 21: 1.28Mcps TDD sub-frame structure examples

6.2 Dedicated physical channel (DPCH)

The DCH as described in subclause 4.1 'Dedicated transport channels' is mapped onto the dedicated physical channel.

6.2.1 Spreading

The spreading of physical channels is the same as in 3.84 Mcps TDD (cf. 5.2.1 'Spreading').

6.2.2 Burst Format

A traffic burst consists of two data symbol fields, a midamble of 144 chips and a guard period. The data fields of the burst are 352 chips long. The corresponding number of symbols depends on the spreading factor, as indicated in table 10 below. The guard period is 16 chip periods long.

The burst format is shown in Figure 22. The contents of the traffic burst fields is described in table 10.

Table 10: number of symbols per data field in a traffic burst

Spreading factor (Q)	Number of symbols (N) per data field in Burst
1	352
2	176
4	88
8	44
16	22

Table 11: The contents of the traffic burst format fields

Chip number (CN)	Length of field in chips	Length of field in symbols	Contents of field
0-351	352	cf table 10	Data symbols
352-495	144	-	Midamble
496-847	352	cf table 10	Data symbols
848-863	16	-	Guard period

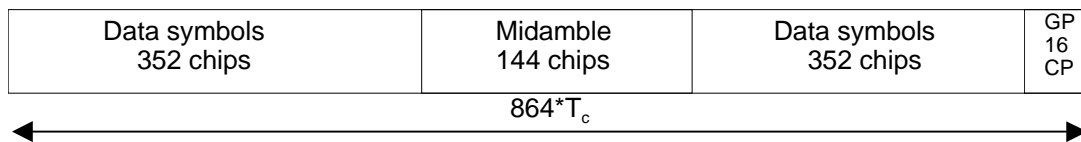

Figure 22: Burst structure of the traffic burst format (GP denotes the guard period and CP the chip periods)

6.2.2.1 Transmission of TFCI

The traffic burst format provides the possibility for transmission of TFCI in uplink and downlink.

The transmission of TFCI is configured by higher Layers. For each CCTrCH it is indicated by higher layer signalling, which TFCI format is applied. Additionally for each allocated timeslot it is signalled individually whether that timeslot carries the TFCI or not. If a time slot contains the TFCI, then it is always transmitted using the first allocated channelisation code in the timeslot, according to the order in the higher layer allocation message.

The transmission of TFCI is done in the data parts of the respective physical channel, this means that TFCI code word bits and data bits are subject to the same spreading procedure as depicted in [8]. Hence the midamble structure and length is not changed.

The TFCI code word bits are equally distributed between the two subframes and the respective data fields. The TFCI code word is to be transmitted possibly either directly adjacent to the midamble or after the SS and TPC symbols. Figure 23 shows the position of the TFCI code word in a traffic burst, if neither SS nor TPC are transmitted. Figure 24 shows the position of the TFCI code word in a traffic burst, if SS and TPC are transmitted.

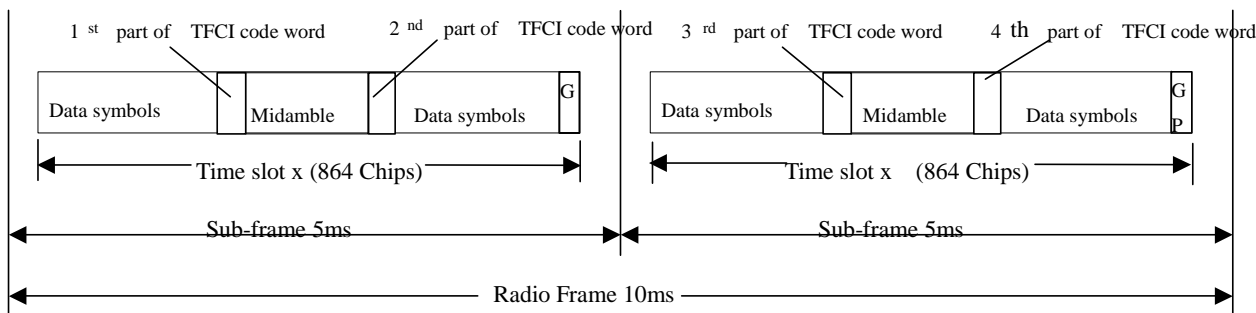

Figure 23: Position of the TFCI code word in the traffic burst in case of no TPC and SS in 1.28 Mcps TDD

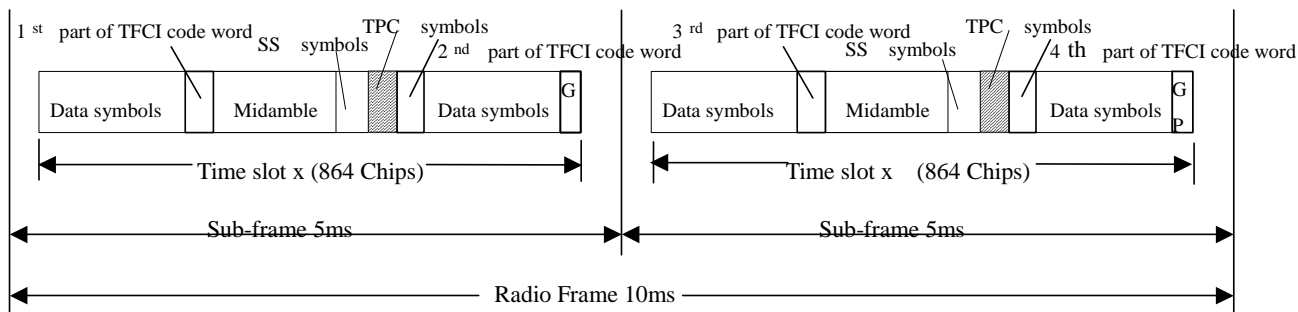

Figure 24: Position of the TFCI code word in the traffic burst in case of TPC and SS in 1.28 Mcps TDD

6.2.2.2 Transmission of TPC

The burst type for dedicated channels provides the possibility for transmission of TPC in uplink and downlink.

The transmission of TPC is done in the data parts of the traffic burst. Hence the midamble structure and length is not changed. The TPC information is to be transmitted directly after the SS information, which is transmitted after the midamble. Figure 25 shows the position of the TPC command in a traffic burst.

For every user the TPC information is to be transmitted at least once per 5ms sub-frame. If applied, transmission of TPC is done in the data parts of the traffic burst and it can be transmitted using the first allocated channelisation code and the first allocated timeslot (according to the order in the higher layer allocation message). Other allocations (more than one TPC transmission in one sub-frame) of TPC are also possible. The TPC is spread with the same spreading factor (SF) and spreading code as the data parts of the respective physical channel.

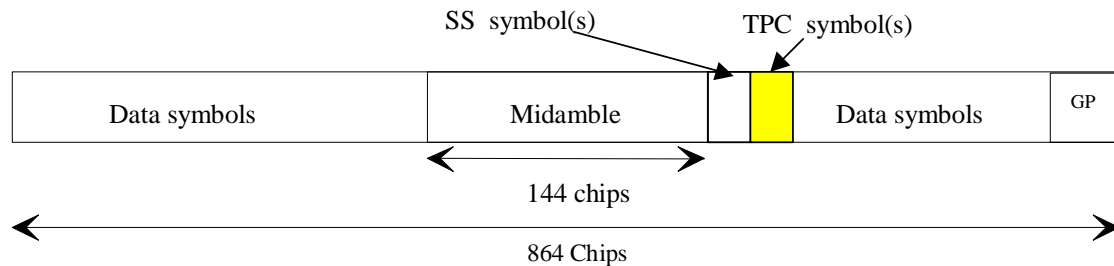

Figure 25: Position of TPC information in the traffic burst in downlink and uplink

For the number of layer 1 symbols per channelisation code there are 3 possibilities for each channelisation code, configured by higher layers:

- 1) one SS and one TPC symbol
- 2) no SS and no TPC symbols
- 3) 16/SF SS and 16/SF TPC symbols

So, in case 3), when SF=1, there are 16 TPC symbols which correspond to 32 bits (for QPSK) and 48 bits (for 8PSK).

In the following the uplink is described only. For the description of the downlink, downlink (DL) and uplink (UL) have to be interchanged.

Each of the TPC symbols for uplink power control in the DL will be associated with an UL time slot and an UL CCTrCH pair. This association varies with

- the number of allocated UL time slots and UL CCTrCHs on these time slots (time slot and CCTrCH pair) and
- the allocated TPC symbols in the DL.

In case a UE has

- more than one channelisation code

and/or

- channelisation codes being of lower spreading factor than 16 and using 16/SF SS and 16/SF TPC symbols,

the TPC commands for each ULtime slot CCTrCH pair (all channelisation codes on that time slot belonging to the same time slot and CCTrCH pair have the same TPC command) will be distributed to the following rules:

1. The ULtime slots and CCTrCH pairs the TPC commands are intended for will be numbered from the first to the last ULtime slot and CCTrCH pair allocated to the regarded UE (starting with 0). The number of a time slot and CCTrCH pair is smaller than the number of another time slot and CCTrCH pair within the same time slot if its spreading code with the lowest SC number according to the following table has a lower SC number than the spreading code with the lowest SC number of the other time slot and CCTrCH pair.
2. The commanding TPC symbols on all DL CCTrCHs allocated to one UE are numbered consecutively starting with zero according to the following rules:
 - a) The numbers of the TPC commands of a regarded DL time slot are lower than those of DL time slots being transmitted after that time slot
 - b) Within a DL time slot the numbers of the TPC commands of a regarded channelisation code are lower than those of channelisation codes having a higher spreading code number

The spreading code number is defined by the following table (see[8]):

SC number	SF (Q)	Walsh code number (k)
0	16	$\mathbf{c}_{Q=16}^{(k=1)}$
	...	
15	16	$\mathbf{c}_{Q=16}^{(k=16)}$
16	8	$\mathbf{c}_{Q=8}^{(k=1)}$
	...	
23	8	$\mathbf{c}_{Q=8}^{(k=8)}$
24	4	$\mathbf{c}_{Q=4}^{(k=1)}$
	...	
27	4	$\mathbf{c}_{Q=4}^{(k=4)}$
28	2	$\mathbf{c}_{Q=2}^{(k=1)}$
29	2	$\mathbf{c}_{Q=2}^{(k=2)}$
30	1	$\mathbf{c}_{Q=1}^{(k=1)}$

Note: Spreading factors 2-8 are not used in DL

- c) Within a channelisation code numbers of the TPC commands are lower than those of TPC commands being transmitted after that time

The following equation is used to determine the UL time slot which is controlled by the regarded TPC symbol in the DL:

$$UL_{pos} = (SFN' \cdot N_{UL_TPCsymbols} + TPC_{DLpos}) \bmod(N_{ULslot}),$$

where

UL_{pos} is the number of the controlled uplink time slot and CCTrCH pairs.

SFN' is the system frame number counting the sub-frames. The system frame number of the radio frames (SFN) can be derived from SFN' by

$SFN = SFN' \text{ div } 2$, where div is the remainder free division operation.

$N_{UL_PCsymbols}$ is the number of UL TPC symbols in a sub-frame.

TPC_{DLpos} is the number of the regarded UL TPC symbol in the DL within the sub-frame.

N_{ULslot} is the number of UL slots and CCTrCH pairs in a frame.

In Annex G two examples of the association of TPC commands to time slots and CCTrCH pairs are shown.

Coding of TPC:

The relationship between the TPC Bits and the transmitter power control command for QPSK is the same as in the 3.84Mcps TDD cf. [5.2.2.5 'Transmission of TPC'].

The relationship between the TPC Bits and the transmitter power control command for 8PSK is given in table 12

Table 12: TPC Bit Pattern for 8PSK

TPC Bits	TPC command	Meaning
000	'Down'	Decrease Tx Power
110	'Up'	Increase Tx Power

6.2.2.3 Transmission of SS

The burst type for dedicated channels provides the possibility for transmission of uplink synchronisation control (ULSC).

The transmission of ULSC is done in the data parts of the traffic burst. Hence the midamble structure and length is not changed. The ULSC information is to be transmitted directly after the midamble. Figure 26 shows the position of the SS command in a traffic burst.

For every user the ULSC information shall be transmitted at least once per transmitted sub-frame. By default the following rules apply:

1. If a TFCI is applied for a CCTrCH, the SS command(s) shall be transmitted using the same channelisation code and the same timeslots as the TFCI.
2. If no TFCI is applied for a CCTrCH, the SS command(s) shall be transmitted using the first allocated channelisation code and the first allocated timeslot, according to the order in the higher layer allocation message.

Apart from the default rules other allocations of SS commands are possible according higher layer signalling – e.g. the transmission of more than one SS command (on more than one time slot).

The SS command is spread with the same spreading factor (SF) and spreading code as the data parts of the respective physical channel.

The SS is utilised to command a timing adjustment by $(k/8) T_c$ each M sub-frames, where T_c is the chip period. The k and M values are signalled by the network. The SS, as one of L1 signals, is to be transmitted once per 5ms sub-frame.

M (1-8) and k (1-8) can be adjusted during call setup or readjusted during the call.

Note: The smallest step for the SS signalled by the UTRAN is $1/8 T_c$. For the UE capabilities regarding the SS adjustment of the UE it is suggested to set the tolerance for the executed command to be $[1/9; 1/7] T_c$.

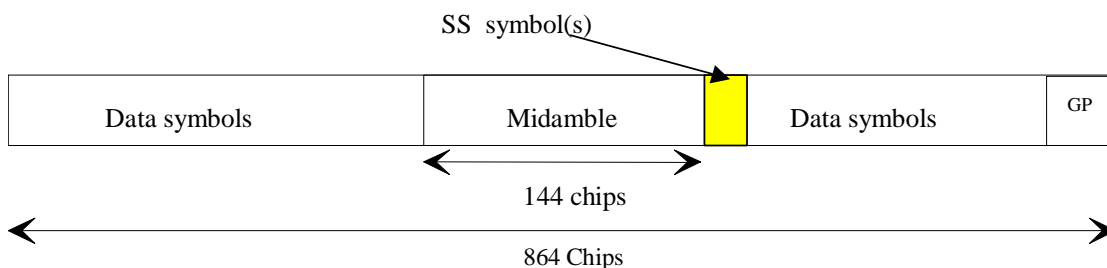

Figure 26: Position of ULSC information in the traffic burst (downlink and uplink)

Note that for the uplink where there is no SS symbol used, the SS symbol space is reserved for future use. This can keep UL and DL slots the same structure.

For the number of layer 1 symbols there are 3 possibilities configurable for each channelisation code during the call setup:

- one SS symbol
- no SS symbol
- $16/SF$ SS symbols

So, in case 3, when $SF=1$, there are 16 SS symbols which correspond to 32 bits (for QPSK) and 48 bits (for 8PSK).

Each of the SS symbols in the DL will be associated with an UL time slot depending on the allocated UL time slots and the allocated SS symbols in the DL.

Note: Even though the different time slots of the UE are controlled with independent SS commands, the UE is not in need to execute SS commands leading to a deviation of more than [3] chip with respect to the average timing advance applied by the UE.

The synchronisation shift commands for each UL time slot (all channelisation codes on that time slot have the same SS command) will be distributed to the following rules:

1. The UL time slots the SS commands are intended for will be numbered from the first to the last UL time slot occupied by the regarded UE (starting with 0) considering all CCTrCHs allocated to that UE.
2. The commanding SS symbols on all downlink CCTrCHs allocated to one UE are numbered consecutively starting with zero according to the following rules:
 - a) The numbers of the SS commands of a regarded DL time slot are lower than those of DL time slots being transmitted after that time slot
 - b) Within a DL time slot the numbers of the SS commands of a regarded channelisation code are lower than those of channelisation codes having a bigger spreading code number

The spreading code number is defined by the following table: (see TS 25.223)

Spreading code number	SF (Q)	Walsh code number (k)
0	16	$c_{Q=16}^{(k=1)}$
	...	
15	16	$c_{Q=16}^{(k=16)}$
	Spreading factors 2-8 are not used in DL	
30	1	$c_{Q=1}^{(k=1)}$

- c) Within a channelisation code numbers of the SS commands are lower than those of SS commands being transmitted after that time

The following equation is used to determine the UL time slot which is controlled by the regarded SS symbol:

$$UL_{pos} = (SFN' \cdot N_{SSymbols} + SS_{pos}) \bmod (N_{ULslot}),$$

where

UL_{pos} is the number of the controlled uplink time slot.

SFN' is the system frame number counting the sub-frames. The system frame number of the radio frames (SFN) can be derived from SFN' by

$SFN = SFN' \text{ div } 2$, where div is the remainder free division operation.

$N_{SSymbols}$ is the number of SS symbols in a frame.

SS_{pos} is the number of the regarded SS symbol within the sub-frame.

N_{ULslot} is the number of UL slots in a frame.

The relationship between the SS Bits and the SS command for QPSK is the given in table 13:

Table 13: Coding of the SS for QPSK

SS Bits	SS command	Meaning
00	'Down'	Decrease synchronisation shift by $k/8 T_c$
11	'Up'	Increase synchronisation shift by $k/8 T_c$
01	'Do nothing'	No change

The relationship between the SS Bits and the SS command for 8PSK is given in table 14:

Table 14: Coding of the SS for 8PSK

SS Bits	SS command	Meaning
000	'Down'	Decrease synchronisation shift by $k/8 T_c$
110	'Up'	Increase synchronisation shift by $k/8 T_c$
011	'Do nothing'	No change

6.2.2.4 Timeslot formats

The timeslot format depends on the spreading factor, the number of the TFCI code word bits, the number of SS and TPC symbols and the applied modulation scheme (QPSK/8PSK) as depicted in the following tables.

6.2.2.4.1 Timeslot formats for QPSK

6.2.2.4.1.1 Downlink timeslot formats

Table 15 : Time slot formats for the Downlink

Slot Format #	Spreading Factor	Midamble length (chips)	N _{TFCI} code word (bits)	N _{SS} & N _{TPC} (bits)	Bits/slot	N _{Data/Slot} (bits)	N _{data/data} field(1) (bits)	N _{data/data} field(2) (bits)
0	16	144	0	0 & 0	88	88	44	44
1	16	144	4	0 & 0	88	86	42	44
2	16	144	8	0 & 0	88	84	42	42
3	16	144	16	0 & 0	88	80	40	40
4	16	144	32	0 & 0	88	72	36	36
5	16	144	0	2 & 2	88	84	44	40
6	16	144	4	2 & 2	88	82	42	40
7	16	144	8	2 & 2	88	80	42	38
8	16	144	16	2 & 2	88	76	40	36
9	16	144	32	2 & 2	88	68	36	32
10	1	144	0	0 & 0	1408	1408	704	704
11	1	144	4	0 & 0	1408	1406	702	704
12	1	144	8	0 & 0	1408	1404	702	702
13	1	144	16	0 & 0	1408	1400	700	700
14	1	144	32	0 & 0	1408	1392	696	696
15	1	144	0	2 & 2	1408	1404	704	700
16	1	144	4	2 & 2	1408	1402	702	700
17	1	144	8	2 & 2	1408	1400	702	698
18	1	144	16	2 & 2	1408	1396	700	696
19	1	144	32	2 & 2	1408	1388	696	692
20	1	144	0	32 & 32	1408	1344	704	640
21	1	144	4	32 & 32	1408	1342	702	640
22	1	144	8	32 & 32	1408	1340	702	638
23	1	144	16	32 & 32	1408	1336	700	636
24	1	144	32	32 & 32	1408	1328	696	632

6.2.2.4.1.2 Uplink timeslot formats

Table 16 : Time slot formats for the Uplink

Slot Format #	Spreading Factor	Midamble length (chips)	N _{TFCI} code word (bits)	N _{SS} & N _{TPC} (bits)	Bits/slot	N _{Data/Slot} (bits)	N _{data/data} field(1) (bits)	N _{data/data} field(2) (bits)
0	16	144	0	0 & 0	88	88	44	44
1	16	144	4	0 & 0	88	86	42	44
2	16	144	8	0 & 0	88	84	42	42
3	16	144	16	0 & 0	88	80	40	40
4	16	144	32	0 & 0	88	72	36	36
5	16	144	0	2 & 2	88	84	44	40
6	16	144	4	2 & 2	88	82	42	40
7	16	144	8	2 & 2	88	80	42	38
8	16	144	16	2 & 2	88	76	40	36
9	16	144	32	2 & 2	88	68	36	32
10	8	144	0	0 & 0	176	176	88	88
11	8	144	4	0 & 0	176	174	86	88
12	8	144	8	0 & 0	176	172	86	86
13	8	144	16	0 & 0	176	168	84	84
14	8	144	32	0 & 0	176	160	80	80
15	8	144	0	2 & 2	176	172	88	84
16	8	144	4	2 & 2	176	170	86	84
17	8	144	8	2 & 2	176	168	86	82
18	8	144	16	2 & 2	176	164	84	80
19	8	144	32	2 & 2	176	156	80	76
20	8	144	0	4 & 4	176	168	88	80
21	8	144	4	4 & 4	176	166	86	80
22	8	144	8	4 & 4	176	164	86	78
23	8	144	16	4 & 4	176	160	84	76
24	8	144	32	4 & 4	176	152	80	72
25	4	144	0	0 & 0	352	352	176	176
26	4	144	4	0 & 0	352	350	174	176
27	4	144	8	0 & 0	352	348	174	174
28	4	144	16	0 & 0	352	344	172	172
29	4	144	32	0 & 0	352	336	168	168
30	4	144	0	2 & 2	352	348	176	172
31	4	144	4	2 & 2	352	346	174	172
32	4	144	8	2 & 2	352	344	174	170
33	4	144	16	2 & 2	352	340	172	168
34	4	144	32	2 & 2	352	332	168	164
35	4	144	0	8 & 8	352	336	176	160
36	4	144	4	8 & 8	352	334	174	160
37	4	144	8	8 & 8	352	332	174	158
38	4	144	16	8 & 8	352	328	172	156
39	4	144	32	8 & 8	352	320	168	152
40	2	144	0	0 & 0	704	704	352	352
41	2	144	4	0 & 0	704	702	350	352
42	2	144	8	0 & 0	704	700	350	350
43	2	144	16	0 & 0	704	696	348	348
44	2	144	32	0 & 0	704	688	344	344
45	2	144	0	2 & 2	704	700	352	348
46	2	144	4	2 & 2	704	698	350	348

Slot Format #	Spreading Factor	Midamble length (chips)	N _{TFCI} code word (bits)	N _{SS} & N _{TPC} (bits)	Bits/slot	N _{Data/Slot} (bits)	N _{data/data} field(1) (bits)	N _{data/data} field(2) (bits)
47	2	144	8	2 & 2	704	696	350	346
48	2	144	16	2 & 2	704	692	348	344
49	2	144	32	2 & 2	704	684	344	340
50	2	144	0	16 & 16	704	672	352	320
51	2	144	4	16 & 16	704	670	350	320
52	2	144	8	16 & 16	704	668	350	318
53	2	144	16	16 & 16	704	664	348	316
54	2	144	32	16 & 16	704	656	344	312
55	1	144	0	0 & 0	1408	1408	704	704
56	1	144	4	0 & 0	1408	1406	702	704
57	1	144	8	0 & 0	1408	1404	702	702
58	1	144	16	0 & 0	1408	1400	700	700
59	1	144	32	0 & 0	1408	1392	696	696
60	1	144	0	2 & 2	1408	1404	704	700
61	1	144	4	2 & 2	1408	1402	702	700
62	1	144	8	2 & 2	1408	1400	702	698
63	1	144	16	2 & 2	1408	1396	700	696
64	1	144	32	2 & 2	1408	1388	696	692
65	1	144	0	32 & 32	1408	1344	704	640
66	1	144	4	32 & 32	1408	1342	702	640
67	1	144	8	32 & 32	1408	1340	702	638
68	1	144	16	32 & 32	1408	1336	700	636
69	1	144	32	32 & 32	1408	1328	696	632

6.2.2.4.2 Time slot formats for 8PSK

The Downlink and the Uplink timeslot formats are described together in the following table.

Table 17: Timeslot formats for 8PSK modulation

Slot Format #	Spreading Factor	Midamble length (chips)	N _{TFCI} code word (bits)	N _{SS} & N _{TPC} (bits)	Bits/slot	N _{Data/Slot} (bits)	N _{data/data} field(1) (bits)	N _{data/data} field(2) (bits)
0	1	144	0	0 & 0	2112	2112	1056	1056
1	1	144	6	0 & 0	2112	2109	1053	1056
2	1	144	12	0 & 0	2112	2106	1053	1053
3	1	144	24	0 & 0	2112	2100	1050	1050
4	1	144	48	0 & 0	2112	2088	1044	1044
5	1	144	0	3 & 3	2112	2106	1056	1050
6	1	144	6	3 & 3	2112	2103	1053	1050
7	1	144	12	3 & 3	2112	2100	1053	1047
8	1	144	24	3 & 3	2112	2094	1050	1044
9	1	144	48	3 & 3	2112	2082	1044	1038
10	1	144	0	48 & 48	2112	2016	1056	960
11	1	144	6	48 & 48	2112	2013	1053	960
12	1	144	12	48 & 48	2112	2010	1053	957
13	1	144	24	48 & 48	2112	2004	1050	954
14	1	144	48	48 & 48	2112	1992	1044	948
15	16	144	0	0 & 0	132	132	66	66
16	16	144	6	0 & 0	132	129	63	66
17	16	144	12	0 & 0	132	126	63	63
18	16	144	24	0 & 0	132	120	60	60
19	16	144	48	0 & 0	132	108	54	54
20	16	144	0	3 & 3	132	126	66	60
21	16	144	6	3 & 3	132	123	63	60
22	16	144	12	3 & 3	132	120	63	57
23	16	144	24	3 & 3	132	114	60	54
24	16	144	48	3 & 3	132	102	54	48

6.2.3 Training sequences for spread bursts

In this subclause, the training sequences for usage as midambles are defined. The training sequences, i.e. midambles, of different users active in the same cell and same time slot are cyclically shifted versions of one single basic midamble code. The applicable basic midamble codes are given in Annex B.1.

The basic midamble codes in Annex B.1 are listed in hexadecimal notation. The binary form of the basic midamble code shall be derived according to table 18 below.

Table 18: Mapping of 4 binary elements m_i on a single hexadecimal digit:

4 binary elements m_i	Mapped on hexadecimal digit
-1 -1 -1 -1	0
-1 -1 -1 1	1
-1 -1 1 -1	2
-1 -1 1 1	3
-1 1 -1 -1	4
-1 1 -1 1	5
-1 1 1 -1	6
-1 1 1 1	7
1 -1 -1 -1	8
1 -1 -1 1	9
1 -1 1 -1	A
1 -1 1 1	B
1 1 -1 -1	C
1 1 -1 1	D
1 1 1 -1	E
1 1 1 1	F

For each particular basic midamble code, its binary representation can be written as a vector \mathbf{m}_p :

$$\mathbf{m}_p = (m_1, m_2, \dots, m_p) \quad (1)$$

According to Annex B.1, the size of this vector \mathbf{m}_p is $P=128$. As QPSK modulation is used, the training sequences are transformed into a complex form, denoted as the complex vector $\underline{\mathbf{m}}_p$:

$$\underline{\mathbf{m}}_p = (\underline{m}_1, \underline{m}_2, \dots, \underline{m}_p) \quad (2)$$

The elements \underline{m}_i of $\underline{\mathbf{m}}_p$ are derived from elements m_i of \mathbf{m}_p using equation (3):

$$\underline{m}_i = (j)^i \cdot m_i \text{ for all } i = 1, \dots, P \quad (3)$$

Hence, the elements \underline{m}_i of the complex basic midamble code are alternating real and imaginary.

To derive the required training sequences, this vector $\underline{\mathbf{m}}_p$ is periodically extended to the size:

$$i_{\max} = L_m + (K - 1)W \quad (4)$$

Notes on equation (4):

K and W are taken from Annex B.1

So we obtain a new vector $\underline{\mathbf{m}}$ containing the periodic basic midamble sequence:

$$\underline{\mathbf{m}} = (\underline{m}_1, \underline{m}_2, \dots, \underline{m}_{i_{\max}}) = (\underline{m}_1, \underline{m}_2, \dots, \underline{m}_{L_m + (K-1)W}) \quad (5)$$

The first P elements of this vector $\underline{\mathbf{m}}$ are the same ones as in vector $\underline{\mathbf{m}}_p$, the following elements repeat the beginning:

$$\underline{m}_i = \underline{m}_{i-P} \text{ for the subset } i = (P + 1), \dots, i_{\max} \quad (6)$$

Using this periodic basic midamble sequence $\underline{\mathbf{m}}$ for each user k a midamble $\underline{\mathbf{m}}^{(k)}$ of length L_m is derived, which can be written as a user specific vector:

$$\underline{\mathbf{m}}^{(k)} = (\underline{m}_1^{(k)}, \underline{m}_2^{(k)}, \dots, \underline{m}_{L_m}^{(k)}) \quad (7)$$

The L_m midamble elements $\underline{m}_i^{(k)}$ are generated for each midamble of the k users ($k = 1, \dots, K$) based on:

$$\underline{m}_i^{(k)} = \underline{m}_{i+(K-k)W} \text{ with } i = 1, \dots, L_m \text{ and } k = 1, \dots, K \quad (8)$$

The midamble sequences derived according to equations (7) to (8) have complex values and are not subject to channelisation or scrambling process, i.e. the elements $\underline{m}_i^{(k)}$ represent complex chips for usage in the pulse shaping process at modulation.

The term 'a midamble code set' or 'a midamble code family' denotes K specific midamble codes $\underline{\mathbf{m}}^{(k)}$; $k=1, \dots, K$, based on a single basic midamble code $\underline{\mathbf{m}}_p$ according to (1).

6.2.4 Beamforming

Beamforming is same as that of the 3.84Mcps TDD, cf. [5.2.4 Beamforming].

6.3 Common physical channels

6.3.1 Primary common control physical channel (P-CCPCH)

The BCH as described in section 4.1.2 'Common Transport Channels' is mapped onto the Primary Common Control Physical Channels (P-CCPCH1 and P-CCPCH2). The position (time slot / code) of the P-CCPCHs is fixed in the 1.28Mcps TDD. The P-CCPCHs are mapped onto the first two code channels of timeslot#0 with spreading factor of 16. The P-CCPCH is always transmitted with an antenna pattern configuration that provides whole cell coverage.

6.3.1.1 P-CCPCH Spreading

The P-CCPCH uses fixed spreading with a spreading factor $SF = 16$. The P-CCPCH1 and P-CCPCH2 always use channelisation code $c_{Q=16}^{(k=1)}$ and $c_{Q=16}^{(k=2)}$ respectively.

6.3.1.2 P-CCPCH Burst Format

The burst format as described in section 6.2.2 is used for the P-CCPCH. No TFCI is applied for the P-CCPCH.

6.3.1.3 P-CCPCH Training sequences

The training sequences, i.e. midambles, as described in subclause 6.2.3 are used for the P-CCPCH. For timeslots#0 in which the P-CCPCH is transmitted, the midambles $m^{(1)}$ and $m^{(2)}$ are reserved for P-CCPCH in order to support Space Code Transmit Diversity (SCTD) and the beacon function, see 6.4 and 6.5. The use of midambles depends on whether SCTD is applied to the P-CCPCH:

- If no antenna diversity is applied to P-CCPCH, $m^{(1)}$ is used and $m^{(2)}$ is left unused.
- If SCTD antenna diversity is applied to P-CCPCH, $m^{(1)}$ is used for the first antenna and $m^{(2)}$ is used for the diversity antenna.

6.3.2 Secondary common control physical channel (S-CCPCH)

PCH and FACH as described in subclause 4.1.2 are mapped onto one or more secondary common control physical channels (S-CCPCH). In this way the capacity of PCH and FACH can be adapted to the different requirements. The time slot and codes used for the S-CCPCH are broadcast on the BCH.

6.3.2.1 S-CCPCH Spreading

The S-CCPCH uses fixed spreading with a spreading factor $SF = 16$. The S-CCPCHs (S-CCPCH 1 and S-CCPCH 2) are always used in pairs, mapped onto two code channels with spreading factor 16. There can be more than one pair of S-CCPCHs in use in one cell.

6.3.2.2 S-CCPCH Burst Format

The burst format as described in section 6.2.2 is used for the S-CCPCH. TFCI may be applied for S-CCPCHs.

6.3.2.3 S-CCPCH Training sequences

The training sequences, i.e. midambles, as described in the subclause 6.2.3 are also used for the S-CCPCH.

6.3.3 Fast Physical Access CHannel (FPACH)

The Fast Physical Access CHannel (FPACH) is used by the Node B to carry, in a single burst, the acknowledgement of a detected signature with timing and power level adjustment indication to a user equipment. FPACH makes use of one code with spreading factor 16, so that its burst is composed by 44 symbols. The spreading code, training sequence and time slot position are configured by the network and signalled on the BCH.

6.3.3.1 FPACH burst

The FPACH burst contains 32 information bits. Table 19 reports the content description of the FPACH information bits and their priority order:

Table 19: FPACH information bits description

Information field	Length (in bits)
Signature Reference Number	3 (MSB)
Relative Sub-Frame Number	2
Received starting position of the UpPCH (UpPCH _{POS})	11
Transmit Power Level Command for RACH message	7
Reserved bits (default value: 0)	9 (LSB)

In the use and generation of the information fields is explained in [9].

6.3.3.1.1 Signature Reference Number

The reported number corresponds to the numbering principle for the cell signatures as described in [8].

The Signature Reference Number value range is 0 – 7 coded in 3 bits such that:

bit sequence(0 0 0) corresponds to the first signature of the cell; ...; bit sequence (1 1 1) corresponds to the 8th signature of the cell.

6.3.3.1.2 Relative Sub-Frame Number

The Relative Sub-Frame Number value range is 0 – 3 coded such that:

bit sequence (0 0) indicates one sub-frame difference; ...; bit sequence (1 1) indicates 4 sub-frame difference.

6.3.3.1.3 Received starting position of the UpPCH (UpPCH_{POS})

The received starting position of the UpPCH value range is 0 – 2047 coded such that:

bit sequence (0 0 ... 0 0 0) indicates the received starting position zero chip; ...; bit sequence (1 1 ... 1 1 1) indicates the received starting position 2047*1/8 chip.

6.3.3.1.4 Transmit Power Level Command for the RACH message

The transmit power level command is transmitted in 7 bits.

6.3.3.2 FPACH Spreading

The FPACH uses only spreading factor SF=16 as described in subclause 6.3.3. The set of admissible spreading codes for use on the FPACH is broadcast on the BCH.

6.3.3.2 FPACH Burst Format

The burst format as described in section 6.2.2 is used for the FPACH.

6.3.3.3 FPACH Training sequences

The training sequences, i.e. midambles, as described in subclause 6.2.3 are used for FPACH.

6.3.3.4 FPACH timeslot formats

The FPACH uses slot format #0 of the DL time slot formats given in subclause 6.2.2.4.1.1.

6.3.4 The physical random access channel (PRACH)

The RACH as described in subclause 4.1.2 is mapped onto one or more uplink physical random access channels (PRACH). In such a way the capacity of RACH can be flexibly scaled depending on the operators need.

6.3.4.1 PRACH Spreading

The uplink PRACH uses either spreading factor SF=16, SF=8 or SF=4 as described in subclause 6.2.1. The set of admissible spreading codes for use on the PRACH and the associated spreading factors are broadcast on the BCH (within the RACH configuration parameters on the BCH).

6.3.4.2 PRACH Burst Format

The burst format as described in section 6.2.2 is used for the PRACH.

6.3.4.3 PRACH Training sequences

The training sequences, i.e. midambles, of different users active in the same time slot are time shifted versions of a single periodic basic code. The basic midamble codes as described in subclause 6.2.3 are used for PRACH.

6.3.4.4 PRACH timeslot formats

The PRACH uses the following time slot formats taken from the uplink timeslot formats described in sub-clause 6.2.2.4.1.2:

Spreading Factor	Slot Format #
16	0
8	10
4	25

6.3.4.5 Association between Training Sequences and Channelisation Codes

The association between training sequences and channelisation codes of PRACH in the 1.28McpsTDD is same as that of the DPCH.

6.3.5 The synchronisation channels (DwPCH, UpPCH)

There are two dedicated physical synchronisation channels —DwPCH and UpPCH in each 5ms sub-frame of the 1.28Mcps TDD. The DwPCH is used for the down link synchronisation and the UpPCH is used for the uplink synchronisation.

The position and the contents of the DwPCH are equal to the DwPTS as described in the subclause 6.1., while the position and the contents of the UpPCH are equal to the UpPTS.

The DwPCH is transmitted at each sub-frame with an antenna pattern configuration which provides whole cell coverage. Furthermore it is transmitted with a constant power level which is signalled by higher layers.

The burst structure of the DwPCH (DwPTS) is described in the figure 27.

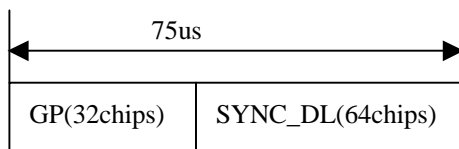

Figure 27: burst structure of the DwPCH (DwPTS)

Note: 'GP' for 'Guard Period'

The burst structure of the UpPCH (UpPTS) is described in the figure 28.

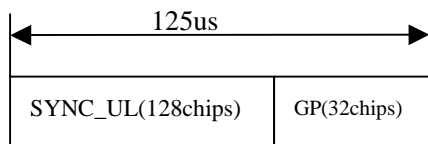

Figure 28: burst structure of the UpPCH (UpPTS)

The SYNC-DL code in DwPCH and the SYNC-UL code in UpPCH are not spreaded. The details about the SYNC-DL and SYNC-UL code are described in the corresponding subclause and annex in [8].

6.3.6 Physical Uplink Shared Channel (PUSCH)

For Physical Uplink Shared Channel (PUSCH) the burst structure of DPCH as described in subclause 6.2 and the training sequences as described in subclause 6.2.3 shall be used. PUSCH provides the possibility for transmission of TFCI, SS, and TPC in uplink.

The PUSCH is common with 3.84 Mcps TDD with respect to Spreading and UE selection, cf. [5.3.5 Physical Uplink Shared Channel (PUSCH)].

6.3.7 Physical Downlink Shared Channel (PDSCH)

For Physical Downlink Shared Channel (PDSCH) the burst structure of DPCH as described in subclause 6.2 and the training sequences as described in subclause 6.2.3 shall be used. PDSCH provides the possibility for transmission of TFCI, SS, and TPC in downlink.

The PDSCH is common with 3.84 Mcps TDD with respect to Spreading and UE selection, cf. [5.3.6 Physical Downlink Shared Channel (PDSCH)].

6.3.8 The Page Indicator Channel (PICH)

The Paging Indicator Channel (PICH) is a physical channel used to carry the paging indicators.

6.3.8.1 Mapping of Paging Indicators to the PICH bits

Figure 29 depicts the structure of a PICH transmission and the numbering of the bits within the bursts. The burst type as described in [6.2.2 ‘Burst Format’] is used for the PICH. N_{PIB} bits are used to carry the paging indicators, where $N_{PIB}=352$.

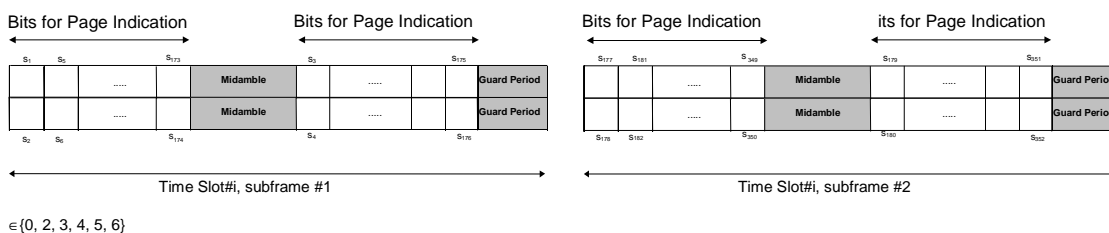

Figure 29: Transmission and numbering of paging indicator carrying bits in the PICH bursts

Each paging indicator P_q (where $P_q, q = 0, \dots, N_{PI}-1, P_q \in \{0, 1\}$) in one radio frame is mapped to the bits $\{s_{2L_{PI} \cdot q+1}, \dots, s_{2L_{PI} \cdot (q+1)}\}$ in subframe #1 or subframe #2.

The setting of the paging indicators and the corresponding PICH bits is described in [7].

N_{PI} paging indicators of length $L_{PI}=2, L_{PI}=4$ or $L_{PI}=8$ symbols are transmitted in each radio frame that contains the PICH. The number of paging indicators N_{PI} per radio frame is given by the paging indicator length, which signalled by higher layers. In table 20 this number is shown for the different possibilities of paging indicator lengths.

Table 20: Number N_{PI} of paging indicators per radio frame for different paging indicator lengths L_{PI}

	$L_{PI}=2$	$L_{PI}=4$	$L_{PI}=8$
N_{PI} per radio frame	88	44	22

6.3.8.2 Structure of the PICH over multiple radio frames

The structure of the PICH over multiple radio frames is common with 3.84 Mcps TDD, cf. [5.3.7.2 Structure of the PICH over multiple radio frames]

6.3.9 High Speed Physical Downlink Shared Channel (HS-PDSCH)

The HS-DSCH as described in subclause 4.1.2 is mapped onto one or more high speed physical downlink shared channels (HS-PDSCH).

6.3.9.1 HS-PDSCH Spreading

Spreading of the HS-PDSCH is common with 3.84 Mcps TDD, cf. [5.3.91HS-PDSCH Spreading]

6.3.9.2 HS-PDSCH Burst Types

The burst type as described in section 6.2.2 shall be used for the HS-PDSCH.

6.3.9.3 HS-PDSCH Training Sequences

The training sequences as described in subclause 6.2.3 are used for the HS-PDSCH.

6.3.9.4 UE Selection

UE selection is common with 3.84 Mcps TDD, cf. [5.3.9.4 UE selection].

6.3.9.5 HS-PDSCH timeslot formats

An HS-PDSCH may use QPSK or 16QAM modulation symbols. The time slot formats are shown in table 21.

Table 21: Time slot formats for the HS-PDSCH

Slot Format #	SF	Midamble length (chips)	N _{TFCI} code word (bits)	N _{SS} & N _{TPC} (bits)	Bits/slot	N _{Data/Slot} (bits)	N _{data/data} field(1) (bits)	N _{data/data} field(2) (bits)
0 (QPSK)	16	144	0	0 & 0	88	88	44	44
1 (16QAM)	16	144	0	0 & 0	176	176	88	88
2 (QPSK)	1	144	0	0 & 0	1408	1408	704	704
3 (16QAM)	1	144	0	0 & 0	2816	2816	1408	1408

6.3.10 Shared Control Channel for HS-DSCH (HS-SCCH)

The HS-SCCH is a DL physical channel that carries higher layer control information for HS-DSCH. The physical layer will process this information according to [7] and will transmit the resulting bits on the HS-SCCH the structure of which is described below.

The information on the HS-SCCH is carried by two separate physical channels (HS-SCCH1 and HS-SCCH2). The term HS-SCCH refers to the ensemble of these physical channels.

6.3.10.1 HS-SCCH Spreading

Spreading of the HS-SCCH is common with 3.84 Mcps TDD, cf. [5.3.10.1 HS-SCCH Spreading].

6.3.10.2 HS-SCCH Burst Types

The burst type as described in section 6.2.2 shall be used for the HS-SCCH.

6.3.10.3 HS-SCCH Training Sequences

The training sequences as described in subclause 6.2.3 are used for the HS-SCCH.

6.3.10.4 HS-SCCH timeslot formats

HS-SCCH1 shall use time slot format #5 and HS-SCCH2 shall use time slot format #0 from table 15, see section 6.2.2.4.1.1, i.e. HS-SCCH shall carry TPC and SS but no TFCI.

6.3.11 Shared Information Channel for HS-DSCH (HS-SICH)

The HS-SICH is a UL physical channel that carries higher layer control information and the Channel Quality Indicator CQI for HS-DSCH. The physical layer will process this information according to [7] and will transmit the resulting bits on the HS-SICH the structure of which is described below.

6.3.11.1 HS-SICH Spreading

Spreading of the HS-SICH is common with 3.84 Mcps TDD, cf. [5.3.11.1 HS-SICH Spreading].

6.3.11.2 HS-SICH Burst Types

The burst type as described in section 6.2.2 shall be used for the HS-SICH.

6.3.11.3 HS-SICH Training Sequences

The training sequences as described in subclause 6.2.3 are used for the HS-SCCH.

5.3.11.4 HS-SICH timeslot formats

The HS-SICH may use time slot format #5 from table 16, see section 6.2.2.4.1.2, i.e., it shall carry TPC and SS but no TFCI.

6.4 Transmit Diversity for DL Physical Channels

Table 22 summarizes the different transmit diversity schemes for different downlink physical channel types in 1.28Mcps TDD that are described in [9].

Table 22: Application of Tx diversity schemes on downlink physical channel types in 1.28Mcps TDD
"X" – can be applied, "-" – must not be applied

Physical channel type	Open loop Tx Diversity		Closed loop Tx Diversity
	TSTD	SCTD	
P-CCPCH	X	X	–
DwPCH	X	–	–
DPCH	X	–	X
PDSCH	X	–	X
HS-SCCH	-	-	X
HS-PDSCH	-	-	X

6.5 Beacon characteristics of physical channels

For the purpose of measurements, physical channels at particular locations (time slot, code) shall have particular physical characteristics, called beacon characteristics. Physical channels with beacon characteristics are called beacon channels. The location of the beacon channels is called beacon location. The beacon channels shall provide the beacon function, i.e. a reference power level at the beacon location, regularly existing in each subframe. Thus, beacon channels must be present in each subframe.

6.5.1 Location of beacon channels

The beacon location is described as follows :

The beacon function shall be provided by the physical channels that are allocated to channelisation code $C_{Q=16}^{(k=1)}$ and $C_{Q=16}^{(k=2)}$ in Timeslot#0.

Note that by this definition the P-CCPCH always has beacon characteristics.

6.5.2 Physical characteristics of the beacon function

The beacon channels shall have the following physical characteristics.

They:

- are transmitted with reference power;
- are transmitted without beamforming;

- use midamble $m^{(1)}$ and $m^{(2)}$ exclusively in this time slot

The reference power corresponds to the sum of the power allocated to both midambles $m^{(1)}$ and $m^{(2)}$. Two possibilities exist:

- If no antenna diversity is applied to the P-CCPCH, all the reference power of any beacon channel is allocated to $m^{(1)}$.
- If SCTD antenna diversity is applied to the P-CCPCH, for any beacon channel midambles $m^{(1)}$ and $m^{(2)}$ are each allocated half of the reference power. Midamble $m^{(1)}$ is used for the first antenna and $m^{(2)}$ is used for the diversity antenna. SCTD is applied to the P-CCPCH, see [9]; for all other beacon channels identical spread data sequences are transmitted on both antennas.

6.6 Midamble Allocation for Physical Channels

The midamble allocation schemes for physical channels are the same as in the 3.84Mcps TDD option. The associations between channelisation codes and midambles for the default and common midamble allocation differ from the 3.84 Mcps TDD option. The associations are given in Annex B.2 [Association between Midambles and channelisation Codes] and D [Signalling of the number of channelisation codes for the DL common midamble case for 1.28Mcps TDD] respectively

6.6.1 Midamble Allocation for DL Physical Channels

Beacon channels shall always use the reserved midambles $m^{(1)}$ and $m^{(2)}$, see 6.5. For the other DL physical channels that are located in timeslot #0, midambles shall be allocated based on the default midamble allocation scheme, using the association for $K=8$ midambles. For all other DL physical channels, the midamble is explicitly assigned by higher layers or allocated by layer 1.

6.6.1.1 Midamble Allocation by signalling from higher layers

The midamble allocation by signalling is the same like in the 3.84 Mcps TDD cf. [5.6.1.1 Midamble allocation by signalling from higher layers]

6.6.1.2 Midamble Allocation by layer 1

6.6.1.2.1 Default midamble

The default midamble allocation by layer 1 is the same like in the 3.84 Mcps TDD cf. [5.6.1.2.1 Default midamble]. The associations between midambles and channelisation codes are given in Annex B.2 [Association between Midambles and channelisation Codes].

6.6.1.2.2 Common Midamble

The common midamble allocation by layer 1 is the same like in the 3.84 Mcps TDD cf. [5.6.1.2.2 Common midamble]. The respective associations are given in Annex D [Signalling of the number of channelisation codes for the DL common midamble case for 1.28 Mcps TDD].

6.6.2 Midamble Allocation for UL Physical Channels

The midamble allocation for UL Physical Channels is the same as in the 3.84 Mcps TDD cf. [5.6.2 Midamble allocation for UL Physical Channels]

6.7 Midamble Transmit Power

The setting of the midamble transmit power is done as in the 3.84 Mcps TDD option cf. 5.7 'Midamble Transmit Power'

7 Mapping of transport channels to physical channels for the 3.84 Mcps option

This clause describes the way in which transport channels are mapped onto physical resources, see figure 30.

Transport Channels	Physical Channels
DCH _____	Dedicated Physical Channel (DPCH)
BCH _____	Primary Common Control Physical Channel (P-CCPCH)
FACH _____	Secondary Common Control Physical Channel (S-CCPCH)
PCH _____	
RACH _____	Physical Random Access Channel (PRACH)
USCH _____	Physical Uplink Shared Channel (PUSCH)
DSCH _____	Physical Downlink Shared Channel (PDSCH)
	Paging Indicator Channel (PICH)
	Synchronisation Channel (SCH)
	Physical Node B Synchronisation Channel (PNBSCH)
HS-DSCH _____	High Speed Physical Downlink Shared Channel (HS-PDSCH)
	Shared Control Channel for HS-DSCH (HS-SCCH)
	Shared Information Channel for HS-DSCH (HS-SICH)

Figure 30: Transport channel to physical channel mapping

7.1 Dedicated Transport Channels

A dedicated transport channel is mapped onto one or more physical channels. An interleaving period is associated with each allocation. The frame is subdivided into slots that are available for uplink and downlink information transfer. The mapping of transport blocks on physical channels is described in TS 25.222 ("multiplexing and channel coding").

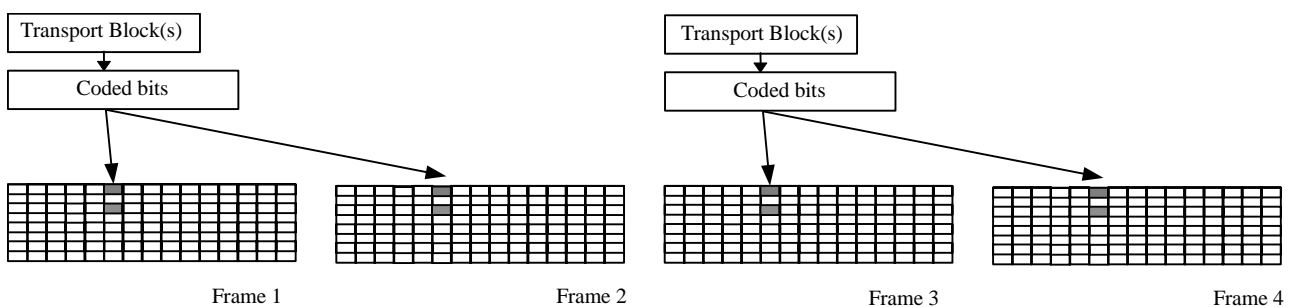

Figure 31: Mapping of Transport Blocks onto the physical bearer

For NRT packet data services, shared channels (USCH and DSCH) can be used to allow efficient allocations for a short period of time.

7.2 Common Transport Channels

7.2.1 The Broadcast Channel (BCH)

The BCH is mapped onto the P-CCPCH. The secondary SCH codes indicate in which timeslot a mobile can find the P-CCPCH containing BCH.

7.2.2 The Paging Channel (PCH)

The PCH is mapped onto one or several S-CCPCHs so that capacity can be matched to requirements. The location of the PCH is indicated on the BCH. It is always transmitted at a reference power level.

To allow an efficient DRX, the PCH is divided into PCH blocks, each of which comprising N_{PCH} paging sub-channels. N_{PCH} is configured by higher layers. Each paging sub-channel is mapped onto 2 consecutive PCH frames within one PCH block. Layer 3 information to a particular UE is transmitted only in the paging sub-channel, that is assigned to the UE by higher layers, see [15]. The assignment of UEs to paging sub-channels is independent of the assignment of UEs to page indicators.

7.2.2.1 PCH/PICH Association

As depicted in figure 32, a paging block consists of one PICH block and one PCH block. If a paging indicator in a certain PICH block is set to '1' it is an indication that UEs associated with this paging indicator shall read their corresponding paging sub-channel within the same paging block. The value $N_{GAP} > 0$ of frames between the end of the PICH block and the beginning of the PCH block is configured by higher layers.

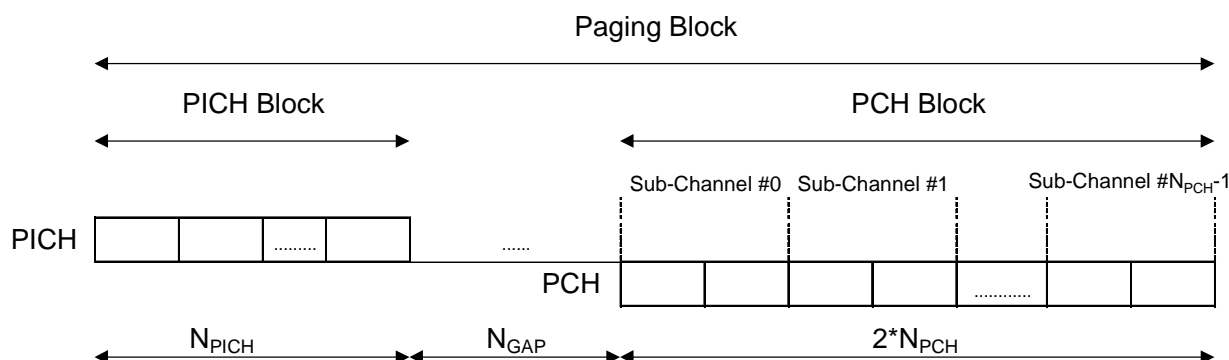

Figure 32: Paging Sub-Channels and Association of PICH and PCH blocks

7.2.3 The Forward Channel (FACH)

The FACH is mapped onto one or several S-CCPCHs. The location of the FACH is indicated on the BCH and both, capacity and location can be changed, if required. FACH may or may not be power controlled.

7.2.4 The Random Access Channel (RACH)

The RACH has intraslot interleaving only and is mapped onto PRACH. The same slot may be used for PRACH by more than one cell. Multiple transmissions using different spreading codes may be received in parallel. More than one slot per frame may be administered for the PRACH. The location of slots allocated to PRACH is broadcast on the BCH. The PRACH uses open loop power control. The details of the employed open loop power control algorithm may be different from the corresponding algorithm on other channels.

7.2.5 The Uplink Shared Channel (USCH)

The uplink shared channel is mapped on one or several PUSCH, see subclause 5.5.

7.2.6 The Downlink Shared Channel (DSCH)

The downlink shared channel is mapped on one or several PDSCH, see subclause 5.6.

7.2.7 The High Speed Downlink Shared Channel (HS-DSCH)

The high speed downlink shared channel is mapped on one or several HS-PDSCH, see subclause 5.3.9.

7.2.7.1 HS-DSCH/HS-SCCH Association and Timing

The HS-DSCH is always associated with one DL DPCH and a number of High Speed Shared Control Channels (HS-SCCH). The number of HS-SCCHs that are associated with an HS-DSCH for one UE can range from a minimum of one HS-SCCH ($M=1$) to a maximum of four HS-SCCH ($M=4$). All relevant Layer 1 control information is transmitted in the associated HS-SCCH i.e. the HS-PDSCH does not carry any Layer 1 control information.

The HS-DSCH related time slot information that is carried on the HS-SCCH refers to the next valid HS-PDSCH allocation, which is given by the following limitation: There shall be an offset of $n_{HS-SCCH} \geq 6$ time slots between the HS-SCCH carrying the HS-DSCH related information and the first indicated HS-PDSCH (in time) for a given UE. The HS-DSCH related time slot information shall not refer to two subsequent radio frames but shall always refer to either the same or the following radio frame, as illustrated in figure 33. Note that the figure only shows the HS-SCCH that carries the HS-DSCH related information for the given UE.

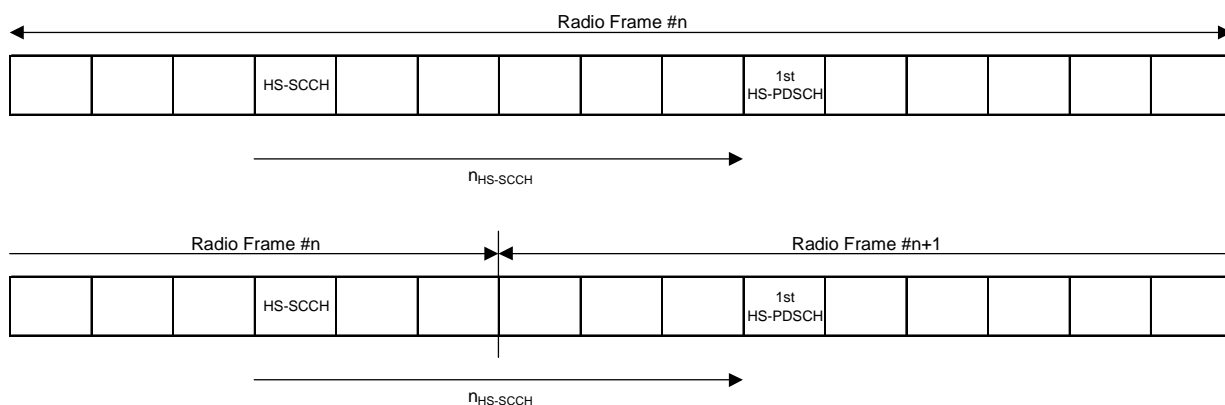

Figure 33: Timing for HS-SCCH and HS-DSCH for different radio frame configurations for a given UE

7.2.7.2 HS-SCCH/HS-DSCH/HS-SICH Association and Timing

The HS-SCCH is always associated with one HS-SICH. The association between the HS-SCCH in DL and HS-SICH in UL shall be pre-defined by higher layers and is common for all UEs.

The UE shall transmit HS-DSCH related information on the next available associated HS-SICH with the following limitation: There shall be an offset of $n_{HS-SICH} \geq 19$ time slots between the last allocated HS-PDSCH (in time) and the HS-SICH for the given UE. Hence, the HS-SICH transmission shall be made in the next or next but one radio frame, following the HS-DSCH transmission, as illustrated in figure 34. Note that the figure only shows the HS-SICH that carries the HS-DSCH related information for the given UE.

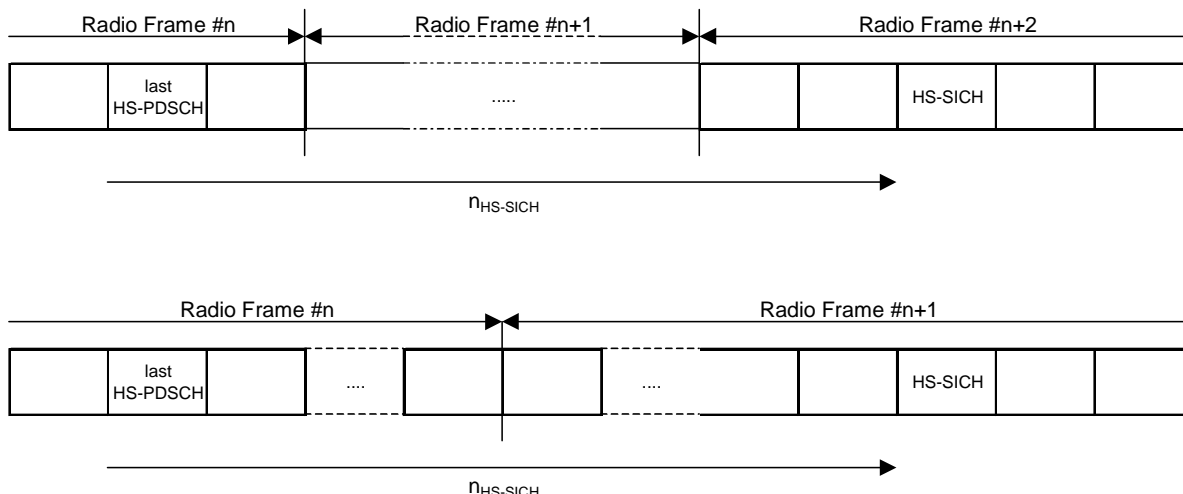

Figure 34: Timing for HS-DSCH and HS-SICH for different radio frame configurations for a given UE

8 Mapping of transport channels to physical channels for the 1.28 Mcps option

This clause describes the way in which the transport channels are mapped onto physical resources, see figure 35.

Transport channels	Physical channels
DCH	Dedicated Physical Channel (DPCH)
BCH	Primary Common Control Physical Channels (P-CCPCH)
PCH	Secondary Common Control Physical Channels(S-CCPCH)
FACH	Secondary Common Control Physical Channels(S-CCPCH)
	PICH
RACH	Physical Random Access Channel (PRACH)
USCH	Physical Uplink Shared Channel (PUSCH)
DSCH	Physical Downlink Shared Channel (PDSCH)
	Down link Pilot Channel (DwPCH)
	Up link Pilot Channel (UpPCH)
	FPACH
HS-DSCH	High Speed Physical Downlink Shared Channel (HS-PDSCH)
	Shared Control Channel for HS-DSCH (HS-SCCH)
	Shared Information Channel for HS-DSCH (HS-SICH)

Figure 35: Transport channel to physical channel mapping for 1.28Mcps TDD

8.1 Dedicated Transport Channels

The mapping of transport blocks to physical bearers is in principle the same as in 3.84 Mcps TDD but due to the subframe structure the coded bits are mapped onto each of the subframes within the given TTI.

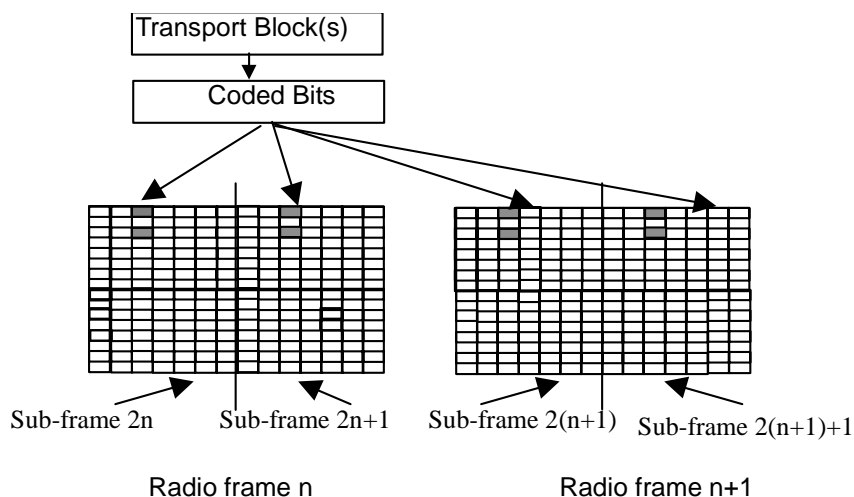

Figure 36 : Mapping of Transport Blocks onto the physical bearer (TTI= 20ms)

8.2 Common Transport Channels

8.2.1 The Broadcast Channel (BCH)

There are two P-CCPCHs, P-CCPCH 1 and P-CCPCH 2 which are mapped onto timeslot#0 using the channelisation codes $C_{Q=16}^{(k=1)}$ and $C_{Q=16}^{(k=2)}$ with spreading factor 16. The BCH is mapped onto the P-CCPCH1+P-CCPCH2.

The position of the P-CCPCHs is indicated by the relative phases of the bursts in the DwPTS with respect to the P-CCPCHs midamble sequences, see [8]. One special combination of the phase differences of the burst in the DwPTS with respect to the P-CCPCH midamble indicates the position of the P-CCPCH in the multi-frame and the start position of the interleaving period.

8.2.2 The Paging Channel (PCH)

The mapping of Paging Channels onto S-CCPCHs and the association between PCHs and Paging Indicator Channels is the same as in the 3.84 Mcps TDD option, cf. 7.2.2 'The paging Channel' and 7.2.2.1 'PCH/PICH Association' respectively.

8.2.3 The Forward Channel (FACH)

The FACH is mapped onto one or several S-CCPCHs. The location of the FACH is indicated on the BCH and both, capacity and location can be changed, if required. FACH may or may not be power controlled.

8.2.4 The Random Access Channel (RACH)

The RACH is mapped onto PRACH. More than one slot per frame may be administered for the PRACH. The location of slots allocated to PRACH is broadcast on the BCH. The uplink sync codes (SYNC-UL sequences) used by the UEs for UL synchronisation have a well known association with the P-RACHs, as broadcast on the BCH. On the PRACH, both power control and uplink synchronisation control are used.

8.2.5 The Uplink Shared Channel (USCH)

The uplink shared channel is mapped onto one or several PUSCH, see subclause 6.3.6 'Physical Uplink Shared Channel (PUSCH)'

8.2.6 The Downlink Shared Channel (DSCH)

The downlink shared channel is mapped onto one or several PDSCH, see subclause 6.3.7 ‘Physical Downlink Shared Channel (PDSCH)’

8.2.7 The High Speed Downlink Shared Channel (HS-DSCH)

The high speed downlink shared channel is mapped on one or several HS-PDSCH, see subclause 6.3.9.

8.2.7.1 HS-DSCH/HS-SCCH Association and Timing

The HS-DSCH is always associated with one DL DPCH and a number of High Speed Shared Control Channels (HS-SCCH). The number of HS-SCCHs that are associated with an HS-DSCH for one UE can range from a minimum of one HS-SCCH ($M=1$) to a maximum of four HS-SCCH ($M=4$). All relevant Layer 1 control information is transmitted in the associated HS-SCCH i.e. the HS-PDSCH does not carry any Layer 1 control information.

The HS-DSCH related time slot information that is carried on the HS-SCCH refers to the next valid HS-PDSCH allocation, which is given by the following limitation: There shall be an offset of $n_{HS-SCCH} \geq 3$ time slots between the HS-SCCH carrying the HS-DSCH related information and the first indicated HS-PDSCH (in time) for a given UE. DwPTS and UpPTS shall not be taken into account in this limitation. The HS-DSCH related time slot information shall not refer to two subsequent sub-frames but shall always refer to either the same or the following sub-frame, as illustrated in figure 37. Note that the figure only shows the HS-SCCH that carries the HS-DSCH related information for the given UE and that DwPTS and UpPTS are not considered in this figure.

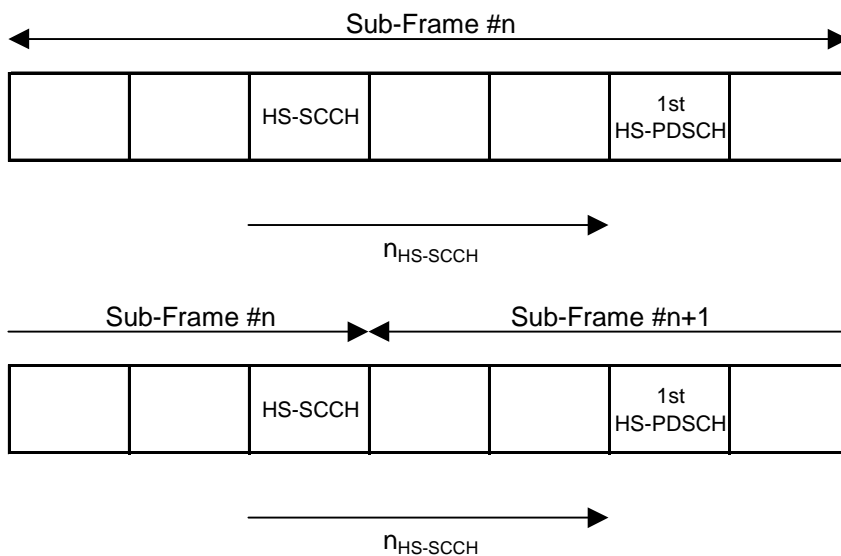

Figure 37: Timing for HS-SCCH and HS-DSCH for different radio frame configurations for a given UE

8.2.7.2 HS-SCCH/HS-DSCH/HS-SICH Association and Timing

The HS-SCCH is always associated with one HS-SICH, carrying the ACK/NACK and Channel Quality information (CQI). The association between the HS-SCCH in DL and HS-SICH in UL shall be pre-defined by higher layers and is common for all UEs.

The UE shall transmit HS-DSCH related information on the next available associated HS-SICH with the following limitation: There shall be an offset of $n_{HS-SICH} \geq 9$ time slots between the last allocated HS-PDSCH (in time) and the HS-SICH for the given UE. DwPTS and UpPTS shall not be taken into account in this limitation. Hence, the HS-SICH transmission shall always be made in the next but one sub-frame, following the HS-DSCH transmission, as illustrated in figure 38. Note that the figure only shows the HS-SICH that carries the HS-DSCH related information for the given UE and that DwPTS and UpPTS are not considered in this figure.

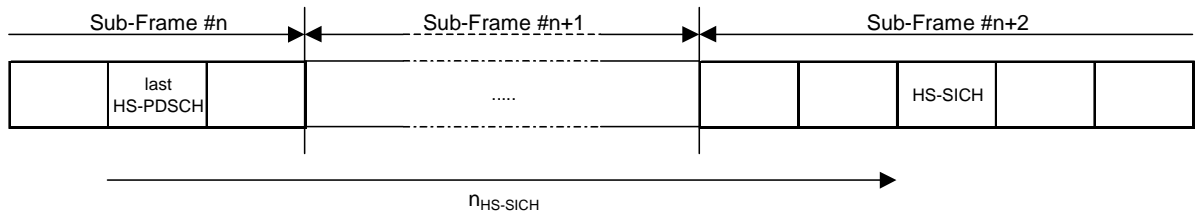

Figure 38: Timing for HS-DSCH and HS-SICH for different radio frame configurations for a given UE

Annex A (normative): Basic Midamble Codes for the 3.84 Mcps option

A.1 Basic Midamble Codes for Burst Type 1 and 3

In the case of burst type 1 or 3 (see subclause 5.2.2) the midamble has a length of $L_m=512$, which is corresponding to: $K'=8$; $W=57$; $P=456$.

Depending on the possible delay spread cells are configured to use K_{Cell} midambles which are generated from the Basic Midamble Codes (see table A-1)

- for all $k=1,2,\dots,K$; $K=2K'$ or
- for $k=1,2,\dots,K'$, only, or
- for odd $k=1,3,5,\dots,\leq K'$, only.

Depending on the cell size midambles for PRACH are generated from the Basic Midamble Codes (see table A-1)

- for $k=1,2,\dots,K'$ or
- for odd $k=1,3,5,\dots,\leq K'$, only.

The cell configuration is broadcast on BCH.

The mapping of these Basic Midamble Codes to Cell Parameters is shown in TS 25.223.

Table A-1: Basic Midamble Codes m_p according to equation (5) from subclause 5.2.3 for case of burst type 1 and 3

Code ID	Basic Midamble Codes m_{PL} of length $P=456$
m_{PL0}	8DF65B01E4650910A4BF89992E48F43860B07FE55FA0028E454EDCD1F0A09A6F029668F55427253FB8A71E5EF2EF360E539C489584413C6DC4
m_{PL1}	4C63F9BC3FD7B655D5401653BE75E1018DC26D271AADA1CF13FD348386759506270F2F953E93A44468E0A76605EAE8526225903B1201077602
m_{PL2}	8522611FFCAEB55A5F07D966036C852E7B15B893B3ABA9672C327380283D168564B8E1200F0E2205AF1BB23A58679899785CFA2A6C131CFDC4
m_{PL3}	F58107E6B777C221999BDE9340E192DC6C31AB8AE85E70AA9BBEB39727435412A5A27C0EF73AB453ED0D28E5B032B94306EC1304736C91E922
m_{PL4}	89670985013DFD2223164B68A63BD58C7867E97316742D3ABD6CDBA4FC4E08C0B0CBE44451575C72F887507956BD1F27C466681800B4B016EE
m_{PL5}	FCDEF63500D6745CDB962594AF171740241E982E9210FC238C4DD85541F08C1A010F7B3161A7F4DF19BAD916FD308AB1CED2A32538C184E92C
m_{PL6}	DB04CE77A5BA7C0E09B6D3551072B11A7A43B6A355C1D6FDCF725D587874999895748DD09832ABC35CEC3008338249612E6FE5005E13B03103
m_{PL7}	D2F61A622D0BA9E448CD29587D398EF8CDC3B6582B6CDD50E9E20BF5FE2B3258041E14D60821DC6725132C22D787CD5D497780D4241E3B420D
m_{PL8}	7318524E62D806FA149ECC5435058A2B74111524B84727FE9A7923B4A1F0D8FCD89208F34BE55CADEB90130F9954BB30605A98C11045FF173D
m_{PL9}	8E832B4FA1A11E0BF318E84F54725C8052E0D099EF0AF54BC342BEE44976C9F38DE701623C7BF6474DF90D2E222A4915C8080E7CD3EC84DAC
m_{PL10}	CFA5BAC90780876C417933C43103B55699A8AD51164E590AF9DA6AF0C18804E1F74862F00CE7ECC899C85B6ABB0CAD5E50836AD7A39878FE2F
m_{PL11}	AD539094A19858A75458F1B98E286A4F7DC3A117083D04724CBE83F34102817C5531329CDB437FFF712241B644BDF0C1FEC8598A63C2F21BD7
m_{PL12}	BEB8483139529BDE23E42DA6AB8170DD0BFBB30CE28A4502FAF3C8EDA219B9A6D5B849D9C9E4451F74E2408EA046061201E0C1D69CF48F3A94
m_{PL13}	C482462CA7846266060D21688BA00B72E1EC84A3D5B7194C8DA39E21A3CE12BF512C8AAB6A7079F73C0D3E4F40AC555A4BCC453F1DFE3F6C82

Code ID	Basic Midamble Codes m_{PL} of length $P=456$
m_{PL14}	9663373935FD5C213AC58C0670206683D579D2526C05B0A81030DDF61A221D8A68EAD8D6F7AA0D662C07C6DCCD0115A54D39F03F7122B0675AC
m_{PL15}	387397AE5CD3F2B3912C26B8F87CE82CEFEC55507DB08FB0C4CF2FD6858896201ACA7264281D0298440DD3481E5E9DDB24C16F30EB7A22948A
m_{PL16}	AFE9266843C892571B6230D808788C63B9065EA3BDFF687B92B8734A8D7099559FEA22C9416576D0C087EB4503E87E356471B330182A24A3E6
m_{PL17}	6E6C550A4CB74010F6C3E0328651DF421C456D9A5E8AE9D3946C10189D72B579184552EE3E799970969C870FE8A37B6C4BA890992103486DC0
m_{PL18}	D803CA71B6F99CFB3105D40F4695D61EB0B62E803F79302EE3D2A6BF12EA70D304B181E8B38B3B74F5022B67EB8109808C62532688C563D4BE
m_{PL19}	E599ED48D01772055DBE9D343A4EA5EABE643DA38F06904FC7523B08C4101F021B199AF759A00D9AC298881D79413A77470992A75C7711492D0
m_{PL20}	9F30AC4162CE5D185953705F3D45F026F38E9B5721AEFE07370214D526A2C4B344B508B57BF B2492320C05903C79CBEE08C6E7F218B57E14D6
m_{PL21}	B5971060DA84685B4D042ED0189FAF13C961B2EF61CC164E363B22AAB14AC8AF607906C1C6E04F2054C687AA6741A9E70639857DA02B6FFFFA
m_{PL22}	97135FC2226C4B4A5CBA5FCA3732763B87455F73A1148006F3DF214BD4C936D061E04045160E2CE33B9CD09D08FDE2A37F4E998322B4401D27
m_{PL23}	4D256D57C861B9791151A78D5299C56D116B6178B2A2D04BB95FB76540AF28341DC6EC4E7E D3BF9E508478D9C8F44914805DA82429E1CF320E
m_{PL24}	858EF5C84CE32D18D9ABA110EEA7474CF0CD70254D2928C3F4DFF6BB3A518587CADA19029078AC90A8336C8178203BE3289E601F07D089CB64
m_{PL25}	920A8796A511650AEF32F93DD3C39C624E07AE03CE8C96139973F54DCB9803C5164ADB502D4FF561564D607037FCD172921F1982B102C3312C
m_{PL26}	485C5DAE76B360A9C56E20B8422EA3E6ACF07CB093B5587CB0E6A5498A4714081EA98DBCD B0482B26E0D097C03444473D233BEF3C8E440DEBF
m_{PL27}	565A9D54EA789892B024F97E728E8EE112411942C48BD0C5BC8AA457D8DC9941F0F7424B38643FFE6521CD306FBC56FE10F1428D4C245B5606
m_{PL28}	5AEF2C0C2C378179A1AC36242E6B3EDB72C42D3624437674F8D51260C0898C201837CBA14E9E23D1EF6451C4ACF27AB031F457A8A1BFD148AE
m_{PL29}	87D8FE685417822A23D925307E6C11081ADAC4702BCCD9BE448E78984D109B50DEF5B7C58B C71EA1F0A6826BA8AD1978843E7697F3E416AADA

Code ID	Basic Midamble Codes m_{PL} of length $P=456$
m_{PL30}	84802B72AF27B5BE724D1FB629E0E627BDB0D9061292562F98350C1D0C9D4B9D8E2BF71123C82EBB161003AE9829E07244D78F19926F8847A2
m_{PL31}	8CCB5128238BCB088E30972D62792AEF02B9BBDDCAD68C9916C00BF91CBE788B0F03851FAAF88605534FD73436C259D270B1013CB14226F658
m_{PL32}	62F4E6FAC2BF1979CE6854AA2D33534BFB2F946519101A6589131C3640707D40E67ED804AF8736AD213CAF5935741900061967E8285C27E34C
m_{PL33}	4095E5B4EEAFCD68A34B267EEA28D8444FA533900F41499E260D2E65C256A52E1DD5861F5227C98E00687D107233F51A1167BCF72FB184654
m_{PL34}	5630E9A79FCAD303404D9E5A802299162657AAC734761C6E90DA8BCE4F61A763E0BB48D3FEB3F78468C828ABA4828DAD06E0F904CFD40421DC
m_{PL35}	CD12B24C0BCA8AAC1FCBF050A3BC684A180E863D888F2506B48C68ECF17F76CB285991FBA18EB6397211FAD002F482D57A258CD45DE3FF1A6
m_{PL36}	AFCF2A50877286CD3405442730C45514F082D9EC296B367C0F64F04C4E0007DCA9E50BEED5C102126E319ACBC64F1729272F2F72C9397029FE
m_{PL37}	18F89EE8589D20882A72A44DCDF0050F0A3D88DBA6531614973D26905FDF41E3F779FF0648E8AF1540928511BCF4C25D9C64AF34AC31B8965
m_{PL38}	F890D550F33F032ECD3A51FED427D634F64EB29AF1332A23CD961258E4BAED040E7B336918E250EC272A12816B9EBFFA1E0AE401185F08C10
m_{PL39}	ACE5DD61506047E80FB7D41BD3992DF4D7F18EB46CC145C0E9105428C2F8F299141F5D66691904A7DC2513A3B83994ACB1292246B32818FE9D
m_{PL40}	150680FF900C9B46E1E24D54BE2238CB950A934E5CCDE9BC3939EB51CB0AE202B7D339EEC2018B33A0AB9B63DA5D512D64FB58C0E51A1C82C2
m_{PL41}	51A579EED2663A002D32D10A0753173612F4D5BA167D1807C61F25C4D42C063682E8E9DD019F79D446A046EB3F75E50FEB228DC52F08E694B6
m_{PL42}	CDC644FE4C0C6897604F9D14D714123BF16FFF0E49F35F674908CA60653702FE27BCCA2A47098453AF8661055C8C549EB6A951A8396AD4B94D
m_{PL43}	750A10366C595373C5001CA3E4239764B1409D602CF6052B39BC6A3255A15FE06C782C4C5F847026A7E79838A2933A61C77BB6CBF5915B2DA5
m_{PL44}	B7490686D78E409082C4C48FE18D4C35429C20AADF96076B92FC4E85490664753DB0891A0B27FD849BB7FCA99E3B38F22F8C662852C0D35AA6
m_{PL45}	D86E1B575B47D23DA811806A54C231281F03317830E7BD305D3CAA7D6382A5233104CFD54D22DF9F34535E5B390D9040CF1375FEA44CEC29E2
m_{PL46}	828655960C026EC67B683480992AC2ED2C43ABC606F5220C2945F373470BE7ED5BCCF7C1AA0986BBCC84F11F1658AA568FAA0A60C5F0B5BFA
m_{PL47}	D76230E02C8533653AAB99B288AA2ADE25A1C1BF28516C04239240EAF1EFC0B98974B51F886861D8A1E9F5D62CFFEC309F071A9716B325101B
m_{PL48}	EA207662865B8A07D69648964DED818EE474A90B94473408871880E63EF0596B9FCFEC3C06B86EA6AD2B06C91672EFB33C70241A5450B59B8A
m_{PL49}	9CB5459549909835FAB22F0D99298C120ACF479F814CCE749079D40688F28101037762F125C776DA9C5FA1FCE0E76E452F8185354FDCDE94E2
m_{PL50}	227506304AEC1D6F93569B51FDC3405A0F38194F65BE17163A3CB9827A35AECEA757D020FE249377ECD561428A38FEED004EC859C272563185
m_{PL51}	96B9AEC9938910F0E533422A3977519B05CD4AD3909BC15A7502D48D49C124FA192A8E57027CFEB11DF542010603CE5C9FDF8E626D4FBF8CF4
m_{PL52}	A6AAD06E095A9BE0BD9F8A2ED40C3CBDBAE91C700CBB778C8696CC06F3A675C16BDB2918E5F2111005A8727206DC6A9684E05655185C398EEB
m_{PL53}	CD168D384A78DA172991AD333EE2A9880905AFE59E2A2A4AC4414C40F82874F98A3CBE7B44F4C7F4710B35FD88AFC0399FAEB070EB9CA4D30A
m_{PL54}	22016CA87AD1549174A8699DD65599697871091457E83E0912E7E77A06531C209394D283D18A38662B73681DD9C5BF330FED978BDA7D487CA8
m_{PL55}	B9401B0843AA6F7827A13BD66C922287E8886C31EB5B90B82B472CCD6DA3D8D4FBF78B8F8496DFA8252B06429D5DD17142F1C908ACCD70EAO C
m_{PL56}	E42B9EFDC5D09AC27B3C7DA28D02493A70521223B9D7A76A9D13E9C171017964D16A70C08EAD02C3DC948889C23E365AFCF01BF20B89B0BF5C
m_{PL57}	9DA0180168DB915E9F3597B59312198E1B5CC00D743C2ECB0DBAADA3E35A2465ED1EAA9D74734D49A313CE4DFF020D0760E3153DC485603943
m_{PL58}	B6C966619ECB98191D719C187C07BD503425650CAA3A2D1F2DF5212B1441D7A0C1D36A4C9C2550240AD17CA43BB3943DFFFBF1E283D81299CC
m_{PL59}	DB0E8C41F08A03D477C1AA548799274C4BF3EB68F2636166FDC8D4B1E7132539930297E228BA232BB5C279FA5ECA3AC10E24361AF050A453B8
m_{PL60}	89BCE2DE2974EEBA833CF32F224C85A2891484478527DB48FA6ECEA84C5E288CC3914CB54ADA0476278750187F68FBEA41017E1E58DF1A5A3D
m_{PL61}	70A457D1314A278625443EEB52520815EC92CEF17417B97440DCB531BC1CE83212F63270418D0FBDE71F6DB9E0EA88772E1E4535B6633E4425

Code ID	Basic Midamble Codes m_{PL} of length $P=456$
m_{PL62}	C388460AD54B36C4452CF0433BD347100ACCC24C79C535AD3E1F23FE0425E93A044C553BFA116E09AA4BB32F13CFA76FBA1BC17520F45EFD44
m_{PL63}	0BAFCADCDF9AA2846681782CD3B90CA036A863C78EE1507620BC394D0C6804B4C97A15BC9C0D7B79E6892EA1BFF1A0DD9573A9213AB140D0D2
m_{PL64}	833B0226789A62882FCD27A30885E67872B1A1C2FA484AD498011599DD57E8E2A07A560B47167AA5F60EF47177DBB1632D5387A2896348640B
m_{PL65}	8F52820323ABA5E6C6B465821B621600B980E59F53A599DA5646BA103214336836CF17E3386CE4FB2BC5F25CCB30CF7F500546828EC8786B8E
m_{PL66}	E2E9A29C3C8207B9A4508FD2F667A159F068EEE8D00686F46EA904C3692C1D79DFF1B32E5103720D47B4B58AC35384A26087027E141B3126A8
m_{PL67}	70E7C39FD2D3AE1DCE341699A544D801A8688A6EE47C5CB3630022147DDC06241FC5337A348A462B2472DEC5E104DD520ADA5114DB065D4B0D
m_{PL68}	9E3483CAB164BD053C4971D4D87494CC689033D589EF80E5453376E4A8DCC02183B98C36B0FF7DDC0AD07FCE8B4D5164371BD03A2110AD1247
m_{PL69}	04DA1C649B0608938DAADD3FE920A4F681690C54505429DBDCDCF10067AB5714BCDDFE1F28692710F794765781C1D233344E119BEE8A8416DC
m_{PL70}	7A18D6D30BDF44410714C3DCA27D8F9EA8A542D87122205640B98313C91AD9A0B993A5A7BC3E035F93B88BBE6D4204BC82A9FA8D4C1A7618CF
m_{PL71}	EB9525E10265A48733C8E0E77E459310112A71DCA680F68AC044B64BC0A31D02EEA0F7ACAAAB7F1E574E94FEA2D1301CB14B03263DA8122B76
m_{PL72}	E706C6ED2D6F89153835079BE0C6D45310845EF2F9F6C6AE91B7419810508BA501C0148BF09955BAD90D6391BA8EBA5CEFB23221CC75143D7
m_{PL73}	DF071A10AC4120CD1431590BEDCFF9483CA7047B19590D035D309240BDB4264E9A3A2761402EC97FD8BC51B4AF32E37FBC47162A2357D18751
m_{PL74}	F0F952B2238139F46D8254D1A2C1C22A16BA71EC0C0C900ED1442452D7F44C798BC65FF40671B88074BA0B74C6510996EEAC495C5B49C37DEB
m_{PL75}	1C86BD82EDA81FD65418D3837B5552A853791456D93B06C62C650D86CFBEC269AFFD772763064062C03751B9428C6DA2E60383025F9E404B70
m_{PL76}	B390978DD2552C88AABA7838489A6F5A8E9C41E95FFA2215819BF8A5BFE39C8A706CC658E549E966611B843A1468406C41C09D1560BEDA4F1B
m_{PL77}	1A69EC9D053C7E84BAE7A48CCC71857D0C6B06D1065E3EA4633B133AA022B8104F6EE7C69B6184B746C8822958B0A16686F27C8A0E3B4FEAD
m_{PL78}	C95B2070816DC97C6D8DD2583263E73F9AAAFD13F0548D2EBD835824418F11E54111005FB713AB234BE412347358281C7DE331EDD21B8BEA52
m_{PL79}	56D6408399F23C2ED85EE0F68111D69A91A3AD9A732AC57CA08F86CC28B3CF4E4B02EBBA0BCE5CAE5BACC4D52004070797C04093A84BB18DBA
m_{PL80}	E662E7043867BE250764DA0596D34A582A619B408B505E6211DD6286E93A37F95B1EA680C0C5F3E777E3F71E8D75495D59043217FC0E222E16
m_{PL81}	27D5E681C222297AD478A079EF12F1A98F744B66335303322EF8880B931FEBF8322F4302944E80BED468A0A516D410B183D863795992DA7DDB
m_{PL82}	5100336C05F9E5BF35201906C1C588858E0DAF56130DF5554B9AB21CA15311A90290624CD63E03F5EDA49DB7A0C32AB5F1CA427A2D5635FDA5
m_{PL83}	C696DC993BFAEA9A61B781B9C5C3F5CF4A4C8339D8B03A9B0387883D0482A41AC78D6522425959846E561D26A30FF79A205C801A85889736B2
m_{PL84}	D562297561AFF42D3168296C1153E4E39BE7B2EB0348BC704625AA08391235075EE0DE0A79AB03222FEDB27218C56F96EAC2F91CC8FCE64B12
m_{PL85}	DD0B6768FC01CC0A551F8ACC36907129623E975AB8B3FF58037F1859E2FA8C62C2D9D1E8506916029A2C3F8CAD9A26AE2CC652F48800859F5C
m_{PL86}	923920696EB3AB413786C41854822282BB83F6900D33A232D470BE198BBF086067B72613300C593B74251E2F079857ADBBCD86583A9DCAA6DC
m_{PL87}	B8EF30C797D8D2C4EF11244F137D806E556A436626D0115A621C92C34D166A68BCEDFA0040DA8FD6F987B1CD5C2AA1C1B045E64475F0F8DABD
m_{PL88}	E1887001D414405ED6419E9EE1D1D346D924ED57ADF04B31B7948099976B2D1501A60DFFB287AD44C8783DF0C1EA5AA5D273D1389C8EA22DCC
m_{PL89}	8C2E379A58AA96748141CA84C35987905F984A49D3AD9BFF7807AC244C16C1DF74343C2E1F25514F5A0954CFBB3C92E25EF783136844998AC5
m_{PL90}	78F8A99E0A54E27F51C0726FE7A11EB26B1E29FE65F55AC8AC58011465900B958488A90F6DF614A58431DC8B6C6B9A6F032EE0E0B1306EC4B4
m_{PL91}	88F7A31B7B20E0F05CA26E729B4F8A1933962D7BD7BE3E1EB130B28C794C0B4D01CADE09006FF97E80117509733F3A9DC225413A0AE08CA662
m_{PL92}	BE4DFCEAC18905AC8D5DA27A794F88A4D3058D2EFA3B075A819DEAE688EAF8940A653ED7104E7B403D490F0A9030264E1F12B8922C75775E61
m_{PL93}	5BA4B79FC4550234D8922963BF3537485E3C8745A5DB90D3E2E454B30FF61112F508155B7C2B3C4C628AF846240C2021ACDE547E5A41F666B8

Code ID	Basic Midamble Codes m _{PL} of length P=456
m _{PL94}	00556D35649F7610AB24A43C4F16D6AC0571FD126F11880C5CD72100D730E4E4D6BB73C33F837FAF1072743B249ADA2E09598B1EB23F1180A7
m _{PL95}	7A0CC9F21BD69CF3023E944545C2176EF0D4F450B765C28359FB8A32137D043D0E5713E67B3F61320985D2C6106605081F87D2296321468A2F
m _{PL96}	DA669880995B0671201172BABFF141D5854A245E211879EF3038A7C84170DADBD368455F24653161E7886E15B253F93E3A3C568EFB17CDEB1A
m _{PL97}	4E294E53D1661C1F6F748302A7723DA951C00FDB8BE8BFF67A68710BA0F1A255DFB1627059D41A23D3961726DE6FEB10E5D209CC4505B209812
m _{PL98}	73385DF701414E144768A67EF72924B1653479E962FB1554B7E54BC5284D9B3E41C0C133F878972230721918AA425501B920B204FECE0C7F8A
m _{PL99}	F4492160805F258CE592DF4D1200566F81D173458D78EA3ABED79A14AF88170DB1D4A9A5931D2B80C58C27FE17D806E3E6A66CDAAD09F118D4
m _{PL100}	44D562D9012D8B07B8F44596467C11A163982BB7EAEAC184078B6B8CE46B5D7E17C39CEF576A025491183017FA09931D070B307B86524B03FF
m _{PL101}	FCAEEFC49A13B4FFA12C0CC6A2B90CF4F57D78B1E98294B04675C2F0991661FDC61A452A247F8C29E0284AA21026F368307375AA2C3F1E12C
m _{PL102}	C486DF0510DCAD5AB86E178A686D398E11A0ECFAC5A326C10129257E5456B22FB8E147E9190D9929A5DFFE44715FA47D62F04CFC9B1C201414
m _{PL103}	C10AF383DC708E257E15A8AB337BCE684A2F4AC7A22DC2C25C277F8E8D0858E79317CDDD9AA2EA6CBE604D24AC0945026103E7B4126FD361A4
m _{PL104}	A5C60A181148D9A931B2DDDB9D169648BA54F366B4EFAE88F6861909EE0F07C037EE349D0EC59A823286E366CA3943589EEA7F828C3728085F
m _{PL105}	96136AEBD5E28462B0421DF292BA899FFA660D80EA01620D2C7490E5347127884AA3C3D1FF44BCFE6C29EC589CDEF200C5742C5964F8B2B52
m _{PL106}	40F63C04ACAD986255D1E16B769A6D4C11A1D075E804BDC0AC61923E9A67F5D7417756328072455F6E22B1C64E06F367D1B0808295C2D90E22
m _{PL107}	F4B82D413578C4888C5F002CF6D0E03778134A860436551FD57537E4CED334B3C9CEBACE615238271717AA762448B86FA53D2074BCE35658A7
m _{PL108}	BCCC92D72C920E685530591FC351743D1E23DE044BF81D32650406113E23ECC757FDE4E386B6E2E7195EE4969717A7BD0812AC312B33A54308
m _{PL109}	6ED59DE0D44370A861CE2B42CF5E578E764A682AB5777905EE027D7160490EDC6C28989B23805AA697FCD215CB401BC5E4D430624C01B16192
m _{PL110}	DE80C0E273B92CC3C5034F7A20DB3914643C430B425C8B9249EAF73ACE8C3BCF17957242CF534D87A67D4DC0252275262E737F4095450CFA14
m _{PL111}	9505C4FEF2A397D5059F4729D013292A8321FFFA929ACB0A210D0A13E13061227C44A68FBD8CE6B66CE3D783363CD039AB35EE52603E09B758
m _{PL112}	E8BE90D7F954B14D8002A4CAC20765ABEED80634498C836D79B0F9338DBC17B28F05CF4E79136779E1C55AA30B6215F890882887B3B53C23E2
m _{PL113}	9F4B622C1358AE5468DC31E4B2CA320E5E20458C1DE5405BF4F9AD7D45A5BCAA39EC0626FFFC698C16A009CCCB7A18A64E85E70BA71731BA24
m _{PL114}	B91B2624843CF48299AFC2B1442570B41F28F578530D1E322E0B54282372131C71ACB924E70768A243EECC3200E7A5EBFA7711D9FB07FEA8AE
m _{PL115}	965F42DDA3A4650FE2F5103932B68F166FA424B9F0F7045311D962C2A9F66B9BC6C66FB480F9800354E0C54A72251071422CF1DFC44F94C00C
m _{PL116}	08ADCE48699FC30FA0788073BDAADB9177BBB4C1CED41F93085218364B8BAD8488561EF0FE1B0DDAA403C602494CB35697D62AA0A2B93A64CF
m _{PL117}	9A313BED80B1220D77C8ADA4B2E0B3D284A5120A94B741380923C78D3AD32BC3E71EC6EEA520E9D447D8727697598BB987F17506F482003ABD
m _{PL118}	24C9AD4C14EFEC002A3473FCAB04E492F2E269161A2960BA8AF09FD710B444A40C4E8B138418E62301E91FBA97AFDC58759A76D00F676736C7
m _{PL119}	6514C7733711CE4942CD2123AB37186EB7FECB7E78ABB28744864942FCF4C0F810054AF55B1042EB53064F0857C61D85B2CF0D2DC5826AF22F
m _{PL120}	B2C80CDC83E48C36BC6FDAB8661208EAD392F3A0571BE41DFAD765E744932ADEA50061E66C05498A5381B2A1F1B446587089DC4E4A2DF03D82
m _{PL121}	639368BA75CC709A3D9F28EDA237E32C2017A9BF1E382045B9426AEE0A4049DCB4E1D7EBE4647B855212824557497CFA039885A3BA42F98F63
m _{PL122}	6A70DDC17D0C8024B1C853F0C1948561EF32510151BE0C63BCA9171F20217891D1021EE72586CAFF557F8973336913A9A2A699B8740B054B8
m _{PL123}	2E32E3A35CCD001172CE310B63B4E406126045A0FA3795BE3E3D9B56F72405FC94FD89946818BAECC24A61BABBBE2D23052AB01EF73CA0CF4A
m _{PL124}	82395C35205A480AC1351C25E234BF52D384A3DE1C5138A650A6F82F739757D812D9C38231AB9FD81AA0648B11F6F6113F9312C57624FC746
m _{PL125}	D98FFE19C0AAAAB0571A9075ECDFD3E7373F5255DC669116A8C6913F0123E598F930934C5F6A601C37C529C371A0C391B59AC5A9E286D04011

Code ID	Basic Midamble Codes m_{PL} of length $P=456$
m_{PL126}	C1A108192BCE96C2430A63C189BB33856BE6B8B524703FCB205DAEF37EF544CD43CA09B6181B417398083FF2F781BA4AE89A5CA291DB928D71
m_{PL127}	42568DF9F61849BF9E7DEE750604BE2E0BC16CC464B1CDE15015E01D6498E9F3E6D6950E5824651F212BA0057CE9529B9CCAB88D8136B8545E

A.2 Basic Midamble Codes for Burst Type 2

In the case of burst type 2 (see subclause 5.2.2) the midamble has a length of $L_m=256$, which is corresponding to:

$K'=3$; $W=64$; $P=192$.

Depending on the possible delay spread cells are configured to use K_{Cell} midambles which are generated from the Basic Midamble Codes (see table A-2)

- for all $k=1,2,\dots,K$; $K=2K'$ or
- for $k=1,2,\dots,K'$, only.

The cell configuration is broadcast on BCH.

The mapping of these Basic Midamble Codes to Cell Parameters is shown in TS 25.223.

Table A-2: Basic Midamble Codes m_p according to equation (5) from subclause 6.2.3 for case of burst type 2

Code ID	Basic Midamble Codes m_{PS} of length $P=192$
m_{PS0}	5D253744435A24EF0ECC21F43AA5B8144FBDB348C746080C
m_{PS1}	9D7174187201B5CE0136B7A6D85D39A9DD8D4B00E23835E4
m_{PS2}	AE90B477C294E55D28467476C6011029CDE29B7325DF0683
m_{PS3}	BC8A44125F823E51E568641EC12A6C68EAFDFA2350E3233C
m_{PS4}	898B7317B830D207C9BC7B521D5715680824DC08347B2943
m_{PS5}	466C7482C8827655BC13F479C7C1417290679A9841297C4A
m_{PS6}	AC0734C27C7DC1B818A8492744290DFE866B0EBA62B0B56E
m_{PS7}	0A92106325B15A8C15FC3764724CE67A5056D50A77F9360E
m_{PS8}	AE69F62E23035083E6094B89493D33E06FDB6532D473A280
m_{PS9}	B485D4E3614C9C373EA1365FA6FA890E9844084EBA90EB0C
m_{PS10}	66182885E2D28360D2FEAB842C65304FFC956CE8DC8A90C7
m_{PS11}	CC30A9B0A742FCC1E9A408415368391F1299AEA3CB6509FE
m_{PS12}	673928915886947F464FDDAAD29A07D182328EBC5839089A
m_{PS13}	4418861C14D62B46EE6D70D4BF05A3ED801A01BD6CDC5235
m_{PS14}	DAD62DC88F52F2D140062C2330BE6540E6F86192322AFB04
m_{PS15}	A2122BAF24529CEA9855FB43CE40923E7CA7B30D92E40702
m_{PS16}	6C44AB41E11F54B0929DF65673BD231F92A380132D9F1712
m_{PS17}	1DC2742E756CDA6421340D0087DD087A615E4B8688CB2F75
m_{PS18}	2E0105328B56E9E07D9B5A62F38B08AF8D8C2817B54F3302
m_{PS19}	88315EC30A94CA4EDB2C77079D9BD810A2E280B50DABB213
m_{PS20}	440E0093D28CB2B2B0A95D18CEB4AB934C33FA45C1CFC7B0
m_{PS21}	CC9BF85D41A96A6EC314F9611D5E1C0672556C8850801BB4
m_{PS22}	1ABEA04C99BC26972715F01957C0B6B959CC71CD88120817
m_{PS23}	EC5A33DA0BA4470442C5CB324A8E47B0A9F7968FC8108EE8
m_{PS24}	F82086290271DB446B5B1DC15D9BE96414B19B3D5E0F540C
m_{PS25}	11A1A790D6958FD3A9157DF1E05D1378248CA201EBCC7592
m_{PS26}	AA8564882231907BCE78092DC6C9DD4F5A0E4A34AFCFB809
m_{PS27}	912EE2238212F87BC7CDA7F30441ED184A6AA954EC4D20C8
m_{PS28}	2D200D8B8891B804673E380A1AF5AB875986E29D37D3FDC9
m_{PS29}	75E086B6C818423491BF9D6365C52FD1C5E42A576E268170
m_{PS30}	50ADBF27DA2A3701470186B699118E16DDB0D10F705607B1
m_{PS31}	656C0692B4E22023590A906D2A74DFD471C883A7B1E0B3A2
m_{PS32}	C21FDACD09A3CDCE74C4794010A3E45769B142505C56A0E6
m_{PS33}	CD9392A87C2D4D7CE5801CDDA8A76339B6F900F008B290E2

Code ID	Basic Midamble Codes m_{PS} of length $P=192$
m_{PS34}	956426FEFD8B8D52073E87984E10C4D255064E1372C04A24
m_{PS35}	C4F4D6DF1B754AD6063FD10C331C1428ABB27B0700134B94
m_{PS36}	B65548082B34E9FAF43F33C4070F79099758CFD41B491A11
m_{PS37}	C8317EA111A82B04E78B88B864B1EF5D711BBEB4A0527036
m_{PS38}	8FB7AD1188E8D1A5219845013672560FD38904E70537403B
m_{PS39}	B41A324E0D80AA0598A8D391C1D7FFC82B4A075218E98EC3
m_{PS40}	49A6350A62E208B011E86528B9A481A0E76D723F6675FF82
m_{PS41}	C344C8C23C42A7B7442E6022E95AE4B08A4BFA786F35F911
m_{PS42}	28F430CF67D69C9DF60E25656413BC5F932A022DB1406C44
m_{PS43}	2FA5D70CF0FED4213F32116051450391C2A627D9B670C428
m_{PS44}	959537D988FDD4F1360B4E84701AE5409229C30EDF8BC404
m_{PS45}	CDD2E0450F9EC12F81391AD4633CB29F315B4A0A890A9A22
m_{PS46}	158776A20B4B82C563EC08F086830EA66DBD2DCCB4DF6026
m_{PS47}	431FCACBE48208975950342709D11F19AD5FB047F3B440C9
m_{PS48}	86B141AC571BA6B42653B12FF04D4F0E6C81F3EB608660A2
m_{PS49}	86D297ABD34E8510F6CDB0EA617F1F1051C8799117B02211
m_{PS50}	80B2D9530B34E781311D95CFA3857F277CC07014D324AF5A
m_{PS51}	2B607B93FD8B45601C1E574E14CFC6912C22AEC1045ADC49
m_{PS52}	D234C5C45E105A837E6DD74BC4E534523A20317BA0625A29
m_{PS53}	768CCDB3E2A7A2B863128382590946B25472BE2BFFC40641
m_{PS54}	3DA38212E0A987EE1F665D4E13C2AA4446E00A76C948A073
m_{PS55}	09173135E4A2CFC8F2678750AB5257110906F013587BDE82
m_{PS56}	522E070B266F35E99C1F3C42D2017F8E415550492B72F086
m_{PS57}	D63E4BD805262A3DEF05C7D86C422E5048921E5531784132
m_{PS58}	564AF806E28131611E5F884229265D446A50E1E488EAFBBA
m_{PS59}	A2603E009D3D30147727B750C35C62299AF754D3E4A54E1C
m_{PS60}	938504B02599D33E28246E4271C375AE81A3BBE8D3F8A920
m_{PS61}	461516B2CAC6FC42A4B707CC6073BBE573C014892C811776
m_{PS62}	29186DE4CCAAB2CD0100BB19EA595879D63F0F0CFA881AA5
m_{PS63}	A064B449CB784A91B803369CDC5EF61A670AAAC044BA3E68
m_{PS64}	8719C454D88FF5149DB943CB6CADA01D0B9664B357A18203
m_{PS65}	A27EC68720F00A714AA2C45A7EF232286984D7B193F5C916
m_{PS66}	AC8361676AB424E48F0789082B0CD2EFB8D2E627D041DD66
m_{PS67}	ABA1BEB0064733A0620906BF2B29C95883F069D7E4C35D39
m_{PS68}	9E22EDED47D92CA1D0B7530EC6062287BD83A04874AE00C
m_{PS69}	0BADEF288B20F5686C5DE3A71219AC2172054326BE831696
m_{PS70}	953801EB2AF58C2F80E49A6CC46085CB554243E3B3BBEC8C
m_{PS71}	333A504C51C8FAC5025994565C3F600F154F64FAEF4EA484
m_{PS72}	A6583E19647662005474153A6F8DD88A473853E94B720CE7
m_{PS73}	90ACAF707D18AF34F5848C58166830AF620ACDC1B2DFDDA8
m_{PS74}	39C5C598A374EA82F3F83378258248DAD3808812DD0E74BB
m_{PS75}	F79525DE694629346D73F6256CC0F140F82603197AAA1844
m_{PS76}	B8C2A8F139097699A693022E78588D4058DB0A65FF52F813
m_{PS77}	449B50C2A52996FA5A828A907F30F9F460EE3D99930DF890
m_{PS78}	62CEC9574D30184BCB4F94EECF0CC23D2D2A8D0003F0AA33
m_{PS79}	B56D258889703F76A0738EE3A7D355994159A4851833E198
m_{PS80}	65894AA54C0F6C9A206521C9FC379A8AAF6E621C03CF849C
m_{PS81}	2D47F3414E30CC02C6835D95C9BA204488F0FFCB4852677D
m_{PS82}	12BE4DD8B906B584010F8A330AB67B278E8642FA33D51B68
m_{PS83}	BC928A90A4B10906CAEE638BF768E08542F48F1676006DF0
m_{PS84}	30C544E437C8ADA143566CD1BC4E9E7BA84139A08505C2F4
m_{PS85}	84FD5B05506192B753FBA2C719B584E0EDA01814999867D2
m_{PS86}	191F14DD00034E03AB5BB4342F1138B2CD33784E60CFD75A
m_{PS87}	B8ACE7990B6A98A80A61162C4D2D5F88F24E8F7DE4207590
m_{PS88}	EC1DBE72E8EED0C61054FC2695422AC0AD2D888265B21AB0
m_{PS89}	9A1B4CA467AB7E082AF4278E44D177EA78424508C23E8B08
m_{PS90}	999EE541C608164AC975214F3A37A677FC2CA03E2C2A4B20
m_{PS91}	1BDCC20265031432917A2EB828FB356A22DF9CB609C0F8F3
m_{PS92}	EB4A81859C93338B8A1B87C02C815AE09D765F6F2249B958
m_{PS93}	E6A5D1629F4CF09A1F280DE0C480D4C73B26ADE321A50AEE
m_{PS94}	BAAB7286DD24C80B15A7958039B904F1CA83C310C8C7AFF2
m_{PS95}	12220F72619E983717C68FFE1C4148F2354B7B1955B65620
m_{PS96}	A198706E24FAA08BD09EE392414816038E667BB34307D6B2

Code ID	Basic Midamble Codes m_{PS} of length $P=192$
m_{PS97}	30B3493B4C035881A7A722E4546527AAE787FA2C0893AC46
m_{PS98}	5A7318126522843DCB7F00A2D9F9BA8F88963E4152BC923C
m_{PS99}	844844B0CACAB702C332CE2692B4166F4B0C63E62BF151BF
m_{PS100}	B8297389526410313692F861DC60DA86A23607F7DDE24755
m_{PS101}	6C1144CF8BC01538D655D29ED62DE6E74A3180EC905BF1E0
m_{PS102}	E9DB3221FACFC5C88691A7013EF09672A130D52C3413AAE2
m_{PS103}	2FD0508615EC4CD4BF18ADD46D777078869130C8921A4F0E
m_{PS104}	40911B4E0525AC874228F6EF642E59154730CB187C7E417A
m_{PS105}	2034C6A027D4D850F5184AA64C3153231F4651B616BBFCF9
m_{PS106}	57833235451525A1DFA213FCE0B419B6494BC7B99F488410
m_{PS107}	6DC3D57F2E39158D036825F8804810D77CA1ECA610ECD894
m_{PS108}	F5C50DE43AA7B731CAB7683524021701F97650499A7070E4
m_{PS109}	F2184D2699785442E09FA22CC2D60A5A13FFF22AE660A470
m_{PS110}	EF0029DE0D79207205458CF4D7328E81A93518D93C9A74BD
m_{PS111}	9D6D8992482FB885AA5E878C3BA2045538B09886C23CDC2D
m_{PS112}	C0A5AB67D1CEA126F6476C75443F0A11CBE749412EF03104
m_{PS113}	1853A5C20CDF968C5A180D8EB5E72BF15517D06680D98412
m_{PS114}	8CEA1223227ADF37D0DAAB320906E1C79029F480D25181A7
m_{PS115}	5561038E96A658EF3EC665612FF92B064065D1ACC1F54812
m_{PS116}	C55A6263F08D664A1E53584560DFF5E611640D8281D9A843
m_{PS117}	4386A8EA59124D043F29056A4598735A4FC7BC11119B90C1
m_{PS118}	D6571B20668BED50BD7C80388C162632BCB069AA67C7FC22
m_{PS119}	4F9F09ABBC1391EC2CCA5359FB52250E533BF04324154106
m_{PS120}	662659F42188C9453F6E6DF00C579627045DA1461A3A0EA5
m_{PS121}	8DCC9274C0C2A9BA6096BF27FACA542CD01CA8653D60A80F
m_{PS122}	5C1210A1E50E505F6B73C90156C9D9F19AE2310BBD820DF0
m_{PS123}	B1E0A7CE26202E223D4FC06D5C9BBA4E5F6D98204D2D5286
m_{PS124}	DB506776958E34552F7E60E4B400D836153218F918E22FA6
m_{PS125}	ECAA60300439B2360B2AC3C43FB6241ACDE5055B295FA71C
m_{PS126}	BF1E6D9AA9CA4AC092BE60500C77D0DC7A6A236520F86722
m_{PS127}	051C5FA122845A30B4EC306B38016B45667C7754F92F13A0

A.3 Association between Midambles and Channelisation Codes

The following mapping schemes apply for the association between midambles and channelisation codes if no midamble is allocated by higher layers. Secondary channelisation codes are marked with a (*). These associations apply both for UL and DL.

A.3.1 Association for Burst Type 1/3 and $K_{Cell}=16$ Midambles

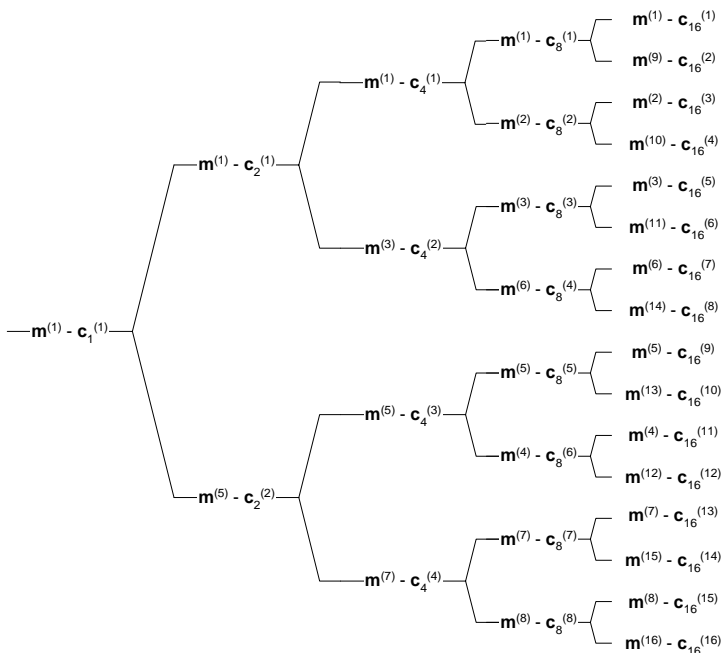

Figure A-1: Association of Midambles to Spreading Codes for Burst Type 1/3 and $K_{Cell}=16$

A.3.2 Association for Burst Type 1/3 and $K_{Cell}=8$ Midambles

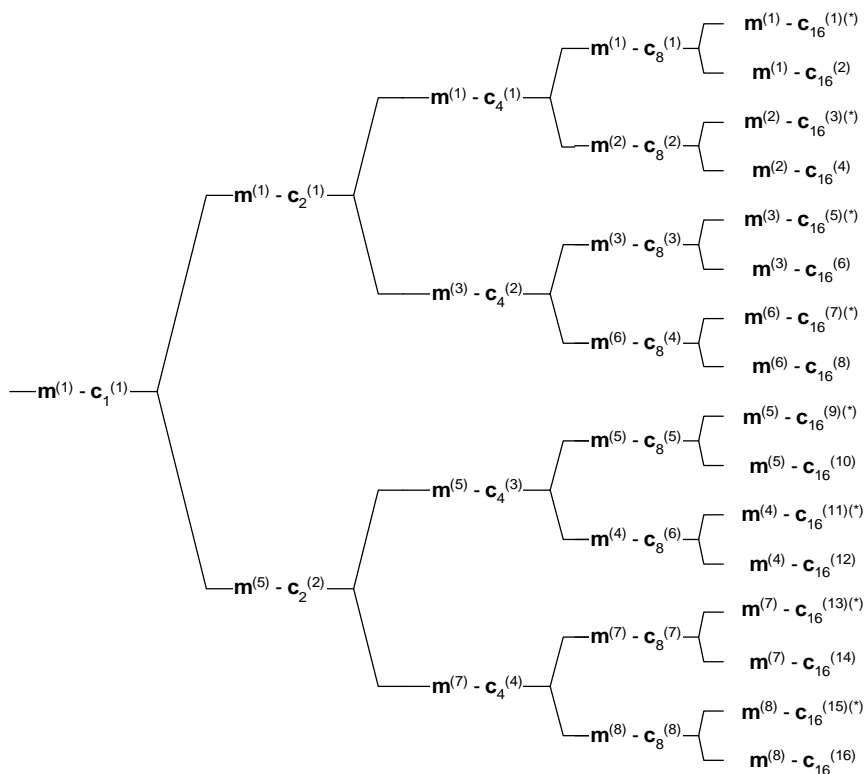

Figure A-2: Association of Midambles to Spreading Codes for Burst Type 1/3 and $K_{Cell}=8$

A.3.3 Association for Burst Type 1/3 and $K_{Cell}=4$ Midambles

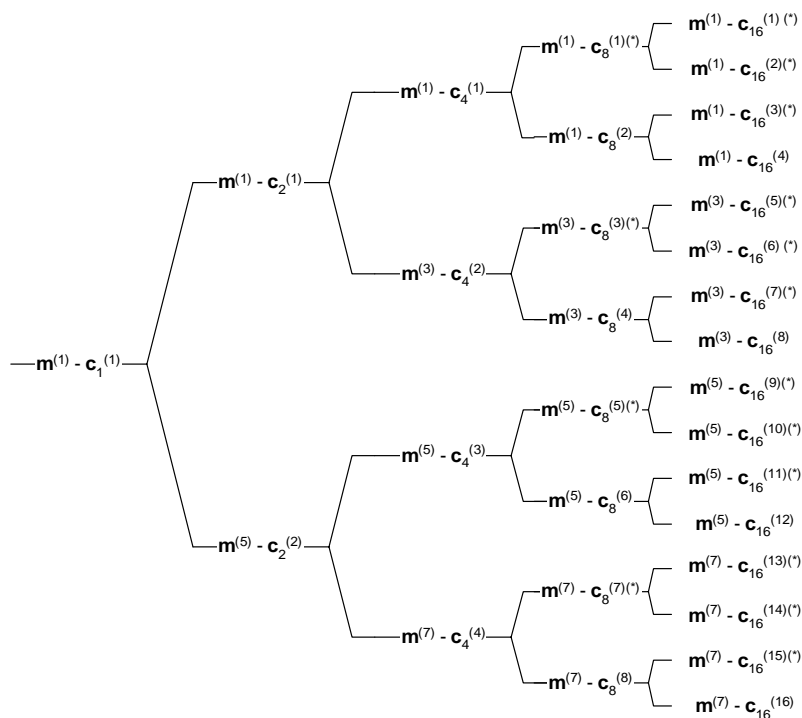

Figure A-3: Association of Midambles to Spreading Codes for Burst Type 1/3 and $K_{Cell}=4$

A.3.4 Association for Burst Type 2 and $K_{Cell}=6$ Midambles

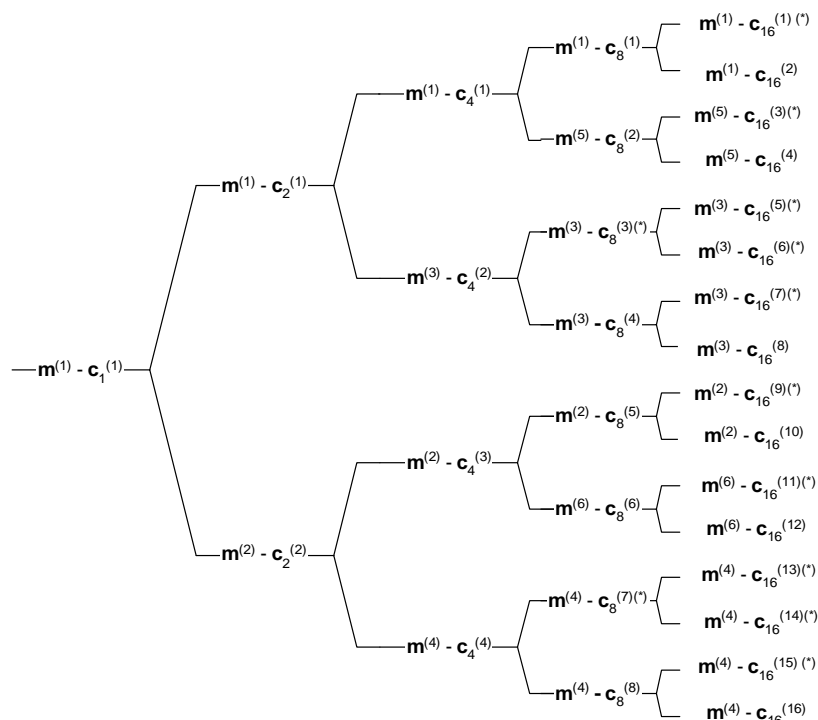

Figure A-4: Association of Midambles to Spreading Codes for Burst Type 2 and $K_{Cell}=6$

A.3.5 Association for Burst Type 2 and $K_{Cell}=3$ Midambles

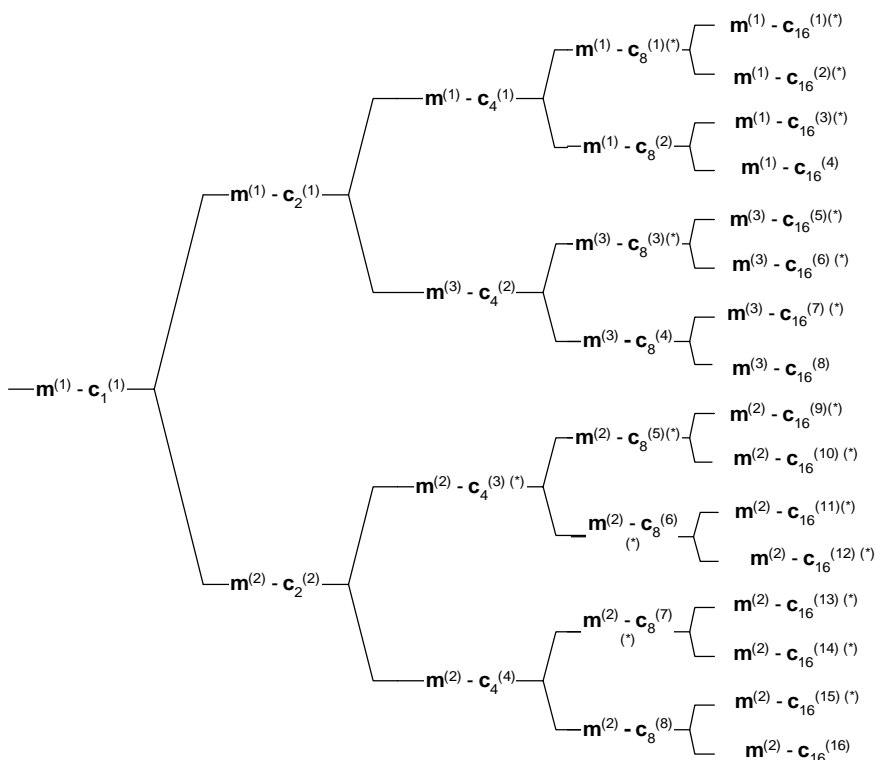

Figure A-5: Association of Midambles to Spreading Codes for Burst Type 2 and $K_{Cell}=3$

Note that the association for burst type 2 can be derived from the association for burst type 1 and 3, using the following table:

Burst Type 1/3	m(1)	m(2)	m(3)	m(4)	m(5)	m(6)	m(7)	m(8)
Burst Type 2	m(1)	m(5)	m(3)	m(6)	m(2)	m(4)	-	-

Annex B (normative): Basic Midamble Codes for the 1.28 Mcps option

B.1 Basic Midamble Codes

The midamble has a length of $L_m=144$, which is corresponding to:

$$K=2, 4, 6, 8, 10, 12, 14, 16, \quad W = \left\lfloor \frac{P}{K} \right\rfloor, P=128$$

Note: that $\lfloor x \rfloor$ denotes the largest integer number less or equal to x .

Depending on the possible delay spread cells are configured to use midambles which are generated from the Basic Midamble Codes (see table B.1). The cell configuration is broadcast on BCH.

The mapping of these Basic Midamble Codes to Cell Parameters is shown in [8].

Table B.1: Basic Midamble Codes m_p according to equation (5) from subclause 6.2.3

Code ID	Basic Midamble Codes m_p of length $P=128$
m_{P0}	B2AC420F7C8DEBFA69505981BCD028C3
m_{P1}	0C2E988E0DBA046643F57B0EA6A435E2
m_{P2}	D5CEC680C36A4454135F86DD37043962
m_{P3}	E150D08CAC2A00FF9B32592A631CF85B
m_{P4}	E0A9C3A8F6E40329B2F2943246003D44
m_{P5}	FE22658100A3A683EA759018739BD690
m_{P6}	B46062F89BB2A1139D76A1EF32450DA0
m_{P7}	EE63D75CC099092579400D956A90C3E0
m_{P8}	D9C0E040756D427A2611DAA35E6CD614
m_{P9}	EB56D03A498EC4FEC98AE220BC390450
m_{P10}	F598703DB0838112ED0BABB98642B665
m_{P11}	A0BC26A992D4558B9918986C14861EFF
m_{P12}	541350D109F1DD68099796637B824F88
m_{P13}	892D344A962314662F01F9455F7BC302
m_{P14}	49F270E29CCD742A40480DD4215E1632
m_{P15}	6A5C0410C6C39AA04E77423C355926DE
m_{P16}	7976615538203103D4DBCC219B16A9E1
m_{P17}	A6C3C3175845400BD2B738C43EE2645F
m_{P18}	A0FD56258D228642C6F641851C3751ED
m_{P19}	EFA48C3FC84AC625783C6C9510A2269A
m_{P20}	62A8EB1A420334B23396E8D76BC19740
m_{P21}	9E96235699D5D41C9816C921023BC741
m_{P22}	4362AE4CAE0DCC32D60A3FED1341A848
m_{P23}	454C068E6C4F190942E0904B95D61DFB
m_{P24}	607FEEA6E2E99206718A49C0D6A25034
m_{P25}	E1D1BCDA39A09095B5C81645103A077C
m_{P26}	994B445E558344DE211C8286DDD3D1A3
m_{P27}	C15233273581417638906ADB61FDCA3C
m_{P28}	8B79A274D542F096FB1388098230F8A1
m_{P29}	DF58AC1C5F44B2A40266385CE1DA5640
m_{P30}	B5949A1CC69962C464401D05FF5C1A7A
m_{P31}	85AC489841ED3EAA2D83BBB0039CC707
m_{P32}	AE371CC144BC95923CA8108D8B49FE82
m_{P33}	7F188484A649D1C22BDA1F09D49B5117
m_{P34}	ADAA3C657089DEF7C0284903A491C9B0
m_{P35}	C3F96893C7504DC3B51488604AF64F4C
m_{P36}	B4002F5AE0CE8623AC979D368E9148C1
m_{P37}	0EEBCC0C795C02A106C24ABB36D08C6E
m_{P38}	4B0F537E384A893F58971580D9894433
m_{P39}	08E0035AB29B7ECC53C15DAA0687CC8F
m_{P40}	8611ACBC4C82781D77654EE862506D60
m_{P41}	63315261A8F1CB02549802DBFD197C07
m_{P42}	9A2609A434F43E7DCADC0E22B2EF4012
m_{P43}	F4C9F0A127A88461209ABF8C69CE4D00
m_{P44}	C79124EE3FFC28C5C4524D2B01670D42
m_{P45}	C91985C4FED53D09361914354BA80E79
m_{P46}	82AA517260779ECFF26212C1A10BDC29
m_{P47}	561DE2040ACB458E0DBD354E43E111D9
m_{P48}	2E58C7202D17392BC1235782CEFABB09
m_{P49}	C4FAA121C698047650F6503126A577C1
m_{P50}	E7B75206A9B410E44346E0DAE842A23C
m_{P51}	3F8B1C32682B28D098D3805ED130EA7F
m_{P52}	8D5FC2C1C6715F824B401434C8D4BB82
m_{P53}	0B2A43453ACC028FE6EB6E1CB0740B59
m_{P54}	BC56948FC700BA4883262EE73E12D82A
m_{P55}	558D136710272912FA4F183D1189A7FD
m_{P56}	5709E7F82DC6500B7B12A3072D182645
m_{P57}	86D4F161C844AE5E20EE39FD5493B044
m_{P58}	8729B6EDC382B152185885F013DAE222
m_{P59}	154C45B50720F4C362C14C77FE8335A1
m_{P60}	C6A0962890351F4EB802DE43A7662C9E

mP61	D19D69D6B380B4B22457CB80033519F0
mP62	C7D89509FB0DAE9255998E0A00C2B262
mP63	DFD481C652C0C905D61D66F1732C4AA2
mP64	06C848619AF1D6C910A8EAC4B622FC06
mP65	0635E29D4E7AC8ABC189890241F45ECA
mP66	B272B020586AAD7B093AC2F459076638
mP67	B608ACE46E1A6BC96181EEDD88B54140
mP68	0A516092B3ED7849B168AFE223B8670E
mP69	D1A658C5009E04D0D7D5E9205EE663E8
mP70	AC316DC39B91EB60B1AABD8280740432
mP71	E3F06825476A026CD287625E514519FC
mP72	A56D092080DDE8994F387C175CC56833
mP73	15EA799DE587C506D0CD99A408217B05
mP74	A59C020BAB9AF6D3F813C391CA244CD2
mP75	74B0101EB9F3167434B94BABC8378882
mP76	CE752975C8DA9B0100386DB82A8C3D20
mP77	BBB38DCDB1E9118570AC147DC05241A4
mP78	944ABBF0866098101F6971731AB2E986
mP79	2BB147B2A30C68B4853F90481A166EB6
mP80	444840ACCF3F23C45B56D7704BF18283
mP81	87604F7450D1AD188C452981A5C7FC9B
mP82	8C3842EBC948A65BC4C8B387F11B7090
mP83	10B4767D071CF5DB2288E4029576135A
mP84	6F07AAB697CD0089572C6B062E2018E4
mP85	D3D65B442057E613A8655060C8D29E27
mP86	5EDA330514C604BF4E0894E09EC57A74
mP87	B0899CD094060724DED82AE85F18A43A
mP88	B2D999B86DF902BC25015CAE3A0823C4
mP89	C23CD40F04242B92D46EED82CD9A9A18
mP90	D22DDCC5CB82960125DD24655F3C8788
mP91	54987218FBD99AE4340FD4C9458E9850
mP92	BE4341822997A7B11EA1E8A1A2767005
mP93	255200FBA6EE48E6DE0A82B0461B8D0F
mP94	6FBD58A663932423503690CF9C171701
mP95	D215033A4AA87EC1C232BAC7EDA09370
mP96	CA0959B01AE48E80204F1E4A3F29CE55
mP97	582043413B9B825903E3A3545ED59463
mP98	5016541922971C703D16E284CBDF633B
mP99	7347EF160A1733CA98D43608A83A920B
mP100	908B22AD433CCA00B3FD47C691F1A290
mP101	BB22A272FC6923DF1B43BA4118806570
mP102	0FA75C87474836B47DC7624D61193802
mP103	A22EBA0658A4D0FF1E9CA5030A65CC06
mP104	6C9C51CA15F1F4981F4C46180A6A6697
mP105	4C847ACF8BC15359C405322851C9BDE2
mP106	C1D29499C0082C9DE473ED15B14D63E0
mP107	7E85ECC98AC761005076C5572869A431
mP108	D8F11121595B8F49F78A7039E44126A0
mP109	1A0BC814445FD71C8E5B1A9163ED2059
mP110	A7591F27F8B0C00C68CC41697954FA04
mP111	6CA2CE595E7406D79C4840183D41B9D0
mP112	C093D3CC701FC20E66F5AB22516C5460
mP113	D0E0CDE9B595546B96C4F8066B469020
mP114	E99F743A451431C8B427054A4E6F2007
mP115	C0D21A344A2C07DF2A6EBE6250C7B91E
mP116	F031223E282CF7A4D8EF174A908668AE
mP117	E4BD244AC16C55C7137FB068FD44280C
mP118	C44920DE2028F19FC2AAB36A0DCFDAD0
mP119	3FA7054E77135250699E6C8A11600742
mP120	D5740B4D8870C1C5B5A214C4266FC537
mP121	F0B7942D43BB6F38446442EB8126AB80
mP122	83DB9534EAD6238FA8968798CDF04848
mP123	EB9663CDDC2B291690703125BABC800
mP124	84D547225D4BBD20DEF1A583240C6E0F

m _{P125}	B51F6A771838BE934724AEA6A2669802
m _{P126}	D92AC05E10496794BBDC115233B1C068
m _{P127}	D3ACF0078EDA9856BBB0AF8651132103

B.2 Association between Midambles and Channelisation Codes

The following mapping schemes apply for the association between midambles and channelisation codes if no midamble is allocated by higher layers. Secondary channelisation codes are marked with (*). These associations apply for both UL and DL.

B.2.1 Association for K=16 Midambles

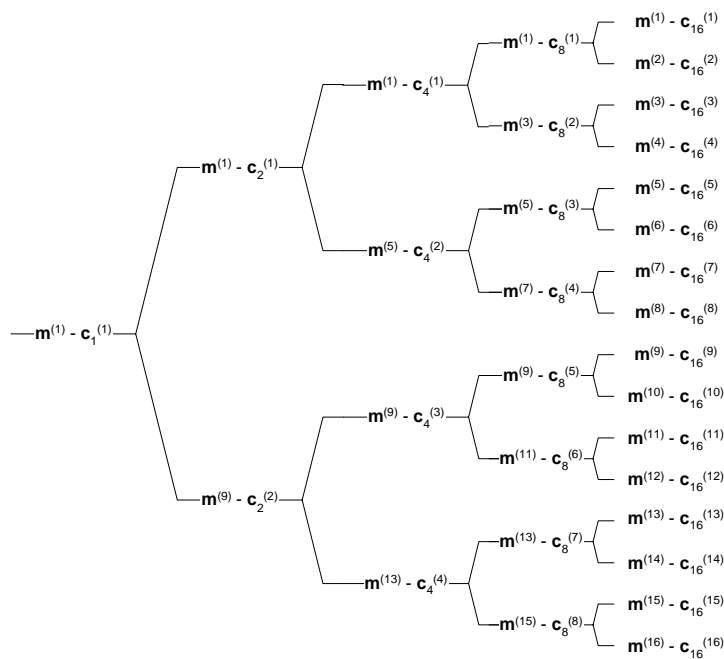

Figure B.2.1: Association of Midambles to Spreading Codes for K=16

B.2.2 Association for K=14 Midambles

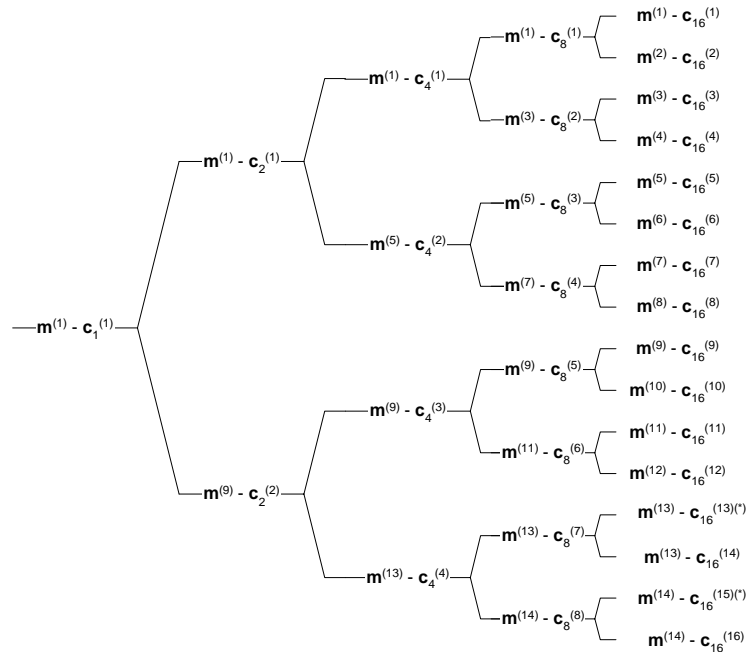

Figure B.2.2: Association of Midambles to Spreading Codes for K=14

B.2.3 Association for K=12 Midambles

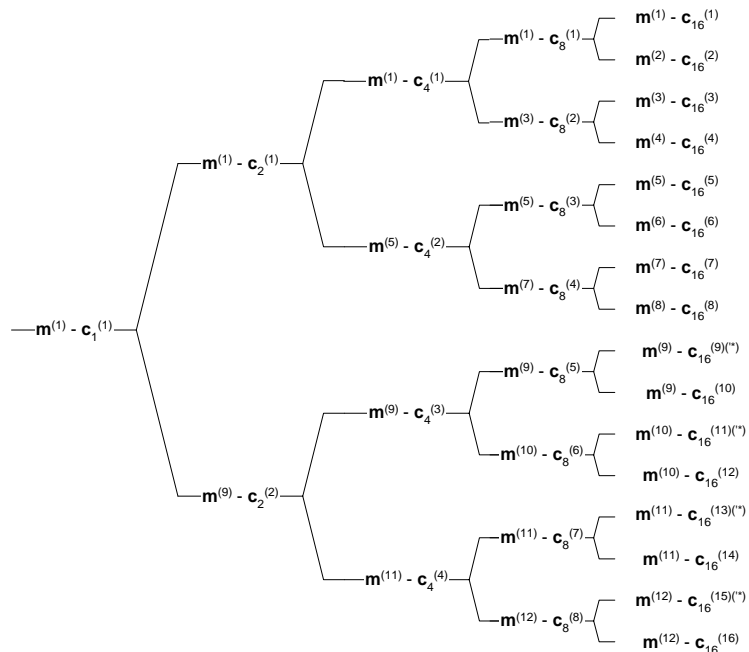

Figure B.2.3: Association of Midambles to Spreading Codes for K=12

B.2.4 Association for K=10 Midambles

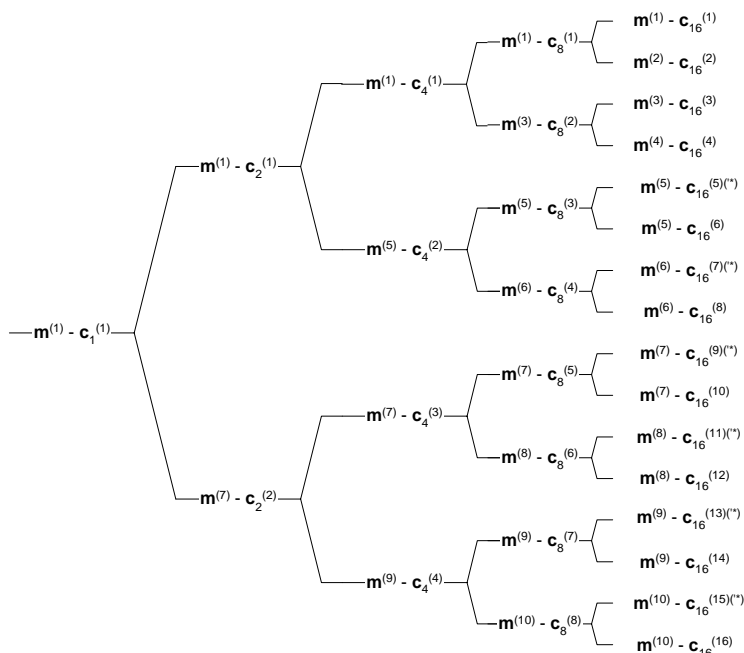

Figure B.2.4: Association of Midambles to Spreading Codes for K=10

B.2.5 Association for K=8 Midambles

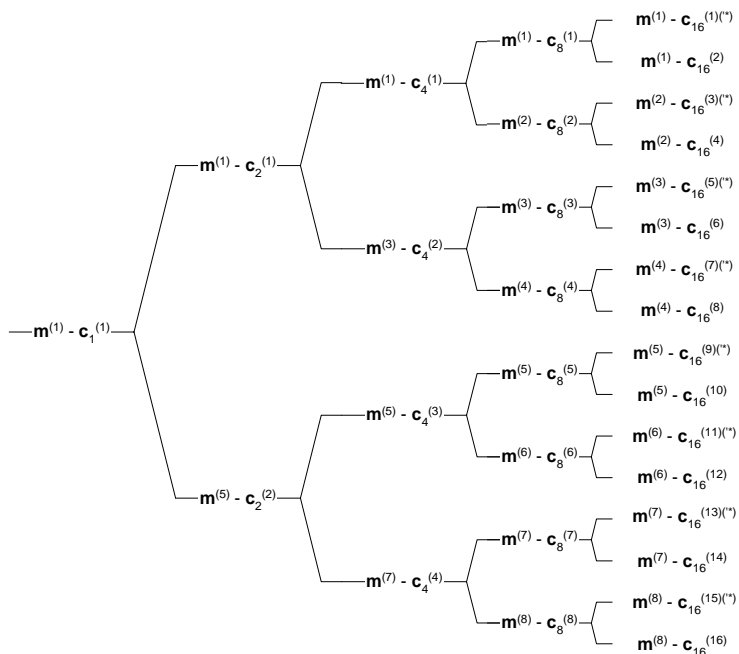

Figure B.2.5: Association of Midambles to Spreading Codes for K=8

B.2.6 Association for K=6 Midambles

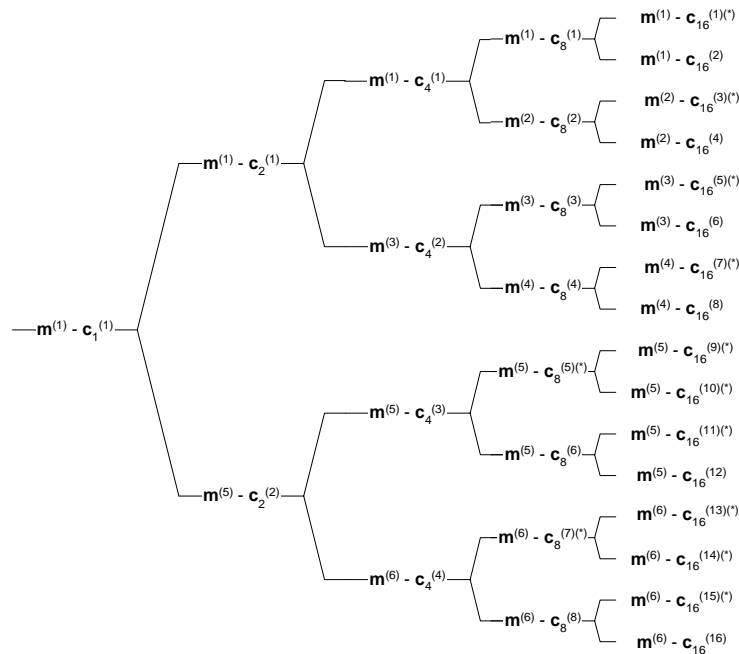

Figure B.2.6: Association of Midambles to Spreading Codes for K=6

B.2.7 Association for K=4 Midambles

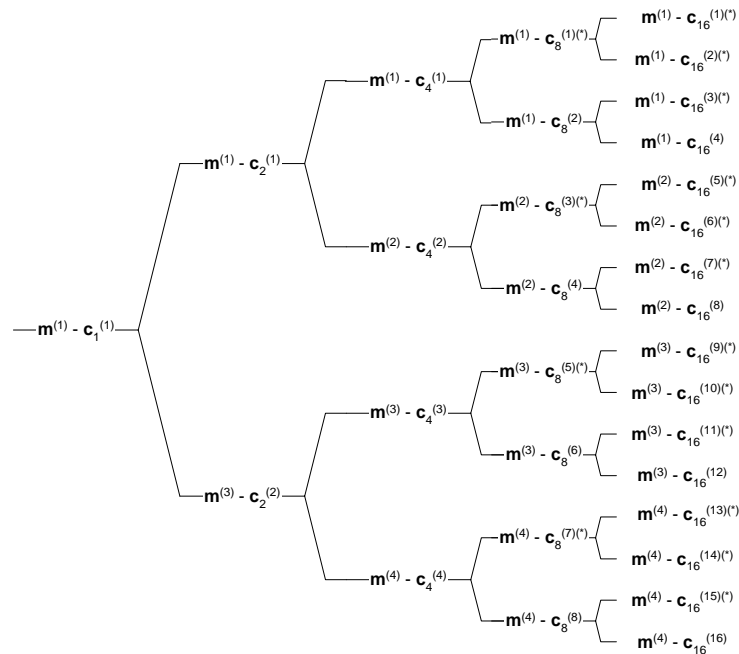

Figure B.2.7: Association of Midambles to Spreading Codes for K=4

B.2.8 Association for K=2 Midambles

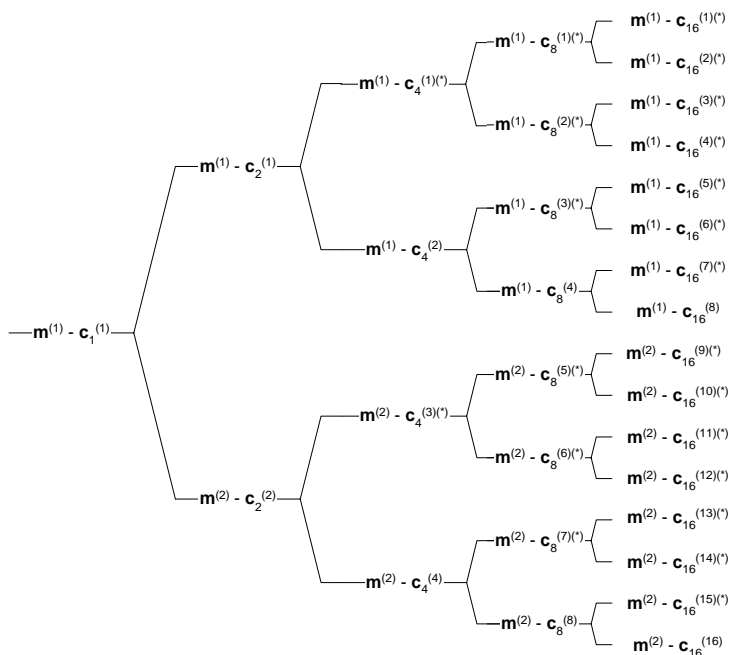

Figure B.2.8: Association of Midambles to Spreading Codes for K=2

Annex C (normative):

Signalling of the number of channelisation codes for the DL common midamble case for 3.84Mcps TDD

The following mapping schemes shall apply for the association between the number of channelisation codes employed in a timeslot and the use of a particular midamble shift in the DL common midamble case. In the following tables the presence of a particular midamble shift is indicated by '1'. Midamble shifts marked with '0' are left unused. Mapping schemes C.4, C.5 and C.6 are not applicable to beacon timeslots where a P-CCPCH is present, because the default midamble allocation scheme is applied to these timeslots. Note that in mapping schemes C.4, C.5 and C.6, the fixed and pre-allocated channelisation code for the beacon channel is included into the number of indicated channelisation codes.

C.1 Mapping scheme for Burst Type 1 and $K_{\text{Cell}}=16$ Midambles

m1	m2	m3	m4	m5	m6	m7	M8	m9	m10	m11	m12	m13	m14	m15	m16	
1	0	0	0	0	0	0	0	0	0	0	0	0	0	0	0	1 code
0	1	0	0	0	0	0	0	0	0	0	0	0	0	0	0	2 codes
0	0	1	0	0	0	0	0	0	0	0	0	0	0	0	0	3 codes
0	0	0	1	0	0	0	0	0	0	0	0	0	0	0	0	4 codes
0	0	0	0	1	0	0	0	0	0	0	0	0	0	0	0	5 codes
0	0	0	0	0	1	0	0	0	0	0	0	0	0	0	0	6 codes
0	0	0	0	0	0	1	0	0	0	0	0	0	0	0	0	7 codes
0	0	0	0	0	0	0	1	0	0	0	0	0	0	0	0	8 codes
0	0	0	0	0	0	0	0	1	0	0	0	0	0	0	0	9 codes
0	0	0	0	0	0	0	0	0	1	0	0	0	0	0	0	10 codes
0	0	0	0	0	0	0	0	0	0	1	0	0	0	0	0	11 codes
0	0	0	0	0	0	0	0	0	0	0	1	0	0	0	0	12 codes
0	0	0	0	0	0	0	0	0	0	0	0	1	0	0	0	13 codes
0	0	0	0	0	0	0	0	0	0	0	0	0	1	0	0	14 codes
0	0	0	0	0	0	0	0	0	0	0	0	0	0	1	0	15 codes
0	0	0	0	0	0	0	0	0	0	0	0	0	0	0	1	16 codes

C.2 Mapping scheme for Burst Type 1 and $K_{\text{Cell}}=8$ Midambles

M1	m2	m3	m4	m5	m6	m7	m8	
1	0	0	0	0	0	0	0	1 code or 9 codes
0	1	0	0	0	0	0	0	2 codes or 10 codes
0	0	1	0	0	0	0	0	3 codes or 11 codes
0	0	0	1	0	0	0	0	4 codes or 12 codes
0	0	0	0	1	0	0	0	5 codes or 13 codes
0	0	0	0	0	1	0	0	6 codes or 14 codes
0	0	0	0	0	0	1	0	7 codes or 15 codes
0	0	0	0	0	0	0	1	8 codes or 16 codes

C.3 Mapping scheme for Burst Type 1 and $K_{\text{Cell}}=4$ Midambles

m1	m3	m5	m7	
1	0	0	0	1 or 5 or 9 or 13 codes
0	1	0	0	2 or 6 or 10 or 14 codes
0	0	1	0	3 or 7 or 11 or 15 codes
0	0	0	1	4 or 8 or 12 or 16 codes

C.4 Mapping scheme for beacon timeslots and $K_{\text{Cell}}=16$ Midambles

m1	m2	m3	M4	m5	m6	m7	M8	m9	m10	m11	M12	m13	m14	m15	m16	
1	$x^{(1)}$	0	0	0	0	0	0	0	0	0	0	0	0	0	0	1 code (see note 1)
1	1	0	0	0	0	0	0	0	0	0	0	0	0	0	0	2 codes (SCTD applied to PICH in this time slot, see note 2)
1	$x^{(1)}$	1	0	0	0	0	0	0	0	0	0	0	0	0	0	13 codes
1	$x^{(1)}$	0	1	0	0	0	0	0	0	0	0	0	0	0	0	2 codes (SCTD not applied to PICH in this time slot) or 14 codes
1	$x^{(1)}$	0	0	1	0	0	0	0	0	0	0	0	0	0	0	3 codes or 15 codes
1	$x^{(1)}$	0	0	0	1	0	0	0	0	0	0	0	0	0	0	4 codes or 16 codes
1	$x^{(1)}$	0	0	0	0	1	0	0	0	0	0	0	0	0	0	5 codes
1	$x^{(1)}$	0	0	0	0	0	1	0	0	0	0	0	0	0	0	6 codes
1	$x^{(1)}$	0	0	0	0	0	0	1	0	1	0	0	0	0	0	7 codes
1	$x^{(1)}$	0	0	0	0	0	0	0	0	0	1	0	0	0	0	8 codes
1	$x^{(1)}$	0	0	0	0	0	0	0	0	0	0	1	0	0	0	9 codes
1	$x^{(1)}$	0	0	0	0	0	0	0	0	0	0	0	1	0	0	10 codes
1	$x^{(1)}$	0	0	0	0	0	0	0	0	0	0	0	0	1	0	11 codes
1	$x^{(1)}$	0	0	0	0	0	0	0	0	0	0	0	0	0	1	12 codes

^(*) For the case of SCTD applied to P-CCPCH and PICH, midamble shift 2 is used by the diversity antenna.

Note 1: If only one code is present in a beacon time slot, this code is a beacon channel and the beacon channel is the only channel in this slot, by default. Therefore, only the beacon midamble(s) shall be used.

Note 2: If SCTD is applied to the PICH and only two codes are present in a beacon time slot, the PICH is the beacon channel and the beacon channel is the only channel in this slot, by default. Therefore, only the beacon midambles shall be used.

C.5 Mapping scheme for beacon timeslots and $K_{\text{Cell}}=8$ Midambles

m1	m2	m3	m4	m5	m6	m7	M8	
1	$x^{(*)}$	0	0	0	0	0	0	1 code (see note 1)
1	1	0	0	0	0	0	0	2 codes (SCTD applied to PICH in this time slot, see note 2)
1	$x^{(*)}$	1	0	0	0	0	0	7 or 13 codes
1	$x^{(*)}$	0	1	0	0	0	0	2 (SCTD not applied to PICH in this time slot) or 8 or 14 codes
1	$x^{(*)}$	0	0	1	0	0	0	3 or 9 or 15 codes
1	$x^{(*)}$	0	0	0	1	0	0	4 or 10 or 16 codes
1	$x^{(*)}$	0	0	0	0	1	0	5 codes or 11 codes
1	$x^{(*)}$	0	0	0	0	0	1	6 codes or 12 codes

(*) For the case of SCTD applied to P-CCPCH and PICH, midamble shift 2 is used by the diversity antenna.

Note 1: If only one code is present in a beacon time slot, this code is a beacon channel and the beacon channel is the only channel in this slot, by default. Therefore, only the beacon midamble(s) shall be used.

Note 2: If SCTD is applied to the PICH and only two codes are present in a beacon time slot, the PICH is the beacon channel and the beacon channel is the only channel in this slot, by default. Therefore, only the beacon midambles shall be used.

C.6 Mapping scheme for beacon timeslots and $K_{\text{Cell}}=4$ Midambles

m1	m3	m5	m7	
1	0	0	0	1code (see note 1)
1	1	0	0	4 or 7 or 10 or 13 or 16 codes
1	0	1	0	2 or 5 or 8 or 11 or 14 codes
1	0	0	1	3 or 6 or 9 or 12 or 15 codes

Note 1: If only one code is present in a beacon time slot, this code is a beacon channel and the beacon channel is the only channel in this slot, by default. Therefore, only the beacon midamble shall be used.

C.7 Mapping scheme for Burst Type 2 and $K_{\text{Cell}}=6$ Midambles

m1	m2	m3	m4	m5	m6	
1	0	0	0	0	0	1 or 7 or 13 codes
0	1	0	0	0	0	2 or 8 or 14 codes
0	0	1	0	0	0	3 or 9 or 15 codes
0	0	0	1	0	0	4 or 10 or 16 codes
0	0	0	0	1	0	5 or 11 codes
0	0	0	0	0	1	6 or 12 codes

C.8 Mapping scheme for Burst Type 2 and $K_{\text{Cell}}=3$ Midambles

m1	m2	m3	
1	0	0	1 or 4 or 7 or 10 or 13 or 16 codes
0	1	0	2 or 5 or 8 or 11 or 14 codes
0	0	1	3 or 6 or 9 or 12 or 15 codes

Annex D (normative): Signalling of the number of channelisation codes for the DL common midamble case for 1.28Mcps TDD

The following mapping schemes shall apply for the association between the number of channelisation codes employed in a timeslot and the use of a particular midamble shift in the DL common midamble case. In the following tables the presence of a particular midamble shift is indicated by '1'. Midamble shifts marked with '0' are left unused.

D.1 Mapping scheme for K=16 Midambles

m1	m2	m3	m4	m5	m6	M7	M8	m9	m10	m11	m12	M13	m14	m15	m16	
1	0	0	0	0	0	0	0	0	0	0	0	0	0	0	0	1 code
0	1	0	0	0	0	0	0	0	0	0	0	0	0	0	0	2 codes
0	0	1	0	0	0	0	0	0	0	0	0	0	0	0	0	3 codes
0	0	0	1	0	0	0	0	0	0	0	0	0	0	0	0	4 codes
0	0	0	0	1	0	0	0	0	0	0	0	0	0	0	0	5 codes
0	0	0	0	0	1	0	0	0	0	0	0	0	0	0	0	6 codes
0	0	0	0	0	0	1	0	0	0	0	0	0	0	0	0	7 codes
0	0	0	0	0	0	0	1	0	0	0	0	0	0	0	0	8 codes
0	0	0	0	0	0	0	0	1	0	0	0	0	0	0	0	9 codes
0	0	0	0	0	0	0	0	0	1	0	0	0	0	0	0	10 codes
0	0	0	0	0	0	0	0	0	0	1	0	0	0	0	0	11 codes
0	0	0	0	0	0	0	0	0	0	0	1	0	0	0	0	12 codes
0	0	0	0	0	0	0	0	0	0	0	0	1	0	0	0	13 codes
0	0	0	0	0	0	0	0	0	0	0	0	0	1	0	0	14 codes
0	0	0	0	0	0	0	0	0	0	0	0	0	0	1	0	15 codes
0	0	0	0	0	0	0	0	0	0	0	0	0	0	0	1	16 codes

D.2 Mapping scheme for K=14 Midambles

m1	m2	m3	m4	m5	m6	M7	M8	m9	m10	m11	m12	M13	m14	
1	0	0	0	0	0	0	0	0	0	0	0	0	0	1 or 15 code(s)
0	1	0	0	0	0	0	0	0	0	0	0	0	0	2 or 16 codes
0	0	1	0	0	0	0	0	0	0	0	0	0	0	3 codes
0	0	0	1	0	0	0	0	0	0	0	0	0	0	4 codes
0	0	0	0	1	0	0	0	0	0	0	0	0	0	5 codes
0	0	0	0	0	1	0	0	0	0	0	0	0	0	6 codes
0	0	0	0	0	0	1	0	0	0	0	0	0	0	7 codes
0	0	0	0	0	0	0	1	0	0	0	0	0	0	8 codes
0	0	0	0	0	0	0	0	1	0	0	0	0	0	9 codes
0	0	0	0	0	0	0	0	0	1	0	0	0	0	10 codes
0	0	0	0	0	0	0	0	0	0	1	0	0	0	11 codes
0	0	0	0	0	0	0	0	0	0	0	1	0	0	12 codes
0	0	0	0	0	0	0	0	0	0	0	0	1	0	13 codes
0	0	0	0	0	0	0	0	0	0	0	0	0	1	14 codes

D.3 Mapping scheme for K=12 Midambles

m1	m2	m3	m4	m5	m6	M7	M8	m9	m10	m11	m12	
1	0	0	0	0	0	0	0	0	0	0	0	1 or 13 code(s)
0	1	0	0	0	0	0	0	0	0	0	0	2 or 14 codes
0	0	1	0	0	0	0	0	0	0	0	0	3 or 15 codes
0	0	0	1	0	0	0	0	0	0	0	0	4 or 16 codes
0	0	0	0	1	0	0	0	0	0	0	0	5 codes
0	0	0	0	0	1	0	0	0	0	0	0	6 codes
0	0	0	0	0	0	1	0	0	0	0	0	7 codes
0	0	0	0	0	0	0	1	0	0	0	0	8 codes
0	0	0	0	0	0	0	0	1	0	0	0	9 codes
0	0	0	0	0	0	0	0	0	1	0	0	10 codes
0	0	0	0	0	0	0	0	0	0	1	0	11 codes
0	0	0	0	0	0	0	0	0	0	0	1	12 codes

D.4 Mapping scheme for K=10 Midambles

m1	m2	m3	m4	m5	m6	M7	M8	m9	m10	
1	0	0	0	0	0	0	0	0	0	1 or 11 code(s)
0	1	0	0	0	0	0	0	0	0	2 or 12 codes
0	0	1	0	0	0	0	0	0	0	3 or 13 codes
0	0	0	1	0	0	0	0	0	0	4 or 14 codes
0	0	0	0	1	0	0	0	0	0	5 or 15 codes
0	0	0	0	0	1	0	0	0	0	6 or 16 codes
0	0	0	0	0	0	1	0	0	0	7 codes
0	0	0	0	0	0	0	1	0	0	8 codes
0	0	0	0	0	0	0	0	1	0	9 codes
0	0	0	0	0	0	0	0	0	1	10 codes

D.5 Mapping scheme for K=8 Midambles

m1	m2	m3	m4	m5	m6	m7	m8	
1	0	0	0	0	0	0	0	1 or 9 code(s)
0	1	0	0	0	0	0	0	2 or 10 codes
0	0	1	0	0	0	0	0	3 or 11 codes
0	0	0	1	0	0	0	0	4 or 12 codes
0	0	0	0	1	0	0	0	5 or 13 codes
0	0	0	0	0	1	0	0	6 or 14 codes
0	0	0	0	0	0	1	0	7 or 15 codes
0	0	0	0	0	0	0	1	8 or 16 codes

D.6 Mapping scheme for K=6 Midambles

m1	m2	m3	m4	m5	m6	
1	0	0	0	0	0	1 or 7 or 13 code(s)
0	1	0	0	0	0	2 or 8 or 14 codes
0	0	1	0	0	0	3 or 9 or 15 codes
0	0	0	1	0	0	4 or 10 or 16 codes
0	0	0	0	1	0	5 or 11 codes
0	0	0	0	0	1	6 or 12 codes

D.7 Mapping scheme for K=4 Midambles

m1	m2	m3	m4	
1	0	0	0	1 or 5 or 9 or 13 code(s)
0	1	0	0	2 or 6 or 10 or 14 codes
0	0	1	0	3 or 7 or 11 or 15 codes
0	0	0	1	4 or 8 or 12 or 16 codes

D.8 Mapping scheme for K=2 Midambles

m1	m2	
1	0	1 or 3 or 5 or 7 or 9 or 11 or 13 or 15 code(s)
0	1	2 or 4 or 6 or 8 or 10 or 12 or 14 or 16 codes

Annex E (informative): CCPCH Multiframe Structure for the 3.84 Mcps option

In the following figures C.1 to C.3 some examples for Multiframe Structures on Primary and Secondary CCPCH are given. The figures show the placement of Common Transport Channels on the Common Control Physical Channels. Additional S-CCPCH capacity can be allocated on other codes and timeslots of course, e.g. FACH capacity is related to overall cell capacity and can be configured according to the actual needs. Channel capacities in the annex are derived using bursts with long midambles (Burst format 1). Every TrCH-box in the figures is assumed to be valid for two frames (see row 'Frame #'), i.e. the transport channels in CCPCHs have an interleaving time of 20msec.

The actual CCPCH Multiframe Scheme used in the cell is described and broadcast on BCH. Thus the system information structure has its roots in this particular transport channel and allocations of other Common Channels can be handled this way, i.e. by pointing from BCH.

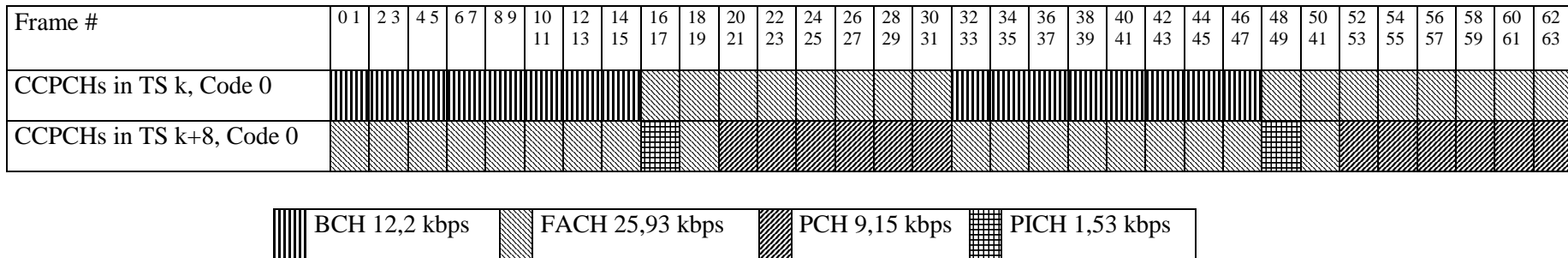

Figure C.1: Example for a multiframe structure for CCPCHs and PICH that is repeated every 64th frame

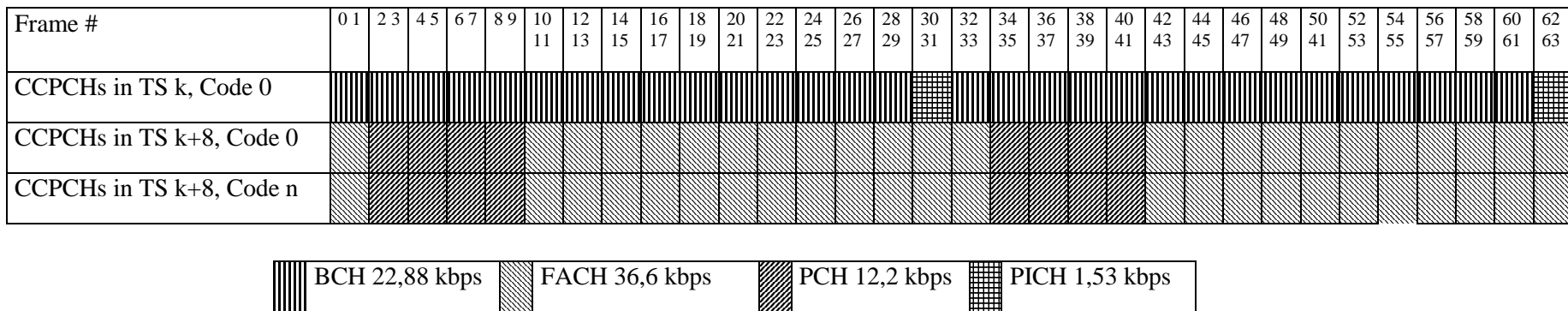

Figure C.2: Example for a multiframe structure for CCPCHs and PICH that is repeated every 64th frame, n=1...7

Annex F (informative): CCPCH Multiframe Structure for the 1.28 Mcps option

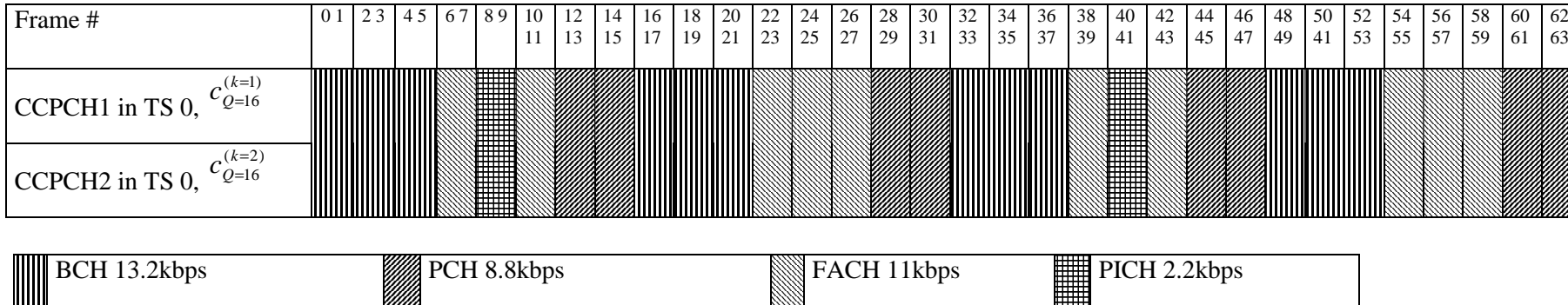

Figure F.1: Example for a multiframe structure for CCPCHs and PICH that is repeated every 64th frame (128 sub-frame)

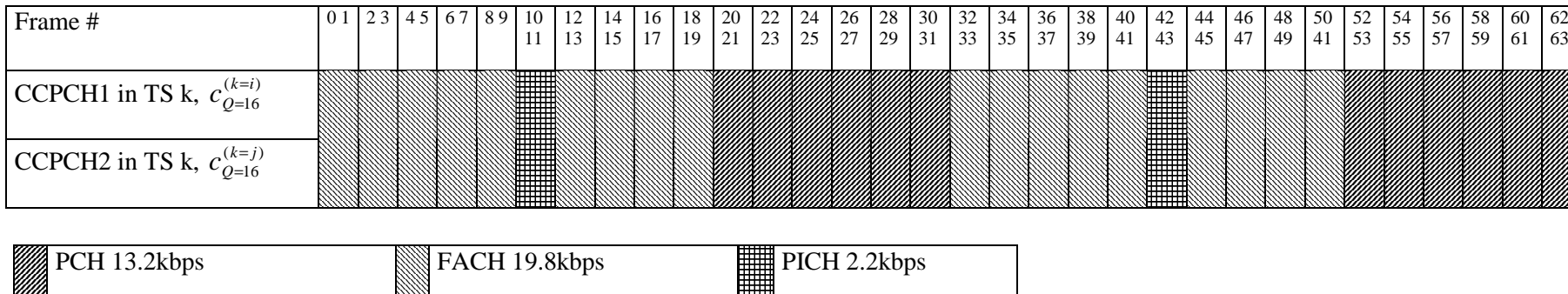

Figure F.2: Example for a multiframe structure for S-CCPCHs and PICH that is repeated every 64th frame, $i, j=1 \dots 16$ ($i \neq j$), $k \neq 0, 1$, (128 sub-frame)

Annex G (informative): Examples of the association of DL TPC commands to UL uplink time slots for 1.28 Mcps TDD

In the following two examples of the association of UL TPC commands to UL time slots and CCTrCHs are shown (see 6.2.2.2):

Table G.1 Two examples of the association of DL TPC commands to UL uplink time slots with NULslot=3

Case 1: $N_{UL_TPCsymbols}=2$; Case 2: $N_{UL_TPCsymbols}=4$

Sub-Frame Number	Case 1 (2 UL TPC symbols)		The order of the served UL time slot and CCTrCH pairs (UL time slot and CCTrCH number)	Case 2 (4 UL TPC symbols)	
	The order of UL TPC symbols			The order of UL TPC symbols	
SFN'=0	(1 st UL _{pos} =0)	0	0 (TS3)	0	(1 st UL _{pos} =0)
		1	1 (TS4)	1	
			2 (TS5)	2	
			0 (TS3)	3	
SFN'=1	(1 st UL _{pos} =2)	0	0 (TS3)	0	(1 st UL _{pos} =1)
		1	1 (TS4)	1	
			2 (TS5)	2	
			0 (TS3)	3	
SFN'=2	(1 st UL _{pos} =1)	0	0 (TS3)	0	(1 st UL _{pos} =2)
		1	1 (TS4)	1	
			2 (TS5)	2	
			0 (TS3)	3	
			1 (TS4)		
			2 (TS5)		
.
.
.

Annex H (informative): Examples of the association of DL SS commands to UL uplink time slots

In the following two examples of the association of DL SS commands to UL uplink time slots are shown (see 6.2.2.3):

Table H.1 Two examples of the association of DL SS commands to UL uplink time slots with $N_{ULslot}=3$

Case 1: $N_{SSsymbols}=2$; Case 2: $N_{SSsymbols}=4$

Sub-Frame Number	Case 1 (2 DL SS symbols)		The order of the served UL time slot (UL time slot number)	Case 2 (4 DL SS symbols)	
	The order of DL SS symbols			The order of DL SS symbols	
SFN'=0	(1 st $UL_{pos}=0$)	0	0 (TS3)	0	(1 st $UL_{pos}=0$)
		1	1 (TS4)	1	
			2 (TS5)	2	
			0 (TS3)	3	
SFN'=1	(1 st $UL_{pos}=2$)	0	0 (TS3)	0	(1 st $UL_{pos}=1$)
		1	1 (TS4)	1	
			2 (TS5)	2	
			0 (TS3)	3	
			1 (TS4)		
SFN'=2	(1 st $UL_{pos}=1$)	0	0 (TS3)	0	(1 st $UL_{pos}=2$)
		1	1 (TS4)	1	
			2 (TS5)	2	
			0 (TS3)	3	
			1 (TS4)		
			2 (TS5)		
.
.
.

Annex I (informative): Change history

Change history							
Date	TSG #	TSG Doc.	CR	Rev	Subject/Comment	Old	New
14/01/00	RAN_05	RP-99591	-		Approved at TSG RAN #5 and placed under Change Control	-	3.0.0
14/01/00	RAN_06	RP-99691	001	02	Primary and Secondary CCPCCH in TDD	3.0.0	3.1.0
14/01/00	RAN_06	RP-99691	002	02	Removal of Superframe for TDD	3.0.0	3.1.0
14/01/00	RAN_06	RP-99691	006	-	Corrections to TS25.221	3.0.0	3.1.0
14/01/00	RAN_06	RP-99691	007	1	Clarifications for Spreading in UTRA TDD	3.0.0	3.1.0
14/01/00	RAN_06	RP-99691	008	-	Transmission of TFCI bits for TDD	3.0.0	3.1.0
14/01/00	RAN_06	RP-99691	009	-	Midamble Allocation in UTRA TDD	3.0.0	3.1.0
14/01/00	RAN_06	RP-99690	010	-	Introduction of the timeslot formats to the TDD specifications	3.0.0	3.1.0
14/01/00	-	-	-	-	Change history was added by the editor	3.1.0	3.1.1
31/03/00	RAN_07	RP-000067	003	2	Cycling of cell parameters	3.1.1	3.2.0
31/03/00	RAN_07	RP-000067	011	-	Correction of Midamble Definition for TDD	3.1.1	3.2.0
31/03/00	RAN_07	RP-000067	012	-	Introduction of the timeslot formats for RACH to the TDD specifications	3.1.1	3.2.0
31/03/00	RAN_07	RP-000067	013	-	Paging Indicator Channel reference power	3.1.1	3.2.0
31/03/00	RAN_07	RP-000067	014	1	Removal of Synchronisation Case 3 in TDD	3.1.1	3.2.0
31/03/00	RAN_07	RP-000067	015	1	Signal Point Constellation	3.1.1	3.2.0
31/03/00	RAN_07	RP-000067	016	-	Association between Midambles and Channelisation Codes	3.1.1	3.2.0
31/03/00	RAN_07	RP-000067	017	-	Removal of ODMA from the TDD specifications	3.1.1	3.2.0
26/06/00	RAN_08	RP-000271	018	1	Removal of the reference to ODMA	3.2.0	3.3.0
26/06/00	RAN_08	RP-000271	019	-	Editorial changes in transport channels section	3.2.0	3.3.0
26/06/00	RAN_08	RP-000271	020	1	TPC transmission for TDD	3.2.0	3.3.0
26/06/00	RAN_08	RP-000271	021	-	Editorial modification of 25.221	3.2.0	3.3.0
26/06/00	RAN_08	RP-000271	023	-	Clarifications on TxDiversity for UTRA TDD	3.2.0	3.3.0
26/06/00	RAN_08	RP-000271	024	-	Clarifications on PCH and PICH in UTRA TDD	3.2.0	3.3.0
23/0900	RAN_09	RP-000344	022	1	Correction to midamble generation in UTRA TDD	3.3.0	3.4.0
23/0900	RAN_09	RP-000344	026	2	Some corrections for TS25.221	3.3.0	3.4.0
23/0900	RAN_09	RP-000344	028	-	Terminology regarding the beacon function	3.3.0	3.4.0
23/0900	RAN_09	RP-000344	030	1	TDD Access Bursts for HOV	3.3.0	3.4.0
23/0900	RAN_09	RP-000344	031	1	Number of codes signalling for the DL common midamble case	3.3.0	3.4.0
15/12/00	RAN_10	RP-000542	034	-	Correction on TFCI & TPC Transmission	3.4.0	3.5.0
15/12/00	RAN_10	RP-000542	035	1	Clarifications on Midamble Associations	3.4.0	3.5.0
15/12/00	RAN_10	RP-000542	036	-	Clarification on PICH power setting	3.4.0	3.5.0
16/03/01	RAN_11	-	-	-	Approved as Release 4 specification (v4.0.0) at TSG RAN #11	3.5.0	4.0.0
16/03/01	RAN_11	RP-010062	033	2	Correction to SCH section	3.5.0	4.0.0
16/03/01	RAN_11	RP-010062	037	1	Bit Scrambling for TDD	3.5.0	4.0.0
16/03/01	RAN_11	RP-010062	039	1	Corrections of PUSCH and PDSCH	3.5.0	4.0.0
16/03/01	RAN_11	RP-010062	040	-	Alteration of SCH offsets to avoid overlapping Midamble	3.5.0	4.0.0
16/03/01	RAN_11	RP-010062	041	-	Clarifications & Corrections for TS25.221	3.5.0	4.0.0
16/03/01	RAN_11	RP-010062	045	1	Corrections on the PRACH and clarifications on the midamble generation and the behaviour in case of an invalid TFI combination on the DCHs	3.5.0	4.0.0
16/03/01	RAN_11	RP-010062	046	-	Clarification of TFCI transmission	3.5.0	4.0.0
16/03/01	RAN_11	RP-010062	048	-	Corrections to Table 5.b "Timeslot formats for the Uplink"	3.5.0	4.0.0
16/03/01	RAN_11	RP-010073	042	2	Introduction of the Physical Node B Synchronization Channel	3.5.0	4.0.0
16/03/01	RAN_11	RP-010071	043	1	Inclusion of 1.28Mcps TDD in TS 25.221	3.5.0	4.0.0
16/03/01	RAN_11	RP-010072	044	-	Correction of beacon characteristics due to IPDLs	3.5.0	4.0.0
15/06/01	RAN_12	RP-010336	051	-	Clarification of Midamble Usage in TS25.221	4.0.0	4.1.0
15/06/01	RAN_12	RP-010336	053	-	Addition to the abbreviation list, correction of references to tables and figures	4.0.0	4.1.0
15/06/01	RAN_12	RP-010342	049	-	Correction of spelling in definition of beacon characteristics	4.0.0	4.1.0
15/06/01	RAN_12	RP-010342	055	-	Correction of Note for PDSCH signalling methods	4.0.0	4.1.0
21/09/01	RAN_13	RP-010522	057	-	TFCI Terminology	4.1.0	4.2.0
21/09/01	RAN_13	RP-010522	063	-	Clarification of notations in TS25.221 and TS25.223	4.1.0	4.2.0
21/09/01	RAN_13	RP-010522	062	-	Addition and correction of the reference	4.1.0	4.2.0
21/09/01	RAN_13	RP-010528	058	1	Corrections for TS 25.221	4.1.0	4.2.0
14/12/01	RAN_14	RP-010741	065	1	Transmit Diversity for P-CCPCH and PICH	4.2.0	4.3.0
14/12/01	RAN_14	RP-010741	067	-	Clarification of midamble transmit power in TS25.221	4.2.0	4.3.0
14/12/01	RAN_14	RP-010746	059	-	Bit Scrambling for 1.28 Mcps TDD	4.2.0	4.3.0
14/12/01	RAN_14	RP-010746	068	-	Transmit Diversity for P-CCPCH and PICH	4.2.0	4.3.0
14/12/01	RAN_14	RP-010746	069	-	Corrections of reference numbers in TS 25.221	4.2.0	4.3.0
08/03/02	RAN_15	RP-020049	071	2	Clarification of spreading for UL physical channels	4.3.0	4.4.0
08/03/02	RAN_15	RP-020049	073	1	Common midamble allocation for beacon time slot	4.3.0	4.4.0
08/03/02	RAN_15	RP-020049	075	3	Correction to a transmission of paging indicators bits	4.3.0	4.4.0

Change history							
Date	TSG #	TSG Doc.	CR	Rev	Subject/Comment	Old	New
08/03/02	RAN_15	RP-020058	076	1	CR to include HSDPA in TS25.221	4.3.0	5.0.0
07/06/02	RAN_16	RP-020434	080	2	Clarification of shared channel functionality for TDD	5.0.0	5.1.0
07/06/02	RAN_16	RP-020313	082	-	Clarification of shared channel functionality for TDD	5.0.0	5.1.0
07/06/02	RAN_16	RP-020317	081	-	TxDiversity for HSDPA in TDD	5.0.0	5.1.0

History

Document history		
V5.0.0	March 2002	Publication
V5.1.0	June 2002	Publication