

ETSI TS 125 305 V10.0.0 (2011-05)

Technical Specification

**Universal Mobile Telecommunications System (UMTS);
Stage 2 functional specification of User Equipment (UE)
positioning in UTRAN
(3GPP TS 25.305 version 10.0.0 Release 10)**



Reference

RTS/TSGR-0225305va00

Keywords

UMTS

ETSI

650 Route des Lucioles
F-06921 Sophia Antipolis Cedex - FRANCE

Tel.: +33 4 92 94 42 00 Fax: +33 4 93 65 47 16

Siret N° 348 623 562 00017 - NAF 742 C
Association à but non lucratif enregistrée à la
Sous-Préfecture de Grasse (06) N° 7803/88

Important notice

Individual copies of the present document can be downloaded from:

<http://www.etsi.org>

The present document may be made available in more than one electronic version or in print. In any case of existing or perceived difference in contents between such versions, the reference version is the Portable Document Format (PDF). In case of dispute, the reference shall be the printing on ETSI printers of the PDF version kept on a specific network drive within ETSI Secretariat.

Users of the present document should be aware that the document may be subject to revision or change of status. Information on the current status of this and other ETSI documents is available at

<http://portal.etsi.org/tb/status/status.asp>

If you find errors in the present document, please send your comment to one of the following services:

http://portal.etsi.org/chaicor/ETSI_support.asp

Copyright Notification

No part may be reproduced except as authorized by written permission.
The copyright and the foregoing restriction extend to reproduction in all media.

© European Telecommunications Standards Institute 2011.
All rights reserved.

DECT™, **PLUGTESTS™**, **UMTS™**, **TIPHON™**, the TIPHON logo and the ETSI logo are Trade Marks of ETSI registered for the benefit of its Members.

3GPP™ is a Trade Mark of ETSI registered for the benefit of its Members and of the 3GPP Organizational Partners.

LTE™ is a Trade Mark of ETSI currently being registered

for the benefit of its Members and of the 3GPP Organizational Partners.

GSM® and the GSM logo are Trade Marks registered and owned by the GSM Association.

Intellectual Property Rights

IPRs essential or potentially essential to the present document may have been declared to ETSI. The information pertaining to these essential IPRs, if any, is publicly available for **ETSI members and non-members**, and can be found in ETSI SR 000 314: *"Intellectual Property Rights (IPRs); Essential, or potentially Essential, IPRs notified to ETSI in respect of ETSI standards"*, which is available from the ETSI Secretariat. Latest updates are available on the ETSI Web server (<http://webapp.etsi.org/IPR/home.asp>).

Pursuant to the ETSI IPR Policy, no investigation, including IPR searches, has been carried out by ETSI. No guarantee can be given as to the existence of other IPRs not referenced in ETSI SR 000 314 (or the updates on the ETSI Web server) which are, or may be, or may become, essential to the present document.

Foreword

This Technical Specification (TS) has been produced by ETSI 3rd Generation Partnership Project (3GPP).

The present document may refer to technical specifications or reports using their 3GPP identities, UMTS identities or GSM identities. These should be interpreted as being references to the corresponding ETSI deliverables.

The cross reference between GSM, UMTS, 3GPP and ETSI identities can be found under <http://webapp.etsi.org/key/queryform.asp>.

Contents

| | |
|--|----|
| Intellectual Property Rights | 2 |
| Foreword..... | 2 |
| Foreword..... | 6 |
| 1 Scope | 7 |
| 2 References | 7 |
| 2.1 Normative references | 7 |
| 2.2 Informative references..... | 8 |
| 3 Definitions and abbreviations..... | 8 |
| 3.1 Definitions..... | 8 |
| 3.2 Abbreviations | 8 |
| 4 Main concepts and requirements..... | 10 |
| 4.1 Assumptions | 10 |
| 4.2 UE Positioning Methods | 11 |
| 4.3 Standard UE Positioning Methods | 11 |
| 4.3.1 Cell ID and Enhanced Cell ID Based Methods..... | 11 |
| 4.3.2 OTDOA-IPDL Method with network configurable idle periods..... | 12 |
| 4.3.3 Network-assisted GNSS Methods..... | 12 |
| 4.3.4 U-TDOA Method..... | 12 |
| 5 UTRAN UE Positioning Architecture..... | 12 |
| 5.1 UE Positioning Operations | 13 |
| 5.1.1 Co-ordination, Measurement and Calculation Functions..... | 14 |
| 5.2 Functional Description of UTRAN UE Positioning related elements..... | 14 |
| 5.2.1 Radio Network Controller (RNC)..... | 14 |
| 5.2.1.1 Serving RNC..... | 14 |
| 5.2.1.1.1 RNC Centric Mode..... | 15 |
| 5.2.1.1.2 SAS Centric Mode..... | 15 |
| 5.2.1.2 Other RNC | 16 |
| 5.2.1.2.1 Controlling RNC | 16 |
| 5.2.1.2.2 Drift RNC..... | 16 |
| 5.2.2 Node B..... | 17 |
| 5.2.3 Location measurement unit (LMU) | 17 |
| 5.2.4 User Equipment (UE) | 18 |
| 5.2.5 Stand-alone SMLC | 18 |
| 6 Signalling protocols and interfaces | 19 |
| 6.1 LCS signalling between SRNC and MSC/SGSN..... | 19 |
| 6.2 SRNC signalling to a target UE..... | 19 |
| 6.3 Controlling RNC signalling to a standalone LMU | 19 |
| 6.4 Controlling RNC signalling to an associated LMU..... | 19 |
| 6.5 RNC-to-RNC signalling for UE Positioning support..... | 19 |
| 6.5a SAS to RNC signalling for PCAP..... | 19 |
| 6.6 Interfaces | 19 |
| 6.6.1 Iu Interface..... | 20 |
| 6.6.2 Iur Interface | 20 |
| 6.6.2.1 Signalling between SRNC and DRNC..... | 20 |
| 6.6.2.2 Signalling between SRNC and CRNC | 20 |
| 6.6.3 Iub Interface..... | 20 |
| 6.6.3.1 Signalling between CRNC and associated LMU | 21 |
| 6.6.4 Uu Interface | 21 |
| 6.6.4.1 Signalling between SRNC and Target UE | 21 |
| 6.6.4.1.1 Assistance Data Delivery to UE | 22 |
| 6.6.4.1.2 Error Handling..... | 23 |
| 6.6.4.1.3 Broadcast of Assistance Data | 23 |

| | | |
|-----------|--|----|
| 6.6.4.1.4 | Signalling Flow for Assistance Data Broadcast Using the Common UTRAN Broadcast Service | 23 |
| 6.6.4.1.5 | UE Positioning Assistance Data Ciphering | 23 |
| 6.6.4.1.6 | UE Positioning Assistance Data Ciphering Algorithm..... | 23 |
| 6.6.4.2 | Signalling between RNC and stand-alone LMU | 24 |
| 6.6.5 | Iupc Interface | 25 |
| 6.6.5.1 | Signalling between RNC and SAS..... | 25 |
| 6.6.5.1.1 | PCAP Position Calculation..... | 25 |
| 6.6.5.1.2 | PCAP Information Exchange | 26 |
| 6.6.5.1.3 | PCAP for SAS based Positioning Method Selection..... | 27 |
| 7 | General UTRAN UE Positioning procedures..... | 28 |
| 7.1 | General procedures in UTRAN for UE Positioning..... | 28 |
| 7.2 | Common procedures supporting UE Positioning interaction between RNCs | 29 |
| 7.2.1 | Signalling in case of SRNS relocation..... | 29 |
| 7.3 | Exception procedures | 29 |
| 7.3.1 | Procedures in the SRNC | 29 |
| 7.3.1.1 | RNC Centric Mode | 29 |
| 7.3.1.2 | SAS Centric Mode | 30 |
| 7.3.2 | Procedures in a LMU..... | 31 |
| 7.3.3 | Procedures in the target UE | 31 |
| 7.3.4 | Procedures in the SAS | 31 |
| 7.3.4.1 | RNC Centric Mode | 31 |
| 7.3.4.2 | SAS Centric Mode | 31 |
| 7.4 | Radio interface timing procedures..... | 32 |
| 7.4.1 | LMU Functions..... | 32 |
| 7.4.2 | CRNC Functions..... | 32 |
| 7.4.3 | LMU-CRNC Interactions | 32 |
| 8 | Cell ID and Enhanced Cell ID based positioning methods | 33 |
| 8.1 | Cell ID determination..... | 36 |
| 8.1.1 | UE Cell ID is not known..... | 36 |
| 8.1.2 | UE Cell ID is known..... | 36 |
| 8.1.2.1 | UE not in Soft handover..... | 36 |
| 8.1.2.2 | UE in Soft handover..... | 36 |
| 8.2 | Mapping the Cell ID to Geographic Co-ordinates or a Service Area..... | 37 |
| 8.3 | Enhanced Cell ID Methods | 37 |
| 8.3.1 | Cell-ID with RTT | 38 |
| 8.3.2 | Cell-ID with Pathloss and Related Measurements..... | 38 |
| 8.3.2.1 | RF Pattern Matching (RFPM)..... | 38 |
| 8.3.3 | Cell-ID with Angle of Arrival..... | 38 |
| 9 | OTDOA positioning method | 38 |
| 9.1 | Use of Idle Periods | 40 |
| 9.2 | Relative Time Difference (RTD)..... | 40 |
| 9.3 | Time of Day (ToD)..... | 41 |
| 9.4 | Node B Synchronisation..... | 41 |
| 9.5 | OTDOA-IPDL and OTDOA Modes | 41 |
| 9.5.1 | Information to be transferred between UTRAN elements | 41 |
| 9.6 | OTDOA network positioning procedures..... | 43 |
| 9.6.1 | RNC based selection of OTDOA..... | 43 |
| 9.6.2 | SAS based selection of OTDOA..... | 45 |
| 10 | Network-assisted GPS positioning method..... | 48 |
| 10.1 | Timing calibration | 49 |
| 10.2 | Timing assistance | 49 |
| 10.3 | GPS assistance data | 49 |
| 10.4 | UE search | 50 |
| 10.5 | Position determination..... | 50 |
| 10.5.1 | Information to be transferred between UTRAN elements | 50 |
| 10.5.1.1 | Almanac data..... | 51 |
| 10.5.1.2 | DGPS corrections..... | 52 |
| 10.5.1.3 | Ionospheric corrections | 52 |

| | | |
|-------------------------------|---|-----------|
| 10.5.1.4 | Ephemeris data and clock correction | 52 |
| 10.5.1.5 | Real Time integrity monitor function..... | 52 |
| 10.5.1.6 | GPS reference time | 53 |
| 10.5.1.7 | UTC..... | 53 |
| 10.5.1.8 | Reference Location | 53 |
| 10.5.1.9 | Additional non-GPS related information | 53 |
| 10.6 | RNC based Network Assisted GPS positioning Procedure..... | 54 |
| 10.7 | SAS initiated Network Assisted GPS positioning Procedure..... | 55 |
| 11 | Information storage | 57 |
| 12 | Uplink-Time Difference Of Arrival (U-TDOA) positioning method | 57 |
| 12.1 | General | 57 |
| 12.2 | U-TDOA SAS architecture..... | 60 |
| 12.3 | RNC based U-TDOA positioning for Cell_DCH and Cell_FACH RRC states | 60 |
| 12.3.1 | UE in CELL_DCH state | 60 |
| 12.3.2 | UE in CELL_FACH state | 61 |
| 12.4 | Optional SAS initiated U-TDOA positioning for Cell_DCH and Cell_FACH RRC states | 63 |
| 12.4.1 | UE in CELL_DCH state | 63 |
| 12.4.1.1 | Message Flow | 63 |
| 12.4.2 | UE in CELL_FACH state | 65 |
| 12.4.2.1 | Message flow | 65 |
| 13 | Network-assisted GNSS positioning method | 67 |
| 13.1 | Network-assisted GPS positioning method..... | 68 |
| 13.2 | Network-assisted Galileo positioning method..... | 68 |
| 13.3 | Network-assisted GLONASS positioning method | 68 |
| 13.4 | Network-assisted Satellite Based Augmentation Systems (SBAS)..... | 68 |
| 13.5 | Network-assisted Quasi-Zenith Satellite System (QZSS) | 68 |
| Annex A (informative): | Definitions and Terms | 69 |
| Annex B (informative): | Reference Model of Functional Entities for UTRAN UE Positioning..... | 71 |
| B.1 | Internal Client Group..... | 73 |
| B.1.1 | Internal UTRAN Location Client Function (U-LCF) | 73 |
| B.2 | UTRAN System Handling group | 73 |
| B.2.1 | UTRAN Location System Control Function (U-LSCF) | 73 |
| B.2.2 | UTRAN Location System Operations Function (U-LSOF)..... | 74 |
| B.2.3 | UTRAN Location Information Relay Function (U-LIRF)..... | 74 |
| B.2.4 | UTRAN Location System Control Function in SAS (U-LSCFS)..... | 74 |
| B.2.5 | UTRAN Location System Assistance Data Function (U-LSADF)..... | 75 |
| B.3 | Positioning group | 75 |
| B.3.1 | UTRAN Position Radio Co-ordination Function (U-PRCF) | 75 |
| B.3.2 | UTRAN Position Calculation Function (U-PCF) | 75 |
| B.3.3 | UTRAN Position Signal Measurement Function (U-PSMF)..... | 75 |
| B.3.4 | UTRAN Position Radio Resource Management (U-PRRM)..... | 76 |
| B.3.5 | UTRAN Position Related Communication Function (U-PRComF) | 76 |
| B.4 | Assignment of LCS Functional Entities to UTRAN Elements..... | 76 |
| Annex C (informative): | Location Services Categories | 78 |
| Annex D (informative): | Change history | 79 |
| History | | 81 |

Foreword

This Technical Specification (TS) has been produced by the 3rd Generation Partnership Project (3GPP).

The contents of the present document are subject to continuing work within the TSG and may change following formal TSG approval. Should the TSG modify the contents of the present document, it will be re-released by the TSG with an identifying change of release date and an increase in version number as follows:

Version x.y.z

where:

- x the first digit:
 - 1 presented to TSG for information;
 - 2 presented to TSG for approval;
 - 3 or greater indicates TSG approved document under change control.
- y the second digit is incremented for all changes of substance, i.e. technical enhancements, corrections, updates, etc.
- z the third digit is incremented when editorial only changes have been incorporated in the document.

1 Scope

The present document specifies the stage 2 of the UE Positioning function of UTRAN, which provides the mechanisms to support the calculation of the geographical position of a UE. UE position knowledge can be used for example in support of Radio Resource Management functions, location-based services for operators, subscribers and third party service providers. The purpose of this stage 2 specification is to define the UTRAN UE Positioning architecture, functional entities and operations to support positioning methods. This description is confined to the UTRAN Access Stratum. It does not define nor describe how the results of the UE position calculation can be utilised in the Core Network (e.g. LCS) or in UTRAN (e.g. RRM).

UE Positioning may be considered as a network provided enabling technology consisting of standardised service capabilities, which enable the provision of location applications. The application(s) may be service provider specific. The description of the numerous and varied possible location applications which are enabled by this technology are outside the scope of the present document. However, clarifying examples of how the functionality being described may be used to provide specific location services may be included.

This stage 2 specification covers the UTRAN positioning methods, state descriptions, and message flows to support UE Positioning.

2 References

The following documents contain provisions which, through reference in this text, constitute provisions of the present document.

- References are either specific (identified by date of publication, edition number, version number, etc.) or non-specific.
- For a specific reference, subsequent revisions do not apply.
- For a non-specific reference, the latest version applies. In the case of a reference to a 3GPP document (including a GSM document), a non-specific reference implicitly refers to the latest version of that document *in the same Release as the present document*.

2.1 Normative references

- [1] Void.
- [2] 3GPP TR 21.905: "Vocabulary for 3GPP Specifications".
- [3] Void.
- [4] 3GPP TS 23.271: "Location Services (LCS); (Functional description) - Stage 2".
- [5] 3GPP TS 22.071: "Location Services (LCS); Service description, Stage 1".
- [6] 3GPP TS 22.100: "UMTS phase 1".
- [7] 3GPP TS 22.101: "Services aspects; Service principles".
- [8] 3GPP TS 22.105: "Services and Service Capabilities".
- [9] 3GPP TS 22.115: "Services aspects; Charging and Billing".
- [10] 3GPP TS 22.121: "Services aspects; The Virtual Home Environment; Stage 1".
- [11] 3GPP TS 23.032: "Universal Geographical Area Description (GAD)".
- [12] 3GPP TS 23.110: "UMTS Access Stratum; Services and Functions".
- [13] 3GPP TS 23.171: "Functional stage 2 description of location services in UMTS".

- [14] 3GPP TS 25.214: "Physical layer procedures (FDD)"
- [15] 3GPP TS 25.215: "Physical layer – Measurements (FDD)".
- [16] 3GPP TS 25.225: "Physical layer – Measurements (TDD)".
- [17] 3GPP TS 25.306: "UE Radio Access Capabilities".
- [18] 3GPP TS 25.331: "Radio Resource Control (RRC); protocol specification".
- [19] 3GPP TS 25.413: "UTRAN Iu interface RANAP signalling".
- [20] 3GPP TS 25.423: "UTRAN Iur interface RNSAP signalling".
- [21] 3GPP TS 25.430: "UTRAN Iub interface: General aspects and Principles".
- [22] 3GPP TS 25.433: "UTRAN Iub interface NBAP signalling".
- [23] ICD-GPS-200: "Navstar GPS Space Segment/Navigation User Interfaces".
- [24] RTCM-SC104: "RTCM Recommended Standards for Differential GNSS Service" (v.2.2.)
- [25] 3GPP TS 24.008: "Mobile radio interface layer 3 specification, Core Network Protocols - Stage 3".
- [26] 3GPP TS 25.224: "Physical layer procedures (TDD)".
- [27] 3GPP TS 25.453: "UTRAN Iupc interface PCAP signalling".
- [28] 3GPP TS 25.412: "Iu interface signalling transport".

2.2 Informative references

- [29] Third generation (3G) mobile communication system; Technical study report on the location services and technologies, ARIB ST9 December 1998.
- [30] The North American Interest Group of the GSM MoU ASSOCIATION: Location Based Services, Service Requirements Document of the Services Working Group.

3 Definitions and abbreviations

3.1 Definitions

For the purposes of the present document, the terms and definitions given in [7] and some of the terms and definitions in annex A apply.

3.2 Abbreviations

For the purposes of the present document, the following abbreviations apply.

| | |
|---------|--|
| 3G-MSC | 3 rd Generation MSC |
| 3G-SGSN | 3 rd Generation SGSN |
| A-GNSS | Assisted Global Navigation Satellite System |
| A-GPS | Assisted Global Positioning Systems |
| ARIB | Association of Radio Industries and Business |
| CAMEL | Customised Application For Mobile Network Enhanced Logic |
| CN | Core Network |
| CRNC | Controlling RNC |
| DGNSS | Differential Global Navigation Satellite System |
| DGPS | Differential Global Positioning Systems |
| DL | Downlink |

| | |
|---------|--|
| DRNC | Drift RNC |
| EGNOS | European Geostationary Navigation Overlay Service |
| GAGAN | GPS Aided Geo Augmented Navigation |
| GLONASS | GLObal'naya NAVigatsionnaya Sputnikovaya Sistema (Engl.: Global Navigation Satellite System) |
| GMLC | Gateway MLC |
| GNSS | Global Navigation Satellite System |
| GPRS | General Packet Radio System |
| GPS | Global Positioning System |
| HLR | Home Location Register |
| IPDL | Idle Period Downlink |
| LBS | Location Based Services |
| LCCF | Location Client Control Function |
| LCF | Location Client Function |
| LCS | LoCation Services |
| LIRF | Location Information Relay Function |
| LMU | Location Measurement Unit |
| LSADF | Location System Assistance Data Function |
| LSCF | Location System Control Function |
| LSCFS | Location System Control Function in SAS |
| LSOF | Location System Operation Function |
| MLC | Mobile Location Centre |
| MSAS | Multi-functional Satellite Augmentation System |
| MSC | Mobile services Switching Centre |
| NAS | Non Access Stratum |
| OTDOA | Observed Time Difference Of Arrival |
| PCAP | Positioning Calculation Application Part |
| PCF | Position Calculation Function |
| PLMN | Public Land Mobile Network |
| PRCF | Positioning Radio Co-ordination Function |
| PRComF | Positioning Radio Communication Function |
| PRRM | Positioning Radio Resource Management |
| PSMF | Positioning Signal Measurement Function |
| QoS | Quality of Service |
| QZSS | Quasi-Zenith Satellite System |
| RAN | Radio Access Network |
| RANAP | Radio Access Network Application Part |
| RNC | Radio Network Controller |
| RRM | Radio Resource Management |
| RTD | Real Time Difference |
| RTT | Round Trip Time |
| SAI | Service Area Identifier |
| SAS | Stand-Alone SMLC |
| SBAS | Satellite Based Augmentation System |
| SGSN | Serving GPRS Support Node |
| SIM | Subscriber Identity Module |
| SMS | Short Message Service |
| SRNC | Serving RNC |
| SSDT | Site Selection Diversity Transmit |
| TOA | Time Of Arrival |
| TOW | Time Of Week |
| U-..... | UMTS-(LCS functional block) |
| UE | User Equipment |
| UL | Uplink |
| UMTS | Universal Mobile Telecommunication System |
| USIM | User Service Identity Module |
| UTC | Universal Time Coordinates |
| U-TDOA | Uplink – Time Difference Of Arrival |
| UTRAN | Universal Terrestrial Radio Access Network |
| WAAS | Wide Area Augmentation System |
| WCDMA | Wideband Code Division Multiple Access |

4 Main concepts and requirements

The stage 1 LCS description providing an overall service description and the core requirements for the LCS at the service level is given in [5]. The stage 2 LCS description providing a system functional model for the whole system, the LCS system architecture, state descriptions and message flows are described in [13].

By measuring radio signals the capability to determine the geographic position and velocity of the UE shall be provided. The position information may be requested by and reported to a client (application) associated with the UE, or by a client within or attached to the CN. The position information may also be utilised internally by UTRAN, for example, for location-assisted handover or to support other features such as home location billing. The position information shall be reported in standard formats, such as those for cell based or geographical co-ordinates, together with the estimated errors (uncertainty) of the position and velocity of the UE and, if available, the positioning method (or the list of the methods) used to obtain the position estimate. Restrictions on the geographic shape encoded within the 'position information' parameter may exist for certain LCS client types. The SRNC shall comply with any shape restrictions defined in GSM/UMTS and, in a particular country, with any shape restrictions defined for a specific LCS client type in relevant national standards. For example, in the US, national interim standard TIA/EIA/IS-J-STD-036 restricts the geographic shape for an emergency services LCS client to minimally either an "ellipsoid point" or an "ellipsoid point with uncertainty circle and confidence" as defined in [11].

It shall be possible for the majority of the UE (active or inactive) within a network to use the feature without compromising the radio transmission or signalling capabilities of the UTRAN.

The uncertainty of the position measurement shall be network implementation dependent at the choice of the network operator. The uncertainty may vary between networks as well as from one area within a network to another. The uncertainty may be hundreds of metres in some areas and only a few metres in others. In the event that the position measurement is also a UE-assisted process, the uncertainty may also depend on the capabilities of the UE. In some jurisdictions, there is a regulatory requirement for location service accuracy that is part of an emergency service. Further details of the accuracy requirements can be found in [5].

The uncertainty of the position information is dependent on the method used, the position of the UE within the coverage area and the activity of the UE. Several design options of the UTRAN system (e.g. size of cell, adaptive antenna technique, path loss estimation, timing accuracy, Node B surveys) shall allow the network operator to choose a suitable and cost effective UE Positioning method for their market.

There are many different possible uses for the positioning information. The positioning functions may be used internally by the UTRAN, by value-added network services, by the UE itself or through the network, and by "third party" services. The feature may also be used by an emergency service (which may be mandated or "value-added"), but the location service is not exclusively for emergencies.

The UTRAN is a new radio system design without a pre-existing deployment of UE operating according to the radio interface. This freedom from legacy equipment enables the location service feature design to make use of appropriate techniques to provide the most accurate results. The technique must also be a cost-effective total solution, must allow evolution to meet evolving service requirements and be able to take advantage of advances in technology over the lifetime of UTRAN deployments.

4.1 Assumptions

As a basis for the operation of UE Positioning in UTRAN the following assumptions apply:

- both TDD and FDD will be supported;
- the provision of the UE Positioning function in UTRAN is optional through support of the specified method(s) in Node B, the SAS, and the RNC;
- UE Positioning is applicable to any target UE whether or not the UE supports LCS, but with restrictions on use of certain positioning method depending on UE capability as defined in [17];
- The SMLC may be either a stand-alone network element (SAS) or an internal function of the RNC;
- UE Positioning information is transported between RNCs via the Iur interface independent of whether the SMLC is a stand-alone network element (SAS) or an internal function of the RNC;

- the positioning information may be used for internal system operations to improve system performance;
- different types of LMU are defined, e.g. a standalone LMU and/or LMU integrated in Node B;
- the UE Positioning architecture and functions shall include the option to accommodate several techniques of measurement and processing to ensure evolution to follow changing service requirements and to take advantage of advancing technology;
- the RNC manages the overall coordination and scheduling of resources required to perform positioning of a UE. It may also calculate the final position and velocity estimate and accuracy.

4.2 UE Positioning Methods

The UTRAN may utilise one or more positioning methods in order to determine the position of an UE.

Positioning the UE involves two main steps:

- signal measurements; and
- Position estimate and optional velocity computation based on the measurements.

The signal measurements may be made by the UE, the Node B or an LMU. The basic signals measured are typically the UTRA radio transmissions, however, some methods may make use of other transmissions such as general radio navigation signals.

The positioning function should not be limited to a single method or measurement. That is, it should be capable of utilising other standard methods and measurements, as are available and appropriate, to meet the required service needs of the location service client. This additional information could consist of readily available UTRAN measurements such as RTT in FDD or Rx Timing deviation measurement and knowledge of the UE timing advance, in TDD.

The position estimate computation may be made by the UE or by the UTRAN (i.e. SRNC or SAS).

4.3 Standard UE Positioning Methods

The standard positioning methods supported within UTRAN are:

- cell ID based method;
- OTDOA method that may be assisted by network configurable idle periods;
- network-assisted GNSS methods;
- U-TDOA.

4.3.1 Cell ID and Enhanced Cell ID Based Methods

In the cell ID based (i.e. cell coverage) method, the position of an UE is estimated with the knowledge of its serving Node B. The information about the serving Node B and cell may be obtained by paging, locating area update, cell update, URA update, or routing area update.

The cell coverage based positioning information can be indicated as the Cell Identity of the used cell, the Service Area Identity or as the geographical co-ordinates of a position related to the serving cell. The position information shall include a QoS estimate (e.g. regarding achieved accuracy) and, if available, the positioning method (or the list of the methods) used to obtain the position estimate.

When geographical co-ordinates are used as the position information, the estimated position of the UE can be a fixed geographical position within the serving cell (e.g. position of the serving Node B), the geographical centre of the serving cell coverage area, or some other fixed position within the cell coverage area. Enhanced Cell ID methods use additional UE and/or UTRAN radio resource related measurements.

The operation of the cell ID and Enhanced Cell ID based positioning methods are described in clause 8.

4.3.2 OTDOA-IPDL Method with network configurable idle periods

The OTDOA-IPDL method involves measurements made by the UE and LMU of the UTRAN frame timing (e.g. SFN-SFN observed time difference). These measures are then sent to the SRNC and, in networks which include an SAS, may be forwarded to the SAS. Depending on the configuration of the network, the position of the UE is calculated in the SRNC or in the SAS.

The simplest case of OTDOA-IPDL is without idle periods. In this case the method can be referred to as simply OTDOA.

The Node B may provide idle periods in the downlink, in order to potentially improve the hearability of neighbouring Node Bs. The support of these idle periods in the UE is optional. Support of idle periods in the UE means that its OTDOA performance will improve when idle periods are available.

Alternatively, the UE may perform the calculation of the position using measurements and assistance data.

The detailed description of the OTDOA-IPDL positioning method and its operation are described in clause 9.

4.3.3 Network-assisted GNSS Methods

These methods make use of UEs, which are equipped with radio receivers capable of receiving GNSS signals.

Examples of GNSS include GPS, Modernized GPS, Galileo, GLONASS, Satellite Based Augmentation Systems (SBAS), and Quasi Zenith Satellite System (QZSS).

In this concept, different GNSS (e.g. GPS, Galileo, etc.) can be used separately or in combination to perform the location of a UE.

The operation of the network-assisted GNSS methods is described in clause 13.

4.3.4 U-TDOA Method

The U-TDOA positioning method is based on network measurements of the Time Of Arrival (TOA) of a known signal sent from the UE and received at four or more LMUs. The method requires LMUs in the geographic vicinity of the UE to be positioned to accurately measure the TOA of the bursts. Since the geographical coordinates of the measurement units are known, the UE position can be calculated via hyperbolic trilateration. This method will work with existing UE without any modification.

The operation of the U-TDOA location method is described in clause 12.

5 UTRAN UE Positioning Architecture

Figure 5.1 shows the general arrangement of the UE positioning feature in UTRAN. Communication among the UTRAN UE Positioning entities makes use of the messaging and signalling capabilities of the UTRAN interfaces (Iub, Iur, Iupc).

The SRNC, receives authenticated requests for UE positioning information from the CN across the Iu interface. RNCs manage the UTRAN resources (including Node Bs, LMUs, the SAS) the UE and calculation functions, to estimate the position of the UE and return the result to the CN. SRNC may also make use of the UE Positioning function for internal purpose e.g. position based handover.

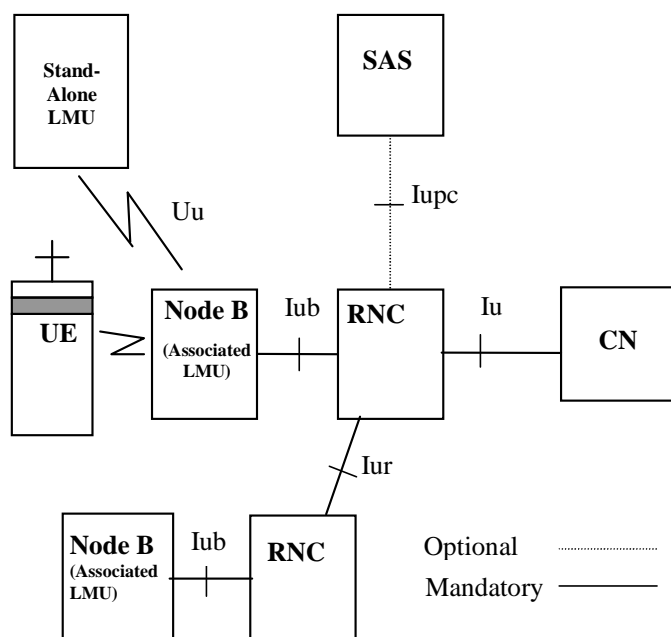

Figure 5.1: General arrangement of UE Positioning in UTRAN

5.1 UE Positioning Operations

The schematic functional description of LCS operations in UMTS is defined in [13].

Upon request from the Core Network or for internal operations, a UTRAN UE Positioning function should:

- request measurements, typically from the UE and one or more Node B;
- send the measurement results to the appropriate calculating function within UTRAN;
- receive the result from the calculating function within UTRAN;
- perform any needed co-ordinate transformations;
- send the results to the LCS entities in the CN or to application entities within UTRAN (this function applies to the RNC only).

In the event that the client is internal to UTRAN the request may be made directly to the UTRAN UE Positioning entities as the internal clients are considered to be "pre-authorized".

As part of its operation, the UTRAN UE Positioning calculating function may require additional information. This may be obtained by the function directly by communication with a database, or it may be through a request to UTRAN UE Positioning entities that will mediate the request and return of information from the appropriate database (or databases if more than one is needed to fulfil the requests).

There may possibly also be available independent information that is able to supply the positioning information directly, or may be able to supply auxiliary information to the calculation function. The UTRAN UE Positioning co-ordination function, as part of its activity to supervise the positioning process, may query the UE or other elements of the UTRAN to determine their capabilities and use this information to select the mode of operation.

This general operation is outlined in the following (generic) sequence diagram figure 5.2. This figure is not intended to show the complete UE Positioning operation for UTRAN, but to simply to outline the basis for operation.

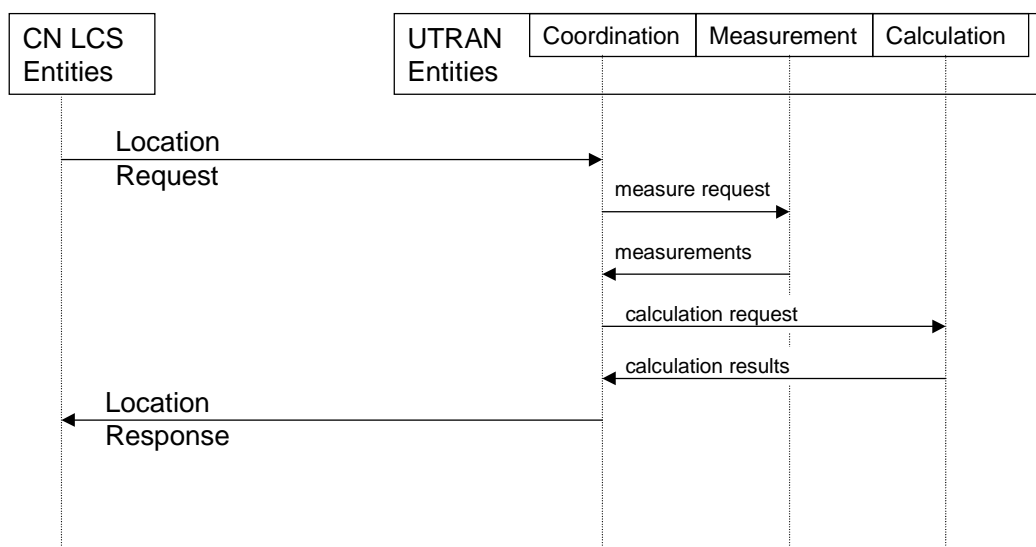

Figure 5.2: General sequence for UE Positioning operation

5.1.1 Co-ordination, Measurement and Calculation Functions

The UTRAN functions for UE Positioning provide the co-ordination, measurement and calculation functions needed to provide a position and optional velocity estimate. The functions interface with the requesting application and select the appropriate positioning method and speed of response. The functions co-ordinate the operations of the radio and measurement equipment to transmit the needed signals and to make the needed measurements. The measurements may be made by the Node Bs, or by the LMU. The LMU may be associated with the Node B, independently located or remote (i.e. communicating over the Uu interface).

The functions may also access databases or other sources of information appropriate for the positioning method. The functions also provide the calculation functions appropriate for the positioning method to estimate the UE position and the accuracy of the report. The functions may also make co-ordinates translations to the geographic co-ordinates system requested by the application. The functions also may record information on the usage of the UE Positioning that may be used for administrative purposes (e.g. forwarded to a billing function in the CN). If needed by the positioning method, the functions will ensure the broadcast of information and gather and update information concerning UTRAN operating parameters (e.g. timing of Node B transmissions) needed for UE Positioning operations.

These entities are mainly concerned with the positioning method, controlling the radio equipment and performing the calculations to determine the position and thus may be associated with the RNC in the UTRAN. These functions may receive location requests from either the CN or from applications internal to the UTRAN.

The UTRAN UE Positioning entities may also request the subscription and authorisation functions in the CN to authenticate an application or a UE subscription or to verify the subscriber privacy parameters.

The RNC functions communicate with the CN across the Iu interface, with other RNC entities across the Iur interface and with the Node B and LMU across the Iub interface, with the SAS across the Iupc interface, and with the UE and the remote LMU across the Uu interface.

5.2 Functional Description of UTRAN UE Positioning related elements

5.2.1 Radio Network Controller (RNC)

5.2.1.1 Serving RNC

The SRNC is a network element of UTRAN and contains functionality required to support LCS in one PLMN. The SRNC can work either in the RNC centric mode or in a SAS centric mode where the SAS has control over the positioning procedures.

5.2.1.1.1 RNC Centric Mode

In RNC centric mode the SRNC provides the following functionality:

- request of information from other RNC:
The SRNC may request information regarding UE Positioning from other RNCs;
- flow control of positioning requests:
If several simultaneous positioning requests are present within one SRNC, the SRNC co-ordinates the positioning requests taking into account priority of the requests (e.g. for Emergency Clients);
- positioning method selection:
The positioning method selection is based on the location request, QoS, capabilities of UE Positioning elements and UE positioning capabilities;
- position calculation:
The SRNC may calculate the position of a UE and may also support conversion of the position estimate between different geographic reference systems. In case RNC estimates the UE position, it is also responsible to estimate the accuracy of the position estimate. This accuracy estimate should include, for example, the effect of geometric dilution of precision (GDOP), the capabilities of the signal measuring hardware, the effects of multipath propagation and the effects of timing and synchronisation unknowns. The accuracy should be returned as a measure of distance in the same units as the position estimate. The accuracy zone may be reported as the axis and orientation of an ellipse surrounding the position estimate. If available, the positioning method (or the list of the methods) used to obtain the position estimate may also be returned to the CN with the position information. If the CN has requested an accuracy for the position estimate, the Location response shall include an indication whether the position estimate satisfies the requested accuracy or not.
- provide UE Positioning assistance data:
The SRNC may provide assistance data in the support of the various positioning methods;
- Overall UE Positioning coordination and control:
If both an SAS and an SRNC with SMLC internal functionality are available, the SRNC is responsible for the overall coordination and control of UE Positioning. For example, although the SAS has a position calculation function, the SRNC may also have a position calculation function. The SRNC is responsible for managing the co-ordination and control of these multiple resources.

The SRNC, of course, also provides CRNC functionality regarding UE Positioning for its associated Node Bs and LMUs.

5.2.1.1.2 SAS Centric Mode

In SAS centric mode the SRNC provides the following functionality:

- Forwarding of location requests to the SAS:
The SRNC forwards incoming location requests to the SAS and provides further information like UE capabilities and UE Cell ID to guide the positioning method selection in the SAS
- Forwarding of UE positioning assistance data and measurement instructions
Upon request from the SAS, the SRNC forwards assistance data and/or measurement instructions from the SAS to the UE in support of the various positioning methods.
- Delivery of positioning information
Upon request from the SAS the SRNC gathers location related information from the NodeBs and the UE and sends this information back to the SAS.
- Forwarding of positioning estimates
The SRNC forwards the positioning result received from the SAS to the requesting CN entity.

5.2.1.2 Other RNC

5.2.1.2.1 Controlling RNC

The CRNC provides the following functionality:

- resources management:
When allocating resources the CRNC determines which UTRAN elements are involved and what to measure. The RNC is also responsible for managing the effect of UE Positioning operations on the overall performance of the radio network by:
 - controlling the variation of the UL and DL signal power level due to UE Positioning;
 - calculating the DL and UL power/interference due to UE Positioning;
 - to admit/reject the new positioning requests;
 - co-operating with Admission Control, and entities of the RRM (such as power control) to provide the system stability in terms of radio resources;
 - controlling the IPDL mechanism for OTDOA measurements. This may include the overall control of the periodical measurement fulfilment. Co-ordination among RNCs (e.g. to assure non-overlapping idle periods) will be communicated through the Iur interface.
- broadcast of system information:
The CRNC broadcasts information in support of the selected positioning method. This broadcast information may be specially coded (i.e. encrypted) to ensure its availability only to subscribers of the service. For the case where there exists an SAS, the broadcast data is generated within the CRNC and/or, depending on the positioning method, may also be generated in the SAS which then forwards it to the CRNC over the Iupc interface for eventual broadcast over the Uu interface.

The information to be broadcast could include, for example:

- identification and spreading codes of the neighbouring cells (the channels that are used for measurements);
- Relative Time Difference (RTD), i.e. the timing offsets, asynchronicity between base stations, could be based on measurement results obtained by LMUs;
- roundtrip delay estimates in connected mode;
- the geographic position co-ordinates of the neighbouring Node B;
- the idle period places within the frame structure for multiple cells;
- the local time-of-day;
- reference time, reference position, DGNSS corrections, ephemeris and clock data, and almanac data.
- request UE Positioning related measurements from its associated Node Bs and LMUs:
The measurements requested by CRNC from its associated Node Bs and LMUs is dependant on the positioning method used. The following measurement returned by a LMU to a CRNC has a general status and may be used for more than one positioning method:
 - radio interface timing information.

Signalling between Node B or LMU and CRNC is transferred using Iub signalling.

5.2.1.2.2 Drift RNC

The DRNC is a UTRAN element that has an active link to the UE that shall be located. The DRNC, of course, also provides CRNC functionality regarding UE Positioning for its associated Node Bs and LMUs.

5.2.2 Node B

Node B is a network element of UTRAN that may provide measurement results for position estimation and makes measurements of radio signals and communicates these measurements to the CRNC.

The Node B may make its measurements in response to requests (e.g. from the CRNC), or it may autonomously measure and report regularly or when there are significant changes in radio conditions (e.g. changes in the UTRAN GPS timing of cell frames or SFN-SFN Observed Time Difference).

5.2.3 Location measurement unit (LMU)

Location Measurement Units (LMU) are associated with either the CRNC or the SAS. LMUs associated with the SAS are outside the scope of this specification.

The Location Measurement Unit (LMU) entity makes measurements (e.g. of radio signals) and communicates these measurements to a RNC. The LMU may also perform calculations associated with the measurements.

All positioning and assistance measurements obtained by an LMU are supplied to a particular CRNC associated with the LMU. Instructions concerning the timing, the nature and any periodicity of these measurements are either provided by the CRNC or are pre-administered in the CRNC (e.g. using O&M).

The LMU may make its measurements in response to requests (e.g. from the CRNC), or it may autonomously measure and report regularly (e.g. timing of Node B transmissions) or when there are significant changes in radio conditions (e.g. changes in the UTRAN GPS timing of cell frames or SFN-SFN Observed Time Difference).

There may be one or more LMU associated with the UTRAN and an UE Positioning request may involve measurements by one or more LMU. The LMU may be of several types and the CRNCs will select the appropriate LMUs depending on the UE Positioning method being used.

The LMU may be used, for example, to measure UTRAN transmissions either UL or DL. These measurements may be made either, for example, to locate the UE or to measure a system parameter needed by the UE Positioning such as the timing offset (UTRAN GPS timing of cell frames or SFN-SFN Observed Time Difference) of transmissions Node Bs. The LMU may also measure other transmissions, such as those of satellite navigation systems (i.e. GPS) and either report the measurements for use by the CRNC, or report the positioning results as determined by internal calculations of the LMU. The details of the measurements to be made by the LMU will be defined by the chosen UE Positioning method.

An LMU makes radio measurements to support one or more positioning methods. These measurements fall into one of two categories:

- (a) positioning measurements specific to one UE and used to compute its position;
- (b) assistance measurements applicable to all UEs in a certain geographic area.

There are two classes of LMU:

- **Stand-Alone LMU:** communicates with RNCs via the Uu interface;
- **Associated LMU:** communicates with RNCs via the Iub interface.

The associated LMU signalling protocol is the NBAP. The protocol for stand-alone LMU UTRAN signalling will be the RRC protocol.

Stand-Alone LMU

A stand-alone LMU is accessed exclusively over the UTRAN air interface (Uu interface). There is no other connection from the stand-alone LMU to any other UTRAN network element.

NOTE 1: This does not preclude a stand-alone LMU from also communicating with other access networks (e.g. GSM) through interfaces that are not part of the present document.

A stand-alone LMU has a serving Node B that provides signalling access to its CRNC. A stand-alone LMU also has a serving 3G-MSC, VLR and a subscription profile in an HLR. A stand-alone LMU always has a unique IMSI and supports all radio resource and mobility management functions of the UTRAN radio interface that are necessary to support signalling. A stand-alone LMU shall support those connection management functions necessary to support UE

Positioning signalling transactions with the CRNC and may support certain call control functions of to support signalling to an CRNC using a circuit switched data connection.

NOTE 2: A network operator may assign specific ranges of IMSI for its LMUs and may assign certain digits within the IMSI to indicate the associated CRNC. Certain digits in the IMSI may also be used as a local identifier for an LMU within an CRNC.

To ensure that a Stand-alone LMU and its associated CRNC can always access one another, an LMU may be homed (camped) on a particular cell site or group of cell sites belonging to one 3G-MSC. For any Stand-alone LMU with a subscription profile in an HLR, a special profile may be used to indicate the assigned supplementary services (e.g. the SMS-PP MT for data download via the SIM application toolkit, and barring of all incoming and possibly outgoing calls). An identifier in the HLR profile also distinguishes an LMU from a normal UE. All other data specific to an LMU is administered in the LMU and in its associated CRNC.

Associated LMU

An associated LMU is accessed over the Iub interface from an RNC. An associated LMU may make use of the radio apparatus and antennas of its associated Node B. The LMU may be either a logically separate network element addressed using some pseudo-cell ID, or connected to or integrated in a Node B. Signalling to an associated LMU is by means of messages routed through the controlling Node B.

An associated LMU may be separated from the Node B, but still communicate with the CRNC via the Node B Iub interface. The interface between the associated LMU and its Node B is not part of the present document.

NOTE 3: An associated LMU is not precluded from also communicating with other access networks (e.g. GSM) through interfaces that are not part of the present document.

Measurements

The assistance measurements obtained by an LMU are generic and are usable by more than one positioning method. These include:

- **Radio Interface Timing measurements:** include UTRAN GPS timing of cell frames or SFN-SFN Observed Time Difference of the signals transmitted by Node B, where timing differences are measured relative to either some common reference clock (UTRAN GPS timing of cell frames) or the signals of another Node B (SFN-SFN Observed Time Difference);
- **Inter-System Timing measurements:** include timing measurements between the UTRAN radio signals transmitted by a Node B and an external system such as the GPS or GSM.

5.2.4 User Equipment (UE)

The UE may transmit the needed signals for uplink based UE Positioning measurements and to make measurements of downlink signals. The measurements to be made will be determined by the chosen positioning method.

The UE may also contain LCS applications, or access an LCS application through communication with a network accessed by the UE or an application residing in the UE. This application may include the needed measurement and calculation functions to determine the UE's position with or without assistance of the UTRAN UE Positioning entities. This is outside of the scope of this specification.

The UE may also, for example, contain an independent positioning function (e.g., GPS) and thus be able to report its position, independent of the UTRAN transmissions. The UE with an independent positioning function may also make use of information broadcast by the UTRAN that assists the function.

5.2.5 Stand-alone SMLC

An SAS performs one or more of the following procedures:

- Provide GNSS assistance data to the RNC, for both UE-assisted and UE-based method types, to be delivered through point-to-point or broadcast channels to UE;
- Act as a location calculation server if the location estimates are not to be calculated in the RNC;
- Performs a U-TDOA positioning of a particular UE on request of the SRNC;

- Optionally, the SAS may determine the most appropriate positioning method or combination of positioning methods. When the SAS location method determination option is selected:
 - o The SAS is responsible to select the set of GNSS assistance data to be sent to the UE for A-GNSS based positioning and provide that assistance data to the SRNC within the PCAP Position Activation Request message;
 - o The SAS is responsible to request UE positioning related information from the SRNC, e.g. channel information or round trip time;
 - o The SAS is responsible for coordination of simultaneous UE positioning requests from the CN.
- Selecting the set of U-TDOA capable LMUs to be involved in a U-TDOA location determination.

The SAS communicates with the RNC over the Iupc interface enabling it to forward UE Positioning assistance data to UEs and to receive UE Positioning measurement data from the RNC.

When timing assistance is needed, the SAS may rely on associated LMUs or on the RNC (and on the possibility to have GNSS receivers co-located with the RNC, the Node Bs and/or present in the UEs) to obtain that.

6 Signalling protocols and interfaces

6.1 LCS signalling between SRNC and MSC/SGSN

LCS signalling between SRNC and MSC/SGSN is handled through the Iu interface, which is described in clause 6.6.1.

6.2 SRNC signalling to a target UE

SRNC signalling to a target UE is handled through the Uu interface, which is described in clause 6.6.4.1.

6.3 Controlling RNC signalling to a standalone LMU

CRNC signalling to a standalone LMU is handled through the Uu interface, which is described in clause 6.6.4.2.

6.4 Controlling RNC signalling to an associated LMU

CRNC signalling to an associated LMU is handled through the Iub interface, which is described in clause 6.6.3.

6.5 RNC-to-RNC signalling for UE Positioning support

The RNC-to-RNC signalling for UE Positioning support is handled through the Iur interface, which is described in clause 6.6.2.

6.5a SAS to RNC signalling for PCAP

The SAS to RNC signalling is described in clause 6.6.5.

6.6 Interfaces

There are five interfaces through which the UE Positioning entities communicate. These are the Iu, Iur, Iub, Uu and Iupc.

NOTE: the interfaces between the Internal or External LCS applications and the 3G-MSC or 3G-SGSN are outside the scope of the present document.

6.6.1 Iu Interface

The Iu interface is used to communicate between the LCS functional entities in the CN and the UE Positioning entities in the UTRAN. Further specification of the messages and operations for LCS across the Iu interface may be found in reference [19].

6.6.2 Iur Interface

UE Positioning operations at the Iur interface are defined in [20].

The Iur interface is used to communicate between the UE Positioning functional entities associated with the SRNC and other RNC in the UTRAN. The Iur interface is also used to communicate between the SRNC and the Internal UE Positioning Applications in the UTRAN. The UE Positioning entities associated with the SRNC are responsible for coordinating and responding to positioning requests received from the LCS entities in the CN or Internal Clients.

When communicating between the SRNC and the UTRAN Internal UE Positioning Applications (e.g. located within other RNCs), the messages and protocols are those used over the Iur interface. Some positioning methods may require measurements by several LMU or Node B, some of which may be associated with other RNC. Commands and responses from these UE Positioning Entities are communicated over the Iur interface. In some cases, the UE Positioning Entities in the SRNC may make use of entities associated with other RNC. For example, a calculating function may be used in another RNC if the SRNC is too busy or does not contain the function or database information required by the chosen positioning method.

Iur shall be used for UE Positioning signalling whenever it is available, even in the case when the RNCs connected to different 3G-MSCs or 3G-SGSN.

Within UTRAN, Iur supports inter-RNC soft handover. Inter-RNC handover should also include UE Positioning, meaning that whenever an inter-RNC soft handover occurs, Iur should be able to support the functionality of the UE Positioning entities in RNCs.

Iur shall be used also to collect RTD and other UE Positioning information from Node Bs under different RNCs that are not involved in handover.

6.6.2.1 Signalling between SRNC and DRNC

Signalling between SRNC and DRNC is used to obtain LCS information specific to a UE that has an UE context to the DRNC.

The signalling between SRNC and DRNC is done by using RNSAP procedures specified in [20].

6.6.2.2 Signalling between SRNC and CRNC

Signalling between SRNC and CRNC is used to obtain UE Positioning information and request LCS related transmissions or other radio operation (e.g. information about IPDL configuration) that is needed by SRNC for a certain positioning method. The requested information may be e.g. GPS assistance data in case a reference GPS receiver is not available at the SRNC or RTD results that may be provided by the CRNC.

The procedures used for the signalling between SRNC and CRNC are not specified yet.

6.6.3 Iub Interface

UE Positioning operations at the Iub interface are defined in [21].

The Iub interface is used to communicate among the UE Positioning entities associated with the CRNC, the Node B and the associated LMU.

This interface passes the request for measurements, the measurement results and requests for UE Positioning related transmissions or other radio operations needed by the positioning method (e.g. broadcast of parameters needed for a UE-based positioning method). Measurement requests and results are signalled by using NBAP procedures.

6.6.3.1 Signalling between CRNC and associated LMU

Signalling exchanges between an CRNC and a LMU under the control of that CRNC will be specified in the NBAP protocol for associated LMUs.

The protocol layers employed to enable signalling between the CRNC and an associated LMU are defined in [22]. The LMU signalling information elements are included directly in the NBAP protocol, defined in [22].

6.6.4 Uu Interface

UE Positioning operations at the Uu interface are generally defined in [13]. This specification defines in more detail the procedures needed for messaging for each individual positioning method.

The Uu interface is used to communicate among the UE Positioning entities associated with the SRNC, the UEs and the stand-alone LMU.

The Uu interface may pass measurement requests and results to and from the UE or the stand-alone LMU.

The Uu interface may also be used for broadcast of information that may be used by the UE or stand-alone LMU for their UE Positioning operations. This may, for example, include timing and code information about nearby Node B transmissions that may assist the UE or LMU in making their measurements.

The Uu interface is also used to transport signalling between LCS entities in the CN and the UE, e.g. positioning requests from internal or external LCS Applications at the UE. This is part of the NAS procedures and it is outside the scope of this specification.

6.6.4.1 Signalling between SRNC and Target UE

UE Positioning related signalling between an SRNC and a target UE is supported by the RRC protocol as specified in [18].

The positioning request to UE signalling flow is generic for all UE-based or UE-assisted positioning methods (OTDOA and Network-assisted GNSS).

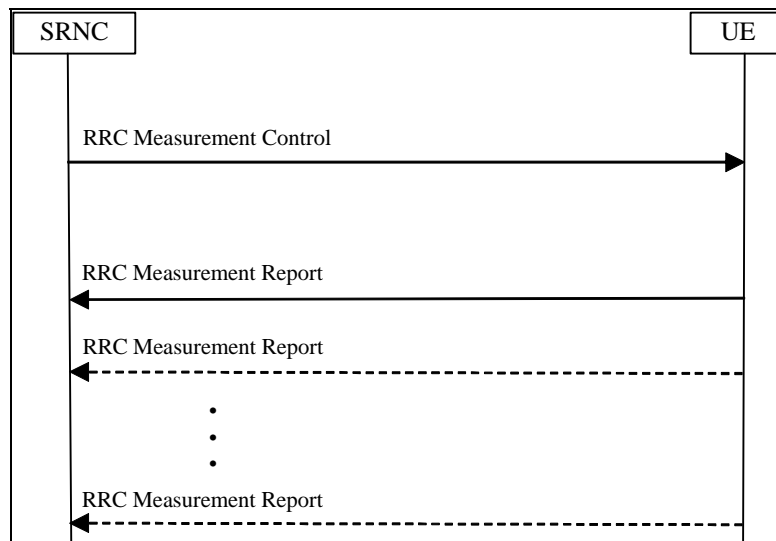

Figure 6.1: OTDOA / GNSS Positioning Message Flow

1. The SRNC determines possible assistance data and sends a MEASUREMENT CONTROL request to the UE. The MEASUREMENT CONTROL message may contain a request for periodic reporting with an amount of reports greater than one. In networks that include an SAS, the assistance data is generated within the SRNC or in the SAS and passed to the SRNC over the Iupc interface. If both an SAS and an SRNC with SMLC internal functionality are available, selection is based on SRNC configuration.
2. The UE performs the requested measurements. If the UE is able to calculate its own position and optionally, velocity, and this is requested, the UE computes a position estimate, and optionally, a velocity estimate based on

measurements. Assistance data necessary to perform these operations will either be provided in the MEASUREMENT CONTROL request and possibly in subsequent MEASUREMENT CONTROL messages or be available from broadcast sources. The resulting measurements or position and optional velocity estimates are returned to UTRAN in a MEASUREMENT REPORT response. If the UE cannot fulfil the request, a MEASUREMENT CONTROL FAILURE message is returned.

3. If periodic reporting was requested in step 1 with an amount of reports greater than one, the UE continues to send MEASUREMENT REPORT messages one reporting interval after the previous MEASUREMENT REPORT message until the requested amount of reports is attained, or until a request from the SRNC is received to stop the periodic reporting.

In case the UE is not able to fulfill the measurements because the assistance data stored in the UE is not sufficient or out of date the UE returns a MEASUREMENT REPORT requesting for more additional data.

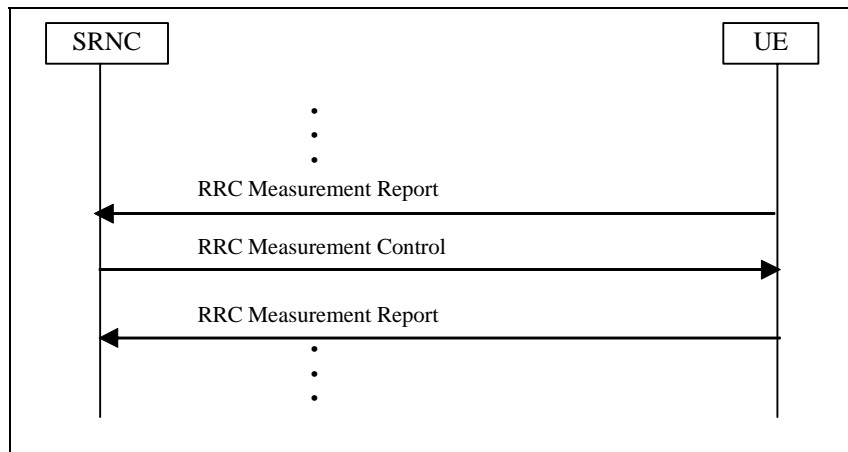

Figure 6.2: OTDOA / GNSS Positioning Message Flow with additional assistance data request

1. The UE cannot fulfil the request or cannot continue to send UE Positioning measurements when the reporting criteria are fulfilled, because its assistance data is not sufficient or out of date, a MEASUREMENT REPORT message is returned requesting for additional assistance data.
2. The SRNC may send more or new assistance data based on UE request.
3. The requested measurement results are returned to the SRNC. The UE continues the measurement reporting according to the stored MEASUREMENT CONTROL information (e.g., when periodic reporting was requested).

6.6.4.1.1 Assistance Data Delivery to UE

The assistance data signalling flow illustrated here is generic for the point-to-point delivery of positioning related assistance data to the UE, including OTDOA and Network-assisted GNSS.

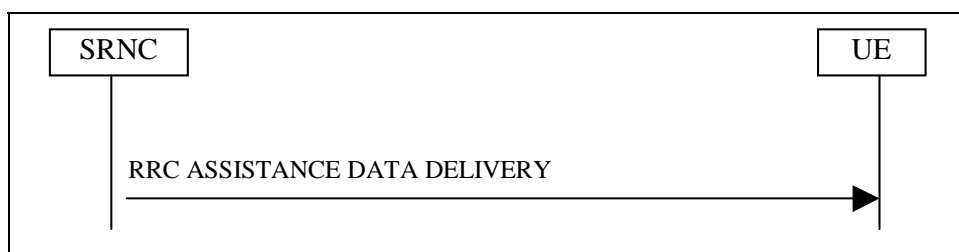

Figure 6.2b: OTDOA or GNSS Assistance Data Delivery Flow

1. The SRNC determines assistance data and sends it in the RRC ASSISTANCE DATA DELIVERY message to the UE. In networks that include an SAS, the UE Positioning assistance data is generated within in the SAS and passed to the SRNC over the Iupc interface.

6.6.4.1.2 Error Handling

The error handling for signalling on the Uu interface is handled by the RRC protocol in [18].

6.6.4.1.3 Broadcast of Assistance Data

For OTDOA and GNSS, UTRAN may broadcast assistance data to the UE.

The assistance data to be broadcast for OTDOA contains the reference and neighbour cells to measure and for each neighbour cell the approximate cell timing and possibly IPDL information. The approximate cell timing may be used to simplify OTDOA measurements. Additionally, RTD values (e.g. in case of a non-synchronised network) and Node B co-ordinates for UE based OTDOA may be included for each neighbour cell. The length of the message depends on how many neighbours are included in the assistance data. Part of the broadcast message (e.g. the serving and neighbour Node B geographic co-ordinates) may be ciphered.

The assistance data to be broadcast for assisted GNSS may contain a subset of or all of the following information: reference time, reference position, DGNSS corrections, ephemeris and clock corrections, and almanac and other data. The broadcast message may be ciphered.

The broadcast channel that is used for the OTDOA and GNSS assistance data makes use of the common UTRAN broadcast service specified in [18].

6.6.4.1.4 Signalling Flow for Assistance Data Broadcast Using the Common UTRAN Broadcast Service

The UTRAN may broadcast positioning related assistance data to UEs within the system information.

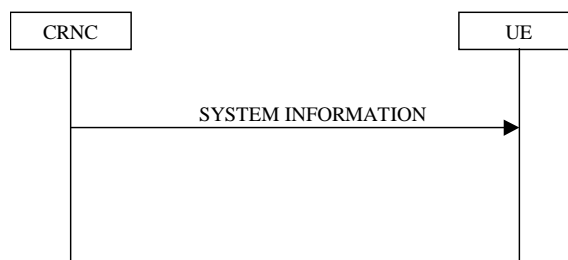

Figure 6.3: Broadcast of system information

6.6.4.1.5 UE Positioning Assistance Data Ciphering

To allow control of access to the assistance data, parts of the broadcast assistance data may be ciphered. Ciphering is done with a specific ciphering key delivered by the CN for this purpose. The management of the key is described in the System Aspects Stage 2 ([13]).

6.6.4.1.6 UE Positioning Assistance Data Ciphering Algorithm

The algorithm used for ciphering the UE Positioning assistance data is the standard 56-bit Data Encryption Standard (DES) algorithm.

The deciphering of broadcast assistance messages is done in the UEs. The deciphering will utilize the deciphering keys delivered during the location update request. Details can be found in [25].

The RNC ciphers the parts of the UE Positioning Broadcast Data message to be protected using the 56-bit DES algorithm and a ciphering keys (56 bits) and Ciphering Serial Number (16 bits) for the broadcast location area.

The ciphered part is variable in length with one bit resolution. By using the UE Positioning Broadcast Data message header, the UEs can determine what part of message is ciphered.

Inputs to the 56-bit DES algorithm are the following:

- 56-bit key K (deciphering key);
- 16-bit Ciphering Serial Number from broadcast message, which is denoted here by IV (Initialisation Vector);
- plain-text bits (the ciphered part of broadcast message).

The ciphering process is illustrated in the following diagram. Ciphering is done by producing a mask bit stream, which is then "XORed" bit-by-bit to the plain-text data to obtain the cipher-text data. First, the Initialisation Vector (IV) is concatenated with 0-bits in order to achieve a 64-bit block I_1 . This block is then encrypted by the DES algorithm using the key K. Output is a 64-bit block I_2 . This constitutes the first 64 bits of the mask bit stream. If the message is longer than 64 bits, then more bits are needed. These are produced by encrypting I_2 again by the DES algorithm using the key K. The output is a 64-bit block I_3 . This is the next 64 bits of the mask bit stream. This iteration is continued until enough bits are produced. The unnecessary bits from the last 64-bit block I_j are discarded. The figure below illustrates the first two mask bit generations and the two ciphered 64-bit blocks.

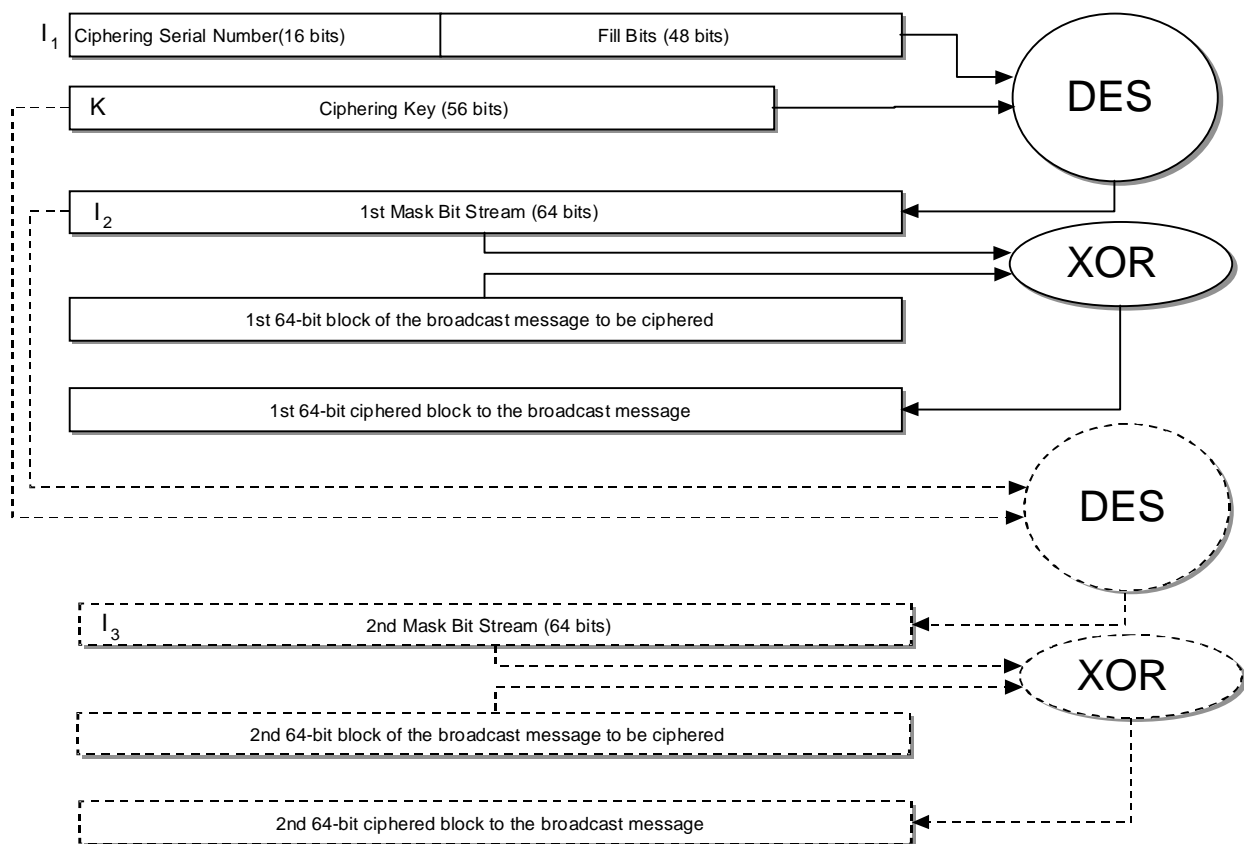

Figure 6.4: Data Assistance Ciphering Algorithm

Deciphering is done similarly. The same mask bit stream is produced and these are XORed, bit-by-bit, to the cipher-text data bits. The result will be the plain-text data.

6.6.4.2 Signalling between RNC and stand-alone LMU

Signalling exchanges between an RNC and a stand-alone LMU under the control of that RNC will be specified in the RRC protocol for stand-alone LMUs. This does not preclude a stand-alone LMU from also communicating with other networks (e.g. GSM) through interfaces (e.g. LLP protocol) that are not part of the present document.

Each update of the LMU measurement (including the initial one) is triggered by a LCS request from the client that is internal to UTRAN. The request may be made directly to the UTRAN LCS entities as the internal clients are considered to be "pre-authorized" (clause 5) or comes from CN with authentication.

The following figure illustrate the protocol layers used to support signalling between an RNC and a stand-alone LMU over the Uu interface.

The protocol layers employed to enable signalling between the RNC and a stand-alone LMU are defined in [18]. The LMU signalling information elements are included directly in the RRC protocol, also defined in [18].

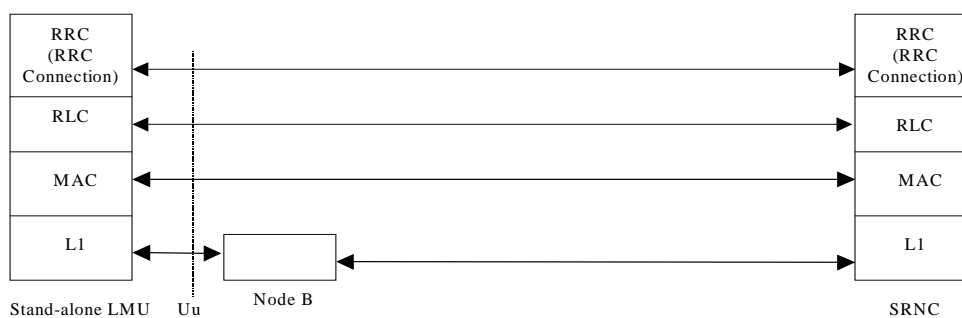

Figure 6.5: Signalling between an RNC and a Stand-Alone LMU using a signalling bearer

6.6.5 Iupc Interface

UE Positioning operations on the Iupc interface are described in [27]. That specification defines in more detail the procedures needed for messages for the UE positioning method.

The Iupc interface is used to allow communication between an RNC and an SAS. This interface is used to signal position and optionally, velocity estimate requests and responses as well as UE Positioning related information using mechanisms consistent with the other internal UTRAN interfaces. The Iupc interface is used for providing the RNC with UE Positioning data to be used for both point-to-point and broadcast purposes. The Iupc interface uses an Iups-like protocol stack for the transport layer which is described in [28].

6.6.5.1 Signalling between RNC and SAS

The signalling between RNC and SAS is done by using PCAP procedures specified in [27].

6.6.5.1.1 PCAP Position Calculation

The PCAP Position Calculation message flow illustrates how an SRNC invokes an SAS to calculate a position estimate of a UE. This message flow is repeated by the SRNC as needed for a periodic location procedure.

The SRNC initiates the PCAP Position Calculation message flow in the RNC centric mode for UEs that support the following positioning method types:

- UE assisted;
- UE assisted is preferred, but UE based is allowed;
- UE based is preferred, but UE assisted is allowed;

when the chosen positioning method type is 'UE Assisted'.

For UEs that only support the UE based positioning method or that, supporting both, have selected the 'UE Based' option, the PCAP Position Calculation message flow is not applicable.

The SRNC also initiates the PCAP Position Calculation Request message flow to invoke the U-TDOA positioning method in the case that U-TDOA is initiated from the SRNC and not from the SAS.

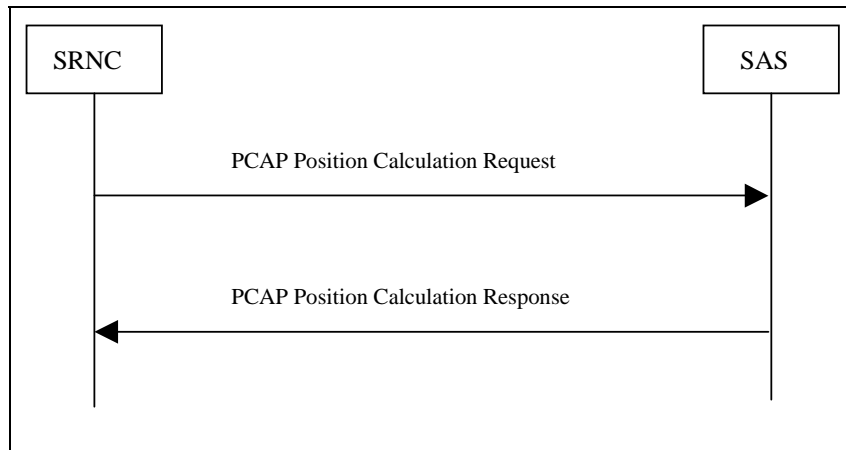

Figure 6.6: PCAP Position Calculation Request Message Flow

1. The SRNC initiates a PCAP Position Calculation Request Message. This message contains data necessary for the SAS to calculate a position, and optionally a velocity estimate for a UE and, if required, initiate U-TDOA positioning for the UE. The PCAP Position Calculation Request message may contain periodic location information (reporting interval and number of outstanding requests for the overall periodic location procedure) to enable the SAS to better fulfil future such requests.
2. If the SAS is able to calculate the position, and optional velocity estimate, possibly after performing U-TDOA positioning if requested in step 1, it shall return it to the SRNC in a PCAP Position Calculation Response Message. If the SAS cannot fulfil the request, it shall return a PCAP Position Calculation Failure Message to the SRNC.

6.6.5.1.2 PCAP Information Exchange

The PCAP Information Exchange message flow illustrates how an RNC initiates and terminates an exchange of UE Positioning related information with an SAS. The UE Positioning related information received from the SAS can be used by the RNC to either provide assistance data to a particular UE through dedicated signalling or to build up System Information Blocks containing assistance data to be broadcast to UEs in a particular area.

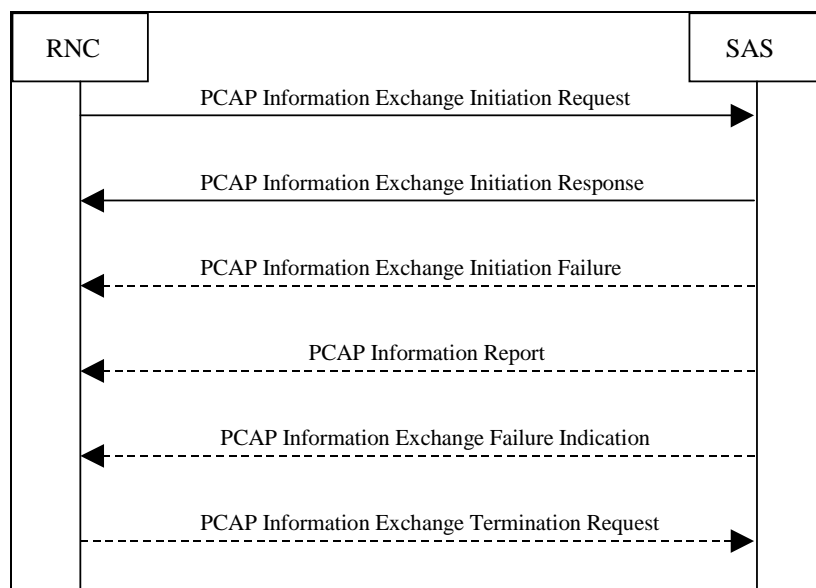

Figure 6.7: PCAP Information Exchange Message Flow

1. The RNC initiates a PCAP Information Exchange Initiation Request Message. This message contains data necessary for the SAS to provide the requested UE Positioning related information to the RNC. Upon reception

of this message, the SAS shall provide the requested UE Positioning related information according to the reporting parameters given in the request. These parameters specify how the UE Positioning related information is to be reported (i.e. on-demand, periodically, or on-modification).

2. If the SAS is able to determine the information requested by the RNC, it shall respond with a PCAP Information Exchange Initiation Response Message.
3. If the SAS cannot provide the requested UE Positioning related information, it shall return a PCAP Information Exchange Initiation Failure Message.
4. In cases where the RNC has specified that the UE Positioning related information is to be reported periodically or on-modification, the SAS shall return the requested information in one or more PCAP Information Report Messages.
5. In cases where the RNC has specified that the UE Positioning related information is to be reported periodically or on-modification, the SAS may initiate an Information Exchange Failure Indication Message to notify the RNC that the requested information associated with a particular reporting activity can no longer be reported.
6. In cases where the RNC has specified that the UE Positioning related information is to be reported periodically or on-modification, the RNC may terminate a particular information reporting activity by initiating a PCAP Information Exchange Termination Request Message. Upon reception, the SAS shall terminate the particular information exchange activity indicated by the RNC.

6.6.5.1.3 PCAP for SAS based Positioning Method Selection

As a configuration option, the SAS shall be able to determine the positioning method used for individual positioning events. In this case the SRNC shall allow A-GNSS, OTDOA, Cell ID and U-TDOA positioning events to be originated by the SAS via PCAP messages on the Iupc interface.

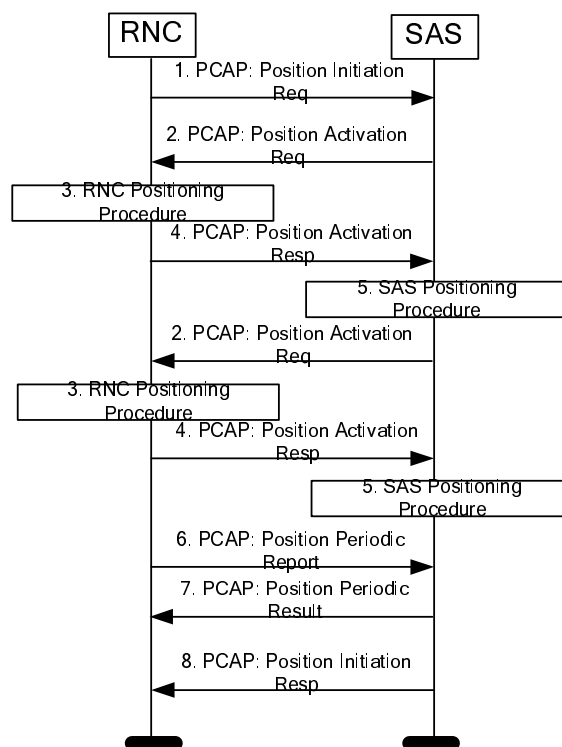

Figure 6.8: Fundamental SAS centric signal flow over the Iupc interface

- 1) 1. The SRNC forwards the information contained in the RANAP Location Reporting Control message plus Cell ID and UE capability information to the SAS in a PCAP Position Initiation Request message.
- 2) 2. The SAS may initiate a specific positioning method by sending a PCAP Position Activation Request message to the SRNC containing the required positioning method and any assistance data and instructions

associated with that positioning method. For positioning methods which require RRC signalling (e.g., OTDOA or A-GPS), the positioning instructions include the required settings for the "measurement validity" IE in the RRC signalling message (e.g., CELL_DCH, all states except CELL_DCH, or all states) [18].

- 3) 3. The SRNC performs the positioning procedure requested by the SAS including any signalling interaction with the UE in the case of UE assisted or UE based positioning (e.g. for A-GNSS or OTDOA).
- 4) 4. The SRNC sends a PCAP Position Activation Response message to the SAS confirming the requested action and providing any information required by the requested positioning method; e.g. UE channel information for the U-TDOA positioning method or A-GNSS measurements for UE assisted A-GNSS. If periodic UE reporting is activated by the SRNC in step 3, the PCAP Position Activation Response message includes the used settings for the IE "measurement validity" in the corresponding RRC signalling [18].
- 5) 5. The SAS instigates any further positioning associated with the positioning method chosen in step 2 – e.g. obtains measurements from LMUs in the case of U-TDOA.

Note:

Repeating steps 2, 3, 4 and 5 to invoke additional positioning methods may provide higher location accuracy or successfully provide UE locations under difficult propagation circumstances, e.g. the hybrid positioning method. When steps 2, 3, 4 and 5 are repeated, the SAS shall not send a new PCAP Position Activation Request message until the SRNC has responded to a previous request or the SAS has timed out on a response. The SAS may, however, send a new PCAP Position Activation Request message in a repetition of step 2 while SAS positioning for a previous step 5 is ongoing. In this case, SAS positioning (e.g. for U-TDOA) could execute in parallel with SRNC positioning (e.g. for A-GNSS or OTDOA) thereby reducing overall response time.

- 1) 6. If an RNC positioning procedure has been invoked in step 3 which requests periodic UE reporting according to subclause 6.6.4.1, the subsequent periodic UE measurement reports (e.g. for A-GPS or OTDOA) are conveyed to the SAS using one or more PCAP Position Periodic Report messages.

NOTE: If a periodic RNC positioning procedure has been invoked by the SRNC in step 3, the PCAP Position Activation Response message in step 4 may be returned immediately (i.e., before step 3) confirming the requested action and not including any measurements. In that case, all periodic measurement reports are conveyed to the SAS using PCAP Position Periodic Report messages.

- 1) 7. If periodic positioning was invoked in step 1, the successive periodic position estimates (or an indication of positioning failure) are conveyed to the SRNC using one or more PCAP Position Periodic Result messages.
8. The SAS provides the UE location or, when periodic positioning was invoked in step 1, the final UE location to the SRNC in a PCAP Position Initiation Response message. In case of periodic positioning, the final location estimate may be provided, as an implementation option, in a PCAP Position Periodic Result message followed by a PCAP Position Initiation Response message that does not contain any UE location estimate.

7 General UTRAN UE Positioning procedures

7.1 General procedures in UTRAN for UE Positioning

The General UE positioning procedure in UTRAN starts with a request over Iu from the CN. The request from the core network may be a request for direct (on demand) reporting or periodic reporting. UTRAN then determines the UE position by selecting a suitable positioning method. UTRAN then responds to the request with the estimated position and optionally, the estimated velocity, possibly the associated accuracies and if available, the positioning method (or the list of the methods) used to obtain the position and optional velocity estimates. If periodic reporting was requested by the CN, UTRAN responds to the request according to the received periodic reporting criteria and sends the estimated position together with other information (e.g., velocity, associated accuracies, positioning methods used, etc.) one reporting interval after the previous report until the desired amount of reports has been attained or the procedure is cancelled by the UTRAN or CN.

7.2 Common procedures supporting UE Positioning interaction between RNCs

In the case that the positioning information is needed from an associated LMU in a Node B that is not controlled by the SRNC then the transfer of this information needs to be supported on the Iur interface. This information is the same information that is signalled between an associated LMU and the corresponding CRNC in the case when Iur support is not needed.

The SRNC requests the information it requires (e.g. GPS timing of cell measurements) from the CRNC of the Node B, which has the associated LMU. The CRNC in turn requests the information from the Node B and upon success returns the results to the SRNC.

Similarly when the SRNC needs a Node B measurement on a UE when that Node B is not controlled by that SRNC there needs to be support on the Iur. One example is the RTT measurement.

Other information that may need to be signalled over the Iur includes LMU parameters (geographical position, covered cells etc.).

NOTE: Confirmation or FS is needed by R3 experts.

7.2.1 Signalling in case of SRNS relocation

In case of SRNC relocation UE Positioning functionalities may be transferred in order for DRNC to be able to handle the responsibility of SRNC in LCS process. Therefore the Source RNC may transfer the following information to the Target RNC:

- last known position, time stamp and accuracy of the position calculation;
- LCS capabilities of the UE.

If there is a positioning procedure going on in order to estimate the position of the UE (e.g. in case of periodic reporting) and an SRNS relocation occurs, the positioning procedure shall be stopped in the old SRNC. After SRNS relocation, it is under the responsibility of the MSC, MSC Server or SGSN to restart an Iu aborted positioning procedure. In the UE, the positioning procedure is going on and positioning information (e.g. measurement results) may be sent back to UTRAN if the UE was requested to do so. The new SRNC then decides whether it wants to use these information or discard them. If an SAS is used, the SRNC shall send an Abort message to the SAS over the Iupc interface.

7.3 Exception procedures

7.3.1 Procedures in the SRNC

The SRNC can work in either the RNC centric mode or in a SAS centric mode where the SAS has control over the positioning procedures.

7.3.1.1 RNC Centric Mode

When a positioning attempt fails due to failure of a position method itself (e.g. due to inaccurate or insufficient position measurements and related data) and the SRNC is unable to instigate another positioning attempt (e.g. due to a requirement on response time), the SRNC shall return a Location response over the Iu interface containing a less accurate position estimate if available, even if this position estimate is not within the accuracy requested from the CN. In this case, the Location response shall indicate that the position estimate does not satisfy the requested accuracy. If a less accurate estimate is not available, the SRNC shall return a Location response message containing no position estimate and indicating the cause of failure.

When a positioning attempt is interrupted by some other unrecoverable error event inside the SRNC, the SRNC shall immediately terminate the positioning attempt and return a Location Response message containing the reason for the positioning attempt cancellation. In that case, SRNC may also abort any dialogue previously opened with an LMU for the purpose of instigating position measurements for the UE being located.

In networks that include an SAS, the SRNC will receive a PCAP Position Calculation Response message on the Iupc interface and then return a Location response over the Iu interface containing the results that were provided over the Iupc interface (a less accurate position estimate, cause of failure indication, etc). This is described in subclause 7.3.4.

If the uplink channel characteristics for the target UE change while a U-TDOA positioning is ongoing, the SRNC shall send a PCAP Position Parameter Modification message to the SAS containing the updated channel characteristics and cell information.

When a positioning attempt is interrupted by some other unrecoverable error event inside the SRNC, the SRNC may also abort any dialogue previously opened with an LMU for the purpose of instigating position measurements for the UE being located.

When periodic reporting was requested from the CN and when no location estimate is available at the SRNC when the reporting criteria are fulfilled (e.g. due to failure of a position method itself), the SRNC shall return a location response message containing no position estimate and indicating the cause of failure.

7.3.1.2 SAS Centric Mode

When the SRNC is unable to accept a PCAP Position Activation Request message due to congestion or any other failure, the PCAP Position Activation Failure message shall be sent to the SAS on the Iupc interface.

If an RRC measurement procedure for periodic UE positioning measurement reporting in the UE has been activated by the SRNC upon reception of a PCAP Position Activation Request message, and if the SRNC or UE terminates the measurement reporting (e.g. after RRC state transition), the SRNC shall send a PCAP Position Periodic Termination message to the SAS indicating the cause of termination.

When the SRNC is unable to continue positioning activity due to cell reselection that results in a different SRNC, loss of contact with the UE or any other reason, the PCAP Abort message shall be sent to the SAS on the Iupc interface.

A PCAP Position Parameter Modification message shall be sent containing updated channel characteristics (including cell information) whenever the RF channel parameters associated with the UE connection change due to cell reselection or handover within the same SRNC, modification of the channel capacity or any other reason within the control of a single RNC. The SRNC shall keep the SAS updated on any change in serving cell status (using PCAP Position Parameter Modification message) so that the SAS can provide correct assistance data to the UE whenever the SAS invokes a positioning method or methods.

If an RRC measurement procedure for periodic UE positioning measurement reporting in the UE has been activated by the SRNC upon reception of a PCAP Position Activation Request message, and if there is a RRC state transition during the RRC measurement procedure, which results not in a termination of the UE measurement reporting, the SRNC shall send a PCAP Position Parameter Modification message informing the SAS about the new UE state. The SRNC shall continue to notify the SAS of such state changes until the periodic position measurement reporting has been completed by the UE, cancelled by the SAS or terminated by the SRNC.

Sending of a PCAP Position Parameter Modification message does not change the status in the SRNC of any position method or position methods that may have been previously activated through receipt of a PCAP Position Activation Request message.

If the SRNC receives a new PCAP Position Activation Request message before it has responded to a previous PCAP request for the same UE or while it is still performing activity for a previous non-periodic request (e.g. in the case of U-TDOA in CELL_FACH state), the SRNC shall terminate all activity for the previous request, including sending any response to the SAS, and shall process the new request.

If the SRNC receives a new PCAP Position Activation Request message for UE position measurement reporting using A-GPS or OTDOA (periodic or non-periodic) while it is still performing activity for a previous A-GPS or OTDOA periodic request, the SRNC shall terminate all activity for the previous request, including terminating the periodic measurement reporting in the UE, and shall process the new request.

If the SRNC receives a new PCAP Position Activation Request message for cell ID-RTT or U-TDOA while it is still performing activity for a previous A-GPS or OTDOA periodic request (but after returning any PCAP Position Activation Response for this request), the SRNC may both continue with the previous request and process the new request.

If an RRC measurement procedure for periodic UE positioning measurement reporting in the UE has been activated by the SRNC upon reception of a PCAP Position Activation Request message, and if the SRNC receives a PCAP Position

Periodic Termination message from the SAS, the SRNC shall terminate the periodic UE positioning measurement reporting in the UE.

If the SRNC receives a request for assistance data from a UE positioning procedure (periodic or non-periodic) that uses A-GNSS, the SRNC should indicate this to the SAS by sending a Position Activation Response message. The Position Activation Response message shall include the assistance data types requested by the UE. In case of periodic UE positioning reporting and after a Position Activation Response message has already been returned to the SAS, the request for additional assistance data may be conveyed in a Position Periodic Report message.

7.3.2 Procedures in a LMU

An LMU shall return an error indication to its CRNC when positioning measurements previously ordered by the RNC cannot be provided due to any error condition.

7.3.3 Procedures in the target UE

A target UE shall terminate any positioning procedure or the transfer of RRC positioning assistance data without sending any response to the SRNC if any UE Positioning RRC message is received from the SRNC that starts some other RRC management procedure. The new RRC procedure shall then be executed by the UE.

7.3.4 Procedures in the SAS

The SAS can work in either the RNC centric mode or in a SAS centric mode where the SAS has control over the positioning procedures.

7.3.4.1 RNC Centric Mode

In the RNC centric mode, when a UE positioning attempt fails (e.g. due to inaccurate or insufficient position measurements and related data), the SAS may return a PCAP Position Calculation Response message over the Iupc interface containing a less accurate position estimate. If a less accurate estimate is not available or will not meet the accuracy requirement, the SAS may instead return a PCAP Position Calculation Failure message containing no position estimate and indicating the cause of failure.

When a positioning attempt is interrupted by some other unrecoverable error event inside the SAS, the SAS shall immediately terminate the positioning attempt and return a PCAP Position Calculation Failure message containing the reason for the positioning attempt cancellation.

7.3.4.2 SAS Centric Mode

If the SAS invokes a positioning method by sending a PCAP Position Activation Request message to the SRNC, it may subsequently receive a PCAP Position Activation Failure or PCAP Abort message from the SRNC, while positioning in the SRNC is active, according to subclause 7.3.1.2. At any time after receiving a PCAP Position Initiation Request message and whether positioning in the SRNC is active or not active, the SAS may receive a PCAP Abort message or PCAP Position Parameter Modification message from the SRNC, according to subclause 7.3.1.2.

If the SAS receives a PCAP Abort message it shall immediately cease positioning attempts and return a PCAP Position Initiation Response message to the SRNC carrying any location estimate already obtained or a Position Initiation Failure message containing a cause of failure indication. If the SAS receives a PCAP Position Activation Failure message, the SAS may either terminate positioning as for receipt of a PCAP Abort or continue the positioning attempt using the same or other positioning methods, e.g. if permitted by the QoS response time requirement. If the SAS receives a PCAP Position Parameter Modification message, the SAS shall take the received information into account in either performing ongoing positioning (e.g. reconfigure LMUs for U-TDOA) or invoking new positioning (e.g. use new serving cell to provide A-GPS timing assistance).

If the SAS is unable to accept or continue processing a PCAP Position Initiation Request from the SRNC due to capacity constraints or equipment failure, a PCAP Position Initiation Failure message shall be sent to the SRNC on the Iupc interface carrying an appropriate cause of the failure indication.

7.4 Radio interface timing procedures

The Radio Interface Timing determination system consists of functions in LMUs in the SRNC, and in the SAS for networks that include an SAS. The system runs continuously offering cell timing information for UE Positioning.

7.4.1 LMU Functions

The Radio Interface Timing functionality in the CRNC associated LMU should be capable of performing the following functions:

- The LMU performs necessary radio interface measurements from signals transmitted by Node Bs;
- If the LMU contains a common reference clock, e.g. GPS TOW, it time stamps reception of Node B signals by performing measurements of UTRAN GPS timing of cell frames;
- If there is no reference clock available, the LMU may make SFN-SFN Observed Time Difference or measurements, i.e. measures the time difference between arrival of SFNs from neighbouring Node Bs and a reference Node B;
- The LMU may perform some processing of measurements, like averaging and filtering, using parameters delivered to it, or in their absence using default settings.

7.4.2 CRNC Functions

The CRNC must be capable of performing the following functions related to Radio Interface Timing determination:

- The CRNC sends to LMUs requests for Radio Interface Timing measurement information;
- The CRNC will communicate regularly with LMUs; thus, the CRNC can monitor operation of LMUs. If a LMU fails to send Radio Interface Timing information, the CRNC shall try to restart the LMU, and if this restarting fails, the CRNC shall inform O&M system. CRNC can use also diagnostics messages to query the status of LMUs;
- The CRNC receives Radio Interface Timing measurement results from LMUs;
- The CRNC stores or queries extra information required for Node B synchronization determination, like Node B and LMU coordinates, Node B identity information;
- The CRNC determines synchronization differences between different downlink signals using LMU measurements and other information;
- Synchronization information is delivered for UE Positioning purposes.

7.4.3 LMU-CRNC Interactions

The request for Radio Interface Timing measurement information from the CRNC to a LMU contains the following parameters:

- Measurement type. This indicates whether the CRNC wants the LMU to perform UTRAN GPS timing of cell frames or SFN-SFN Observed Time Difference;
- Measurement result reporting frequency. This indicates how often the LMU should send Radio Interface Timing measurement results;
- Measurement duration. This indicates how long the LMU should make measurements and report results;
- Instructions about filtering of raw measurement data;
- Instructions about Primary CPICH signals to be measured. The LMU unit can measure autonomously a certain number of most strongly received signals. Another possibility is that the CRNC tells which Node B signals it should measure;

- In the SFN-SFN Observed Time Difference case, which common Primary CPICH the LMU should use as a reference in the measurements;
- Instruction of how the measurement quality should be reported.

In case a SFN-SFN Observed Time Difference measurement was requested by the CRNC, the LMU returns the following information to CRNC:

- Identity of the Node B at which the associated LMU is residing;
- Primary CPICH info of the measured signals;
- SFN-SFN observed time difference between neighbour cells and reference cell;
- Identity of the neighbour cells;
- SFN-SFN drift between neighbour cells and reference cell;
- Time stamp of the measurement (e.g. SFN);
- Accuracy of the measurement.

In case a UTRAN GPS timing of cell frames measurement was requested by the CRNC, the LMU returns the following information to the CRNC:

- Cell id of the measured cell;
- SFN;
- Time stamp (e.g. GPS TOW) of the SFN;
- Node B clock drift;
- Accuracy of the measurement.

8 Cell ID and Enhanced Cell ID based positioning methods

The Cell ID and Enhanced Cell ID based positioning method can work in either the RNC centric mode or in an SAS centric mode where the SAS has control over the positioning procedures.

This subclause outlines the procedures for Cell ID and Enhanced Cell ID positioning methods. Subclause 8.1 provides procedures for the determination of the cell ID depending on the operational status of the target UE. Subclause 8.2 provides a procedure for the mapping of the cell ID to a corresponding SAI to be returned to the LCS application in the CN. Subclause 8.3 provides additional information on other Enhanced Cell ID methods.

In the RNC centric Cell ID based method, the SRNC determines the identification of the cell providing coverage for the target UE and may request additional UE and/or UTRAN measurements for Enhanced Cell ID methods. The general flow to determine the cell ID and UE and/or UTRAN measurements for Enhanced Cell ID methods is shown in figure 8.1. For Enhanced Cell ID methods, the SRNC may request measurements either from the Node B(s) (e.g., RTT, Rx Timing Deviation, Angle of Arrival) or from the target UE using RRC measurement procedure (e.g., pathloss, CPICH RSCP, CPICH Ec/No). The available measurements for Enhanced Cell ID are described in Section 8.3. If the location request from the CN is a request for periodic reporting, the general procedure may be repeated and UTRAN sends an LCS response one reporting interval after the previous LCS response message until the desired amount of reports is attained, or until the procedure is cancelled by UTRAN or CN.

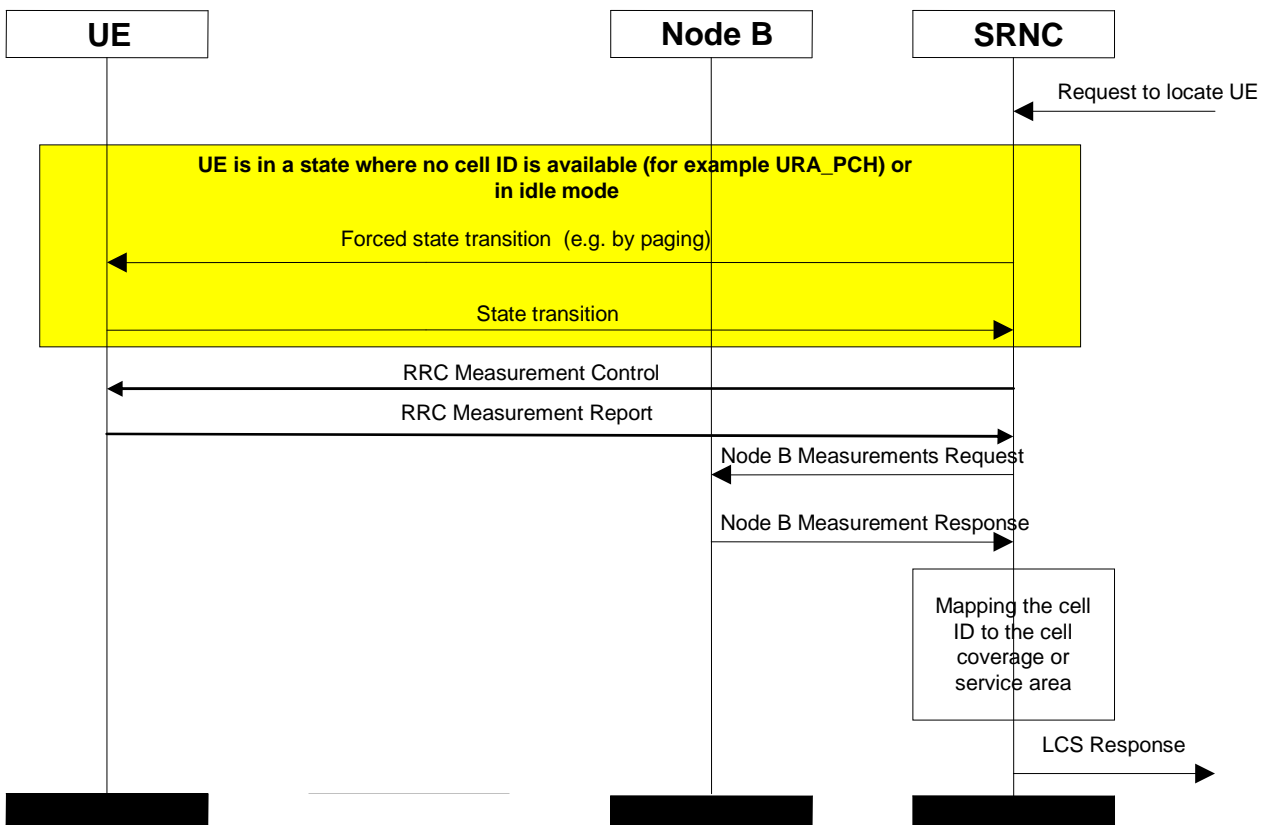

Figure 8.1: RNC Centric, Cell ID and Enhanced Cell ID Based Methods

In the SAS centric mode the request for a Cell ID or Enhanced Cell ID based position may be originated by an associated SAS via a PCAP Position Activation Request message on the Iupc interface as discussed in subclause 6.6.5.1.3. In this case the Cell ID and other measurements for Enhanced Cell ID would be provided to the SAS in a PCAP Position Activation Response message as shown in figure 8.2.

For periodic reporting, the SAS may continue to invoke Cell ID or Enhanced Cell ID based position via PCAP Position Activation Request messages and the SAS sends the periodic location reports to the SRNC in PCAP Position Periodic Result messages until the desired amount of reports is attained (or until the procedure is cancelled by UTRAN or CN) as shown in Figure 8.2. The final location estimate may be provided to the SRNC either in a PCAP Position Periodic Result or in a PCAP Position Initiation Response message, as described in subclause 6.6.5.1.3.

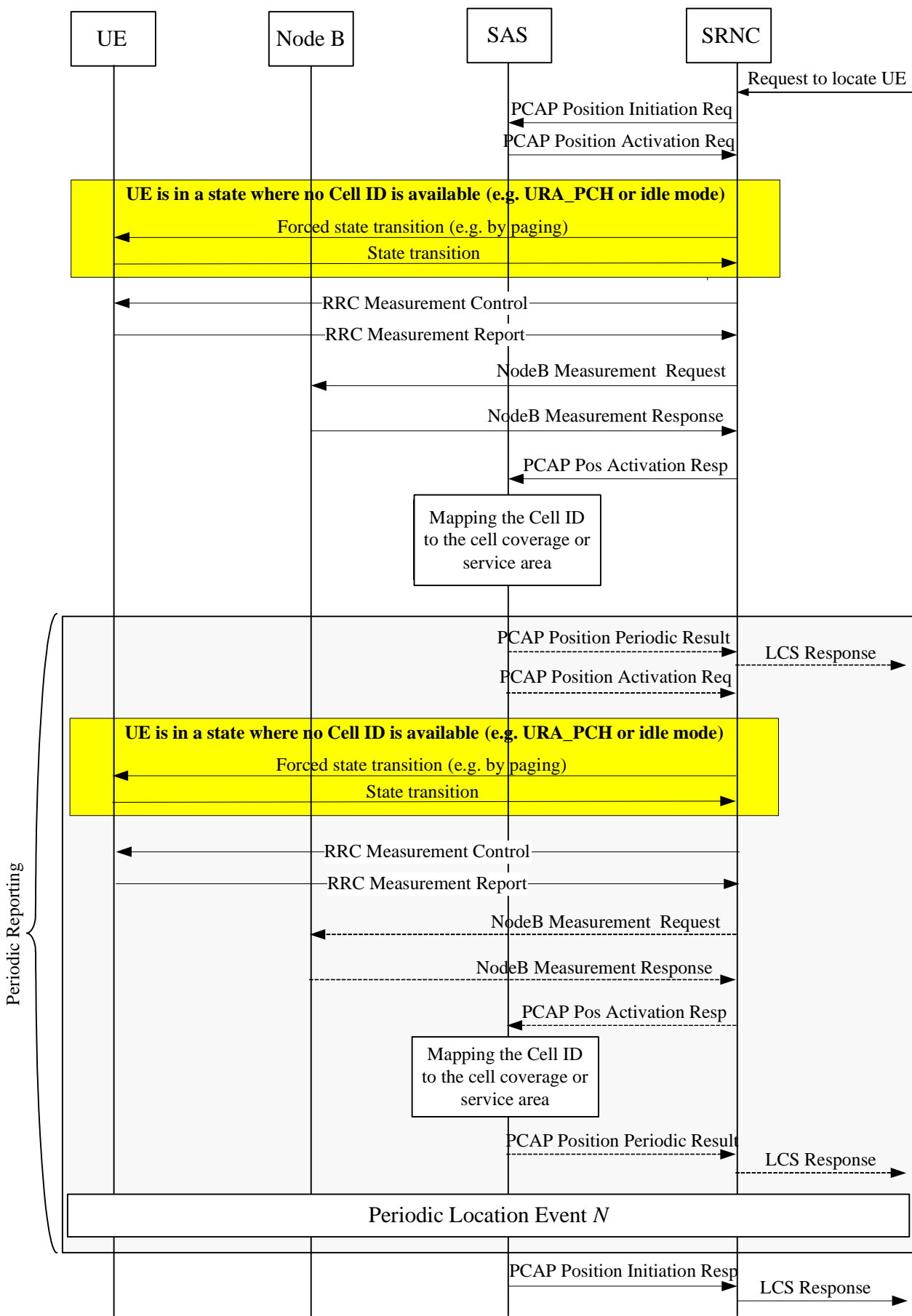

Figure 8.2: SAS Centric, Cell ID and Enhanced Cell ID Based Methods

8.1 Cell ID determination

In order for the SRNC to determine the cell ID when an UE Positioning request is received, additional operations may be needed depending on the operational status of the UE.

When the LCS request is received from the CN the SRNC checks the state of the target UE. If the UE is in a state where the cell ID is available, the target cell ID is chosen as the basis for the UE Positioning. In states where the cell ID is not available, the UE is paged, so that SRNC can establish the cell with which the target UE is associated. The SRNC may also map the cell ID to a corresponding SAI to match the service coverage information available in the CN.

The cell ID based method shall determine the position of the UE regardless of the UE RRC mode (i.e. connected or idle).

8.1.1 UE Cell ID is not known

For UE for which the cell ID is not known at the time the UE Positioning request is received at the SRNC, the UE may be paged to locate its current cell ID. If the UE is in an idle mode and there is a need for it to be paged, then the paging shall be initiated by the CN. If the UE is in URA_PCH state the paging may be initiated by the SRNC in UTRAN. For example, the UE can be forced to perform a transition to a Cell_FACH state to define the cell ID of its current cell.

If the UE is in an idle mode, or in a RRC connected state when there is a need to page for the UE to obtain the cell ID, the CN may initiate paging, authentication and ciphering, as specified in [13].

Alternatively, the cell ID may be determined as the one that was used during the last active connection to the UE. In the case the UE is not reachable, the last known position should include the age of location field.

8.1.2 UE Cell ID is known

8.1.2.1 UE not in Soft handover

The cell ID may be determined as the cell that is providing an active connection for the UE at the time of receiving the UE Positioning request at the SRNC.

8.1.2.2 UE in Soft handover

In order for the SRNC to provide the geographical co-ordinates of a target UE in soft handover, the SRNC combines the information about all cells associated with the UE.

In soft handover, the UE may have several signal branches connected to different cells, reporting different cell IDs. A reference cell ID may be determined by the SRNC based on the coverage area of each cell. The reference cell ID may be selected based on one or more of the following principles:

- the cell ID may be selected based on the parameters defining the quality of the received signal branches. That is, the cell ID with the best quality signal branch is selected as the reference cell ID;
- the cell ID may be selected that was used during connection set-up between the UE and the serving Node B;
- the cell ID of the cell most recently associated with the UE may be selected;
- the cell ID of the latest "new" cell that the UE has started to receive, but has not yet been handed over to may be selected;
- the cell ID may be selected as the cell to which UE has the shortest distance (to the Node B site);
- the cell ID may be selected as the cell that provides an active connection for the UE at the time of receiving the UE Positioning request at the SRNC.

The selection may also be based on RTT measurements, power levels and received signal strengths in UE and related Node B or LMU.

Other relevant mechanisms such as IPDL or SSTD power control should also be taken into account when applying the cell ID selection procedure for UE in a soft handover mode.

8.2 Mapping the Cell ID to Geographic Co-ordinates or a Service Area

A UTRAN cell ID should be mapped to geographical coordinates or a SAI before being sent from UTRAN to the CN. The Service Area Identifier may include one or several cells. The mapping may be accomplished either in the SRNC, in a Network Management System, including Network Management Unit or by co-operation of various access network elements.

The CN may request the geographical co-ordinates or the SAI, or both for the target UE. The SAI may be used for routing of corresponding Emergency calls, or for CAMEL services to correspond to the usage of Cell ID in the core network of GSM. However, the MSC shall not send the Service Area Identity to GMLC.

Although the mapping of the cell(s) associated with the target UE into geographical co-ordinates by the SRNC is not standardised, the response to the CN Location request with geographical co-ordinates shall be as defined in [11].

In order to determine a cell coverage estimate and to map it to the geographical coordinates or Service Area parameter Identity, the SRNC may use parameters such as the best reference signal, RTT in FDD [15] or Rx Timing Deviation [16] and knowledge of the UE timing advance in TDD, as well as antenna beam direction parameters.

Alternatively, the service area coverage of a cell may be determined by using a reference signal power budget. Based on the reference signal power budget it is possible to obtain, for example, the Node B transmitted power, isotropic path loss, coverage threshold at coverage area border for a given location probability, and a cell radius for an indoor and outdoor coverage.

The SRNC may use a reference signal link budget based cell radius estimate, in conjunction with the cell identifier, to make a coverage estimation for the cell(s) related to the target UE.

Additionally, the SRNC may compare the received power levels with the power budget, whereby more accurate information of the position of the UE may be provided.

Also, the interaction between neighbouring cell coverage areas may be used to determine a more exact UE Positioning.

8.3 Enhanced Cell ID Methods

Techniques which use additional UE and/or UTRAN radio resource related measurements are defined under Enhanced Cell ID. Measurements for these ECID methods may include:

UE measurements:

- UE Rx-Tx Time Difference (FDD);
- pathloss;
- CPICH RSCP (FDD);
- CPICH Ec/No (FDD);
- Timing Advance (TDD).

UTRAN measurements:

- RTT (FDD);
- Rx Timing Deviation (TDD);
- Angle of Arrival (1.28 Mcps TDD).

Various techniques exist to use these measurements to estimate the location of the target UE. The specific techniques are beyond the scope of this specification. Examples of other Enhanced Cell ID methods include the following:

8.3.1 Cell-ID with RTT

Cell-ID with Round Trip Time measurements:

This variant uses in addition NodeB measurements of the signal Round-Trip-Time (RTT). These measurements can be made for all NodeBs in the active set. If RTT measurements to several geographically dispersed NodeBs are available, the UE location may be found via trilateration. The RTT measurements may be complemented by the UE measurement of the Rx-Tx Time Difference Type 1 and/or Type 2. In case of TDD mode, the distance measurement may be based on RX Timing Deviation and/or Timing Advance.

8.3.2 Cell-ID with Pathloss and Related Measurements

Cell-ID and Pathloss related measurements:

This variant uses in addition several UE measurements for the serving and neighboring cells related to pathloss or SNR. UE measurements which could be used include:

- Pathloss (as defined in [18] subclause 10.3.7.3);
- CPICH RSCP (FDD);
- CPICH E_c/N_0 (FDD).

These measurements may be used to obtain distance related information, or the measurements may be used for statistical modeling approaches, etc.

8.3.2.1 RF Pattern Matching (RFPM)

The RF Pattern Matching positioning method is based on radio link measurements collected from the network and/or the UE. The method relies on predictions or models of the radio environment against which it performs an algorithmic comparison of the measurements to determine a best match estimation of the UE's location. RFPM may utilize measurements other than the pathloss measurements noted above.

8.3.3 Cell-ID with Angle of Arrival

Cell-ID with Angle-Of-Arrival (AOA) measurements (1.28 Mcps TDD only):

This variant uses NodeB angle-of-arrival measurements, usually together with distance related measurements obtained via timing advance to estimate the UE location.

9 OTDOA positioning method

The primary standard OTDOA measurement is the "SFN-SFN observed time difference" observed at the UE (see [15] and [16]). These measurements, together with other information concerning the surveyed geographic position of the transmitters and the RTD of the actual transmissions of the downlink signals may be used to calculate an estimate of the position and optionally, the velocity of the UE. Each OTDOA measurement for a pair of downlink transmissions describes a line of constant difference (a hyperbola (see note 1)) along which the UE may be located. The UE's position is determined by the intersection of these lines for at least two pairs of Node Bs. The accuracy of the position estimates made with this technique depends on the precision of the timing measurements, the relative position of the Node Bs involved (see note 2), and is also subject to the effects of multipath radio propagation. This is illustrated in the figure 9.1.

NOTE 1: This is really a figure in three dimensions, a hyperboloid. For convenience here, this will be simplified to the hyperbola representing the intersection of this surface with the surface of the earth. For location service in three dimensions the hyperboloid must be considered.

NOTE 2: The geometry of the Node B positions may affect the accuracy of the position and optional velocity estimates. The best results are when the Node Bs equally surround the UE. If they do not, there is a reduction in accuracy, which is sometimes termed the Geometric Dilution of Position (GDP).

The primary OTDOA measurements (made by the UE) are sent to the SRNC. These measures are sent via signaling over the Uu_Iub (and Iur) interfaces between the UE and the SRNC. In networks with a SAS, the SRNC may forward the measurement results over the $Iupc$ interface to the SAS. The calculation function makes use of the measurements, the known positions of the transmitter sites and the RTD of the transmissions to estimate the UE's position.

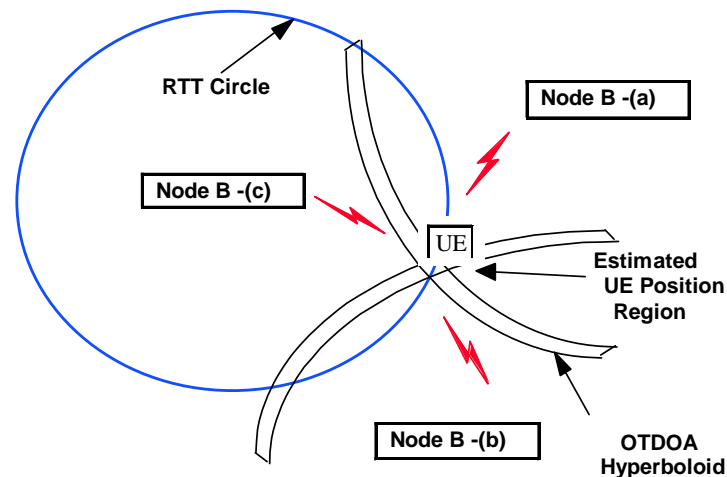

Figure 9.1: OTDOA Positioning Method

The OTDOA method may be operated in two modes: UE-assisted OTDOA and UE-based OTDOA. The two modes differ in where the actual position calculation is carried out.

In the *UE-assisted* mode, the UE measures the difference in time of arrival of several cells and signals the measurement results to the network, where the SRNC or the SAS carries out the position calculation.

In the *UE-based* mode, the UE makes the measurements and also carries out the position calculation, and thus requires additional information (such as the position of the measured Node Bs) that is required for the position calculation.

The signalling requirements for the two OTDOA modes are described in subclause 9.6. As the UE Positioning involves measurements, there is always uncertainty in the results. Physical conditions, errors and resolution limits in the apparatus all contribute to uncertainty. To minimise the uncertainty in the UE Positioning result, it is important that as many measurements of OTDOA (and assistance data as RTT in FDD and Rx Timing Deviation in TDD) as are possible for a UE are provided to the UE. Thus it is important that the standard UE Positioning method not be restricted to rely on a single measure. The UE thus provides SFN-SFN observed time difference measurements for as many cells as it can receive. The cells to be measured shall include those in the active set and the monitored set.

In order to support the OTDOA method, the positions of the UTRAN transmitters needs to be accurately known by the calculation function in SRNC or SAS (for UE-assisted method) or UE (for UE-based method). This information may be measured by appropriate conventional surveying techniques (see note 3). The surveyed position should be the electrical centre of the transmitting antenna (and not the position of the radio equipment building). The use of antenna diversity, beamforming or beam steering techniques may cause the effective antenna position to change with time and this information is also needed to perform calculations. The methods of measuring the position of the UTRAN transmitters are outside the scope of the present document.

NOTE 3: These surveying methods may, for example, make use of a GPS receiver.

In order to support the OTDOA method, the RTD of the DL transmissions must also be known to perform the calculation. If the UTRAN transmitters are unsynchronised, the RTD will change over time as the individual clocks drift. Thus, RTD estimations may need to be made regularly and the calculation function updated appropriately.

One convenient method is to make use of an LMU at a fixed position. This unit performs timing measurements (e.g. UTRAN GPS timing of cell frames or SFN-SFN Observed Time Difference) of all the local transmitters. The CRNC then may convert these measures into the actual (absolute) relative time difference for each of the transmitters by making use of the known position of the LMU and the transmitters.

In some conditions a sufficient number of cells may not be available for measure at the UE. This may occur, for example, if the UE is located quite close to the UTRAN transmitter and its receiver is blocked by the strong local transmissions. This is referred to as the "hearability" problem.

9.1 Use of Idle Periods

Location based services needs the support of physical layer as a prerequisite, so that the measurements required for the UE position, and optional velocity calculation can be carried out. In UTRAN there are several factors that must be taken into account while considering the physical layer procedures related to location services:

- hearability: a basic consequence of a CDMA radio system is that a terminal near its serving Node B cannot hear other Node Bs on the same frequency. In order to calculate its position the UE should be able to receive at least three Node Bs. To facilitate this some special means are required;
- asynchronous network causes significant uncertainty to the time-difference-of-arrival (TDOA) measurements. To compensate for the effects of this, the relative time difference (the synchronicity) between Node B transmissions must be measured, and used for correcting OTDOA measurement;
- capacity loss: signalling related to position calculation may take capacity from other services. This capacity loss should be minimised.

Based on the results in [29] a solution for the above mentioned hearability problem is the IPDL method. In this method each Node B ceases its transmission for short periods of time (idle periods). Therefore the Node B is configured appropriately by the CRNC using the NBAP protocol [22]. During an idle period of a Node B, terminals within the cell can measure other Node Bs and the hearability problem is reduced. The UEs are made aware of the occurrences of IPDLs by using RRC signalling over the Uu interface [18]. Also, during idle periods the real time difference measurements can be carried out. Because the IPDL method is based on downlink the location service can be provided efficiently to a large number of terminals simultaneously.

The specification and operation of the IPDL technique are provided in [14] and [26].

9.2 Relative Time Difference (RTD)

In order to calculate the estimate of the position of the UE, the calculation function needs to know:

- the OTDOA measurements;
- the surveyed geographic positions of the Node Bs that have had their signals measured; and
- the actual relative time difference between the transmissions of the Node Bs at the time the OTDOA measurements were made.

The accuracy of each of these measurements contributes to the overall accuracy of the position estimate. The measurement of the RTD is described in the following.

There are several approaches to determining the RTD. One is to synchronise the transmissions of Node B. In this technique the RTD are known constant values (see NOTE) that may be entered in the database and used by the calculation function when making a position estimate. The synchronisation must be done to a level of accuracy of the order of tens of nanoseconds (as 10 nanoseconds uncertainty contributes 3 metres error in the position estimate). Drift and jitter in the synchronisation timing must also be well controlled as these also contribute uncertainty in the position estimate. Synchronisation to this level of accuracy is currently only readily available through satellite based time-transfer techniques. Generally in the TDD operating mode, the Node Bs are synchronised.

NOTE: The transmission times may all be aligned to a common reference (such as UTC) in which case all RTD have a common value. However, in a more general case the transmissions may have a fixed offset with reference to UTC, and thus the RTD values are non-zero and may be stored in the database for use by the calculation function.

Alternatively (typically in FDD mode), Node Bs may be left to free run within some constraint of maximum frequency error. In this scenario, the RTD will change (slowly) with time. The rate of change will depend on the frequency difference and jitter between Node Bs. If, for example, the maximum frequency difference between two Node Bs is $\pm 10^{-9}$, then the start of transmission of a 10 millisecond code sequence will drift through a cycle in about 1 390 hours (or 57 days). With this relatively slow rate of drift the measurements needed to obtain the RTD can be performed by fixed LMUs at known positions and stored in the database for use by the calculation function. The jitter and drift of the individual oscillators in each Node B may cause the change of timing to slow, remain constant or reverse direction over time. Ongoing measurements may be made to assure the most current values are available for the calculation function. The measurement units needed to support RTD estimation may be co-located with the Node Bs or installed at other convenient positions in the UTRAN coverage area, and report their results through the UTRAN signalling.

The LMUs may directly measure the SFN-SFN Observed Time Difference between neighbouring and reference cells and return the measurements to the CRNC. Alternatively the LMUs may measure the UTRAN GPS timing of cell frames of the neighbouring and reference cells and return the measurements to the CRNC. If the CRNC is not the SRNC the information is also forwarded from CRNC to SRNC. In networks with a SAS the information may also be forwarded to the SAS.

The SRNC or SAS then uses the UTRAN GPS timing of cell frames or SFN-SFN Observed Time Difference measurements to calculate the RTD values. The information to be transferred in each case is listed in 7.4.3.

9.3 Time of Day (ToD)

If there are frequency drifts between the (unsynchronised) Node Bs, as noted in subclause 9.2, the OTDOA measurements must be reported together with the time-of-day they were made (timestamp). This is necessary so that the appropriate value of the RTD may be used by the calculation function.

In order to assure less than a 20 nanosecond uncertainty in the RTD value, the time of day must be known to better than 10 seconds (if the maximum frequency difference between the Node Bs is $\pm 10^{-9}$). The method by which the ToD is measured is the system frame number, which provides a 10 millisecond resolution and can be unambiguous up to 40.95 seconds.

9.4 Node B Synchronisation

It is preferable that the positioning methods do not require the Node B to be synchronised. The needed level of synchronisation accuracy for UE Positioning is not by any means straightforward to achieve. The necessary information to obtain RTD between Node Bs can be measured by LMU (e.g. UTRAN GPS timing of cell frames or SFN-SFN Observed Time Difference) and distributed in the network (e.g. as broadcast information). Also, these measurements may benefit from the IPDL option.

In the TDD operating mode the Node Bs will typically be synchronised and this may be of assistance to the UE Positioning technique.

9.5 OTDOA-IPDL and OTDOA Modes

There are two modes of operation for the OTDOA-IPDL and OTDOA methods.

In the *UE-assisted* mode, the UE measures the difference in time of arrival of several cells and signals the measurement results to the network, where the SRNC or SAS carries out the position calculation.

In the *UE-based* mode, the UE makes the measurements and also carries out the position calculation, and thus requires additional information (such as the position of the measured Node Bs) that is required for the position calculation. This information is provided by the System Information Broadcast.

9.5.1 Information to be transferred between UTRAN elements

Table 9.1 lists the required information for both UE-assisted and UE-based modes that may be sent from UTRAN to UE. The required information can be signalled to the UE either in a broadcast channel or partly also as dedicated signalling.

Table 9.1: Information to be transferred from UTRAN to UE ('Yes' = information required, 'No' = Information not required)

| Information | UE-assisted | UE-based |
|--|-------------|----------|
| Intra frequency Cell Info (neighbour list) | Yes | Yes |
| Ciphering information for UE Positioning (see note 1) | No | Yes |
| Measurement control information (idle period locations) | Yes | Yes |
| Sectorisation of the neighbouring cells | No | Yes |
| Measurements results needed for RTD values for Cells mentioned at Intra frequency Cell Info | No | Yes |
| RTD accuracy | No | Yes |
| Measured roundtrip delay for primary serving cell | No | Yes |
| Geographical position of the primary serving cell | No | Yes |
| Relative neighbour cell geographical position | No | Yes |
| Accuracy range of the geographic position values | No | Yes |
| IPDL parameters | Yes | Yes |
| IPDL-Alpha parameter for Open Loop Power Control when using IPDLs in TDD (see note 2) | Yes | Yes |
| Maximum Power increase the UE may use when using IPDLs in TDD (see note 2) | Yes | Yes |
| NOTE 1: The idea behind UE Positioning specific ciphering information is e.g. that the operator can sell information that the UE needs for calculating its position. For reference in the GSM world see [4]. | | |
| NOTE 2: These parameters are not required for 1.28 Mcps TDD in this release. | | |

When IPDLs for 3.84/7.68 Mcps TDD are applied and the IPDLs occur in the slot carrying the PCCPCH, a special alpha parameter needs to be signalled from SRNC to the UE in order to take the impact of the IPDLs on the Open Loop Power Control into account. Additionally the UE shall not increase the transmit power by a certain value between an IPDL slot and the next slot carrying the PCCPCH when IPDLs are applied within a cell. OTDOA for 1.28 Mcps TDD is based on DwPTS and so these requirements do not apply.

The information that may be signalled from UE to SRNC is listed in table 9.2.

Table 9.2: Information to be transferred from UE to SRNC

| Information | UE-assisted | UE-based |
|---|-------------|----------|
| OTDOA measurement results | Yes | No |
| OTDOA measurement accuracy | Yes | No |
| UE geographical position | No | Yes |
| Position accuracy indicator (based on the signalled and measurement accuracies) | No | Yes |

Table 9.3 shows the information that may be transferred from Node B to its CRNC. If the CRNC is not the SRNC the information is also forwarded from CRNC to SRNC.

Table 9.3: Information to be transferred from Node B/LMU to CRNC and between RNCs

| Information | UE assisted | UE based |
|--|-------------|----------|
| Measured UTRAN GPS timing of cell frames or SFN-SFN Observed Time Difference values for Cells mentioned at Intra frequency Cell Info | Yes | Yes |
| UTRAN GPS timing of cell frames or SFN-SFN Observed Time Difference accuracy | Yes | Yes |

Table 9.4 shows the information that may be transferred from CRNC to Node B. If the CRNC is not the SRNC the information may also be sent from CRNC to SRNC.

Table 9.4: Information to be transferred from CRNC to Node B/LMU and between RNCs

| Information | UE assisted | UE based |
|-----------------|-------------|----------|
| IPDL parameters | Yes | Yes |

Table 9.5 shows the information that may be transferred between RNCs.

Table 9.5: Information to be transferred between RNCs

| Information | UE assisted | UE based |
|---|-------------|----------|
| Geographical position of the primary serving cell | Yes | Yes |
| Relative neighbour cell geographical position | Yes | Yes |
| Accuracy range of the geographic position values | Yes | Yes |
| IPDL-Alpha parameter for Open Loop Power Control when using IPDLs in 3.84/7.68 Mcps TDD | Yes | Yes |
| Maximum Power the UE may use when using IPDLs in 3.84/7.68 Mcps TDD | Yes | Yes |

9.6 OTDOA network positioning procedures

OTDOA may be selected by the SRNC as the method to be used on receipt of an LCS positioning request from the CN or, optionally, when the SRNC receives a PCAP Position Activation Request message indicating the OTDOA positioning method from a SAS that is configured to select the positioning method. In the SAS initiated case the OTDOA measurement information will be returned to the SAS in a PCAP Position Activation Response message, or – if periodic reporting was requested – in one or more PCAP Position Periodic Report messages as discussed below.

9.6.1 RNC based selection of OTDOA

The following diagram illustrates the operations for the OTDOA method for UE Positioning when the request for positioning information is initiated by an LCS application from the CN.

This illustration only includes the information flow related to UE Positioning operations and does not indicate other operations that may be required, for example, to establish a signalling connection between the UE and the SRNC. Also not illustrated is the signalling used to initiate the location service request from the CN or a UE-based application.

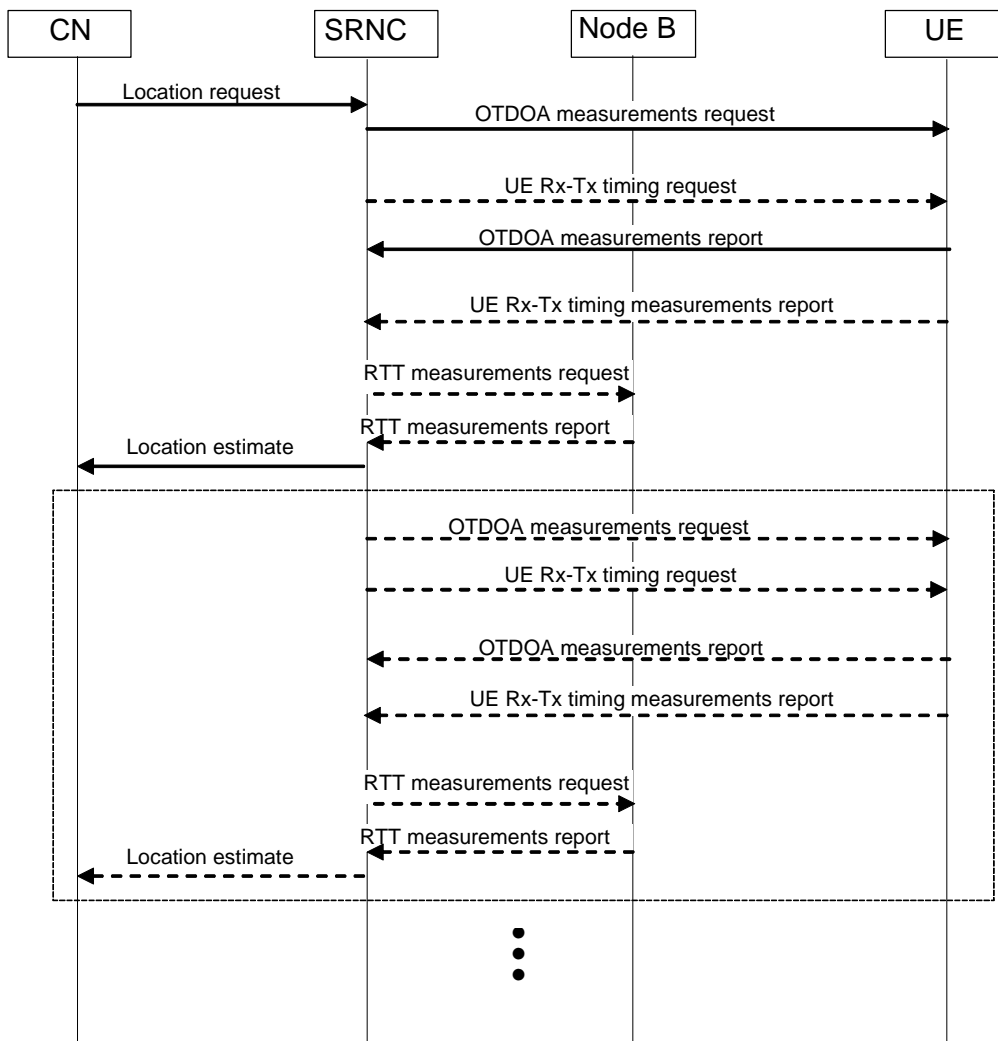

Figure 9.2: OTDOA Signalling Operations

1. The operation begins with an authenticated request for positioning information about a UE from an application in the CN being received at the SRNC. The request from the CN may be a request for on-demand or periodic reporting. The SRNC considers the request and the UTRAN and UE capabilities.
2. The SRNC requests from the UE the measurement of the OTDOA for the signals in the active and neighbourhood sets. These measurements are made while the UE is in connected mode CELL_DCH state. If the location request from the CN in step 1 contained periodic reporting information (reporting interval and amount of reports), the SRNC may at this step request periodic OTDOA measurement reporting from the UE according to subclause 6.6.4.1.
3. If it is considered advantageous to do so, the SRNC requests the UE Rx-Tx timing difference (FDD only) or UE timing advance, T_{ADV} , (1.28 Mcps TDD) information from the UE. If the location request from the CN in step 1 contained periodic reporting information (reporting interval and amount of reports), the SRNC may at this step request periodic measurement reporting from the UE according to subclause 6.6.4.1.
4. The UE returns the OTDOA measures to the SRNC. The SRNC receives the OTDOA information and coordinates obtaining other information to support the calculation request.
5. The UE returns the UE Rx-Tx timing difference (FDD only) or UE timing advance, T_{ADV} , (1.28 Mcps TDD) information to the SRNC, together with a time stamp of when the value was obtained.
6. If there are insufficient OTDOA measures, or it is otherwise considered advantageous to do so, the SRNC requests the RTT (in FDD) or Rx timing deviation (in TDD) and/or angle of arrival (in 1.28 Mcps TDD) measure for the UE from the serving Node B.

7. In FDD, the SRNC requests the RTD values for the associated transmitters from the associated database. These may be stored locally if they are constant over time, otherwise they must be updated to represent the RTD timing at the time-of-day the OTDOA measurements were made.
8. The Node B returns the RTT (in FDD) or Rx Timing Deviation (in TDD) and/or angle of arrival (in 1.28 Mcps TDD) measures to the SRNC if they were requested.
9. The SRNC performs a position, and optional velocity calculation using the OTDOA, RTD and, if necessary, RTT (in FDD) or Rx timing deviation and UE timing advance (in TDD) information and angle of arrival information (1.28 Mcps TDD). The calculation may include a co-ordinate transformation to the geographic system requested by the application. The position estimate includes the position and the estimated accuracy of the results. The optional velocity estimate may also include an estimated accuracy. In networks that include the SAS, the SAS may perform the position calculation and then pass the position estimate to the SRNC.
10. The SRNC passes the position estimate to the CN including, if available, the positioning method (or the list of the methods) used to obtain the position and optional velocity estimate. If the CN has requested an accuracy for the position estimate, the Location response shall include an indication whether the position estimate satisfies the requested accuracy or not.
11. If periodic reporting was requested from the CN in step 1, and steps 2 or 3 requested periodic UE reporting according to subclause 6.6.4.1, steps 4 to 10 are repeated. If periodic reporting was requested from the CN in step 1, but the SRNC does not request periodic UE reporting at steps 2 or 3, the SRNC repeats steps 2 to 10. The SRNC sends a location estimate to the CN one reporting interval after the previous location estimate until the desired amount of reports has been attained (or until the procedure is cancelled by UTRAN or CN).

9.6.2 SAS based selection of OTDOA

The following describes the signalling for the optional selection of the OTDOA positioning procedure by the SAS when the CN has requested UE positioning.

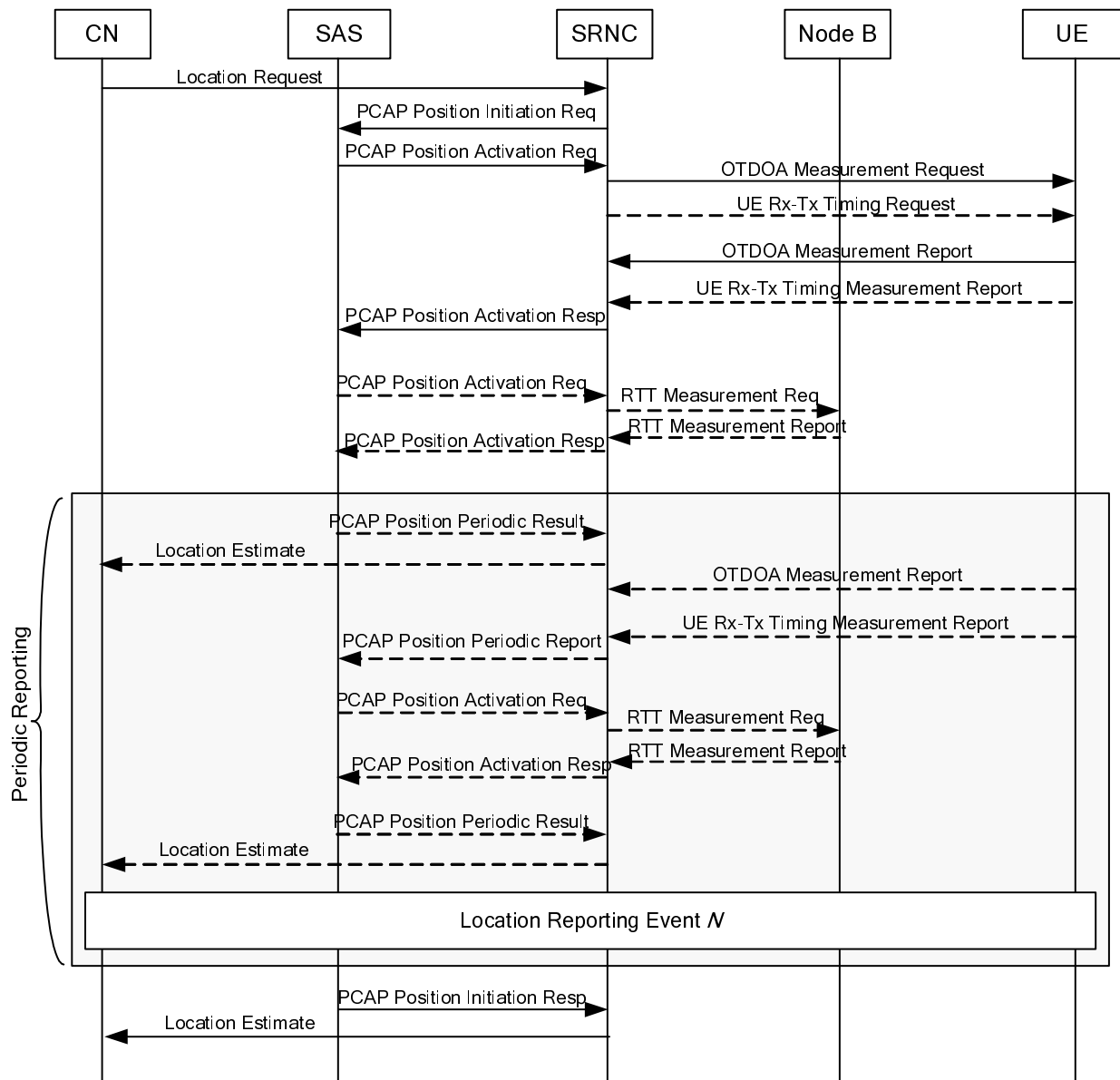

Figure 9.3: OTDOA Signalling Operations for SAS based positioning method selection

1. The operation begins with an authenticated request for positioning information about a UE from an application in the CN being received at the SRNC. The request from the CN may be a request for on-demand or periodic reporting. The SRNC considers the request and the UTRAN and UE capabilities.
2. The SRNC forwards the information contained in the RANAP Location Reporting Control message, including any periodic reporting information, plus the Cell ID and UE capability information to the SAS in a PCAP Position Initiation Request message.
3. The SAS sends a PCAP Position Activation Request message to the SRNC that requests the OTDOA positioning method and may also request the UE Rx-Tx timing difference (FDD only) or UE timing advance, T_{ADV} , (1.28 Mcps TDD) information from the UE. The PCAP Position Activation Request message may include periodic reporting information (amount of reports and reporting interval).
4. The SRNC requests from the UE the measurement of the OTDOA for the signals in the active and neighbourhood sets. The OTDOA measurement request may include a request for periodic reporting as described in subclause 6.6.4.1. These measurements are made while the UE is in connected mode CELL_DCH state.
5. If the SAS has requested Rx-Tx timing information, the SRNC requests the UE Rx-Tx timing difference (FDD only) or UE timing advance, T_{ADV} , (1.28 Mcps TDD) information from the UE. The measurement request may include a request for periodic reporting as described in subclause 6.6.4.1.

6. The UE returns the OTDOA measures to the SRNC. The SRNC receives the OTDOA information and coordinates obtaining other information to support the calculation request.
7. The UE returns the UE Rx-Tx timing difference (FDD only) or UE timing advance, T_{ADV} , (1.28 Mcps TDD) information to the SRNC, together with a time stamp of when the value was obtained.
8. The SRNC forward the OTDOA measurement report information and, if available, the UE Rx-Tx timing measurement report information to the SAS in a PCAP Position Activation Response message.
9. If there are insufficient OTDOA measures, or it is otherwise considered advantageous to do so, the SAS requests the RTT (in FDD) or Rx timing deviation (in TDD) and/or angle of arrival (in 1.28 Mcps TDD) measure for the UE from the serving Node B by sending a PCAP Position Activation Request message that requires the SRNC to execute the Cell ID positioning method toward the UE being positioned.
10. In FDD, the RTD values for the associated transmitters are calculated and stored in the SAS based upon input from its associated LMUs.
11. The Node B returns the RTT (in FDD) or Rx Timing Deviation (in TDD) and/or angle of arrival (in 1.28 Mcps TDD) measures to the SRNC if they were requested.
12. The SRNC forwards Cell ID and RTT (in FDD) or Rx timing deviation and UE timing advance (in TDD) information and angle of arrival information (1.28 Mcps TDD) to the SAS in a PCAP: Position Activation Response message.
13. The SAS performs the OTDOA based or Cell ID based position calculation. If periodic reporting was not requested in step 1, the SAS forwards the position information to the SRNC in a PCAP: Position Initiation Response message. If periodic reporting was requested in step 1, the SAS forwards the position information to the SRNC in a PCAP Position Periodic Result message. The calculation may include a co-ordinate transformation to the geographic system requested by the application. The position estimate includes the position and the estimated accuracy of the results. The optional velocity estimate may also include an estimated accuracy.
14. The SRNC passes the position estimate to the CN including, if available, the positioning method (or the list of the methods) used to obtain the position and optional velocity estimate. If the CN has requested accuracy for the position estimate, the Location response shall include an indication whether the position estimate satisfies the requested accuracy or not.
15. If periodic UE reporting was requested in step 4 or 5, the UE continues to send OTDOA measurements or UE Rx-Tx timing difference (FDD only) or UE timing advance, T_{ADV} , (1.28 Mcps TDD) information to the SRNC, together with a time stamp of when the value was obtained, one reporting interval after the previous measurement report. The SRNC forwards the OTDOA measurement report information and, if available, the UE Rx-Tx timing measurement report information to the SAS in a PCAP Position Periodic Report message. The SRNC may aggregate the OTDOA measurement report information and the UE Rx-Tx timing measurement report information, if both are received from the UE in separate RRC messages, into the same PCAP Position Periodic Report message or may send this information in two separate PCAP Position Periodic Report messages. Steps 9 to 12 may be repeated for each new position estimate, and the SAS performs OTDOA based or Cell ID based position calculation and forwards each new position information to the SRNC in a PCAP Position Periodic Result message. The SRNC passes the new position estimate to the CN including, if available, the positioning method (or the list of the methods) used to obtain the position and optional velocity estimate. If the CN has requested accuracy for the position estimate, the Location response shall include an indication whether the position estimate satisfies the requested accuracy or not. This step 15 is repeated until the desired amount of reports has been attained or the procedure is cancelled by the CN or UTRAN. The SAS may send the final location estimate in a PCAP Position Initiation Response message to the SRNC, and the SRNC forwards the final location information to the CN.
16. If periodic UE reporting was not requested in step 4 or 5, but was requested in step 2, the SAS may repeat the steps 3 to 14 as for the first request until the desired amount of reports has been attained or the procedure is canceled by the CN or UTRAN. When repeating step 13 for the final request, the SAS returns the resulting final position estimate to the SRNC in a PCAP: Position Initiation Response message.

10 Network-assisted GPS positioning method

When GPS is designed to inter-work with the UTRAN, the network assists the UE GPS receiver to improve the performance in several respects. These performance improvements will:

- reduce the UE GPS start-up and acquisition times; the search window can be limited and the measurements sped up significantly;
- increase the UE GPS sensitivity; positioning assistance messages are obtained via UTRAN so the UE GPS can operate also in low SNR situations when it is unable to demodulate UE GPS signals;
- allow the UE to consume less handset power than with stand-alone GPS; this is due to rapid start-up times as the GPS can be in idle mode when it is not needed.

The Network-assisted GPS methods rely on signalling between UE GPS receivers (possibly with reduced complexity) and a continuously operating GPS reference receiver network, which has clear sky visibility of the same GPS constellation as the assisted UEs. GPS reference receivers may be connected to the UTRAN to enable derivation of UE assistance signals.

Figures 10.1 and 10.2 provide an example of the end-to-end call flows for UE-assisted and UE-based positioning respectively. The SAS is an optional network element and the call segments do not apply in a network where the UE Positioning resides within the SRNC.

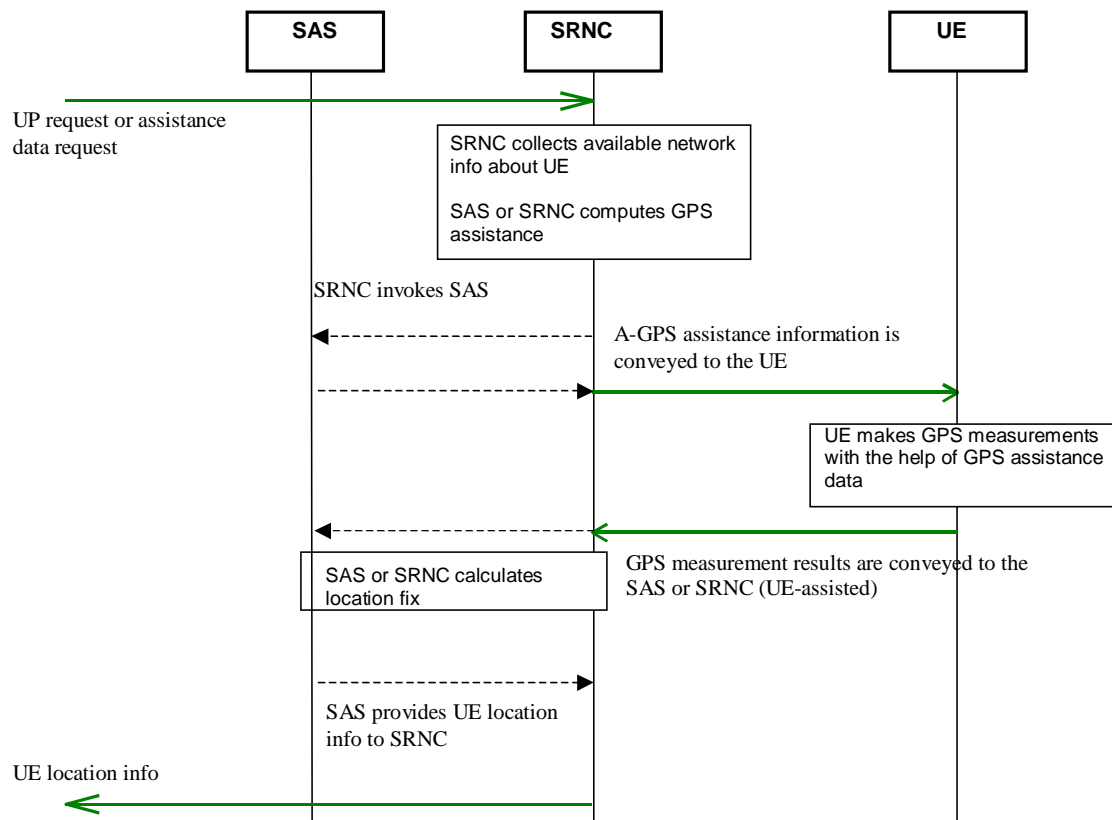

Figure 10.1: Network-assisted GPS methods – UE-Assisted

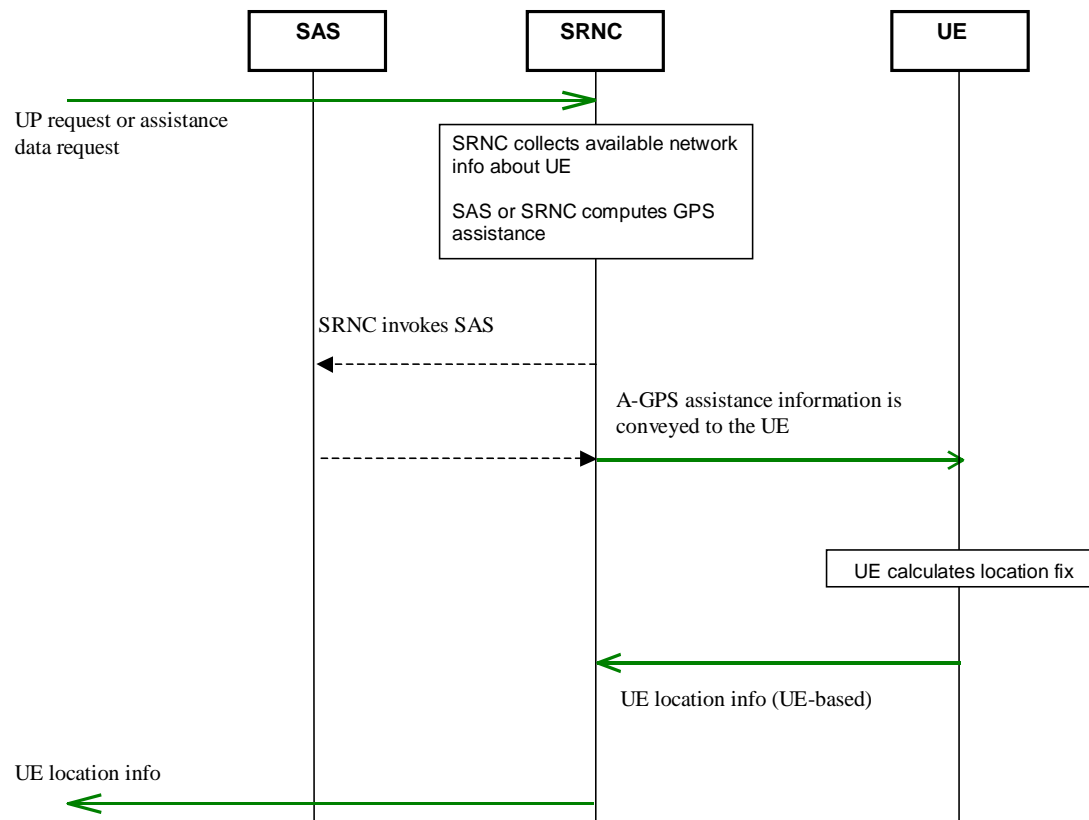

Figure 10.2: Network-assisted GPS methods – UE-Based

10.1 Timing calibration

Timing calibration is achieved by using UE or UTRAN GPS timing measurements as specified in [15].

10.2 Timing assistance

The UTRAN may derive the estimated UE position using UTRAN parameters (e.g. Cell-ID or IPDL) and may use this information, in conjunction with satellite specific ephemeris data received from the GPS reference receiver network, to derive the estimated times of arrival (code phases) for equivalent GPS satellite signals received by the UE-based GPS receiver functionality. For the UE-assisted method, the estimated code phase data may be conveyed, together with $T_{\text{UTRAN-GPS}}$ (as specified in [15] and [16]), from the UTRAN to the UE using higher layer signalling. The estimated code phase data value is uncertain to a degree depending on the accuracy of the UTRAN timing calibration and initial position determination methods used.

Alternatively, for the UE-based method, the UE itself may derive its location aided by assistance messages. The ephemeris data are transmitted from UTRAN to the UE using higher layer signalling. The UE may use this information, in conjunction with the UE's reference location, to derive the times of arrival (code phases) for GPS satellite signals received by the UE-based GPS receiver functionality.

10.3 GPS assistance data

The UE may receive GPS information through the UTRAN radio interface, using higher layer signalling. Once a UE Positioning measurement is setup by the SRNC the UE is responsible to maintain valid and up to date GPS assistance data in order to report the requested measurement results. In case that the UE has not sufficient assistance data or the data is out of date then the UE should indicate it to the SRNC and additionally request for assistance data.

When the UE is unable to detect a sufficient number of satellites, the assisted GPS method can be combined with other positioning methods. Altitude assistance can compensate for one satellite measurement.

The assistance data signalled to the UE may include all information listed below or a selected subset:

- data assisting the measurements; e.g. reference time, visible satellite list, satellite signal Doppler, code phase, Doppler and code phase search windows. This data can be valid for a few minutes (e.g., less than 5 minutes) or longer depending on the code phase and Doppler search window size that can be accommodated by the UE;
- data providing means for position calculation; e.g. reference time, reference position, satellite ephemeris, clock corrections. Satellite ephemeris and clock corrections data can be used for up to six hours.

NOTE: Certain types of GPS Assistance data may be derived, wholly or partially, from other types of GPS Assistance data.

If DGPS is utilised, then differential corrections may also be transmitted. If Selective Availability is turned off, these corrections can be valid for a few minutes or more. The DGPS data is valid for a large geographical area, so one centrally located reference receiver can be used to service this large region.

10.4 UE search

Provided that timing assistance, data assistance, and/or frequency reference is available in the UE, they should be applied in the GPS signal search procedure. The UE search procedure involves a three-dimensional search for a satellite pseudorandom code, time of arrival of a signal and the associated carrier Doppler.

"Modulation wipe-off" is defined here to mean a removal of the GPS navigation data bit modulation to GPS signals received at the UE, through the application of UTRAN timing and data assistance provided from the UTRAN to the UE. This process allows the UE to coherently integrate received GPS signals beyond 1 data bit period (i.e., 20 milliseconds).

10.5 Position determination

There are two types of network-assisted GPS methods, namely UE-based and UE-assisted, which differ according to where the actual position and optional velocity calculation is carried out.

Computation of the position and optional velocity fix can either be performed in UTRAN (i.e. SRNC or SAS) for UE-assisted or in the UE for UE-based.

The UE-based method maintains a full GPS receiver functionality in the UE, and the position and optional velocity calculation is carried out by the UE, thus allowing stand-alone position and optionally, velocity fixes.

In the UE-assisted method, the UE employs a reduced complexity GPS receiver functionality. This carries out the pseudorange (code phase) measurements. These are signalled, using higher layer signalling, to the specific network element that estimates the position of the UE and carries out the remaining GPS operations. In this method, accurately timed code phase signalling (as specified in [15] and [16]) is required on the downlink. If DGPS is performed in the UE, then differential corrections must be signalled to it. On the other hand, DGPS corrections can be applied to the final result in the network to improve the position accuracy without extra signalling to the UE.

10.5.1 Information to be transferred between UTRAN elements

Table 10.1 lists information for both UE-assisted and UE-based modes that may be sent from the network to UE. This information can be signalled to the UE either in a broadcast channel or as dedicated signalling.

Table 10.1: Information that may be transferred from the network to UE('Yes' = information applicable 'No' = information not applicable)

| Information | UE-assisted | UE-based |
|---|-------------|----------|
| Number of satellites for which assistance is provided | Yes | Yes |
| reference time for GPS ($T_{\text{UTRAN-GPS}}$) (specified in [15] and [16]) | Yes | Yes |
| 3-d reference position (specified in [11]) | No | Yes |
| ionospheric corrections | No | Yes |
| satellite ID for identifying the satellites for which assistance data is provided | Yes | Yes |
| Ephemeris & clock corrections | Yes | Yes |
| UTC offset | No | Yes |
| DGPS corrections | No | Yes |
| almanac data | Yes | Yes |
| real-time integrity (e.g. a list of unusable satellites) | No | Yes |
| doppler (0 th order term) | Yes | No |
| Doppler Search Window width | Yes | No |
| doppler (1 st order term) | Yes | No |
| azimuth | Yes | No |
| elevation | Yes | No |
| code phase | Yes | No |
| code phase centre and search window width | Yes | No |

The information that may be signalled from UE to the network is listed in table 10.2.

Table 10.2: Information that may be transferred from UE to the network

| Information | UE-assisted | UE-based |
|--|-------------|----------|
| reference time for GPS ($T_{\text{UE-GPS}}$) (specified in [15] and [16]) | Yes | Yes |
| serving cell information | No | Yes |
| Latitude/Longitude/Altitude/Error ellipse | No | Yes |
| velocity estimate in the UE | No | Yes |
| satellite ID for which measurement data is valid | Yes | No |
| Whole/Fractional chips for information about the code-phase measurement | Yes | No |
| C/N ₀ of the received signal from the particular satellite used in the measurements | Yes | No |
| doppler frequency measured by the UE for the particular satellite | Yes | No |
| pseudorange RMS error | Yes | No |
| multipath indicator | Yes | No |
| number of Pseudoranges | Yes | No |

Table 10.3 shows the information that may be transferred from Node B to its CRNC. If the CRNC is not the SRNC the information is also forwarded from CRNC to SRNC.

Table 10.3: Information that may be transferred from Node B/LMU to CRNC and between RNCs

| Information | UE-assisted | UE-based |
|--|-------------|----------|
| reference time for GPS ($T_{\text{UTRAN-GPS}}$) (specified in [15] and [16]) | Yes | Yes |

10.5.1.1 Almanac data

The almanac parameters specify the coarse, long-term model of the satellite positions and clocks. These parameters are a subset of the ephemeris and clock correction parameters in the Navigation Model, although with reduced resolution and accuracy. The almanac model is useful for receiver tasks that require coarse accuracy, such as determining satellite visibility. The model is valid for up to one year, typically. Since it is a long-term model, the field should be provided for all satellites in the GPS constellation.

Optionally, "SV Global Health" information may accompany this almanac information. This additional information is composed of the sequence of all non-parity data bits contained in words 3-10 of page 25 of subframe 4 of the GPS navigation message followed by the sequence of all non-parity bits contained in words 3-10 of page 25 of subframe 5 of the GPS navigation message. The following GPS navigation message fields are excluded when constructing these sequences: "Data ID", "SV (Page) ID", and "t".

10.5.1.2 DGPS corrections

In order to allow a UE to estimate its position more accurate, biases in the pseudorange measurements may be provided to the UE.

Status/Health

This information indicates the status of the differential corrections contained in the message.

IODE

This is the sequence number for the ephemeris for the particular satellite. The UE can use this information to determine if new ephemeris is used for calculating the corrections that are provided in the broadcast message. This eight-bit IE is incremented for each new set of ephemeris for the satellite and may occupy the numerical range of [0, 239] during normal operations. More information about this field can be found from [24].

User Differential Range Error (UDRE)

The UDRE provides an estimate of the uncertainty ($1-\sigma$) in the corrections for the particular satellite. The value in this field shall be multiplied by the UDRE Scale Factor in the common Corrections Status/Health field to determine the final UDRE estimate for the particular satellite. More information about this field can be found from [24].

Pseudo-Range Correction (PRC)

The PRC indicates the correction to the pseudorange for the particular satellite at the GPS Reference Time, t_0 . The PRC definition here is different from the one given in [24].

Pseudo-Range Rate Correction (RRC)

This information indicates the rate-of-change of the pseudorange correction for the particular satellite, using the satellite ephemeris identified by the IODE IE. The RRC definition here is different from the one given in [24].

10.5.1.3 Ionospheric corrections

The Ionospheric Model contains information needed to model the propagation delays of the GPS signals through the ionosphere. Proper use of these information allows a single-frequency GPS receiver to remove approximately 50% of the ionospheric delay from the range measurements. The Ionospheric Model is valid for the entire constellation and changes slowly relative to the Navigation Model.

10.5.1.4 Ephemeris data and clock correction

Ephemeris data and clock corrections provide an accurate model of the satellite positions to the UE.

10.5.1.5 Real Time integrity monitor function

An Integrity Monitor (IM) function in the network should detect unhealthy (i.e., failed/failing) satellites. Excessively large pseudo range errors, as evidenced by the magnitude of the corresponding DGPS correction determined by the IM, may be used to detect unhealthy satellites. Unhealthy satellites should be detected very close to the occurrence of the satellite failure (e.g. 10 seconds) and marked in an unhealthy satellite list as unusable/bad. When unhealthy satellites are detected, the assistance and/or DGPS correction data should not be supplied for these satellites. Upon receiving the list of unhealthy satellites from the SRNC, the UE shall consider the data associated with these satellites to be invalid.

The IM function should also inform the UE of measurement quality in DGPS modes when satellites are healthy. This can be done by computing the position of the DGPS reference receiver using its derived pseudo ranges and differential corrections at the IM, and differencing the IM computed position with the known location of the DGPS reference

receiver to compute a position error. When the error in the IM computed position is excessive for solutions based upon healthy satellites only, DGPS users should be informed of measurement quality through the supplied User Differential Range Error (UDRE) adjusted values based on the operation of the IM. The UE should use the measurement quality as a factor in weighing data obtained from associated satellites in its position calculation.

NOTE: UDRE is one of the IEs contained in the DGPS information ([19]).

The real-time Integrity Monitor function provides the following information to a UE:

- BadSATid;
- UDRE value adjusted based on the measurement quality.

BadSATid is a list of unhealthy (i.e., failed/failing) satellites. The UE shall consider any assistance or DGPS data of these satellites as invalid.

Adjusted UDRE value reports the measurement quality of the corresponding satellites. The UE should consider the quality while calculating its position.

10.5.1.6 GPS reference time

GPS reference time may be used to provide a mapping between UTRAN and GPS time.

GPS TOW Assist

This information contains several fields in the Telemetry (TLM) Word and Handover Word (HOW) that are currently being broadcast by the respective GPS satellites. Combining this information with GPS TOW helps the UE with time-recovery needed to predict satellite signal.

TLM Message

This information contains a 14-bit value representing the Telemetry Message (TLM) being broadcast by the GPS satellite identified by the particular SatID, with the MSB occurring first in the satellite transmission.

Anti-Spoof/Alert

These information contain the Anti-Spoof and Alert flags that are being broadcast by the GPS satellite identified by SatID.

TLM Reserved

These information contain the two reserved bits in the TLM Word being broadcast by the GPS satellite identified by SatID, with the MSB occurring first in the satellite transmission.

10.5.1.7 UTC

UTC parameters may be used to provide Coordinated Universal Time to the UE.

10.5.1.8 Reference Location

The Reference Location contains a 3-D location (with uncertainty) specified as per [11]. The purpose of this field is to provide the UE with a priori knowledge of its position in order to improve GPS receiver performance.

10.5.1.9 Additional non-GPS related information

Additional non-GPS measurements performed by UTRAN or UE may be used by the SRNC to improve the performance of the UE-assisted GPS method. This information may be RTT in FDD or Rx Timing Deviation in TDD, UE receiving transmitting time (UE Rx-Tx), SFN-SFN observed time difference or CPICH Ec/No. All the additional measurements are defined in [15] and [16] and can be made available through RRC signalling for UE measurements or NBAP signalling for UTRAN measurements.

Furthermore, to those UE technologies requiring externally provided sensitivity and time aiding data, some navigation bits may be sent from UTRAN to UE for sensitivity assistance and time recovery.

10.6 RNC based Network Assisted GPS positioning Procedure

The diagram in Figure 10.3 and Figure 10.2 illustrate the operations for the network assisted GPS when the request for position information is initiated by a LCS application signalled from the Core Network. A detailed description of the positioning procedure is given as follows. Note that the procedure is for illustration purpose and actual implementations may vary.

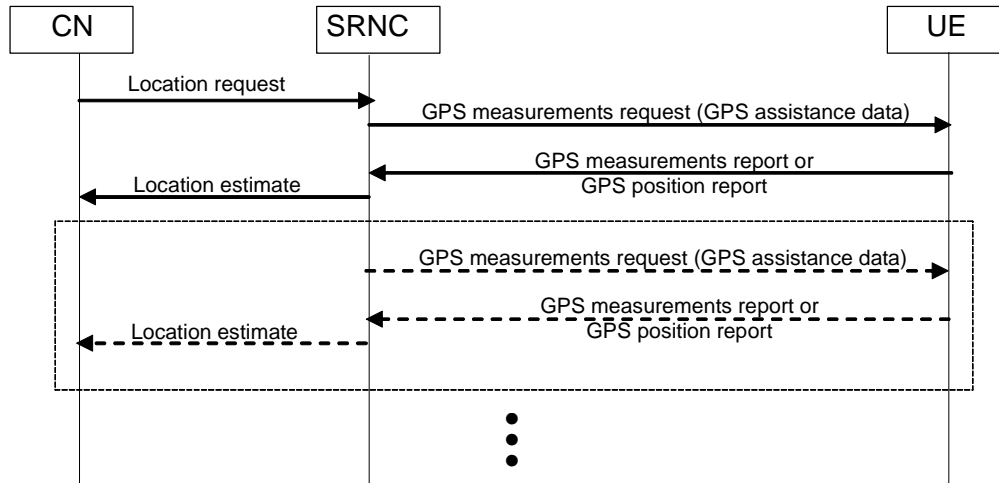

Figure 10.3: RNC based Network-assisted GPS methods

1. The operation begins with an authenticated request for positioning information about a UE from an application in the core network being received at the SRNC. The request from the CN may be a request for on-demand or periodic reporting. The SRNC acts as interface between the Core Network and the UE Positioning entities in the UTRAN. The SRNC considers the request and the capabilities of the UE and the UTRAN. In networks that include the SAS, the SRNC may invoke the SAS via the Iupc interface.
2. Depending on the UE capabilities, the network sends to the UE certain GPS assistance information. This information may include: the reference time for GPS, the satellite IDs, the Doppler frequency, the search window and its centre, the ephemeris and clock corrections, the almanac, and other information specified in 10.5.1. Depending on the UE capabilities, the network sends a request for GPS positioning to the UE. If the location request from the CN in step 1 contained periodic reporting information (reporting interval and amount of reports), the SRNC may at this step request periodic measurement reporting from the UE according to subclause 6.6.4.1. If the UE has not enough assistance data to perform the measurements, the UE should indicate it to the SRNC and additionally request for assistance data.

For UE-based method, jump to step 8.

3. For UE-assisted method, the SRNC may optionally request the following information before the assistance message(s) is (are) sent to the UE: the LMU update (see NOTE), the RTT measurements (from the Node Bs in the active set) to compensate for the one-way propagation delays. The LMU (associated or stand-alone) returns the information containing the time difference between the Node B and the GPS (e.g. UTRAN GPS timing of cell frames or SFN-SFN Observed Time Difference) to the CRNC. The Node B returns its RTT measurement to the CRNC. If the CRNC is not the SRNC, the CRNC forwards this information to SRNC.
4. The network requests from the UE the measurement of GPS satellite pseudoranges and other information specified in 10.5.1. These measurements may be made while the UE is in RRC connected mode CELL_DCH state. The SRNC may request SFN-SFN Observed Time Difference measurements and Rx-Tx timing difference information from the UE to support the processing related to the RTT measurements.
5. The UE returns to the network the measurement of GPS satellite pseudoranges and other information specified in 10.5.1. If requested, the UE returns to the SRNC SFN-SFN measurements and the Rx-Tx time difference information, together with a time stamp of when these values were obtained.
6. The UE position and optional velocity is calculated in the network.
7. If there is insufficient information to yield a UE positioning estimate, the SRNC may start a new process from step 3.

8. In case of UE based method, UE returns the position and optional velocity estimate to the SRNC. This estimate includes the position and optionally, velocity, the estimated accuracy of the results and the time of the estimate.
9. In networks that include the SAS, the SAS passes the position estimate to the SRNC.
10. The SRNC passes the position and optional velocity estimate to the CN including, if available, the positioning method (or the list of the methods) used to obtain the position estimate. If the CN has requested an accuracy for the position estimate, the Location response shall include an indication whether the position estimate satisfies the requested accuracy or not.
11. If periodic reporting was requested from the CN in step 1, and the SRNC requested periodic UE reporting in step 2 according to subclause 6.6.4.1, steps 5 to 10 are repeated and the UE reports new measurements one reporting interval after the previous measurement report. If periodic reporting was requested from the CN in step 1, but the SRNC does not request periodic UE reporting in step 2, the SRNC repeats steps 2 to 10. The SRNC sends a location estimate to the CN one reporting interval after the previous location estimate until the desired amount of reports has been attained (or until the procedure is cancelled by UTRAN or CN).

NOTE: The LMU update (of the time difference between the GPS and the Node B) may be performed on a per-request basis (with respect to each UE Positioning request) or be performed timely that is independent of individual UE Positioning request. The latter is preferable when there is a large volume of UE Positioning requests.

10.7 SAS initiated Network Assisted GPS positioning Procedure

The following describes the signalling for the optional initiation of the network assisted GPS positioning procedure by the SAS.

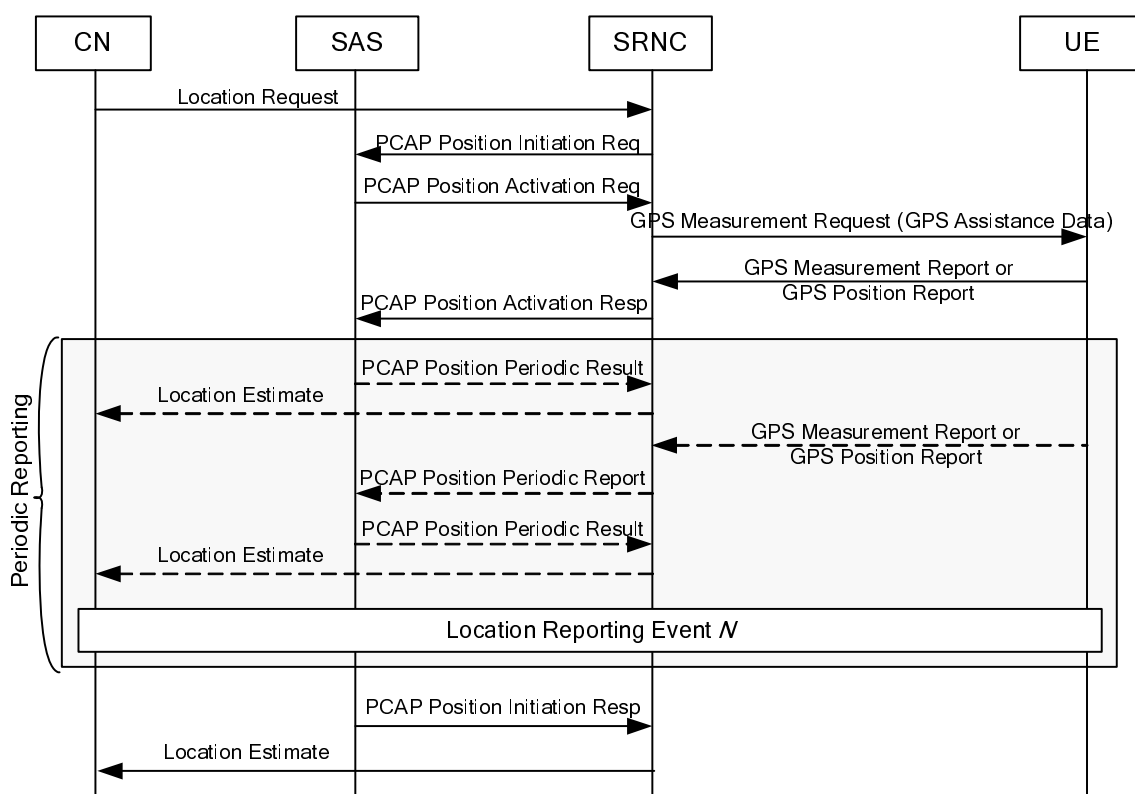

Figure 10.4: Network-assisted GPS methods when initiated by the SAS

1. The operation begins with an authenticated request for positioning information about a UE from an application in the core network being received at the SRNC. The request from the CN may be a request for on-demand or periodic reporting. The SRNC acts as interface between the Core Network and the UE Positioning entities in the UTRAN.

2. The SRNC sends parameters received in the location request, including any periodic reporting information, together with the Cell ID and UE capability information to the SAS in a PCAP: Position Initiation Request message via the Iupc interface.
3. Depending on the UE capabilities, the SAS initiates an A-GPS positioning procedure by sending a PCAP: Position Activation Request message containing A-GPS assistance data to the SRNC via the Iupc interface. The PCAP Position Activation Request message may include periodic reporting information (number of reports and reporting interval). The SAS may provide all or some A-GPS assistance data needed by the UE. This may include timing assistance data that the SAS may have obtained from associated LMUs or from another source (e.g. GPS Reference Network or measurements from UEs previously positioned by the SAS using A-GPS).
4. The SRNC forwards to the UE the A-GPS positioning request received from the SAS using RRC signalling. The SRNC also forwards in the RRC signalling message(s) the SAS request for either A-GPS measurements, in the case of UE assisted A-GPS, or an A-GPS position and optional velocity estimate, in the case of UE based A-GPS. The RRC signalling may include a request for periodic reporting as described in subclause 6.6.4.1 if this was received in step 3. For a description of UE based A-GPS, jump to step 9.
5. For UE assisted A-GPS, the SRNC requests from the UE the measurement of GPS satellite pseudoranges and other information specified in subclause 10.5.1. These measurements may be made while the UE is in RRC connected mode CELL_DCH state. The SRNC may request SFN-SFN Observed Time Difference measurements and Rx-Tx timing difference information from the UE to support the processing related to the RTT measurements.
6. The UE returns to the SRNC the measurement of GPS satellite pseudoranges and other information specified in 10.5.1. If requested, the UE returns to the SRNC SFN-SFN measurements and the Rx-Tx time difference information, together with a time stamp of when these values were obtained.
7. The information obtained in step 6 is sent from the SRNC to the SAS in a PCAP: Position Activation Response message.
8. The SAS calculates the UE position and optional velocity. If periodic reporting was not requested in step 2, the SAS returns the UE position and optional velocity to the SRNC in a PCAP: Position Initiation Response message. If periodic reporting was requested in step 2, the SAS forwards the position information to the SRNC in a PCAP Position Periodic Result message. The PCAP Position Initiation Response or PCAP Position Periodic Result message may include the positioning method(s) used and an indication of whether the position estimate satisfies the requested accuracy or not.
9. In case of UE based method, the UE returns the position and optional velocity estimate to the SRNC via RRC signalling. The SRNC forwards the position and optional velocity estimate to the SAS in a PCAP: Position Activation Response message. This estimate includes the position and optionally, velocity, the estimated accuracy of the results and the time of the estimate.
10. The SAS may verify the UE position estimate received in step 9 (e.g. using cell ID information). If periodic reporting was not requested in step 2, the SAS returns the resulting estimate to the SRNC in a PCAP: Position Initiation Response message. If periodic reporting was requested in step 2, the SAS forwards the position estimate to the SRNC in a PCAP Position Periodic Result message. The PCAP Position Initiation Response or PCAP Position Periodic Result message may include the positioning method(s) used and an indication of whether the position estimate satisfies the requested accuracy or not.
11. If there is insufficient information to yield a UE positioning estimate satisfying the requested accuracy, the SAS may start a new process from step 3.
12. The SRNC passes the position estimate received from the SAS to the CN including the positioning method (or the list of the methods) used to obtain the position estimate. If the CN has requested accuracy for the position estimate, the Location response shall include an indication whether the position estimate satisfies the requested accuracy or not.
13. If periodic UE reporting was requested in step 4, the UE continues to send GPS measurement reports one reporting interval after the previous measurement report. The SRNC forward the GPS measurement report information to the SAS in a PCAP Position Periodic Report message. The SAS may calculate the UE position and optional velocity and may verify the calculated UE position estimate or the received UE position estimate (e.g. using cell ID information) and sends the position information to the SRNC in a PCAP Position Periodic Result message. The SRNC passes the new position estimate to the CN including, if available, the positioning

method (or the list of the methods) used to obtain the position and optional velocity estimate. If the CN has requested accuracy for the position estimate, the Location response shall include an indication whether the position estimate satisfies the requested accuracy or not. This step 13 is repeated until the desired amount of reports has been attained or the procedure is cancelled by the CN or UTRAN. The SAS may send the final location estimate in a PCAP Position Initiation Response message to the SRNC, and the SRNC forwards the final location information to the CN.

14. If periodic UE reporting was not requested in step 4, but was requested in step 2, the SAS may repeat the steps 3 to 12 as for the first request until the desired amount of reports has been attained or the procedure is cancelled by the CN or UTRAN. When repeating step 10 for the final request, the SAS returns the resulting final position estimate to the SRNC in a PCAP: Position Initiation Response message.

NOTE: An update to the SAS from an associated LMU, of the time difference between GPS and the Node B, may be performed on a per-request basis (with respect to each UE Positioning request) or be performed in a timely manner that is independent of individual UE Positioning requests. The latter is preferable when there is a large volume of UE Positioning requests.

11 Information storage

NOTE This clause just outlines the information that may need to be stored in the UTRAN UE Positioning that may need to be standardised (if any).

12 Uplink-Time Difference Of Arrival (U-TDOA) positioning method

12.1 General

The U-TDOA method calculates the location of a transmitting UE by using the difference in time of arrival of signals at different LMUs. The time required for a signal transmitted by a UE to reach a U-TDOA capable LMU is proportional to the length of the transmission path between the UE and the U-TDOA capable LMU. The U-TDOA method does not require knowledge of the time the UE transmits nor does it require any new functionality in the UE.

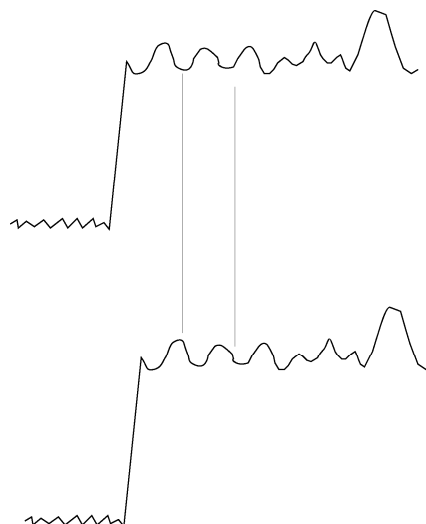

Figure 12.1: Ideal Signal Collection

Figure 12.1 shows a time domain representations of two perfectly matched signals as received from the same UE by two U-TDOA capable LMUs in ideal conditions, including high signal-to-noise ratio and no multipath distortion.

Because the receivers are at different distances from the transmitting UE, the signals are out of phase; they do not correlate.

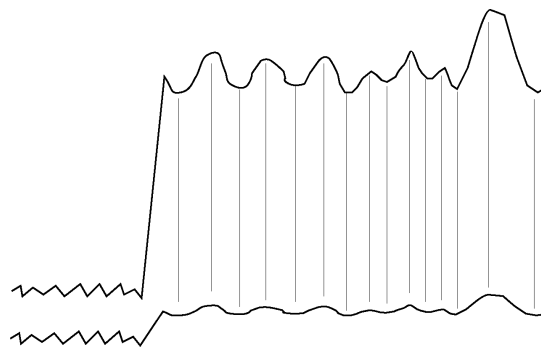

Figure 12.2. Ideal and Attenuated Waveforms

Figure 12.2 shows the theoretical effects of increased distance, multipath distortion, and interference on a received signal. The top signal was received under ideal conditions. The lower one represents what that signal would look like in more realistic conditions. It is attenuated to a level much closer to the noise floor. Nevertheless, there is a correlation with the original signal.

Cross-correlation is a statistical technique that compares the waveforms of two signals point for point. Identical signals in perfect phase would yield a correlation coefficient of 1. In Figure 12.3, even though the waveform in (b) is attenuated compared to (a), the alignment would still yield a very high correlation, say 0.999.

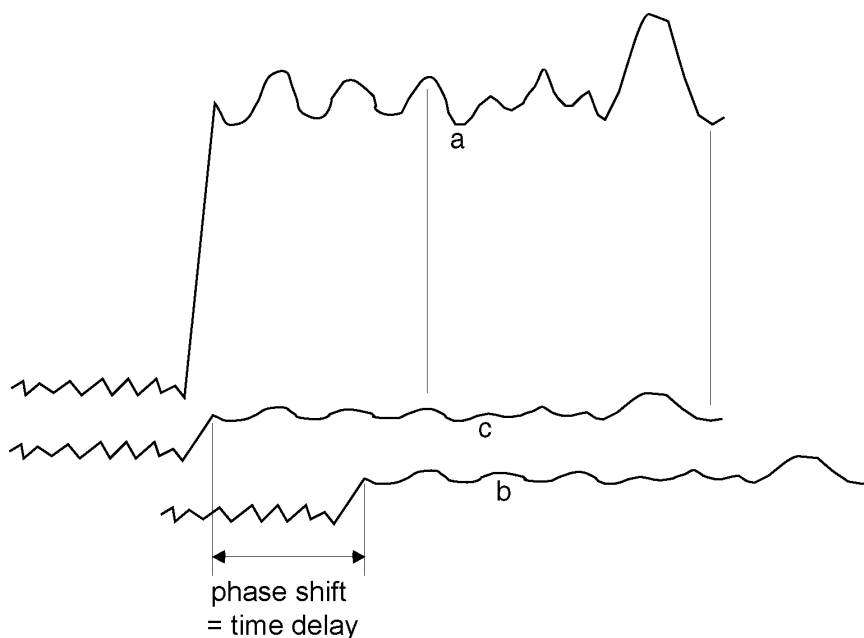

Figure 12.3. Using Cross-Correlation to Compute Time Delay

Figure 12.3 shows (a) a signal received by a U-TDOA capable LMU that is close to the transmitter and (b) the same signal received by a second U-TDOA capable LMU farther away. The latter signal is attenuated and perhaps distorted. It is also out of phase with the original signal because it was received at a later time. The correlation coefficient between (b) and (a) would be quite low. However, by shifting the (b) curve to the left, it is possible to find a position in which the correlation coefficient is maximized (shown by (c)). For this position, the amount of shift required is equal to the arrival time difference of the signal between the two U-TDOA capable LMUs.

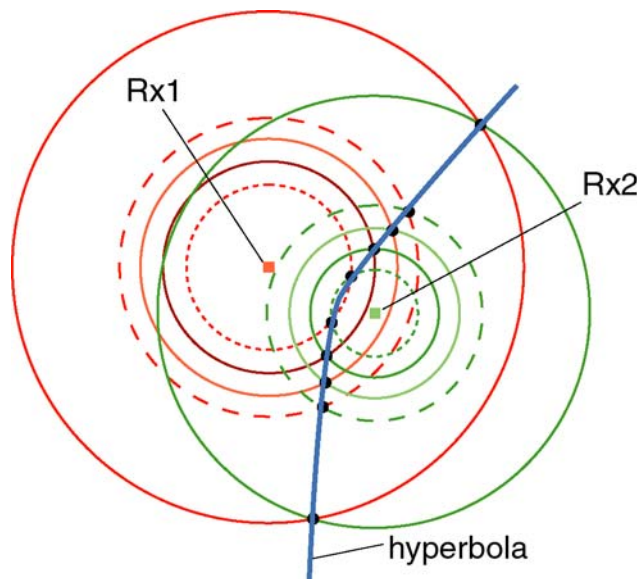

Figure 12.4. Deriving the Hyperbolic Function for Time Delay

In this model (Figure 12.4), Rx1 and Rx2 represent fixed locations of two U-TDOA capable LMUs in a network. The pairs of intersecting circles centered around Rx1 and Rx2 have radii such that each radius represents the time, t_{TR} , it takes a signal to travel from a UE transmitter to each U-TDOA capable LMU (that time being unknown). The difference between radii is a constant equal to the difference between t_{TR1} for the first U-TDOA capable LMU and t_{TR2} for the second U-TDOA capable LMU. $t_{TR1} - t_{TR2}$ is the value that the U-TDOA system measures. When you plot and connect the points of intersections between each pair of circles, the resulting shape is a hyperbola. The hyperbola defined by the reference site in comparison to another site constitutes a baseline. If you constructed a similar hyperbola for another pair of U-TDOA capable LMUs receiving transmissions from the same UE, that hyperbola would intersect at two points with the first hyperbola, yielding two possible locations for the UE. A third such hyperbola (Figure 12.5) would yield a unique location for the calling phone, so that a minimum of four reception sites is needed to obtain the unique location estimate.

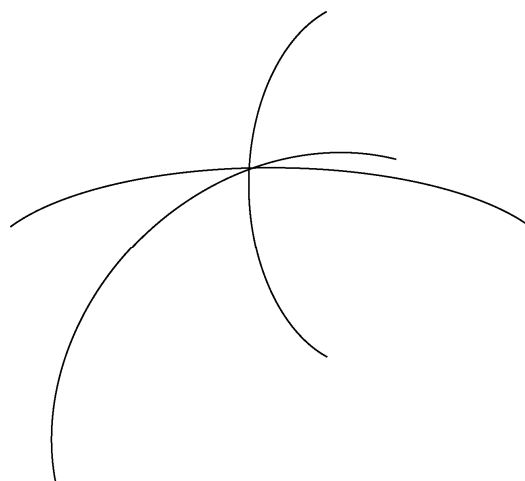

Figure 12.5. Intersection of Three Hypothetical Hyperbolas Calculated from Time Delay Differences

In the U-TDOA method, the reference measurement is the one that represents the U-TDOA capable LMU site that collects the signal with the highest quality. That site is usually the site closest to the UE, and normally generates the highest signal level as well as the highest SNR. In addition, it presumably exhibits the lowest multi-path error. Therefore the reference time delay is the one against which time differences are measured. Any errors introduced into the time delay measurement yield inaccuracies in the intersection point. Since the speed of light is approximately 0.3 m/nsec in air, a nanosecond error in time delay measurement introduces 0.3 meters of error.

The more hyperbolas that are calculated, that is, the more cooperating U-TDOA capable LMUs used in the calculation, the more accurate is the estimate of the UE's position. This is another way of saying that statistical confidence improves with an increase in sample points. When many sites enter into the calculation, the effects of a large time delay measurement error at a single site are minimized.

12.2 U-TDOA SAS architecture

The overall network architecture is similar to the previous architecture and is illustrated in Figure 12.6. The only difference is that the U-TDOA capable LMU are connected directly to the SAS via an overlay network.

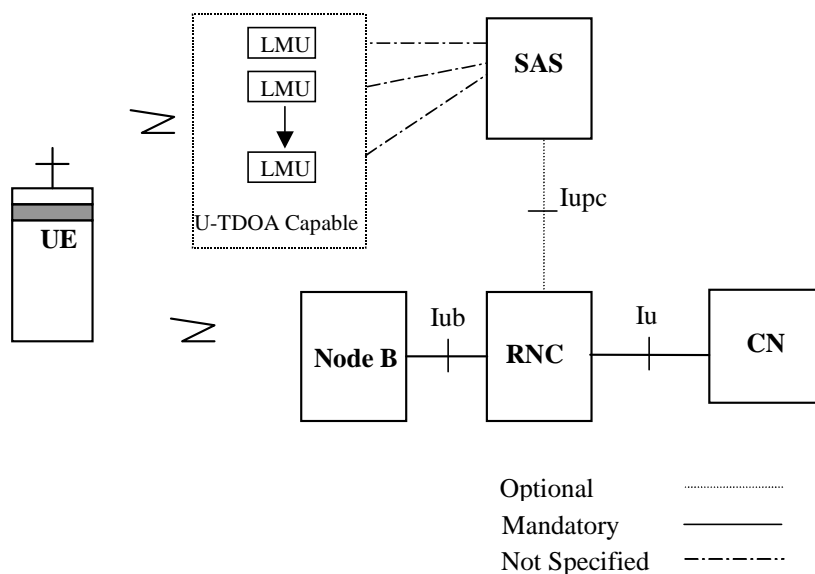

Figure 12.6 – U-TDOA SAS Architecture

The impact on the SAS centric approach due to the presence of the Iur is FFS.

12.3 RNC based U-TDOA positioning for Cell_DCH and Cell_FACH RRC states

The U-TDOA positioning method can be performed when the UE is in either the CELL_DCH or CELL_FACH RRC states. If the UE is in the CELL_PCH or URA_PCH state the SRNC shall first bring the UE to the CELL_FACH or CELL_DCH states so that the U-TDOA measurements can be performed by the LMUs and to provide the current serving Cell ID if the UE was in the URA_PCH state.

12.3.1 UE in CELL_DCH state

The SRNC may invoke the U-TDOA positioning method using the PCAP: Position Calculation Request message that contains the Cell ID and RF channel information for the UE being positioned when that UE is in the CELL_DCH state. The SAS executes the U-TDOA positioning method and returns the location and optional velocity, or appropriate error indication to the SRNC using the PCAP: Position Calculation Response message as described below.

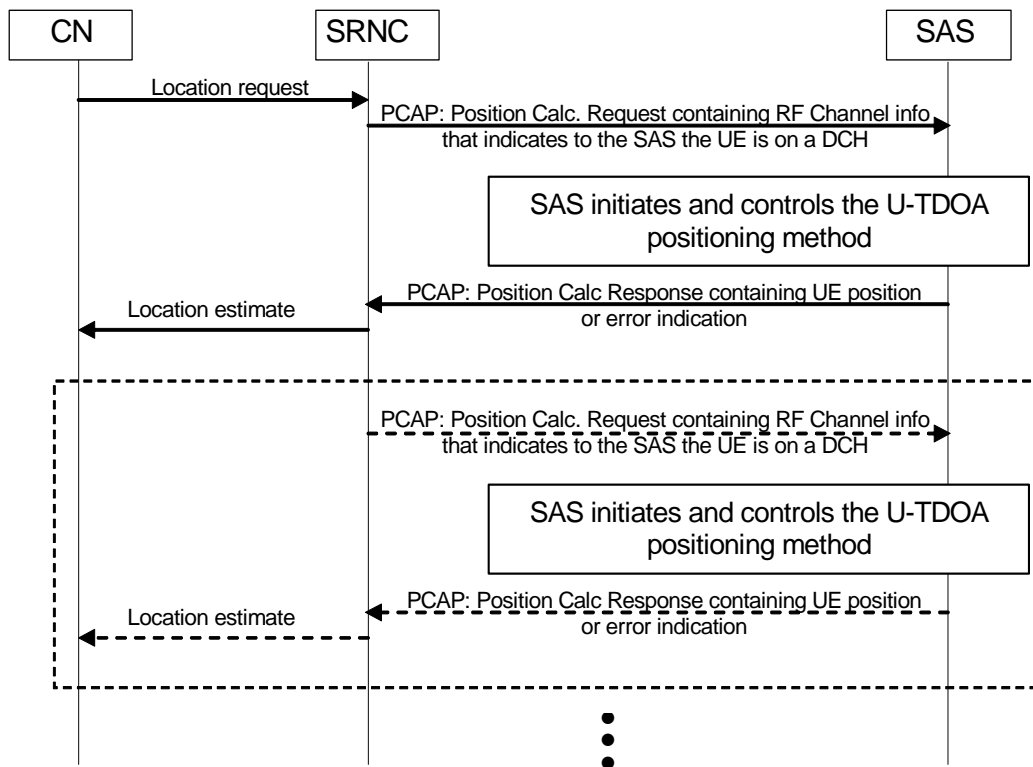

Figure 12.7: RNC initiated U-TDOA positioning procedure in CELL_DCH state

1. The operation begins with an authenticated request for positioning information about a UE from an application in the core network being received at the SRNC in a RANAP: Location Reporting Control message. The request from the CN may be a request for on-demand or periodic reporting. The SRNC may invoke the U-TDOA positioning method via the Iupc interface.
2. The SRNC sends a PCAP: Position Calculation Request message to the SAS containing the contents of the RANAP Location Reporting Control message, the RF channel information and Cell ID for the UE being positioned. This information indicates that the UE is in the CELL_DCH state.
3. The SAS configures the U-TDOA capable LMUs, analyzes the returned information and calculates the UE position and optionally, velocity.
4. The SAS returns the UE position and optionally the velocity or error indication to the SRNC in a PCAP: Position Calculation Response message.
5. The SRNC returns the UE position and optionally the velocity, to the CN in a RANAP: Location Report message.
6. If periodic reporting was requested by the CN at step 1, steps 2 to 5 may be repeated until the desired amount of reports has been attained, or the procedure is cancelled by UTRAN or CN.

12.3.2 UE in CELL_FACH state

The SRNC may invoke the U-TDOA positioning method using the PCAP: Position Calculation Request message that contains the contents of the RANAP Location Reporting Control message, Cell ID and RF channel information for the UE being positioned. If the UE is in the CELL_FACH state the SRNC, after sending the Position Calculation Request message, shall execute a procedure that causes the UE being positioned to transmit a certain number of pre-coded bits within a certain period of time. The procedure described in steps 6-8 in subclause 12.4.2.1 below is offered as an example that could be used for the U-TDOA positioning method when the UE is in the CELL_FACH state.

The SAS executes the U-TDOA positioning method and returns the location or appropriate error indication to the SRNC using the PCAP: Position Calculation Response message as described below.

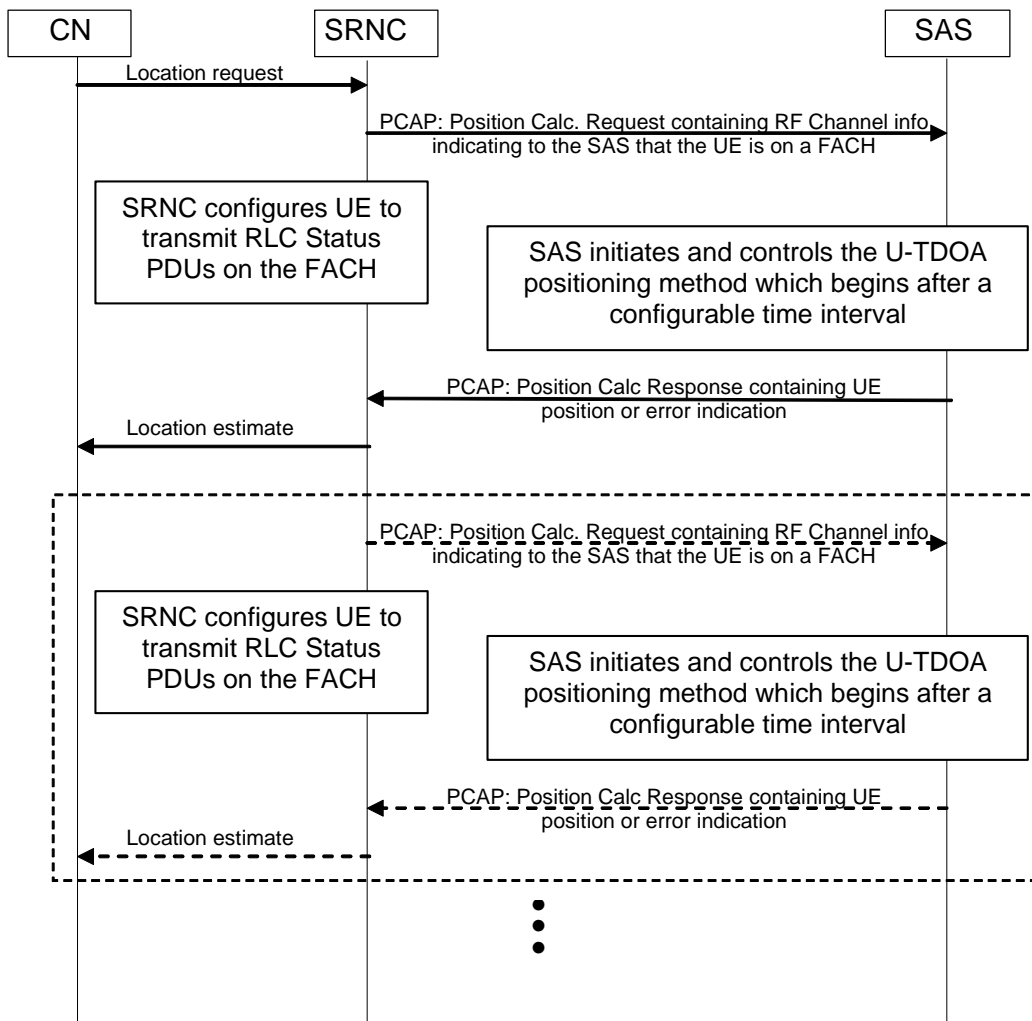

Figure 12.8: RNC initiated U-TDOA positioning procedure in CELL_FACH state

1. The operation begins with an authenticated request for positioning information about a UE from an application in the core network being received at the SRNC in a RANAP: Location Reporting Control message. The request from the CN may be a request for either on-demand or periodic reporting. The SRNC may invoke the U-TDOA positioning method via the Iupc interface.
2. The SRNC sends a PCAP: Position Calculation Request message to the SAS containing the contents of the RANAP Location Reporting Control message, the RF channel information and Cell ID for the UE being positioned. This information indicates that the UE is on a FACH.
3. After sending the Position Calculation Request message the SRNC shall execute a procedure that causes the UE being positioned to transmit a certain minimum number of pre-coded bits within a recommended maximum time interval of three seconds. The number of bits and actual time interval should be related to the required location accuracy, the propagation conditions in the serving cell and the LMU configuration for the SAS and may be determined in an implementation dependent manner. As an example of a method to cause the UE to transmit, the SRNC may configure the UE to transmit RLC Status PDUs as described in subclause 12.4.2 below.
4. After a configurable time interval the SAS configures the U-TDOA capable LMUs, analyzes the returned information and calculates the UE position and optionally, velocity.

5. The SAS returns the UE position and optionally, velocity to the SRNC in a PCAP: Position Calculation Response message.
6. The SRNC returns the UE position and optionally, the velocity to the CN in a RANAP: Location Report message.
7. If periodic reporting was requested by the CN at step 1, steps 2 to 6 may be repeated until the desired amount of reports has been attained, or the procedure is cancelled by UTRAN or CN.

12.4 Optional SAS initiated U-TDOA positioning for Cell_DCH and Cell_FACH RRC states

This subclause describes the U-TDOA positioning procedures in the CELL_DCH and CELL_FACH states when the location method to be used is determined by the SAS.

12.4.1 UE in CELL_DCH state

FDD Mode:

Data (either signalling data (DCCH) or user data (DTCH)) transmitted by a UE in CELL_DCH state will always be sent on the DCH (Transport Channel). The DCH in turn is mapped to the DPDCH (Dedicated Physical Data Channel) by the physical layer. The DPDCH is identified by the allocated frequency, the channelization code and the scrambling code.

The DPDCH always has an associated DPCCH (Dedicated Physical Control Channel). The DPCCH carries control information relevant to the physical layer. The DPCCH is under the same scrambling code, but uses a different spreading code.

While the DPDCH is active only during actual transmission of user data, the DPCCH is continuously transmitted as long as the UE is in the CELL_DCH state. The UE transmits either the DPCCH *and* the DPDCH, or solely the DPCCH – the scrambling code allocated to the UE can be received continuously as long as the UE is in the CELL_DCH state.

When the UE is in CELL_DCH state, the allocated scrambling code can be used to identify the UE for U-TDOA positioning determination. No additional interference is generated to locate the UE using the U-TDOA positioning method when in the CELL_DCH state.

TDD Mode:

Data (either signalling data (DCCH) or user data (DTCH)) transmitted by a UE in CELL_DCH state will always be sent on the DCH (Transport Channel). The DCH in turn is mapped to the DPCH (Dedicated Physical Channel) by the physical layer. The DPCH is identified by the allocated frequency, the channelization code(s)/timeslot(s) and the scrambling code associated with the cell that the UE is attached to (the scrambling code is cell-specific)..

The DPCH is active:

- during actual transmission of user data
- during the transmission of special bursts [26].

Special bursts are generated periodically when the UE has no data to send.

When the UE is in CELL_DCH state, the allocated uplink scrambling code assigned to the UE's cell and the channelisation code(s) / timeslot(s) can be used to identify the UE for U-TDOA positioning determination. No additional interference is generated to locate the UE using the U-TDOA positioning method when in the CELL_DCH state.

12.4.1.1 Message Flow

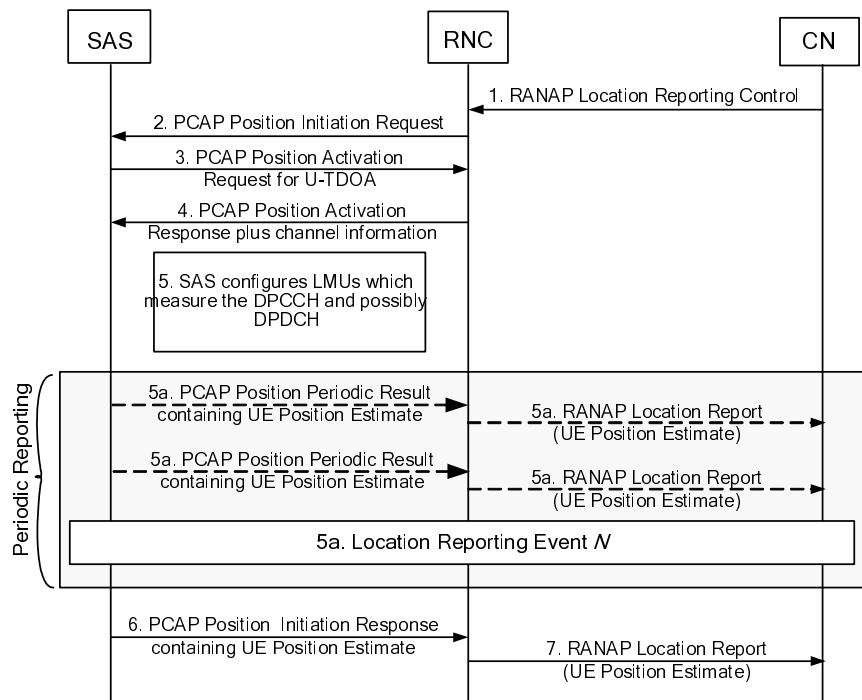

Figure 12.9 U-TDOA message flow, UE in the CELL_DCH state

- 1) 1) The procedure starts when a RANAP: Location Reporting Control message requesting a geographical UE position is received at the SRNC. The RANAP Location Reporting Control message may contain periodic location information (amount of reports and reporting interval).
- 2) 2) Location Reporting Control message parameters, including any periodic location information, plus UE capability information plus Cell ID are forwarded to the SAS in the PCAP: Position Initiation Request message.
- 3) 3) Based upon the service type (emergency service, etc), and the requested QoS, the SAS initiates a U-TDOA position, and sends a PCAP: Position Activation Request message indicating U-TDOA to the SRNC. The SRNC chooses to bring the UE to the CELL_DCH state if not already in this state.
- 4) 4) The SRNC returns U-TDOA channel information in a PCAP: Position Activation Response message to the SAS.
- 5) 5) The SAS configures the U-TDOA capable LMUs to perform measurements. The U-TDOA capable LMUs measure the [FDD: DPCCCH and possibly DPDCH] [TDD: DPCH].
- 6) 5a) If periodic reporting was requested in step 2, the SAS obtains a position, and optionally a velocity estimate using the U-TDOA capable LMU measurements and returns it to the SRNC in a PCAP: Position Periodic Result message. The SAS continues to send PCAP: Position Periodic Result messages to the SRNC until the requested amount of reports has been attained or the procedure is cancelled by UTRAN or CN. The SAS sends the final location information to the SRNC in a PCAP Position Initiation Response message. The SAS may repeat steps 3 and 4 at any time to obtain or verify the U-TDOA channel information. The SRNC returns the individual position estimates and optionally the velocity estimate to the CN in a RANAP: Location Report message.
- 7) 6) If periodic reporting was not requested in step 2, the SAS obtains a position, and optionally a velocity estimate using the U-TDOA capable LMU measurements and returns it to the SRNC in a PCAP: Position Initiation Response message.
- 8) 7) The SRNC returns the position estimate and optionally the velocity estimate to the CN in a RANAP: Location Report message.

12.4.2. UE in CELL_FACH state

In the CELL_FACH state the mobile is sharing a common uplink channel and is usually not sending data in the uplink direction. It is not possible to rely on the user application to cause the UE to transmit. For the U-TDOA location method the SRNC must force the UE to transmit.

As an example, this may be achieved by sending a RRC Radio Bearer Reconfiguration message that causes the UE to periodically send a RLC: Status PDU to the SRNC for an Acknowledged Mode DCCH. When sufficient repetitions have occurred to meet the requested location QoS the RRC Radio Bearer Reconfiguration message would be used to return the UE to the default state. In the TDD mode, the DCCH signalling radio bearer carrying the status PDUs shall be mapped to the RACH transport channel, not the USCH.

12.4.2.1 Message flow

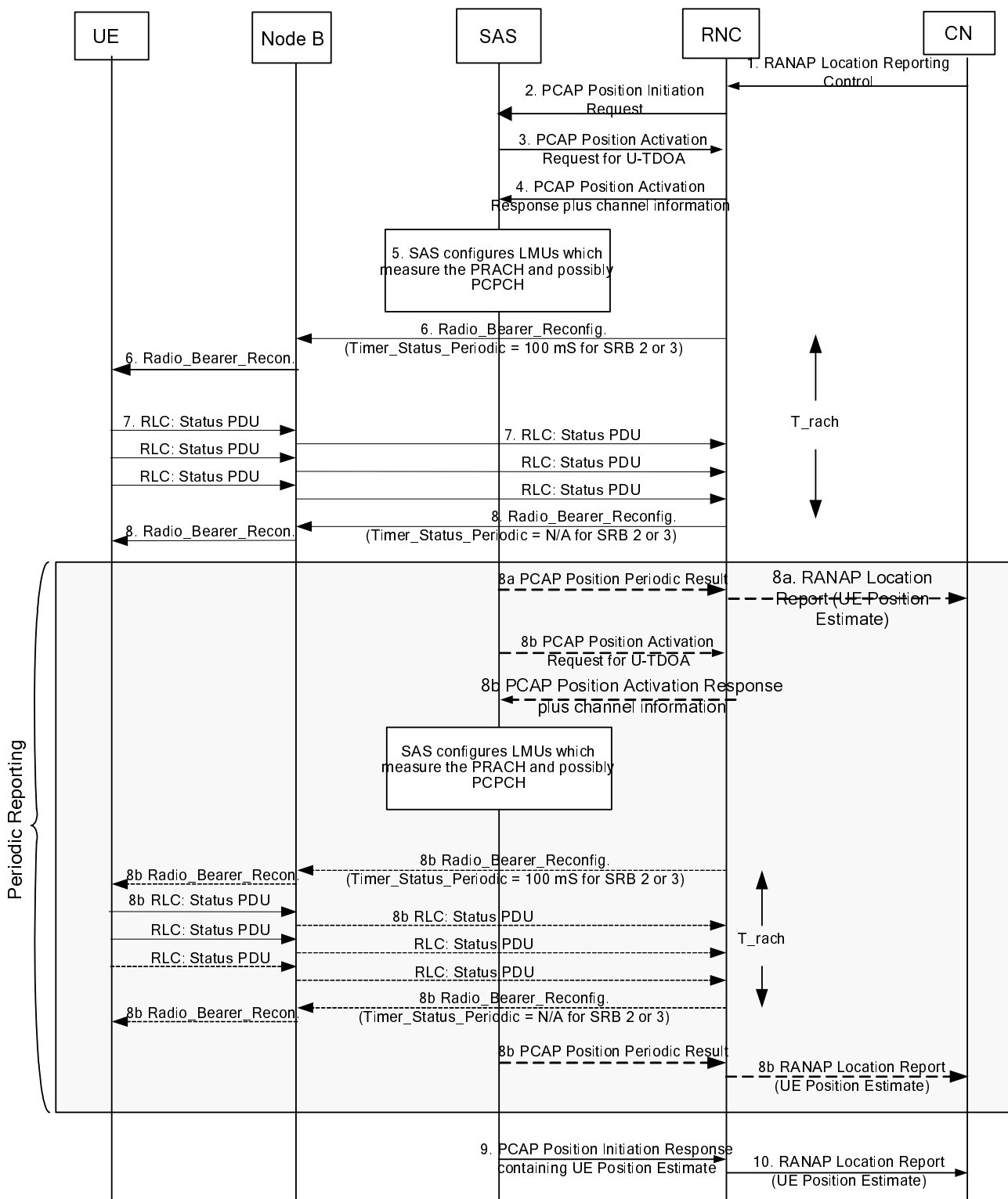

Figure 12.10 Example U-TDOA message flow, UE in the CELL_FACH state

- 1) 1) The procedure starts when a RANAP: Location Reporting Control message requesting a geographical UE position is received at the SRNC. The RANAP Location Reporting Control message may contain periodic location information (amount of reports and reporting interval).

- 2) 2) Location Reporting Control message parameters, including any periodic location information, plus Cell ID plus UE capability information are forwarded to the SAS in the PCAP: Position Initiation Request message.
- 3) 3) Based upon the service type (emergency service, etc), and the requested QOS, the SAS initiates a U-TDOA position, and sends a PCAP: Position Activation Request message indicating U-TDOA to the SRNC. The SRNC chooses to bring the UE to the CELL_FACH state if initially in the CELL_PCH or URA_PCH state.
- 4) 4) The SRNC returns U-TDOA channel information in a PCAP: Position Activation Response message to the SAS.
- 5) 5) The SAS configures the U-TDOA capable LMUs to perform measurements. The U-TDOA capable LMUs measure the PRACH or PCPCH bursts associated with the UE being positioned.
- 6) 6) The SRNC, after sending the PCAP Position Activation Response message, shall execute a procedure that causes the UE being positioned to transmit a certain number of pre-coded bits within a certain period of time. The number of pre-coded bits and period of time should be based upon (e.g. set equal to) a recommended number of bits and recommended time interval defined by the SAS in the PCAP Position Activation Request message invoking U-TDOA positioning. As an example, the SRNC could reconfigure the radio bearer so that the UE begins to send RLC status PDUs every 100 mS by sending the UE a Radio_Bearer_Reconfiguration message with the TimerStatusPeriodic IE configured for 100 milliseconds.
- 7) 7) The UE begins to send RLC status PDUs every 100 milliseconds.
- 8) 8) After expiration of the configurable T_rach timer the SRNC sends the UE a Radio_Bearer_Reconfiguration message with the TimerStatusPeriodic IE set to NA in order to stop the periodic status reporting.
- 9) 8a) If periodic reporting was requested in step 2, the SAS obtains a position, and optionally a velocity estimate using the U-TDOA capable LMU measurements and returns it to the SRNC in a PCAP: Position Periodic Result message. The SRNC returns the position estimate and optionally the velocity estimate to the CN in a RANAP: Location Report message. When the periodic reporting interval transpired, the SAS may send a new PCAP: Position Activation Request message to the SRNC and steps 3 to 8 may be repeated until the requested amount of reports has been attained or the procedure is cancelled by UTRAN or CN. The SAS sends the final location information to the SRNC in a PCAP Position Initiation Response message. The SRNC returns the individual position estimates and optionally the velocity estimate to the CN in a RANAP: Location Report message.
- 10) 9) If periodic reporting was not requested in step 2, the SAS obtains a position, and optionally a velocity estimate using the U-TDOA capable LMU measurements and returns it to the SRNC in a PCAP: Position Initiation Response message.
- 11) 10) The SRNC returns the position estimate and optionally a velocity estimate to the CN in a RANAP: Location Report message.

13 Network-assisted GNSS positioning method

In this concept, different GNSS (e.g. GPS, Galileo, GLONASS) can be used separately or in combination to perform the location of a UE. The aim of such combination is to improve:

- the availability of the location service,
- the accuracy of the position,
- the sensitivity to e.g. fading,
- the integrity of the signal,
- the reliability of the signal,
- the in-building penetration.

This can be done thanks to the combination of different global navigation satellite systems and the increased number of satellites.

13.1 Network-assisted GPS positioning method

Refer to clause 10.

"Modernized-GPS" refers to a family of modernized GPS satellites which bring support for new navigation signals, such as a Civilian L2 (L2C) signal, a Safety-of-Life L5 signal, and a new Civilian L1 (L1C) signal, together with improved navigation message data.

13.2 Network-assisted Galileo positioning method

The procedure is the same as for network-assisted GPS positioning method except that the Galileo satellites and parameters are used instead of those of the GPS.

13.3 Network-assisted GLONASS positioning method

The procedure is the same as for network-assisted GPS positioning method except that the GLONASS satellites and parameters are used instead of those of the GPS.

13.4 Network-assisted Satellite Based Augmentation Systems (SBAS)

Several independent but compatible satellite based augmentation systems exist: The American Wide Area Augmentation System (WAAS), the European Geostationary Navigation Overlay Service (EGNOS), the Indian GPS Aided GEO Augmented Navigation System (GAGAN), and the Japanese Multi-functional Satellite Augmentation System (MSAS). The (GPS-like) ranging signals from all these SBASs are here considered as a single GNSS, although this GNSS is not a standalone positioning system because of the small number of satellites and their distribution in space. Usually, this GNSS is used in combination with e.g., GPS, Galileo, or GLONASS ranging signals.

The procedure is the same as for network-assisted GPS positioning method except that the SBAS satellites and parameters are used instead of those of the GPS.

13.5 Network-assisted Quasi-Zenith Satellite System (QZSS)

Quasi-Zenith Satellite System (QZSS) is a regional navigation satellite system. The eccentricity and elevation of the satellite orbits are selected so that the minimum elevation angle through 24 hours in Japan is larger than about 60 degrees. The satellite signals are fully compatible and interoperable with current and modernized future GPS. Similar to SBAS ranging signals, this GNSS is not a standalone positioning system and is usually used in combination with other GNSS ranging signals, such as GPS, Galileo, GLONASS, etc.

The procedure is the same as for network-assisted GPS positioning method except that the QZSS satellites and parameters are used instead of those of the GPS.

Annex A (informative): Definitions and Terms

This annex provides definitions and terms for the general LCS. Not all of these are applicable to the UTRAN environment.

CAMEL: CAMEL is a network functionality, which provides the mechanisms of Intelligent Network to a UE.

Current Position: after a location attempt has successfully delivered a position estimate and its associated time stamp, the position estimate and time stamp is referred to as the 'current position' at that point in time.

Deferred location request: a location request where the location response (responses) is (are) not required immediately.

Frequency reference: the frequency reference of the UE obtained from the UTRAN radio interface that may be used to minimize the frequency search associated with acquiring GPS satellite signals. When the UE acquisition process is aligned to this reference, the carrier Doppler uncertainty that must be searched for a particular satellite signal need only account for minor residual uncertainties related to UE dynamics and initial position. This frequency reference may also be used to maintain the UE's estimate of GPS time between positioning events, thus making accurate GPS time available within the UE to support reacquisition of satellite signals.

Global Positioning System: the Global Positioning System (GPS) consists of three functional elements: Space Segment (satellites), User Segment (receivers), and Control Segment (maintenance etc.). The GPS receiver estimates its own location based on the observed times of arrival of the satellite signals.

Immediate location request: a location request where a single location response only is required immediately.

Initial Position: in the context of an originating emergency call the position estimate and the associated time stamp at the commencement of the call set-up is referred to as 'initial position'.

Last Known Position: the current position estimate and its associated time stamp for Target UE stored in the LCS Server is referred to as the 'last known position' and until replaced by a later position estimate and a new time stamp is referred to as the 'last known position'.

LCS (LoCation Services): LCS is a service concept in system (e.g. GSM or UMTS) standardisation. LCS specifies all the necessary network elements and entities, their functionalities, interfaces, as well as communication messages, due to implement the location service functionality in a cellular network.

NOTE: LCS does not specify any location based (value added) services except locating of emergency calls.

LCS Client: a software and/or hardware entity that interacts with a LCS Server for the purpose of obtaining location information for one or more UEs. LCS Clients subscribe to LCS in order to obtain location information. LCS Clients may or may not interact with human users. The LCS Client is responsible for formatting and presenting data and managing the user interface (dialogue). The LCS Client may reside in the UE.

LCS Client Access barring list: an optional list of MSISDNs per LCS Client where the LCS Client is not allowed to locate any MSISDN therein.

LCS Client Subscription Profile: a collection of subscription attributes of LCS related parameters that have been agreed for a contractual period of time between the LCS client and the service provider.

LCS Feature: the capability of a PLMN to support LCS Client/server interactions for locating Target UEs.

LCS Server: a software and/or hardware entity offering LCS capabilities. The LCS Server accepts requests, services requests, and sends back responses to the received requests. The LCS server consists of LCS components, which are distributed to one or more PLMN and/or service provider.

Local Service: a service, which can be exclusively provided in the current serving network by a Value added Service Provider.

Local Information: information related to a given location, or general information, which is made available in a given location.

Location (Based) Application: a location application is an application software processing location information or utilising it in some way. The location information can be input by a user or detected by UTRAN or UE. Navigation is one location application example.

Location Based Service (LBS): a service provided either by teleoperator or a 3rd party service provider that utilises the available location information of the terminal. Location Application offers the User Interface for the service. LBS is either a pull or a push type of service (see Location Dependent Services and Location Independent Services).

Location Dependent Service: a service provided either by teleoperator or a 3rd party service provider that is available (pull type) or is activated (push type) when the user arrives to a certain area. It doesn't require any subscription in advance, but the push type activation shall be confirmed by the user. The offered service itself can be any kind of service (e.g. a public Xerox machine or the discount list in a store).

Location Independent Service: a service provided either by teleoperator or a 3rd party service provider that is available and therefore can be activated anywhere in the network coverage. It is activated by the user's request or by other user's activated service, and therefore it requires a subscription in advance (pull type). The offered service itself can be any kind of service (e.g. MMS, SWDL, or LBS!).

Position Estimate: the geographic position of a UE expressed in latitude and longitude data, and optionally altitude data. The Position Estimate shall be represented in a well-defined universal format. Translation from this universal format to another geographic positioning system may be supported, although the details are considered outside the scope of the primitive services.

Positioning: positioning is a functionality, which estimates a geographical position (of e.g. a UE).

Positioning method: a principle and/or algorithm that the estimation of geographical position is based on, e.g. AOA, TOA, TDOA. For example, GPS is based on TOA, and E-OTD (on GSM) or OTDOA (on UMTS) are based on TDOA.

Positioning technology: a technology or system concept including the specifications of RF interfaces, data types, etc. to process the estimation of a geographical position, e.g. GPS, E-OTD (GSM), and IPDL-TDOA (UMTS).

PLMN Access barring list: an optional list of MSISDN per PLMN where any LCS Client is not allowed to locate any MSISDN therein except for certain exceptional cases.

Predefined area: a geographical area that is not related to cell or radio coverage. The UE may take special action when it recognises it has entered or left a predefined area.

Privacy Class: list of LCS Clients defined within a privacy exception class to which permission may be granted to locate the target UE. The permission shall be granted either on activation by the target UE or permanently for a contractual period of time agreed between the target UE and the service provider.

Privacy Exception List: a list consisting of various types of privacy classes (i.e. operator related, personal etc.). Certain types of classes may require agreement between the service provider and the target UE.

Prohibited area: an area where the UE must not activate its transmitter. The Prohibited area may be a Predefined area described above or related to radio cell(s).

Subscription Profile: the profile detailing the subscription to various types of privacy classes.

Target UE: the UE being located.

Velocity Estimate: the speed and direction of a UE expressed as horizontal speed and bearing data, and optionally vertical speed data.

Annex B (informative): Reference Model of Functional Entities for UTRAN UE Positioning

The UTRAN functional entities for UE Positioning are shown in figure B.1 and figure B.2. In these reference models, the LCS clients in the core network communicate with the UTRAN UE Positioning entities across the Iu interface. The RNC LCS Handling Entities and the Positioning Handling Entities work together with the UE to measure and calculate the position information for the requested target UE. These entities within the UTRAN are described in more detail in the following subclauses.

The figure shows the general arrangement of the UE Positioning function in UTRAN. Communication among these entities makes use of the messaging and signalling capabilities of the UTRAN across the Iu, Iur, Iub, Iupc and Uu interfaces. A LMU is also added to the UTRAN to make measurements as needed by the selected positioning method.

This figure does not include elements of 3G Core Network, but focuses on those that participate with the UE Positioning functions in the UTRAN. The association of the LCS entities within the Core Network (CN) (e.g. with 3G-MSC or 3G-SGSN) is outside the scope of the present document and is not illustrated in the diagram.

Within the UTRAN, the UE Positioning Entities may be associated with, or part of the SAS, RNC, the Node B and the UE. Internal LCS Applications may also be part of the RNC and the UE.

The UE Position Calculation Function (PCF) is logically associated with the SRNC or with the SAS.

The UE Positioning in UTRAN also makes use of the standardised Iur interface between RNCs, when Node B information, measurements and results are collected.

The functional model presented in the figure includes functional entities for UE utilising either or both circuit switched (CS) and packet switched (PS) services. This model also supports all the entities needed for different positioning methods (e.g. network-based, UE-based, UE-assisted, and network assisted (see note 1) methods) exploiting either uplink or downlink measurements.

NOTE 1: In this approach UE may use the GPS technique but still make use of auxiliary information from the serving network.

NOTE 2: Figure B.2 shows the SMLC as a node that implements the PCF. In actuality it is more than the PCF, for example, the SMLC can provide GPS assistance data. See Subclause 5.2.5 for the normative definition of an SMLC.

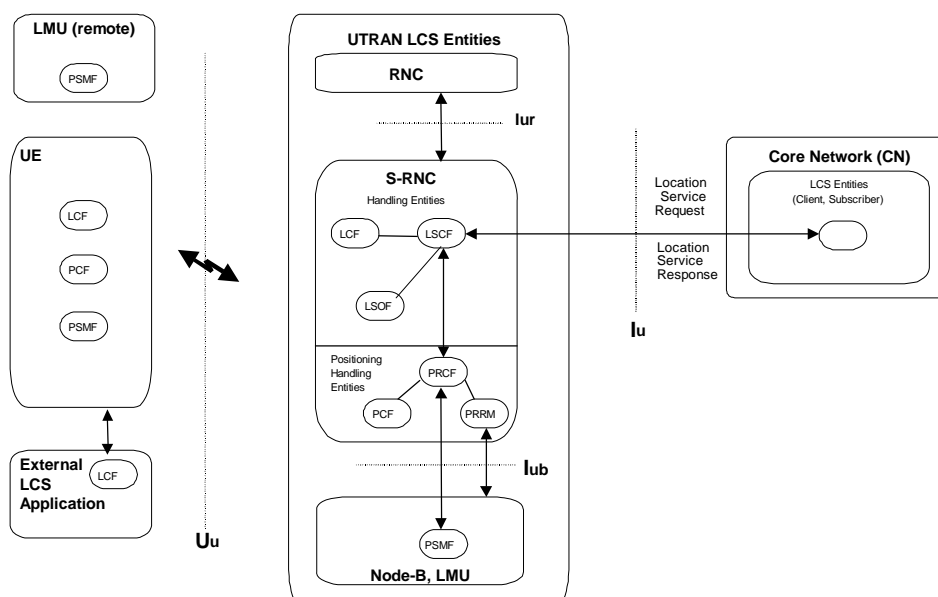

Figure B.1: UTRAN UE Positioning Functional Entities (RNC centric mode)

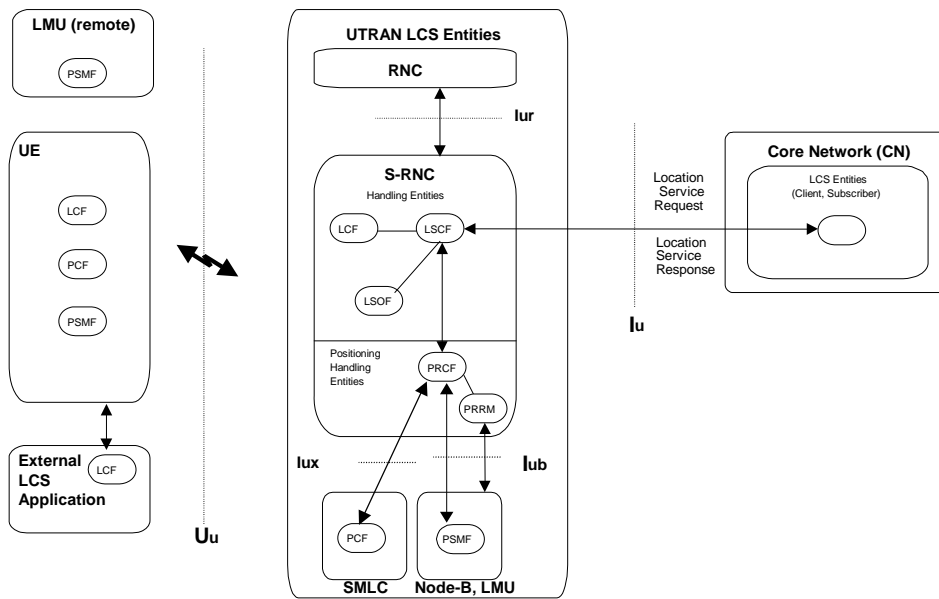

Figure B.2: UTRAN UE Positioning Functional Entities – SAS version (RNC centric mode)

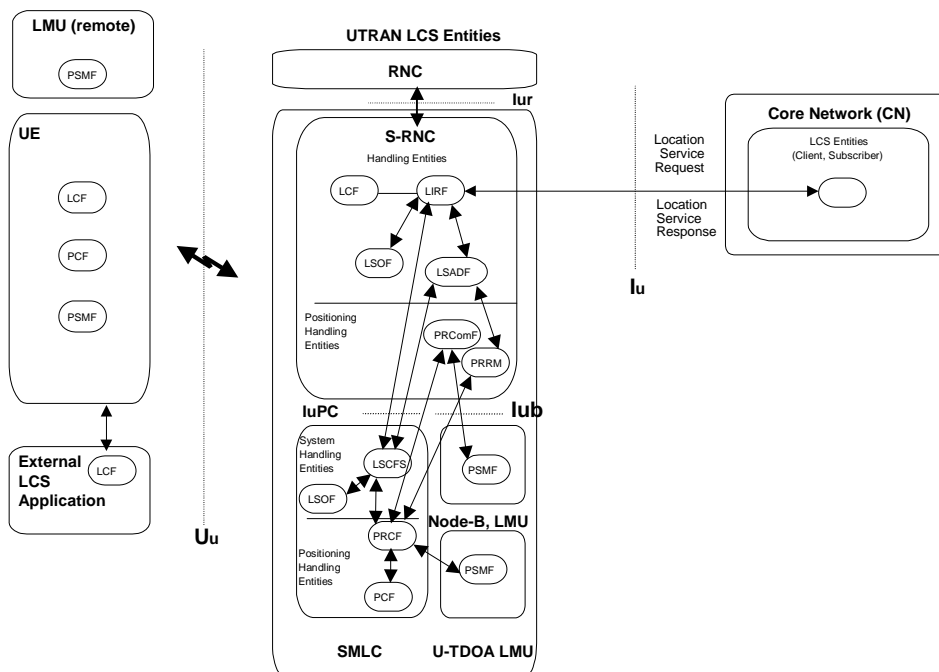

Figure B.3: UTRAN UE Positioning Functional Entities – SAS version (SAS centric mode)

Several functional groupings may be defined to describe the UE Positioning functions. These groupings occur in both the CN and the UTRAN. The overall LCS functional grouping is described in reference [13]. Each grouping encompasses a number of functional components and functions.

Within UTRAN the functional entities may be grouped as follows:

- the *Internal Client* group that includes:
 - Internal UTRAN Location Client Function (U-LCF);
- the *UTRAN System Handling* group that includes:

For RNC centric mode:

- UTRAN Location System Control Function (U-LSCF),

- UTRAN Location System Operations Function (U-LSOF);

For SAS centric mode:

- UTRAN Location Information Relay Function (U-LIRF)
- UTRAN Location System Control Function in SAS (U-LSCFS)
- UTRAN Location System Assistance Data Function (U-LSADF)
- the *UTRAN Positioning* group that includes:
 - UTRAN Position Radio Co-ordination Function (U-PRCF),
 - UTRAN Position Calculation Function (U-PCF),
 - UTRAN Position Signal Measurement Function (U-PSMF),
 - UTRAN Position Radio Resource Management (U-PRRM).
 - UTRAN Position Related Communication Function (U-PRComF) for SAS centric mode.

The functions within the UTRAN are described in more detail in the following subclauses.

B.1 Internal Client Group

B.1.1 Internal UTRAN Location Client Function (U-LCF)

The UTRAN Location Client Function (U-LCF) represents a logical interface between the internal UTRAN LCS applications and the LCS RNC Handling entities (e.g. the Location System Control Function (U-LSCF) in the RNC).

NOTE: There is not necessarily a requirement for a LCCF (Location Client Control Function) for the UTRAN Internal Client as is described for external clients in reference [13] (the system stage specification).

The UTRAN may make use of positioning information for internal operations such as location assisted handover. In such a case, a U-LCF representing the internal UTRAN LCS application may communicate with the U-LSCF to request and receive the positioning information.

B.2 UTRAN System Handling group

B.2.1 UTRAN Location System Control Function (U-LSCF)

The UTRAN Location System Control Function (U-LSCF) **in RNC** is responsible for co-ordinating UE Positioning requests within the RNC handling entity. This function manages call-related and non-call-related UE Positioning requests and allocates network resources for handling them. This function "insulates" the Location clients in the Core Network from the detailed operation of the positioning method in order that the UTRAN may be used by several types of core network and with several positioning methods.

The U-LSCF provides flow control between simultaneous UE Positioning requests. Simultaneous UE Positioning requests must be queued in a controlled manner to account for priority requests (e.g. for Emergency Clients). The details of the flow control, priority selection and queuing are beyond the scope of the present document.

The U-LSCF will select the appropriate positioning method based on the availability of resources and parameters of the UE Positioning request. The U-LSCF co-ordinates resources and activities needed to obtain data (e.g. Node B geographic co-ordinates) needed for the positioning method. It also records LCS RNC usage data for the location service request that may be passed to a Location System Recording Function (U-LSRF) or OA&M function in the Core Network.

If the positioning method requires the broadcast of system information, the LSCF initiates and maintains this activity through the Position Radio Co-ordination Function (U-PRCF). Broadcast information (such as the geographic co-ordinates of the Node Bs) may be required, for example, to support a Position Calculation Function (U-PCF) located in

the UE. These broadcasts may also include other information (such as currently observable satellites) that may assist a UE in the use of external location services.

The information to be broadcast is selected based on the positioning methods offered for use by the LCS and the needs of the UE. This broadcast information may be specially coded (i.e. encrypted) to ensure its availability only to subscribers of the service. The use of broadcasts or other methods for signalling to the UE or the LMU may be selected based on the chosen positioning method.

The information to be broadcast could include, for example:

- identification and spreading codes of the neighbouring Node Bs (the channels that are used for measurements);
- Relative Time Difference (RTD), i.e. the timing offsets, asynchronicity between Node Bs, could be obtained from measurement results obtained by LMUs;
- roundtrip delay estimates in connected mode;
- the geographic position, co-ordinates, of the neighbouring Node Bs;
- the idle period places within the frame structure for multiple Node Bs;
- the local time-of-day.

Some of this information may be broadcast to support other UTRAN operations (e.g. handover). The function of the LSCF is to ensure information is broadcast when needed for the LCS operations and the LSCF may make use of other UTRAN processes to do so.

B.2.2 UTRAN Location System Operations Function (U-LSOF)

The UTRAN Location System Operations Function (U-LSOF) is responsible for provisioning of data, positioning capabilities, data related to clients and subscription (LCS client data and UE data), fault management and performance management of LCS within the RNC.

An LSOF may be associated with each entity. The LSOF interacts with Internal (OAM) Clients for administration and maintenance of the data.

The Iur interface may pass messages relating to changes or reporting of the data associated with the LSOF in the RNC.

The Iub interface may pass messages relating to changes or reporting of the data associated with the LSOF in the Node B or the LMU.

The Uu interface may pass messages relating to changes or reporting of the data associated with the LSOF in the UE or the remote LMU. When the SAS is present, with either RNC or SAS centric mode, the U-LSOF may be split across SAS and SRNC.

B.2.3 UTRAN Location Information Relay Function (U-LIRF)

The UTRAN Location Information Relay Function (U-LIRF) is responsible for forwarding of Location Requests from to the LCS clients to the U-LSCFS and for forwarding of UE positioning estimates to the requesting LCS client. The U-LRIF also interfaces with the U-LSOF to obtain provisioned location information.

The U-LIRF communicates with the U-LSADF to handle assistance data requests received from the CN. The U-LIRF also forwards the UE positioning capability information and a coarse position estimate to the U-LSCFS.

B.2.4 UTRAN Location System Control Function in SAS (U-LSCFS)

The UTRAN Location System Control Function in SAS (U-LSCFS) is only used in the SAS centric mode. It performs similar tasks as the U-LSCF in the RNC centric mode, but instead of communicating directly with the LCS clients, it communicates with the U-LIRF in the SRNC.

B.2.5 UTRAN Location System Assistance Data Function (U-LSADF)

The UTRAN Location System Assistance Data Function (U-LSADF) is responsible for the handling location related assistance data within the RNC. This includes handling of location related assistance data requests from the CN and the broadcasting of location related assistance data, if requested by the U-LSCFS.

B.3 Positioning group

B.3.1 UTRAN Position Radio Co-ordination Function (U-PRCF)

The UTRAN Position Radio Co-ordination Function (U-PRCF) manages a UE Positioning for a UE through overall co-ordination and scheduling of resources to perform positioning measurements. This function interfaces with the U-PSMF, the U-PRRM and the U-PCF. The U-PRCF determines the positioning method to be used based on the UE Positioning request, the QoS, the capabilities of the UTRAN, and the UE's capabilities. The U-PRCF also manages the needed radio resources through the U-PRRM. It determines which U-PSMFs are to be involved, what to measure, and obtains processed signal measurements from the U-PSMF.

Some positioning methods may involve measurements made at the UE. In this case the U-PRCF interfaces with the UE to obtain the measurements (or the positioning results if they have been determined by the UE). Some positioning methods may involve measurements or information from several sources, including radio units at several Node B (or other LMU) and involve a series of transmissions and receptions. The U-PRCF entity also provides ancillary measurements in case of network-assisted positioning method. Ancillary information may be extracted from navigating systems like GPS.

The U-PRCF forwards the signal measurement data to the U-PCF.

It is the function of the U-PRCF to co-ordinate the sequence of activities and compensate for failures (if they occur) to provide the position estimate. In SAS centric mode the U-PRCF communicates to LMU, NodeB and UE via the U-PRComF.

B.3.2 UTRAN Position Calculation Function (U-PCF)

The UTRAN Position Calculation Function (U-PCF) is responsible for calculating the position of the UE. This function applies an algorithmic computation on the collected signal measurements to compute the final position estimate and accuracy.

The U-PCF may also support conversion of the position estimate between different geographic reference systems. It may obtain related data (e.g.: Node B geographic co-ordinates) needed for the calculation. There may be more than one calculating function available within, or associated with, the calculation function of the UTRAN.

In the cell ID based positioning method, the U-PCF shall determine the geographical co-ordinates corresponding to the cell(s) associated with the target UE.

The PCF is also responsible for estimating the accuracy of the position estimate. This accuracy estimate should include, for example, the effect of geometric dilution of precision (GDOP), the capabilities of the signal measuring hardware, the effects of multipath propagation and the effects of timing and synchronisation unknowns. The accuracy should be returned as a measure of distance in the same units as the position estimate. The accuracy zone may be reported as the axis and orientation of an ellipse surrounding the position estimate.

B.3.3 UTRAN Position Signal Measurement Function (U-PSMF)

The UTRAN Position Signal Measurement Function (U-PSMF) is responsible for performing and gathering uplink or downlink radio signal measurements for use in the calculation of a UE position. These measurements can be positioning related or ancillary.

There may be one or more PSMF within a UTRAN and they may be located at the UE, the Node B, or a separate LMU. The PSMF, generally, may provide measurement of signals (i.e. satellite signals) in addition to measurements of the UTRA radio transmissions. The measurements to be made will depend on the selected positioning method.

B.3.4 UTRAN Position Radio Resource Management (U-PRRM)

The UTRAN Position Radio Resource Management (U-PRRM) entity is responsible for managing the effect of LCS operations on the overall performance of the radio network. This may ensure, for example, that the operation of the U-PSMF does not degrade the QoS of other calls. The U-PRRM handles following functions:

- controlling the variation of the UL and DL signal power level due to the LCS application;
- calculating the DL and UL power/interference due to UE positioning operations;
- to admit/reject the new LCS requests;
- co-operating with Admission Control, and entities of the RRM (such as power control) to provide the system stability in terms of radio resources;
- controlling the RTD obtaining mechanism. It may also forward the results of the UTRAN GPS timing of cell frames or SFN-SFN Observed Time Difference (or any similar timing parameter) measurements to the PRCF (or PCF);
- controlling the IPDL mechanism for positioning measurements. This may include the overall control of the periodical measurement fulfilment. Co-ordination among RNCs (e.g. to assure non-overlapping idle periods) will be communicated through the Iur interface.

B.3.5 UTRAN Position Related Communication Function (U-PRComF)

The UTRAN Position Related Communication Function (U-PRComF) manages the collection of positioning measurements as requested by the U-PRCF.

The U-PRComF terminates the NBAP protocol for positioning related measurements requested from NodeB or LMU.

The U-PRComF terminates the RRC protocol for positioning related measurements requested from the UE.

B.4 Assignment of LCS Functional Entities to UTRAN Elements

Figure B.1, Figure B.2, Figure B.3 and tables B.1 and B.2 show the generic configuration for different positioning methods, including network-based, UE-based, UE-assisted and network-assisted methods. With this approach both UTRAN and the UE are able to measure the timing of signals and compute the UE position estimate. Depending on the applied positioning method it is possible to utilise the corresponding configuration containing all needed entities. For instance, if a network-based positioning method is applied, the entities that are involved in measuring the UE's signal and calculating its position estimate are allocated to the network elements of the access stratum. On the other hand, in case UE-based or network-assisted methods are used these entities should be allocated to the UE.

Table B.1: Example Allocation of LCS Functional Entities to Network Elements for RNC centric mode

| UTRAN | UE | Node B | LMU | RNC | SAS |
|-------|----|--------|-----|-----|-----|
| LCF | X | | | X | |
| LSCF | | | | X | |
| PRCF | | | | X | |
| PCF | X | | | X | X |
| PRRM | | | | X | |
| PSMF | X | X | X | | |
| LSOF | X | X | X | X | |

Table B.2: Example Allocation of LCS Functional Entities to Network Elements for SAS centric mode

| UTRAN | UE | Node B | LMU | RNC | SAS |
|--------|----|--------|-----|-----|-----|
| LCF | X | | | X | |
| LSCFS | | | | | X |
| LIRF | | | | X | |
| PRCF | | | | | X |
| PCF | X | | | | X |
| PRRM | | | | X | |
| PSMF | X | X | X | | |
| LSOF | X | X | X | X | X |
| PRComF | | | | X | |

Annex C (informative): Location Services Categories

Generally there are four categories of usage of the location service:

- the **Commercial LCS** (or **Value Added Services**);
- the **Internal LCS**;
- the **Emergency LCS**;
- the **Lawful Intercept LCS**.

These location services categories are further defined in [13] and [5].

Annex D (informative): Change history

| Change history | | | | | | | |
|----------------|-------|-----------|-----|-----|--|-------|-------|
| Date | TSG # | TSG Doc. | CR | Rev | Subject/Comment | Old | New |
| 12/1999 | RP-06 | RP-99635 | - | | Approved at TSG-RAN #6 and placed under Change Control | - | 3.0.0 |
| 03/2000 | RP-07 | RP-000038 | 001 | 3 | Network assisted GPS LCS | 3.0.0 | 3.1.0 |
| | RP-07 | RP-000038 | 002 | 1 | Enhancements for cell coverage based positioning | 3.0.0 | 3.1.0 |
| | RP-07 | RP-000038 | 003 | | Replacement for Figure 4.1 | 3.0.0 | 3.1.0 |
| | RP-07 | RP-000038 | 004 | 1 | Restructuring | 3.0.0 | 3.1.0 |
| | RP-07 | RP-000038 | 006 | | Target UE-RNC signalling model | 3.0.0 | 3.1.0 |
| | RP-07 | RP-000038 | 007 | | LMU description | 3.0.0 | 3.1.0 |
| | RP-07 | RP-000038 | 008 | 2 | LMU signalling description | 3.0.0 | 3.1.0 |
| | RP-07 | RP-000038 | 009 | | Incorporation of R1 Liaisons R2-000022 and R2-000023 | 3.0.0 | 3.1.0 |
| | RP-07 | RP-000038 | 010 | 3 | OTDOA - GPS Location Procedures | 3.0.0 | 3.1.0 |
| | RP-07 | RP-000038 | 011 | 1 | Clarification of the different LMU types | 3.0.0 | 3.1.0 |
| 06/2000 | RP-08 | RP-000218 | 013 | 2 | Modifications to LCS text on cell-ID method | 3.1.0 | 3.2.0 |
| | RP-08 | RP-000218 | 015 | | Editorial modifications of OTDOA descriptions for alignment with TDD | 3.1.0 | 3.2.0 |
| | RP-08 | RP-000218 | 016 | | Update on clause 5 | 3.1.0 | 3.2.0 |
| | RP-08 | RP-000218 | 017 | 1 | Editorial additions | 3.1.0 | 3.2.0 |
| | RP-08 | RP-000218 | 018 | | Clarification of OTDOA signalling operation | 3.1.0 | 3.2.0 |
| | RP-08 | RP-000218 | 019 | 1 | Assisted GPS procedures | 3.1.0 | 3.2.0 |
| 09/2000 | RP-09 | RP-000356 | 020 | | Alignment of FDD and TDD positioning methods and editorial changes | 3.2.0 | 3.3.0 |
| | RP-09 | RP-000356 | 021 | 3 | Assisted GPS Procedures | 3.2.0 | 3.3.0 |
| | RP-09 | RP-000356 | 022 | 2 | TDD/FDD alignment of OTDOA and GPS assisted positioning methods | 3.2.0 | 3.3.0 |
| | RP-09 | RP-000356 | 023 | | Clean-up | 3.2.0 | 3.3.0 |
| | RP-09 | RP-000356 | 024 | | Corrections from LCS Ad Hoc | 3.2.0 | 3.3.0 |
| 12/2000 | RP-10 | RP-000566 | 025 | 1 | Editorial and Minor Technical Clean-up | 3.3.0 | 3.4.0 |
| | RP-10 | RP-000566 | 026 | | Editorial corrections | 3.3.0 | 3.4.0 |
| | RP-10 | RP-000566 | 027 | | Removal of SoLSA concepts | 3.3.0 | 3.4.0 |
| | RP-10 | RP-000566 | 029 | 1 | Signalling flows on lub and lur | 3.3.0 | 3.4.0 |
| | RP-10 | RP-000566 | 030 | 1 | LCS functionality during SRNS relocation | 3.3.0 | 3.4.0 |
| | RP-10 | RP-000566 | 031 | | UE Search Correction from R2-001721 (CR 021r3) | 3.3.0 | 3.4.0 |
| | RP-10 | RP-000566 | 032 | 2 | Signaling Between RNC and Stand-Alone LMU | 3.3.0 | 3.4.0 |
| | RP-10 | RP-000566 | 033 | 5 | Use of RTT measurements in the Assisted GPS procedure | 3.3.0 | 3.4.0 |
| | RP-10 | RP-000566 | 034 | 1 | LCS assistance data delivery | 3.3.0 | 3.4.0 |
| | RP-10 | RP-000566 | 035 | 2 | Description for frequency reference | 3.3.0 | 3.4.0 |
| | RP-10 | RP-000566 | 036 | 2 | Editorial clean-up | 3.3.0 | 3.4.0 |
| | RP-10 | RP-000566 | 038 | 2 | Clarification on information to be transferred between UTRAN nodes | 3.3.0 | 3.4.0 |
| | RP-10 | RP-000566 | 039 | 1 | Moving of semantic descriptions from RRC | 3.3.0 | 3.4.0 |
| 03/2001 | RP-11 | RP-010023 | 040 | | Correction to Assistance Data Delivery procedure | 3.4.0 | 3.5.0 |
| | RP-11 | RP-010023 | 041 | 1 | Clarification of assisted GPS related parameters | 3.4.0 | 3.5.0 |
| | RP-11 | RP-010023 | 042 | | Clarification of paging initiation | 3.4.0 | 3.5.0 |
| | RP-11 | RP-010023 | 045 | 1 | Editorial Corrections | 3.4.0 | 3.5.0 |
| | RP-11 | RP-010023 | 046 | 1 | Clarification of Timing Assistance | 3.4.0 | 3.5.0 |
| | RP-11 | RP-010023 | 047 | | Clarification of Integrity Monitor Function | 3.4.0 | 3.5.0 |
| | RP-11 | RP-010040 | 048 | 1 | Introduction of IPDLs for TDD | 3.5.0 | 4.0.0 |
| | RP-11 | RP-010044 | 044 | 4 | Support of Stand-Alone A-GPS SMLC over an open interface | 4.0.0 | 5.0.0 |
| 06/2001 | RP-12 | RP-010306 | 053 | | Removal of positioning request transfer during SRNS relocation | 5.0.0 | 5.1.0 |
| | RP-12 | RP-010325 | 054 | | lupc architectural aspects modifications | 5.0.0 | 5.1.0 |
| | RP-12 | RP-010325 | 055 | | Removal of RAN3 dependency w.r.t. PCAP signalling flows | 5.0.0 | 5.1.0 |
| | RP-12 | RP-010325 | 056 | 1 | PCAP message flows | 5.0.0 | 5.1.0 |
| 09/2001 | RP-13 | RP-010556 | 060 | 1 | Support for all Rel. 4 positioning methods in standalone SMLC | 5.1.0 | 5.2.0 |
| 12/2001 | RP-14 | RP-010757 | 065 | | Correction of broadcast of assistance data | 5.2.0 | 5.3.0 |
| | RP-14 | RP-010757 | 072 | | Migration of Descriptive Text from TS 25.331 | 5.2.0 | 5.3.0 |
| | RP-14 | RP-010770 | 062 | | Correction of RTD usage in TDD | 5.2.0 | 5.3.0 |
| 03/2002 | RP-15 | RP-020080 | 074 | | Corrections Relating to IPDL and Timing Advance for 1.28 Mcps TDD | 5.3.0 | 5.4.0 |
| | RP-15 | RP-020065 | 081 | 1 | Correction to CELL ID positioning when UE is not reachable | 5.3.0 | 5.4.0 |
| | RP-15 | RP-020090 | 075 | | Including IPDL, UE Timing Advance and Angle of Arrival for 1.28 Mcps TDD | 5.3.0 | 5.4.0 |
| 03/2003 | RP-19 | RP-030110 | 085 | | Update to figure 5.1, LMU terminology | 5.4.0 | 5.5.0 |
| 06/2003 | RP-20 | RP-030290 | 088 | | Handling of UP assistance data | 5.5.0 | 5.6.0 |

| | | | | | | | |
|---------|-------|-----------|------|---|--|-------|--------|
| | RP-20 | RP-030300 | 089 | | Addition of Position Method Used, to attributes returned with position estimate | 5.5.0 | 5.6.0 |
| 09/2003 | RP-21 | RP-030481 | 092 | | Correction to UE Positioning privacy procedures | 5.6.0 | 5.7.0 |
| | RP-21 | RP-030481 | 095 | | Alignment with 25.331 regarding A-GPS assistance data | 5.6.0 | 5.7.0 |
| | RP-21 | RP-030481 | 098 | | UE positioning support in the UE | 5.6.0 | 5.7.0 |
| 12/2003 | RP-22 | RP-030613 | 101 | 2 | Correction to Location Reporting procedure | 5.7.0 | 5.8.0 |
| | RP-22 | - | - | | Upgrade to Release 6 - no technical change | 5.8.0 | 6.0.0 |
| 06/2004 | RP-24 | RP-040209 | 103 | | Corrections to time stamp in position information report and to SRNC relocation | 6.0.0 | 6.1.0 |
| | RP-24 | RP-040216 | 104 | | Indication of achieved accuracy in position estimate | 6.0.0 | 6.1.0 |
| 06/2005 | RP-28 | RP-050330 | 0105 | | Addition of the U-TDOA location method to the UTRAN | 6.1.0 | 7.0.0 |
| 09/2005 | RP-29 | RP-050478 | 0106 | | Enabling the Providing of Velocity | 7.0.0 | 7.1.0 |
| | RP-29 | RP-050619 | 0107 | 1 | Harmonization with the Stage 3 specification (TS 25.453) and addition of TDD functionality for the U-TDOA positioning method | 7.0.0 | 7.1.0 |
| 03/2006 | RP-31 | RP-060098 | 0108 | | 7.68 Mpcs TDD Option (Release 7) | 7.1.0 | 7.2.0 |
| 06/2006 | RP-32 | RP-060356 | 0109 | | Introducing A-GNSS in UTRAN | 7.2.0 | 7.3.0 |
| | RP-32 | RP-060357 | 0110 | | Addition of Periodic Location Procedures | 7.2.0 | 7.3.0 |
| 09/2007 | RP-37 | RP-070577 | 0111 | | SAS-Centric A-GPS - UE requesting additional Assistance Data | 7.3.0 | 7.4.0 |
| 12/2007 | RP-38 | - | - | | Upgrade to the Release 8 - no technical change | 7.4.0 | 8.0.0 |
| 12/2008 | RP-42 | RP-081029 | 0112 | - | Support for additional navigation satellite systems in UTRAN | 8.0.0 | 8.1.0 |
| 12/2009 | RP-46 | - | - | | Upgrade to the Release 9 - no technical change | 8.1.0 | 9.0.0 |
| 09/2010 | RP-49 | - | - | - | Upgrade to the Release 10 - no technical change | 9.0.0 | 10.0.0 |
| | RP-49 | RP-100864 | 0119 | 1 | Support of RF Pattern Matching in UTRAN | 9.0.0 | 10.0.0 |

History

| Document history | | |
|-------------------------|----------|-------------|
| V10.0.0 | May 2011 | Publication |
| | | |
| | | |
| | | |
| | | |