

ETSI TS 125 308 V8.4.0 (2009-01)

Technical Specification

**Universal Mobile Telecommunications System (UMTS);
High Speed Downlink Packet Access (HSDPA);
Overall description;
Stage 2
(3GPP TS 25.308 version 8.4.0 Release 8)**



Reference

RTS/TSGR-0225308v840

Keywords

UMTS

ETSI

650 Route des Lucioles
F-06921 Sophia Antipolis Cedex - FRANCE

Tel.: +33 4 92 94 42 00 Fax: +33 4 93 65 47 16

Siret N° 348 623 562 00017 - NAF 742 C
Association à but non lucratif enregistrée à la
Sous-Préfecture de Grasse (06) N° 7803/88

Important notice

Individual copies of the present document can be downloaded from:

<http://www.etsi.org>

The present document may be made available in more than one electronic version or in print. In any case of existing or perceived difference in contents between such versions, the reference version is the Portable Document Format (PDF). In case of dispute, the reference shall be the printing on ETSI printers of the PDF version kept on a specific network drive within ETSI Secretariat.

Users of the present document should be aware that the document may be subject to revision or change of status. Information on the current status of this and other ETSI documents is available at

<http://portal.etsi.org/tb/status/status.asp>

If you find errors in the present document, please send your comment to one of the following services:

http://portal.etsi.org/chaicor/ETSI_support.asp

Copyright Notification

No part may be reproduced except as authorized by written permission.
The copyright and the foregoing restriction extend to reproduction in all media.

© European Telecommunications Standards Institute 2009.
All rights reserved.

DECTTM, **PLUGTESTS**TM, **UMTS**TM, **TIPHON**TM, the TIPHON logo and the ETSI logo are Trade Marks of ETSI registered for the benefit of its Members.

3GPPTM is a Trade Mark of ETSI registered for the benefit of its Members and of the 3GPP Organizational Partners.

LTETM is a Trade Mark of ETSI currently being registered

for the benefit of its Members and of the 3GPP Organizational Partners.

GSM[®] and the GSM logo are Trade Marks registered and owned by the GSM Association.

Intellectual Property Rights

IPRs essential or potentially essential to the present document may have been declared to ETSI. The information pertaining to these essential IPRs, if any, is publicly available for **ETSI members and non-members**, and can be found in ETSI SR 000 314: "*Intellectual Property Rights (IPRs); Essential, or potentially Essential, IPRs notified to ETSI in respect of ETSI standards*", which is available from the ETSI Secretariat. Latest updates are available on the ETSI Web server (<http://webapp.etsi.org/IPR/home.asp>).

Pursuant to the ETSI IPR Policy, no investigation, including IPR searches, has been carried out by ETSI. No guarantee can be given as to the existence of other IPRs not referenced in ETSI SR 000 314 (or the updates on the ETSI Web server) which are, or may be, or may become, essential to the present document.

Foreword

This Technical Specification (TS) has been produced by ETSI 3rd Generation Partnership Project (3GPP).

The present document may refer to technical specifications or reports using their 3GPP identities, UMTS identities or GSM identities. These should be interpreted as being references to the corresponding ETSI deliverables.

The cross reference between GSM, UMTS, 3GPP and ETSI identities can be found under <http://webapp.etsi.org/key/queryform.asp>.

Contents

Intellectual Property Rights	2
Foreword.....	2
Foreword.....	5
1 Scope	6
2 References	6
3 Definitions and abbreviations.....	6
3.1 Definitions	6
3.2 Abbreviations	7
4 Background and Introduction.....	7
5 Basic structure of HS-DSCH.....	8
5.1 Protocol structure	8
5.2 Basic physical structure.....	9
5.2.1 HS-DSCH Characteristics.....	9
5.2.2 DL HS-DSCH Physical layer model.....	10
5.2.2.1 FDD Downlink Physical layer Model.....	10
5.2.2.2 TDD Downlink Physical layer model	12
5.2.3 UL Physical layer model.....	15
5.2.4 HS-DSCH physical-layer structure in the code domain.....	17
5.2.4.1 FDD.....	17
5.2.4.2 TDD	17
5.3 Transport channel attributes	17
6 MAC architecture	18
6.1 HS-DSCH MAC architecture – UE side	18
6.1.1 Overall architecture.....	18
6.1.2 Details of MAC-d	19
6.1.3 Details of MAC-c/sh.....	21
6.1.4 Details of MAC-hs.....	22
6.1.5 Details of MAC-ehs	23
6.2 HS-DSCH MAC architecture – UTRAN side	24
6.2.1 Overall architecture.....	25
6.2.2 Details of MAC-c/sh.....	27
6.2.3 Details of MAC-hs.....	27
6.2.4 Details of MAC-ehs	29
7 HARQ protocol	30
7.1 Signalling	30
7.1.1 Uplink	30
7.1.2 Downlink	30
7.1.2.1 Shared control channel signalling	30
7.1.2.2 In-band signalling on HS-DSCH.....	31
7.2 Void.....	31
7.3 Void.....	31
7.4 Error handling	31
8 Signalling parameters.....	32
8.1 Downlink signalling parameters.....	32
8.1.1 UE identification.....	32
8.1.2 Transport Block Sizes.....	32
8.1.3 Channelisation codes (FDD only).....	32
8.1.4 HS-PDSCH configuration (TDD only).....	32
8.1.5 HARQ information	32
8.1.6 Measurement feedback rate (FDD only).....	32
8.1.7 HS-PDSCH power offset.....	32

8.1.8	Void	32
8.1.9	Void	32
8.1.10	HS-SCCH Cyclic Sequence Number (HCSN) (TDD only)	32
8.2	Uplink signalling parameters	33
8.2.1	ACK/NACK	33
8.2.2	Measurement report	33
9	Mobility procedures	33
9.1	Serving HS-DSCH cell change	34
9.2	Serving HS-DSCH cell change mechanisms	35
9.3	Intra-Node B synchronised serving HS-DSCH cell change	35
9.4	Inter-Node B synchronised serving HS-DSCH cell change during hard handover	36
9.5	Inter-Node B synchronised serving HS-DSCH cell change after active set update (radio link addition)	37
9.6	Serving HS-DSCH cell change with target cell pre-configuration	39
10	Resource management	41
11	Discontinuous UL DPCH transmission and discontinuous reception of F-DPCH and HSPA DL channels in FDD	42
11.1	Discontinuous uplink transmission	42
11.1.1	Uplink DRX	43
11.2	Downlink DRX	44
12	HS-SCCH-less HS-DSCH transmission in FDD	46
12.1	HS-SCCH-less timing and operation	47
13	MIMO modelling and operation in HSDPA channel in FDD	47
14	HS-DSCH reception in CELL_FACH state (FDD only)	49
14.1	UE operation	49
14.2	Initial link adaptation	50
14.3	Measurement Occasion	50
14.4	Discontinuous reception	50
14.4.1	HS-DSCH DRX operation in CELL_FACH state	50
15	HS-DSCH reception in CELL_PCH and URA_PCH states (FDD only)	51
15.1	UE operation	52
16	HS-DSCH reception in CELL_FACH state (1.28Mcps TDD only)	52
16.1	UE operation	53
16.2	Initial link adaptation	54
16.3	Link adaptation when H-RNTI is allocated	54
16.4	Discontinuous reception	54
16.4.1	HS-DSCH DRX operation in CELL_FACH state	55
16.5	Measurement Occasion	55
17	HS-DSCH reception in CELL_PCH and URA_PCH states (1.28Mcps TDD only)	55
17.1	UE operation	56
18	Dual Cell HSDPA Operation (FDD only)	57
19	HS-SCCH-less HS-DSCH transmission in 1.28Mcps TDD	58
19.1	HS-SCCH-less timing and operation	58
Annex A:	Void	59
Annex B (informative):	Change history	60
History		61

Foreword

This Technical Specification has been produced by the 3rd Generation Partnership Project (3GPP).

The contents of the present document are subject to continuing work within the TSG and may change following formal TSG approval. Should the TSG modify the contents of the present document, it will be re-released by the TSG with an identifying change of release date and an increase in version number as follows:

Version x.y.z

where:

- x the first digit:
 - 1 presented to TSG for information;
 - 2 presented to TSG for approval;
 - 3 or greater indicates TSG approved document under change control.
- y the second digit is incremented for all changes of substance, i.e. technical enhancements, corrections, updates, etc.
- z the third digit is incremented when editorial only changes have been incorporated in the document.

1 Scope

The present document is a technical specification of the overall support of High Speed Downlink Packet Access in UTRA.

2 References

The following documents contain provisions which, through reference in this text, constitute provisions of the present document.

- References are either specific (identified by date of publication, edition number, version number, etc.) or non-specific.
- For a specific reference, subsequent revisions do not apply.
- For a non-specific reference, the latest version applies. In the case of a reference to a 3GPP document (including a GSM document), a non-specific reference implicitly refers to the latest version of that document *in the same Release as the present document*.

- [1] 3GPP TR 25.855: "High Speed Downlink Packet Access (HSDPA): Overall UTRAN Description".
- [2] 3GPP TS 25.321: "Medium Access Control (MAC) protocol specification".
- [3] 3GPP TS 25.319: "FDD Enhanced Uplink: Overall description".
- [4] 3GPP TS 25.214: "Physical Layer Procedures (FDD)".
- [5] 3GPP TS 25.331 "Radio Resource Control (RRC)".
- [6] 3GPP TS 25.211 "Physical channels and mapping of transport channels onto physical channels (FDD)".
- [7] 3GPP TS 25.301 "Radio interface protocol architecture".
- [8] 3GPP TS25.304 "User Equipment (UE) procedures in idle mode and procedures for cell reselection in connected mode".

3 Definitions and abbreviations

3.1 Definitions

For the purposes of the present document, the following terms and definitions apply.

Data block: The data transmitted to one UE on HS-DSCH in one transport block (one or two transport blocks are transmitted per TTI in single and dual stream transmission respectively).

Priority class: One flow of data within a HS-DSCH transport channel. One HS-DSCH can transport several priority classes (no more priority classes per TTI than the number of transport blocks). There is only one priority class per TTI (MAC-hs only) or several priority classes per TTI (MAC-ehs only).

HARQ Process: Peer state machines capable of achieving error correction by retransmission. One process can be used only for one data block at a time.

HARQ Entity: Consists of all the HARQ processes of a UE for one HS-DSCH transport channel, controlling part or all the available soft buffer capacity.

Serving HS-DSCH radio link: The radio link that the HS-PDSCH physical channel(s) allocated to the UE belongs to.

Serving HS-DSCH cell: The cell associated with the UTRAN access point performing transmission and reception of the serving HS-DSCH radio link for a given UE. The serving HS-DSCH cell is always part of the current active set of the UE.

Serving HS-DSCH Node B: A role a Node B may take with respect to a UE having one or several HS-PDSCHs allocated. The serving HS-DSCH Node B is the Node B controlling the serving HS-DSCH cell.

HS-SCCH set: a set of HS-SCCH which is used for HS-PDSCH allocation. There is a maximum of four HS-SCCHs in a given HS-SCCH set. There can be multiple HS-SCCH sets in one cell. HS-SCCH sets are independent, i.e. they can overlap or have no intersection.

Serving HS-SCCH set: the HS-SCCH set being used by a given UE for HS-PDSCH allocations.

MAC-d flow: a MAC-d flow is a flow of MAC-d PDUs which belong to logical channels which are MAC-d multiplexed.

Common MAC Flow: a Common MAC Flow is a flow of MAC-c PDU mapped to HS-DSCH configured for UEs in Cell_FACH.

Paging MAC Flow: a Paging MAC Flow is a flow of MAC-c PDU mapped to HS-DSCH configured for UEs in Cell_PCH and URA_PCH.

3.2 Abbreviations

For the purposes of the present document, the following abbreviations apply:

16QAM	16 Quadrature Amplitude Modulation
CCTrCH	Coded Composite Transport Channel
CQI	Channel Quality Indicator
HARQ	Hybrid Automatic Repeat Request
HSDPA	High Speed Downlink Packet Access
HS-DSCH	High Speed Downlink Shared Channel
HS-PDSCH	High Speed Physical Downlink Shared Channel
HS-SCCH	Shared Control Channel for HS-DSCH
HS-SICH	Shared Information Channel for HS-DSCH
MCS	Modulation and Coding scheme
NW	Network
QPSK	Quadrature Phase Shift Keying
TFCI	Transport Format Combination Indicator
TFRC	Transport Format Resource Combination
TFRI	Transport Format and Resource Indicator
TPC	Transmit Power Control
TSN	Transmission Sequence Number
UE	User Equipment

4 Background and Introduction

High Speed Downlink Packet Access is based on techniques such as adaptive modulation and hybrid ARQ to achieve high throughput, reduce delay and achieve high peak rates.

It relies on a new type of transport channel, the HS-DSCH, which is terminated in the Node B.

In FDD and 1.28Mcps TDD, the HS-DSCH reception is also supported in CELL_FACH, CELL_PCH and URA_PCH state.

5 Basic structure of HS-DSCH

5.1 Protocol structure

The HS-DSCH functionality should be able to operate in an environment where certain cells are not updated with HS-DSCH functionality. The PDCP and MAC-d layers are unchanged from the Release '99 and Release 4 architecture. In addition to the RLC layer from Release '99, it is possible to use Release 7 RLC layer, which is modified to support flexible RLC PDU sizes for RLC AM, when MAC-ehs is configured.

RLC can operate in either AM or UM mode. RLC can operate in TM mode when BCCH or PCCH is mapped on HS-DSCH in FDD and 1.28Mcps TDD.

PDCP can be configured either to perform or not to perform header compression.

MAC-d is retained in the S-RNC. Transport channel type switching is therefore feasible.

The new functionalities of hybrid ARQ, segmentation (MAC-ehs only) and HS-DSCH scheduling are included in the MAC layer. In the UTRAN these functions are included in a new entities called MAC-hs and MAC-ehs located in Node B. Upper layers configure which of the two entities, MAC-hs or MAC-ehs, is to be applied to handle HS-DSCH functionality. The transport channel that the HS-DSCH functionality uses is called HS-DSCH (High Speed Downlink Shared Channel) and is controlled by the MAC-hs or MAC-ehs.

Two MAC protocol configurations are possible on the UTRAN side:

- Configuration with MAC-c/sh: In this case, the MAC-hs or MAC-ehs in Node B is located below MAC-c/sh in CRNC. MAC-c/sh shall provide functions to HS-DSCH identical to those provided for the DSCH in the Release '99. The HS-DSCH FP (frame protocol) will handle the data transport from SRNC to CRNC (if the Iur interface is involved) and between CRNC and the Node B.
- Configuration without MAC-c/sh: In this case, the CRNC does not have any user plane function for the HS-DSCH. MAC-d in SRNC is located directly above MAC-hs or MAC-ehs in Node B, i.e. in the HS-DSCH user plane the SRNC is directly connected to the Node B, thus bypassing the CRNC.

Both configurations are transparent to both the UE and Node B. Figures 5.1-1 and 5.1-2 show the respective radio interface protocol architecture with termination points for the above two configurations.

The same architecture supports both FDD and TDD modes of operation, though some details of the associated signalling for HS-DSCH are different.

In FDD, CELL_FACH, CELL_PCH and URA_PCH state HS-DSCH reception is defined in clauses 14, and 15, a single Iub HS-DSCH FP connection can be shared by CCCH and MAC-d(s) of different UEs.

In 1.28Mcps TDD, CELL_FACH, CELL_PCH and URA_PCH state HS-DSCH reception is defined in clauses 16, and 17, a single Iub HS-DSCH FP connection can be shared by CCCH and MAC-d(s) of different UEs.

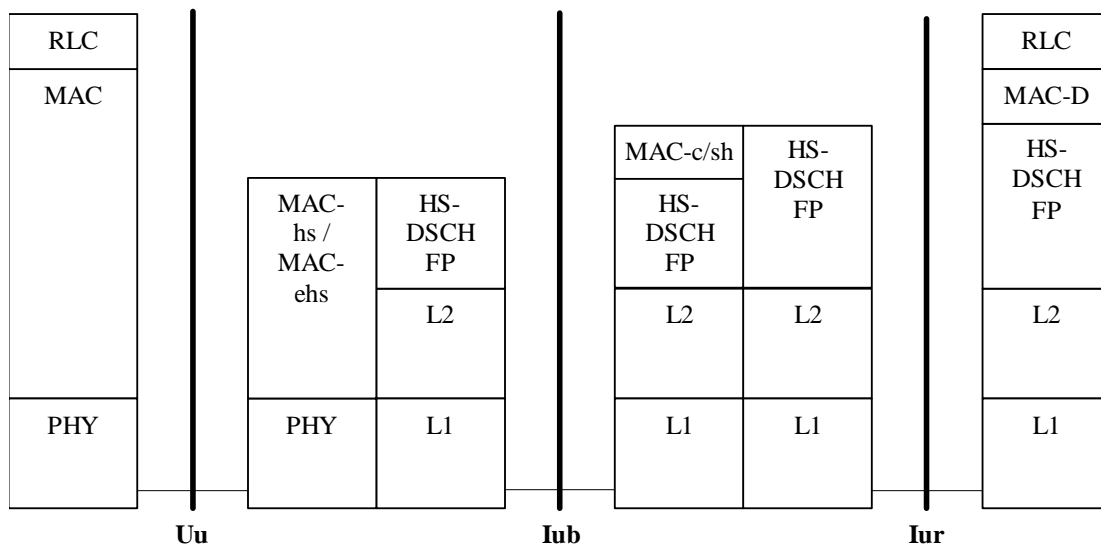

Figure 5.1-1: Protocol Architecture of HS-DSCH, Configuration with MAC-c/sh

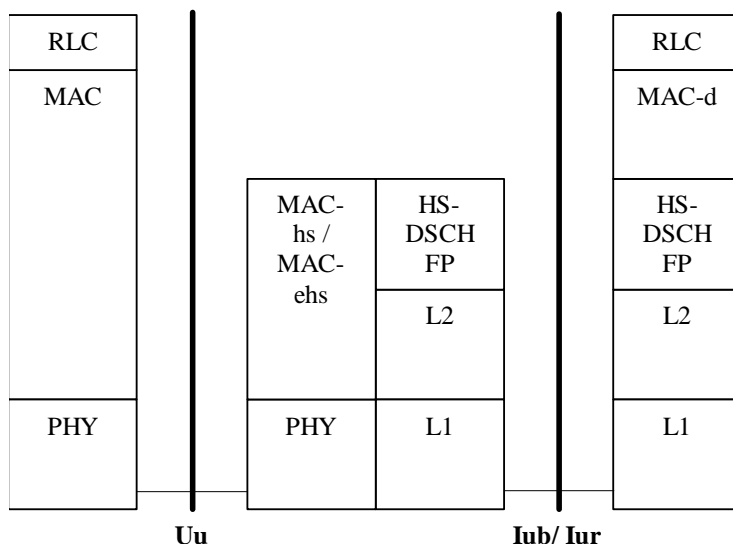

Figure 5.1-2: Protocol Architecture of HS-DSCH, Configuration without MAC-c/sh

5.2 Basic physical structure

5.2.1 HS-DSCH Characteristics

The HS-DSCH transport channel has the following characteristics:

- An HS-DSCH transport channel is processed and decoded from one CCTrCH;
- For FDD and 3.84 Mcps/7.68 Mcps TDD, there is only one CCTrCH of HS-DSCH type per UE, for 1.28 Mcps TDD, there is only one CCTrCH of HS-DSCH type per carrier per UE;
- The CCTrCH can be mapped to one or several physical channels;
- There is only one HS-DSCH per CCTrCH;
- Existence in downlink only;
- Possibility to use beam forming;

- Possibility to use MIMO;
- Possibility of applying link adaptation techniques other than power control;
- Possibility to be broadcast in the entire cell;
- For FDD, when operating in CELL_DCH state, is always associated with a DPCH or a F-DPCH (FDD only) and one or more shared physical control channels (HS-SCCHs);
- For TDD, is associated with one or more shared physical control channels (HS-SCCHs).

5.2.2 DL HS-DSCH Physical layer model

5.2.2.1 FDD Downlink Physical layer Model

DCH model with HS-DSCH

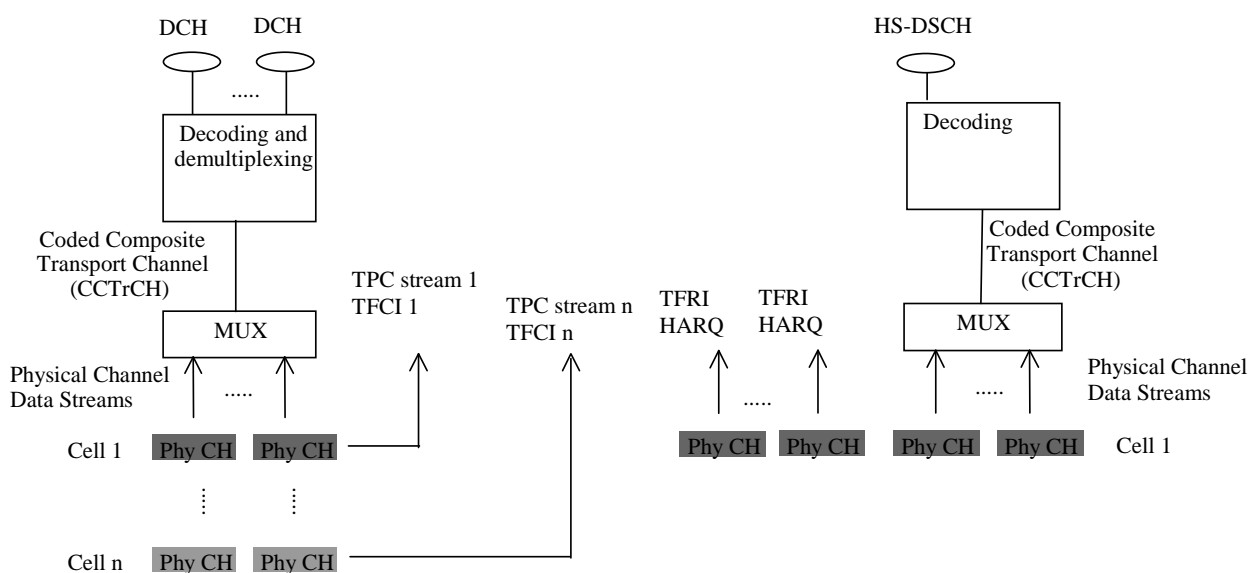

Figure 5.2.2.1-1: Model of the UE's Downlink physical layer - HS-PDSCH with associated DPCH or F-DPCH (FDD only) in CELL_DCH state. HS-PDSCH is transmitted from cell 1 in this figure

When operating in CELL_DCH state the basic downlink channel configuration consists of one or several HS-PDSCHs along with an associated DPCH or a F-DPCH (FDD only) combined with a number of separate shared physical control channels, HS-SCCHs.

When operating in CELL_FACH, CELL_PCH and URA_PCH state, as defined in clauses 14 and 15, the basic downlink channel configuration consists of one or several HS-PDSCHs along with a number of separate shared physical control channels, HS-SCCHs.

The set of shared physical control channels allocated to the UE at a given time is called an HS-SCCH set. The UTRAN may use more than one HS-SCCH set in one given cell. There is a fixed time offset between the start of the HS-SCCH information and the start of the corresponding HS-PDSCH subframe.

HS-DSCH model in CELL_FACH, CELL_PCH and URA_PCH state

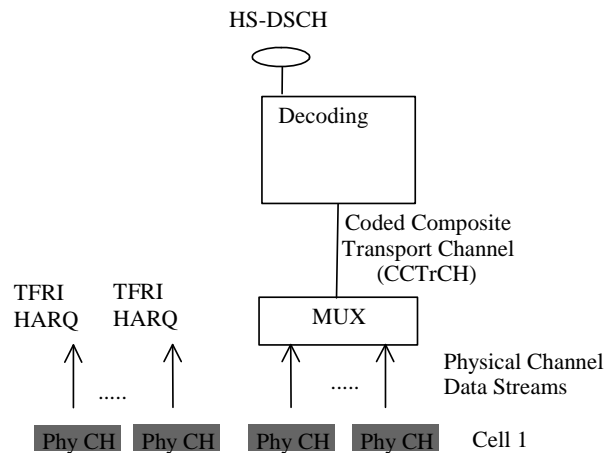

Figure 5.2.2.1-2: Model of the UE's Downlink physical layer in CELL_FACH, CELL_PCH and URA_PCH state (FDD only)-

The UE is provided one HS-SCCH set on HS-PDSCH configuration/re-configuration via RRC signalling.

When operating in CELL_FACH CELL_PCH and URA_PCH state as defined in clauses 14 and 15, the UE obtains the HS-SCCH and HS-PDSCH configuration from system information broadcast.

The number of HS-SCCHs in a HS-SCCH set as seen from the UE's point-of-view can range from a minimum of one HS-SCCH to a maximum of four HS-SCCHs. The UE shall monitor continuously all the HS-SCCHs in the allocated set.

A two-step signalling approach is used for indicating which UE has been scheduled and for signalling the necessary information required for the UE to decode the HS-PDSCHs.

For each HS-DSCH TTI, each Shared Control Channel (HS-SCCH) carries HS-DSCH-related downlink signalling for one UE. The following information is carried on the HS-SCCH:

- Transport Format and Resource Indicator (TFRI):
The TFRI includes information about the dynamic part of the HS-DSCH transport format, including transport block size. The HS-SCCH also includes information about the modulation scheme and the set of physical channels (channelisation codes) onto which HS-DSCH is mapped in the corresponding HS-DSCH TTI. If MIMO mode is configured, it also contains the number of transport blocks and the precoding weight information which informs the UE of which precoding weight that is applied to the primary transport block.
- Hybrid-ARQ-related Information (HARQ information):
This includes the HARQ protocol related information for the corresponding HS-DSCH TTI (subclause 7.1.2.1) and information about the redundancy version.

The HS-SCCH carries a UE identity (via a UE-specific CRC) that identifies the UE for which it is carrying the information necessary for decoding the HS-PDSCH(s).

The HS-PDSCH channelisation codes that are used in a given cell are not sent to the UE using RRC signalling. The HS-SCCH signals the set of HS-PDSCH channelisation codes which are allocated to a UE for a given TTI.

The first part of the HS-SCCH contains the channelisation code set, precoding weight information, number of transport blocks and the modulation scheme for the HS-DSCH allocation with the second part containing the transport block size and H-ARQ related information. One CRC is calculated over both parts and the UE id, and attached to the HS-SCCH information.

In case of HS-DSCH transmission to the same UE in consecutive HS-DSCH TTIs, the same HS-SCCH should be used for the corresponding associated downlink signalling.

When operating in CELL_DCH state the upper layer signalling on the DCCH can be mapped to the DCH mapped to the associated DPCH or the HS-DSCH.

5.2.2.2 TDD Downlink Physical layer model

HS-DSCH(s) with DL DPCH

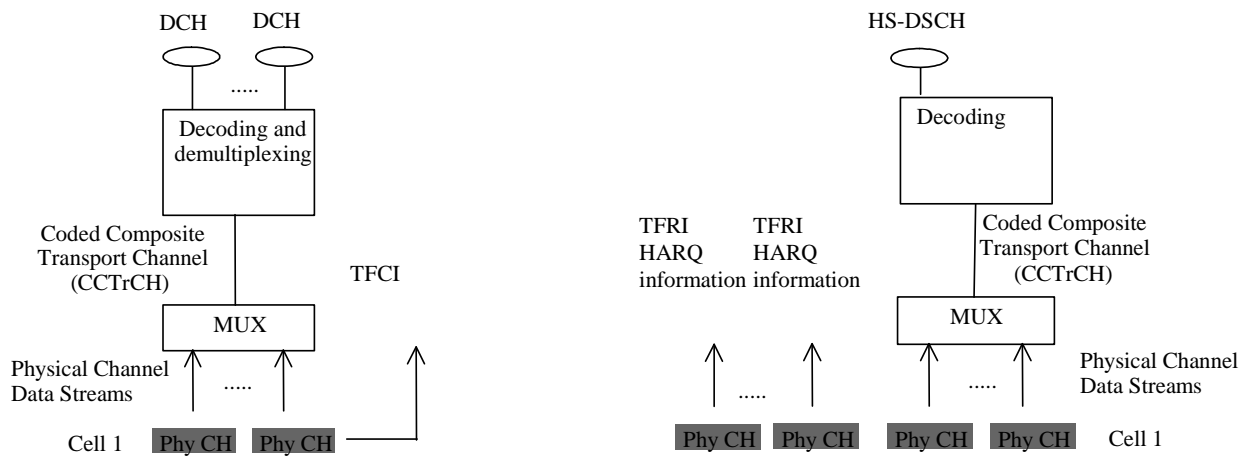

HS-DSCH(s) with no DL DPCH

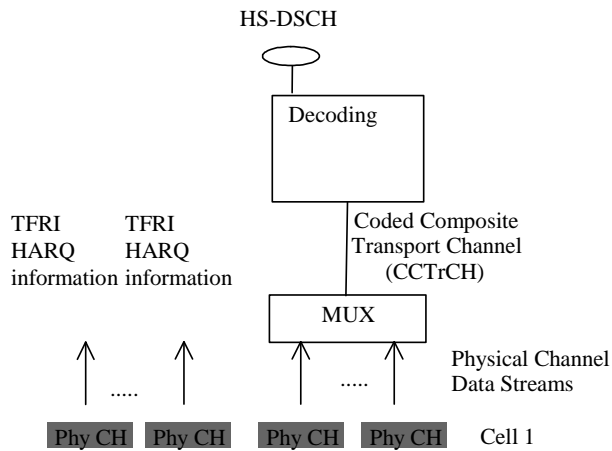
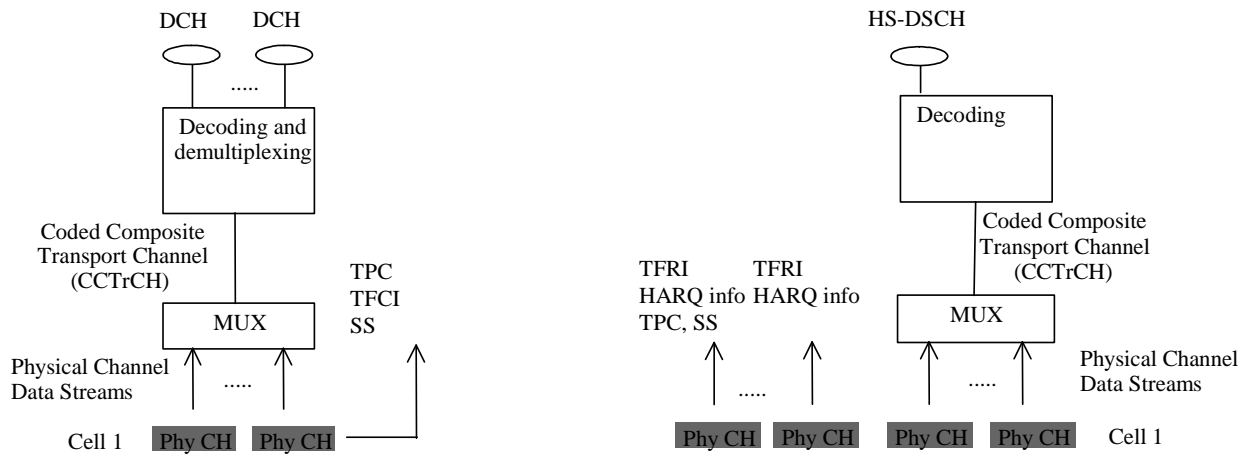

Figure 5.2.2.2-1: Model of the UE's physical layer (3.84 and 7.68 Mcps TDD)

HS-DSCH(s) with DL DPCH



HS-DSCH(s) without DL DPCH

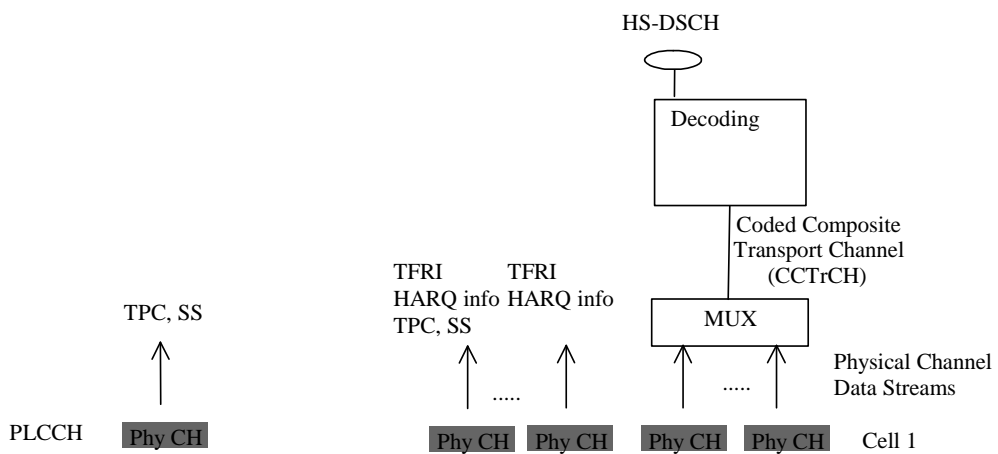
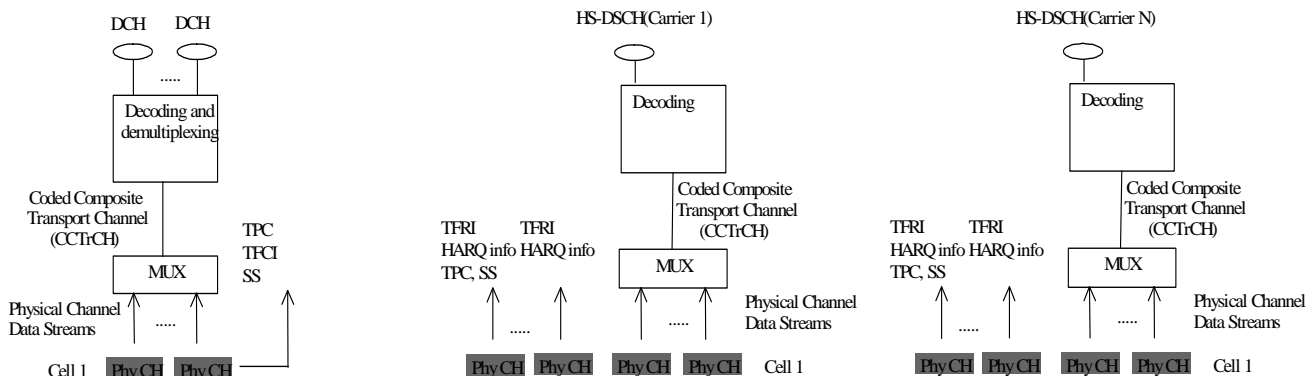

Figure 5.2.2-2: Model of the UE's physical layer in CELL_DCH state (1.28 Mcps TDD)

HS-DSCH(s) with DL DPCH



HS-DSCH(s) without DL DPCH

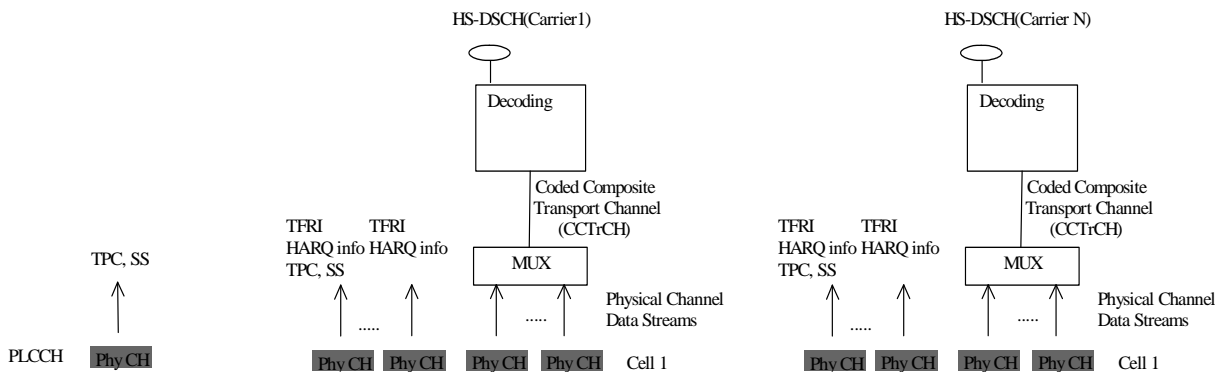

Figure 5.2.2.2-3: Model of the UE's physical layer in CELL_DCH state (1.28Mcps TDD multi-frequency HS-DSCH operation mode only)

HS-DSCH(s) without DL DPCH

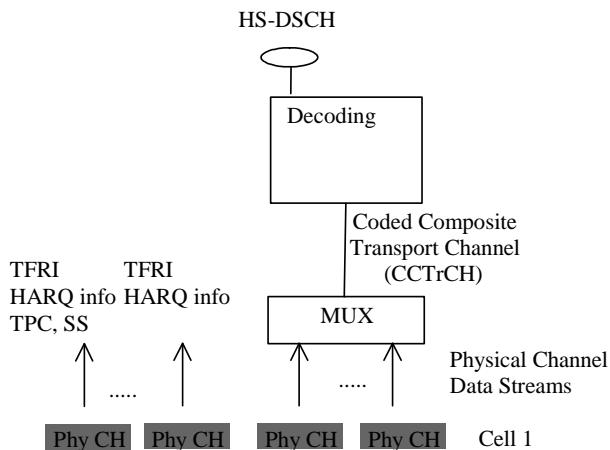

Figure 5.2.2.2-4: Model of the UE's physical layer in CELL_FACH, CELL_PCH and URA_PCH state (1.28 Mcps TDD)

When operating in CELL_DCH state, the TDD overall downlink signalling structure is based on associated dedicated physical channels and shared physical control channels. The downlink signalling information for support of HS-DSCH is carried by the HS-SCCH.

For 1.28 Mcps TDD multi-frequency HS-DSCH operation mode, the associated downlink control channel and uplink control channel pair controlling the HS-DSCH transmission on the certain carrier shall be allocated on the same carrier. The downlink control channel carries the HS-DSCH operation related info and the uplink control channel carries the feedback info from the UE side.

When operating in CELL_FACH, CELL_PCH and URA_PCH state, as defined in subclauses 16 and 17, the basic downlink channel configuration consists of one or several HS-PDSCHs along with a number of shared physical control channels, HS-SCCHs, The UE obtains the HS-SCCH and HS-DSCH configuration from system information broadcast.

As in Release '99, the associated dedicated physical channel can also be a fractionated channel for efficient resource usage with a corresponding repetition period in terms of TTIs. The UE is informed of an HS-DSCH allocation by means of a signalling message on an HS-SCCH.

For 3.84 Mcps TDD and 7.68Mcps TDD, the UE shall be allocated a set of up to four HS-SCCHs, and shall monitor all of these HS-SCCHs continuously. In any given TTI, a maximum of one of these HS-SCCHs may be addressed to the UE. In the case that a UE detects a message for it on a specific HS-SCCH, then it may restrict its monitoring of HS-SCCHs to only that HS-SCCH in the next TTI.

For 1.28 Mcps TDD, the UE shall be allocated a set of up to four HS-SCCHs per carrier, and shall monitor all of these HS-SCCHs continuously. In any given TTI, a maximum of one of these HS-SCCHs may be addressed to the UE on each carrier. In the case that a UE detects a message for it on a specific HS-SCCH on the certain carrier then it may restrict its monitoring of HS-SCCHs to only that HS-SCCH in the next TTI on this carrier.

5.2.3 UL Physical layer model

DCH model with HS-DSCH support

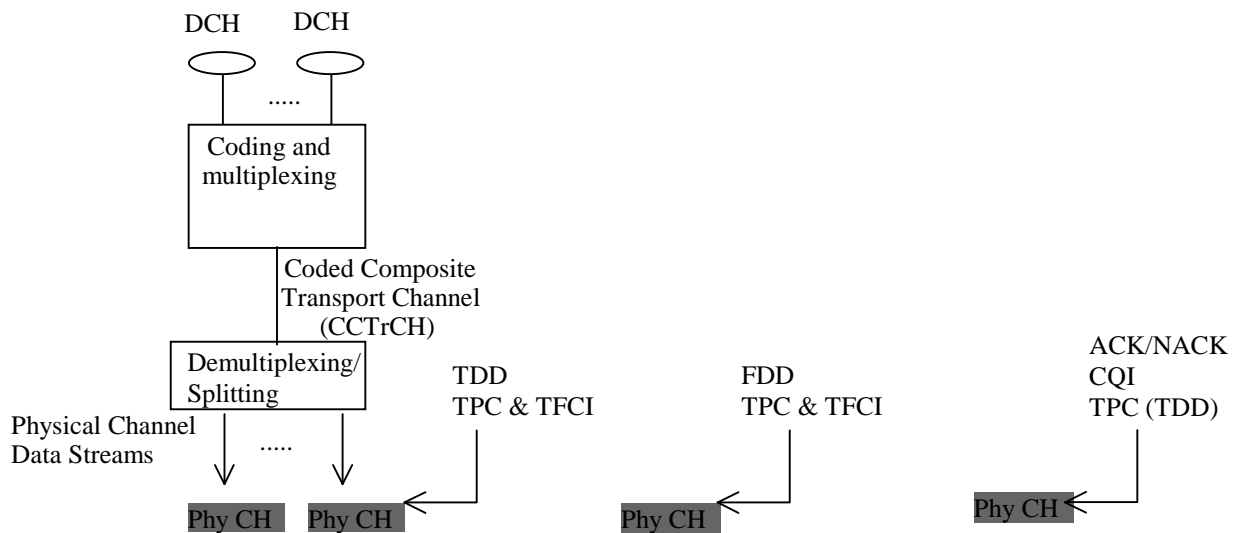

Figure 5.2.3-1: Model of the UE's Uplink physical layer in CELL_DCH state

DCH model with HS-DSCH support

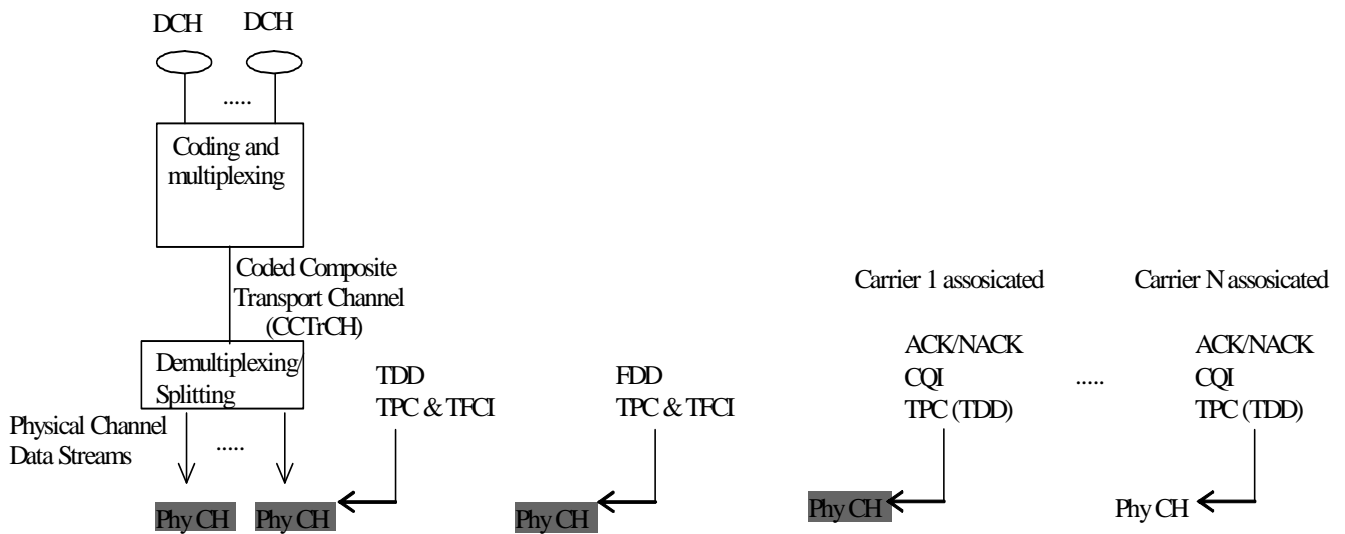

Figure 5.2.3-2: Model of the UE's Uplink physical layer in CELL_DCH state (1.28 Mcps TDD multi-frequency HS-DSCH operation mode only)

In FDD, when operating in CELL_DCH state the uplink signalling uses an additional DPCCCH with SF=256 that is code multiplexed with the existing dedicated uplink physical channels. The HS-DSCH related uplink signalling consists of H-ARQ acknowledgement and channel quality indicator.

In FDD, when operating in CELL_FACH, CELL_PCH and URA_PCH state HS-DSCH reception is as defined in clause 14 and the UE uses the common E-DCH for uplink transmission if the UE and cell support it, otherwise it uses the RACH for uplink transmission. The transmission of HS-DPCCH for HS-DSCH related ACK/NACK and CQI signalling is only supported when the UE is using a common E-DCH resource, is transmitting DTCH/DCCH data, has successfully resolved collision, and has been so configured by the network. Otherwise the transmission of HS-DPCCH is not supported.

In TDD, when operating in CELL_DCH state, the UE shall use a shared uplink resource (the HS-SICH) for transmitting ACK/NACK and CQI information. The relation between the HS-SCCH in DL and the HS-SICH in UL is pre-defined and is not signalled dynamically on the HS-SCCH.

In 1.28Mcps TDD, when operating in CELL_FACH, CELL_PCH and URA_PCH state, HS-DSCH reception is defined in subclause 16 and 17. UE uses E-DCH for uplink transmission. UE in CELL_FACH state with dedicated H-RNTI can send ACK/NACK and CQI signalling on related HS-SICH.

For 1.28 Mcps TDD multi-frequency HS-DSCH operation mode, the associated downlink control channel and uplink control channel pair controlling the HS-DSCH transmission on the certain carrier shall be allocated on the same carrier. The downlink control channel carries the HS-DSCH operation related info and the uplink control channel carries the feedback info from the UE side.

5.2.4 HS-DSCH physical-layer structure in the code domain

5.2.4.1 FDD

HS-DSCH relies on channelisation codes at a fixed spreading factor, SF=16. A UE may be assigned multiple channelisation codes in the same TTI, depending on its UE capability. Furthermore, multiplexing of multiple UEs in the code domain within a HS-DSCH TTI is allowed.

5.2.4.2 TDD

HS-DSCH relies on one or more channelisation codes with either SF=16 or SF=1, but not both simultaneously. Transmission on one or more timeslots is also allowed. Furthermore, a combination of code multiplexing and time multiplexing by timeslot within a HS-DSCH TTI is allowed, but the same set of channelisation codes must be used in all timeslots allocated to the HS-DSCH. The HS-DSCH TTI is not allowed to cross the frame (3.84 Mcps TDD) or the sub-frame (1.28 Mcps TDD) boundary.

5.3 Transport channel attributes

The following is a list of HS-DSCH transport channel attributes:

1. Transport block size - dynamic for first transmission. An identical transport block size shall be applied for any retransmission. In TDD, there shall be no support for blind transport format detection. If FDD, the blind transport format detection is supported in HS-SCCH less operation as defined in subclause 12.1.
2. Transport block set size. The transport block set contains only one transport block for single stream transmission and two transport blocks for dual stream transmission.
3. Transmission Time Interval (TTI). For FDD the HS-DSCH TTI is fixed and equal to 2ms. The HS-DSCH TTI for 3.84 Mcps TDD is 10 ms. For 1.28 Mcps TDD a fixed 5 ms TTI shall apply.
4. Coding parameters:
 - Type of error protection: turbo code rate 1/3.
5. Modulation - dynamic for first transmission and retransmission. Support for QPSK is mandatory in the UE whereas support for 16QAM and 64 QAM depends on the UE capability.
6. Redundancy version - dynamic.
7. CRC size - fixed size of 24 bits. There is one CRC per TB, i.e. one CRC per TTI for single stream transmission and two CRCs per TTI for dual stream transmission.

6 MAC architecture

6.1 HS-DSCH MAC architecture – UE side

This subclause describes the architecture of the MAC and functional split required to support HS-DSCH on the UE side. Both MAC-hs and MAC-ehs handle the HS-DSCH specific functions. Upper layers configure which of the two entities, MAC-hs or MAC-ehs, is to be applied to handle HS-DSCH functionality.

6.1.1 Overall architecture

Figure 6.1.1-1 shows the overall MAC architecture. The data received on HS-DSCH is mapped to the MAC-hs or MAC-ehs. The MAC-hs or MAC-ehs is configured via the MAC Control SAP by RRC similar to the MAC-c/sh and MAC-d, to set the parameters in the MAC-hs or MAC-ehs such as allowed transport format combinations for the HS-DSCH.

The associated Downlink Signalling carries information for support of HS-DSCH while the associated Uplink Signalling carries feedback information.

In FDD, when operating in CELL_FACH CELL_PCH and URA_PCH state HS-DSCH reception is defined in clause 14 and the transmission of HS-DPCCH for HS-DSCH related ACK/NACK and CQI signalling is only supported when the UE is using a common E-DCH resource, is transmitting DTCH/DCCH data, has successfully resolved collision, and has been so configured by the network. Otherwise the transmission of HS-DPCCH is not supported.

In 1.28Mcps TDD, when operating in CELL_FACH HS-DSCH reception is defined in clause 16 and UE with dedicated H-RNTI sends ACK/NACK and CQI signalling on the related HS-SICH.

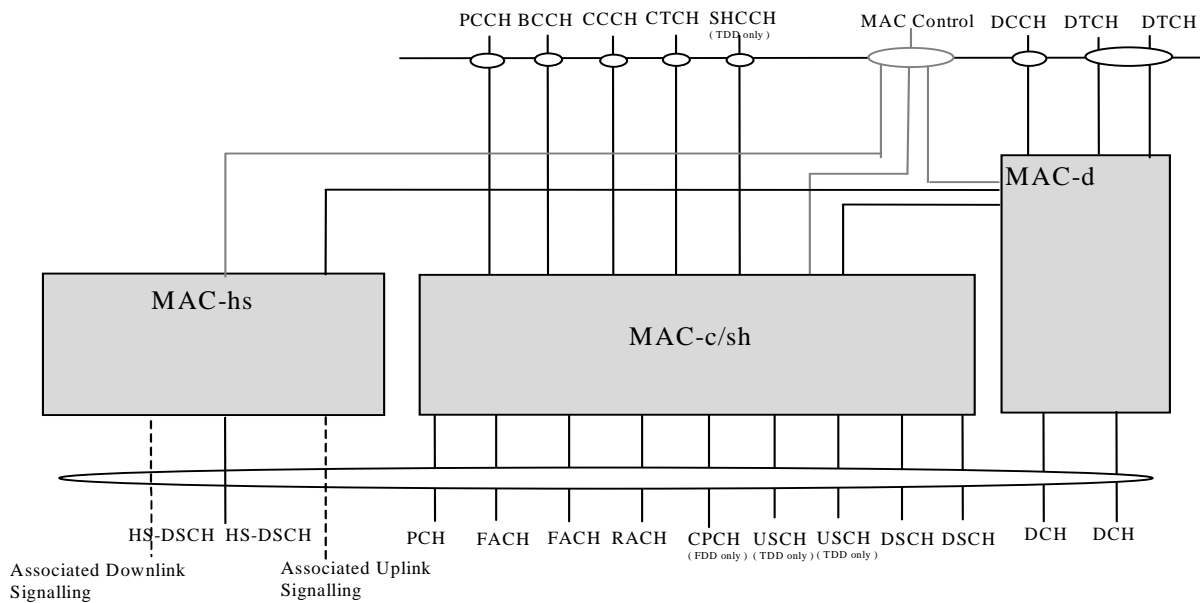

Figure 6.1.1-1: UE side MAC architecture with HS-DSCH (MAC-hs)

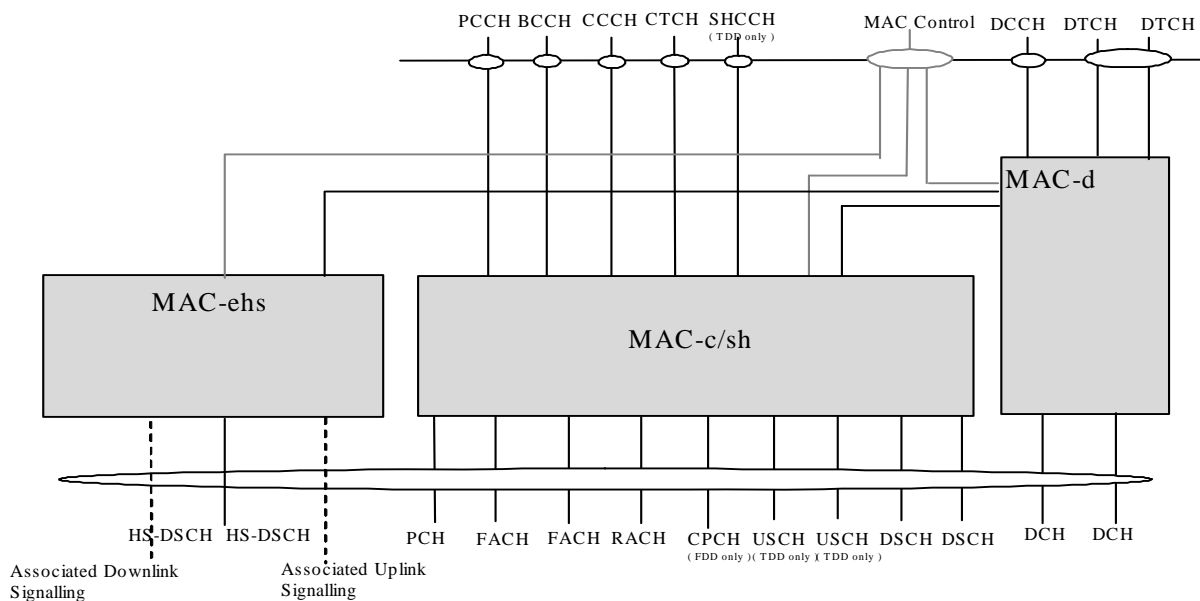
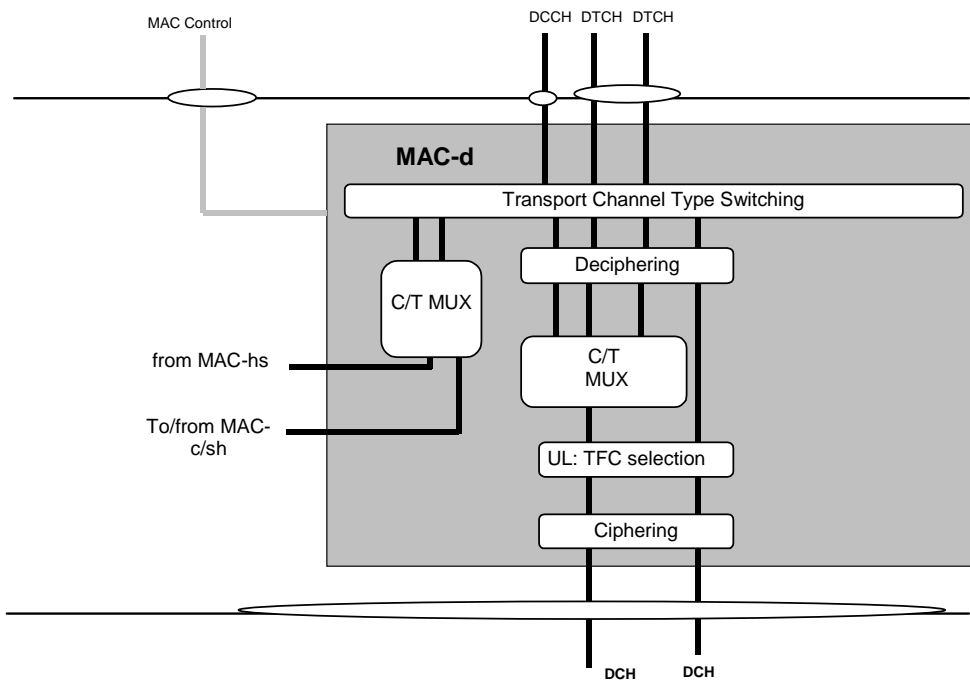

Figure 6.1.1-2: UE side MAC architecture with HS-DSCH (MAC-ehs)

6.1.2 Details of MAC-d

The MAC-d entity is modified with the addition of a link to the MAC-hs or MAC-ehs entity. The links to MAC-hs, MAC-ehs and MAC-c/sh cannot be configured simultaneously in one UE.

The mapping between C/T MUX entity in MAC-d and the reordering buffer in MAC-hs is configured by higher layers. One reordering buffer maps to one C/T MUX entity and many reordering buffers can map to the same C/T MUX entity. If MAC-ehs is configured, C/T MUX toward MAC-ehs is not used.



Note 1: For DCH , DSCH and HS-DSCH, different scheduling mechanism apply
 Note 2: Ciphering is performed in MAC-d only for transparent RLC mode

Figure 6.1.2-1: MAC-d architecture for MAC-hs

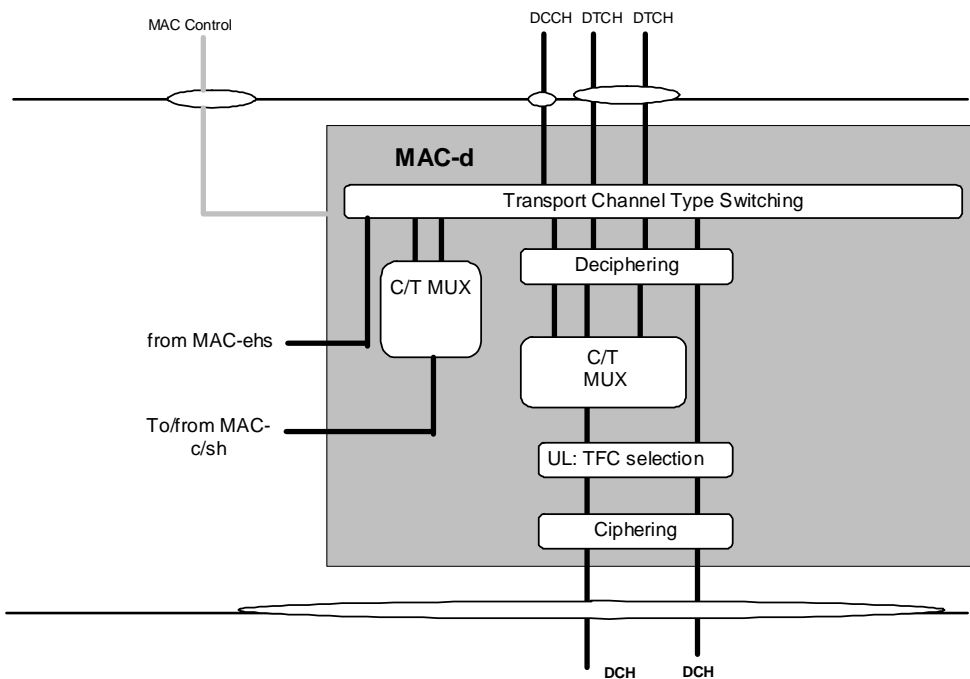

Note 1: For DCH , DSCH and HS-DSCH, different scheduling mechanism apply
 Note 2: Ciphering is performed in MAC-d only for transparent RLC mode

Figure 6.1.2-1b: MAC-d architecture for MAC-ehs

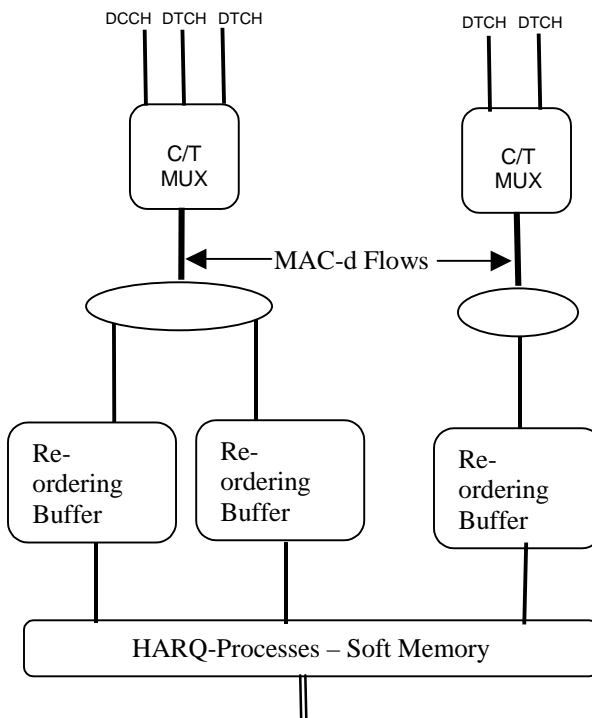

Figure 6.1.2-2: Simplified architecture showing MAC-ds inter-working in UE

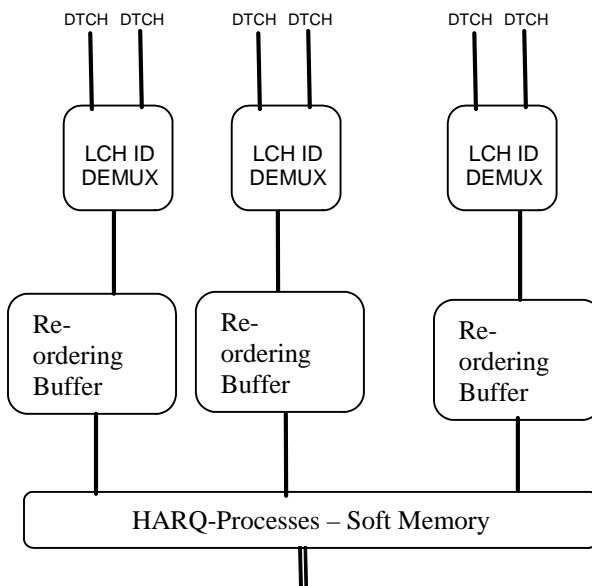

Figure 6.1.2-3: Simplified architecture showing MAC-es inter-working in UE

6.1.3 Details of MAC-c/sh

The MAC-c/sh/m on the UE side is not modified for HS-DSCH operation in CELL_DCH state.

In FDD and 1.28Mcps TDD, when operating in CELL_FACH, CELL_PCH and URA_PCH state, HS-DSCH reception is as defined in clauses 14 and 15 for FDD, 16 and 17 for 1.28Mcps TDD, and the MAC-c/sh is depicted in figure 6.1.3-1.

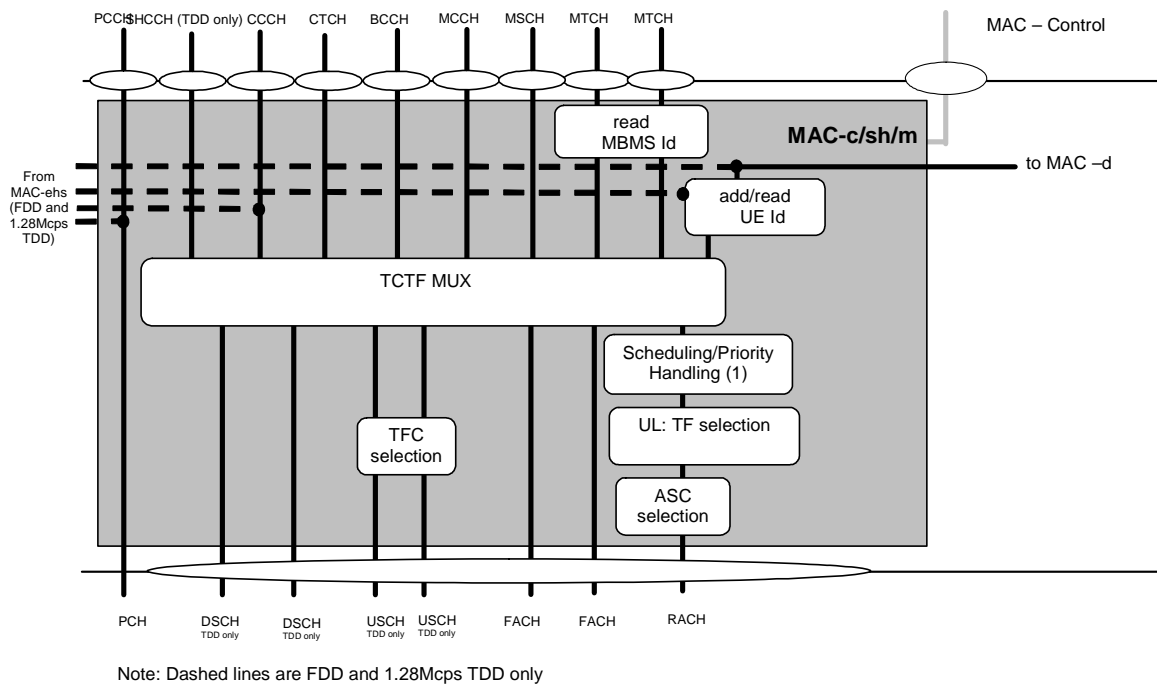

Figure 6.1.3-1: UE side MAC architecture / MAC-c/sh/m details

6.1.4 Details of MAC-hs

In the model below the MAC-hs comprises the following entity:

- HARQ:

The HARQ entity is responsible for handling the HARQ protocol. For FDD and 3.84 Mcps/7.68 Mcps TDD, there shall be one HARQ process per HS-DSCH per TTI, for 1.28 Mcps TDD, there shall be one HARQ process per HS-DSCH on each carrier per TTI. The HARQ functional entity handles all the tasks that are required for hybrid ARQ. It is for example responsible for generating ACKs or NACKs. The detailed configuration of the hybrid ARQ protocol is provided by RRC over the MAC-Control SAP.
- Reordering:

The reordering entity organises received data blocks according to the received TSN. Data blocks with consecutive TSNs are delivered to higher layers upon reception. A timer mechanism determines delivery of non-consecutive data blocks to higher layers. There is one reordering entity for each priority class.
- The following is allowed:
 - One MAC-hs PDU contains only MAC-d PDUs with the same priority, and from the same MAC-d flow;
 - Different MAC-d PDU sizes can be supported in a given MAC-hs PDU.

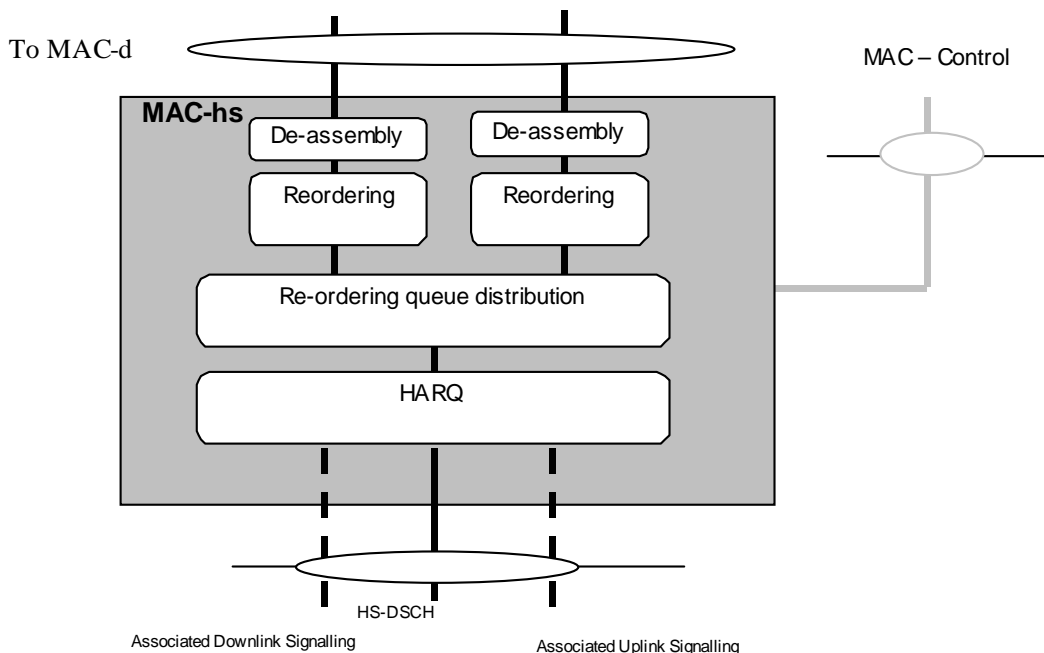

Figure 6.1.4-1: UE side MAC architecture/MAC-hs details

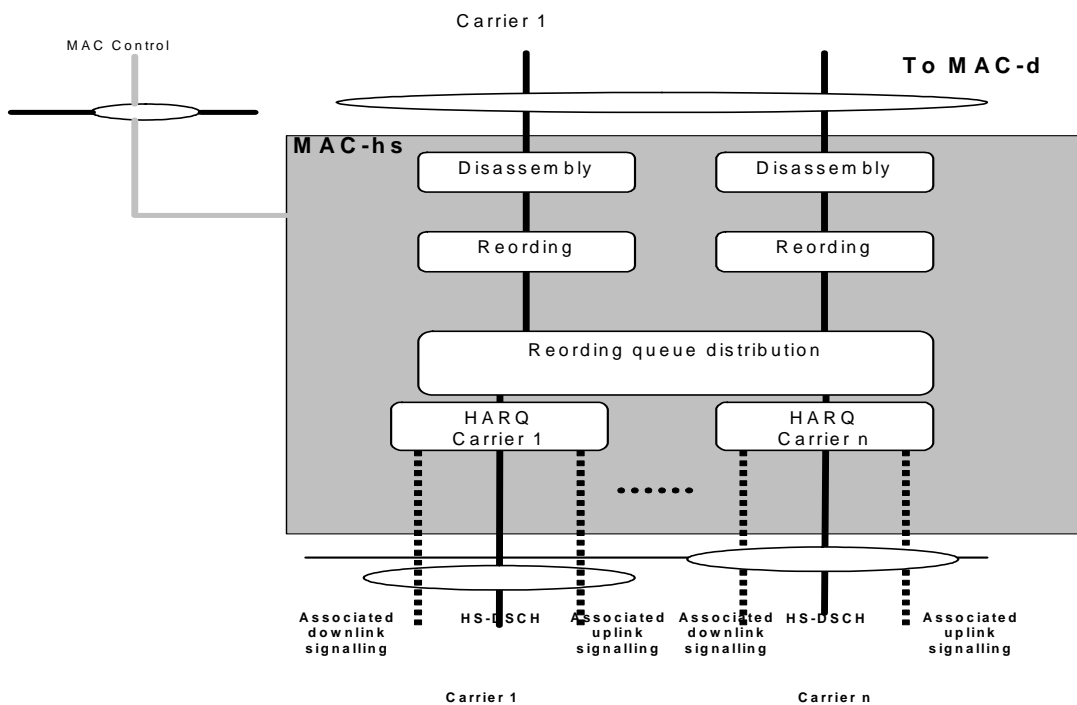

Figure 6.1.4-2: UE side MAC architecture / MAC-hs details (1.28Mcps TDD multi-frequency HS-DSCH operation mode only)

6.1.5 Details of MAC-ehs

The model for MAC-ehs comprises the following entities:

- HARQ:
The HARQ entity is responsible for handling the HARQ protocol. There shall be one HARQ process per HS-DSCH per TTI for single stream transmission and two HARQ processes per HS-DSCH per TTI for dual stream

transmission. The HARQ functional entity handles all the tasks that are required for hybrid ARQ. It is for example responsible for generating ACKs or NACKs. The detailed configuration of the hybrid ARQ protocol is provided by RRC over the MAC-Control SAP.

- Disassembly
The disassembly entity disassembles the MAC-ehs PDUs.
- Reordering queue distribution
The reordering queue distribution function routes the received MAC-ehs SDUs or segments of MAC-ehs SDUs to correct reordering queues based on the received logical channel identifier.
- Reordering:
The reordering entity organises received MAC-ehs SDUs or segments of MAC-ehs SDUs according to the received TSN. Data blocks with consecutive TSNs are delivered to higher layers upon reception. A timer mechanism determines delivery of non-consecutive data blocks to higher layers. There is one reordering entity for each priority class.
- LCH-ID demultiplexing:
The demultiplexing entity routes the MAC-ehs SDUs or segments of MAC-ehs SDUs to correct reassembly entity based on the received logical channel identifier.
- Reassembly:
The reassembly entity reassembles segmented MAC-ehs SDUs to MAC PDUs and forwards the MAC PDUs to upper layers.
- The following is allowed:
 - The MAC-ehs SDUs included in a MAC-ehs PDU can have a different size and a different priority and can be mapped to different MAC-d flows.

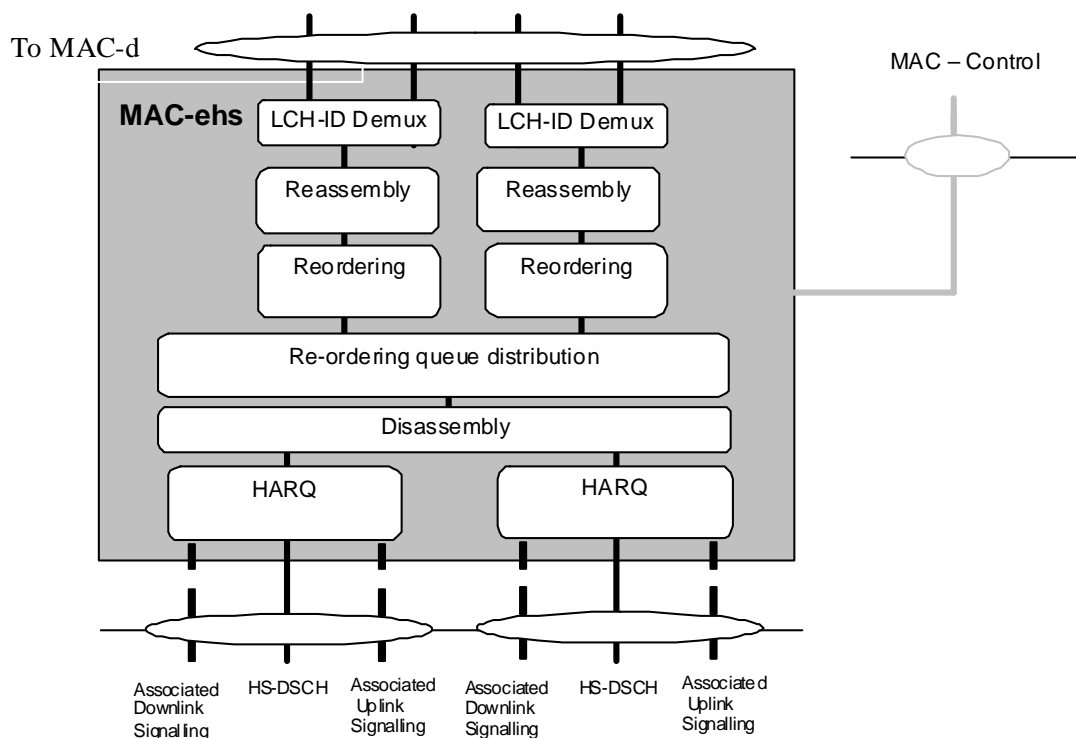

Figure 6.1.5-1: UE side MAC architecture/MAC-ehs details

6.2 HS-DSCH MAC architecture – UTRAN side

This subclause describes the modifications to the MAC model with respect to the Release '99 model to support the features for HS-DSCH on the UTRAN side. Both MAC-hs and MAC-ehs are responsible for handling the data transmitted on the HS-DSCH. Furthermore they are responsible for the management of the physical resources allocated

to HS-DSCH. Upper layers configure which of the two entities, MAC-hs or MAC-ehs, is to be applied to handle HS-DSCH functionality.

6.2.1 Overall architecture

New MAC functional entities, the MAC-hs and the MAC-ehs, are added to the MAC architecture of Release '99. Both the MAC-hs and the MAC-ehs are located in the Node B. If an HS-DSCH is assigned to the UE the MAC-hs and MAC-ehs SDUs, i.e. MAC-d PDUs to be transmitted are transferred from MAC-c/sh to the MAC-hs or MAC-ehs via the Iub interface in case of Configuration with MAC-c/sh, or from the MAC-d via Iur/Iub in case of Configuration without MAC-c/sh.

In FDD and 1.28Mcps TDD, in HS-DSCH transmission for the UE in CELL_FACH, CELL_PCH and URA_PCH state, the HS-DSCH operation is as defined in clause 14 and 15 for FDD, 16 and 17 for 1.28Mcps TDD, and the same overall MAC architecture is used, with the addition that MAC-c/sh SDUs from CCCH and PCCH can be transferred to MAC-ehs.

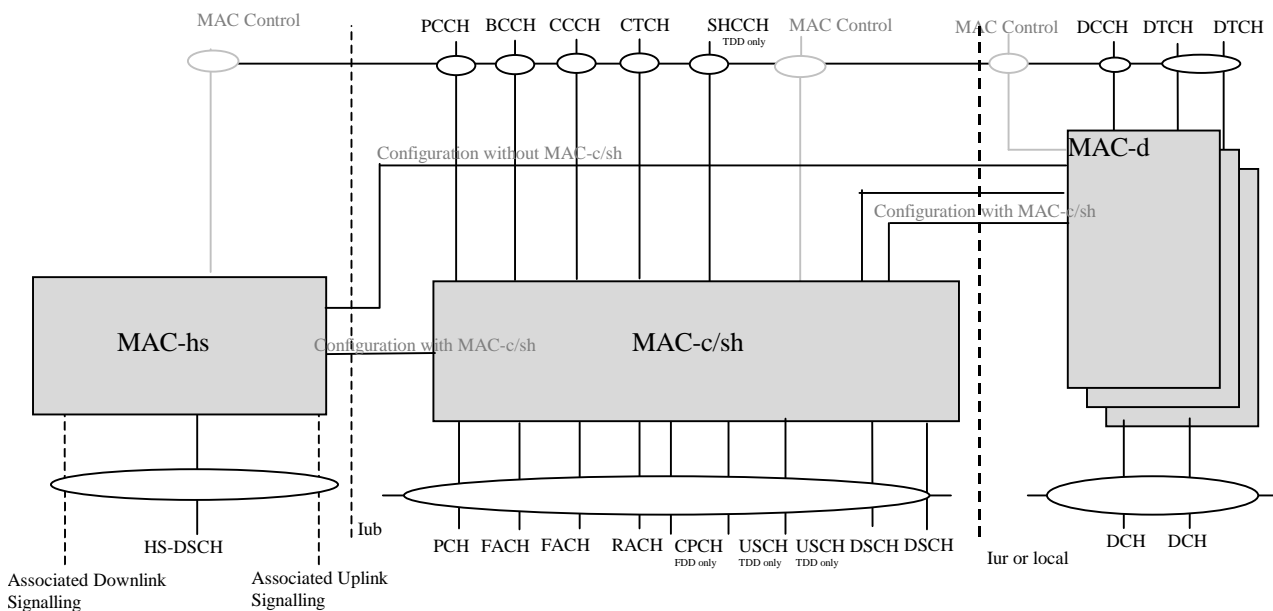

Figure 6.2.1-1: UTRAN side overall MAC architecture, MAC-hs

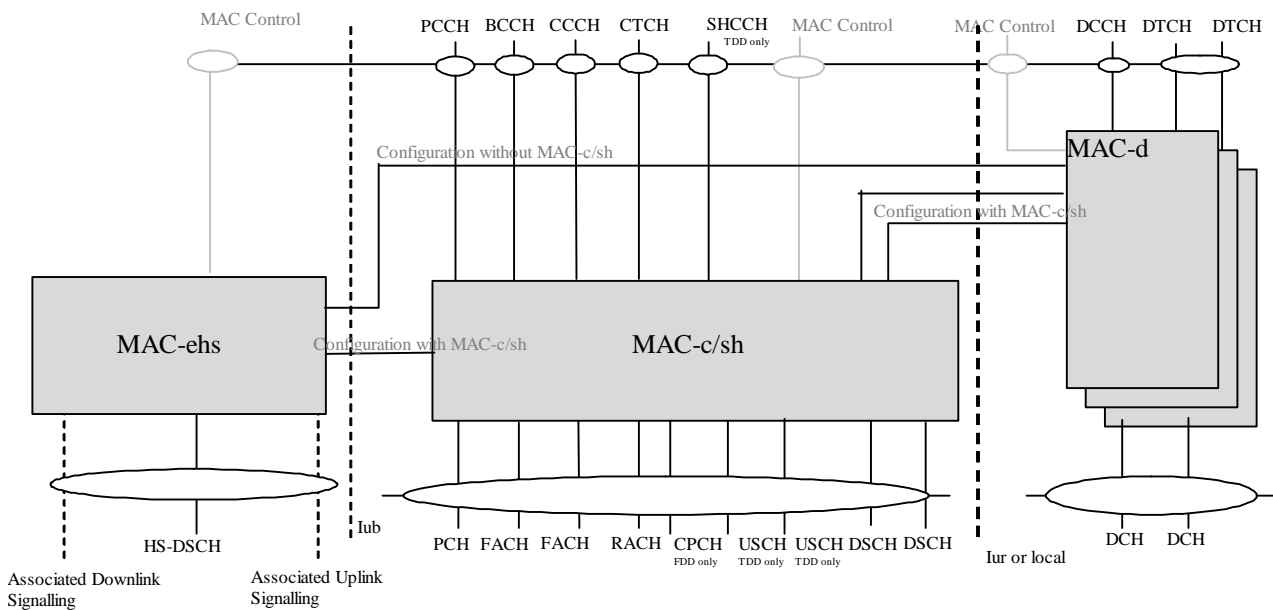

Figure 6.2.1-1b: UTRAN side overall MAC architecture, MAC-ehs

The multiplexing chain for HS-DSCH on the UTRAN side is illustrated below:

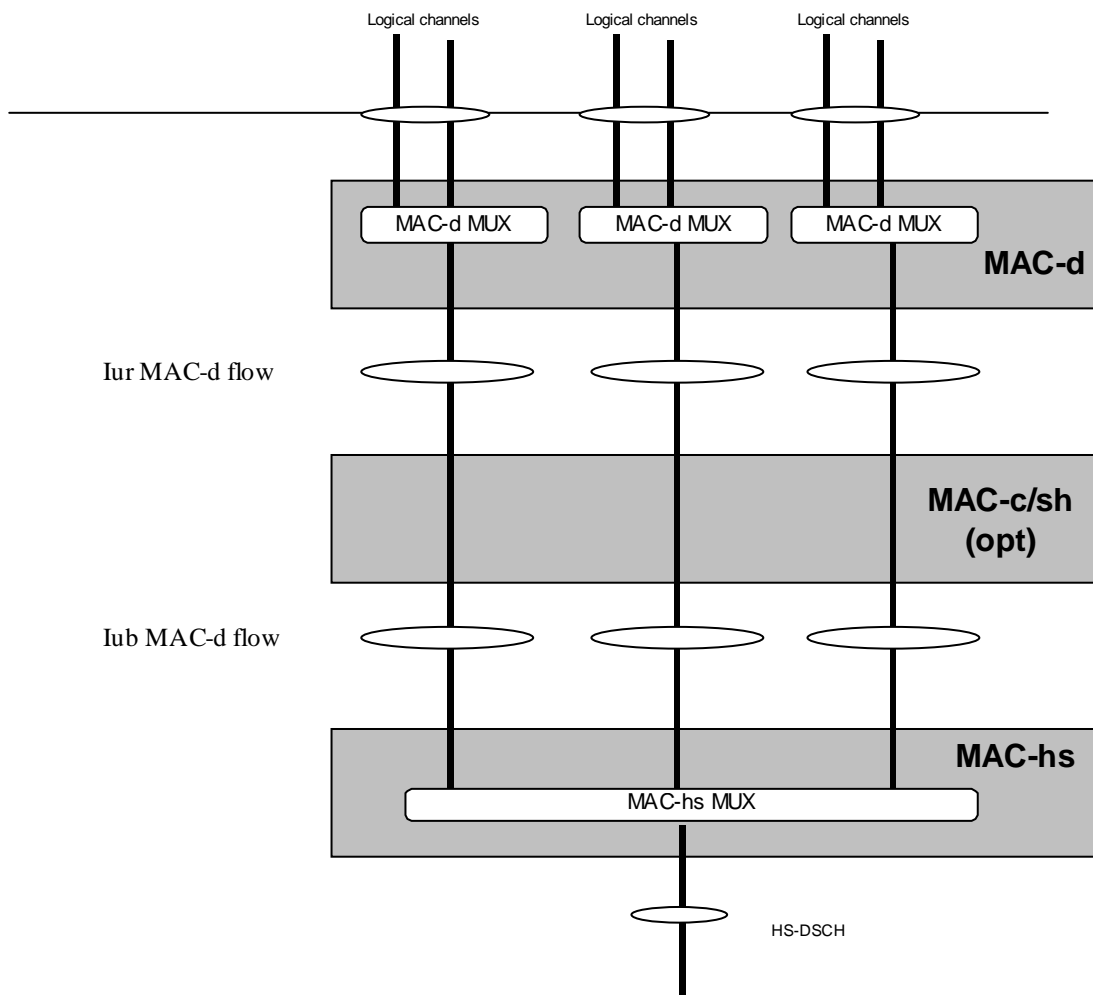

Figure 6.2.1-2: UTRAN side of MAC multiplexing for MAC-hs

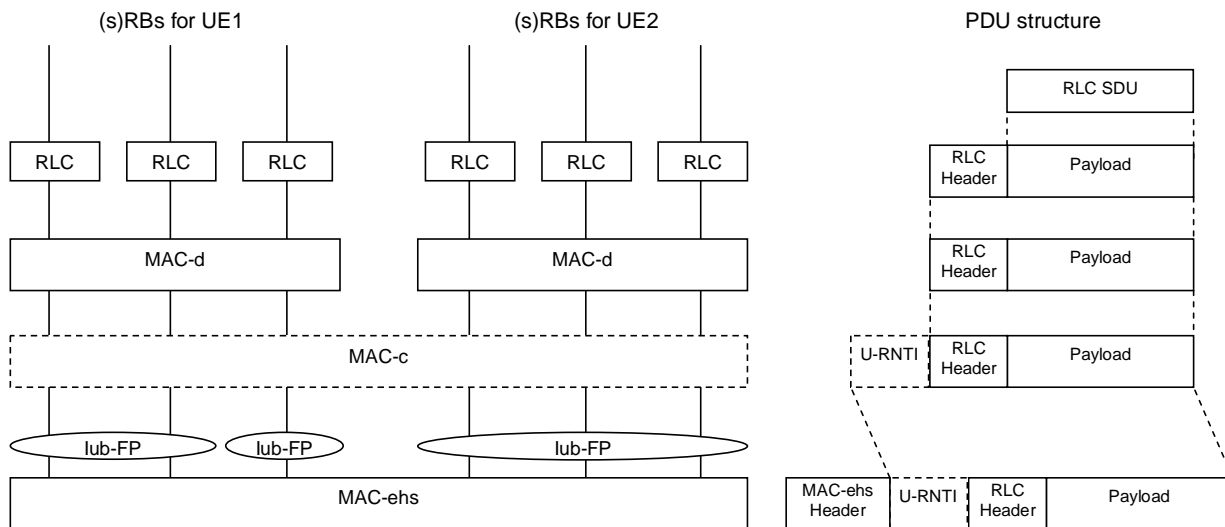

Figure 6.2.1-3: Multiplexing and protocol architecture for MAC-ehs.

NOTE: In figure 6.2.1-3 the MAC-ehs support multiplexing between different UEs similarly to MAC-hs.

6.2.2 Details of MAC-c/sh

The data for the HS-DSCH is subject to flow control between the serving and the drift RNC.

A new flow control function is included to support the data transfer between MAC-d and MAC-hs/MAC-ehs.

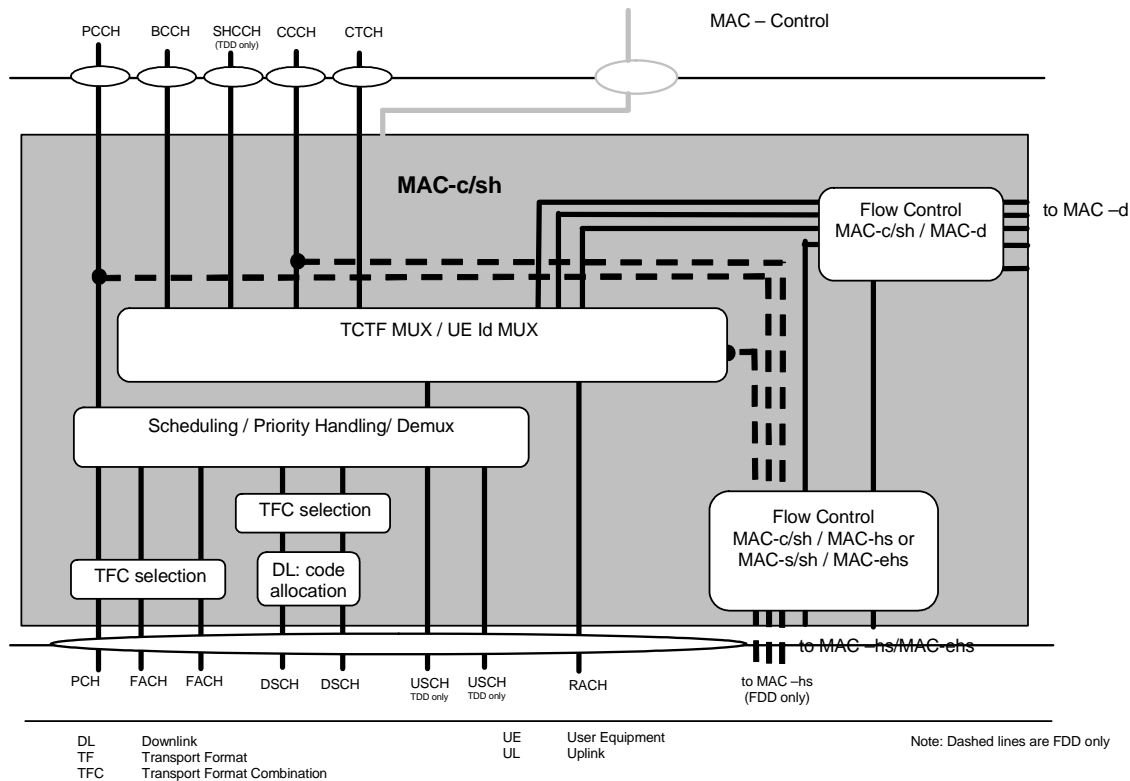

Figure 6.2.2-1: UTRAN side MAC architecture/MAC-c/sh details

In FDD and 1.28Mcps TDD, when operating in CELL_FACH, CELL_PCH and URA_PCH, HS-DSCH reception is as defined in clauses 14 and 15 for FDD, 16 and 17 for 1.28Mcps TDD, and the MAC-c/sh can transfer CCCH and PCCH PDUs to MAC-ehs and the MAC-c/sh does not include any MAC-c/sh protocol header for those logical channels. MAC-c adds the U-RNTI when required to the RLC PDU of the SRB#1.

6.2.3 Details of MAC-hs

MAC-hs receives configuration parameters from the RRC layer via the MAC-Control SAP. There shall be priority handling per MAC-d PDU in the MAC-hs. The MAC-hs is comprised of four different functional entities:

- **Flow Control:**
This is the companion flow control function to the flow control function in the MAC-c/sh in case of Configuration with MAC-c/sh and MAC-d in case of Configuration without MAC-c/sh. Both entities together provide a controlled data flow between the MAC-c/sh and the MAC-hs (Configuration with MAC-c/sh) or the MAC-d and MAC-hs (Configuration without MAC-c/sh) taking the transmission capabilities of the air interface into account in a dynamic manner. This function is intended to limit layer 2 signalling latency and reduce discarded and retransmitted data as a result of HS-DSCH congestion. Flow control is provided independently per priority class for each MAC-d flow.
- **Scheduling/Priority Handling:**
This function manages HS-DSCH resources between HARQ entities and data flows according to their priority class. Based on status reports from associated uplink signalling either new transmission or retransmission is determined when operating in CELL_DCH state. In FDD, When operating in CELL_FACH, CELL_PCH and URA_PCH state HS-DSCH reception as defined in clauses 14 and 15, the MAC-hs can perform retransmission without uplink signalling. Further it sets the priority class identifier and TSN for each new data block being serviced. To maintain proper transmission priority a new transmission can be initiated on a HARQ process at any time. The TSN is unique to each priority class within a HS-DSCH, and is incremented for each new data

block. It is not permitted to schedule new transmissions, including retransmissions originating in the RLC layer, within the same TTI, along with retransmissions originating from the HARQ layer.

- HARQ:
One HARQ entity handles the hybrid ARQ functionality for one user. One HARQ entity is capable of supporting multiple instances (HARQ process) of stop and wait HARQ protocols. For FDD and 3.84 Mcps/7.68 Mcps TDD, there shall be one HARQ process per TTI, for 1.28 Mcps TDD, there shall be one HARQ process per HS-DSCH on each carrier per TTI.

In 1.28 Mcps TDD multi-frequency HS-DSCH cell:

- multiple HARQ processes are assigned for HS-DSCH operation on every carrier for every user, namely HARQ sub-entity; only one HARQ process in HARQ sub-entity is allowed to receive HS-DSCH in one TTI for each carrier.
- Choice of 6bit or 9bit TSN is configured by upper layer signalling.
- TFRI selection:
Selection of an appropriate transport format and resource combination for the data to be transmitted on HS-DSCH.

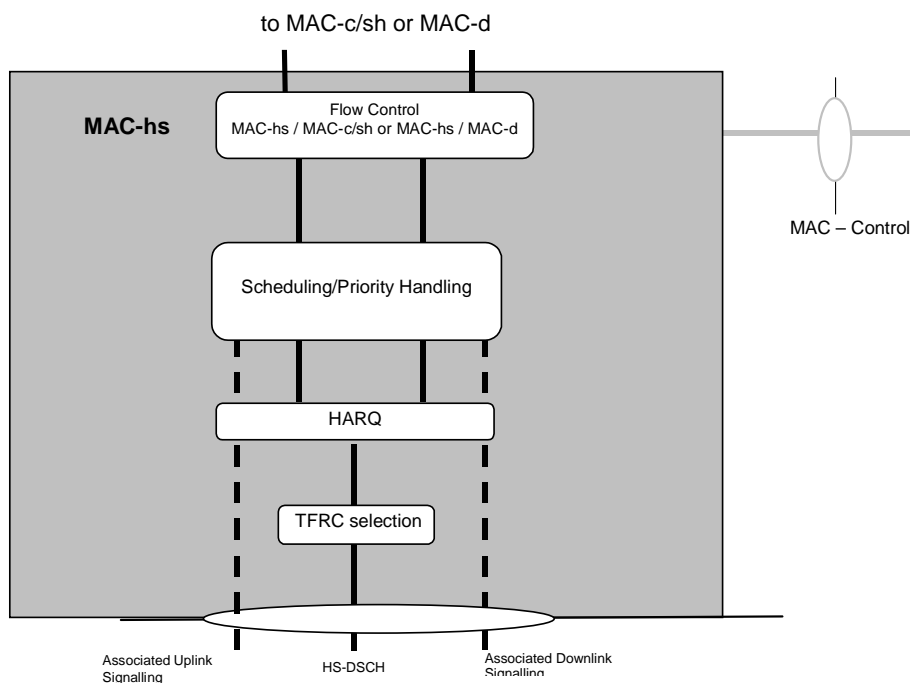

Figure 6.2.3-1: UTRAN side MAC architecture/MAC-hs details

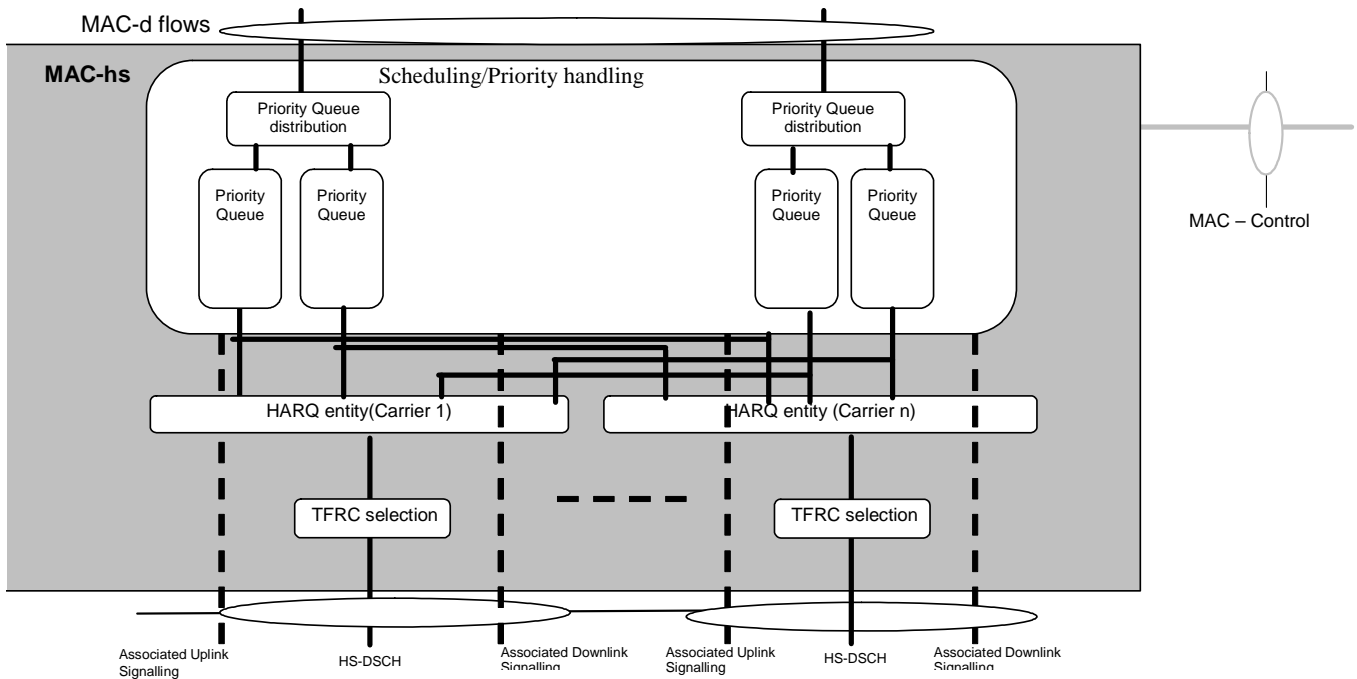

Figure 6.2.3-2: UTRAN side MAC architecture / MAC-hs details(1.28Mcps TDD multi-frequency HS-DSCH operation mode only)

6.2.4 Details of MAC-ehs

MAC-ehs receives configuration parameters from the RRC layer via the MAC-Control SAP. There shall be priority handling per MAC-ehs SDU in the MAC-ehs.

The MAC-ehs comprises of six different functional entities:

- Flow Control:
The flow control for MAC-ehs is identical to the flow control for MAC-hs.
- Scheduling/Priority Handling:
This function manages HS-DSCH resources between HARQ entities and data flows according to their priority class. In FDD, the scheduler determines for each TTI if single or dual stream transmission should be used. Based on status reports from associated uplink signalling either new transmission or retransmission is determined when operating in CELL_DCH state. In FDD, when operating in CELL_FACH, CELL_PCH and URA_PCH state HS-DSCH reception, the MAC-ehs can perform retransmission without uplink signalling. Further it sets the logical channel identifiers for each new reordering SDU and TSNs for each new reordering PDU being serviced. To maintain proper transmission priority a new transmission can be initiated on a HARQ process at any time. The TSN is unique to each priority class within a HS-DSCH. It is not permitted to schedule new transmissions, including retransmissions originating in the RLC layer, within the same TTI over the same HS-DSCH, along with retransmissions originating from the HARQ layer.
- HARQ:
One HARQ entity handles the hybrid ARQ functionality for one user per HS-DSCH transport channel. One HARQ entity is capable of supporting multiple instances (HARQ process) of stop and wait HARQ protocols. There shall be one HARQ entity per HS-DSCH, one HARQ process per TTI for single stream transmission and two HARQ processes per TTI for dual stream transmission.
- TFRI selection:
The TFRI selection for MAC-ehs is identical to the TFRI selection of the MAC-hs.
- Priority Queue MUX:
This function determinates the number of octets to be included in a MAC-ehs PDU from each priority queue based on the scheduling decision and available TRFI for this function.

- Segmentation:
This function performs necessary segmentation of MAC-ehs SDUs.

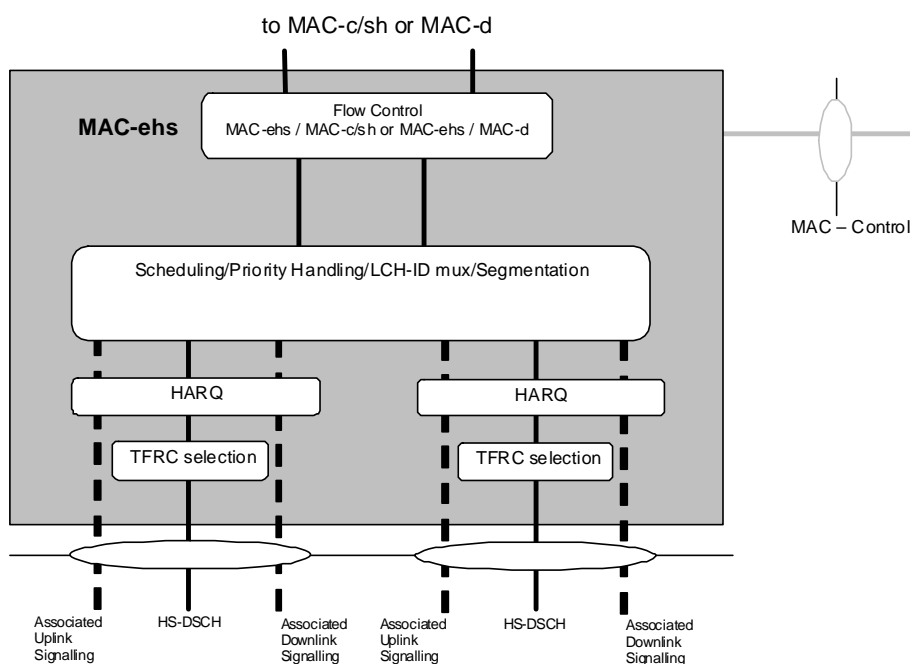

Figure 6.2.4-1: UTRAN side MAC architecture/MAC-ehs details.

7 HARQ protocol

The HARQ protocol is based on an asynchronous downlink and synchronous uplink scheme. The ARQ combining scheme is based on Incremental redundancy. Chase Combining is considered to be a particular case of Incremental Redundancy. The UE soft memory capability shall be defined according to the needs for Chase combining. The soft memory is partitioned across the HARQ processes in a semi-static fashion through upper layer signalling. The UTRAN should take into account the UE soft memory capability when configuring the different transport formats (including possibly multiple redundancy versions for the same effective code rate) and when selecting transport formats for transmission and retransmission.

7.1 Signalling

7.1.1 Uplink

In the uplink, a report is used indicating either ACK (positive acknowledgement) or NACK (negative acknowledgement).

7.1.2 Downlink

7.1.2.1 Shared control channel signalling

The following HARQ protocol parameters are carried on the HS-SCCH:

- HARQ process identifier:
 - Every HARQ process is assigned an identifier, which is used to couple the processes in the transmitter and the receiver. For dual stream transmission a pair of HARQ process identifiers is indicated by the HS-SCCH.

- New data indicator:
 - It is used to distinguish between data blocks. It is specific to the HARQ process. It is incremented for each new data block. For MIMO mode, the new data indicator is implied by the redundancy version indicator carried on the HS-SCCH.

7.1.2.2 In-band signalling on HS-DSCH

The following parameters are signalled in-band in the MAC-hs header to support in-sequence delivery and priority handling at the UE. These parameters are protected by the same CRC as the Data block. For MAC-hs the parameters are:

- Re-ordering Queue Identity:
 - It is used to identify the re-ordering buffer destination of a MAC-hs PDU.
- Transmission sequence number:
 - It is incremented for each new data block destined to a re-ordering buffer. It is used for reordering to support in-sequence delivery.

For MAC-ehs, the parameters are:

- Logical Channel Identity:
 - It is used to identify the logical channel and the re-ordering buffer destination of a MAC-ehs SDUs or segments of MAC-ehs SDUs.
- Transmission sequence number:
 - It is used for reordering to support in-sequence delivery.
- Length of the MAC-ehs SDU or the segment of the MAC-ehs SDU included in the MAC-ehs PDU.

Additionally the following parameter is signalled in-band in the MAC-ehs header to support MAC-ehs SDU segmentation in Node B and reassembly at the UE.

- Segmentation indication.

7.2 Void

7.3 Void

7.4 Error handling

The most frequent error cases to be handled are the following:

- NACK is detected as an ACK. The NW starts afresh with new data in the HARQ process. The data block is discarded in the NW and lost. Retransmission is left up to higher layers.
- ACK is detected as a NACK: If the network retransmits the data block, the UE will re-send an ACK to the network. If in this case the transmitter at the network sends an abort indicator by incrementing the New Packet Indicator, the receiver at the UE will continue to process the data block as in the normal case.
- If a CRC error on the HS-SCCH is detected, UE receives no data and sends no status report. If the absence of the status report is detected, NW can retransmit the block.

8 Signalling parameters

8.1 Downlink signalling parameters

8.1.1 UE identification

This identifies the UE (or UEs) for which data is transmitted in the corresponding HS-DSCH TTI. The UE identity is implicitly carried on the HS-SCCH through inclusion in the CRC calculation.

8.1.2 Transport Block Sizes

This defines what transport block size is used in the corresponding HS-DSCH TTI. The signalled parameter is an index to a pre-defined set of available transport block sizes. Note that for MIMO, there can be two transport block sizes in a TTI.

8.1.3 Channelisation codes (FDD only)

This identifies to the UE (or UEs) the codes it (they) should receive and decode.

8.1.4 HS-PDSCH configuration (TDD only)

This identifies to a UE the timeslots and codes it should receive and decode. Additionally, which transport formats are applied on HS-DSCH is also signalled. An identical set of channelisation codes is used in each of the identified timeslots.

8.1.5 HARQ information

Details of signalling parameters for the HARQ Protocol can be found in subclause 7.1.2. In addition, to support the Incremental Redundancy combining scheme, the Redundancy version is also signalled on the HS-SCCH.

8.1.6 Measurement feedback rate (FDD only)

This identifies the feedback rate for downlink quality measurement. This information may be sent at a much lower rate than the other parameters described in this subclause.

8.1.7 HS-PDSCH power offset

Default power offset between HS-DSCH code channel and P-CPICH (or S-CPICH in case beamforming with S-CPICH is used).

8.1.8 Void

8.1.9 Void

8.1.10 HS-SCCH Cyclic Sequence Number (HCSN) (TDD only)

A cyclic counter that is incremented each time a HS-SCCH transmission is sent to a given UE. Separate counters are maintained for each UE. The counter is used by the UE to estimate the BLER on the HS-SCCH for the purposes of closed loop power control.

In 1.28Mcps TDD, in HS-DSCH transmission in CELL_FACH and CELL_PCH state as defined in subclause 16 and 17, UE without a dedicated H-RNTI in CELL_FACH state and UE in CELL_PCH state ignores the value of HCSN.

8.2 Uplink signalling parameters

8.2.1 ACK/NACK

A one-bit indication per stream is used by the HARQ protocol to indicate a successful/unsuccessful transmission on the HS-DSCH.

In FDD in HS-DSCH reception in CELL_FACH state is as defined in clause 14, the ACK/NACK feedback is provided only if the UE is transmitting on a common E-DCH resource, is transmitting DTCH/DCCH traffic, has successfully resolved collision, and has been so configured by the network. Otherwise ACK/NACK feedback is not provided.

In 1.28Mcps TDD in HS-DSCH reception in CELL_FACH state as defined in clause 16, the ACK/NACK feedback is provided only when UE has a dedicated H-RNTI.

8.2.2 Measurement report

Measurement feedback information contains channel quality indicator that may be used to select transport format and resource by HS-DSCH serving Node-B. For FDD, the transmission rate of the measurement report to the network is configured by higher layer signalling. For TDD, when operating in CELL_DCH state, when operating in CELL_DCH state, a measurement report is associated with each HS-SCCH transmission.

In FDD in HS-DSCH reception in CELL_FACH state as defined in clause 14, the measurement result on RACH can be used for link adaptation as defined in subclause 14.2. Other measurement feedback information, such as CQI, can be sent if the UE is transmitting on a common E-DCH resource, is transmitting DTCH/DCCH has successfully resolved collision, and has been so configured by the network. The transmission rate of this other measurement feedback information is configured by higher layer signalling.

In 1.28Mcps TDD in HS-DSCH reception in CELL_FACH state as defined in clause 16, the measurement result on RACH can be used for initial link adaptation as defined in subclause 16.2. When UE is allocated a dedicated H-RNTI, a measurement report is associated with each HS-SCCH transmission.

9 Mobility procedures

While in CELL_DCH state, the UE may be allocated one or more HS-PDSCH(s), allowing it to receive data on the HS-DSCH(s).

Mobile evaluated hard-handover and soft-handover mechanisms provide the RRC connection mobility in CELL_DCH state. The mobility procedures are affected by the fact that the HS-PDSCH allocation for a given UE belongs to only one of the radio links assigned to the UE, the *-serving HS-DSCH radio link*. The cell associated with the serving HS-DSCH radio link is defined as the *-serving HS-DSCH cell*.

A *-serving HS-DSCH cell change* facilitates the transfer of the role of serving HS-DSCH radio link from one radio link belonging to the source HS-DSCH cell to a radio link belonging to the target HS-DSCH cell.

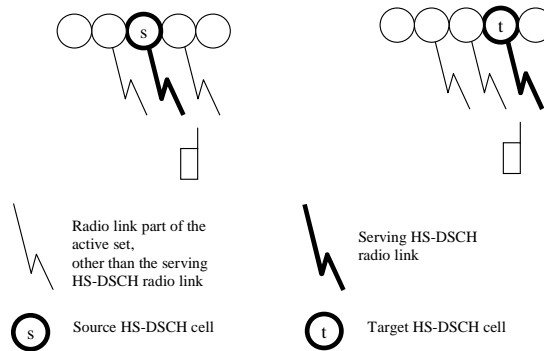

Figure 9-1: Serving HS-DSCH cell change

The serving HS-DSCH cell change may be further categorised in regards to whether the decision of the target HS-DSCH cell is made by the UE or by the network. In Release 5, only network controlled serving HS-DSCH cell changes shall be supported.

In case of a *network-controlled serving HS-DSCH cell change* the network makes the decision of the target HS-DSCH cell, and the decision could be based on UE measurement reports and other information available in the network. A network controlled HS-DSCH cell change is performed as an RRC layer signalling procedure and is based on the existing handover procedures in CELL_DCH state.

9.1 Serving HS-DSCH cell change

NOTE: This sub-clause needs to be reviewed.

With regard to the way a serving HS-DSCH cell change is performed with respect to the dedicated physical channel configuration, the following categories exist:

1. Serving HS-DSCH cell change while keeping the dedicated physical channel configuration and the active set;
2. Serving HS-DSCH cell change in combination with an establishment, release and/or reconfiguration of dedicated physical channels (note: this may by definition imply an update of the active set);
3. Serving HS-DSCH cell change in combination with active set update in soft handover.

With respect to synchronisation between UE and UTRAN as to when transmission and reception is stopped and restarted, two possibilities for a serving HS-DSCH cell change exist:

1. Synchronised serving HS-DSCH cell change: Start and stop of HS-DSCH transmission and reception is performed at a certain time typically selected by the network;
2. Unsynchronised serving HS-DSCH cell change: Start and stop of HS-DSCH transmission and reception is performed "as soon as possible" (stated by UE performance requirements) at either side.

The serving HS-DSCH cell change may also be categorised with respect to the serving HS-DSCH Node B:

1. Intra-Node B serving HS-DSCH cell change: The source and target HS-DSCH cells are both controlled by the same Node B. The serving HS-DSCH Node B is not changed.
2. Inter-Node B serving HS-DSCH cell change: The Node B controlling the target HS-DSCH cell is different from the Node B controlling the source HS-DSCH cell.

The cell-Node B relations shall remain transparent for the UE and the UE should therefore shall not be aware of whether the serving HS-DSCH cell change procedure is of an intra-Node B or inter-Node B nature.

At an Inter-Node B serving HS-DSCH cell change, a *serving HS-DSCH Node B relocation* needs to be performed at the UTRAN. Serving HS-DSCH Node B relocation and serving HS-DSCH cell change are two separate procedures, even if serving HS-DSCH Node B relocation cannot be performed without a serving HS-DSCH cell change (but the other way is possible).

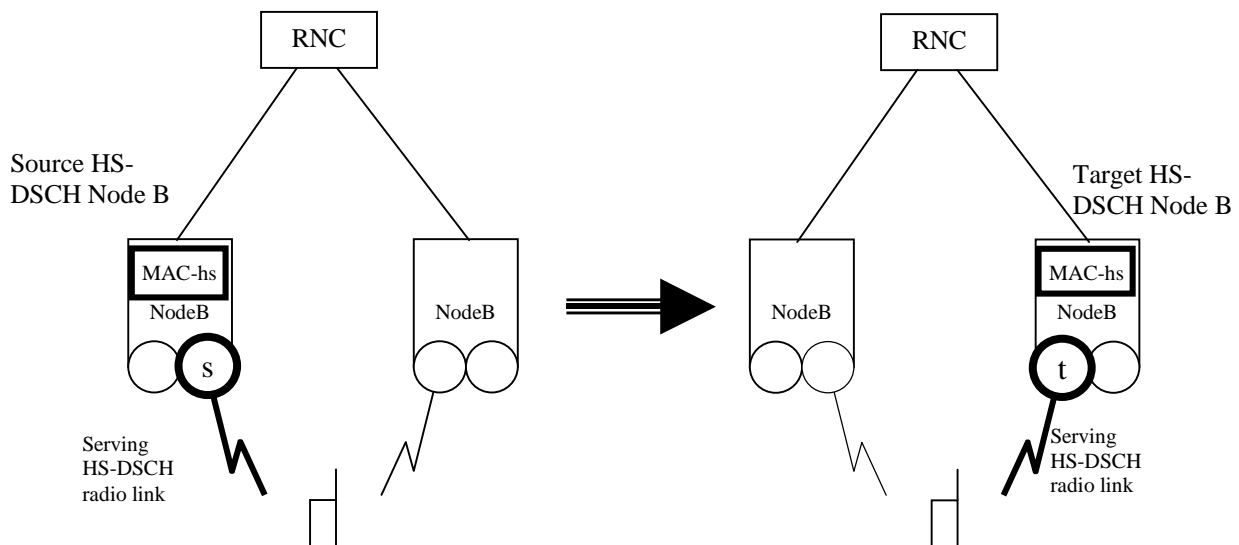

Figure 9.1-1: Inter-Node B serving HS-DSCH cell change combined with serving HS-DSCH Node B relocation

During a serving HS-DSCH Node B relocation, the HARQ entities located in the source HS-DSCH Node B belonging to the specific UE are deleted and new HARQ entities in the target HS-DSCH Node B are established. Different CRNCs may control the source and target HS-DSCH Node B.

9.2 Serving HS-DSCH cell change mechanisms

In the case of AM RLC mode, the polling function either pre- or post- HS-DSCH cell change can be utilised to obtain the status of the data transmission to the UE at the RLC level. In the case of UM RLC mode, the need for relocating the PDUs not transmitted to the UE, is FFS.

NOTE: Additional mechanisms would need to be defined in the relevant TSG-RAN WG3 specifications to indicate to the Node B to stop transmission to the UE on a decision to execute an HS-DSCH cell change.

9.3 Intra-Node B synchronised serving HS-DSCH cell change

Figure 9.3-1 illustrates an intra-Node B serving HS-DSCH cell change while keeping the dedicated physical channel configuration and the active set, using the Physical channel reconfiguration procedure. The transition from source to target HS-DSCH cell is performed synchronised, i.e. at a given activation time.

In this example, the UE transmits a MEASUREMENT REPORT message containing intra-frequency measurement results, here assumed to be triggered by the event 1D "change of best cell". When the SRNC has performed the handover decision, the Node B is prepared for the serving HS-DSCH cell change at an activation time indicated with CPHY-RL-Commit-REQ primitive. The SRNC then sends a PHYSICAL CHANNEL RECONFIGURATION message, which indicates the target HS-DSCH cell and the activation time to the UE. Since the same Node B controls both the source and target HS-DSCH cells we assume there is no need to reset the MAC-hs or MAC-ehs entities. When the UE has completed the serving HS-DSCH cell change it transmits a PHYSICAL CHANNEL RECONFIGURATION COMPLETE message to the network.

In this example it is assumed that HS-DSCH transport channel and radio bearer parameters do not change. If transport channel or radio bearer parameters shall be changed, the serving HS-DSCH cell change would need to be executed by a Transport channel reconfiguration procedure or a Radio bearer reconfiguration procedure, respectively.

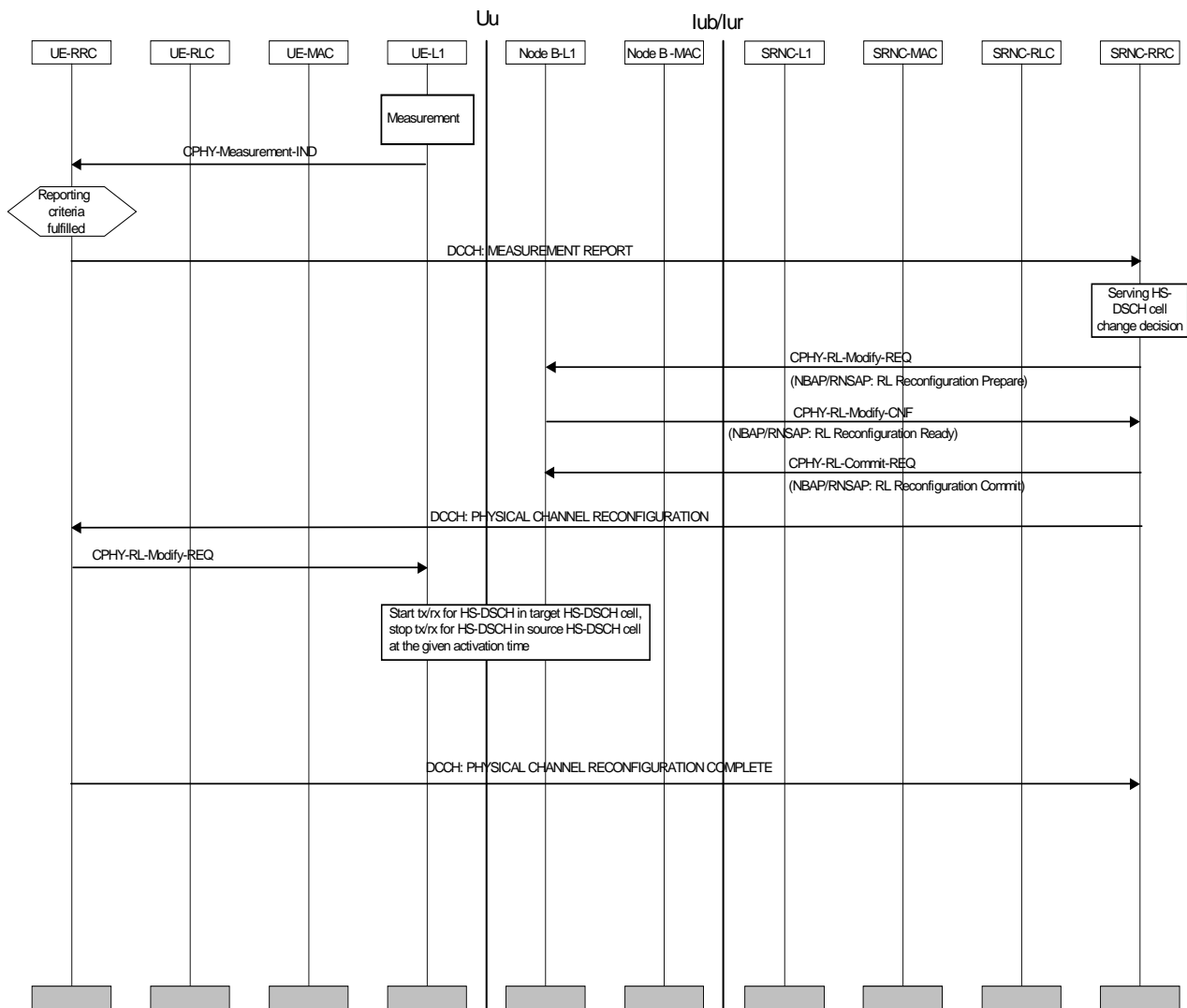

Figure 9.3-1: Intra-Node B synchronised serving HS-DSCH cell change

9.4 Inter-Node B synchronised serving HS-DSCH cell change during hard handover

Figure 9.4-1 illustrates a synchronised inter-Node B serving HS-DSCH cell change in combination with hard handover. The reconfiguration is performed in two steps within UTRAN. On the radio interface only a single RRC procedure is used.

Here we assume the UE transmits a MEASUREMENT REPORT message containing intra-frequency measurement results, triggered by the event 1D "change of best cell". The SRNC determines the need for hard handover based on received measurement reports and/or load control algorithms (measurements may be performed in compressed mode for FDD).

In the first step, the SRNC establishes a new radio link in the target Node B. In the second step this newly created radio link is prepared for a synchronised reconfiguration to be executed at a given activation time indicated in the CPHY-RL-Commit-REQ primitive. After the first step, the target Node B starts transmission and reception on dedicated channels. At the indicated activation time, transmission of HS-DSCH is started in the target HS-DSCH Node B and stopped in the source HS-DSCH Node B.

The SRNC then sends a TRANSPORT CHANNEL RECONFIGURATION message on the old configuration. This message indicates the configuration after handover, both for DCH and HS-DSCH. The TRANSPORT CHANNEL RECONFIGURATION message includes a flag indicating that the MAC-hs or the MAC-ehs entity in the UE shall be

reset. The message also includes an update of transport channel related parameters for the HS-DSCH in the target HS-DSCH cell.

The UE terminates transmission and reception on the old radio link at the activation time indicated in the TRANSPORT CHANNEL RECONFIGURATION message, and configures its physical layer to begin reception on the new radio link. After L1 synchronisation has been established, the UE sends a TRANSPORT CHANNEL RECONFIGURATION COMPLETE message. The SRNC then terminates reception and transmission on the old radio link for dedicated channels and releases all resources allocated to the considered UE.

Note that in this inter-Node B handover example, RLC for transmission/reception on HS-DSCH is stopped at both the UTRAN and UE sides prior to reconfiguration and continued when the reconfiguration is completed. It is furthermore assumed in this example that the TRANSPORT CHANNEL RECONFIGURATION message indicates to the UE that the MAC-hs or MAC-ehs entity should be reset. A reset of the UE MAC-hs or MAC-ehs entity triggers the delivery of the content in the re-ordering buffer to higher layers.

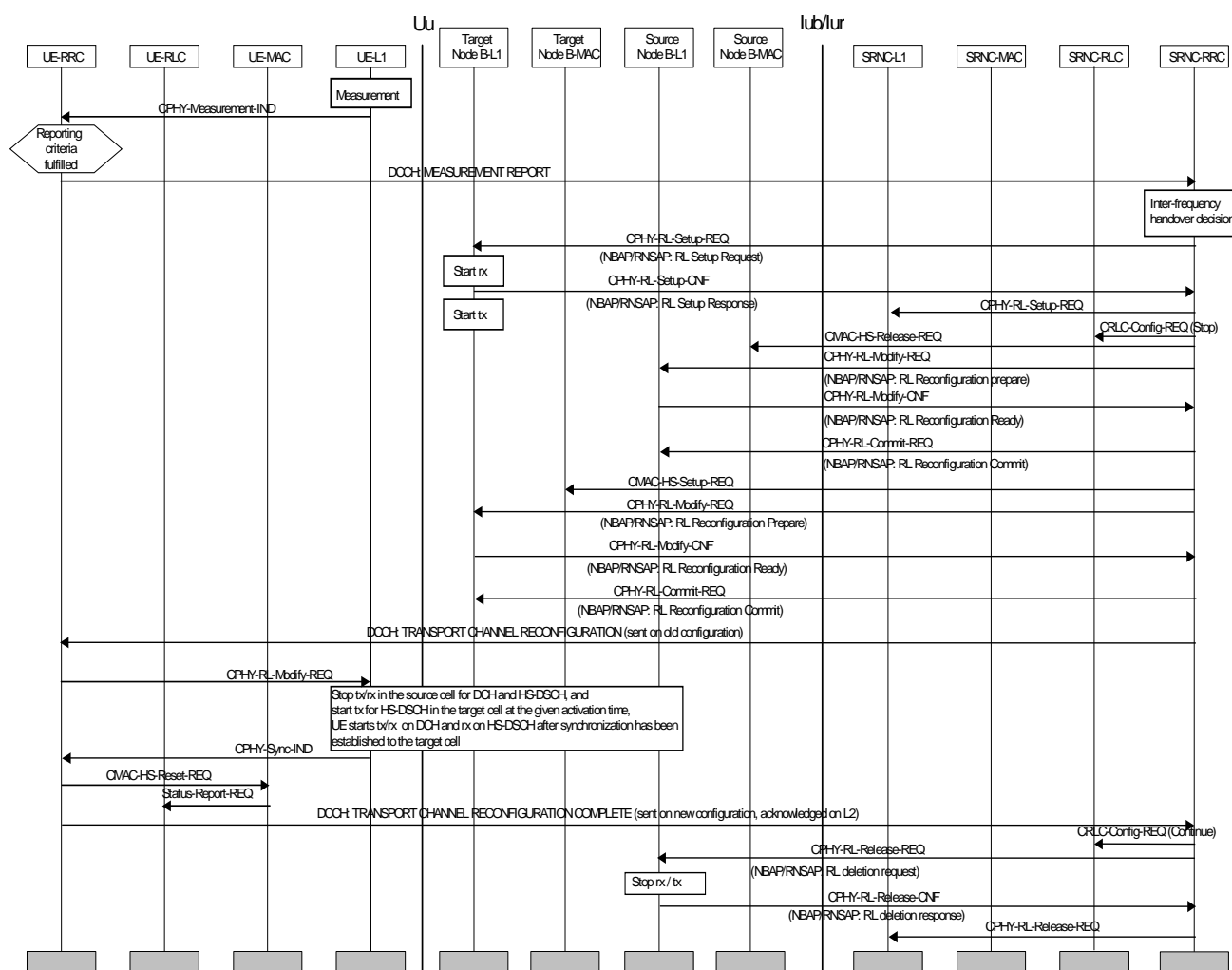

Figure 9.4-1: Inter-Node B synchronised serving HS-DSCH cell change during hard handover

9.5 Inter-Node B synchronised serving HS-DSCH cell change after active set update (radio link addition)

Figure 9.5-1 illustrates an inter-Node B serving HS-DSCH cell change performed subsequent to an active set update. In this example it is assumed that a new radio link is added which belongs to a target Node B different from the source Node B. The cell which is added to the active set is assumed to become the serving HS-DSCH cell in the second step. This combined procedure is comprised of an ordinary Active Set Update procedure in the first step and a synchronised serving HS-DSCH cell change in the second step.

We assume the UE transmits a MEASUREMENT REPORT message containing intra-frequency measurement results. The SRNC determines the need for the combined radio link addition and serving HS-DSCH cell change based on received measurement reports and/or load control algorithms (measurements may be performed in compressed mode for FDD).

As the first step, the SRNC establishes the new radio link in the target Node B for the dedicated physical channels and transmits an ACTIVE SET UPDATE message to the UE. The ACTIVE SET UPDATE message includes the necessary information for establishment of the dedicated physical channels in the added radio link (but not the HS-PDSCH). When the UE has added the new radio link it returns an ACTIVE SET UPDATE COMPLETE message.

The SRNC will now carry on with the next step of the procedure, which is the serving HS-DSCH cell change. The target HS-DSCH cell is the newly added radio link, so far only including dedicated physical channels. For the synchronised serving HS-DSCH cell change, both the source and target Node Bs are first prepared for execution of the handover at the activation time indicated with CPHY-RL-Commit-REQ primitive.

The SRNC then sends a TRANSPORT CHANNEL RECONFIGURATION message, which indicates the target HS-DSCH cell and the activation time to the UE. The message may also include a configuration of transport channel related parameters for the target HS-DSCH cell, including an indication to reset the MAC-hs or MAC-ehs entity.

Since source and target HS-DSCH cell are controlled by different Node Bs, MAC-hs or MAC-ehs in source and target Node B need to be released and setup, respectively, which is assumed to be done with CMAC-HS-Release-REQ and CMAC-HS-Setup-REQ primitives. These MAC-hs and MAC-ehs control primitives are assumed to be carried on the same NBAP/RNSAP messages, which carry the CPHY-RL-Reconfig-REQ primitives. Execution of release and setup of MAC-hs or MAC-ehs entities shall also be performed at the indicated activation time.

When the UE has completed the serving HS-DSCH cell change it returns a TRANSPORT CHANNEL RECONFIGURATION COMPLETE message to the network.

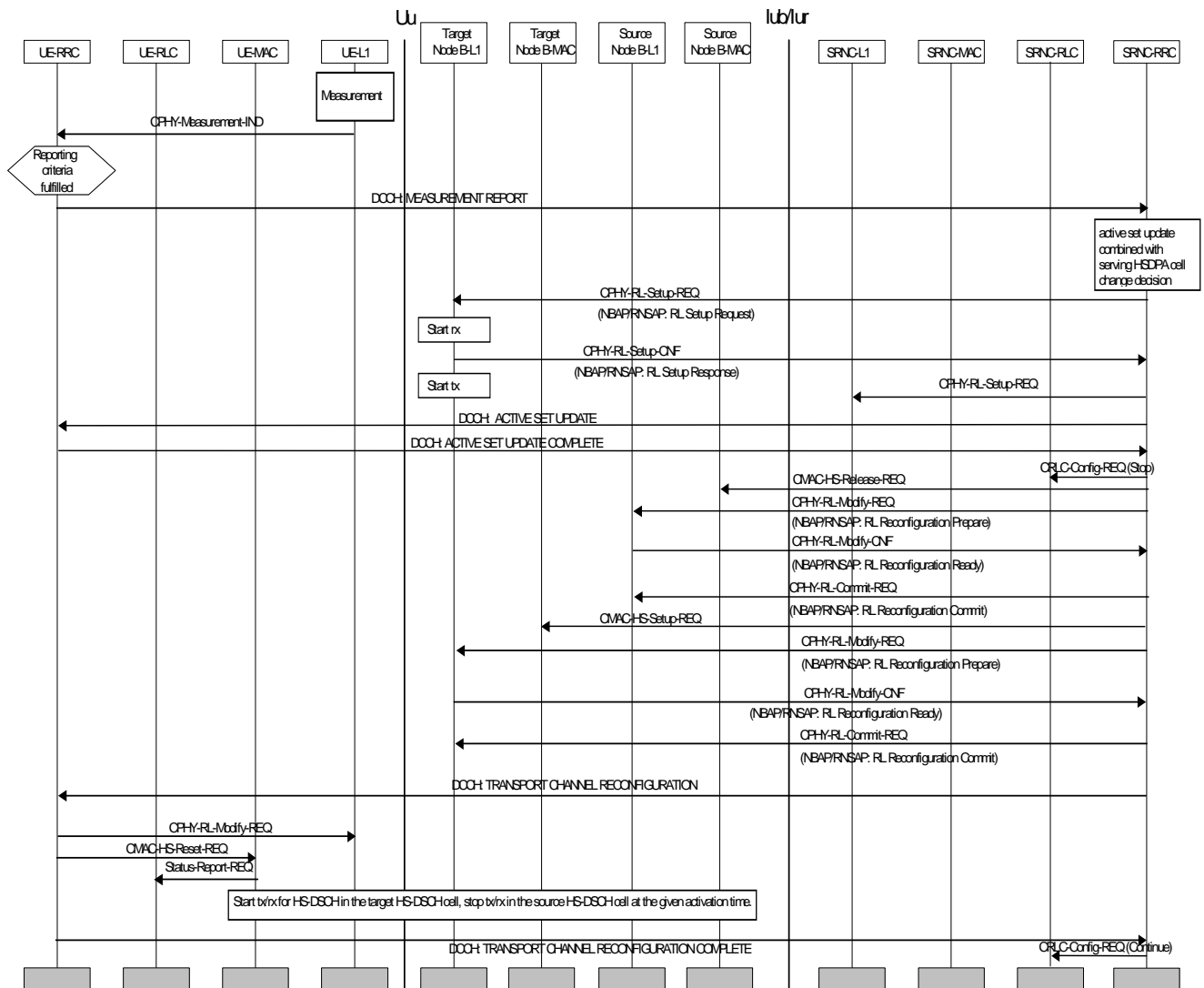

Figure 9.5-1: Inter-Node B synchronised serving HS-DSCH cell change after active set update

9.6 Serving HS-DSCH cell change with target cell pre-configuration

Figure 9.6-1 illustrates the inter-Node B serving HS-DSCH cell change procedure with target cell pre-configuration. Target cell pre-configuration adds robustness to the serving HS-DSCH cell change procedure by allowing the network to send the serving HS-DSCH cell change command either over the source cell and/or over the target cell using the HS-SCCH. The use of target cell pre-configuration is configured by the network during the active set update procedure.

The UE transmits a MEASUREMENT REPORT 1A or 1C message containing intra-frequency measurement results requesting the addition of a new cell into the active set. The SRNC establishes the new radio link in the target Node B for the dedicated physical channels and transmits an ACTIVE SET UPDATE message to the UE. The ACTIVE SET UPDATE message includes the necessary information for establishment of the dedicated physical channels in the added radio link. If SRNC decides to preconfigure the target cell, the ACTIVE SET UPDATE message will also include the HS serving cell related configuration (e.g. H-RNTI, HS-SCCH configuration, etc.) of the new cell. When the UE has added the new radio link it returns an ACTIVE SET UPDATE COMPLETE message.

In a second step, the UE transmits a MEASUREMENT REPORT 1D to request the change of the HS-DSCH serving cell to a target cell. The MEASUREMENT REPORT message may include a calculated Activation time of the requested cell change, that the UE has calculated using an offset signalled in the ACTIVE SET UPDATE message before, if configured by the NW in the ASU message. The UE then starts monitoring one HS-SCCH channel in the target cell in addition to the four HS-SCCH channels in the source cell. The SRNC then may send a RADIO BEARER SETUP, RADIO BEARER RECONFIGURATION, TRANSPORT CHANNEL RECONFIGURATION or PHYSICAL CHANNEL RECONFIGURATION message, which indicates the target HS-DSCH cell and possibly an activation time

to the UE depending on the configuration. The message may also include a configuration of transport channel related parameters for the target HS-DSCH cell, including an indication to reset the MAC-hs or MAC-ehs entity.

In parallel, the target Node B may transmit the HS-SCCH in the target cell to initiate the serving HS-DSCH cell change. If the UE has not received a RADIO BEARER SETUP, RADIO BEARER RECONFIGURATION, TRANSPORT CHANNEL RECONFIGURATION or PHYSICAL CHANNEL RECONFIGURATION message, it will upon receiving the HS-SCCH in the target cell execute serving HS-DSCH cell change.

Since source and target HS-DSCH cells may be controlled by different Node Bs, MAC-hs or MAC-ehs in source and target Node B need to be released and setup, respectively, which is assumed to be done with CMAC-HS-Release-REQ and CMAC-HS-Setup-REQ primitives. These MAC-hs and MAC-ehs control primitives are assumed to be carried on the same NBAP/RNSAP messages, which carry the CPHY-RL-Reconfig-REQ primitives. Execution of release and setup of MAC-hs or MAC-ehs entities may also be performed at the indicated activation time.

When the UE has completed the serving HS-DSCH cell change it returns a RADIO BEARER SETUP COMPLETE, RADIO BEARER RECONFIGURATION COMPLETE, TRANSPORT CHANNEL RECONFIGURATION COMPLETE or PHYSICAL CHANNEL RECONFIGURATION COMPLETE message to the network, regardless if the cell change was triggered by reception of RADIO BEARER SETUP, RADIO BEARER RECONFIGURATION, TRANSPORT CHANNEL RECONFIGURATION or PHYSICAL CHANNEL RECONFIGURATION message in the source cell or HS-SCCH in the target cell. The response message type, including the RRC transaction Id that shall be used, are provided in the configuration given in the ACTIVE SET UPDATE message.

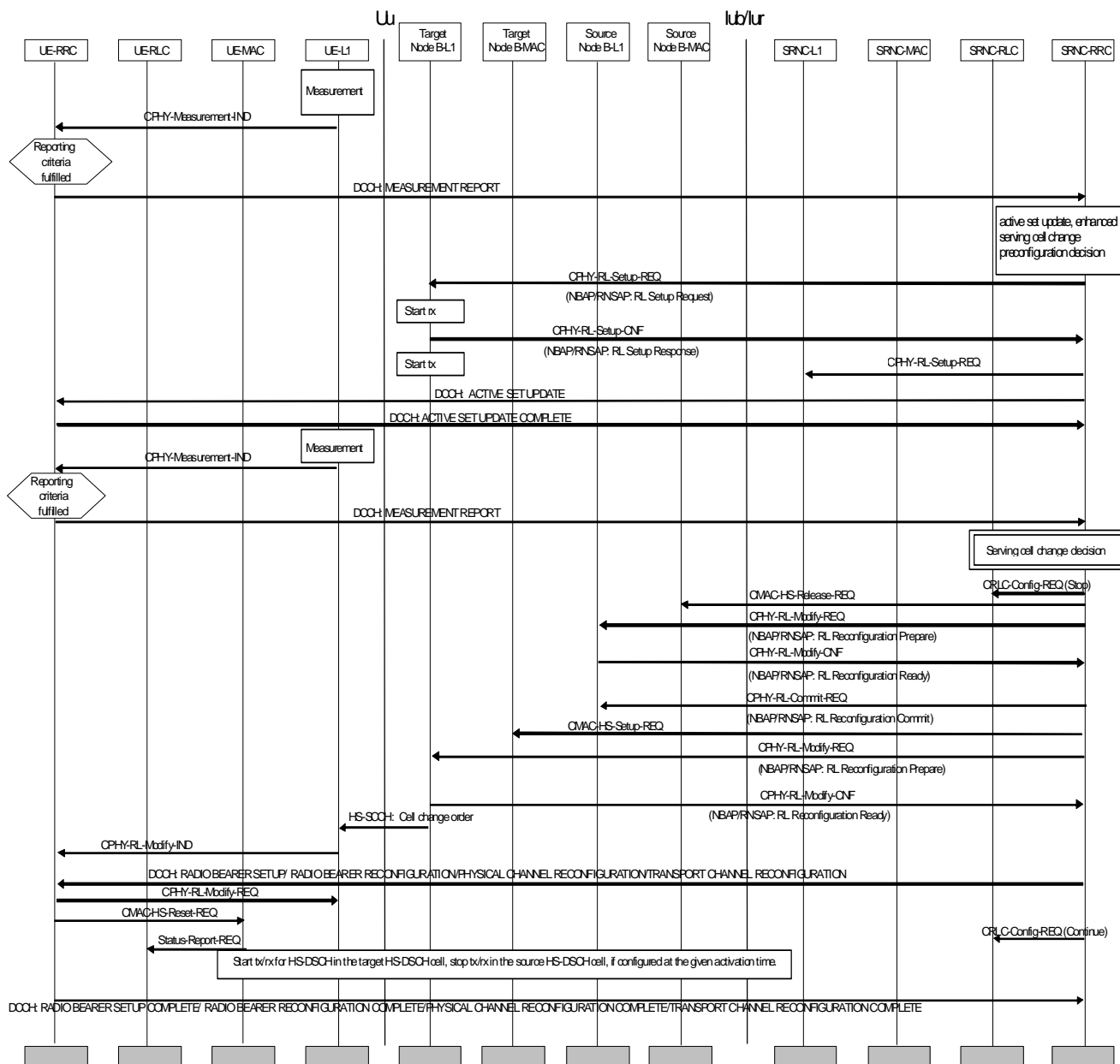

Figure 9.6-1: Inter-Node B serving HS-DSCH cell change with target cell pre-configuration

10 Resource management

For HS-DSCH, the resources at a cell level shall be:

- Channelisation Codes and timeslots (TDD) that can be used for the mapping of HS-PDSCH and the HS-SCCH physical channels.
- Power that can be used for HS-DSCH, i.e. for HS-DSCHs and HS-SCCHs.

The HS-DSCH resources are assigned by the CRNC to a Node B on a cell basis.

The HS-SCCH set for a given UE is decided by the Node B.

11 Discontinuous UL DPCCH transmission and discontinuous reception of F-DPCH and HSPA DL channels in FDD

In FDD the discontinuous transmission and reception is a configuration of CELL_DCH state, when F-DPCH is configured without DCH configured in Downlink or Uplink, where the resources are allocated but discontinuous uplink DPCCH transmission (Uplink DTX) and discontinuous downlink reception (Downlink DRX) are possible during data inactivity. One of the options of the Uplink DTX also allows the Node B to DRX (Uplink DRX), by restricting the starting points of new data transmission after inactivity by the UE. The Node B has a fast mechanism to revert to the continuous DL transmission, and the UE can revert to the continuous UL transmission autonomously and instantaneously based on standardised rules if more data arrives to the transmission buffer.

The discontinuous transmission and reception schemes are always enabled, upon configuration, only after a certain configurable time. This allows synchronisation and power control stabilisation.

From the continuous transmission, the UE and Node B can autonomously and instantaneously revert to discontinuous UL and DL transmission based on standardised rules.

The discontinuous transmission and reception also allows a configuration of a new UL DPCCH slot format with an increased number of TPC bits as defined in [6].

The configuration of Uplink DTX, Downlink DRX is always in the control of the SRNC. In order to allow SHO with Node Bs under the control of another RNC, the SRNC must be aware of the capabilities of all the Node Bs that provide RLs in the UE active set. [FFS]

11.1 Discontinuous uplink transmission

The discontinuous uplink transmission is a mechanism that defines how the UE will discontinuously transmit the uplink DPCCH, when configured by the RNC. The uplink DPCCH burst pattern and the uplink DPCCH preamble and postamble together define the discontinuous uplink DPCCH operation. The discontinuous uplink transmission is dependent on the E-DCH and HS-DPCCH activity as described in [3] and below. The uplink DTX is mechanism that can be configured without configuring also the uplink DRX (subclause 11.1.1), or Downlink DRX (subclause 11.2). Additionally, the uplink DTX can operate with or without configuring the HS-SCCH-less HS-DSCH transmission mechanisms (clause 12).

There are two patterns that can be defined for discontinuous uplink DPCCH operation, *UE_DTX_cycle_1* and *UE_DTX_cycle_2*. The latter is used whenever there is no uplink data transmission activity, whilst the former is applied depending on the duration of E-DCH inactivity. This allows uplink DPCCH transmission rate to autonomously (based on standardised rules) adapt to the data transmission activity, and data transmission dependent gains: for higher data transmission activity uplink DPCCH can be configured to be transmitted more frequently and operation is more similar to Rel-6, and for lower data transmission activity DPCCH can be configured to be transmitted less often to achieve higher DTX gain.

The DPCCH burst patterns can be offset using *UE_DTX_DRX_Offset* so that different UEs can have the DPCCH transmission phase in their DTX cycles at different times. This offset is common for the Uplink DRX and Downlink DRX schemes, as specified in subclauses 11.1.1 and 11.2 respectively.

The DPCCH is transmitted whenever E-DCH or HS-DPCCH is transmitted. *UE_DTX_cycle_1* and *UE_DTX_cycle_2* define only the DPCCH DTX during the E-DCH and HS-DPCCH inactivity, and have no impact on the E-DCH or HS-DPCCH ACK/NACK transmissions as if Uplink DRX is not configured as described in subclause 11.1.1, the E-DCH transmission is performed as defined in Rel6. When Uplink DRX is configured, the start times of E-DCH transmissions for new data transmissions can be restricted, after some configurable inactivity time, to a *MAC_DTX_cycle* which coincides with the *UE_DTX_cycle_1*.

When the UE is not transmitting data (on E-DCH) or HS-DPCCH, the UE shall not transmit DPCCH except for a short burst of *UE_DPCCH_burst_1* subframes once every *UE_DTX_cycle_1* subframes. If the UE has not transmitted E-DCH during the last *inactivity_threshold_for_UE_DTX_cycle_2* E-DCH subframes, the UE shall not transmit DPCCH except for a short burst of *UE_DPCCH_burst_2* subframes once every *UE_DTX_cycle_2* subframes. The UE shall DTX if it does not have any data to transmit and when no DPCCH or HS-DPCCH transmission is defined.

Before the uplink DPCCH transmission the UE has to transmit a 2 slots default preamble uplink DPCCH and afterwards a 1 slot postamble uplink DPCCH. In association with *UE_DTX_cycle_2* if *UE_DTX_long_preamble* is TRUE and if there was no E-DCH transmission for the last *Inactivity_Threshold_for_UE_DTX_cycle_2* subframes the UE has to apply a longer preamble of (max.) 15 slots before restarting E-DCH transmission.

The CQI on HS-DPCCH is transmitted in the HS-DPCCH sub-frames when the CQI reporting period defined transmission overlaps with the DPCCH transmission. However, the RNC can also configure the discontinuous uplink transmission such that the CQI reporting takes priority over the DTX pattern for a number of subframes after an HS-DSCH reception. If there has been no HS-DSCH reception after a configurable period, the DTX takes priority over the CQI reporting.

The UE only receives the TPC commands on F-DPCH corresponding to actually transmitted UL DPCCH slots.

The serving Node B can command the UE to disable (respectively re-enable) the discontinuous uplink DPCCH transmission and revert back to continuous DPCCH transmission by using a specific HS-SCCH- command (The operation in SHO is FFS).

The Uplink DPCCH burst pattern is illustrated in Figure 11.1-1 for 2ms E-DCH TTI and Figure 11.1-2 for 10ms E-DCH TTI. The uplink DPCCH burst pattern defines the minimum set of slots where the UE shall transmit the UL-DPCCH. Thus the pattern defines the length of the transmission cycle (*UE_DTX_cycle_1*, *UE_DTX_cycle_2*), number of slot, and slot position in the transmission cycle that UE shall transmit UL-DPCCH.

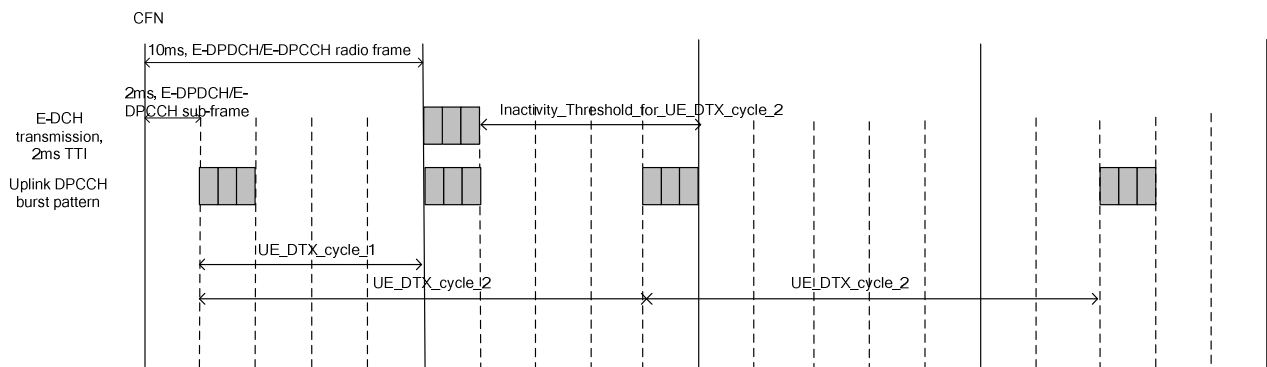

Figure 11.1-1: Example for UL DPCCH discontinuous burst pattern for 2ms E-DCH TTI

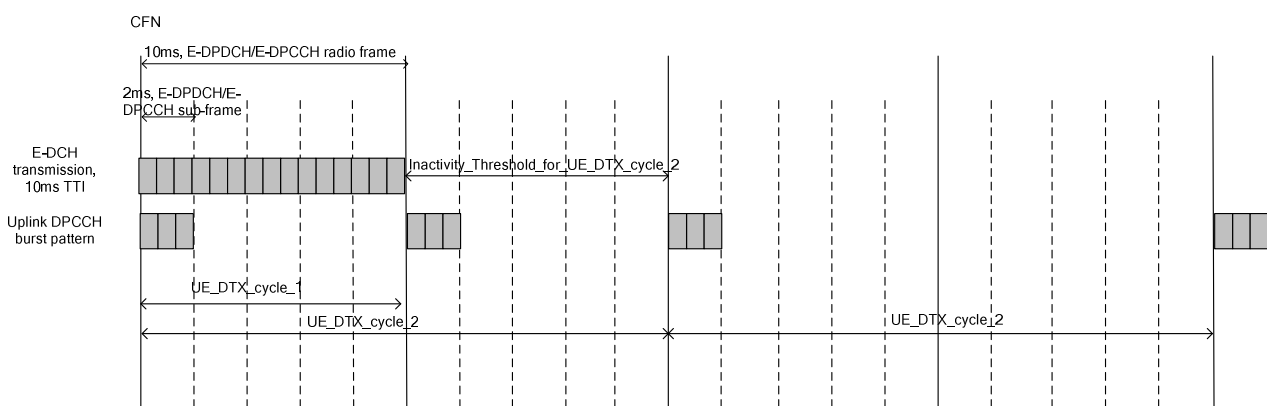

Figure 11.1-2: Example for UL DPCCH discontinuous burst pattern for 10ms E-DCH TTI

11.1.1 Uplink DRX

The RNC can configure the UE to restrict the start of E-DCH transmissions to the *MAC_DTX_cycle* pattern, if there has been no E-DCH transmission for a configurable number of TTIs (*UE_Inactivity_Threshold*). The allowed E-DCH start times can be offset using *UE_DTX_DRX_Offset* so that different UEs have the allowed E-DCH start time at different time instants. The network should configure *MAC_DTX_cycle* in such manner that it does not collide with an

inactivated HARQ process. The uplink DRX cannot be configured without an Uplink DTX configuration as specified in subclause 11.1.

Whenever the UE transmits one E-DCH TTI the UE can use subsequent TTIs for E-DCH transmission as long as its transmission is continued (re-started) within *UE_Inactivity_Threshold* TTIs, and in addition the pending retransmissions can be done in the corresponding HARQ processes (retransmission times are not impacted by the inactivity threshold).

11.2 Downlink DRX

The downlink DRX is configurable by the RNC and allows the UE to restrict the downlink reception times. Note that UE is also allowed to receive continuously; discontinuous reception is not required even if it would be configured. Nevertheless, the Downlink DRX cannot be configured without an Uplink DTX configuration as specified in subclause 11.1.

When the discontinuous downlink reception is enabled, the UE is not required to receive physical downlink channels, except if any of the following conditions apply:

1. The UE has received DRX de-activation that was not followed by a DRX activation
2. The UE shall receive E-HICH (sub-)frame corresponding to an E-DCH transmission.
3. The UE shall receive an HS-SCCH subframe due to the HS-SCCH reception pattern.
4. The UE shall receive an HS-PDSCH subframe due to correctly received HS-SCCH
5. The UE has detected an E-AGCH or an E-RGCH subframe transmission from cell(s) in the serving RLS during the required HS-SCCH reception time and the UE still needs to decode the rest of the E-AGCH or E-RGCH frame.
6. The UE has received an HS-SCCH or an HS-PDSCH subframe during the last *Inactivity_Threshold_for_UE_DRX_cycle* subframes.
7. The UE has sent scheduled E-DCH transmission during *Inactivity_Threshold_for_UE_Grant_Monitoring* and/or has scheduled data in the buffer for transmission.

The HS-SCCH reception pattern is defined in such a way that the UE must receive one HS-SCCH sub-frame every *UE_DRX_cycle* sub-frames. The HS-SCCH reception pattern can be offset using *UE_DTX_DRX_Offset* so that different UEs have the HS-SCCH reception phase at different times.

The serving Node B can command the UE to disable (respectively re-enable) the discontinuous downlink reception and revert back to continuous downlink reception by using a specific HS-SCCH- command (Operation in SHO is FFS).

The HS-SCCH reception pattern is illustrated by Figure 11.2-1 for a 2 ms TTI E-DCH. The grey subframes correspond to the HS-SCCH reception pattern *UE_DRX_cycle=4*. The HS-SCCH discontinuous reception radio frame is 10 ms long independently from E-DCH TTI and it is indexed using *CFN_DRX*. The HS-SCCH discontinuous radio frame is divided to five HS-SCCH subframes are numbered *S_DRX=0* to *S_DRX=4*. *S_DRX* defines the HS-SCCH reception timing as defined in [4].

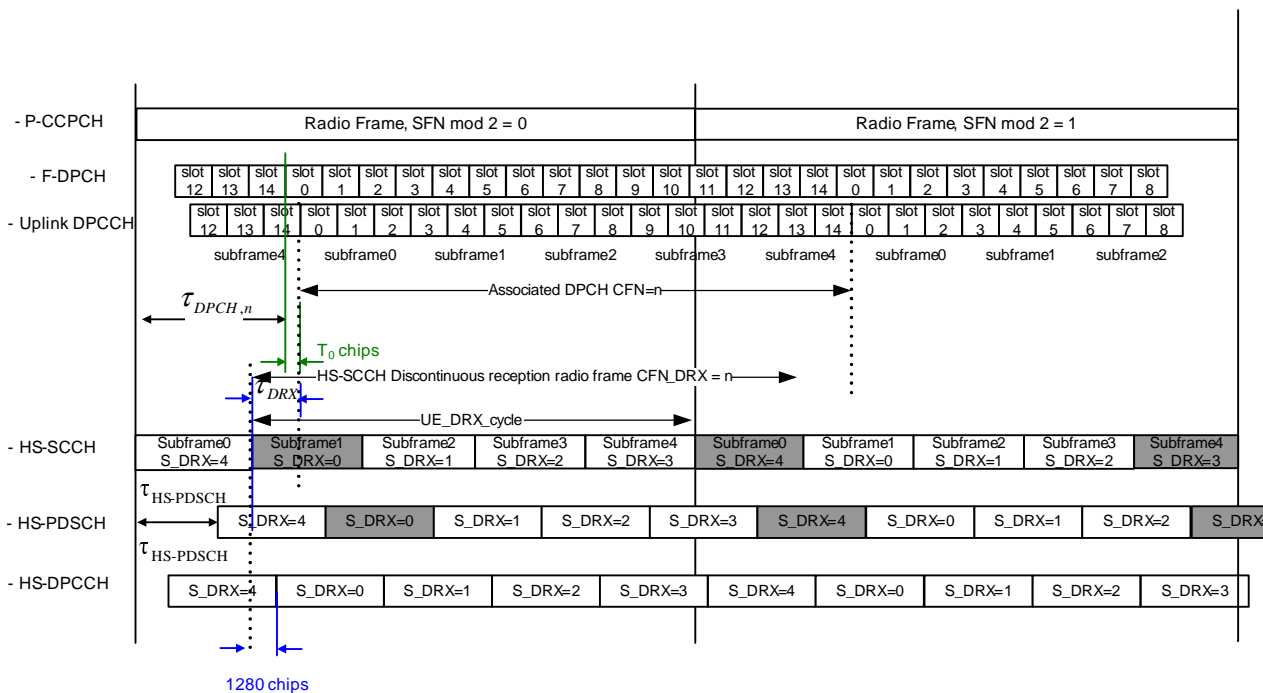

Figure 11.2-1: Example for HS-SCCH reception pattern, 2ms E-DCH TTI

The HS-SCCH reception pattern is illustrated by Figure 11.2-2 for a 10 ms TTI E-DCH. The grey subframes correspond to the HS-SCCH reception pattern $UE_DRX_cycle=5$.

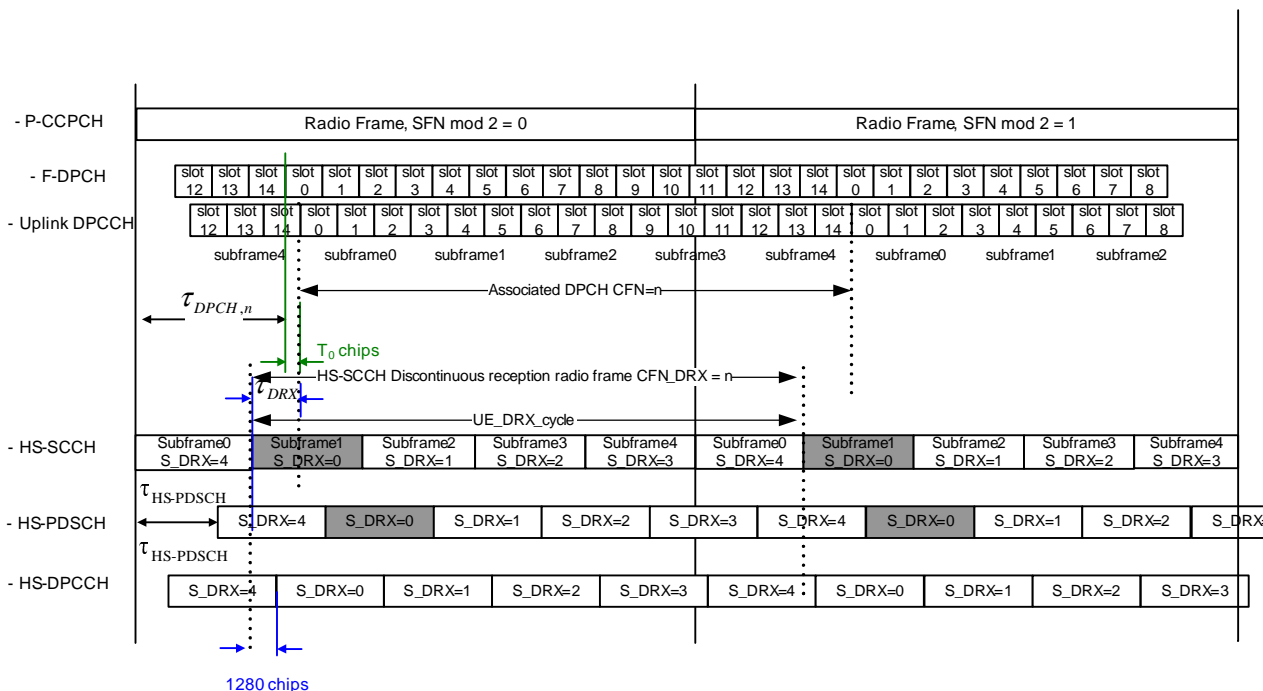

Figure 11.2-2: Example for HS-SCCH reception pattern, 10ms E-DCH TTI

Furthermore, there should be no impact to the UE mobility since the UE cannot DRX if it is required to perform measurements as specified in [5]

12 HS-SCCH-less HS-DSCH transmission in FDD

The HS-SCCH-less HS-DSCH transmission is a mechanism whereby the first HS-DSCH transmission of small transport blocks on predefined HS-DSCH is performed without the accompanying HS-SCCH and HARQ retransmissions of the first HS-DSCH transmission are accompanied by the HS-SCCH.

HS-SCCH-less HS-DSCH transmission mechanism is configuration of CELL_DCH state, when F-DPCH is configured without DCH configured in Downlink or Uplink. The HS-SCCH-less HS-DSCH transmission mechanism can be configured with or without a configuration of discontinuous transmission and reception as defined in subclause 11. However, if Downlink DRX is configured the times at which the UE is mandated to be receiving HS-PDSCH and/or HS-SCCH should be taken into account by the Node B scheduler.

Furthermore, an HS-SCCH-less HS-DSCH transmission has the following characteristics:

- The modulation used is restricted to QPSK.
- Only 4 pre-defined TB formats for MAC-hs or MAC-ehs PDUs are allowed.
 - These 4 formats are chosen semi-statically, and maybe independently configured per UE.
- The HS-PDSCH CRC is 24-bits long and is UE specific.
 - Its generation follows the same procedure as the CRC currently on the HS-SCCH, and therefore is covered by the 16-bit UE specific H-RNTI.
- At most two pre-defined HS-PDSCH OVSF codes are assigned per UE
 - The pre-defined HS-PDSCH OVSF codes are semi-statically assigned per UE.
 - At anytime, the UE may receive an HS-SCCH-less HS-DSCH transmission on one or two of the configured codes and must perform blind decoding on all 4 configured formats.
 - In order to perform blind decoding on the pre-defined HS-PDSCH OVSF codes, UE must maintain a cyclic soft buffer storing 13 contiguous TTIs.
- The UE does not transmit negative acknowledgements (NACK) in the first transmission when decoding the chosen formats. It transmits ACK or NACKs for the retransmissions.
- HARQ is limited to:
 - 2 retransmissions.
 - The redundancy version is pre-defined and not configurable.
- The HARQ retransmissions of an HS-SCCH-less HS-DSCH transmission are accompanied by an HS-SCCH, which is sent with the same channel coding and decoding as the Release 5/6 HS-SCCH. Some of the bits of the HS-SCCH are reinterpreted in order to signal the UE the following information.
 - That the HS-SCCH is intended for HS-SCCH-less operation
 - Whether the retransmission is the first retransmission or the second retransmission
 - The channelization code and the transport block size used by the HARQ process
 - The HARQ combining information – in the form of an offset from the current TTI indicating where the previous transmission was sent

In addition, the UE continues to attempt reception of the legacy HS-SCCH in the configured HS-SCCH set.

For a UE configured for HS-SCCH-less operation, the serving HS-DSCH cell can deactivate and reactivate HS-SCCH-less operation by transmitting an HS-SCCH order to the UE.

12.1 HS-SCCH-less timing and operation

The timing of the HS-SCCH-less operation is similar to the timing in legacy HSDPA operation. It is depicted in Figure 12.1-1.

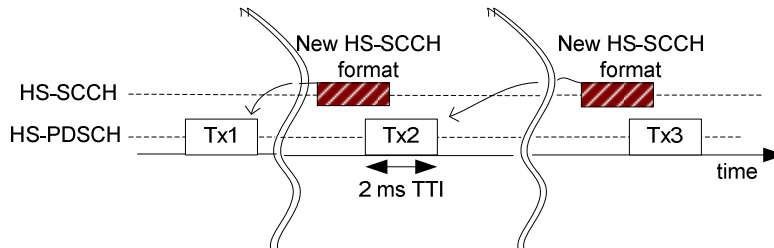

Figure 12.1-1: Illustration of the HS-SCCH-less operation

The first and second retransmissions can be asynchronous with respect to the first transmission, and with respect to each other. The accompanying HS-SCCH follows the same timing relationship with the HS-PDSCH transmission as legacy transmissions do; namely the HS-SCCH starts and ends one slot before the HS-PDSCH transmission boundaries.

If the UE is able to decode the first transmission successfully, it sends an ACK to the Node B over the HS-DPCCH. If it is not able to decode the first transmission, it buffers the data sent on the TTI. The retransmissions do not require any blind combining or decoding operation as the HS-SCCH accompanying the retransmissions carry the information needed.

In order to combine the initial HS-SCCH-less HS-DSCH transmission with the subsequent retransmissions, the new HS-SCCH format contains a pointer to the TTI where the previous transmission has been performed. In addition, the redundancy version is pre-defined for the initial transmission as well as the potential subsequent retransmissions.

13 MIMO modelling and operation in HSDPA channel in FDD

In FDD, certain categories of UE in CELL_DCH state may be configured to operate in a dual stream MIMO mode.

When the UE is configured in the MIMO mode, the HS-DSCH shall be operated according to the following:

- Use of MIMO in a cell does not enforce use of transmit diversity on overhead channels
- A MIMO capable UE can be signalled to operate in 'MIMO mode' by RRC. When not in MIMO mode it would operate as a regular non-MIMO UE.
- in MIMO mode dynamic scheduling of single and dual stream transmission is possible.
- when operating in MIMO mode, the use of F-DPCH as associated channel shall be supported
 - when operating in MIMO mode and using F-DPCH as associated channel, only single antenna transmission or STTD has to be supported on F-DPCH.
- when operating in MIMO mode, the use of DPCH as associated channel shall be supported.
 - additionally the data rate on DPCH should be limited (e.g. to 64 kbps) when operating in MIMO mode.
- the Rel-6 transport block sizes shall be reused without changes
- the Node B signals the number of scheduled streams and the used antenna weights through HS-SCCH.
- a precoding codebook with 4 vectors has been defined
- the precoding will stay constant during one HS-PDSCH TTI in MIMO mode
- for dual stream transmissions, orthogonal precoding vectors are used

- the Node B scheduler decides on which precoding vector(s) is/are used
- the UE signals 1 out of 4 possible precoding vectors in the uplink
- the UE sends sufficient information to the Node B to select the number of streams and the MCSs of each stream
- for the purpose of CQI evaluation, the UE assumes to get symmetric code allocation across streams
- the UE will ACK/NACK each transmitted transport block separately.

14 HS-DSCH reception in CELL_FACH state (FDD only)

The HS-DSCH reception in CELL_FACH state is enabled by the UTRAN by including the parameters for HS-DSCH reception in CELL_FACH state in the system information broadcast. Parameters include HS-SCCH, HS-DSCH configuration and common H-RNTI. UTRAN may also reconfigure HS-DSCH reception parameters (H-RNTI) by dedicated RRC signalling.

When HS-DSCH reception is configured in the cell, it shall take precedence instead of reception of S-CCPCH and FACH for dedicated signalling data in CELL_FACH state.

The BCCH is mapped on HS-DSCH for transmitting system information change information to the UEs in CELL_FACH state receiving HS-DSCH. The transmission of BCCH on HS-DSCH is performed by using BCCH specific H-RNTI on specific HS-SCCH code indicated in system information broadcast.

Simultaneous reception of HS-DSCH and S-CCPCH is only required in case of reception of CTCH and MBMS ptm transmission.

The UE in CELL_FACH state receiving HS-DSCH performs normal cell reselection process except during periods when it is transmitting on common E-DCH resource, during which the UE is prevented from making cell reselections. The inter frequency and inter RAT cell reselection is supported by HS-DSCH measurement occasions as defined in subclause 14.3. When UE enters to a new cell, it obtains the valid HS-SCCH configuration from system information broadcast and performs Cell Update procedure.

UTRAN obtains the knowledge of the UE supporting the enhanced CELL_FACH state from the RRC Connection Request / Setup Complete messages and the Cell / URA update messages.

The HSDPA reception in CELL_FACH state utilizes the enhanced L2 architecture with flexible RLC PDU size and MAC-ehs segmentation as defined in clause 6 and in [7].

14.1 UE operation

When HS-DSCH reception is configured in the system information broadcast, the UE shall after sending the RRC connection request or Cell Update, while not having a valid C-RNTI, monitor the common H-RNTI value on the HS-SCCH.

When the UE detects the common H-RNTI the UE shall receive the corresponding HS-DSCH TTI;

- if after decoding the data, the CRC is correct the UE shall pass the data to MAC-ehs;
- if the UE received MAC-ehs PDU containing CCCH message, the UE passes MAC-ehs PDU to MAC-ehs reordering reassembly function. The UE identity is included in the RRC message;
- if the UE received MAC-ehs PDU containing SRB#1 message the UE passes MAC-ehs PDU to MAC-ehs reordering reassembly function. UE shall decode the U-RNTI in MAC-c header to determine if the MAC PDU is for it.

When the UE has an RRC connection and a valid C-RNTI and H-RNTI, the UE shall monitor the dedicated H-RNTI on the HS-SCCH.

When the UE detects the correct H-RNTI value the UE shall receive the corresponding HS-DSCH TTI;

- if after decoding the data, the CRC is correct the UE passes the data to MAC-ehs for reassembly and reordering;
- after MAC-ehs processing the UE passes the complete MAC-ehs SDU directly to the corresponding RLC entity.

For uplink transmission the UE shall use the common E-DCH if the UE and cell support it, otherwise the UE shall use the RACH.

During the state transition from CELL_FACH to CELL_DCH, if the reconfiguration message does not include new H-RNTI the UE keeps monitoring the HS-SCCH with the H-RNTI value used in CELL_FACH state during the uplink synchronisation procedure, if the uplink synchronization procedure is necessary. The UE shall continue to use the H-RNTI in CELL_DCH state after completing the state transition to CELL_DCH state.

14.2 Initial link adaptation

The UE includes available, i.e. UE does not delay reporting due to performing measurements, measurement results on RACH to uplink RRC messages based on configuration parameters set in SIB11/12. The UE includes the measurement results on RACH in Cell Update message when performing Cell update procedure. If UE has valid C-RNTI and H-RNTI the UE sends the Measurement Report message on SRB#2.

The HS-DSCH data frame header includes a "RACH Measurement Result" field to which the RNC can include the received measurement results on RACH. The Node B HS-DSCH scheduler can use this information to determine the MCS and DL transmit power for the HS-SCCH and HS-PDSCH transmissions.

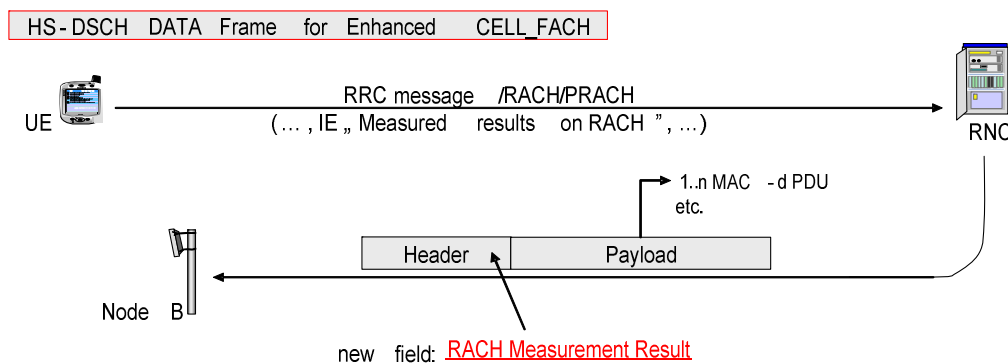

Figure 14.2-1: Link adaptation based on measurement results on RACH

14.3 Measurement Occasion

When HS-DSCH reception in CELL_FACH with measurement occasions is configured the measurement period is 10ms. The measurement occasion cycle length coefficient is signalled to the UE and to the Node B by a corresponding IE in RRC and NBAP signalling protocol(s).

The Node B uses the dedicated H-RNTI and the cycle length coefficient to calculate the UE's measurement period and considers it accordingly in the scheduling of HS-DSCH transmissions. UE disregards the measurement occasions while a common E-DCH resource is allocated to the UE

The Node B HS-DSCH scheduling can ensure that the complete HS-SCCH and HS-PDSCH frames are received by the UE outside its measurement period.

14.4 Discontinuous reception

In CELL_FACH state, the UE performs continuous reception of the HS-SCCH (expect measurement occasion frames) if DRX operation in CELL_FACH is not configured. The discontinuous reception is enabled for the UE by the UTRAN by the following methods:

- Moving the UE to CELL/URA_PCH state by means of dedicated RRC reconfiguration procedure.
- Configuring the UE with a DRX Cycle configuration for usage in CELL_FACH state. Details of the DRX operation are described in subclause 14.4.1.

In the reconfiguration procedure to CELL_PCH or URA_PCH states, the UTRAN may indicate two DRX cycles and inactivity time. The UE shall use the first DRX cycle and start the inactivity timer after completing the state transition. If the inactivity timer expires in CELL/URA_PCH state the UE shall start using second DRX cycles.

14.4.1 HS-DSCH DRX operation in CELL_FACH state

For the HS-DSCH DRX operation in CELL_FACH, the UTRAN indicates an inactivity time, a DRX cycle length and a RX burst length. This information is stored by the UE for use when in CELL_FACH state. The HS-DSCH DRX operation in CELL_FACH state is only possible when the UE has a dedicated H-RNTI configured.

The HS-DSCH DRX operation in CELL_FACH state is initialized when the inactivity timer expires. The inactivity timer is triggered whenever no data transmission activities are ongoing. At this point, the UE shall continuously receive HS-DSCH for the length of the inactivity time configured. Once the inactivity timer has expired, the UE may choose not to receive HS-DSCH for a given time within the period of the configured DRX Cycle. The UE shall receive HS-DSCH for the RX burst length of the DRX Cycle configured. This operation is illustrated in Figure 14.4.1-1.

The UE shall interrupt DRX operation in CELL_FACH state and continuously receive HS-DSCH, if data transmission activity is initiated.

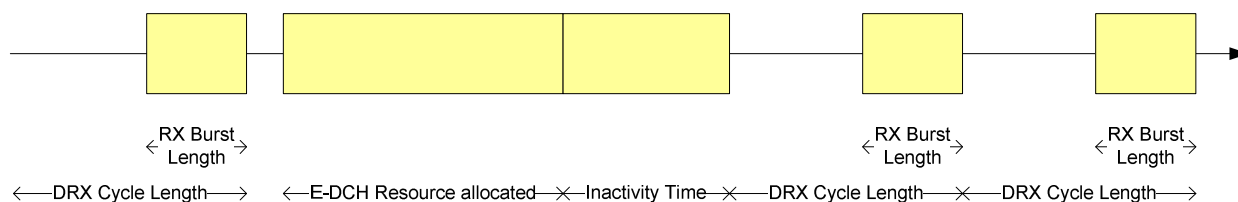

Figure 14.4.1-1: Discontinuous HS-DSCH reception in CELL_FACH state

15 HS-DSCH reception in CELL_PCH and URA_PCH states (FDD only)

The HS-DSCH reception in CELL_PCH and URA_PCH state is enabled by the UTRAN by including the parameters for HS-DSCH reception in CELL_PCH and URA_PCH state in the system information broadcast. Parameters include PICH, HS-SCCH, and HS-DSCH configuration used for PCCH transmission in CELL_PCH and URA_PCH state. The HS-DSCH reception in CELL_PCH and URA_PCH state supports discontinuous reception as when DRX is used the UE needs only to monitor one Page Indicator, PI, in one Paging Occasion per DRX cycle.

When HS-DSCH reception is enabled in the cell, it shall take precedence instead of reception of S-CCPCH and PCH for paging messages in CELL_PCH and URA_PCH states.

UTRAN obtains the knowledge of the UE supporting the reception of HS-DSCH in CELL_PCH and URA_PCH state from the RRC Connection Setup Complete message and the URA update message.

When the HS-DSCH reception in CELL_PCH is enabled, the UTRAN can configure the UEs to store the C-RNTIs and dedicated H-RNTIs when performing reconfiguration to CELL_PCH.

For UEs with stored C-RNTI and dedicated H-RNTI, the network should use the stored dedicated H-RNTI to transmit DCCH and DTCH to the UE. When UE receives dedicated H-RNTI on HS-SCCH, the UE shall initiate actions on measurement reporting on RRC as defined in subclause 14.2. When UE has uplink data to transmit, UEs shall initiate the measurement reporting on RRC as defined in subclause 14.2. The UE shall use the stored C-RNTI to transmit DTCH and DCCH without first performing the Cell Update procedure.

If UTRAN has not configured the UE to store the C-RNTI and H-RNTI in CELL_PCH the UTRAN should send paging message on PCCH mapped on HS-DSCH by HS-PDSCH code and transport block sizes broadcasted in system information. There is one HS-PDSCH code, maximum two transport block sizes and the number of retransmissions (n) broadcasted in system information.

The UE is only required to monitor either dedicated H-RNTI or HS-PDSCH code after paging, at any given time for DCCH and DTCH or PCCH transmissions.

The BCCH is mapped on HS-DSCH for transmitting system information change information to the UEs in CELL_PCH state receiving HS-DSCH. The transmission of BCCH on HS-DSCH is performed by using BCCH specific H-RNTI on specific HS-SCCH code indicated in system information broadcast.

The UE in CELL_PCH and URA_PCH states receiving HS-DSCH performs normal cell reselection process. The inter frequency and inter RAT cell reselection is supported as previous releases. When UE enters to a new cell, it obtains the valid HS-SCCH configuration from system information broadcast and performs Cell Update procedure.

The DCCH/DTCH over HSDPA reception in CELL_PCH state utilizes the enhanced L2 architecture with flexible RLC PDU size and MAC-ehs segmentation as defined in clause 6 and in [7].

15.1 UE operation

When HS-DSCH reception is configured in the system information broadcast, the UE shall after receiving a paging indication on PICH for its specific paging group, start monitoring either a stored dedicated H-RNTI value on the HS-SCCH or if the UE does not have a dedicated H-RNTI value, it shall start monitoring the broadcasted HS-PDSCH code using indicated transport block sizes used for PCCH transmissions.

The UE shall monitor either the HS-SCCH or the HS-PDSCH for n subframes after time offset defined between PICH and HS-PDSCH. The parameter n is broadcasted in system information and the maximum value of n is 5 subframes.

When the UE in URA_PCH or CELL_PCH without dedicated H-RNTI detects the PICH identifying PCCH transmission, the UE shall receive the corresponding HS-DSCH TTIs;

- considering that paging message is retransmitted in n subframes;
- combine retransmissions to same HARQ buffer;
- if after decoding the data, the CRC is correct the UE shall pass the data to MAC-ehs;
- if the CRC fails after receiving n subframes the UE resumes the DRX operation.

NOTE: When the UE receives the HS-PDSCH due to reception of PCCH, the UE is not required to receive any HS-SCCH.

When the UE in CELL_PCH with dedicated H-RNTI detects the PICH identifying DCCH/DTCH transmission, the UE shall receive the corresponding HS-SCCH subframes:

- if the UE detects the dedicated H-RNTI on the HS-SCCH, the UE shall receive the corresponding HS-DSCH TTI and indicate RRC to initiate sending the measurement results on RACH in uplink:
 - if after decoding the data, the CRC is correct the UE passes the data to MAC-ehs for reassembly and reordering;
 - after MAC-ehs processing the UE passes the complete MAC-ehs SDU directly to the corresponding RLC entity.
- if UE does not detect the dedicated on H-RNTI in any of the n subframes the UE resumes the DRX operation.

The UE shall perform the state transition to CELL_FACH state when sending the measurement results on RACH as defined in 14.2. For uplink transmission the UE shall use the common E-DCH if the UE and cell support it, otherwise it shall use the RACH. After initiating the uplink transmission, the UE shall remain in CELL_FACH state, unless a state change is triggered by RRC signalling. In case, that state change to CELL_DCH is indicated in RRC message the UE shall initiate uplink synchronisation procedure immediately, if the uplink synchronization procedure is necessary, even if MAC layer has not indicated transmission of the RRC message containing the measurement results on RACH.

During the state transition from CELL_PCH to CELL_DCH, if the reconfiguration message on DCCH does not include new H-RNTI the UE keeps monitoring the HS-SCCH with the dedicated H-RNTI value used in CELL_PCH or URA_PCH state during the uplink synchronisation procedure. The UE shall continue to use the dedicated H-RNTI in CELL_DCH state after completing the state transition to CELL_DCH state.

16 HS-DSCH reception in CELL_FACH state (1.28Mcps TDD only)

The HS-DSCH reception in CELL_FACH state is always linked with E-DCH transmission in CELL_FACH and Idle mode.

The HS-DSCH reception in CELL_FACH state is enabled by the UTRAN by including the parameters for HS-DSCH reception in CELL_FACH state in the system information broadcast. Parameters include HS-SCCH, HS-SICH, HS-DSCH configuration and common H-RNTI. UTRAN may also reconfigure HS-DSCH reception parameters (H-RNTI) by dedicated RRC signalling.

In a multi-frequency cell, HS-DSCH resource in CELL_FACH state can be established on primary frequency and secondary frequencies. HS-DSCH resources include HS-SCCH, HS-SICH, and HS-PDSCH. UTRAN can configure a working frequency for a particular UE. Uplink transmission and downlink HS-DSCH reception for a specific UE is on the same carrier, on which both the uplink random access resource and downlink HS-DSCH resource should be established.

When HS-DSCH reception is configured in the cell, it shall take precedence instead of reception of S-CCPCH and FACH for dedicated signalling data in CELL_FACH state.

The BCCH is mapped on HS-DSCH for transmitting system information change information to the UEs in CELL_FACH state receiving HS-DSCH. The transmission of BCCH on HS-DSCH is performed by using BCCH specific H-RNTI on specific HS-SCCH code indicated in system information broadcast. In a multi-frequency cell, the transmission of BCCH on HS-DSCH is performed on all frequencies where CELL_FACH state UEs stay and UE detects the BCCH specific H-RNTI on its working frequency.

Simultaneous reception of HS-DSCH and S-CCPCH is only required in case of reception of CTCH and MBMS ptm transmission.

The UE in CELL_FACH state receiving HS-DSCH performs normal cell reselection process. When UE enters to a new cell, it obtains the valid HS-SCCH configuration from system information broadcast and performs Cell Update procedure.

UTRAN obtains the knowledge of the UE supporting the enhanced CELL_FACH state from the RRC Connection Request message. Mandatory UE support of Enhanced CELL_FACH state in Rel-8 is FFS.

The HSDPA reception in CELL_FACH state utilizes the enhanced L2 architecture with flexible RLC PDU size and MAC-ehs segmentation as defined in clause 6 and in [7]. The UE in CELL_FACH state receiving HS-DSCH uses E-DCH for the uplink transmission.

16.1 UE operation

When HS-DSCH reception is configured in the system information broadcast, the UE shall after sending the RRC connection request or Cell Update, while not having a dedicated H-RNTI, monitor the common H-RNTI value on the HS-SCCH.

In a multi-frequency cell, UE performs initial access on primary frequency, i.e. UE sends RRC Connection Request or CELL Update when entering a new cell after cell re-selection on primary frequency. And then UE monitors common H-RNTI on primary frequency.

When the UE detects the common H-RNTI the UE shall receive the corresponding HS-DSCH TTI;

- if after decoding the data, the CRC is correct the UE shall pass the data to MAC-ehs;
- if the UE received MAC-ehs PDU containing CCCH message, the UE passes MAC-ehs PDU to MAC-ehs reordering reassembly function. The UE identity is included in the RRC message;
- if the UE received MAC-ehs PDU containing SRB#1 message the UE passes MAC-ehs PDU to MAC-ehs reordering reassembly function. UE shall decode the U-RNTI in MAC-c header to determine if the MAC PDU is for it.

When receiving UE's initial access request, i.e. RRC connection request or Cell Update after cell re-selection, RNC configure a dedicated H-RNTI, E-RNTI and a working frequency for the UE. When the UE has an RRC connection and a valid H-RNTI, the UE shall monitor the dedicated H-RNTI on the HS-SCCH.

When the UE detects the correct H-RNTI value the UE shall receive the corresponding HS-DSCH TTI;

- if after decoding the data, the CRC is correct the UE passes the data to MAC-ehs for reassembly and reordering;
- after MAC-ehs processing the UE passes the complete MAC-ehs SDU directly to the corresponding RLC entity.

For uplink transmission the UE uses E-DCH. Uplink transmission and downlink HS-DSCH reception for a specific UE is on a same carrier.

During the state transition from CELL_FACH to CELL_DCH, if the reconfiguration message does not include new H-RNTI the UE keeps monitoring the HS-SCCH with the H-RNTI value used in CELL_FACH state during the uplink synchronisation procedure. The UE shall continue to use the H-RNTI in CELL_DCH state after completing the state transition to CELL_DCH state.

16.2 Initial link adaptation

If UE has no dedicated H-RNTI, the UE includes available, i.e. UE does not delay reporting due to performing measurements, measurement results on RACH to uplink RRC messages based on configuration parameters set in SIB11/12. The UE includes the measurement results on RACH in Cell Update message when performing Cell update procedure.

The HS-DSCH data frame header includes a "Measured Results on RACH" field to which the RNC can include the received measurement results on RACH. The Node B HS-DSCH scheduler can use this information to determine the MCS, retransmission times and DL transmit power for the HS-SCCH and HS-PDSCH transmissions.

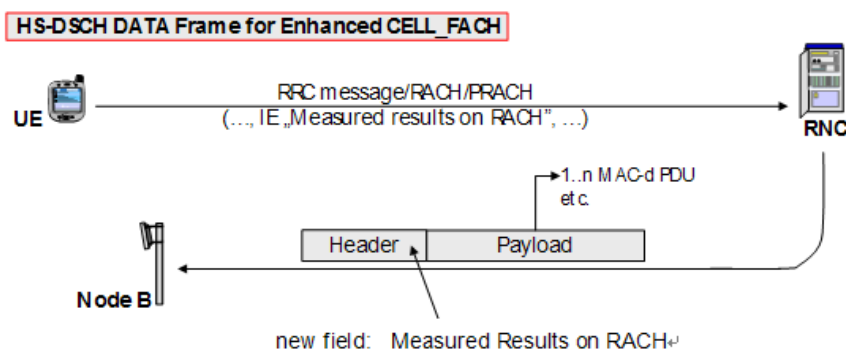

Figure 16.2-1: Link adaptation based on measurement results on RACH

16.3 Link adaptation when H-RNTI is allocated

If UE has valid H-RNTI the UE sends ACK/NACK feedback and CQI report on the related HS-SICH. The Node B HS-DSCH scheduler can use this information to determine the MCS, retransmission and DL transmit power for the HS-SCCH and HS-PDSCH transmissions.

Maintaining of Uplink synchronization is not needed in CELL_FACH state, UE could be out of synchronization after a period of transmission pause. When DL transmission is recommenced following a transmission pause, Node B shall order UE to establish the UL synchronization via HS-SCCH in case it detects the UE is out of UL synchronization. The synchronization detection in Node B is based on timer mechanism. Response to the synchronization establishment command, UE then initiates the UL synchronization procedure. When it accomplishes the UL synchronization establishment, UE sends E-RUCCH to Node B. During the procedure, no HS-SICH is sent. If Node B receives E-RUCCH from the UE, the Node B can then resume the HS-DSCH transmission for the UE.

16.4 Discontinuous reception

In CELL_FACH state, the UE performs continuous reception of the HS-SCCH (expect measurement occasion frames) if DRX operation in CELL_FACH is not configured. The discontinuous reception is enabled for the UE by the UTRAN by the following methods:

- Moving the UE to CELL/URA_PCH state by means of dedicated RRC reconfiguration procedure.
- Configuring the UE with a DRX Cycle configuration for usage in CELL_FACH state. The DRX configuration is CELL specific. Details of the DRX operation are described in 16.4.1.

In the reconfiguration procedure to CELL_PCH or URA_PCH states, the UTRAN may indicate two DRX cycles and inactivity time. The UE shall use the first DRX cycle and start the inactivity timer after completing the state transition. If the inactivity timer expires in CELL/URA_PCH state the UE shall start using second DRX cycles.

16.4.1 HS-DSCH DRX operation in CELL_FACH state

For the HS-DSCH DRX operation in CELL_FACH, the UTRAN indicates an inactivity timer, a DRX cycle length and a RX burst length. This information is stored by the UE for use when in CELL_FACH state. The HS-DSCH DRX operation in CELL_FACH state is only possible when the UE has a dedicated H-RNTI configured.

The HS-DSCH DRX operation in CELL_FACH state is initialized when the inactivity timer expires. The inactivity timer is triggered whenever no data transmission activities are on-going. At this point, the UE shall continuously receive HS-DSCH for the length of the inactivity timer configured. Once the inactivity timer has expired, the UE may choose not to receive HS-DSCH for a given time within the period of the configured DRX Cycle. The UE shall receive HS-DSCH for the RX burst length of the DRX Cycle configured.

The UE shall interrupt DRX operation in CELL_FACH state and continuously receive HS-DSCH, if data transmission activity is initiated.

UE with dedicated H-RNTI, after state transition from CELL_PCH to CELL_FACH, shall not initiate discontinuously reception until it has detected its dedicated H-RNTI on HS-SCCH indicating HS-DSCH reception.

16.5 Measurement Occasion

When HS-SCCH(s) in TS0 is configured for HS-DSCH transmission in CELL_FACH state in a certain frequency, the Node B HS-DSCH scheduling shall ensure that the HS-SCCH(s) in the TS0 is not received by the UE in its measurement period. To achieve this, the measurement period N is set to a fixed value, and the measurement occasion cycle length coefficient is signalled to the UE and to the Node B by a corresponding IE in RRC and NBAP signalling protocol(s). The Node B uses the dedicated H-RNTI, measurement period N and the cycle length coefficient to calculate the UE's measurement period and considers it accordingly in the scheduling of HS-DSCH transmissions on that frequency.

Whether DRX OFF period (if DRX configured) rather than measurement occasions is used for interfrequency and interRAT measurements is FFS.

17 HS-DSCH reception in CELL_PCH and URA_PCH states (1.28Mcps TDD only)

The HS-DSCH reception in CELL_PCH and URA_PCH state is enabled by the UTRAN by including the parameters for HS-DSCH reception in CELL_PCH and URA_PCH state in the system information broadcast. Parameters include PICH, HS-SCCH, and HS-DSCH configuration used for PCCH and DCCH/DTCH transmission in CELL_PCH and URA_PCH state. The HS-DSCH reception in CELL_PCH and URA_PCH state supports discontinuous reception as when DRX is used the UE needs only to monitor one Page Indicator, PI, in one Paging Occasion per DRX cycle.

In a multi-frequency cell, resources for HS-DSCH reception in CELL_PCH and URA_PCH including PICH, HS-SCCH and HS-DSCH configuration is only on primary frequency.

UTRAN obtains the knowledge of the UE supporting the reception of HS-DSCH in CELL_PCH and URA_PCH state from the RRC Connection Request/Complete message. Mandatory UE support of HS-DSCH reception in CELL_PCH and URA_PCH state is in Rel-8 is FFS.

When the HS-DSCH reception in CELL_PCH is enabled, the UTRAN can configure the UEs to store the E-RNTIs and dedicated H-RNTIs when performing reconfiguration to CELL_PCH.

For UE with stored H-RNTI, the network should use the stored dedicated H-RNTI to inform the UE to establish the uplink synchronization via HS-SCCH before transmitting DCCH and DTCH to the UE. When UE receives dedicated H-RNTI on HS-SCCH, the UE shall initiate the uplink synchronization procedure and transit to CELL_FACH state.

For UE without the E-RNTI and H-RNTI in CELL_PCH and URA_PCH, if PCH is configured in the cell, the PCCH is sent on the legacy PCH, otherwise UTRAN can send paging message on PCCH mapped on HS-DSCH.

The same paging block structure for PCH is used when PCCH is mapped on HS-DSCH, details in [8].

The BCCH is mapped on HS-DSCH for transmitting system information change information to the UEs with dedicated H-RNTI in CELL_PCH state receiving HS-DSCH. The transmission of BCCH on HS-DSCH is performed by using BCCH specific H-RNTI on specific HS-SCCH code indicated in system information broadcast. In a multi-frequency cell, the transmission of BCCH on HS-DSCH to the UE in CELL_PCH state is only on primary frequency.

The UE in CELL_PCH and URA_PCH states receiving HS-DSCH performs normal cell reselection process. The inter frequency and inter RAT cell reselection is supported as previous releases. When UE enters to a new cell, it obtains the valid HS-SCCH configuration from system information broadcast and performs Cell Update procedure.

The DCCH/DTCH over HSDPA reception in CELL_PCH state utilizes the enhanced L2 architecture with flexible RLC PDU size and MAC-ehs segmentation as defined in clause 6 and in [7].

17.1 UE operation

When HS-DSCH reception is configured in the system information broadcast, the UE shall after receiving a paging indication on PICH for its specific PI, start monitoring either a stored dedicated H-RNTI value on the HS-SCCH or if the UE does not have a dedicated H-RNTI value, it shall start monitoring the broadcasted HS-PDSCH code using indicated transport block sizes used for PCCH transmissions.

In a multi-frequency cell, UEs in URA_PCH or CELL_PCH stay on primary frequency.

The UE shall monitor either the HS-SCCH or the HS-PDSCH after time offset N_{GAP} defined between PICH and HS-SCCH or the HS-PDSCH.

When the UE in URA_PCH or CELL_PCH without dedicated H-RNTI detects the PICH identifying PCCH transmission, the UE shall receive the corresponding HS-DSCH TTIs:

- considering that paging message is retransmitted in $2*m$ subframes, the parameter m is the number of frame that each paging sub-channel occupies.
- combine retransmissions to same HARQ buffer;
- if the CRC is correct the UE shall pass the data to MAC-ehs;
- if the CRC fails after receiving $2*m$ subframes the UE resumes the DRX operation.

NOTE: When the UE receives the HS-PDSCH due to reception of PCCH, the UE is not required to receive any HS-SCCH.

When the UE in CELL_PCH with dedicated H-RNTI detects the PICH identifying DCCH/DTCH transmission, the UE shall receive the corresponding HS-SCCH subframes:

- if the UE detects the dedicated H-RNTI on the HS-SCCH, the UE shall initiate the uplink synchronization procedure and transit to CELL_FACH state;
- if UE does not detect the dedicated on H-RNTI on HS-SCCH in any of the n subframes the UE resumes the DRX operation, n is configured by higher layer.

The UE in CELL_PCH with dedicated H-RNTI shall also detect BCCH specific H-RNTI when it detects the PICH identifying DCCH/DTCH transmission:

- if the UE detects the BCCH specific H-RNTI on the HS-SCCH in any of the n subframes, the UE shall receive the corresponding HS-DSCH TTI.

For uplink transmission the UE shall use the E-DCH. The UE shall perform the state transition to CELL_FACH state when initiate the uplink transmission. After initiating the uplink transmission, the UE shall remain in CELL_FACH state, unless a state change is triggered by RRC signalling.

During the state transition from CELL_PCH to CELL_DCH, if the reconfiguration message on DCCH does not include new H-RNTI the UE keeps monitoring the HS-SCCH with the dedicated H-RNTI value used in CELL_PCH or URA_PCH state during the uplink synchronisation procedure. The UE shall continue to use the dedicated H-RNTI in CELL_DCH state after completing the state.

18 Dual Cell HSDPA Operation (FDD only)

Dual Cell operation is characterized as simultaneous reception of more than one HS-DSCH transport channel. Certain categories of UEs may be configured into Dual Cell operation in CELL_DCH state. Dual Cell operation may be activated and deactivated using HS-SCCH orders.

When the UE is configured into Dual Cell operation and a common transmitting MAC-ehs entity is used for data transmission, the HS-DSCH channels shall be operated in the following manner,

- the receiving MAC-ehs entity supports more than one HS-DSCH transport channel,
- each of these HS-DSCH transport channels has its own associated uplink and downlink signalling, and own HARQ entity (further composed of multiple HARQ processes),
- reordering, duplicate detection, segmentation and reassembly functions are joint for these HS-DSCH transport channels and HARQ entities.

When the UE is configured into Dual Cell operation,

- the mobility procedures, as defined in section 9, are supported based on the serving HS-DSCH cell. Figure 18-1 shows an example of combined active set update and HS-Serving Cell Change based on received measurement report 1A. The procedure may also be performed in two steps with separate Active Set Update and Radio Bearer Reconfiguration messages.
- the DRX status and activation and deactivation of the DRX with HS-SCCH is common to both serving and secondary serving HS-DSCH cells, and the related HS-SCCH signaling can be sent on either serving or secondary serving HS-DSCH cell,
- HS-SCCH-less operation is restricted to the serving HS-DSCH cell.

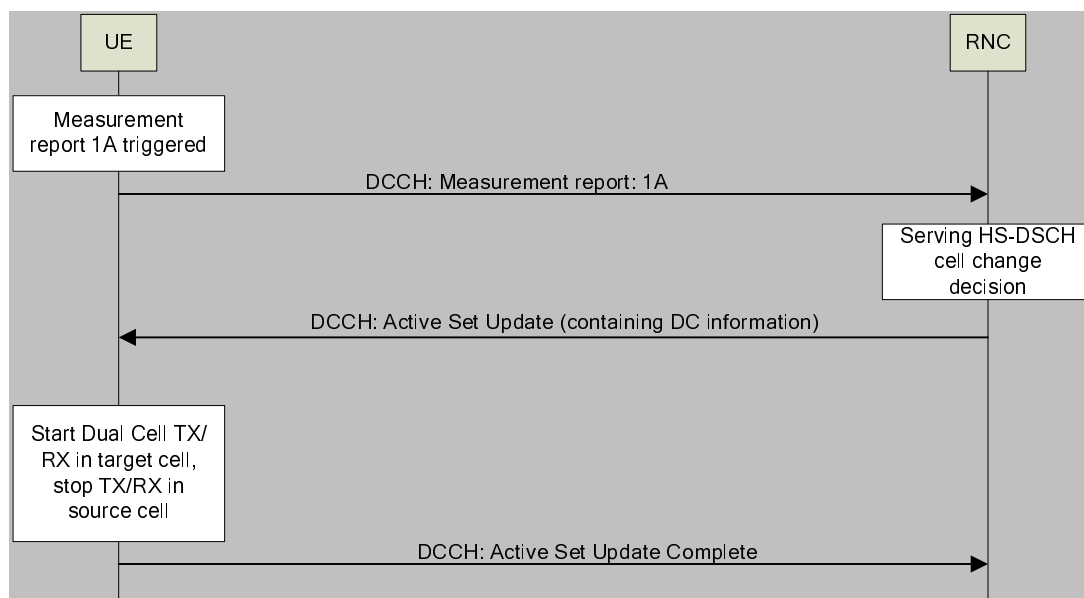

Figure 18-1: Intra-Node B synchronised serving HS-DSCH cell change for Dual Cell operation

19 HS-SCCH-less HS-DSCH transmission in 1.28Mcps TDD

The HS-SCCH-less HS-DSCH transmission is a mechanism whereby the first HS-DSCH transmission of transport blocks on the semi-persistent HS-DSCH resources is performed without the accompanying HS-SCCH and HARQ retransmissions of the first HS-DSCH transmission on the semi-persistent HS-DSCH resources are accompanied by a new format HS-SCCH.

HS-SCCH-less HS-DSCH transmission mechanism is a configuration of CELL_DCH state, when the semi-persistent HS-DSCH resources are configured for a UE. And the semi-persistent HS-DSCH resources can be configured and reconfigured by a new format HS-SCCH.

Furthermore, an HS-SCCH-less HS-DSCH transmission has the following characteristics:

- Only 4 pre-defined TB formats for MAC-hs or MAC-ehs PDUs are allowed.
 - These 4 formats are chosen semi-statically, and maybe independently configured per UE.
- HARQ is limited to:
 - The redundancy version is pre-defined.
- The HARQ retransmissions of an HS-SCCH-less HS-DSCH transmission are accompanied by an HS-SCCH.

In addition, the UE continues to attempt reception of the legacy HS-SCCH in the configured HS-SCCH set.

19.1 HS-SCCH-less timing and operation

For the retransmission, the timing of the HS-SCCH-less operation is similar to the timing in legacy HSDPA operation.

The retransmissions can be asynchronous with respect to the first transmission, and with respect to each other. The accompanying HS-SCCH follows the same timing relationship with the HS-PDSCH transmission as legacy transmissions do.

If the UE is able to decode the first transmission successfully, it sends an ACK to the Node B over the HS-SICH. If it is not able to decode the first transmission, it sends a NACK to the Node B over the HS-SICH and buffers the data sent on the TTI. The retransmissions do not require any blind combining or decoding operation as the new format HS-SCCH accompanying the retransmissions carry the information needed.

In order to combine the initial HS-SCCH-less HS-DSCH transmission with the subsequent retransmissions, the new HS-SCCH format contains a pointer to the TTI where the previous transmission has been performed.

Annex A:
Void

Annex B (informative): Change history

Change history							
Date	TSG #	TSG Doc.	CR	Rev	Subject/Comment	Old	New
09/2001	RP-13	RP-010643	-		Approved at TSG-RAN #13 and placed under Change Control	-	5.0.0
12/2001	RP-14	RP-010774	001		Update to HSDPA Stage 2	5.0.0	5.1.0
03/2002	RP-15	RP-020093	002		HSDPA Updates	5.1.0	5.2.0
	RP-18	RP-020734	003	2	Alignment with the physical layer specifications	5.2.0	5.3.0
12/2002	RP-18	RP-020734	004		Generation of RLC Status Reports to coordinate with MAC-hs reset	5.2.0	5.3.0
03/2003	RP-19	RP-030114	005		Correction on HS-DSCH MAC architecture	5.3.0	5.4.0
	RP-19	RP-030114	006		Correction to HS-SCCH detection description	5.3.0	5.4.0
12/2003	RP-22	-	-		Upgrade to Release 6 - no technical changes	5.4.0	6.0.0
03/2004	RP-23	RP-040103	008		Corrections to HS-DSCH cell change, applicability of HS-DSCH and Need for Re-ordering queue	6.0.0	6.1.0
09/2004	RP-25	RP-040369	010	1	Application of HS-DSCH to signalling radio bearers, correction to MAC-hs entity and correction to a response message from UE	6.1.0	6.2.0
12/2004	RP-26	RP-040515	012		Removal of sentences into brackets	6.2.0	6.3.0
03/2006	RP-31	-	-		Upgrade to Release 7 - no technical changes	6.3.0	7.0.0
12/2006	RP-34	RP-060725	0013	3	Introduction of CPC	7.0.0	7.1.0
03/2007	RP-35	RP-070165	0015		Alignment of 25.308 with 25.302, 25.321 and 25.331 to enable HS-DSCH operation without an associated DL DPCH for all TDD modes	7.1.0	7.2.0
	RP-35	RP-070163	0016		25.308 DL HOM CR	7.1.0	7.2.0
	RP-35	RP-070161	0017		Introduction of MIMO in 25.308	7.1.0	7.2.0
	RP-35	RP-070155	0018	2	L2 enhancements: Stage 2	7.1.0	7.2.0
	RP-35	RP-070156	0019	2	Stage 2 updates for Enhanced CELL_FACH state in FDD	7.1.0	7.2.0
06/2007	RP-36	RP-070403	0021	1	Measurement reporting, state transitions, and DRX in enhanced CELL_FACH state	7.2.0	7.3.0
	RP-36	RP-070407	0022		Removing an incomplete optimization for RLC operations during HSDPA cell change	7.2.0	7.3.0
09/2007	RP-37	RP-070627	0023		L1 parameter name changes	7.3.0	7.4.0
	RP-37	RP-070636	0024	1	General update of the 25.308	7.3.0	7.4.0
	RP-37	RP-070650	0025		Introduction of multi-frequency operation for LCR TDD	7.3.0	7.4.0
12/2007	RP-38	RP-070898	0026		Definitions on Common Paging MAC Flow and Paging MAC Flow	7.4.0	7.5.0
	RP-38	RP-070898	0027		URA_PCH UE receive system information change indication from PCCH	7.4.0	7.5.0
		-	-		Upgrade to the Release 8 - no technical change	7.5.0	8.0.0
03/2008	RP-39	RP-080190	0029	-	Correction of figure on UE side MAC architecture/MAC-ehs details	8.0.0	8.1.0
	RP-39	RP-080201	0030	1	HS-DSCH applicability to CS bearers	8.0.0	8.1.0
05/2008	RP-40	RP-080440	0032	2	HS-SCCH orders for HS-SCCH-less operation	8.1.0	8.2.0
	RP-40	RP-080416	0033	2	Introduction of DRX operation in CELL_FACH State	8.1.0	8.2.0
	RP-40	RP-080396	0035	1	RLC TM mode allowing for HS-DSCH	8.1.0	8.2.0
	RP-40	RP-080395	0037	-	Change of MAC-d flow definition for MAC-ehs	8.1.0	8.2.0
09/2008	RP-41	RP-080681	0039	-	Editorial correction to HS-DSCH frame protocol header field	8.2.0	8.3.0
	RP-41	RP-080697	0040	-	Corrections to Enhanced UE DRX	8.2.0	8.3.0
	RP-41	RP-080699	0041	3	Introduction of HS Serving cell change	8.2.0	8.3.0
	RP-41	RP-080700	0042	-	Introduction of Dual Cell HSDPA operation	8.2.0	8.3.0
	RP-41	RP-080698	0043	1	Stage 2 updates for Enhanced DL in CELL_FACH state	8.2.0	8.3.0
12/2008	RP-42	RP-081004	0045	-	Removal of FFs and correction to the messages used for UE capability signalling	8.3.0	8.4.0
	RP-42	RP-081030	0049	-	Corrections to Dual Cell operation	8.3.0	8.4.0
	RP-42	RP-081026	0050	1	Introduction the CPC for 1.28Mcps TDD	8.3.0	8.4.0
	RP-42	RP-081022	0051	1	Addition of HS-DPCCH feedback in CELL_FACH state	8.3.0	8.4.0
	RP-42	RP-081025	0052	-	Stage 2 updates for Enhanced CELL_FACH state in 1.28Mcps TDD	8.3.0	8.4.0
	RP-42	RP-081028	0053	-	CR to 25.308 on Introduction of HS-DSCH cell change enhancements	8.3.0	8.4.0

History

Document history		
V8.2.0	October 2008	Publication
V8.3.0	October 2008	Publication
V8.4.0	January 2009	Publication