

ETSI TS 125 319 V7.5.0 (2008-04)

Technical Specification

**Universal Mobile Telecommunications System (UMTS);
Enhanced uplink;
Overall description;
Stage 2
(3GPP TS 25.319 version 7.5.0 Release 7)**



Reference

RTS/TSGR-0225319V750

Keywords

UMTS

ETSI

650 Route des Lucioles
F-06921 Sophia Antipolis Cedex - FRANCE

Tel.: +33 4 92 94 42 00 Fax: +33 4 93 65 47 16

Siret N° 348 623 562 00017 - NAF 742 C
Association à but non lucratif enregistrée à la
Sous-Préfecture de Grasse (06) N° 7803/88

Important notice

Individual copies of the present document can be downloaded from:

<http://www.etsi.org>

The present document may be made available in more than one electronic version or in print. In any case of existing or perceived difference in contents between such versions, the reference version is the Portable Document Format (PDF). In case of dispute, the reference shall be the printing on ETSI printers of the PDF version kept on a specific network drive within ETSI Secretariat.

Users of the present document should be aware that the document may be subject to revision or change of status. Information on the current status of this and other ETSI documents is available at

<http://portal.etsi.org/tb/status/status.asp>

If you find errors in the present document, please send your comment to one of the following services:

http://portal.etsi.org/chaicor/ETSI_support.asp

Copyright Notification

No part may be reproduced except as authorized by written permission.
The copyright and the foregoing restriction extend to reproduction in all media.

© European Telecommunications Standards Institute 2008.
All rights reserved.

DECT™, **PLUGTESTS™**, **UMTS™**, **TIPHON™**, the TIPHON logo and the ETSI logo are Trade Marks of ETSI registered for the benefit of its Members.

3GPP™ is a Trade Mark of ETSI registered for the benefit of its Members and of the 3GPP Organizational Partners.

Intellectual Property Rights

IPRs essential or potentially essential to the present document may have been declared to ETSI. The information pertaining to these essential IPRs, if any, is publicly available for **ETSI members and non-members**, and can be found in ETSI SR 000 314: "*Intellectual Property Rights (IPRs); Essential, or potentially Essential, IPRs notified to ETSI in respect of ETSI standards*", which is available from the ETSI Secretariat. Latest updates are available on the ETSI Web server (<http://www.etsi.org/legal/home.htm>).

Pursuant to the ETSI IPR Policy, no investigation, including IPR searches, has been carried out by ETSI. No guarantee can be given as to the existence of other IPRs not referenced in ETSI SR 000 314 (or the updates on the ETSI Web server) which are, or may be, or may become, essential to the present document.

Foreword

This Technical Specification (TS) has been produced by the ETSI 3rd Generation Partnership Project (3GPP).

The present document may refer to technical specifications or reports using their 3GPP identities, UMTS identities or GSM identities. These should be interpreted as being references to the corresponding ETSI deliverables.

The cross reference between GSM, UMTS, 3GPP and ETSI identities can be found under <http://webapp.etsi.org/key/queryform.asp>.

Contents

Intellectual Property Rights	2
Foreword.....	2
Foreword.....	5
1 Scope	6
2 References	6
3 Definitions and abbreviations.....	6
3.1 Definitions	6
3.1.1 General.....	7
3.1.2 FDD	7
3.1.3 TDD	8
3.2 Abbreviations	8
4 Background and introduction	8
5 Requirements.....	8
6 Overall architecture of enhanced uplink DCH	9
6.1 Protocol architecture.....	9
6.2 Transport channel attributes	10
6.3 Basic physical structure.....	10
6.3.1 UL Physical layer model.....	10
6.3.1.1 FDD.....	10
6.3.1.2 TDD	11
6.3.2 DL Physical layer model.....	12
6.3.2.1 FDD.....	12
6.3.2.2 3.84 Mcps and 7.68 Mcps TDD	13
6.3.2.3 1.28 Mcps TDD.....	13
7 MAC architecture	15
7.1 General Principle.....	15
7.1.1 MAC multiplexing.....	15
7.1.2 Reordering entity	15
7.2 MAC architecture – UE side	15
7.2.1 Overall architecture.....	15
7.2.2 Details of MAC-d	17
7.2.3 Details of MAC-c/sh.....	17
7.2.4 Details of MAC-hs.....	17
7.2.5 Details of MAC-es/MAC-e.....	17
7.3 MAC architecture – UTRAN side	19
7.3.1 Overall architecture.....	19
7.3.2 Details of MAC-d	20
7.3.3 Details of MAC-c/sh.....	21
7.3.4 Details of MAC-hs.....	21
7.3.5 Details of MAC-es	21
7.3.6 Details of MAC-e	23
8 HARQ protocol	24
8.1 General principle	24
8.2 Error handling	26
8.3 Signalling	26
8.3.1 Uplink	27
8.3.2 Downlink	27
9 Node B controlled scheduling	27
9.1 General principle	27
9.2 UE scheduling operation	29

9.2.1	Grants from the Serving RLS	29
9.2.1.1	FDD.....	29
9.2.1.2	TDD	30
9.2.2	Grants from the Non-serving RL (FDD only)	30
9.2.3	Reception of Grants from both the Serving RLS and Non-serving RL(s) (FDD only).....	31
9.3	Signalling	31
9.3.1	Uplink	31
9.3.1.1	Scheduling information	31
9.3.1.1.1	Content	31
9.3.1.1.2	Triggers	32
9.3.1.1.3	Transmission and Reliability scheme	32
9.3.1.2	Happy bit of E-DPCCH (FDD only).....	34
9.3.2	Downlink	34
10	Non-scheduled transmissions	34
11	QoS control	35
11.1	General Principle.....	35
11.1.1	QoS configuration principles	36
11.2	TFC and E-TFC selection.....	37
11.3	Setting of Power offset attributes of MAC-d flows.....	38
12	Signalling parameters	38
12.1	Uplink signalling parameters.....	38
12.2	Downlink signalling parameters.....	38
13	Mobility procedures	41
13.1	Change of serving cell and/or serving RLS.....	41
14	Resource management.....	42
14.1	Scheduler control from CRNC to Node B (FDD only)	42
14.2	Node B to CRNC reporting (FDD only)	42
15	Timing Advance and Synchronisation (3.84/7.68 Mcps TDD only)	43
Annex A (informative): Change history		44
History		45

Foreword

This Technical Specification has been produced by the 3rd Generation Partnership Project (3GPP).

The contents of the present document are subject to continuing work within the TSG and may change following formal TSG approval. Should the TSG modify the contents of the present document, it will be re-released by the TSG with an identifying change of release date and an increase in version number as follows:

Version x.y.z

where:

- x the first digit:
 - 1 presented to TSG for information;
 - 2 presented to TSG for approval;
 - 3 or greater indicates TSG approved document under change control.
- y the second digit is incremented for all changes of substance, i.e. technical enhancements, corrections, updates, etc.
- z the third digit is incremented when editorial only changes have been incorporated in the document.

1 Scope

The present document is a technical specification of the overall support of FDD, TDD Enhanced Uplink in UTRA.

2 References

The following documents contain provisions which, through reference in this text, constitute provisions of the present document.

- References are either specific (identified by date of publication, edition number, version number, etc.) or non-specific.
- For a specific reference, subsequent revisions do not apply.
- For a non-specific reference, the latest version applies. In the case of a reference to a 3GPP document (including a GSM document), a non-specific reference implicitly refers to the latest version of that document *in the same Release as the present document*.

- [1] 3GPP TR 25.896: "Feasibility Study for Enhanced Uplink for UTRA FDD".
- [2] 3GPP TR 21.905: "Vocabulary for 3GPP Specifications".
- [3] 3GPP TS 25.214: "Physical layer procedures (FDD)".
- [4] 3GPP TS 25.321: "Medium Access Control (MAC) protocol specification".
- [5] 3GPP TS 25.427: "UTRAN Iub/Iur interface user plane protocol for DCH data streams".
- [6] 3GPP TS 25.212: "Multiplexing and channel coding (FDD)".
- [7] 3GPP TS 25.215: "Physical layer - Measurements (FDD)".
- [8] 3GPP TS 25.306: "UE Radio Access capabilities".
- [9] 3GPP TR 25.804: "Feasibility Study on Uplink Enhancements for UTRA TDD".
- [10] 3GPP TR 25.224: "Physical layer procedures (TDD)".
- [11] 3GPP TS 25.225: "Physical layer – Measurements (TDD)".
- [12] 3GPP TR 25.826: "3.84 Mcps TDD Enhanced Uplink: Physical Layer Aspects".
- [13] 3GPP TS 25.221: "Physical Channels and Mapping of Transport Channels onto Physical Channels (TDD)".
- [14] 3GPP TR 25.827: "1.28 Mcps TDD Enhanced Uplink: Physical Layer Aspects".
- [15] 3GPP TS 25.222: "Multiplexing and channel coding (TDD)".

3 Definitions and abbreviations

3.1 Definitions

For the purposes of the present document, the terms and definitions given in 3GPP TR 21.905 [2] and the following apply:

3.1.1 General

E-DCH: Enhanced DCH, a new dedicated transport channel type or enhancements to an existing dedicated transport channel type

HARQ profile: One HARQ profile consists of a power offset attribute and maximum number of transmissions.

Power offset attribute (FDD): Represents the power offset between E-DPDCH(s) and reference E-DPDCH power level for a given E-TFC. This power offset attribute is set to achieve the required QoS in this MAC-d flow when carried alone in a MAC-e PDU and subsequently in the corresponding CCTrCh of E-DCH type. Details on the mapping on Beta factors can be found in [3]. The reference E-DPDCH power offset is signaled to the UE for one (or several) reference E-TFC(s) (see details in subclause 11.1).

Power offset attribute (TDD): This represents the power offset between E-PUCH and reference E-PUCH power level P_{e-base} for a given E-TFC. This power offset attribute is set to achieve the required QoS in this MAC-d flow when carried alone in a MAC-e PDU and subsequently in the corresponding CCTrCh of E-DCH type. Details on the mapping on Beta factors can be found in [10]. The reference E-PUCH power offset is signaled to the UE for one (or several) reference E-TFC(s).

Primary Absolute Grant: Absolute Grant received with the primary E-RNTI. Note that the primary E-RNTI is the only E-RNTI for TDD.

Serving E-DCH cell: Cell from which the UE receives Absolute Grants from the Node-B scheduler. A UE has one Serving E-DCH cell.

3.1.2 FDD

Active Process: HARQ process for which Scheduling Grants are applicable, i.e. scheduled data can be sent.

Data Description Indicator (DDI): MAC-e header field used to identify the logical channel, MAC-d flow and the size of the MAC-d PDUs concatenated into a MAC-es PDU.

E-DCH: Enhanced DCH, a new dedicated transport channel type or enhancements to an existing dedicated transport channel type.

E-DCH active set: The set of cells which carry the E-DCH for one UE.

E-DCH MAC-d flow: MAC-es PDUs, carrying MAC-d data sharing the same traffic characteristics, and that can be multiplexed with MAC-es PDUs of same or other MAC-d flows on MAC-e.

HARQ profile: One HARQ profile consists of a power offset attribute and maximum number of transmissions.

Inactive Process: HARQ process for which Scheduling Grants are not applicable, i.e. scheduled data cannot be sent.

INACTIVE: Absolute Grant value that can be sent by the serving cell's scheduler on the E-AGCH to deactivate a process or to switch the UE to its secondary E-RNTI.

Power offset attribute: Represents the power offset between E-DPDCH(s) and reference E-DPDCH power level for a given E-TFC. This power offset attribute is set to achieve the required QoS in this MAC-d flow when carried alone in a MAC-e PDU and subsequently in the corresponding CCTrCh of E-DCH type. Details on the mapping on Beta factors can be found in [3]. The reference E-DPDCH power offset is signaled to the UE for one (or several) reference E-TFC(s) (see details in subclause 11.1).

Primary Absolute Grant: Absolute Grant received with the primary E-RNTI.

Secondary Absolute Grant: Absolute Grant received with the secondary E-RNTI.

Serving E-DCH cell: Cell from which the UE receives Absolute Grants from the Node-B scheduler. A UE has one Serving E-DCH cell.

Serving E-DCH RLS or Serving RLS: Set of cells which contains at least the Serving E-DCH cell and from which the UE can receive and combine one Relative Grant. The UE has only one Serving E-DCH RLS.

Non-serving E-DCH RL or Non-serving RL: Cell which belongs to the E-DCH active set but does not belong to the Serving E-DCH RLS and from which the UE can receive one Relative Grant. The UE can have zero, one or several Non-serving E-DCH RL(s).

3.1.3 TDD

<FFS>

3.2 Abbreviations

For the purposes of the present document, the abbreviations given in 3GPP TR 21.905 [2] and the following apply:

AG	Absolute Grant
E-AGCH	E-DCH Absolute Grant Channel
E-DPCCH	E-DCH Dedicated Physical Control Channel (FDD only)
E-DPDCH	E-DCH Dedicated Physical Data Channel (FDD only)
E-HICH	E-DCH HARQ Acknowledgement Indicator Channel
E-PUCH	Enhanced Uplink Physical Channel (TDD only)
E-RGCH	E-DCH Relative Grant Channel
E-RUCCH	E-DCH Random Access Uplink Control Channel (TDD only)
E-RNTI	E-DCH Radio Network Temporary Identifier
E-TFC	E-DCH Transport Format Combination
E-UCCH	E-DCH Uplink Control Channel (TDD only)
HARQ	Hybrid Automatic Repeat Request
HSDPA	High Speed Downlink Packet Access
RG	Relative Grant
RLS	Radio Link Set
RSN	Retransmission Sequence Number
SG	Serving Grant
TSN	Transmission Sequence Number

4 Background and introduction

The technical purpose of the Enhanced Uplink feature is to improve the performance of uplink dedicated transport channels, i.e. to increase capacity and throughput and reduce delay. This is applicable for UTRA TDD and FDD.

The following techniques are part of the Enhanced Uplink feature:

- Node B controlled scheduling: possibility for the Node B to control, within the limits set by the RNC, the set of TFCs from which the UE may choose a suitable TFC.
- Node B controlled physical resource scheduling (TDD only).
- Hybrid ARQ: rapid retransmissions of erroneously received data packets between UE and Node B.
- Higher order modulation (16QAM) (TDD and FDD).
- Intra-frame code hopping (3.84 Mcps and 7.68 Mcps TDD only).
- Shorter TTI: possibility of introducing a 2 ms TTI (FDD only).

5 Requirements

- The Enhanced Uplink feature shall aim at providing significant enhancements in terms of user experience (throughput and delay) and/or capacity. The coverage is an important aspect of the user experience and that it is desirable to allow an operator to provide for consistency of performance across the whole cell area.
- The focus shall be on urban, sub-urban and rural deployment scenarios.

- Full mobility shall be supported, i.e., mobility should be supported for high-speed cases also, but optimisation should be for low-speed to medium-speed scenarios.
- Improvements in the uplink performance of dedicated transport channels are required, with priority given to improving performance with respect to streaming, interactive and background services. Relevant QoS mechanisms shall allow the support of streaming, interactive and background PS services.
- It is highly desirable to keep the Enhanced Uplink as simple as possible. New techniques or group of techniques shall therefore provide significant incremental gain for an acceptable complexity. The value added per feature/technique should be considered in the evaluation. It is also desirable to avoid unnecessary options in the specification of the feature.
- The UE and network complexity shall be minimised for a given level of system performance.
- The impact on current releases in terms of both protocol and hardware perspectives shall be taken into account.
- It shall be possible to introduce the Enhanced Uplink feature in a network which has terminals from Release'99, Release 4 and Release 5. The Enhanced Uplink feature shall enable to achieve significant improvements in overall system performance when operated together with HSDPA. Emphasis shall be given on the potential impact the new feature may have on the downlink capacity. Likewise it shall be possible to deploy the Enhanced Uplink feature without any dependency on the deployment of the HSDPA feature. However, a terminal supporting the Enhanced Uplink feature shall support HSDPA.
- Commonality between TDD and FDD E-DCH features is desired as long as system performance is not impaired.
- For TDD, it shall be possible to run enhanced uplink in parallel with HS-DSCH without associated (or otherwise) uplink or downlink dedicated physical channels.

6 Overall architecture of enhanced uplink DCH

6.1 Protocol architecture

The following modifications to the existing nodes are needed to support enhanced uplink DCH:

UE

A new MAC entity (MAC-es/MAC-e) is added in the UE below MAC-d. MAC-es/MAC-e in the UE handles HARQ retransmissions, scheduling and MAC-e multiplexing, E-DCH TFC selection.

Node B

A new MAC entity (MAC-e) is added in the Node B to handle HARQ retransmissions, scheduling and MAC-e demultiplexing.

S-RNC

A new MAC entity (MAC-es) is added in the SRNC to provide in-sequence delivery (reordering) and to handle combining of data from different Node Bs in case of soft handover.

The resulting protocol architecture is shown in Figure 6.1-1:

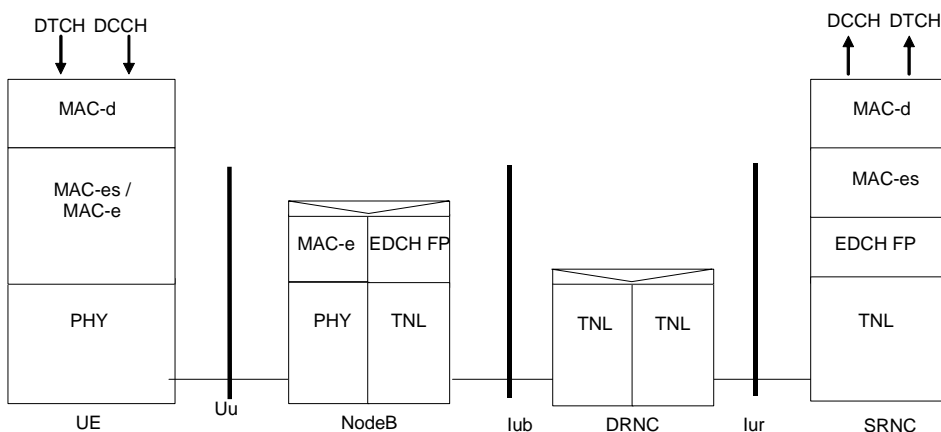

Figure 6.1-1: Protocol Architecture of E-DCH

6.2 Transport channel attributes

The E-DCH transport channel has the following characteristics:

- E-DCH and DCH use separate CCTrCHs
- There is only one CCTrCH of E-DCH type per UE;
- There is only one E-DCH per CCTrCH of E-DCH type;
- There is only one transport block per TTI;
- Both 2 ms TTI and 10 ms TTI are supported by FDD E-DCH. Only a 5 ms TTI is supported by 1.28 Mcps TDD E-DCH. Only a 10 ms TTI is supported by 3.84 Mcps and 7.68 Mcps TDD E-DCH.
- For FDD:
 - The support of 10 ms TTI is mandatory for all UEs. The support of the 2 ms TTI by the UE is only mandatory for certain UE categories. Switching between the two TTIs can be performed by UTRAN through L3 signalling;
- For all UE categories, the uplink DCH capability is limited to 64kbps when E-DCH is configured for the radio link (see [8]).
- CRC size = 24 bits;
- channel coding = turbo 1/3;
- redundancy version: always use RV index 0, or use table defined in [6] for FDD and in [15] for TDD.

6.3 Basic physical structure

6.3.1 UL Physical layer model

6.3.1.1 FDD

E-DCH model with DCH and HS-DSCH

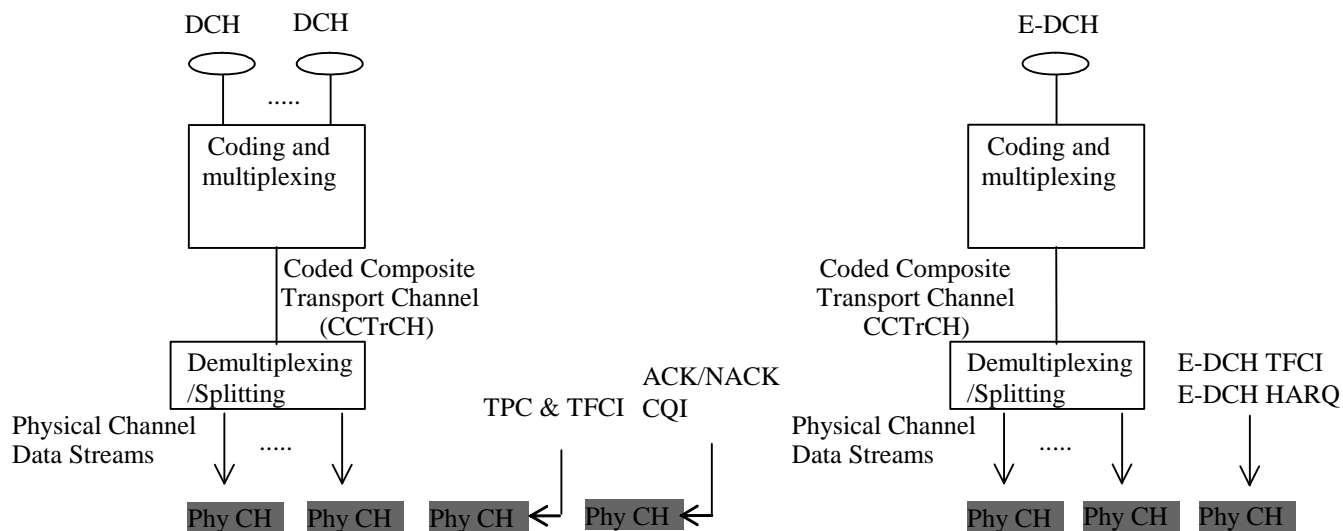

Figure 6.3.1.1-1: Model of the UE's Uplink physical layer

There is only one E-DCH per CCTrCh of E-DCH type.

For both 2 ms and 10 ms TTI, the information carried on the E-DPCCH consists of 10 bits in total: the E-TFCI (7 bits), the RSN (2 bits) and the 'happy' bit (see in subclause 9.3.1.2).

The E-DPCCH is sent with a power offset relative to the DPCCH. The power offset is signalled by RRC.

6.3.1.2 TDD

E-DCH model with HS-DSCH

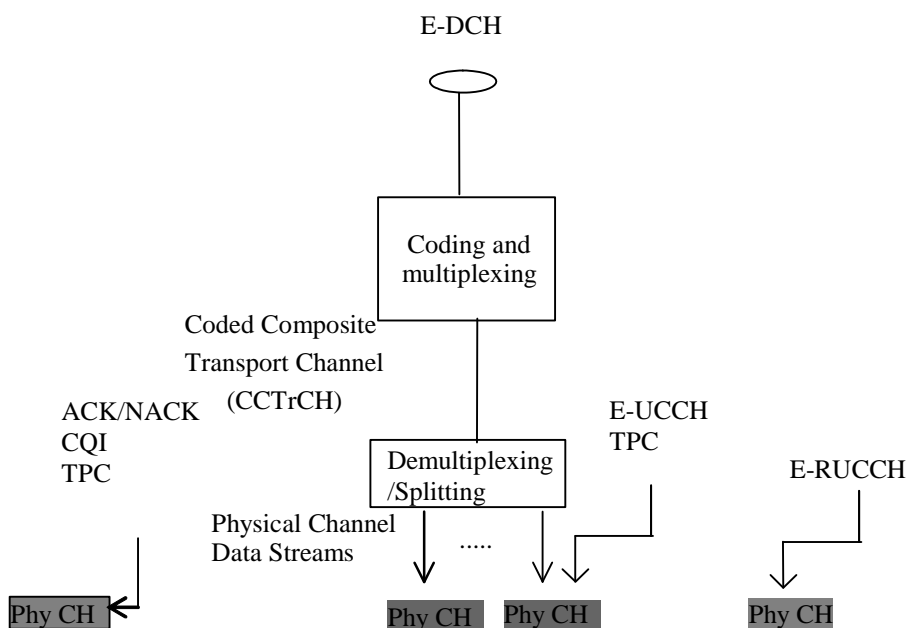

Figure 6.3.1.2-1: Model of the UE's Uplink physical layer

E-DCH model with DCH and HS-DSCH

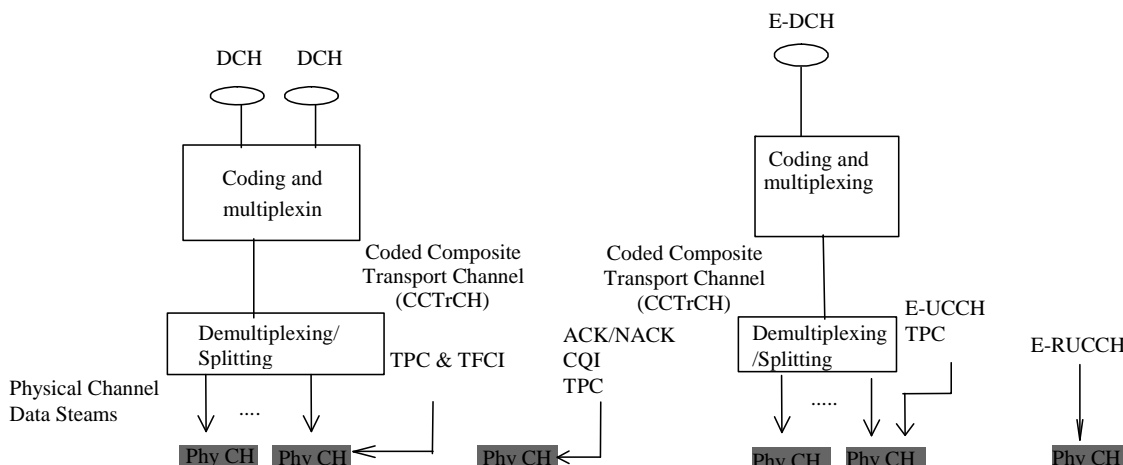

Figure 6.3.1.2-2: Model of the UE's Uplink physical layer (E-DCH with DCH and HS-DSCH)

6.3.2 DL Physical layer model

6.3.2.1 FDD

E-DCH model with DCH and HS-DSCH

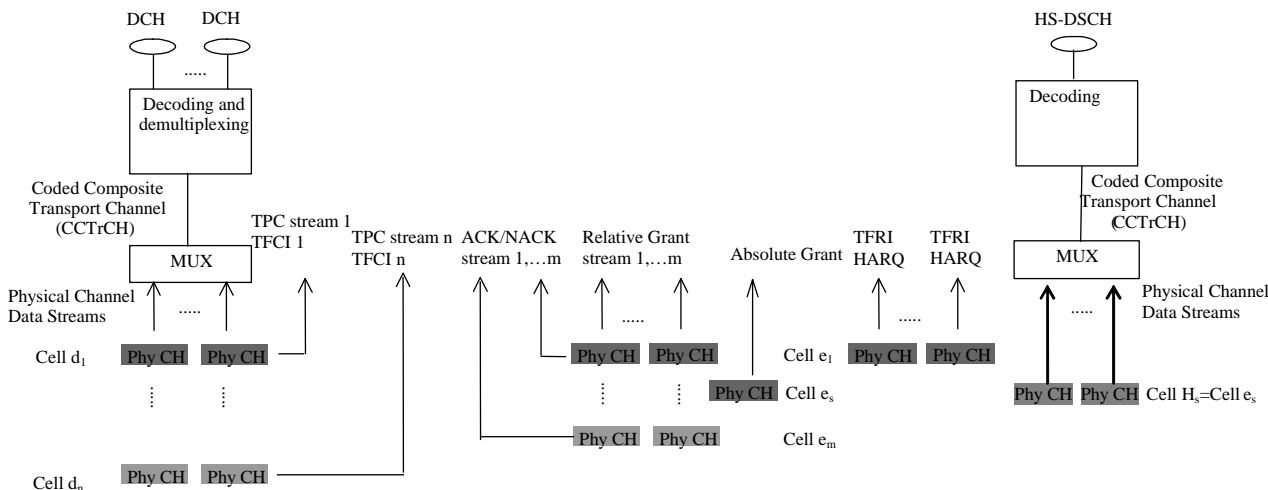

Figure 6.3.2.1-1: Model of the UE's Downlink physical layer. HS-DSCH serving cell is cell H_s in this figure

The DPCH active set contains cells d_1, \dots, d_n .

The E-DCH active set can be identical or a subset of the DCH active set. The E-DCH active set is decided by the SRNC.

The E-DCH ACK/NACKs are transmitted by each cell of the E-DCH active set on a physical channel called E-HICH. The E-HICHs of the cells belonging to the same RLS (same MAC-e entity i.e. same Node B) shall have the same content and modulation and be combined by the UE.

NOTE: The set of cells transmitting identical ACK/NACK information is the same as the set of cells sending identical TPC bits (excluding the cells which are not in the E-DCH active set).

The E-DCH Absolute Grant is transmitted by a single cell, the Serving E-DCH cell (Cell e_s on figure 6.3.2-1) on a physical channel called E-AGCH.

The Serving E-DCH cell and the HS-DSCH Serving cell shall be identical. The RRC signalling is independent for both.

The E-DCH Relative Grants can be transmitted by each cell of the E-DCH active set on a physical channel called E-RGCH. The E-RGCHs of the cells belonging to the serving RLS shall have the same content and be combined by the UE. The E-RGCHs of the cells not belonging to the serving E-DCH RLS are cell specific and cannot be combined: the Non Serving RLS. Both configurations are signalled from the SRNC to the UE in RRC: optionally one E-RGCH configuration per cell for the Serving E-DCH RLS (containing the Serving E-DCH cell) and optionally one E-RGCH configuration per Non-serving E-DCH RL.

The ACK/NACKs received from UTRAN after combining (see Note above), the Absolute Grant information received from UTRAN (from the Serving E-DCH cell), and the Relative Grants received from UTRAN (optionally one from the Serving E-DCH RLS after combining, and optionally one from each Non-serving RL), are all sent to MAC by L1.

6.3.2.2 3.84 Mcps and 7.68 Mcps TDD

E-DCH model with HS-DSCH

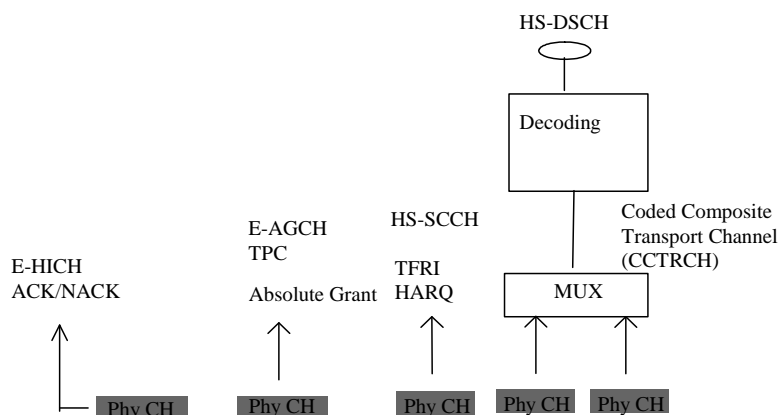

Figure 6.3.2.2-1: Model of the UE's Downlink physical layer.

6.3.2.3 1.28 Mcps TDD

E-DCH model with HS-DSCH

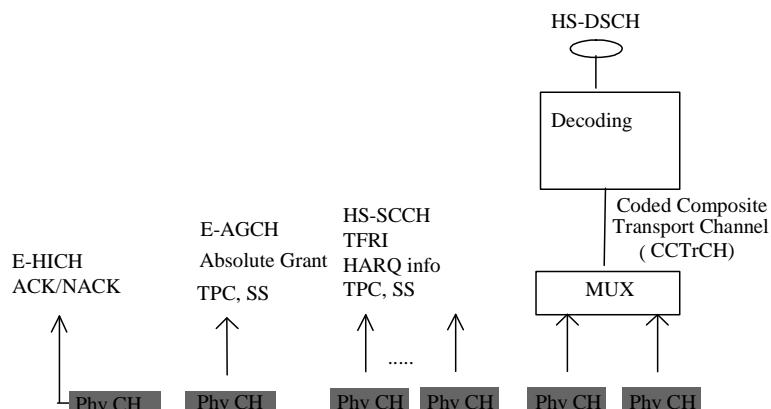

Figure 6.3.2.3-1: Model of the UE's Downlink physical layer (E-DCH model with HS-DSCH).

E-DCH model with DCH and HS-DSCH

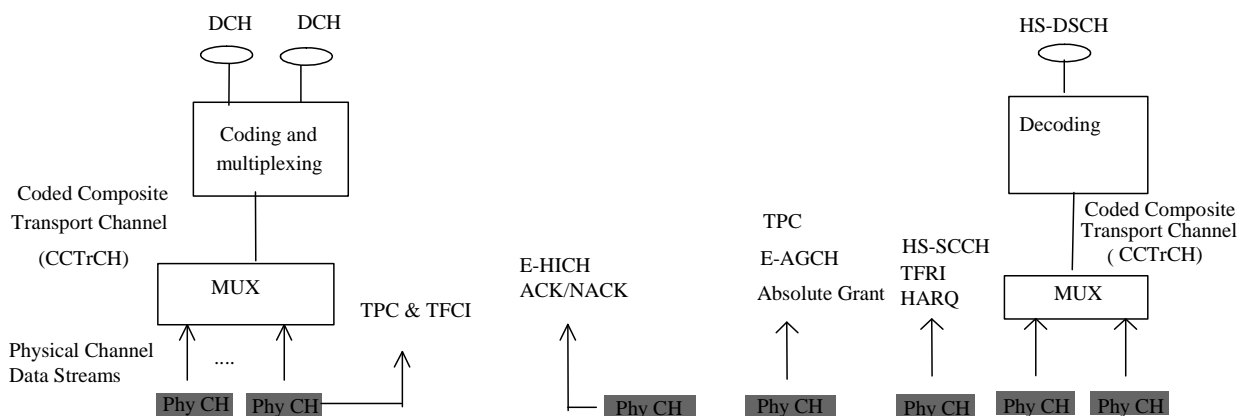

Figure 6.3.2.3-2: Model of the UE's Downlink physical layer (E-DCH with DCH and HS-DSCH).

The ACK/NACKs received from UTRAN are all sent to MAC by L1.

The UE monitors a set of E-AGCH channels in every frame (E-AGCH₁, E-AGCH₂,, E-AGCH_{max}). It receives an Absolute Grant if it decodes its E-RNTI on one of these E-AGCHs.

E-DCH ACK/NACKs are transmitted on a physical channel called the E-HICH. A single E-HICH per frame shall carry the ACK/NACK for all of the UE's requiring H-ARQ acknowledgement in that frame.

7 MAC architecture

7.1 General Principle

7.1.1 MAC multiplexing

The E-DCH MAC multiplexing has the following characteristics:

- Logical channel multiplexing is supported at MAC-e level;
- Multiple MAC-d flows can be configured for one UE;
- The multiplexing of different MAC-d flows within the same MAC-e PDU is supported. But not all the combinations may be allowed for one UE. The allowed combinations are under the control of the SRNC (see in clause 11);
- There can be up to 8 MAC-d flows for a UE;
- Up to 15 logical channels can be multiplexed on an E-DCH transport channel.

7.1.2 Reordering entity

The re-ordering entity is part of a separate MAC sub-layer, MAC-es, in the SRNC. Data coming from different MAC-d flows are reordered in different reordering queues. There is one reordering queue per logical channel.

The reordering is based on a specific TSN included in the MAC-es PDU for FDD and on Node-B tagging with a (CFN, subframe number). For each MAC-es PDU, the SRNC receives the TSN originating from the UE, for FDD as well as the CFN and subframe number originating from the Node-B to perform the re-ordering. Additional mechanisms (e.g. timer-based and/or window-based) are up to SRNC implementation and will not be standardised. Furthermore, the reordering entity detects and removes duplicated received MAC-es PDUs.

7.2 MAC architecture – UE side

7.2.1 Overall architecture

The overall UE MAC architecture, which is shown in Figure 7.2.1-1, includes a new MAC-es/MAC-e entity which controls access to the E-DCH. A new connection from MAC-d to MAC-es/MAC-e is added to the architecture, as well as a connection between MAC-es/MAC-e and the MAC Control SAP.

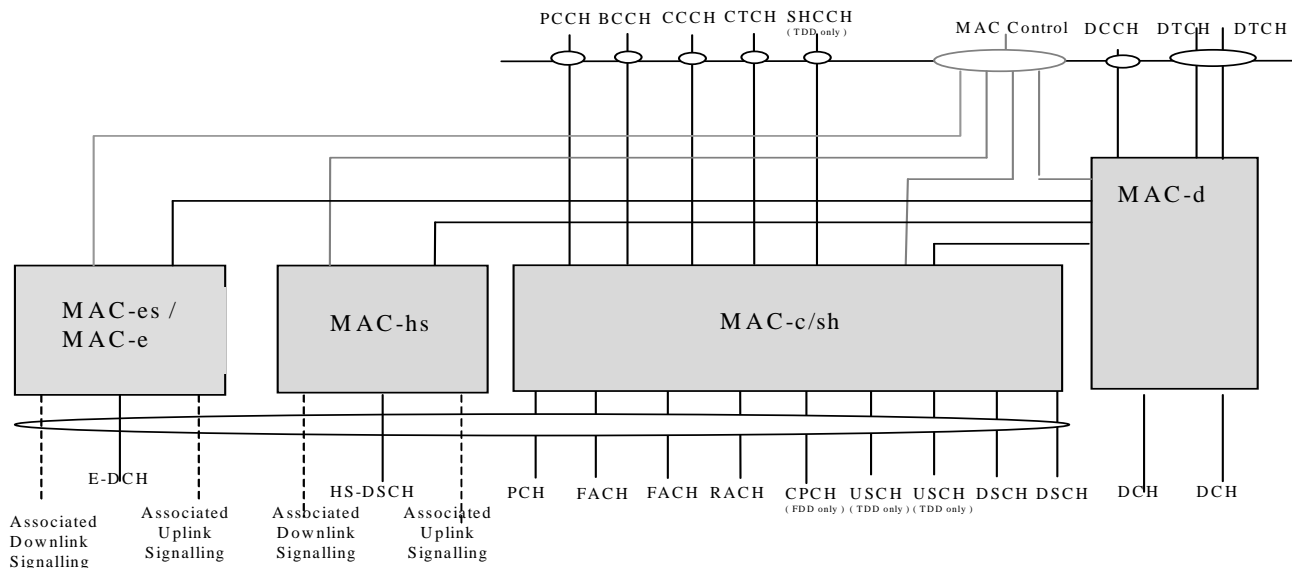

Figure 7.2.1-1: UE side MAC architecture

As shown in Figure 7.2.1-2, a RLC PDU enters MAC-d on a logical channel. The MAC-d C/T multiplexing is bypassed. In the MAC-e header, the DDI (Data Description Indicator) field (6 bits) identifies logical channel, MAC-d flow and MAC-d PDU size. A mapping table is signalled over RRC, to allow the UE to set DDI values. The N field (fixed size of 6 bits) indicates the number of consecutive MAC-d PDUs corresponding to the same DDI value. A special value of the DDI field indicates that no more data is contained in the remaining part of the MAC-e PDU. The TSN field (6 bits) provides the transmission sequence number on the E-DCH. The MAC-e PDU is forwarded to a Hybrid ARQ entity, which then forwards the MAC-e PDU to layer 1 for transmission in one TTI.

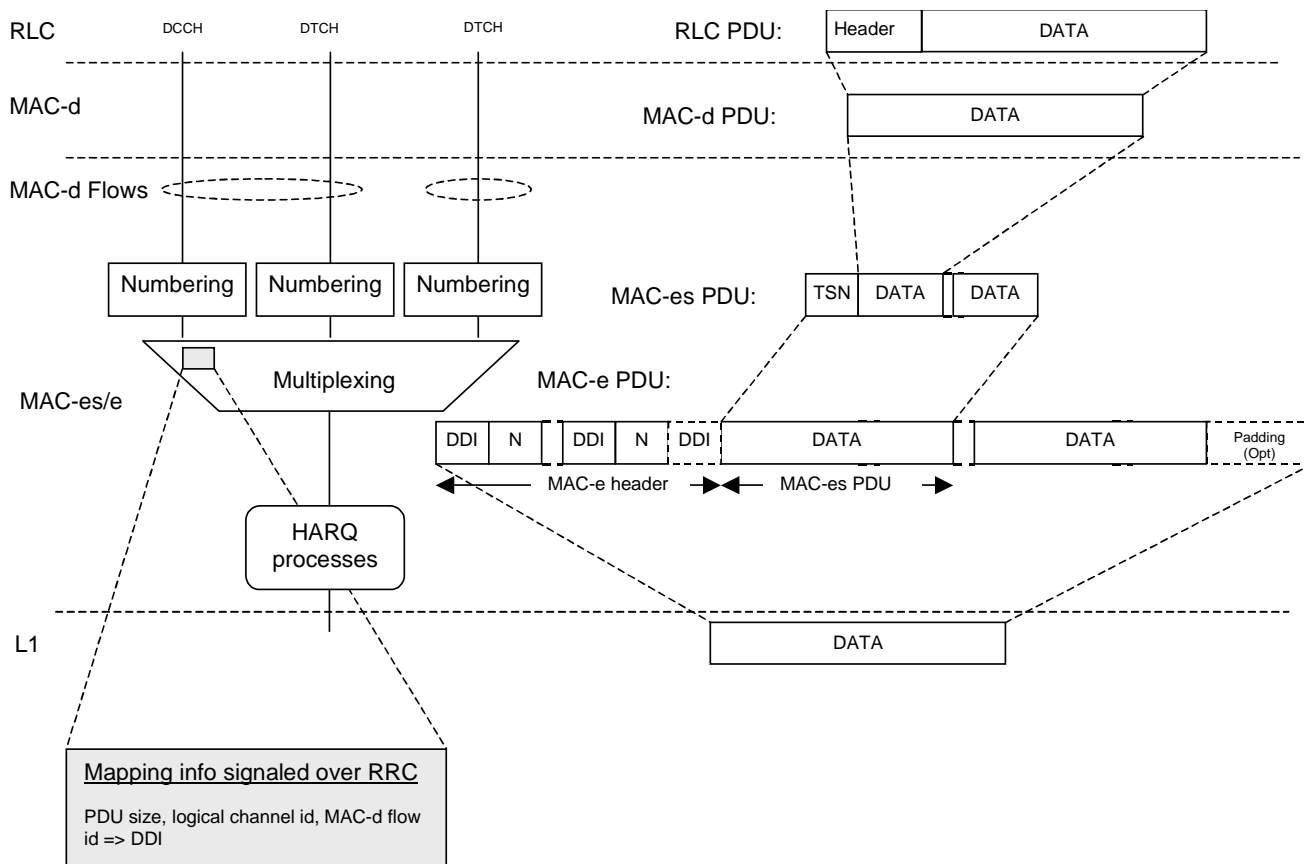

Figure 7.2.1-2: Simplified architecture showing MAC inter-working in UE. The left part shows the functional split while the right part shows PDU construction.

7.2.2 Details of MAC-d

For support of E-DCH a new connection to MAC-es is added.

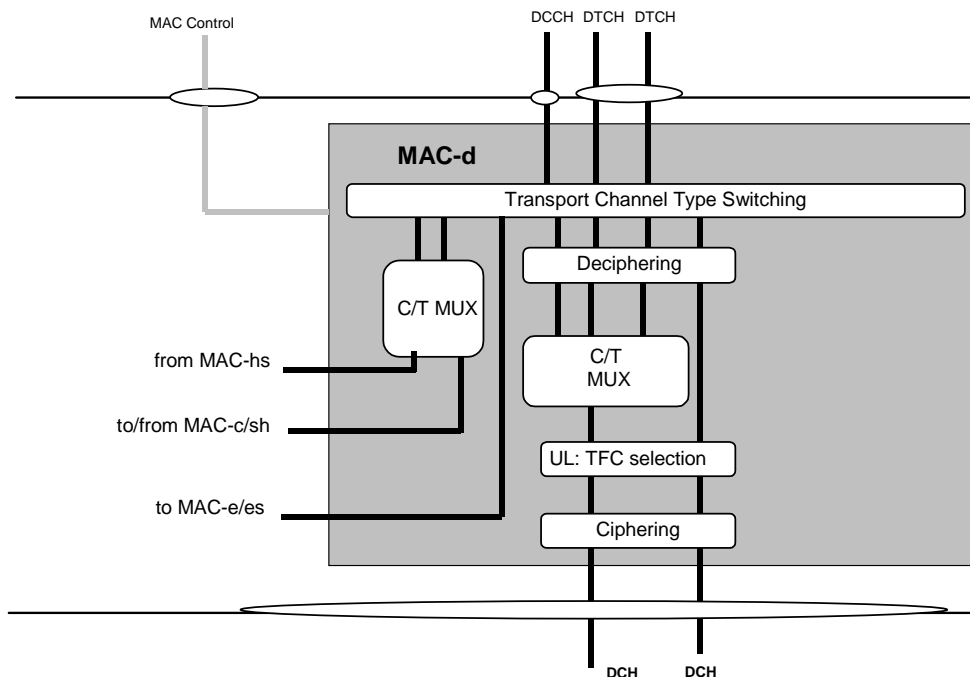

Figure 7.2.2-1: UE side MAC architecture/ MAC-d details

7.2.3 Details of MAC-c/sh

The support of E-DCH implies no change to the UE MAC-c/sh entity.

7.2.4 Details of MAC-hs

The support of E-DCH implies no change to the UE MAC-hs entity.

7.2.5 Details of MAC-es/MAC-e

The MAC-es/e handles the E-DCH specific functions. The split between MAC-e and MAC-es in the UE is not detailed. In the model below the MAC-e/es comprises the following entities:

- HARQ:
The HARQ entity is responsible for handling the MAC functions relating to the HARQ protocol. It is responsible for storing MAC-e payloads and re-transmitting them. The detailed configuration of the hybrid ARQ protocol is provided by RRC over the MAC-Control SAP. The HARQ entity provides the E-TFC, the retransmission sequence number (RSN), and the power offset to be used by L1. Redundancy version (RV) of the HARQ transmission is derived by L1 from RSN, CFN and in case of 2 ms TTI from the sub-frame number. RRC signalling can also configure the HARQ entity to use RV=0 for every transmission.
- Multiplexing and TSN setting:
The multiplexing and TSN setting entity is responsible for concatenating multiple MAC-d PDUs into MAC-es PDUs, and to multiplex one or multiple MAC-es PDUs into a single MAC-e PDU, to be transmitted in the next TTI, as instructed by the E-TFC selection function. It is also responsible for managing and setting the TSN per logical channel for each MAC-es PDU.
- E-TFC selection:
This entity is responsible for E-TFC selection according to the scheduling information (Relative Grants and Absolute Grants) received from UTRAN via L1, and for arbitration among the different flows mapped on the

E-DCH. The detailed configuration of the E-TFC entity is provided by RRC over the MAC-Control SAP. The E-TFC selection function controls the multiplexing function.

- Scheduling Access Control (TDD only):

The Scheduling Access Control entity is responsible for routing associated uplink signalling via E-UCCH and MAC-e PDU (in the case that E-DCH resources are assigned) or via E-RUCCH (in the case that no E-DCH resources are assigned). It is also responsible for obtaining and formatting the appropriate information to be carried on E-UCCH/E-RUCCH.

NOTE: HARQ process ID and RSN are carried on E-UCCH.

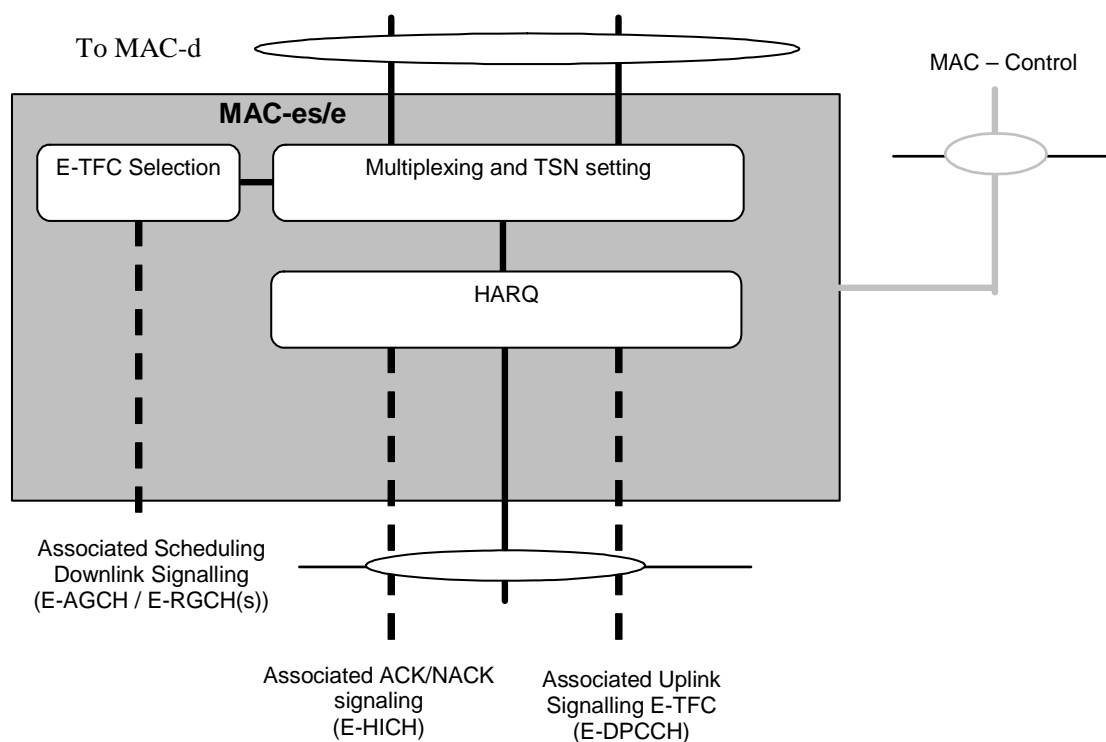

Figure 7.2.5-1: UE side MAC architecture / MAC-es/e details (FDD)

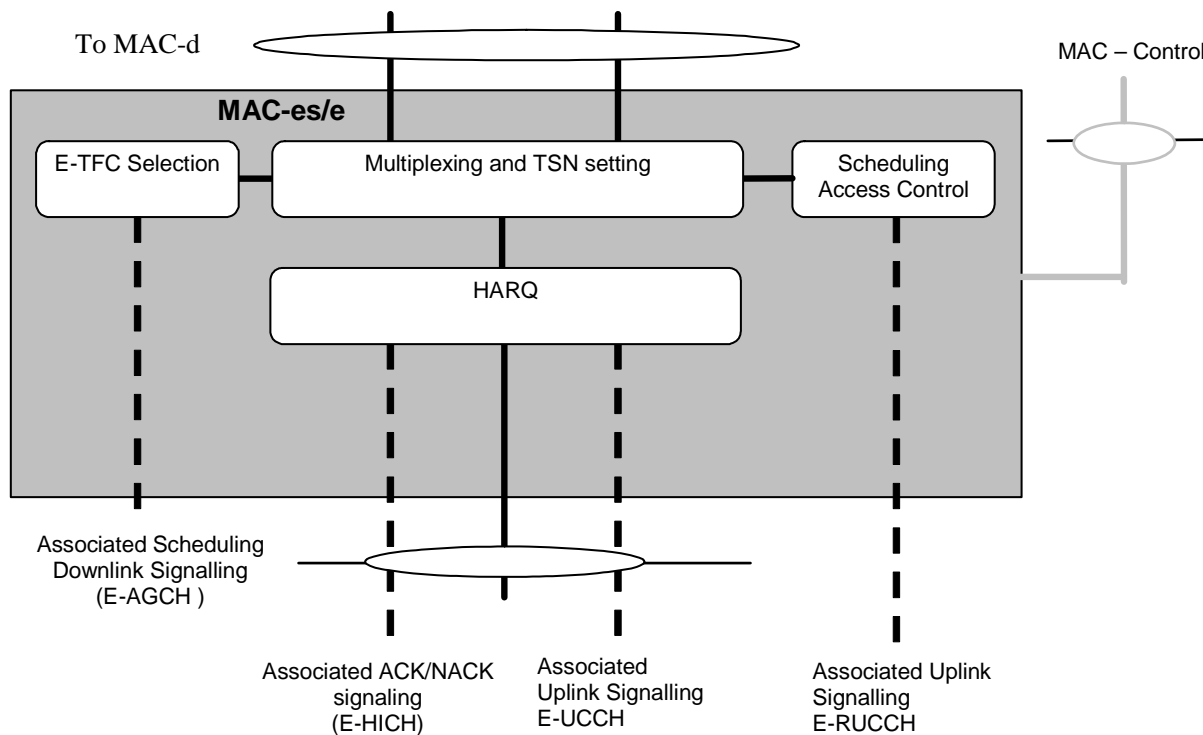

Figure 7.2.5-2: UE side MAC architecture / MAC-es/e details (TDD)

7.3 MAC architecture – UTRAN side

7.3.1 Overall architecture

The overall UTRAN MAC architecture, which is shown in Figure 7.3.1-1, includes a new MAC-e entity and a new MAC-es entity. For each UE that uses E-DCH, one MAC-e entity per Node-B and one MAC-es entity in the SRNC are configured. MAC-e, located in the Node B, controls access to the E-DCH and is connected to MAC-es, located in the SRNC. MAC-es is further connected to MAC-d. For control information, new connections are defined between MAC-e and a MAC Control SAP in the Node B, and between MAC-es and the MAC Control SAP in the SRNC.

There is one Iub transport bearer per MAC-d flow (i.e. MAC-es PDUs carrying MAC-d PDUs from the same MAC-d flow).

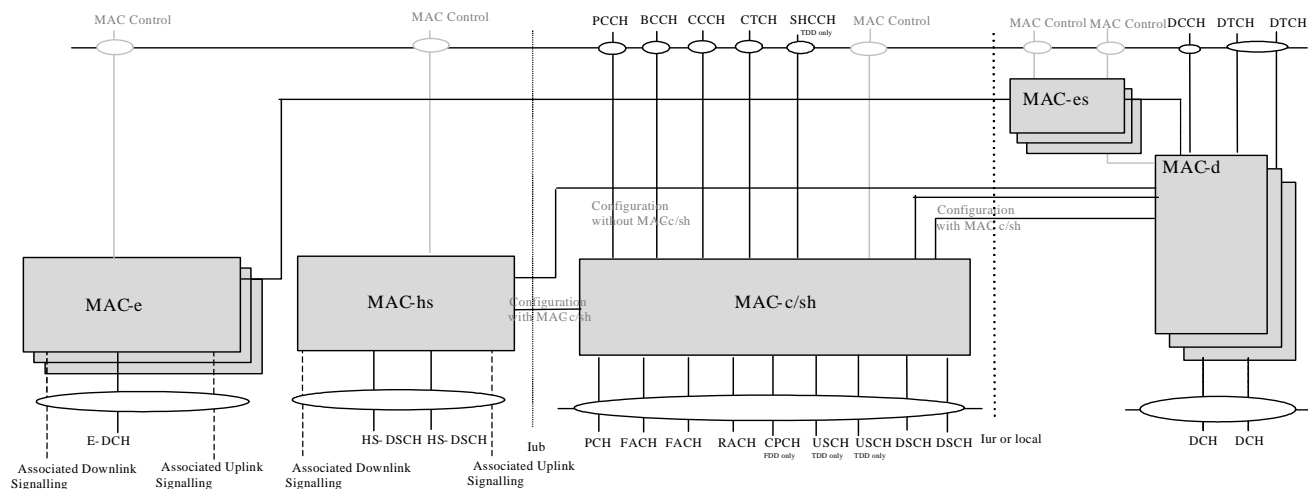

Figure 7.3.1-1: UTRAN side MAC architecture (SHO not shown)

As shown in Figure 7.3.1-2, a MAC-e PDU enters MAC from layer 1. After Hybrid ARQ handling, the MAC-e PDU is demultiplexed to form MAC-es PDUs aimed for one or more MAC-d flows. The mapping between the DDI (Data Description Indicator) fields (6 bits) and the MAC-d flow and MAC-d PDU size is provided to the Node B by the SRNC. The mapping of the MAC-d flow into its Iub bearer is defined by the SRNC. A special value of the DDI field indicates that no more data is contained in the remaining part of the MAC-e PDU. The MAC-es PDUs are sent over Iub to MAC-es, where they are distributed on the reordering queue of each logical channel. After re-ordering, the in-sequence data units are disassembled. The resulting MAC-d PDUs are forwarded to MAC-d and RLC.

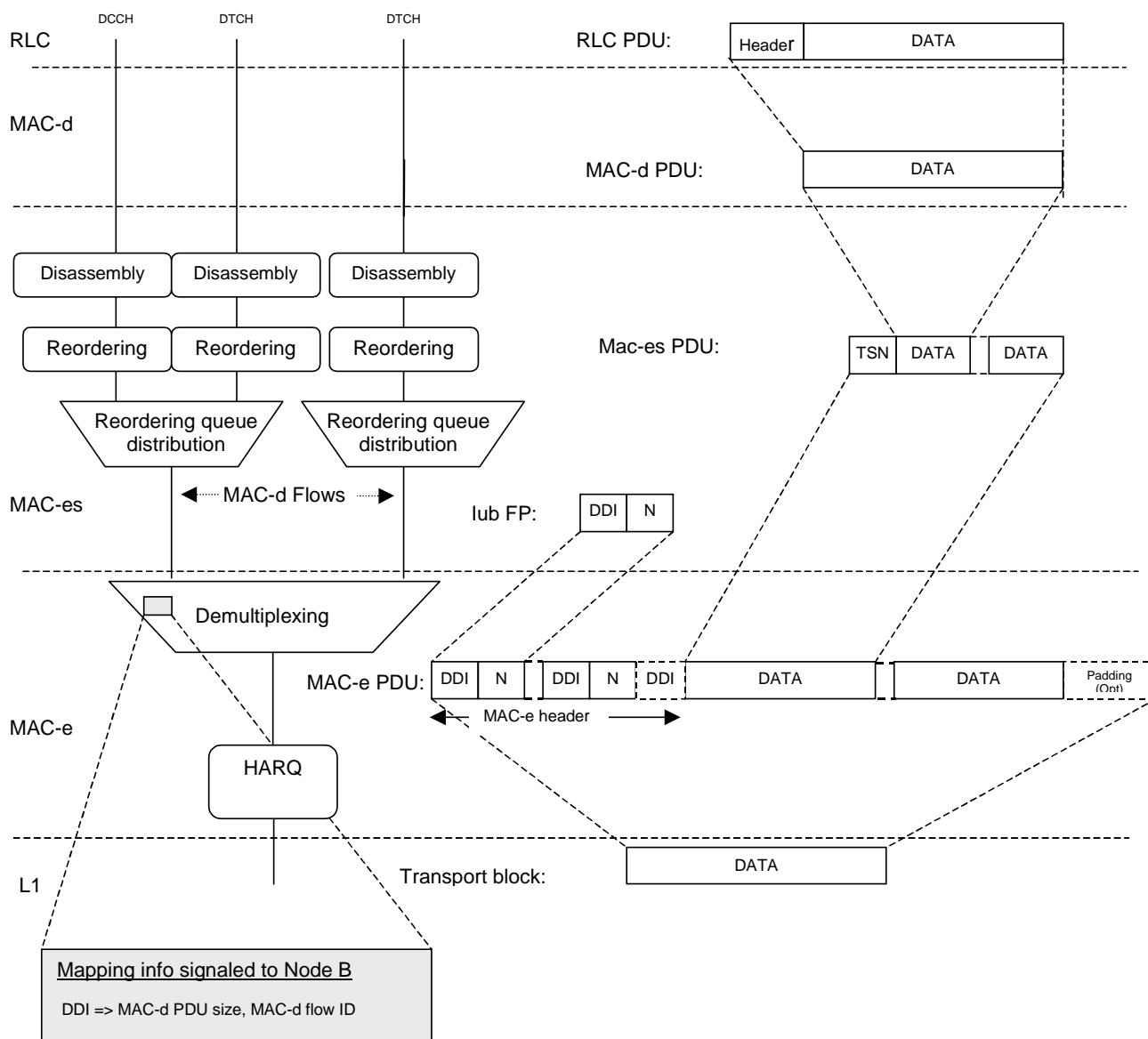

Figure 7.3.1-2: Simplified architecture showing MAC inter-working in UTRAN. The left part shows the functional split while the right part shows PDU decomposition.

7.3.2 Details of MAC-d

For support of E-DCH a new connection to MAC-es is added.

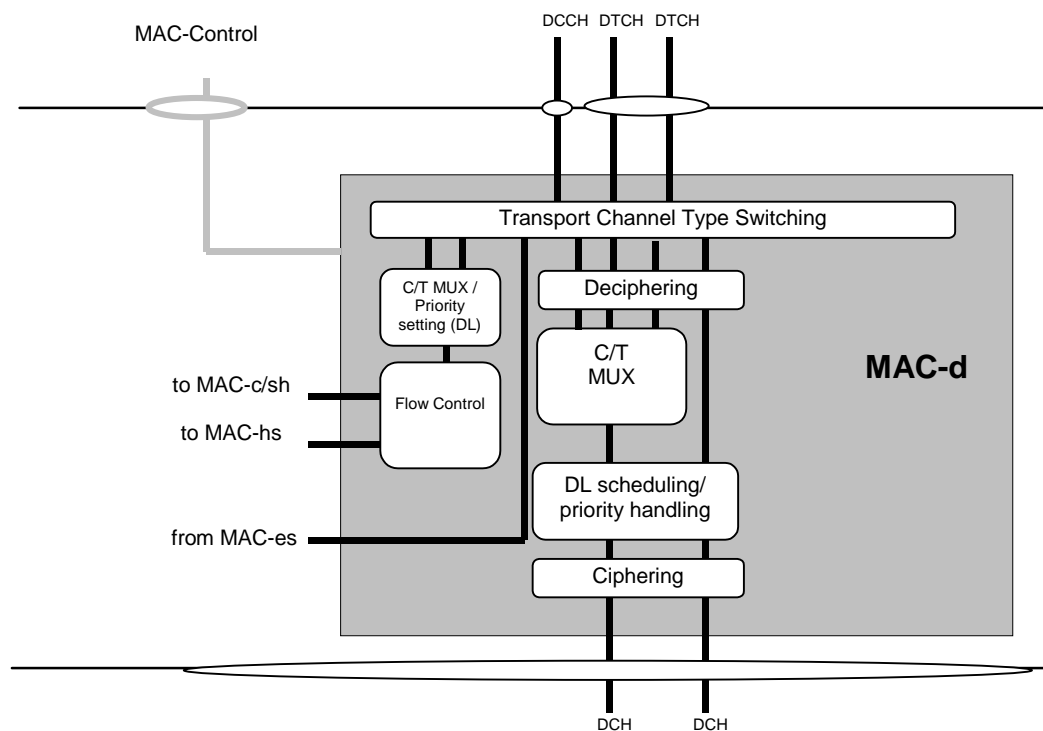

Figure 7.3.2-1: UTRAN side MAC architecture / MAC-d details

7.3.3 Details of MAC-c/sh

The support of E-DCH implies no change to the UTRAN MAC-c/sh entity

7.3.4 Details of MAC-hs

The support of E-DCH implies no change to the UTRAN MAC-hs entity

7.3.5 Details of MAC-es

For each UE, there is one MAC-es entity in the SRNC. The MAC-es sublayer handles E-DCH specific functionality, which is not covered in the MAC-e entity in Node B. In the model below, the MAC-es comprises the following entities:

- Reordering Queue Distribution:
The reordering queue distribution function routes the MAC-es PDUs to the correct reordering buffer based on the SRNC configuration.
- Reordering:
This function reorders received MAC-es PDUs according to the received TSN and for FDD Node-B tagging i.e. CFN, subframe number. MAC-es PDUs with consecutive TSNs are delivered to the disassembly function upon reception. Mechanisms for reordering mac-es PDUs are left to the implementation. The number of reordering entities is controlled by the SRNC. There is one Reordering Queue per logical channel.
- Macro diversity selection (FDD only):
The function is performed in the MAC-es, in case of soft handover with multiple Node-Bs (The soft combining for all the cells of a Node-B takes place in the Node-B). This means that the reordering function receives MAC-es PDUs from each Node-B in the E-DCH active set. The exact implementation is not specified. However the model below is based on one Reordering Queue Distribution entity receiving all the MAC-d flow from all the Node-Bs, and one MAC-es entity per UE.
- Disassembly:
The disassembly function is responsible for disassembly of MAC-es PDUs. When a MAC-es PDU is disassembled the MAC-es header is removed, the MAC-d PDU's are extracted and delivered to MAC-d.

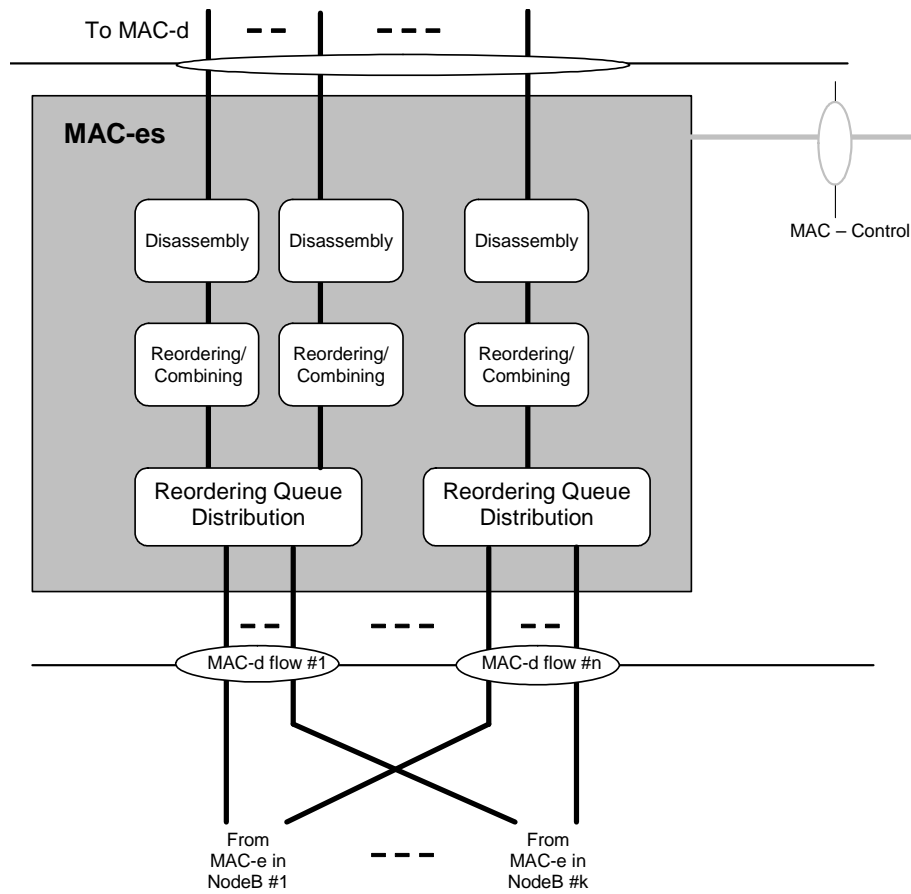

Figure 7.3.5-1: UTRAN side MAC architecture / MAC-es details (SHO case, FDD only)

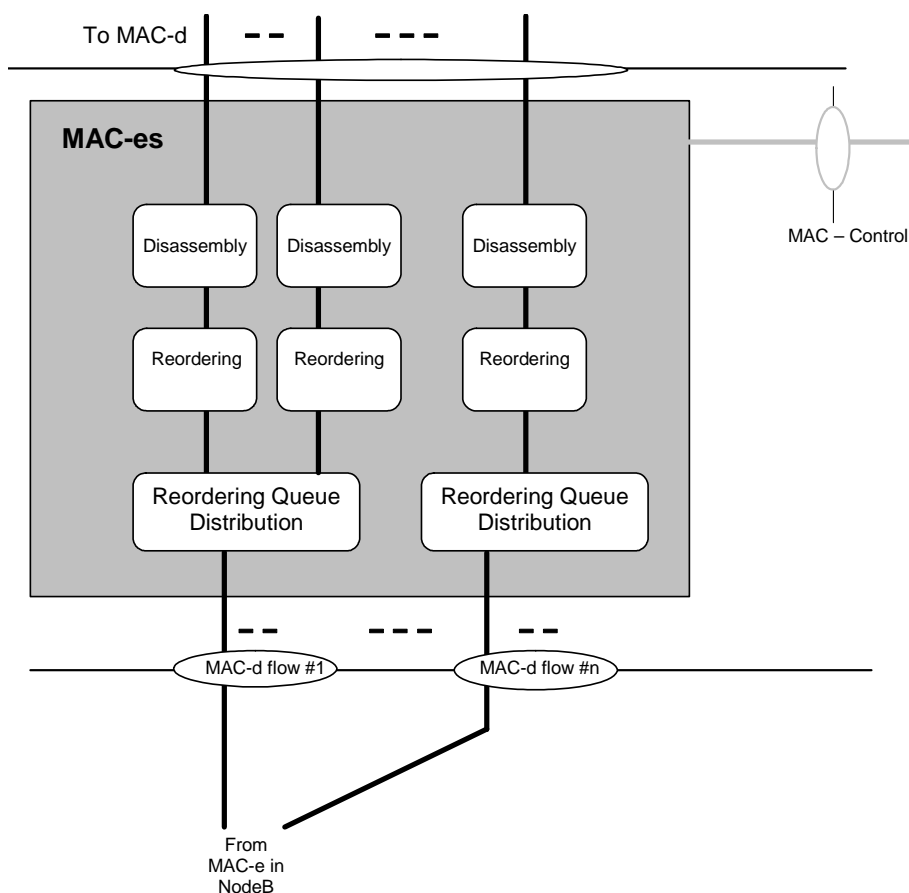

Figure 7.3.5-2: UTRAN side MAC architecture / MAC-es details (TDD only)

7.3.6 Details of MAC-e

There is one MAC-e entity in the NodeB for each UE and one E-DCH scheduler function in the Node-B. The MAC-e and E-DCH scheduler handle Enhanced Uplink specific functions in the NodeB. In the model below, the MAC-e and E-DCH scheduler comprises the following entities:

- E-DCH Scheduling:
This function manages E-DCH cell resources between UEs. Based on scheduling requests, Scheduling Grants are determined and transmitted. The general principles of the E-DCH scheduling are described in subclause 9.1 below. However implementation is not specified (i.e. depends on RRM strategy).
- E-DCH Control:
The E-DCH control entity is responsible for reception of scheduling requests and transmission of Scheduling Grants. The general principles of the E-DCH scheduling are described in subclause 9.1 below.
- De-multiplexing:
This function provides de-multiplexing of MAC-e PDUs. MAC-es PDUs are forwarded to the associated MAC-d flow.
- HARQ:
One HARQ entity is capable of supporting multiple instances (HARQ processes) of stop and wait HARQ protocols. Each process is responsible for generating ACKs or NACKs indicating delivery status of E-DCH transmissions. The HARQ entity handles all tasks that are required for the HARQ protocol.

The associated signalling shown in the figure illustrates the exchange of information between layer 1 and layer 2 provided by primitives.

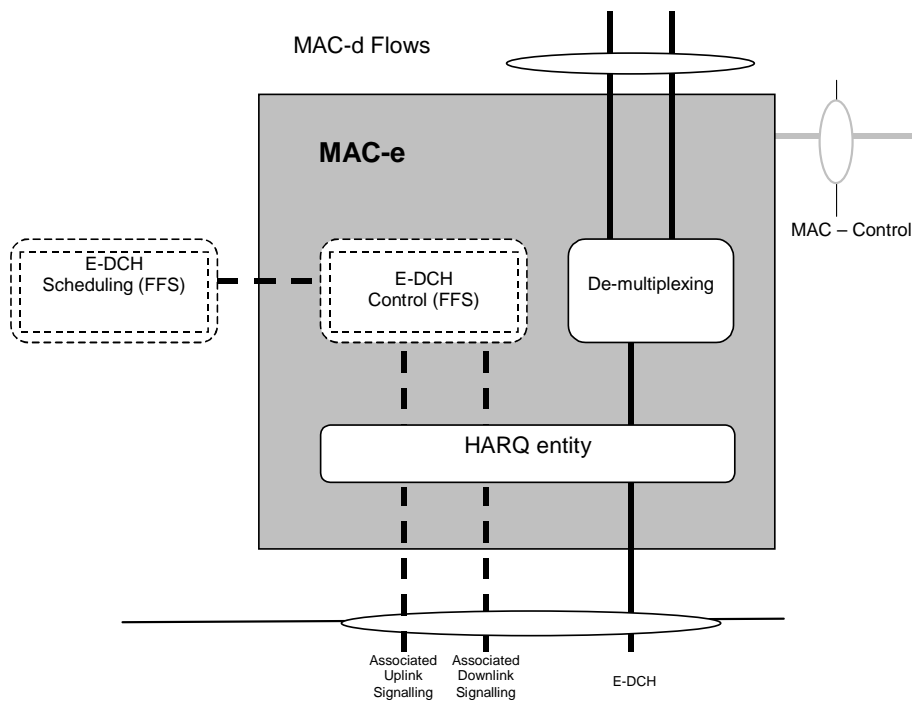

Figure 7.3.6-1: UTRAN side MAC architecture / MAC-e details (FDD only)

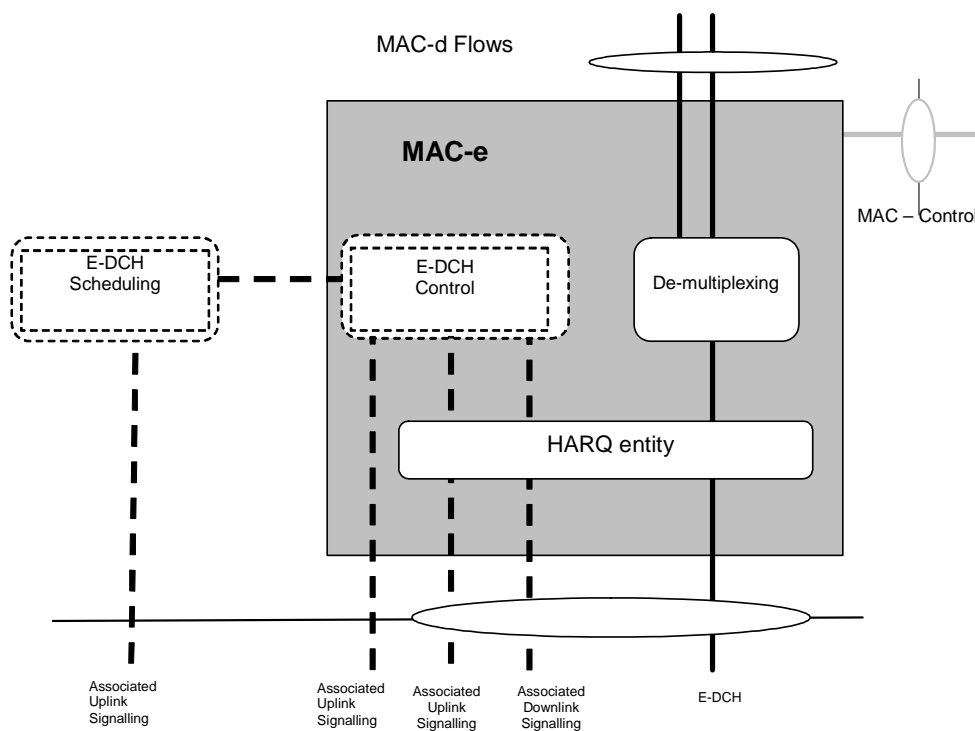

Figure 7.3.6-2: UTRAN side MAC architecture / MAC-e details (TDD only)

8 HARQ protocol

8.1 General principle

The HARQ protocol has the following characteristics:

- Stop and wait HARQ is used;
- The HARQ is based on synchronous downlink ACK/NACKs;
- There will be an upper limit to the number of retransmissions. The UE decides on a maximum number of transmissions for a MAC-e PDU based on the maximum number of transmissions attribute (see subclause 11.1.1), according to the following principles:
 - The UE selects the highest 'maximum number of transmissions' among all the considered HARQ profiles associated to the MAC-d flows in the MAC-e PDU.
- Pre-emption will not be supported by E-DCH (ongoing re-transmissions will not be pre-empted by higher priority data for a particular process);
- Incremental redundancy shall be supported by the specifications with Chase combining as a subcase:
 - The first transmission shall be self decodable;
 - The UTRAN configures the UE to either use the same incremental redundancy version (RV) for all transmissions, or to set the RV according to set of rules based on E-TFC, Retransmission Sequence Number (RSN) and the transmission timing;

For FDD:

- The HARQ is based on synchronous retransmissions in the uplink:
 - The number of processes depends on the TTI: 8 processes for the 2ms TTI and 4 processes for the 10ms TTI. For both scheduled and non-scheduled transmission for a given UE, it is possible to restrict the transmission to specific processes for the 2ms E-DCH TTI;
 - In case of TTI reconfiguration, the MAC-e HARQ processes are flushed and no special mechanism is defined to lower SDU losses.
- Intra Node B macro-diversity and Inter Node B macro-diversity should be supported for the E-DCH with HARQ;
- There shall be no need, from the HARQ operation point of view, to reconfigure the Node B from upper layers when moving in or out of soft handover situations.

For TDD:

- There are 8 HARQ processes (4 for scheduled transmissions and 4 for non-scheduled transmissions);
- If an Absolute Grant is received in Frame (i) then the UE transmits a data block in Frame (i+T1)
- For a data block transmitted in Frame (i+T1) the UE receives an ACK/NACK in Frame (i+T1+T2), see Figure 8.1, E-HICH is decoded on the basis of slots and channelisation codes assigned via the Grant [13].
- If NACK is received in Frame (i+T1+T2) then the UE cannot retransmit any data block previously transmitted in Frame (i+T1) (now stored for potential retransmission) until it receives an Absolute Grant.
- The interval T3 between reception of NACK and reception of a Grant for a subsequent retransmission is variable and depends on a Node B scheduling decision.
- If an ACK is received in Frame (i+T1+T2) then data blocks previously transmitted in Frame (i+T1) (stored for potential retransmission) are discarded and the HARQ process identity associated with the previously transmitted data blocks can now be reassigned.
- The number of HARQ processes is a function of T1 and T2

Where:

T1 is the difference between the index of the frame in which Absolute Grant is received and the index of the frame in which the UE shall transmit/retransmit data, e.g. if an Absolute Grant is received in Frame (i) and data shall be transmitted/retransmitted in Frame (i+3) then T1 = 3.

T_2 is the difference between the index of the frame in which a data block is transmitted/retransmitted and the index of the frame in which ACK/NACK is received for that data block, e.g. if a data block is sent in Frame (k) and ACK/NACK is received in Frame ($k+2$) then $T_2=2$.

The values of T_1 and T_2 are derived from the physical layer timings given in [13].

NOTE: For 1.28 Mcps TDD, 5 ms subframe is used instead of 10 ms frame in the physical layer timings.

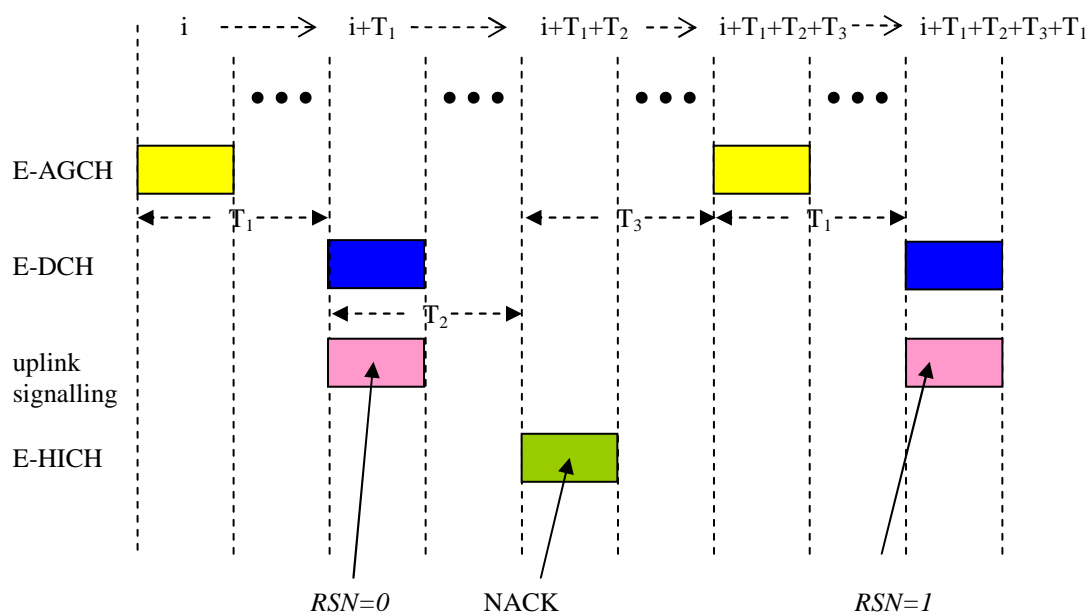

Figure 8.1: TDD E-DCH HARQ

8.2 Error handling

The most frequent error cases to be handled are the following:

- NACK is detected as an ACK: the UE starts afresh with new data in the HARQ process. The previously transmitted data block is discarded in the UE and lost. Retransmission is left up to higher layers;
- ACK is detected as a NACK: For TDD the UE cannot retransmit a data block until an Absolute Grant is received. If the UE retransmits the data block for which the NW has previously sent ACK then the NW will re-send an ACK to the UE. If in this case the transmitter at the UE sends the RSN set to zero, the receiver at the NW will continue to process the data block as in the normal case;
- For FDD, error cases have been identified regarding the HARQ operation during soft handover:
 - In case the HARQ control information transmitted on the E-DPCCH could not be detected RSN_{max} times in a row for one HARQ process, a soft buffer corruption might occur. Each HARQ process uses RSN and the transmission time (CFN, sub-frame) elapsed since storing data in the associated soft buffer in order to flush the soft buffer and to avoid a wrong combining of data blocks.
 - Duplication of data blocks may occur at the RNC during soft handover. The reordering protocol needs to handle the detected duplications of data blocks.

8.3 Signalling

8.3.1 Uplink

- TSN (in-band in MAC-es header), for re-ordering purposes.
- For FDD, RSN (in E-DPCCH).
- For TDD, HARQ process identifier and RSN are signalled on the E-UCCH.

8.3.2 Downlink

In the downlink, a report is used to indicate either ACK (positive acknowledgement) or NACK (negative acknowledgement).

9 Node B controlled scheduling

9.1 General principle

The Node B controlled scheduling is based on uplink and downlink control together with a set of rules on how the UE shall behave with respect to this signaling.

In the downlink, a resource indication (Scheduling Grant) is required to indicate to the UE the maximum amount of uplink resources it may use. When issuing Scheduling Grants, the Node B may use QoS-related information provided by the SRNC (see subclause 11.1.1) and from the UE in Scheduling Requests (see subclause 9.3.1)

The Scheduling Grants have the following characteristics:

- Scheduling Grants are only to be used for the E-DCH TFC selection algorithm (i.e. they do not influence the TFC selection for the DCHs);
- For FDD, Scheduling Grants control the maximum allowed E-DPDCH/DPCCH power ratio of the active processes. For the inactive processes, the power ratio is 0 and the UE is not allowed to transmit scheduled data;
- For TDD, Scheduling Grants control the maximum allowed rate to be used in E-TFC selection according to information received in the Absolute Grant;
- All grants are deterministic;
- Scheduling Grants can be sent once per TTI or slower;
- There are two types of grants:
 - The Absolute Grants provide an absolute limitation of the maximum amount of UL resources the UE may use;
 - The Relative Grants (FDD only) increase or decrease the resource limitation compared to the previously used value;
- Absolute Grants are sent by the Serving E-DCH cell:
 - They are valid for one UE;
 - For FDD they may also be valid for a group of UEs or for all UEs;
 - The UE identity to be used in the Serving E-DCH cell, the E-RNTI, is signalled to the UE via RRC;
 - For FDD, the Absolute Grant contains:
 - the identity (E-RNTI) of the UE (or group of UEs) for which the grant is intended (through an ID-specific CRC attachment);
 - the maximum power ratio the UE is allowed to use, on 5 bits;

- in case of 2ms TTI an HARQ process activation flag indicating if the Primary Absolute Grant activates or deactivates one or all HARQ processes. That bit is also used to switch the UE from its primary E-RNTI to its secondary E-RNTI for both the 2ms and the 10ms TTI. When the E-DCH is configured with a 10ms TTI the flag shall always indicate that the Absolute Grant Scope is set to all HARQ processes. For Secondary Absolute Grants the flag shall always indicate that the Absolute Grant Scope is set to all HARQ processes in this version of the protocol.
- For TDD, the Absolute Grant contains:
 - details of the physical resources to be used for transmission
 - The grant value – maximum transmit power per resource unit (per slot). The grant value is indicated in form of the ratio of the maximum expected E-PUCH received power per resource unit (per slot) to P_{e-base} via E-AGCH from Node B.
 - Timeslots
 - Channelisation code
 - Resource duration
 - E-HICH Indicator(EI), which is used to inform UE which E-HICH the feedback info is carried on(1.28Mcps TDD only)
 - E-UCCH Number Indicator(ENI), which is used to indicate the detailed number of E-UCCH(1.28Mcps TDD only)
- For FDD, Group Identities are supported. Group identities or dedicated identities are not distinguished by the UE. It is up to UTRAN to allocate the same identity to a group of UEs;
- For FDD, up to two identities (E-RNTIs), one primary and one secondary, can be allocated to a UE at a time. In that case, both identities shall use the same E-AGCH channel. The allocation is done by the Node-B and sent by the SRNC in RRC.
- For TDD, one identity (E-RNTI) is allocated to a UE at any time. This allocation is performed by the Node B and is sent to the UE by the SRNC (via RRC).
- The identity consists of 16 bits;
- For FDD:
 - Relative Grants (updates) may be sent by the Serving and Non-Serving Node-Bs as a complement to Absolute Grants:
 - The UE behaviour is exactly the same for Relative Grants for one UE, for a group of UEs and for all UEs;
 - The Relative Grant from the Serving E-DCH RLS can take one of the three values: "UP", "HOLD" or "DOWN";
 - The Relative Grant from the Non-serving E-DCH RL can take one of the two values: "HOLD" or "DOWN". The "HOLD" command is sent as DTX. The "DOWN" command corresponds to an "overload indicator";
 - For each UE, the non-serving Node-B operation is as follows:
 - If the Node-B could not decode the E-DPCCH/E-DPDCH for the last n_1 TTIs (where n_1 is TBD) because of processing issue, it shall notify the SRNC;
 - The non-serving Node-B is allowed to send a "DOWN" command only for RoT reasons (see conditions for sending "DOWN" command in subclause 14.1) and not because of lack of internal processing resources.
- For TDD:
 - An Absolute Grant is sent via one of a set of E_AGCHs

- For each frame, a UE is required to monitor a set of E-AGCHs
- An Absolute Grant is received by the UE if it decodes it using the E-RNTI that it has been allocated
- Details of the set of E-AGCHs to be monitored are signalled to the UE via RRC

9.2 UE scheduling operation

9.2.1 Grants from the Serving RLS

9.2.1.1 FDD

The UE shall be able to receive Absolute Grants from the Serving E-DCH cell and Relative Grants from the Serving E-DCH RLS.

The UE shall handle the Grant from the Serving E-DCH RLS as follows:

- The UE maintains a "Serving Grant" (SG);
- The SG is used in the E-TFC selection algorithm as the maximum allowed E-DPDCH/DPCCH power ratio for the transmission of scheduled data in active HARQ processes;
- Each Absolute Grant and Relative Grant is associated with a specific uplink E-DCH TTI i.e. HARQ process. This association is implicitly based on the timing of the E-AGCH and E-RGCH (see [3]). The timing is tight enough that this relationship is un-ambiguous;
- The SG is updated according to the following algorithm, regardless of the transmission/retransmission status of the HARQ process. The SG is not used for the E-TFC selection algorithm if the HARQ process is in retransmission;
- When receiving an "Absolute Grant" on the E-AGCH of the serving E-DCH cell:
 - Primary Absolute Grants always affect the SG;
 - Secondary Absolute Grants only affect the SG if the last Primary Absolute Grant was set to 'INACTIVE' and, in case of 2ms TTI, the process activation flag was set to 'All' (transition trigger), or if the latest Absolute Grant that affected the SG was the Secondary one. When transition to the secondary E-RNTI is triggered, UE shall update the SG with the latest received Absolute Grant on the secondary E-RNTI (UE shall listen to both E-RNTIs in parallel, if both E-RNTIs are configured);
 - In case of 10ms TTI, SG is set to the received value if the grant value is different from 'INACTIVE';
 - In case of 2ms TTI and a Primary Absolute Grant was received:
 - If the received value is different from 'INACTIVE', the SG is set to that value and the following activation mechanism is applied to processes that are not disabled as per L3 signalling:
 - In case of an AG associated to an inactive process, the process activation flag indicates whether all processes or only this particular process becomes active;
 - In case of an AG associated to an active process, the process activation flag will indicate whether all processes become active ('all') or the activation status of the processes is not changed ('single');
 - If the received value is 'INACTIVE', the UE behaviour depends on the process activation flag:
 - If the flag is set to 'single', this active process becomes inactive;
 - If the activation flag is set to 'All' and the secondary E-RNTI is configured:
 - All L3-enabled processes that are deactivated become active.
 - If the activation flag is set to 'All' and the secondary E-RNTI is not configured:

- All L3-enabled processes are deactivated (if a process was inactive it remains inactive, if a process was active it becomes inactive).
- In case of 2ms TTI and a Secondary Absolute Grant was received:
 - In case the Secondary Absolute Grant affects the SG, the SG is set to the received value.
- If no "Absolute Grant" is received by the UE in a TTI and the last SG update was due to a Primary Absolute Grant from the E-AGCH or from RRC signalling, then the UE shall follow the "Relative Grant" of the Serving E-DCH RLS:
 - A Serving Relative Grant is interpreted relative to the UE power ratio in the previous TTI for the same hybrid ARQ process as the transmission which the Relative Grant will affect (see figure 9.2.1-1);

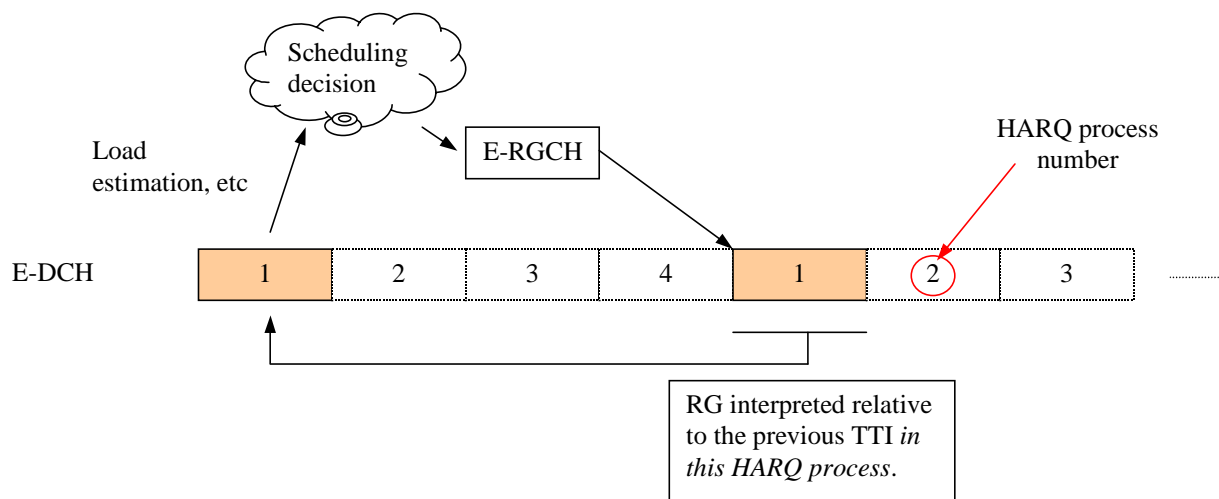

Figure 9.2.1-1: Timing relation for Relative Grant

- If no data was transmitted at the same hybrid ARQ process in the previous TTI, the UE shall ignore the Relative Grant.
- Else
 - The UE shall calculate its new SG by applying a Delta compared with its last used power ratio. See details in [4];
 - When the UE receives a "HOLD" (i.e. DTX) from the Serving E-DCH RLS:
 - SG remains unchanged.

9.2.1.2 TDD

- The UE shall be able to receive Absolute Grant from the Serving E-DCH cell and shall select the maximum allowed rate in E-TFC selection according to information received in the Absolute Grant.
- When the UE receives an Absolute Grant:
 - **if** there are MAC-e PDUs awaiting retransmission and the resources assigned by the Grant enable transmission of a MAC-e PDU awaiting retransmission **then** it is used for a retransmission (oldest first) **else** it is used for a new transmission.

9.2.2 Grants from the Non-serving RL (FDD only)

Non-serving RLs may only send Relative Grants to the UE. The UE shall handle the RG from these non-serving E-DCH RLs as follows:

- When the UE receives a "DOWN" from at least one Non-serving E-DCH RL, it is interpreted relative to the UE power ratio in the previous TTI for the same hybrid ARQ process as the transmission which the Relative Grant will affect (see figure 9.2.1-1). The UE shall calculate its new SG, see details in [4].;
- Following reception of a non-serving 'DOWN', UE shall ensure that its SG is not increased (due to E-AGCH or E-RGCH signalling) during one HARQ cycle.

9.2.3 Reception of Grants from both the Serving RLS and Non-serving RL(s) (FDD only)

In the case of a UE receiving grants from both the Serving RLS and Non-Serving RL(s), the UE behaviour is the following:

- When the UE receives a scheduling grant from the Serving E-DCH RLS and a "DOWN" command from at least one Non-Serving E-DCH RL:
 - new SG is set to the minimum between the resulting SG from the non-serving E-DCH RL and the resulting SG from the serving RLS.

9.3 Signalling

9.3.1 Uplink

For the UE to request resources from the Node B(s), Scheduling Requests will be transmitted in the uplink in the form of Scheduling Information and Happy Bit (FDD only). The Scheduling information will be transmitted for the logical channels for which RRC configured that reporting needed to be made. For FDD, the Happy Bit shall always be included in the E-DPCCH, whenever the E-DPCCH is transmitted.

9.3.1.1 Scheduling information

9.3.1.1.1 Content

The UE includes the following in the Scheduling Information (only taking into account the logical channels for which RRC configured that reporting was required and always excluding logical channels mapped on non-scheduled MAC-d flows):

- Logical channel ID of the highest priority channel with data in buffer, on 4 bits. The logical channel ID field identifies unambiguously the highest priority logical channel with available data and QoS information related to this indicated logical channel;
- UE Buffer occupancy (in Bytes):
 - Buffer status for the highest priority logical channel with data in buffer, on 4 bits, as a fraction of the total reported buffer;
 - Total buffer status, on 5 bits;
- UE Power Headroom (UPH): For FDD, the UPH field indicates the ratio of the maximum UE transmission power and the corresponding DPCCH code power defined in [7]. For 3.84 Mcps and 7.68 Mcps TDD, the UPH field indicates the ratio of the maximum power and the calculated UE transmit power as defined in [10] that would result for β_e equal to 0. For 1.28 Mcps TDD, the UPH field indicates the ratio of the maximum power and the P_{e-base} defined in [11]. The UPH field is 5 bits.
- For TDD: Path Loss:
 - Information derived from measurements of serving cell and neighbour cell's RSCP (5 bits);

9.3.1.1.2 Triggers

In the case where the UE is not allowed to transmit scheduled data (because it has no Serving Grant available or it has received an Absolute Grant preventing it from transmitting in any process) and it has Scheduled data to send on a logical channel for which Scheduling Information shall be reported:

- For FDD:
 - Scheduling Information shall be sent to the Serving E-DCH RLS in a MAC-e PDU;
 - Periodic reporting to protect against NACK-to-ACK misinterpretation;
 - Scheduling Information could be sent alone, or with non-scheduled data, if such exist;
 - Scheduling Information will also be triggered if higher priority data arrives in buffer.
- For 3.84 Mcps and 7.68 Mcps TDD:
 - Scheduling Information shall be sent to the Node B on the E-RUCCH (E-DCH Random access Uplink Control Channel)
 - Buffer Information, Physical Layer Information plus the E-RNTI is sent on the E-RUCCH
 - Scheduling information may also be sent with non-scheduled data.

In the case where the UE is allowed to transmit scheduled data and it has Scheduled data to send on a logical channel for which Scheduling Information shall be reported:

- it shall send the Scheduling Information to the Serving E-DCH RLS in the MAC-e PDU;
 - the Scheduling Information is sent periodically (period defined by RRC);

The details on how Scheduling Information is included in the MAC-e PDU can be found in [4].

- For 1.28 Mcps TDD:
 - In the case where the UE has no Grant and it has data to send:
 - Buffer Information and Physical Layer Information plus the E-RNTI shall be sent to the Node B on the E-RUCCH (E-DCH Random access Uplink Control Channel).
 - In the case where the UE has a Grant and has data to send:
 - It shall send Buffer Information and Physical Layer Information to the Node B in the MAC-e PDU.
 - In the case where UE transits from having a Grant to not having a Grant and has data to send, a timer T_WAIT is provided as a delay time to send buffer information mapped on E-RUCCH (T_WAIT is configured by RRC, default value is 8TTIs):
 - When UE has sent data on E-PUCH in the last TTI before the current Grant expires:
 - The timer T_WAIT shall be started.
 - When a grant is received before the timer expires:
 - The timer shall be stopped.
 - When the timer T_WAIT expires:
 - A new E-RUCCH transmission shall be made (the timer T_WAIT shall be stopped).

9.3.1.1.3 Transmission and Reliability scheme

Two transmission mechanisms are defined, depending on whether the Scheduling Information is transmitted alone, or with data (scheduled and/or non-scheduled):

1. When the Scheduling Information is sent alone:

For FDD:

- The power offset is configured by RRC and the maximum number of re-transmissions is defined by the standard;
- HARQ (re)transmissions are performed until an ACK from the RLS containing the serving cell is received or until the max number of transmissions is reached.

For TDD:

- Scheduling Information sent via the E-RUCCH (no Scheduling Grant) is transmitted at appropriate power and forward error correction, as defined by physical layer specifications. If the UE does not receive a response in the form of an Absolute Grant is received then the UE is required to resend Scheduling Information.

2. When Scheduling Information is sent with data:

- Use the HARQ power offset attribute of the highest priority data, and the maximum number of transmissions among all the considered HARQ profiles associated to the MAC-d flows for the MAC-e PDU to be transmitted;
- HARQ (re)transmissions are performed until an ACK is received, or until the max number of transmissions is reached.
 - For FDD, if the UE receives an ACK from an RLS not containing the serving cell for a packet that includes scheduling information which was triggered by an event or a timer as per section 9.3.1.1.2, it flushes the packet and includes the scheduling information with new data payload in the following packet.

For 3.84 Mcps and 7.68 Mcps TDD:

- A timer value T-RUCCH is used to control retransmission of buffer information if there has been no grant received. The timer T_R manages retransmission of scheduling information if the UE does not receive a grant following an E-RUCCH transmission.
- Even when the scheduling information is sent on E-PUCH it is possible that the Node B may send a NACK (indicating that the buffer information was not correctly decoded) which the UE wrongly interprets as an ACK. Therefore, timers are also required to control retransmission of scheduling information sent on E-PUCH.

(T-RUCCH is configured by RRC, in Radio Bearer Setup Request, default value is 200 ms).

- When the aggregate buffer volume transitions from zero to greater than zero or the scheduling information delay timer $\geq T_SCHED + T_RUCCH / 2$:
 - E-RUCCH shall be sent (carrying scheduling information) and T_R shall be started/restarted.
- When timer $T_R \geq T_RUCCH$ a new E-RUCCH transmission shall be made (the timer is restarted) once a successful draw has been made using the E-RUCCH persistence value.
- Timer T_R is stopped (if running) when a grant is received
- The scheduling information delay timer is restarted whenever scheduling information is sent on the E-PUCH

For 1.28 Mcps TDD

- A timer T_RUCCH and a maximum number of transmissions N_RUCCH are used to control the retransmission of scheduling information in this case. The timer is a mechanism to serve the fact that the UE does not know about the successful reception of buffer information following an E-RUCCH transmission. The maximum number of transmissions N_RUCCH is a mechanism to prevent the redundant transmission. T_RUCCH and N_RUCCH will be configured by higher layer and act as follows.
 - When the aggregate buffer volume transitions from zero to greater than zero or when the timer T_WAIT expires:

- the UE sends information mapped on E-RUCCH;
- the timer T_RUCCH shall be started and a counter is set to 1.
- When a grant is received:
 - the timer T_RUCCH shall be stopped and not be restarted, the counter shall be reset.
- When the timer T_RUCCH expires:
 - if the counter is not greater than N_RUCCH:
 - a new E-RUCCH transmission shall be made (restart the timer and increment the counter).
 - else
- the timer T_RUCCH shall be stopped and not be restarted, the counter shall be reset.

9.3.1.2 Happy bit of E-DPCCH (FDD only)

One bit of the E-DPCCH is used to indicate whether or not the UE is satisfied ('happy') with the current Serving Grant. This bit shall always be present during uplink transmission of E-DPCCH.

The UE shall indicate that it is 'unhappy' if the following criteria are met:

- 1) UE is transmitting as much scheduled data as allowed by the current Serving Grant; and
- 2) UE has enough power available to transmit at higher data rate; and
- 3) Total buffer status would require more than Happy_Bit_Delay_Condition ms to be transmitted with the current Serving_Grant \times the ratio of active processes to the total number of processes.

The first criteria is always true for a deactivated process and the ratio of the third criteria is always 1 for 10ms TTI.

Otherwise, the UE shall indicate that it is 'happy'.

9.3.2 Downlink

For each UE, there can only be one Absolute Grant transmitted by the serving E-DCH cell using the E-AGCH.

For FDD:

- For each UE, there can be one Relative Grant transmitted per Serving RLS and one per Non-serving RL from the E-DCH active set cells.
- The channel(s) (one per cell) on which the Relative Grant is transmitted is(are) signalled separately to each UE (this allows for the same channel to be monitored by multiple UEs if UTRAN decides so).

10 Non-scheduled transmissions

When non-scheduled transmission is configured by the SRNC, the UE is allowed to send E-DCH data at any time, up to a configured number of bits, without receiving any scheduling command from the Node B. Thus, signalling overhead and scheduling delay are minimized.

Typical examples of data that may use non-scheduled transmission are the SRBs and GBR services.

Non-scheduled transmissions have the following characteristics:

- Non-scheduled transmissions are defined per MAC-d flow;
- The resource for non-scheduled transmission is given by the SRNC in terms of maximum number of bits that can be included in a MAC-e PDU, and is called non-scheduled grant;

- Scheduled logical channels cannot use a non-scheduled grant.
- For TDD a non scheduled grant is defined by:
 - The codes and timeslots available for transmission in TTIs designated for unscheduled use
 - The frames designated for unscheduled use (specified by means of start frame number, repetition period and repetition length)
- For FDD:
 - UTRAN can restrict a non-scheduled MAC-d flow to use a limited number of HARQ processes in case of 2ms TTI;
 - UTRAN can reserve some HARQ processes for non-scheduled transmission (i.e. scheduled data cannot be sent using these processes, they are considered disabled) in case of 2ms TTI;
 - Reserving certain HARQ processes for non-scheduled transmission and restricting non-scheduled transmission to specific HARQ processes are scheduling mechanisms under the control of the serving cell Node B; Serving cell Node B signals the applicability of allocated resources for non-scheduled/scheduled transmission to HARQ processes according to the restriction/reservation decision to S-RNC, which informs other Node Bs in the E-DCH active set.
- Multiple non-scheduled MAC-d flows may be configured in parallel by the SRNC;
 - The UE is then allowed to transmit non-scheduled transmissions up to the sum of the non-scheduled grant if multiplexed in the same TTI;
- For TDD, HARQ process identifiers 0 – 3 are reserved for scheduled transmissions and HARQ process identifiers 4 – 7 are reserved for non-scheduled transmissions;
- For FDD, Scheduled grants will be considered on top of non-scheduled transmissions;
- Logical channels mapped on a non-scheduled MAC-d flow cannot transmit data using a Scheduling Grant;
- Logical channels mapped on a non-scheduled MAC-d flow can only transmit up to the non-scheduled grant configured for that MAC-d flow;
- The multiplexing list restricting the set of HARQ profiles that can be used by a given logical channel will apply both for scheduled and non-scheduled logical channels;
- Logical channels will be served in the order of their priorities until the non-scheduled grant and scheduled grants are exhausted, or the maximum transmit power is reached;
 - When multiple logical channels are assigned the highest priority, the selection of the HARQ profile for these logical channels is not specified.

11 QoS control

11.1 General Principle

The QoS of ongoing flows mapped on E-DCH for a UE is maintained by the serving Node B and by the UE. The Node B controls the resources allocated to a UE versus other UEs by means of scheduling as specified in clause 9. The UE controls the QoS of all its logical channels mapped on E-DCH by means of E-TFC selection as specified in subclause 11.2, and by HARQ operation, specified in clause 8.

In addition to these mechanisms, guaranteed bit rate services for MAC-d flows are also supported through non-scheduled transmission. A flow using non-scheduled transmission is defined by the SRNC and provided in the UE and in the Node B. Details on non-scheduled transmission can be found in section 10.

11.1.1 QoS configuration principles

RAB attributes are available in the SRNC according to R'99 principles. To enable QoS control for the E-DCH, QoS-related information is made available in the UE and in the Node B as outlined below.

To the UE, the following QoS-related information is provided from the SRNC to enable QoS-based E-TFC selection, multiplexing of logical channels in MAC-e PDUs, and HARQ operation:

- Logical channel priority for each logical channel (as in Rel-5);
- Mapping between logical channel(s) and MAC-d flow(s) (as in Rel-5);
- Allowed MAC-d flow combinations in one MAC-e PDU;
- Power offset for reference E-TFC(s). The UE then calculates the power offsets for its other E-TFCs so that the quality (protection of a MAC-e PDU) when using any of the E-TFCs is identical to that of the reference E-TFC(s);
- The E-DPCCH power offset (FDD only). This is used to set the protection level for E-DPCCH transmissions;
- The E-RUCCH power offset (3.84 Mcps and 7.68 Mcps TDD only): This is used to set the power level for E-RUCCH transmissions;
- E_UCCH protection level (3.84 Mcps and 7.68 Mcps TDD only): This is set to the FEC protection level for E-UCCH transmissions;
- HARQ profile per MAC-d flow. One HARQ profile consists of a power offset attribute and a maximum number of transmissions attribute and for 1.28 Mcps TDD a retransmission timer attribute. The power offset attribute is used in E-TFC selection to regulate the BLER operating point for the transmission. The maximum number of transmissions attribute is used in the HARQ operation to regulate maximal latency and residual BLER of MAC-d flows. The retransmission timer (1.28 Mcps TDD only) is used to control the retransmission of a MAC-e PDU;
- The non-scheduled grant (only for MAC-d flows that are configured for non-scheduled transmission).

To the Node Bs in the E-DCH active set, the following QoS-related parameters are provided by the SRNC to enable scheduling and resource reservation:

- Power offsets for reference E-TFC(s). The Node B then calculates the power offsets for the other E-TFCs. This information is used whenever the nodeB needs to convert between rate and power in its resource allocation operation;
- For FDD, E-DPCCH power offset. This is used whenever the Node B needs to convert between rate and power in its resource allocation operation;
- For 3.84 Mcps and 7.68 Mcps TDD, E-RUCCH power offset and E-UCCH FEC protection level.
- HARQ profile per MAC-d flow. One HARQ profile consists of a power offset attribute and a maximum number of transmissions attribute and for 1.28 Mcps TDD a retransmission timer attribute. The power offset attribute is used whenever the Node B needs to convert between rate and power in its resource allocation operation;
- Guaranteed bit rate for logical channels that carry guaranteed bit rate services. It is used to allocate grants to UEs;
- The non-scheduled grant for MAC-d flows that are configured for non-scheduled transmission. It is used for the Node B to reserve sufficient amount of resources. The need for additional mechanisms to optimize the Node-B hardware is FFS (e.g. the UE may tell the Node-B ahead that a non-scheduled transmission is coming);
- Maximum UL UE power, as a minimum of the UE maximum transmit power (as per UE power class) and maximum allowed UL Tx power configured by UTRAN. This information is only sent to the serving cell's nodeB (whether the max UL UE power can also be signalled to other nodeBs in the active set or not is FFS);

- Scheduling priority per logical channel of logical channels mapped to E-DCH and the corresponding mapping between logical channel identifier and DDI value. This information enables Node B to consider QoS related information of the logical channels for efficient scheduling.

11.2 TFC and E-TFC selection

For FDD:

- Logical channels mapped on the DCHs are always prioritised over those mapped on E-DCH.
- The principle of the TFC selection across E-DCH and DCH is the following:
 - The UE performs TFC restriction for the CCTrCH of DCH type;
 - The UE performs the TFC selection for the DCHs;

E-TFC restriction is performed with the following characteristics;

- The E-TFC restriction mechanism is independent of the existing TFC restriction;
- The E-TFC states defined per MAC-d flow are managed independently of the TFC states;
- The UE uses the power offsets for the reference E-TFC(s), the signalled power offset attributes for its MAC-d flows, the required E-TFC dependent backoff, and the UE remaining power to determine the E-TFC states;
- For FDD, the HS-DPCCH, DPCCH, DPDCH and E-DPCCH powers are taken into account when calculating the remaining power;
- The result of E-TFC restriction is a state (blocked or supported) per E-TFC and MAC-d flow;
- For FDD:
 - The minimum set of E-TFCs is defined as the number of bits that can be transmitted in a TTI independent of the power situation in the UE, provided there is nothing sent on the DCH, and is configurable from the RNC as one E-TFC per UE. When there is nothing sent on DCH, the E-TFCs belonging to the minimum set are in supported state;
 - In the case where 2ms TTI is configured, E-TFC selection shall not be performed for TTIs that overlap with an uplink compressed mode gap;
 - The UE performs the E-TFC selection for the E-DCH, taking into account the following rules:
 - The E-TFC selection is based on logical channel priorities like in the Release '99, i.e. the UE shall maximise the transmission of higher priority data;
 - The UE shall respect the allowed combinations of MAC-d flows in the same MAC-e PDU;
 - The UE shall use the multiplexing list of the different MAC-d flows to see if a certain MAC-d flow can use the power offset of the highest priority MAC-d flow to be transmitted;
 - The supported/blocked E-TFCs for a MAC-e PDU including MAC-d PDUs coming from one or several MAC-d flows are obtained as follows:
 - The UE uses the E-TFC restriction result (i.e. blocked/supported E-TFCs) associated to the MAC-d flow with the highest priority logical channel in the MAC-e PDU;
 - For FDD, if a 10ms TTI E-DPDCH frame that overlaps with a compressed mode gap, the Serving Grant shall be scaled back according to the procedure described in [4];
 - Among the supported E-TFCs, the UE selects the smallest E-TFC that maximises the transmission of data according to the non-scheduled grant(s) or the serving grant;
 - For each transmission, the MAC-e entity gives the selected power offset to L1 in addition to the E-TFC;
 - For FDD, the power offset given to L1 is of E-DPDCH(s) relative to DPCCH;

- For TDD the power offset given to L1 is E-PUCH(s) relative to the power base P_{e-base} ;
- In case the maximum UE transmit power is exceeded;
 - For FDD, the UE shall scale down the E-DPDCH only on slot level for both initial transmission and retransmissions. Further details on uplink power reduction mechanisms can be found in [3].
 - For TDD, the UE shall scale down all physical channels present.

11.3 Setting of Power offset attributes of MAC-d flows

Power offset attributes of MAC-d flows are part of the HARQ profiles of the MAC-d flow. They are provided by the UTRAN to the UE according to the following principles:

- For FDD, the DPCCCH transmission power is controlled the same way as in Release '99;
- For TDD:
 - Power control of the CCTrCH of E-DCH type is based on a combination of open loop power control component as used in Release '99/4/5/6 and a closed loop TPC component (signalled from Node B to UE alongside the Absolute Grant).
 - With each MAC-es PDU transmitted to the SRNC, the Node-B includes the number of transmissions that have been required to correctly decode the PDU. Also, the serving nodeB shall send an HARQ failure indication in case of unsuccessful decoding of the E-DCH payload (see [5]);
 - Using the information provided by the Node B(s), the SRNC may maintain up to date power offsets;
 - The SRNC may decide to signal to the UE and the node Bs in the E-DCH active set new values for the power offset attributes for one (or several) MAC-d flow(s);

12 Signalling parameters

12.1 Uplink signalling parameters

Void.

12.2 Downlink signalling parameters

With RRC signalling, the UE will in addition be informed about:

- The E-RNTI(s) assigned
- The E-HICH configuration
 - For FDD, this includes signature sequence number and channelisation code;
 - For 3.84 Mcps and 7.68 Mcps TDD, this includes timeslot, channelisation code, midamble and burst type;
 - For 1.28 Mcps TDD:
 - In the case of scheduled transmission, a set of E-HICHs can be configured for a UE:
 - Including timeslot, channelisation code, midamble;
 - The mapping between EI (E-HICH Indicator) and E-HICH physical resource.
 - In the case of non-scheduled transmission, only one E-HICH shall be configured for a UE:
 - Including timeslot, channelisation code, midamble;

- Index of the pre-defined signature sequence table[10].
- For FDD:
 - The E-RGCH configuration
 - Including signature sequence number, channelisation code (same as the E-HICH), RG reference step size for serving RLS, RG step size for non-serving RL and Serving E-DCH RLS ID;
 - The E-AGCH configuration
 - Including E-RNTI(s) and channelisation code;
 - The E-DPCCH configuration
 - E-DPCCH/DPCCH Power Offset;
 - Threshold (in TTIs) used by the UE when evaluating the time needed to completely empty its buffers. Used as a conditions for setting the 'happy' bit in E-DPCCH;
- For 3.84 Mcps and 7.68 Mcps TDD:
 - T-SCHED
 - The set of E-AGCHs configured
 - including timeslot and channelisation code, midamble, burst type for each E_AGCH;
 - E-UCCH configuration
 - FEC protection level
 - E-RUCCH configuration
 - constant value, persistence scaling, rate matching attribute
 - timeslot, midamble, SF16 or SF8, channelisation codes
 - T-RUCCH
 - The E-PUCH configuration including:
 - timeslots assigned to E-PUCH
 - identities of the E-PUCH timeslots which are to carry TPC and TFCI bits
 - reference Beta values to use:
 - for each reference T-TFC a (nominal) beta factor is calculated based on the power offset signalled for each reference E-TFC via RRC (maximum number of reference E-TFCs is 8 for 16QAM and for 8PSK)
 - for each E-PUCH timeslot:
 - burst type and midamble to be used
 - minimum code rate and maximum code rate
- For 1.28 Mcps TDD:
 - The set of E-AGCHs configured
 - Including timeslot and channelisation code, midamble for each E-AGCH
 - TPC step size for E-AGCHs
 - E-UCCH configuration for non-scheduled transmission
 - E-RUCCH configuration

- T_WAIT
- T_RUCCH
- N_RUCCH
- The E-PUCH configuration including:
 - reference Beta values to use.
 - For each reference E-TFC a (nominal) beta factor is calculated based on the power offset signalled for each reference E-TFC via RRC
 - timeslots assigned to E-PUCH
 - identities of the E-PUCH timeslots which are to carry TPC and TFCI bits
 - reference Desired E-PUCH RX power
 - for each E-PUCH timeslot:
 - midamble
 - minimum code rate, maximum code rate
 - TPC step size for E-PUCH
- For FDD, a UE is allocated one and only one TB size table by RRC.
- For FDD, a total of four TB size tables are defined by the standard:
 - Exponentially distributed TB sizes over the corresponding dynamic range, one optimized table for 2ms TTI and one optimized table for 10ms TTI;
 - TB sizes for 336 bit RLC PDU size, one optimized table for 2ms TTI and one optimized table for 10ms TTI;
- For 1.28 Mcps TDD, a total of 8 TB size tables are defined by the standard according to UE capabilities:
 - 3 optimized tables for UE supporting QPSK only and 5 optimized tables for UE supporting both QPSK and 16QAM; Each TB size table is defined to include 128 exponentially distributed TB sizes for a certain number of timeslot resources for 5 ms TTI.
- For 3.84 Mcps and 7.68 Mcps TDD
 - one TB size table is defined, exponentially distributed TB sizes for a 10 ms TTI;
- For each reference E-TFC a (nominal) beta factor is calculated based on the power offset signalled for each reference E-TFC via RRC (maximum number of reference E-TFCs is 8);
- For FDD, a minimum set of E-TFCs, which is the largest E-TFC that can be used by the UE independent of the UE power situation, given that a valid grant is available and there is no transmission on DCH;
- HARQ Incremental Redundancy Version configuration. Always use RV=0 or use the RV table;
- For FDD:
 - Maximum number of E-DPDCH channelisation code along with minimum SF;
 - $PL_{\text{non-max}}$ (Puncturing Limit used to determine the combination of SF and the number of codes that are used for transmitting E-DCH with a certain data rate);
 - Processes in which transmission of a MAC-d flow using non-scheduled data is allowed for the 2ms E-DCH TTI;
 - Processes in which transmission of scheduled data is allowed (L3-enabled processes) for the 2ms E-DCH TTI;

- E-DCH Scheduling Information parameters:
 - Logical channels for which Scheduling Information is expected to be reported by the UE;
 - Logical channel identity of logical channels mapped to E-DCH;
 - Period for sending Scheduling Information (applicable when UE is not allowed to transmit scheduled data);
 - Period for sending Scheduling Information (applicable when UE is allowed to transmit scheduled data);
 - For FDD, power offset to use when sending Scheduling Information alone;
- Grant information:
 - Non-scheduled grant;
 - For TDD, this includes:
 - timeslots allocated;
 - maximum transmit power granted per resource unit (per slot);
 - repetition periodicity in TTIs and repetition length;
 - code resource information;
 - reference Desired E-PUCH RX power (1.28 Mcps TDD only)
 - For FDD:
 - Initial Serving Grant to be used by UE, as well as initial grant selector information (primary or secondary).
- For 1.28 Mcps TDD: SYNC_UL used for E-DCH random access configuration:
 - Indicate SYNC_ULs dedicatedly used for E-DCH random access.

RRC will signal the mapping between logical channel, MAC-d PDU size, MAC-d flow ID and Data Description Indicator (see clause 7).

RRC will signal for each MACd-flow, the MAC-d flow specific power offset, the maximum number of transmissions, and the multiplexing list (indicating with which other MAC-d flows, MAC-d PDU's of this flow can be multiplexed in the same MAC-e PDU).

13 Mobility procedures

13.1 Change of serving cell and/or serving RLS

Change of serving cell and/or change of serving RLS for E-DCH (FDD only) scheduling is supported via RRC signalling.

For FDD, UTRAN may:

- For the serving RLS, select the RLS with the highest data throughput;
- For the serving cell, select that cell out of the serving RLS, which provides the best downlink quality.

For TDD, UTRAN may:

- select the serving E-DCH cell.

UE based change of serving cell and/or change of serving RLS or mechanisms using L2 signalling are not supported for E-DCH mobility.

When an E-DCH serving cell change is triggered:

- For FDD:
 - The E-RNTI (primary or secondary) the UE will initially use to update its SG is given by RRC;
 - The new SG is signaled through RRC;
 - All L2-deactivated processes become active;
- For TDD:
 - The E-RNTI that the UE will use is given by RRC;
 - For non-scheduled transmissions, resources are signalled via RRC;
 - For scheduled transmissions, the resources to be used are signalled via an Absolute Grant.
- Processes can be enabled/disabled via RRC;

14 Resource management

14.1 Scheduler control from CRNC to Node B (FDD only)

The CRNC may send a maximum total RTWP value to the Node B to control cell coverage. The value reflects total interference including contributions from all uplink traffic and external interferers. The scheduler can use this value when issuing grants. The result of the scheduling should be such that the maximum total RTWP value is not exceeded.

The CRNC may send to Node B the Reference Received Total Wideband Power. This value represents the received noise power level in a particular cell and can be used e.g. when making noise rise estimates in the Node B scheduler. The usage of this value in the Node B scheduler is optional.

The CRNC may send the target value of Non-serving E-DCH to total E-DCH power ratio per cell to the Node-B. Node-B should not send Non-serving RL RG "Down" command, unless both of the following criteria are met:

1. Experienced total RTWP > Target RTWP signalled from CRNC
2. Non-serving E-DCH to total E-DCH power ratio > Target ratio signalled from CRNC

Non-serving E-DCH to total E-DCH power ratio is the ratio of power from UEs for which this cell is a non-serving RL and the total E-DCH power. Received non-serving E-DCH power and total E-DCH power may be calculated from the E-TFC information on the E-DPCCH and a reference power offset. A reference power offset is defined per UE using the same value range as the MAC-d flow specific HARQ offset and signalled from SRNC to Node-B for this calculation. When using the E-TFCI for computing the E-DCH power received in a cell which is part of a multi-cell RLS, the Node-B shall allocate the computed power equally divided among all cells in the RLS (also considering cells not in the E-DCH active set) regardless of whether the RLS contains the E-DCH serving cell or not.

14.2 Node B to CRNC reporting (FDD only)

Radio Access Bearers with strict quality requirements (mapped on E-DCH or DCH) are subject to admission control. To support such admission control and to enable noise floor estimation, the Node B shall measure/estimate and signal to the CRNC the following:

- Total RTWP (as in Rel-5);
- Received scheduled E-DCH power share (RSEPS) [7];
- Provided bit rate per logical channel priority per cell, taking into account only logical channels mapped on E-DCH.

For the received scheduled E-DCH power share (RSEPS) [7] of a cell the Node B shall take into account only:

- scheduled part of the E-DPDCH transport block and
- the corresponding portion of the E-DPCCH

for all UEs for which this cell is the serving E-DCH cell unless E-DPCCH can not be decoded successfully. In this case E-DPCCH and the E-DPDCH transport block contributions are not taken into account. If the E-DPDCH transport block can not be decoded successfully even from subsequent retransmissions, it is considered as scheduled transmission.

For the provided bitrate measurement, the Node-B shall allocate the bitrate received over a multi-cell RLS, equally divided among all cells in the RLS which are part of the E-DCH active set, regardless of whether the RLS contains the E-DCH serving cell or not.

To enable the CRNC to manage resources between cells, a load excess indicator shall be signalled from Node-B to CRNC if the frequency of the "Down" commands towards UEs for which this cell is a non-serving RL becomes more than a pre-defined level.

15 Timing Advance and Synchronisation (3.84/7.68 Mcps TDD only)

In the case of non synchronised handover and E-DCH/HS-DSCH operation without an uplink DPCH the UE adjusts timing of transmissions by obtaining Timing Advance (TA). This is achieved by the UE transmitting "Timing Advance Request" message via the E-RUCCH and the Node B sending "Timing Advance Response" via the E-AGCH. Special message formats are specified for "Timing Advance Request" and "Timing Advance Response".

In the case of E-DCH/HS-DSCH operation without a uplink DPCH after a period T-adv (configured by higher layers [7]) of no uplink transmission on the E-DCH or E_RUCCH if the UE has information to send on the E-DCH or HS-SICH then the UE shall obtain timing advance and synchronisation by transmission of Timing Advance Request on the E-RUCCH and by receiving Timing Advance Response on the E-AGCH.

When the Node B receives a transmission on E-RUCCH (whether a conventional E-RUCCH carrying Scheduling Information or a TA Request) the timing deviation measured is sent to the SRNC in the Rx Timing Deviation Frame Protocol (when timing deviation measurements are configured at the Node B). The Rx Timing Deviation Frame Protocol indicates whether the deviation was measured on a conventional E-RUCCH carrying Scheduling Information or a TA Request.

Annex A (informative): Change history

Change history							
Date	TSG #	TSG Doc.	CR	Rev	Subject/Comment	Old	New
2006-06	RP-32	RP-060274			Approved and placed under change control at RAN32 (inherited from TS 25.309 version 6.6.0).	2.0.0	7.0..0
2006-09	RP-33	RP-060495	0001	1	Introduction of a Node B measurement for E-DCH RRM	7.0.0	7.1.0
	RP-33	RP-060580	0002		Inconsistent terminology in Enhanced Uplink stage 2	7.0.0	7.1.0
	RP-33	RP-060586	0003		Introduction of 3.84 Mcps and 7.68 Mcps TDD E-DCH	7.0.0	7.1.0
2007-03	RP-35	RP-070157	0004		Introduction of 1.28Mcps TDD E-DCH	7.1.0	7.2.0
	RP-35	RP-070162	0005		25.319 UL HOM CR	7.1.0	7.2.0
	RP-35	RP-070160	0006		Editorial Corrections Related to 3.84/7.68 Mcps TDD E-DCH	7.1.0	7.2.0
2007-09	RP-37	RP-070629	0007		Timing Advance Corrections for 3.84/7.68 Mcps TDD E-DCH	7.2.0	7.3.0
2007-12	RP-38	RP-070903	0008		Correction to description of the TB size table for 1.28Mcps TDD	7.3.0	7.4.0
2008-03	RP-39	RP-080185	0010	-	Clarification of Absolute Grant value for TDD E-DCH	7.4.0	7.5.0
	RP-39	RP-080184	0012	-	Transmission and reliability of scheduling information for 3.84/7.68 Mcps TDD E-DCH	7.4.0	7.5.0

History

Document history		
V7.2.0	March 2007	Publication
V7.3.0	October 2007	Publication
V7.4.0	January 2008	Publication
V7.5.0	April 2008	Publication