

ETSI TS 125 321 V7.5.0 (2007-06)

Technical Specification

Universal Mobile Telecommunications System (UMTS); Medium Access Control (MAC) protocol specification (3GPP TS 25.321 version 7.5.0 Release 7)



Reference

RTS/TSGR-0225321v750

Keywords

UMTS

ETSI

650 Route des Lucioles
F-06921 Sophia Antipolis Cedex - FRANCE

Tel.: +33 4 92 94 42 00 Fax: +33 4 93 65 47 16

Siret N° 348 623 562 00017 - NAF 742 C
Association à but non lucratif enregistrée à la
Sous-Préfecture de Grasse (06) N° 7803/88

Important notice

Individual copies of the present document can be downloaded from:

<http://www.etsi.org>

The present document may be made available in more than one electronic version or in print. In any case of existing or perceived difference in contents between such versions, the reference version is the Portable Document Format (PDF). In case of dispute, the reference shall be the printing on ETSI printers of the PDF version kept on a specific network drive within ETSI Secretariat.

Users of the present document should be aware that the document may be subject to revision or change of status. Information on the current status of this and other ETSI documents is available at

<http://portal.etsi.org/tb/status/status.asp>

If you find errors in the present document, please send your comment to one of the following services:

http://portal.etsi.org/chaicor/ETSI_support.asp

Copyright Notification

No part may be reproduced except as authorized by written permission.
The copyright and the foregoing restriction extend to reproduction in all media.

© European Telecommunications Standards Institute 2007.
All rights reserved.

DECTTM, **PLUGTESTS**TM and **UMTS**TM are Trade Marks of ETSI registered for the benefit of its Members.
TIPHONTM and the **TIPHON logo** are Trade Marks currently being registered by ETSI for the benefit of its Members.
3GPPTM is a Trade Mark of ETSI registered for the benefit of its Members and of the 3GPP Organizational Partners.

Intellectual Property Rights

IPRs essential or potentially essential to the present document may have been declared to ETSI. The information pertaining to these essential IPRs, if any, is publicly available for **ETSI members and non-members**, and can be found in ETSI SR 000 314: "*Intellectual Property Rights (IPRs); Essential, or potentially Essential, IPRs notified to ETSI in respect of ETSI standards*", which is available from the ETSI Secretariat. Latest updates are available on the ETSI Web server (<http://webapp.etsi.org/IPR/home.asp>).

Pursuant to the ETSI IPR Policy, no investigation, including IPR searches, has been carried out by ETSI. No guarantee can be given as to the existence of other IPRs not referenced in ETSI SR 000 314 (or the updates on the ETSI Web server) which are, or may be, or may become, essential to the present document.

Foreword

This Technical Specification (TS) has been produced by ETSI 3rd Generation Partnership Project (3GPP).

The present document may refer to technical specifications or reports using their 3GPP identities, UMTS identities or GSM identities. These should be interpreted as being references to the corresponding ETSI deliverables.

The cross reference between GSM, UMTS, 3GPP and ETSI identities can be found under <http://webapp.etsi.org/key/queryform.asp>.

Contents

| | |
|----------------------------------------------------------------------------|----|
| Intellectual Property Rights | 2 |
| Foreword..... | 2 |
| Foreword..... | 7 |
| 1 Scope | 8 |
| 2 References | 8 |
| 3 Definitions and abbreviations..... | 9 |
| 3.1 Definitions | 9 |
| 3.1.1 HS-DSCH Specific Definitions | 9 |
| 3.1.2 E-DCH Specific Definitions | 9 |
| 3.1.2.1 General | 9 |
| 3.1.2.2 FDD..... | 10 |
| 3.1.3 DTX-DRX and HS-SCCH less Specific definitions (FDD only) | 10 |
| 3.2 Abbreviations | 11 |
| 4 General | 12 |
| 4.1 Objective | 12 |
| 4.2 MAC architecture | 12 |
| 4.2.1 MAC Entities | 12 |
| 4.2.2 MAC-b..... | 13 |
| 4.2.3 Traffic Related Architecture - UE Side..... | 13 |
| 4.2.3.1 MAC-c/sh/m entity – UE Side | 14 |
| 4.2.3.2 MAC-d entity – UE Side | 16 |
| 4.2.3.3 MAC-hs entity – UE Side | 17 |
| 4.2.3.4 MAC-e/es entity – UE Side..... | 18 |
| 4.2.3.5 MAC-ehs entity – UE Side | 20 |
| 4.2.4 Traffic Related Architecture - UTRAN Side | 21 |
| 4.2.4.1 MAC-c/sh/m entity – UTRAN Side..... | 22 |
| 4.2.4.2 MAC-d entity – UTRAN Side | 23 |
| 4.2.4.3 MAC-hs entity – UTRAN Side..... | 25 |
| 4.2.4.4 MAC-es entity – UTRAN Side | 26 |
| 4.2.4.5 MAC-e entity – UTRAN Side..... | 28 |
| 4.2.4.6 MAC-ehs entity UTRAN Side | 29 |
| 4.3 Channel structure..... | 30 |
| 4.3.1 Transport channels | 31 |
| 4.3.2 Logical Channels | 31 |
| 4.3.2.1 Logical channel structure | 31 |
| 4.3.2.2 Control Channels..... | 32 |
| 4.3.2.3 Traffic Channels..... | 32 |
| 5 Services provided to upper layers | 32 |
| 5.1 Description of Services provided to upper layers..... | 32 |
| 6 Functions | 32 |
| 6.1 Description of the MAC functions | 32 |
| 6.2 Relation between MAC Functions and Transport Channels | 34 |
| 6.2.1 Relation between MAC Functions and Transport Channels in UTRAN | 34 |
| 6.2.2 Relation of MAC Functions and Transport Channels in UE | 35 |
| 7 Services expected from physical layer | 35 |
| 8 Elements for layer-to-layer communication..... | 35 |
| 8.1 Primitives between layers 1 and 2 | 36 |
| 8.1.1 Primitives..... | 36 |
| 8.1.2 Parameters..... | 36 |
| 8.2 Primitives between MAC and RLC..... | 36 |
| 8.2.1 Primitives..... | 36 |

| | | |
|-----------|-----------------------------------------------------------------------------------------------------------------|----|
| 8.2.2 | Parameters..... | 37 |
| 8.3 | Primitives between MAC and RRC | 38 |
| 8.3.1 | Primitives..... | 38 |
| 8.3.2 | Parameters..... | 39 |
| 9 | Elements for peer-to-peer communication | 40 |
| 9.1 | Protocol data units | 40 |
| 9.1.1 | General..... | 40 |
| 9.1.2 | MAC PDU (not HS-DSCH or E-DCH) | 40 |
| 9.1.3 | MAC-d PDU (HS-DSCH) | 41 |
| 9.1.4 | MAC PDU (HS-DSCH)..... | 41 |
| 9.1.5 | MAC PDU (E-DCH) | 42 |
| 9.2 | Formats and parameters..... | 43 |
| 9.2.1 | MAC PDU: Parameters of the MAC PDU header (not HS-DSCH or E-DCH) and MAC-d PDU header (HS-DSCH and E-DCH) | 43 |
| 9.2.1.1 | MAC header for DTCH and DCCH (not mapped on HS-DSCH or E-DCH) | 46 |
| 9.2.1.1a | MAC-d Header for DTCH and DCCH (mapped on HS-DSCH) | 47 |
| 9.2.1.1b | MAC-d Header for DTCH and DCCH (mapped on E-DCH) | 47 |
| 9.2.1.1c | MAC Headers for DTCH and DCCH (mapped on HS-DSCH, FDD only) | 47 |
| 9.2.1.2 | MAC header for BCCH | 48 |
| 9.2.1.3 | MAC header for PCCH | 48 |
| 9.2.1.4 | MAC header for CCCH | 48 |
| 9.2.1.5 | MAC Header for CTCH..... | 49 |
| 9.2.1.6 | MAC Header for SHCCH | 49 |
| 9.2.2 | MAC PDU: Parameters of the MAC header (HS-DSCH) | 50 |
| 9.2.2.1 | MAC header for DTCH and DCCH..... | 52 |
| 9.2.3 | Signalling of Transport Block size for HS-DSCH | 52 |
| 9.2.3.1 | Transport block size for FDD..... | 52 |
| 9.2.3.2 | Transport block size for 3.84 Mcps TDD..... | 55 |
| 9.2.3.2a | Transport block size for 7.68 Mcps TDD..... | 58 |
| 9.2.3.3 | Transport block size for 1.28 Mcps TDD..... | 61 |
| 9.2.4 | MAC PDU: Parameters of the MAC header (E-DCH) | 63 |
| 9.2.4.1 | MAC-es header parameters | 63 |
| 9.2.4.2 | MAC-e header parameters | 63 |
| 9.2.5 | Signaling of control information for FDD E-DCH | 64 |
| 9.2.5.1 | HARQ information..... | 64 |
| 9.2.5.2 | DL Scheduling information..... | 64 |
| 9.2.5.2.1 | Relative Grants | 64 |
| 9.2.5.2.2 | Absolute Grant | 67 |
| 9.2.5.3 | UL Scheduling information..... | 67 |
| 9.2.5.3.1 | Happy Bit | 67 |
| 9.2.5.3.2 | Scheduling Information | 67 |
| 9.2.5.4 | Transport block size | 69 |
| 9.2.6 | Signaling of control information for TDD E-DCH..... | 70 |
| 9.2.6.1 | HARQ information..... | 70 |
| 9.2.6.2 | DL Scheduling information..... | 71 |
| 9.2.6.2.1 | Absolute Grant | 71 |
| 9.2.6.3 | UL Scheduling Information | 72 |
| 9.2.6.4 | Transport block size | 73 |
| 9.2.6.4.1 | 3.84 Mcps TDD Transport Block Size | 73 |
| 9.2.6.4.2 | 7.68 Mcps TDD Transport Block Size | 73 |
| 9.2.6.4.3 | 1.28 Mcps TDD Transport Block Size | 74 |
| 10 | Handling of unknown, unforeseen and erroneous protocol data | 74 |
| 11 | Specific functions | 75 |
| 11.1 | Traffic volume measurement for dynamic radio bearer control | 75 |
| 11.2 | Control of RACH transmissions..... | 75 |
| 11.2.1 | Access Service Class selection | 76 |
| 11.2.2 | Control of RACH transmissions for FDD mode..... | 76 |
| 11.2.3 | Control of RACH transmissions for TDD | 79 |
| 11.2.3.1 | Control of RACH transmissions for 3.84 Mcps TDD and 7.68 Mcps TDD | 79 |
| 11.2.3.2 | Control of RACH Transmissions for 1.28 Mcps TDD..... | 80 |

| | | |
|--------------|--------------------------------------------------------------------------------------|-----|
| 11.2.3.2.1 | Control of E-RUCCH transmissions | 82 |
| 11.2.3.2.1.1 | Access Service Class selection | 82 |
| 11.2.3.2.1.2 | Transport Format selection | 82 |
| 11.3 | Void..... | 83 |
| 11.4 | Transport format combination selection in UE (non E-DCH)..... | 83 |
| 11.5 | Ciphering..... | 84 |
| 11.6 | Control of HS-DSCH transmission and reception..... | 85 |
| 11.6.1 | Network operation | 85 |
| 11.6.1.1 | Scheduler..... | 85 |
| 11.6.1.2 | HARQ entity | 86 |
| 11.6.1.3 | HARQ process | 86 |
| 11.6.2 | UE operation..... | 86 |
| 11.6.2.1 | HARQ Entity..... | 86 |
| 11.6.2.2 | HARQ process | 86 |
| 11.6.2.3 | Reordering entity..... | 87 |
| 11.6.2.3.1 | Definitions..... | 87 |
| 11.6.2.3.2 | Reordering functionality..... | 88 |
| 11.6.2.4 | Disassembly entity | 90 |
| 11.6.2.5 | MAC-hs Reset..... | 90 |
| 11.6.2.6 | Reconfiguration of MAC-hs parameters | 90 |
| 11.6.2.7 | HARQ procedure for HS-SCCH less operation (FDD only) | 91 |
| 11.6.3 | Network operation | 91 |
| 11.6.3.1 | Scheduler..... | 91 |
| 11.6.3.2 | HARQ entity | 92 |
| 11.6.3.3 | HARQ process | 93 |
| 11.6.4 | UE operation..... | 93 |
| 11.6.4.1 | HARQ Entity..... | 93 |
| 11.6.4.2 | HARQ process | 93 |
| 11.6.4.3 | Disassembly entity | 94 |
| 11.6.4.4 | Reordering queue distribution entity..... | 94 |
| 11.6.4.5 | Reordering entity..... | 94 |
| 11.6.4.5.1 | Definitions | 94 |
| 11.6.4.5.2 | Reordering functionality..... | 95 |
| 11.6.4.6 | Reassembly unit | 97 |
| 11.6.4.7 | Demultiplexing entity..... | 97 |
| 11.6.4.8 | MAC-ehs Reset | 98 |
| 11.6.4.9 | Reconfiguration of MAC-ehs parameters | 98 |
| 11.7 | HS-DSCH Provided Bit Rate measurement | 98 |
| 11.8 | Control of E-DCH transmission and reception (FDD)..... | 99 |
| 11.8.1 | UE operation..... | 99 |
| 11.8.1.1 | HARQ Operation..... | 99 |
| 11.8.1.1.1 | HARQ entity..... | 99 |
| 11.8.1.1.2 | HARQ process..... | 99 |
| 11.8.1.2 | Multiplexing and TSN setting entity..... | 100 |
| 11.8.1.2.1 | TSN setting process operation..... | 100 |
| 11.8.1.3 | Serving Grant Update..... | 101 |
| 11.8.1.3.1 | Baseline Procedure | 101 |
| 11.8.1.3.2 | Handling at start of E-DCH transmission | 102 |
| 11.8.1.3.3 | Handling at serving cell change..... | 103 |
| 11.8.1.3.4 | Handling at TTI change..... | 103 |
| 11.8.1.3.5 | Higher Layer Signalling | 103 |
| 11.8.1.4 | E-TFC Selection..... | 104 |
| 11.8.1.5 | Happy Bit Setting..... | 106 |
| 11.8.1.6 | Scheduling Information reporting | 107 |
| 11.8.1.6.1 | Report Triggering when SG = "Zero_Grant" or all processes are deactivated..... | 107 |
| 11.8.1.6.2 | Report Triggering when SG <> "Zero_Grant" and at least one process is activated..... | 107 |
| 11.8.1.7 | MAC-es/e Reset | 108 |
| 11.8.1.8 | Monitoring of Absolute and Relative Grant Channels | 108 |
| 11.8.2 | Node B operation..... | 109 |
| 11.8.2.1 | HARQ Operation | 109 |
| 11.8.2.1.1 | HARQ entity..... | 109 |
| 11.8.2.1.2 | HARQ process..... | 109 |

| | | |
|--------------------------------|------------------------------------------------------------------|------------|
| 11.8.2.2 | De-multiplexing | 109 |
| 11.8.2.3 | Scheduler..... | 109 |
| 11.8.2.4 | E-DCH Provided Bit Rate measurement..... | 109 |
| 11.8.3 | RNC operation | 110 |
| 11.8.3.1 | Re-ordering entity | 110 |
| 11.9 | Control of E-DCH transmission and reception (TDD)..... | 110 |
| 11.9.1 | UE operation..... | 110 |
| 11.9.1.1 | HARQ Operation | 110 |
| 11.9.1.1.1 | HARQ entity..... | 111 |
| 11.9.1.1.2 | HARQ process..... | 112 |
| 11.9.1.2 | Multiplexing and TSN setting entity..... | 113 |
| 11.9.1.3 | Receiving a Grant..... | 113 |
| 11.9.1.4 | E-TFC Selection..... | 113 |
| 11.9.1.5 | Scheduling Information reporting (1.28 Mcps TDD only)..... | 114 |
| 11.9.2 | Node B operation..... | 115 |
| 11.9.2.1 | HARQ Operation | 115 |
| 11.9.2.1.1 | HARQ entity..... | 115 |
| 11.9.2.1.2 | HARQ process..... | 115 |
| 11.9.2.2 | De-multiplexing | 115 |
| 11.9.2.3 | Scheduler..... | 115 |
| 11.9.2.4 | E-DCH Provided Bit Rate measurement..... | 116 |
| 11.9.3 | RNC operation | 116 |
| 11.9.3.1 | Re-ordering entity | 116 |
| Annex A (normative): | HS-DSCH Transport Block Size Table for FDD | 117 |
| Annex B (normative): | E-DCH Transport Block Size Tables for FDD..... | 121 |
| B.1 | 2ms TTI E-DCH Transport Block Size Table 0 | 121 |
| B.2 | 2ms TTI E-DCH Transport Block Size Table 1 | 121 |
| B.2a | 2ms TTI E-DCH Transport Block Size Table 2 | 122 |
| B.2b | 2ms TTI E-DCH Transport Block Size Table 3 | 123 |
| B.3 | 10ms TTI E-DCH Transport Block Size Table 0 | 124 |
| B.4 | 10ms TTI E-DCH Transport Block Size Table 1 | 124 |
| Annex BA (normative): | E-DCH Transport Block Size Tables for 3.84 Mcps TDD | 126 |
| BA.1 | 10ms TTI E-DCH Transport Block Size Table 0 | 126 |
| Annex BB (normative): | E-DCH Transport Block Size Tables for 7.68 Mcps TDD | 129 |
| BB.1 | 10ms TTI E-DCH Transport Block Size Table 0 | 129 |
| Annex BC (normative): | E-DCH Transport Block Size Tables for 1.28 Mcps TDD | 132 |
| BC.1 | 5ms TTI E-DCH Transport Block Size Table 0 | 132 |
| Annex C (informative): | Pseudo-Code for E-TFC Selection (FDD)..... | 137 |
| Annex CA (informative): | Pseudo-Code for E-TFC Selection (TDD)..... | 139 |
| Annex D (informative): | Change history | 141 |
| History | | 145 |

Foreword

This Technical Specification (TS) has been produced by the 3rd Generation Partnership Project (3GPP).

The contents of the present document are subject to continuing work within the TSG and may change following formal TSG approval. Should the TSG modify the contents of the present document, it will be re-released by the TSG with an identifying change of release date and an increase in version number as follows:

Version x.y.z

where:

- x the first digit:
 - 1 presented to TSG for information;
 - 2 presented to TSG for approval;
 - 3 or greater indicates TSG approved document under change control.
- y the second digit is incremented for all changes of substance, i.e. technical enhancements, corrections, updates, etc.
- z the third digit is incremented when editorial only changes have been incorporated in the document.

1 Scope

The present document specifies the MAC protocol.

The specification describes:

- MAC architecture;
- MAC entities;
- channel structure;
- services provided to upper layers;
- MAC functions;
- services expected from the physical layer;
- elements for layer-to-layer communication including primitives between MAC and RLC;
- elements for peer-to-peer communication;
- protocol data units, formats and parameters;
- elementary procedures.

2 References

The following documents contain provisions which, through reference in this text, constitute provisions of the present document.

- References are either specific (identified by date of publication, edition number, version number, etc.) or non-specific.
- For a specific reference, subsequent revisions do not apply.
- For a non-specific reference, the latest version applies. In the case of a reference to a 3GPP document (including a GSM document), a non-specific reference implicitly refers to the latest version of that document *in the same Release as the present document*.

- [1] 3GPP TR 21.905: "Vocabulary for 3GPP Specifications".
- [2] 3GPP TS 25.301: "Radio Interface Protocol Architecture".
- [3] 3GPP TS 25.302: "Services provided by the Physical Layer".
- [4] 3GPP TS 25.303: "Interlayer Procedures in Connected Mode".
- [5] 3GPP TS 25.304: "UE Procedures in Idle Mode and Procedures for Cell Reselection in Connected Mode".
- [6] 3GPP TS 25.322: "RLC Protocol Specification".
- [7] 3GPP TS 25.331: "Radio Resource Control (RRC); protocol specification".
- [8] 3GPP TR 25.921: "Guidelines and Principles for Protocol Description and Error Handling".
- [9] 3GPP TR 25.990: "Vocabulary for the UTRAN".
- [10] 3GPP TS 33.102: "Security architecture".
- [11] 3GPP TS 25.425: "UTRAN Iur Interface User Plane Protocols for Common Transport Channel Data Streams".

- [12] 3GPP TS 25.133: "Requirements for support of radio resource management (FDD)".
- [13] 3GPP TS 25.214: "Physical layer procedures (FDD)".
- [14] 3GPP TS 25.123: "Requirements for support of radio resource management (TDD)".
- [15] 3GPP TS 33.105: "Cryptographic Algorithm Requirements".
- [16] 3GPP TS 25.212: "Multiplexing and Channel Coding (FDD)".
- [17] 3GPP TS 25.215: "Physical layer - Measurements (FDD)".
- [18] 3GPP TS 25.224: "Physical layer procedures (TDD)".
- [19] 3GPP TS 25.222: "Multiplexing and Channel Coding (TDD)".
- [20] 3GPP TS 25.225: "Physical layer – Measurements (TDD)".
- [21] 3GPP TS 25.221 "Physical Channels and Mapping of Transport Channels onto Physical Channels (TDD)"
- [22] 3GPP TS 25.213: "Spreading and modulation (FDD)".

3 Definitions and abbreviations

3.1 Definitions

For the purposes of the present document, the terms and definitions given below and in [9] and [1] apply.

3.1.1 HS-DSCH Specific Definitions

3.1.2 E-DCH Specific Definitions

3.1.2.1 General

E-DCH: The Enhanced Dedicated Channel (E-DCH) is an uplink transport channel.

HARQ profile: One HARQ profile consists of a power offset attribute and maximum number of transmissions. For 1.28 Mcps TDD, it also includes a retransmission timer attribute.

Power offset attribute (FDD): This represents the power offset between E-DPDCH(s) and reference E-DPDCH power level for a given E-TFC. This power offset attribute is set to achieve the required QoS in this MAC-d flow when carried alone in a MAC-e PDU and subsequently in the corresponding CCTrCh of E-DCH type. Details on the mapping on Beta factors can be found in [13]. The reference E-DPDCH power offset is signalled to the UE for one (or several) reference E-TFC(s) (see details in subclause 11.1).

Power offset attribute (TDD): This represents the power offset between E-PUCH and reference E-PUCH power level P_{e-base} for a given E-TFC. This power offset attribute is set to achieve the required QoS in this MAC-d flow when carried alone in a MAC-e PDU and subsequently in the corresponding CCTrCh of E-DCH type. Details on the power offset can be found in [18]. The reference beta value is signalled to the UE for one (or several) reference code rate(s).

Primary Absolute Grant: Absolute Grant received with the primary E-RNTI. Note that the primary E-RNTI is the only E-RNTI for TDD.

Serving E-DCH cell: Cell from which the UE receives Absolute Grants from the Node-B scheduler. A UE has one Serving E-DCH cell.

Serving_Grant (FDD): The state variable `Serving_Grant` indicates the maximum E-DPDCH to DPCCCH power ratio that the UE is allowed to use for scheduled data in the following transmission. The value in the appropriate state variable will be provided to the E-TFC selection function to help in selecting the best format for the upcoming

transmission. Possible values are: "Zero_Grant" and numerical values. The DPCCH power assumed for the Serving_Grant in a compressed frame is the actual DPCCH power in the compressed frame minus the Δ_{PILLOT} power as defined in [13].

Serving_Grant (TDD): The state variable Serving_Grant indicates the maximum E-PUCH to reference power level $P_{e_{\text{base}}}$ power ratio that the UE is allowed to use for scheduled data on the physical resources associated with the E-AGCH grant. The value in the appropriate state variable will be provided to the E-TFC selection function to help in selecting the best format for the upcoming transmission. Possible values are: "Zero_Grant" and numerical values.

3.1.2.2 FDD

Active Process: HARQ process for which Scheduling Grant are applicable, i.e. scheduled data can be sent.

AG_Timer: This timer is set to one HARQ RTT (40ms in the case of 10ms TTI, 16ms in the case of 2ms TTI).

E-DCH active set: The set of cells which carry the E-DCH for one UE.

Inactive Process: HARQ process for which Scheduling Grants are not applicable, i.e. scheduled data cannot be sent.

INACTIVE: Absolute Grant value that can be sent by the serving cell's scheduler on the E-AGCH to deactivate a process or to switch the UE to its secondary E-RNTI.

Maximum_Serving_Grant: The variable Maximum_Serving_Grant indicates the maximum E-DPDCH to DPCCH power ratio that the UE is allowed to use for scheduled data while the timer Non_Serving_RG_Timer has not expired.

Maximum number of re-transmissions, Maximum number of transmissions: Maximum number of re-transmissions = maximum number of transmissions - 1. Both these notations are used.

Minimum_Grant: The value Minimum_Grant corresponds to the minimum E-DPDCH to DPCCH power ratio that the UE considers. This value is in index 0 of the configured scheduling grant table described in subclause 9.2.5.2.1.

Non-serving E-DCH RL or Non-serving RL: Cell which belongs to the E-DCH active set but does not belong to the Serving E-DCH RLS and from which the UE can receive one Relative Grant. The UE can have zero, one or several Non-serving E-DCH RL(s).

Non_Serving_RG_Timer: This timer is set to one HARQ RTT (40ms in the case of 10ms TTI, 16ms in the case of 2ms TTI).

Primary Absolute Grant: Absolute Grant received with the primary E-RNTI.

Primary_Grant_Available: This state variable is a Boolean, indicating whether the UE's serving grant is only affected by Primary Absolute Grants and Relative Grants (i.e. not by Secondary Absolute Grants).

reference_ETPR: The state variable reference_ETPR holds the E-DPDCH to DPCCH power ratio used as reference for relative grant commands. This variable is set to the E-DPDCH to DPCCH power ratio used for the E-TFC selected for the previous TTI on this HARQ process, calculated using the amplitude ratios prior to the quantization according to subclause 5.1.2.5B.2.3 of [13], excluding non-scheduled transmissions, excluding any scaling applied according to subclause 5.1.2.6 of [13] and is obtained from the physical layer. In case no scheduled transmission took place on a HARQ process in the previous TTI, reference_ETPR shall be set to Minimum_Grant for this HARQ process.

Secondary Absolute Grant: Absolute Grant received with the secondary E-RNTI.

Serving E-DCH RLS or Serving RLS: Set of cells which contains at least the Serving E-DCH cell and from which the UE can receive and combine one Relative Grant. The UE has only one Serving E-DCH RLS.

Stored_Secondary_Grant: This state variable is used to store the last received Secondary Absolute Grant Value. Possible values are: "Zero_Grant" and numerical values.

3.1.3 DTX-DRX and HS-SCCH less Specific definitions (FDD only)

MAC DTX cycle: Defines the pattern of time instances where the start the uplink E-DCH transmission after inactivity is allowed.

MAC Inactivity Threshold: E-DCH inactivity time after which the UE can start E-DCH transmission only at given times.

UE DTX DRX Offset: Uplink DPCCCH transmission pattern and HS-SCCH reception pattern offset in subframes.

HS-SCCH less mode of operation: HS-SCCH less mode of operation is enabled when the variable HS_SCCH_LESS_STATUS defined in [7] is set to TRUE.

Inactivity Threshold for UE Grant Monitoring: Determines the number of subframes after an E-DCH scheduled transmission during which the UE is required to monitor the full E-AGCH transmissions from the serving radio link and the full E-RGCH(s) from all the cells in the E-DCH active set.

3.2 Abbreviations

For the purposes of the present document, the following abbreviations apply:

| | |
|---------|-------------------------------------------------------|
| AG | Absolute Grant |
| ASC | Access Service Class |
| BCCH | Broadcast Control Channel |
| BCH | Broadcast Channel |
| C- | Control- |
| CCCH | Common Control Channel |
| DCCH | Dedicated Control Channel |
| DCH | Dedicated Channel |
| DL | Downlink |
| DSCH | Downlink Shared Channel |
| DTCH | Dedicated Traffic Channel |
| E-AGCH | E-DCH Absolute Grant Channel |
| E-DCH | Enhanced Dedicated Transport Channel |
| E-DPCCH | E-DCH Dedicated Physical Control Channel (FDD only) |
| ENI | E-UCCH Number Indication (1.28Mcps TDD only) |
| E-HICH | E-DCH HARQ Acknowledgement Indicator Channel |
| E-PUCH | Enhanced Uplink Physical Channel (TDD only) |
| E-RGCH | E-DCH Relative Grant Channel |
| E-RGCH | E-DCH Relative Grant Channel (FDD only) |
| E-RNTI | E-DCH Radio Network Temporary Identifier |
| E-RUCCH | E-DCH Random Access Uplink Control Channel (TDD only) |
| E-TFC | E-DCH Transport Format Combination |
| E-TFCI | E-DCH Transport Format Combination Indicator |
| E-UCCH | E-DCH Uplink Control Channel (TDD only) |
| FACH | Forward Link Access Channel |
| FDD | Frequency Division Duplex |
| HARQ | Hybrid Automatic Repeat Request |
| HCSN | HS-SCCH Cyclic Sequence Number |
| HSDPA | High Speed Downlink Packet Access |
| HS-DSCH | High Speed Downlink Shared Channel |
| L1 | Layer 1 (physical layer) |
| L2 | Layer 2 (data link layer) |
| L3 | Layer 3 (network layer) |
| MAC | Medium Access Control |
| MBMS | Multimedia Broadcast Multicast Service |
| MCCH | MBMS point-to-multipoint Control Channel |
| MTCH | MBMS point-to-multipoint Traffic Channel |
| MSCH | MBMS point-to-multipoint Scheduling Channel |
| PCCH | Paging Control Channel |
| PCH | Paging Channel |
| PDU | Protocol Data Unit |
| PHY | Physical layer |
| PhyCH | Physical Channels |
| RACH | Random Access Channel |
| RG | Relative Grant |
| RLC | Radio Link Control |

| | |
|-------|--------------------------------------------|
| RLS | Radio Link Set |
| RNC | Radio Network Controller |
| RNS | Radio Network Subsystem |
| RNTI | Radio Network Temporary Identity |
| RRC | Radio Resource Control |
| RSN | Retransmission Sequence Number |
| SAP | Service Access Point |
| SDU | Service Data Unit |
| SHCCH | Shared Channel Control Channel |
| SRNC | Serving Radio Network Controller |
| SRNS | Serving Radio Network Subsystem |
| TDD | Time Division Duplex |
| TFCI | Transport Format Combination Indicator |
| TFI | Transport Format Indicator |
| TSN | Transmission Sequence Number |
| U- | User- |
| UE | User Equipment |
| UL | Uplink |
| UMTS | Universal Mobile Telecommunications System |
| USCH | Uplink Shared Channel |
| UTRA | UMTS Terrestrial Radio Access |
| UTRAN | UMTS Terrestrial Radio Access Network |

4 General

4.1 Objective

The objective is to describe the MAC architecture and the different MAC entities from a functional point of view.

4.2 MAC architecture

The description in this subclause is a model and does not specify or restrict implementations.

According to the RRC functions the RRC is generally in control of the internal configuration of the MAC.

Both MAC-hs and MAC-ehs are responsible for handling the data transmitted on the HS-DSCH. Furthermore they are responsible for the management of the physical resources allocated to HS-DSCH. Upper layers configure which of the two entities, MAC-hs or MAC-ehs, is to be applied to handle HS-DSCH functionality.

4.2.1 MAC Entities

The diagrams that describe the MAC architecture are constructed from MAC entities.

The entities are assigned the following names.

- MAC-b is the MAC entity that handles the following transport channels:
 - broadcast channel (BCH)
- MAC-c/sh/m, is the MAC entity that handles the following transport channels:
 - paging channel (PCH)
 - forward access channel (FACH)
 - random access channel (RACH)
 - downlink shared channel (DSCH). The DSCH exists only in TDD mode.
 - uplink shared channel (USCH). The USCH exists only in TDD mode.

- MAC-d is the MAC entity that handles the following transport channels:
 - dedicated transport channel (DCH)
- MAC-hs/ehs is the MAC entity that handles the following transport channels:
 - high speed downlink shared channel (HS-DSCH)
- MAC-m is the MAC entity that handles the following transport channels:
 - forward access channel (FACH).
- MAC-e/es are the MAC entities that handle the following transport channels:
 - enhanced dedicated transport channel (E-DCH).

The exact functions completed by the entities are different in the UE from those completed in the UTRAN.

NOTE: When a UE is allocated resources for exclusive use by the bearers that it supports the MAC-d entities dynamically share the resources between the bearers and are responsible for selecting the TFI/ TFCI that is to be used in each transmission time interval.

4.2.2 MAC-b

The following diagram illustrates the connectivity of the MAC-b entity in a UE and in each cell of the UTRAN.

MAC-b represents the control entity for the broadcast channel (BCH).

There is one (current cell) or multiple (current and neighbour cells) MAC-b entities in each UE and one MAC-b in the UTRAN for each cell.

The MAC Control SAP is used to transfer Control information to MAC-b.

The MAC-b entity is located in the Node B.

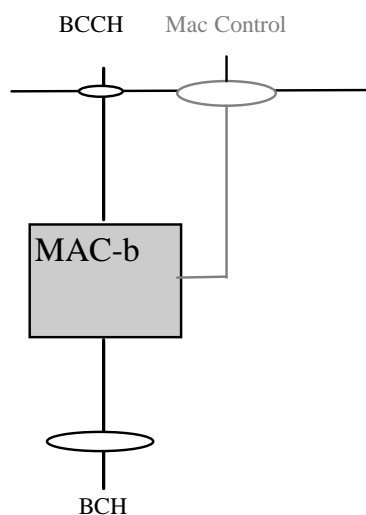

Figure 4.2.2.1: UE side and UTRAN side architecture

4.2.3 Traffic Related Architecture - UE Side

Figure 4.2.3.1 illustrates the connectivity of MAC entities.

The MAC-c/sh/m controls access to all common transport channels, except the HS-DSCH transport channel.

The MAC-d controls access to all dedicated transport channels, to MAC-c/sh/m and MAC-hs/ehs.

The MAC-hs/ehs handles the HSDPA specific functions and controls access to the HS-DSCH transport channel. Upper layers configure which of the two entities, MAC-hs or MAC-ehs, is to be applied to handle HS-DSCH functionality.

The MAC-e/es controls access to the E-DCH transport channel.

In case of selective combining of MTCH channels from multiple cells, the MAC-m controls access to the FACH transport channels used to carry MTCH and MSCH.

In the downlink, if logical channels of dedicated type are mapped to common transport channels then MAC-d receives the data from MAC-c/sh/m or MAC-hs/ehs via the illustrated connection between the functional entities.

In the uplink, if logical channels of dedicated type are mapped to common transport channels then MAC-d submits the data to MAC-c/sh/m via the illustrated connection between the functional entities.

The mapping of logical channels on transport channels depends on the multiplexing that is configured by RRC.

The MAC Control SAP is used to transfer Control information to each MAC entity.

The associated signalling shown in the figure illustrates the exchange of information between layer 1 and layer 2 provided by primitives shown in [3].

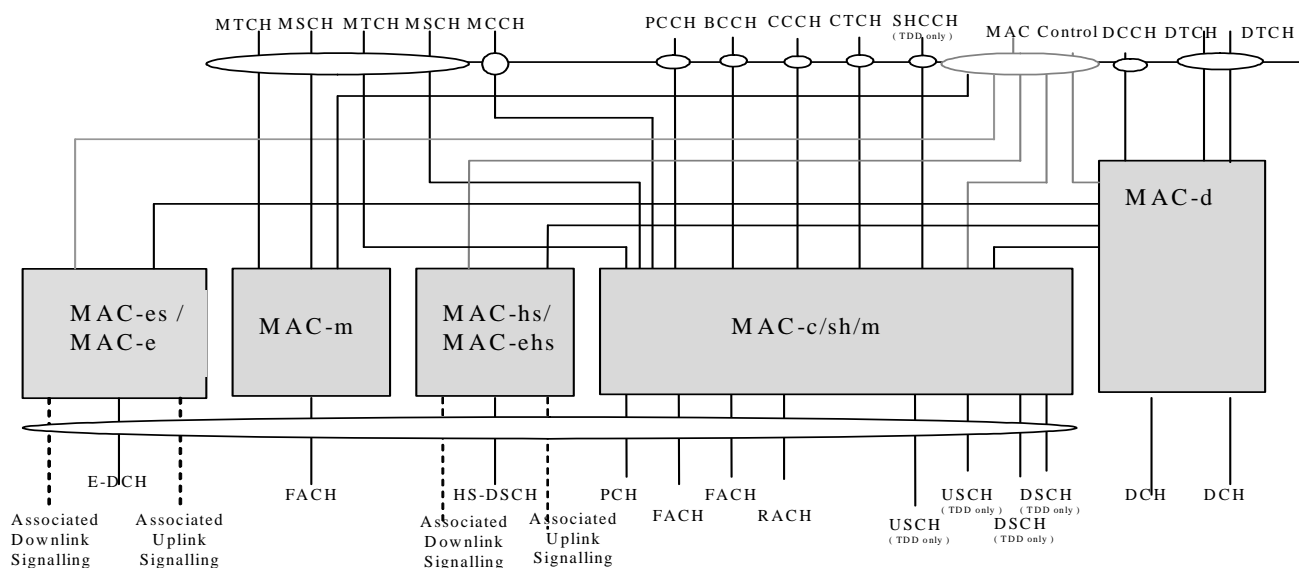

Figure 4.2.3.1: UE side MAC architecture

4.2.3.1 MAC-c/sh/m entity – UE Side

Figure 4.2.3.1.1 shows the UE side MAC-c/sh/m entity.

The following functionality is covered:

- TCTF MUX:
 - this function represents the handling (insertion for uplink channels and detection and deletion for downlink channels) of the TCTF field in the MAC header, and the respective mapping between logical and transport channels.
The TCTF field indicates the common logical channel type, or if a dedicated logical channel is used;
- add/read UE Id:
 - the UE Id is added for RACH transmissions;
 - the UE Id, when present, identifies data to this UE.

- read MBMS Id:
 - the MBMS Id is read in case of MTCH reception;
 - the MBMS Id identifies received data to an MBMS service.
- UL: TF selection:
 - in the uplink, the possibility of transport format selection exists.
- ASC selection:
 - For RACH, MAC indicates the ASC associated with the PDU to the physical layer. This is to ensure that RACH messages associated with a given Access Service Class (ASC) are sent on the appropriate signature(s) and time slot(s). MAC also applies the appropriate back-off parameter(s) associated with the given ASC. When sending an RRC CONNECTION REQUEST message, RRC will determine the ASC; in all other cases MAC selects the ASC;
- scheduling /priority handling
 - this functionality is used to transmit the information received from MAC-d on RACH based on logical channel priorities. This function is related to TF selection.
- TFC selection
 - transport format and transport format combination selection according to the transport format combination set (or transport format combination subset) configured by RRC is performed,

The RLC provides RLC-PDUs to the MAC, which fit into the available transport blocks on the transport channels.

There is one MAC-c/sh/m entity in each UE.

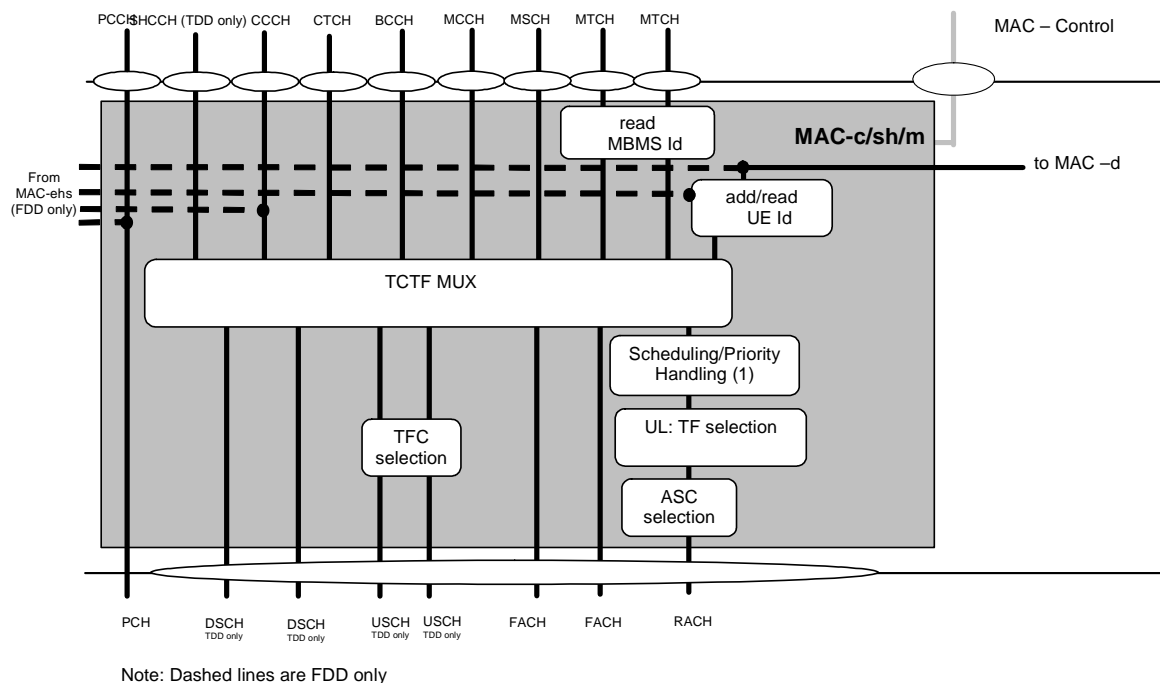

Figure 4.2.3.1.1: UE side MAC architecture / MAC-c/sh/m details

4.2.3.1b MAC-m entity – UE Side

Figure 4.2.3.1b.1 shows the UE side MAC-m entity.

The following functionality is covered:

- TCTF DEMUX:
 - this function represents the handling (detection and deletion for downlink channels) of the TCTF field in the MAC header, and the respective mapping between logical and transport channels.
 - The TCTF field indicates the common logical channel type;
- read MBMS Id
 - the MBMS Id is read in case of MTCH reception;
 - the MBMS Id identifies received data to an MBMS service.

The MAC Control SAP is used to transfer control information to MAC-m.

If MTCH channels are selectively combined, the MAC-m entity exists in the UE. Otherwise, the MAC-m entity does not exist.

In case of selective combining of MTCH channels from multiple cells, there are one MAC-c/sh/m for the current cell and one MAC-m entity for each neighboring cell in the UE.

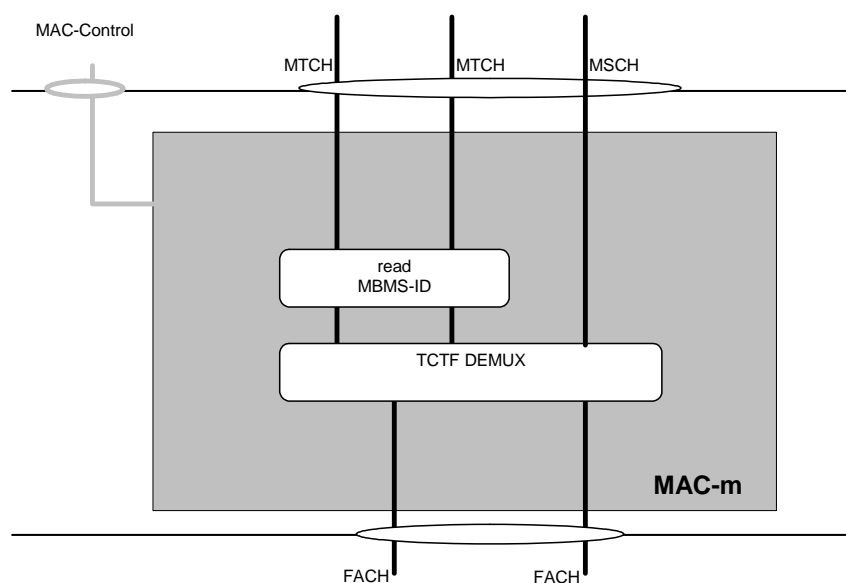

Figure 4.2.3.1b.1: UE side MAC architecture / MAC-m details

4.2.3.2 MAC-d entity – UE Side

Figure 4.2.3.2.1 shows the UE side MAC-d entity.

The following functionality is covered:

- Transport Channel type switching
 - Transport Channel type switching is performed by this entity, based on decision taken by RRC. This is related to a change of radio resources. If requested by RRC, MAC shall switch the mapping of one designated logical channel between common and dedicated transport channels.
- C/T MUX:
 - The C/T MUX is used when multiplexing of several dedicated logical channels onto one transport channel (other than HS-DSCH) or one MAC-d flow (HS-DSCH) is used. An unambiguous identification of the logical channel is included. If MAC-ehs is configured, C/T MUX toward MAC-ehs is not used.
- Ciphering:
 - Ciphering for transparent mode data to be ciphered is performed in MAC-d. Details about ciphering can be found in [10].

- Deciphering:
 - Deciphering for ciphered transparent mode data is performed in MAC-d. Details about ciphering can be found in [10].
- UL TFC selection:
 - Transport format and transport format combination selection according to the transport format combination set (or transport format combination subset) configured by RRC is performed.

The MAC-d entity is responsible for mapping dedicated logical channels for the uplink either onto dedicated transport channels or to transfer data to MAC-c/sh/m to be transmitted via common channels.

One dedicated logical channel can be mapped simultaneously onto DCH and DSCH in TDD mode.

One dedicated logical channel can be simultaneously mapped onto DCH and HS-DSCH.

The MAC-d entity has a connection to the MAC-c/sh/m entity. This connection is used to transfer data to the MAC-c/sh/m to transmit data on transport channels that are handled by MAC-c/sh/m (uplink) or to receive data from transport channels that are handled by MAC-c/sh/m (downlink).

The MAC-d entity has a connection to the MAC-hs or MAC-ehs entity. This connection is used to receive data from the HS-DSCH transport channel which is handled by MAC-hs or MAC-ehs (downlink).

The MAC-d entity has a connection to the MAC-e/es entity. This connection is used to transmit data on the E-DCH transport channel which is handled by the MAC-e/es (uplink).

There is one MAC-d entity in the UE.

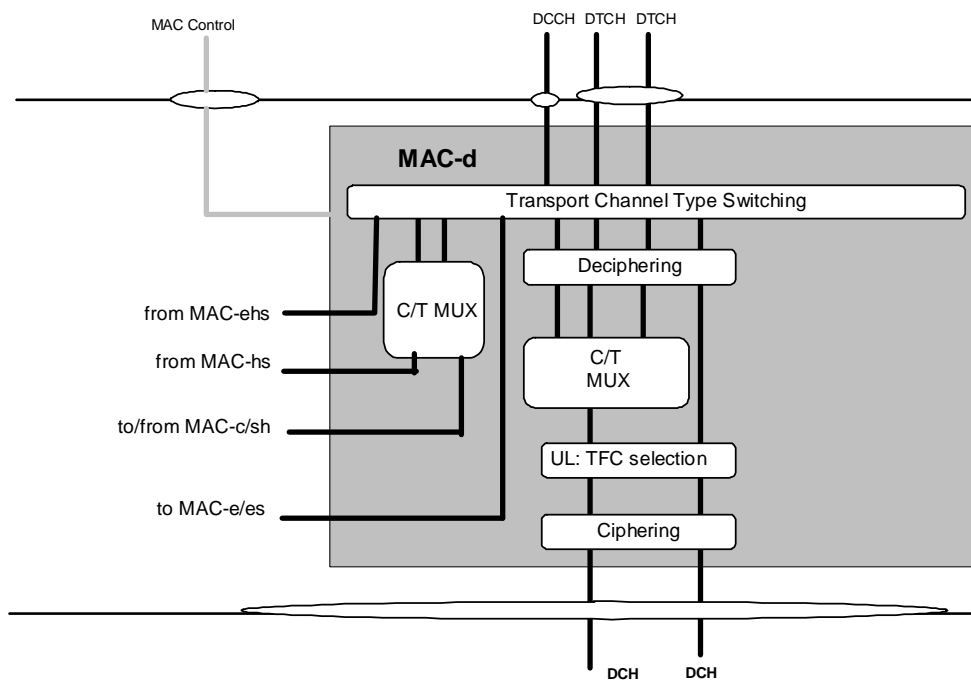

Figure 4.2.3.2.1: UE side MAC architecture / MAC-d details

4.2.3.3 MAC-hs entity – UE Side

In the model below the MAC-hs comprises the following entities:

- HARQ:

The HARQ entity is responsible for handling the MAC functions relating to the HARQ protocol. The HARQ functional entity handles all the tasks that are required for hybrid ARQ. It is responsible for generating ACKs or NACKs. The detailed configuration of the hybrid ARQ protocol is provided by RRC over the MAC-Control SAP. Depending on the HS-DSCH physical layer category, the maximum number of HARQ process per HS-

DSCH per TTI on which an HS-DSCH transmission can be received may be one or two. The HS-DSCH physical layer categories for which the maximum number of HARQ process per HS-DSCH per TTI on which an HS-DSCH transmission can be received is two require the MAC-hs entity to be configured with the enhanced MAC-hs format which is FFS.

- Reordering Queue distribution:
The reordering queue distribution function routes the MAC-hs PDUs to the correct reordering buffer based on the Queue ID.
- Reordering:
The reordering entity reorders received MAC-hs PDUs according to the received TSN. MAC-hs PDUs with consecutive TSNs are delivered to the disassembly function upon reception. MAC-hs PDUs are not delivered to the disassembly function if MAC-hs PDUs with lower TSN are missing. There is one reordering entity for each Queue ID configured at the UE.
- Disassembly:
The disassembly entity is responsible for the disassembly of MAC-hs PDUs. When a MAC-hs PDU is disassembled the MAC-hs header is removed, the MAC-d PDUs are extracted and any present padding bits are removed. Then the MAC-d PDUs are delivered to higher layer.

The associated signalling shown in the figure illustrates the exchange of information between layer 1 and layer 2 provided by primitives shown in [3].

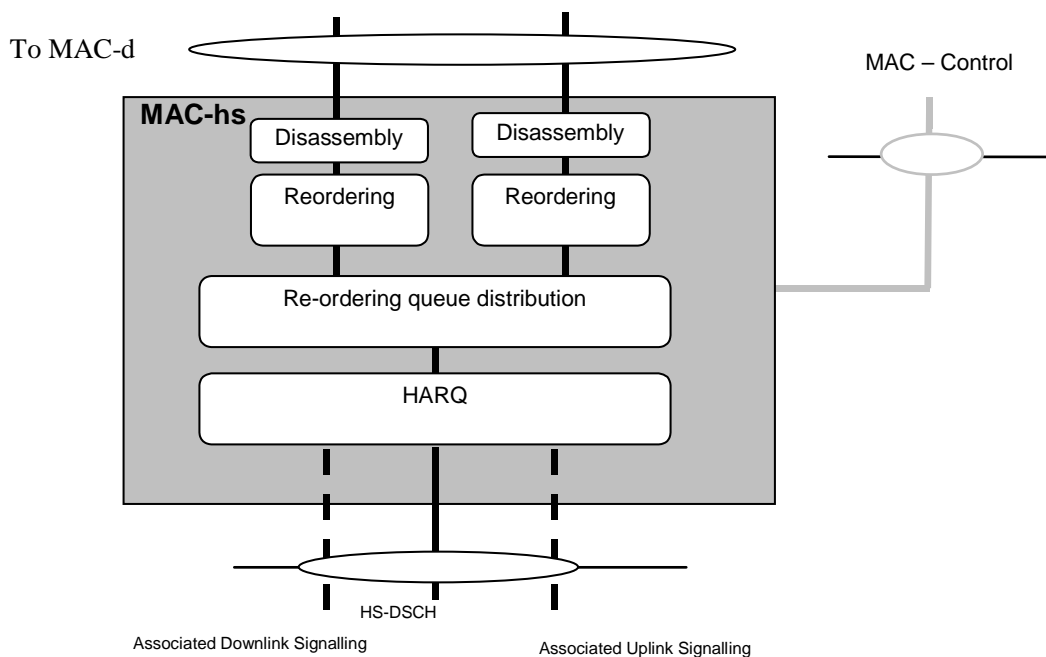

Figure 4.2.3.3.1: UE side MAC architecture / MAC-hs details

4.2.3.4 MAC-e/es entity – UE Side

The MAC-es/e handles the E-DCH specific functions. The split between MAC-e and MAC-es in the UE is not detailed. In the model below the MAC-e/es comprises the following entities:

- HARQ:
The HARQ entity is responsible for handling the MAC functions relating to the HARQ protocol. It is responsible for storing MAC-e payloads and re-transmitting them. The detailed configuration of the hybrid ARQ protocol is provided by RRC over the MAC-Control SAP.
- For FDD: The HARQ entity provides the E-TFC, the retransmission sequence number (RSN), and the power offset to be used by L1. Redundancy version (RV) of the HARQ transmission is derived by L1 from RSN, CFN and in case of 2 ms TTI from the sub-frame number.

- For TDD: The HARQ entity provides the HARQ process identity, the E-TFC, the retransmission sequence number (RSN) and an indication of the power offset to be used by L1. The redundancy version (RV) of the HARQ transmission is derived by L1 from RSN. RRC signalling can also configure the L1 to use RV=0 for every transmission.
- Multiplexing and TSN setting:
The multiplexing and TSN setting entity is responsible for concatenating multiple MAC-d PDUs into MAC-es PDUs, and to multiplex one or multiple MAC-es PDUs into a single MAC-e PDU, to be transmitted in the next TTI, as instructed by the E-TFC selection function. It is also responsible for managing and setting the TSN per logical channel for each MAC-es PDU.
- E-TFC selection:
This entity is responsible for E-TFC selection according to the scheduling information, Relative Grants (FDD only) and Absolute Grants, received from UTRAN via L1 and Serving Grant value signalled through RRC, and for arbitration among the different flows mapped on the E-DCH. The detailed configuration of the E-TFC entity is provided by RRC over the MAC-Control SAP. The E-TFC selection function controls the multiplexing function.
- Scheduling Access Control (TDD only):
The Scheduling Access Control entity is responsible for routing associated uplink signalling via E-UCCH and MAC-e PDU (in the case that E-DCH resources are assigned) or via E-RUCCH (in the case that no E-DCH resources are assigned). It is also responsible for obtaining and formatting the appropriate information to be carried on E-UCCH/E-RUCCH.

NOTE: HARQ process ID and RSN are carried on E-UCCH.

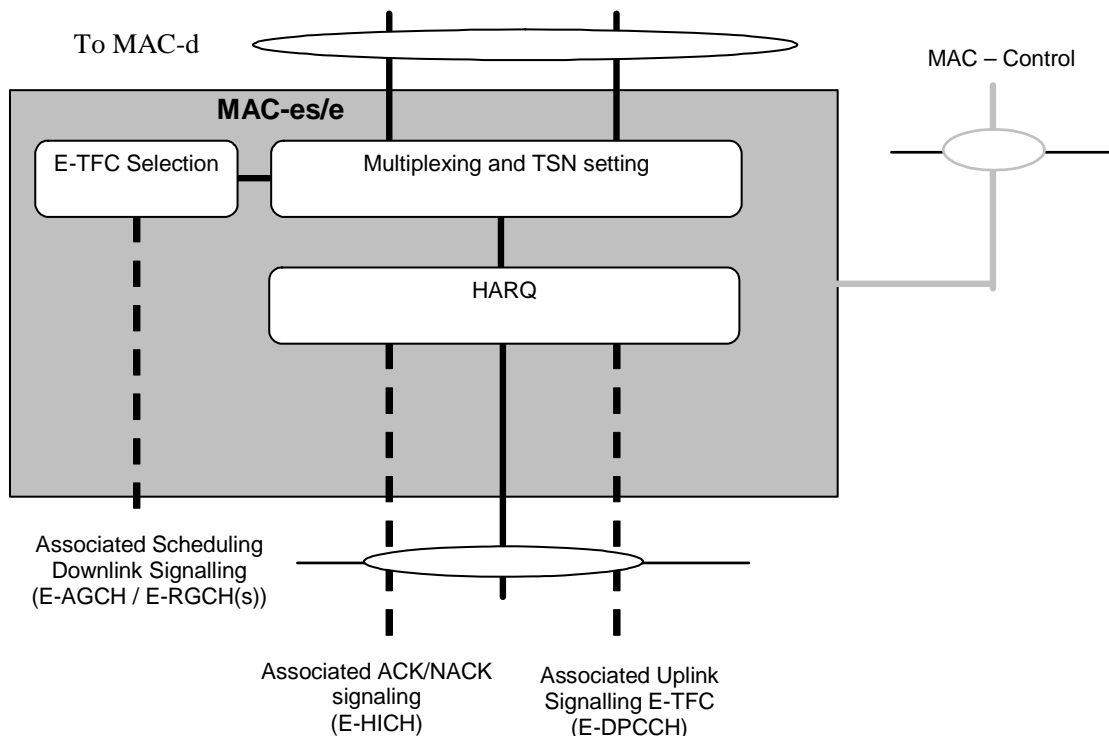

Figure 4.2.3.4.1a: UE side MAC architecture / MAC-e/es details (FDD)

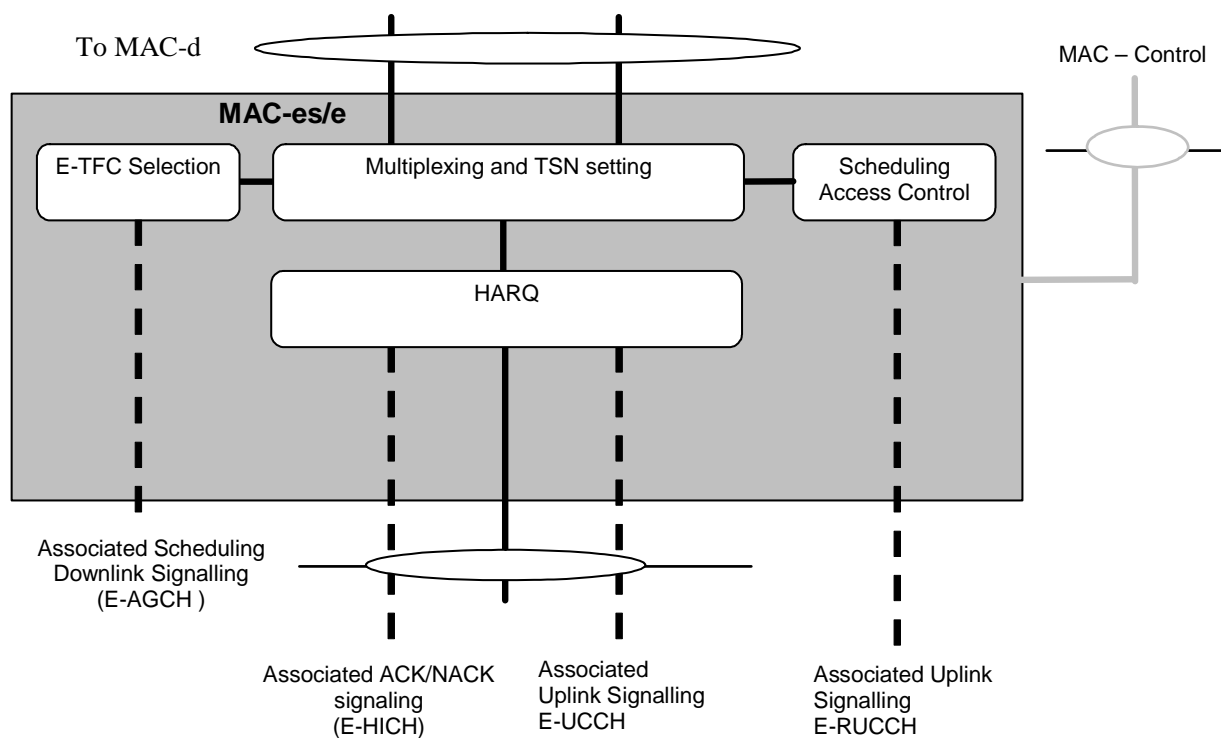

Figure 4.2.3.4.1b: UE side MAC architecture / MAC-e/es details (TDD)

4.2.3.5 MAC-ehs entity – UE Side

In the model below the MAC-ehs comprise the following entities:

- HARQ:
The HARQ entity is responsible for handling the HARQ protocol. There shall be one HARQ process per HS-DSCH per TTI for single stream transmission and two HARQ processes per HS-DSCH per TTI for dual stream transmission. The HARQ functional entity handles all the tasks that are required for hybrid ARQ. It is for example responsible for generating ACKs or NACKs. The detailed configuration of the hybrid ARQ protocol is provided by RRC over the MAC-Control SAP.
- Disassembly
The disassembly entity disassembles the MAC-ehs PDUs by removing the MAC-ehs header and possible padding.
- Reordering queue distribution
The reordering queue distribution function routes the received MAC-ehs SDUs or segments of MAC-ehs SDUs to correct reordering queues based on the received logical channel identifier.
- Reordering:
The reordering entity organises received MAC-ehs SDUs or segments of MAC-ehs SDUs according to the received TSN. Data blocks with consecutive TSNs are delivered to reassembly entity upon reception. A timer mechanism determines delivery of non-consecutive data blocks to higher layers. There is one reordering entity for each priority class.
- Reassembly:
The reassembly entity reassembles segmented MAC-ehs SDUs (corresponding to either MAC-c or MAC-d PDUs) and forwards the MAC PDUs to LCH-ID demultiplexing entity.
- LCH-ID demultiplexing:
The demultiplexing entity routes the MAC-ehs SDUs to correct logical channel based on the received logical channel identifier.

- The following is allowed:
The MAC-ehs SDUs included in a MAC-ehs PDU can have a different size and a different priority and can be mapped to different MAC-d flows.

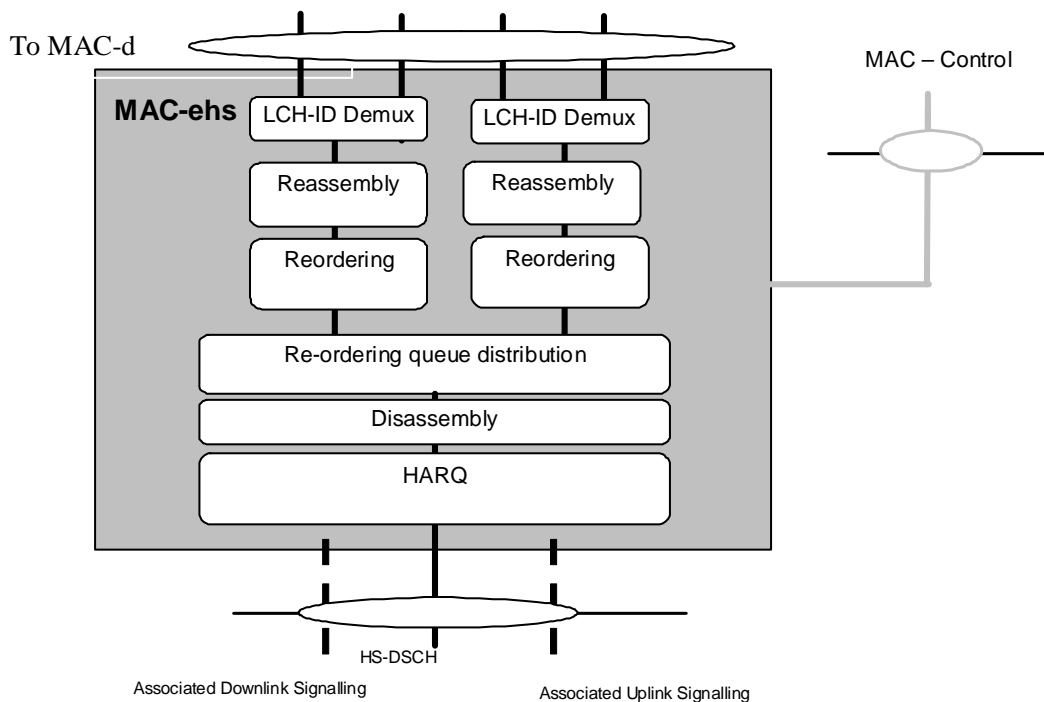

Figure 4.2.3.5-1: UE side MAC architecture/MAC-ehs details.

4.2.4 Traffic Related Architecture - UTRAN Side

Figure 4.2.4.1 illustrates the connectivity between the MAC entities from the UTRAN side.

It is similar to the UE case with the exception that there will be one MAC-d for each UE and each UE (MAC-d) that is associated with a particular cell may be associated with that cell's MAC-c/sh/m.

MAC-c/sh/m is located in the controlling RNC while MAC-d is located in the serving RNC. MAC-hs/ehs is located in the Node B. The MAC-d PDUs to be transmitted are transferred from MAC-c/sh/m to the MAC-hs/ehs via the Iub interface in case of configuration with MAC-c/sh/m, or from the MAC-d via Iur/Iub in case of configuration without MAC-c/sh/m.

For each UE that uses E-DCH, one MAC-e entity per Node-B and one MAC-es entity in the SRNC are configured. MAC-e, located in the Node B, controls access to the E-DCH and is connected to MAC-es, located in the SRNC. MAC-es is further connected to MAC-d. There is one transport bearer set up per E-DCH MAC-d flow.

The MAC Control SAP is used to transfer Control information to each MAC entity belonging to one UE.

The associated signalling shown in the figure illustrates the exchange of information between layer 1 and layer 2 provided by primitives shown in [3].

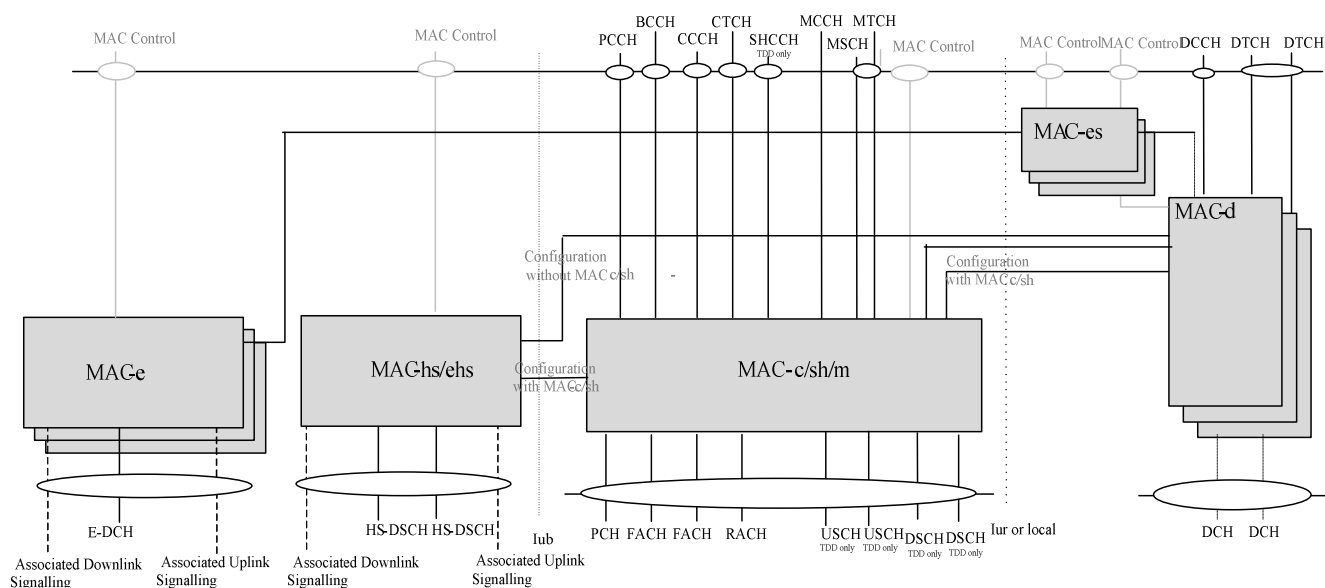

Figure 4.2.4.1: UTRAN side MAC architecture

4.2.4.1 MAC-c/sh/m entity – UTRAN Side

Figure 4.2.4.1.1 shows the UTRAN side MAC-c/sh/m entity. The following functionality is covered:

- Scheduling – Buffering – Priority Handling;
 - this function manages FACH and for TDD DSCH resources between the UEs and between data flows according to their priority and delay requirements set by higher layers.
- TCTF MUX
 - this function represents the handling (insertion for downlink channels and detection and deletion for uplink channels) of the TCTF field in the MAC header, and the respective mapping between logical and transport channels. The TCTF field indicates the common logical channel type, or if a dedicated logical channel is used;
- UE Id Mux;
 - for dedicated type logical channels, the UE Id field in the MAC header is used to distinguish between UEs;
- MBMS Id Mux;
 - for MTCH channels, the MBMS Id field in the MAC header is used to distinguish between MBMS services;
- TFC selection:
 - in the downlink, transport format combination selection is done for FACH and PCH and for TDD DSCHs;
- Demultiplex;
 - for TDD operation the demultiplex function is used to separate USCH data from different UEs, i.e. to be transferred to different MAC-d entities;
- DL code allocation;
 - for TDD this function is used to indicate the code used on the DSCH;

- Flow control;
- a flow control function exists toward MAC-d to limit buffering between MAC-d and MAC-c/sh/m entities. a flow control function also exists towards MAC-hs/ehs in case of configuration with MAC-c/sh/m.

The RLC provides RLC-PDUs to the MAC, which fit into the available transport blocks on the transport channels.

There is one MAC-c/sh/m entity in the UTRAN for each cell;

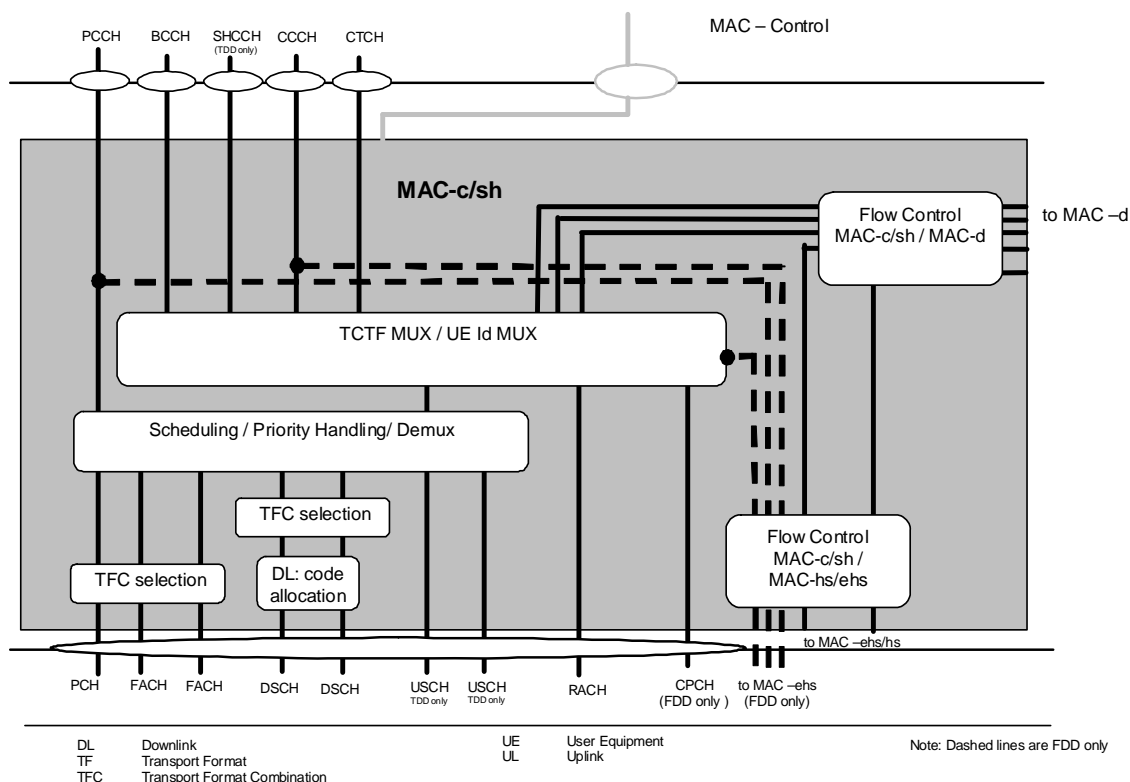

Figure 4.2.4.1.1: UTRAN side MAC architecture / MAC-c/sh/m details

4.2.4.2 MAC-d entity – UTRAN Side

Figure 4.2.4.2.1 shows the UTRAN side MAC-d entity.

The following functionality is covered:

- Transport Channel type switching:
 - Transport Channel type switching is performed by this entity, based on decision taken by RRC; this is related to a change of radio resources. If requested by RRC, MAC shall switch the mapping of one designated logical channel between common and dedicated transport channels.
- C/T MUX box;
 - the function includes the C/T field when multiplexing of several dedicated logical channels onto one transport channel (other than HS-DSCH) or one MAC-d flow (HS-DSCH) is used. If MAC-ehs is configured, C/T MUX toward MAC-ehs is not used.
- Priority setting;
 - This function is responsible for priority setting on data received from DCCH / DTCH;
- Ciphering;

- Ciphering for transparent mode data to be ciphered is performed in MAC-d. Details about ciphering can be found in [10].
- Deciphering;
 - Deciphering for ciphered transparent mode data is performed in MAC-d. Details about ciphering can be found in [10].
- DL Scheduling/Priority handling;
 - in the downlink, scheduling and priority handling of transport channels is performed within the allowed transport format combinations of the TFCS assigned by the RRC.
- Flow Control;
 - a flow control function exists toward MAC-c/sh/m to limit buffering between MAC-d and MAC-c/sh/m entities. This function is intended to limit layer 2 signalling latency and reduce discarded and retransmitted data as a result of FACH or for TDD DSCH congestion. For the Iur interface this is specified in [11]. A flow control function also exists towards MAC-hs/ehs in case of configuration without MAC-c/sh/m, see subclause 4.2.4.2.

A MAC-d entity using common channels other than the high speed downlink shared channel is connected to a MAC-c/sh/m entity that handles the scheduling of the common channels to which the UE is assigned and DL (FACH) priority identification to MAC-c/sh/m;

A MAC-d entity using downlink shared channel is connected to a MAC-c/sh/m entity that handles the shared channels to which the UE is assigned and indicates the level of priority of each PDU to MAC-c/sh/m;

A MAC-d entity using the high speed downlink shared channel may be connected to a MAC-c/sh/m entity that in turn is connected to the MAC-hs/ehs entity in the Node B (configuration with MAC-c/sh/m); alternately, a MAC-d entity using the high speed downlink shared channel may be connected to the MAC-hs/ehs entity in the Node B in case of configuration without MAC-c/sh/m.

A MAC-d entity using the enhanced dedicated transport channel (Uplink only) is connected to a MAC-es entity that handles the re-ordering and combining of data received from different Node Bs. Given that the MAC-es is collocated in the SRNC, it is not necessary to flow control this connection. The MAC-es indicates the logical channel for which the data is intended, to allow the MAC-d to route it appropriately.

A MAC-d entity is responsible for mapping dedicated logical channels onto the available dedicated transport channels or routing the data received on a DCCH or DTCH to MAC-c/sh/m or to MAC-hs/ehs.

One dedicated logical channel can be mapped simultaneously on DCH and DSCH in TDD mode. Different scheduling mechanisms apply for DCH and DSCH. One dedicated logical channel can be mapped simultaneously on DCH and HS-DSCH.

There is one MAC-d entity in the UTRAN for each UE that has one or more dedicated logical channels to or from the UTRAN.

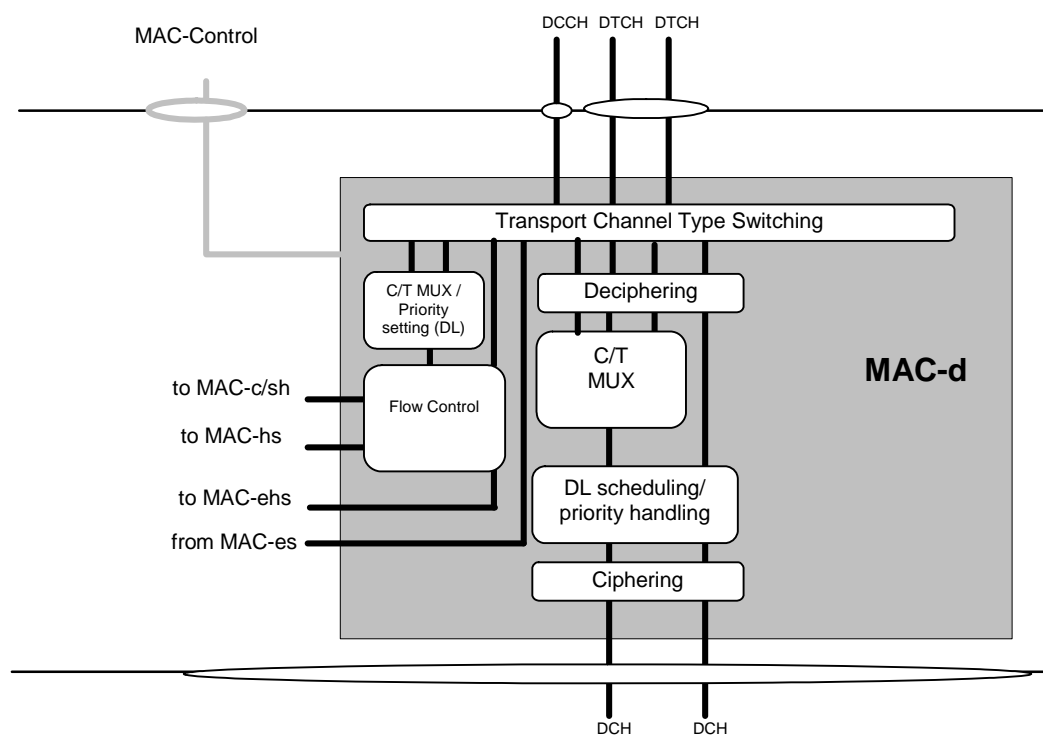

Figure 4.2.4.2.1: UTRAN side MAC architecture / MAC-d details

4.2.4.3 MAC-hs entity – UTRAN Side

There is one MAC-hs entity in the UTRAN for each cell that supports HS-DSCH transmission. The MAC-hs is responsible for handling the data transmitted on the HS-DSCH when configured by upper layers. Furthermore, when configured by upper layers, it is responsible for the management of the physical resources allocated to HSDPA. MAC-hs receives configuration parameters from the RRC layer via the MAC-Control SAP. There should be priority handling per MAC-d PDU in the MAC-hs. The MAC-hs is comprised of four different functional entities:

- **Flow Control:**
This is the companion flow control function to the flow control function in the MAC-c/sh/m in case of configuration with MAC-c/sh/m and MAC-d in case of configuration without MAC-c/sh/m. Both entities together provide a controlled data flow between the MAC-c/sh/m and the MAC-hs (Configuration with MAC-c/sh/m) or the MAC-d and MAC-hs (Configuration without MAC-c/sh/m) taking the transmission capabilities of the air interface into account in a dynamic manner. This function is intended to limit layer 2 signalling latency and reduce discarded and retransmitted data as a result of HS-DSCH congestion. Flow control is provided independently by MAC-d flow for a given MAC-hs entity.
- **Scheduling/Priority Handling:**
This function manages HS-DSCH resources between HARQ entities and data flows according to their priority. Based on status reports from associated uplink signalling either new transmission or retransmission is determined. Further it determines the Queue ID and TSN for each new MAC-hs PDU being serviced, and in the case of TDD the HCSN is determined. A new transmission can be initiated instead of a pending retransmission at any time to support the priority handling.
- **HARQ:**
One HARQ entity handles the hybrid ARQ functionality for one user. One HARQ entity is capable of supporting multiple instances (HARQ process) of stop and wait HARQ protocols. Depending on the HS-DSCH physical layer category, the maximum number of HARQ process per HS-DSCH per TTI on which an HS-DSCH transmission is performed may be one or two. The HS-DSCH physical layer categories for which the maximum number of HARQ process per HS-DSCH per TTI on which an HS-DSCH transmission can be received is two require the MAC-hs entity to be configured with the enhanced MAC-hs format which is FFS.

- TFRC selection:
Selection of an appropriate transport format and resource for the data to be transmitted on HS-DSCH.

The associated signalling shown in the figure illustrates the exchange of information between layer 1 and layer 2 provided by primitives shown in [3].

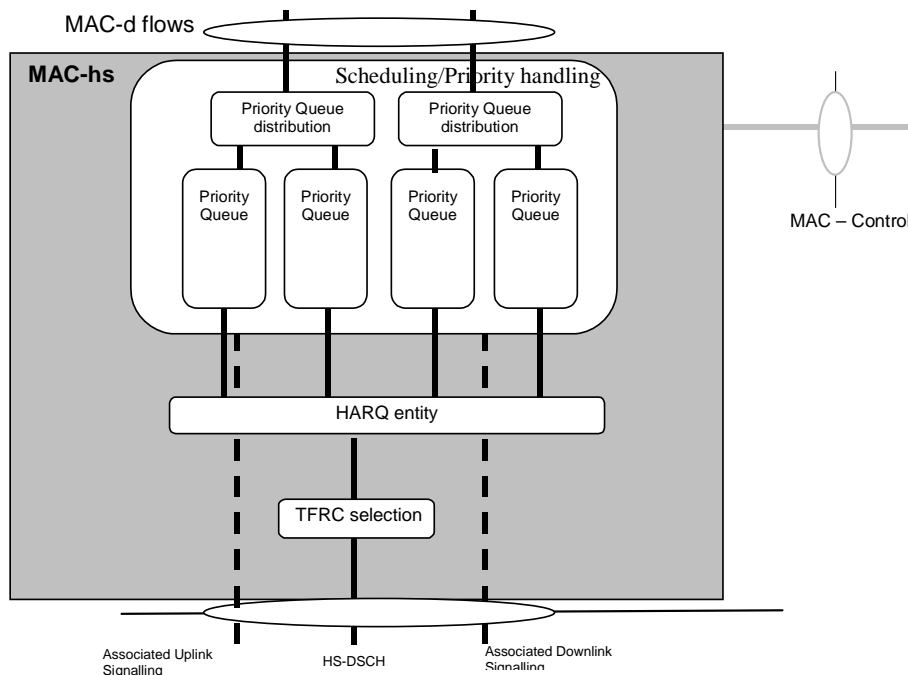

Figure 4.2.4.3.1: UTRAN side MAC architecture / MAC-hs details

4.2.4.4 MAC-es entity – UTRAN Side

For each UE, there is one MAC-es entity in the SRNC. The MAC-es sublayer handles E-DCH specific functionality, which is not covered in the MAC-e entity in Node B. In the model below, the MAC-es comprises the following entities:

- Reordering Queue Distribution:
The reordering queue distribution function routes the MAC-es PDUs to the correct reordering buffer based on the SRNC configuration.
- Reordering:
This function reorders received MAC-es PDUs according to the received TSN and Node-B tagging i.e. (CFN, subframe number). MAC-es PDUs with consecutive TSNs are delivered to the disassembly function upon reception. Mechanisms for reordering MAC-es PDUs received out-of-order are left up to the implementation. There is one Re-ordering Process per logical channel.
- Macro diversity selection (FDD only):
The function is performed in the MAC-es, in case of soft handover with multiple Node-Bs (The soft combining for all the cells of a Node-B takes place in the Node-B). This means that the reordering function receives MAC-es PDUs from each Node-B in the E-DCH active set. The exact implementation is not specified. However the model below is based on one Reordering Queue Distribution entity receiving all the MAC-d flow from all the Node-Bs, and one MAC-es entity per UE.
- Disassembly:
The disassembly function is responsible for disassembly of MAC-es PDUs. When a MAC-es PDU is disassembled the MAC-es header is removed, the MAC-d PDU's are extracted and delivered to MAC-d.

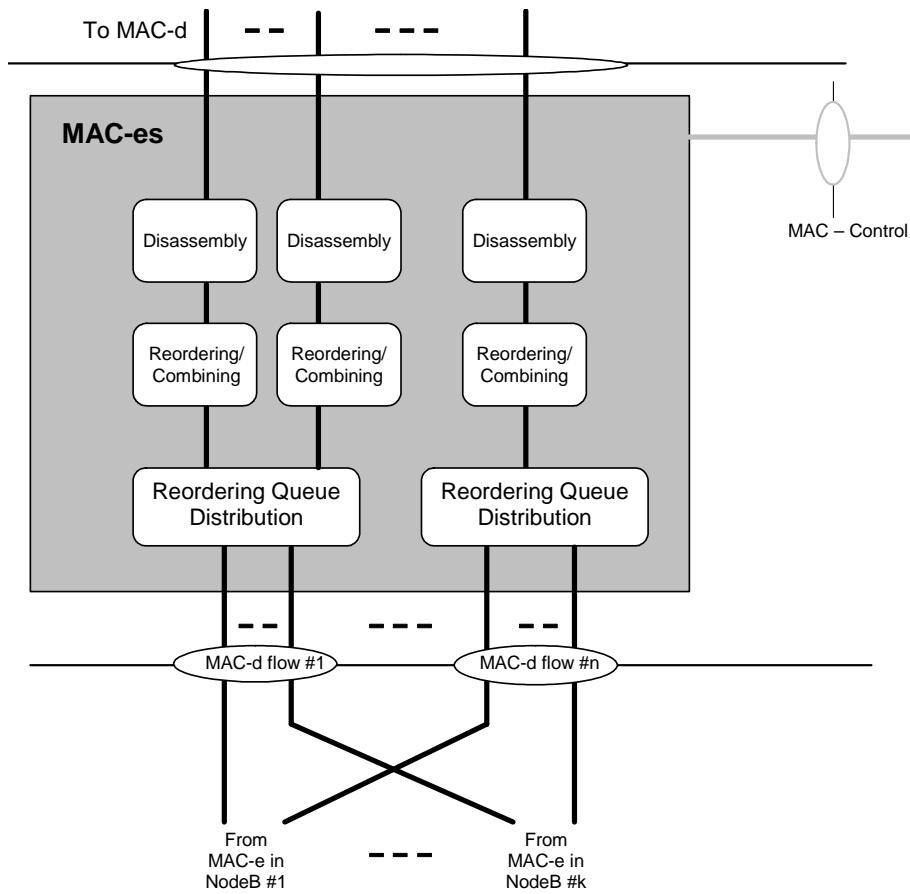

Figure 4.2.4.4-1: UTRAN side MAC architecture / MAC-es details (SHO case, FDD only)

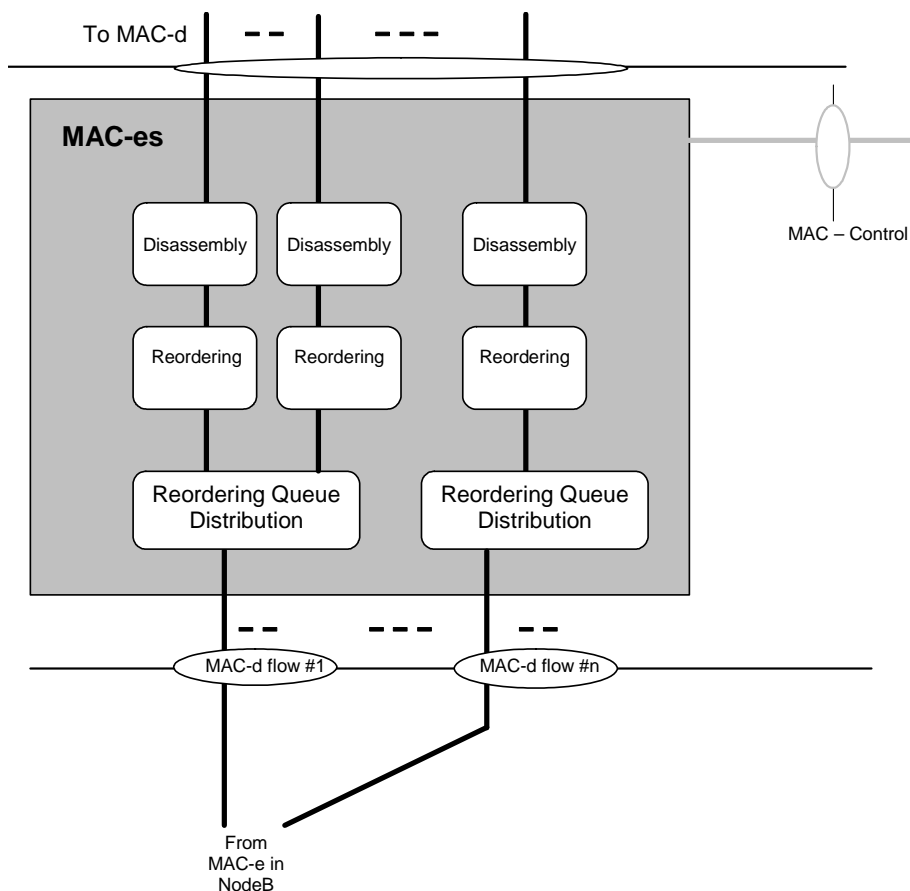

Figure 4.2.4.4-1b: UTRAN side MAC architecture / MAC-es details (TDD)

4.2.4.5 MAC-e entity – UTRAN Side

There is one MAC-e entity in the Node B for each UE and one E-DCH scheduler function in the Node-B. The MAC-e and E-DCH scheduler handle HSUPA specific functions in the Node B. In the model below, the MAC-e and E-DCH scheduler comprises the following entities:

- E-DCH Scheduling:
This function manages E-DCH cell resources between UEs. Based on scheduling requests, Scheduling Grants are determined and transmitted. The general principles of the E-DCH scheduling are described in subclauses 11.8.2.3 and 11.9.2.3 below. However implementation is not specified (i.e. depends on RRM strategy).
- E-DCH Control:
The E-DCH control entity is responsible for reception of scheduling requests and transmission of Scheduling Grants. The general principles of the E-DCH scheduling are described in subclauses 11.8.2.3 and 11.9.2.3 below.
- De-multiplexing:
This function provides de-multiplexing of MAC-e PDUs. MAC-es PDUs are forwarded to the associated MAC-d flow.
- HARQ:
One HARQ entity is capable of supporting multiple instances (HARQ processes) of stop and wait HARQ protocols. Each process is responsible for generating ACKs or NACKs indicating delivery status of E-DCH transmissions. The HARQ entity handles all tasks that are required for the HARQ protocol.

The associated signalling shown in the figures illustrates the exchange of information between layer 1 and layer 2 provided by primitives.

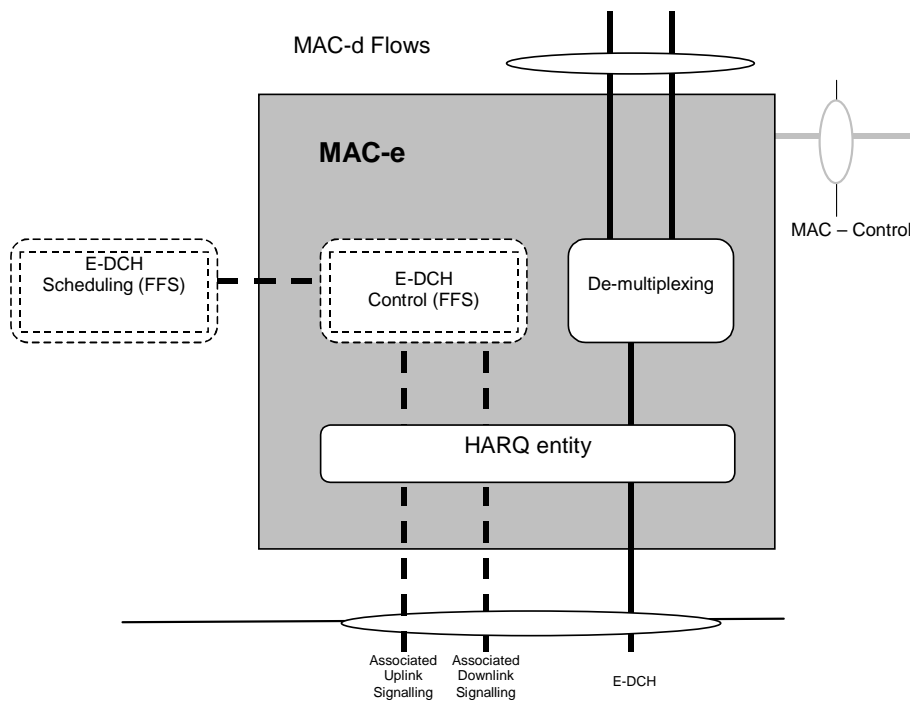

Figure 4.2.4.5-1a: UTRAN side MAC architecture / MAC-e details (FDD)

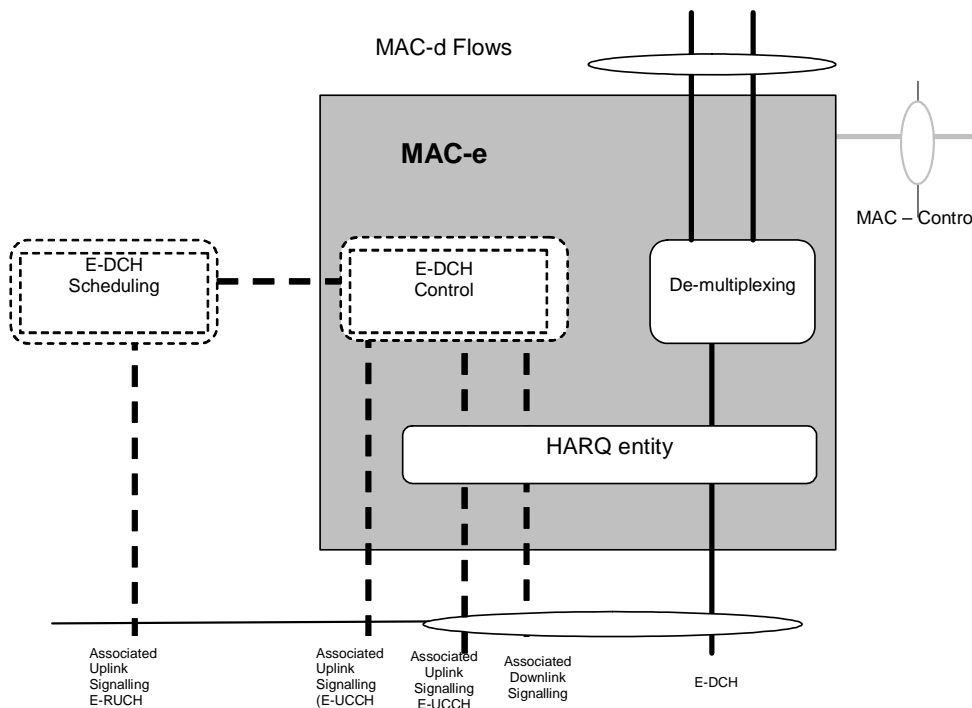

Figure 4.2.4.5-1b: UTRAN side MAC architecture / MAC-e details (TDD)

4.2.4.6 MAC-ehs entity UTRAN Side

There is one MAC-ehs entity in the UTRAN for each cell that supports HS-DSCH transmission. The MAC-ehs is responsible for handling the data transmitted on the HS-DSCH when configured. MAC-hs receives configuration parameters from the RRC layer via the MAC-Control SAP. There should be priority handling per MAC-ehs SDU in the MAC-ehs. The MAC-ehs is comprised of six different functional entities:

- Flow Control:
The flow control for MAC-ehs is identical to the flow control for MAC-hs.

- Scheduling/Priority Handling:
This function manages HS-DSCH resources between HARQ entities and data flows according to their priority class. In FDD, the scheduler determines for each TTI if single or dual stream transmission should be used. Based on status reports from associated uplink signalling either new transmission or retransmission is determined when operating in CELL_DCH state. In FDD, when operating in CELL_FACH, CELL_PCH and URA_PCH state HS-DSCH reception, the MAC-ehs can perform retransmission without uplink signalling. Further it sets the logical channel identifiers and TSNs for each new data block being serviced. To maintain proper transmission priority a new transmission can be initiated on a HARQ process at any time. The TSN is unique to each priority class within a HS-DSCH. It is not permitted to schedule new transmissions, including retransmissions originating in the RLC layer, within the same TTI, along with retransmissions originating from the HARQ layer.
- HARQ:
One HARQ entity handles the hybrid ARQ functionality for one user. One HARQ entity is capable of supporting multiple instances (HARQ process) of stop and wait HARQ protocols. There shall be one HARQ process per TTI for single stream transmission and two HARQ processes per TTI for dual stream transmission.
- TFRI selection:
The TFRI selection for MAC-ehs is identical to the TFRI selection of the MAC-hs.
- LCH-ID mux:
This function determinates the number of octets to be included to MAC-ehs PDU from each logical channel based on the scheduling decision and available TRFI this function.
- Segmentation:
This function performs necessary segmentation of MAC-ehs SDUs.
- The following is allowed:
The MAC-ehs SDUs included in a MAC-ehs PDU can have a different size and a different priority and can be mapped to different MAC-d flows.

The associated signalling shown in the figure illustrates the exchange of information between layer 1 and layer 2 provided by primitives shown in [3].

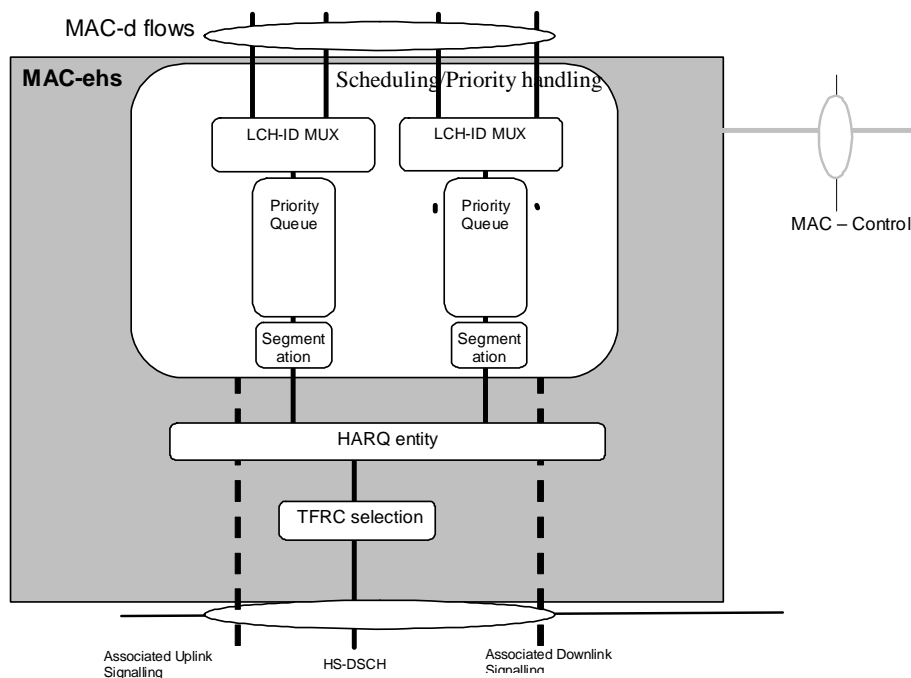

Figure 4.2.4.6-1: UTRAN side MAC architecture / MAC-ehs details

4.3 Channel structure

The MAC operates on the channels defined below; the transport channels are described between MAC and Layer 1, the logical channels are described between MAC and RLC.

The following subclauses provide an overview, the normative description can be found in [2] and [3] respectively.

4.3.1 Transport channels

Common transport channel types are:

- Random Access Channel(s) (RACH);
- Forward Access Channel(s) (FACH);
- Downlink Shared Channel(s) (DSCH), for TDD operation only;
- High Speed Downlink Shared Channel(s) (HS-DSCH);
- Uplink Shared Channel(s) (USCH), for TDD operation only;
- Broadcast Channel (BCH);
- Paging Channel (PCH).

Dedicated transport channel types are:

- Dedicated Channel (DCH);
- Enhanced Dedicated Channel (E-DCH) for UL operation only.

4.3.2 Logical Channels

The MAC layer provides data transfer services on logical channels. A set of logical channel types is defined for different kinds of data transfer services as offered by MAC.

Each logical channel type is defined by what type of information is transferred.

4.3.2.1 Logical channel structure

The configuration of logical channel types is depicted in figure 4.3.2.1.

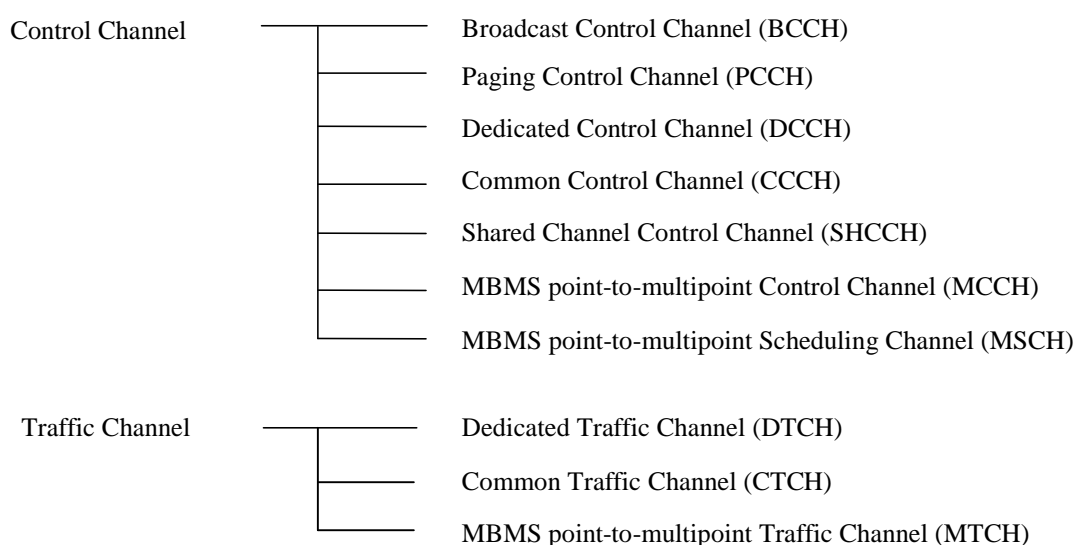

Figure 4.3.2.1: Logical channel structure

4.3.2.2 Control Channels

Following control channels are used for transfer of control plane information only:

- Broadcast Control Channel (BCCH);
- Paging Control Channel (PCCH);
- Common Control Channel (CCCH);
- Dedicated Control Channel (DCCH);
- Shared Channel Control Channel (SHCCH);
- MBMS point-to-multipoint Control Channel (MCCH);
- MBMS point-to-multipoint Scheduling Channel (MSCH)

4.3.2.3 Traffic Channels

Following traffic channels are used for the transfer of user plane information only:

- Dedicated Traffic Channel (DTCH);
- Common Traffic Channel (CTCH);
- MBMS point-to-multipoint Traffic Channel (MTCH).

5 Services provided to upper layers

This clause describes the different services provided by the MAC to higher layers. For a detailed description of the following functions see [2].

5.1 Description of Services provided to upper layers

- Data transfer: This service provides unacknowledged transfer of MAC SDUs between peer MAC entities without data segmentation.
- Reallocation of radio resources and MAC parameters: This service performs on request of RRC execution of radio resource reallocation and change of MAC parameters.
- Reporting of measurements: Local measurements are reported to RRC.

6 Functions

6.1 Description of the MAC functions

The functions of MAC include:

- mapping between logical channels and transport channels;
- selection of appropriate Transport Format for each Transport Channel depending on instantaneous source rate;
- priority handling between data flows of one UE;
- priority handling between UEs by means of dynamic scheduling;
- identification of UEs on common transport channels;
- identification of MBMS services on common transport channels;

- multiplexing/demultiplexing of upper layer PDUs into/from transport blocks delivered to/from the physical layer on common transport channels;
- multiplexing/demultiplexing of upper layer PDUs into/from transport block sets delivered to/from the physical layer on dedicated transport channels;
- segmentation and reassembly of upper layer PDUs
- traffic volume measurement;
- Transport Channel type switching;
- ciphering for transparent mode RLC;
- Access Service Class selection for RACH transmission;
- control of HS-DSCH transmission and reception including support of HARQ;
- HS-DSCH Provided Bit Rate measurement;
- control of E-DCH transmission and reception including support of HARQ;
- generation of uplink scheduling information to assist with E-DCH resource allocation;
- E-DCH Provided Bit-rate measurement.

6.2 Relation between MAC Functions and Transport Channels

6.2.1 Relation between MAC Functions and Transport Channels in UTRAN

Table 6.2.1.1: UTRAN MAC functions corresponding to the transport channel

| Associated MAC Functions | Logical Ch | Transport Ch | TF Selection | Priority handling between UEs | Priority handling (one UE) | Scheduling | Identification of UEs or MBMS services | Mux/ Demux on common transport channels | Mux/ Demux on dedicated transport channels | HARQ support | Segmentation |
|--------------------------|------------|--------------|--------------|-------------------------------|----------------------------|------------|----------------------------------------|-----------------------------------------|--------------------------------------------|--------------|--------------|
| Uplink (Rx) | CCCH | RACH | | | | | | X | | | |
| | DCCH | RACH | | | | | X | X | | | |
| | DCCH | DCH | | | | | | | X | | |
| | DTCH | RACH | | | | | X | X | | | |
| | DTCH | DCH | | | | | | | X | | |
| | SHCCH | RACH | | | | | X | X | | | |
| | SHCCH | USCH | | | | | | X | | | |
| | DTCH | USCH | | | | | | X | | | |
| | DCCH | USCH | | | | | | X | | | |
| | DTCH | E-DCH | | | | X | | | X | X | |
| DCCH | E-DCH | | | | X | | | X | X | | |
| Downlink (Tx) | BCCH | BCH | | | | X | | | | | |
| | BCCH | FACH | X | | | X | | X | | | |
| | BCCH | HS-DSCH | X (1) | | | X | | X | | X | (2) |
| | PCCH | PCH | X | | | X | | | | | |
| | PCCH | HS-DSCH | X (1) | | | X | | X | | X | (2) |
| | CCCH | FACH | X | X | | X | | X | | | |
| | CCCH | HS-DSCH | X (1) | | | X | | X | | X | X |
| | CTCH | FACH | X | | | X | | X | | | |
| | MCCH | FACH | X | | | X | | X | | | |
| | MSCH | FACH | X | | | X | | X | | | |
| | MTCH | FACH | X | | | X | X | X | | | |
| | CTCH | FACH | X | | | X | | X | | | |
| | DCCH | FACH | X | X | | X | X | X | | | |
| | DCCH | DSCH | X | X | | | X | X | | | |
| | DCCH | DCH | X | | X | | | | X | | |
| | DCCH | HS-DSCH | X (1) | X | X | X | X | X | | X | X |
| | DTCH | FACH | X | X | | X | X | X | | | |
| DTCH | DSCH | X | X | | | X | X | | | | |
| DTCH | DCH | X | | X | | | | X | | | |
| DTCH | HS-DSCH | X (1) | X | X | X | X | X | | X | X | |
| SHCCH | FACH | X | X | | X | | X | | | | |
| SHCCH | DSCH | X | X | | | | X | | | | |

NOTE 1: In case of HS-DSCH the TF selection is replaced by TFRC selection.

NOTE 2: The UTRAN should not perform MAC-ehs segmentation for MAC-ehs SDUs from BCCH and PCCH logical channels.

6.2.2 Relation of MAC Functions and Transport Channels in UE

Table 6.2.2.1: UE MAC functions corresponding to the transport channel

| Associated MAC Functions | Logical Ch | Transport Ch | TF Selection | Priority handling (one UE) | Identification | Mux/Demux on common transport channels | Mux/Demux on dedicated transport channels | HARQ support | Segmentation |
|--------------------------|------------|--------------|--------------|----------------------------|----------------|----------------------------------------|-------------------------------------------|--------------|--------------|
| Uplink (Tx) | CCCH | RACH | | | | X | | | |
| | DCCH | RACH | X | X | X | X | | | |
| | DCCH | DCH | X | X | | | X | | |
| | DTCH | RACH | X | X | X | X | | | |
| | DTCH | DCH | X | X | | | X | | |
| | SHCCH | RACH | | | | X | | | |
| | SHCCH | USCH | X | X | | X | | | |
| | DCCH | USCH | X | X | | X | | | |
| | DTCH | USCH | X | X | | X | | | |
| | DCCH | E-DCH | X | X | | | X | X | |
| | DTCH | E-DCH | X | X | | | X | X | |
| Downlink (Rx) | BCCH | BCH | | | | | | | |
| | BCCH | FACH | | | | X | | | |
| | BCCH | HS-DSCH | | | | X | | X | |
| | PCCH | PCH | | | | | | | |
| | PCCH | HS-DSCH | | | | X | | X | |
| | CCCH | FACH | | | | X | | | |
| | CCCH | HS-DSCH | | | | X | | X | X |
| | CTCH | FACH | | | | X | | | |
| | MCCH | FACH | | | | X | | | |
| | MSCH | FACH | | | | X | | | |
| | MTCH | FACH | | | X | X | | | |
| | DCCH | FACH | | | X | X | | | |
| | DCCH | DSCH | | | | X | | | |
| | DCCH | DCH | | | | | X | | |
| | DCCH | HS-DSCH | | | X | X | | X | X |
| | DTCH | FACH | | | X | X | | | |
| | DTCH | DSCH | | | | X | | | |
| DTCH | DCH | | | | | X | | | |
| DTCH | HS-DSCH | | | X | X | | X | X | |
| SHCCH | FACH | | | | X | | | | |
| SHCCH | DSCH | | | | X | | | | |

7 Services expected from physical layer

The physical layer offers information transfer services to MAC. For detailed description, see [3].

8 Elements for layer-to-layer communication

The interaction between the MAC layer and other layers are described in terms of primitives where the primitives represent the logical exchange of information and control between the MAC layer and other layers. The primitives shall not specify or constrain implementations. The MAC is connected to layer 1, RLC and RRC. The following subclauses describe the primitives between these layers.

8.1 Primitives between layers 1 and 2

8.1.1 Primitives

The primitives are described in [3].

8.1.2 Parameters

a) Transport Format Resource Indicator (TFRI) for HS-DSCH:

- For HS-DSCH the Transport Block size is derived from the TFRI value signalled on the HS-SCCH. The mapping between TFRI value and Transport Block size is specified in subclause 9.2.3.

b) HARQ information for E-DCH:

- ACK/NACK information (details specified in subclause 9.2.5.1).
- RSN information (details specified in subclause 9.2.5.1).
- Power offset (details specified in subclauses 11.8.1.4 and 11.9.1.4).
- E-TFCI (details specified in subclauses 11.8.1.4 and 11.9.1.4).

c) Relative Grant information for E-DCH (FDD only):

- Serving Relative Grant information (details specified in subclause 9.2.5.2.1).
- Non-serving Relative Grant information (details specified in subclause 9.2.5.2.1).

d) Absolute Grant information for E-DCH (details specified in subclause 9.2.5.2.2 for FDD and in 9.2.6.2.1 for TDD).

- Identity Type for E-DCH (FDD only).
- Absolute Grant Value.
- Absolute Grant Scope (FDD only).
- Absolute Grant Code Resource (TDD only)
- Absolute Grant Timeslot Resource (TDD only)
- Absolute Grant Resource Duration (TDD only)
- E-HICH Indicator (1.28 Mcps TDD only)
- E-UCCH Number Indicator (1.28 Mcps TDD only)

e) Happy Bit (FDD only, details specified in subclause 9.2.5.2.2).

8.2 Primitives between MAC and RLC

8.2.1 Primitives

The primitives between MAC layer and RLC layer are shown in table 8.2.1.1.

Table 8.2.1.1: Primitives between MAC layer and RLC layer

| Generic Name | Parameter | | | |
|-------------------|-------------------------------------------------|------------------------------------------|---------------------|---------|
| | Request | Indication | Response | Confirm |
| MAC-DATA | Data, BO, UE-ID type indicator, RLC Entity Info | Data, No_TB, TD (note), Error indication | | |
| MAC-STATUS | | No_PDU, PDU_Size, TX status | BO, RLC Entity Info | |
| NOTE: TDD only. | | | | |

MAC-DATA-Req/Ind:

- MAC-DATA-Req primitive is used to request that an upper layer PDU be sent using the procedures for the information transfer service;
- MAC-DATA-Ind primitive indicates the arrival of upper layer PDUs received within one transmission time interval by means of the information transfer service.

MAC-STATUS-Ind/Resp:

- MAC-STATUS-Ind primitive indicates to RLC for each logical channel the rate at which it may transfer data to MAC. Parameters are the number of PDUs that can be transferred in each transmission time interval and the PDU size; it is possible that MAC would use this primitive to indicate that it expects the current buffer occupancy of the addressed logical channel in order to provide for optimised TFC selection on transport channels with long transmission time interval. At the UE, MAC-STATUS-Ind primitive is also used to indicate from MAC to RLC that MAC has requested data transmission by PHY (i.e. PHY-DATA-REQ has been submitted, see Fig. 11.2.2.1), or that transmission of an RLC PDU on RACH has failed due to exceeded preamble ramping cycle counter.
- MAC-STATUS-Resp primitive enables RLC to acknowledge a MAC-STATUS-Ind. It is possible that RLC would use this primitive to indicate that it has nothing to send or that it is in a suspended state or to indicate the current buffer occupancy to MAC.

8.2.2 Parameters

a) Data:

- it contains the RLC layer messages (RLC-PDU) to be transmitted, or the RLC layer messages that have been received by the MAC sub-layer.

b) Number of transmitted transport blocks (No_TB) :

- indicates the number of transport blocks transmitted by the peer entity within the transmission time interval, based on the TFI value.

c) Buffer Occupancy (BO):

- the parameter Buffer Occupancy (BO) indicates for each logical channel the amount of data in number of bytes that is available for transmission and retransmission in RLC layer. When MAC is connected to an AM RLC entity, control PDUs to be transmitted and RLC PDUs outside the RLC Tx window shall also be included in the BO. RLC PDUs that have been transmitted but not negatively acknowledged by the peer entity shall not be included in the BO.

d) RX Timing Deviation (TD), TDD only:

- it contains the RX Timing Deviation as measured by the physical layer for the physical resources carrying the data of the Message Unit. This parameter is optional and only for Indication. It is needed for the transfer of the RX Timing Deviation measurement of RACH transmissions carrying CCCH data to RRC.

e) Number of PDU (No_PDU):

- specifies the number of PDUs that the RLC is permitted to transfer to MAC within a transmission time interval.

- f) PDU Size (PDU_Size):
- specifies the size of PDU that can be transferred to MAC within a transmission time interval.
- g) UE-ID Type Indicator:
- indicates the UE-ID type to be included in MAC for a DCCH and DTCH when they are mapped onto a common transport channel (i.e. FACH, RACH in FDD). On the UE side UE-ID Type Indicator shall always be set to C-RNTI.
- h) TX status:
- when set to value "transmission unsuccessful" this parameter indicates to RLC that transmission of an RLC PDU failed in the previous Transmission Time Interval, when set to value "transmission successful" this parameter indicates to RLC that the requested RLC PDU(s) has been submitted for transmission by the physical layer.
- i) RLC Entity Info
- indicates to MAC the configuration parameters that are critical to TFC selection depending on its mode and the amount of data that could be transmitted at the next TTI. This primitive is meant to insure that MAC can perform TFC selection (see subclause 11.4).
- j) Error indication
- When a MAC SDU is delivered to upper layer, an error indication is given for the SDU to upper layer if an error indication for the SDU has been received from lower layer.
- k) (Void)

8.3 Primitives between MAC and RRC

8.3.1 Primitives

The primitives between MAC and RRC are shown in table 8.3.1.1.

Table 8.3.1.1: Primitives between MAC sub-layer and RRC

| Generic Name | Parameter | | | |
|-------------------------|----------------------------------------------------------------------------------------------------------------------------------------------------------------------------------------------------------------|--------------------|----------|---------|
| | Request | Indication | Response | Confirm |
| CMAC-CONFIG | UE information elements, RB information elements, TrCH information elements, RACH transmission control elements, Ciphering elements, MBMS information elements, E-DCH configuration elements | | | |
| CMAC-MEASUREMENT | Measurement information elements | Measurement result | | |
| CMAC-STATUS | | Status info | | |

CMAC-CONFIG-Req:

- CMAC-CONFIG-Req is used to request for setup, release and configuration of a logical channel, e.g. RNTI allocation, switching the connection between logical channels and transport channels, TFCS update or scheduling priority of logical channel.

CMAC-MEASUREMENT-Req/Ind:

- CMAC-MEASUREMENT-Req is used by RRC to request MAC to perform measurements, e.g. traffic volume measurements;
- CMAC-MEASUREMENT-Ind is used to notify RRC of the measurement result.

CMAC-STATUS-Ind:

- CMAC-STATUS-Ind primitive notifies RRC of status information.

8.3.2 Parameters

See [7] for a detailed description of the UE, RB and TrCH information elements.

- a) UE information elements
 - S-RNTI
 - SRNC identity
 - C-RNTI
 - Activation time
 - Primary E-RNTI configured
 - Secondary E-RNTI configured
- b) RB information elements
 - RB multiplexing info (Transport channel identity, Logical channel identity, MAC logical channel priority)
 - DDI mapping table for E-DCH transmission
 - Indication whether the Logical channel is considered when the Scheduling Information is generated
- c) TrCH information elements
 - Transport Format Combination Set
 - MAC-hs/ehs reset indicator
 - MAC-es/e reset indicator
 - Re-ordering release timer (T1)
 - HARQ Profile parameters (power offset, maximum number of re-transmissions and for 1.28 Mcps TDD retransmission timer)
 - E-DCH TTI duration (FDD only)
 - Allowed combinations for multiplexing of MAC-d flows into MAC-e PDUs
 - E-DCH grant type of MAC-d flows (scheduled or non-scheduled)
 - List of HARQ processes on which non-scheduled grants are allowed (for FDD only, this is if the grant type is non-scheduled and the E-DCH TTI duration is 2ms)
- d) Measurement information elements
 - Reporting Quantity identifiers
 - Time interval to take an average or a variance (applicable when Average or Variance is Reporting Quantity)
- e) Measurement result
 - Reporting Quantity
- f) Status info
 - when set to value "transmission unsuccessful" this parameter indicates to RRC that transmission of a TM RLC PDU failed (due to e.g. Maximum number of preamble ramping cycles reached for RACH in FDD), when set to value "transmission successful" this parameter indicates to RRC that the requested TM RLC PDU(s) has been submitted for transmission by the physical layer.
- g) RACH transmission control elements
 - Set of ASC parameters (identifier for PRACH partitions, persistence values)
 - Maximum number of preamble ramping cycles (FDD) or synchronisation attempts (1.28 Mcps TDD) M_{\max}
 - Minimum and maximum number of time units between two preamble ramping cycles, N_{BO1min} and N_{BO1max} (FDD only)
 - ASC for RRC CONNECTION REQUEST message
 - Type of random access procedure (1.28 Mcps only)
- h) Ciphering elements
 - Ciphering mode
 - Ciphering key
 - Ciphering sequence number
- i) (Void)

- j) MBMS information elements
 - MBMS Id
- k) E-DCH configuration elements
 - E-DPCCCH to DPCCCH power offset (FDD only)
 - Happy bit delay condition (FDD only)
 - E-TFCI table index
 - minimum set E-TFCI (FDD only)
 - Reference E-TFCI (FDD only)
 - Periodicities for Scheduling Information with and without grant (FDD only)
 - The code, timeslots and maximum power available per TDD resource unit per slot in TTIs designated for non-scheduled use by a given UE (TDD only)
 - The frames designated for non-scheduled use by a given UE (specified by means of a start frame number, repetition period and repetition length) (3.84/7.68 Mcps TDD only)
 - The subframes designated for non-scheduled use by a given UE (specified by means of a start subframe number, repetition period and repetition length) (1.28 Mcps TDD only)
 - Scheduling Information power offset
 - List of HARQ processes on which scheduled grants are allowed (for FDD only, this is if the E-DCH TTI duration is 2ms)
 - Initial Serving Grant value and type (FDD only)
 - E-DCH maximum and minimum allowed coderates (3.84/7.68 Mcps TDD only)
 - A table of paired values, each pair consists of ENI value and E-DCH maximum allowed and minimum allowed coderates (1.28 Mcps TDD only)
 - A table of paired values, each pair consists of code rate and β normative value (TDD only).
- l) DTX-DRX and HS-SCCH less Information Elements (FDD only)
 - MAC DTX Cycle
 - MAC Inactivity Threshold
 - UE DTX DRX Offset
 - HS-SCCH less mode of operation
 - Inactivity Threshold for UE Grant Monitoring

9 Elements for peer-to-peer communication

9.1 Protocol data units

9.1.1 General

A MAC PDU is a bit string, with a length not necessarily a multiple of 8 bits. In the drawings in clause 9.1, bit strings are represented by tables in which the first bit is the leftmost one on the first line of the table, the last bit is the rightmost on the last line of the table, and more generally the bit string is to be read from left to right and then in the reading order of the lines.

Depending on the provided service, MAC SDUs are bit strings with any non-null length, or bit strings with an integer number of octets in length. An SDU is included into a MAC PDU from first bit onward.

In the UE for the uplink, all MAC PDUs delivered to the physical layer within one TTI are defined as Transport Block Set (TBS). It consists of one or several Transport Blocks, each containing one MAC PDU. The Transport Blocks, shall be transmitted in the order as delivered from RLC. When multiplexing of RLC PDUs from different logical channels is performed on MAC, the order of all Transport Blocks originating from the same logical channel shall be the same as the order of the sequence delivered from RLC. The order of the different logical channels in a TBS is set by the MAC protocol.

9.1.2 MAC PDU (not HS-DSCH or E-DCH)

A MAC PDU consists of an optional MAC header and a MAC Service Data Unit (MAC SDU), see figure 9.1.2.1. Both the MAC header and the MAC SDU are of variable size.

The content and the size of the MAC header depends on the type of the logical channel, and in some cases none of the parameters in the MAC header are needed.

The size of the MAC-SDU depends on the size of the RLC-PDU, which is defined during the setup procedure.

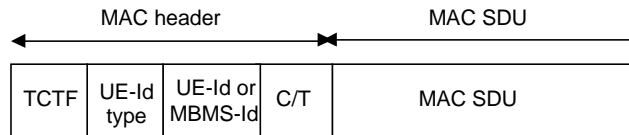

Figure 9.1.2.1: MAC PDU

9.1.3 MAC-d PDU (HS-DSCH)

For HS-DSCH the MAC-d PDU format equals the MAC PDU format for the non HS-DSCH case.

9.1.4 MAC PDU (HS-DSCH)

There are two different MAC PDU formats for HS-DSCH. Depending on configuration by higher layers the format is either MAC-hs or MAC-ehs. The MAC PDU format is determined by upper layer signalling [7].

When MAC-hs is configured, a MAC PDU for HS-DSCH consists of one MAC-hs header and one or more MAC-hs SDUs where each MAC-hs SDU equals a MAC-d PDU. A maximum of one MAC-hs PDU can be transmitted in a TTI per UE. The MAC-hs header is of variable size. The MAC-hs SDUs in one TTI belongs to the same reordering queue.

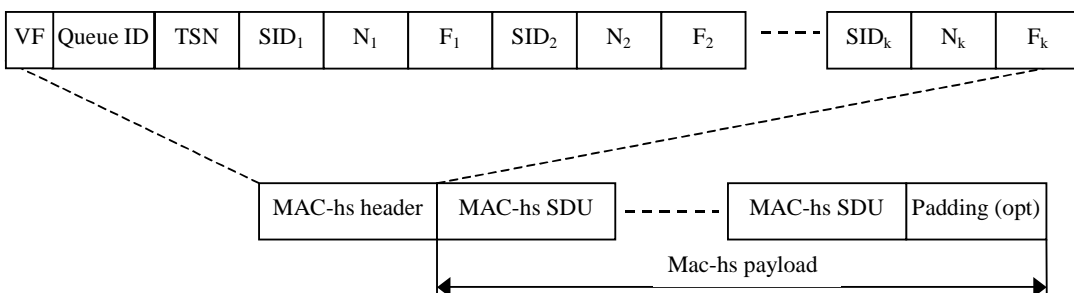

Figure 9.1.4.1: MAC-hs PDU

When MAC-ehs is configured, a MAC PDU for HS-DSCH consists of one MAC-ehs header and one or more reordering PDUs where each reordering PDU consists of one or more MAC-ehs SDUs or segments of a MAC-ehs SDUs belonging to the same priority queue. Each MAC-ehs SDU equals a MAC-d PDU or a MAC-c PDU (FDD only). The LCH-ID and L fields are repeated per MAC-ehs SDU or segment of MAC-ehs SDU. The TSN and SI fields are repeated per reordering PDU.

The presence of the TSN_i and SI_i fields is based on the value of the LCH-ID_i; if the LCH-ID_i is mapped to the same reordering queue as LCH-ID_{i-1}, there is no TSN_i or SI_i field. The mapping of the LCH-ID to the reordering queue is provided by upper layers [7]. The TSN₁ and SI₁ fields are always present.

A maximum of one MAC-ehs PDU can be transmitted in a TTI per UE.

The MAC-ehs SDUs in one TTI can belong to different reordering queues. The MAC-ehs SDUs in one TTI can belong to at most 3 priority queues. If MAC-ehs SDUs in one TTI belong to more than 3 priority queues, the UE behaviour is unspecified. The MAC-ehs header is of variable size.

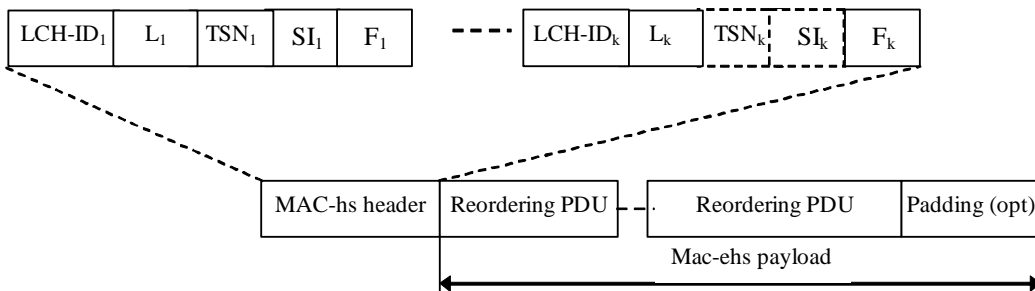

Figure 9.1.4.2: MAC-ehs PDU

9.1.5 MAC PDU (E-DCH)

In the case of E-DCH there are two MAC sublayers, MAC-e and MAC-es. MAC-es sits on top of MAC-e and receives PDUs directly from MAC-d. MAC-es SDUs (i.e. MAC-d PDUs) of the same size, coming from a particular logical channel are multiplexed together into a single MAC-es payload. There is one and only one MAC-es PDU per logical channel per TTI (since only one MAC-d PDU size is allowed per logical channel per TTI). To this payload is prepended the MAC-es header (see subclause 9.2.4.1). The number of PDUs, as well as the one DDI value identifying the logical channel, the MAC-d flow and the MAC-es SDU size are included as part of the MAC-e header. In case sufficient space is left in the E-DCH transport block or if Scheduling Information needs to be transmitted, an SI will be included at the end of the MAC-e PDU (see subclause 9.2.4.2). Multiple MAC-es PDUs from multiple logical channels, but only one MAC-e PDU can be transmitted in a TTI.

In the example MAC-e PDU shown in figure 9.1.5.2a, the field DDI_0 is referring to the specific DDI value that indicates that there is an SI included in the MAC-e PDU (see subclause 9.2.4.2). This header will not be associated with a new MAC-es payload. Figure 9.1.5.2b shows the MAC-e PDU format when SI is sent alone. In this case DDI_0 is not included in the MAC-e PDU and E-TFCI value 0 is used.

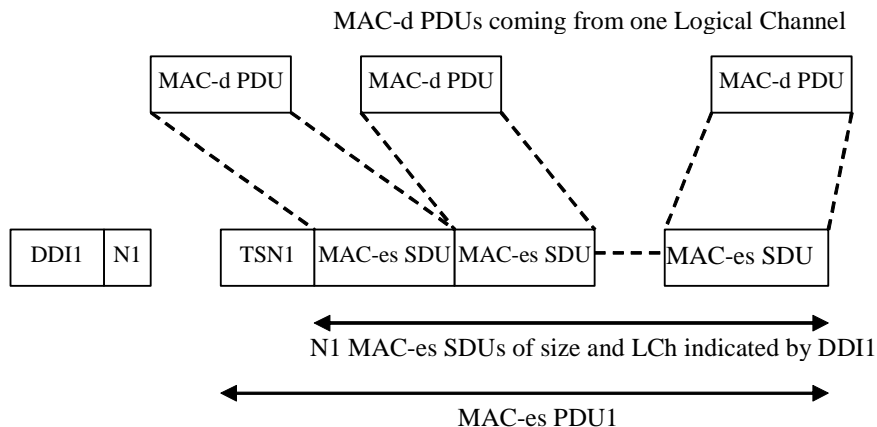

Figure 9.1.5.1 MAC-es PDU

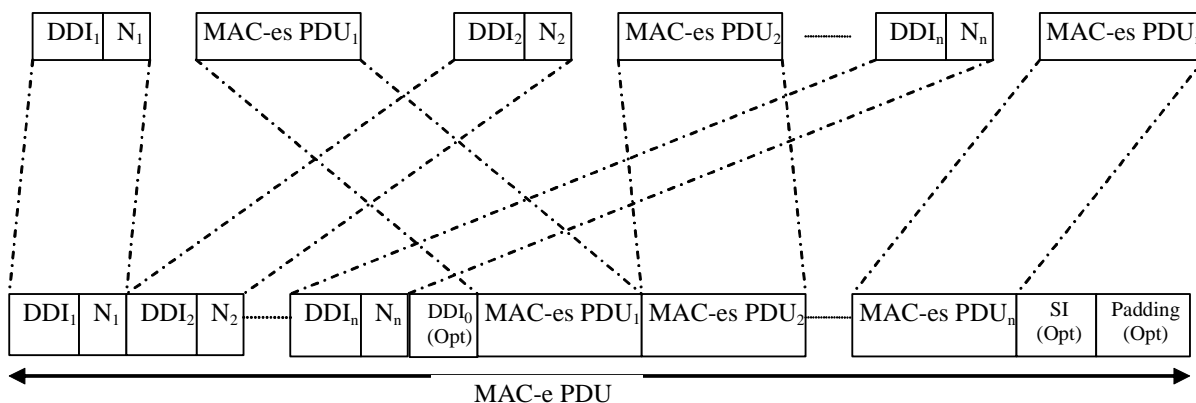

Figure 9.1.5.2a: MAC-e PDU

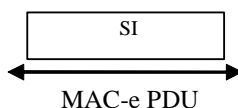

Figure 9.1.5.2b: MAC-e PDU (SI is sent alone)

9.2 Formats and parameters

NOTE: MAC header field encodings as specified in this clause with designation "Reserved" are forbidden to be used by a sender in this version of the protocol.

9.2.1 MAC PDU: Parameters of the MAC PDU header (not HS-DSCH or E-DCH) and MAC-d PDU header (HS-DSCH and E-DCH)

The following fields are defined for the MAC header for transport channels other than HS-DSCH and for the MAC-d PDU header for HS-DSCH:

- Target Channel Type Field
The TCTF field is a flag that provides identification of the logical channel class on FACH, USCH (TDD only), DSCH (TDD only) and RACH transport channels, i.e. whether it carries BCCH, CCCH, CTCH, SHCCH, MCCH, MTCH, MSCH or dedicated logical channel information. The size and coding of TCTF for FDD and TDD are shown in tables 9.2.1.1, 9.2.1.2, 9.2.1.3, 9.2.1.4 and 9.2.1.5. Note that the size of the TCTF field of FACH for FDD is 2,4 or 8 bits and for TDD is either 3 or 5 bits depending on the value of the 3 most significant bits. The TCTF of the RACH for TDD is either 2 or 4 bits depending on the value of the 2 most significant bits.

Table 9.2.1.1: Coding of the Target Channel Type Field on FACH for TDD

| TCTF | Designation |
|-------------|---------------------------------------------------------------------------------------------|
| 000 | BCCH |
| 001 | CCCH |
| 010 | CTCH |
| 01100 | DCCH or DTCH over FACH |
| 01101 | MCCH |
| 01110 | MTCH |
| 01111 | MSCH |
| 100 | SHCCH |
| 101-111 | Reserved (PDUs with this coding will be discarded by this version of the protocol) |

Table 9.2.1.2: Coding of the Target Channel Type Field on FACH for FDD

| TCTF | Designation |
|-----------------------|---------------------------------------------------------------------------------------------|
| 00 | BCCH |
| 01000000 | CCCH |
| 01000001- 01001111 | Reserved (PDUs with this coding will be discarded by this version of the protocol) |
| 01010000 | MCCH |
| 01010001- 01011110 | Reserved (PDUs with this coding will be discarded by this version of the protocol) |
| 01011111 | MSCH |
| 0110 | MTCH |
| 0111 | Reserved (PDUs with this coding will be discarded by this version of the protocol) |
| 10000000 | CTCH |
| 10000001- 10111111 | Reserved (PDUs with this coding will be discarded by this version of the protocol) |
| 11 | DCCH or DTCH over FACH |

Table 9.2.1.3: Coding of the Target Channel Type Field on USCH or DSCH (TDD only)

| TCTF | Designation |
|-------------|-----------------------------------|
| 0 | SHCCH |
| 1 | DCCH or DTCH over USCH or DSCH |

Table 9.2.1.4: Coding of the Target Channel Type Field on RACH for FDD

| TCTF | Designation |
|-------|---------------------------------------------------------------------------------------------|
| 00 | CCCH |
| 01 | DCCH or DTCH over RACH |
| 10-11 | Reserved (PDUs with this coding will be discarded by this version of the protocol) |

Table 9.2.1.5: Coding of the Target Channel Type Field on RACH for TDD

| TCTF | Designation |
|---------------|---------------------------------------------------------------------------------------------|
| 00 | CCCH |
| 0100 | DCCH or DTCH Over RACH |
| 0101- 0111 | Reserved (PDUs with this coding will be discarded by this version of the protocol) |
| 10 | SHCCH |
| 11 | Reserved (PDUs with this coding will be discarded by this version of the protocol) |

- C/T field

The C/T field provides identification of the logical channel instance when multiple logical channels are carried on the same transport channel (other than HS-DSCH) or same MAC-d flow (HS-DSCH). The C/T field is used also to provide identification of the logical channel type on dedicated transport channels and on FACH and RACH when used for user data transmission. The size of the C/T field is fixed to 4 bits for both common transport channels and dedicated transport channels. Table 9.2.1.5a shows the 4-bit C/T field.

Table 9.2.1.5a: Structure of the C/T field

| C/T field | Designation |
|-----------|---------------------------------------------------------------------------------------------|
| 0000 | Logical channel 1 |
| 0001 | Logical channel 2 |
| ... | ... |
| 1110 | Logical channel 15 |
| 1111 | Reserved (PDUs with this coding will be discarded by this version of the protocol) |

- UE-Id

The UE-Id field provides an identifier of the UE on common transport channels. The following types of UE-Id used on MAC are defined:

- UTRAN Radio Network Temporary Identity (U-RNTI) may be used in the MAC header of DCCH using RLC UM (SRB1), when mapped onto common transport channels in downlink direction; the U-RNTI is never used in uplink direction;
- Cell Radio Network Temporary Identity (C-RNTI) is used on DTCH and DCCH in uplink, and may be used on DCCH in downlink and is used on DTCH in downlink when mapped onto common transport channels, except when mapped onto DSCH transport channel in TDD;

Table 9.2.1.6: Lengths of UE Id field

| UE Id type | Length of UE Id field |
|------------|-----------------------|
| U-RNTI | 32 bits |
| C-RNTI | 16 bits |

- UE-Id Type

The UE-Id Type field is needed to ensure correct decoding of the UE-Id field in MAC Headers.

Table 9.2.1.7: UE-Id Type field definition

| UE-Id Type field 2 bits | UE-Id Type |
|-------------------------|---------------------------------------------------------------------------------------|
| 00 | U-RNTI |
| 01 | C-RNTI |
| 10 | Reserved (PDUs with this coding will be discarded by this version of the protocol) |
| 11 | Reserved (PDUs with this coding will be discarded by this version of the protocol) |

- MBMS-Id

The MBMS-Id field provides an identifier of MTCH for an MBMS service carried on FACH. The MBMS-Id is used in the MAC header of MTCH mapped onto FACH in downlink direction; the MBMS-Id is never used in uplink direction. The MBMS Id to be used by MAC is configured through the MAC control SAP. The length of the MBMS-Id field is 4 bits. Table 9.2.1.7a shows the 4-bit MBMS-Id field.

Table 9.2.1.8: Structure of the MBMS-Id field

| MBMS-Id field | MBMS logical channel identity [7] |
|---------------|---------------------------------------------------------------------------------------|
| 0000 | 1 |
| 0001 | 2 |
| ... | ... |
| 1110 | 15 |
| 1111 | Reserved (PDUs with this coding will be discarded by this version of the protocol) |

9.2.1.1 MAC header for DTCH and DCCH (not mapped on HS-DSCH or E-DCH)

a) DTCH or DCCH mapped to DCH, no multiplexing of dedicated channels on MAC:

- no MAC header is required.

b) DTCH or DCCH mapped to DCH, with multiplexing of dedicated channels on MAC:

- C/T field is included in MAC header.

c) DTCH or DCCH mapped to RACH/FACH:

- TCTF field, C/T field, UE-Id type field and UE-Id are included in the MAC header. For FACH, the UE-Id type field used is the C-RNTI or U-RNTI. For RACH, the UE-Id type field used is the C-RNTI.

d) DTCH or DCCH mapped to DSCH or USCH:

- the TCTF field is included in the MAC header. The C/T field is included if multiplexing on MAC is applied.

e) DTCH or DCCH mapped to DSCH or USCH where DTCH or DCCH are the only logical channels:

- The C/T field is included in the MAC header if multiplexing on MAC is applied.

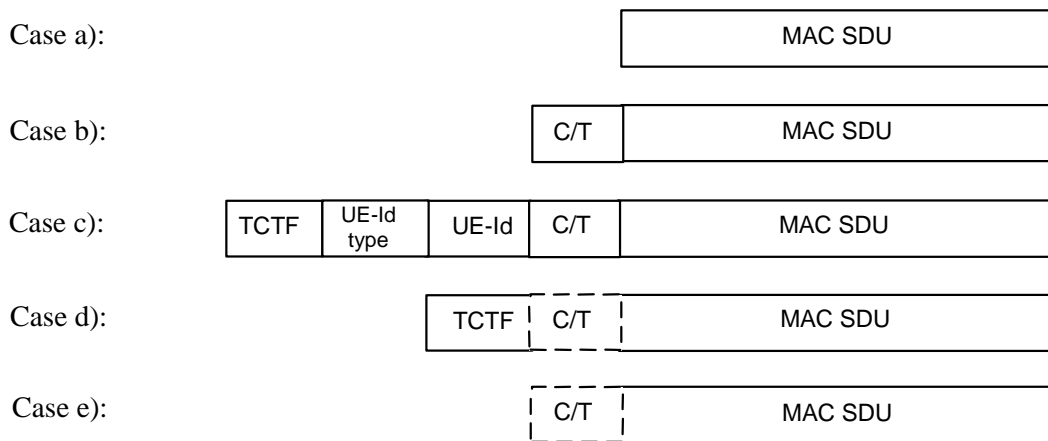

Figure 9.2.1.1.1: MAC PDU formats for DTCH and DCCH

9.2.1.1a MAC-d Header for DTCH and DCCH (mapped on HS-DSCH)

In CELL_DCH state, the MAC-d PDU header for DTCH and DCCH mapped on HS-DSCH is as shown in figure 9.2.1.1a.1.

- C/T field is included in the MAC-d PDU header if multiplexing on MAC is applied.
- If MAC-ehs is configured by upper layers [7], no MAC-d PDU header is required.

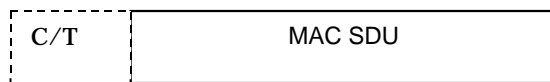

Figure 9.2.1.1a.1 MAC-d PDU format for DTCH and DCCH mapped on HS-DSCH

9.2.1.1b MAC-d Header for DTCH and DCCH (mapped on E-DCH)

For DTCH and DCCH mapped on E-DCH there is no need for a MAC-d header. Therefore, the MAC-d PDU is as shown in figure 9.2.1.1b.1.

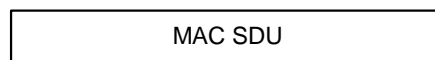

Figure 9.2.1.1b.1 MAC-d PDU format for DTCH and DCCH mapped on E-DCH

9.2.1.1c MAC Headers for DTCH and DCCH (mapped on HS-DSCH, FDD only)

In FDD, the MAC PDU header for DTCH and DCCH mapped on HS-DSCH CELL_FACH, CELL_PCH state is as shown in figure 9.2.1.1c-1.

- there is no MAC-d header included for DTCH and DCCH.
- there is no MAC-c header included for DTCH and DCCH when UE dedicated H-RNTI is used.

- the U-RNTI is only included as MAC-c header to MAC-d PDU for DCCH (SRB#1 only) when common H-RNTI is used

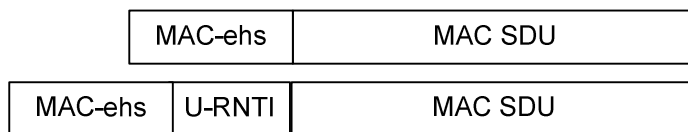

Figure 9.2.1.1c-1: MAC PDU format for DTCH and DCCH mapped on HS-DSCH (FDD only)

9.2.1.2 MAC header for BCCH

- a) BCCH mapped to BCH:
 - no MAC header is included.
- b) BCCH mapped to FACH:
 - the TCTF field is included in MAC header.
- c) in FDD, when BCCH mapped to HS-DSCH
 - the MAC-ehs header is included.

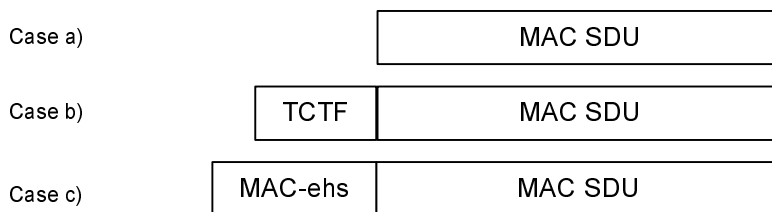

Figure 9.2.1.2.1: MAC PDU formats for BCCH

9.2.1.3 MAC header for PCCH

There is no MAC header for PCCH when mapped on PCH.

In FDD when PCCH is mapped on HS-DSCH:

- the MAC-ehs header is included as depicted in Figure 9.2.1.3-1.



Figure 9.2.1.3-1: MAC PDU format for PCCH (FDD only)

9.2.1.4 MAC header for CCCH

CCCH mapped to RACH/FACH:

- TCTF field is included in MAC header. .

In FDD, CCCH mapped to HS-DSCH

- no MAC-c header is included.

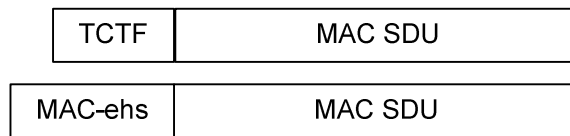

Figure 9.2.1.4.1: MAC PDU formats for CCCH

9.2.1.5 MAC Header for CTCH

The TCTF field is included as MAC header for CTCH as shown in figure 9.2.1.5.1.

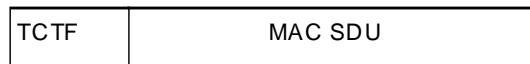

Figure 9.2.1.5.1: MAC PDU format for CTCH

9.2.1.6 MAC Header for SHCCH

The MAC header for SHCCH is as shown in figure 9.2.1.6.1.

- a) SHCCH mapped to RACH and USCH/FACH and DSCH:
 - TCTF has to be included.
- b) SHCCH mapped to RACH and USCH/FACH and DSCH, where SHCCH is the only channel.

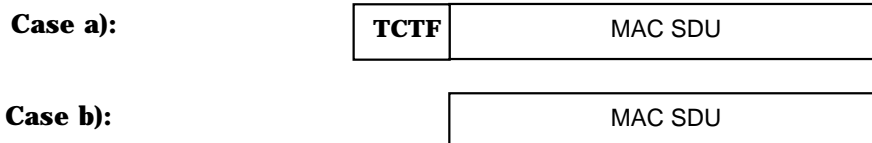

Figure 9.2.1.6.1: MAC PDU format for SHCCH

9.2.1.7 MAC Header for MCCH

The MAC PDU format for MCCH is as shown in figure 9.2.1.7.1.

- a) If the MAC header for MCCH is not configured through the MAC control SAP:
 - there is no MAC header for MCCH.
- b) If the MAC header for MCCH is configured through the MAC control SAP:
 - TCTF field is included in the MAC header for MCCH.

NOTE: If MCCH is not the only channel on the FACH, the MAC header shall be configured for the MCCH.

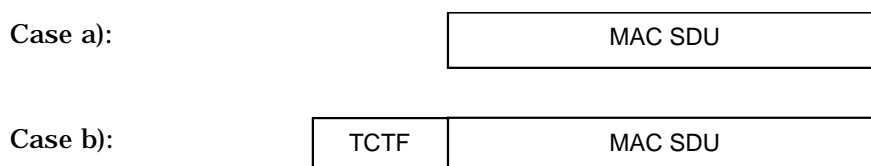

Figure 9.2.1.7.1: MAC PDU format for MCCH

9.2.1.8 MAC Header for MTCH

The TCTF field and MBMS-Id field are included in the MAC header for MTCH as shown in figure 9.2.1.8.1.



Figure 9.2.1.8.1: MAC PDU format for MTCH

9.2.1.9 MAC Header for MSCH

The MAC PDU format for MSCH is as shown in figure 9.2.1.9.1.

- a) If the MAC header for MSCH is not configured through the MAC control SAP:
 - there is no MAC header for MSCH.
- b) If the MAC header for MSCH is configured through the MAC control SAP:
 - TCTF field is included in the MAC header for MSCH.

NOTE: If MSCH is not the only channel on the FACH, the MAC header shall be configured for the MSCH.

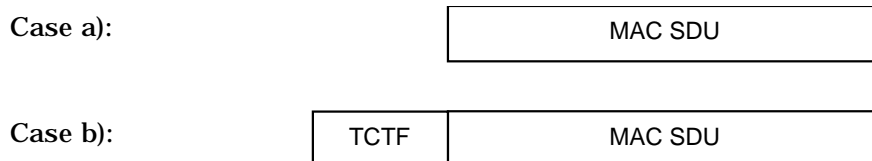

Figure 9.2.1.9.1: MAC PDU format for MSCH

9.2.2 MAC PDU: Parameters of the MAC header (HS-DSCH)

If MAC-hs is configured by upper layers [7], the parameters for the MAC header are:

- Version Flag (VF):
The VF field is a one bit flag providing extension capabilities of the MAC-hs PDU format. The VF field shall be set to zero and the value one is reserved in this version of the protocol.
- Queue identifier (Queue ID):
The Queue ID field provides identification of the reordering queue in the receiver, in order to support independent buffer handling of data belonging to different reordering queues. The length of the Queue ID field is 3 bit.
- Transmission Sequence Number (TSN):
The TSN field provides an identifier for the transmission sequence number on the HS-DSCH. The TSN field is used for reordering purposes to support in-sequence delivery to higher layers. The length of the TSN field is 6 bit.
- Size index identifier (SID):
The SID fields identifies the size of a set of consecutive MAC-d PDUs. The MAC-d PDU size for a given SID is configured by higher layers and is independent for each Queue ID. The length of the SID field is 3 bit.
- Number of MAC-D PDUs (N):
The number of consecutive MAC-d PDUs with equal size is identified with the N field. The length of the N field is 7 bits. In FDD mode, the maximum number of PDUs transmitted in a single TTI shall be assumed to be 70. In 1.28 Mcps TDD mode, the maximum number of PDUs transmitted in a single TTI shall be assumed to be 45. In 3.84 Mcps TDD mode, the maximum number of PDUs transmitted in a single TTI shall be assumed to be 318. In 7.68 Mcps TDD mode, the maximum number of PDUs transmitted in a single TTI shall be assumed to be 636. If

more PDUs than the defined maximum number of PDUs for the corresponding mode are received, the UE behaviour is unspecified.

- Flag (F):
The F field is a flag indicating if more fields are present in the MAC-hs header or not. If the F field is set to "0" the F field is followed by an additional set of SID, N and F fields. If the F field is set to "1" the F field is followed by a MAC-d PDU. The maximum number of MAC-hs header extensions, i.e. number of fields F set to "0", in a single TTI shall be assumed to be 7. If more extensions than the maximum defined for the corresponding mode are included in a TTI, the UE behaviour is unspecified.

If MAC-ehs is configured by upper layers [7], the parameters for the MAC header are:

- Logical channel identifier (LCH-ID):

The LCH-ID field provides identification of the logical channel at the receiver and the re-ordering buffer destination of a MAC-ehs SDU or segments of MAC-ehs SDUs.

The length of the LCH-ID is 4 bits.

In FDD, when SDU from BCCH or PCCH logical channel is transmitted on HS-DSCH the LCH-ID field in MAC-ehs header is set to 1111. The identification of the logical channel is done based on H-RNTI value used for broadcast information in or for paging in HS-SCCH.

- Transmission Sequence Number (TSN):

The TSN field provides an identifier for the transmission sequence number on the HS-DSCH. The TSN field is used for reordering purposes to support in-sequence delivery to higher layers.

The length of the TSN field is 6 bit.

- Segmentation Indication (SI)

The SI field indicates if the MAC-ehs SDU has been segmented. Table 9.2.2-1 shows the 2 bit SI field.

Table 9.2.2-1: Structure of the SI field

| SI Field | Segmentation indication |
|----------|--------------------------------------------------------------------------------------------------------------------------------------------------------------------------------------------------------------------------------|
| 00 | The first MAC-ehs SDU of the reordering PDU is a complete MAC-d or MAC-c PDU. The last MAC-ehs SDU of the reordering PDU is a complete MAC-d or MAC-c PDU. |
| 01 | If there is more than one MAC-ehs SDU in the reordering PDU, the last MAC-ehs SDU of the reordering PDU is a complete MAC-d or MAC-c PDU. The first MAC-ehs SDU of the reordering PDU is a segment of a MAC-d or MAC-c PDU. |
| 10 | If there is more than one MAC-ehs SDU in the reordering PDU, the first MAC-ehs SDU of the reordering PDU is a complete MAC-d or MAC-c PDU. The last MAC-ehs SDU of the reordering PDU is a segment of a MAC-d or MAC-c PDU. |
| 11 | The first MAC-ehs SDU of the reordering PDU is a segment of a MAC-d or MAC-c PDU. The last MAC-ehs SDU of reordering PDU is a segment of a MAC-d or MAC-c PDU. |

- Length (L)

The L field provides the length of the reordering PDU in octets. The reordering PDU size can vary for each MAC-ehs SDU in the MAC-ehs PDU, and is set for each MAC-ehs SDU individually.

If the reordering PDU contains an unsegmented MAC-d or MAC-c PDU, the L field is set to the length of the MAC-d PDU. If the reordering PDU contains a segment of the MAC-d or MAC-c PDU, the L field is set to the length of the segment. The length of the Length field is 11 bits.

- Flag (F)

The F field is a flag indicating if more fields are present in the MAC-ehs header or not. If the F field is set to "0" the F field is followed by an additional set of LCH-ID and L fields and optionally (as described in section 9.1.4) TSN and SI fields. If the F field is set to "1" the F field is followed by a reordering PDU. Each header extension corresponds to one MAC-ehs SDU or segment of MAC-ehs SDU.

9.2.2.1 MAC header for DTCH and DCCH

If MAC-hs is configured by upper layers [7]:

- a) DTCH or DCCH mapped to HS-DSCH:

- The Queue ID field and TSN field are always included in the MAC-hs header. One SID field, N field and F field is included for each MAC-d PDU size included in the MAC-hs PDU. Padding is not explicitly indicated but is included in the end of the MAC-hs PDU if the total size of the MAC-hs payload plus the MAC-hs header is smaller than the transport block set size.

If MAC-ehs is configured by upper layers [7]:

- a) DTCH or DCCH mapped to HS-DSCH:

- There is always one LCH ID field and L field for each MAC-ehs SDU included in the MAC-ehs PDU and one TSN and SI field for each reordering PDU included in the MAC-ehs PDU. Padding is not explicitly indicated but is included in the end of the MAC-ehs PDU if the total size of the MAC-ehs payload plus the MAC-ehs header is smaller than the transport block set size.

9.2.3 Signalling of Transport Block size for HS-DSCH

For HS-DSCH the transport block size is derived from the TFRI value signalled on the HS-SCCH. The mapping between the TFRI value and the transport block size for each mode is specified below:

9.2.3.1 Transport block size for FDD

For all transmissions of a transport block, the transport block size is derived from the TFRI value as specified below, except only in those cases of retransmissions where the Node-B selects a combination for which no mapping exists between the original transport block size and the selected combination of channelisation Code set and modulation type. In such cases, the transport block size index value signalled to the UE shall be set to 111111, i.e., $k_i=63$.

Let k_i be the TFRI signalled on the HS-SCCH value and let $k_{0,i}$ be the value in table 9.2.3.1 or table 9.2.3.2 (as configured by higher layers) corresponding to the modulation and the number of codes signalled on the HS-SCCH. Let k_t be the sum of the two values: $k_t = k_i + k_{0,i}$. The transport block size $L(k_t)$ can be obtained by accessing the position k_t in one of the tables in Annex A (normative) or by using one of the corresponding formulas below (informative).

The use of table 9.2.3.2 requires the MAC-hs entity to be configured with the enhanced MAC-hs format which is FFS.

Formula corresponding to table 9.2.3.1:

If $k_t < 40$

$$L(k_t) = 125 + 12 \cdot k_t$$

else

$$L(k_t) = \lfloor L_{\min} p^{k_t} \rfloor$$

$$p = 2085 / 2048$$

$$L_{\min} = 296$$

end

Table 9.2.3.1: Table 0 of values of $k_{0,i}$ for different numbers of channelization codes and modulation schemes (QPSK and 16QAM)

| Combination i | Modulation scheme | Number of channelization codes | $k_{0,i}$ |
|-----------------|-------------------|--------------------------------|-----------|
| 0 | QPSK | 1 | 1 |
| 1 | | 2 | 40 |
| 2 | | 3 | 63 |
| 3 | | 4 | 79 |
| 4 | | 5 | 92 |
| 5 | | 6 | 102 |
| 6 | | 7 | 111 |
| 7 | | 8 | 118 |
| 8 | | 9 | 125 |
| 9 | | 10 | 131 |
| 10 | | 11 | 136 |
| 11 | | 12 | 141 |
| 12 | | 13 | 145 |
| 13 | | 14 | 150 |
| 14 | | 15 | 153 |
| 15 | 16QAM | 1 | 40 |
| 16 | | 2 | 79 |
| 17 | | 3 | 102 |
| 18 | | 4 | 118 |
| 19 | | 5 | 131 |
| 20 | | 6 | 141 |
| 21 | | 7 | 150 |
| 22 | | 8 | 157 |
| 23 | | 9 | 164 |
| 24 | | 10 | 169 |
| 25 | | 11 | 175 |
| 26 | | 12 | 180 |
| 27 | | 13 | 184 |
| 28 | | 14 | 188 |
| 29 | | 15 | 192 |

Formula corresponding to table 9.2.3.2:

If $k_t < 40$

$$L(k_t) = (14 + k_t) * 8$$

else

$$L(k_t) = \lfloor L_{\min} p^{k_t} \rfloor * 8$$

$$p = \left(\frac{5392}{27} \right)^{\frac{1}{297-1}}$$

$$L_{\min} = 27$$

end

Table 9.2.3.2: Table 1 of values of $k_{0,i}$ for different numbers of channelization codes and modulation schemes (QPSK, 16QAM and 64QAM)

| Combination i | Modulation scheme | Number of channelization codes | $k_{0,i}$ |
|-----------------|-------------------|--------------------------------|-----------|
| 0 | QPSK | 1 | 20 |
| 1 | | 2 | 60 |
| 2 | | 3 | 82 |
| 3 | | 4 | 98 |
| 4 | | 5 | 111 |
| 5 | | 6 | 121 |
| 6 | | 7 | 130 |
| 7 | | 8 | 137 |
| 8 | | 9 | 144 |
| 9 | | 10 | 150 |
| 10 | | 11 | 155 |
| 11 | | 12 | 160 |
| 12 | | 13 | 164 |
| 13 | | 14 | 168 |
| 14 | | 15 | 172 |
| 15 | 16QAM | 1 | 60 |
| 16 | | 2 | 98 |
| 17 | | 3 | 121 |
| 18 | | 4 | 137 |
| 19 | | 5 | 150 |
| 20 | | 6 | 160 |
| 21 | | 7 | 168 |
| 22 | | 8 | 176 |
| 23 | | 9 | 182 |
| 24 | | 10 | 188 |
| 25 | | 11 | 194 |
| 26 | | 12 | 198 |
| 27 | | 13 | 203 |
| 28 | | 14 | 207 |
| 29 | | 15 | 211 |
| 30 | 64QAM | 1 | 82 |
| 31 | | 2 | 121 |
| 32 | | 3 | 144 |
| 33 | | 4 | 160 |
| 34 | | 5 | 172 |
| 35 | | 6 | 182 |
| 36 | | 7 | 191 |
| 37 | | 8 | 198 |
| 38 | | 9 | 205 |
| 39 | | 10 | 211 |
| 40 | | 11 | 216 |
| 41 | | 12 | 221 |
| 42 | | 13 | 226 |
| 43 | | 14 | 230 |
| 44 | | 15 | 234 |

9.2.3.2 Transport block size for 3.84 Mcps TDD

Let k be the signalled TFRI value, then the corresponding HS-DSCH transport block size L_k is given by :

If $k=1..510$

$$L_k = \lfloor L_{\min} p^k \rfloor$$

$$p = \frac{8313}{8192}$$

$$L_{\min} = 57$$

If $k = 511$

$$L_k = 102000$$

If $k=0$, L_k indicates NULL and shall not be used to signal a transport block size in the TFRI.

Transport block sizes calculated by this formula shall equal the values indicated in Table 9.2.3.2.1

Table 9.2.3.2.1: HSDPA Transport Block Sizes for 3.84 Mcps TDD

| TB index (k) | TB size [bits] | TB index (k) | TB size [bits] | TB index (k) | TB size [bits] | TB index (k) | TB size [bits] |
|--------------|----------------|--------------|----------------|--------------|----------------|--------------|----------------|
| 0 | NULL | 128 | 372 | 256 | 2432 | 384 | 15890 |
| 1 | 57 | 129 | 377 | 257 | 2468 | 385 | 16124 |
| 2 | 58 | 130 | 383 | 258 | 2504 | 386 | 16362 |
| 3 | 59 | 131 | 389 | 259 | 2541 | 387 | 16604 |
| 4 | 60 | 132 | 394 | 260 | 2579 | 388 | 16849 |
| 5 | 61 | 133 | 400 | 261 | 2617 | 389 | 17098 |
| 6 | 62 | 134 | 406 | 262 | 2656 | 390 | 17351 |
| 7 | 63 | 135 | 412 | 263 | 2695 | 391 | 17607 |
| 8 | 64 | 136 | 418 | 264 | 2735 | 392 | 17867 |
| 9 | 65 | 137 | 424 | 265 | 2775 | 393 | 18131 |
| 10 | 66 | 138 | 431 | 266 | 2816 | 394 | 18399 |
| 11 | 66 | 139 | 437 | 267 | 2858 | 395 | 18671 |
| 12 | 67 | 140 | 443 | 268 | 2900 | 396 | 18946 |
| 13 | 68 | 141 | 450 | 269 | 2943 | 397 | 19226 |
| 14 | 69 | 142 | 457 | 270 | 2986 | 398 | 19510 |
| 15 | 71 | 143 | 463 | 271 | 3030 | 399 | 19798 |
| 16 | 72 | 144 | 470 | 272 | 3075 | 400 | 20091 |
| 17 | 73 | 145 | 477 | 273 | 3121 | 401 | 20388 |
| 18 | 74 | 146 | 484 | 274 | 3167 | 402 | 20689 |
| 19 | 75 | 147 | 491 | 275 | 3213 | 403 | 20994 |
| 20 | 76 | 148 | 499 | 276 | 3261 | 404 | 21304 |
| 21 | 77 | 149 | 506 | 277 | 3309 | 405 | 21619 |
| 22 | 78 | 150 | 514 | 278 | 3358 | 406 | 21938 |
| 23 | 79 | 151 | 521 | 279 | 3408 | 407 | 22263 |
| 24 | 81 | 152 | 529 | 280 | 3458 | 408 | 22591 |
| 25 | 82 | 153 | 537 | 281 | 3509 | 409 | 22925 |
| 26 | 83 | 154 | 545 | 282 | 3561 | 410 | 23264 |
| 27 | 84 | 155 | 553 | 283 | 3613 | 411 | 23607 |
| 28 | 85 | 156 | 561 | 284 | 3667 | 412 | 23956 |

| | | | | | | | |
|----|-----|-----|------|-----|------|-----|-------|
| 29 | 87 | 157 | 569 | 285 | 3721 | 413 | 24310 |
| 30 | 88 | 158 | 578 | 286 | 3776 | 414 | 24669 |
| 31 | 89 | 159 | 586 | 287 | 3832 | 415 | 25033 |
| 32 | 91 | 160 | 595 | 288 | 3888 | 416 | 25403 |
| 33 | 92 | 161 | 604 | 289 | 3946 | 417 | 25778 |
| 34 | 93 | 162 | 613 | 290 | 4004 | 418 | 26159 |
| 35 | 95 | 163 | 622 | 291 | 4063 | 419 | 26545 |
| 36 | 96 | 164 | 631 | 292 | 4123 | 420 | 26938 |
| 37 | 98 | 165 | 640 | 293 | 4184 | 421 | 27335 |
| 38 | 99 | 166 | 650 | 294 | 4246 | 422 | 27739 |
| 39 | 100 | 167 | 659 | 295 | 4309 | 423 | 28149 |
| 40 | 102 | 168 | 669 | 296 | 4372 | 424 | 28565 |
| 41 | 103 | 169 | 679 | 297 | 4437 | 425 | 28987 |
| 42 | 105 | 170 | 689 | 298 | 4502 | 426 | 29415 |
| 43 | 107 | 171 | 699 | 299 | 4569 | 427 | 29849 |
| 44 | 108 | 172 | 709 | 300 | 4636 | 428 | 30290 |
| 45 | 110 | 173 | 720 | 301 | 4705 | 429 | 30738 |
| 46 | 111 | 174 | 730 | 302 | 4774 | 430 | 31192 |
| 47 | 113 | 175 | 741 | 303 | 4845 | 431 | 31652 |
| 48 | 115 | 176 | 752 | 304 | 4916 | 432 | 32120 |
| 49 | 116 | 177 | 763 | 305 | 4989 | 433 | 32594 |
| 50 | 118 | 178 | 775 | 306 | 5063 | 434 | 33076 |
| 51 | 120 | 179 | 786 | 307 | 5138 | 435 | 33564 |
| 52 | 122 | 180 | 798 | 308 | 5213 | 436 | 34060 |
| 53 | 123 | 181 | 809 | 309 | 5290 | 437 | 34563 |
| 54 | 125 | 182 | 821 | 310 | 5369 | 438 | 35074 |
| 55 | 127 | 183 | 834 | 311 | 5448 | 439 | 35592 |
| 56 | 129 | 184 | 846 | 312 | 5528 | 440 | 36117 |
| 57 | 131 | 185 | 858 | 313 | 5610 | 441 | 36651 |
| 58 | 133 | 186 | 871 | 314 | 5693 | 442 | 37192 |
| 59 | 135 | 187 | 884 | 315 | 5777 | 443 | 37742 |
| 60 | 137 | 188 | 897 | 316 | 5862 | 444 | 38299 |
| 61 | 139 | 189 | 910 | 317 | 5949 | 445 | 38865 |
| 62 | 141 | 190 | 924 | 318 | 6037 | 446 | 39439 |
| 63 | 143 | 191 | 937 | 319 | 6126 | 447 | 40021 |
| 64 | 145 | 192 | 951 | 320 | 6217 | 448 | 40613 |
| 65 | 147 | 193 | 965 | 321 | 6308 | 449 | 41212 |
| 66 | 150 | 194 | 980 | 322 | 6402 | 450 | 41821 |
| 67 | 152 | 195 | 994 | 323 | 6496 | 451 | 42439 |
| 68 | 154 | 196 | 1009 | 324 | 6592 | 452 | 43066 |
| 69 | 156 | 197 | 1024 | 325 | 6689 | 453 | 43702 |
| 70 | 159 | 198 | 1039 | 326 | 6788 | 454 | 44347 |
| 71 | 161 | 199 | 1054 | 327 | 6889 | 455 | 45002 |
| 72 | 163 | 200 | 1070 | 328 | 6990 | 456 | 45667 |
| 73 | 166 | 201 | 1085 | 329 | 7094 | 457 | 46342 |
| 74 | 168 | 202 | 1101 | 330 | 7198 | 458 | 47026 |
| 75 | 171 | 203 | 1118 | 331 | 7305 | 459 | 47721 |
| 76 | 173 | 204 | 1134 | 332 | 7413 | 460 | 48426 |
| 77 | 176 | 205 | 1151 | 333 | 7522 | 461 | 49141 |
| 78 | 178 | 206 | 1168 | 334 | 7633 | 462 | 49867 |

| | | | | | | | |
|-----|-----|-----|------|-----|-------|-----|--------|
| 79 | 181 | 207 | 1185 | 335 | 7746 | 463 | 50603 |
| 80 | 184 | 208 | 1203 | 336 | 7860 | 464 | 51351 |
| 81 | 186 | 209 | 1221 | 337 | 7976 | 465 | 52109 |
| 82 | 189 | 210 | 1239 | 338 | 8094 | 466 | 52879 |
| 83 | 192 | 211 | 1257 | 339 | 8214 | 467 | 53660 |
| 84 | 195 | 212 | 1276 | 340 | 8335 | 468 | 54453 |
| 85 | 198 | 213 | 1294 | 341 | 8458 | 469 | 55257 |
| 86 | 201 | 214 | 1313 | 342 | 8583 | 470 | 56073 |
| 87 | 204 | 215 | 1333 | 343 | 8710 | 471 | 56901 |
| 88 | 207 | 216 | 1353 | 344 | 8839 | 472 | 57742 |
| 89 | 210 | 217 | 1373 | 345 | 8969 | 473 | 58595 |
| 90 | 213 | 218 | 1393 | 346 | 9102 | 474 | 59460 |
| 91 | 216 | 219 | 1413 | 347 | 9236 | 475 | 60338 |
| 92 | 219 | 220 | 1434 | 348 | 9373 | 476 | 61230 |
| 93 | 222 | 221 | 1456 | 349 | 9511 | 477 | 62134 |
| 94 | 226 | 222 | 1477 | 350 | 9652 | 478 | 63052 |
| 95 | 229 | 223 | 1499 | 351 | 9794 | 479 | 63983 |
| 96 | 232 | 224 | 1521 | 352 | 9939 | 480 | 64928 |
| 97 | 236 | 225 | 1543 | 353 | 10086 | 481 | 65887 |
| 98 | 239 | 226 | 1566 | 354 | 10235 | 482 | 66860 |
| 99 | 243 | 227 | 1589 | 355 | 10386 | 483 | 67848 |
| 100 | 246 | 228 | 1613 | 356 | 10539 | 484 | 68850 |
| 101 | 250 | 229 | 1637 | 357 | 10695 | 485 | 69867 |
| 102 | 254 | 230 | 1661 | 358 | 10853 | 486 | 70899 |
| 103 | 258 | 231 | 1685 | 359 | 11013 | 487 | 71946 |
| 104 | 261 | 232 | 1710 | 360 | 11176 | 488 | 73009 |
| 105 | 265 | 233 | 1736 | 361 | 11341 | 489 | 74087 |
| 106 | 269 | 234 | 1761 | 362 | 11508 | 490 | 75182 |
| 107 | 273 | 235 | 1787 | 363 | 11678 | 491 | 76292 |
| 108 | 277 | 236 | 1814 | 364 | 11851 | 492 | 77419 |
| 109 | 281 | 237 | 1840 | 365 | 12026 | 493 | 78563 |
| 110 | 285 | 238 | 1868 | 366 | 12204 | 494 | 79723 |
| 111 | 290 | 239 | 1895 | 367 | 12384 | 495 | 80901 |
| 112 | 294 | 240 | 1923 | 368 | 12567 | 496 | 82095 |
| 113 | 298 | 241 | 1952 | 369 | 12752 | 497 | 83308 |
| 114 | 303 | 242 | 1981 | 370 | 12941 | 498 | 84539 |
| 115 | 307 | 243 | 2010 | 371 | 13132 | 499 | 85787 |
| 116 | 312 | 244 | 2039 | 372 | 13326 | 500 | 87054 |
| 117 | 316 | 245 | 2070 | 373 | 13523 | 501 | 88340 |
| 118 | 321 | 246 | 2100 | 374 | 13722 | 502 | 89645 |
| 119 | 326 | 247 | 2131 | 375 | 13925 | 503 | 90969 |
| 120 | 331 | 248 | 2163 | 376 | 14131 | 504 | 92313 |
| 121 | 336 | 249 | 2195 | 377 | 14340 | 505 | 93676 |
| 122 | 340 | 250 | 2227 | 378 | 14551 | 506 | 95060 |
| 123 | 346 | 251 | 2260 | 379 | 14766 | 507 | 96464 |
| 124 | 351 | 252 | 2293 | 380 | 14984 | 508 | 97889 |
| 125 | 356 | 253 | 2327 | 381 | 15206 | 509 | 99335 |
| 126 | 361 | 254 | 2362 | 382 | 15430 | 510 | 100802 |
| 127 | 366 | 255 | 2397 | 383 | 15658 | 511 | 102000 |

9.2.3.2a Transport block size for 7.68 Mcps TDD

Let k be the signalled TFRI value, then the corresponding HS-DSCH transport block size L_k is given by :

If $k=1..510$

$$L_k = \lfloor L_{\min} p^k \rfloor$$

$$p = \frac{33297}{32768}$$

$$L_{\min} = 57$$

If $k = 511$

$$L_k = 204000$$

If $k=0$, L_k indicates NULL and shall not be used to signal a transport block size in the TFRI.

Transport block sizes calculated by this formula shall equal the values indicated in Table 9.2.3.2.1

Table 9.2.3.2a.1: HSDPA Transport Block Sizes for 7.68 Mcps TDD

| TB index (k) | TB size [bits] | TB index (k) | TB size [bits] | TB index (k) | TB size [bits] | TB index (k) | TB size [bits] |
|--------------|----------------|--------------|----------------|--------------|----------------|--------------|----------------|
| 0 | NULL | 128 | 442 | 256 | 3438 | 384 | 26709 |
| 1 | 57 | 129 | 449 | 257 | 3494 | 385 | 27140 |
| 2 | 58 | 130 | 457 | 258 | 3550 | 386 | 27578 |
| 3 | 59 | 131 | 464 | 259 | 3607 | 387 | 28023 |
| 4 | 60 | 132 | 472 | 260 | 3666 | 388 | 28476 |
| 5 | 61 | 133 | 479 | 261 | 3725 | 389 | 28935 |
| 6 | 62 | 134 | 487 | 262 | 3785 | 390 | 29402 |
| 7 | 63 | 135 | 495 | 263 | 3846 | 391 | 29877 |
| 8 | 64 | 136 | 503 | 264 | 3908 | 392 | 30360 |
| 9 | 65 | 137 | 511 | 265 | 3971 | 393 | 30850 |
| 10 | 66 | 138 | 519 | 266 | 4035 | 394 | 31348 |
| 11 | 67 | 139 | 528 | 267 | 4101 | 395 | 31854 |
| 12 | 69 | 140 | 536 | 268 | 4167 | 396 | 32368 |
| 13 | 70 | 141 | 545 | 269 | 4234 | 397 | 32891 |
| 14 | 71 | 142 | 553 | 270 | 4302 | 398 | 33422 |
| 15 | 72 | 143 | 562 | 271 | 4372 | 399 | 33961 |
| 16 | 73 | 144 | 572 | 272 | 4443 | 400 | 34509 |
| 17 | 74 | 145 | 581 | 273 | 4514 | 401 | 35066 |
| 18 | 76 | 146 | 590 | 274 | 4587 | 402 | 35633 |
| 19 | 77 | 147 | 600 | 275 | 4661 | 403 | 36208 |
| 20 | 78 | 148 | 609 | 276 | 4736 | 404 | 36792 |
| 21 | 79 | 149 | 619 | 277 | 4813 | 405 | 37386 |
| 22 | 81 | 150 | 629 | 278 | 4891 | 406 | 37990 |
| 23 | 82 | 151 | 639 | 279 | 4970 | 407 | 38603 |
| 24 | 83 | 152 | 650 | 280 | 5050 | 408 | 39226 |
| 25 | 85 | 153 | 660 | 281 | 5131 | 409 | 39860 |
| 26 | 86 | 154 | 671 | 282 | 5214 | 410 | 40503 |
| 27 | 87 | 155 | 682 | 283 | 5298 | 411 | 41157 |
| 28 | 89 | 156 | 693 | 284 | 5384 | 412 | 41822 |

| | | | | | | | |
|----|-----|-----|------|-----|-------|-----|-------|
| 29 | 90 | 157 | 704 | 285 | 5471 | 413 | 42497 |
| 30 | 92 | 158 | 715 | 286 | 5559 | 414 | 43183 |
| 31 | 93 | 159 | 727 | 287 | 5649 | 415 | 43880 |
| 32 | 95 | 160 | 739 | 288 | 5740 | 416 | 44588 |
| 33 | 96 | 161 | 751 | 289 | 5833 | 417 | 45308 |
| 34 | 98 | 162 | 763 | 290 | 5927 | 418 | 46040 |
| 35 | 99 | 163 | 775 | 291 | 6023 | 419 | 46783 |
| 36 | 101 | 164 | 787 | 292 | 6120 | 420 | 47538 |
| 37 | 103 | 165 | 800 | 293 | 6219 | 421 | 48306 |
| 38 | 104 | 166 | 813 | 294 | 6319 | 422 | 49085 |
| 39 | 106 | 167 | 826 | 295 | 6421 | 423 | 49878 |
| 40 | 108 | 168 | 840 | 296 | 6525 | 424 | 50683 |
| 41 | 109 | 169 | 853 | 297 | 6630 | 425 | 51501 |
| 42 | 111 | 170 | 867 | 298 | 6737 | 426 | 52333 |
| 43 | 113 | 171 | 881 | 299 | 6846 | 427 | 53178 |
| 44 | 115 | 172 | 895 | 300 | 6957 | 428 | 54036 |
| 45 | 117 | 173 | 910 | 301 | 7069 | 429 | 54908 |
| 46 | 119 | 174 | 924 | 302 | 7183 | 430 | 55795 |
| 47 | 120 | 175 | 939 | 303 | 7299 | 431 | 56696 |
| 48 | 122 | 176 | 954 | 304 | 7417 | 432 | 57611 |
| 49 | 124 | 177 | 970 | 305 | 7537 | 433 | 58541 |
| 50 | 126 | 178 | 986 | 306 | 7658 | 434 | 59486 |
| 51 | 128 | 179 | 1001 | 307 | 7782 | 435 | 60446 |
| 52 | 131 | 180 | 1018 | 308 | 7908 | 436 | 61422 |
| 53 | 133 | 181 | 1034 | 309 | 8035 | 437 | 62414 |
| 54 | 135 | 182 | 1051 | 310 | 8165 | 438 | 63421 |
| 55 | 137 | 183 | 1068 | 311 | 8297 | 439 | 64445 |
| 56 | 139 | 184 | 1085 | 312 | 8431 | 440 | 65486 |
| 57 | 142 | 185 | 1103 | 313 | 8567 | 441 | 66543 |
| 58 | 144 | 186 | 1120 | 314 | 8705 | 442 | 67617 |
| 59 | 146 | 187 | 1138 | 315 | 8846 | 443 | 68709 |
| 60 | 148 | 188 | 1157 | 316 | 8988 | 444 | 69818 |
| 61 | 151 | 189 | 1175 | 317 | 9134 | 445 | 70945 |
| 62 | 153 | 190 | 1194 | 318 | 9281 | 446 | 72091 |
| 63 | 156 | 191 | 1214 | 319 | 9431 | 447 | 73254 |
| 64 | 158 | 192 | 1233 | 320 | 9583 | 448 | 74437 |
| 65 | 161 | 193 | 1253 | 321 | 9738 | 449 | 75639 |
| 66 | 164 | 194 | 1274 | 322 | 9895 | 450 | 76860 |
| 67 | 166 | 195 | 1294 | 323 | 10055 | 451 | 78101 |
| 68 | 169 | 196 | 1315 | 324 | 10217 | 452 | 79361 |
| 69 | 172 | 197 | 1336 | 325 | 10382 | 453 | 80643 |
| 70 | 174 | 198 | 1358 | 326 | 10550 | 454 | 81945 |
| 71 | 177 | 199 | 1380 | 327 | 10720 | 455 | 83267 |
| 72 | 180 | 200 | 1402 | 328 | 10893 | 456 | 84612 |
| 73 | 183 | 201 | 1425 | 329 | 11069 | 457 | 85978 |
| 74 | 186 | 202 | 1448 | 330 | 11248 | 458 | 87366 |
| 75 | 189 | 203 | 1471 | 331 | 11429 | 459 | 88776 |
| 76 | 192 | 204 | 1495 | 332 | 11614 | 460 | 90209 |
| 77 | 195 | 205 | 1519 | 333 | 11801 | 461 | 91666 |
| 78 | 198 | 206 | 1543 | 334 | 11992 | 462 | 93145 |

| | | | | | | | |
|-----|-----|-----|------|-----|-------|-----|--------|
| 79 | 201 | 207 | 1568 | 335 | 12185 | 463 | 94649 |
| 80 | 205 | 208 | 1594 | 336 | 12382 | 464 | 96177 |
| 81 | 208 | 209 | 1619 | 337 | 12582 | 465 | 97730 |
| 82 | 211 | 210 | 1646 | 338 | 12785 | 466 | 99308 |
| 83 | 215 | 211 | 1672 | 339 | 12992 | 467 | 100911 |
| 84 | 218 | 212 | 1699 | 340 | 13201 | 468 | 102540 |
| 85 | 222 | 213 | 1727 | 341 | 13414 | 469 | 104195 |
| 86 | 225 | 214 | 1755 | 342 | 13631 | 470 | 105877 |
| 87 | 229 | 215 | 1783 | 343 | 13851 | 471 | 107587 |
| 88 | 233 | 216 | 1812 | 344 | 14075 | 472 | 109324 |
| 89 | 237 | 217 | 1841 | 345 | 14302 | 473 | 111088 |
| 90 | 240 | 218 | 1871 | 346 | 14533 | 474 | 112882 |
| 91 | 244 | 219 | 1901 | 347 | 14767 | 475 | 114704 |
| 92 | 248 | 220 | 1932 | 348 | 15006 | 476 | 116556 |
| 93 | 252 | 221 | 1963 | 349 | 15248 | 477 | 118438 |
| 94 | 256 | 222 | 1994 | 350 | 15494 | 478 | 120350 |
| 95 | 260 | 223 | 2027 | 351 | 15744 | 479 | 122293 |
| 96 | 265 | 224 | 2059 | 352 | 15999 | 480 | 124267 |
| 97 | 269 | 225 | 2093 | 353 | 16257 | 481 | 126273 |
| 98 | 273 | 226 | 2126 | 354 | 16519 | 482 | 128312 |
| 99 | 278 | 227 | 2161 | 355 | 16786 | 483 | 130383 |
| 100 | 282 | 228 | 2196 | 356 | 17057 | 484 | 132488 |
| 101 | 287 | 229 | 2231 | 357 | 17332 | 485 | 134627 |
| 102 | 291 | 230 | 2267 | 358 | 17612 | 486 | 136800 |
| 103 | 296 | 231 | 2304 | 359 | 17897 | 487 | 139009 |
| 104 | 301 | 232 | 2341 | 360 | 18185 | 488 | 141253 |
| 105 | 306 | 233 | 2379 | 361 | 18479 | 489 | 143533 |
| 106 | 311 | 234 | 2417 | 362 | 18777 | 490 | 145850 |
| 107 | 316 | 235 | 2456 | 363 | 19081 | 491 | 148205 |
| 108 | 321 | 236 | 2496 | 364 | 19389 | 492 | 150597 |
| 109 | 326 | 237 | 2536 | 365 | 19702 | 493 | 153029 |
| 110 | 331 | 238 | 2577 | 366 | 20020 | 494 | 155499 |
| 111 | 337 | 239 | 2619 | 367 | 20343 | 495 | 158010 |
| 112 | 342 | 240 | 2661 | 368 | 20671 | 496 | 160560 |
| 113 | 348 | 241 | 2704 | 369 | 21005 | 497 | 163152 |
| 114 | 353 | 242 | 2748 | 370 | 21344 | 498 | 165786 |
| 115 | 359 | 243 | 2792 | 371 | 21689 | 499 | 168463 |
| 116 | 365 | 244 | 2837 | 372 | 22039 | 500 | 171182 |
| 117 | 371 | 245 | 2883 | 373 | 22395 | 501 | 173946 |
| 118 | 377 | 246 | 2929 | 374 | 22756 | 502 | 176754 |
| 119 | 383 | 247 | 2977 | 375 | 23124 | 503 | 179608 |
| 120 | 389 | 248 | 3025 | 376 | 23497 | 504 | 182507 |
| 121 | 395 | 249 | 3074 | 377 | 23876 | 505 | 185454 |
| 122 | 402 | 250 | 3123 | 378 | 24262 | 506 | 188447 |
| 123 | 408 | 251 | 3174 | 379 | 24653 | 507 | 191490 |
| 124 | 415 | 252 | 3225 | 380 | 25051 | 508 | 194581 |
| 125 | 421 | 253 | 3277 | 381 | 25456 | 509 | 197722 |
| 126 | 428 | 254 | 3330 | 382 | 25867 | 510 | 200914 |
| 127 | 435 | 255 | 3384 | 383 | 26284 | 511 | 204000 |

9.2.3.3 Transport block size for 1.28 Mcps TDD

The mapping of transport block size, in bits, to TFRI value is dependent upon the UE's HS-DSCH capability class.

If k is the signalled TFRI value then the corresponding HS-DSCH transport block size L_k is given by:

If $k = 1..62$

$$L_k = \lfloor L_{\min} p^{k-1} \rfloor$$

where

$$p = \frac{6214}{5973} \text{ if the HS-DSCH physical layer category is between 1 and 3 inclusively,}$$

$$p = \frac{1292}{1228} \text{ if the HS-DSCH physical layer category is between 4 and 6 inclusively,}$$

$$p = \frac{1901}{1795} \text{ if the HS-DSCH physical layer category is between 7 and 9 inclusively,}$$

$$p = \frac{9445}{8877} \text{ if the HS-DSCH physical layer category is between 10 and 12 inclusively,}$$

$$p = \frac{2345}{2196} \text{ if the HS-DSCH physical layer category is between 13 and 15 inclusively,}$$

and

$$L_{\min} = 240$$

If $k = 63$ then,

$L_k = 2788$ if the HS-DSCH physical layer category is between 1 and 3 inclusively,

5600 if the HS-DSCH physical layer category is between 4 and 6 inclusively,

8416 if the HS-DSCH physical layer category is between 7 and 9 inclusively,

11226 if the HS-DSCH physical layer category is between 10 and 12 inclusively,

14043 if the HS-DSCH physical layer category is between 13 and 15 inclusively.

If $k=0$, L_k indicates NULL and shall not be used to signal a transport block size in the TFRI.

Transport block sizes calculated by this formula shall equal the values indicated in the following tables: –

Table 9.2.3.3.1: HSDPA Transport Block Sizes for 1.28 Mcps TDD, for HS-DSCH physical layer category [1, 3]

| TB index (k) | TB size [bits] | TB index (k) | TB size [bits] | TB index (k) | TB size [bits] | TB index (k) | TB size [bits] |
|--------------|----------------|--------------|----------------|--------------|----------------|--------------|----------------|
| 0 | NULL | 16 | 434 | 32 | 817 | 48 | 1540 |
| 1 | 240 | 17 | 451 | 33 | 851 | 49 | 1602 |
| 2 | 249 | 18 | 470 | 34 | 885 | 50 | 1667 |
| 3 | 259 | 19 | 489 | 35 | 921 | 51 | 1734 |
| 4 | 270 | 20 | 508 | 36 | 958 | 52 | 1804 |

| | | | | | | | |
|----|-----|----|-----|----|------|----|------|
| 5 | 281 | 21 | 529 | 37 | 996 | 53 | 1877 |
| 6 | 292 | 22 | 550 | 38 | 1037 | 54 | 1952 |
| 7 | 304 | 23 | 572 | 39 | 1078 | 55 | 2031 |
| 8 | 316 | 24 | 596 | 40 | 1122 | 56 | 2113 |
| 9 | 329 | 25 | 620 | 41 | 1167 | 57 | 2198 |
| 10 | 342 | 26 | 645 | 42 | 1214 | 58 | 2287 |
| 11 | 356 | 27 | 671 | 43 | 1263 | 59 | 2380 |
| 12 | 370 | 28 | 698 | 44 | 1314 | 60 | 2476 |
| 13 | 385 | 29 | 726 | 45 | 1367 | 61 | 2575 |
| 14 | 401 | 30 | 755 | 46 | 1423 | 62 | 2679 |
| 15 | 417 | 31 | 786 | 47 | 1480 | 63 | 2788 |

Table 9.2.3.3.2: HSDPA Transport Block Sizes for 1.28 Mcps TDD, for HS-DSCH physical layer category [4, 6]

| TB index (k) | TB size [bits] | TB index (k) | TB size [bits] | TB index (k) | TB size [bits] | TB index (k) | TB size [bits] |
|--------------|----------------|--------------|----------------|--------------|----------------|--------------|----------------|
| 0 | NULL | 16 | 514 | 32 | 1159 | 48 | 2613 |
| 1 | 240 | 17 | 541 | 33 | 1219 | 49 | 2749 |
| 2 | 252 | 18 | 569 | 34 | 1283 | 50 | 2893 |
| 3 | 265 | 19 | 598 | 35 | 1350 | 51 | 3043 |
| 4 | 279 | 20 | 630 | 36 | 1420 | 52 | 3202 |
| 5 | 294 | 21 | 662 | 37 | 1494 | 53 | 3369 |
| 6 | 309 | 22 | 697 | 38 | 1572 | 54 | 3544 |
| 7 | 325 | 23 | 733 | 39 | 1654 | 55 | 3729 |
| 8 | 342 | 24 | 772 | 40 | 1740 | 56 | 3924 |
| 9 | 360 | 25 | 812 | 41 | 1831 | 57 | 4128 |
| 10 | 379 | 26 | 854 | 42 | 1926 | 58 | 4343 |
| 11 | 398 | 27 | 899 | 43 | 2027 | 59 | 4570 |
| 12 | 419 | 28 | 946 | 44 | 2132 | 60 | 4808 |
| 13 | 441 | 29 | 995 | 45 | 2244 | 61 | 5058 |
| 14 | 464 | 30 | 1047 | 46 | 2361 | 62 | 5322 |
| 15 | 488 | 31 | 1101 | 47 | 2484 | 63 | 5600 |

Table 9.2.3.3.3: HSDPA Transport Block Sizes for 1.28 Mcps TDD, for HS-DSCH physical layer category [7, 9]

| TB index (k) | TB size [bits] | TB index (k) | TB size [bits] | TB index (k) | TB size [bits] | TB index (k) | TB size [bits] |
|--------------|----------------|--------------|----------------|--------------|----------------|--------------|----------------|
| 0 | NULL | 16 | 567 | 32 | 1421 | 48 | 3559 |
| 1 | 240 | 17 | 601 | 33 | 1505 | 49 | 3769 |
| 2 | 254 | 18 | 636 | 34 | 1594 | 50 | 3991 |
| 3 | 269 | 19 | 674 | 35 | 1688 | 51 | 4227 |
| 4 | 285 | 20 | 713 | 36 | 1787 | 52 | 4477 |
| 5 | 301 | 21 | 756 | 37 | 1893 | 53 | 4741 |
| 6 | 319 | 22 | 800 | 38 | 2005 | 54 | 5021 |
| 7 | 338 | 23 | 848 | 39 | 2123 | 55 | 5318 |
| 8 | 358 | 24 | 898 | 40 | 2249 | 56 | 5632 |
| 9 | 379 | 25 | 951 | 41 | 2383 | 57 | 5964 |
| 10 | 402 | 26 | 1007 | 42 | 2522 | 58 | 6317 |
| 11 | 425 | 27 | 1066 | 43 | 2671 | 59 | 6690 |
| 12 | 451 | 28 | 1129 | 44 | 2829 | 60 | 7085 |
| 13 | 477 | 29 | 1196 | 45 | 2996 | 61 | 7503 |
| 14 | 505 | 30 | 1267 | 46 | 3173 | 62 | 7946 |
| 15 | 535 | 31 | 1341 | 47 | 3360 | 63 | 8416 |

Table 9.2.3.3.4: HSDPA Transport Block Sizes for 1.28 Mcps TDD, for HS-DSCH physical layer category [10, 12]

| TB index (k) | TB size [bits] | TB index (k) | TB size [bits] | TB index (k) | TB size [bits] | TB index (k) | TB size [bits] |
|--------------|----------------|--------------|----------------|--------------|----------------|--------------|----------------|
| 0 | NULL | 16 | 608 | 32 | 1641 | 48 | 4427 |
| 1 | 240 | 17 | 647 | 33 | 1746 | 49 | 4711 |
| 2 | 255 | 18 | 688 | 34 | 1858 | 50 | 5012 |
| 3 | 271 | 19 | 732 | 35 | 1977 | 51 | 5333 |
| 4 | 289 | 20 | 779 | 36 | 2103 | 52 | 5674 |
| 5 | 307 | 21 | 829 | 37 | 2238 | 53 | 6037 |
| 6 | 327 | 22 | 882 | 38 | 2381 | 54 | 6424 |
| 7 | 348 | 23 | 939 | 39 | 2533 | 55 | 6835 |
| 8 | 370 | 24 | 999 | 40 | 2695 | 56 | 7272 |
| 9 | 394 | 25 | 1063 | 41 | 2868 | 57 | 7737 |
| 10 | 419 | 26 | 1131 | 42 | 3051 | 58 | 8232 |
| 11 | 446 | 27 | 1203 | 43 | 3247 | 59 | 8759 |
| 12 | 474 | 28 | 1280 | 44 | 3455 | 60 | 9320 |
| 13 | 505 | 29 | 1362 | 45 | 3676 | 61 | 9916 |
| 14 | 537 | 30 | 1449 | 46 | 3911 | 62 | 10550 |
| 15 | 571 | 31 | 1542 | 47 | 4161 | 63 | 11226 |

Table 9.2.3.3.5 : HSDPA Transport Block Sizes for 1.28 Mcps TDD, for HS-DSCH physical layer category [13,15]

| TB index (k) | TB size [bits] | TB index (k) | TB size [bits] | TB index (k) | TB size [bits] | TB index (k) | TB size [bits] |
|--------------|----------------|--------------|----------------|--------------|----------------|--------------|----------------|
| 0 | NULL | 16 | 642 | 32 | 1836 | 48 | 5250 |
| 1 | 240 | 17 | 686 | 33 | 1961 | 49 | 5606 |
| 2 | 256 | 18 | 732 | 34 | 2094 | 50 | 5987 |
| 3 | 273 | 19 | 782 | 35 | 2236 | 51 | 6393 |
| 4 | 292 | 20 | 835 | 36 | 2388 | 52 | 6827 |
| 5 | 312 | 21 | 892 | 37 | 2550 | 53 | 7290 |
| 6 | 333 | 22 | 952 | 38 | 2723 | 54 | 7785 |
| 7 | 355 | 23 | 1017 | 39 | 2908 | 55 | 8313 |
| 8 | 380 | 24 | 1086 | 40 | 3105 | 56 | 8877 |
| 9 | 405 | 25 | 1160 | 41 | 3316 | 57 | 9479 |
| 10 | 433 | 26 | 1238 | 42 | 3541 | 58 | 10123 |
| 11 | 462 | 27 | 1322 | 43 | 3781 | 59 | 10809 |
| 12 | 494 | 28 | 1412 | 44 | 4037 | 60 | 11543 |
| 13 | 527 | 29 | 1508 | 45 | 4311 | 61 | 12326 |
| 14 | 563 | 30 | 1610 | 46 | 4604 | 62 | 13162 |
| 15 | 601 | 31 | 1719 | 47 | 4916 | 63 | 14043 |

9.2.4 MAC PDU: Parameters of the MAC header (E-DCH)

9.2.4.1 MAC-es header parameters

- Transmission Sequence Number (TSN):

The TSN field provides the transmission sequence number for the MAC-es PDU. This information is used for reordering purposes to support in-sequence delivery to higher layers. The length of the TSN field is 6 bits.

9.2.4.2 MAC-e header parameters

- Data description indicator (DDI):

The DDI field identifies the logical channel, MAC-d flow and size of the MAC-d PDUs concatenated into the

associated MAC-es PDU. The mapping between the DDI values and the logical channel ID, MAC-d flow and PDU size is provided by higher layers. The length of the DDI field is 6 bits.

- For FDD: When, due to the quantization in the transport block sizes that can be supported or triggering of the Scheduling Information, the size of the data plus header is less than or equal to the TB size of the E-TFC selected by the UE minus 24 bits, the DDI value [111111] shall be appended at the end of the MAC-e header and a Scheduling Information shall be concatenated into this MAC-e PDU, where DDI value [111111] indicates that there is a Scheduling Information concatenated in this MAC-e PDU. Otherwise, if the size of the data plus header is less than or equal to the TB size of the E-TFC selected by the UE minus 18 bits, a Scheduling Information shall be concatenated into this MAC-e PDU. In any other case it is understood that another MAC-es PDU or Scheduling Information does not fit and it is therefore not necessary to reserve room in the transport block for an additional DDI field.
- For TDD: When, due to the quantization in the transport block sizes that can be supported or triggering of the Scheduling Information, the size of the data plus header is less than or equal to the TB size of the E-TFC selected by the UE minus 29bits, the DDI value [111111] shall be appended at the end of the MAC-e header and a Scheduling Information shall be concatenated into this MAC-e PDU, where DDI value [111111] indicates that there is a Scheduling Information concatenated in this MAC-e PDU. Otherwise, if the size of the data plus header is less than or equal to the TB size of the E-TFC selected by the UE minus 23 bits, a Scheduling Information shall be concatenated into this MAC-e PDU. In any other case it is understood that another MAC-es PDU or Scheduling Information does not fit and it is therefore not necessary to reserve room in the transport block for an additional DDI field.
- Number of MAC-d PDUs (N):
The number of consecutive MAC-d PDUs corresponding to the same DDI value. The length of the N field is 6 bits.

9.2.5 Signaling of control information for FDD E-DCH

9.2.5.1 HARQ information

This control information is used in support of the uplink hybrid ARQ functionality.

- ACK/NACK information:
Transmitted on downlink on the E-HICH from each cell in the E-DCH active set, the ACK/NACK information indicates the successful or un-successful decoding of the corresponding uplink transmission. This information allows the UE to know whether to make another transmission for the same MAC-e PDU or to start the transmission of a new one. The length of the ACK/NACK field is 1 bit.
- RSN:
Transmitted on the E-DPCCH, the RSN is used to convey the uplink HARQ transmission number. Because of the limitation in the field size, the RSN saturates to the maximum value once that is reached. The combination of the RSN and the transmission timing allows the receiver to determine the exact transmission number (see [16]). The length of the RSN field is 2 bits.

9.2.5.2 DL Scheduling information

This control information is used by Node-Bs in a UE's E-DCH active set in order to control its use of E-DCH system resources.

9.2.5.2.1 Relative Grants

- Serving Relative Grant:
Transmitted on downlink on the E-RGCH from all cells in the serving E-DCH RLS, the serving relative grant allows the Node B scheduler to incrementally adjust the serving grant of UEs under its control. By definition, there can only be one serving relative grant command received at any one time. This indication can take three different values, "UP", "DOWN" or "HOLD".
- Non-serving Relative Grant:
Transmitted on downlink on the E-RGCH from a non-serving E-DCH RL, the non-serving relative grant allows neighboring Node Bs to adjust the transmitted rate of UEs that are not under their control in order to avoid

overload situations. By definition, there could be multiple non-serving relative grant commands received by MAC at any time. This indication can take two different values, "DOWN" or "HOLD".

The handling of the Relative Grant signalling is based on the Scheduling Grant table configured by higher layers and shown in Tables 9.2.5.2.1.1 and 9.2.5.2.1.2.

Table 9.2.5.2.1.1: Scheduling Grant Table 1 (SG-table)

| Index | Scheduled Grant |
|-------|------------------|
| 37 | $(168/15)^{2*6}$ |
| 36 | $(150/15)^{2*6}$ |
| 35 | $(168/15)^{2*4}$ |
| 34 | $(150/15)^{2*4}$ |
| 33 | $(134/15)^{2*4}$ |
| 32 | $(119/15)^{2*4}$ |
| 31 | $(150/15)^{2*2}$ |
| 30 | $(95/15)^{2*4}$ |
| 29 | $(168/15)^2$ |
| 28 | $(150/15)^2$ |
| 27 | $(134/15)^2$ |
| 26 | $(119/15)^2$ |
| 25 | $(106/15)^2$ |
| 24 | $(95/15)^2$ |
| 23 | $(84/15)^2$ |
| 22 | $(75/15)^2$ |
| 21 | $(67/15)^2$ |
| 20 | $(60/15)^2$ |
| 19 | $(53/15)^2$ |
| 18 | $(47/15)^2$ |
| 17 | $(42/15)^2$ |
| 16 | $(38/15)^2$ |
| 15 | $(34/15)^2$ |
| 14 | $(30/15)^2$ |
| 13 | $(27/15)^2$ |
| 12 | $(24/15)^2$ |
| 11 | $(21/15)^2$ |
| 10 | $(19/15)^2$ |
| 9 | $(17/15)^2$ |
| 8 | $(15/15)^2$ |
| 7 | $(13/15)^2$ |
| 6 | $(12/15)^2$ |
| 5 | $(11/15)^2$ |
| 4 | $(9/15)^2$ |
| 3 | $(8/15)^2$ |
| 2 | $(7/15)^2$ |
| 1 | $(6/15)^2$ |
| 0 | $(5/15)^2$ |

Table 9.2.5.2.1.2: Scheduling Grant Table 2 (SG-table)

| Index | Scheduled Grant |
|-------|-----------------------|
| 37 | $(376/15)^2 \times 4$ |
| 36 | $(336/15)^2 \times 4$ |
| 35 | $(237/15)^2 \times 6$ |
| 34 | $(212/15)^2 \times 6$ |
| 33 | $(237/15)^2 \times 4$ |
| 32 | $(168/15)^{2*6}$ |

| | |
|----|-------------------------|
| 31 | $(150/15)^{2 \times 6}$ |
| 30 | $(168/15)^{2 \times 4}$ |
| 29 | $(150/15)^{2 \times 4}$ |
| 28 | $(134/15)^{2 \times 4}$ |
| 27 | $(119/15)^{2 \times 4}$ |
| 26 | $(150/15)^{2 \times 2}$ |
| 25 | $(95/15)^{2 \times 4}$ |
| 24 | $(168/15)^2$ |
| 23 | $(150/15)^2$ |
| 22 | $(134/15)^2$ |
| 21 | $(119/15)^2$ |
| 20 | $(106/15)^2$ |
| 19 | $(95/15)^2$ |
| 18 | $(84/15)^2$ |
| 17 | $(75/15)^2$ |
| 16 | $(67/15)^2$ |
| 15 | $(60/15)^2$ |
| 14 | $(53/15)^2$ |
| 13 | $(47/15)^2$ |
| 12 | $(42/15)^2$ |
| 11 | $(38/15)^2$ |
| 10 | $(34/15)^2$ |
| 9 | $(30/15)^2$ |
| 8 | $(27/15)^2$ |
| 7 | $(24/15)^2$ |
| 6 | $(21/15)^2$ |
| 5 | $(19/15)^2$ |
| 4 | $(17/15)^2$ |
| 3 | $(15/15)^2$ |
| 2 | $(13/15)^2$ |
| 1 | $(12/15)^2$ |
| 0 | $(11/15)^2$ |

When the Serving_Grant needs to be determined due to E-RGCH signalling (see subclause 11.8.1.3.2), the UE shall:

- Determine the lowest power ratio in the configured SG-table (table 9.2.5.2.1.1 or table 9.2.5.2.1.2) that is equal or higher to the reference_ETPR, and determine the corresponding index in the SG-table: SG_{LUPR} ;
- If the UE received a Serving Relative Grant "UP", based on the thresholds "3-index-step threshold" and "2-index-step threshold" configured by higher layers, determine the Serving_Grant as follows:
 - if $SG_{LUPR} < \text{"3-index-step threshold"}$:
 - Serving_Grant = $SG[\text{MIN}(SG_{LUPR} + 3, 37)]$.
 - if $\text{"3-index-step threshold"} \leq SG_{LUPR} < \text{"2-index-step threshold"}$:
 - Serving_Grant = $SG[\text{MIN}(SG_{LUPR} + 2, 37)]$.
 - if $\text{"2-index-step threshold"} \leq SG_{LUPR}$:
 - Serving_Grant = $SG[\text{MIN}(SG_{LUPR} + 1, 37)]$.
- If the UE received a Serving Relative Grant "DOWN", determine the Serving_Grant:
 - Serving_Grant = $SG[\text{MAX}(SG_{LUPR} - 1, 0)]$.
- If the UE received a Non-serving Relative Grant "DOWN", determine the Serving_Grant:
 - Serving_Grant = $SG[\text{MAX}(SG_{LUPR} - 1, 0)]$.

9.2.5.2.2 Absolute Grant

The absolute grant message is sent on downlink, on the configured E-AGCH, from the serving E-DCH cell and allows the Node B scheduler to directly adjust the granted rate of UEs under its control.

The E-AGCH is a shared channel that uses an E-RNTI specific CRC in order to address messages to specific users (see [16]). The RRC may configure the MAC-e with two different E-RNTIs, one primary and one secondary. Based on the identity that is used, the following information will be conveyed implicitly when an absolute grant message is received:

- Identity Type:
This variable will take the value "Primary" or "Secondary" respectively based on whether the message was addressed to the primary or the secondary E-RNTI.

The absolute grant message itself includes multiple fields that are multiplexed together into 6 bits inside the MAC-e of the Node B and then submitted to the physical layer for transmission on the E-AGCH. These fields are:

- Absolute Grant Value:
This field indicates the maximum E-DCH traffic to pilot ratio (E-DPDCH/DPCCH) that the UE is allowed to use in the next transmission. The length of the Absolute Grant Value field is 5 bits.
- Absolute Grant Scope:
This field indicates the applicability of the Absolute Grant. It can take two different values, "Per HARQ process" or "All HARQ processes", allowing to indicate whether the HARQ process activation/de-activation will affect one or all processes. The Absolute Grant Scope is encoded in 1 bit. When the E-DCH is configured with 10ms TTI, only the value "All HARQ processes" is valid (see subclause 10). In case Identity Type is "Secondary", only the value "All HARQ processes" is valid in this version of the protocol.

9.2.5.3 UL Scheduling information

This control information is used by UEs to indicate to their serving E-DCH Node-B the amount of resources they require.

9.2.5.3.1 Happy Bit

The happy bit is a single bit field that is passed from MAC to the physical layer for inclusion on the E-DPCCH. This field takes two values, "Not Happy" and "Happy" indicating respectively whether the UE could use more resources or not. The setting of the Happy Bit is defined in subclause 11.8.1.5.

9.2.5.3.2 Scheduling Information

The Scheduling Information is located at the end of the MAC-e PDU and is used to provide the serving Node B with a better view of the amount of system resources needed by the UE and the amount of resources it can actually make use of. The transmission of this information will be initiated due to the quantization of the transport block sizes that can be supported or based on the triggers defined in subclause 11.8.1.6. When a Scheduling Information is transmitted, its contents shall always be updated in new transmissions with the buffer status after application of the E-TFC selection procedure described in subclause 11.8.1.4. The logical channels for which a non-scheduled grant is configured shall never be taken into account when putting together this information. In addition, the RRC may restrict applicability for logical channels for which no non-scheduled grant was configured.

This information includes the following fields:

- Highest priority Logical channel ID (HLID):
The HLID field identifies unambiguously the highest priority logical channel with available data. If multiple logical channels exist with the highest priority, the one corresponding to the highest buffer occupancy will be reported. The length of the HLID is 4 bits. In case the TEBS is indicating index 0 (0 byte), the HLID shall indicate the value "0000".
- Fields related to amount of available data:
- Total E-DCH Buffer Status (TEBS):
The TEBS field identifies the total amount of data available across all logical channels for which reporting has been requested by the RRC and indicates the amount of data in number of bytes that is available for transmission and retransmission in RLC layer. When MAC is connected to an AM RLC entity, control PDUs to be

transmitted and RLC PDUs outside the RLC Tx window shall also be included in the TEBS. RLC PDUs that have been transmitted but not negatively acknowledged by the peer entity shall not be included in the TEBS.

The length of this field is 5 bits. The values taken by TEBS are shown in Table 9.2.5.3.2.1.

Table 9.2.5.3.2-1: TEBS Values

| Index | TEBS Value (bytes) |
|-------|----------------------------------|
| 0 | TEBS = 0 |
| 1 | $0 < \text{TEBS} \leq 10$ |
| 2 | $10 < \text{TEBS} \leq 14$ |
| 3 | $14 < \text{TEBS} \leq 18$ |
| 4 | $18 < \text{TEBS} \leq 24$ |
| 5 | $24 < \text{TEBS} \leq 32$ |
| 6 | $32 < \text{TEBS} \leq 42$ |
| 7 | $42 < \text{TEBS} \leq 55$ |
| 8 | $55 < \text{TEBS} \leq 73$ |
| 9 | $73 < \text{TEBS} \leq 97$ |
| 10 | $97 < \text{TEBS} \leq 129$ |
| 11 | $129 < \text{TEBS} \leq 171$ |
| 12 | $171 < \text{TEBS} \leq 228$ |
| 13 | $228 < \text{TEBS} \leq 302$ |
| 14 | $302 < \text{TEBS} \leq 401$ |
| 15 | $401 < \text{TEBS} \leq 533$ |
| 16 | $533 < \text{TEBS} \leq 708$ |
| 17 | $708 < \text{TEBS} \leq 940$ |
| 18 | $940 < \text{TEBS} \leq 1248$ |
| 19 | $1248 < \text{TEBS} \leq 1658$ |
| 20 | $1658 < \text{TEBS} \leq 2202$ |
| 21 | $2202 < \text{TEBS} \leq 2925$ |
| 22 | $2925 < \text{TEBS} \leq 3884$ |
| 23 | $3884 < \text{TEBS} \leq 5160$ |
| 24 | $5160 < \text{TEBS} \leq 6853$ |
| 25 | $6853 < \text{TEBS} \leq 9103$ |
| 26 | $9103 < \text{TEBS} \leq 12092$ |
| 27 | $12092 < \text{TEBS} \leq 16062$ |
| 28 | $16062 < \text{TEBS} \leq 21335$ |
| 29 | $21335 < \text{TEBS} \leq 28339$ |
| 30 | $28339 < \text{TEBS} \leq 37642$ |
| 31 | $37642 < \text{TEBS}$ |

- Highest priority Logical channel Buffer Status (HLBS):
The HLBS field indicates the amount of data available from the logical channel identified by HLID, relative to the highest value of the buffer size range reported by TEBS when the reported TEBS index is not 31, and relative to 50000 bytes when the reported TEBS index is 31. The length of HLBS is 4 bits. The values taken by HLBS are shown in table 9.2.5.3.2.2. In case the TEBS field is indicating index 0 (0 byte), the HLBS field shall indicate index 0.

Table 9.2.5.3.2-2: HLBS Values

| Index | HLBS values (%) |
|-------|----------------------------|
| 0 | $0 < \text{HLBS} \leq 4$ |
| 1 | $4 < \text{HLBS} \leq 6$ |
| 2 | $6 < \text{HLBS} \leq 8$ |
| 3 | $8 < \text{HLBS} \leq 10$ |
| 4 | $10 < \text{HLBS} \leq 12$ |
| 5 | $12 < \text{HLBS} \leq 14$ |
| 6 | $14 < \text{HLBS} \leq 17$ |
| 7 | $17 < \text{HLBS} \leq 21$ |
| 8 | $21 < \text{HLBS} \leq 25$ |
| 9 | $25 < \text{HLBS} \leq 31$ |
| 10 | $31 < \text{HLBS} \leq 37$ |
| 11 | $37 < \text{HLBS} \leq 45$ |
| 12 | $45 < \text{HLBS} \leq 55$ |
| 13 | $55 < \text{HLBS} \leq 68$ |
| 14 | $68 < \text{HLBS} \leq 82$ |
| 15 | $82 < \text{HLBS}$ |

- UE Power Headroom (UPH):

The UPH field indicates the ratio of the maximum UE transmission power and the corresponding DPCCCH code power defined in [17]. The length of UPH is 5 bits.

The Scheduling Information message is represented in figure 9.2.5.3.2-1 where for each field, the LSB is the rightmost bit in the figure and the MSB is the leftmost bit.

| | | | |
|----------------|-----------------|-----------------|-----------------|
| UPH (5bits) | TEBS (5bits) | HLBS (4bits) | HLID (4bits) |
|----------------|-----------------|-----------------|-----------------|

Figure 9.2.5.3.2-1: Scheduling Information format

9.2.5.4 Transport block size

RRC can configure the MAC-e to use one of two Transport block size sets for the 10ms TTI duration and one of four Transport block size sets for the 2ms TTI duration. The normative description of the mapping between the E-TFCI and the corresponding transport block size is provided in Annex B:

- If the UE is configured with E-TFCI table 0 (see [7]) and 2ms TTI, it shall use the mapping defined in Annex B.1
- If the UE is configured with E-TFCI table 1 (see [7]) and 2ms TTI, it shall use the mapping defined in Annex B.2
- If the UE is configured with E-TFCI table 2 (see [7]) and 2ms TTI, it shall use the mapping defined in Annex B.2a
- If the UE is configured with E-TFCI table 3 (see [7]) and 2ms TTI, it shall use the mapping defined in Annex B.2b
- If the UE is configured with E-TFCI table 0 (see [7]) and 10ms TTI, it shall use the mapping defined in Annex B.3
- If the UE is configured with E-TFCI table 1 (see [7]) and 10ms TTI, it shall use the mapping defined in Annex B.4

The mapping in Transport block size table 0 for 2ms TTI (see table in Annex B.1) can also be obtained using the formula below.

Let k be the chosen E-TFCI, then the corresponding E-DCH transport block size L_k is given by the following formula (informative):

$$L_0 = 18$$

$$\text{if } k = 0..126$$

$$L_{k+1} = \lfloor 120 * (\rho)^k \rfloor$$

where

$$\rho = \left(\frac{11484}{120} \right)^{\frac{1}{127-1}}$$

The mapping in Transport block size table 2 for 2ms TTI (see table in Annex B.2a) can also be obtained using the formula below.

Let k be the chosen E-TFCI, then the corresponding E-DCH transport block size L_k is given by the following formula (informative):

$$L_0 = 18$$

$$\text{if } k = 0..126$$

$$L_{k+1} = \lfloor 120 * (\rho)^k \rfloor$$

where

$$\rho = \left(\frac{22996}{120} \right)^{\frac{1}{127-1}}$$

The mapping in Transport block size table 0 for 10ms TTI (see table in Annex B.3) can also be obtained using the formula below.

Let k be the chosen E-TFCI, then the corresponding E-DCH transport block size L_k is given by the following formula (informative):

$$L_0 = 18$$

$$\text{if } k = 0..126$$

$$L_{k+1} = \lfloor 120 * (\rho)^k \rfloor$$

where

$$\rho = \left(\frac{20000}{120} \right)^{\frac{1}{127-1}}$$

9.2.6 Signaling of control information for TDD E-DCH

9.2.6.1 HARQ information

This control information is used in support of the uplink hybrid ARQ functionality.

- ACK/NACK information:

Transmitted on the E-HICH in the serving E-DCH cell, the ACK/NACK information indicates the successful or unsuccessful decoding of the corresponding uplink transmission. If NACK is received then the UE may retransmit if appropriate physical resources are available, otherwise it must receive a further Grant before it can retransmit the MAC-e PDU. The length of the ACK/NACK field is 1 bit.

- RSN:
Transmitted on the E-UCCH, the RSN is used to convey the uplink HARQ transmission number. Because of the limitation in the field size, the maximum value that the RSN can represent is equal to 3. Once the RSN reaches this value, the RSN shall alternate between the values of 2 and 3 for any subsequent consecutive retransmissions. Thus, the RSN sequence follows the pattern 0,1,2,3,2,3,2,3,...(see subclause 11.9.1.1.2). The length of the RSN field is 2 bits.
- HARQ Process Identifier
Transmitted on the E-UCCH, the HARQ process identifier is selected by the UE and identifies the HARQ process for which the MAC-e PDU is being transmitted/retransmitted. The length of the HARQ process identifier field is 3 bits. For TDD, the MSB of the HARQ Process Identifier is not transmitted by the physical layer but may be inferred by the Node-B according to the nature of the physical resources used (scheduled or unscheduled). HARQ processes associated with scheduled transmission utilise HARQ Process Identifiers 0 to 3.

9.2.6.2 DL Scheduling information

This control information is used by a Node-B in order to control its use of E-DCH system resources.

9.2.6.2.1 Absolute Grant

The Absolute Grant is sent on downlink on a set of configured E-AGCHs from the serving E-DCH cell and allows the Node B scheduler to directly adjust the granted rate and assigned physical resources for UEs under its control. The physical resource assignment indicates to the UE the maximum amount of uplink resources that it may use for a scheduled transmission.

The E-AGCH is a shared channel that uses an E-RNTI specific CRC in order to address messages to specific UEs (see [19]). For TDD, the RRC shall configure the MAC with a primary E-RNTI only.

A UE is required to monitor a set of E-AGCHs. The RRC signals to the UE details of the set of E-AGCHs that are to be monitored. The UE decodes an Absolute Grant intended for it on the basis of the E-RNTI sent to it by the Node B via the SRNC and by RRC. The following information will be conveyed in an absolute grant message:

- Absolute Grant Value – maximum power granted per resource unit (per slot)
- The physical resources to be used for transmission
 - Channelisation Code
 - Timeslots
 - Resource Duration (optional)

The absolute grant message itself includes multiple fields that are multiplexed together into between 14 and 28 bits for 3.84/7.68 Mcps TDD and between 23 and 26 bits for 1.28 Mcps TDD (depending on the system configuration) inside the MAC-e of the Node B and then submitted to the physical layer for transmission on the E-AGCH. These fields are:

- Absolute Grant Value:
For TDD, this field indicates the maximum E-DCH traffic to reference power ratio ($E\text{-P}U\text{C}H/P_{e\text{-base}}$) per TDD resource unit that the UE is allowed to use on the E-DCH resources associated with the Absolute Grant. A TDD resource unit is defined as one sixteenth of the OVFSF codespace in one timeslot. The length of the Absolute Grant Value field for TDD is 5 bits.
- Channelisation Code:
This field describes the code component of the physical resource grant. For 1.28/3.84 Mcps TDD it comprises an enumerated value of length 5 bits indicating which node on the OVFSF code tree has been allocated. For 7.68 Mcps TDD it comprises an enumerated value of length 6 bits indicating which node on the OVFSF tree has been allocated. The mapping between the allocated OVFSF and the enumerated node 0...30 for 1.28/3.84 Mcps and 0...62 for 7.68 Mcps is as given in [19].
- Timeslot Resource Related Information:
This field describes the timeslot component of the physical resource grant and comprises a bitmap of length n_{TRRI} indicating which of the timeslots configured for E-DCH use by RRC have been allocated with the LSB corresponding to the lowest numbered E-DCH timeslot and the MSB corresponding to the highest numbered timeslot. The length of the TRRI field (n_{TRRI}) is 5 bits for 1.28 Mcps TDD and is configurable by RRC on a per-cell basis between 1 and 12 bits for 3.84/7.68 Mcps TDD.
- Resource Duration Indicator:
Optionally, RRC may configure, on a per-cell basis the presence of a resource duration indicator field on E-

AGCH for TDD. If configured as present in a cell, 3 bits are used to indicate the number of TTI's allocated and the spacing between the allocated TTIs via a single grant according to table 9.2.6.2.1-2. If the field is configured as not present on E-AGCH in the cell, a value of 0 is implicitly assumed by the UE corresponding to 1 TTI.

Table 9.2.6.2.1-2 – Resource Duration Indicator (RDI) interpretation

| Resource Duration Indicator (3 bits) | TTIs allocated | TTI spacing |
|-----------------------------------------|----------------|-------------|
| 0 | 1 | 1 |
| 1 | 2 | 1 |
| 2 | 2 | 2 |
| 3 | 2 | 4 |
| 4 | 4 | 1 |
| 5 | 4 | 2 |
| 6 | 4 | 4 |
| 7 | 8 | 1 |

- E-AGCH Cyclic Sequence Number (ECSN):
The ECSN is a 3-bit field used to assist the UE with outer-loop power control of E-AGCH (cf. HCSN for HS-SCCH).
- E-HICH Indicator(EI) (1.28 Mcps TDD only)
The E-HICH indicator (EI) consists of 2 bits and is used to indicate which E-HICH will convey the acknowledgement indicator for the scheduled UEs.
- E-UCCH Number Indicator (ENI) (1.28 Mcps TDD only)
The E-UCCH Number Indicator (ENI) is a 3-bit field used to indicate the detailed number of E-UCCH.

9.2.6.3 UL Scheduling Information

This control information is used by UEs to indicate to the Node B the amount of resources they require. Scheduling Information is sent via the E-PUCH in the MAC-e header when the UE is granted resource and by the E-RUCCH when no resource has been granted. Scheduling Information consists of three components as defined in subclause 9.2.6.3.3 -

- Buffer Information: This consists of:
 - Highest priority Logical Channel (HLID)
 - Total E-DCH Buffer Status (TEBS)
 - Highest priority Logical channel Buffer Status (HLBS)
- UE Power Headroom (UPH): The UPH field indicates the ratio of the maximum UE transmission power and the calculated UE transmit power defined as in [18] that would result for β_e equal to 0. The length of UPH is 5 bits.
- Serving and Neighbour Cell Pathloss (SNPL): This may be used by the Node-B to assist with its estimation of the degree of intercell interference each UE will generate and hence the absolute grant power value and physical resources to assign . The length of SNPL is 5 bits.

The Scheduling Information message is represented in figure 9.2.6.3-1.

| SNPL | UPH | TEBS | HLBS | HLID |
|----------|----------|----------|----------|----------|
| (5 bits) | (5 bits) | (5 bits) | (4 bits) | (4 bits) |

Figure 9.2.6.3-1: Scheduling Information format

If Scheduling Information is sent via the E-RUCCH then the E-RNTI is also sent via the E-RUCCH, as shown by Figure 9.2.6.3-2:

| | |
|-----------------------------------------|-------------------------|
| Scheduling Information (23 bits) | E-RNTI (16 bits) |
|-----------------------------------------|-------------------------|

Figure 9.2.6.3-2: Format of information sent on E-RUCCH

9.2.6.4 Transport block size

For 1.28 Mcps TDD, the normative description of the mapping between the E-TFC index and the corresponding transport block size is provided in Annex BC.

For 3.84 Mcps TDD, the normative description of the mapping between the E-TFC index and the corresponding transport block size is provided in Annex BA.

For 7.68 Mcps TDD, the normative description of the mapping between the E-TFC index and the corresponding transport block size is provided in Annex BB.

9.2.6.4.1 3.84 Mcps TDD Transport Block Size

For 3.84 Mcps TDD, the mapping of transport block size L to signalled index $k_i = \{0,1,\dots,127\}$ (see Annex BA.1) is given by the formula:

$$L = \left\lfloor 60 \times \rho^{k_n + k_i} \right\rfloor$$

In the above formula $\rho = 128^{\frac{1}{127}}$, k_i is the TBS index (0...127) and k_n is an integer selected based upon the number of timeslots allocated (n). Values for k_n are tabulated in Table 9.2.6.4.1.

Table 9.2.6.4.1: k_n tabulated as a function of the number of timeslots (n)

| n | k_n |
|-----|-------|
| 1 | 0 |
| 2 | 18 |
| 3 | 28 |
| 4 | 36 |
| 5 | 42 |
| 6 | 46 |
| 7 | 50 |
| 8 | 54 |
| 9 | 57 |
| 10 | 60 |
| 11 | 62 |
| 12 | 65 |

9.2.6.4.2 7.68 Mcps TDD Transport Block Size

For 7.68 Mcps TDD, the mapping of transport block size L to signalled index $k_i = \{0,1,\dots,127\}$ (see Annex BB.1) is given by the formula:

$$L = \left\lfloor 60 \times \rho^{k_n + k_i} \right\rfloor$$

In the above formula, $\rho = 256^{\frac{1}{127}}$, k_i is the TBS index (0...127) and k_n is an integer selected based upon the number of timeslots allocated (n). Values for k_n are tabulated in Table 9.2.6.4.2.

Table 9.2.6.4.2: k_n tabulated as a function of the number of timeslots (n)

| | |
|----|-------|
| n | k_n |
| 1 | 0 |
| 2 | 15 |
| 3 | 25 |
| 4 | 31 |
| 5 | 36 |
| 6 | 41 |
| 7 | 44 |
| 8 | 47 |
| 9 | 50 |
| 10 | 52 |
| 11 | 54 |
| 12 | 56 |

9.2.6.4.3 1.28 Mcps TDD Transport Block Size

For 1.28 Mcps TDD, the mapping of transport block size L to signalled index $k = \{0,1,\dots,127\}$ (see Annex BC.1) is given by the formula:

Table 9.2.6.4.3: formula used to calculate the Transport Block Size

| Category 1-2 | | | Category 3-5 | | | |
|----------------------------------------------------------------------------------|----------------------------------------------|----------------------------------------------|----------------------------------------------|----------------------------------------------|----------------------------------------------|-----------------------------------------------|
| 1 Timeslot | 2 Timeslot | 3 Timeslot | 1 Timeslot | 2 Timeslot | 3 Timeslot | 4&5 Timeslot |
| $L_0 = 23, L_{\min} = 50, L_k = \lfloor L_{\min} p^{k-1} \rfloor, k \in [1,126]$ | | | | | | |
| $L_{127} = 1346,$ $p = \frac{1163}{1133}$ | $L_{127} = 2754,$ $p = \frac{1437}{1392}$ | $L_{127} = 4162,$ $p = \frac{1479}{1428}$ | $L_{127} = 2720,$ $p = \frac{2018}{1955}$ | $L_{127} = 5532,$ $p = \frac{2073}{1997}$ | $L_{127} = 8348,$ $p = \frac{2236}{2147}$ | $L_{127} = 11160,$ $p = \frac{2285}{2189}$ |

10 Handling of unknown, unforeseen and erroneous protocol data

The list of error cases is reported below:

- a) Use of reserved coding in the MAC header

If the MAC entity receives a MAC PDU with a header field using a value marked as reserved for this version of the protocol, it shall discard the PDU, unless explicitly mentioned otherwise.

- b) Inconsistent MAC header

If the MAC entity receives a MAC PDU with a header inconsistent with the configuration received from RRC, it shall discard the PDU. E.g.: In case DTCH is mapped to RACH/FACH, the MAC entity shall discard a PDU with a C/T field indicating a logical channel number that is not configured.

- c) Erroneous MAC header fields

The MAC PDU shall be discarded if the lower layer gives an error indication for a MAC PDU and a MAC header is included in the MAC PDU.

- d) Inconsistent information received on MAC control channels

If the MAC entity receives inconsistent information on the E-AGCH, it shall ignore the entire message. The following conditions constitute inconsistent information:

- The Absolute Grant Scope is "Per HARQ process" and the E-DCH TTI is configured to 10ms.
- The Identity Type is "Secondary" and the Absolute Grant Value is "INACTIVE".
- The Identity Type is "Secondary" and the Absolute Grant Scope is "Per HARQ process" in this version of the protocol.
- The Identity type is "Primary", the Absolute Grant value is "INACTIVE", the Absolute Grant Scope is "All HARQ processes", the E-DCH TTI is configured to 10ms and a secondary E-RNTI was not configured.

11 Specific functions

11.1 Traffic volume measurement for dynamic radio bearer control

Dynamic radio bearer control is performed by RRC, based on the traffic volume measurements reported by MAC. Traffic volume information is measured in MAC layer and the results are reported from MAC layer to RRC layer.

At least every TTI, the MAC layer shall receive from each RLC entity the value of its Buffer Occupancy (BO), expressed in bytes. RRC can configure MAC to keep track of statistics (i.e. raw BO, average of BO and variance of BO) on the BO (see [7]) values of all Radio Bearers mapped onto a given transport channel. When the average or variance are requested, an averaging interval duration will also be provided.

Every time the BO values are reported to MAC, the UE shall verify whether an event was triggered or if a periodic report is required (see [7]). If reporting is required (multiple reports may be triggered in a single TTI), the MAC shall deliver to RRC the reporting quantities required for the corresponding RBs. In the case of average and variance of BO, the averaging should be performed for the interval with the configured duration ending at the time when the event was triggered.

RRC requests MAC measurement report with the primitive CMAC-Measure-REQ including following parameters.

Measurement information elements.

- Reporting Quantity identifiers
Indicates what should be reported to RRC layer
For each RB, BO (optional), Average of BO (optional), or Variance of BO(optional)
- Time interval to take an average or a variance (applicable when Average or Variance is Reporting Quantity)
Indicates time interval to take an average or a variance of BO
The calculation of average and variance of BO shall be based on one sample of BO per 10ms during the time interval given in this information element. All samples taken in the time interval shall have equal weight in the calculation.

MAC receives RLC PDUs with the primitive MAC-Data-REQ including following parameters.

- Buffer Occupancy (BO)
The parameter Buffer Occupancy (BO) indicates for each logical channel the amount of data in number of bytes that is available for transmission and retransmission in RLC layer. When MAC is connected to an AM RLC entity, control PDUs to be transmitted and RLC PDUs outside the RLC Tx window shall also be included in the BO. RLC PDUs that have been transmitted but not negatively acknowledged by the peer entity shall not be included in the BO.

11.2 Control of RACH transmissions

The MAC sublayer is in charge of controlling the timing of RACH transmissions on transmission time interval level (the timing on access slot level is controlled by L1). Note that retransmissions in case of erroneously received RACH message part are under control of higher layers, i.e. RLC, or RRC for CCCH (and SHCCH for TDD).

11.2.1 Access Service Class selection

The physical RACH resources (i.e. access slots and preamble signatures for FDD, timeslot and channelisation code for 3.84 Mcps TDD and 7.68 Mcps TDD, SYNC1 code for 1.28 Mcps TDD) may be divided between different Access Service Classes in order to provide different priorities of RACH usage. It is possible for more than one ASC or for all ASCs to be assigned to the same access slot/signature space or SYNC1 code.

Access Service Classes are numbered in the range $0 \leq i \leq \text{NumASC} \leq 7$ (i.e. the maximum number of ASCs is 8). An ASC is defined by an identifier i that defines a certain partition of the PRACH resources and an associated persistence value P_i . A set of ASC parameters consists of $\text{NumASC}+1$ such parameters (i, P_i) , $i = 0, \dots, \text{NumASC}$. The PRACH partitions and the persistence values P_i are derived by the RRC protocol from system information (see [7]). The set of ASC parameters is provided to MAC with the CMAC-Config-REQ primitive. The ASC enumeration is such that it corresponds to the order of priority (ASC 0 = highest priority, ASC 7 = lowest priority). ASC 0 shall be used in case of Emergency Call or for reasons with equivalent priority.

At radio bearer setup/reconfiguration each involved logical channel is assigned a MAC Logical channel Priority (MLP) in the range $1, \dots, 8$. When the MAC sublayer is configured for RACH transmission in the UE, these MLP levels shall be employed for ASC selection on MAC.

The following ASC selection scheme shall be applied, where NumASC is the highest available ASC number and MinMLP the highest logical channel priority assigned to one logical channel:

- in case all TBs in the TB set have the same MLP, select $\text{ASC} = \min(\text{NumASC}, \text{MLP})$;
- in case TBs in a TB set have different priority, determine the highest priority level MinMLP and select $\text{ASC} = \min(\text{NumASC}, \text{MinMLP})$.

When an RRC CONNECTION REQUEST message is sent RRC determines ASC by means of the access class [7]. The ASC to be used in these circumstances is signalled to MAC by means of the CMAC-CONFIG-REQ message.

If MAC has knowledge of a U-RNTI then the ASC is determined in the MAC entity. If no U-RNTI has been indicated to MAC then MAC will use the ASC indicated in the CMAC-CONFIG-REQ primitive.

11.2.2 Control of RACH transmissions for FDD mode

The RACH transmissions are controlled by the UE MAC sublayer as outlined in figure 11.2.2.1.

NOTE: The figure shall illustrate the operation of the transmission control procedure as specified below. It shall not impose restrictions on implementation. MAC controls the timing of each initial preamble ramping cycle as well as successive preamble ramping cycles in case that none or a negative acknowledgement is received on AICH.

NOTE: In Cell-FACH state, the UE should co-ordinate the UL transmission schedule with the measurement schedule in FACH measurement occasions so as to minimise any delays associated with inter-frequency measurements.

MAC receives the following RACH transmission control parameters from RRC with the CMAC-CONFIG-Req primitive:

- a set of Access Service Class (ASC) parameters, which includes for each ASC, $i=0, \dots, \text{NumASC}$ an identification of a PRACH partition and a persistence value P_i (transmission probability);
- maximum number of preamble ramping cycles M_{max} ;
- range of backoff interval for timer T_{BO1} , given in terms of numbers of transmission 10 ms time intervals N_{BO1max} and N_{BO1min} , applicable when negative acknowledgement on AICH is received.

When there is data to be transmitted, MAC selects the ASC from the available set of ASCs, which consists of an identifier i of a certain PRACH partition and an associated persistence value P_i . The procedure to be applied for ASC selection is described in subclause 11.2.1.

Based on the persistence value P_i , the UE decides whether to start the L1 PRACH transmission procedure (see [13]) in the present transmission time interval or not. If transmission is allowed, the PRACH transmission procedure (starting with a preamble power ramping cycle) is initiated by sending of a PHY-ACCESS-REQ primitive. MAC then waits for

access information from L1 via PHY-ACCESS-CNF primitive. If transmission is not allowed, a new persistency check is performed in the next transmission time interval. The persistency check is repeated until transmission is permitted.

When the preamble has been acknowledged on AICH, L1 access information with parameter value "ready for data transmission" is indicated to MAC with PHY-ACCESS-CNF primitive. Then data transmission is requested with PHY-DATA-REQ primitive, and the PRACH transmission procedure shall be completed with transmission of the PRACH message part according to L1 specifications. Successful completion (TX status) of the MAC transmission control procedure shall be indicated to higher layer.

When PHY indicates that no acknowledgement on AICH is received while the maximum number of preamble retransmissions is reached (defined by parameter Preamble_Retrans_Max on L1), a new persistency test is performed in the next transmission time interval. The timer T_2 ensures that two successive persistency tests are separated by at least one 10 ms time interval.

In case that a negative acknowledgement has been received on AICH a backoff timer T_{BO1} is started. After expiry of the timer, persistence check is performed again. Backoff timer T_{BO1} is set to an integer number N_{BO1} of 10 ms time intervals, randomly drawn within an interval $0 \leq N_{BO1min} \leq N_{BO1} \leq N_{BO1max}$ (with uniform distribution). N_{BO1min} and N_{BO1max} may be set equal when a fixed delay is desired, and even to zero when no delay other than the one due to persistency is desired.

Before a persistency test is performed it shall be checked whether any new RACH transmission control parameters have been received from RRC with CMAC-CONFIG-Req primitive. The latest set of RACH transmission control parameters shall be applied.

If the maximum number of preamble ramping cycles M_{max} is exceeded, failure of RACH transmission shall be reported to higher layer.

Both, transmission failure and successful completion of the MAC transmission control procedure, shall be indicated individually for each logical channel of which data was included in the transport block set of that access attempt. When transparent mode RLC is employed (i.e. for CCCH), transmission status is reported to RRC with CMAC-STATUS-Ind primitive. For logical channels employing acknowledged or unacknowledged mode RLC, transmission status is reported to RLC with MAC-STATUS-Ind primitive.

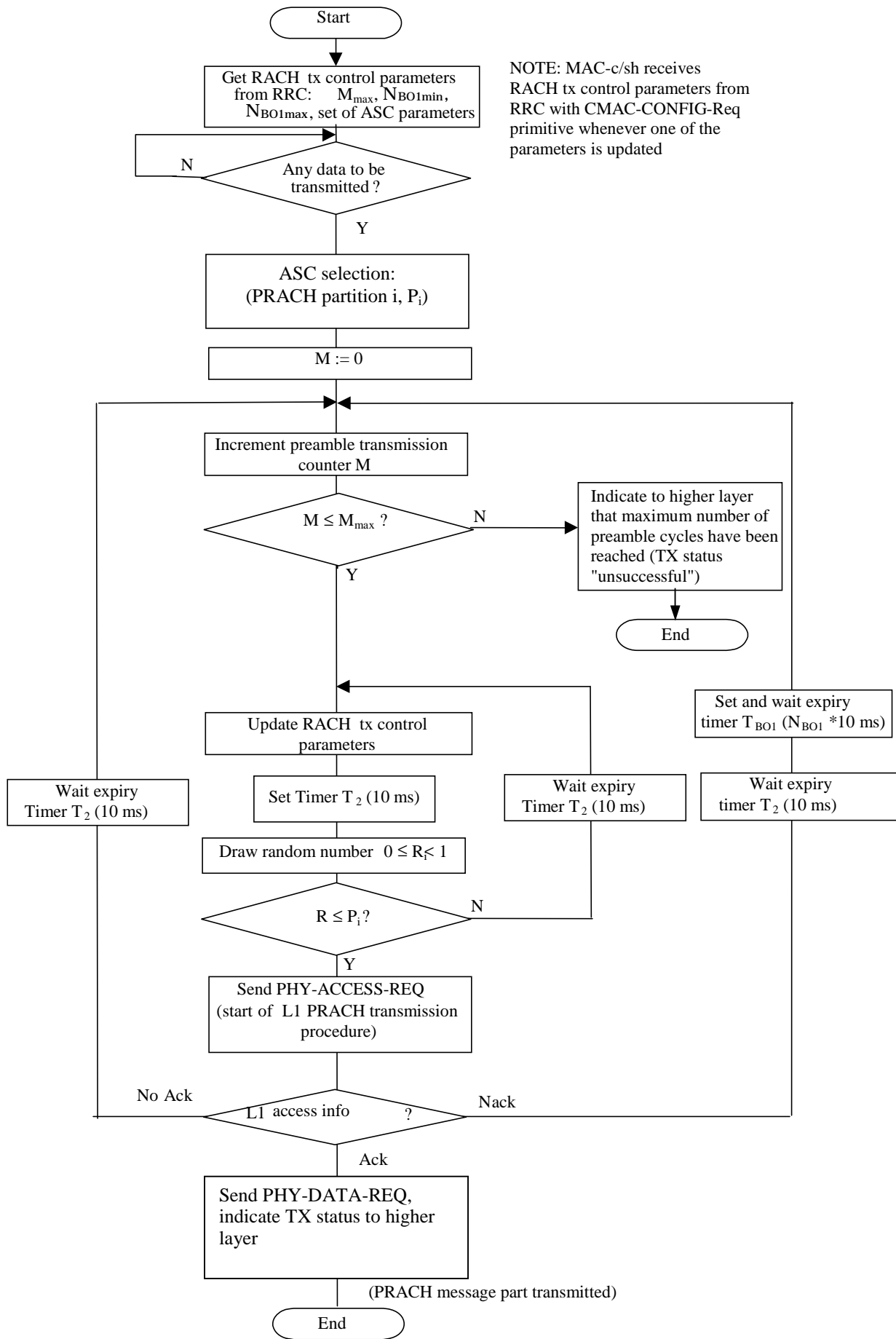

Figure 11.2.2.1: RACH transmission control procedure (UE side, informative)

11.2.3 Control of RACH transmissions for TDD

11.2.3.1 Control of RACH transmissions for 3.84 Mcps TDD and 7.68 Mcps TDD

The RACH transmissions are performed by the UE as shown in figure 11.2.3.2.

NOTE: The figure shall illustrate the operation of the transmission control procedure as specified below. It shall not impose restrictions on implementation.

MAC receives the following RACH transmission control parameters from RRC with the CMAC-Config-REQ primitive:

- a set of Access Service Class (ASC) parameters, which includes for each ASC, $i=0, \dots, \text{NumASC}$ an identification of a PRACH partition and a persistence value P_i (transmission probability).

When there is data to be transmitted, MAC selects the ASC from the available set of ASCs, which consists of an identifier i of a certain PRACH partition and an associated persistence value P_i . The procedure to be applied for ASC selection is described in subclause 11.2.1.

In order to separate different ASCs each PRACH has N sub-channels associated with it (numbered from 0 to $N-1$). N may be assigned the value 1,2,4, or 8 by higher layer signalling. Sub-channel i for a PRACH defined in timeslot k is defined as the k :th slot in the frames where $\text{SFN mod } N = i$. Therefore follows the definition:

- Sub-channel i associated to a PRACH defined in timeslot k is defined as the k :th timeslot in the frames where $\text{SFN mod } N = i$.

Figure 11.2.3.1 illustrates the eight possible subchannels for the case, $N=8$. For illustration, the figure assumes that the PRACH is assigned timeslot 3.

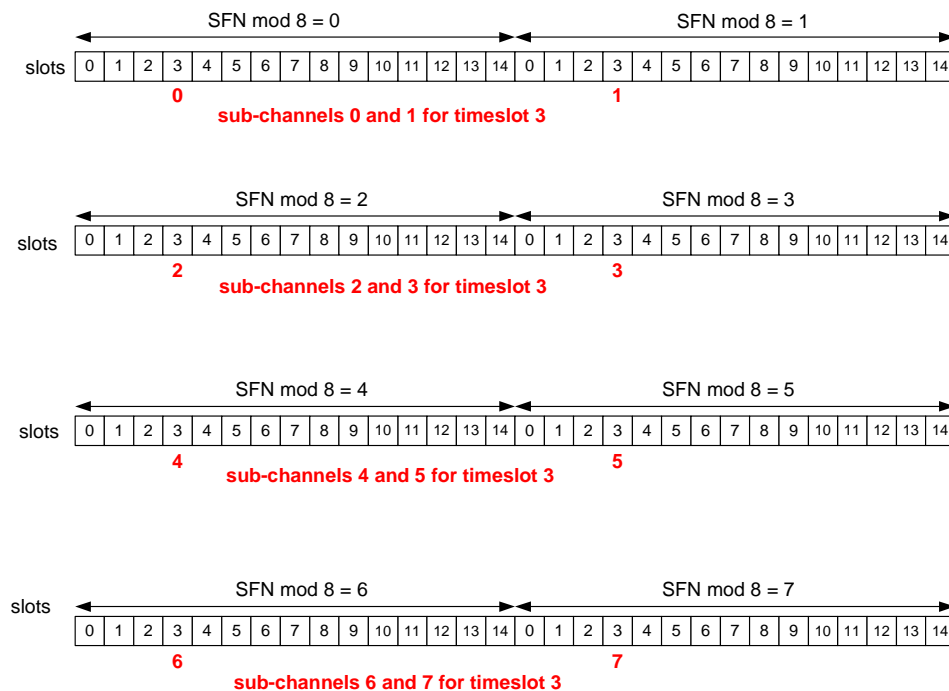

Figure 11.2.3.1 Eight sub-channels for timeslot 3

Based on the persistence value P , the UE decides whether to send the message on the RACH. If transmission is not allowed, a new persistency check is performed in the next transmission time interval. The persistency check is repeated until transmission is permitted. If transmission is allowed, a subchannel is randomly selected from the set of available subchannels for this ASC. The random subchannel selection shall be such that each of the allowed selections is chosen with equal probability. If an available subchannel is not found, the persistency check and subchannel assignment is repeated for the next subchannel period. If an available subchannel is found the PRACH transmission procedure is initiated by sending of a PHY-Data-REQ primitive.

Successful completion (TX status) of the MAC transmission control procedure shall be indicated to higher layer individually for each logical channel of which data was included in the transport block set of that access attempt. When transparent mode RLC is employed (i.e. for CCCH), transmission status is reported to RRC with CMAC-STATUS-Ind primitive. For logical channels employing acknowledged or unacknowledged mode RLC, transmission status is reported to RLC with MAC-STATUS-Ind primitive.

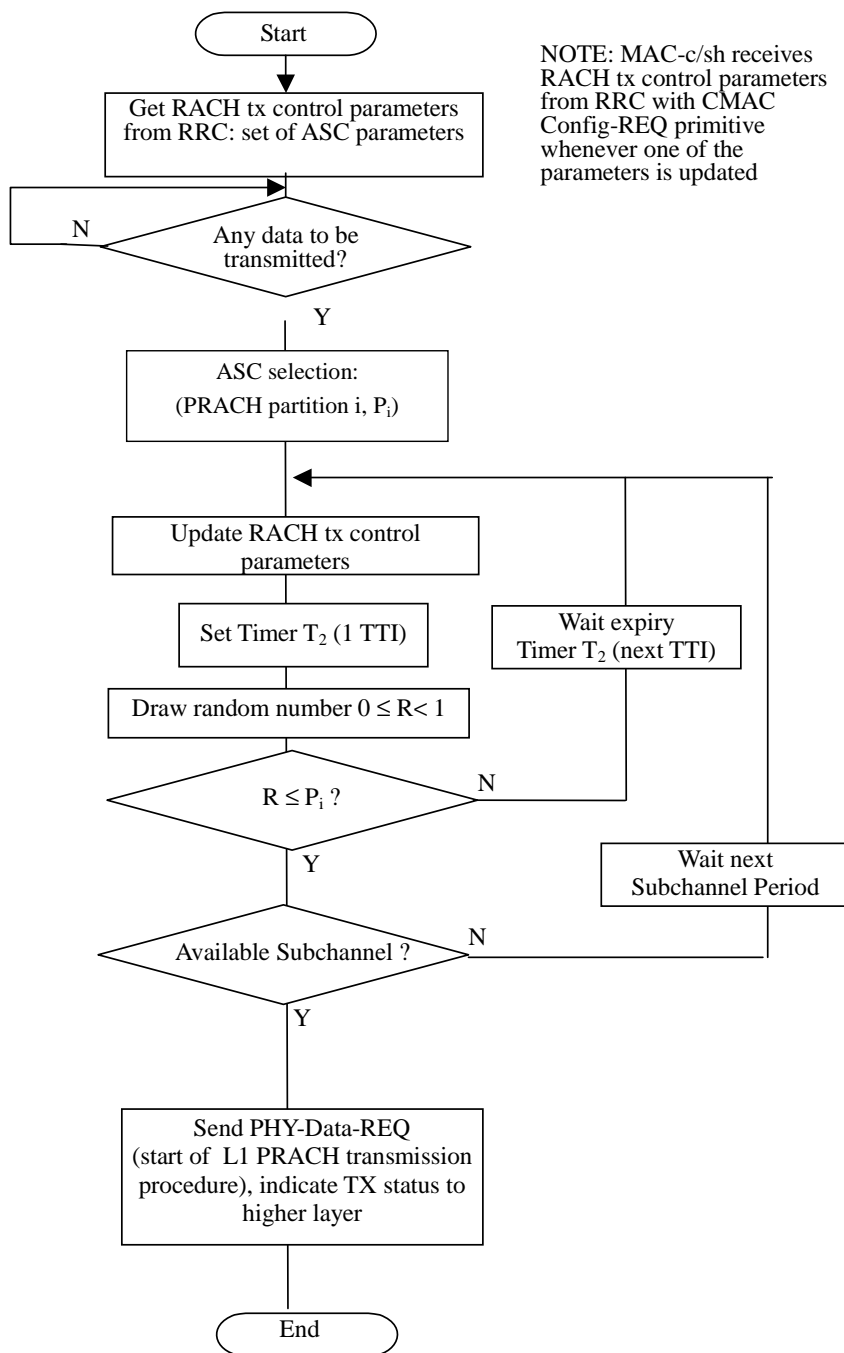

Figure 11.2.3.2: RACH transmission control procedure for TDD (UE side, informative)

11.2.3.2 Control of RACH Transmissions for 1.28 Mcps TDD

The RACH transmissions are performed by the UE as shown in figure 11.2.3.3.

NOTE: The figure shall illustrate the operation of the transmission control procedure as specified below. It shall not impose restrictions on implementation.

UE MAC receives the following RACH transmission control parameters from RRC with the CMAC-Config-REQ primitive:

- a set of Access Service Class (ASC) parameters, which includes for each ASC, $i=0, \dots, \text{NumASC}$ an identification of a PRACH partition and a persistence value P_i (transmission probability),
- maximum number of synchronisation attempts M_{max} .

When there is data to be transmitted, MAC selects the ASC from the available set of ASCs, which consists of an identifier i of a certain PRACH partition and an associated persistence value P_i .

Based on the persistence value P_i , MAC decides whether to start the L1 PRACH procedure in the present transmission time interval or not. If transmission is allowed, the PRACH transmission procedure (starting with the SYNC_UL/FPACH power ramping sequence) is initiated by the sending of a PHY-ACCESS-REQ primitive. MAC then waits for access information from L1 via the PHY-ACCESS-CNF primitive. If transmission is not allowed, a new persistency check is performed in the next transmission time interval. The persistency check is repeated until transmission is permitted.

If a synchronisation burst has been acknowledged on its associated FPACH, PHY will inform MAC by a PHY-ACCESS-CNF primitive indicating "ready for RACH data transmission". Then MAC requests data transmission with a PHY-DATA-REQ primitive, and the PRACH transmission procedure will be completed with transmission on the PRACH resources associated with the FPACH.

Successful completion of the MAC procedure is indicated to higher layer individually for each logical channel of which data was included in the transport block set of that access attempt. When transparent mode RLC is employed (i.e. for CCCH), transmission status is reported to RRC with CMAC-STATUS-Ind primitive. For logical channels employing acknowledged or unacknowledged mode RLC, transmission status is reported to RLC with MAC-STATUS-Ind primitive.

If no synchronisation burst received an acknowledgement on the FPACH within the maximum number of transmissions permitted in a power ramping cycle, PHY will inform MAC by a PHY-ACCESS-CNF primitive indicating "no response received on FPACH". If the maximum number of synchronisation attempts permitted, M_{max} , has not been exceeded, then MAC commences a new persistency test sequence in the next transmission time interval and the PHY-ACCESS-REQ procedure is repeated. The timer T_2 ensures that two successive persistency tests are separated by at least one transmission time interval. If the maximum number of synchronisation attempts is exceeded then MAC abandons the RACH procedure. Failure to complete the MAC procedure is indicated to higher layer by the CMAC-STATUS-Ind or MAC-STATUS-Ind primitives.

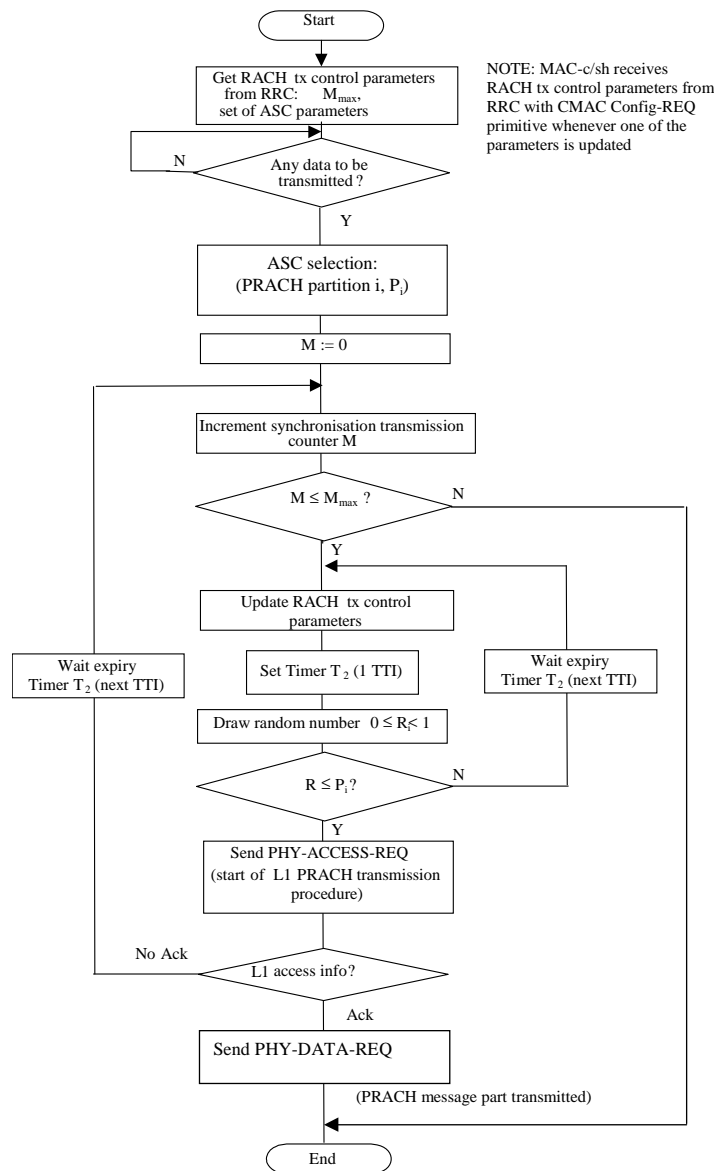

Figure 11.2.3.3: RACH transmission control procedure for 1.28 Mcps TDD (UE side, informative)

11.2.3.2.1 Control of E-RUCCH transmissions

The MAC-e sublayer is in charge of controlling the timing of E-RUCCH transmission.

11.2.3.2.1.1 Access Service Class selection

For E-RUCCH transmission, the following ASC selection scheme shall be applied:

- select ASC = min (NumASC, MinMLP);

Where NumASC is the highest available ASC number and MinMLP is the highest logical channel priority of the logical channel which has data buffered for transmission.

11.2.3.2.1.2 Transport Format selection

For E-RUCCH transmission, MAC-e can randomly select one of TFs configured for RACH in system information.

11.3 Void

11.4 Transport format combination selection in UE (non E-DCH)

RRC can control the scheduling of uplink data by giving each logical channel a priority between 1 and 8, where 1 is the highest priority and 8 the lowest. TFC selection in the UE shall be done in accordance with the priorities indicated by RRC. Logical channels have absolute priority, i.e. the UE shall maximise the transmission of higher priority data.

If the uplink TFCS or TFC Subset configured by UTRAN follows the guidelines described in [7] the UE shall perform the TFC selection according to the rules specified below. If these guidelines are not followed then the UE behaviour is not specified.

A given TFC can be in any of the following states:

- Supported state;
- Excess-power state;
- Blocked state.

TDD mode UEs in CELL_FACH state using the USCH transport channel and UEs in CELL_DCH state using a DCH shall continuously monitor the state of each TFC based on its required transmit power versus the maximum UE transmit power (see [7]). The state transition criteria and the associated requirements are described in [12, 14]. The UE shall consider that the Blocking criterion is never met for TFCs included in the minimum set of TFCs (see [7]).

The following diagram illustrates the state transitions for the state of a given TFC:

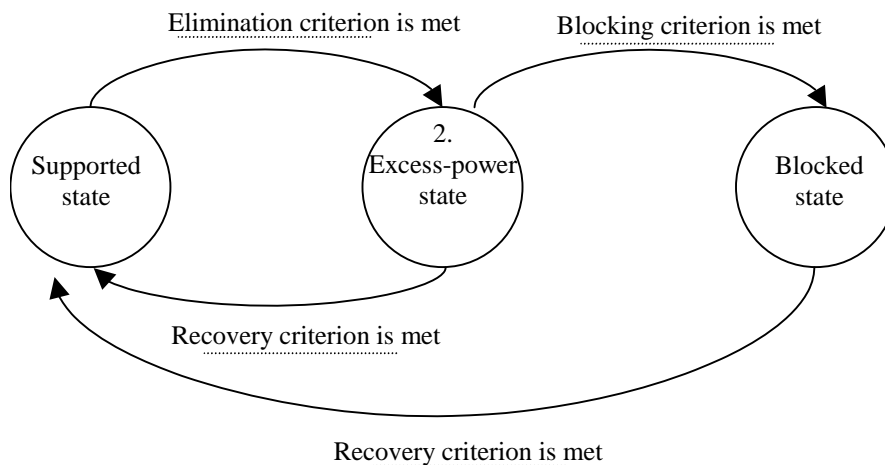

Figure 11.4.1: State transitions for the state of a given TFC

FDD Mode UEs in CELL_FACH state may estimate the channel path loss and set to excess power state all the TFCs requiring more power than the Maximum UE transmitter power (see [7]). All other TFCs shall be set to Supported state.

Every time the set of supported TFCs changes, the available bitrate shall be indicated to upper layers for each logical channel in order to facilitate the adaptation of codec data rates when codecs supporting variable-rate operation are used. The details of the computation of the available bitrate and the interaction with the application layer are not further specified.

Before selecting a TFC, i.e. at every boundary of the shortest TTI, or prior to each transmission on PRACH the set of valid TFCs shall be established. All TFCs in the set of valid TFCs shall:

1. belong to the TFCS.
 - 1a. not be restricted by higher layer signalling (e.g. TFC Control, see [7]).
2. not be in the Blocked state.

3. be compatible with the RLC configuration.
4. not require RLC to produce padding PDUs (see [6] for definition).
5. not carry more bits than can be transmitted in a TTI (e.g. when compressed mode by higher layer scheduling is used and the presence of compressed frames reduces the number of bits that can be transmitted in a TTI using the Minimum SF configured).

The UE may remove from the set of valid TFCs, TFCs in Excess-power state in order to maintain the quality of service for sensitive applications (e.g. speech). However, this shall not apply to TFCs included in the minimum set of TFCs (see [7]). Additionally, if compressed frames are present within the longest configured TTI to which the next transmission belongs, the UE may remove TFCs from the set of valid TFCs in order to account for the higher power requirements.

The chosen TFC shall be selected from within the set of valid TFCs and shall satisfy the following criteria in the order in which they are listed below:

1. No other TFC shall allow the transmission of more highest priority data than the chosen TFC.
2. No other TFC shall allow the transmission of more data from the next lower priority logical channels. Apply this criterion recursively for the remaining priority levels.
3. No other TFC shall have a lower bit rate than the chosen TFC.

In FDD mode the above rules for TFC selection in the UE shall apply to DCH, and the same rules shall apply for TF selection on RACH.

In 3.84 Mcps TDD mode and in 7.68 Mcps TDD mode the above rules for TFC selection in the UE shall apply to DCH and USCH.

11.5 Cipherring

The cipherring function is performed in MAC (i.e. only in MAC-d) if a radio bearer is using the transparent RLC mode. The part of the MAC PDU that is cipherrered is the MAC SDU and this is shown in Figure 11.5.1 below.

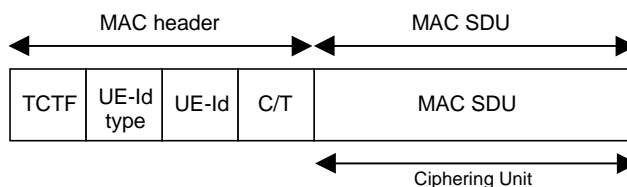

Figure 11.5.1: Cipherrered part unit for a MAC PDU

In case a TTI contains multiple MAC PDUs for a given Transparent mode RB, the cipherring unit for this RB is the bitstring concatenation of all the MAC SDUs, resulting in the PLAINTEXT BLOCK, as defined in [15]. In case there is only one MAC PDU for a given Transparent mode RB, the cipherring unit is the MAC SDU, resulting in the PLAINTEXT BLOCK. The concatenation order is the same as the order of transmission of the Transport Blocks between MAC and Physical layer.

The KEYSTREAM BLOCK as defined in [10] is applied to the PLAINTEXT BLOCK, and the end result, CIPHERTEXT BLOCK, becomes the cipherrered part for the MAC PDU, in case there is only one MAC PDU per RB. In case there is more than one MAC PDU per RB, the CIPHERTEXT BLOCK is split into the corresponding cipherrered parts for each MAC PDU. The split order is the same as the order of transmission of the Transport Blocks between MAC and Physical layer.

The cipherring algorithm and key to be used are configured by upper layers [7] and the cipherring method shall be applied as specified in [10].

The parameters that are required by MAC for cipherring are defined in [10] and are input to the cipherring algorithm. The parameters required by MAC which are provided by upper layers [7] are listed below:

- MAC-d HFN (Hyper frame number for radio bearers that are mapped onto transparent mode RLC)
- BEARER defined as the radio bearer identifier in [10]. It will use the value RB identity -1 as in [7])

- CK (Ciphering Key)

If the TTI consists of more than one 10 ms radio frame, the CFN of the first radio frame in the TTI shall be used as input to the ciphering algorithm for all the data in the TTI.

11.6 Control of HS-DSCH transmission and reception

If MAC-hs is configured by upper layers [7], the control of HS-DSCH transmission and reception is defined in subclauses 11.6.1 and 11.6.2.

If MAC-ehs version is configured by upper layers [7], the control of HS-DSCH transmission and reception is defined in subclauses 11.6.3 and 11.6.4.

11.6.1 Network operation

The following are the functions of the various functional entities at the network in support of the HARQ protocol used on HS-DSCH when MAC-hs is configured by upper layers [7].

11.6.1.1 Scheduler

The scheduler performs the following functions:

- Schedules all UEs within a cell;
- Services priority queues:
 - The scheduler schedules MAC-hs SDUs based on information from upper layers. One UE may be associated with one or more MAC-d flows. Each MAC-d flow contains HS-DSCH MAC-d PDUs for one or more priority queues.
- Determines the HARQ Entity and the queue to be serviced;
- Sets the TSN for new data blocks being transferred from the selected queue;
 - set the TSN to value 0 for the first MAC-hs PDU transmitted for each Queue ID within an HS-DSCH;
 - increment the TSN with one for each transmitted MAC-hs PDU on each Queue ID within an HS-DSCH.

NOTE: The scheduler may re-use TSNs by toggling the NDI bit in order to resume pre-empted transmissions or to force the UE to flush the soft buffer. In this case the content of the payload may be changed but care should be taken to preserve the higher layer data order.

- Indicates the Queue ID and TSN to the HARQ entity for each MAC-hs PDU to be transmitted;
- Schedules new transmissions and retransmissions:
 - Based on the status reports from HARQ Processes the scheduler determines if either a new transmission or a retransmission should be made. A new transmission can however be initiated on a HARQ process at any time. Based on a delay attribute provided by upper layers, the scheduler may decide to discard any 'out-of-date' MAC-hs SDU.
- Determines the redundancy version:
 - The scheduler determines a suitable redundancy version for each transmitted and retransmitted MAC-hs PDU and indicates the redundancy version to lower layer.
- Determines the TDD HCSN;
 - Increment UE specific HCSN for each HS-SCCH transmission.

11.6.1.2 HARQ entity

- There is one HARQ entity per UE in UTRAN.
- The HARQ entity sets the Queue ID in transmitted MAC-hs PDUs to the value indicated by the UTRAN scheduler.
- The HARQ entity sets the transmission sequence number (TSN) in transmitted MAC-hs PDUs to the value indicated by the UTRAN scheduler.
- The HARQ entity sets the HARQ process identifier in transmitted MAC-hs PDUs. UTRAN should:
 - determine a suitable HARQ process to service the MAC-hs PDU and set the HARQ process identifier accordingly.

11.6.1.3 HARQ process

- The HARQ process sets the New data indicator in transmitted MAC-hs PDUs. UTRAN should:
 - set the New Data Indicator to the value "0" for the first MAC-hs PDU transmitted by a HARQ process;
 - not increment the New Data Indicator for retransmissions of a MAC-hs PDU;
 - increment the New Data Indicator with one for each transmitted MAC-hs PDU containing new data.
- The HARQ process processes received status messages. UTRAN should:
 - deliver received status messages to the scheduler.

11.6.2 UE operation

The UE operation in support of the HARQ protocol used on HS-DSCH is split among the following four functional units with their associated functions.

11.6.2.1 HARQ Entity

There is one HARQ entity at the UE which processes the HARQ process identifiers received on the HS-SCCH transmissions associated with MAC-hs PDUs received on the HS-DSCH.

A number of parallel HARQ processes are used in the UE to support the HARQ entity. The number of HARQ processes is configured by upper layers:

- Each received MAC-hs PDU shall be allocated to the HARQ process indicated by the HARQ process identifier of the MAC-hs PDU.

11.6.2.2 HARQ process

The HARQ process processes the New Data Indicator indicated by lower layers for each received MAC-hs PDU.

The UE may:

- for FDD, if the MAC-hs PDU is received within 5 sub-frames from the reception of the previous MAC-hs PDU intended for this HARQ process; or
- for TDD, if the MAC-hs PDU is received before generation of feedback resulting from reception of a previous MAC-hs PDU for the same H-ARQ process:
 - discard the MAC-hs PDU.

The UE shall:

- if the New Data Indicator has been incremented compared to the value in the previous received transmission in this HARQ process or this is the first received transmission in the HARQ process:
 - replace the data currently in the soft buffer for this HARQ process with the received data.
 - if the Transport Block Size index value is equal to 111111 (FDD only):
 - generate a positive acknowledgement (ACK) of the data in this HARQ process;
 - discard the received data;
 - assume that the data has been successfully decoded.
- if the New Data Indicator is identical to the value used in the previous received transmission in the HARQ process:
 - if the Transport Block Size index value is equal to 111111 (FDD only):
 - assume that the transport block size is identical to the last valid transport block size signalled for this HARQ process.
 - if the data has not yet been successfully decoded:
 - combine the received data with the data currently in the soft buffer for this HARQ process.
 - if the transport block size is different from the last valid transport block size signalled for this HARQ process:
 - the UE may replace the data currently in the soft buffer for this HARQ process with the received data.
- if the data in the soft buffer has been successfully decoded and no error was detected:
 - deliver the decoded MAC-hs PDU to the reordering entity;
 - generate a positive acknowledgement (ACK) of the data in this HARQ process.
- else:
 - generate a negative acknowledgement (NAK) of the data in this HARQ process;
- schedule the generated positive or negative acknowledgement for transmission and the time of transmission relative to the reception of data in a HARQ process is configured by upper layer.

The HARQ process processes the Queue ID in the received MAC-hs PDUs. The UE shall:

- arrange the received MAC-hs PDUs in queues based on the Queue ID.

11.6.2.3 Reordering entity

11.6.2.3.1 Definitions

In the functions described in this section the following definitions apply:

Parameters

- Transmitter window size (TRANSMIT_WINDOW_SIZE)
TRANSMIT_WINDOW_SIZE is the size of the transmitter window according to the definition below. This is a parameter in the Node B and the value of the parameter is configured by higher layers.
- Receiver window size (RECEIVE_WINDOW_SIZE)
RECEIVE_WINDOW_SIZE is the size of the receiver window according to the definition below. This is a parameter in the UE and the value of the parameter is configured by higher layers.

State variables

All state variables are non-negative integers. MAC-hs PDUs are numbered by modulo integer Transmission sequence numbers (TSN) cycling through the field 0 to 63. All arithmetic operations contained in the present document on `next_expected_TSN`, `RcvWindow_UpperEdge`, `T1_TSN` and `TSN_flush` are affected by the 64 modulus. When performing arithmetic comparisons of state variables or Transmission sequence number values a 64 modulus base shall be used. This modulus base is subtracted (within the appropriate field) from all the values involved and then an absolute comparison is performed. `RcvWindow_UpperEdge – RECEIVE_WINDOW_SIZE + 1` shall be assumed to be the modulus base.

- `next_expected_TSN`:
The `next_expected_TSN` is the Transmission sequence number (TSN) following the TSN of the last in-sequence MAC-hs PDU received. It shall be updated according to the procedures given in subclauses 11.6.2.3.2, 11.6.2.5 and 11.6.2.6. The initial value of `next_expected_TSN` =0.
- `RcvWindow_UpperEdge`:
The `RcvWindow_UpperEdge` represents the TSN, which is at the upper edge of the receiver window. After the first MAC-hs PDU has been received successfully, it also corresponds to the MAC-hs PDU with the highest TSN of all received MAC-hs PDUs. The initial `RcvWindow_UpperEdge` equals 63. `RcvWindow_UpperEdge` is updated based on the reception of new MAC-hs PDU according to the procedure given below.
- `T1_TSN`:
The TSN of the latest MAC-hs PDU that cannot be delivered to the disassembly entity, when the timer T1 is started.

Timers

- Re-ordering release timer (T1):
The Re-ordering release timer T1 controls the stall avoidance in the UE reordering buffer as described below. The value of T1 is configured by upper layers.

Other definitions

- Receiver window:
The receiver window defines TSNs of those MAC-hs PDUs that can be received in the receiver without causing an advancement of the receiver window according to the procedure below. The size of the receiver window equals `RECEIVE_WINDOW_SIZE` and spans TSNs going from `RcvWindow_UpperEdge – RECEIVE_WINDOW_SIZE + 1` to `RcvWindow_UpperEdge` included.

11.6.2.3.2 Reordering functionality

If no timer T1 is active:

- the timer T1 shall be started when a MAC-hs PDU with `TSN > next_expected_TSN` is correctly received.
- `T1_TSN` shall be set to the TSN of this MAC-hs PDU.

If a timer T1 is already active:

- no additional timer shall be started, i.e. only one timer T1 may be active at a given time.

The timer T1 shall be stopped if:

- the MAC-hs PDU with `TSN = T1_TSN` can be delivered to the disassembly entity before the timer expires.

When the timer T1 expires and `T1_TSN > next_expected_TSN`:

- all correctly received MAC-hs PDUs with `TSN > next_expected_TSN` up to and including `T1_TSN-1` shall be delivered to the disassembly entity;
- all correctly received MAC-hs PDUs up to the next not received MAC-hs PDU shall be delivered to the disassembly entity.
- `next_expected_TSN` shall be set to the TSN of the next not received MAC-hs PDU.

When the timer T1 is stopped or expires, and there still exist some received MAC-hs PDUs that can not be delivered to higher layer:

- timer T1 is started
- set T1_TSN to the highest TSN among those of the MAC-hs PDUs that can not be delivered.

Transmitter operation:

After the transmitter has transmitted a MAC-hs PDU with TSN=SN, any MAC-hs PDU with TSN ≤ SN – TRANSMIT_WINDOW_SIZE should not be retransmitted to avoid sequence number ambiguity in the receiver.

Receiver operation:

When a MAC-hs PDU with TSN = SN is received:

- if SN is within the receiver window:
 - if SN < next_expected_TSN, or this MAC-hs PDU has previously been received:
 - the MAC-hs PDU shall be discarded;
 - else:
 - the MAC-hs PDU shall be placed in the reordering buffer at the place indicated by the TSN.
- if SN is outside the receiver window:
 - the received MAC-hs PDU shall be placed above the highest received TSN in the reordering buffer, at the position indicated by SN;
 - RcvWindow_UpperEdge shall be set to SN thus advancing the receiver window;
 - any MAC-hs PDUs with TSN ≤ RcvWindow_UpperEdge – RECEIVE_WINDOW_SIZE, i.e. outside the receiver window after its position is updated, shall be removed from the reordering buffer and be delivered to the disassembly entity;
 - if next_expected_TSN is below the updated receiver window:
 - next_expected_TSN shall be set to RcvWindow_UpperEdge – RECEIVE_WINDOW_SIZE + 1;
 - if the MAC-hs PDU with TSN = next_expected_TSN is stored in the reordering buffer:
 - all received MAC-hs PDUs with consecutive TSNs from next_expected_TSN (included) up to the first not received MAC-hs PDU shall be delivered to the disassembly entity;
 - next_expected_TSN shall be advanced to the TSN of this first not received MAC-hs PDU.

In case a UE has insufficient memory to process a received MAC-hs PDU, it shall perform the following set of operations:

- select TSN_flush such that: next_expected_TSN < TSN_flush ≤ RcvWindow_UpperEdge + 1;
- deliver all correctly received MAC-hs PDUs with TSN < TSN_flush to the disassembly entity;
- if the MAC-hs PDU with TSN=TSN_flush has previously been received:
 - deliver all received MAC-hs PDUs with consecutive TSNs from TSN_flush (included) up to the first not received MAC-hs PDU to the disassembly entity;
 - advance next_expected_TSN to the TSN of this first not received MAC-hs PDU.

- else:
 - set next_expected_TSN to TSN_flush.

11.6.2.4 Disassembly entity

For each MAC-hs PDU that is delivered to the disassembly entity, the UE shall:

- remove any padding bits if present;
- remove the MAC-hs header;
- deliver the MAC-d PDUs in the MAC-hs PDU to MAC-d.

11.6.2.5 MAC-hs Reset

If a reset of the MAC-hs entity is requested by upper layers, the UE shall at the activation time indicated by higher layers:

- flush soft buffer for all configured HARQ processes;
- stop all active re-ordering release timer (T1) and set all timer T1 to their initial value;
- start TSN with value 0 for the next transmission on every configured HARQ process;
- initialise the variables RcvWindow_UpperEdge and next_expected_TSN to their initial values;
- disassemble all MAC-hs PDUs in the re-ordering buffer and deliver all MAC-d PDUs to the MAC-d entity;
- flush the re-ordering buffer.

11.6.2.6 Reconfiguration of MAC-hs parameters

The parameters for a MAC-hs entity may be reconfigured (modified) by upper layers.

When a parameter is reconfigured by the upper layer, the UE shall:

- start using the reconfigured value of the parameter at the activation time indicated by higher layers.

If the parameter T1 is reconfigured for an already existing re-ordering queue, the UE shall:

- start to use the new value of T1 the next time T1 is started.

If the MAC-d PDU size info (i.e. mapping of MAC-d PDU size index to MAC-d PDU size) is reconfigured for an already existing re-ordering queue, at the activation time indicated by higher layers, the UE shall:

- stop timer T1 if running;
- set next_expected_TSN to (highest TSN of received MAC-hs PDU of this re-ordering queue + 1);
- deliver all correctly received MAC-hs PDUs in this re-ordering queue to the disassembly entity and use the old MAC-d PDU size info for these MAC-hs PDUs.

If the parameter RECEIVE_WINDOW_SIZE is reconfigured for a re-ordering queue, the UE shall:

- set RECEIVE_WINDOW_SIZE to the new value;
- remove any MAC-hs PDUs in this re-ordering queue with $TSN \leq RcvWindow_UpperEdge - RECEIVE_WINDOW_SIZE$ (i.e. outside the receiver window after its size is updated) from the reordering buffer and deliver these MAC-hs PDUs to the disassembly entity;
- if next_expected_TSN is below the receiver window after its size is updated:
 - set next_expected_TSN to $RcvWindow_UpperEdge - RECEIVE_WINDOW_SIZE + 1$;

- deliver all received MAC-hs PDUs in this re-ordering queue with consecutive TSNs from next_expected_TSN (included) up to the first not received MAC-hs PDU to the disassembly entity;
- advance next_expected_TSN to the TSN of this first not received MAC-hs PDU.

If the "Memory Partitioning" (see [7]) for soft buffer is reconfigured, the UE shall:

- flush soft buffer for all configured HARQ processes.

11.6.2.7 HARQ procedure for HS-SCCH less operation (FDD only)

When the HS-SCCH less mode of operation is enabled, the UE shall be able to store 13 TTIs in a cyclic soft buffer.

For each received MAC-hs PDU provided by the lower layers the UE shall:

- If the associated HS-SCCH corresponds to an HS-SCCH less retransmission as defined in subclause 4.6A.2.1.2 of [16];
 - combine the received data with the data currently in the soft buffer identified by $[5 \cdot \text{CFN} + \text{subframe number} - 6 - \text{PTR}] \bmod 13$ where PTR is the value of the pointer to the previous transmission as defined in subclause 4.6A.2.1.2.1 of [16].
 - If the combined data has been successfully decoded and no error was detected;
 - deliver the decoded MAC-hs PDU to the reordering entity;
 - generate a positive acknowledgement (ACK) of the data corresponding to this TTI.
 - else:
 - place the combined data for the HS-SCCH less TTI in the soft buffer identified by $[5 \cdot \text{CFN} + \text{subframe number}] \bmod 13$, replacing any data previously stored in that buffer.
 - generate a negative acknowledgement (NACK) of the data corresponding to this TTI.
- Else if the associated HS-SCCH corresponds to a HS-SCCH type 1 as defined in subclause 4.6 of [16];
 - process the received MAC-hs PDU provided by the lower layers as per subclause 11.6.2.2.
- Else;
 - If the data has been successfully decoded and no error was detected;
 - deliver the decoded MAC-hs PDU to the reordering entity;
 - generate a positive acknowledgement (ACK) of the data corresponding to this TTI.
 - else
 - place the data for the HS-SCCH less TTI in the soft buffer identified by $[5 \cdot \text{CFN} + \text{subframe number}] \bmod 13$, replacing any data previously stored in that buffer.

11.6.3 Network operation

The following are the functions of the various functional entities at the network in support of the HARQ protocol used on HS-DSCH when MAC-hs is configured by upper layers [7].

11.6.3.1 Scheduler

The scheduler performs the following functions:

- Schedules all UEs within a cell;
- Services priority queues;

- The scheduler schedules reordering PDUs (see subsection 9.1.4) based on information from upper layers. One UE operating in CELL_DCH may be associated with one or more MAC-d flows.
- In FDD, when transmitting to the UE in CELL_FACH or CELL_PCH or URA_PCH state there can be multiple service priority queues. One service priority queue can be associated to multiple H-RNTIs.
- Determines the HARQ Entity and the queues to be serviced;
- Sets the TSN values for new data blocks being transferred from the selected queue;
 - set the TSN to value 0 for the first reordering PDU transmitted from the selected queue;
 - increment the TSN with one for each subsequent reordering PDU transmitted from the selected queue.
 - increment the TSN with one for each subsequent reordering PDU transmitted from the selected queue per H-RNTI within an HS-DSCH, when transmitting to the UEs in CELL_FACH, CELL_PCH or URA_PCH state.

NOTE: The scheduler may re-use TSNs by toggling the NDI bit in order to resume pre-empted transmissions or to force the UE to flush the soft buffer. In this case the content of the payload may be changed but care should be taken to preserve the higher layer data order.

- Indicates the LCH ID and L field values for each MAC-ehs SDU or segment of MAC-ehs SDU to be transmitted and the TSN field and SI field values for for each reordering PDU to be transmitted to the HARQ entity;
- Schedules new transmissions and retransmissions:
 - When transmitting for a UE in CELL_DCH state the scheduler determines based on the status reports from HARQ Processes if either a new transmission or a retransmission should be made. A new transmission can however be initiated on a HARQ process at any time. Based on a delay attribute provided by upper layers, the scheduler may decide to discard any 'out-of-date' MAC-ehs SDU.
 - In FDD when transmitting for a UE in CELL_FACH state the scheduler determines based on RRM and IE "Transmitted Power Level" received on Iub FP the number of retransmission that should be made after new transmission. A new transmission can however be initiated on a HARQ process at any time. Based on a delay attribute provided by upper layers, the scheduler may decide to discard any 'out-of-date' MAC-hs SDU.
- Determines the redundancy version:
 - The scheduler determines a suitable redundancy version for each transmitted and retransmitted MAC-ehs PDU and indicates the redundancy version to lower layer.
- Determines the TDD HCSN;
- Increment UE specific HCSN for each HS-SCCH transmission.

11.6.3.2 HARQ entity

- There is one HARQ entity per UE operating in CELL_DCH state in UTRAN.
- In FDD, there is one HARQ entity per H-RNTI in UTRAN used for transmitting data for UE(s) in CELL_FACH state.
- The HARQ entity sets the logical channel ID (LCH ID) fields in transmitted MAC-ehs PDUs to the values indicated by the UTRAN scheduler.
- The HARQ entity sets the Length (L) fields in transmitted MAC-ehs PDUs to the values indicated by the UTRAN scheduler.
- The HARQ entity sets the Segmentation Indication (SI) fields in transmitted MAC-ehs PDUs to the values indicated by the UTRAN scheduler.
- The HARQ entity sets the transmission sequence number (TSN) fields in transmitted MAC-ehs PDUs to the values indicated by the UTRAN scheduler.
- The HARQ entity sets the HARQ process identifier in transmitted MAC-ehs PDUs. UTRAN should:

- determine a suitable HARQ process to service the MAC-ehs PDU and set the HARQ process identifier accordingly.

11.6.3.3 HARQ process

- The HARQ process sets the New Data indicator in transmitted MAC-ehs PDUs. UTRAN should:
 - set the New Data Indicator to the value "0" for the first MAC-ehs PDU transmitted by a HARQ process;
 - not increment the New Data Indicator for retransmissions of a MAC-ehs PDU;
 - increment the New Data Indicator with one for each transmitted MAC-ehs PDU containing new data.
- The HARQ process processes received status messages. UTRAN should:
 - deliver received status messages to the scheduler.

11.6.4 UE operation

The UE operation in support of the HARQ protocol used on HS-DSCH is split among the following five functional units with their associated functions.

11.6.4.1 HARQ Entity

There is one HARQ entity at the UE which processes the HARQ process identifiers received on the HS-SCCH transmissions associated with MAC-ehs PDUs received on the HS-DSCH.

A number of parallel HARQ processes are used in the UE to support the HARQ entity. The number of HARQ processes is configured by upper layers:

- Each received MAC-ehs PDU shall be allocated to the HARQ process indicated by the HARQ process identifier of the MAC-ehs PDU.

11.6.4.2 HARQ process

The HARQ process processes the New Data Indicator indicated by lower layers for each received MAC-ehs PDU.

The UE may:

- for FDD, when operating in CELL_DCH state, or in CELL_FACH state with a dedicated H-RNTI, if the MAC-ehs PDU is received within 5 sub-frames from the reception of the previous MAC-ehs PDU intended for this HARQ process; or
- for TDD, if the MAC-ehs PDU is received before generation of feedback resulting from reception of a previous MAC-ehs PDU for the same H-ARQ process:
 - discard the MAC-ehs PDU.

The UE shall:

- if the New Data Indicator has been incremented compared to the value in the previous received transmission in this HARQ process or this is the first received transmission in the HARQ process:
 - replace the data currently in the soft buffer for this HARQ process with the received data.
- if the Transport Block Size index value is equal to 111111 (FDD only):
 - generate a positive acknowledgement (ACK) of the data in this HARQ process;
 - discard the received data;
 - assume that the data has been successfully decoded.

- if the New Data Indicator is identical to the value used in the previous received transmission in the HARQ process:
 - if the Transport Block Size index value is equal to 111111 (FDD only):
 - assume that the transport block size is identical to the last valid transport block size signalled for this HARQ process.
 - if the data has not yet been successfully decoded:
 - combine the received data with the data currently in the soft buffer for this HARQ process.
 - if the transport block size is different from the last valid transport block size signalled for this HARQ process:
 - the UE may replace the data currently in the soft buffer for this HARQ process with the received data.
- if the data in the soft buffer has been successfully decoded and no error was detected:
 - deliver the decoded MAC-ehs PDU to the disassembly entity;
 - when operating in CELL_DCH state generate a positive acknowledgement (ACK) of the data in this HARQ process.
- else:
 - when operating in CELL_DCH state generate a negative acknowledgement (NAK) of the data in this HARQ process;
- schedule the generated positive or negative acknowledgement for transmission and the time of transmission relative to the reception of data in a HARQ process is configured by upper layer.

11.6.4.3 Disassembly entity

For each MAC-ehs PDU that is delivered to the disassembly entity, the UE shall:

- remove any padding bits if present;
- remove the MAC-ehs header;
- deliver the reordering PDUs in the MAC-ehs PDU to reordering distribution entity.

11.6.4.4 Reordering queue distribution entity

For each reordering PDU in the MAC-ehs PDU, the UE shall:

- route the reordering PDU to the correct reordering queue based on the received LCH ID. The mapping of the LCH ID to queue is provided by upper layers [7].

11.6.4.5 Reordering entity

11.6.4.5.1 Definitions

In the functions described in this section the following definitions apply:

Parameters

- Transmitter window size (TRANSMIT_WINDOW_SIZE)
TRANSMIT_WINDOW_SIZE is the size of the transmitter window according to the definition below. This is a parameter in the Node B and the value of the parameter is configured by higher layers.
- Receiver window size (RECEIVE_WINDOW_SIZE)
RECEIVE_WINDOW_SIZE is the size of the receiver window according to the definition below. This is a parameter in the UE and the value of the parameter is configured by higher layers.

State variables

All state variables are non-negative integers. Reordering PDUs are numbered by modulo integer Transmission sequence numbers (TSN) cycling through the field 0 to 63. All arithmetic operations contained in the present document on `next_expected_TSN`, `RcvWindow_UpperEdge`, `T1_TSN` and `TSN_flush` are affected by the 64 modulus. When performing arithmetic comparisons of state variables or Transmission sequence number values a 64 modulus base shall be used. This modulus base is subtracted (within the appropriate field) from all the values involved and then an absolute comparison is performed. `RcvWindow_UpperEdge – RECEIVE_WINDOW_SIZE + 1` shall be assumed to be the modulus base.

- `next_expected_TSN`:
The `next_expected_TSN` is the Transmission sequence number (TSN) following the TSN of the last in-sequence reordering PDU received. It shall be updated according to the procedures given in subclauses 11.6a.2.3.2, 11.6a.2.5 and 11.6a.2.6. The initial value of `next_expected_TSN` =0.
- `RcvWindow_UpperEdge`:
The `RcvWindow_UpperEdge` represents the TSN, which is at the upper edge of the receiver window. After the first reordering PDU has been received successfully, it also corresponds to the reordering PDU with the highest TSN of all received reordering PDUs. The initial `RcvWindow_UpperEdge` equals 63. `RcvWindow_UpperEdge` is updated based on the reception of new reordering PDU according to the procedure given below.
- `T1_TSN`:
The TSN of the latest MAC-ehs SDU that cannot be delivered to the reassembly entity, when the timer T1 is started.

Timers

- Re-ordering release timer (T1):
The Re-ordering release timer T1 controls the stall avoidance in the UE reordering buffer as described below. The value of T1 is configured by upper layers.

Other definitions

- Receiver window:
The receiver window defines TSNs of those reordering PDUs that can be received in the receiver without causing an advancement of the receiver window according to the procedure below. The size of the receiver window equals `RECEIVE_WINDOW_SIZE` and spans TSNs going from `RcvWindow_UpperEdge – RECEIVE_WINDOW_SIZE + 1` to `RcvWindow_UpperEdge` included.

11.6.4.5.2 Reordering functionality

If no timer T1 is active:

- the timer T1 shall be started when a reordering PDU with `TSN > next_expected_TSN` is correctly received.
- `T1_TSN` shall be set to the TSN of this reordering PDU.

If a timer T1 is already active:

- no additional timer shall be started, i.e. only one timer T1 may be active at a given time.

The timer T1 shall be stopped if:

- the reordering PDU with `TSN = T1_TSN` can be delivered to the reassembly entity before the timer expires.

When the timer T1 expires and `T1_TSN > next_expected_TSN`:

- all correctly received reordering PDUs with `TSN > next_expected_TSN` up to and including `T1_TSN-1` shall be delivered to the reassembly entity;
- all correctly received reordering PDUs up to the next not received reordering PDU shall be delivered to the reassembly entity.
- `next_expected_TSN` shall be set to the TSN of the next not received reordering PDU.

When the timer T1 is stopped or expires, and there still exist some received reordering PDUs that can not be delivered to higher layer:

- timer T1 is started
- set T1_TSN to the highest TSN among those of the sets pf MAC-ehs SDUs that can not be delivered.

Transmitter operation:

After the transmitter has transmitted a reordering PDU with TSN=SN, any reordering PDU with TSN ≤ SN – TRANSMIT_WINDOW_SIZE should not be retransmitted to avoid sequence number ambiguity in the receiver.

Receiver operation:

When a reordering PDU with TSN = SN is received:

- if SN is within the receiver window:
 - if SN < next_expected_TSN, or this reordering PDU has previously been received:
 - the reordering PDU shall be discarded;
 - else:
 - the reordering PDU shall be placed in the reordering buffer at the place indicated by the TSN.
- if SN is outside the receiver window:
 - the received reordering PDU shall be placed above the highest received TSN in the reordering buffer, at the position indicated by SN;
 - RcvWindow_UpperEdge shall be set to SN thus advancing the receiver window;
 - any reordering PDU with TSN ≤ RcvWindow_UpperEdge – RECEIVE_WINDOW_SIZE, i.e. outside the receiver window after its position is updated, shall be removed from the reordering buffer and be delivered to the reassembly entity;
 - if next_expected_TSN is below the updated receiver window:
 - next_expected_TSN shall be set to RcvWindow_UpperEdge – RECEIVE_WINDOW_SIZE + 1;
 - if the reordering PDU with TSN = next_expected_TSN is stored in the reordering buffer:
 - all received reordering PDUs with consecutive TSNs from next_expected_TSN (included) up to the first not received reordering PDU shall be delivered to the reassembly entity;
 - next_expected_TSN shall be advanced to the TSN of this first not received reordering PDU.

In case a UE has insufficient memory to process a received reordering PDU, it shall perform the following set of operations:

- select TSN_flush such that: next_expected_TSN < TSN_flush ≤ RcvWindow_UpperEdge + 1;
- deliver all correctly received reordering PDUs with TSN < TSN_flush to the reassembly entity;
- if the reordering PDU with TSN=TSN_flush has previously been received:
 - deliver all received reordering PDUs with consecutive TSNs from TSN_flush (included) up to the first not received reordering PDU to the reassembly entity;
 - advance next_expected_TSN to the TSN of this first not received reordering PDU.
- else:
- set next_expected_TSN to TSN_flush.

11.6.4.6 Reassembly unit

The reassembly unit processes the SI field associated with a reordering PDU. The UE shall:

- if SI field is set to "00":
 - deliver all MAC-d or MAC-c PDUs corresponding to MAC-ehs SDUs in the reordering PDU to demultiplexing entity;
- if SI field is set to "01":
 - if the received and stored segments of a MAC-ehs SDU are consecutive:
 - combine the first segment of the received MAC-ehs SDU with the stored segment of MAC-ehs SDU;
 - deliver the MAC-d or MAC-c PDU corresponding to the combined MAC-ehs SDU to demultiplexing entity.
 - if the received and stored segments of MAC-ehs SDU are not consecutive
 - discard the first received and stored segment of MAC-ehs SDU.
 - deliver all MAC-d or MAC-c PDUs corresponding to subsequent MAC-ehs SDUs in the reordering queue to demultiplexing entity;
- if SI field is set to "10":
 - deliver all MAC-d or MAC-c PDUs corresponding to all but last MAC-ehs SDU in the reordering PDU to the demultiplexing entity;
 - discard any previously stored segment of MAC-ehs SDU and store the last segment of MAC-ehs SDU of the received reordering PDU
- if SI field is set to "11":
 - if the received and stored MAC-ehs SDUs are consecutive:
 - if there is only one segment of MAC-ehs SDU in the reordering PDU:
 - combine the received segment of MAC-ehs SDU with the stored segment of MAC-ehs SDU:
 - if is more than one segment of MAC-ehs SDUs or MAC-ehs SDU in the reordering PDU:
 - combine the first received segment of MAC-ehs SDU with the stored segment MAC-ehs SDU;
 - deliver the MAC-d or MAC-c PDU corresponding to the combined MAC-ehs SDU to demultiplexing entity.
 - deliver all MAC-d or MAC-c PDUs corresponding to all but last MAC-ehs SDU in the reordering PDU to demultiplexing entity;
 - discard any previously stored segment of MAC-ehs SDU and store the last segment of MAC-ehs SDU of the received reordering PDU.
 - if the received and stored segments of the MAC-ehs SDU are not consecutive:
 - discard the stored segment and the first received segment of MAC-ehs SDU;
 - if is more than one segment of MAC-ehs SDUs or MAC-ehs SDU in the reordering PDU:
 - deliver all MAC-d or MAC-c PDUs corresponding to all but first and last MAC-ehs SDUs in the reordering PDU to demultiplexing entity and store the last segment of MAC-ehs SDU of the received reordering PDU;

11.6.4.7 Demultiplexing entity

For each MAC-d or MAC-c PDU that is delivered to the demultiplexing entity, the UE shall:

- route MAC-d or MAC-c PDU to the correct MAC-d flow based on the corresponding LCH ID field.

11.6.4.8 MAC-ehs Reset

If a reset of the MAC-ehs entity is requested by upper layers, the UE shall at the activation time indicated by higher layers:

- flush soft buffer for all configured HARQ processes;
- stop all active re-ordering release timer (T1) and set all timer T1 to their initial value;
- start TSN with value 0 for the next transmission on every configured HARQ process;
- initialise the variables RcvWindow_UpperEdge and next_expected_TSN to their initial values;
- deliver all reordering PDUs in the re-ordering buffer to the reassembly entity;
- deliver any successfully reassembled MAC-ehs SDUs to logical channel demultiplexing entity;
- route any MAC-d or MAC-c PDUs delivered to the demultiplexing entity to the correct logical channel;
- flush the re-ordering buffer;
- discard any stored segment in the resegmentation entity.

11.6.4.9 Reconfiguration of MAC-ehs parameters

The parameters for a MAC-ehs entity may be reconfigured (modified) by upper layers.

When a parameter is reconfigured by the upper layer, the UE shall:

- start using the reconfigured value of the parameter at the activation time indicated by higher layers.

If the parameter T1 is reconfigured for an already existing re-ordering queue, the UE shall:

- start to use the new value of T1 the next time T1 is started.

If the parameter RECEIVE_WINDOW_SIZE is reconfigured for a re-ordering queue, the UE shall:

- set RECEIVE_WINDOW_SIZE to the new value;
- remove any reordering PDUs in this re-ordering queue with $TSN \leq RcvWindow_UpperEdge - RECEIVE_WINDOW_SIZE$ (i.e. outside the receiver window after its size is updated) from the reordering buffer and deliver these reordering PDUs to the reassembly entity;
- if next_expected_TSN is below the receiver window after its size is updated:
 - set next_expected_TSN to $RcvWindow_UpperEdge - RECEIVE_WINDOW_SIZE + 1$;
 - deliver all received reordering PDUs in this re-ordering queue with consecutive TSNs from next_expected_TSN (included) up to the first not received reordering PDU to the reassembly entity;
 - advance next_expected_TSN to the TSN of this first not received reordering PDU.

If the "Memory Partitioning" (see [7]) for soft buffer is reconfigured, the UE shall:

- flush soft buffer for all configured HARQ processes.

11.7 HS-DSCH Provided Bit Rate measurement

The HS-DSCH Provided Bit Rate measurements is defined as follows:

- for each priority class the MAC-hs/ehs entity measures the total number of MAC-d PDU bits whose transmission over the radio interface has been considered successful by MAC-hs in Node-B during the last measurement period, divided by the duration of the measurement period;

- the values reported by MAC-hs/ehs shall be raw samples;
- the measurement period shall be [100 ms];
- when the cell portions are defined in a cell, the HS-DSCH Provided Bit Rate shall be measured for each cell portion.

11.8 Control of E-DCH transmission and reception (FDD)

11.8.1 UE operation

11.8.1.1 HARQ Operation

11.8.1.1.1 HARQ entity

There is one HARQ entity at the UE. A number of parallel HARQ processes are used in the UE to support the HARQ entity, allowing transmissions to take place continuously while waiting for the feedback on the successful or unsuccessful reception of previous transmissions.

At a given TTI, the HARQ entity identifies the HARQ process for which a transmission should take place. Also, based on the timing, it routes the receiver feedback (ACK/NACK information), relayed by the physical layer, to the appropriate HARQ process.

The number of HARQ processes is equal to the HARQ round-trip-time (HARQ_RTT). The HARQ_RTT is equal to 4 for 10ms TTI and 8 for 2ms TTI. The TTI duration shall be configured by the higher layers. Each process is associated with a number from 0 to HARQ_RTT-1.

After each TTI, the HARQ entity shall:

- if the buffer of the HARQ process corresponding to the next TTI is empty:
 - notify the E-TFC selection entity that the next TTI is available for a new transmission;
 - if the "E-TFC Selection" entity indicates the need for a new transmission:
 - obtain the transmission information (i.e. HARQ profile, whether triggered Scheduling Information is included and whether it is sent alone) from the "E-TFC Selection" entity;
 - obtain the MAC-e PDU to transmit from the "Multiplexing and TSN setting" entity;
 - instruct the HARQ process corresponding to this TTI to trigger the transmission of this new payload using the identified HARQ profile parameters.
- else:
 - instruct the HARQ process to generate a re-transmission.

11.8.1.1.2 HARQ process

Each HARQ process is associated with a physical buffer (HARQ buffer).

Each HARQ process maintains the state variable CURRENT_TX_NB, which indicates the number of transmissions that have taken place for the MAC-e PDU currently in the buffer. When the HARQ process is established, CURRENT_TX_NB shall be initialized to 0.

At the time of a new transmission, the HARQ entity provides the HARQ profile to use for all transmissions and re-transmissions of this MAC-e PDU. This HARQ profile includes information on the maximum number of transmissions to perform, and the power offset with which to configure the physical layer.

If the HARQ entity provides a new PDU, the HARQ process shall:

- set CURRENT_TX_NB to 0;

- set CURRENT_RSN to 0;
- store the MAC-e PDU in the associated HARQ buffer;
- generate a transmission as described below.

If the HARQ entity requests a re-transmission, the HARQ process shall:

- generate a transmission as described below.

To generate a transmission, the HARQ process shall, regardless of any overlapping with a compressed mode gap:

- instruct the physical layer to set the RSN field on the E-DPCCH to CURRENT_RSN;
- instruct the physical layer to generate a transmission with the power offset corresponding to the HARQ profile and the redundancy version corresponding to the RSN value and the transmission timing (i.e. the CFN and in the case of 2ms TTI, sub-frame number as described in [16]);
- if CURRENT_RSN < 3:
 - increment CURRENT_RSN by 1;
- increment CURRENT_TX_NB by 1;

The HARQ process shall:

- if an ACK is received from the RLS containing the serving cell; or
- if an ACK is received from any RLS and the transmission included higher layer data (i.e. not only included Scheduling Information); or
- if CURRENT_TX_NB \geq maximum number of transmissions indicated in the transmission HARQ profile:
 - flush the HARQ buffer;
 - if the transmission included Scheduling Information which was triggered per subclause 11.8.1.6 and if no ACK for that transmission was received from the RLS containing the serving cell:
 - notify the Scheduling Information Reporting function that the HARQ process failed to deliver the triggered Scheduling Information to the RLS containing the serving cell (see subclause 11.8.1.6.3).

NOTE: In the case where the Scheduling Information is transmitted alone, without any higher layer data the UE will keep re-transmitting the Scheduling Information until an ACK is received from the RLS containing the serving cell or the maximum number of re-transmissions is reached. In the latter case, periodic triggering will be relied upon for reliability.

11.8.1.2 Multiplexing and TSN setting entity

There is one Multiplexing and TSN setting entity at the UE. A number of TSN setting processes are used to support independent numbering of transmissions from different logical channels.

11.8.1.2.1 TSN setting process operation

There is one TSN setting process at the UE for each logical channel. When a MAC-es PDU is transmitted, the UE operation in support of the re-ordering functionality consists in generating an explicit sequence number (TSN) for the MAC-es PDU intended for the associated re-ordering queue. In one TTI, there is only one TSN per logical channel: one for the MAC-es PDU that is transmitted.

Each TSN setting process maintains the state variable CURRENT_TSN, which indicates the sequence number to be included in the header of the following MAC-es PDU to be generated. When the TSN setting process is established, CURRENT_TSN shall be initialized to 0.

When a new payload needs to be generated for the associated re-ordering queue, the Multiplexing and TSN setting entity shall:

- set the TSN of the transmission to CURRENT_TSN;

After each MAC-es PDU is multiplexed:

- increment CURRENT_TSN by 1;
- if CURRENT_TSN > 63:
 - set CURRENT_TSN = 0.

11.8.1.3 Serving Grant Update

UEs in CELL_DCH state, configured with an E-DCH transport channel shall maintain a Serving Grant and the list of active HARQ processes based on the absolute and relative grant commands decoded on the configured E-AGCH and E-RGCH(s).

Each Absolute Grant or Relative Grant command is applied at a specific TTI. This association is implicit based on the timing of the E-AGCH and E-RGCH (see [13]). The timing is tight enough that this relationship is un-ambiguous.

The activation/deactivation of one or all processes is only applicable to processes for which transmission of scheduled data is allowed according to RRC signalling

Process activation of an active process does not result in any action taken by the UE.

11.8.1.3.1 Baseline Procedure

The Serving Grant Update procedure shall be applied at every TTI boundary and shall take into account the Absolute Grant message, Serving Relative Grant and non-serving Relative Grants that apply to the TTI.

The UE shall:

- 1> set reference_ETPR to the E-DPDCH to DPCCH power ratio as defined in subclause 3.1.2;
- 1> if an Absolute Grant was received for this TTI:
 - 2> if the Identity type is "Primary", and the Absolute Grant value is set to "INACTIVE":
 - 3> if Absolute Grant Scope indicates "Per HARQ process" and a 2ms TTI is configured:
 - 4> de-activate the process given by the value of CURRENT_HARQ_PROCESS.
 - 3> if Absolute Grant Scope indicates "All HARQ processes" and a secondary E-RNTI was configured by higher layers:
 - 4> activate all HARQ processes;
 - 4> set Serving_Grant = Stored_Secondary_Grant;
 - 4> set Primary_Grant_Available to "False".
 - 3> if Absolute Grant Scope indicates "All HARQ processes", a 2ms TTI is configured and a secondary E-RNTI was not configured by higher layers:
 - 4> deactivate all HARQ processes (if a process was inactive it remains inactive, if a process was active it becomes inactive).
 - 2> else if the Absolute Grant Value is different from "INACTIVE":
 - 3> if the Identity Type is "Secondary":
 - 4> set Stored_Secondary_Grant = Absolute Grant Value.
 - 3> if the Identity Type is "Primary" or Primary_Grant_Available is set to "False":
 - 4> set Serving_Grant = Absolute Grant Value.
 - 4> if the Identity Type is "Primary":
 - 5> set Primary_Grant_Available to "True";

- 5> if Absolute Grant Scope indicates "Per HARQ process":
 - 6> activate the process given by the value of CURRENT_HARQ_PROCESS.
- 5> if Absolute Grant Scope indicates "All HARQ processes":
 - 6> activate all HARQ processes.
- 5> if AG_Timer is not active, it shall be started, otherwise it shall be restarted.
- 1> else (no Absolute Grant received):
 - 2> if the HARQ process given by the value of CURRENT_HARQ_PROCESS is active; and
 - 2> if Primary_Grant_Available is equal to "True"; and
 - 2> if Serving_Grant <> "Zero_Grant" ; and
 - 2> if AG_Timer has expired; and
 - 2> if there was a scheduled transmission (see NOTE) in the previous TTI of the HARQ process given by the value of CURRENT_HARQ_PROCESS:
 - 3> if the Serving Relative Grant indicates "UP":
 - 4> determine the Serving_Grant in accordance with subclause 9.2.5.2.1.
 - 3> else, if the Serving Relative Grant indicates "DOWN":
 - 4> determine the Serving_Grant in accordance with subclause 9.2.5.2.1.
- 1> if any Non-Serving Relative Grants indicate "DOWN" for this TTI and Serving_Grant <> "Zero_Grant":
 - 2> Serving_Grant = MIN(Serving_Grant, Maximum_Serving_Grant, Serving_Grant determined in accordance with subclause 9.2.5.2.1);
 - 2> Maximum_Serving_Grant = Serving_Grant.
 - 2> if Non_Serving_RG_Timer is not active it shall be started, otherwise it shall be restarted;
- 1> else if no Non-Serving Relative Grants indicate "DOWN" for this TTI:
 - 2> if Non_Serving_RG_Timer has not expired:
 - 3> Serving_Grant = MIN(Maximum_Serving_Grant, Serving_Grant).
- 1> if Non_Serving_RG_Timer expires:
 - 2> set the Maximum_Serving_Grant to the highest possible value (i.e. index 37 in table 9.2.5.2.1.1 or 9.2.5.2.1.2 as configured by higher layers).

NOTE 1: MIN("Zero_Grant", any numerical value) = "Zero_Grant".

NOTE 2: Scheduling Information sent alone is not considered as a scheduled transmission.

11.8.1.3.2 Handling at start of E-DCH transmission

When E-DCH transmission is started (i.e. the RRC variable E_DCH_TRANSMISSION is changed from "false" to "true"), the UE shall:

- activate all HARQ processes;
- if the IE's "Serving Grant value" and "Primary/Secondary Grant Selector" are provided by higher layers:
 - update the state variables and timers according to subclause 11.8.1.3.5.
- else:

- initialise the state variable `Serving_Grant` to `Zero_Grant`;
- initialise the state variable `Primary_Grant_Available` to "False";
- initialise the state variable `Stored_Secondary_Grant` to "Zero_Grant".
- initialise the state variables `reference_ETPR` to "Minimum_Grant";
- initialise the state variable `Maximum_Serving_Grant` to the highest possible value (i.e. index 37 in table 9.2.5.2.1.1 or 9.2.5.2.1.2 as configured by higher layers).

11.8.1.3.3 Handling at serving cell change

At E-DCH serving cell change, the UTRAN may configure the UE with the grant value to use in the new cell and shall indicate whether the UE should monitor Absolute Grant Messages with the secondary E-RNTI.

The UE shall:

- activate all HARQ processes;
- if the IE's "Serving Grant value" and "Primary/Secondary Grant Selector" are provided by higher layers:
 - update the state variables and timers according to subclause 11.8.1.3.5.
- else:
 - continue to use the current values of state variables `Serving_Grant` and `Primary_Grant_Available`;
 - initialise the state variable `Stored_Secondary_Grant` to "Zero_Grant".

11.8.1.3.4 Handling at TTI change

At E-DCH TTI change, the UE shall:

- activate all HARQ processes;
- initialise the state variables `reference_ETPR` to "Minimum_Grant";
- reset `Non_Serving_RG_Timer` and `AG_Timer`;
- set the state variable `Maximum_Serving_Grant` to the highest possible value (i.e. index 37 in table 9.2.5.2.1.1 or 9.2.5.2.1.2 as configured by higher layers).
- if the IE's "Serving Grant value" and "Primary/Secondary Grant Selector" are provided by higher layers:
 - update the state variables and timers according to subclause 11.8.1.3.5.
- else:
 - continue to use the current values of state variables `Serving_Grant` and `Primary_Grant_Available`;
 - initialise the state variable `Stored_Secondary_Grant` to "Zero_Grant".

11.8.1.3.5 Higher Layer Signalling

When the IE's "Serving Grant value" and "Primary/Secondary Grant Selector" are provided by higher layers:

- set the state variable `Serving_Grant` to the value of the IE's "Serving Grant value" provided by higher layers;
- if the IE's "Primary/Secondary Grant Selector" is provided by higher layers as "Primary":
 - if `AG_Timer` is not active, it shall be started, otherwise it shall be restarted;
 - set the state variable `Primary_Grant_Available` to "True";
 - set the state variable `Stored_Secondary_Grant` to "Zero_Grant".

- if the IE's "Primary/Secondary Grant Selector" is provided by higher layers as "Secondary":
 - set the state variable Primary_Grant_Available to "False";
 - set the state variable Stored_Secondary_Grant to the value of the IE's "Serving Grant value" provided by higher layers.

11.8.1.4 E-TFC Selection

In FDD mode, the rules for E-TFC selection provided below shall apply to UEs in CELL_DCH state with an E-DCH transport channel configured. These UEs shall apply the E-TFC selection procedure when invoked by the HARQ entity (see subclause 11.8.1.1.1). In the case where a 2ms TTI is configured, E-TFC selection shall not be performed for TTIs that overlap with an uplink compressed mode gap. The E-TFC restriction procedure described in [12] shall always be applied before the E-TFC selection process below. E-TFCs which (according to calculations in [16]) require channelisation codes which are not allowed by the value given by the Maximum channelisation codes for E-DPDCH or are not supported by the UE capability shall be considered as blocked. Furthermore, for UEs that are also configured with a DCH transport channel on uplink, the TFC selection procedure shall be applied before either of these.

For each MAC-d flow, RRC configures MAC with a HARQ profile and a multiplexing list. Additionally, RRC configures MAC with a power offset for "Control-only" transmissions. This power offset and a maximum number of HARQ transmissions of 8 will be used to define a HARQ profile for "Control-only" transmissions which will be used, in case the Scheduling Information needs to be transmitted without any higher-layer data. The HARQ profile includes the power offset and maximum number of HARQ transmissions to use for this MAC-d flow. The multiplexing list identifies for each MAC-d flow(s), the other MAC-d flows from which data can be multiplexed in a transmission that uses the power offset included in its HARQ profile.

RRC can control the scheduling of uplink data by giving each logical channel a priority between 1 and 8, where 1 is the highest priority and 8 the lowest. E-TFC selection in the UE shall be done in accordance with the priorities indicated by RRC. Logical channels have absolute priority, i.e. the UE shall maximise the transmission of higher priority data.

RRC can allocate non-scheduled transmission grants to individual MAC-d flows in order to reduce the transmission delays. When a 2ms TTI is configured each non-scheduled grant is applicable to the specific set of HARQ processes indicated by RRC. The applicability of scheduled grants can be also restricted to a specific set of HARQ processes when a 2ms TTI is configured. HARQ process restriction and reservation is under the control of the serving cell Node B and indicated to the UE by RRC.

For each configured MAC-d flow, a given E-TFC can be in any of the following states:

- Supported state;
- Blocked state.

At each TTI boundary, UEs in CELL_DCH state with an E-DCH transport channel configured shall determine the state of each E-TFC for every MAC-d flow configured based on its required transmit power versus the maximum UE transmit power (see [7] and [12]). If no DCH transport channel is configured or if a DCH transport channel is configured and the selected TFC is "empty" (see [3]), the UE shall consider that E-TFCs included in the minimum set of E-TFCs are always in supported state (see [7]).

At every TTI boundary for which a new transmission is requested by the HARQ entity (see subclause 11.8.1.1.1), the UE shall perform the operations described below. UEs configured both with DCH and E-DCH transport channels shall perform TFC selection before performing E-TFC selection.

The Serving Grant Update function provides the E-TFC selection function with the maximum E-DPDCH to DPCCH power ratio that the UE is allowed to allocate for the upcoming transmission for scheduled data (held in the Serving Grant state variable – see subclause 11.8.1.3). This power ratio shall be used to determine a maximum number of bits of scheduled data with a 1 bit granularity for the upcoming transmission, calculated from the $K_{e,ref,m}$ of the m^{th} reference E-TFC (E-TFC_{ref,m}), and that the highest value is lower or equal to:

$$\left\lfloor K_{e,ref,m} \cdot \frac{\text{Serving_Grant}}{L_{e,ref,m} \cdot A_{ed,ref,m}^2 \cdot 10^{\Delta_{harq}/10}} \right\rfloor$$

Where $K_{e,ref,m}$ and $L_{e,ref,m}$ are given in [13]. $A_{ed,ref,m}$ is the signalled reference amplitude ratio which corresponds to E-TFC_{ref,m} [22].

This maximum number of bits shall be lower than $K_{e,ref,n}$ bits, where $K_{e,ref,n}$ corresponds to any higher n^{th} reference E-TFC (E-TFC_{ref,n}) and shall be higher or equal to $K_{e,ref,m}$ of E-TFC_{ref,m} except if $m=1$.

The HARQ process ID for the upcoming transmission is determined using the following formulae:

- For 2ms TTI: $\text{CURRENT_HARQ_PROCESS_ID} = [5 * \text{CFN} + \text{subframe number}] \bmod \text{HARQ_RTT}$
- For 10ms TTI: $\text{CURRENT_HARQ_PROCESS_ID} = [\text{CFN}] \bmod \text{HARQ_RTT}$

Based on this current HARQ process ID and the RRC configuration, the UE shall determine whether to take the scheduled and non-scheduled grants into account in the upcoming transmission. If they are not supposed to be taken into account, then the corresponding grant shall be assumed to not exist. If the variable `Serving_Grant` has the value "Zero_Grant" after the Serving Grant Update, then the Serving Grant shall not be taken into account in the upcoming transmission.

When Scheduling Information is triggered per subclause 11.8.1.6, the E-TFC selection and data-allocation process shall assume that a non-scheduled grant is available for its transmission and that Scheduling Information has a priority higher than any other logical channel. Furthermore the HARQ process used for the upcoming transmission shall be assumed to be active and not L3 restricted for the transmission of the Scheduling Information, i.e. transmission of Scheduling Information can take place on this process.

The transmission format and data allocation shall follow the requirements below:

- Only E-TFCs from the configured E-TFCS shall be considered for the transmission;
- For all logical channels, if the logical channel belongs to a non-scheduled MAC-d flow, its data shall be considered as available up to the corresponding non-scheduled grant, if the logical channel does not belong to a non-scheduled MAC-d flow, its data shall be considered as available up to the Serving Grant;
- The power offset for the transmission is the one from the HARQ profile of the MAC-d flow that allows highest-priority data to be transmitted. If more than one MAC-d flow allows data of the same highest priority to be transmitted, it is left to implementation to select which MAC-d flow to prefer);
- In case the variable `Serving_Grant` has the value "Zero_Grant" after the Serving Grant Update function and there is no data available for MAC-d flows for which non-scheduled grants were configured and the transmission of Scheduling Information has been triggered, the "Control-only" HARQ profile configured by the higher layers shall be used.
- The Nominal Power Offset shall be set to the power offset included in the transmission HARQ profile;
- The data allocation shall maximize the transmission of higher priority data. When scheduled and non-scheduled grants are taken into account for the upcoming transmission:
 - Data of a given priority belonging to a scheduled MAC-d flow shall have precedence over any lower priority data, whether they belong to a scheduled or a non-scheduled MAC-d flow;
 - Data of a given priority belonging to a non-scheduled MAC-d flow shall have precedence over any lower priority data, whether they belong to a scheduled or a non-scheduled MAC-d flow;
- The amount of data and corresponding MAC-e/es headers from MAC-d flows for which non-scheduled grants were configured shall not exceed the value of the non-scheduled grant.
- If a 10ms TTI is configured and the TTI for the upcoming transmission overlaps with a compressed mode gap, the `Serving_Grant` provided by the Serving Grant Update function shall be scaled back as follows:

$$SG' = SG * \left(\frac{N_c}{15}\right)$$

where SG' represents the modified serving grant considered by the E-TFC selection algorithm and N_C represents the number of non DTX slots in the compressed TTI;

- If the transmission contains any scheduled data, the size of the selected MAC-e PDU shall not exceed the total of:
 - all non-scheduled grants which are applicable for transmission in this TTI;
 - the maximum number of scheduled bits based on the Serving Grant (after adjustment for compressed frames) and the power offset from the selected HARQ profile;
 - the size of the triggered scheduling information (if any).
- In the case a 2ms TTI is configured and the HARQ process is inactive, the UE shall not include in the transmission any data from MAC-d flows for which no non-scheduled grants were configured;
- The Scheduling Information is always sent when triggered (see subclause 11.8.1.6);
- Only E-TFCs in supported state shall be considered;
- Once all other requirements have been fulfilled, the E-TFC resulting in the smallest amount of padding for the selected MAC-es PDUs and corresponding MAC-e/es headers, shall be selected including the case when the Scheduling Information needs to be transmitted.

While respecting all the above listed requirements, for each logical channel using RLC-UM, at every TTI, the UE may select the RLC PDU size so as to maximise the amount of data of this logical channel that can be transmitted.

Once an appropriate E-TFC and data allocation are found according to the rules above, the "Multiplexing and TSN Setting" entity shall generate the corresponding MAC-e PDU.

The E-TFC selection function shall provide this MAC-e PDU and transmission HARQ profile to the HARQ entity. The maximum number of HARQ transmissions and the power offset in this profile, shall be set respectively to the maximum of the Max Number of HARQ Transmissions of the HARQ profiles from all the MAC-d flows from which data is multiplexed into the transmission and to the Nominal Power Offset. The HARQ entity shall also be informed of whether the transmission includes Scheduling Information and whether this information is sent by itself or with higher-layer data. The E-TFC selection function shall provide the E-TFCI for the selected E-TFC to the HARQ entity.

In FDD, in case the DTX feature is configured by higher layers and no E-DCH transmission is performed in this TTI:

- if $MAC\ Inactivity\ Threshold > 1$ and no E-DCH transmission has been performed for $MAC\ Inactivity\ Threshold - 1$ previous TTIs or,
- if $MAC\ Inactivity\ Threshold = 1$:
 - E-TFC selection shall only be performed for the TTIs where the following conditions are fulfilled:
 - For 2ms TTI: $[5 * CFN + subframe\ number - UE\ DTX\ DRX\ Offset] \bmod MAC\ DTX\ Cycle = 0$;
 - For 10ms TTI: $[5 * CFN - UE\ DTX\ DRX\ Offset] \bmod MAC\ DTX\ Cycle = 0$.

11.8.1.5 Happy Bit Setting

The Happy Bit is included on the E-DPCCH for every E-DCH transmission. E-DCH transmissions shall not be triggered specifically to allow the transmission of the happy bit.

RRC configures MAC with the duration `Happy_Bit_Delay_Condition`, over which to evaluate the current grant relative to the TEBS after application of the E-TFC selection procedure described in subclause 11.8.1.4.

For every E-DCH transmission, the Happy Bit shall be set to "unhappy" if the three following criteria are met:

- 1) UE is transmitting as much scheduled data as allowed by the current `Serving_Grant` in E-TFC selection; and
- 2) UE has enough power available to transmit at higher data rate; and

- 3) Based on the same power offset as the one selected in E-TFC selection to transmit data in the same TTI as the Happy Bit, TEBS would require more than $\text{Happy_Bit_Delay_Condition}$ ms to be transmitted with the current $\text{Serving_Grant} \times$ the ratio of active processes to the total number of processes.

The first criteria is always true for a deactivated process and the ratio of the third criteria is always 1 for 10ms TTI..

Otherwise, the Happy Bit shall be set to "happy".

In order to assess if it has enough power available to transmit at higher data rate the UE shall:

- 1) Identify the E-TFC that has a transport block size at least x bits larger than the transport block size of the E-TFC selected for transmission in the same TTI as the Happy Bit, where x is the smallest RLC PDU size configured among all the logical channels that do not belong to non-scheduled MAC-d flows and which have data in the buffer; and
- 2) Based on the same power offset as the one selected in E-TFC selection to transmit data in the same TTI as the Happy Bit, check that the identified E-TFC is supported i.e. not blocked.

11.8.1.6 Scheduling Information reporting

Scheduling information reports will be triggered differently depending on the value of the variable Serving_Grant after the $\text{Serving Grant Update}$ function. The triggering of a report shall be indicated to the E-TFC selection function at the first new transmission opportunity (this process may be delayed in case the HARQ processes are occupied with re-transmissions).

Even if multiple events are triggered by the time a new transmission can take place, only a single scheduling information header will be included in the payload.

The Scheduling Information shall not be transmitted if the TEBS is zero, even if it was triggered by one of the configured triggering mechanisms. If the Scheduling Information needs to be included in the MAC-e PDU according to subclause 9.2.4.2, it shall be transmitted regardless of TEBS status.

The transmission of Scheduling Information can take place on every HARQ process, even on those processes for which transmission is restricted according to RRC or deactivated by absolute grants, i.e. processes on which scheduled and/or non-scheduled transmission can not take place.

The description of the behaviour in the two cases is provided below.

11.8.1.6.1 Report Triggering when $\text{SG} = \text{"Zero_Grant"}$ or all processes are deactivated

If the Serving_Grant has the value "Zero_Grant" or all processes are deactivated, and the TEBS becomes larger than zero, the transmission of Scheduling Information shall be triggered.

If data with higher priority than the data already in the transmission buffer arrives, the transmission of a Scheduling Information shall be triggered.

RRC can also configure MAC with periodic Scheduling Information triggering. The periodic trigger timer T_SING (Timer Scheduling Information – "Zero_Grant") shall be started once the Serving_Grant variable becomes "Zero_Grant" or all processes are deactivated and TEBS is larger than zero.

When T_SING expires, the transmission of a Scheduling Information shall be triggered.

T_SING shall be restarted when the transmission of a Scheduling Information is triggered.

T_SING shall be stopped and reset once the Serving_Grant variable in the $\text{Serving Grant Update}$ function takes a value other than "Zero_Grant" and at least one process is activated.

11.8.1.6.2 Report Triggering when $\text{SG} <> \text{"Zero_Grant"}$ and at least one process is activated

If an E-DCH serving cell change occurs and if the new E-DCH serving cell was not part of the previous Serving E-DCH RLS , the transmission of a Scheduling Information shall be triggered.

RRC can configure MAC with periodic triggering also for the case when the variable `Serving_Grant` $\langle \rangle$ "Zero_Grant" and at least one process is activated. The periodic trigger timer `T_SIG` (Timer Scheduling Information – different from "Zero_Grant") can be configured to a different value than `T_SING`.

`T_SIG` shall be started once the `Serving_Grant` variable becomes $\langle \rangle$ "Zero_Grant" and at least one process is activated.

When `T_SIG` expires, the transmission of a new Scheduling Information shall be triggered.

`T_SIG` shall be stopped and reset once the `Serving_Grant` variable in the Serving Grant Update function becomes equal to "Zero_Grant" or all processes are deactivated.

`T_SIG` shall be restarted when the transmission of a Scheduling Information is triggered.

Once the `Serving_Grant` variable in the Serving Grant Update function becomes equal to "Zero_Grant" or all processes are deactivated and `TEBS` is larger than zero, the transmission of a Scheduling Information shall be triggered.

11.8.1.6.3 HARQ delivery failure for triggered Scheduling Information

If the HARQ process fails to deliver a MAC-e PDU containing a triggered Scheduling Information to the RLS containing the serving cell:

- if the Scheduling Information was transmitted without any higher layer data multiplexed in the same MAC-e PDU:
 - no further action is required (rely on periodic triggering).
- else (Scheduling Information was transmitted together with higher layer data multiplexed in the same MAC-e PDU):
 - the transmission of a new Scheduling Information shall be triggered.

11.8.1.7 MAC-es/e Reset

If a reset of the MAC-es/e entity is requested by upper layers, the UE shall at the activation time indicated by higher layers:

- flush all HARQ processes;
- set `CURRENT_TSN` to 0 for all the logical channels mapped to E-DCH.

NOTE: In this case, the HARQ entity will not notify the Scheduling Information Reporting function if a flushed MAC-e PDU contained a triggered Scheduling Information (rely on periodic triggering).

11.8.1.8 Monitoring of Absolute and Relative Grant Channels

When the DRX feature is enabled by higher layers, and in addition to the conditions defined in subclause 6C.3 of [13] the downlink reception of E-AGCH and E-RGCH sets is required in the following conditions:

- At least one MAC-d flow is configured with a scheduled transmission and `TEBS` > 0 or;
- a scheduled E-DCH transmission has been performed in any of the *Inactivity Threshold for UE Grant Monitoring* previous TTIs or;
- the E-AGCH and E-RGCH commands overlap with an E-HICH corresponding to a scheduled E-DCH transmission.

11.8.2 Node B operation

11.8.2.1 HARQ Operation

11.8.2.1.1 HARQ entity

There is one HARQ entity per UE in each Node-B in its E-DCH active set. The HARQ entity routes the payload and the associated RSN value to the appropriate HARQ process based on the transmission timing. Based on the outcome of the decoding, the HARQ entity transmits an ACK or a NACK in return.

11.8.2.1.2 HARQ process

The HARQ process uses the RSN and the transmission timing (CFN, sub-frame) to establish the transmission number. Based on this it identifies the transmission redundancy version and attempts to decode the transmission. The outcome of the decoding is reported to the HARQ entity, so that it may be fed back to the UE.

11.8.2.2 De-multiplexing

There is one de-multiplexing entity per UE in the Node B. The SRNC configures the Node B with the mapping between the active DDI values and the corresponding MAC-d flow and PDU size. Also, it provides it with the mapping between MAC-d flow IDs and the corresponding Iub bearer.

The de-multiplexing entity uses the MAC-e header information (DDI, N) to determine the size of each MAC-es PDU and based on this it segments the MAC-e payload into MAC-es PDUs. These are then routed onto the Iub bearer indicated by the DDI value.

With each MAC-es PDU, the Node B will send to the SRNC:

- the associated DDI and N values;
- the CFN and sub-frame number when the payload including the MAC-es PDU was decoded correctly;
- the total number of transmissions that were needed for the MAC-e PDU to be decoded correctly.

11.8.2.3 Scheduler

There is one E-DCH Node B scheduler per Node B. The Node B scheduler is responsible for the following functions:

- Allocating uplink resources to UEs for which it acts as the serving Node B;
- Monitoring other-cell interference and accordingly sending relative grants to UEs for which it does not act as the serving Node B;
- Reporting to the SRNC on the lack of processing resources;

11.8.2.4 E-DCH Provided Bit Rate measurement

The E-DCH Provided Bit Rate measurement is defined as follows:

- for each priority class the MAC-e function in the Node B measures the total number of MAC-d PDU bits whose transmission over the radio interface has been considered successful by MAC-e in Node-B during the last measurement period, divided by the duration of the measurement period;
- the number of MAC-d PDU bits from UEs in softer handover shall be considered after soft combining;
- the Node-B shall allocate the bit rate received over an RLS equally divided among all cells in the RLS regardless of whether the RLS contains the E-DCH serving cell or not;
- the values reported shall be raw samples;
- the measurement period shall be 100 ms.

11.8.3 RNC operation

11.8.3.1 Re-ordering entity

The re-ordering entity is part of the MAC-es sublayer in the SRNC. There is one re-ordering entity per UE. Each re-ordering entity will support one re-ordering process per logical channel. The DDI value is used to determine the logical channel for which each MAC-es PDU is meant. Based on this information, the MAC-es PDUs are routed to the proper re-ordering process. The re-ordering process may use the explicit TSN indication as well as the timing information provided by the Node B in order to eliminate duplicates and deliver the packets in order to RLC. The details of the re-ordering mechanism are left up to the implementation.

11.9 Control of E-DCH transmission and reception (TDD)

11.9.1 UE operation

11.9.1.1 HARQ Operation

The TDD HARQ protocol is a stop and wait protocol based on synchronous downlink ACK/NACKs with asynchronous retransmissions in the uplink. If NACK is received then the UE may only retransmit the previously transmitted MAC-e PDU if suitable physical resources are available, otherwise it must wait until it receives an appropriate Absolute Grant (or in the case of non-scheduled transmission, the UE must wait until resource is next designated as available for non-scheduled transmission/retransmission). There are a maximum of 8 HARQ processes (instances of the HARQ entity). Operation of the HARQ protocol is as follows:

- If an Absolute Grant is received in Frame (i) then the UE transmits a data block (MAC-e PDU) in Frame (i+T1)
- For a MAC-e PDU transmitted in Frame (i+T1) the UE receives an ACK/NACK in Frame (i+T1+T2)
- If NACK is received in Frame (i+T1+T2) then the UE cannot retransmit the MAC-e PDU previously transmitted in Frame (i+T1) (now stored for potential retransmission) until suitable physical resources are available (e.g. until Absolute Grant received)
- The interval T3 between reception of NACK and the availability of suitable resources via reception of a Grant for a subsequent retransmission is variable and depends on Node B scheduling decisions
- If an ACK is received in Frame (i+T1+T2) then the MAC-e PDU previously transmitted in Frame (i+T1) (stored for potential retransmission) is discarded and the HARQ process identity associated with the previously transmitted data block can now be reassigned.

NOTE: For 1.28 Mcps TDD, "subframe" should be used to describe the above timing relation. T1 and T2 may be derived from the physical layer timings given in [21].

Operation of the TDD HARQ protocol is illustrated by Figure 11.9.1.1.

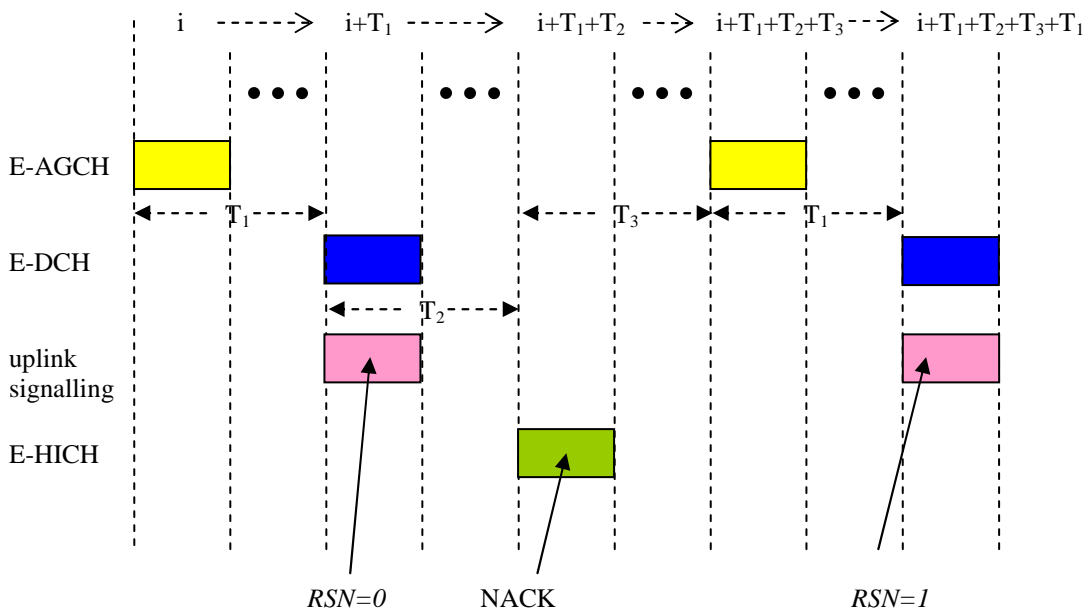

Figure 11.9.1.1: TDD E-DCH HARQ Operation

11.9.1.1.1 HARQ entity

There is one HARQ entity in the UE. A number of parallel HARQ processes (identified by a HARQ process identifier) are used in the UE to support the HARQ entity, allowing transmissions to take place continuously while the UE is granted resources. The HARQ entity identifies the HARQ process for which transmission should take place if resources are available. Also, based on timing with respect to a previously-transmitted MAC-e PDU it routes the receiver feedback (ACK/NACK information), relayed by the physical layer, to the appropriate HARQ process.

The minimum number of HARQ processes is a function of T1 and T2 (see subclause 11.9.1.1). The maximum number of HARQ process identifiers is 8. Each process is associated with a HARQ process identifier numbered from 0 to 7.

The HARQ entity is responsible for determining which HARQ process will use the assigned resources in a given TTI (for both scheduled and non-scheduled resource types). It is further responsible for determining for each HARQ process whether new data or existing data should be transmitted from the HARQ process buffer, including the case in which new data is transmitted before successful delivery of the existing data.

For transmission in a given TTI, the HARQ entity shall only consider those HARQ processes associated with the resource grant type (scheduled / non-scheduled). HARQ processes 0 to 3 are associated with scheduled transmission whilst HARQ processes 4 to 7 are associated with non-scheduled transmission. In the following, the set of HARQ processes associated with the resource grant type is denoted the "associated set".

The following rules control the operation of the HARQ entity:

- If retransmissions are pending for any of the HARQ processes of the associated set:
 - the HARQ entity shall determine for each HARQ process of the associated set whether the current resource grant is sufficient to allow retransmission of the data. The grant is deemed to be sufficient if the corresponding transport block size is supportable within the allocated resources as determined by the E-TFC selection entity (see subclause 11.9.1.4);

- if the grant is sufficient for retransmission by at least one of the HARQ processes of the associated set, select the HARQ process containing the oldest MAC-e PDU for retransmission and notify the E-TFC selection entity that the TTI shall be used for retransmission;
- if the grant is not sufficient for retransmission by any of the HARQ processes of the associated set, the HARQ entity shall select an available HARQ process from the associated set for transmission of new data. In the case that none of the HARQ processes in the associated set are available (all contain data for retransmission) the HARQ entity shall discard the data from the HARQ process in the associated set containing the oldest MAC-e PDU and shall select that HARQ process for transmission of new data. In either case, the HARQ entity shall notify the E-TFC selection entity that the TTI shall be used for a new transmission.
- else:
 - the HARQ entity shall select an available HARQ process from the associated set for transmission of new data and shall notify the E-TFC selection entity that the TTI shall be used for a new transmission of scheduled data.

11.9.1.1.2 HARQ process

Each HARQ process is associated with a physical buffer (HARQ buffer).

Each HARQ process maintains the state variable `CURRENT_TX_NB`, which indicates the number of transmissions that have taken place for the MAC-e PDU currently in the buffer. For 1.28 Mcps TDD, each HARQ process also maintains the timer `RTX_TIMER` used to determine whether a pending retransmission should be discarded. When the HARQ process is established, `CURRENT_TX_NB` shall be initialized to 0.

At the time of a new transmission, the HARQ entity provides the HARQ profile to use for all transmissions and re-transmissions of this MAC-e PDU. This HARQ profile includes information on the maximum number of transmissions to perform, and the power offset with which to configure the physical layer. For 1.28 Mcps TDD, the HARQ profile also includes a retransmission timer attribute.

If the HARQ entity provides a new PDU, the HARQ process shall:

- set `CURRENT_TX_NB` to 0;
- set `CURRENT_RSN` to 0;
- store the MAC-e PDU in the associated HARQ buffer;
- generate a transmission as described below.

If the HARQ entity requests a re-transmission, the HARQ process shall:

- generate a transmission as described below.
- for 1.28 Mcps TDD, start `RTX_TIMER` for this MAC-e PDU if NACK is received for the initial transmission.

To generate a transmission, the HARQ process shall:

- instruct the physical layer to set the RSN field on the E-UCCH to `CURRENT_RSN`;
- instruct the physical layer to generate a transmission with the power offset corresponding to the HARQ profile and the redundancy version corresponding to the RSN value
- if `CURRENT_RSN < 3`
 - increment `CURRENT_RSN` by 1;
- else
 - decrement `CURRENT_RSN` by 1;
- increment `CURRENT_TX_NB` by 1;
- if `CURRENT_TX_NB ≥` maximum number of transmissions indicated in the transmission HARQ profile:

- flush the HARQ buffer;
- for 1.28 Mcps TDD, if RTX_TIMER expires which value indicated in the transmission HARQ profile:
 - flush the HARQ buffer;

If an ACK is received, the HARQ process shall:

- flush the HARQ buffer;
- set CURRENT_TX_NB to 0;
- set CURRENT_RSN to 0.
- for 1.28 Mcps TDD, if RTX_TIMER is active, it shall be stopped.

11.9.1.2 Multiplexing and TSN setting entity

As subclause 11.8.1.2.

11.9.1.3 Receiving a Grant

The UE determines whether each TTI is available for scheduled or non-scheduled transmissions.

The parameters applicable to a transmission are timeslots, code and maximum power. In the case of non-scheduled transmission, these parameters are set by RRC and retransmissions and/or new transmissions may occur in frames at intervals set by RRC. For scheduled transmission, the parameters are received via the E-AGCH.

For given grant, the HARQ entity determines which HARQ process to use in the TTI (see subclause 11.9.1.1.1).

11.9.1.4 E-TFC Selection

In TDD, rules for E-TFC selection shall be applied as provided below.

UEs shall apply E-TFC selection when invoked by the HARQ entity (see subclause 11.9.1.1.1).

For each MAC-d flow, RRC configures MAC-e with a HARQ profile and multiplexing list. Additionally, RRC configures MAC with a power offset in case the Scheduling Information needs to be transmitted without any higher-layer data. The HARQ profile includes the power offset and maximum number of HARQ transmissions to use for this MAC-d flow. For 1.28 Mcps TDD, the HARQ profile also includes a retransmission timer attribute. The multiplexing list identifies for each MAC-d flow(s), the other MAC-d flows for which data can be multiplexed in a transmission that uses the power offset included in its HARQ profile.

RRC can control the scheduling of uplink data by giving each logical channel a priority between 1 and 8, where 1 is the highest priority and 8 the lowest. E-TFC selection in the UE shall be done in accordance with the priorities indicated by RRC. Logical channels have absolute priority, i.e. the UE shall maximise the transmission of higher priority data.

RRC can allocate non-scheduled transmission grants to individual MAC-d flows in order to reduce the transmission delays.

The UE shall determine whether to take scheduled or non-scheduled grants into account in the upcoming transmission. If neither are supposed to be taken into account (i.e. the TTI is not available for non-scheduled transmission and no Grant for scheduled transmission has been received) then no grant shall be assumed to exist. If a grant exists then the transmission format and data allocation shall follow the requirements below.

For each configured MAC-d flow, a given E-TFC can be in any of the following states:

- Supported state;
- Blocked state.

The E-TFC states are derived according to the following:

- If the transmission is a retransmission then only the E-TFC with the same block size as the original transmission may be in the supported state.

- Only E-TFCs from the E-TFCS (the table of TB sizes) which can be supported by (exactly) the number of slots assigned by the grant shall be considered for the transmission;
- Only E-TFCs which result (for the granted timeslot and code physical resources) in a coderate lying between the maximum and minimum (inclusive) allowable coderates set by RRC [7] shall be considered for the transmission {note: the definition of the term “coderate” as used here is the same as that provided by [18]}. This shall be evaluated for both QPSK and 16-QAM modulation;
- P_{HARQ} , the HARQ profile power offset is selected (the HARQ profile for the transmission shall be selected among the HARQ profiles of MAC-d flows on which the highest priority logical channels with available data are mapped; Scheduling Information power offset shall be used when Scheduling Information is transmitted without any higher-layer data.)
- Only E-TFCs whose calculated transmission power requirement $P_{\text{E-PUCH}}$ (see [18]) is less than or equal to the available or granted power shall be considered for the transmission (note: this requirement does not apply in the case of a retransmission on non-scheduled resources).

For 3.84Mcps/7.68Mcps TDD, from those E-TFCs in the supported state the UE determines the largest block size that it is permitted to transmit within the given constraints.

For 1.28Mcps TDD, from those E-TFCs in the supported state, UE determines a candidate set with maximum number of 64 E-TFCs, including the largest one and the next smaller 62 E-TFCs, in addition to the E-TFC dedicated for SI. If the number of E-TFCs in the supported state is not greater than 63, all the E-TFCs in the supported state shall be included in the candidate set. From the candidate set the UE determines the largest block size that is permitted to transmit within the given constraints.

The UE shall select the modulation type associated with the determined E-TFC (note: if an E-TFC is supported by both QPSK and 16-QAM then 16-QAM modulation shall be used if its power requirement ($P_{\text{E-PUCH}}$) is lower than the power requirement for QPSK, otherwise QPSK modulation shall be used).

Data allocation shall then be performed in accordance with the following:

- For all logical channels, if the logical channel belongs to a non-scheduled MAC-d flow, its data shall be considered as available up to the largest block size determined for the corresponding non-scheduled grant. If the logical channel does not belong to a non-scheduled MAC-d flow, its data shall be considered as available up to the largest block size determined for the Serving Grant;
- The data allocation shall maximise the transmission of higher priority data;
- The UE shall select the E-TFC, SF and modulation which minimises the power used (3.84/7.68 Mcps TDD only);
- The UE shall select the E-TFC and modulation which minimises the power used (1.28 Mcps TDD only);

Once an appropriate E-TFC and data allocation are found according to the rules above, the "Multiplexing and TSN Setting" entity shall generate the corresponding MAC-e PDU.

In 1.28Mcps TDD, when Scheduling Information is triggered by timer per subclause 11.9.1.5, the E-TFC selection and data-allocation process shall assume that Scheduling Information has a priority higher than any other logical channel.

The E-TFC selection function shall provide this MAC-e PDU and transmission HARQ profile to the HARQ entity. The maximum number of HARQ transmissions and the power offset in this profile shall be set respectively to the maximum of both the Max Number of HARQ Transmissions and of the power offset of the HARQ profiles from all the MAC-d flows from which data is multiplexed into the transmission. For 1.28 Mcps TDD, the retransmission timer shall be set to the maximum of the retransmission timer value of the HARQ profiles that are permitted to be multiplexed into the transmission. Each HARQ process which is associated with a buffer holding a MAC-e PDU for potential retransmission shall maintain the HARQ profile and the number of re-transmissions that have occurred. For 1.28 Mcps TDD, the HARQ process shall also maintain the value of RTX_TIMER.

Further information on E-TFC selection is provided in Annex CA.

11.9.1.5 Scheduling Information reporting (1.28 Mcps TDD only)

If a UE has no Grant and the TEBS becomes larger than zero, the transmission of Scheduling Information shall be triggered via E-RUCCH.

If the UE has a Grant, the scheduling information needs to be included in the MAC-e PDU according to subclause 9.2.4.2, and it shall be transmitted regardless of TEBS status. Additional timer mechanism is used to avoid long pause duration of scheduling information reporting (period defined by RRC and set the same value as below T_WAIT). When the scheduling information is included in MAC-e PDU and sent, the timer will be reset and restarted immediately; when the timer expires, scheduling information shall be sent in a new MAC-e PDU.

RRC can configure MAC with a delay timer to be used when the UE transits from having a Grant to not having a Grant and the TEBS is still larger than zero. The delay timer T_WAIT shall be started once the Grant expires and shall be stopped and reset when a Grant is received. When T_WAIT expires, the transmission of a Scheduling Information shall be triggered via E-RUCCH (T_WAIT shall be stopped and reset).

11.9.2 Node B operation

11.9.2.1 HARQ Operation

11.9.2.1.1 HARQ entity

There is one HARQ entity per UE in the Node-B. The HARQ entity routes the payload and the associated RSN value to the indicated HARQ process (the HARQ process identifier is signalled to the Node B via the E-UCCH). Based on the outcome of the decoding, the HARQ entity transmits an ACK or a NACK in return.

11.9.2.1.2 HARQ process

The HARQ process uses the RSN to identify the redundancy version, The Node B uses the identified redundancy version to attempt to decode the transmission. The outcome of the decoding is reported to the HARQ entity, so that it may be fed back to the UE as ACK or NACK.

11.9.2.2 De-multiplexing

There is one de-multiplexing entity per UE in the Node B. The SRNC configures the Node B with the mapping between the active DDI values and the corresponding MAC-d flow and PDU size. Also, it provides it with the mapping between MAC-d flow IDs and the corresponding Iub bearer.

The de-multiplexing entity uses the MAC-e header information (DDI, N) to determine the size of each MAC-es PDU and based on this it segments the MAC-e payload into MAC-es PDUs. These are then routed onto the Iub bearer indicated by the DDI value.

With each MAC-es PDU, the Node B will send to the SRNC:

- the associated DDI and N values;
- the CFN when the payload including the MAC-es PDU was decoded correctly (3.84/7.68 Mcps only);
- the CFN and sub-frame number when the payload including the MAC-es PDU was decoded correctly (1.28 Mcps TDD only);
- the total number of transmissions that were needed for the MAC-e PDU to be decoded correctly.

11.9.2.3 Scheduler

There is one E-DCH Node B scheduler per Node B. The Node B scheduler is responsible for the following functions:

- Allocating uplink resources to UEs and signalling these to UEs via Absolute Grants;
- Reporting uplink interference measurements to the SRNC
- Reporting to the SRNC on the lack of processing resources
- Determining the TDD ECSN (the UE specific ECSN is incremented for each E-AGCH transmission)
- Determining which E-HICH will be used for the incoming transmission and the value of the associated E-HICH Indicator (1.28 Mcps TDD only)

- Determining how many E-UCCHs should be carried on the incoming E-PUCHs and the value of the associated E-UCCH Number Indicator (1.28 Mcps TDD only).

11.9.2.4 E-DCH Provided Bit Rate measurement

The E-DCH Provided Bit Rate measurement is defined as follows:

- for each priority class the MAC-e function in the Node B measures the total number of MAC-d PDU bits whose transmission over the radio interface has been considered successful by MAC-e in Node-B during the last measurement period, divided by the duration of the measurement period;
- the measurement period shall be [100 ms].

11.9.3 RNC operation

11.9.3.1 Re-ordering entity

The re-ordering entity is part of the MAC-es sublayer in the SRNC. There is one re-ordering entity per UE. Each re-ordering entity will support one re-ordering process per logical channel. The DDI value is used to determine the logical channel for which each MAC-es PDU is meant. Based on this information, the MAC-es PDUs are routed to the proper re-ordering process. The re-ordering process may use the explicit TSN indication as well as the timing information provided by the Node B in order to eliminate duplicates and deliver the packets in order to RLC. The details of the re-ordering mechanism are left up to the implementation.

Annex A (normative): HS-DSCH Transport Block Size Table for FDD

The following table provides the mapping between k_t (as per the definition in subclause 9.2.3.1) and the HS-DSCH Transport Block Size ($L(k_t)$) corresponding to table 9.2.3.1:

| Index | TB Size | Index | TB Size | Index | TB Size |
|-------|---------|-------|---------|-------|---------|
| 1 | 137 | 86 | 1380 | 171 | 6324 |
| 2 | 149 | 87 | 1405 | 172 | 6438 |
| 3 | 161 | 88 | 1430 | 173 | 6554 |
| 4 | 173 | 89 | 1456 | 174 | 6673 |
| 5 | 185 | 90 | 1483 | 175 | 6793 |
| 6 | 197 | 91 | 1509 | 176 | 6916 |
| 7 | 209 | 92 | 1537 | 177 | 7041 |
| 8 | 221 | 93 | 1564 | 178 | 7168 |
| 9 | 233 | 94 | 1593 | 179 | 7298 |
| 10 | 245 | 95 | 1621 | 180 | 7430 |
| 11 | 257 | 96 | 1651 | 181 | 7564 |
| 12 | 269 | 97 | 1681 | 182 | 7700 |
| 13 | 281 | 98 | 1711 | 183 | 7840 |
| 14 | 293 | 99 | 1742 | 184 | 7981 |
| 15 | 305 | 100 | 1773 | 185 | 8125 |
| 16 | 317 | 101 | 1805 | 186 | 8272 |
| 17 | 329 | 102 | 1838 | 187 | 8422 |
| 18 | 341 | 103 | 1871 | 188 | 8574 |
| 19 | 353 | 104 | 1905 | 189 | 8729 |
| 20 | 365 | 105 | 1939 | 190 | 8886 |
| 21 | 377 | 106 | 1974 | 191 | 9047 |
| 22 | 389 | 107 | 2010 | 192 | 9210 |
| 23 | 401 | 108 | 2046 | 193 | 9377 |
| 24 | 413 | 109 | 2083 | 194 | 9546 |
| 25 | 425 | 110 | 2121 | 195 | 9719 |
| 26 | 437 | 111 | 2159 | 196 | 9894 |
| 27 | 449 | 112 | 2198 | 197 | 10073 |
| 28 | 461 | 113 | 2238 | 198 | 10255 |
| 29 | 473 | 114 | 2279 | 199 | 10440 |
| 30 | 485 | 115 | 2320 | 200 | 10629 |
| 31 | 497 | 116 | 2362 | 201 | 10821 |
| 32 | 509 | 117 | 2404 | 202 | 11017 |
| 33 | 521 | 118 | 2448 | 203 | 11216 |
| 34 | 533 | 119 | 2492 | 204 | 11418 |
| 35 | 545 | 120 | 2537 | 205 | 11625 |
| 36 | 557 | 121 | 2583 | 206 | 11835 |
| 37 | 569 | 122 | 2630 | 207 | 12048 |
| 38 | 581 | 123 | 2677 | 208 | 12266 |
| 39 | 593 | 124 | 2726 | 209 | 12488 |
| 40 | 605 | 125 | 2775 | 210 | 12713 |
| 41 | 616 | 126 | 2825 | 211 | 12943 |
| 42 | 627 | 127 | 2876 | 212 | 13177 |
| 43 | 639 | 128 | 2928 | 213 | 13415 |
| 44 | 650 | 129 | 2981 | 214 | 13657 |
| 45 | 662 | 130 | 3035 | 215 | 13904 |

| | | | | | |
|----|------|-----|------|-----|-------|
| 46 | 674 | 131 | 3090 | 216 | 14155 |
| 47 | 686 | 132 | 3145 | 217 | 14411 |
| 48 | 699 | 133 | 3202 | 218 | 14671 |
| 49 | 711 | 134 | 3260 | 219 | 14936 |
| 50 | 724 | 135 | 3319 | 220 | 15206 |
| 51 | 737 | 136 | 3379 | 221 | 15481 |
| 52 | 751 | 137 | 3440 | 222 | 15761 |
| 53 | 764 | 138 | 3502 | 223 | 16045 |
| 54 | 778 | 139 | 3565 | 224 | 16335 |
| 55 | 792 | 140 | 3630 | 225 | 16630 |
| 56 | 806 | 141 | 3695 | 226 | 16931 |
| 57 | 821 | 142 | 3762 | 227 | 17237 |
| 58 | 836 | 143 | 3830 | 228 | 17548 |
| 59 | 851 | 144 | 3899 | 229 | 17865 |
| 60 | 866 | 145 | 3970 | 230 | 18188 |
| 61 | 882 | 146 | 4042 | 231 | 18517 |
| 62 | 898 | 147 | 4115 | 232 | 18851 |
| 63 | 914 | 148 | 4189 | 233 | 19192 |
| 64 | 931 | 149 | 4265 | 234 | 19538 |
| 65 | 947 | 150 | 4342 | 235 | 19891 |
| 66 | 964 | 151 | 4420 | 236 | 20251 |
| 67 | 982 | 152 | 4500 | 237 | 20617 |
| 68 | 1000 | 153 | 4581 | 238 | 20989 |
| 69 | 1018 | 154 | 4664 | 239 | 21368 |
| 70 | 1036 | 155 | 4748 | 240 | 21754 |
| 71 | 1055 | 156 | 4834 | 241 | 22147 |
| 72 | 1074 | 157 | 4921 | 242 | 22548 |
| 73 | 1093 | 158 | 5010 | 243 | 22955 |
| 74 | 1113 | 159 | 5101 | 244 | 23370 |
| 75 | 1133 | 160 | 5193 | 245 | 23792 |
| 76 | 1154 | 161 | 5287 | 246 | 24222 |
| 77 | 1175 | 162 | 5382 | 247 | 24659 |
| 78 | 1196 | 163 | 5480 | 248 | 25105 |
| 79 | 1217 | 164 | 5579 | 249 | 25558 |
| 80 | 1239 | 165 | 5680 | 250 | 26020 |
| 81 | 1262 | 166 | 5782 | 251 | 26490 |
| 82 | 1285 | 167 | 5887 | 252 | 26969 |
| 83 | 1308 | 168 | 5993 | 253 | 27456 |
| 84 | 1331 | 169 | 6101 | 254 | 27952 |
| 85 | 1356 | 170 | 6211 | | |

The following table provides the mapping between k_t (as per the definition in subclause 9.2.3.1) and the HS-DSCH Transport Block Size ($L(k_t)$) corresponding to table 9.2.3.2:

| Index | TB Size | Index | TB Size | Index | TB Size | Index | TB Size |
|-------|---------|-------|---------|-------|---------|-------|---------|
| 1 | 120 | 86 | 1000 | 171 | 4600 | 256 | 21080 |
| 2 | 128 | 87 | 1024 | 172 | 4688 | 257 | 21464 |
| 3 | 136 | 88 | 1040 | 173 | 4768 | 258 | 21848 |
| 4 | 144 | 89 | 1056 | 174 | 4856 | 259 | 22248 |
| 5 | 152 | 90 | 1080 | 175 | 4944 | 260 | 22648 |
| 6 | 160 | 91 | 1096 | 176 | 5032 | 261 | 23056 |
| 7 | 168 | 92 | 1120 | 177 | 5128 | 262 | 23472 |
| 8 | 176 | 93 | 1136 | 178 | 5216 | 263 | 23896 |
| 9 | 184 | 94 | 1160 | 179 | 5312 | 264 | 24328 |
| 10 | 192 | 95 | 1176 | 180 | 5408 | 265 | 24768 |
| 11 | 200 | 96 | 1200 | 181 | 5504 | 266 | 25216 |
| 12 | 208 | 97 | 1224 | 182 | 5608 | 267 | 25672 |
| 13 | 216 | 98 | 1240 | 183 | 5704 | 268 | 26128 |
| 14 | 224 | 99 | 1264 | 184 | 5808 | 269 | 26600 |
| 15 | 232 | 100 | 1288 | 185 | 5912 | 270 | 27088 |
| 16 | 240 | 101 | 1312 | 186 | 6024 | 271 | 27576 |
| 17 | 248 | 102 | 1336 | 187 | 6128 | 272 | 28072 |
| 18 | 256 | 103 | 1360 | 188 | 6240 | 273 | 28576 |
| 19 | 264 | 104 | 1384 | 189 | 6352 | 274 | 29096 |
| 20 | 272 | 105 | 1408 | 190 | 6472 | 275 | 29616 |
| 21 | 280 | 106 | 1432 | 191 | 6584 | 276 | 30152 |
| 22 | 288 | 107 | 1464 | 192 | 6704 | 277 | 30696 |
| 23 | 296 | 108 | 1488 | 193 | 6824 | 278 | 31256 |
| 24 | 304 | 109 | 1512 | 194 | 6952 | 279 | 31816 |
| 25 | 312 | 110 | 1544 | 195 | 7072 | 280 | 32392 |
| 26 | 320 | 111 | 1568 | 196 | 7200 | 281 | 32976 |
| 27 | 328 | 112 | 1600 | 197 | 7328 | 282 | 33576 |
| 28 | 336 | 113 | 1624 | 198 | 7464 | 283 | 34176 |
| 29 | 344 | 114 | 1656 | 199 | 7600 | 284 | 34800 |
| 30 | 352 | 115 | 1688 | 200 | 7736 | 285 | 35424 |
| 31 | 360 | 116 | 1720 | 201 | 7880 | 286 | 36064 |
| 32 | 368 | 117 | 1752 | 202 | 8016 | 287 | 36712 |
| 33 | 376 | 118 | 1784 | 203 | 8160 | 288 | 37376 |
| 34 | 384 | 119 | 1816 | 204 | 8312 | 289 | 38056 |
| 35 | 392 | 120 | 1848 | 205 | 8464 | 290 | 38744 |
| 36 | 400 | 121 | 1880 | 206 | 8616 | 291 | 39440 |
| 37 | 408 | 122 | 1912 | 207 | 8768 | 292 | 40152 |
| 38 | 416 | 123 | 1944 | 208 | 8928 | 293 | 40880 |
| 39 | 424 | 124 | 1984 | 209 | 9088 | 294 | 41616 |
| 40 | 440 | 125 | 2016 | 210 | 9256 | 295 | 42368 |
| 41 | 448 | 126 | 2056 | 211 | 9424 | 296 | 43128 |
| 42 | 456 | 127 | 2096 | 212 | 9592 | | |
| 43 | 464 | 128 | 2128 | 213 | 9760 | | |
| 44 | 472 | 129 | 2168 | 214 | 9944 | | |
| 45 | 480 | 130 | 2208 | 215 | 10120 | | |
| 46 | 488 | 131 | 2248 | 216 | 10304 | | |
| 47 | 496 | 132 | 2288 | 217 | 10488 | | |
| 48 | 504 | 133 | 2328 | 218 | 10680 | | |
| 49 | 512 | 134 | 2368 | 219 | 10872 | | |
| 50 | 528 | 135 | 2416 | 220 | 11064 | | |
| 51 | 536 | 136 | 2456 | 221 | 11264 | | |
| 52 | 544 | 137 | 2504 | 222 | 11472 | | |

| | | | | | |
|----|-----|-----|------|-----|-------|
| 53 | 552 | 138 | 2552 | 223 | 11680 |
| 54 | 560 | 139 | 2592 | 224 | 11888 |
| 55 | 576 | 140 | 2640 | 225 | 12104 |
| 56 | 584 | 141 | 2688 | 226 | 12320 |
| 57 | 592 | 142 | 2736 | 227 | 12544 |
| 58 | 608 | 143 | 2784 | 228 | 12768 |
| 59 | 616 | 144 | 2840 | 229 | 13000 |
| 60 | 632 | 145 | 2888 | 230 | 13240 |
| 61 | 640 | 146 | 2944 | 231 | 13472 |
| 62 | 648 | 147 | 2992 | 232 | 13720 |
| 63 | 664 | 148 | 3048 | 233 | 13968 |
| 64 | 672 | 149 | 3104 | 234 | 14216 |
| 65 | 688 | 150 | 3160 | 235 | 14480 |
| 66 | 696 | 151 | 3216 | 236 | 14736 |
| 67 | 712 | 152 | 3272 | 237 | 15000 |
| 68 | 728 | 153 | 3336 | 238 | 15272 |
| 69 | 736 | 154 | 3392 | 239 | 15552 |
| 70 | 752 | 155 | 3456 | 240 | 15832 |
| 71 | 768 | 156 | 3520 | 241 | 16120 |
| 72 | 776 | 157 | 3584 | 242 | 16408 |
| 73 | 792 | 158 | 3648 | 243 | 16704 |
| 74 | 808 | 159 | 3712 | 244 | 17008 |
| 75 | 824 | 160 | 3776 | 245 | 17312 |
| 76 | 840 | 161 | 3848 | 246 | 17624 |
| 77 | 856 | 162 | 3920 | 247 | 17944 |
| 78 | 872 | 163 | 3992 | 248 | 18272 |
| 79 | 880 | 164 | 4064 | 249 | 18600 |
| 80 | 904 | 165 | 4136 | 250 | 18936 |
| 81 | 920 | 166 | 4208 | 251 | 19280 |
| 82 | 936 | 167 | 4288 | 252 | 19624 |
| 83 | 952 | 168 | 4360 | 253 | 19976 |
| 84 | 968 | 169 | 4440 | 254 | 20336 |
| 85 | 984 | 170 | 4520 | 255 | 20704 |

Annex B (normative): E-DCH Transport Block Size Tables for FDD

The mapping between the chosen E-TFCI and the corresponding E-DCH transport block size is given in the following tables:

B.1 2ms TTI E-DCH Transport Block Size Table 0

| E-TFCI | TB Size (bits) | E-TFCI | TB Size (bits) | E-TFCI | TB Size (bits) | E-TFCI | TB Size (bits) | E-TFCI | TB Size (bits) |
|--------|----------------|--------|----------------|--------|----------------|--------|----------------|--------|----------------|
| 0 | 18 | 30 | 342 | 60 | 1015 | 90 | 3008 | 120 | 8913 |
| 1 | 120 | 31 | 355 | 61 | 1053 | 91 | 3119 | 121 | 9241 |
| 2 | 124 | 32 | 368 | 62 | 1091 | 92 | 3234 | 122 | 9582 |
| 3 | 129 | 33 | 382 | 63 | 1132 | 93 | 3353 | 123 | 9935 |
| 4 | 133 | 34 | 396 | 64 | 1173 | 94 | 3477 | 124 | 10302 |
| 5 | 138 | 35 | 410 | 65 | 1217 | 95 | 3605 | 125 | 10681 |
| 6 | 143 | 36 | 426 | 66 | 1262 | 96 | 3738 | 126 | 11075 |
| 7 | 149 | 37 | 441 | 67 | 1308 | 97 | 3876 | 127 | 11484 |
| 8 | 154 | 38 | 458 | 68 | 1356 | 98 | 4019 | | |
| 9 | 160 | 39 | 474 | 69 | 1406 | 99 | 4167 | | |
| 10 | 166 | 40 | 492 | 70 | 1458 | 100 | 4321 | | |
| 11 | 172 | 41 | 510 | 71 | 1512 | 101 | 4480 | | |
| 12 | 178 | 42 | 529 | 72 | 1568 | 102 | 4645 | | |
| 13 | 185 | 43 | 548 | 73 | 1626 | 103 | 4816 | | |
| 14 | 192 | 44 | 569 | 74 | 1685 | 104 | 4994 | | |
| 15 | 199 | 45 | 590 | 75 | 1748 | 105 | 5178 | | |
| 16 | 206 | 46 | 611 | 76 | 1812 | 106 | 5369 | | |
| 17 | 214 | 47 | 634 | 77 | 1879 | 107 | 5567 | | |
| 18 | 222 | 48 | 657 | 78 | 1948 | 108 | 5772 | | |
| 19 | 230 | 49 | 682 | 79 | 2020 | 109 | 5985 | | |
| 20 | 238 | 50 | 707 | 80 | 2094 | 110 | 6206 | | |
| 21 | 247 | 51 | 733 | 81 | 2172 | 111 | 6435 | | |
| 22 | 256 | 52 | 760 | 82 | 2252 | 112 | 6672 | | |
| 23 | 266 | 53 | 788 | 83 | 2335 | 113 | 6918 | | |
| 24 | 275 | 54 | 817 | 84 | 2421 | 114 | 7173 | | |
| 25 | 286 | 55 | 847 | 85 | 2510 | 115 | 7437 | | |
| 26 | 296 | 56 | 878 | 86 | 2603 | 116 | 7711 | | |
| 27 | 307 | 57 | 911 | 87 | 2699 | 117 | 7996 | | |
| 28 | 318 | 58 | 944 | 88 | 2798 | 118 | 8290 | | |
| 29 | 330 | 59 | 979 | 89 | 2901 | 119 | 8596 | | |

B.2 2ms TTI E-DCH Transport Block Size Table 1

| E-TFCI | TB Size (bits) | E-TFCI | TB Size (bits) | E-TFCI | TB Size (bits) |
|--------|----------------|--------|----------------|--------|----------------|
| 0 | 18 | 43 | 2724 | 86 | 7252 |
| 1 | 186 | 44 | 2742 | 87 | 7288 |
| 2 | 204 | 45 | 3042 | 88 | 7428 |
| 3 | 354 | 46 | 3060 | 89 | 7464 |

| | | | | | |
|----|------|----|------|-----|-------|
| 4 | 372 | 47 | 3078 | 90 | 7764 |
| 5 | 522 | 48 | 3298 | 91 | 7800 |
| 6 | 540 | 49 | 3316 | 92 | 7908 |
| 7 | 674 | 50 | 3334 | 93 | 7944 |
| 8 | 690 | 51 | 3378 | 94 | 8100 |
| 9 | 708 | 52 | 3396 | 95 | 8136 |
| 10 | 726 | 53 | 3414 | 96 | 8436 |
| 11 | 858 | 54 | 3732 | 97 | 8472 |
| 12 | 876 | 55 | 3750 | 98 | 8564 |
| 13 | 1026 | 56 | 3972 | 99 | 8600 |
| 14 | 1044 | 57 | 3990 | 100 | 8772 |
| 15 | 1062 | 58 | 4068 | 101 | 8808 |
| 16 | 1194 | 59 | 4086 | 102 | 9108 |
| 17 | 1212 | 60 | 4404 | 103 | 9144 |
| 18 | 1330 | 61 | 4422 | 104 | 9220 |
| 19 | 1348 | 62 | 4628 | 105 | 9256 |
| 20 | 1362 | 63 | 4646 | 106 | 9444 |
| 21 | 1380 | 64 | 4740 | 107 | 9480 |
| 22 | 1398 | 65 | 4758 | 108 | 9780 |
| 23 | 1530 | 66 | 5076 | 109 | 9816 |
| 24 | 1548 | 67 | 5094 | 110 | 9876 |
| 25 | 1698 | 68 | 5284 | 111 | 9912 |
| 26 | 1716 | 69 | 5302 | 112 | 10116 |
| 27 | 1734 | 70 | 5412 | 113 | 10152 |
| 28 | 1866 | 71 | 5430 | 114 | 10452 |
| 29 | 1884 | 72 | 5748 | 115 | 10488 |
| 30 | 1986 | 73 | 5766 | 116 | 10532 |
| 31 | 2004 | 74 | 5940 | 117 | 10568 |
| 32 | 2022 | 75 | 5958 | 118 | 10788 |
| 33 | 2034 | 76 | 6084 | 119 | 10824 |
| 34 | 2052 | 77 | 6102 | 120 | 11124 |
| 35 | 2070 | 78 | 6420 | 121 | 11178 |
| 36 | 2370 | 79 | 6438 | 122 | 11188 |
| 37 | 2388 | 80 | 6596 | 123 | 11242 |
| 38 | 2406 | 81 | 6614 | 124 | 11460 |
| 39 | 2642 | 82 | 6756 | 125 | 11478 |
| 40 | 2660 | 83 | 6774 | | |
| 41 | 2678 | 84 | 7092 | | |
| 42 | 2706 | 85 | 7110 | | |

B.2a 2ms TTI E-DCH Transport Block Size Table 2

| E-TFCI | TB Size (bits) | E-TFCI | TB Size (bits) | E-TFCI | TB Size (bits) | E-TFCI | TB Size (bits) | E-TFCI | TB Size (bits) |
|--------|----------------|--------|----------------|--------|----------------|--------|----------------|--------|----------------|
| 0 | 18 | 30 | 402 | 60 | 1405 | 90 | 4913 | 120 | 17173 |
| 1 | 120 | 31 | 419 | 61 | 1465 | 91 | 5122 | 121 | 17904 |
| 2 | 125 | 32 | 437 | 62 | 1528 | 92 | 5341 | 122 | 18667 |
| 3 | 130 | 33 | 455 | 63 | 1593 | 93 | 5568 | 123 | 19462 |
| 4 | 135 | 34 | 475 | 64 | 1661 | 94 | 5805 | 124 | 20291 |
| 5 | 141 | 35 | 495 | 65 | 1731 | 95 | 6053 | 125 | 21155 |
| 6 | 147 | 36 | 516 | 66 | 1805 | 96 | 6310 | 126 | 22056 |
| 7 | 154 | 37 | 538 | 67 | 1882 | 97 | 6579 | 127 | 22995 |
| 8 | 160 | 38 | 561 | 68 | 1962 | 98 | 6859 | | |
| 9 | 167 | 39 | 585 | 69 | 2046 | 99 | 7152 | | |
| 10 | 174 | 40 | 610 | 70 | 2133 | 100 | 7456 | | |

| | | | | | | | |
|----|-----|----|------|----|------|-----|-------|
| 11 | 182 | 41 | 636 | 71 | 2224 | 101 | 7774 |
| 12 | 189 | 42 | 663 | 72 | 2319 | 102 | 8105 |
| 13 | 197 | 43 | 691 | 73 | 2417 | 103 | 8450 |
| 14 | 206 | 44 | 721 | 74 | 2520 | 104 | 8810 |
| 15 | 215 | 45 | 752 | 75 | 2628 | 105 | 9185 |
| 16 | 224 | 46 | 784 | 76 | 2740 | 106 | 9577 |
| 17 | 233 | 47 | 817 | 77 | 2856 | 107 | 9985 |
| 18 | 243 | 48 | 852 | 78 | 2978 | 108 | 10410 |
| 19 | 254 | 49 | 888 | 79 | 3105 | 109 | 10853 |
| 20 | 265 | 50 | 926 | 80 | 3237 | 110 | 11316 |
| 21 | 276 | 51 | 965 | 81 | 3375 | 111 | 11798 |
| 22 | 288 | 52 | 1007 | 82 | 3519 | 112 | 12300 |
| 23 | 300 | 53 | 1049 | 83 | 3669 | 113 | 12824 |
| 24 | 313 | 54 | 1094 | 84 | 3825 | 114 | 13370 |
| 25 | 326 | 55 | 1141 | 85 | 3988 | 115 | 13940 |
| 26 | 340 | 56 | 1189 | 86 | 4158 | 116 | 14534 |
| 27 | 354 | 57 | 1240 | 87 | 4335 | 117 | 15153 |
| 28 | 370 | 58 | 1293 | 88 | 4520 | 118 | 15798 |
| 29 | 385 | 59 | 1348 | 89 | 4712 | 119 | 16471 |

B.2b 2ms TTI E-DCH Transport Block Size Table 3

| E-TFCI | TB Size (bits) | E-TFCI | TB Size (bits) | E-TFCI | TB Size (bits) | E-TFCI | TB Size (bits) | E-TFCI | TB Size (bits) |
|--------|----------------|--------|----------------|--------|----------------|--------|----------------|--------|----------------|
| 0 | 18 | 30 | 1902 | 60 | 6614 | 90 | 14184 | 120 | 21966 |
| 1 | 186 | 31 | 1986 | 61 | 6774 | 91 | 14538 | 121 | 22302 |
| 2 | 204 | 32 | 2004 | 62 | 7110 | 92 | 14874 | 122 | 22430 |
| 3 | 354 | 33 | 2034 | 63 | 7270 | 93 | 15210 | 123 | 22638 |
| 4 | 372 | 34 | 2052 | 64 | 7446 | 94 | 15546 | 124 | 22996 |
| 5 | 522 | 35 | 2370 | 65 | 7782 | 95 | 15882 | | |
| 6 | 540 | 36 | 2388 | 66 | 7926 | 96 | 16218 | | |
| 7 | 558 | 37 | 2642 | 67 | 8118 | 97 | 16554 | | |
| 8 | 674 | 38 | 2660 | 68 | 8454 | 98 | 16890 | | |
| 9 | 692 | 39 | 2706 | 69 | 8582 | 99 | 17226 | | |
| 10 | 708 | 40 | 2724 | 70 | 8790 | 100 | 17562 | | |
| 11 | 858 | 41 | 3042 | 71 | 9126 | 101 | 17802 | | |
| 12 | 876 | 42 | 3060 | 72 | 9238 | 102 | 17898 | | |
| 13 | 894 | 43 | 3298 | 73 | 9462 | 103 | 18252 | | |
| 14 | 1026 | 44 | 3316 | 74 | 9798 | 104 | 18476 | | |
| 15 | 1044 | 45 | 3378 | 75 | 9894 | 105 | 18588 | | |
| 16 | 1194 | 46 | 3396 | 76 | 10134 | 106 | 18924 | | |
| 17 | 1212 | 47 | 3750 | 77 | 10470 | 107 | 19132 | | |
| 18 | 1230 | 48 | 3990 | 78 | 10550 | 108 | 19260 | | |
| 19 | 1330 | 49 | 4086 | 79 | 10806 | 109 | 19596 | | |
| 20 | 1348 | 50 | 4422 | 80 | 11160 | 110 | 19788 | | |
| 21 | 1362 | 51 | 4646 | 81 | 11224 | 111 | 19932 | | |
| 22 | 1380 | 52 | 4758 | 82 | 11496 | 112 | 20268 | | |
| 23 | 1530 | 53 | 5094 | 83 | 11880 | 113 | 20444 | | |
| 24 | 1548 | 54 | 5302 | 84 | 12168 | 114 | 20604 | | |
| 25 | 1566 | 55 | 5430 | 85 | 12536 | 115 | 20940 | | |
| 26 | 1698 | 56 | 5766 | 86 | 12840 | 116 | 21100 | | |
| 27 | 1716 | 57 | 5958 | 87 | 13192 | 117 | 21276 | | |
| 28 | 1866 | 58 | 6102 | 88 | 13512 | 118 | 21612 | | |
| 29 | 1884 | 59 | 6438 | 89 | 13848 | 119 | 21774 | | |

B.3 10ms TTI E-DCH Transport Block Size Table 0

| E-TFCI | TB Size (bits) | E-TFCI | TB Size (bits) | E-TFCI | TB Size (bits) | E-TFCI | TB Size (bits) | E-TFCI | TB Size (bits) |
|--------|----------------|--------|----------------|--------|----------------|--------|----------------|--------|----------------|
| 0 | 18 | 30 | 389 | 60 | 1316 | 90 | 4452 | 120 | 15051 |
| 1 | 120 | 31 | 405 | 61 | 1371 | 91 | 4636 | 121 | 15675 |
| 2 | 124 | 32 | 422 | 62 | 1428 | 92 | 4828 | 122 | 16325 |
| 3 | 130 | 33 | 440 | 63 | 1487 | 93 | 5029 | 123 | 17001 |
| 4 | 135 | 34 | 458 | 64 | 1549 | 94 | 5237 | 124 | 17706 |
| 5 | 141 | 35 | 477 | 65 | 1613 | 95 | 5454 | 125 | 18440 |
| 6 | 147 | 36 | 497 | 66 | 1680 | 96 | 5680 | 126 | 19204 |
| 7 | 153 | 37 | 517 | 67 | 1749 | 97 | 5915 | 127 | 20000 |
| 8 | 159 | 38 | 539 | 68 | 1822 | 98 | 6161 | | |
| 9 | 166 | 39 | 561 | 69 | 1897 | 99 | 6416 | | |
| 10 | 172 | 40 | 584 | 70 | 1976 | 100 | 6682 | | |
| 11 | 180 | 41 | 608 | 71 | 2058 | 101 | 6959 | | |
| 12 | 187 | 42 | 634 | 72 | 2143 | 102 | 7247 | | |
| 13 | 195 | 43 | 660 | 73 | 2232 | 103 | 7547 | | |
| 14 | 203 | 44 | 687 | 74 | 2325 | 104 | 7860 | | |
| 15 | 211 | 45 | 716 | 75 | 2421 | 105 | 8186 | | |
| 16 | 220 | 46 | 745 | 76 | 2521 | 106 | 8525 | | |
| 17 | 229 | 47 | 776 | 77 | 2626 | 107 | 8878 | | |
| 18 | 239 | 48 | 809 | 78 | 2735 | 108 | 9246 | | |
| 19 | 249 | 49 | 842 | 79 | 2848 | 109 | 9629 | | |
| 20 | 259 | 50 | 877 | 80 | 2966 | 110 | 10028 | | |
| 21 | 270 | 51 | 913 | 81 | 3089 | 111 | 10444 | | |
| 22 | 281 | 52 | 951 | 82 | 3217 | 112 | 10877 | | |
| 23 | 293 | 53 | 991 | 83 | 3350 | 113 | 11328 | | |
| 24 | 305 | 54 | 1032 | 84 | 3489 | 114 | 11797 | | |
| 25 | 317 | 55 | 1074 | 85 | 3634 | 115 | 12286 | | |
| 26 | 331 | 56 | 1119 | 86 | 3784 | 116 | 12795 | | |
| 27 | 344 | 57 | 1165 | 87 | 3941 | 117 | 13325 | | |
| 28 | 359 | 58 | 1214 | 88 | 4105 | 118 | 13877 | | |
| 29 | 374 | 59 | 1264 | 89 | 4275 | 119 | 14453 | | |

B.4 10ms TTI E-DCH Transport Block Size Table 1

| E-TFCI | TB Size (bits) | E-TFCI | TB Size (bits) | E-TFCI | TB Size (bits) |
|--------|----------------|--------|----------------|--------|----------------|
| 0 | 18 | 41 | 5076 | 82 | 11850 |
| 1 | 186 | 42 | 5094 | 83 | 12132 |
| 2 | 204 | 43 | 5412 | 84 | 12186 |
| 3 | 354 | 44 | 5430 | 85 | 12468 |
| 4 | 372 | 45 | 5748 | 86 | 12522 |
| 5 | 522 | 46 | 5766 | 87 | 12804 |
| 6 | 540 | 47 | 6084 | 88 | 12858 |
| 7 | 690 | 48 | 6102 | 89 | 13140 |
| 8 | 708 | 49 | 6420 | 90 | 13194 |
| 9 | 858 | 50 | 6438 | 91 | 13476 |
| 10 | 876 | 51 | 6756 | 92 | 13530 |
| 11 | 1026 | 52 | 6774 | 93 | 13812 |
| 12 | 1044 | 53 | 7092 | 94 | 13866 |
| 13 | 1194 | 54 | 7110 | 95 | 14148 |

| | | | | | |
|----|------|----|-------|-----|-------|
| 14 | 1212 | 55 | 7428 | 96 | 14202 |
| 15 | 1362 | 56 | 7464 | 97 | 14484 |
| 16 | 1380 | 57 | 7764 | 98 | 14556 |
| 17 | 1530 | 58 | 7800 | 99 | 14820 |
| 18 | 1548 | 59 | 8100 | 100 | 14892 |
| 19 | 1698 | 60 | 8136 | 101 | 15156 |
| 20 | 1716 | 61 | 8436 | 102 | 15228 |
| 21 | 1866 | 62 | 8472 | 103 | 15492 |
| 22 | 1884 | 63 | 8772 | 104 | 15564 |
| 23 | 2034 | 64 | 8808 | 105 | 15828 |
| 24 | 2052 | 65 | 9108 | 106 | 15900 |
| 25 | 2370 | 66 | 9144 | 107 | 16164 |
| 26 | 2388 | 67 | 9444 | 108 | 16236 |
| 27 | 2706 | 68 | 9480 | 109 | 16500 |
| 28 | 2724 | 69 | 9780 | 110 | 16572 |
| 29 | 3042 | 70 | 9816 | 111 | 17172 |
| 30 | 3060 | 71 | 10116 | 112 | 17244 |
| 31 | 3378 | 72 | 10152 | 113 | 17844 |
| 32 | 3396 | 73 | 10452 | 114 | 17916 |
| 33 | 3732 | 74 | 10488 | 115 | 18516 |
| 34 | 3750 | 75 | 10788 | 116 | 18606 |
| 35 | 4068 | 76 | 10824 | 117 | 19188 |
| 36 | 4086 | 77 | 11124 | 118 | 19278 |
| 37 | 4404 | 78 | 11178 | 119 | 19860 |
| 38 | 4422 | 79 | 11460 | 120 | 19950 |
| 39 | 4740 | 80 | 11514 | | |
| 40 | 4758 | 81 | 11796 | | |

Annex BA (normative): E-DCH Transport Block Size Tables for 3.84 Mcps TDD

The mapping between the chosen E-TFC index and the corresponding E-DCH transport block size is given in the following tables:

BA.1 10ms TTI E-DCH Transport Block Size Table 0

| N_{slots} | 1 | 2 | 3 | 4 | 5 | 6 | 7 | 8 | 9 | 10 | 11 | 12 |
|-------------|-----|-----|-----|------|------|------|------|------|------|------|------|------|
| K_n | 0 | 18 | 28 | 36 | 42 | 46 | 50 | 54 | 57 | 60 | 62 | 65 |
| TBS index | / | | | | | | | | | | | |
| 0 | 60 | 119 | 174 | 237 | 298 | 347 | 405 | 472 | 529 | 593 | 641 | 718 |
| 1 | 62 | 123 | 181 | 246 | 310 | 361 | 421 | 490 | 550 | 616 | 665 | 746 |
| 2 | 64 | 128 | 188 | 256 | 322 | 375 | 437 | 509 | 571 | 641 | 691 | 775 |
| 3 | 67 | 133 | 196 | 266 | 334 | 390 | 454 | 529 | 593 | 665 | 718 | 806 |
| 4 | 69 | 139 | 203 | 276 | 347 | 405 | 472 | 550 | 616 | 691 | 746 | 837 |
| 5 | 72 | 144 | 211 | 287 | 361 | 421 | 490 | 571 | 641 | 718 | 775 | 870 |
| 6 | 75 | 150 | 219 | 298 | 375 | 437 | 509 | 593 | 665 | 746 | 806 | 904 |
| 7 | 78 | 155 | 228 | 310 | 390 | 454 | 529 | 616 | 691 | 775 | 837 | 939 |
| 8 | 81 | 162 | 237 | 322 | 405 | 472 | 550 | 641 | 718 | 806 | 870 | 975 |
| 9 | 84 | 168 | 246 | 334 | 421 | 490 | 571 | 665 | 746 | 837 | 904 | 1013 |
| 10 | 87 | 174 | 256 | 347 | 437 | 509 | 593 | 691 | 775 | 870 | 939 | 1053 |
| 11 | 91 | 181 | 266 | 361 | 454 | 529 | 616 | 718 | 806 | 904 | 975 | 1094 |
| 12 | 94 | 188 | 276 | 375 | 472 | 550 | 641 | 746 | 837 | 939 | 1013 | 1136 |
| 13 | 98 | 196 | 287 | 390 | 490 | 571 | 665 | 775 | 870 | 975 | 1053 | 1181 |
| 14 | 102 | 203 | 298 | 405 | 509 | 593 | 691 | 806 | 904 | 1013 | 1094 | 1227 |
| 15 | 106 | 211 | 310 | 421 | 529 | 616 | 718 | 837 | 939 | 1053 | 1136 | 1275 |
| 16 | 110 | 219 | 322 | 437 | 550 | 641 | 746 | 870 | 975 | 1094 | 1181 | 1324 |
| 17 | 114 | 228 | 334 | 454 | 571 | 665 | 775 | 904 | 1013 | 1136 | 1227 | 1376 |
| 18 | 119 | 237 | 347 | 472 | 593 | 691 | 806 | 939 | 1053 | 1181 | 1275 | 1429 |
| 19 | 123 | 246 | 361 | 490 | 616 | 718 | 837 | 975 | 1094 | 1227 | 1324 | 1485 |
| 20 | 128 | 256 | 375 | 509 | 641 | 746 | 870 | 1013 | 1136 | 1275 | 1376 | 1543 |
| 21 | 133 | 266 | 390 | 529 | 665 | 775 | 904 | 1053 | 1181 | 1324 | 1429 | 1603 |
| 22 | 139 | 276 | 405 | 550 | 691 | 806 | 939 | 1094 | 1227 | 1376 | 1485 | 1665 |
| 23 | 144 | 287 | 421 | 571 | 718 | 837 | 975 | 1136 | 1275 | 1429 | 1543 | 1730 |
| 24 | 150 | 298 | 437 | 593 | 746 | 870 | 1013 | 1181 | 1324 | 1485 | 1603 | 1798 |
| 25 | 155 | 310 | 454 | 616 | 775 | 904 | 1053 | 1227 | 1376 | 1543 | 1665 | 1868 |
| 26 | 162 | 322 | 472 | 641 | 806 | 939 | 1094 | 1275 | 1429 | 1603 | 1730 | 1941 |
| 27 | 168 | 334 | 490 | 665 | 837 | 975 | 1136 | 1324 | 1485 | 1665 | 1798 | 2016 |
| 28 | 174 | 347 | 509 | 691 | 870 | 1013 | 1181 | 1376 | 1543 | 1730 | 1868 | 2095 |
| 29 | 181 | 361 | 529 | 718 | 904 | 1053 | 1227 | 1429 | 1603 | 1798 | 1941 | 2176 |
| 30 | 188 | 375 | 550 | 746 | 939 | 1094 | 1275 | 1485 | 1665 | 1868 | 2016 | 2261 |
| 31 | 196 | 390 | 571 | 775 | 975 | 1136 | 1324 | 1543 | 1730 | 1941 | 2095 | 2349 |
| 32 | 203 | 405 | 593 | 806 | 1013 | 1181 | 1376 | 1603 | 1798 | 2016 | 2176 | 2441 |
| 33 | 211 | 421 | 616 | 837 | 1053 | 1227 | 1429 | 1665 | 1868 | 2095 | 2261 | 2536 |
| 34 | 219 | 437 | 641 | 870 | 1094 | 1275 | 1485 | 1730 | 1941 | 2176 | 2349 | 2634 |
| 35 | 228 | 454 | 665 | 904 | 1136 | 1324 | 1543 | 1798 | 2016 | 2261 | 2441 | 2737 |
| 36 | 237 | 472 | 691 | 939 | 1181 | 1376 | 1603 | 1868 | 2095 | 2349 | 2536 | 2844 |
| 37 | 246 | 490 | 718 | 975 | 1227 | 1429 | 1665 | 1941 | 2176 | 2441 | 2634 | 2954 |
| 38 | 256 | 509 | 746 | 1013 | 1275 | 1485 | 1730 | 2016 | 2261 | 2536 | 2737 | 3070 |
| 39 | 266 | 529 | 775 | 1053 | 1324 | 1543 | 1798 | 2095 | 2349 | 2634 | 2844 | 3189 |

| | | | | | | | | | | | | |
|----|------|------|------|------|-------|-------|-------|-------|-------|-------|-------|-------|
| 40 | 276 | 550 | 806 | 1094 | 1376 | 1603 | 1868 | 2176 | 2441 | 2737 | 2954 | 3313 |
| 41 | 287 | 571 | 837 | 1136 | 1429 | 1665 | 1941 | 2261 | 2536 | 2844 | 3070 | 3442 |
| 42 | 298 | 593 | 870 | 1181 | 1485 | 1730 | 2016 | 2349 | 2634 | 2954 | 3189 | 3576 |
| 43 | 310 | 616 | 904 | 1227 | 1543 | 1798 | 2095 | 2441 | 2737 | 3070 | 3313 | 3716 |
| 44 | 322 | 641 | 939 | 1275 | 1603 | 1868 | 2176 | 2536 | 2844 | 3189 | 3442 | 3861 |
| 45 | 334 | 665 | 975 | 1324 | 1665 | 1941 | 2261 | 2634 | 2954 | 3313 | 3576 | 4011 |
| 46 | 347 | 691 | 1013 | 1376 | 1730 | 2016 | 2349 | 2737 | 3070 | 3442 | 3716 | 4167 |
| 47 | 361 | 718 | 1053 | 1429 | 1798 | 2095 | 2441 | 2844 | 3189 | 3576 | 3861 | 4329 |
| 48 | 375 | 746 | 1094 | 1485 | 1868 | 2176 | 2536 | 2954 | 3313 | 3716 | 4011 | 4498 |
| 49 | 390 | 775 | 1136 | 1543 | 1941 | 2261 | 2634 | 3070 | 3442 | 3861 | 4167 | 4673 |
| 50 | 405 | 806 | 1181 | 1603 | 2016 | 2349 | 2737 | 3189 | 3576 | 4011 | 4329 | 4855 |
| 51 | 421 | 837 | 1227 | 1665 | 2095 | 2441 | 2844 | 3313 | 3716 | 4167 | 4498 | 5044 |
| 52 | 437 | 870 | 1275 | 1730 | 2176 | 2536 | 2954 | 3442 | 3861 | 4329 | 4673 | 5241 |
| 53 | 454 | 904 | 1324 | 1798 | 2261 | 2634 | 3070 | 3576 | 4011 | 4498 | 4855 | 5445 |
| 54 | 472 | 939 | 1376 | 1868 | 2349 | 2737 | 3189 | 3716 | 4167 | 4673 | 5044 | 5657 |
| 55 | 490 | 975 | 1429 | 1941 | 2441 | 2844 | 3313 | 3861 | 4329 | 4855 | 5241 | 5877 |
| 56 | 509 | 1013 | 1485 | 2016 | 2536 | 2954 | 3442 | 4011 | 4498 | 5044 | 5445 | 6106 |
| 57 | 529 | 1053 | 1543 | 2095 | 2634 | 3070 | 3576 | 4167 | 4673 | 5241 | 5657 | 6344 |
| 58 | 550 | 1094 | 1603 | 2176 | 2737 | 3189 | 3716 | 4329 | 4855 | 5445 | 5877 | 6591 |
| 59 | 571 | 1136 | 1665 | 2261 | 2844 | 3313 | 3861 | 4498 | 5044 | 5657 | 6106 | 6848 |
| 60 | 593 | 1181 | 1730 | 2349 | 2954 | 3442 | 4011 | 4673 | 5241 | 5877 | 6344 | 7115 |
| 61 | 616 | 1227 | 1798 | 2441 | 3070 | 3576 | 4167 | 4855 | 5445 | 6106 | 6591 | 7392 |
| 62 | 641 | 1275 | 1868 | 2536 | 3189 | 3716 | 4329 | 5044 | 5657 | 6344 | 6848 | 7680 |
| 63 | 665 | 1324 | 1941 | 2634 | 3313 | 3861 | 4498 | 5241 | 5877 | 6591 | 7115 | 7979 |
| 64 | 691 | 1376 | 2016 | 2737 | 3442 | 4011 | 4673 | 5445 | 6106 | 6848 | 7392 | 8289 |
| 65 | 718 | 1429 | 2095 | 2844 | 3576 | 4167 | 4855 | 5657 | 6344 | 7115 | 7680 | 8612 |
| 66 | 746 | 1485 | 2176 | 2954 | 3716 | 4329 | 5044 | 5877 | 6591 | 7392 | 7979 | 8948 |
| 67 | 775 | 1543 | 2261 | 3070 | 3861 | 4498 | 5241 | 6106 | 6848 | 7680 | 8289 | 9296 |
| 68 | 806 | 1603 | 2349 | 3189 | 4011 | 4673 | 5445 | 6344 | 7115 | 7979 | 8612 | 9658 |
| 69 | 837 | 1665 | 2441 | 3313 | 4167 | 4855 | 5657 | 6591 | 7392 | 8289 | 8948 | 10034 |
| 70 | 870 | 1730 | 2536 | 3442 | 4329 | 5044 | 5877 | 6848 | 7680 | 8612 | 9296 | 10425 |
| 71 | 904 | 1798 | 2634 | 3576 | 4498 | 5241 | 6106 | 7115 | 7979 | 8948 | 9658 | 10831 |
| 72 | 939 | 1868 | 2737 | 3716 | 4673 | 5445 | 6344 | 7392 | 8289 | 9296 | 10034 | 11253 |
| 73 | 975 | 1941 | 2844 | 3861 | 4855 | 5657 | 6591 | 7680 | 8612 | 9658 | 10425 | 11691 |
| 74 | 1013 | 2016 | 2954 | 4011 | 5044 | 5877 | 6848 | 7979 | 8948 | 10034 | 10831 | 12146 |
| 75 | 1053 | 2095 | 3070 | 4167 | 5241 | 6106 | 7115 | 8289 | 9296 | 10425 | 11253 | 12620 |
| 76 | 1094 | 2176 | 3189 | 4329 | 5445 | 6344 | 7392 | 8612 | 9658 | 10831 | 11691 | 13111 |
| 77 | 1136 | 2261 | 3313 | 4498 | 5657 | 6591 | 7680 | 8948 | 10034 | 11253 | 12146 | 13622 |
| 78 | 1181 | 2349 | 3442 | 4673 | 5877 | 6848 | 7979 | 9296 | 10425 | 11691 | 12620 | 14152 |
| 79 | 1227 | 2441 | 3576 | 4855 | 6106 | 7115 | 8289 | 9658 | 10831 | 12146 | 13111 | 14703 |
| 80 | 1275 | 2536 | 3716 | 5044 | 6344 | 7392 | 8612 | 10034 | 11253 | 12620 | 13622 | 15276 |
| 81 | 1324 | 2634 | 3861 | 5241 | 6591 | 7680 | 8948 | 10425 | 11691 | 13111 | 14152 | 15871 |
| 82 | 1376 | 2737 | 4011 | 5445 | 6848 | 7979 | 9296 | 10831 | 12146 | 13622 | 14703 | 16489 |
| 83 | 1429 | 2844 | 4167 | 5657 | 7115 | 8289 | 9658 | 11253 | 12620 | 14152 | 15276 | 17131 |
| 84 | 1485 | 2954 | 4329 | 5877 | 7392 | 8612 | 10034 | 11691 | 13111 | 14703 | 15871 | 17798 |
| 85 | 1543 | 3070 | 4498 | 6106 | 7680 | 8948 | 10425 | 12146 | 13622 | 15276 | 16489 | 18491 |
| 86 | 1603 | 3189 | 4673 | 6344 | 7979 | 9296 | 10831 | 12620 | 14152 | 15871 | 17131 | 19212 |
| 87 | 1665 | 3313 | 4855 | 6591 | 8289 | 9658 | 11253 | 13111 | 14703 | 16489 | 17798 | 19960 |
| 88 | 1730 | 3442 | 5044 | 6848 | 8612 | 10034 | 11691 | 13622 | 15276 | 17131 | 18491 | 20737 |
| 89 | 1798 | 3576 | 5241 | 7115 | 8948 | 10425 | 12146 | 14152 | 15871 | 17798 | 19212 | 21545 |
| 90 | 1868 | 3716 | 5445 | 7392 | 9296 | 10831 | 12620 | 14703 | 16489 | 18491 | 19960 | 22384 |
| 91 | 1941 | 3861 | 5657 | 7680 | 9658 | 11253 | 13111 | 15276 | 17131 | 19212 | 20737 | 23256 |
| 92 | 2016 | 4011 | 5877 | 7979 | 10034 | 11691 | 13622 | 15871 | 17798 | 19960 | 21545 | 24161 |

| | | | | | | | | | | | | |
|-----|------|-------|-------|-------|-------|-------|-------|-------|-------|-------|-------|-------|
| 93 | 2095 | 4167 | 6106 | 8289 | 10425 | 12146 | 14152 | 16489 | 18491 | 20737 | 22384 | 25102 |
| 94 | 2176 | 4329 | 6344 | 8612 | 10831 | 12620 | 14703 | 17131 | 19212 | 21545 | 23256 | 26080 |
| 95 | 2261 | 4498 | 6591 | 8948 | 11253 | 13111 | 15276 | 17798 | 19960 | 22384 | 24161 | 27095 |
| 96 | 2349 | 4673 | 6848 | 9296 | 11691 | 13622 | 15871 | 18491 | 20737 | 23256 | 25102 | 28151 |
| 97 | 2441 | 4855 | 7115 | 9658 | 12146 | 14152 | 16489 | 19212 | 21545 | 24161 | 26080 | 29247 |
| 98 | 2536 | 5044 | 7392 | 10034 | 12620 | 14703 | 17131 | 19960 | 22384 | 25102 | 27095 | 30386 |
| 99 | 2634 | 5241 | 7680 | 10425 | 13111 | 15276 | 17798 | 20737 | 23256 | 26080 | 28151 | 31569 |
| 100 | 2737 | 5445 | 7979 | 10831 | 13622 | 15871 | 18491 | 21545 | 24161 | 27095 | 29247 | 32799 |
| 101 | 2844 | 5657 | 8289 | 11253 | 14152 | 16489 | 19212 | 22384 | 25102 | 28151 | 30386 | 34076 |
| 102 | 2954 | 5877 | 8612 | 11691 | 14703 | 17131 | 19960 | 23256 | 26080 | 29247 | 31569 | 35403 |
| 103 | 3070 | 6106 | 8948 | 12146 | 15276 | 17798 | 20737 | 24161 | 27095 | 30386 | 32799 | 36782 |
| 104 | 3189 | 6344 | 9296 | 12620 | 15871 | 18491 | 21545 | 25102 | 28151 | 31569 | 34076 | 38214 |
| 105 | 3313 | 6591 | 9658 | 13111 | 16489 | 19212 | 22384 | 26080 | 29247 | 32799 | 35403 | 39703 |
| 106 | 3442 | 6848 | 10034 | 13622 | 17131 | 19960 | 23256 | 27095 | 30386 | 34076 | 36782 | 41249 |
| 107 | 3576 | 7115 | 10425 | 14152 | 17798 | 20737 | 24161 | 28151 | 31569 | 35403 | 38214 | 42855 |
| 108 | 3716 | 7392 | 10831 | 14703 | 18491 | 21545 | 25102 | 29247 | 32799 | 36782 | 39703 | 44524 |
| 109 | 3861 | 7680 | 11253 | 15276 | 19212 | 22384 | 26080 | 30386 | 34076 | 38214 | 41249 | 46258 |
| 110 | 4011 | 7979 | 11691 | 15871 | 19960 | 23256 | 27095 | 31569 | 35403 | 39703 | 42855 | 48060 |
| 111 | 4167 | 8289 | 12146 | 16489 | 20737 | 24161 | 28151 | 32799 | 36782 | 41249 | 44524 | 49932 |
| 112 | 4329 | 8612 | 12620 | 17131 | 21545 | 25102 | 29247 | 34076 | 38214 | 42855 | 46258 | 51876 |
| 113 | 4498 | 8948 | 13111 | 17798 | 22384 | 26080 | 30386 | 35403 | 39703 | 44524 | 48060 | 53896 |
| 114 | 4673 | 9296 | 13622 | 18491 | 23256 | 27095 | 31569 | 36782 | 41249 | 46258 | 49932 | 55995 |
| 115 | 4855 | 9658 | 14152 | 19212 | 24161 | 28151 | 32799 | 38214 | 42855 | 48060 | 51876 | 58176 |
| 116 | 5044 | 10034 | 14703 | 19960 | 25102 | 29247 | 34076 | 39703 | 44524 | 49932 | 53896 | 60442 |
| 117 | 5241 | 10425 | 15276 | 20737 | 26080 | 30386 | 35403 | 41249 | 46258 | 51876 | 55995 | 62796 |
| 118 | 5445 | 10831 | 15871 | 21545 | 27095 | 31569 | 36782 | 42855 | 48060 | 53896 | 58176 | 65241 |
| 119 | 5657 | 11253 | 16489 | 22384 | 28151 | 32799 | 38214 | 44524 | 49932 | 55995 | 60442 | 67782 |
| 120 | 5877 | 11691 | 17131 | 23256 | 29247 | 34076 | 39703 | 46258 | 51876 | 58176 | 62796 | 70422 |
| 121 | 6106 | 12146 | 17798 | 24161 | 30386 | 35403 | 41249 | 48060 | 53896 | 60442 | 65241 | 73164 |
| 122 | 6344 | 12620 | 18491 | 25102 | 31569 | 36782 | 42855 | 49932 | 55995 | 62796 | 67782 | 76013 |
| 123 | 6591 | 13111 | 19212 | 26080 | 32799 | 38214 | 44524 | 51876 | 58176 | 65241 | 70422 | 78974 |
| 124 | 6848 | 13622 | 19960 | 27095 | 34076 | 39703 | 46258 | 53896 | 60442 | 67782 | 73164 | 82049 |
| 125 | 7115 | 14152 | 20737 | 28151 | 35403 | 41249 | 48060 | 55995 | 62796 | 70422 | 76013 | 85245 |
| 126 | 7392 | 14703 | 21545 | 29247 | 36782 | 42855 | 49932 | 58176 | 65241 | 73164 | 78974 | 88565 |
| 127 | 7680 | 15276 | 22384 | 30386 | 38214 | 44524 | 51876 | 60442 | 67782 | 76013 | 82049 | 92014 |

Annex BB (normative): E-DCH Transport Block Size Tables for 7.68 Mcps TDD

The mapping between the chosen E-TFC index and the corresponding E-DCH transport block size is given in the following tables:

BB.1 10ms TTI E-DCH Transport Block Size Table 0

| Nslots | 1 | 2 | 3 | 4 | 5 | 6 | 7 | 8 | 9 | 10 | 11 | 12 |
|-----------|-----|-----|-----|------|------|------|------|------|------|------|------|------|
| kn | 0 | 15 | 25 | 31 | 36 | 41 | 44 | 47 | 50 | 52 | 54 | 56 |
| TBS index | | | | | | | | | | | | |
| 0 | 60 | 115 | 178 | 232 | 288 | 359 | 409 | 467 | 532 | 581 | 634 | 691 |
| 1 | 62 | 120 | 186 | 242 | 301 | 375 | 428 | 487 | 556 | 606 | 662 | 722 |
| 2 | 65 | 126 | 195 | 253 | 315 | 392 | 447 | 509 | 581 | 634 | 691 | 755 |
| 3 | 68 | 131 | 203 | 264 | 329 | 409 | 467 | 532 | 606 | 662 | 722 | 788 |
| 4 | 71 | 137 | 212 | 276 | 344 | 428 | 487 | 556 | 634 | 691 | 755 | 823 |
| 5 | 74 | 143 | 222 | 288 | 359 | 447 | 509 | 581 | 662 | 722 | 788 | 860 |
| 6 | 77 | 150 | 232 | 301 | 375 | 467 | 532 | 606 | 691 | 755 | 823 | 899 |
| 7 | 81 | 156 | 242 | 315 | 392 | 487 | 556 | 634 | 722 | 788 | 860 | 939 |
| 8 | 85 | 163 | 253 | 329 | 409 | 509 | 581 | 662 | 755 | 823 | 899 | 981 |
| 9 | 88 | 171 | 264 | 344 | 428 | 532 | 606 | 691 | 788 | 860 | 939 | 1024 |
| 10 | 92 | 178 | 276 | 359 | 447 | 556 | 634 | 722 | 823 | 899 | 981 | 1070 |
| 11 | 96 | 186 | 288 | 375 | 467 | 581 | 662 | 755 | 860 | 939 | 1024 | 1118 |
| 12 | 101 | 195 | 301 | 392 | 487 | 606 | 691 | 788 | 899 | 981 | 1070 | 1168 |
| 13 | 105 | 203 | 315 | 409 | 509 | 634 | 722 | 823 | 939 | 1024 | 1118 | 1220 |
| 14 | 110 | 212 | 329 | 428 | 532 | 662 | 755 | 860 | 981 | 1070 | 1168 | 1275 |
| 15 | 115 | 222 | 344 | 447 | 556 | 691 | 788 | 899 | 1024 | 1118 | 1220 | 1331 |
| 16 | 120 | 232 | 359 | 467 | 581 | 722 | 823 | 939 | 1070 | 1168 | 1275 | 1391 |
| 17 | 126 | 242 | 375 | 487 | 606 | 755 | 860 | 981 | 1118 | 1220 | 1331 | 1453 |
| 18 | 131 | 253 | 392 | 509 | 634 | 788 | 899 | 1024 | 1168 | 1275 | 1391 | 1518 |
| 19 | 137 | 264 | 409 | 532 | 662 | 823 | 939 | 1070 | 1220 | 1331 | 1453 | 1586 |
| 20 | 143 | 276 | 428 | 556 | 691 | 860 | 981 | 1118 | 1275 | 1391 | 1518 | 1656 |
| 21 | 150 | 288 | 447 | 581 | 722 | 899 | 1024 | 1168 | 1331 | 1453 | 1586 | 1730 |
| 22 | 156 | 301 | 467 | 606 | 755 | 939 | 1070 | 1220 | 1391 | 1518 | 1656 | 1808 |
| 23 | 163 | 315 | 487 | 634 | 788 | 981 | 1118 | 1275 | 1453 | 1586 | 1730 | 1888 |
| 24 | 171 | 329 | 509 | 662 | 823 | 1024 | 1168 | 1331 | 1518 | 1656 | 1808 | 1973 |
| 25 | 178 | 344 | 532 | 691 | 860 | 1070 | 1220 | 1391 | 1586 | 1730 | 1888 | 2061 |
| 26 | 186 | 359 | 556 | 722 | 899 | 1118 | 1275 | 1453 | 1656 | 1808 | 1973 | 2153 |
| 27 | 195 | 375 | 581 | 755 | 939 | 1168 | 1331 | 1518 | 1730 | 1888 | 2061 | 2249 |
| 28 | 203 | 392 | 606 | 788 | 981 | 1220 | 1391 | 1586 | 1808 | 1973 | 2153 | 2349 |
| 29 | 212 | 409 | 634 | 823 | 1024 | 1275 | 1453 | 1656 | 1888 | 2061 | 2249 | 2454 |
| 30 | 222 | 428 | 662 | 860 | 1070 | 1331 | 1518 | 1730 | 1973 | 2153 | 2349 | 2564 |
| 31 | 232 | 447 | 691 | 899 | 1118 | 1391 | 1586 | 1808 | 2061 | 2249 | 2454 | 2678 |
| 32 | 242 | 467 | 722 | 939 | 1168 | 1453 | 1656 | 1888 | 2153 | 2349 | 2564 | 2798 |
| 33 | 253 | 487 | 755 | 981 | 1220 | 1518 | 1730 | 1973 | 2249 | 2454 | 2678 | 2922 |
| 34 | 264 | 509 | 788 | 1024 | 1275 | 1586 | 1808 | 2061 | 2349 | 2564 | 2798 | 3053 |
| 35 | 276 | 532 | 823 | 1070 | 1331 | 1656 | 1888 | 2153 | 2454 | 2678 | 2922 | 3189 |
| 36 | 288 | 556 | 860 | 1118 | 1391 | 1730 | 1973 | 2249 | 2564 | 2798 | 3053 | 3331 |
| 37 | 301 | 581 | 899 | 1168 | 1453 | 1808 | 2061 | 2349 | 2678 | 2922 | 3189 | 3480 |
| 38 | 315 | 606 | 939 | 1220 | 1518 | 1888 | 2153 | 2454 | 2798 | 3053 | 3331 | 3636 |

| | | | | | | | | | | | | |
|----|------|------|-------|-------|-------|-------|-------|-------|-------|-------|-------|-------|
| 39 | 329 | 634 | 981 | 1275 | 1586 | 1973 | 2249 | 2564 | 2922 | 3189 | 3480 | 3798 |
| 40 | 344 | 662 | 1024 | 1331 | 1656 | 2061 | 2349 | 2678 | 3053 | 3331 | 3636 | 3967 |
| 41 | 359 | 691 | 1070 | 1391 | 1730 | 2153 | 2454 | 2798 | 3189 | 3480 | 3798 | 4144 |
| 42 | 375 | 722 | 1118 | 1453 | 1808 | 2249 | 2564 | 2922 | 3331 | 3636 | 3967 | 4329 |
| 43 | 392 | 755 | 1168 | 1518 | 1888 | 2349 | 2678 | 3053 | 3480 | 3798 | 4144 | 4523 |
| 44 | 409 | 788 | 1220 | 1586 | 1973 | 2454 | 2798 | 3189 | 3636 | 3967 | 4329 | 4725 |
| 45 | 428 | 823 | 1275 | 1656 | 2061 | 2564 | 2922 | 3331 | 3798 | 4144 | 4523 | 4935 |
| 46 | 447 | 860 | 1331 | 1730 | 2153 | 2678 | 3053 | 3480 | 3967 | 4329 | 4725 | 5156 |
| 47 | 467 | 899 | 1391 | 1808 | 2249 | 2798 | 3189 | 3636 | 4144 | 4523 | 4935 | 5386 |
| 48 | 487 | 939 | 1453 | 1888 | 2349 | 2922 | 3331 | 3798 | 4329 | 4725 | 5156 | 5626 |
| 49 | 509 | 981 | 1518 | 1973 | 2454 | 3053 | 3480 | 3967 | 4523 | 4935 | 5386 | 5877 |
| 50 | 532 | 1024 | 1586 | 2061 | 2564 | 3189 | 3636 | 4144 | 4725 | 5156 | 5626 | 6140 |
| 51 | 556 | 1070 | 1656 | 2153 | 2678 | 3331 | 3798 | 4329 | 4935 | 5386 | 5877 | 6414 |
| 52 | 581 | 1118 | 1730 | 2249 | 2798 | 3480 | 3967 | 4523 | 5156 | 5626 | 6140 | 6700 |
| 53 | 606 | 1168 | 1808 | 2349 | 2922 | 3636 | 4144 | 4725 | 5386 | 5877 | 6414 | 6999 |
| 54 | 634 | 1220 | 1888 | 2454 | 3053 | 3798 | 4329 | 4935 | 5626 | 6140 | 6700 | 7311 |
| 55 | 662 | 1275 | 1973 | 2564 | 3189 | 3967 | 4523 | 5156 | 5877 | 6414 | 6999 | 7638 |
| 56 | 691 | 1331 | 2061 | 2678 | 3331 | 4144 | 4725 | 5386 | 6140 | 6700 | 7311 | 7979 |
| 57 | 722 | 1391 | 2153 | 2798 | 3480 | 4329 | 4935 | 5626 | 6414 | 6999 | 7638 | 8335 |
| 58 | 755 | 1453 | 2249 | 2922 | 3636 | 4523 | 5156 | 5877 | 6700 | 7311 | 7979 | 8707 |
| 59 | 788 | 1518 | 2349 | 3053 | 3798 | 4725 | 5386 | 6140 | 6999 | 7638 | 8335 | 9095 |
| 60 | 823 | 1586 | 2454 | 3189 | 3967 | 4935 | 5626 | 6414 | 7311 | 7979 | 8707 | 9501 |
| 61 | 860 | 1656 | 2564 | 3331 | 4144 | 5156 | 5877 | 6700 | 7638 | 8335 | 9095 | 9925 |
| 62 | 899 | 1730 | 2678 | 3480 | 4329 | 5386 | 6140 | 6999 | 7979 | 8707 | 9501 | 10368 |
| 63 | 939 | 1808 | 2798 | 3636 | 4523 | 5626 | 6414 | 7311 | 8335 | 9095 | 9925 | 10831 |
| 64 | 981 | 1888 | 2922 | 3798 | 4725 | 5877 | 6700 | 7638 | 8707 | 9501 | 10368 | 11314 |
| 65 | 1024 | 1973 | 3053 | 3967 | 4935 | 6140 | 6999 | 7979 | 9095 | 9925 | 10831 | 11819 |
| 66 | 1070 | 2061 | 3189 | 4144 | 5156 | 6414 | 7311 | 8335 | 9501 | 10368 | 11314 | 12347 |
| 67 | 1118 | 2153 | 3331 | 4329 | 5386 | 6700 | 7638 | 8707 | 9925 | 10831 | 11819 | 12898 |
| 68 | 1168 | 2249 | 3480 | 4523 | 5626 | 6999 | 7979 | 9095 | 10368 | 11314 | 12347 | 13474 |
| 69 | 1220 | 2349 | 3636 | 4725 | 5877 | 7311 | 8335 | 9501 | 10831 | 11819 | 12898 | 14075 |
| 70 | 1275 | 2454 | 3798 | 4935 | 6140 | 7638 | 8707 | 9925 | 11314 | 12347 | 13474 | 14703 |
| 71 | 1331 | 2564 | 3967 | 5156 | 6414 | 7979 | 9095 | 10368 | 11819 | 12898 | 14075 | 15360 |
| 72 | 1391 | 2678 | 4144 | 5386 | 6700 | 8335 | 9501 | 10831 | 12347 | 13474 | 14703 | 16045 |
| 73 | 1453 | 2798 | 4329 | 5626 | 6999 | 8707 | 9925 | 11314 | 12898 | 14075 | 15360 | 16761 |
| 74 | 1518 | 2922 | 4523 | 5877 | 7311 | 9095 | 10368 | 11819 | 13474 | 14703 | 16045 | 17509 |
| 75 | 1586 | 3053 | 4725 | 6140 | 7638 | 9501 | 10831 | 12347 | 14075 | 15360 | 16761 | 18291 |
| 76 | 1656 | 3189 | 4935 | 6414 | 7979 | 9925 | 11314 | 12898 | 14703 | 16045 | 17509 | 19107 |
| 77 | 1730 | 3331 | 5156 | 6700 | 8335 | 10368 | 11819 | 13474 | 15360 | 16761 | 18291 | 19960 |
| 78 | 1808 | 3480 | 5386 | 6999 | 8707 | 10831 | 12347 | 14075 | 16045 | 17509 | 19107 | 20851 |
| 79 | 1888 | 3636 | 5626 | 7311 | 9095 | 11314 | 12898 | 14703 | 16761 | 18291 | 19960 | 21781 |
| 80 | 1973 | 3798 | 5877 | 7638 | 9501 | 11819 | 13474 | 15360 | 17509 | 19107 | 20851 | 22753 |
| 81 | 2061 | 3967 | 6140 | 7979 | 9925 | 12347 | 14075 | 16045 | 18291 | 19960 | 21781 | 23769 |
| 82 | 2153 | 4144 | 6414 | 8335 | 10368 | 12898 | 14703 | 16761 | 19107 | 20851 | 22753 | 24830 |
| 83 | 2249 | 4329 | 6700 | 8707 | 10831 | 13474 | 15360 | 17509 | 19960 | 21781 | 23769 | 25938 |
| 84 | 2349 | 4523 | 6999 | 9095 | 11314 | 14075 | 16045 | 18291 | 20851 | 22753 | 24830 | 27095 |
| 85 | 2454 | 4725 | 7311 | 9501 | 11819 | 14703 | 16761 | 19107 | 21781 | 23769 | 25938 | 28305 |
| 86 | 2564 | 4935 | 7638 | 9925 | 12347 | 15360 | 17509 | 19960 | 22753 | 24830 | 27095 | 29568 |
| 87 | 2678 | 5156 | 7979 | 10368 | 12898 | 16045 | 18291 | 20851 | 23769 | 25938 | 28305 | 30888 |
| 88 | 2798 | 5386 | 8335 | 10831 | 13474 | 16761 | 19107 | 21781 | 24830 | 27095 | 29568 | 32266 |
| 89 | 2922 | 5626 | 8707 | 11314 | 14075 | 17509 | 19960 | 22753 | 25938 | 28305 | 30888 | 33706 |
| 90 | 3053 | 5877 | 9095 | 11819 | 14703 | 18291 | 20851 | 23769 | 27095 | 29568 | 32266 | 35211 |
| 91 | 3189 | 6140 | 9501 | 12347 | 15360 | 19107 | 21781 | 24830 | 28305 | 30888 | 33706 | 36782 |
| 92 | 3331 | 6414 | 9925 | 12898 | 16045 | 19960 | 22753 | 25938 | 29568 | 32266 | 35211 | 38424 |
| 93 | 3480 | 6700 | 10368 | 13474 | 16761 | 20851 | 23769 | 27095 | 30888 | 33706 | 36782 | 40139 |

| | | | | | | | | | | | | |
|-----|-------|-------|-------|-------|-------|-------|--------|--------|--------|--------|--------|--------|
| 94 | 3636 | 6999 | 10831 | 14075 | 17509 | 21781 | 24830 | 28305 | 32266 | 35211 | 38424 | 41930 |
| 95 | 3798 | 7311 | 11314 | 14703 | 18291 | 22753 | 25938 | 29568 | 33706 | 36782 | 40139 | 43801 |
| 96 | 3967 | 7638 | 11819 | 15360 | 19107 | 23769 | 27095 | 30888 | 35211 | 38424 | 41930 | 45756 |
| 97 | 4144 | 7979 | 12347 | 16045 | 19960 | 24830 | 28305 | 32266 | 36782 | 40139 | 43801 | 47798 |
| 98 | 4329 | 8335 | 12898 | 16761 | 20851 | 25938 | 29568 | 33706 | 38424 | 41930 | 45756 | 49932 |
| 99 | 4523 | 8707 | 13474 | 17509 | 21781 | 27095 | 30888 | 35211 | 40139 | 43801 | 47798 | 52160 |
| 100 | 4725 | 9095 | 14075 | 18291 | 22753 | 28305 | 32266 | 36782 | 41930 | 45756 | 49932 | 54488 |
| 101 | 4935 | 9501 | 14703 | 19107 | 23769 | 29568 | 33706 | 38424 | 43801 | 47798 | 52160 | 56920 |
| 102 | 5156 | 9925 | 15360 | 19960 | 24830 | 30888 | 35211 | 40139 | 45756 | 49932 | 54488 | 59460 |
| 103 | 5386 | 10368 | 16045 | 20851 | 25938 | 32266 | 36782 | 41930 | 47798 | 52160 | 56920 | 62114 |
| 104 | 5626 | 10831 | 16761 | 21781 | 27095 | 33706 | 38424 | 43801 | 49932 | 54488 | 59460 | 64886 |
| 105 | 5877 | 11314 | 17509 | 22753 | 28305 | 35211 | 40139 | 45756 | 52160 | 56920 | 62114 | 67782 |
| 106 | 6140 | 11819 | 18291 | 23769 | 29568 | 36782 | 41930 | 47798 | 54488 | 59460 | 64886 | 70807 |
| 107 | 6414 | 12347 | 19107 | 24830 | 30888 | 38424 | 43801 | 49932 | 56920 | 62114 | 67782 | 73967 |
| 108 | 6700 | 12898 | 19960 | 25938 | 32266 | 40139 | 45756 | 52160 | 59460 | 64886 | 70807 | 77268 |
| 109 | 6999 | 13474 | 20851 | 27095 | 33706 | 41930 | 47798 | 54488 | 62114 | 67782 | 73967 | 80717 |
| 110 | 7311 | 14075 | 21781 | 28305 | 35211 | 43801 | 49932 | 56920 | 64886 | 70807 | 77268 | 84319 |
| 111 | 7638 | 14703 | 22753 | 29568 | 36782 | 45756 | 52160 | 59460 | 67782 | 73967 | 80717 | 88082 |
| 112 | 7979 | 15360 | 23769 | 30888 | 38424 | 47798 | 54488 | 62114 | 70807 | 77268 | 84319 | 92014 |
| 113 | 8335 | 16045 | 24830 | 32266 | 40139 | 49932 | 56920 | 64886 | 73967 | 80717 | 88082 | 96120 |
| 114 | 8707 | 16761 | 25938 | 33706 | 41930 | 52160 | 59460 | 67782 | 77268 | 84319 | 92014 | 100410 |
| 115 | 9095 | 17509 | 27095 | 35211 | 43801 | 54488 | 62114 | 70807 | 80717 | 88082 | 96120 | 104891 |
| 116 | 9501 | 18291 | 28305 | 36782 | 45756 | 56920 | 64886 | 73967 | 84319 | 92014 | 100410 | 109573 |
| 117 | 9925 | 19107 | 29568 | 38424 | 47798 | 59460 | 67782 | 77268 | 88082 | 96120 | 104891 | 114463 |
| 118 | 10368 | 19960 | 30888 | 40139 | 49932 | 62114 | 70807 | 80717 | 92014 | 100410 | 109573 | 119572 |
| 119 | 10831 | 20851 | 32266 | 41930 | 52160 | 64886 | 73967 | 84319 | 96120 | 104891 | 114463 | 124908 |
| 120 | 11314 | 21781 | 33706 | 43801 | 54488 | 67782 | 77268 | 88082 | 100410 | 109573 | 119572 | 130483 |
| 121 | 11819 | 22753 | 35211 | 45756 | 56920 | 70807 | 80717 | 92014 | 104891 | 114463 | 124908 | 136306 |
| 122 | 12347 | 23769 | 36782 | 47798 | 59460 | 73967 | 84319 | 96120 | 109573 | 119572 | 130483 | 142390 |
| 123 | 12898 | 24830 | 38424 | 49932 | 62114 | 77268 | 88082 | 100410 | 114463 | 124908 | 136306 | 148744 |
| 124 | 13474 | 25938 | 40139 | 52160 | 64886 | 80717 | 92014 | 104891 | 119572 | 130483 | 142390 | 155383 |
| 125 | 14075 | 27095 | 41930 | 54488 | 67782 | 84319 | 96120 | 109573 | 124908 | 136306 | 148744 | 162318 |
| 126 | 14703 | 28305 | 43801 | 56920 | 70807 | 88082 | 100410 | 114463 | 130483 | 142390 | 155383 | 169562 |
| 127 | 15360 | 29568 | 45756 | 59460 | 73967 | 92014 | 104891 | 119572 | 136306 | 148744 | 162318 | 177130 |

Annex BC (normative): E-DCH Transport Block Size Tables for 1.28 Mcps TDD

The mapping between the chosen E-TFC index and the corresponding E-DCH transport block size is given in the following tables:

BC.1 5ms TTI E-DCH Transport Block Size Table 0

| TB index | Category 1-2 | | | Category 3-5 | | | | |
|----------|----------------|----------------|----------------|----------------|----------------|----------------|----------------|----------------|
| | 1 Timeslot TBS | 2 Timeslot TBS | 3 Timeslot TBS | 1 Timeslot TBS | 2 Timeslot TBS | 3 Timeslot TBS | 4 Timeslot TBS | 5 Timeslot TBS |
| 0 | 23 | 23 | 23 | 23 | 23 | 23 | 23 | 23 |
| 1 | 50 | 50 | 50 | 50 | 50 | 50 | 50 | 50 |
| 2 | 51 | 51 | 51 | 51 | 51 | 52 | 52 | 52 |
| 3 | 52 | 53 | 53 | 53 | 53 | 54 | 54 | 54 |
| 4 | 54 | 55 | 55 | 54 | 55 | 56 | 56 | 56 |
| 5 | 55 | 56 | 57 | 56 | 58 | 58 | 59 | 59 |
| 6 | 56 | 58 | 59 | 58 | 60 | 61 | 61 | 61 |
| 7 | 58 | 60 | 61 | 60 | 62 | 63 | 64 | 64 |
| 8 | 60 | 62 | 63 | 62 | 64 | 66 | 67 | 67 |
| 9 | 61 | 64 | 66 | 64 | 67 | 69 | 70 | 70 |
| 10 | 63 | 66 | 68 | 66 | 69 | 72 | 73 | 73 |
| 11 | 64 | 68 | 71 | 68 | 72 | 75 | 76 | 76 |
| 12 | 66 | 70 | 73 | 70 | 75 | 78 | 80 | 80 |
| 13 | 68 | 73 | 76 | 73 | 78 | 81 | 83 | 83 |
| 14 | 70 | 75 | 78 | 75 | 81 | 84 | 87 | 87 |
| 15 | 72 | 78 | 81 | 77 | 84 | 88 | 91 | 91 |
| 16 | 73 | 80 | 84 | 80 | 87 | 91 | 95 | 95 |

| | | | | | | | | |
|----|-----|-----|-----|-----|-----|-----|-----|-----|
| 17 | 75 | 83 | 87 | 83 | 90 | 95 | 99 | 99 |
| 18 | 77 | 85 | 90 | 85 | 94 | 99 | 103 | 103 |
| 19 | 80 | 88 | 94 | 88 | 97 | 103 | 108 | 108 |
| 20 | 82 | 91 | 97 | 91 | 101 | 108 | 113 | 113 |
| 21 | 84 | 94 | 100 | 94 | 105 | 112 | 117 | 117 |
| 22 | 86 | 97 | 104 | 97 | 109 | 117 | 123 | 123 |
| 23 | 88 | 100 | 108 | 100 | 113 | 122 | 128 | 128 |
| 24 | 91 | 103 | 112 | 103 | 118 | 127 | 134 | 134 |
| 25 | 93 | 107 | 116 | 107 | 122 | 132 | 140 | 140 |
| 26 | 96 | 110 | 120 | 110 | 127 | 138 | 146 | 146 |
| 27 | 98 | 114 | 124 | 114 | 132 | 143 | 152 | 152 |
| 28 | 101 | 118 | 128 | 117 | 137 | 149 | 159 | 159 |
| 29 | 103 | 121 | 133 | 121 | 142 | 155 | 166 | 166 |
| 30 | 106 | 125 | 138 | 125 | 147 | 162 | 173 | 173 |
| 31 | 109 | 129 | 143 | 129 | 153 | 169 | 181 | 181 |
| 32 | 112 | 134 | 148 | 133 | 159 | 176 | 189 | 189 |
| 33 | 115 | 138 | 153 | 137 | 165 | 183 | 197 | 197 |
| 34 | 118 | 142 | 159 | 142 | 171 | 191 | 206 | 206 |
| 35 | 121 | 147 | 164 | 146 | 178 | 198 | 215 | 215 |
| 36 | 124 | 152 | 170 | 151 | 184 | 207 | 224 | 224 |
| 37 | 128 | 157 | 176 | 156 | 191 | 215 | 234 | 234 |
| 38 | 131 | 162 | 183 | 161 | 199 | 224 | 244 | 244 |
| 39 | 134 | 167 | 189 | 166 | 206 | 234 | 255 | 255 |
| 40 | 138 | 172 | 196 | 172 | 214 | 243 | 266 | 266 |
| 41 | 142 | 178 | 203 | 177 | 222 | 253 | 278 | 278 |
| 42 | 145 | 184 | 210 | 183 | 231 | 264 | 290 | 290 |
| 43 | 149 | 190 | 218 | 189 | 240 | 275 | 303 | 303 |
| 44 | 153 | 196 | 226 | 195 | 249 | 286 | 316 | 316 |
| 45 | 157 | 202 | 234 | 201 | 258 | 298 | 330 | 330 |
| 46 | 162 | 209 | 242 | 208 | 268 | 310 | 344 | 344 |
| 47 | 166 | 216 | 251 | 215 | 278 | 323 | 360 | 360 |

| | | | | | | | | |
|----|-----|-----|-----|-----|------|------|------|------|
| 48 | 170 | 223 | 260 | 222 | 289 | 337 | 375 | 375 |
| 49 | 175 | 230 | 269 | 229 | 300 | 351 | 392 | 392 |
| 50 | 179 | 237 | 279 | 236 | 311 | 365 | 409 | 409 |
| 51 | 184 | 245 | 289 | 244 | 323 | 381 | 427 | 427 |
| 52 | 189 | 253 | 299 | 252 | 335 | 396 | 446 | 446 |
| 53 | 194 | 261 | 310 | 260 | 348 | 413 | 465 | 465 |
| 54 | 199 | 269 | 321 | 268 | 361 | 430 | 486 | 486 |
| 55 | 205 | 278 | 332 | 277 | 375 | 448 | 507 | 507 |
| 56 | 210 | 287 | 344 | 286 | 390 | 466 | 529 | 529 |
| 57 | 216 | 296 | 356 | 295 | 404 | 486 | 553 | 553 |
| 58 | 221 | 306 | 369 | 304 | 420 | 506 | 577 | 577 |
| 59 | 227 | 316 | 382 | 314 | 436 | 527 | 602 | 602 |
| 60 | 233 | 326 | 396 | 324 | 452 | 549 | 629 | 629 |
| 61 | 239 | 337 | 410 | 335 | 470 | 571 | 656 | 656 |
| 62 | 246 | 348 | 425 | 346 | 488 | 595 | 685 | 685 |
| 63 | 252 | 359 | 440 | 357 | 506 | 620 | 715 | 715 |
| 64 | 259 | 371 | 456 | 368 | 525 | 646 | 746 | 746 |
| 65 | 266 | 383 | 472 | 380 | 545 | 672 | 779 | 779 |
| 66 | 273 | 395 | 489 | 392 | 566 | 700 | 813 | 813 |
| 67 | 280 | 408 | 506 | 405 | 588 | 729 | 849 | 849 |
| 68 | 288 | 421 | 524 | 418 | 610 | 760 | 886 | 886 |
| 69 | 295 | 435 | 543 | 432 | 633 | 791 | 925 | 925 |
| 70 | 303 | 449 | 563 | 446 | 658 | 824 | 966 | 966 |
| 71 | 311 | 463 | 583 | 460 | 683 | 858 | 1008 | 1008 |
| 72 | 319 | 478 | 603 | 475 | 709 | 894 | 1053 | 1053 |
| 73 | 328 | 494 | 625 | 490 | 736 | 931 | 1099 | 1099 |
| 74 | 336 | 510 | 647 | 506 | 764 | 969 | 1147 | 1147 |
| 75 | 345 | 526 | 671 | 522 | 793 | 1009 | 1197 | 1197 |
| 76 | 354 | 543 | 694 | 539 | 823 | 1051 | 1250 | 1250 |
| 77 | 364 | 561 | 719 | 556 | 854 | 1095 | 1305 | 1305 |
| 78 | 374 | 579 | 745 | 574 | 887 | 1140 | 1362 | 1362 |
| 79 | 383 | 598 | 772 | 593 | 920 | 1188 | 1422 | 1422 |
| 80 | 394 | 617 | 799 | 612 | 955 | 1237 | 1484 | 1484 |
| 81 | 404 | 637 | 828 | 632 | 992 | 1288 | 1549 | 1549 |
| 82 | 415 | 657 | 857 | 652 | 1030 | 1342 | 1617 | 1617 |

| | | | | | | | | |
|-----|------|------|------|------|------|------|------|------|
| 83 | 426 | 679 | 888 | 673 | 1069 | 1397 | 1688 | 1688 |
| 84 | 437 | 701 | 920 | 695 | 1110 | 1455 | 1762 | 1762 |
| 85 | 449 | 723 | 953 | 717 | 1152 | 1516 | 1839 | 1839 |
| 86 | 461 | 747 | 987 | 740 | 1196 | 1578 | 1920 | 1920 |
| 87 | 473 | 771 | 1022 | 764 | 1241 | 1644 | 2004 | 2004 |
| 88 | 485 | 796 | 1058 | 789 | 1288 | 1712 | 2092 | 2092 |
| 89 | 498 | 822 | 1096 | 814 | 1337 | 1783 | 2184 | 2184 |
| 90 | 511 | 848 | 1135 | 841 | 1388 | 1857 | 2280 | 2280 |
| 91 | 525 | 876 | 1176 | 868 | 1441 | 1934 | 2380 | 2380 |
| 92 | 539 | 904 | 1218 | 896 | 1496 | 2014 | 2484 | 2484 |
| 93 | 553 | 933 | 1261 | 925 | 1553 | 2098 | 2593 | 2593 |
| 94 | 568 | 963 | 1307 | 954 | 1612 | 2185 | 2707 | 2707 |
| 95 | 583 | 994 | 1353 | 985 | 1674 | 2275 | 2825 | 2825 |
| 96 | 598 | 1027 | 1402 | 1017 | 1737 | 2369 | 2949 | 2949 |
| 97 | 614 | 1060 | 1452 | 1050 | 1803 | 2468 | 3079 | 3079 |
| 98 | 630 | 1094 | 1503 | 1084 | 1872 | 2570 | 3214 | 3214 |
| 99 | 647 | 1130 | 1557 | 1119 | 1943 | 2677 | 3355 | 3355 |
| 100 | 664 | 1166 | 1613 | 1155 | 2017 | 2788 | 3502 | 3502 |
| 101 | 682 | 1204 | 1670 | 1192 | 2094 | 2903 | 3656 | 3656 |
| 102 | 700 | 1243 | 1730 | 1230 | 2174 | 3024 | 3816 | 3816 |
| 103 | 718 | 1283 | 1792 | 1270 | 2257 | 3149 | 3983 | 3983 |
| 104 | 737 | 1324 | 1856 | 1311 | 2342 | 3279 | 4158 | 4158 |
| 105 | 757 | 1367 | 1922 | 1353 | 2432 | 3415 | 4340 | 4340 |
| 106 | 777 | 1411 | 1991 | 1397 | 2524 | 3557 | 4531 | 4531 |
| 107 | 798 | 1457 | 2062 | 1442 | 2620 | 3704 | 4729 | 4729 |
| 108 | 819 | 1504 | 2136 | 1488 | 2720 | 3858 | 4937 | 4937 |
| 109 | 840 | 1553 | 2212 | 1536 | 2823 | 4018 | 5153 | 5153 |
| 110 | 863 | 1603 | 2291 | 1586 | 2931 | 4185 | 5379 | 5379 |
| 111 | 886 | 1655 | 2373 | 1637 | 3043 | 4358 | 5615 | 5615 |
| 112 | 909 | 1708 | 2458 | 1690 | 3158 | 4539 | 5862 | 5862 |
| 113 | 933 | 1764 | 2545 | 1744 | 3279 | 4727 | 6119 | 6119 |
| 114 | 958 | 1821 | 2636 | 1800 | 3403 | 4923 | 6387 | 6387 |
| 115 | 983 | 1880 | 2731 | 1858 | 3533 | 5127 | 6667 | 6667 |
| 116 | 1009 | 1940 | 2828 | 1918 | 3667 | 5340 | 6960 | 6960 |
| 117 | 1036 | 2003 | 2929 | 1980 | 3807 | 5561 | 7265 | 7265 |

| | | | | | | | | |
|-----|------|------|------|------|------|------|-------|-------|
| 118 | 1063 | 2068 | 3034 | 2044 | 3952 | 5791 | 7584 | 7584 |
| 119 | 1092 | 2135 | 3142 | 2110 | 4102 | 6031 | 7916 | 7916 |
| 120 | 1120 | 2204 | 3254 | 2178 | 4258 | 6282 | 8263 | 8263 |
| 121 | 1150 | 2275 | 3371 | 2248 | 4420 | 6542 | 8626 | 8626 |
| 122 | 1181 | 2349 | 3491 | 2320 | 4589 | 6813 | 9004 | 9004 |
| 123 | 1212 | 2424 | 3616 | 2395 | 4763 | 7096 | 9399 | 9399 |
| 124 | 1244 | 2503 | 3745 | 2472 | 4945 | 7390 | 9811 | 9811 |
| 125 | 1277 | 2584 | 3879 | 2552 | 5133 | 7696 | 10242 | 10242 |
| 126 | 1311 | 2667 | 4017 | 2634 | 5328 | 8015 | 10691 | 10691 |
| 127 | 1346 | 2754 | 4162 | 2720 | 5532 | 8348 | 11160 | 11160 |

Annex C (informative): Pseudo-Code for E-TFC Selection (FDD)

The pseudo-code below describes one possible implementation of the E-TFC Selection as described in subclause 11.8.1.4:

- 1> determine whether to take the scheduled and non-scheduled grants into account in the upcoming transmission.
- 1> if scheduled and/or non-scheduled data can be transmitted:
 - 2> select a MAC-d flow that allows highest-priority data to be transmitted (when more than one MAC-d flow allows data of the same highest priority to be transmitted, it is left to implementation to select which MAC-d flow to prefer);
 - 2> identify the MAC-d flow(s) whose multiplexing lists allow them to be transmitted in the same TTI as this MAC-d flow, and whose grants allow them to transmit in this TTI and ignore the one(s) that cannot.
 - 2> based on the HARQ profile of this MAC-d flow, identify the power offset to use;
 - 2> based on this power offset and the E-TFC restriction procedure, determine the "Maximum Supported Payload" (i.e. maximum MAC-e PDU size or E-TFC that can be sent by the UE during the upcoming transmission);
 - 2> if the upcoming transmission overlaps with a compressed mode gap on 10ms TTI, scale down the current serving grant (SG);
 - 2> set "Remaining Scheduled Grant Payload" to the highest payload that could be transmitted according to SG and selected power offset;
 - 2> for each MAC-d flow with a non-scheduled grant, set the "Remaining Non-scheduled Payload" to the value of the grant;
 - 2> if Scheduling Information needs to be transmitted:
 - 3> set "Total Granted Payload" to the sum of "Remaining Non Scheduled Payload" for all non-scheduled MAC-d flows + "Remaining Scheduled Grant Payload" + size of the scheduling information.
 - 2> else:
 - 3> set "Total Granted Payload" to the sum of "Remaining Non Scheduled Payload" for all non-scheduled MAC-d flows + "Remaining Scheduled Grant Payload".
 - 2> set "Remaining Available Payload" to MIN ("Max Supported Payload", "Total Granted Payload");
 - 2> set "Quantization Loss" to the value of "Remaining Available Payload" – ("Remaining Available Payload" rounded down to the next smaller E-TFC);
 - 2> if scheduling information needs to be transmitted:
 - 3> subtract the size of scheduling information from "Remaining Available Payload".
 - 2> set "Quantisation Applied" to FALSE;
 - 2> perform the following loop for each logical channel, in the order of their priorities:
 - 3> if this logical channel belongs to a MAC-d flow with a non-scheduled grant, then:
 - 4> consider the "Remaining Non-scheduled Payload" corresponding to the MAC-d flow on which this logical channel is mapped;
 - 4> fill the MAC-e PDU with SDU(s) from this logical channel up to MIN ("Remaining Non-scheduled Payload" taking into account the MAC-e/es headers, Available Data for this logical channel, "Remaining Available Payload" taking into account the MAC-e/es headers);

- 4> subtract the corresponding bits if any from "Remaining Available Payload" and "Remaining Non-scheduled Payload" taking into account the MAC-e/es headers.
- 3> else:
 - 4> If "Quantisation Applied" is TRUE:
 - 5> fill the MACe PDU with SDU(s) from this logical channel up to MIN ("Remaining Scheduled Grant Payload" taking into account the MAC-e/es headers, Available Data for this logical channel, "Remaining Available Payload" taking into account the MAC-e/es headers);
 - 5> subtract the corresponding bits if any from "Remaining Available Payload" and "Remaining Scheduled Grant Payload" taking into account the MAC-e/es headers.
 - 4> else:
 - 5> fill the MAC-e PDU with SDU(s) from this logical channel up to MIN ("Remaining Scheduled Grant Payload" taking into account the MAC-e/es headers, Available Data for this logical channel, "Remaining Available Payload" – "Quantisation Loss" taking into account the MAC-e/es headers);
 - 5> if bits can be transmitted on this logical channel:
 - 6> set "Remaining Available Payload" to ("Remaining Available Payload" – "Quantisation Loss");
 - 6> subtract the corresponding bits from "Remaining Available Payload" and "Remaining Scheduled Grant Payload" taking into account the MAC-e/es headers;
 - 6> set "Quantisation Applied" to TRUE.
- 2> if Scheduling Information needs to be transmitted:
 - 3> add Scheduling Information to the MAC-e PDU;
 - 3> determine the smallest E-TFC that can carry the resulting MAC-e PDU;
 - 3> if the padding allows a DDI_0 to be sent, add it to the end of the MAC-e header.
- 2> else:
 - 3> determine the smallest E-TFC that can carry the resulting MAC-e PDU;
 - 3> if the padding allows a Scheduling Information to be sent, add it to the MAC-e PDU;
 - 3> if a Scheduling Information was added to the PDU and if the padding allows a DDI_0 to be sent, add it to the end of the MAC-e header.
- 2> set the maximum number of HARQ transmissions to the maximum among the maximum number of HARQ transmissions of the HARQ profiles of the MAC-d flows selected for transmissions.
- 1> else if Scheduling Information needs to be transmitted:
 - 2> select the "control-only" HARQ profile;
 - 2> fill the MAC-e PDU with the scheduling information;
 - 2> select the smallest E-TFC.

Annex CA (informative): Pseudo-Code for E-TFC Selection (TDD)

The pseudo-code below describes one possible implementation of UE E-TFC Selection as described in subclause 11.9.1.4. It consists of three separate procedures which are normally executed Procedure 1, 2 and then 3:

Procedure 1:

- 1> Determine set B, the set of logical channels which consist of a) the highest priority logical channel which has data buffered for transmission b) the set of logical channels which have data buffered for transmission and which may be multiplexed with the highest priority channel. The detailed steps involved are as follows:
 - 2> Determine whether or not a TTI is designated for scheduled or non scheduled transmission.
 - 2> Determine the set A of logical channels which have data buffered for transmission and which are consistent with the TTI designation (scheduled or non-scheduled).
 - 2> Determine X, the highest priority logical channel in set A.
 - 2> Select the HARQ profile of the MAC-d flow, flow Y, to which logical channel X belongs. (*Note: A logical channel can only belong to one MAC-d flow and can therefore only have one HARQ profile*)
 - 2> Determine set B, the set of logical channels which are in set A and which belong to flow Y or to a flow which may be multiplexed with flow Y

Procedure 2:

- 1> Generate the largest block size that can be supported by the resources granted. The detailed steps involved are as follows:
 - 2> Determine the sets of TFCs C_1 (QPSK) and C_2 (16-QAM) whose code rates fall within the allowed maximum and minimum (inclusive) coderates specified by RRC for the assigned number of time slots and the assigned channelisation code (the UE is not allowed to use more or less slots than are assigned nor to use a code associated with a lower spreading factor). For 1.28 Mcps TDD, the spreading factor can not be changed by the UE and the current value of ENI should be considered when choosing the allowed maximum and minimum code rates if a scheduled transmission is designated.
 - 2> Determine the subsets D_1 and D_2 of C_1 and C_2 respectively which require transmit power that is less than or equal to the power available taking into account of the power offset of the HARQ profile of flow y, P_{e-base} and beta values associated with TFCs for QPSK and 16QAM.
 - 2> Determine k, the largest MAC-e PDU block size that can be supported, from the sets D_1 and D_2
 - 2> If k belongs exclusively to set D_1 , select QPSK modulation. If k belongs exclusively to set D_2 , select 16-QAM modulation. If k appears in both sets D_1 and D_2 , select 16-QAM modulation only if it offers a lower power requirement than QPSK, otherwise select QPSK modulation.

Procedure 3:

- 1> Generate the largest MAC-e PDU, having a size $\leq k$, by taking MAC-d PDUs from logical channels in set B (in order of priority) and select SF (for 1.28 Mcps TDD, the SF can not be changed) and modulation so as to minimise the power used. The detailed steps are as follows:
 - 2> Generate the largest MAC-e PDU $\leq k$, taking MAC-d PDUs from logical channels belonging to set B (in priority order);
 - 2> If this is successful (i.e. sufficient resources granted):
 - 3> select the SF (for 1.28 Mcps TDD, the SF cannot be changed) and modulation to use in order to minimise the power used to transmit the MAC-e PDU;
 - 3> transmit the MAC-e PDU.
 - 2> If this is not successful (i.e. the MAC-e PDU is empty due to insufficient resources granted):

3> $A := A - B$;

3> if A is not empty (i.e. other logical channels have data buffered for transmission):

4> determine a new set B (repeat Procedure 1 and then Procedure 3).

3> if A is empty (i.e. no other logical channels have data buffered for transmission):

4> transmit scheduling information only in the MAC-e PDU.

Annex D (informative): Change history

| Change history | | | | | | | | |
|----------------|---------|-----------|----------|-----|-------------------------------------------------------------------------------------------------------------------------|-------------------------------------------|-------|-------|
| Date | TSG # | TSG Doc. | CR | Rev | Subject/Comment | Old | New | |
| 06/1999 | RP-04 | RP-99312 | - | | Approved at TSG-RAN #4 and placed under Change Control | - | 3.0.0 | |
| 10/1999 | RP-05 | RP-99463 | 001 | 1 | Modified MAC handling of PCH and FACH | 3.0.0 | 3.1.0 | |
| | RP-05 | RP-99463 | 002 | | Modifications of MAC primitives | 3.0.0 | 3.1.0 | |
| | RP-05 | RP-99463 | 003 | 2 | RACH/FACH MAC header – Channel type identification | 3.0.0 | 3.1.0 | |
| | RP-05 | RP-99463 | 004 | | Support for USCH/DSCH signalling in TDD | 3.0.0 | 3.1.0 | |
| | RP-05 | RP-99463 | 006 | | Clarification on RACH partitioning and prioritization via access service class (ASC) and relation to back-off algorithm | 3.0.0 | 3.1.0 | |
| | RP-05 | RP-99463 | 010 | 1 | Modifications on UE-Id formats | 3.0.0 | 3.1.0 | |
| | RP-05 | RP-99463 | 011 | | CPCH primitives | 3.0.0 | 3.1.0 | |
| | RP-05 | RP-99463 | 012 | | Timing advance for TDD | 3.0.0 | 3.1.0 | |
| | RP-05 | RP-99463 | 013 | 1 | Traffic volume measurement report procedure | 3.0.0 | 3.1.0 | |
| | RP-05 | RP-99463 | 014 | | Mapping of BCCH logical channel onto FACH transport channel | 3.0.0 | 3.1.0 | |
| | RP-05 | RP-99463 | 015 | 1 | MAC PDU formats for DCCH/DTCH on DSCH and for PCCH | 3.0.0 | 3.1.0 | |
| | RP-05 | RP-99463 | 016 | 1 | Informative parts that shall not specify or constrain implementations | 3.0.0 | 3.1.0 | |
| | RP-05 | RP-99463 | 017 | 1 | Modification of RACH transmission control procedure | 3.0.0 | 3.1.0 | |
| | RP-05 | RP-99463 | 018 | | Removal of MAC function for system information and paging scheduling | 3.0.0 | 3.1.0 | |
| | RP-05 | RP-99463 | 019 | 1 | RACH transmission control procedure on MAC for TDD mod | 3.0.0 | 3.1.0 | |
| | RP-05 | RP-99463 | 021 | 1 | Removal of Annex A and B of TS 25.321 | 3.0.0 | 3.1.0 | |
| | 12/1999 | RP-06 | RP-99638 | 022 | 3 | Modified MAC header field sizes | 3.1.0 | 3.2.0 |
| | | RP-06 | RP-99638 | 023 | | MAC: Multiple shared channels (DSCH/USCH) | 3.1.0 | 3.2.0 |
| RP-06 | | RP-99638 | 024 | | Parameters for Status Primitive | 3.1.0 | 3.2.0 | |
| RP-06 | | RP-99638 | 025 | 1 | Support of shared channel operation in TDD | 3.1.0 | 3.2.0 | |
| RP-06 | | RP-99638 | 028 | | Modification of Cell Broadcast Service (CBS) | 3.1.0 | 3.2.0 | |
| RP-06 | | RP-99637 | 030 | 1 | Editorial changes | 3.1.0 | 3.2.0 | |
| RP-06 | | RP-99638 | 031 | 1 | Simultaneous mapping of logical channels on | 3.1.0 | 3.2.0 | |
| 03/2000 | RP-07 | RP-000039 | 032 | | Bit Aligned TDD MAC Headers | 3.2.0 | 3.3.0 | |
| | RP-07 | RP-000039 | 035 | 2 | CPCH including Channel Assignment | 3.2.0 | 3.3.0 | |
| | RP-07 | RP-000039 | 036 | | UE-ID type indication | 3.2.0 | 3.3.0 | |
| | RP-07 | RP-000039 | 037 | 1 | RACH transmission control procedure | 3.2.0 | 3.3.0 | |
| | RP-07 | RP-000039 | 039 | | CPCH start of message indication | 3.2.0 | 3.3.0 | |
| | RP-07 | RP-000039 | 040 | | Removal of SCH and SCCH | 3.2.0 | 3.3.0 | |
| | RP-07 | RP-000039 | 041 | 1 | Clarification of bit order | 3.2.0 | 3.3.0 | |
| 06/2000 | RP-08 | RP-000219 | 042 | | CPCH correction | 3.3.0 | 3.4.0 | |
| | RP-08 | RP-000219 | 043 | 1 | End of CPCH transmission | 3.3.0 | 3.4.0 | |
| | RP-08 | RP-000219 | 044 | 2 | Clarification of prioritisation of logical channels in UE | 3.3.0 | 3.4.0 | |
| | RP-08 | RP-000219 | 045 | 1 | CPCH MAC procedures | 3.3.0 | 3.4.0 | |
| | RP-08 | RP-000219 | 046 | | Traffic Volume Measurement for dynamic radio bearer control | 3.3.0 | 3.4.0 | |
| 09/2000 | RP-09 | RP-000357 | 047 | | Movement of primitives text to the correct section | 3.4.0 | 3.5.0 | |
| | RP-09 | RP-000357 | 048 | | Corrections to RACH procedure | 3.4.0 | 3.5.0 | |
| | RP-09 | RP-000357 | 049 | | Clarification on the parameters of the MAC-RLC primitives | 3.4.0 | 3.5.0 | |
| | RP-09 | RP-000357 | 051 | 1 | Editorial Cleanup | 3.4.0 | 3.5.0 | |
| 12/2000 | RP-10 | RP-000567 | 053 | 2 | Corrections to logical channel priorities in MAC Protocol | 3.5.0 | 3.6.0 | |
| | RP-10 | RP-000567 | 055 | 1 | Removal of FAUSCH | 3.5.0 | 3.6.0 | |
| | RP-10 | RP-000567 | 056 | 2 | General MAC clarification | 3.5.0 | 3.6.0 | |
| | RP-10 | RP-000567 | 057 | 1 | Error Handling in MAC | 3.5.0 | 3.6.0 | |
| | RP-10 | RP-000567 | 058 | 1 | Error handling for MAC RACH and CPCH transmission control procedure | 3.5.0 | 3.6.0 | |
| | RP-10 | RP-000567 | 059 | | Inclusion of stage 3 for ciphering | 3.5.0 | 3.6.0 | |
| 03/2001 | RP-11 | RP-010025 | 061 | | Removal of FAUSCH | 3.6.0 | 3.7.0 | |
| | RP-11 | RP-010025 | 066 | 3 | TFC selection algorithm correction | 3.6.0 | 3.7.0 | |
| | RP-11 | RP-010025 | 067 | 3 | Miscellaneous corrections | 3.6.0 | 3.7.0 | |
| | RP-11 | RP-010025 | 068 | 2 | Clarification on Traffic Volume Measurement Procedure | 3.6.0 | 3.7.0 | |
| | RP-11 | RP-010025 | 070 | 1 | Clarification on parameters of the primitives | 3.6.0 | 3.7.0 | |
| 06/2001 | RP-11 | RP-010037 | 064 | | 1.28Mcps TDD | 3.7.0 | 4.0.0 | |
| | RP-12 | RP-010308 | 074 | | RLC Tr Discard | 4.0.0 | 4.1.0 | |
| | RP-12 | RP-010308 | 076 | | Clarification on compressed mode | 4.0.0 | 4.1.0 | |
| | RP-12 | RP-010308 | 078 | | Correction of relation between MAC functions and transport channels | 4.0.0 | 4.1.0 | |
| | RP-12 | RP-010308 | 080 | | Rate adaptation | 4.0.0 | 4.1.0 | |
| | RP-12 | RP-010308 | 082 | | Cleanup of MAC services and functions | 4.0.0 | 4.1.0 | |
| | RP-12 | RP-010322 | 083 | | Correction to control of RACH Transmissions for 1.28Mcps TDD | 4.0.0 | 4.1.0 | |

| Change history | | | | | | | | |
|----------------|---------|-----------|-----------|-----|-----------------------------------------------------------------------------|--------------------------------------------------------------|-------|-------|
| Date | TSG # | TSG Doc. | CR | Rev | Subject/Comment | Old | New | |
| 09/2001 | RP-13 | RP-010541 | 085 | | Setting of UE Id in MAC | 4.1.0 | 4.2.0 | |
| | RP-13 | RP-010541 | 087 | | MAC ASC selection operation when access class is used to determine ASC | 4.1.0 | 4.2.0 | |
| | RP-13 | RP-010541 | 089 | | Addition of neighbour cell BCH to MAC-b model for the UE | 4.1.0 | 4.2.0 | |
| | RP-13 | RP-010541 | 093 | 1 | Clarification on TFC selection | 4.1.0 | 4.2.0 | |
| | 12/2001 | RP-14 | RP-010760 | 091 | 1 | Cautionary Note for Interfrequency Measurements in Cell-FACH | 4.2.0 | 4.3.0 |
| | | RP-14 | RP-010760 | 095 | | Correction on Control of RACH Transmissions | 4.2.0 | 4.3.0 |
| RP-14 | | RP-010760 | 097 | | Correction on Traffic Volume Control | 4.2.0 | 4.3.0 | |
| | RP-14 | RP-010760 | 099 | | General correction on Access Service Class selection | 4.2.0 | 4.3.0 | |
| | RP-14 | RP-010760 | 101 | | TFC selection in compressed mode | 4.2.0 | 4.3.0 | |
| | 03/2002 | RP-15 | RP-020067 | 103 | | Clarification on ciphering | 4.3.0 | 4.4.0 |
| RP-15 | | RP-020067 | 106 | | TDD MAC Layer Subchannel Assignment | 4.3.0 | 4.4.0 | |
| RP-15 | | RP-020067 | 110 | | Missing DTCH channel type in UE-ID Type Indicator | 4.3.0 | 4.4.0 | |
| | RP-15 | RP-020067 | 112 | | Correction on UE Id for DSCH | 4.3.0 | 4.4.0 | |
| | RP-15 | RP-020067 | 114 | | UE undefined behaviour when padding is required | 4.3.0 | 4.4.0 | |
| | RP-15 | RP-020094 | 104 | 2 | Introduction of HSDPA | 4.4.0 | 5.0.0 | |
| 06/2002 | RP-16 | RP-020326 | 117 | | Update References to include 25.123 (TDD) | 5.0.0 | 5.1.0 | |
| | RP-16 | RP-020326 | 120 | | TFCS selection guideline correction | 5.0.0 | 5.1.0 | |
| | RP-16 | RP-020341 | 121 | | HSDPA related MAC corrections | 5.0.0 | 5.1.0 | |
| | RP-16 | RP-020341 | 122 | | Description for MAC-hs reset | 5.0.0 | 5.1.0 | |
| | 09/2002 | RP-17 | RP-020538 | 130 | | MAC TVM Corrections | 5.1.0 | 5.2.0 |
| | | RP-17 | RP-020538 | 133 | | MAC header for DTCH and DCCH | 5.1.0 | 5.2.0 |
| RP-17 | | RP-020556 | 123 | | Optional use of a maximum transmission delay for MAC-hs SDUs | 5.1.0 | 5.2.0 | |
| | RP-17 | RP-020556 | 124 | | MAC-hs: Scheduler and HARQ entity functions for TSN | 5.1.0 | 5.2.0 | |
| | RP-17 | RP-020556 | 125 | | Correction on C/T field definition for HS-DSCH | 5.1.0 | 5.2.0 | |
| | RP-17 | RP-020556 | 126 | | Corrections to re-ordering protocol description | 5.1.0 | 5.2.0 | |
| | RP-17 | RP-020556 | 127 | | Limiting of number of PDUs per TTI | 5.1.0 | 5.2.0 | |
| | RP-17 | RP-020556 | 134 | | Signaling of Transport Block Sizes for HS-DSCH | 5.1.0 | 5.2.0 | |
| | RP-17 | RP-020556 | 135 | | Transport block size signalling 3.84 Mcps TDD | 5.1.0 | 5.2.0 | |
| | RP-17 | RP-020556 | 136 | | Static HSDPA Transport Block Sizes for 1.28 Mcps TDD | 5.1.0 | 5.2.0 | |
| | 12/2002 | RP-18 | RP-020718 | 142 | 1 | TFC selection for RACH transmissions | 5.2.0 | 5.3.0 |
| | | RP-18 | RP-020718 | 145 | | RB id in ciphering | 5.2.0 | 5.3.0 |
| RP-18 | | RP-020718 | 148 | | Correction to TFC selection for TDD | 5.2.0 | 5.3.0 | |
| | RP-18 | RP-020718 | 151 | | Unblockable TFCs in excess power state | 5.2.0 | 5.3.0 | |
| | RP-18 | RP-020735 | 137 | | Generation of RLC Status Reports to coordinate with MAC-hs reset | 5.2.0 | 5.3.0 | |
| | RP-18 | RP-020735 | 138 | | Re-ordering Mechanism | 5.2.0 | 5.3.0 | |
| | RP-18 | RP-020735 | 139 | | Transport Block Size Signalling for 1.28Mcps TDD | 5.2.0 | 5.3.0 | |
| | RP-18 | RP-020735 | 153 | | Limitation on number of PDUs per single TTI for 1.28 Mcps TDD | 5.2.0 | 5.3.0 | |
| | RP-18 | RP-020735 | 154 | | The Number of mac-d pdu's in a single mac-hs PDU for TDD | 5.2.0 | 5.3.0 | |
| | RP-18 | RP-020851 | 155 | | HSDPA Retransmission block Size | 5.2.0 | 5.3.0 | |
| | RP-18 | RP-020874 | 158 | | Ciphering of multiple PDUs per TTI | 5.2.0 | 5.3.0 | |
| | RP-19 | RP-030100 | 166 | | Setting of ciphering activation time for TM bearers | 5.3.0 | 5.4.0 | |
| | RP-19 | RP-030100 | 169 | 1 | TFC Control Implementation | 5.3.0 | 5.4.0 | |
| | RP-19 | RP-030115 | 159 | | TDD HCSN determination in MAC-hs | 5.3.0 | 5.4.0 | |
| | RP-19 | RP-030115 | 160 | | Correction to the use of Transport Block Size index equal to 111111 for TDD | 5.3.0 | 5.4.0 | |
| | RP-19 | RP-030115 | 163 | | Editorial changes to MAC-hs | 5.3.0 | 5.4.0 | |
| | RP-19 | RP-030115 | 170 | | Re-ordering entity corrections | 5.3.0 | 5.4.0 | |
| | 06/2003 | RP-20 | RP-030302 | 171 | | Text clean up of the description of the reordering entity | 5.4.0 | 5.5.0 |
| RP-20 | | RP-030302 | 172 | | MAC header for DTCH and DCCH mapped to HS-DSCH | 5.4.0 | 5.5.0 | |
| 09/2003 | RP-21 | RP-030501 | 178 | | TFCS selection guidelines for TFC Subset | 5.5.0 | 5.6.0 | |
| | RP-21 | RP-030536 | 174 | 2 | MAC-hs Re-ordering Protocol Correction & MAC-hs window re-ordering | 5.5.0 | 5.6.0 | |
| | RP-21 | RP-030494 | 175 | | Addition of HS-DSCH Provided Bit Rate measurement | 5.5.0 | 5.6.0 | |
| 12/2003 | RP-22 | RP-030624 | 179 | | Corrections Relating to HSDPA TB Sizes for 1.28Mcps TDD | 5.6.0 | 5.7.0 | |
| | RP-22 | RP-030624 | 180 | | HSDPA Transport block size table for 3.84Mcps TDD | 5.6.0 | 5.7.0 | |
| | RP-22 | RP-030624 | 181 | | HSDPA TB size table | 5.6.0 | 5.7.0 | |
| | RP-22 | RP-030624 | 182 | | Unwarranted HARQ re-transmissions | 5.6.0 | 5.7.0 | |
| | RP-22 | RP-030624 | 183 | | MAC-hs Re-ordering Protocol Flushing correction | 5.6.0 | 5.7.0 | |
| | RP-22 | RP-030624 | 184 | | Correction to window based stall avoidance mechanism | 5.6.0 | 5.7.0 | |
| | RP-22 | - | - | | Upgrade to Release 6 - no technical change | 5.7.0 | 6.0.0 | |
| | 03/2004 | RP-23 | RP-040104 | 186 | 1 | UE handling of NDI and TBS for HSDPA | 6.0.0 | 6.1.0 |
| | | RP-23 | RP-040104 | 188 | | HSDPA related corrections on MAC-hs reconfiguration | 6.0.0 | 6.1.0 |
| RP-23 | | RP-040104 | 190 | | Reconfiguration of soft memory buffer partitioning | 6.0.0 | 6.1.0 | |
| 06/2004 | RP-24 | RP-040200 | 194 | | Use of U-RNTI in downlink | 6.1.0 | 6.2.0 | |
| | RP-24 | RP-040234 | 196 | | State variables arithmetic comparison | 6.1.0 | 6.2.0 | |
| 12/2004 | RP-26 | RP-040480 | 198 | | MAC-hs header extension | 6.2.0 | 6.3.0 | |
| | RP-26 | RP-040480 | 200 | | Clarification on the C/T field use in the HSDPA Mac-d header | 6.2.0 | 6.3.0 | |
| | RP-26 | RP-040489 | 201 | 1 | Introduction of MBMS MAC header | 6.2.0 | 6.3.0 | |

| Change history | | | | | | | |
|----------------|-------|-----------|------|-----|----------------------------------------------------------------------------------------------|-------|-------|
| Date | TSG # | TSG Doc. | CR | Rev | Subject/Comment | Old | New |
| | RP-26 | RP-040489 | 202 | | Introduction of MBMS | 6.2.0 | 6.3.0 |
| | RP-26 | RP-040497 | 203 | | Introduction of EUL in MAC specification | 6.2.0 | 6.3.0 |
| 03/2005 | RP-27 | RP-050078 | 204 | | Correction to MBMS header for MBMS | 6.3.0 | 6.4.0 |
| 06/2005 | RP-28 | RP-050301 | 0207 | | Correction of HSDPA state variable | 6.4.0 | 6.5.0 |
| | RP-28 | RP-050319 | 0208 | | Corrections to the description of TCTF field | 6.4.0 | 6.5.0 |
| | RP-28 | RP-050301 | 0210 | | Reconfiguration of MAC-hs parameters | 6.4.0 | 6.5.0 |
| | RP-28 | RP-050308 | 0212 | | Feature Clean-up: Removal of DSCH (FDD) | 6.4.0 | 6.5.0 |
| | RP-28 | RP-050309 | 0214 | | Feature Clean Up: Removal of CPCH | 6.4.0 | 6.5.0 |
| | RP-28 | RP-050323 | 0215 | | HS-DSCH Provided Bit Rate measurement per Cell Portion | 6.4.0 | 6.5.0 |
| | RP-28 | RP-050375 | 0216 | 2 | Additional text on EUL in MAC specification | 6.4.0 | 6.5.0 |
| 09/2005 | RP-29 | RP-050462 | 0218 | | Correction of TB size for 1.28 Mcps TDD | 6.5.0 | 6.6.0 |
| | RP-29 | RP-050602 | 0219 | 5 | Additional text on EUL in MAC specification | 6.5.0 | 6.6.0 |
| | RP-29 | RP-050452 | 0220 | | Definition of UE power Headroom | 6.5.0 | 6.6.0 |
| | RP-29 | RP-050457 | 0222 | | Feature Clean Up: Removal of CPCH | 6.5.0 | 6.6.0 |
| 12/2005 | RP-30 | RP-050791 | 0223 | | Multi-step handling for E-RGCH | 6.6.0 | 6.7.0 |
| | RP-30 | RP-050791 | 0224 | | Clarifications and Corrections of E-TFC Selection | 6.6.0 | 6.7.0 |
| | RP-30 | RP-050791 | 0225 | 1 | Criteria for the Happy Bit | 6.6.0 | 6.7.0 |
| | RP-30 | RP-050791 | 0226 | 1 | Correction to definition of reference_ETPR | 6.6.0 | 6.7.0 |
| | RP-30 | RP-050791 | 0227 | | TEBS and HLBS Coding | 6.6.0 | 6.7.0 |
| | RP-30 | RP-050791 | 0228 | | Correction on MAC-e PDU format | 6.6.0 | 6.7.0 |
| | RP-30 | RP-050791 | 0229 | | SI Triggering Timer | 6.6.0 | 6.7.0 |
| | RP-30 | RP-050791 | 0230 | | Maximum number of transmissions for control-only information | 6.6.0 | 6.7.0 |
| | RP-30 | RP-050791 | 0231 | | Additional error case on the Absolute Grant channel | 6.6.0 | 6.7.0 |
| | RP-30 | RP-050791 | 0232 | | HARQ process restriction/reservation | 6.6.0 | 6.7.0 |
| | RP-30 | RP-050791 | 0233 | | Behavior at E-DCH TTI change | 6.6.0 | 6.7.0 |
| | RP-30 | RP-050792 | 0234 | | Buffer status for Scheduling Information | 6.6.0 | 6.7.0 |
| | RP-30 | RP-050792 | 0235 | | Buffer definition for Happy Bit setting | 6.6.0 | 6.7.0 |
| | RP-30 | RP-050792 | 0236 | | Specification of rate control combining rules in baseline procedure for Serving Grant update | 6.6.0 | 6.7.0 |
| | RP-30 | RP-050792 | 0237 | | Definition of sample for E-DCH bit rate measurement | 6.6.0 | 6.7.0 |
| | RP-30 | RP-050792 | 0238 | | Size of Absolute Grant field | 6.6.0 | 6.7.0 |
| | RP-30 | RP-050792 | 0239 | | Transmission of Scheduling Information without higher layer data | 6.6.0 | 6.7.0 |
| | RP-30 | RP-050792 | 0241 | | Size of UPH field and assembly of Scheduling Information message | 6.6.0 | 6.7.0 |
| | RP-30 | RP-050792 | 0242 | | E-DCH SI MAC-e PDU and SI timers | 6.6.0 | 6.7.0 |
| | RP-30 | RP-050792 | 0243 | | MAC es/e reset indicator | 6.6.0 | 6.7.0 |
| | RP-30 | RP-050792 | 0244 | | E-DCH handling at serving cell change | 6.6.0 | 6.7.0 |
| | RP-30 | RP-050792 | 0245 | | RSN sequence in the presence of compressed mode transmission gaps | 6.6.0 | 6.7.0 |
| 03/2006 | RP-31 | RP-060085 | 0246 | | Definition of reference_ETPR | 6.7.0 | 6.8.0 |
| | RP-31 | RP-060085 | 0247 | 1 | AG_Timer for IE "Serving Grant" | 6.7.0 | 6.8.0 |
| | RP-31 | RP-060085 | 0248 | | TEBS and HLBS Coding | 6.7.0 | 6.8.0 |
| | RP-31 | RP-060194 | 0249 | 1 | Correction related to automatic triggering of SI retransmissions | 6.7.0 | 6.8.0 |
| | RP-31 | RP-060085 | 0250 | | Clarifications at TTI Change | 6.7.0 | 6.8.0 |
| | RP-31 | RP-060085 | 0251 | 2 | MAC-es/e and MAC-hs reset procedure | 6.7.0 | 6.8.0 |
| | RP-31 | RP-060085 | 0254 | | Enhanced Uplink Corrections | 6.7.0 | 6.8.0 |
| | RP-31 | RP-060085 | 0255 | | E-TFC Selection Pseudo Code Correction | 6.7.0 | 6.8.0 |
| | RP-31 | RP-060088 | 0256 | | Correction of MBMS-Id field (MAC header of MTCH) | 6.7.0 | 6.8.0 |
| | RP-31 | RP-060085 | 0257 | | E-DCH Serving Grant Update | 6.7.0 | 6.8.0 |
| | RP-31 | RP-060085 | 0258 | | One PDU size per logical channel per TTI | 6.7.0 | 6.8.0 |
| | RP-31 | RP-060098 | 0253 | | 7.68 Mcps TDD Option (Release 7) | 6.8.0 | 7.0.0 |
| 06/2006 | RP-32 | RP-060352 | 0260 | | Buffer Status for the Happy Bit and Scheduling Information Reporting | 7.0.0 | 7.1.0 |
| | RP-32 | RP-060352 | 0262 | | Serving RG and Scheduling Information | 7.0.0 | 7.1.0 |
| | RP-32 | RP-060352 | 0264 | | Definition of RG_step_size | 7.0.0 | 7.1.0 |
| | RP-32 | RP-060352 | 0266 | | Correction to AG_Timer Start | 7.0.0 | 7.1.0 |
| | RP-32 | RP-060352 | 0268 | | Miscellaneous corrections for E-DCH | 7.0.0 | 7.1.0 |
| | RP-32 | RP-060353 | 0270 | | Correction to Notification of SI transmission failure and variable resets | 7.0.0 | 7.1.0 |
| | RP-32 | RP-060353 | 0272 | | Correction to Handling at Start of E-DCH Transmission | 7.0.0 | 7.1.0 |
| | RP-32 | RP-060353 | 0274 | | Additional inconsistent information on E-AGCH | 7.0.0 | 7.1.0 |
| | RP-32 | RP-060370 | 0276 | | Clarifications on E-TFCI | 7.0.0 | 7.1.0 |
| | RP-32 | RP-060353 | 0282 | | Transmission of SI if TEBS is zero | 7.0.0 | 7.1.0 |
| | RP-32 | RP-060419 | 0284 | 1 | Serving_Grant and Unquantized E-DPDCH to DPCCH power ratios | 7.0.0 | 7.1.0 |
| 09/2006 | RP-33 | RP-060625 | 0286 | 2 | Maximum number of transmissions | 7.1.0 | 7.2.0 |
| | RP-33 | RP-060574 | 0289 | | HLBS values in Scheduling Information message | 7.1.0 | 7.2.0 |
| | RP-33 | RP-060580 | 0290 | 1 | Note on Serving Grant Update with Zero Grant | 7.1.0 | 7.2.0 |
| | RP-33 | RP-060586 | 0291 | | Introduction of 3.84 Mcps and 7.68 Mcps TDD E-DCH | 7.1.0 | 7.2.0 |

| Change history | | | | | | | |
|----------------|-------|-----------|------|-----|--------------------------------------------------------------------------------------|-------|-------|
| Date | TSG # | TSG Doc. | CR | Rev | Subject/Comment | Old | New |
| | RP-33 | RP-060578 | 0293 | | MAC-hs reset | 7.1.0 | 7.2.0 |
| 12/2006 | RP-34 | RP-060716 | 0301 | | Grant and MAC-e/es headers for E-DCH | 7.2.0 | 7.3.0 |
| | RP-34 | RP-060716 | 0303 | | Clarification to Maximum channelisation codes and E-TFC selection | 7.2.0 | 7.3.0 |
| | RP-34 | RP-060716 | 0305 | 1 | Correction for E-DCH SG and compressed mode | 7.2.0 | 7.3.0 |
| | RP-34 | RP-060716 | 0307 | | SG update procedure correction | 7.2.0 | 7.3.0 |
| 03/2007 | RP-35 | RP-070150 | 0310 | | Modification of HS-DSCH TB size for LCR TDD | 7.3.0 | 7.4.0 |
| | RP-35 | RP-070163 | 0312 | 1 | Introduction of 64QAM in MAC specification | 7.3.0 | 7.4.0 |
| | RP-35 | RP-070157 | 0313 | | Introduction of 1.28 Mcps TDD E-DCH | 7.3.0 | 7.4.0 |
| | RP-35 | RP-070160 | 0314 | | Editorial Corrections for 3.84/7.68 Mcps TDD E-DCH | 7.3.0 | 7.4.0 |
| | RP-35 | RP-070158 | 0315 | | Introduction of DTX-DRX and HS-SCCH less in MAC | 7.3.0 | 7.4.0 |
| | RP-35 | RP-070161 | 0316 | | Introducing MIMO in MAC specification | 7.3.0 | 7.4.0 |
| 06/2007 | RP-36 | RP-070402 | 0311 | 2 | Introducing 16QAM uplink support | 7.4.0 | 7.5.0 |
| | RP-36 | RP-070393 | 0317 | - | "Maximum_Serving_Grant" setting at TTI change | 7.4.0 | 7.5.0 |
| | RP-36 | RP-070405 | 0318 | 3 | Introduction of Improved L2 support for high data rates and Enhanced CELL_FACH state | 7.4.0 | 7.5.0 |
| | RP-36 | RP-070407 | 0319 | - | Removing an incomplete optimization for RLC operations during HSDPA cell change | 7.4.0 | 7.5.0 |
| | RP-36 | RP-070397 | 0321 | - | Clarification for control of E-RUCCH transmission in LCR TDD | 7.4.0 | 7.5.0 |
| | RP-36 | RP-070397 | 0322 | - | Some Small Editorial Corrections to TS 25.321 | 7.4.0 | 7.5.0 |
| | RP-36 | RP-070397 | 0323 | - | Introduction of E-TFC Selection for 1.28Mcps TDD | 7.4.0 | 7.5.0 |
| | RP-36 | RP-070397 | 0324 | - | Some clarifications related to E-DCH Scheduling Information in TDD mode | 7.4.0 | 7.5.0 |
| | RP-36 | RP-070393 | 0326 | - | Clarification on calculation of "Scheduled Grant Payload" | 7.4.0 | 7.5.0 |
| | RP-36 | RP-070393 | 0327 | - | Recommandation on RLC PDU size selection on E-DCH | 7.4.0 | 7.5.0 |
| | RP-36 | RP-070491 | 0329 | - | Clarifications on priority of requirements in E-TFC selection | 7.4.0 | 7.5.0 |

History

| Document history | | |
|-------------------------|----------------|-------------|
| V7.0.0 | March 2006 | Publication |
| V7.1.0 | June 2006 | Publication |
| V7.2.0 | September 2006 | Publication |
| V7.3.0 | December 2006 | Publication |
| V7.4.0 | March 2007 | Publication |
| V7.5.0 | June 2007 | Publication |