

ETSI TS 125 331 V4.1.0 (2001-06)

Technical Specification

Universal Mobile Telecommunications System (UMTS); RRC Protocol Specification (3GPP TS 25.331 version 4.1.0 Release 4)



Reference

RTS/TSGR-0225331Uv4R1

Keywords

UMTS

ETSI

650 Route des Lucioles
F-06921 Sophia Antipolis Cedex - FRANCE

Tel.: +33 4 92 94 42 00 Fax: +33 4 93 65 47 16

Siret N° 348 623 562 00017 - NAF 742 C
Association à but non lucratif enregistrée à la
Sous-Préfecture de Grasse (06) N° 7803/88

Important notice

Individual copies of the present document can be downloaded from:

<http://www.etsi.org>

The present document may be made available in more than one electronic version or in print. In any case of existing or perceived difference in contents between such versions, the reference version is the Portable Document Format (PDF). In case of dispute, the reference shall be the printing on ETSI printers of the PDF version kept on a specific network drive within ETSI Secretariat.

Users of the present document should be aware that the document may be subject to revision or change of status. Information on the current status of this and other ETSI documents is available at <http://www.etsi.org/tb/status/>

If you find errors in the present document, send your comment to:
editor@etsi.fr

Copyright Notification

No part may be reproduced except as authorized by written permission.
The copyright and the foregoing restriction extend to reproduction in all media.

© European Telecommunications Standards Institute 2001.

All rights reserved.

Intellectual Property Rights

IPRs essential or potentially essential to the present document may have been declared to ETSI. The information pertaining to these essential IPRs, if any, is publicly available for **ETSI members and non-members**, and can be found in ETSI SR 000 314: "*Intellectual Property Rights (IPRs); Essential, or potentially Essential, IPRs notified to ETSI in respect of ETSI standards*", which is available from the ETSI Secretariat. Latest updates are available on the ETSI Web server (<http://www.etsi.org/ipr>).

Pursuant to the ETSI IPR Policy, no investigation, including IPR searches, has been carried out by ETSI. No guarantee can be given as to the existence of other IPRs not referenced in ETSI SR 000 314 (or the updates on the ETSI Web server) which are, or may be, or may become, essential to the present document.

Foreword

This Technical Specification (TS) has been produced by the ETSI 3rd Generation Partnership Project (3GPP).

The present document may refer to technical specifications or reports using their 3GPP identities, UMTS identities or GSM identities. These should be interpreted as being references to the corresponding ETSI deliverables.

The cross reference between GSM, UMTS, 3GPP and ETSI identities can be found under www.etsi.org/key.

Contents

| | |
|--|----|
| Foreword..... | 24 |
| 1 Scope..... | 25 |
| 2 References..... | 25 |
| 3 Definitions and abbreviations | 27 |
| 3.1 Definitions..... | 27 |
| 3.2 Abbreviations | 27 |
| 4 General..... | 28 |
| 4.1 Overview of the specification..... | 29 |
| 4.2 RRC Layer Model | 29 |
| 4.3 Protocol specification principles | 32 |
| 5 RRC Functions and Services provided to upper layers..... | 32 |
| 5.1 RRC Functions | 32 |
| 5.2 RRC Services provided to upper layers..... | 32 |
| 5.3 Primitives between RRC and upper layers | 33 |
| 6 Services expected from lower layers | 33 |
| 6.1 Services expected from Layer 2 | 33 |
| 6.2 Services expected from Layer 1 | 33 |
| 6.3 Signalling Radio Bearers | 33 |
| 7 Protocol states | 34 |
| 7.1 Overview of RRC States and State Transitions including GSM | 34 |
| 7.2 Processes in UE modes/states..... | 34 |
| 7.2.1 UE Idle mode..... | 34 |
| 7.2.2 UTRA RRC Connected mode..... | 35 |
| 7.2.2.1 URA_PCH or CELL_PCH state..... | 35 |
| 7.2.2.2 CELL_FACH state | 35 |
| 7.2.2.3 CELL_DCH state..... | 35 |
| 8 RRC procedures..... | 36 |
| 8.1 RRC Connection Management Procedures | 36 |
| 8.1.1 Broadcast of system information | 36 |
| 8.1.1.1 General..... | 37 |
| 8.1.1.1.1 System information structure | 37 |
| 8.1.1.1.2 System information blocks..... | 37 |
| 8.1.1.1.3 Segmentation and concatenation of system information blocks..... | 42 |
| 8.1.1.1.4 Re-assembly of segments | 43 |
| 8.1.1.1.5 Scheduling of system information..... | 44 |
| 8.1.1.2 Initiation..... | 44 |
| 8.1.1.3 Reception of SYSTEM INFORMATION messages by the UE | 44 |
| 8.1.1.4 Reception of SYSTEM INFORMATION messages broadcast on a FACH transport channel | 45 |
| 8.1.1.5 Actions upon reception of the Master Information Block and Scheduling Block(s) | 45 |
| 8.1.1.6 Actions upon reception of system information blocks..... | 48 |
| 8.1.1.6.1 System Information Block type 1..... | 49 |
| 8.1.1.6.2 System Information Block type 2..... | 50 |
| 8.1.1.6.3 System Information Block type 3..... | 50 |
| 8.1.1.6.4 System Information Block type 4..... | 50 |
| 8.1.1.6.5 System Information Block type 5..... | 50 |
| 8.1.1.6.6 System Information Block type 6..... | 51 |
| 8.1.1.6.7 System Information Block type 7..... | 51 |
| 8.1.1.6.8 System Information Block type 8..... | 51 |
| 8.1.1.6.9 System Information Block type 9..... | 52 |
| 8.1.1.6.10 System Information Block type 10..... | 52 |
| 8.1.1.6.11 System Information Block type 11..... | 52 |
| 8.1.1.6.12 System Information Block type 12..... | 53 |

| | | |
|------------|---|----|
| 8.1.1.6.13 | System Information Block type 13..... | 54 |
| 8.1.1.6.14 | System Information Block type 14..... | 54 |
| 8.1.1.6.15 | System Information Block type 15..... | 54 |
| 8.1.1.6.16 | System Information Block type 16..... | 56 |
| 8.1.1.6.17 | System Information Block type 17..... | 56 |
| 8.1.1.6.18 | System Information Block type 18..... | 57 |
| 8.1.1.7 | Modification of system information | 57 |
| 8.1.1.7.1 | Modification of system information blocks using a value tag..... | 57 |
| 8.1.1.7.2 | Synchronised modification of system information blocks | 57 |
| 8.1.1.7.3 | Actions upon system information change | 58 |
| 8.1.1.7.4 | Actions upon expiry of a system information expiry timer..... | 58 |
| 8.1.2 | Paging..... | 59 |
| 8.1.2.1 | General..... | 59 |
| 8.1.2.2 | Initiation..... | 59 |
| 8.1.2.3 | Reception of a PAGING TYPE 1 message by the UE..... | 59 |
| 8.1.3 | RRC connection establishment..... | 60 |
| 8.1.3.1 | General..... | 60 |
| 8.1.3.2 | Initiation..... | 61 |
| 8.1.3.3 | RRC CONNECTION REQUEST message contents to set | 61 |
| 8.1.3.4 | Reception of an RRC CONNECTION REQUEST message by the UTRAN..... | 61 |
| 8.1.3.5 | Cell re-selection or T300 timeout | 62 |
| 8.1.3.6 | Reception of an RRC CONNECTION SETUP message by the UE..... | 62 |
| 8.1.3.7 | Physical channel failure or cell re-selection | 64 |
| 8.1.3.8 | Invalid RRC CONNECTION SETUP message, unsupported configuration or invalid configuration | 65 |
| 8.1.3.9 | Reception of an RRC CONNECTION REJECT message by the UE..... | 65 |
| 8.1.3.10 | Invalid RRC CONNECTION REJECT message | 67 |
| 8.1.4 | RRC connection release..... | 68 |
| 8.1.4.1 | General..... | 69 |
| 8.1.4.2 | Initiation..... | 69 |
| 8.1.4.3 | Reception of an RRC CONNECTION RELEASE message by the UE | 69 |
| 8.1.4.4 | Invalid RRC CONNECTION RELEASE message | 71 |
| 8.1.4.5 | Cell re-selection or radio link failure | 71 |
| 8.1.4.6 | Expiry of timer T308, unacknowledged mode transmission..... | 71 |
| 8.1.4.7 | Void | 72 |
| 8.1.4.8 | Reception of an RRC CONNECTION RELEASE COMPLETE message by UTRAN..... | 72 |
| 8.1.4.9 | Unsuccessful transmission of the RRC CONNECTION RELEASE COMPLETE message, acknowledged mode transmission | 72 |
| 8.1.4.10 | Detection of loss of dedicated physical channel by UTRAN in CELL_DCH state | 72 |
| 8.1.4.11 | Failure to receive RRC CONNECTION RELEASE COMPLETE message by UTRAN..... | 72 |
| 8.1.5 | Void | 72 |
| 8.1.6 | Transmission of UE capability information..... | 73 |
| 8.1.6.1 | General..... | 73 |
| 8.1.6.2 | Initiation..... | 73 |
| 8.1.6.3 | Reception of an UE CAPABILITY INFORMATION message by the UTRAN..... | 74 |
| 8.1.6.4 | Reception of the UE CAPABILITY INFORMATION CONFIRM message by the UE..... | 74 |
| 8.1.6.5 | Invalid UE CAPABILITY INFORMATION CONFIRM message..... | 74 |
| 8.1.6.6 | T304 timeout..... | 74 |
| 8.1.7 | UE capability enquiry | 75 |
| 8.1.7.1 | General..... | 75 |
| 8.1.7.2 | Initiation..... | 75 |
| 8.1.7.3 | Reception of an UE CAPABILITY ENQUIRY message by the UE..... | 75 |
| 8.1.7.4 | Invalid UE CAPABILITY ENQUIRY message..... | 75 |
| 8.1.8 | Initial Direct transfer..... | 76 |
| 8.1.8.1 | General..... | 76 |
| 8.1.8.2 | Initiation of Initial direct transfer procedure in the UE..... | 76 |
| 8.1.8.3 | Reception of INITIAL DIRECT TRANSFER message by the UTRAN..... | 77 |
| 8.1.9 | Downlink Direct transfer | 77 |
| 8.1.9.1 | General..... | 77 |
| 8.1.9.2 | Initiation of downlink direct transfer procedure in the UTRAN..... | 77 |
| 8.1.9.3 | Reception of a DOWNLINK DIRECT TRANSFER message by the UE | 78 |
| 8.1.9.3a | No signalling connection exists..... | 78 |
| 8.1.9.4 | Invalid DOWNLINK DIRECT TRANSFER message | 78 |

| | | |
|------------|--|-----|
| 8.1.10 | Uplink Direct transfer | 79 |
| 8.1.10.1 | General | 79 |
| 8.1.10.2 | Initiation of uplink direct transfer procedure in the UE | 79 |
| 8.1.10.3 | Reception of UPLINK DIRECT TRANSFER message by the UTRAN | 80 |
| 8.1.11 | UE dedicated paging | 80 |
| 8.1.11.1 | General | 80 |
| 8.1.11.2 | Initiation | 80 |
| 8.1.11.3 | Reception of a PAGING TYPE 2 message by the UE | 80 |
| 8.1.11.4 | Invalid PAGING TYPE 2 message | 81 |
| 8.1.12 | Security mode control | 81 |
| 8.1.12.1 | General | 81 |
| 8.1.12.2 | Initiation | 81 |
| 8.1.12.2.1 | Ciphering configuration change | 81 |
| 8.1.12.2.2 | Integrity protection configuration change | 82 |
| 8.1.12.3 | Reception of SECURITY MODE COMMAND message by the UE | 82 |
| 8.1.12.4 | Void | 85 |
| 8.1.12.4a | Incompatible simultaneous security reconfiguration | 85 |
| 8.1.12.4b | Cell update procedure during security reconfiguration | 85 |
| 8.1.12.4c | Invalid configuration | 86 |
| 8.1.12.5 | Reception of SECURITY MODE COMPLETE message by the UTRAN | 87 |
| 8.1.12.6 | Invalid SECURITY MODE COMMAND message | 87 |
| 8.1.13 | Signalling connection release procedure | 88 |
| 8.1.13.1 | General | 88 |
| 8.1.13.2 | Initiation of SIGNALLING CONNECTION RELEASE by the UTRAN | 88 |
| 8.1.13.3 | Reception of SIGNALLING CONNECTION RELEASE by the UE | 88 |
| 8.1.13.4 | Invalid SIGNALLING CONNECTION RELEASE message | 88 |
| 8.1.14 | Signalling connection release request procedure | 89 |
| 8.1.14.1 | General | 89 |
| 8.1.14.2 | Initiation | 89 |
| 8.1.14.3 | Reception of SIGNALLING CONNECTION RELEASE REQUEST by the UTRAN | 89 |
| 8.1.15 | Counter check procedure | 90 |
| 8.1.15.1 | General | 90 |
| 8.1.15.2 | Initiation | 90 |
| 8.1.15.3 | Reception of a COUNTER CHECK message by the UE | 90 |
| 8.1.15.4 | Reception of the COUNTER CHECK RESPONSE message by UTRAN | 91 |
| 8.1.15.5 | Cell re-selection | 91 |
| 8.1.15.6 | Invalid COUNTER CHECK message | 91 |
| 8.2 | Radio Bearer control procedures | 91 |
| 8.2.1 | Radio bearer establishment | 91 |
| 8.2.2 | Reconfiguration procedures | 92 |
| 8.2.2.1 | General | 94 |
| 8.2.2.2 | Initiation | 94 |
| 8.2.2.3 | Reception of RADIO BEARER SETUP or RADIO BEARER RECONFIGURATION or RADIO BEARER RELEASE or TRANSPORT CHANNEL RECONFIGURATION or PHYSICAL CHANNEL RECONFIGURATION message by the UE | 95 |
| 8.2.2.4 | Transmission of a response message by the UE, normal case | 99 |
| 8.2.2.5 | Reception of a response message by the UTRAN, normal case | 100 |
| 8.2.2.6 | Unsupported configuration in the UE | 101 |
| 8.2.2.7 | Physical channel failure | 102 |
| 8.2.2.8 | Cell re-selection | 102 |
| 8.2.2.9 | Transmission of a response message by the UE, failure case | 103 |
| 8.2.2.10 | Reception of a response message by the UTRAN, failure case | 103 |
| 8.2.2.11 | Invalid configuration | 103 |
| 8.2.2.12 | Incompatible simultaneous reconfiguration | 104 |
| 8.2.2.12a | Incompatible simultaneous security reconfiguration | 104 |
| 8.2.2.12b | Cell update procedure during security reconfiguration | 105 |
| 8.2.2.13 | Invalid received message | 105 |
| 8.2.3 | Radio bearer release | 106 |
| 8.2.4 | Transport channel reconfiguration | 106 |
| 8.2.5 | Transport format combination control | 106 |
| 8.2.5.1 | General | 106 |
| 8.2.5.2 | Initiation | 106 |

| | | |
|-----------|---|-----|
| 8.2.5.3 | Reception of a TRANSPORT FORMAT COMBINATION CONTROL message by the UE..... | 107 |
| 8.2.5.4 | Invalid configuration..... | 107 |
| 8.2.5.5 | Invalid TRANSPORT FORMAT COMBINATION CONTROL message..... | 108 |
| 8.2.6 | Physical channel reconfiguration..... | 108 |
| 8.2.7 | Physical Shared Channel Allocation [TDD only]..... | 109 |
| 8.2.7.1 | General..... | 109 |
| 8.2.7.2 | Initiation..... | 109 |
| 8.2.7.3 | Reception of a PHYSICAL SHARED CHANNEL ALLOCATION message by the UE..... | 109 |
| 8.2.7.4 | Invalid PHYSICAL SHARED CHANNEL ALLOCATION message..... | 111 |
| 8.2.8 | PUSCH capacity request [TDD only]..... | 111 |
| 8.2.8.1 | General..... | 111 |
| 8.2.8.2 | Initiation..... | 112 |
| 8.2.8.3 | PUSCH CAPACITY REQUEST message contents to set..... | 112 |
| 8.2.8.4 | Reception of a PUSCH CAPACITY REQUEST message by the UTRAN..... | 113 |
| 8.2.8.5 | T310 expiry..... | 113 |
| 8.2.9 | Void..... | 113 |
| 8.2.10 | Uplink Physical Channel Control [TDD only]..... | 114 |
| 8.2.10.1 | General..... | 114 |
| 8.2.10.2 | Initiation..... | 114 |
| 8.2.10.3 | Reception of UPLINK PHYSICAL CHANNEL CONTROL message by the UE..... | 114 |
| 8.2.10.4 | Invalid UPLINK PHYSICAL CHANNEL CONTROL message..... | 114 |
| 8.2.11 | Physical channel reconfiguration failure..... | 115 |
| 8.2.11.1 | General..... | 115 |
| 8.2.11.2 | Runtime error due to overlapping compressed mode configurations..... | 115 |
| 8.2.11.3 | Runtime error due to overlapping compressed mode configuration and PDSCH reception..... | 116 |
| 8.3 | RRC connection mobility procedures..... | 116 |
| 8.3.1 | Cell and URA update procedures..... | 116 |
| 8.3.1.1 | General..... | 118 |
| 8.3.1.2 | Initiation..... | 119 |
| 8.3.1.3 | CELL UPDATE / URA UPDATE message contents to set..... | 122 |
| 8.3.1.4 | T305 expiry and the UE detects "out of service area"..... | 123 |
| 8.3.1.4.1 | Re-entering "in service area"..... | 123 |
| 8.3.1.4.2 | Expiry of timer T307..... | 124 |
| 8.3.1.5 | Reception of an CELL UPDATE/URA UPDATE message by the UTRAN..... | 124 |
| 8.3.1.6 | Reception of the CELL UPDATE CONFIRM/URA UPDATE CONFIRM message by the UE..... | 125 |
| 8.3.1.7 | Transmission of a response message to UTRAN..... | 129 |
| 8.3.1.7a | Physical channel failure..... | 131 |
| 8.3.1.8 | Unsupported configuration by the UE..... | 133 |
| 8.3.1.9 | Invalid configuration..... | 134 |
| 8.3.1.9a | Incompatible simultaneous reconfiguration..... | 135 |
| 8.3.1.10 | Confirmation error of URA ID list..... | 136 |
| 8.3.1.11 | Invalid CELL UPDATE CONFIRM/URA UPDATE CONFIRM message..... | 137 |
| 8.3.1.12 | T302 expiry or cell reselection..... | 138 |
| 8.3.1.13 | T314 expiry..... | 140 |
| 8.3.1.14 | T315 expiry..... | 141 |
| 8.3.1.15 | Reception of the UTRAN MOBILITY INFORMATION CONFIRM message by the UTRAN..... | 141 |
| 8.3.2 | URA update..... | 141 |
| 8.3.3 | UTRAN mobility information..... | 142 |
| 8.3.3.1 | General..... | 142 |
| 8.3.3.2 | Initiation..... | 142 |
| 8.3.3.3 | Reception of UTRAN MOBILITY INFORMATION message by the UE..... | 142 |
| 8.3.3.4 | Reception of an UTRAN MOBILITY INFORMATION CONFIRM message by the UTRAN..... | 144 |
| 8.3.3.5 | Cell re-selection..... | 144 |
| 8.3.3.5a | Incompatible simultaneous security reconfiguration..... | 144 |
| 8.3.3.6 | Invalid UTRAN MOBILITY INFORMATION message..... | 145 |
| 8.3.4 | Active set update..... | 145 |
| 8.3.4.1 | General..... | 145 |
| 8.3.4.2 | Initiation..... | 146 |
| 8.3.4.3 | Reception of an ACTIVE SET UPDATE message by the UE..... | 146 |
| 8.3.4.4 | Unsupported configuration in the UE..... | 147 |
| 8.3.4.5 | Invalid configuration..... | 148 |
| 8.3.4.5a | Incompatible simultaneous reconfiguration..... | 148 |

| | | |
|-----------|--|-----|
| 8.3.4.6 | Reception of the ACTIVE SET UPDATE COMPLETE message by the UTRAN..... | 149 |
| 8.3.4.7 | Reception of the ACTIVE SET UPDATE FAILURE message by the UTRAN..... | 149 |
| 8.3.4.8 | Invalid ACTIVE SET UPDATE message..... | 149 |
| 8.3.4.9 | Reception of an ACTIVE SET UPDATE message in wrong state..... | 150 |
| 8.3.5 | Hard handover..... | 150 |
| 8.3.5.1 | Timing re-initialised hard handover..... | 150 |
| 8.3.5.1.1 | General..... | 150 |
| 8.3.5.1.2 | Initiation..... | 150 |
| 8.3.5.2 | Timing-maintained hard handover..... | 151 |
| 8.3.5.2.1 | General..... | 151 |
| 8.3.5.2.2 | Initiation..... | 151 |
| 8.3.6 | Inter-RAT handover to UTRAN..... | 152 |
| 8.3.6.1 | General..... | 152 |
| 8.3.6.2 | Initiation..... | 152 |
| 8.3.6.3 | Reception of HANDOVER TO UTRAN COMMAND message by the UE..... | 153 |
| 8.3.6.4 | Invalid Handover to UTRAN command message..... | 155 |
| 8.3.6.4a | Unsupported configuration in HANDOVER TO UTRAN COMMAND message..... | 156 |
| 8.3.6.5 | UE fails to perform handover..... | 156 |
| 8.3.6.6 | Reception of message HANDOVER TO UTRAN COMPLETE by the UTRAN..... | 156 |
| 8.3.7 | Inter-RAT handover from UTRAN..... | 156 |
| 8.3.7.1 | General..... | 156 |
| 8.3.7.2 | Initiation..... | 157 |
| 8.3.7.3 | Reception of a HANDOVER FROM UTRAN COMMAND message by the UE..... | 157 |
| 8.3.7.4 | Successful completion of the inter-RAT handover..... | 157 |
| 8.3.7.5 | UE fails to complete requested handover..... | 158 |
| 8.3.7.6 | Invalid HANDOVER FROM UTRAN COMMAND message..... | 158 |
| 8.3.7.7 | Reception of an HANDOVER FROM UTRAN FAILURE message by UTRAN..... | 159 |
| 8.3.7.8 | Unsupported configuration in HANDOVER FROM UTRAN COMMAND message..... | 159 |
| 8.3.7.8a | Reception of HANDOVER FROM UTRAN COMMAND message by UE in CELL_FACH..... | 159 |
| 8.3.8 | Inter-RAT cell reselection to UTRAN..... | 160 |
| 8.3.8.1 | General..... | 160 |
| 8.3.8.2 | Initiation..... | 160 |
| 8.3.8.3 | UE fails to complete an inter-RAT cell reselection..... | 160 |
| 8.3.9 | Inter-RAT cell reselection from UTRAN..... | 160 |
| 8.3.9.1 | General..... | 160 |
| 8.3.9.2 | Initiation..... | 160 |
| 8.3.9.3 | Successful cell reselection..... | 161 |
| 8.3.9.4 | Expiry of timer T309..... | 161 |
| 8.3.10 | Inter-RAT cell change order to UTRAN..... | 161 |
| 8.3.10.1 | General..... | 161 |
| 8.3.10.2 | Initiation..... | 161 |
| 8.3.10.3 | UE fails to complete an inter-RAT cell change order..... | 161 |
| 8.3.11 | Inter-RAT cell change order from UTRAN..... | 162 |
| 8.3.11.1 | General..... | 162 |
| 8.3.11.2 | Initiation..... | 162 |
| 8.3.11.3 | Reception of an CELL CHANGE ORDER FROM UTRAN message by the UE..... | 162 |
| 8.3.11.4 | Successful completion of the cell change order..... | 163 |
| 8.3.11.5 | Expiry of timer T309 or UE fails to complete requested cell change order..... | 163 |
| 8.3.11.6 | Unsupported configuration in CELL CHANGE ORDER FROM UTRAN message..... | 164 |
| 8.3.11.7 | Invalid CELL CHANGE ORDER FROM UTRAN message..... | 164 |
| 8.4 | Measurement procedures..... | 165 |
| 8.4.1 | Measurement control..... | 167 |
| 8.4.1.1 | General..... | 167 |
| 8.4.1.2 | Initiation..... | 167 |
| 8.4.1.3 | Reception of MEASUREMENT CONTROL by the UE..... | 167 |
| 8.4.1.4 | Unsupported measurement in the UE..... | 169 |
| 8.4.1.4a | Configuration Incomplete..... | 169 |
| 8.4.1.5 | Invalid MEASUREMENT CONTROL message..... | 169 |
| 8.4.1.6 | Measurements after transition from CELL_DCH to CELL_FACH/CELL_PCH/URA_PCH state..... | 170 |
| 8.4.1.6.1 | Intra-frequency measurement..... | 170 |
| 8.4.1.6.2 | Inter-frequency measurement..... | 170 |
| 8.4.1.6.3 | Inter-RAT measurement..... | 170 |

| | | |
|------------|---|-----|
| 8.4.1.6.4 | Quality measurement..... | 170 |
| 8.4.1.6.5 | UE internal measurement | 171 |
| 8.4.1.6.6 | Traffic volume measurement..... | 171 |
| 8.4.1.7 | Measurements after transition from CELL_FACH to CELL_DCH state | 171 |
| 8.4.1.7.1 | Intra-frequency measurement..... | 172 |
| 8.4.1.7.2 | Inter-frequency measurement..... | 172 |
| 8.4.1.7.3 | Inter-RAT measurement..... | 172 |
| 8.4.1.7.4 | Traffic volume measurement..... | 172 |
| 8.4.1.8 | Measurements after transition from idle mode to CELL_DCH state..... | 173 |
| 8.4.1.8.1 | Intra-frequency measurement..... | 173 |
| 8.4.1.8.2 | Inter-frequency measurement..... | 173 |
| 8.4.1.8.3 | Inter-RAT measurement..... | 173 |
| 8.4.1.8.4 | Traffic volume measurement..... | 174 |
| 8.4.1.9 | Measurements after transition from idle mode to CELL_FACH state..... | 174 |
| 8.4.1.9.1 | Intra-frequency measurement..... | 174 |
| 8.4.1.9.2 | Inter-frequency measurement..... | 174 |
| 8.4.1.9.3 | Inter-RAT measurement..... | 174 |
| 8.4.1.9.4 | Traffic volume measurement..... | 174 |
| 8.4.1.9a | Measurements after transition from connected mode to idle mode..... | 174 |
| 8.4.1.9a.1 | Intra-frequency measurement..... | 175 |
| 8.4.1.9a.2 | Inter-frequency measurement..... | 175 |
| 8.4.1.9a.3 | Inter-RAT measurement..... | 175 |
| 8.4.1.10 | Measurements when measurement object is no longer valid | 175 |
| 8.4.1.10.1 | Traffic volume measurement..... | 175 |
| 8.4.2 | Measurement report | 175 |
| 8.4.2.1 | General..... | 175 |
| 8.4.2.2 | Initiation..... | 175 |
| 8.4.3 | Assistance Data Delivery..... | 177 |
| 8.4.3.1 | General..... | 177 |
| 8.4.3.2 | Initiation..... | 177 |
| 8.4.3.3 | Reception of ASSISTANCE DATA DELIVERY message by the UE | 177 |
| 8.4.3.4 | Invalid ASSISTANCE DATA DELIVERY message..... | 177 |
| 8.5 | General procedures..... | 178 |
| 8.5.1 | Selection of initial UE identity | 178 |
| 8.5.2 | Actions when entering idle mode from connected mode..... | 178 |
| 8.5.3 | Open loop power control upon establishment of DPCCCH | 179 |
| 8.5.4 | Physical channel establishment criteria | 179 |
| 8.5.5 | Actions in "out of service area" and "in service area" | 179 |
| 8.5.5.1 | Detection of "out of service" area | 179 |
| 8.5.5.1.1 | Actions following detection of "out of service" area in URA_PCH or CELL_PCH state | 179 |
| 8.5.5.1.2 | Actions following detection of "out of service" area in CELL_FACH state..... | 179 |
| 8.5.5.2 | Detection of "in service" area | 180 |
| 8.5.5.2.1 | Actions following Re-entry into "in service area" in URA_PCH or CELL_PCH state | 180 |
| 8.5.5.2.2 | Actions following re-entry into "in service area" in CELL_FACH state | 180 |
| 8.5.5.3 | T316 expiry..... | 180 |
| 8.5.5.4 | T317 expiry..... | 180 |
| 8.5.6 | Radio link failure criteria and actions upon radio link failure | 181 |
| 8.5.7 | Open loop power control | 181 |
| 8.5.8 | Maintenance of Hyper Frame Numbers..... | 183 |
| 8.5.9 | START value calculation..... | 184 |
| 8.5.10 | Integrity protection | 184 |
| 8.5.10.1 | Integrity protection in downlink..... | 185 |
| 8.5.10.2 | Integrity protection in uplink..... | 186 |
| 8.5.10.3 | Calculation of message authentication code..... | 186 |
| 8.5.11 | FACH measurement occasion calculation | 187 |
| 8.5.12 | Establishment of Access Service Classes | 187 |
| 8.5.13 | Mapping of Access Classes to Access Service Classes | 188 |
| 8.5.14 | PLMN Type Selection | 188 |
| 8.5.14a | Neighbour cells list narrowing for cell reselection | 188 |
| 8.5.15 | CFN calculation | 189 |
| 8.5.15.1 | Initialisation for CELL_DCH state after state transition..... | 189 |
| 8.5.15.2 | Initialisation in CELL_DCH state at hard handover | 189 |

| | | |
|----------|---|-----|
| 8.5.15.3 | Initialisation for CELL_FACH | 189 |
| 8.5.15.4 | Initialisation after intersystem handover to UTRAN | 189 |
| 8.5.16 | Configuration of CTCH occasions..... | 190 |
| 8.5.17 | PRACH selection..... | 190 |
| 8.5.18 | Selection of RACH TTI..... | 191 |
| 8.5.18.1 | FDD Mode | 191 |
| 8.5.18.2 | 1.28Mcps TDD..... | 192 |
| 8.5.19 | Secondary CCPCH selection | 192 |
| 8.6 | Generic actions on receipt and absence of an information element..... | 193 |
| 8.6.1 | CN information elements..... | 193 |
| 8.6.1.1 | Void | 193 |
| 8.6.1.2 | CN information info..... | 193 |
| 8.6.1.3 | Signalling connection release indication..... | 193 |
| 8.6.2 | UTRAN mobility information elements | 194 |
| 8.6.2.1 | URA identity..... | 194 |
| 8.6.2.2 | Mapping info | 194 |
| 8.6.3 | UE information elements | 194 |
| 8.6.3.1 | Activation time | 194 |
| 8.6.3.1a | CN domain specific DRX cycle length coefficient | 195 |
| 8.6.3.2 | UTRAN DRX Cycle length coefficient | 195 |
| 8.6.3.3 | Generic state transition rules depending on received information elements | 196 |
| 8.6.3.4 | Ciphering mode info | 196 |
| 8.6.3.5 | Integrity protection mode info | 198 |
| 8.6.3.6 | Void | 200 |
| 8.6.3.7 | Void | 200 |
| 8.6.3.8 | Integrity check info..... | 200 |
| 8.6.3.9 | New C-RNTI | 200 |
| 8.6.3.10 | New U-RNTI..... | 200 |
| 8.6.3.11 | RRC transaction identifier..... | 201 |
| 8.6.3.12 | Capability Update Requirement | 204 |
| 8.6.4 | Radio bearer information elements | 205 |
| 8.6.4.1 | Signalling RB information to setup list..... | 205 |
| 8.6.4.2 | RAB information for setup | 206 |
| 8.6.4.2a | RAB information to reconfigure | 206 |
| 8.6.4.3 | RB information to setup..... | 207 |
| 8.6.4.4 | RB information to be affected..... | 207 |
| 8.6.4.5 | RB information to reconfigure..... | 207 |
| 8.6.4.6 | RB information to release | 208 |
| 8.6.4.7 | RB with PDCP information | 208 |
| 8.6.4.8 | RB mapping info..... | 208 |
| 8.6.4.9 | RLC Info..... | 211 |
| 8.6.4.10 | PDCP Info | 211 |
| 8.6.4.11 | PDCP SN Info | 211 |
| 8.6.4.12 | NAS Synchronisation Indicator..... | 211 |
| 8.6.5 | Transport channel information elements..... | 211 |
| 8.6.5.1 | Transport Format Set | 211 |
| 8.6.5.2 | Transport format combination set..... | 213 |
| 8.6.5.3 | Transport format combination subset | 214 |
| 8.6.5.4 | DCH quality target..... | 215 |
| 8.6.5.5 | Added or Reconfigured UL TrCH information | 215 |
| 8.6.5.6 | Added or Reconfigured DL TrCH information | 215 |
| 8.6.5.7 | Deleted UL TrCH information..... | 216 |
| 8.6.5.8 | Deleted DL TrCH information..... | 216 |
| 8.6.5.9 | UL Transport channel information common for all transport channels | 216 |
| 8.6.5.10 | DL Transport channel information common for all transport channels | 217 |
| 8.6.5.11 | DRAC static information | 217 |
| 8.6.5.12 | TFCS Reconfiguration/Addition Information | 218 |
| 8.6.5.13 | TFCS Removal Information..... | 218 |
| 8.6.5.14 | TFCS Field 2 Information..... | 218 |
| 8.6.5.15 | TFCS Explicit Configuration | 218 |
| 8.6.6 | Physical channel information elements..... | 219 |
| 8.6.6.1 | Frequency info..... | 219 |

| | | |
|-----------|--|-----|
| 8.6.6.2 | Void | 219 |
| 8.6.6.2a | PNBSCH allocation | 219 |
| 8.6.6.3 | Void | 219 |
| 8.6.6.4 | Downlink information for each radio link | 220 |
| 8.6.6.5 | Void | 220 |
| 8.6.6.6 | Uplink DPCH info | 220 |
| 8.6.6.7 | Void | 220 |
| 8.6.6.8 | Maximum allowed UL TX power..... | 220 |
| 8.6.6.9 | PDSCH with SHO DCH Info (FDD only)..... | 221 |
| 8.6.6.10 | PDSCH code mapping (FDD only)..... | 221 |
| 8.6.6.11 | Uplink DPCH power control info | 223 |
| 8.6.6.12 | Secondary CPICH info..... | 223 |
| 8.6.6.13 | Primary CPICH usage for channel estimation..... | 223 |
| 8.6.6.14 | DPCH frame offset..... | 224 |
| 8.6.6.15 | DPCH Compressed mode info | 224 |
| 8.6.6.16 | Repetition period, Repetition length, Offset (TDD only)..... | 226 |
| 8.6.6.17 | Primary CCPCH info | 226 |
| 8.6.6.18 | Primary CPICH info..... | 226 |
| 8.6.6.19 | CPCH SET Info (FDD only)..... | 226 |
| 8.6.6.20 | CPCH set ID (FDD only)..... | 227 |
| 8.6.6.21 | Default DPCH Offset Value..... | 227 |
| 8.6.6.22 | Secondary Scrambling Code, Code Number..... | 227 |
| 8.6.6.23 | PDSCH Power Control info | 228 |
| 8.6.6.24 | Tx Diversity Mode | 228 |
| 8.6.6.25 | SSDT Information..... | 228 |
| 8.6.6.26 | UL Timing Advance Control (TDD only)..... | 228 |
| 8.6.6.26a | Uplink synchronisation parameters | 228 |
| 8.6.6.27 | Downlink information common for all radio links..... | 229 |
| 8.6.6.28 | Downlink DPCH info common for all radio links | 229 |
| 8.6.6.29 | ASC setting | 230 |
| 8.6.6.30 | SRB delay, PC preamble..... | 231 |
| 8.6.6.31 | FPACH/PRACH Selection (1.28 Mcps TDD only) | 231 |
| 8.6.7 | Measurement information elements..... | 231 |
| 8.6.7.1 | Measurement validity | 231 |
| 8.6.7.2 | Filter coefficient..... | 232 |
| 8.6.7.3 | Intra-frequency/Inter-frequency/Inter-RAT cell info list | 232 |
| 8.6.7.4 | Intra-frequency measurement quantity | 238 |
| 8.6.7.5 | Inter-RAT measurement quantity | 238 |
| 8.6.7.6 | Inter-RAT reporting quantity | 238 |
| 8.6.7.7 | Cell Reporting Quantities | 239 |
| 8.6.7.8 | Periodical Reporting Criteria | 240 |
| 8.6.7.9 | Reporting Cell Status | 240 |
| 8.6.7.10 | Traffic Volume Measurement | 241 |
| 8.6.7.11 | Traffic Volume Measurement Reporting Criteria | 241 |
| 8.6.7.12 | FACH measurement occasion info..... | 242 |
| 8.6.7.13 | Measurement Reporting Mode..... | 242 |
| 8.6.7.14 | Inter-frequency measurement..... | 243 |
| 8.6.7.15 | Inter-RAT measurement..... | 243 |
| 8.6.7.16 | Intra-frequency measurement..... | 243 |
| 8.6.7.17 | Quality measurement..... | 243 |
| 8.6.7.18 | UE internal measurement | 243 |
| 8.6.7.19 | UE positioning GPS real-time integrity | 244 |
| 8.6.7.20 | UE positioning OTDOA neighbour cell info | 244 |
| 8.6.8 | Void | 244 |
| 9 | Handling of unknown, unforeseen and erroneous protocol data | 244 |
| 9.1 | General | 244 |
| 9.2 | ASN.1 violation or encoding error | 244 |
| 9.3 | Unknown or unforeseen message type | 245 |
| 9.3a | Unsolicited received message | 245 |
| 9.3b | Unexpected critical message extension..... | 246 |
| 9.4 | Unknown or unforeseen information element value, mandatory information element | 246 |

| | | |
|------------|--|-----|
| 9.5 | Conditional information element error | 247 |
| 9.6 | Unknown or unforeseen information element value, conditional information element | 247 |
| 9.7 | Unknown or unforeseen information element value, optional information element | 248 |
| 9.8 | Unexpected non-critical message extension | 248 |
| 10 | Message and information element functional definition and content | 250 |
| 10.1 | General..... | 250 |
| 10.1.1 | Protocol extensions | 251 |
| 10.1.1.1 | Non-critical extensions..... | 254 |
| 10.1.1.1.1 | Extension of an information element with additional values or choices | 254 |
| 10.1.1.1.2 | Extension of a message with additional information elements | 254 |
| 10.1.1.2 | Critical extensions..... | 254 |
| 10.1.1.2.1 | Extension of an information element with additional values or choices | 254 |
| 10.1.1.2.2 | Extension of a message with additional information elements | 254 |
| 10.2 | Radio Resource Control messages..... | 254 |
| 10.2.1 | ACTIVE SET UPDATE..... | 254 |
| 10.2.2 | ACTIVE SET UPDATE COMPLETE..... | 256 |
| 10.2.3 | ACTIVE SET UPDATE FAILURE | 256 |
| 10.2.4 | ASSISTANCE DATA DELIVERY | 257 |
| 10.2.5 | CELL CHANGE ORDER FROM UTRAN | 257 |
| 10.2.6 | CELL CHANGE ORDER FROM UTRAN FAILURE..... | 258 |
| 10.2.7 | CELL UPDATE..... | 259 |
| 10.2.8 | CELL UPDATE CONFIRM..... | 260 |
| 10.2.9 | COUNTER CHECK | 263 |
| 10.2.10 | COUNTER CHECK RESPONSE | 264 |
| 10.2.11 | DOWNLINK DIRECT TRANSFER..... | 264 |
| 10.2.12 | HANDOVER TO UTRAN COMMAND..... | 265 |
| 10.2.13 | HANDOVER TO UTRAN COMPLETE..... | 268 |
| 10.2.14 | INITIAL DIRECT TRANSFER | 268 |
| 10.2.15 | HANDOVER FROM UTRAN COMMAND..... | 269 |
| 10.2.16 | HANDOVER FROM UTRAN FAILURE | 271 |
| 10.2.17 | MEASUREMENT CONTROL | 271 |
| 10.2.18 | MEASUREMENT CONTROL FAILURE | 272 |
| 10.2.19 | MEASUREMENT REPORT..... | 273 |
| 10.2.20 | PAGING TYPE 1 | 274 |
| 10.2.21 | PAGING TYPE 2 | 274 |
| 10.2.22 | PHYSICAL CHANNEL RECONFIGURATION | 275 |
| 10.2.23 | PHYSICAL CHANNEL RECONFIGURATION COMPLETE | 277 |
| 10.2.24 | PHYSICAL CHANNEL RECONFIGURATION FAILURE | 278 |
| 10.2.25 | PHYSICAL SHARED CHANNEL ALLOCATION | 279 |
| 10.2.26 | PUSCH CAPACITY REQUEST..... | 280 |
| 10.2.27 | RADIO BEARER RECONFIGURATION | 281 |
| 10.2.28 | RADIO BEARER RECONFIGURATION COMPLETE | 284 |
| 10.2.29 | RADIO BEARER RECONFIGURATION FAILURE | 285 |
| 10.2.30 | RADIO BEARER RELEASE..... | 286 |
| 10.2.31 | RADIO BEARER RELEASE COMPLETE..... | 289 |
| 10.2.32 | RADIO BEARER RELEASE FAILURE..... | 291 |
| 10.2.33 | RADIO BEARER SETUP..... | 291 |
| 10.2.34 | RADIO BEARER SETUP COMPLETE..... | 294 |
| 10.2.35 | RADIO BEARER SETUP FAILURE | 296 |
| 10.2.36 | RRC CONNECTION REJECT | 296 |
| 10.2.37 | RRC CONNECTION RELEASE | 297 |
| 10.2.38 | RRC CONNECTION RELEASE COMPLETE..... | 298 |
| 10.2.39 | RRC CONNECTION REQUEST..... | 298 |
| 10.2.40 | RRC CONNECTION SETUP | 299 |
| 10.2.41 | RRC CONNECTION SETUP COMPLETE | 301 |
| 10.2.42 | RRC STATUS | 302 |
| 10.2.43 | SECURITY MODE COMMAND..... | 303 |
| 10.2.44 | SECURITY MODE COMPLETE..... | 304 |
| 10.2.45 | SECURITY MODE FAILURE | 305 |
| 10.2.46 | SIGNALLING CONNECTION RELEASE..... | 305 |
| 10.2.47 | SIGNALLING CONNECTION RELEASE REQUEST | 306 |

| | | |
|----------------|---|-----|
| 10.2.48 | SYSTEM INFORMATION..... | 307 |
| 10.2.48.1 | First Segment | 308 |
| 10.2.48.2 | First Segment (short)..... | 308 |
| 10.2.48.3 | Subsequent Segment | 309 |
| 10.2.48.4 | Last Segment..... | 309 |
| 10.2.48.5 | Last Segment (short) | 309 |
| 10.2.48.6 | Complete SIB | 310 |
| 10.2.48.7 | Complete SIB (short) | 310 |
| 10.2.48.8 | System Information Blocks..... | 310 |
| 10.2.48.8.1 | Master Information Block | 311 |
| 10.2.48.8.2 | Scheduling Block 1..... | 311 |
| 10.2.48.8.3 | Scheduling Block 2..... | 311 |
| 10.2.48.8.4 | System Information Block type 1 | 312 |
| 10.2.48.8.5 | System Information Block type 2..... | 312 |
| 10.2.48.8.6 | System Information Block type 3..... | 312 |
| 10.2.48.8.7 | System Information Block type 4..... | 313 |
| 10.2.48.8.8 | System Information Block type 5..... | 313 |
| 10.2.48.8.9 | System Information Block type 6..... | 314 |
| 10.2.48.8.10 | System Information Block type 7..... | 315 |
| 10.2.48.8.11 | System Information Block type 8..... | 316 |
| 10.2.48.8.12 | System Information Block type 9..... | 316 |
| 10.2.48.8.13 | System Information Block type 10..... | 317 |
| 10.2.48.8.14 | System Information Block type 11..... | 317 |
| 10.2.48.8.15 | System Information Block type 12..... | 317 |
| 10.2.48.8.16 | System Information Block type 13..... | 318 |
| 10.2.48.8.16.1 | System Information Block type 13.1..... | 318 |
| 10.2.48.8.16.2 | System Information Block type 13.2..... | 318 |
| 10.2.48.8.16.3 | System Information Block type 13.3..... | 319 |
| 10.2.48.8.16.4 | System Information Block type 13.4..... | 319 |
| 10.2.48.8.17 | System Information Block type 14..... | 319 |
| 10.2.48.8.18 | System Information Block type 15..... | 319 |
| 10.2.48.8.18.1 | System Information Block type 15.1..... | 320 |
| 10.2.48.8.18.2 | System Information Block type 15.2..... | 320 |
| 10.2.48.8.18.3 | System Information Block type 15.3..... | 321 |
| 10.2.48.8.18.4 | System Information Block type 15.4..... | 321 |
| 10.2.48.8.19 | System Information Block type 16..... | 321 |
| 10.2.48.8.20 | System Information Block type 17..... | 322 |
| 10.2.48.8.21 | System Information Block type 18..... | 322 |
| 10.2.49 | SYSTEM INFORMATION CHANGE INDICATION..... | 322 |
| 10.2.50 | TRANSPORT CHANNEL RECONFIGURATION | 323 |
| 10.2.51 | TRANSPORT CHANNEL RECONFIGURATION COMPLETE | 326 |
| 10.2.52 | TRANSPORT CHANNEL RECONFIGURATION FAILURE..... | 327 |
| 10.2.53 | TRANSPORT FORMAT COMBINATION CONTROL..... | 328 |
| 10.2.54 | TRANSPORT FORMAT COMBINATION CONTROL FAILURE..... | 329 |
| 10.2.55 | UE CAPABILITY ENQUIRY | 330 |
| 10.2.56 | UE CAPABILITY INFORMATION | 330 |
| 10.2.57 | UE CAPABILITY INFORMATION CONFIRM | 331 |
| 10.2.58 | UPLINK DIRECT TRANSFER..... | 331 |
| 10.2.59 | UPLINK PHYSICAL CHANNEL CONTROL..... | 332 |
| 10.2.60 | URA UPDATE | 334 |
| 10.2.61 | URA UPDATE CONFIRM..... | 334 |
| 10.2.62 | UTRAN MOBILITY INFORMATION | 335 |
| 10.2.63 | UTRAN MOBILITY INFORMATION CONFIRM..... | 336 |
| 10.2.64 | UTRAN MOBILITY INFORMATION FAILURE..... | 337 |
| 10.3 | Information element functional definitions..... | 338 |
| 10.3.1 | CN Information elements..... | 338 |
| 10.3.1.1 | CN domain identity | 338 |
| 10.3.1.2 | CN Domain System Information..... | 338 |
| 10.3.1.3 | CN Information info..... | 339 |
| 10.3.1.3a | CN Information info full | 339 |
| 10.3.1.4 | IMEI..... | 339 |
| 10.3.1.5 | IMSI (GSM-MAP)..... | 340 |

| | | |
|------------|---|-----|
| 10.3.1.6 | Intra Domain NAS Node Selector | 340 |
| 10.3.1.7 | Location Area Identification | 342 |
| 10.3.1.8 | NAS message | 342 |
| 10.3.1.9 | NAS system information (GSM-MAP) | 342 |
| 10.3.1.10 | Paging record type identifier | 343 |
| 10.3.1.11 | PLMN identity | 343 |
| 10.3.1.12 | PLMN Type | 343 |
| 10.3.1.13 | P-TMSI (GSM-MAP) | 343 |
| 10.3.1.14 | RAB identity | 344 |
| 10.3.1.15 | Routing Area Code | 344 |
| 10.3.1.16 | Routing Area Identification | 344 |
| 10.3.1.17 | TMSI (GSM-MAP) | 344 |
| 10.3.2 | UTRAN mobility Information elements | 345 |
| 10.3.2.1 | Cell Access Restriction | 345 |
| 10.3.2.2 | Cell identity | 345 |
| 10.3.2.3 | Cell selection and re-selection info for SIB3/4 | 346 |
| 10.3.2.4 | Cell selection and re-selection info for SIB11/12 | 348 |
| 10.3.2.5 | Mapping Info | 349 |
| 10.3.2.6 | URA identity | 350 |
| 10.3.3 | UE Information elements | 350 |
| 10.3.3.1 | Activation time | 350 |
| 10.3.3.2 | Capability Update Requirement | 350 |
| 10.3.3.3 | Cell update cause | 351 |
| 10.3.3.4 | Ciphering Algorithm | 351 |
| 10.3.3.5 | Ciphering mode info | 351 |
| 10.3.3.6 | CN domain specific DRX cycle length coefficient | 352 |
| 10.3.3.7 | CPCH Parameters | 352 |
| 10.3.3.8 | C-RNTI | 354 |
| 10.3.3.9 | DRAC system information | 354 |
| 10.3.3.10 | RRC State Indicator | 354 |
| 10.3.3.11 | Establishment cause | 354 |
| 10.3.3.12 | Expiration Time Factor | 355 |
| 10.3.3.13 | Failure cause | 355 |
| 10.3.3.14 | Failure cause and error information | 356 |
| 10.3.3.15 | Initial UE identity | 356 |
| 10.3.3.16 | Integrity check info | 357 |
| 10.3.3.17 | Integrity protection activation info | 358 |
| 10.3.3.18 | Integrity protection Algorithm | 358 |
| 10.3.3.19 | Integrity protection mode info | 359 |
| 10.3.3.20 | Maximum bit rate | 359 |
| 10.3.3.21 | Measurement capability | 360 |
| 10.3.3.21a | Measurement capability extension | 362 |
| 10.3.3.22 | Paging cause | 364 |
| 10.3.3.23 | Paging record | 365 |
| 10.3.3.24 | PDCP capability | 365 |
| 10.3.3.25 | Physical channel capability | 367 |
| 10.3.3.26 | Protocol error cause | 369 |
| 10.3.3.27 | Protocol error indicator | 369 |
| 10.3.3.28 | RB timer indicator | 370 |
| 10.3.3.29 | Redirection info | 370 |
| 10.3.3.30 | Re-establishment timer | 370 |
| 10.3.3.31 | Rejection cause | 370 |
| 10.3.3.32 | Release cause | 370 |
| 10.3.3.33 | RF capability FDD | 371 |
| 10.3.3.33a | RF capability FDD extension | 371 |
| 10.3.3.33b | RF capability TDD | 371 |
| 10.3.3.34 | RLC capability | 372 |
| 10.3.3.35 | RLC re-establish indicator | 372 |
| 10.3.3.36 | RRC transaction identifier | 372 |
| 10.3.3.37 | Security capability | 372 |
| 10.3.3.38 | START | 373 |
| 10.3.3.39 | Transmission probability | 373 |

| | | |
|------------|--|-----|
| 10.3.3.40 | Transport channel capability | 374 |
| 10.3.3.41 | UE multi-mode/multi-RAT capability | 375 |
| 10.3.3.42 | UE radio access capability | 376 |
| 10.3.3.42a | UE radio access capability extension | 377 |
| 10.3.3.43 | UE Timers and Constants in connected mode..... | 377 |
| 10.3.3.44 | UE Timers and Constants in idle mode..... | 379 |
| 10.3.3.45 | UE positioning capability..... | 380 |
| 10.3.3.46 | URA update cause..... | 380 |
| 10.3.3.47 | U-RNTI | 380 |
| 10.3.3.48 | U-RNTI Short | 380 |
| 10.3.3.49 | UTRAN DRX cycle length coefficient | 381 |
| 10.3.3.50 | Wait time..... | 381 |
| 10.3.4 | Radio Bearer Information elements | 381 |
| 10.3.4.0 | Default configuration identity | 381 |
| 10.3.4.1 | Downlink RLC STATUS info..... | 381 |
| 10.3.4.2 | PDCP info | 382 |
| 10.3.4.3 | PDCP SN info | 384 |
| 10.3.4.4 | Polling info..... | 385 |
| 10.3.4.5 | Predefined configuration identity | 385 |
| 10.3.4.6 | Predefined configuration value tag..... | 385 |
| 10.3.4.7 | Predefined RB configuration..... | 385 |
| 10.3.4.8 | RAB info | 386 |
| 10.3.4.9 | RAB info Post | 386 |
| 10.3.4.10 | RAB information for setup..... | 387 |
| 10.3.4.11 | RAB information to reconfigure | 387 |
| 10.3.4.12 | NAS Synchronization indicator..... | 387 |
| 10.3.4.13 | RB activation time info | 387 |
| 10.3.4.14 | RB COUNT-C MSB information..... | 387 |
| 10.3.4.15 | RB COUNT-C information..... | 388 |
| 10.3.4.16 | RB identity | 388 |
| 10.3.4.17 | RB information to be affected | 388 |
| 10.3.4.18 | RB information to reconfigure | 389 |
| 10.3.4.19 | RB information to release | 389 |
| 10.3.4.20 | RB information to setup | 389 |
| 10.3.4.21 | RB mapping info | 389 |
| 10.3.4.22 | RB with PDCP information..... | 391 |
| 10.3.4.23 | RLC info | 392 |
| 10.3.4.24 | Signalling RB information to setup..... | 393 |
| 10.3.4.25 | Transmission RLC Discard | 394 |
| 10.3.5 | Transport CH Information elements | 395 |
| 10.3.5.1 | Added or Reconfigured DL TrCH information | 395 |
| 10.3.5.2 | Added or Reconfigured UL TrCH information | 396 |
| 10.3.5.3 | CPCH set ID..... | 396 |
| 10.3.5.4 | Deleted DL TrCH information | 396 |
| 10.3.5.5 | Deleted UL TrCH information..... | 396 |
| 10.3.5.6 | DL Transport channel information common for all transport channels | 397 |
| 10.3.5.7 | DRAC Static Information..... | 397 |
| 10.3.5.8 | Power Offset Information..... | 398 |
| 10.3.5.9 | Predefined TrCH configuration..... | 398 |
| 10.3.5.10 | Quality Target | 399 |
| 10.3.5.11 | Semi-static Transport Format Information | 400 |
| 10.3.5.12 | TFCI Field 2 Information | 400 |
| 10.3.5.13 | TFCS Explicit Configuration | 401 |
| 10.3.5.14 | TFCS Information for DSCH (TFCI range method)..... | 401 |
| 10.3.5.15 | TFCS Reconfiguration/Addition Information | 401 |
| 10.3.5.16 | TFCS Removal Information..... | 403 |
| 10.3.5.17 | Transparent mode signalling info..... | 403 |
| 10.3.5.18 | Transport channel identity..... | 403 |
| 10.3.5.19 | Transport Format Combination (TFC) | 403 |
| 10.3.5.20 | Transport Format Combination Set..... | 403 |
| 10.3.5.21 | Transport Format Combination Set Identity..... | 404 |
| 10.3.5.22 | Transport Format Combination Subset | 405 |

| | | |
|------------|--|-----|
| 10.3.5.23 | Transport Format Set..... | 406 |
| 10.3.5.24 | UL Transport channel information common for all transport channels | 408 |
| 10.3.6 | Physical CH Information elements | 408 |
| 10.3.6.1 | AC-to-ASC mapping..... | 408 |
| 10.3.6.2 | AICH Info | 408 |
| 10.3.6.3 | AICH Power offset..... | 409 |
| 10.3.6.4 | Allocation period info | 409 |
| 10.3.6.5 | Alpha..... | 409 |
| 10.3.6.6 | ASC setting | 410 |
| 10.3.6.7 | Block STTD indicator | 411 |
| 10.3.6.8 | CCTrCH power control info | 411 |
| 10.3.6.8a | Cell and Channel Identity info | 411 |
| 10.3.6.9 | Cell parameters Id | 412 |
| 10.3.6.10 | Common timeslot info..... | 412 |
| 10.3.6.11 | Constant value..... | 412 |
| 10.3.6.12 | CPCH persistence levels | 413 |
| 10.3.6.13 | CPCH set info | 413 |
| 10.3.6.14 | CPCH Status Indication mode..... | 416 |
| 10.3.6.15 | CSICH Power offset..... | 416 |
| 10.3.6.16 | Default DPCH Offset Value..... | 416 |
| 10.3.6.17 | Downlink channelisation codes..... | 416 |
| 10.3.6.18 | Downlink DPCH info common for all RL | 418 |
| 10.3.6.19 | Downlink DPCH info common for all RL Post | 419 |
| 10.3.6.20 | Downlink DPCH info common for all RL Pre..... | 419 |
| 10.3.6.21 | Downlink DPCH info for each RL..... | 420 |
| 10.3.6.22 | Downlink DPCH info for each RL Post..... | 421 |
| 10.3.6.23 | Downlink DPCH power control information | 422 |
| 10.3.6.24 | Downlink information common for all radio links..... | 422 |
| 10.3.6.25 | Downlink information common for all radio links Post..... | 422 |
| 10.3.6.26 | Downlink information common for all radio links Pre | 423 |
| 10.3.6.27 | Downlink information for each radio link..... | 423 |
| 10.3.6.28 | Downlink information for each radio link Post..... | 423 |
| 10.3.6.29 | Void..... | 424 |
| 10.3.6.30 | Downlink PDSCH information | 424 |
| 10.3.6.31 | Downlink rate matching restriction information | 424 |
| 10.3.6.32 | Downlink Timeslots and Codes | 424 |
| 10.3.6.33 | DPCH compressed mode info | 425 |
| 10.3.6.34 | DPCH Compressed Mode Status Info..... | 428 |
| 10.3.6.35 | Dynamic persistence level..... | 429 |
| 10.3.6.35a | FPACH info | 429 |
| 10.3.6.36 | Frequency info | 430 |
| 10.3.6.37 | Individual timeslot info | 430 |
| 10.3.6.38 | Individual Timeslot interference | 430 |
| 10.3.6.39 | Maximum allowed UL TX power | 430 |
| 10.3.6.40 | Void..... | 431 |
| 10.3.6.41 | Midamble shift and burst type..... | 431 |
| 10.3.6.42 | PDSCH Capacity Allocation info..... | 432 |
| 10.3.6.43 | PDSCH code mapping | 433 |
| 10.3.6.44 | PDSCH info | 435 |
| 10.3.6.45 | PDSCH Power Control info | 435 |
| 10.3.6.46 | PDSCH system information | 435 |
| 10.3.6.47 | PDSCH with SHO DCH Info..... | 436 |
| 10.3.6.48 | Persistence scaling factors..... | 436 |
| 10.3.6.49 | PICH Info | 438 |
| 10.3.6.50 | PICH Power offset | 439 |
| 10.3.6.51 | PRACH Channelisation Code List..... | 439 |
| 10.3.6.51a | PRACH Channelisation Code 1.28Mcps TDD | 439 |
| 10.3.6.52 | PRACH info (for RACH)..... | 440 |
| 10.3.6.53 | PRACH partitioning..... | 441 |
| 10.3.6.54 | PRACH power offset | 441 |
| 10.3.6.55 | PRACH system information list..... | 442 |
| 10.3.6.56 | Predefined PhyCH configuration | 443 |

| | | |
|------------|---|-----|
| 10.3.6.57 | Primary CCPCH info | 443 |
| 10.3.6.58 | Primary CCPCH info post..... | 443 |
| 10.3.6.59 | Primary CCPCH TX Power | 444 |
| 10.3.6.60 | Primary CPICH info..... | 444 |
| 10.3.6.61 | Primary CPICH Tx power..... | 444 |
| 10.3.6.62 | Primary CPICH usage for channel estimation..... | 444 |
| 10.3.6.63 | PUSCH info | 445 |
| 10.3.6.64 | PUSCH Capacity Allocation info..... | 445 |
| 10.3.6.65 | PUSCH power control info | 445 |
| 10.3.6.66 | PUSCH system information..... | 446 |
| 10.3.6.67 | RACH transmission parameters | 446 |
| 10.3.6.68 | Radio link addition information | 447 |
| 10.3.6.69 | Radio link removal information | 447 |
| 10.3.6.70 | SCCPCH Information for FACH | 448 |
| 10.3.6.71 | Secondary CCPCH info | 449 |
| 10.3.6.72 | Secondary CCPCH system information..... | 450 |
| 10.3.6.73 | Secondary CPICH info..... | 450 |
| 10.3.6.74 | Secondary scrambling code..... | 450 |
| 10.3.6.75 | SFN Time info..... | 451 |
| 10.3.6.75a | Special Burst Scheduling | 451 |
| 10.3.6.76 | SSDT cell identity | 451 |
| 10.3.6.77 | SSDT information | 451 |
| 10.3.6.78 | STTD indicator | 451 |
| 10.3.6.78a | SYNC_UL info | 452 |
| 10.3.6.79 | TDD open loop power control | 452 |
| 10.3.6.80 | TFC Control duration..... | 453 |
| 10.3.6.81 | TFCI Combining Indicator..... | 453 |
| 10.3.6.82 | TGPSI | 453 |
| 10.3.6.83 | Time info..... | 453 |
| 10.3.6.84 | Timeslot number | 454 |
| 10.3.6.85 | TPC combination index..... | 454 |
| 10.3.6.85a | TSTD indicator | 454 |
| 10.3.6.86 | TX Diversity Mode | 454 |
| 10.3.6.87 | UL interference | 454 |
| 10.3.6.88 | Uplink DPCH info..... | 455 |
| 10.3.6.89 | Uplink DPCH info Post..... | 456 |
| 10.3.6.90 | Uplink DPCH info Pre | 456 |
| 10.3.6.91 | Uplink DPCH power control info | 456 |
| 10.3.6.92 | Uplink DPCH power control info Post..... | 457 |
| 10.3.6.93 | Uplink DPCH power control info Pre | 458 |
| 10.3.6.94 | Uplink Timeslots and Codes | 458 |
| 10.3.6.95 | Uplink Timing Advance..... | 459 |
| 10.3.6.96 | Uplink Timing Advance Control..... | 460 |
| 10.3.7 | Measurement Information elements | 462 |
| 10.3.7.1 | Additional measurements list | 462 |
| 10.3.7.2 | Cell info..... | 462 |
| 10.3.7.3 | Cell measured results | 464 |
| 10.3.7.4 | Cell measurement event results | 464 |
| 10.3.7.5 | Cell reporting quantities..... | 465 |
| 10.3.7.6 | Cell synchronisation information | 465 |
| 10.3.7.7 | Event results | 466 |
| 10.3.7.8 | FACH measurement occasion info..... | 466 |
| 10.3.7.9 | Filter coefficient | 467 |
| 10.3.7.10 | HCS Cell re-selection information | 467 |
| 10.3.7.11 | HCS neighbouring cell information | 468 |
| 10.3.7.12 | HCS Serving cell information | 468 |
| 10.3.7.13 | Inter-frequency cell info list..... | 468 |
| 10.3.7.14 | Inter-frequency event identity | 469 |
| 10.3.7.15 | Inter-frequency measured results list | 470 |
| 10.3.7.16 | Inter-frequency measurement..... | 471 |
| 10.3.7.17 | Inter-frequency measurement event results..... | 471 |
| 10.3.7.18 | Inter-frequency measurement quantity..... | 472 |

| | | |
|------------|---|-----|
| 10.3.7.19 | Inter-frequency measurement reporting criteria | 472 |
| 10.3.7.20 | Inter-frequency measurement system information | 473 |
| 10.3.7.21 | Inter-frequency reporting quantity | 474 |
| 10.3.7.22 | Inter-frequency SET UPDATE | 474 |
| 10.3.7.23 | Inter-RAT cell info list | 474 |
| 10.3.7.24 | Inter-RAT event identity | 475 |
| 10.3.7.25 | Inter-RAT info | 475 |
| 10.3.7.26 | Inter-RAT measured results list | 476 |
| 10.3.7.27 | Inter-RAT measurement | 477 |
| 10.3.7.28 | Inter-RAT measurement event results | 477 |
| 10.3.7.29 | Inter-RAT measurement quantity | 478 |
| 10.3.7.30 | Inter-RAT measurement reporting criteria | 478 |
| 10.3.7.31 | Inter-RAT measurement system information | 479 |
| 10.3.7.32 | Inter-RAT reporting quantity | 479 |
| 10.3.7.33 | Intra-frequency cell info list | 479 |
| 10.3.7.34 | Intra-frequency event identity | 480 |
| 10.3.7.35 | Intra-frequency measured results list | 480 |
| 10.3.7.36 | Intra-frequency measurement | 481 |
| 10.3.7.37 | Intra-frequency measurement event results | 481 |
| 10.3.7.38 | Intra-frequency measurement quantity | 482 |
| 10.3.7.39 | Intra-frequency measurement reporting criteria | 482 |
| 10.3.7.40 | Intra-frequency measurement system information | 485 |
| 10.3.7.41 | Intra-frequency reporting quantity | 485 |
| 10.3.7.42 | Intra-frequency reporting quantity for RACH reporting | 485 |
| 10.3.7.43 | Maximum number of reported cells on RACH | 486 |
| 10.3.7.44 | Measured results | 486 |
| 10.3.7.45 | Measured results on RACH | 487 |
| 10.3.7.46 | Measurement Command | 489 |
| 10.3.7.47 | Measurement control system information | 489 |
| 10.3.7.48 | Measurement Identity | 489 |
| 10.3.7.49 | Measurement reporting mode | 490 |
| 10.3.7.50 | Measurement Type | 490 |
| 10.3.7.51 | Measurement validity | 490 |
| 10.3.7.52 | Observed time difference to GSM cell | 490 |
| 10.3.7.53 | Periodical reporting criteria | 490 |
| 10.3.7.53a | PLMN identities of neighbour cells | 491 |
| 10.3.7.54 | Primary CCPCCH RSCP info | 491 |
| 10.3.7.54a | Qhcs | 493 |
| 10.3.7.55 | Quality measured results list | 494 |
| 10.3.7.56 | Quality measurement | 495 |
| 10.3.7.57 | Quality measurement event results | 495 |
| 10.3.7.58 | Quality measurement reporting criteria | 495 |
| 10.3.7.59 | Quality reporting quantity | 496 |
| 10.3.7.60 | Reference time difference to cell | 496 |
| 10.3.7.61 | Reporting Cell Status | 496 |
| 10.3.7.62 | Reporting information for state CELL_DCH | 498 |
| 10.3.7.63 | SFN-SFN observed time difference | 499 |
| 10.3.7.64 | Time to trigger | 499 |
| 10.3.7.65 | Timeslot ISCP info | 499 |
| 10.3.7.66 | Traffic volume event identity | 499 |
| 10.3.7.67 | Traffic volume measured results list | 500 |
| 10.3.7.68 | Traffic volume measurement | 501 |
| 10.3.7.69 | Traffic volume measurement event results | 501 |
| 10.3.7.70 | Traffic volume measurement object | 502 |
| 10.3.7.71 | Traffic volume measurement quantity | 502 |
| 10.3.7.72 | Traffic volume measurement reporting criteria | 502 |
| 10.3.7.73 | Traffic volume measurement system information | 503 |
| 10.3.7.74 | Traffic volume reporting quantity | 504 |
| 10.3.7.75 | UE internal event identity | 504 |
| 10.3.7.76 | UE internal measured results | 505 |
| 10.3.7.77 | UE internal measurement | 506 |
| 10.3.7.78 | UE internal measurement event results | 506 |

| | | |
|------------|---|-----|
| 10.3.7.79 | UE internal measurement quantity | 506 |
| 10.3.7.80 | UE internal measurement reporting criteria | 507 |
| 10.3.7.81 | UE internal measurement system information | 508 |
| 10.3.7.82 | UE Internal reporting quantity | 508 |
| 10.3.7.83 | UE Rx-Tx time difference type 1 | 508 |
| 10.3.7.84 | UE Rx-Tx time difference type 2 | 509 |
| 10.3.7.85 | UE Transmitted Power info..... | 509 |
| 10.3.7.86 | UE positioning Ciphering info | 509 |
| 10.3.7.87 | UE positioning Error | 510 |
| 10.3.7.88 | UE positioning GPS acquisition assistance | 510 |
| 10.3.7.88a | UE positioning GPS Additional Assistance Data Request | 512 |
| 10.3.7.89 | UE positioning GPS almanac | 512 |
| 10.3.7.90 | UE positioning GPS assistance data..... | 513 |
| 10.3.7.90a | UE positioning GPS Ephemeris and Clock Correction parameters..... | 514 |
| 10.3.7.91 | UE positioning GPS DGPS corrections | 515 |
| 10.3.7.92 | UE positioning GPS ionospheric model..... | 517 |
| 10.3.7.93 | UE positioning GPS measured results..... | 517 |
| 10.3.7.94 | UE positioning GPS navigation model | 519 |
| 10.3.7.95 | UE positioning GPS real-time integrity | 519 |
| 10.3.7.96 | UE positioning GPS reference time | 520 |
| 10.3.7.97 | UE positioning GPS UTC model | 520 |
| 10.3.7.98 | UE positioning IPDL parameters | 521 |
| 10.3.7.99 | UE positioning measured results..... | 522 |
| 10.3.7.100 | UE positioning measurement | 522 |
| 10.3.7.101 | UE positioning measurement event results | 523 |
| 10.3.7.102 | Void..... | 523 |
| 10.3.7.103 | UE positioning OTDOA assistance data | 523 |
| 10.3.7.104 | Void..... | 523 |
| 10.3.7.105 | UE positioning OTDOA measurement | 524 |
| 10.3.7.106 | UE positioning OTDOA neighbour cell info | 524 |
| 10.3.7.107 | UE positioning OTDOA quality..... | 526 |
| 10.3.7.108 | UE positioning OTDOA reference cell info..... | 527 |
| 10.3.7.109 | UE positioning position estimate info | 527 |
| 10.3.7.110 | UE positioning reporting criteria..... | 528 |
| 10.3.7.111 | UE positioning reporting quantity..... | 529 |
| 10.3.7.112 | UpPCH _{ADV} | 530 |
| 10.3.8 | Other Information elements | 531 |
| 10.3.8.1 | BCCH modification info | 531 |
| 10.3.8.2 | BSIC..... | 531 |
| 10.3.8.3 | CBS DRX Level 1 information | 531 |
| 10.3.8.4 | Cell Value tag..... | 531 |
| 10.3.8.4a | Ellipsoid point | 531 |
| 10.3.8.4b | Ellipsoid point with Altitude | 532 |
| 10.3.8.4c | Ellipsoid point with Altitude and uncertainty ellipsoid..... | 532 |
| 10.3.8.4d | Ellipsoid point with uncertainty Circle..... | 533 |
| 10.3.8.4e | Ellipsoid point with uncertainty Ellipse | 534 |
| 10.3.8.5 | Inter-RAT change failure | 534 |
| 10.3.8.6 | Inter-RAT handover failure..... | 535 |
| 10.3.8.7 | Inter-RAT UE radio access capability..... | 535 |
| 10.3.8.8 | Void..... | 535 |
| 10.3.8.8a | Inter-RAT UE security capability | 536 |
| 10.3.8.9 | MIB Value tag..... | 536 |
| 10.3.8.10 | PLMN Value tag | 536 |
| 10.3.8.10a | PNBSCH allocation | 536 |
| 10.3.8.11 | Predefined configuration identity and value tag..... | 536 |
| 10.3.8.12 | Protocol error information..... | 537 |
| 10.3.8.13 | References to other system information blocks..... | 537 |
| 10.3.8.14 | References to other system information blocks and scheduling blocks | 537 |
| 10.3.8.15 | Rplmn information | 537 |
| 10.3.8.16 | Scheduling information..... | 539 |
| 10.3.8.17 | SEG COUNT | 540 |
| 10.3.8.18 | Segment index | 540 |

| | | |
|------------|---|-----|
| 10.3.8.19 | SIB data fixed..... | 540 |
| 10.3.8.20 | SIB data variable | 540 |
| 10.3.8.20a | SIB occurrence identity | 540 |
| 10.3.8.20b | SIB occurrence identity and value tag..... | 541 |
| 10.3.8.20c | SIB occurrence value tag..... | 541 |
| 10.3.8.21 | SIB type..... | 541 |
| 10.3.8.22 | SIB type SIBs only..... | 542 |
| 10.3.9 | ANSI-41 Information elements..... | 543 |
| 10.3.9.1 | ANSI 41 Core Network Information..... | 543 |
| 10.3.9.2 | ANSI-41 Global Service Redirection information | 543 |
| 10.3.9.3 | ANSI-41 NAS parameter | 543 |
| 10.3.9.4 | ANSI-41 NAS system information | 544 |
| 10.3.9.5 | ANSI-41 Private Neighbour List information..... | 544 |
| 10.3.9.6 | ANSI-41 RAND information | 544 |
| 10.3.9.7 | ANSI-41 User Zone Identification information | 544 |
| 10.3.9.8 | MIN_P_REV..... | 544 |
| 10.3.9.9 | NID | 544 |
| 10.3.9.10 | P_REV | 545 |
| 10.3.9.11 | SID | 545 |
| 10.3.10 | Multiplicity values and type constraint values..... | 545 |
| 11 | Message and Information element abstract syntax (with ASN.1) | 548 |
| 11.0 | General..... | 548 |
| 11.1 | General message structure | 548 |
| 11.2 | PDU definitions | 552 |
| 11.3 | Information element definitions..... | 587 |
| 11.4 | Constant definitions | 698 |
| 11.5 | RRC information between network nodes | 699 |
| 11.6 | RRC information between UE and other RATs..... | 704 |
| 12 | Message transfer syntax | 705 |
| 12.1 | Structure of encoded RRC messages | 705 |
| 12.1.1 | Basic production | 705 |
| 12.1.2 | Extension | 705 |
| 12.1.3 | Padding | 705 |
| 12.2 | ECN link module for RRC..... | 708 |
| 12.3 | ECN modules for RRC | 708 |
| 13 | Protocol timers, counters, other parameters and default configurations..... | 709 |
| 13.1 | Timers for UE..... | 710 |
| 13.2 | Counters for UE..... | 711 |
| 13.3 | UE constants and parameters | 712 |
| 13.4 | UE variables..... | 712 |
| 13.4.0 | CELL INFO LIST..... | 712 |
| 13.4.00 | CELL_POSITION | 713 |
| 13.4.0a | CELL_UPDATE_STARTED..... | 713 |
| 13.4.1 | CIPHERING_STATUS | 714 |
| 13.4.2 | Void | 714 |
| 13.4.2a | CONFIGURATION_INCOMPLETE | 714 |
| 13.4.3 | C_RNTI | 714 |
| 13.4.4 | DOFF | 714 |
| 13.4.5 | ESTABLISHED_RABS | 715 |
| 13.4.5a | ESTABLISHED_SIGNALLING_CONNECTIONS | 715 |
| 13.4.6 | ESTABLISHMENT_CAUSE..... | 715 |
| 13.4.7 | FAILURE_CAUSE | 715 |
| 13.4.8 | FAILURE_INDICATOR..... | 716 |
| 13.4.8a | INCOMPATIBLE_SECURITY_RECONFIGURATION | 716 |
| 13.4.9 | INITIAL_UE_IDENTITY..... | 716 |
| 13.4.9a | INTEGRITY_PROTECTION_ACTIVATION_INFO..... | 716 |
| 13.4.10 | INTEGRITY_PROTECTION_INFO | 716 |
| 13.4.11 | INVALID_CONFIGURATION..... | 717 |
| 13.4.11a | LATEST_CONFIGURED_CN_DOMAIN | 717 |
| 13.4.12 | MEASUREMENT_IDENTITY | 717 |

| | | |
|----------|--|-----|
| 13.4.13 | Void | 718 |
| 13.4.14 | ORDERED_RECONFIGURATION | 718 |
| 13.4.15 | PDCP_SN_INFO | 718 |
| 13.4.16 | PROTOCOL_ERROR_INDICATOR | 718 |
| 13.4.17 | PROTOCOL_ERROR_INFORMATION | 719 |
| 13.4.18 | PROTOCOL_ERROR_REJECT | 719 |
| 13.4.19 | RB_TIMER_INDICATOR | 719 |
| 13.4.20 | RB_UPLINK_CIPHERING_ACTIVATION_TIME_INFO | 719 |
| 13.4.21 | SELECTED_PLMN | 719 |
| 13.4.22 | START_THRESHOLD | 720 |
| 13.4.23 | START_VALUE_TO_TRANSMIT | 720 |
| 13.4.24 | TFC_SUBSET | 720 |
| 13.4.25 | TGPS_IDENTITY | 721 |
| 13.4.26 | TGSN_REPORTED | 721 |
| 13.4.26a | TIMERS_AND_CONSTANTS | 721 |
| 13.4.27 | TRANSACTIONS | 722 |
| 13.4.27a | TRIGGERED_1A_EVENTS | 722 |
| 13.4.27b | TRIGGERED_1B_EVENTS | 722 |
| 13.4.27c | TRIGGERED_1C_EVENTS | 723 |
| 13.4.27d | BEST_CELL_1D_EVENT | 723 |
| 13.4.27e | TRIGGERED_1E_EVENTS | 723 |
| 13.4.27f | TRIGGERED_1F_EVENTS | 723 |
| 13.4.27g | UE_CAPABILITY_REQUESTED | 724 |
| 13.4.28 | UE_CAPABILITY_TRANSFERRED | 724 |
| 13.4.29 | UNSUPPORTED_CONFIGURATION | 725 |
| 13.4.30 | URA_IDENTITY | 725 |
| 13.4.31 | U_RNTI | 725 |
| 13.4.32 | VALUE_TAG | 725 |
| 13.5 | UE RRC Procedure Performance | 727 |
| 13.5.1 | Definitions | 727 |
| 13.5.2 | RRC procedure performance values | 727 |
| 13.6 | RB information parameters for signalling radio bearer RB 0 | 732 |
| 13.6a | RB information parameters for SHCCH | 733 |
| 13.6b | RB information parameters for BCCH mapped to FACH | 733 |
| 13.6c | RB information parameters for PCCH mapped to PCH | 733 |
| 13.6d | Parameters for BCCH mapped to BCH | 734 |
| 13.7 | Parameter values for default radio configurations | 734 |
| 14 | Specific functions | 748 |
| 14.1 | Intra-frequency measurements | 748 |
| 14.1.1 | Intra-frequency measurement quantities | 748 |
| 14.1.2 | Intra-frequency reporting events for FDD | 748 |
| 14.1.2.1 | Reporting event 1A: A Primary CPICH enters the reporting range | 748 |
| 14.1.2.2 | Reporting event 1B: A primary CPICH leaves the reporting range | 750 |
| 14.1.2.3 | Reporting event 1C: A non-active primary CPICH becomes better than an active primary CPICH | 752 |
| 14.1.2.4 | Reporting event 1D: Change of best cell | 754 |
| 14.1.2.5 | Reporting event 1E: A Primary CPICH becomes better than an absolute threshold | 755 |
| 14.1.2.6 | Reporting event 1F: A Primary CPICH becomes worse than an absolute threshold | 756 |
| 14.1.3 | Intra-frequency reporting events for TDD | 758 |
| 14.1.3.1 | Reporting event 1G: Change of best cell (TDD) | 758 |
| 14.1.3.2 | Reporting event 1H: Timeslot ISCP below a certain threshold (TDD) | 759 |
| 14.1.3.3 | Reporting event 1I: Timeslot ISCP above a certain threshold (TDD) | 759 |
| 14.1.4 | Event-triggered periodic intra-frequency measurement reports | 760 |
| 14.1.4.1 | Cell addition failure (FDD only) | 760 |
| 14.1.4.2 | Cell replacement failure (FDD only) | 761 |
| 14.1.5 | Mechanisms available for modifying intra-frequency measurement reporting behaviour | 761 |
| 14.1.5.1 | Hysteresis | 761 |
| 14.1.5.2 | Time-to-trigger | 762 |
| 14.1.5.3 | Cell individual offsets | 763 |
| 14.1.5.4 | Forbid a Primary CPICH to affect the reporting range (FDD only) | 764 |
| 14.1.6 | Report quantities | 765 |
| 14.2 | Inter-frequency measurements | 765 |

| | | |
|----------|---|-----|
| 14.2.1 | Inter-frequency reporting events..... | 766 |
| 14.2.1.1 | Event 2a: Change of best frequency..... | 766 |
| 14.2.1.2 | Event 2b: The estimated quality of the currently used frequency is below a certain threshold and the estimated quality of a non-used frequency is above a certain threshold..... | 766 |
| 14.2.1.3 | Event 2c: The estimated quality of a non-used frequency is above a certain threshold | 766 |
| 14.2.1.4 | Event 2d: The estimated quality of the currently used frequency is below a certain threshold..... | 766 |
| 14.2.1.5 | Event 2e: The estimated quality of a non-used frequency is below a certain threshold | 767 |
| 14.2.1.6 | Event 2 f: The estimated quality of the currently used frequency is above a certain threshold..... | 767 |
| 14.3 | Inter-RAT measurements..... | 767 |
| 14.3.1 | Inter-RAT reporting events..... | 767 |
| 14.3.1.1 | Event 3a: The estimated quality of the currently used UTRAN frequency is below a certain threshold and the estimated quality of the other system is above a certain threshold..... | 767 |
| 14.3.1.2 | Event 3b: The estimated quality of other system is below a certain threshold | 768 |
| 14.3.1.3 | Event 3c: The estimated quality of other system is above a certain threshold | 768 |
| 14.3.1.4 | Event 3d: Change of best cell in other system..... | 768 |
| 14.3.2 | GSM measurements in compressed mode | 768 |
| 14.3.2.1 | GSM RSSI measurements | 768 |
| 14.3.2.2 | Initial BSIC identification | 768 |
| 14.3.2.3 | BSIC re-confirmation..... | 768 |
| 14.4 | Traffic Volume Measurements | 769 |
| 14.4.1 | Traffic Volume Measurement Quantity..... | 769 |
| 14.4.2 | Traffic Volume reporting triggers..... | 769 |
| 14.4.2.1 | Reporting event 4 A: Transport Channel Traffic Volume exceeds an absolute threshold | 769 |
| 14.4.2.2 | Reporting event 4 B: Transport Channel Traffic Volume becomes smaller than an absolute threshold.. | 770 |
| 14.4.3 | Traffic volume reporting mechanisms | 770 |
| 14.4.3.1 | Pending time after trigger..... | 770 |
| 14.4.4 | Interruption of user data transmission..... | 771 |
| 14.5 | Quality Measurements | 771 |
| 14.5.1 | Quality reporting measurement quantities | 771 |
| 14.5.2 | Quality reporting events..... | 771 |
| 14.5.2.1 | Reporting event 5A: A predefined number of bad CRCs is exceeded | 771 |
| 14.6 | UE internal measurements..... | 772 |
| 14.6.1 | UE internal measurement quantities | 772 |
| 14.6.2 | UE internal measurement reporting events..... | 772 |
| 14.6.2.1 | Reporting event 6A: The UE Tx power becomes larger than an absolute threshold..... | 772 |
| 14.6.2.2 | Reporting event 6B: The UE Tx power becomes less than an absolute threshold | 773 |
| 14.6.2.3 | Reporting event 6C: The UE Tx power reaches its minimum value | 773 |
| 14.6.2.4 | Reporting event 6D: The UE Tx power reaches its maximum value | 773 |
| 14.6.2.5 | Reporting event 6E: The UE RSSI reaches the UE's dynamic receiver range | 774 |
| 14.6.2.6 | Reporting event 6F: The UE Rx-Tx time difference for a RL included in the active set becomes larger than an absolute threshold | 774 |
| 14.6.2.7 | Reporting event 6G: The UE Rx-Tx time difference for a RL included in the active set becomes less than an absolute threshold | 774 |
| 14.7 | UE positioning measurements | 774 |
| 14.7.1 | UE positioning measurement quantity | 774 |
| 14.7.2 | UE positioning reporting quantity | 775 |
| 14.7.3 | UE positioning reporting events | 775 |
| 14.7.3.1 | Reporting Event 7a: The UE position changes more than an absolute threshold | 775 |
| 14.7.3.2 | Reporting Event 7b: SFN-SFN measurement changes more than an absolute threshold..... | 775 |
| 14.7.3.3 | Reporting Event 7c: GPS time and SFN time have drifted apart more than an absolute threshold..... | 775 |
| 14.8 | Dynamic Resource Allocation Control of Uplink DCH (FDD only)..... | 775 |
| 14.9 | Downlink power control | 776 |
| 14.9.1 | Generalities..... | 776 |
| 14.9.2 | Downlink power control in compressed mode | 776 |
| 14.10 | Calculated Transport Format Combination..... | 777 |
| 14.11 | UE autonomous update of active set on non-used frequency (FDD only)..... | 777 |
| 14.12 | Provision and reception of RRC information between network nodes | 778 |
| 14.12.0 | General..... | 778 |
| 14.12.0a | General error handling for RRC information containers..... | 778 |
| 14.12.1 | RRC Information to target RNC | 779 |
| 14.12.2 | RRC information, target RNC to source RNC..... | 779 |
| 14.12.3 | RRC information, target RNC to source system..... | 780 |

| | | |
|-----------|--|-----|
| 14.12.4 | RRC information containers exchanged between network nodes..... | 781 |
| 14.12.4.1 | HANDOVER TO UTRAN INFO | 781 |
| 14.12.4.1 | SRNS RELOCATION INFO | 781 |
| 14.12.4.3 | RRC INFORMATION CONTAINER FAILURE INFO | 787 |
| 14.13 | RRC information transferred between UE and other systems | 787 |
| 14.13.0 | General..... | 787 |
| 14.13.1 | RRC information, another RAT to UE | 788 |
| 14.13.1.1 | Void..... | 788 |
| 14.13.2 | RRC information, UE to another RAT | 788 |
| 14.13.2.1 | UE capability information..... | 788 |
| 14.13.2.2 | UE security information | 788 |
| 14.13.2.3 | Pre-defined configuration status information..... | 788 |
| 14.13.2.4 | Void..... | 789 |
| 14.14 | Versatile Channel Assignment Mode (VCAM) mapping rule (FDD only) | 789 |

| | | |
|-------------------------------|--|------------|
| Annex A (informative): | USIM parameters..... | 790 |
| A.1 | Introduction | 790 |
| A.2 | Ciphering information | 790 |
| A.3 | Frequency information | 790 |
| A.4 | Multiplicity values and type constraint values | 791 |

| | | |
|-------------------------------|---|------------|
| Annex B (informative): | Description of RRC state transitions..... | 792 |
| B.1 | RRC states and state transitions including GSM..... | 792 |
| B.2 | Transition from Idle Mode to UTRA RRC Connected Mode | 792 |
| B.2.1 | Transitions for Emergency Calls | 792 |
| B.3 | UTRA RRC Connected Mode States and Transitions..... | 792 |
| B.3.1 | CELL_DCH state..... | 792 |
| B.3.1.1 | Transition from CELL_DCH to Idle Mode | 793 |
| B.3.1.2 | Transition from CELL_DCH to CELL_FACH state | 793 |
| B.3.1.3 | Transition from CELL_DCH to CELL_PCH state | 793 |
| B.3.1.4 | Transition from CELL_DCH to URA_PCH state | 793 |
| B.3.1.5 | Radio Resource Allocation tasks (CELL_DCH) | 793 |
| B.3.1.6 | RRC Connection mobility tasks (CELL_DCH)..... | 793 |
| B.3.1.7 | UE Measurements (CELL_DCH)..... | 794 |
| B.3.1.8 | Acquisition of system information (CELL_DCH)..... | 794 |
| B.3.2 | CELL_FACH state | 794 |
| B.3.2.1 | Transition from CELL_FACH to CELL_DCH state..... | 794 |
| B.3.2.2 | Transition from CELL_FACH to CELL_PCH state..... | 794 |
| B.3.2.3 | Transition from CELL_FACH to Idle Mode | 794 |
| B.3.2.4 | Transition from CELL_FACH to URA_PCH State..... | 794 |
| B.3.2.5 | Radio Resource Allocation Tasks (CELL_FACH)..... | 794 |
| B.3.2.6 | RRC Connection mobility tasks (CELL_FACH) | 795 |
| B.3.2.7 | UE Measurements (CELL_FACH)..... | 795 |
| B.3.2.8 | Transfer and update of system information (CELL_FACH) | 795 |
| B.3.3 | CELL_PCH state | 796 |
| B.3.3.1 | Transition from CELL_PCH to CELL_FACH state..... | 796 |
| B.3.3.2 | Radio Resource Allocation Tasks (CELL_PCH)..... | 796 |
| B.3.3.3 | RRC Connection mobility tasks (CELL_PCH) | 796 |
| B.3.3.4 | UE Measurements (CELL_PCH) | 796 |
| B.3.3.5 | Transfer and update of system information (CELL_PCH) | 796 |
| B.3.4 | URA_PCH State | 797 |
| B.3.4.1 | Transition from URA_PCH State to CELL_FACH State (URA_PCH)..... | 797 |
| B.3.4.2 | Radio Resource Allocation Tasks (URA_PCH) | 797 |
| B.3.4.3 | RRC Connection mobility tasks (URA_PCH)..... | 797 |
| B.3.4.4 | UE Measurements (URA_PCH)..... | 797 |
| B.3.4.5 | Transfer and update of system information (URA_PCH)..... | 798 |
| B.3.5 | States and Transitions for Cell Reselection in URA_PCH, CELL_PCH, and CELL_FACH | 798 |
| B.4 | Inter-RAT handover with CS domain services..... | 798 |
| B.5 | Inter-RAT handover with PS domain services | 799 |
| B.6 | Inter-RAT handover with simultaneous PS and CS domain services..... | 799 |
| B.6.1 | Inter-RAT handover UTRAN to GSM / BSS | 799 |
| B.6.2 | Inter-RAT handover GSM / BSS to UTRAN | 799 |

Annex C (informative): **Change history** **800**

Foreword

This Technical Specification has been produced by the 3rd Generation Partnership Project (3GPP).

The contents of the present document are subject to continuing work within the TSG and may change following formal TSG approval. Should the TSG modify the contents of the present document, it will be re-released by the TSG with an identifying change of release date and an increase in version number as follows:

Version x.y.z

where:

- x the first digit:
 - 1 presented to TSG for information;
 - 2 presented to TSG for approval;
 - 3 or greater indicates TSG approved document under change control.
- y the second digit is incremented for all changes of substance, i.e. technical enhancements, corrections, updates, etc.
- z the third digit is incremented when editorial only changes have been incorporated in the document.

1 Scope

The present document specifies the Radio Resource Control protocol for the UE-UTRAN radio interface.

The scope of this specification also includes:

- the information to be transported in a transparent container between source RNC and target RNC in connection with SRNC relocation;
- the information to be transported in a transparent container between a target RNC and another system.

2 References

The following documents contain provisions which, through reference in this text, constitute provisions of the present document.

- References are either specific (identified by date of publication, edition number, version number, etc.) or non-specific.
- For a specific reference, subsequent revisions do not apply.
- For a non-specific reference, the latest version applies. In the case of a reference to a 3GPP document (including a GSM document), a non-specific reference implicitly refers to the latest version of that document *in the same Release as the present document*.

- [1] 3GPP TR 21.905: "Vocabulary for 3GPP Specifications".
- [2] 3GPP TS 25.301: "Radio Interface Protocol Architecture".
- [3] 3GPP TS 25.303: "Interlayer Procedures in Connected Mode".
- [4] 3GPP TS 25.304: "UE Procedures in Idle Mode and Procedures for Cell Reselection in Connected Mode".
- [5] 3GPP TS 24.008: "Mobile radio interface layer 3 specification, Core Network Protocols - Stage 3".
- [6] 3GPP TS 25.103: "RF Parameters in Support of RRM".
- [7] 3GPP TS 25.215: "Physical layer – Measurements (FDD)".
- [8] 3GPP TS 25.225: "Physical layer – Measurements (TDD)".
- [9] 3GPP TS 25.401: "UTRAN overall description".
- [10] 3GPP TS 25.402: "Synchronization in UTRAN, stage 2".
- [11] 3GPP TS 23.003: "Numbering, addressing and identification".
- [12] ICD-GPS-200: "Navstar GPS Space Segment/Navigation User Interface".
- [13] RTCM-SC104: "RTCM Recommended Standards for Differential GNSS Service (v.2.2)".
- [14] 3GPP TR 25.921: "Guidelines and Principles for protocol description and error handling".
- [15] 3GPP TS 25.321: "MAC protocol specification".
- [16] 3GPP TS 25.322: "RLC Protocol Specification".
- [17] 3GPP TS 24.007: "Mobile radio interface signalling layer 3" General Aspects.
- [18] 3GPP TS 25.305: "Stage 2 Functional Specification of Location Services in UTRAN".
- [19] 3GPP TS 25.133: "Requirements for Support of Radio Resource Management (FDD)".

- [20] 3GPP TS 25.123: "Requirements for Support of Radio Resource Management (TDD)".
- [21] 3GPP TS 25.101: "UE Radio Transmission and Reception (FDD)".
- [22] 3GPP TS 25.102: "UE Radio Transmission and Reception (TDD)".
- [23] 3GPP TS 23.060: "General Packet Radio Service (GPRS), Service description, Stage 2".
- [24] 3GPP TS 23.032: "Universal Geographical Area Description (GAD)".
- [25] 3GPP TS 23.122: "NAS Functions related to Mobile Station (MS) in idle mode".
- [26] 3GPP TS 25.211: "Physical channels and mapping of transport channels onto physical channels (FDD)".
- [27] 3GPP TS 25.212: "Multiplexing and channel coding (FDD)".
- [28] 3GPP TS 25.213: "Spreading and modulation (FDD)".
- [29] 3GPP TS 25.214: "Physical layer procedures (FDD)".
- [30] 3GPP TS 25.221: "Physical channels and mapping of transport channels onto physical channels (TDD)".
- [31] 3GPP TS 25.222: "Multiplexing and channel coding (TDD)".
- [32] 3GPP TS 25.223: "Spreading and modulation (TDD)".
- [33] 3GPP TS 25.224: "Physical Layer Procedures (TDD)".
- [34] 3GPP TS 25.302: "Services provided by the physical layer".
- [35] 3GPP TS 25.306 "UE Radio Access Capabilities".
- [36] 3GPP TS 25.323: "Packet Data Convergence Protocol (PDCP) Specification".
- [37] 3GPP TS 25.324: "Broadcast/Multicast Control BMC".
- [38] 3GPP TR 25.922: "Radio resource management strategies".
- [39] 3GPP TR 25.925: "Radio interface for broadcast/multicast services".
- [40] 3GPP TS 33.102: "Security Architecture".
- [41] 3GPP TS 34.108: "Common Test Environments for User Equipment (UE) Conformance Testing".
- [42] 3GPP TS 34.123-2: "User Equipment (UE) conformance specification; Part 2: Implementation Conformance Statement (ICS) proforma specification".
- [43] 3GPP TS 04.18: "Mobile radio interface layer 3 specification, Radio Resource Control Protocol".
- [44] 3GPP TS 04.60: "General Packet Radio Service (GPRS), MS-BSS interface; RLC/MAC".
- [45] 3GPP TS 05.05: "Radio transmission and reception".
- [46] 3GPP TS 05.08: "Radio subsystem link control".
- [47] ITU-T Recommendation X.680, (12/97) "Information Technology - Abstract Syntax Notation One (ASN.1): Specification of basic notation".
- [48] ITU-T Recommendation X.681, (12/97) "Information Technology - Abstract Syntax Notation One (ASN.1): Information object specification".
- [49] ITU-T Recommendation X.691, (12/97) "Information technology - ASN.1 encoding rules - Specification of Packed Encoding Rules (PER)".
- [50] 3GPP TS 31.102: "Characteristics of the USIM Application".

3 Definitions and abbreviations

3.1 Definitions

For the purposes of the present document, the terms and definitions given in [1] apply.

3.2 Abbreviations

For the purposes of the present document, the following abbreviations apply:

| | |
|--------|--|
| ACK | Acknowledgement |
| AICH | Acquisition Indicator CHannel |
| AM | Acknowledged Mode |
| AS | Access Stratum |
| ASC | Access Service Class |
| ASN.1 | Abstract Syntax Notation.1 |
| BCCH | Broadcast Control Channel |
| BCFE | Broadcast Control Functional Entity |
| BER | Bit Error Rate |
| BLER | Block Error Rate |
| BSS | Base Station Sub-system |
| CH | Conditional on history |
| CV | Conditional on value |
| CCPCH | Common Control Physical CHannel |
| CCCH | Common Control Channel |
| CN | Core Network |
| CM | Connection Management |
| CPCH | Common Packet CHannel |
| C-RNTI | Cell RNTI |
| CTCH | Common Traffic CHannel |
| CTFC | Calculated Transport Format Combination |
| DCA | Dynamic Channel Allocation |
| DCCH | Dedicated Control Channel |
| DCFE | Dedicated Control Functional Entity |
| DCH | Dedicated Channel |
| DC-SAP | Dedicated Control SAP |
| DGPS | Differential Global Positioning System |
| DL | Downlink |
| DRAC | Dynamic Resource Allocation Control |
| DSCH | Downlink Shared Channel |
| DTCH | Dedicated Traffic Channel |
| FACH | Forward Access Channel |
| FDD | Frequency Division Duplex |
| FFS | For Further Study |
| GC-SAP | General Control SAP |
| HCS | Hierarchical Cell Structure |
| HFN | Hyper Frame Number |
| ID | Identifier |
| IETF | Internet Engineering Task Force |
| IMEI | International Mobile Equipment Identity |
| IMSI | International Mobile Subscriber Identity |
| IE | Information element |
| IP | Internet Protocol |
| ISCP | Interference on Signal Code Power |
| LAI | Location Area Identity |
| L1 | Layer 1 |
| L2 | Layer 2 |
| L3 | Layer 3 |
| MD | Mandatory default |

| | |
|--------|---|
| MP | Mandatory present |
| MAC | Media Access Control |
| MCC | Mobile Country Code |
| MM | Mobility Management |
| MNC | Mobile Network Code |
| NAS | Non Access Stratum |
| Nt-SAP | Notification SAP |
| NW | Network |
| OP | Optional |
| PCCH | Paging Control Channel |
| PCH | Paging Channel |
| PDCP | Packet Data Convergence Protocol |
| PDSCH | Physical Downlink Shared Channel |
| PDU | Protocol Data Unit |
| PLMN | Public Land Mobile Network |
| PNFE | Paging and Notification Control Functional Entity |
| PRACH | Physical Random Access CHannel |
| P-TMSI | Packet Temporary Mobile Subscriber Identity |
| PUSCH | Physical Uplink Shared Channel |
| QoS | Quality of Service |
| RAB | Radio access bearer |
| RAT | Radio Access Technology |
| RAI | Routing Area Identity |
| RACH | Random Access CHannel |
| RB | Radio Bearer |
| RFE | Routing Functional Entity |
| RL | Radio Link |
| RLC | Radio Link Control |
| RNTI | Radio Network Temporary Identifier |
| RNC | Radio Network Controller |
| RRC | Radio Resource Control |
| RSCP | Received Signal Code Power |
| RSSI | Received Signal Strength Indicator |
| SAP | Service Access Point |
| SCFE | Shared Control Function Entity |
| SF | Spreading Factor |
| SHCCH | Shared Control Channel |
| SIR | Signal to Interference Ratio |
| SSDT | Site Selection Diversity Transmission |
| S-RNTI | SRNC - RNTI |
| TDD | Time Division Duplex |
| TF | Transport Format |
| TFCS | Transport Format Combination Set |
| TFS | Transport Format Set |
| TM | Transparent Mode |
| TME | Transfer Mode Entity |
| TMSI | Temporary Mobile Subscriber Identity |
| Tr | Transparent |
| Tx | Transmission |
| UE | User Equipment |
| UL | Uplink |
| UM | Unacknowledged Mode |
| URA | UTRAN Registration Area |
| U-RNTI | UTRAN-RNTI |
| USCH | Uplink Shared Channel |
| UTRAN | Universal Terrestrial Radio Access Network |

4 General

If not specified differently, descriptions are relevant for both FDD and TDD. Descriptions for TDD only are relevant for both 1.28 Mcps TDD and 3.84 Mcps TDD if not specified differently.

4.1 Overview of the specification

This specification is organised as follows:

- Subclause 4.2 contains the description of the model of the RRC protocol layer;
- Clause 5 lists the RRC functions and the services provided to upper layers;
- Clause 6 lists the services expected from the lower layers and specifies the radio bearers available for usage by the RRC messages;
- Clause 7 specifies the UE states for the Access Stratum, and also specifies the processes running in the UE in the respective states;
- Clause 8 specifies RRC procedures, including UE state transitions;
- Clause 9 specifies the procedures for the handling of unknown, unforeseen, and erroneous protocol data by the receiving entity;
- Clause 10 describes the message in a Tabular format; these messages descriptions are referenced in clause 8;
- Clause 11 specifies the encoding of the messages of the RRC protocol. This is based on the Tabular description in clause 10.
- Clause 12 specifies the transfer syntax for RRC PDUs derived from the encoding definition;
- Clause 13 lists the protocol timers, counters, constants and variables to be used by the UE;
- Clause 14 specifies some of the processes applicable in UTRA RRC connected mode e.g. measurement processes, and also the RRC information to be transferred between network nodes. Note that not all the processes applicable in UTRA RRC connected mode are specified here i.e. some UTRA RRC connected mode processes are described in [4] e.g. cell re-selection; Annex A contains recommendations about the network parameters to be stored on the USIM;

Annex B contains informative Stage 2 description of the RRC protocol states and state transitions.

The following figure summarises the mapping of UE states, including states in GSM, to the appropriate UTRA and GSM specifications that specify the UE behaviour.

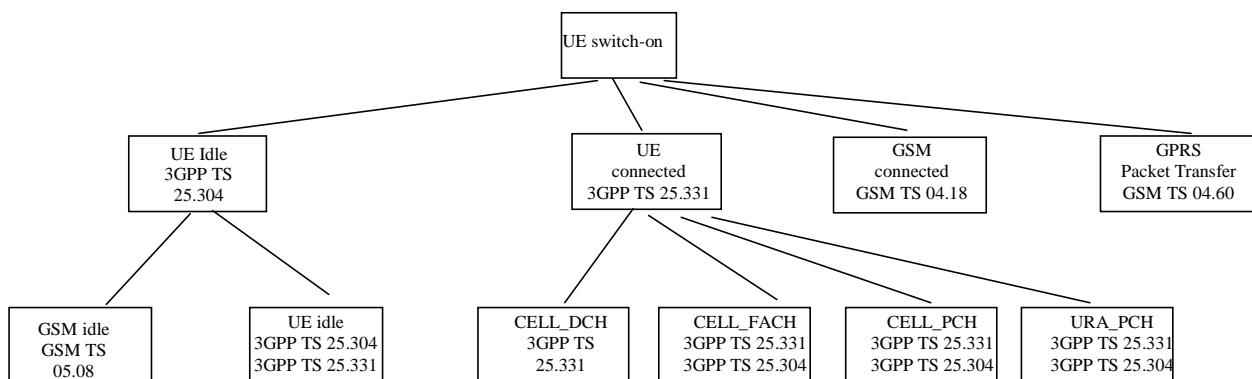

Figure 1: Mapping of UE state to 3GPP Specifications

4.2 RRC Layer Model

The functional entities of the RRC layer are described below:

- Routing of higher layer messages to different MM/CM entities (UE side) or different core network domains (UTRAN side) is handled by the Routing Function Entity (**RFE**)

- Broadcast functions are handled in the broadcast control function entity (**BCFE**). The BCFE is used to deliver the RRC services, which are required at the GC-SAP. The BCFE can use the lower layer services provided by the Tr-SAP and UM-SAP.
- Paging of UEs that do not have an RRC connection is controlled by the paging and notification control function entity (**PNFE**). The PNFE is used to deliver the RRC services that are required at the Nt-SAP. The PNFE can use the lower layer services provided by the Tr-SAP and UM-SAP.
- The Dedicated Control Function Entity (**DCFE**) handles all functions specific to one UE. The DCFE is used to deliver the RRC services that are required at the DC-SAP and can use lower layer services of UM/AM-SAP and Tr-SAP depending on the message to be sent and on the current UE service state.
- In TDD mode, the DCFE is assisted by the Shared Control Function Entity (SCFE) location in the C-RNC, which controls the allocation of the PDSCH and PUSCH using lower layers services of UM-SAP and Tr-SAP.
- The Transfer Mode Entity (TME) handles the mapping between the different entities inside the RRC layer and the SAPs provided by RLC.

NOTE: Logical information exchange is necessary also between the RRC sublayer functional entities. Most of that is implementation dependent and not necessary to present in detail in a specification.

Figure 2 shows the RRC model for the UE and Figure 3 and Figure 4 show the RRC model for the UTRAN.

NOTE: The figure shows only the types of SAPs that are used. Multiple instances of Tr-SAP, UM-SAP and AM-SAP are possible. Especially, different functional entities usually use different instances of SAP types.

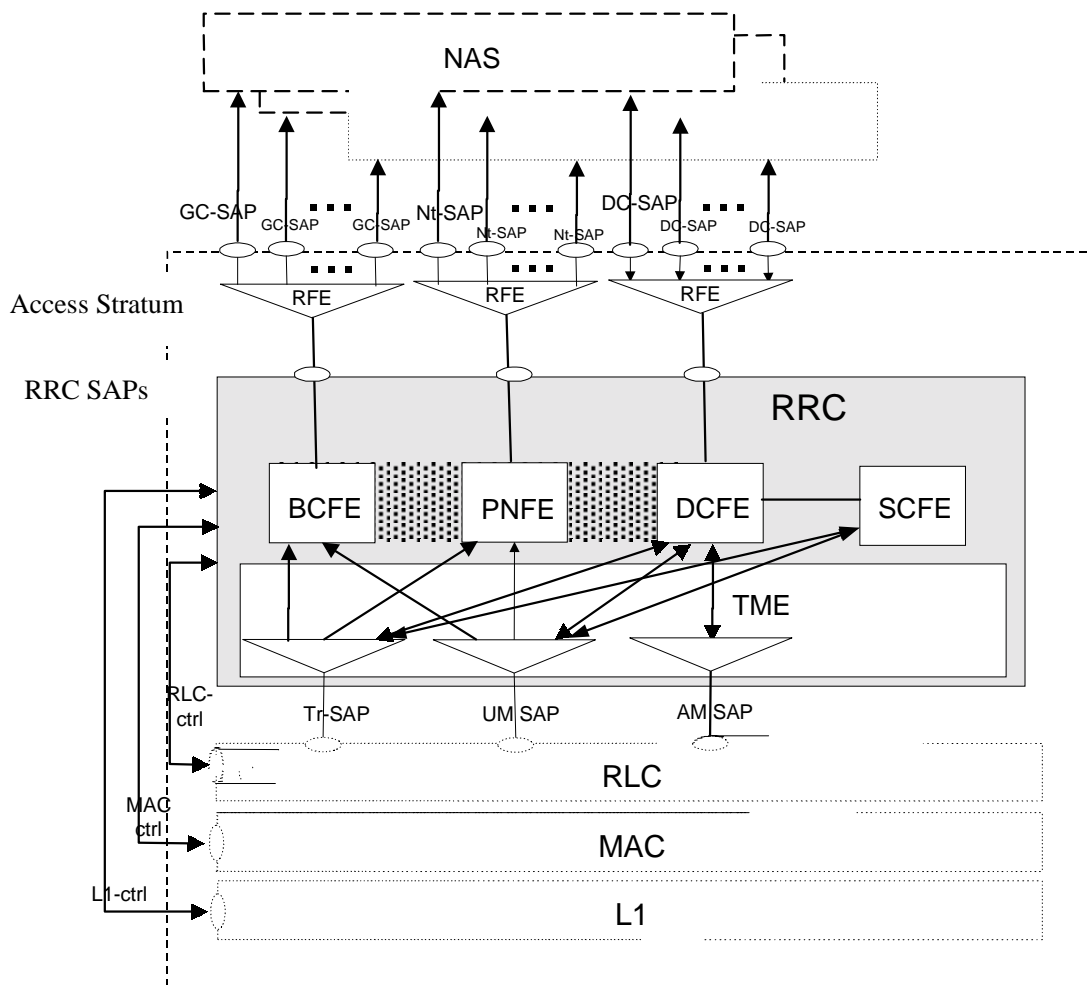

Figure 2: UE side model of RRC

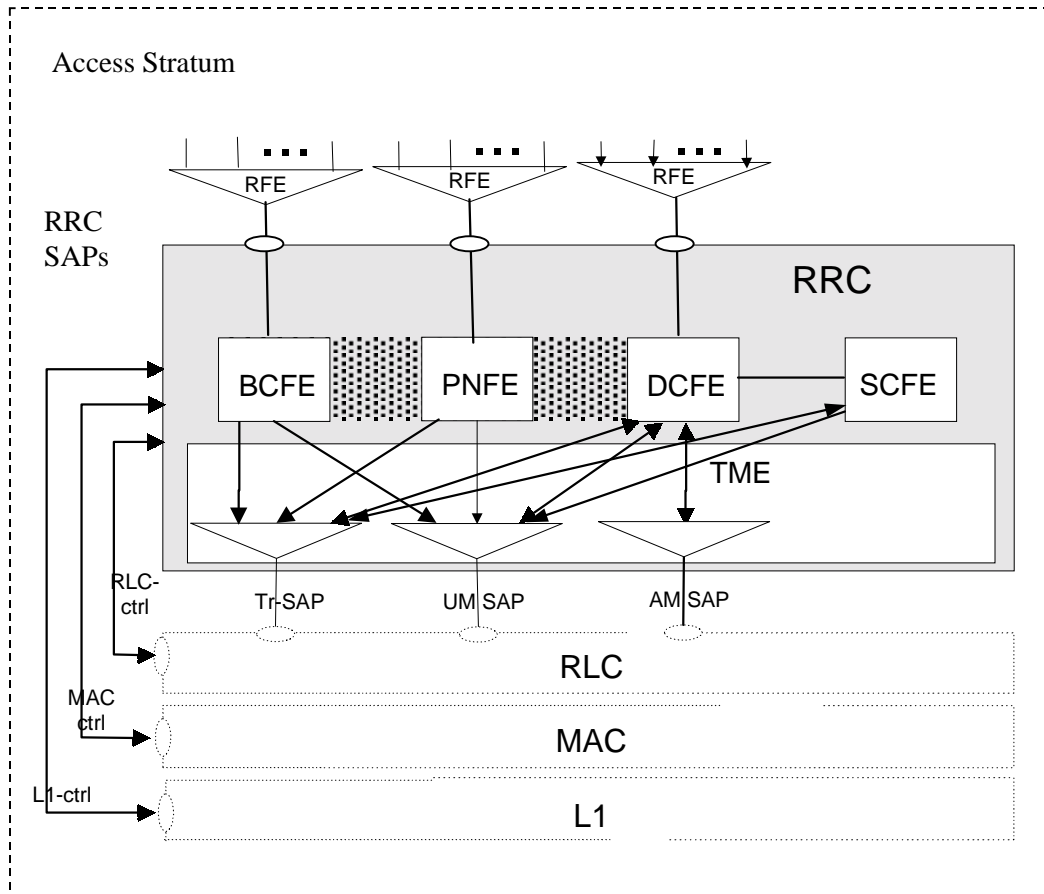

Figure 3: UTRAN side RRC model (DS-MAP system)

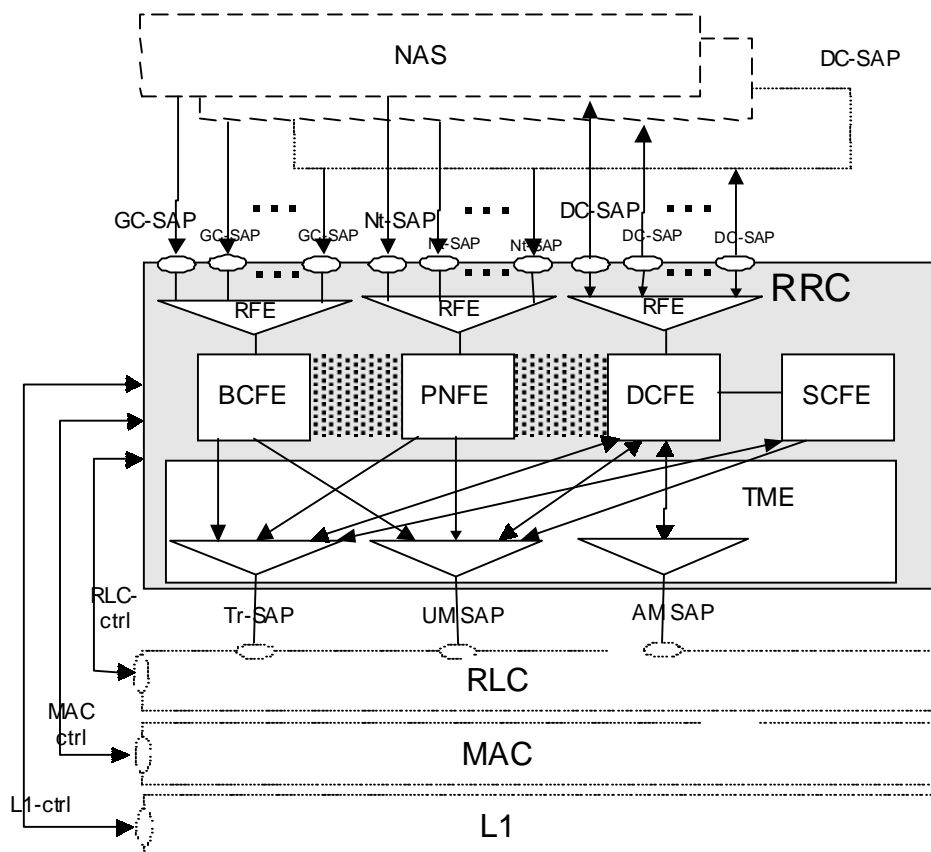

Figure 4: UTRAN side RRC model (DS-41 System)

4.3 Protocol specification principles

This protocol specification is based on the applicable general guidelines given in [14].

In this specification, a notation of variables is used. The variables are defined in subclause 13.4. Variables are typically used to represent a status or a result of an action, such as reception of an information element in a message, which is used to specify a behaviour somewhere else in the specification, such as when setting the value of an information element in a transmitted message. The variables only serve the purpose of specifying the protocol, and do not therefore impose any particular implementation.

When specifying the UE behaviour at reception of messages, the behaviour that is tied to reception or non-reception of individual information elements, and in some cases combinations of information elements, is specified in one location (subclause 8.6).

5 RRC Functions and Services provided to upper layers

5.1 RRC Functions

The RRC performs the functions listed below. A more detailed description of these functions is provided in [2]:

- Broadcast of information related to the non-access stratum (Core Network);
- Broadcast of information related to the access stratum;
- Establishment, maintenance and release of an RRC connection between the UE and UTRAN;
- Establishment, reconfiguration and release of Radio Bearers;
- Assignment, reconfiguration and release of radio resources for the RRC connection;
- RRC connection mobility functions;
- Control of requested QoS;
- UE measurement reporting and control of the reporting;
- Outer loop power control;
- Control of ciphering;
- Slow DCA (TDD mode);
- Paging;
- Initial cell selection and cell re-selection;
- Arbitration of radio resources on uplink DCH;
- RRC message integrity protection;
- Timing advance (TDD mode);
- CBS control.

5.2 RRC Services provided to upper layers

The RRC offers the following services to upper layers, a description and primitives of these services are provided in [2], [17].

- General Control;

- Notification;
- Dedicated control.

The RRC layer provides the UE-UTRAN portion of signalling connections to the upper layers to support the exchange of upper layer's information flow. The signalling connection is used between the user equipment and the core network to transfer upper layer information. For each core network domain, at most one signalling connection may exist at the same time. The RRC layer maps the signalling connections for one UE on a single RRC connection. For the upper layer data transfer on signalling connections, the RRC layer supports the discrimination between two different classes, named "High priority" (corresponding to "SAPI 0" for a GSM-MAP based core network) and "Low priority" (corresponding to "SAPI 3" for a GSM-MAP based core network).

5.3 Primitives between RRC and upper layers

The primitives between RRC and the upper layers are described in [17].

6 Services expected from lower layers

6.1 Services expected from Layer 2

The services provided by layer 2 are described in [2], [15] and [16].

6.2 Services expected from Layer 1

The services provided by layer 1 are described in [2].

6.3 Signalling Radio Bearers

The Radio Bearers (RB) available for transmission of RRC messages are defined as "signalling radio bearers" and are specified in the following. The UE and UTRAN shall select the signalling radio bearers for RRC messages using RLC-TM, RLC-UM or RLC-AM on the DCCH and CCCH, according to the following:

- Signalling radio bearer RB0 shall be used for all messages sent on the CCCH (UL: RLC-TM, DL: RLC-UM).
- Signalling radio bearer RB1 shall be used for all messages sent on the DCCH, when using RLC unacknowledged mode (RLC-UM).
- Signalling radio bearer RB2 shall be used for all messages sent on the DCCH, when using RLC acknowledged mode (RLC-AM), except for the RRC messages carrying higher layer (NAS) signalling.
- Signalling radio bearer RB3 and optionally Signalling radio bearer RB4 shall be used for the RRC messages carrying higher layer (NAS) signalling and sent on the DCCH in RLC acknowledged mode (RLC-AM), as specified in subclauses 8.1.8., 8.1.9 and 8.1.10.
- Additionally, RBs whose identities shall be set between 5 and 31 may be used as signalling radio bearer for the RRC messages on the DCCH sent in RLC transparent mode (RLC-TM).
- RRC messages on the SHCCH are mapped either on RACH or on the USCH with the lowest assigned Transport Channel Id in the uplink and either on FACH or on the DSCH with the lowest assigned Transport Channel Id using RLC-TM. These messages are only specified for TDD mode.

The Radio Bearer configuration for signalling radio bearer RB0, SHCCH, BCCH on FACH and PCCH on PCH are specified in subclauses 13.6, 13.6a, 13.6b and 13.6c.

When an RRC message is transmitted in DL on CCCH or SHCCH using RLC UM, RRC should indicate to RLC that a special RLC length indicator should be used [16]. The UE shall assume that this indication has been given. The special length indicator indicates that an RLC SDU begins in the beginning of an RLC PDU.

7 Protocol states

7.1 Overview of RRC States and State Transitions including GSM

Figure 5 shows the RRC states in UTRA RRC Connected Mode, including transitions between UTRA RRC connected mode and GSM connected mode for CS domain services, and between UTRA RRC connected mode and GSM/GPRS packet modes for PS domain services. It also shows the transitions between Idle Mode and UTRA RRC Connected Mode and furthermore the transitions within UTRA RRC connected mode.

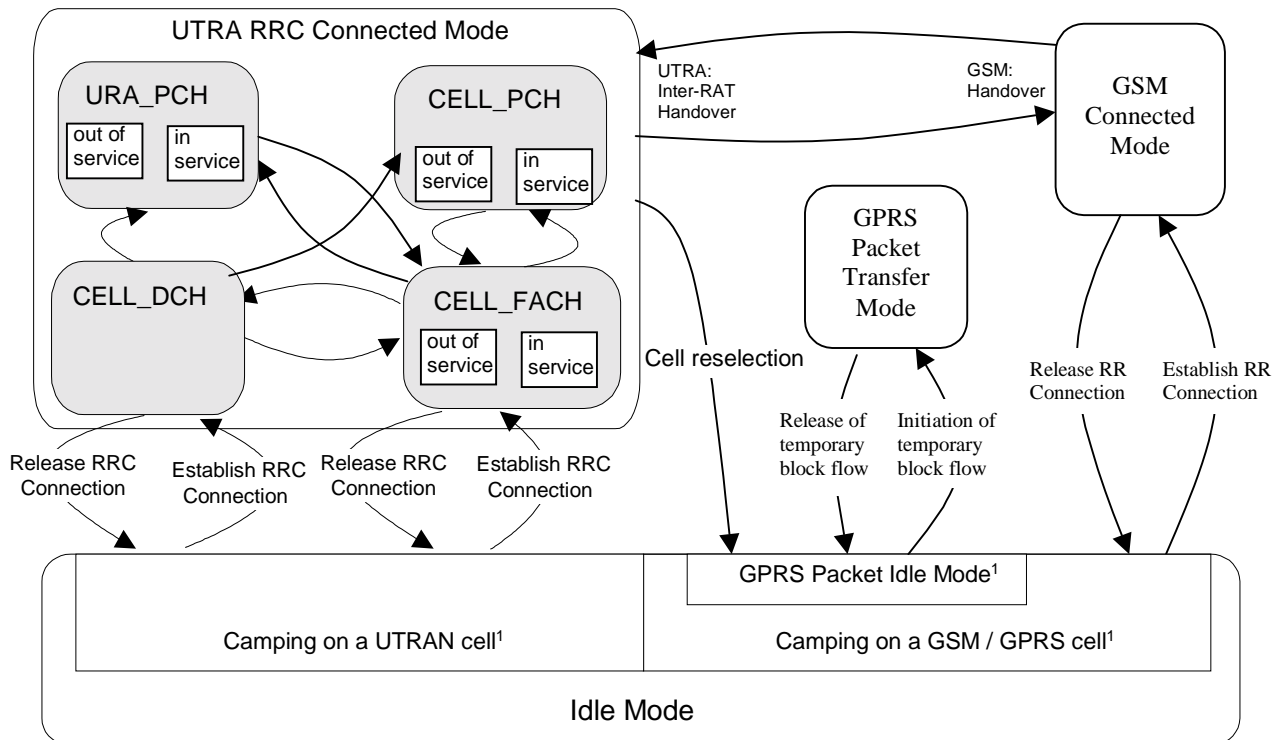

Figure 5: RRC States and State Transitions including GSM

[¹: The indicated division within Idle Mode is only included for clarification and shall not be interpreted as states.]

The RRC connection is defined as a point-to-point bi-directional connection between RRC peer entities in the UE and the UTRAN characterised by the allocation of a U-RNTI. A UE has either zero or one RRC connection.

NOTE: The state transitions are specified in clause 8.

7.2 Processes in UE modes/states

NOTE: This subclause specifies what processes shall be active in the UE in the different RRC modes/states. The related procedures and the conditions on which they are triggered are specified either in clause 8 or elsewhere in the relevant process definition.

7.2.1 UE Idle mode

UE processes that are active in UE Idle mode are specified in [4].

The UE shall perform a periodic search for higher priority PLMNs as specified in [25]

7.2.2 UTRA RRC Connected mode

In this specification unless otherwise mentioned "connected mode" shall refer to "UTRA RRC connected mode".

7.2.2.1 URA_PCH or CELL_PCH state

In the URA_PCH or CELL_PCH state the UE shall perform the following actions:

- if the UE is "in service area":
 - maintain up-to-date system information as broadcast by the serving cell as specified in the sub-clause 8.1.1;
 - perform cell reselection process as specified in [4];
 - perform a periodic search for higher priority PLMNs as specified in [25];
 - monitor the paging occasions and PICH monitoring occasions determined according to subclause 8.6.3.1a and 8.6.3.2 and receive paging information on the PCH mapped on the S-CCPCH selected by the UE according to the procedure in subclause 8.5.19;
 - perform measurements process according to measurement control information as specified in subclause 8.4 and in subclause 14.4;
 - maintain up-to-date BMC data if it supports Cell Broadcast Service (CBS) as specified in [37];
 - run timer T305 for periodical URA update if the UE is in URA_PCH or for periodical cell update if the UE is in CELL_PCH;
- if the UE is "out of service area":
 - perform cell reselection process as specified in [4];
 - run timer T316;
 - run timer T305

7.2.2.2 CELL_FACH state

In the CELL_FACH state the UE shall perform the following actions:

- if the UE is "in service area":
 - DCCH and DTCH are available;
 - perform cell reselection process as specified in [4];
 - perform measurements process according to measurement control information as specified in subclause 8.4 and in subclause 14.4;
 - run timer T305 (periodical cell update);
 - listen to all FACH transport channels mapped on the S-CCPCH selected by the UE according to the procedure in subclause 8.5.19;
- if the UE is "out of service area":
 - perform cell reselection process as specified in [4];
 - run timers T305 (periodical cell update), and T317 (cell update when re-entering "in service") or T307 (transition to Idle mode)

7.2.2.3 CELL_DCH state

In the CELL_DCH state the UE shall perform the following actions:

- if DCCH and DTCH are available:
 - read system information broadcast on FACH as specified in subclause 8.1.1.3 (applicable only to UEs with certain capabilities and in FDD mode);
 - read the system information as specified in subclause 8.1.1 (for UEs in TDD mode);
 - perform measurements process according to measurement control information as specified in subclause 8.4 and in clause 14;

8 RRC procedures

The UE shall be able to process several simultaneous RRC procedures. After the reception of a message which invoked a procedure, the UE shall be prepared to receive and act on another message which may invoke a second procedure. Whether this second invocation of a procedure (transaction) is accepted or rejected by the UE is specified in the subclauses of this clause, and in particular in subclause 8.6.3.11 (RRC transaction identifier).

On receiving a message the UE shall first apply integrity check as appropriate and then proceed with error handling as specified in clause 9 before continuing on with the procedure as specified in the relevant subclause. The RRC entity in the UE shall consider PDUs to have been transmitted when they are submitted to the lower layers. If the RRC entity in the UE submits a message for transmission using AM RLC, it shall consider the message successfully transmitted when UTRAN reception of all relevant PDUs is acknowledged by RLC. In the UE, timers are started when the PDUs are sent on the radio interface in the case of the transmission using the CCCH.

8.1 RRC Connection Management Procedures

8.1.1 Broadcast of system information

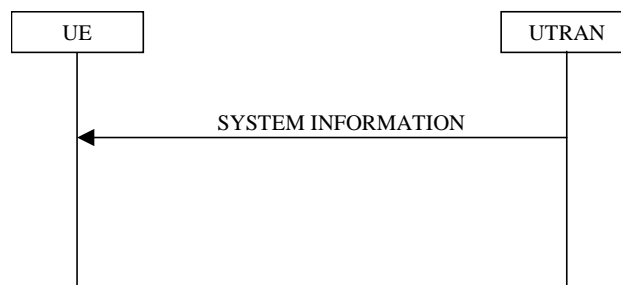

Figure 6: Broadcast of system information

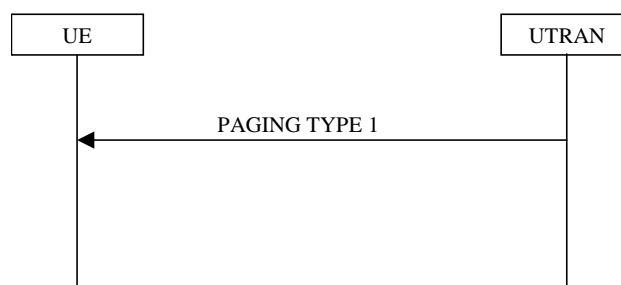

Figure 6a: Notification of system information modification for UEs in idle mode, CELL_PCH state and URA_PCH state

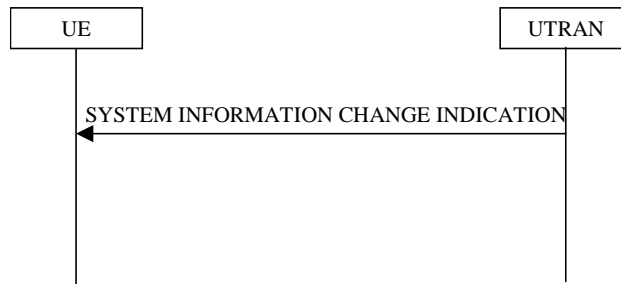

Figure 6b: Notification of system information modification for UEs in CELL_FACH state

8.1.1.1 General

The purpose of this procedure is to broadcast system information from the UTRAN to UEs in a cell.

8.1.1.1.1 System information structure

The system information elements are broadcast in *system information blocks*. A system information block groups together system information elements of the same nature. Different system information blocks may have different characteristics, e.g. regarding their repetition rate and the requirements on UEs to re-read the system information blocks.

The system information is organised as a tree. A *master information block* gives references and scheduling information to a number of system information blocks in a cell. The system information blocks contain the actual system information. The master information block may optionally also contain reference and scheduling information to one or two *scheduling blocks*, which give references and scheduling information for additional system information blocks. Scheduling information for a system information block may only be included in either the master information block or one of the scheduling blocks.

For all system information blocks except System Information Block types 15.2, 15.3 and 16, the content is the same in each occurrence for system information blocks using value tag. System Information Block types 15.2, 15.3 and 16 may occur more than once with different content. In this case scheduling information is provided for each such occurrence of the system information block. System information blocks that do not use value tag may have different content for each occurrence.

8.1.1.1.2 System information blocks

Table 8.1.1 specifies all system information blocks and their characteristics.

The *area scope column* in table 8.1.1 specifies the area where a system information block's value tag is valid. If the area scope is *cell*, the UE shall consider the system information block to be valid only in the cell in which it was read. If system information blocks have been previously stored for this cell, the UE shall check whether the value tag for the system information block in the entered cell is different compared to the stored value tag. If the area scope is *PLMN*, the UE shall check the value tag for the system information block when a new cell is selected. If the value tag for the system information block in the new cell is different compared to the value tag for the system information block stored in the UE, the UE shall re-read the system information block.

For System information block types 15.2, 15.3 and 16, which may have multiple occurrences, each occurrence has its own independent value tag. The UE shall re-read a particular occurrence if the value tag of this occurrence has changed compared to that stored in the UE.

The *UE mode/state column when block is valid* in Table 8.1.1 specifies in which UE mode or UE state the IEs in a system information block shall be regarded as valid by the UE. In other words, the indicated system information block becomes invalid upon change to a mode/state that is not included in this column. In some cases, the states are inserted in brackets to indicate that the validity is dependent on the broadcast of the associated System Information Blocks by the network as explained in the relevant procedure section.

The *UE mode/state column when block is read* in Table 8.1.1 specifies in which UE mode or UE state the IEs in a system information block may be read by the UE. The UE shall have the necessary information prior to execution of any procedure requiring information to be obtained from the appropriate system information block. The requirements on the UE in terms of when to read the system information may therefore be derived from the procedure specifications

that specify which IEs are required in the different UE modes/states in conjunction with the different performance requirements that are specified. System Information Block type 10 shall only be read by the UE while in CELL_DCH.

NOTE: There are a number of system information blocks that include the same IEs while the UE mode/state in which the information is valid differs. This approach is intended to allow the use of different IE values in different UE mode/states.

The *Scheduling information* column in Table 8.1.1 specifies the position and repetition period for the SIB.

The *modification of system information* column in Table 8.1.1 specifies the update mechanisms applicable for a certain system information block. For system information blocks with a value tag, the UE shall update the information according to subclause 8.1.1.7.1 or 8.1.1.7.2. For system information blocks with an expiration timer, the UE shall, when the timer expires, perform an update of the information according to subclause 8.1.1.7.4.

Table 8.1.1: Specification of system information block characteristics

| System information block | Area scope | UE mode/state when block is valid | UE mode/state when block is read | Scheduling information | Modification of system information | Additional comment |
|---------------------------------|------------|--|--|--|------------------------------------|--|
| Master information block | Cell | Idle mode, CELL_FACH, CELL_PCH, URA_PCH | Idle mode, CELL_FACH, CELL_PCH, URA_PCH | SIB_POS = 0 SIB_REP = 8 (FDD) SIB_REP = 8, 16, 32 (TDD) SIB_OFF=2 | Value tag | |
| Scheduling block 1 | Cell | Idle mode, CELL_FACH, CELL_PCH, URA_PCH | Idle mode, CELL_FACH, CELL_PCH, URA_PCH | Specified by the IE "Scheduling information" in MIB | Value tag | |
| Scheduling block 2 | Cell | Idle mode, CELL_FACH, CELL_PCH, URA_PCH | Idle mode, CELL_FACH, CELL_PCH, URA_PCH | Specified by the IE "Scheduling information" in MIB | Value tag | |
| System information block type 1 | PLMN | Idle mode CELL_FACH, CELL_PCH, URA_PCH, CELL_DCH | Idle | Specified by the IE "Scheduling information" | Value tag | |
| System information block type 2 | Cell | URA_PCH | URA_PCH | Specified by the IE "Scheduling information" | Value tag | |
| System information block type 3 | Cell | Idle mode, (CELL_FACH, CELL_PCH, URA_PCH) | Idle mode, (CELL_FACH, CELL_PCH, URA_PCH) | Specified by the IE "Scheduling information" | Value tag | |
| System information block type 4 | Cell | CELL_FACH, CELL_PCH, URA_PCH | CELL_FACH, CELL_PCH, URA_PCH | Specified by the IE "Scheduling information" | Value tag | If System information block type 4 is not broadcast in a cell, the connected mode UE shall apply information in System information block type 3 in connected mode. |
| System information block type 5 | Cell | Idle mode, (CELL_FACH, CELL_PCH, URA_PCH, CELL_DCH (TDD only)) | Idle mode, (CELL_FACH, CELL_PCH, URA_PCH, CELL_DCH (TDD only)) | Specified by the IE "Scheduling information" | Value tag | |

| | | | | | | |
|----------------------------------|------|--|--|--|--|---|
| System information block type 6 | Cell | CELL_FACH, CELL_PCH, URA_PCH, CELL_DCH (TDD only) | CELL_FACH, CELL_PCH, URA_PCH, CELL_DCH (TDD only) | Specified by the IE "Scheduling information" | Value tag | <p>If system information block type 6 is not broadcast in a cell, the connected mode UE shall read System information block type 5.</p> <p>If some of the optional IEs are not included in System information block type 6, the UE shall read the corresponding IEs in System information block type 5</p> <p>In TDD mode system information block 6 shall only be read in CELL_DCH if required for open loop power control as specified in subclause 8.5.7 and/or if shared transport channels are assigned to the UE. If in these cases system information block type 6 is not broadcast the UE shall read system information block type 5.</p> |
| System information block type 7 | Cell | Idle mode, CELL_FACH, CELL_PCH, URA_PCH, CELL_DCH (TDD only) | Idle mode, CELL_FACH, CELL_PCH, URA_PCH, CELL_DCH (TDD only) | Specified by the IE "Scheduling information" | Expiration timer = MAX([320 ms], SIB_REP * ExpirationTimeFactor) | In TDD mode system information block type 7 shall only be read in CELL_DCH if shared transport channels are assigned to the UE. |
| System information block type 8 | Cell | CELL_FACH, CELL_PCH, URA_PCH | CELL_FACH, CELL_PCH, URA_PCH | Specified by the IE "Scheduling information" | Value tag | |
| System information block type 9 | Cell | CELL_FACH, CELL_PCH, URA_PCH | CELL_FACH, CELL_PCH, URA_PCH | Specified by the IE "Scheduling information" | Expiration timer = SIB_REP | |
| System information block type 10 | Cell | CELL_DCH | CELL_DCH | Specified by the IE "Scheduling information" | Expiration timer = SIB_REP | |
| System information block type 11 | Cell | Idle mode (CELL_FACH, CELL_PCH, URA_PCH, CELL_DCH) | Idle mode (CELL_FACH, CELL_PCH, URA_PCH) | Specified by the IE "Scheduling information" | Value tag | |

| | | | | | | |
|------------------------------------|------|---|---|--|--|--|
| System information block type 12 | Cell | CELL_FACH, CELL_PCH, URA_PCH, CELL_DCH | CELL_FACH, CELL_PCH, URA_PCH | Specified by the IE "Scheduling information" | Value tag | If system information block type 12 is not broadcast in a cell, the connected mode UE shall read System information block type 11. If some of the optional IEs are not included in System information block type 12, the UE shall read the corresponding IEs in System information block type 11. |
| System information block type 13 | Cell | Idle Mode, CELL_FACH, CELL_PCH, URA_PCH | Idle Mode, CELL_FACH, CELL_PCH, URA_PCH | Specified by the IE "Scheduling information" | Value tag | |
| System information block type 13.1 | Cell | Idle Mode, CELL_FACH, CELL_PCH, URA_PCH | Idle Mode, CELL_FACH, CELL_PCH, URA_PCH | Specified by the IE "Scheduling information" | Value tag | |
| System information block type 13.2 | Cell | Idle Mode, CELL_FACH, CELL_PCH, URA_PCH | Idle Mode, CELL_FACH, CELL_PCH, URA_PCH | Specified by the IE "Scheduling information" | Value tag | |
| System information block type 13.3 | Cell | Idle Mode, CELL_FACH, CELL_PCH, URA_PCH | Idle Mode, CELL_FACH, CELL_PCH, URA_PCH | Specified by the IE "Scheduling information" | Value tag | |
| System information block type 13.4 | Cell | Idle Mode, CELL_FACH, CELL_PCH, URA_PCH | Idle Mode, CELL_FACH, CELL_PCH, URA_PCH | Specified by the IE "Scheduling information" | Value tag | |
| System information block type 14 | Cell | Idle Mode, CELL_FACH, CELL_PCH, URA_PCH, CELL_DCH | Idle Mode, CELL_FACH, CELL_PCH, URA_PCH, CELL_DCH | Specified by the IE "Scheduling information" | Expiration timer = MAX([320 ms], SIB_REP * ExpirationTimeFactor) | This system information block is used in TDD mode only. System information block type 14 shall only be read in CELL_DCH if required for open loop power control as specified in subclause 8.5.7. |
| System information block type 15 | Cell | Idle Mode, CELL_FACH, CELL_PCH, URA_PCH | Idle Mode, CELL_FACH, CELL_PCH, URA_PCH | Specified by the IE "Scheduling information" | Value tag | |
| System information block type 15.1 | Cell | Idle Mode, CELL_FACH, CELL_PCH, URA_PCH | Idle Mode, CELL_FACH, CELL_PCH, URA_PCH | Specified by the IE "Scheduling information" | Value tag | |
| System information block type 15.2 | Cell | Idle Mode, CELL_FACH, CELL_PCH, URA_PCH | Idle Mode, CELL_FACH, CELL_PCH, URA_PCH | Specified by the IE "Scheduling information" | Value tag | For this system information block there may be multiple occurrences |
| System information block type 15.3 | PLMN | Idle Mode, CELL_FACH, CELL_PCH, URA_PCH | Idle Mode, CELL_FACH, CELL_PCH, URA_PCH | Specified by the IE "Scheduling information" | Value tag | For this system information block there may be multiple occurrences |
| System information block type 15.4 | Cell | Idle Mode, CELL_FACH, CELL_PCH, URA_PCH | Idle Mode, CELL_FACH, CELL_PCH, URA_PCH | Specified by the IE "Scheduling information" | Value tag | |

| | | | | | | |
|----------------------------------|------|---|---|--|----------------------------|--|
| System information block type 16 | PLMN | Idle Mode, CELL_FACH, CELL_PCH, URA_PCH | Idle Mode, CELL_FACH, CELL_PCH, URA_PCH | Specified by the IE "Scheduling information" | Value tag | For this system information block there may be multiple occurrences |
| System information block type 17 | Cell | CELL_FACH, CELL_PCH, URA_PCH, CELL_DCH | CELL_FACH, CELL_PCH, URA_PCH, CELL_DCH | Specified by the IE "Scheduling information" | Expiration timer = SIB_REP | This system information block is used in TDD mode only. System information block type 17 shall only be read if shared transport channels are assigned to the UE. |
| System Information Block type 18 | Cell | Idle mode, CELL_FACH, CELL_PCH, URA_PCH, CELL_DCH | Idle mode, CELL_FACH, CELL_PCH, URA_PCH | Specified by the IE "Scheduling information" | Value tag | |

The UE shall acquire all system information blocks except system information block type 10 on BCH. System Information Block type 10 shall be acquired on the FACH and only by UEs with support for simultaneous reception of one SCCPCH and one DPCH. If System Information Block type 10 is not broadcast in a cell, the DRAC procedures do not apply in this cell. System Information Block type 10 is used in FDD mode only.

8.1.1.1.3 Segmentation and concatenation of system information blocks

A generic SYSTEM INFORMATION message is used to convey the system information blocks on the BCCH. A given BCCH may be mapped onto either a BCH or a FACH transport channel according to subclause 8.1.1.1.2. The size of the SYSTEM INFORMATION message shall fit the size of a BCH or a FACH transport block.

The RRC layer in UTRAN performs segmentation and concatenation of encoded system information blocks. If the encoded system information block is larger than the size of a SYSTEM INFORMATION message, it will be segmented and transmitted in several messages. If the encoded system information block is smaller than a SYSTEM INFORMATION message, UTRAN may concatenate several system information blocks, or the first segment or the last segment into the same message as specified in the remainder of this clause.

Four different segment types are defined:

- First segment;
- Subsequent segment;
- Last segment;
- Complete.

Each of the types - *First*, *Subsequent* and *Last segment* - is used to transfer segments of a master information block, scheduling block or a system information block. The segment type, *Complete*, is used to transfer a complete master information block, complete scheduling block or a complete system information block.

Each segment consists of a header and a data field. The data field carries the encoded system information elements. The header contains the following parameters:

- The number of segments in the system information block (SEG_COUNT). This parameter is only included in the header if the segment type is "First segment".
- SIB type. The SIB type uniquely identifies the master information block, scheduling block or a system information block.
- Segment index. This parameter is only included in the header if the segment type is "Subsequent segment" or "Last segment".

UTRAN may combine one or several segments of variable length in the same SYSTEM INFORMATION message. The following combinations are allowed:

1. No segment;

2. First segment;
3. Subsequent segment;
4. Last segment;
5. Last segment + First segment;
6. Last segment + one or several Complete;
7. Last segment + one or several Complete + First segment;
8. One or several Complete;
9. One or several Complete + First segment;
10. One Complete of size 215 to 226;
11. Last segment of size 215 to 222.

The "No segment" combination is used when there is no master information block, scheduling block or system information block scheduled for a specific BCH transport block.

UEs are not required to support the reception of multiple occurrences of the same system information block type within one SYSTEM INFORMATION message.

NOTE: Since the SIB type is the same for each occurrence of the system information block, the UE does not know the order in which the occurrences, scheduled for this SYSTEM INFORMATION message, appear. Therefore, the UE is unable to determine which scheduling information, e.g., value tag relates to which occurrence of the system information block.

8.1.1.1.4 Re-assembly of segments

The RRC layer in the UE shall perform re-assembly of segments. All segments belonging to the same master information block, scheduling block or system information block shall be assembled in ascending order with respect to the segment index. When all segments of the master information block, scheduling block or a system information block have been received, the UE shall perform decoding of the complete master information block, scheduling block or system information block. For System Information Block type 16 which may have multiple occurrences, each occurrence shall be re-assembled independently.

The UE shall discard system information blocks of which segments were missing, of which segments were received out of sequence and/or for which duplicate segments were received. The only valid sequence is an ascending one with the sequence starting with the First Segment of the associated System Information Block.

If the UE receives a Subsequent segment or Last segment where the index in IE "Segment index" is larger than the number of segments stated in IE "SEG_COUNT" in the scheduling information for that scheduling block or system information block,

- the UE may
 - read all the segments to create a system information block as defined by the scheduling information read by the UE;
 - store the content of the system information block with a value tag set to the value NULL; and
 - consider the content of the scheduling block or system information block as valid,
 - until it receives the same type of scheduling block or system information block in a position according to its scheduling information or
 - at most for 6 hours after reception.
- and the UE shall:
 - re-read scheduling information for that scheduling block or system information block.

If the UE receives a Subsequent segment or Last segment where the index in IE "Segment index" is larger than the number of segments stated in IE "SEG_COUNT" in the First segment, the UE shall

- discard all segments for that master information block, scheduling block or system information block and
- re-read the scheduling information for that system information block.
- then re-read all segments for that system information block.

8.1.1.1.5 Scheduling of system information

Scheduling of system information blocks is performed by the RRC layer in UTRAN. If segmentation is used, it should be possible to schedule each segment separately.

To allow the mixing of system information blocks with short repetition period and system information blocks with segmentation over many frames, UTRAN may multiplex segments from different system information blocks. Multiplexing and de-multiplexing is performed by the RRC layer.

The scheduling of each system information block broadcast on a BCH transport channel is defined by the following parameters:

- the number of segments (SEG_COUNT);
- the repetition period (SIB_REP). The same value applies to all segments;
- the position (phase) of the first segment within one cycle of the Cell System Frame Number (SIB_POS(0)). Since system information blocks are repeated with period SIB_REP, the value of SIB_POS(i), $i = 0, 1, 2, \dots, \text{SEG_COUNT}-1$ must be less than SIB_REP for all segments;
- the offset of the subsequent segments in ascending index order (SIB_OFF(i), $i = 1, 2, \dots, \text{SEG_COUNT}-1$). The position of the subsequent segments is calculated using the following: $\text{SIB_POS}(i) = \text{SIB_POS}(i-1) + \text{SIB_OFF}(i)$.

The scheduling is based on the Cell System Frame Number (SFN). The SFN of a frame at which a particular segment, i , with $i = 0, 1, 2, \dots, \text{SEG_COUNT}-1$ of a system information block occurs, fulfils the following relation:

$$\text{SFN mod SIB_REP} = \text{SIB_POS}(i)$$

In FDD and TDD the scheduling of the master information block is fixed as defined in Table 8.1.1. For TDD, UTRAN may apply one of the values allowed for the master information block's repetition period. The value that UTRAN is using in TDD is not signalled; UEs have to determine it by trial and error.

8.1.1.2 Initiation

The system information is continuously broadcast on a regular basis in accordance with the scheduling defined for each system information block.

8.1.1.3 Reception of SYSTEM INFORMATION messages by the UE

The UE shall read SYSTEM INFORMATION messages broadcast on a BCH transport channel in idle mode and in the connected mode in states CELL_FACH, CELL_PCH, URA_PCH and CELL_DCH (TDD only). In addition, UEs which support simultaneous reception of one SCCPCH and one DPCH shall read system information on a FACH transport channel when in CELL_DCH state.

In idle mode and connected mode different combinations of system information blocks are valid. The UE shall acquire the system information blocks that are needed according to Table 8.1.1.

The UE may store system information blocks with cell or PLMN area scope (including their value tag if applicable) for different cells and different PLMNs, to be used if the UE returns to these cells.

The UE shall consider all stored system information blocks as invalid after it has been switched off. Some information obtained from system information may be stored by the UE or in the USIM for use in a stored information cell selection.

When selecting a new cell within the currently used PLMN, the UE shall consider all current system information blocks with area scope cell to be invalid. If the UE has stored valid system information blocks for the newly selected cell, the UE may set those as current system information blocks.

After selecting a new PLMN, the UE shall consider all current system information blocks to be invalid. If the UE has previously stored valid system information blocks for the selected cell of the new PLMN, the UE may set those as current system information blocks. Upon selection of a new PLMN the UE shall store all information elements specified within variable `SELECTED_PLMN` for the new PLMN within this variable.

8.1.1.4 Reception of SYSTEM INFORMATION messages broadcast on a FACH transport channel

System information block type 10 may be broadcast on FACH, as specified in subclause 8.1.1.1.2.

When reading system information blocks on FACH, the UE shall perform the actions as defined in subclause 8.1.1.6.

8.1.1.5 Actions upon reception of the Master Information Block and Scheduling Block(s)

When selecting a new cell, the UE shall read the master information block. The UE may use the pre-defined scheduling information to locate the master information block in the cell.

Upon reception of the master information block, the UE shall:

- if the "PLMN type" in the variable `SELECTED_PLMN` has the value "GSM-MAP" and the IE "PLMN Type" has the value "GSM-MAP" or "GSM-MAP and ANSI-41":
 - check the IE "PLMN identity" in the master information block and verify that it is the selected PLMN, stored as "PLMN identity" in the variable `SELECTED_PLMN`;
- if the "PLMN type" in the variable `SELECTED_PLMN` has the value "ANSI-41" and the IE "PLMN Type" has the value "ANSI-41" or "GSM-MAP and ANSI-41":
 - store the ANSI-41 Information elements contained in the master information block and perform initial process for ANSI-41;
 - compare the value tag in the master information block with the value tag stored for this cell and this PLMN in the variable `VALUE_TAG`;
 - if the value tags differ, or if no IEs for the master information block are stored:
 - store the value tag into the variable `VALUE_TAG` for the master information block;
 - read and store scheduling information included in the master information block;
 - if the value tags are the same the UE may use stored system information blocks and scheduling blocks using value tag that were stored for this cell and this PLMN as valid system information.

For all system information blocks or scheduling blocks that are supported by the UE referenced in the master information block or the scheduling blocks, the UE shall perform the following actions:

- for all system information blocks with area scope "PLMN" that use value tags:
 - compare the value tag read in scheduling information for that system information block with the value stored within the variable `VALUE_TAG` for that system information block;
 - if the value tags differ, or if no IEs for the corresponding system information block are stored:
 - store the value tag read in scheduling information for that system information block into the variable `VALUE_TAG`;
 - read and store the IEs of that system information block;
 - if the value tags are the same the UE may use stored system information blocks using value tag that were stored in this PLMN as valid system information;

- for all system information blocks or scheduling blocks with area scope cell that use value tags:
 - compare the value tag read in scheduling information for that system information block or scheduling block with the value stored within the variable VALUE_TAG for that system information block or scheduling block;
 - if the value tags differ, or if no IEs for the corresponding system information block or scheduling block are stored:
 - store the value tag read in scheduling information for that system information block or scheduling block into the variable VALUE_TAG;
 - read and store the IEs of that system information block or scheduling block;
 - if the value tags are the same the UE may use stored system information blocks using value tags that were stored for this cell and this PLMN as valid system information;
- for system information blocks which may have multiple occurrences:
 - compare the value tag and the configuration or multiple occurrence identity for the occurrence of the system information blocks read in scheduling information with the value tag and configuration or multiple occurrence identity stored within the variable VALUE_TAG;
 - if the value tags differ, or if no IEs from the occurrence with that configuration or multiple occurrence identity of the system information block are stored:
 - store the value tag read in scheduling information for that system information block and the occurrence with that configuration or multiple occurrence identity into the variable VALUE_TAG;
 - read and store the IEs of that system information block;
 - if the value tags and the configuration or multiple occurrence identity are identical to those stored, the UE may use stored occurrences of system information blocks that were stored for this cell and this PLMN as valid system information.

For system information blocks, not supported by the UE, but referenced either in the master information block or in the scheduling blocks, the UE may:

- skip reading this system information block;
- skip monitoring changes to this system information block.

If the UE:

- receives a scheduling block at a position different from its position according to the scheduling information for the scheduling block; or
- receives a scheduling block for which scheduling information has not been received:

the UE may:

- store the content of the scheduling block with a value tag set to the value NULL; and
- consider the content of the scheduling block as valid until it receives the same type of scheduling block in a position according to its scheduling information or at most for 6 hours after reception.

If the UE does not find a scheduling block in a position where it should be according to its scheduling information, but a transport block with correct CRC was found at that position, the UE shall:

- read the scheduling information for this scheduling block.

If the UE does not find the master information block in a position fulfilling

$$\text{SFN mod } 32 = 0$$

but a transport block with correct CRC was found at that position), the UE shall:

- consider the master information block as not found; and
- consider the cell to be barred according to [4]; and
- consider the barred cell as using the value "allowed" in the IE "Intra-frequency cell re-selection indicator", and the maximum value in the IE " T_{barred} "; and
- not initiate emergency calls in the cell.

NOTE: This permits a different repetition for the MIB in later versions for FDD. In TDD it allows for a variable SIB_REP in this and future releases.

If in idle mode and system information block type 1 is not scheduled on BCH, and system information block type 13 is not scheduled on BCH, the UE shall:

- consider the cell to be barred according to [4]; and
- consider the barred cell as using the value "allowed" in the IE "Intra-frequency cell re-selection indicator", and the maximum value in the IE " T_{barred} "; and
- not initiate emergency calls in the cell.

If the UE only supports GSM-MAP but finds a cell that broadcasts System Information Block type 13 but not System Information Block type 1, the UE shall:

- consider the cell barred.

If in idle mode and if

- system information block type 1 is not scheduled on BCH; and
- the "PLMN Type" in the variable SELECTED_PLMN has the value "GSM-MAP"; and
- the IE "PLMN type" in the Master Information Block has the value "GSM-MAP" or "GSM-MAP and ANSI-41":

the UE shall:

- indicate to upper layers that no CN system information is available.

If in idle mode and System Information Block type 3 is not scheduled on BCH, the UE shall:

- consider the cell to be barred according to [4]; and
- consider the barred cell as using the value "allowed" in the IE "Intra-frequency cell re-selection indicator", and the maximum value in the IE " T_{barred} "; and
- not initiate emergency calls in the cell.

If in connected mode and System Information Block type 3 is not scheduled on BCH, and System Information Block type 4 is not scheduled on BCH, the UE shall:

- consider the cell to be barred according to [4]; and
- consider the barred cell as using the value "allowed" in the IE "Intra-frequency cell re-selection indicator", and the maximum value in the IE " T_{barred} "; and
- not initiate emergency calls in the cell.

If in idle mode and System Information Block type 5 is not scheduled on BCH or System Information Block type 5 is scheduled but AICH info or PICH info is not present, the UE shall:

- consider the cell to be barred according to [4]; and
- consider the barred cell as using the value "allowed" in the IE "Intra-frequency cell re-selection indicator", and the maximum value in the IE " T_{barred} "; and
- not initiate emergency calls in the cell.

If in connected mode and System Information Block type 5 is not scheduled on BCH, and System Information Block type 6 is not scheduled on BCH, or any of System Information Block type 5 or type 6 is scheduled but IE "AICH info" or IE "PICH info" is not present, the UE shall:

- consider the cell to be barred according to [4]; and
- consider the barred cell as using the value "allowed" in the IE "Intra-frequency cell re-selection indicator", and the maximum value in the IE " T_{barred} "; and
- not initiate emergency calls in the cell.

If System Information Block type 7 is not scheduled on BCH, the UE shall:

- consider the cell to be barred according to [4]; and
- consider the barred cell as using the value "allowed" in the IE "Intra-frequency cell re-selection indicator", and the maximum value in the IE " T_{barred} "; and
- not initiate emergency calls in the cell.

8.1.1.6 Actions upon reception of system information blocks

The UE may use the scheduling information included within the master information block and the scheduling blocks to locate each system information block to be acquired.

The UE should only expect one occurrence of the scheduling information for a system information block in the master information block and any of the scheduling blocks except for System Information Block type 16, System Information Block type 15.2 and System Information Block type 15.3, which may have multiple occurrences. However, to enable future introduction of new system information blocks, the UE shall also be able to receive system information blocks other than the ones indicated within the scheduling information. The UE may ignore contents of such system information block.

If the UE

- receives a system information block in a position according to the scheduling information for the system information block; and
- this system information block uses a value tag; or
- this system information block uses a value tag and configuration or multiple occurrence identity:

the UE shall:

- store the content of the system information block together with the value of its value tag or the values of configuration and multiple occurrence identity and the associated value tag in the scheduling information for the system information block; and
- consider the content of the system information block valid until, if used, the value tag in the scheduling information for the system information block is changed or at most for 6 hours after reception.

If the UE

- receives a system information block in a position according to the scheduling information for the system information block; and
- this system information block does not use a value tag according to the system information block type:

the UE shall:

- store the content of the system information block; and
- start an expiration timer using a value as defined in Table 8.1.1 for that system information block type; and
- consider the content of the system information block valid until, the expiration timer expires.

If the UE

- receives a system information block at a position different from its position according to the scheduling information for the system information block; or
- receives a system information block for which scheduling information has not been received; and
- this system information block uses a value tag:

the UE may:

- store the content of the system information block with a value tag set to the value NULL; and
- consider the content of the system information block as valid until it receives the same type of system information block in a position according to its scheduling information or at most for 6 hours after reception.

If the UE

- receives a system information block with multiple occurrences at a position different from its position according to the scheduling information for the system information block; or
- receives a system information block with multiple occurrences for which scheduling information has not been received; and
- this system information block uses a value tag and configuration or multiple occurrence identity:

the UE shall:

- ignore this information.

If the UE does not find a system information block in a position where it should be according to its scheduling information, but a transport block with correct CRC was found at that position, the UE shall read the scheduling information for this system information block.

The UE shall act upon all received information elements as specified in subclause 8.6 unless specified otherwise in the following subclauses.

8.1.1.6.1 System Information Block type 1

If in idle mode, the UE should store all relevant IEs included in this system information block if the "PLMN Type" in the variable `SELECTED_PLMN` has the value "GSM-MAP" and the IE "PLMN type" in the Master Information Block has the value "GSM-MAP" or "GSM-MAP and ANSI-41". The UE shall also:

- forward the content of the IE "CN common GSM-MAP NAS system information" to upper layers;
- for the IE "CN domain system information list":
 - for each IE "CN domain system information" that is present:
 - forward the content of the IE "CN domain specific NAS system information" and the IE "CN domain identity" to upper layers;
 - use the IE "CN domain specific DRX cycle length coefficient" to calculate frame number for the Paging Occasions as specified in [4];
 - if an IE "CN domain system information" is not present for a particular CN domain:
 - indicate to upper layers that no CN system information is available for that CN domain;
- use the values in the IE "UE Timers and constants in idle mode" for the relevant timers and constants;
- store the values of the IE "UE Timers and constants in idle mode" in the variable `TIMERS_AND_CONSTANTS`.

If in connected mode the UE shall not use the values of the IEs in this system information block except for the timers and constant values given by the IE "UE timers and constants in connected mode".

8.1.1.6.2 System Information Block type 2

If in connected mode the UE should store all relevant IEs included in this system information block. The UE shall:

- if in state URA_PCH, start to perform URA updates using the information in the IE "URA identity".

If in idle mode, the UE shall not use the values of the IEs in this system information block.

8.1.1.6.3 System Information Block type 3

The UE should store all relevant IEs included in this system information block. The UE shall:

- if in connected mode, and System Information Block 4 is indicated as used in the cell:
 - read and act on information sent in that block.

If the value of the IE "Cell Reservation Extension" is set to "reserved", the UE shall:

- consider the cell to be barred according to [4]; and.
- consider the barred cell as using the value "allowed" in the IE "Intra-frequency cell re-selection indicator", and the maximum value in the IE "Tbarred"; and
- not initiate emergency calls in the cell.

8.1.1.6.4 System Information Block type 4

If in connected mode, the UE should store all relevant IEs included in this system information block.

If in idle mode, the UE shall not use the values of the IEs included in this system information block.

If the value of the IE "Cell Reservation Extension" is set to "reserved", the UE shall:

- consider the cell to be barred according to [4]; and.
- consider the barred cell as using the value "allowed" in the IE "Intra-frequency cell re-selection indicator", and the maximum value in the IE "Tbarred"; and
- not initiate emergency calls in the cell.

8.1.1.6.5 System Information Block type 5

The UE should store all relevant IEs included in this system information block. The UE shall:

- if in connected mode, and System Information Block type 6 is indicated as used in the cell:
 - read and act on information sent in System Information Block type 6.
- replace the TFS of the RACH with the one stored in the UE if any;
- let the physical channel(s) of type PRACH given by the IE(s) "PRACH info" be the default in uplink for the PRACH if UE is in CELL_FACH state;
- start to receive the physical channel of type AICH using the parameters given by the IE "AICH info" (FDD only) when given allocated PRACH is used;
- replace the TFS of the FACH/PCH with the one stored in the UE if any;
- select a Secondary CCPCH as specified in subclause 8.6, and start to receive the physical channel of type PICH associated with the PCH carried by the selected Secondary CCPCH using the parameters given by the IE "PICH info" if UE is in Idle mode or in CELL_PCH or URA_PCH state;
- start to monitor its paging occasions on the selected PICH if UE is in Idle mode or in CELL_PCH or URA_PCH state;

- start to receive the selected physical channel of type Secondary CCPCH using the parameters given by the IE(s) "Secondary CCPCH info" if UE is in CELL_FACH state;
- in 3.84 Mcps TDD:
 - use the IE "TDD open loop power control" as defined in subclause 8.5.7 when allocated PRACH is used;
- in TDD:
 - if the IE "PDSCH system information" and/or the IE "PUSCH system information" is included:
 - store each of the configurations given there with the associated identity given in the IE "PDSCH Identity" and/or "PUSCH Identity" respectively. For every configuration, for which the IE "SFN Time info" is included, the information shall be stored for the duration given there.

8.1.1.6.6 System Information Block type 6

If in connected mode, the UE should store all relevant IEs included in this system information block. The UE shall:

- replace the TFS of the RACH with the one stored in the UE if any;
- let the physical channel(s) of type PRACH given by the IE(s) "PRACH info" be the default in uplink if UE is in CELL_FACH state. If the IE "PRACH info" is not included, the UE shall read the corresponding IE(s) in System Information Block type 5 and use that information to configure the PRACH;
- start to receive the physical channel of type AICH using the parameters given by the IE "AICH info" when associated PRACH is used. If the IE "AICH info" is not included, the UE shall read the corresponding IE in System Information Block type 5 and use that information (FDD only);
- replace the TFS of the FACH/PCH with the one stored in the UE if any;
- select a Secondary CCPCH as specified in subclause 8.6, and start to receive the physical channel of type PICH associated with the PCH carried by the selected Secondary CCPCH using the parameters given by the IE "PICH info" if the UE is in CELL_PCH or URA_PCH state. If the IE "PICH info" is not included, the UE shall read the corresponding IE in System Information Block type 5 and use that information;
- start to monitor its paging occasions on the selected PICH if the UE is in CELL_PCH or URA_PCH state;
- start to receive the selected physical channel of type Secondary CCPCH using the parameters given by the IE(s) "Secondary CCPCH info" if the UE is in CELL_FACH state. If the IE "Secondary CCPCH info" is not included, the UE shall read the corresponding IE(s) in System Information Block type 5 and use that information;
- in 3.84 Mcps TDD: use the IE "TDD open loop power control" as defined in subclause 8.5.7;
- in TDD: if the IE "PDSCH system information" and/or the IE "PUSCH system information" is included, store each of the configurations given there with the associated identity given in the IE "PDSCH Identity" and/or "PUSCH Identity" respectively. For every configuration, for which the IE "SFN Time info" is included, the information shall be stored for the duration given there.

If in idle mode, the UE shall not use the values of the IEs in this system information block.

8.1.1.6.7 System Information Block type 7

The UE should store all relevant IEs included in this system information block.

8.1.1.6.8 System Information Block type 8

This system information block type is used only in FDD.

If in connected mode, the UE should store all relevant IEs included in this system information block.

If in idle mode, the UE shall not use the values of the IEs in this system information block.

8.1.1.6.9 System Information Block type 9

This system information block type is used only in FDD.

If in connected mode, the UE should store all relevant IEs included in the system information block. The UE shall:

- start a timer set to the value given by the repetition period (SIB_REP) for that system information block

If in idle mode, the UE shall not use the values of the IEs in this system information block.

8.1.1.6.10 System Information Block type 10

This system information block type is used only in FDD.

If in state CELL_DCH, the UE should store all relevant IEs included in this system information block. The UE shall:

- start a timer set to the value given by the repetition period (SIB_REP) for that system information block;
- perform actions defined in subclause 14.8.

If in idle mode, state CELL_FACH, state CELL_PCH or state URA_PCH, the UE shall not use the values of the IEs in this system information block.

8.1.1.6.11 System Information Block type 11

The UE should store all relevant IEs included in this system information block. The UE shall:

- if in connected mode, and System Information Block type 12 is indicated as used in the cell:
 - read and act on information sent in System Information Block type 12;
- for each measurement type:
 - start a measurement using the set of IEs specified for that measurement type;
 - associate each measurement with the identity number given by the IE "Measurement identity";
 - clear the variable CELL_INFO_LIST;
 - act upon the received IE "Intra-frequency/Inter-frequency/Inter-RAT cell info list" as described in subclause 8.6.7.3;
- if included, store the IE "Intra-frequency reporting quantity" and the IE "Intra-frequency measurement reporting criteria" or "Periodical reporting criteria" in order to activate reporting when state CELL_DCH is entered;
- If IE "Use of HCS" is set to "used", indicating that HCS is used, do the following:
 - If IE "HCS neighbouring cell information" is not included in the first occurrence of IE "Intra-frequency cell info list", use the default values specified for the IE "HCS neighbouring cell information" for that cell;
 - If IE "HCS neighbouring cell information" is not included in other occurrence of IE "Intra-frequency cell info list", for that cell use the same parameter values as used for the preceding IE "Intra-frequency cell info list";
 - If IE "HCS neighbouring cell information" is not included in the first occurrence of IE "Inter-frequency cell info list", use the default values specified for the IE "HCS neighbouring cell information" for that cell;
 - If IE "HCS neighbouring cell information" is not included in other occurrence of IE "Inter-frequency cell info list", for that cell use the same parameter values as used for the preceding IE "Inter-frequency cell info list";
 - If IE "HCS neighbouring cell information" is not included in the first occurrence of IE "Inter-RAT Cell info list", use the default values specified for the IE "HCS neighbouring cell information" for that cell;
 - If IE "HCS neighbouring cell information" is not included in other occurrence of IE "Inter-RAT cell info list", for that cell use the same parameter values as used for the preceding IE "Inter-RAT cell info list";
- If IE "FACH measurement occasion info" is included:

- act as specified in subclause 8.6.7
- else:
 - may perform inter-frequency/inter-RAT measurements or inter-frequency/inter-RAT cell re-selection evaluation, if the UE capabilities permit such measurements while simultaneously receiving the S-CCPCH of the serving cell.

8.1.1.6.12 System Information Block type 12

If in connected mode, the UE should store all relevant IEs included in this system information block. The UE shall:

- for each measurement type:
 - start (or continue) a measurement using the set of IEs specified for that measurement type;
- act upon the received IE "Intra-frequency/Inter-frequency/Inter-RAT cell info list" as described in subclause 8.6.7.3;
- if any of the IEs "Intra-frequency measurement quantity", "Intra-frequency reporting quantity for RACH reporting", "Maximum number of reported cells on RACH" or "Reporting information for state CELL_DCH" are not included in the system information block, read the corresponding IE(s) in system information block type 11 and use that information for the intra-frequency measurement;
- if included in this system information block or in System Information Block type 11, store the IE "Intra-frequency reporting quantity" and the IE "Intra-frequency measurement reporting criteria" or "Periodical reporting criteria" in order to activate reporting when state CELL_DCH is entered;
- if the IE "Inter-frequency measurement quantity" is not included in the system information block, read the corresponding IE in System Information Block type 11 and use that information for the inter-frequency measurement;
- if the IE "Inter-RAT measurement quantity" is not included in the system information block, read the corresponding IE in System Information Block type 11 and use that information for the inter-RAT measurement;
- if in state CELL_FACH, start traffic volume measurement reporting as specified in the IE "Traffic volume reporting quantity";
- associate each measurement with the identity number given by the IE "Measurement identity";
- If IE "Use of HCS" is set to "used", indicating that HCS is used, do the following:
 - If IE "HCS neighbouring cell information" is not included in the first occurrence of IE "Intra-frequency cell info list", use the default values specified for the IE "HCS neighbouring cell information" for that cell;
 - If IE "HCS neighbouring cell information" is not included in other occurrence of IE "Intra-frequency cell info list", for that cell use the same parameter values as used for the preceding IE "Intra-frequency cell info list";
 - If IE "HCS neighbouring cell information" is not included in the first occurrence of IE "Inter-frequency cell info list", use the default values specified for the IE "HCS neighbouring cell information" for that cell;
 - If IE "HCS neighbouring cell information" is not included in other occurrence of IE "Inter-frequency cell info list", for that cell use the same parameter values as used for the preceding IE "Inter-frequency cell info list";
 - If IE "HCS neighbouring cell information" is not included in the first occurrence of IE "Inter-RAT cell info list", use the default values specified for the IE "HCS neighbouring cell information" for that cell;
 - If IE "HCS neighbouring cell information" is not included in other occurrence of IE "Inter-RAT cell info list", for that cell use the same parameter values as used for the preceding IE "Inter-RAT cell info list".
- If IE "FACH measurement occasion info" is included:
 - act as specified in subclause 8.6.7
- else:

- perform neither inter-frequency/inter-RAT measurements nor inter-frequency/inter-RAT cell re-selection evaluation, independent of UE measurement capabilities.

If in idle mode, the UE shall not use the values of the IEs in this system information block.

8.1.1.6.13 System Information Block type 13

If in idle or connected mode, the UE should store all relevant IEs included in this system information block except for the IEs "CN domain specific DRX cycle length coefficient", "UE timers and constants in idle mode" and "Capability update requirement" which shall be stored only in the idle mode case. The UE shall read System Information Block type 13 and the associated System Information Block types 13.1, 13.2, 13.3 and 13.4 only when the "PLMN Type" in the variable SELECTED_PLMN has the value "ANSI-41" and the IE "PLMN type" in the Master Information Block has the value "ANSI-41" or "GSM-MAP and ANSI-41". The UE shall also:

- forward the content of the IE "CN domain specific NAS system information" to the non-access stratum entity indicated by the IE "CN domain identity";
- use the IE "CN domain specific DRX cycle length coefficient" to calculate frame number for the Paging Occasions and Page indicator as specified in [4].

Refer to TIA/EIA/IS-2000.5-A for actions on information contained in System Information Block types 13.1, 13.2, 13.3 and 13.4.

8.1.1.6.14 System Information Block type 14

This system information block type is used only in TDD.

The UE should store all relevant IEs included in this system information block. The UE shall:

- use the IE "UL Timeslot Interference" to calculate PRACH, DPCH and PUSCH transmit power for TDD uplink open loop power control as defined in subclause 8.5.7.

8.1.1.6.15 System Information Block type 15

If the UE is in idle or connected mode, and supports GPS location services and/or OTDOA location services it should store all relevant IEs included in this system information block. The UE shall:

- if the IE "Cipher GPS Data Indicator" is included, and the UE has a full or reduced complexity GPS receiver functionality (the UE will know that the broadcast GPS data is ciphered in accordance with the Data Assistance Ciphering Algorithm detailed in [18]):
 - store the parameters contained within this IE (see 10.3.7.86 for details); and
 - use them to decipher the broadcast UE positioning GPS information contained within the System Information Block types 15.1, 15.2 and 15.3;
- use IE "Reference Location" as a priori knowledge of the approximate location of the UE;
- if the IE "NODE B Clock Drift" is included:
 - use it as an estimate of the drift rate of the NODE B clock relative to GPS time;
- if the IE "NODE B Clock Drift" is not included:
 - assume the value 0;
- if SFN is included:
 - use it as the relationship between GPS time and air-interface timing of the NODE B transmission in the serving cell;
- use "Reference GPS TOW" as GPS Time of Week which is the start of the frame with SFN=0;

NOTE: For efficiency purposes, the UTRAN should broadcast System Information Block type 15 if it is broadcasting System Information Block type 15.2.

8.1.1.6.15.1 System Information Block type 15.1

The UE should store all the relevant IEs included in this system information block . The UE shall:

- use "Status/Health" to determine the status of the differential corrections;
- act on IE group "DGPS information" in a similar manner as specified in [13] except that the scale factors for PRC and RRC are different. In addition, the IE group DGPS information also includes Delta PRC2 and Delta RRC2. Delta PRC2 is the difference in the pseudorange correction between the satellite's ephemeris identified by IODE and the previous ephemeris two issues ago IODE-2. Delta RRC2 is the difference in the pseudorange rate-of-change correction between the satellite's ephemeris identified by IODE and IODE-2. These two additional IEs can extend the life of the raw ephemeris data up to 6 hours.

8.1.1.6.15.2 System Information Block type 15.2

For System Information Block type 15.2 multiple occurrences may be used; one occurrence for one satellite. To identify the different occurrences, the scheduling information for System Information Block type 15.2 includes IE "SIB occurrence identity and value tag". The UE should store all the relevant IEs included in this system information block . The UE shall:

- compare for each occurrence the value tag of the stored occurrence, if any, with the occurrence value tag included in the IE "SIB occurrence identity and value tag" for the occurrence of the SIB with the same occurrence identity;
- in case the UE has no SIB occurrence stored with the same identity or in case the occurrence value tag is different:
 - store the occurrence information together with its identity and value tag for later use;
- in case an occurrence with the same identity but different value tag was stored:
 - overwrite this one with the new occurrence read via system information for later use;
- interpret IE "Transmission TOW" as a very coarse estimate of the current time, i.e., the approximate GPS time-of-week when the message is broadcast;
- interpret IE "SatID" as the satellite ID of the data from which this message was obtained;
- act on the rest of the IEs in a manner similar to that specified in [12]. In addition, the UE can utilise these IEs for GPS time dissemination and sensitivity improvement.

The IE "Transmission TOW" may be different each time a particular SIB occurrence is transmitted. The UTRAN should not increment the value tag of the SIB occurrence if the IE "Transmission TOW" is the only IE that is changed.

The UE may not need to receive all occurrences before it can use the information from any one occurrence.

8.1.1.6.15.3 System Information Block type 15.3

For System Information Block type 15.3 multiple occurrences may be used; one occurrence for each set of satellite data. To identify the different occurrences, the scheduling information for System Information Block type 15.3 includes IE "SIB occurrence identity and value tag". The UE should store all the relevant IEs included in this system information block . The UE shall:

- compare for each occurrence the value tag of the stored occurrence, if any, with the occurrence value tag included in the IE "SIB occurrence identity and value tag" for the occurrence of the SIB with the same occurrence identity;
- in case the UE has no SIB occurrence stored with the same identity or in case the occurrence value tag is different:
 - store the occurrence information together with its identity and value tag for later use;
- in case an occurrence with the same identity but different value tag was stored:
 - overwrite this one with the new occurrence read via system information for later use;

- interpret IE "Transmission TOW" as a very coarse estimate of the current time, i.e., the approximate GPS time-of-week when the message is broadcast;
- interpret IE "SatMask" as the satellites that contain the pages being broadcast in this message;
- interpret IE "LSB TOW" as the least significant 8 bits of the TOW ([12]);
- interpret IE "Data ID" as the Data ID field contained in the indicated subframe, word 3, most significant 2 bits, as defined by [12];
- act on the rest of the IEs in a similar manner as specified in [12]. In addition, the UE can utilise these IEs including non-information bits for GPS time dissemination and sensitivity improvement.

The IE "Transmission TOW" may be different each time a particular SIB occurrence is transmitted. The UTRAN should not increment the value tag of the SIB occurrence if the IE "Transmission TOW" is the only IE that is changed. One SIB occurrence value tag is assigned to the table of Subclause 10.2.48.8.18.3.

The UE may not need to receive all occurrences before it can use the information for any one occurrence.

8.1.1.6.15.4 System Information Block type 15.4

If the UE is in idle or connected mode, and supports the OTDOA UE positioning method the UE shall store all relevant IEs included in this system information block.

8.1.1.6.16 System Information Block type 16

For System Information Block type 16 multiple occurrences may be used; one occurrence for each predefined configuration. To identify the different predefined configurations, the scheduling information for System Information Block type 16 includes IE "Predefined configuration identity and value tag".

The UE should store all relevant IEs included in this system information block. The UE shall:

- compare for each predefined configuration the value tag of the stored predefined configuration with the preconfiguration value tag included in the IE "Predefined configuration identity and value tag" for the occurrence of the SIB with the same predefined configuration identity;
- in case the UE has no predefined configuration stored with the same identity or in case the predefined configuration value tag is different:
 - store the predefined configuration information together with its identity and value tag for later use e.g. during handover to UTRAN;
- in case a predefined configuration with the same identity but different value tag was stored:
 - overwrite this one with the new configuration read via system information for later use e.g. during handover to UTRAN.

The above handling applies regardless of whether the previously stored predefined configuration information has been obtained via UTRA or via another RAT.

The UE is not required to complete reading of all occurrences of System Information Block type 16 before initiating RRC connection establishment.

8.1.1.6.17 System Information Block type 17

This system information block type is used only for TDD.

If in connected mode, the UE should store all relevant IEs included in this system information block. The UE shall:

- if the IE "PDSCH system information" and/or the IE "PUSCH system information" is included, store each of the configurations given there with the associated identity given in the IE "PDSCH Identity" and/or "PUSCH Identity" respectively. This information shall become invalid after the time specified by the repetition period (SIB_REP) for this system information block.

If in idle mode, the UE shall not use the values of the IEs in this system information block.

8.1.1.6.18 System Information Block type 18

If the System Information Block type 18 is present, a UE may obtain knowledge of the PLMN identity of the neighbour cells to be considered for cell reselection, and may behave as specified in this subclause and in subclause 8.5.14a.

The UE should store all the relevant IEs included in this system information block.

A UE in idle mode shall act according to the following rules:

- any PLMN list of a given type (IEs "PLMNs of intra-frequency cells list", "PLMNs of inter-frequency cells list", "PLMNs of inter-RAT cell lists") included in the IE "Idle mode PLMN identities" is paired with the list of cells of the same type derived from System Information Block type 11;
- the PLMN identity located at a given rank in the PLMN list is that of the cell with the same ranking in the paired list of cells, the cells being considered in the increasing order of their associated identities ("Intra-frequency cell id", "Inter-frequency cell id", "Inter-RAT cell id");
- if the number of identities in a PLMN list exceeds the number of neighbour cells in the paired list (if any), the extra PLMN identities are considered as unnecessary and ignored;
- if the number of identities in a PLMN list (if any) is lower than the number of neighbour cells in the paired list, the missing PLMN identities are replaced by the last PLMN identity in the list if present, otherwise by the identity of the selected PLMN.

A UE in connected mode shall act in the same manner as a UE in idle mode with the following modifications:

- the PLMN lists to be considered are the ones included, when present, in the IE "Connected mode PLMN identities"; otherwise, the UE shall use, in place of any missing list, the corresponding one in the IE "Idle mode PLMN identities";
- the paired lists of cells are the ones derived from System Information Block type 11, and System Information Block type 12 if present.

8.1.1.7 Modification of system information

For System Information Block type 16 that may have multiple occurrences, the UE shall handle each occurrence independently as specified in the previous; that is each occurrence is handled as a separate system information block.

NOTE: It should be noted that for the proper operation of the BCCH Modification Information sent on a PCH, the System Information should not be changed more frequently than can be accommodated by mobile stations operating at the maximum DRX cycle length supported by the UTRAN.

8.1.1.7.1 Modification of system information blocks using a value tag

Upon modifications of system information blocks using value tags, UTRAN should notify the new value tag for the master information block in the IE "BCCH modification info", transmitted in the following way:

- to reach UEs in idle mode, CELL_PCH state and URA_PCH state, the IE "BCCH modification info" is contained in a PAGING TYPE 1 message transmitted on the PCCH in all paging occasions in the cell;
- to reach UEs in CELL_FACH state, the IE "BCCH modification info" is contained in a SYSTEM INFORMATION CHANGE INDICATION message transmitted on the BCCH mapped on at least one FACH on every Secondary CCPCH in the cell.

Upon reception of a PAGING TYPE 1 message or a SYSTEM INFORMATION CHANGE INDICATION message containing the IE "BCCH modification info" containing the IE "MIB value tag" but not containing the IE "BCCH modification time", the UE shall perform actions as specified in subclause 8.1.1.7.3.

If the IE "BCCH modification time" is included the UE shall perform actions as specified in subclause 8.1.1.7.2.

8.1.1.7.2 Synchronised modification of system information blocks

For modification of some system information elements, e.g. reconfiguration of the channels, it is important for the UE to know exactly when a change occurs. In such cases, the UTRAN should notify the SFN when the change will occur as

well as the new value tag for the master information block in the IE "BCCH modification info" transmitted in the following way:

- To reach UEs in idle mode, CELL_PCH state and URA_PCH state, the IE "BCCH modification info" is contained in a PAGING TYPE 1 message transmitted on the PCCH in all paging occasions in the cell;
- To reach UEs in CELL_FACH state, the IE "BCCH modification info" is contained in a SYSTEM INFORMATION CHANGE INDICATION message transmitted on the BCCH mapped on at least one FACH on every Secondary CCPCH in the cell.

Upon reception of a PAGING TYPE 1 message or a SYSTEM INFORMATION CHANGE INDICATION message containing the IE "BCCH modification info" containing the IE "MIB value tag" and containing the "IE BCCH modification time", the UE shall:

- perform the actions as specified in subclause 8.1.1.7.3 at the time, indicated in the IE "BCCH Modification Information".

8.1.1.7.3 Actions upon system information change

The UE shall:

- compare the value of IE "MIB value tag" in the IE "BCCH modification info" with the value tag stored for the master information block in variable VALUE_TAG.
- if the value tags differ:
 - read the master information block on BCH;
 - if the value tag of the master information block in the system information is the same as the value in IE "MIB value tag" in "BCCH modification info" but different from the value tag stored in the variable VALUE_TAG:
 - perform actions as specified in subclause 8.1.1.5;
 - if the value tag of the master information block in the system information is the same as the value tag stored in the variable VALUE_TAG:
 - for the next occurrence of the master information block:
 - perform actions as specified in subclause 8.1.1.7.3 again;
 - if the value tag of the master information block in the system information is different from the value tag stored in the variable VALUE_TAG, and is different from the value in IE "MIB value tag" in "BCCH modification info":
 - perform actions as specified in subclause 8.1.1.5;
 - if $(VTCI - VTMIB) \bmod 8 < 4$, where VTCI is the value tag in the IE "MIB value tag" in "BCCH modification info" and VTMIB is the value tag of the master information block in the system information:
 - for the next occurrence of the master information block:
 - perform actions as specified in subclause 8.1.1.7.3 again.

8.1.1.7.4 Actions upon expiry of a system information expiry timer

When the expiry timer of a system information block not using a value tag expires

the UE shall:

consider the content of the system information block invalid;

- re-acquire the system information block again before the content can be used;

the UE may:

- postpone reading the system information block until the content is needed.

8.1.2 Paging

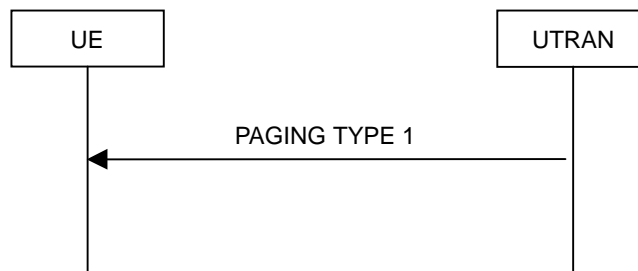

Figure 7: Paging

8.1.2.1 General

This procedure is used to transmit paging information to selected UEs in idle mode, CELL_PCH or URA_PCH state using the paging control channel (PCCH). Upper layers in the network may request paging, to e.g. establish a signalling connection. UTRAN may initiate paging for UEs in CELL_PCH or URA_PCH state to trigger a cell update procedure. In addition, UTRAN may initiate paging for UEs in idle mode, CELL_PCH and URA_PCH state to trigger reading of updated system information.

8.1.2.2 Initiation

UTRAN initiates the paging procedure by transmitting a PAGING TYPE 1 message on an appropriate paging occasion on the PCCH.

UTRAN may repeat transmission of a PAGING TYPE 1 message to a UE in several paging occasions to increase the probability of proper reception of a page.

UTRAN may page several UEs in the same paging occasion by including one IE "Paging record" for each UE in the PAGING TYPE 1 message.

For CN originated paging, UTRAN should set the IE "Paging cause" to the cause for paging received from upper layers. If no cause for paging is received from upper layers, UTRAN should set the value "Terminating – cause unknown".

UTRAN may also indicate that system information has been updated, by including the value tag of the master information block in the IE "BCCH modification information" in the PAGING TYPE 1 message. In this case, UTRAN may omit the IEs "Paging record".

8.1.2.3 Reception of a PAGING TYPE 1 message by the UE

A UE in idle mode, CELL_PCH state or URA_PCH state shall receive the paging information for all its monitored paging occasions. For a UE in idle mode, the paging occasions are specified in [4] and depend on the IE "CN domain specific DRX cycle length coefficient", as specified in subclause 8.6.3.1a. For a UE in CELL_PCH state or URA_PCH state, the paging occasions depend also on the IE "UTRAN DRX cycle length coefficient" and the IE "RRC State Indicator", as specified in subclauses 8.6.3.2 and 8.6.3.3 respectively.

When the UE receives a PAGING TYPE 1 message, it shall perform the actions as specified below.

If the UE is in idle mode, for each occurrence of the IE "Paging record" included in the message the UE shall:

- if the IE "Used paging identity" is a CN identity:
 - compare the IE "UE identity" with all of its allocated CN UE identities:
 - if one match is found:
 - indicate reception of paging; and
 - forward the IE "CN domain identity", the IE "UE identity" and the IE "Paging cause" to the upper layers;

- otherwise:
 - ignore that paging record.

If the UE is in connected mode, for each occurrence of the IE "Paging record" included in the message the UE shall:

- if the IE "Used paging identity" is a UTRAN identity and if this U-RNTI is the same as the U-RNTI allocated to the UE:
 - if the optional IE "CN originated page to connected mode UE" is included:
 - indicate reception of paging; and
 - forward the IE "CN domain identity", the IE "Paging cause" and the IE "Paging record type identifier" to the upper layers;
 - perform a cell update procedure with cause "paging response" as specified in subclause 8.3.1.2;
 - ignore any other remaining IE "Paging record" that may be present in the message;
- otherwise:
 - ignore that paging record.

If the IE "BCCH modification info" is included, any UE in idle mode, CELL_PCH or URA_PCH state shall perform the actions as specified in subclause 8.1.1 in addition to any actions caused by the IE "Paging record" occurrences in the message as specified above.

8.1.3 RRC connection establishment

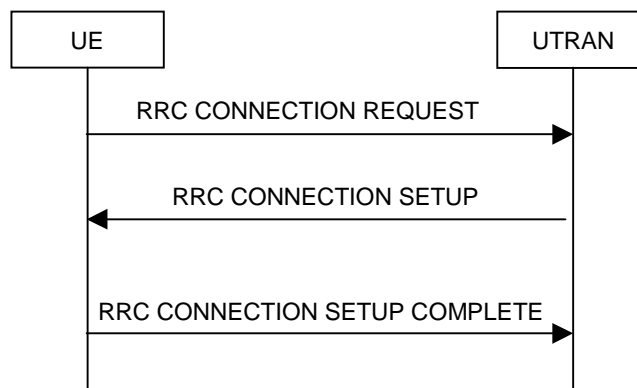

Figure 8: RRC Connection Establishment, network accepts RRC connection

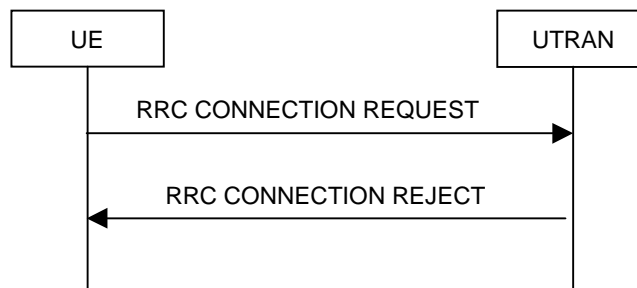

Figure 9: RRC Connection Establishment, network rejects RRC connection

8.1.3.1 General

The purpose of this procedure is to establish an RRC connection.

8.1.3.2 Initiation

The UE shall initiate the procedure when upper layers in the UE requests the establishment of a signalling connection and the UE is in idle mode (no RRC connection exists), as specified in subclause 8.1.8.

Upon initiation of the procedure, the UE shall:

- set the variable `PROTOCOL_ERROR_INDICATOR` to `FALSE`;
- if the USIM is present:
 - set the value of "THRESHOLD" in the variable "START_THRESHOLD" by the 20 MSBs of the value stored in the USIM [50] for the maximum value of START for each CN Domain;
- set the IE "Initial UE identity" in the variable `INITIAL_UE_IDENTITY` according to subclause 8.5.1;
- set the contents of the RRC CONNECTION REQUEST message according to subclause 8.1.3.3;
- set CFN in relation to SFN of current cell according to subclause 8.5.15;
- perform the mapping of the Access Class to an Access Service Class as specified in subclause 8.5.13, and apply the given Access Service Class when accessing the RACH;
- submit the RRC CONNECTION REQUEST message for transmission on the uplink CCCH;
- set counter V300 to 1; and
- start timer T300 when the MAC layer indicates success or failure to transmit the message;
- select a Secondary CCPCH according to [4];
- start receiving all FACH transport channels mapped on the selected Secondary CCPCH.

8.1.3.3 RRC CONNECTION REQUEST message contents to set

The UE shall, in the transmitted RRC CONNECTION REQUEST message:

- set the IE "Establishment cause" to the value of the variable `ESTABLISHMENT_CAUSE`;
- set the IE "Initial UE identity" to the value of the variable `INITIAL_UE_IDENTITY`;
- set the IE "Protocol error indicator" to the value of the variable `PROTOCOL_ERROR_INDICATOR`;
- include a measurement report in the IE "Measured results on RACH", as specified in the IE "Intra-frequency reporting quantity for RACH reporting" and the IE "Maximum number of reported cells on RACH" in System Information Block type 11.

8.1.3.4 Reception of an RRC CONNECTION REQUEST message by the UTRAN

Upon receiving an RRC CONNECTION REQUEST message, UTRAN should either:

- submit an RRC CONNECTION SETUP message to the lower layers for transmission on the downlink CCCH; or

NOTE: The RRC CONNECTION SETUP message always includes the IEs "Added or Reconfigured TrCH information list", both for uplink and downlink transport channels, even if UTRAN orders the UE to move to CELL_FACH and hence need not configure any transport channels. In these cases, UTRAN may include a configuration that adds little to the encoded message size e.g. a DCH with a single zero size transport format. At a later stage, UTRAN may either remove or reconfigure this configuration.

- submit an RRC CONNECTION REJECT message on the downlink CCCH. In the RRC CONNECTION REJECT message, the UTRAN may direct the UE to another UTRA carrier or to another system. After the RRC CONNECTION REJECT message has been sent, all context information for the UE may be deleted in UTRAN.

8.1.3.5 Cell re-selection or T300 timeout

- if the UE has not yet received an RRC CONNECTION SETUP message with the value of the IE "Initial UE identity" equal to the value of the variable INITIAL_UE_IDENTITY; and
- if cell re-selection or expiry of timer T300 occurs;

the UE shall:

- check the value of V300; and
 - if V300 is equal to or smaller than N300:
 - if cell re-selection occurred:
 - set CFN in relation to SFN of current cell according to subclause 8.5.15;
 - set the IEs in the RRC CONNECTION REQUEST message according to subclause 8.1.3.3;
 - perform the mapping of the Access Class to an Access Service Class as specified in subclause 8.5.13; and
 - apply the given Access Service Class when accessing the RACH;
 - submit a new RRC CONNECTION REQUEST message to lower layers for transmission on the uplink CCCH;
 - increment counter V300;
 - restart timer T300 when the MAC layer indicates success or failure to transmit the message;
 - if V300 is greater than N300:
 - enter idle mode.
 - consider the procedure to be unsuccessful;
 - Other actions the UE shall perform when entering idle mode from connected mode are specified in subclause 8.5.2;
 - the procedure ends.

8.1.3.6 Reception of an RRC CONNECTION SETUP message by the UE

The UE shall compare the value of the IE "Initial UE identity" in the received RRC CONNECTION SETUP message with the value of the variable INITIAL_UE_IDENTITY.

If the values are different, the UE shall:

- ignore the rest of the message;

If the values are identical, the UE shall:

- stop timer T300, and act upon all received information elements as specified in subclause 8.6, unless specified otherwise in the following;
- if the UE will be in the CELL_FACH state at the conclusion of this procedure:
 - if the IE "Frequency info" is included:
 - select a suitable UTRA cell according to [4] on that frequency;
 - select PRACH according to subclause 8.5.17;
 - select Secondary CCPCH according to subclause 8.5.19;
- perform the physical layer synchronisation procedure as specified in [29];

- enter a state according to subclause 8.6.3.3;
- submit an RRC CONNECTION SETUP COMPLETE message to the lower layers on the uplink DCCH after successful state transition per subclause 8.6.3.3, with the contents set as specified below:
 - set the IE "RRC transaction identifier" to
 - the value of "RRC transaction identifier" in the entry for the RRC CONNECTION SETUP message in the table "Accepted transactions" in the variable TRANSACTIONS; and
 - clear that entry.
 - if the USIM is present:
 - set the "START" for each CN domain in the IE "START list" in the RRC CONNECTION SETUP COMPLETE message with the corresponding START value that is stored in the USIM [50]; and then
 - set the START value stored in the USIM [50] for any CN domain to the value "THRESHOLD" of the variable START_THRESHOLD;
 - if the USIM is not present:
 - set the "START" for each CN domain in the IE "START list" in the RRC CONNECTION SETUP message to zero;
 - retrieve its UTRA UE radio access capability information elements from variable UE_CAPABILITY_REQUESTED; and then
 - include this in IE "UE radio access capability" and IE "UE radio access capability extension", provided this IE is included in variable UE_CAPABILITY_REQUESTED;
 - retrieve its inter-RAT-specific UE radio access capability information elements from variable UE_CAPABILITY_REQUESTED; and then
 - include this in IE "UE system specific capability".

When of the RRC CONNECTION SETUP COMPLETE message has been submitted to lower layers for transmission the UE shall:

- if the UE has entered CELL_FACH state:
 - start timer T305 using its initial value if periodical update has been configured by T305 in the IE "UE Timers and constants in connected mode" set to any other value than "infinity" in system information block type 1;
- store the contents of the variable UE_CAPABILITY_REQUESTED into the variable UE_CAPABILITY_TRANSFERRED;
- clear the variable UE_CAPABILITY_REQUESTED;
- if the IE "Transport format combination subset" was not included in the RRC CONNECTION SETUP message:
 - set the IE "Current TFC subset" in the variable TFS_SUBSET to "Full transport format combination set";
- set the "Status" in the variable CIPHERING_STATUS to "Not started";
- set the "Reconfiguration" in the variable CIPHERING_STATUS to FALSE;
- set the "Status" in the variable INTEGRITY_PROTECTION_INFO to "Not started";
- set the "Historical status" in the variable INTEGRITY_PROTECTION_INFO to "Never been active";
- set the "Reconfiguration" in the variable INTEGRITY_PROTECTION_INFO to FALSE;
- set the variable CELL_UPDATE_STARTED to FALSE;
- set the variable CONFIGURATION_INCOMPLETE to FALSE;
- set the variable ORDERED_RECONFIGURATION to FALSE;

- set the variable FAILURE_INDICATOR to FALSE;
- set the variable INCOMPATIBLE_SECURITY_RECONFIGURATION to FALSE;
- set the variable INVALID_CONFIGURATION to FALSE;
- set the variable PROTOCOL_ERROR_INDICATOR to FALSE;
- set the variable PROTOCOL_ERROR_REJECT to FALSE;
- set the variable TGSN_REPORTED to FALSE;
- set the variable UNSUPPORTED_CONFIGURATION to FALSE;
- clear all optional IEs in all variables, except those optional IEs that are set in this procedure;
- consider the procedure to be successful;

And the procedure ends.

8.1.3.7 Physical channel failure or cell re-selection

- If the UE failed to establish, per subclause 8.5.4, the physical channel(s) indicated in the RRC CONNECTION SETUP message; or
- if the UE performs cell re-selection; or
- if the UE will be in the CELL_FACH state at the conclusion of this procedure; and
 - if the received RRC CONNECTION SETUP message included the IE "Primary CPICH info" (for FDD) or "Primary CCPCCH info" (for TDD), and the UE selected another cell than indicated by this IE; or
 - if the contents of the variable C_RNTI is empty
- after having received an RRC CONNECTION SETUP message with the value of the IE "Initial UE identity" equal to the value of the variable INITIAL_UE_IDENTITY; and
- before the RRC CONNECTION SETUP COMPLETE message is delivered to lower layers for transmission:

the UE shall:

- clear the entry for the RRC CONNECTION SETUP message in the table "Accepted transactions" in the variable TRANSACTIONS;
- check the value of V300, and:
 - if V300 is equal to or smaller than N300:
 - set CFN in relation to SFN of current cell according to subclause 8.5.15;
 - set the IEs in the RRC CONNECTION REQUEST message according to subclause 8.1.3.3;
 - perform the mapping of the Access Class to an Access Service Class as specified in subclause 8.5.13, and apply the given Access Service Class when accessing the RACH;
 - submit a new RRC CONNECTION REQUEST message to the lower layers for transmission on the uplink CCCH;
 - increment counter V300; and
 - restart timer T300 when the MAC layer indicates success or failure in transmitting the message;
 - if V300 is greater than N300:
 - enter idle mode;
 - perform the actions specified in subclause 8.5.2 when entering idle mode from connected mode;

- consider the procedure to be successful;
- the procedure ends.

8.1.3.8 Invalid RRC CONNECTION SETUP message, unsupported configuration or invalid configuration

If the UE receives an RRC CONNECTION SETUP message which contains an IE "Initial UE identity" with a value which is identical to the value of the variable INITIAL_UE_IDENTITY, but the RRC CONNECTION SETUP message contains a protocol error causing the variable PROTOCOL_ERROR_REJECT to be set to TRUE according to clause 9, the UE shall perform procedure specific error handling as follows. The UE shall:

- clear the entry for the RRC CONNECTION SETUP message in the table "Rejected transactions" in the variable TRANSACTIONS and proceed as below;

If the UE receives an RRC CONNECTION SETUP message which contains an IE "Initial UE identity" with a value which is identical to the value of the variable INITIAL_UE_IDENTITY; and

- the RRC CONNECTION SETUP message contained a configuration the UE does not support; and/or
- the variable UNSUPPORTED_CONFIGURATION becomes set to TRUE due to the received RRC CONNECTION SETUP message; and/or
- the variable INVALID_CONFIGURATION becomes set to TRUE due to the received RRC CONNECTION SETUP message;

the UE shall:

- clear the entry for the RRC CONNECTION SETUP message in the table "Accepted transactions" in the variable TRANSACTIONS and proceed as below;
- if V300 is equal to or smaller than N300:
 - set the variable PROTOCOL_ERROR_INDICATOR to TRUE;
 - set the IEs in the RRC CONNECTION REQUEST message according to subclause 8.1.3.3;
 - perform the mapping of the Access Class to an Access Service Class as specified in subclause 8.5.13; and
 - apply the given Access Service Class when accessing the RACH;
 - submit a new RRC CONNECTION REQUEST message to the lower layers for transmission on the uplink CCCH;
 - increment counter V300; and
 - restart timer T300 when the MAC layer indicates success or failure in transmitting the message;
- if V300 is greater than N300:
 - enter idle mode;
 - perform the actions specified in subclause 8.5.2 when entering idle mode from connected mode;
 - consider the procedure to be successful;
 - the procedure ends.

8.1.3.9 Reception of an RRC CONNECTION REJECT message by the UE

When the UE receives an RRC CONNECTION REJECT message on the downlink CCCH, it shall compare the value of the IE "Initial UE identity" in the received RRC CONNECTION REJECT message with the value of the variable INITIAL_UE_IDENTITY:

If the values are different, the UE shall ignore the rest of the message;

If the values are identical, the UE shall stop timer T300 and:

- if the IE "wait time" \neq '0', and
 - if the IE "frequency info" is present and:
 - if V300 is equal to or smaller than N300:
 - initiate cell selection on the designated UTRA carrier;
 - after having selected and camped on a cell:
 - set CFN in relation to SFN of current cell according to subclause 8.5.15;
 - set the contents of the RRC CONNECTION REQUEST message according to subclause 8.1.3.3;
 - perform the mapping of the Access Class to an Access Service Class as specified in subclause 8.5.13, and apply the given Access Service Class when accessing the RACH;
 - transmit an RRC CONNECTION REQUEST message on the uplink CCCH;
 - reset counter V300;
 - start timer T300 when the MAC layer indicates success or failure in transmitting the message;
 - disable cell reselection to original carrier until the time stated in the IE "wait time" has elapsed;
 - if a cell selection on the designated carrier fails:
 - wait for the time stated in the IE "wait time";
 - set CFN in relation to SFN of current cell according to subclause 8.5.15;
 - set the IEs in the RRC CONNECTION REQUEST message according to subclause 8.1.3.3;
 - perform the mapping of the Access Class to an Access Service Class as specified in subclause 8.5.13, and apply the given Access Service Class when accessing the RACH;
 - then submit a new RRC CONNECTION REQUEST message to the lower layers for transmission on the uplink CCCH of the original serving cell;
 - increment counter V300;
 - restart timer T300 when the MAC layer indicates success or failure to transmit the message;
 - if V300 is greater than N300:
 - enter idle mode;
 - perform the actions specified in subclause 8.5.2 when entering idle mode from connected mode;
 - consider the procedure to be successful;
 - the procedure ends.
 - if the IE "inter-RAT info" is present and:
 - if V300 is equal to or smaller than N300:
 - perform cell selection in the designated system;
 - delay cell reselection to the original system until the time stated in the IE "wait time" has elapsed.
 - if cell selection in the designated system fails:
 - wait at least the time stated in the IE "wait time";
 - set CFN in relation to SFN of current cell according to subclause 8.5.15;

- set the IEs in the RRC CONNECTION REQUEST message according to subclause 8.1.3.2.
- perform the mapping of the Access Class to an Access Service Class as specified in subclause 8.5.13, and apply the given Access Service Class when accessing the RACH;
- then submit a new RRC CONNECTION REQUEST message to the lower layers for transmission on the uplink CCCH;
- increment counter V300;
- restart timer T300 when the MAC layer indicates success or failure to transmit the message;
- if V300 is greater than N300:
 - enter idle mode;
 - perform the actions specified in subclause 8.5.2 when entering idle mode from connected mode;
 - consider the procedure to be successful;
 - the procedure ends.
- If neither the IEs "frequency info" nor "inter-RAT info" are present and:
 - if V300 is equal to or smaller than N300:
 - wait at least the time stated in the IE "wait time";
 - set the IEs in the RRC CONNECTION REQUEST message according to subclause 8.1.3.2;
 - perform the mapping of the Access Class to an Access Service Class as specified in subclause 8.5.13, and apply the given Access Service Class when accessing the RACH;
 - submit a new RRC CONNECTION REQUEST message to the lower layers for transmission on the uplink CCCH;
 - increment counter V300;
 - restart timer T300 when the MAC layer indicates success or failure to transmit the message;
 - if V300 is greater than N300:
 - enter idle mode;
 - perform the actions specified in subclause 8.5.2 when entering idle mode from connected mode;
 - consider the procedure to be successful;
 - the procedure ends.
- if the IE "wait time" = '0':
 - enter idle mode;
 - perform the actions specified in subclause 8.5.2 when entering idle mode from connected mode;
 - consider the procedure to be successful;
 - the procedure ends.

8.1.3.10 Invalid RRC CONNECTION REJECT message

If the UE receives an RRC CONNECTION REJECT message which contains an IE "Initial UE identity" with a value which is identical to the value of the IE "Initial UE identity" in the most recent RRC CONNECTION REQUEST message sent by the UE; but the RRC CONNECTION REJECT message contains a protocol error causing the variable PROTOCOL_ERROR_REJECT to be set to TRUE according to clause 9, the UE shall perform procedure specific error handling as follows:

The UE shall:

- if the IE "wait time" is $\neq 0$, and:
 - if V300 is equal to or smaller than N300:
 - wait for the time stated in the IE "wait time";
 - set the variable `PROTOCOL_ERROR_INDICATOR` to `TRUE`;
 - set the IEs in the RRC CONNECTION REQUEST message according to subclause 8.1.3.3;
 - perform the mapping of the Access Class to an Access Service Class as specified in subclause 8.5.13, and apply the given Access Service Class when accessing the RACH;
 - submit a new RRC CONNECTION REQUEST message to the lower layers for transmission on the uplink CCCH;
 - increment counter V300;
 - restart timer T300 when the MAC layer indicates success or failure to transmit the message;
 - if V300 is greater than N300:
 - enter idle mode;
 - perform the actions specified in subclause 8.5.2 when entering idle mode from connected mode;
 - consider the procedure to be successful;
 - the procedure ends.
- if the IE "wait time" is = 0:
 - enter idle mode;
 - perform the actions specified in subclause 8.5.2 when entering idle mode from connected mode;
 - consider the procedure to be successful;
 - the procedure ends.

8.1.4 RRC connection release

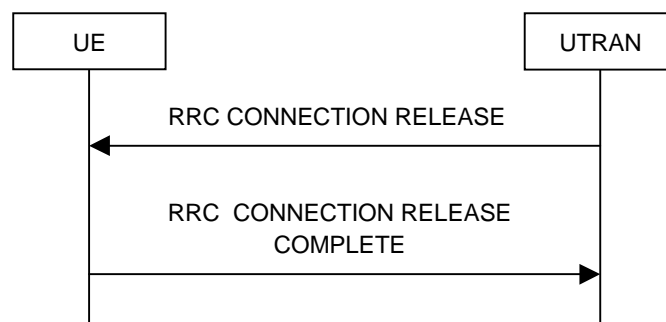

Figure 10: RRC Connection Release procedure on the DCCH



Figure 11: RRC Connection Release procedure on the CCCH

8.1.4.1 General

The purpose of this procedure is to release the RRC connection including and all radio bearers between the UE and the UTRAN. By doing so, all established signalling connections will be released.

8.1.4.2 Initiation

When the UE is in state CELL_DCH or CELL_FACH, the UTRAN may at anytime initiate an RRC connection release by transmitting an RRC CONNECTION RELEASE message using UM RLC.

When UTRAN transmits an RRC CONNECTION RELEASE message in response to a CELL UPDATE (subclause 8.3.1) or URA UPDATE (subclause 8.3.2) message from the UE, UTRAN should use the downlink CCCH to transmit the message. In all other cases the downlink DCCH should be used.

UTRAN may transmit several RRC CONNECTION RELEASE messages to increase the probability of proper reception of the message by the UE. In such a case, the RRC SN for these repeated messages shall be the same. This shall also apply to the RRC CONNECTION RELEASE COMPLETE message. The number of repeated messages and the interval between the messages is a network option.

8.1.4.3 Reception of an RRC CONNECTION RELEASE message by the UE

The UE shall receive and act on an RRC CONNECTION RELEASE message in states CELL_DCH and CELL_FACH. Furthermore this procedure can interrupt any ongoing procedures with the UE in the above listed states.

When the UE receives the first RRC CONNECTION RELEASE message, it shall:

- if the USIM is present; and
- if the "START" stored in the USIM [50] for a CN domain is greater than the value "THRESHOLD" of the variable START_THRESHOLD:
 - delete the ciphering and integrity keys that are stored in the USIM for that CN domain;
 - inform the deletion of these keys to upper layers;
- in state CELL_DCH:
 - initialise the counter V308 to zero;
 - set the IE "RRC transaction identifier" in the RRC CONNECTION RELEASE COMPLETE message to the value of "RRC transaction identifier" in the entry for the RRC CONNECTION RELEASE message in the table "Accepted transactions" in the variable TRANSACTIONS; and
 - clear that entry.
 - submit an RRC CONNECTION RELEASE COMPLETE message to the lower layers for transmission using UM RLC on the DCCH to the UTRAN;
 - if the IE "Rplmn information" is present:
 - the UE may:
 - store the IE on the ME together with the PLMN id for which it applies;

- the UE may then:
 - utilise this information, typically indicating where a number of BCCH frequency ranges of a RAT may be expected to be found, during subsequent Rplmn selections of the indicated PLMN;
- start timer T308 when the RRC CONNECTION RELEASE COMPLETE message is sent on the radio interface.
- in state CELL_FACH:
 - if the RRC CONNECTION RELEASE message was received on the DCCH:
 - set the IE "RRC transaction identifier" in the RRC CONNECTION RELEASE COMPLETE message to the value of "RRC transaction identifier" in the entry for the RRC CONNECTION RELEASE message in the table "Accepted transactions" in the variable TRANSACTIONS; and
 - clear that entry;
 - submit an RRC CONNECTION RELEASE COMPLETE message to the lower layers for transmission using AM RLC on the DCCH to the UTRAN.
 - when the successful transmission of the RRC CONNECTION RELEASE COMPLETE message has been confirmed by the lower layers:
 - release all its radio resources; and
 - indicate the release of the established signalling connections (as stored in the variable ESTABLISHED_SIGNALLING_CONNECTIONS) and established radio access bearers (as stored in the variable ESTABLISHED_RABS) to upper layers; and
 - clear the variable ESTABLISHED_SIGNALLING_CONNECTIONS;
 - clear the variable ESTABLISHED_RABS;
 - pass the value of the IE "Release cause" received in the RRC CONNECTION RELEASE message to upper layers;
 - enter idle mode;
 - perform the actions specified in subclause 8.5.2 when entering idle mode;
 - and the procedure ends.
 - if the RRC CONNECTION RELEASE message was received on the CCCH:
 - release all its radio resources;
 - indicate the release of the established signalling connections (as stored in the variable ESTABLISHED_SIGNALLING_CONNECTIONS) and established radio access bearers (as stored in the variable ESTABLISHED_RABS) to the upper layers;
 - clear the variable ESTABLISHED_SIGNALLING_CONNECTIONS;
 - clear the variable ESTABLISHED_RABS;
 - pass the value of the IE "Release cause" received in the RRC CONNECTION RELEASE message to upper layers;
 - enter idle mode;
 - perform the actions specified in subclause 8.5.2 when entering idle mode;
 - and the procedure ends.

8.1.4.4 Invalid RRC CONNECTION RELEASE message

If the RRC CONNECTION RELEASE message contains a protocol error causing the variable PROTOCOL_ERROR_REJECT to be set to TRUE according to clause 9, and if the "protocol error cause" in PROTOCOL_ERROR_INFORMATION is set to any cause value except "ASN.1 violation or encoding error", the UE shall perform procedure specific error handling as follows:

The UE shall:

- ignore any IE(s) causing the error but treat the rest of the RRC CONNECTION RELEASE message as normal according to subclause 8.1.4.3, with an addition of the following actions;
- if the RRC CONNECTION RELEASE message was received on the DCCH:
 - set the IE "RRC transaction identifier" in the RRC CONNECTION RELEASE COMPLETE message to the value of "RRC transaction identifier" in the entry for the RRC CONNECTION RELEASE message in the table "Rejected transactions" in the variable TRANSACTIONS; and
 - clear that entry.
 - include the IE "Error indication" in the RRC CONNECTION RELEASE COMPLETE message with:
 - the IE "Failure cause" set to the cause value "Protocol error" and
 - the IE "Protocol error information" set to the value of the variable PROTOCOL_ERROR_INFORMATION;

8.1.4.5 Cell re-selection or radio link failure

If the UE performs cell re-selection or the radio link failure criteria in subclause 8.5.6 is met at any time during the RRC connection release procedure and the UE has not yet entered idle mode, the UE shall:

- if cell re-selection occurred (CELL_FACH state):
 - perform a cell update procedure according to subclause 8.3.1 using the cause "Cell reselection";
- if radio link failure occurred (CELL_DCH state):
 - select a suitable UTRA cell according to [4];
 - perform a cell update procedure according to subclause 8.3.1 using the cause "radio link failure".

8.1.4.6 Expiry of timer T308, unacknowledged mode transmission

When in state CELL_DCH and the timer T308 expires, the UE shall:

- increment V308 by one;
- if V308 is equal to or smaller than N308:
 - retransmit the RRC CONNECTION RELEASE COMPLETE message, without incrementing "Uplink RRC Message sequence number" for signalling radio bearer RB1 in the variable INTEGRITY_PROTECTION_INFO;
- if V308 is greater than N308:
 - release all its radio resources;
 - indicate the release of the established signalling connections (as stored in the variable ESTABLISHED_SIGNALLING_CONNECTIONS) and established radio access bearers (as stored in the variable ESTABLISHED_RABS) to upper layers;
 - clear the variable ESTABLISHED_SIGNALLING_CONNECTIONS;
 - clear the variable ESTABLISHED_RABS;

- enter idle mode;
- perform the actions specified in subclause 8.5.2 when entering idle mode;
- and the procedure ends.

8.1.4.7 Void

8.1.4.8 Reception of an RRC CONNECTION RELEASE COMPLETE message by UTRAN

When UTRAN receives an RRC CONNECTION RELEASE COMPLETE message from the UE, it should:

- release all UE dedicated resources and the procedure ends on the UTRAN side.

8.1.4.9 Unsuccessful transmission of the RRC CONNECTION RELEASE COMPLETE message, acknowledged mode transmission

When acknowledged mode was used and RLC does not succeed in transmitting the RRC CONNECTION RELEASE COMPLETE message, the UE shall:

- release all its radio resources;
- indicate the release of the established signalling connections (as stored in the variable ESTABLISHED_SIGNALLING_CONNECTIONS) and established radio access bearers (as stored in the variable ESTABLISHED_RABS) to upper layers;
- clear the variable ESTABLISHED_SIGNALLING_CONNECTIONS;
- clear the variable ESTABLISHED_RABS;
- enter idle mode;
- perform the actions specified in subclause 8.5.2 when entering idle mode;
- and the procedure ends.

8.1.4.10 Detection of loss of dedicated physical channel by UTRAN in CELL_DCH state

If the release is performed from the state CELL_DCH, and UTRAN detects loss of the dedicated physical channel according to subclause 8.5.6, UTRAN may release all UE dedicated resources, even if no RRC CONNECTION RELEASE COMPLETE message has been received.

8.1.4.11 Failure to receive RRC CONNECTION RELEASE COMPLETE message by UTRAN

If UTRAN does not receive any RRC CONNECTION RELEASE COMPLETE message, it should release all UE dedicated resources.

8.1.5 Void

8.1.6 Transmission of UE capability information

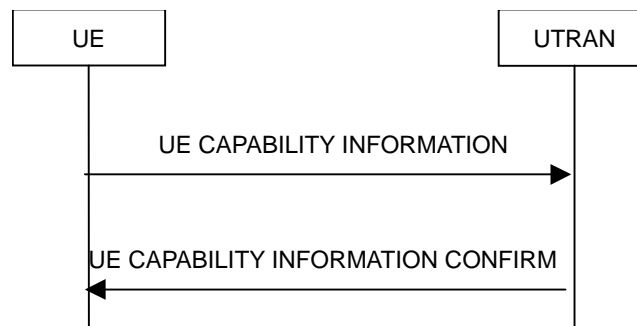

Figure 12: Transmission of UE capability information, normal flow

8.1.6.1 General

The UE capability update procedure is used by the UE to convey UE specific capability information to the UTRAN.

8.1.6.2 Initiation

The UE shall initiate the UE capability update procedure in the following situations:

- the UE receives a UE CAPABILITY ENQUIRY message from the UTRAN;
- while in connected mode the UE capabilities change compared to those stored in the variable UE_CAPABILITY_TRANSFERRED

If the UE CAPABILITY INFORMATION message is sent in response to a UE CAPABILITY ENQUIRY message, the UE shall:

- include the IE "RRC transaction identifier"; and
- set it to the value of "RRC transaction identifier" in the entry for the UE CAPABILITY ENQUIRY message in the table "Accepted transactions" in the variable TRANSACTIONS; and
- clear that entry;
- retrieve its UTRA UE radio access capability information elements from variable UE_CAPABILITY_REQUESTED; and
- include this in IE "UE radio access capability" and in IE "UE radio access capability extension", provided this IE is included in variable UE_CAPABILITY_REQUESTED;
- retrieve its inter-RAT-specific UE radio access capability information elements from variable UE_CAPABILITY_REQUESTED; and
- include this in IE "UE system specific capability".

If the UE CAPABILITY INFORMATION message is sent because one or more of the UE capabilities change compared to those stored in the variable UE_CAPABILITY_TRANSFERRED while in connected state, the UE shall include the information elements associated with the capabilities that have changed in the UE CAPABILITY INFORMATION message.

If the UE is in CELL_PCH or URA_PCH state, it shall first perform a cell update procedure using the cause "uplink data transmission", see subclause 8.3.1.

The UE RRC shall submit the UE CAPABILITY INFORMATION message to the lower layers for transmission on the uplink DCCH using AM RLC. When the message has been sent on the radio interface the UE RRC shall start timer T304 and set counter V304 to 1.

8.1.6.3 Reception of an UE CAPABILITY INFORMATION message by the UTRAN

Upon reception of a UE CAPABILITY INFORMATION message, the UTRAN should transmit a UE CAPABILITY INFORMATION CONFIRM message on the downlink DCCH using UM or AM RLC. After the UE CAPABILITY INFORMATION CONFIRM message has been submitted to the lower layers for transmission, the procedure is complete.

8.1.6.4 Reception of the UE CAPABILITY INFORMATION CONFIRM message by the UE

Upon reception of a UE CAPABILITY INFORMATION CONFIRM message, the UE shall:

- stop timer T304;
- update its variable UE_CAPABILITY_TRANSFERRED with the UE capabilities it has last transmitted to the UTRAN during the current RRC connection;
- clear the variable UE_CAPABILITY_REQUESTED;
- and the procedure ends.

8.1.6.5 Invalid UE CAPABILITY INFORMATION CONFIRM message

If the UE receives a UE CAPABILITY INFORMATION CONFIRM message, which contains a protocol error causing the variable PROTOCOL_ERROR_REJECT to be set to TRUE according to clause 9, the UE shall perform procedure specific error handling as follows:

- stop timer T304;
- transmit an RRC STATUS message on the uplink DCCH using AM RLC;
- include the IE "Identification of received message"; and
- set the IE "Received message type" to UE CAPABILITY INFORMATION CONFIRM; and
- set the IE "RRC transaction identifier" to the value of "RRC transaction identifier" in the entry for the UE CAPABILITY INFORMATION CONFIRM message in the table "Rejected transactions" in the variable TRANSACTIONS; and
- clear that entry;
- include the IE "Protocol error information" with contents set to the value of the variable PROTOCOL_ERROR_INFORMATION;
- when the RRC STATUS message has been submitted to lower layers for transmission:
 - restart timer T304 and continue with any ongoing procedures or processes as if the invalid UE CAPABILITY INFORMATION CONFIRM message has not been received.

8.1.6.6 T304 timeout

Upon expiry of timer T304, the UE shall check the value of V304 and:

- if V304 is smaller than or equal to N304:
 - retransmit a UE CAPABILITY INFORMATION message with the IEs as set in the last unsuccessful attempt, without incrementing "Uplink RRC Message sequence number" for signalling radio bearer RB2 in the variable INTEGRITY_PROTECTION_INFO;
 - restart timer T304;
 - increment counter V304;
- if V304 is greater than N304:

- initiate the Cell update procedure as specified in subclause 8.3.1, using the cause "Radio link failure".

8.1.7 UE capability enquiry

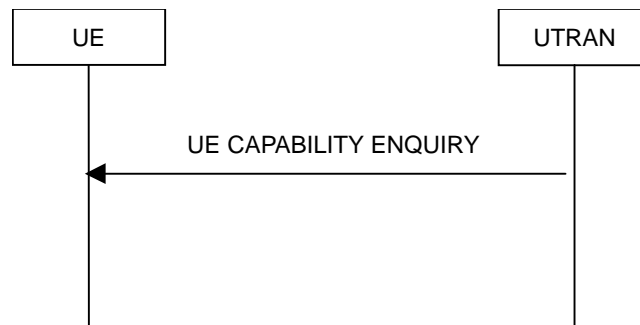

Figure 13: UE capability enquiry procedure, normal flow

8.1.7.1 General

The UE capability enquiry can be used to request the UE to transmit its capability information related to any radio access network that is supported by the UE.

8.1.7.2 Initiation

The UE capability enquiry procedure is initiated by the UTRAN by transmitting a UE CAPABILITY ENQUIRY message on the DCCH using UM or AM RLC.

8.1.7.3 Reception of an UE CAPABILITY ENQUIRY message by the UE

Upon reception of an UE CAPABILITY ENQUIRY message, the UE shall act on the received information elements as specified in subclause 8.6 and initiate the transmission of UE capability information procedure, which is specified in subclause 8.1.6.

8.1.7.4 Invalid UE CAPABILITY ENQUIRY message

If the UE receives a UE CAPABILITY ENQUIRY message, which contains a protocol error causing the variable `PROTOCOL_ERROR_REJECT` to be set to `TRUE` according to clause 9, the UE shall perform procedure specific error handling as follows:

- transmit an RRC STATUS message on the uplink DCCH using AM RLC;
- include the IE "Identification of received message"; and
- set the IE "Received message type" to UE CAPABILITY ENQUIRY; and
- set the IE "RRC transaction identifier" to the value of "RRC transaction identifier" in the entry for the UE CAPABILITY ENQUIRY message in the table "Rejected transactions" in the variable `TRANSACTIONS`; and
- clear that entry;
- include the IE "Protocol error information" with contents set to the value of the variable `PROTOCOL_ERROR_INFORMATION`;
- when the RRC STATUS message has been submitted to lower layers for transmission:
 - continue with the ongoing processes and procedures as if the invalid UE CAPABILITY ENQUIRY message has not been received.

8.1.8 Initial Direct transfer

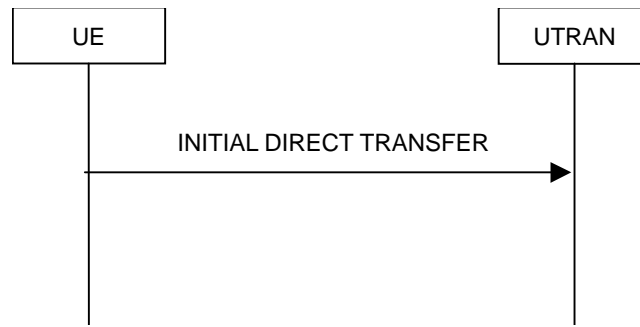

Figure 14: Initial Direct transfer in the uplink, normal flow

8.1.8.1 General

The initial direct transfer procedure is used in the uplink to establish a signalling connection. It is also used to carry an initial upper layer (NAS) message over the radio interface.

8.1.8.2 Initiation of Initial direct transfer procedure in the UE

In the UE, the initial direct transfer procedure shall be initiated, when the upper layers request establishment of a signalling connection. This request also includes a request for the transfer of a NAS message.

Upon initiation of the initial direct transfer procedure when the UE is in idle mode, the UE shall

- set the variable ESTABLISHMENT_CAUSE to the cause for establishment indicated by upper layers;
- perform an RRC connection establishment procedure, according to subclause 8.1.3;
- if the RRC connection establishment procedure was not successful:
 - indicate failure to establish the signalling connection to upper layers and end the procedure;
- when the RRC connection establishment procedure is completed successfully:
 - continue with the initial direct transfer procedure as below;

Upon initiation of the initial direct transfer procedure when the UE is in CELL_PCH or URA_PCH state, the UE shall:

- perform a cell update procedure, according to subclause 8.3.1, using the cause "uplink data transmission";
- when the cell update procedure completed successfully:
 - continue with the initial direct transfer procedure as below.

The UE shall, in the INITIAL DIRECT TRANSFER message:

- set the IE "NAS message" as received from upper layers; and
- set the IE "CN domain identity" as indicated by the upper layers; and
- set the IE "Intra Domain NAS Node Selector" as indicated by the upper layers.

In CELL_FACH state, the UE shall:

- if RACH measurement reporting has been requested in the IE "Intra-frequency reporting quantity for RACH reporting" and the IE "Maximum number of reported cells on RACH" in "System Information Block type 12" (or "System Information Block type 11" if "System Information Block type 12" is not being broadcast):
 - include IE "Measured results on RACH" in the INITIAL DIRECT TRANSFER message.

The UE shall:

- transmit the INITIAL DIRECT TRANSFER message on the uplink DCCH using AM RLC on signalling radio bearer RB3;
- when the INITIAL DIRECT TRANSFER message has been submitted to lower layers for transmission:
 - confirm the establishment of a signalling connection to upper layers; and
 - add the signalling connection with the identity indicated by the IE "CN domain identity" in the variable ESTABLISHED_SIGNALLING_CONNECTIONS; and
- the procedure ends.

When not stated otherwise elsewhere, the UE may also initiate the initial direct transfer procedure when another procedure is ongoing, and in that case the state of the latter procedure shall not be affected.

A new signalling connection request may be received from upper layers subsequent to the indication of the release of a previously established signalling connection to upper layers. From the time of the indication of release to upper layers until the UE has entered idle mode, any such upper layer request to establish a new signalling connection shall be queued. This request shall be processed after the UE has entered idle mode.

8.1.8.3 Reception of INITIAL DIRECT TRANSFER message by the UTRAN

On reception of the INITIAL DIRECT TRANSFER message the NAS message should be routed using the IE "CN Domain Identity". UTRAN may also use the IE "Intra Domain NAS Node Selector" for routing among the CN nodes for the addressed CN domain.

If no signalling connection exists towards the chosen node, then a signalling connection is established.

If the IE "Measured results on RACH" is present in the message, the UTRAN should extract the contents to be used for radio resource control.

When the UTRAN receives an INITIAL DIRECT TRANSFER message, it shall not affect the state of any other ongoing RRC procedures, when not stated otherwise elsewhere.

8.1.9 Downlink Direct transfer



Figure 15: Downlink Direct transfer, normal flow

8.1.9.1 General

The downlink direct transfer procedure is used in the downlink direction to carry upper layer (NAS) messages over the radio interface.

8.1.9.2 Initiation of downlink direct transfer procedure in the UTRAN

In the UTRAN, the direct transfer procedure is initiated when the upper layers request the transfer of a NAS message after the initial signalling connection is established. The UTRAN may also initiate the downlink direct transfer procedure when another RRC procedure is ongoing, and in that case the state of the latter procedure shall not be affected. The UTRAN shall transmit the DOWNLINK DIRECT TRANSFER message on the downlink DCCH using AM RLC on signalling radio bearer RB3 or signalling radio bearer RB4. The UTRAN should:

- if upper layers indicate "low priority" for this message:
 - select signalling radio bearer RB4, if available. Specifically, for a GSM-MAP based CN, signalling radio bearer RB4 should, if available, be selected when "SAPI 3" is requested;
 - select signalling radio bearer RB3 when signalling radio bearer RB4 is not available;
- if upper layers indicate "high priority" for this message:
 - select signalling radio bearer RB3. Specifically, for a GSM-MAP based CN, signalling radio bearer RB3 should be selected when "SAPI 0" is requested.

The UTRAN sets the IE "CN Domain Identity" to indicate, which CN domain the NAS message is originated from.

8.1.9.3 Reception of a DOWNLINK DIRECT TRANSFER message by the UE

Upon reception of the DOWNLINK DIRECT TRANSFER message, the UE RRC shall, using the IE "CN Domain Identity", route the contents of the IE "NAS message" and the value of the IE "CN Domain Identity" to upper layers.

The UE shall clear the entry for the DOWNLINK DIRECT TRANSFER message in the table "Accepted transactions" in the variable TRANSACTIONS.

When the UE receives a DOWNLINK DIRECT TRANSFER message, it shall not affect the state of any other ongoing RRC procedures when not stated otherwise elsewhere.

8.1.9.3a No signalling connection exists

If the UE receives a DOWNLINK DIRECT TRANSFER message, and the signalling connection identified with the IE "CN domain identity" does not exist according to the variable ESTABLISHED_SIGNALLING_CONNECTIONS, the UE shall:

- ignore the content of the DOWNLINK DIRECT TRANSFER message;
- transmit an RRC STATUS message on the uplink DCCH using AM RLC;
- include the IE "Identification of received message"; and
- set the IE "Received message type" to DOWNLINK DIRECT TRANSFER; and
- set the IE "RRC transaction identifier" to the value of "RRC transaction identifier" in the entry for the DOWNLINK DIRECT TRANSFER message in the table "Accepted transactions" in the variable TRANSACTIONS; and
- clear that entry;
- include the IE "Protocol error information" with the IE "Protocol error cause" set to "Message not compatible with receiver state".

When the RRC STATUS message has been submitted to lower layers for transmission, the UE shall:

- continue with any ongoing processes and procedures as if the DOWNLINK DIRECT TRANSFER message has not been received.

8.1.9.4 Invalid DOWNLINK DIRECT TRANSFER message

If the UE receives a DOWNLINK DIRECT TRANSFER message, which contains a protocol error causing the variable PROTOCOL_ERROR_REJECT to be set to TRUE according to clause 9, the UE shall perform procedure specific error handling as follows:

- transmit an RRC STATUS message on the uplink DCCH using AM RLC;
- include the IE "Identification of received message"; and
- set the IE "Received message type" to DOWNLINK DIRECT TRANSFER; and

- set the IE "RRC transaction identifier" to the value of "RRC transaction identifier" in the entry for the DOWNLINK DIRECT TRANSFER message in the table "Rejected transactions" in the variable TRANSACTIONS; and
- clear that entry;
- include the IE "Protocol error information" with contents set to the value of the variable PROTOCOL_ERROR_INFORMATION.

When the RRC STATUS message has been submitted to lower layers for transmission, the UE shall:

- continue with any ongoing processes and procedures as if the invalid DOWNLINK DIRECT TRANSFER message has not been received.

8.1.10 Uplink Direct transfer

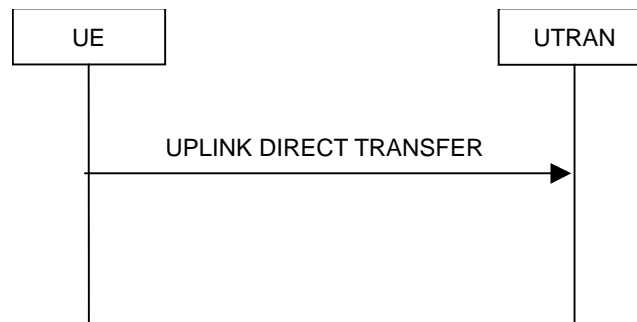

Figure 16: Uplink Direct transfer, normal flow

8.1.10.1 General

The uplink direct transfer procedure is used in the uplink direction to carry all subsequent upper layer (NAS) messages over the radio interface belonging to a signalling connection.

8.1.10.2 Initiation of uplink direct transfer procedure in the UE

In the UE, the uplink direct transfer procedure shall be initiated when the upper layers request a transfer of a NAS message on an existing signalling connection. When not stated otherwise elsewhere, the UE may initiate the uplink direct transfer procedure when another procedure is ongoing, and in that case the state of the latter procedure shall not be affected.

Upon initiation of the uplink direct transfer procedure in CELL_PCH or URA_PCH state, the UE shall:

- perform a cell update procedure, according to subclause 8.3.1, using the cause "uplink data transmission";
- when the cell update procedure has been completed successfully:
 - continue with the uplink direct transfer procedure as below.

The UE shall transmit the UPLINK DIRECT TRANSFER message on the uplink DCCH using AM RLC on signalling radio bearer RB3 or signalling radio bearer RB4. The UE shall:

- if upper layers indicate "low priority" for this message:
 - select signalling radio bearer RB4, if available. Specifically, for a GSM-MAP based CN, signalling radio bearer RB4 shall, if available, be selected when "SAPI 3" is requested;
 - select signalling radio bearer RB3 when signalling radio bearer RB4 is not available;
- if upper layers indicate "high priority" for this message:
 - select signalling radio bearer RB3. Specifically, for a GSM-MAP based CN, signalling radio bearer RB3 shall be selected when "SAPI 0" is requested.

The UE shall set the IE "NAS message" as received from upper layers and set the IE "CN domain identity" as indicated by the upper layers.

When the UPLINK DIRECT TRANSFER message has been submitted to lower layers for transmission the procedure ends.

8.1.10.3 Reception of UPLINK DIRECT TRANSFER message by the UTRAN

On reception of the UPLINK DIRECT TRANSFER message the NAS message should be routed using the value indicated in the IE "CN domain identity".

If the IE "Measured results on RACH" is present in the message, the UTRAN should extract the contents to be used for radio resource control.

When the UTRAN receives an UPLINK DIRECT TRANSFER message, it shall not affect the state of any other ongoing RRC procedures, when not stated otherwise elsewhere.

8.1.11 UE dedicated paging

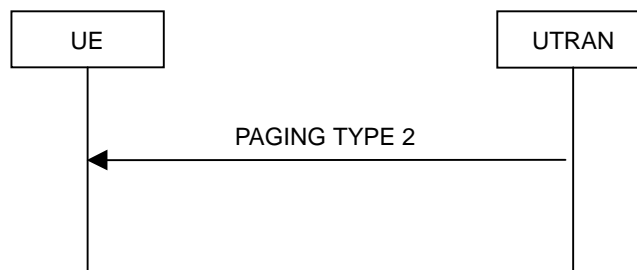

Figure 17: UE dedicated paging

8.1.11.1 General

This procedure is used to transmit dedicated paging information to one UE in connected mode in CELL_DCH or CELL_FACH state. Upper layers in the network may request initiation of paging.

8.1.11.2 Initiation

For a UE in CELL_DCH or CELL_FACH state, UTRAN initiates the procedure by transmitting a PAGING TYPE 2 message on the DCCH using AM RLC. When not stated otherwise elsewhere, the UTRAN may initiate the UE dedicated paging procedure also when another RRC procedure is ongoing, and in that case the state of the latter procedure shall not be affected.

UTRAN should set the IE "Paging cause" to the cause for paging received from upper layers. If no cause for paging is received from upper layers, UTRAN should set the value "Terminating – cause unknown".

8.1.11.3 Reception of a PAGING TYPE 2 message by the UE

When the UE receives a PAGING TYPE 2 message, it shall not affect the state of any other ongoing RRC procedures, when not stated otherwise elsewhere.

The UE shall:

- indicate reception of paging; and
- forward the IE "Paging cause" and the IE "Paging record type identifier" to upper layers.

The UE shall:

- clear the entry for the PAGING TYPE 2 message in the table "Accepted transactions" in the variable TRANSACTIONS.

8.1.11.4 Invalid PAGING TYPE 2 message

If the UE receives a PAGING TYPE 2 message, which contains a protocol error causing the variable `PROTOCOL_ERROR_REJECT` to be set to `TRUE` according to clause 9, the UE shall perform procedure specific error handling as follows:

- transmit an RRC STATUS message on the uplink DCCH using AM RLC;
- include the IE "Identification of received message"; and
- set the IE "Received message type" to PAGING TYPE 2; and
- set the IE "RRC transaction identifier" to the value of "RRC transaction identifier" in the entry for the PAGING TYPE 2 message in the table "Rejected transactions" in the variable `TRANSACTIONS`; and
- clear that entry;
- include the IE "Protocol error information" with contents set to the value of the variable `PROTOCOL_ERROR_INFORMATION`.
- when the RRC STATUS message has been submitted to lower layers for transmission:
 - continue with any ongoing processes and procedures as if the invalid PAGING TYPE 2 message has not been received.

8.1.12 Security mode control

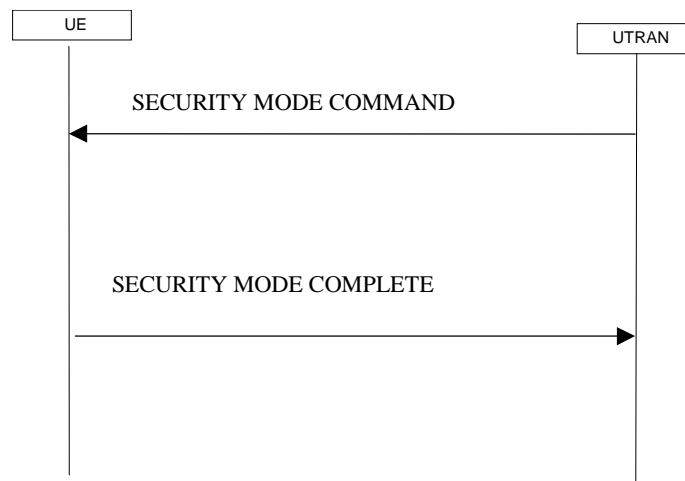

Figure 18: Security mode control procedure

8.1.12.1 General

The purpose of this procedure is to trigger the stop or start of ciphering or to command the restart of the ciphering with a new ciphering configuration, for all radio bearers and for all signalling radio bearers.

It is also used to start integrity protection or to modify the integrity protection configuration for all signalling radio bearers.

8.1.12.2 Initiation

8.1.12.2.1 Ciphering configuration change

To stop or start/restart ciphering, UTRAN sends a SECURITY MODE COMMAND message on the downlink DCCH in AM RLC using the most recent ciphering configuration. If no such ciphering configuration exists then the SECURITY MODE COMMAND is not ciphered.

Prior to sending the SECURITY MODE COMMAND, for the CN domain indicated in the IE "CN domain identity" in the SECURITY MODE COMMAND, UTRAN should:

- if this is the first SECURITY MODE COMMAND sent for this RRC connection:
 - use the value "START" in the most recently received IE "START list" that belongs to the CN domain as indicated in the IE "CN domain identity" to initialise all hyper frame numbers for all the signalling radio bearers; while
 - setting the 20 most significant bits of the hyper frame numbers for all signalling radio bearers to the START for that CN domain;
 - setting the remaining bits of the hyper frame numbers equal to zero;
- suspend all radio bearers using RLC-AM and RLC-UM;
- suspend all signalling radio bearers using RLC-AM and RLC-UM, except the signalling radio bearer used to send the SECURITY MODE COMMAND message on the downlink DCCH in RLC-AM;
- set, for the signalling radio bearer used to send the SECURITY MODE COMMAND, the "RLC send sequence number" in IE "Radio bearer downlink ciphering activation time info" in the IE "Ciphering mode info", at which time the new ciphering configuration shall be applied;
- include "Ciphering activation time for DPCH" in IE "Ciphering mode info" when a DPCH exists and is used for radio bearers using transparent mode RLC, at which time the new ciphering configuration shall be applied;
- set, for each suspended radio bearer and signalling radio bearer that has no pending ciphering activation time set by a previous security mode control procedure, an "RLC send sequence number" in IE "Radio bearer downlink ciphering activation time info" in the IE "Ciphering mode info", at which time the new ciphering configuration shall be applied;
- set, for each suspended radio bearer and signalling radio bearer that has a pending ciphering activation time set by a previous security mode control procedure, the "RLC send sequence number" in IE "Radio bearer downlink ciphering activation time info" in the IE "Ciphering mode info" to the value used in the previous security mode control procedure, at which time the latest ciphering configuration shall be applied.

While suspended, radio bearers and signalling radio bearers shall not deliver RLC PDUs with sequence number greater than or equal to the number in IE "Radio bearer downlink ciphering activation time info".

When the successful delivery of the SECURITY MODE COMMAND has been confirmed by RLC, UTRAN shall:

- resume all the suspended radio bearers and signalling radio bearers. The old ciphering configuration shall be applied for the transmission of RLC PDUs with RLC sequence number less than the number indicated in the IE "Radio bearer downlink ciphering activation time info", as sent to the UE. The new ciphering configuration shall be applied for the transmission of RLC PDUs with RLC sequence number greater than or equal to the number indicated in IE "Radio bearer downlink ciphering activation time info", sent to the UE.

8.1.12.2.2 Integrity protection configuration change

To start or modify integrity protection, UTRAN sends a SECURITY MODE COMMAND message on the downlink DCCH in AM RLC using the new integrity protection configuration.

When the successful delivery of the SECURITY MODE COMMAND has been confirmed by RLC, UTRAN should:

- for the radio bearers and signalling radio bearers:
 - send an indication to upper layers that the new integrity protection configuration has been activated when the activation time has elapsed.

8.1.12.3 Reception of SECURITY MODE COMMAND message by the UE

Upon reception of the SECURITY MODE COMMAND message, the UE shall perform the actions for the received information elements according to subclause 8.6.

If the IE "Ciphering mode info" and the IE "Integrity protection mode info" are both not included in the SECURITY MODE COMMAND, the UE shall:

- set the variable INVALID_CONFIGURATION to TRUE.

If the IE "Security capability" is the same as indicated by variable UE_CAPABILITY_TRANSFERRED, and the IE "GSM security capability" (if included in the SECURITY MODE COMMAND) is the same as indicated by the variable UE_CAPABILITY_TRANSFERRED, the UE shall:

- set the variable LATEST_CONFIGURED_CN_DOMAIN equal to the IE "CN domain identity";
- if prior to the reception of SECURITY MODE COMMAND, the value of the IE "Status" in the variable "CIPHERING_STATUS" is "Not started" and the value of the IE "Historical status" in the variable "INTEGRITY_PROTECTION_INFO" is "Never been active":
 - use the value "START" in the most recently sent IE "START list" that belongs to the CN domain as indicated in the IE "CN domain identity" to initialise all hyper frame numbers for all the signalling radio bearers; while
 - setting the 20 most significant bits of the hyper frame numbers for all signalling radio bearers to the START for that CN domain;
 - setting the remaining bits of the hyper frame numbers equal to zero;
- suspend all radio bearers and signalling radio bearers (except the signalling radio bearer used to transmit the SECURITY MODE COMPLETE message on the uplink DCCH in RLC-AM) using RLC-AM or RLC-UM that belong to the CN domain indicated in the IE "CN domain identity"; and
- set the "RLC send sequence number" in IE "Radio bearer uplink ciphering activation time info", at which time the new ciphering configuration shall be applied;
- set the IE "RRC transaction identifier" in the SECURITY MODE COMPLETE message to the value of "RRC transaction identifier" in the entry for the SECURITY MODE COMMAND message in the table "Accepted transactions" in the variable TRANSACTIONS; and
- clear that entry;
- if the SECURITY MODE COMMAND message contained the IE "Ciphering mode info":
 - include and set the IE "Radio bearer uplink ciphering activation time info" to the value of the variable RB_UPLINK_CIPHERING_ACTIVATION_TIME_INFO, for the respective radio bearer and signalling radio bearer;
- if the SECURITY MODE COMMAND message contained the IE "Integrity protection mode info" with the IE "Integrity protection mode command" set to "Modify":
 - include and set the IE "Integrity protection activation info" to the value of the variable INTEGRITY_PROTECTION_ACTIVATION_INFO;
- for radio bearers using RLC-TM:
 - apply the old ciphering configuration for the receiving and transmission of RLC TrD PDUs with CFN less than the number indicated in the IE "Ciphering activation time for DPCH", as sent by the UTRAN;
 - apply the new ciphering configuration for the receiving and transmission of RLC TrD PDUs with CFN greater than or equal to the number indicated in IE "Ciphering activation time for DPCH", as sent by the UTRAN;
- when the radio bearers and signalling radio bearers using RLC-AM or RLC-UM have been suspended:
 - send a SECURITY MODE COMPLETE message on the uplink DCCH in AM RLC, using the old ciphering configurations;
 - if the IE "Integrity protection mode info" was present in the SECURITY MODE COMMAND message:
 - start applying the new integrity protection configuration in the uplink for signalling radio bearer RB2 from and including the transmitted SECURITY MODE COMPLETE message;

- when the successful delivery of the SECURITY MODE COMPLETE message has been confirmed by RLC:
 - resume data transmission on any suspended radio bearer and signalling radio bearer mapped on RLC-AM or RLC-UM;
 - if the SECURITY MODE COMMAND message contained the IE "Ciphering mode info":
 - set the IE "Reconfiguration" in the variable CIPHERING_STATUS to FALSE; and
 - clear the variable RB_UPLINK_CIPHERING_ACTIVATION_TIME_INFO;
 - if the SECURITY MODE COMMAND message contained the IE "Integrity protection mode info":
 - set the IE "Reconfiguration" in the variable INTEGRITY_PROTECTION_INFO to FALSE; and
 - clear the variable INTEGRITY_PROTECTION_ACTIVATION_INFO;
 - the procedure ends. If a RLC reset or re-establishment occurs after the SECURITY MODE COMPLETE message has been confirmed by RLC, but before the activation time for the new ciphering configuration has been reached, then the activation time shall be ignored and the new ciphering configuration shall be applied immediately after the RLC reset or RLC re-establishment;
 - notify upper layers upon change of the security configuration.

For radio bearers and signalling radio bearers used by the CN indicated in the IE "CN domain identity", the UE shall:

- if a new integrity protection key has been received:
 - in the downlink:
 - use the new key;
 - set the IE "Downlink RRC HFN" for all signalling radio bearers in the variable INTEGRITY_PROTECTION_INFO of the downlink COUNT-I to zero when the RRC sequence number in a received RRC message on the particular signalling radio bearer reaches the value for that signalling radio bearer indicated in IE "Downlink integrity protection activation info" included in the IE "Integrity protection mode info";
 - in the uplink:
 - use the new key;
 - set the IE "Uplink RRC HFN" for all signalling radio bearers in the variable INTEGRITY_PROTECTION_INFO of the uplink COUNT-I to zero when the RRC sequence number in a transmitted RRC message on the particular signalling radio bearer reaches the value for that signalling radio bearer indicated in IE "Uplink integrity protection activation info";
- if a new ciphering key is available:
 - for radio bearers using RLC-TM:
 - use the new key in uplink and downlink;
 - set the HFN component of the COUNT-C to zero at the CFN as indicated in the IE "Ciphering activation time for DPCH" in the IE "Ciphering mode info";
 - for radio bearers using RLC-AM and RLC-UM:
 - in the downlink, at and after the RLC sequence number indicated in IE "Radio bearer downlink ciphering activation time info" in the IE "Ciphering mode info":
 - use the new key;
 - set the HFN component of the downlink COUNT-C to zero;
 - in the uplink, at and after the RLC sequence number indicated in IE "Radio bearer uplink ciphering activation time info":

- use the new key;
- set the HFN component of the uplink COUNT-C to zero.

If the IE "Security capability" is not the same as indicated by the variable UE_CAPABILITY_TRANSFERRED, or the IE "GSM security capability" (if included in the SECURITY MODE COMMAND) is not the same as indicated by the variable UE_CAPABILITY_TRANSFERRED, or if the IE "GSM security capability" is not included in the SECURITY MODE COMMAND and is included in the variable UE_CAPABILITY_TRANSFERRED, the UE shall:

- release all its radio resources;
- indicate the release of the established signalling connections (as stored in the variable ESTABLISHED_SIGNALLING_CONNECTIONS) and established radio access bearers (as stored in the variable ESTABLISHED_RABS) to upper layers;
- clear the variable ESTABLISHED_SIGNALLING_CONNECTIONS;
- clear the variable ESTABLISHED_RABS;
- enter idle mode;
- perform actions when entering idle mode as specified in subclause 8.5.2;
- and the procedure ends.

8.1.12.4 Void

8.1.12.4a Incompatible simultaneous security reconfiguration

If the variable INCOMPATIBLE_SECURITY_RECONFIGURATION becomes set to TRUE of the received SECURITY MODE COMMAND message, the UE shall:

- transmit a SECURITY MODE FAILURE message on the uplink DCCH using AM RLC, using the ciphering and integrity protection configurations prior to the reception of this SECURITY MODE COMMAND;
- set the IE "RRC transaction identifier" in the SECURITY MODE FAILURE message to the value of "RRC transaction identifier" in the entry for the SECURITY MODE COMMAND message in the table "Accepted transactions" in the variable TRANSACTIONS; and
- clear that entry;
- set the IE "failure cause" to the cause value "incompatible simultaneous reconfiguration";
- when the successful delivery of the SECURITY MODE FAILURE message has been confirmed by RLC:
 - set the variable INCOMPATIBLE_SECURITY_RECONFIGURATION to FALSE;
 - continue with any ongoing processes and procedures as if the invalid SECURITY MODE COMMAND message has not been received;
- and the procedure ends.

8.1.12.4b Cell update procedure during security reconfiguration

If:

- a cell update procedure according to subclause 8.3.1 is initiated; and
- the received SECURITY MODE COMMAND message causes either,
 - the IE "Reconfiguration" in the variable CIPHERING_STATUS to be set to TRUE; and/or
 - the IE "Reconfiguration" in the variable INTEGRITY_PROTECTION_INFO to be set to TRUE:

the UE shall:

- abort the ongoing integrity and/or ciphering reconfiguration;
- resume data transmission on any suspended radio bearer and signalling radio bearer mapped on RLC-AM or RLC-UM;
- transmit a SECURITY MODE FAILURE message on the uplink DCCH using AM RLC, using the ciphering and integrity protection configurations prior to the reception of this SECURITY MODE COMMAND;
- set the IE "RRC transaction identifier" in the SECURITY MODE FAILURE message to the value of "RRC transaction identifier" in the entry for the SECURITY MODE COMMAND message in the table "Accepted transactions" in the variable TRANSACTIONS; and
- clear that entry;
- set the IE "failure cause" to the cause value "cell update occurred";
- when the successful delivery of the SECURITY MODE FAILURE message has been confirmed by RLC:
 - if the SECURITY MODE COMMAND message contained the IE "Ciphering mode info":
 - set the IE "Reconfiguration" in the variable CIPHERING_STATUS to FALSE; and
 - clear the variable RB_UPLINK_CIPHERING_ACTIVATION_TIME_INFO;
 - if the SECURITY MODE COMMAND message contained the IE "Integrity protection mode info":
 - set the IE "Reconfiguration" in the variable INTEGRITY_PROTECTION_INFO to FALSE; and
 - clear the variable INTEGRITY_PROTECTION_ACTIVATION_INFO;
 - continue with any ongoing processes and procedures as if the invalid SECURITY MODE COMMAND message has not been received; and
 - the procedure ends.

8.1.12.4c Invalid configuration

If the variable INVALID_CONFIGURATION is set to TRUE due to the received SECURITY MODE COMMAND message, the UE shall:

- transmit a SECURITY MODE FAILURE message on the DCCH using AM RLC after setting the IEs as specified below;
 - set the IE "RRC transaction identifier" in the SECURITY MODE FAILURE message to the value of "RRC transaction identifier" in the entry for the SECURITY MODE COMMAND message in the table "Accepted transactions" in the variable TRANSACTIONS; and
 - clear that entry;
 - set the IE "failure cause" to the cause value "invalid configuration";
- when the successful delivery of the SECURITY MODE FAILURE message has been confirmed by RLC:
 - set the variable INVALID_CONFIGURATION to FALSE;
 - continue with any ongoing processes and procedures as if the invalid SECURITY MODE COMMAND message has not been received;
 - and the procedure ends.

8.1.12.5 Reception of SECURITY MODE COMPLETE message by the UTRAN

UTRAN should apply integrity protection on the received SECURITY MODE COMPLETE message and all subsequent messages with the new integrity protection configuration, if changed. When UTRAN has received a SECURITY MODE COMPLETE message and the integrity protection has successfully been applied, UTRAN shall:

- for radio bearers using RLC-AM or RLC-UM:
 - use the old ciphering configuration for received RLC PDUs with RLC sequence number less than the RLC sequence number indicated in the IE "Radio bearer uplink ciphering activation time info" sent by the UE;
 - use the new ciphering configuration for received RLC PDUs with RLC sequence number greater than or equal to the RLC sequence number indicated in the IE "Radio bearer uplink ciphering activation time info" sent by the UE;
 - if an RLC reset or re-establishment occurs after the SECURITY MODE COMPLETE message has been received by UTRAN before the activation time for the new ciphering configuration has been reached, ignore the activation time and apply the new ciphering configuration immediately after the RLC reset or RLC re-establishment;
- for radio bearers using RLC-TM:
 - use the old ciphering configuration for the received RLC PDUs before the CFN as indicated in the IE "Ciphering activation time for DPCH" in the IE "Ciphering mode info" as included in the SECURITY MODE COMMAND;
 - use the new ciphering configuration for the received RLC PDUs at the CFN as indicated in the IE "Ciphering activation time for DPCH" in the IE "Ciphering mode info" as included in the SECURITY MODE COMMAND;
- and the procedure ends.

8.1.12.6 Invalid SECURITY MODE COMMAND message

If the SECURITY MODE COMMAND message contains a protocol error causing the variable PROTOCOL_ERROR_REJECT to be set to TRUE according to clause 9, the UE shall perform procedure specific error handling as follows:

- transmit a SECURITY MODE FAILURE message on the uplink DCCH using AM RLC;
- set the IE "RRC transaction identifier" in the SECURITY MODE FAILURE message to the value of "RRC transaction identifier" in the entry for the SECURITY MODE COMMAND message in the table "Rejected transactions" in the variable TRANSACTIONS; and
- clear that entry;
- set the IE "failure cause" to the cause value "protocol error";
- include the IE "Protocol error information" with contents set to the value of the variable PROTOCOL_ERROR_INFORMATION.
- when the successful delivery of the SECURITY MODE FAILURE message has been confirmed by RLC:
 - continue with any ongoing processes and procedures as if the invalid SECURITY MODE COMMAND message has not been received;
 - and the procedure ends.

8.1.13 Signalling connection release procedure



Figure 19: Signalling connection release procedure, normal case

8.1.13.1 General

The signalling connection release procedure is used to notify to the UE that one of its ongoing signalling connections has been released. The procedure does not initiate the release of the RRC connection.

8.1.13.2 Initiation of SIGNALLING CONNECTION RELEASE by the UTRAN

To initiate the procedure, the UTRAN transmits a SIGNALLING CONNECTION RELEASE message on DCCH using AM RLC.

8.1.13.3 Reception of SIGNALLING CONNECTION RELEASE by the UE

Upon reception of a SIGNALLING CONNECTION RELEASE message, the UE shall:

- indicate the release of the signalling connection and pass the value of the IE "CN domain identity" to upper layers;
- remove the signalling connection with the identity indicated by the IE "CN domain identity" from the variable ESTABLISHED_SIGNALLING_CONNECTIONS;
- clear the entry for the SIGNALLING CONNECTION RELEASE message in the table "Accepted transactions" in the variable TRANSACTIONS;
- the procedure ends.

8.1.13.4 Invalid SIGNALLING CONNECTION RELEASE message

If the UE receives a SIGNALLING CONNECTION RELEASE message, which contains a protocol error causing the variable `PROTOCOL_ERROR_REJECT` to be set to `TRUE` according to clause 9, the UE shall perform procedure specific error handling as follows:

- include the IE "Identification of received message"; and
- set the IE "Received message type" to SIGNALLING CONNECTION RELEASE;
- set the IE "RRC transaction identifier" to the value of "RRC transaction identifier" in the entry for the SIGNALLING CONNECTION RELEASE message in the table "Rejected transactions" in the variable TRANSACTIONS; and
- clear that entry;
- include the IE "Protocol error information" with contents set to the value of the variable `PROTOCOL_ERROR_INFORMATION`;
- transmit an RRC STATUS message on the uplink DCCH using AM RLC

- when the RRC STATUS message has been submitted to lower layers for transmission:
- continue with any ongoing processes and procedures as if the invalid SIGNALLING CONNECTION RELEASE message has not been received.

8.1.14 Signalling connection release request procedure



Figure 20: Signalling connection release request procedure, normal case

8.1.14.1 General

The signalling connection release request procedure is used by the UE to request the UTRAN that one of its signalling connections should be released. The procedure may in turn initiate the signalling connection release or RRC connection release procedure.

8.1.14.2 Initiation

The UE shall, on receiving a request to release (abort) the signalling connection from upper layers:

- initiate the signalling connection release request procedure.

Upon initiation of the signalling connection release request procedure in CELL_PCH or URA_PCH state, the UE shall:

- perform a cell update procedure, according to subclause 8.3.1, using the cause "uplink data transmission";
- when the cell update procedure completed successfully:
 - continue with the signalling connection release request procedure as below;

The UE shall:

- set the IE "CN Domain Identity" to the value indicated by the upper layers. The value of the IE indicates the CN domain whose associated signalling connection the upper layers are requesting to be released;
- transmit a SIGNALLING CONNECTION RELEASE REQUEST message on DCCH using AM RLC.

When the SIGNALLING CONNECTION RELEASE REQUEST message has been submitted to lower layers for transmission the procedure ends.

8.1.14.3 Reception of SIGNALLING CONNECTION RELEASE REQUEST by the UTRAN

Upon reception of a SIGNALLING CONNECTION RELEASE REQUEST message, the UTRAN requests the release of the signalling connection from upper layers. Upper layers may then initiate the release of the signalling connection.

8.1.15 Counter check procedure

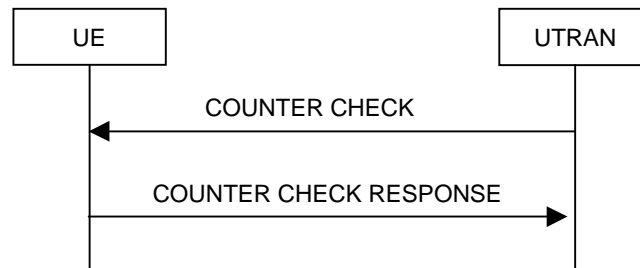

Figure 21: Counter check procedure

8.1.15.1 General

The counter check procedure is used by the UTRAN to perform a local authentication. The purpose of the procedure is to check that the amount of data sent in both directions (uplink and downlink) over the duration of the RRC connection is identical at the UTRAN and at the UE (to detect a possible intruder – a 'man-in-the-middle' – from operating). It should be noted that this requires that the COUNT-C values for each radio bearer are maintained even if ciphering is not used. This procedure is only applicable to radio bearers using UM or AM mode of RLC. In this version, this procedure is not applied for radio bearers using transparent mode RLC.

8.1.15.2 Initiation

The UTRAN monitors the COUNT-C value associated with each radio bearer using UM or AM RLC. The procedure is triggered whenever any of these values reaches a critical checking value. The granularity of these checking values and the values themselves are defined to the UTRAN by the visited network. The UTRAN initiates the procedure by sending a COUNTER CHECK message on the downlink DCCH.

8.1.15.3 Reception of a COUNTER CHECK message by the UE

When the UE receives a COUNTER CHECK message it shall compare the COUNT-C MSB values received in the IE "RB COUNT-C MSB information" in the COUNTER CHECK message to the COUNT-C MSB values of the corresponding radio bearers.

The UE shall:

- set the IE "RRC transaction identifier" in the COUNTER CHECK RESPONSE message to the value of "RRC transaction identifier" in the entry for the COUNTER CHECK message in the table "Accepted transactions" in the variable TRANSACTIONS; and
- clear that entry.

If

- there is one or more radio bearer(s) using UM or AM RLC mode stored in the variable ESTABLISHED_RABS, which is (are) not included in the IE "RB COUNT-C MSB information"; or
- there is one or more radio bearer(s) included in the IE "RB COUNT-C MSB information", which is (are) not stored in the variable ESTABLISHED_RABS; or
- for any radio bearer (excluding signalling radio bearers) using UM or AM RLC mode stored in the variable ESTABLISHED_RABS and included in the IE "RB COUNT-C MSB information" with COUNT-C MSB values different from the MSB part of the COUNT-C values in the UE

the UE shall:

- include these radio bearers in the IE "RB COUNT-C information" in the COUNTER CHECK RESPONSE message. For any RB which is included in the IE "RB COUNT-C MSB information" in the COUNTER CHECK message but not stored in the variable ESTABLISHED_RABS in the UE, the MSB part of COUNT-C values in the COUNTER CHECK RESPONSE message shall be set identical to COUNT-C-MSB values in the COUNTER CHECK message. The LSB part shall be filled by 0s;

The UE shall:

- submit a COUNTER CHECK RESPONSE message to lower layers for transmission on the uplink DCCH using AM RLC.

When the COUNTER CHECK RESPONSE message has been submitted to lower layers for transmission the procedure ends.

8.1.15.4 Reception of the COUNTER CHECK RESPONSE message by UTRAN

If the UTRAN receives a COUNTER CHECK RESPONSE message that does not contain any COUNT-C values, the procedure ends.

If the UTRAN receives a COUNTER CHECK RESPONSE message that contains one or several COUNT-C values the UTRAN may release the RRC connection.

8.1.15.5 Cell re-selection

If the UE performs cell re-selection anytime during this procedure it shall, without interrupting the procedure:

- initiate the cell update procedure according to subclause 8.3.1.

8.1.15.6 Invalid COUNTER CHECK message

If the UE receives a COUNTER CHECK message, which contains a protocol error causing the variable `PROTOCOL_ERROR_REJECT` to be set to TRUE according to clause 9, the UE shall perform procedure specific error handling as follows. The UE shall:

- transmit an RRC STATUS message on the uplink DCCH using AM RLC;
- include the IE "Identification of received message"; and
- set the IE "Received message type" to COUNTER CHECK; and
- set the IE "RRC transaction identifier" to the value of "RRC transaction identifier" in the entry for the UE COUNTER CHECK message in the table "Rejected transactions" in the variable `TRANSACTIONS`; and
- clear that entry;
- include the IE "Protocol error information" with contents set to the value of the variable `PROTOCOL_ERROR_INFORMATION`;
- when the RRC STATUS message has been submitted to lower layers for transmission:
 - continue with any ongoing processes and procedures as if the invalid COUNTER CHECK message has not been received.

8.2 Radio Bearer control procedures

8.2.1 Radio bearer establishment

See subclause 8.2.2 Reconfiguration procedures.

8.2.2 Reconfiguration procedures

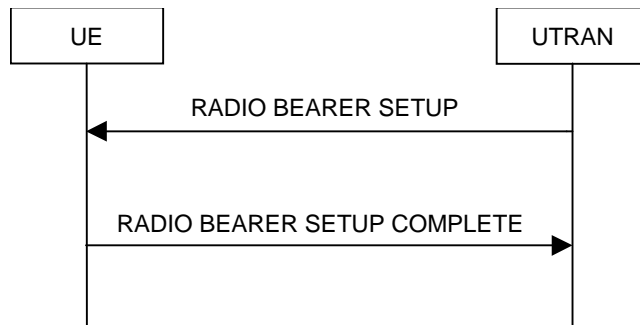

Figure 22: Radio Bearer Establishment, normal case

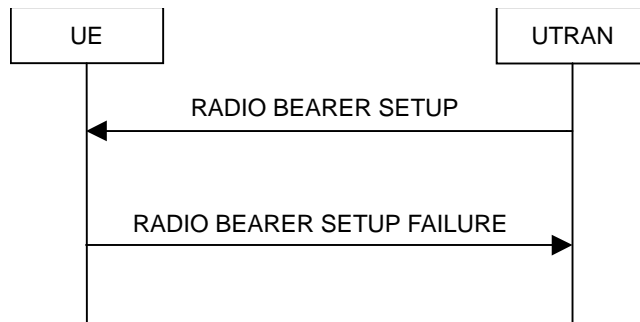

Figure 23: Radio Bearer Establishment, failure case

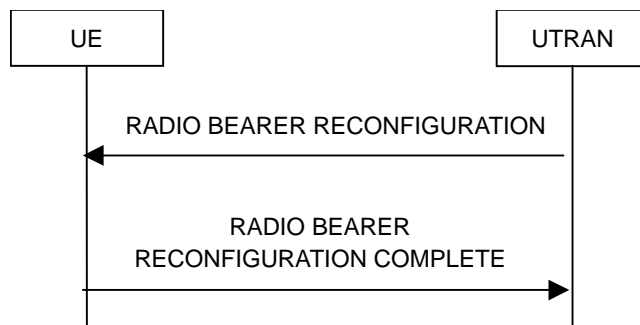

Figure 24: Radio bearer reconfiguration, normal flow

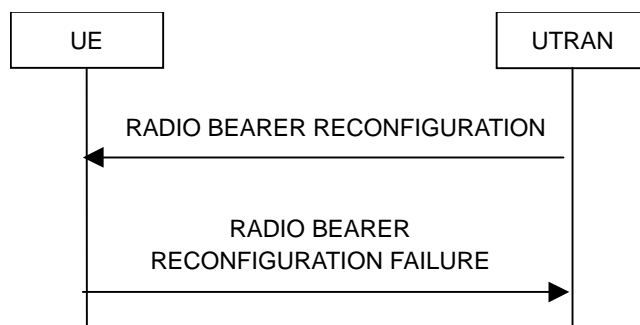

Figure 25: Radio bearer reconfiguration, failure case

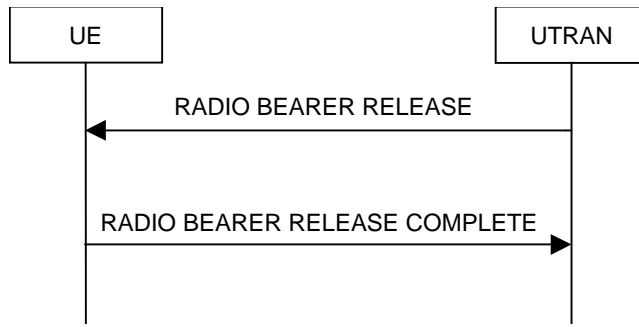

Figure 26: Radio Bearer Release, normal case

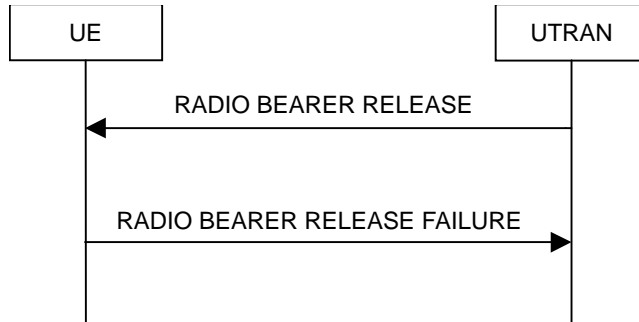

Figure 27: Radio Bearer Release, failure case

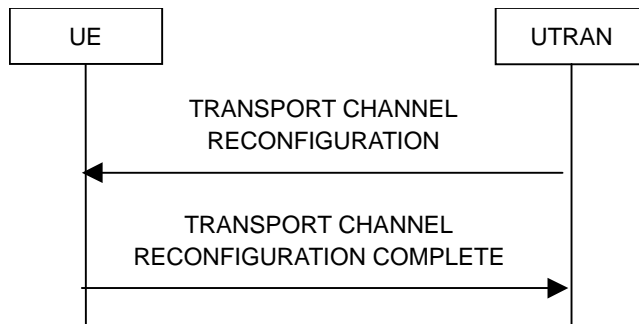

Figure 28: Transport channel reconfiguration, normal flow

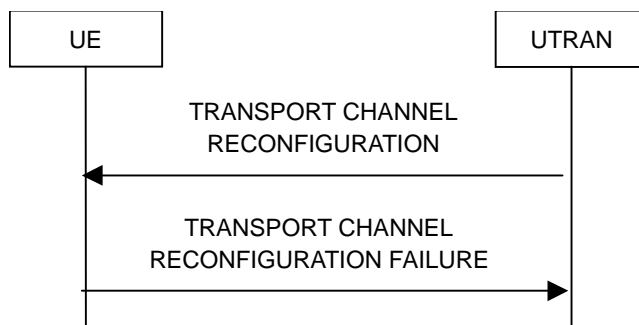

Figure 29: Transport channel reconfiguration, failure case

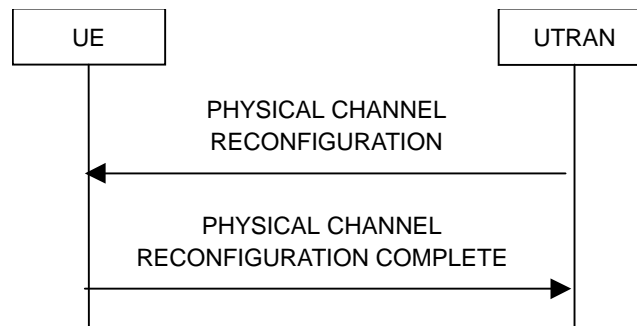

Figure 30: Physical channel reconfiguration, normal flow

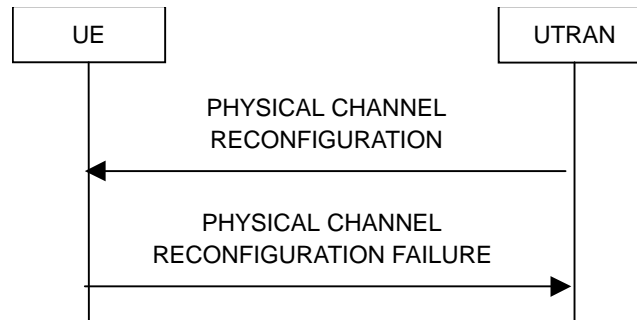

Figure 31: Physical channel reconfiguration, failure case

8.2.2.1 General

Reconfiguration procedures include the following procedures:

- the radio bearer establishment procedure;
- radio bearer reconfiguration procedure;
- the radio bearer release procedure;
- the transport channel reconfiguration procedure; and
- the physical channel reconfiguration procedure.

The radio bearer establishment procedure is used to establish new radio bearer(s).

The radio bearer reconfiguration procedure is used to reconfigure parameters for a radio bearer.

The radio bearer release procedure is used to release radio bearer(s).

The transport channel reconfiguration procedure is used to reconfigure transport channel parameters.

The physical channel reconfiguration procedure is used to establish, reconfigure and release physical channels.

While performing any of the above procedures, these procedures may perform a hard handover - see subclause 8.3.5.

8.2.2.2 Initiation

To initiate any one of the reconfiguration procedures, UTRAN should:

- configure new radio links in any new physical channel configuration;
- start transmission and reception on the new radio links;
- for a radio bearer establishment procedure:
 - transmit a RADIO BEARER SETUP message on the downlink DCCH using AM or UM RLC;

- for a radio bearer reconfiguration procedure:
 - transmit a RADIO BEARER RECONFIGURATION message on the downlink DCCH using AM or UM RLC;
- for a radio bearer release procedure:
 - transmit a RADIO BEARER RELEASE message on the downlink DCCH using AM or UM RLC;
- for a transport channel reconfiguration procedure:
 - transmit a TRANSPORT CHANNEL RECONFIGURATION message on the downlink DCCH using AM or UM RLC;
- for a physical channel reconfiguration procedure:
 - transmit a PHYSICAL CHANNEL RECONFIGURATION message on the downlink DCCH using AM or UM RLC;
- if the reconfiguration procedure is simultaneous with SRNS relocation procedure, and ciphering and/or integrity protection are activated:
 - transmit new ciphering and/or integrity protection information to be used after reconfiguration.
- if transport channels are added, reconfigured or deleted in uplink and/or downlink:
 - set TFCS according to the new transport channel(s).
- if transport channels are added or deleted in uplink and/or downlink, and RB Mapping Info applicable to the new configuration has not been previously provided to the UE, the UTRAN should:
 - send the RB Mapping Info for the new configuration.

In the Radio Bearer Reconfiguration procedure UTRAN may indicate that uplink transmission shall be stopped or continued on certain radio bearers. Uplink transmission on a signalling radio bearer used by the RRC signalling (signalling radio bearer RB1 or signalling radio bearer RB2) should not be stopped.

NOTE 1: The RADIO BEARER RECONFIGURATION message always includes the IE "RB information to reconfigure", even if UTRAN does not require the reconfiguration of any RB. In these cases, UTRAN may include only the IE "RB identity" within the IE "RB information to reconfigure".

NOTE 2: The RADIO BEARER RECONFIGURATION message always includes the IE "Downlink information per radio link list", even if UTRAN does not require the reconfiguration of any RL. In these cases, UTRAN may re-send the currently assigned values for the mandatory IEs included within the IE "Downlink information per radio link list ". Moreover, the RADIO BEARER RECONFIGURATION message always includes the IE "Primary CPICH Info" (FDD) or IE "Primary CCPCH Info" (TDD). This implies that in case UTRAN applies the RADIO BEARER RECONFIGURATION message to move the UE to CELL_FACH state, it has to indicate a cell. However, UTRAN may indicate any cell; the UE anyhow performs cell selection and notifies UTRAN if it selects another cell than indicated by UTRAN.

If the IE "Activation Time" is included, UTRAN should set it to a value taking the UE performance requirements into account.

UTRAN should take the UE capabilities into account when setting the new configuration.

If the message is used to initiate a transition from CELL_DCH to CELL_FACH state, the UTRAN may assign a common channel configuration of a given cell and C-RNTI to be used in that cell to the UE.

8.2.2.3 Reception of RADIO BEARER SETUP or RADIO BEARER RECONFIGURATION or RADIO BEARER RELEASE or TRANSPORT CHANNEL RECONFIGURATION or PHYSICAL CHANNEL RECONFIGURATION message by the UE

The UE shall be able to receive any of the following messages:

- RADIO BEARER SETUP message; or
- RADIO BEARER RECONFIGURATION message; or
- RADIO BEARER RELEASE message; or
- TRANSPORT CHANNEL RECONFIGURATION message; or
- PHYSICAL CHANNEL RECONFIGURATION message

and perform a hard handover, even if no prior UE measurements have been performed on the target cell and/or frequency.

If the UE receives:

- a RADIO BEARER SETUP message; or
- a RADIO BEARER RECONFIGURATION message; or
- a RADIO BEARER RELEASE message; or
- a TRANSPORT CHANNEL RECONFIGURATION message; or
- a PHYSICAL CHANNEL RECONFIGURATION message

it shall:

- set the variable ORDERED_RECONFIGURATION to TRUE;
- perform the physical layer synchronisation procedure as specified in [29];
- act upon all received information elements as specified in subclause 8.6, unless specified in the following and perform the actions below.

The UE may first release the physical channel configuration used at reception of the reconfiguration message. The UE shall then:

- in FDD, if the IE "PDSCH code mapping" is included but the IE "PDSCH with SHO DCH Info" is not included and if the DCH has only one link in its active set:
 - act upon the IE "PDSCH code mapping" as specified in subclause 8.6 and:
 - infer that the PDSCH will be transmitted from the cell from which the downlink DPCH is transmitted;
- enter a state according to subclause 8.6.3.3.

In case the UE receives a RADIO BEARER RECONFIGURATION message including the IE "RB information to reconfigure" that only includes the IE "RB identity", the UE shall:

- handle the message as if IE "RB information to reconfigure" was absent.

NOTE: The RADIO BEARER RECONFIGURATION message always includes the IE "RB information to reconfigure". UTRAN has to include it even if it does not require the reconfiguration of any RB.

If the UE was in CELL_DCH state upon reception of the reconfiguration message and remains in CELL_DCH state, the UE shall:

- if the IE "UL DPCH Info" is absent, not change its current UL Physical channel configuration;
- if the IE "DL DPCH Info for each RL" is absent, not change its current DL Physical channel configuration.

If after state transition the UE enters CELL_FACH state, the UE shall, after the state transition:

- if the IE "Frequency info" is included in the received reconfiguration message:
 - select a suitable UTRA cell according to [4] on that frequency;
- if the IE "Frequency info" is not included in the received reconfiguration message:

- select a suitable UTRA cell according to [4];
- if the received reconfiguration message included the IE "Primary CPICH info" (for FDD) or "Primary CCPCH info" (for TDD), and the UE selects another cell than indicated by this IE or the received reconfiguration message did not include the IE "Primary CPICH info" (for FDD) or "Primary CCPCH info" (for TDD):
 - initiate a cell update procedure according to subclause 8.3.1 using the cause "Cell reselection";
 - when the cell update procedure completed successfully:
 - if the UE is in CELL_PCH or URA_PCH state:
 - initiate a cell update procedure according to subclause 8.3.1 using the cause "Uplink data transmission";
 - proceed as below;
- start timer T305 using its initial value if timer T305 is not running and if periodical update has been configured by T305 in the IE "UE Timers and constants in connected mode" set to any other value than "infinity" in system information block type 1;
- select PRACH according to subclause 8.5.17;
- select Secondary CCPCH according to subclause 8.5.19;
- use the transport format set given in system information;
- if the IE "UTRAN DRX cycle length coefficient" is included in the same message:
 - ignore that IE and stop using DRX;
- if the contents of the variable C_RNTI is empty:
 - perform a cell update procedure according to subclause 8.3.1 using the cause "Cell reselection";
 - when the cell update procedure completed successfully:
 - if the UE is in CELL_PCH or URA_PCH state:
 - initiate a cell update procedure according to subclause 8.3.1 using the cause "Uplink data transmission";
 - proceed as below;

The UE shall transmit a response message as specified in subclause 8.2.2.4, setting the information elements as specified below. The UE shall:

- if the received reconfiguration message included the IE "Downlink counter synchronisation info":
 - calculate the START value according to subclause 8.5.9;
 - include the calculated START values for each CN domain in the IE "START list" in the IE "Uplink counter synchronisation info";
- if the received reconfiguration message did not include the IE "Downlink counter synchronisation info":
 - if the variable START_VALUE_TO_TRANSMIT is set:
 - include and set the IE "START" to the value of that variable;
 - if the variable START_VALUE_TO_TRANSMIT is not set and the IE "New U-RNTI" is included:
 - calculate the START value according to subclause 8.5.9;
 - include the calculated START values for each CN domain in the IE "START list" in the IE "Uplink counter synchronisation info";
- if the received reconfiguration message contained the IE "Ciphering mode info":

- include and set the IE "Radio bearer uplink ciphering activation time info" to the value of the variable RB_UPLINK_CIPHERING_ACTIVATION_TIME_INFO;
- if the received reconfiguration message contained the IE "Integrity protection mode info" with the IE "Integrity protection mode command" set to "Modify":
 - include and set the IE "Integrity protection activation info" to the value of the variable INTEGRITY_PROTECTION_ACTIVATION_INFO;
- if the received reconfiguration message did not contain the IE "Ciphering activation time for DPCH" in IE "Ciphering mode info":
 - if prior to this procedure there exist no transparent mode RLC radio bearers:
 - if, at the conclusion of this procedure, the UE will be in CELL_DCH state; and
 - if, at the conclusion of this procedure, at least one transparent mode RLC radio bearer exists:
 - include the IE "COUNT-C activation time" and specify a CFN value other than the default, "Now", for this IE;
 - if prior to this procedure there exists at least one transparent mode RLC radio bearer:
 - if, at the conclusion of this procedure, no transparent mode RLC radio bearers exist:
 - include the IE "COUNT-C activation time" in the response message and specify a CFN value other than the default, "Now", for this IE;
- set the IE "RRC transaction identifier" to the value of "RRC transaction identifier" in the entry for the received message in the table "Accepted transactions" in the variable TRANSACTIONS; and
- clear that entry;
- if the variable PDCP_SN_INFO is not empty:
 - include the IE "RB with PDCP information list" and set it to the value of the variable PDCP_SN_INFO;
- in TDD, if the procedure is used to perform a handover to a cell where timing advance is enabled, and the UE can calculate the timing advance value in the new cell (i.e. in a synchronous TDD network):
 - set the IE "Uplink Timing Advance" to the calculated value;
- if the IE "Integrity protection mode info" was present in the received reconfiguration message:
 - start applying the new integrity protection configuration in the uplink for signalling radio bearer RB2 from and including the transmitted response message;

If after state transition the UE enters CELL_PCH or URA_PCH state, the UE shall, after the state transition and transmission of the response message:

- if the IE "Frequency info" is included in the received reconfiguration message:
 - select a suitable UTRA cell according to [4] on that frequency;
- if the IE "Frequency info" is not included in the received reconfiguration message:
 - select a suitable UTRA cell according to [4];
- prohibit periodical status transmission in RLC;
- remove any C-RNTI from MAC;
- clear the variable C_RNTI;
- start timer T305 using its initial value if timer T305 is not running and if periodical update has been configured by T305 in the IE "UE Timers and constants in connected mode" set to any other value than "infinity" in system information block type 1;

- select Secondary CCPCH according to subclause 8.5.19;
- if the IE "UTRAN DRX cycle length coefficient" is included in the same message:
 - use the value in the IE "UTRAN DRX Cycle length coefficient" for calculating Paging occasion and PICH Monitoring Occasion as specified in subclause 8.6.3.2;
- if the UE enters CELL_PCH state from CELL_DCH state, and the received reconfiguration message included the IE "Primary CPICH info" (for FDD) or "Primary CCPCH info" (for TDD), and the UE selected another cell than indicated by this IE or the received reconfiguration message did not include the IE "Primary CPICH info" (for FDD) or "Primary CCPCH info" (for TDD):
 - initiate a cell update procedure according to subclause 8.3.1 using the cause "cell reselection";
 - when the cell update procedure completed successfully:
 - the procedure ends;
- if the UE enters CELL_PCH state from CELL_FACH state, and the received reconfiguration message included the IE "Primary CPICH info" (for FDD) or "Primary CCPCH info" (for TDD), and the UE selected another cell than indicated by this IE:
 - initiate a cell update procedure according to subclause 8.3.1 using the cause "cell reselection";
 - when the cell update procedure is successfully completed:
 - the procedure ends;
- if the UE enters URA_PCH state, and after cell selection the criteria for URA update caused by "URA reselection" according to subclause 8.3.1 is fulfilled:
 - initiate a URA update procedure according to subclause 8.3.1 using the cause "URA reselection";
 - when the URA update procedure is successfully completed:
 - the procedure ends.

8.2.2.4 Transmission of a response message by the UE, normal case

In case the procedure was triggered by reception of a RADIO BEARER SETUP message, the UE shall:

- transmit a RADIO BEARER SETUP COMPLETE as response message on the uplink DCCH using AM RLC;

In case the procedure was triggered by reception of a RADIO BEARER RECONFIGURATION message, the UE shall:

- transmit a RADIO BEARER RECONFIGURATION COMPLETE as response message on the uplink DCCH using AM RLC;

In case the procedure was triggered by reception of a RADIO BEARER RELEASE message, the UE shall:

- transmit a RADIO BEARER RELEASE COMPLETE as response message on the uplink DCCH using AM RLC;

In case the procedure was triggered by reception of a TRANSPORT CHANNEL RECONFIGURATION message, the UE shall:

- transmit a TRANSPORT CHANNEL RECONFIGURATION COMPLETE as response message on the uplink DCCH using AM RLC;

In case the procedure was triggered by reception of a PHYSICAL CHANNEL RECONFIGURATION message, the UE shall:

- transmit a PHYSICAL CHANNEL RECONFIGURATION COMPLETE as response message on the uplink DCCH using AM RLC;

If the new state is CELL_DCH or CELL_FACH, the response message shall be transmitted using the new configuration after the state transition, and the UE shall:

- if the variable PDCP_SN_INFO is empty:
 - if the received reconfiguration message contained the IE "Ciphering mode info":
 - when RLC has confirmed the successful transmission of the response message:
 - notify upper layers upon change of the security configuration;
 - perform the actions below;
 - if the received reconfiguration message did not contain the IE "Ciphering mode info":
 - when RLC has been requested to transmit the response message:
 - perform the actions below;
 - if the variable PDCP_SN_INFO is non-empty:
 - when RLC has confirmed the successful transmission of the response message:
 - for each radio bearer in the variable PDCP_SN_INFO:
 - if the IE "RB started" in the variable ESTABLISHED_RABS is set to "started":
 - configure the RLC entity for that radio bearer to "continue";
 - perform the actions below.

If the new state is CELL_PCH or URA_PCH, the response message shall be transmitted using the old configuration before the state transition, but the new C-RNTI shall be used if the IE "New C-RNTI" was included in the received reconfiguration message, and the UE shall:

- when RLC has confirmed the successful transmission of the response message:
 - for each radio bearer in the variable PDCP_SN_INFO:
 - if the IE "RB started" in the variable ESTABLISHED_RABS is set to "started":
 - configure the RLC entity for that radio bearer to "continue";
 - enter the new state (CELL_PCH or URA_PCH, respectively);
 - perform the actions below.

The UE shall:

- set the variable ORDERED_RECONFIGURATION to FALSE;
- if the received reconfiguration message contained the IE "Ciphering mode info":
 - set the IE "Reconfiguration" in the variable CIPHERING_STATUS to FALSE; and
 - clear the variable RB_UPLINK_CIPHERING_ACTIVATION_TIME_INFO;
- if the received reconfiguration message contained the IE "Integrity protection mode info":
 - set the IE "Reconfiguration" in the variable INTEGRITY_PROTECTION_INFO to FALSE; and
 - clear the variable INTEGRITY_PROTECTION_ACTIVATION_INFO;
- clear the variable PDCP_SN_INFO;
- clear the variable START_VALUE_TO_TRANSMIT.

8.2.2.5 Reception of a response message by the UTRAN, normal case

When UTRAN has received

- the RADIO BEARER SETUP COMPLETE message; or
- the RADIO BEARER RECONFIGURATION COMPLETE message; or
- the RADIO BEARER RELEASE COMPLETE message; or
- the TRANSPORT CHANNEL RECONFIGURATION COMPLETE message; or
- the PHYSICAL CHANNEL RECONFIGURATION COMPLETE message;

UTRAN may:

- delete the old configuration.

If the procedure caused the UE to leave the CELL_FACH state, UTRAN may:

- delete the C-RNTI of the UE.

If the IE "UL Timing Advance" is included, UTRAN shall:

- evaluate the timing advance value that the UE has to use in the new cell after handover.

If the IE "START" or the IE "START list " is included, UTRAN should:

- set the START value for each CN domain with the corresponding values as received in this response message;
- consequently, then use the START values to initialise the hyper frame numbers, in the same way as specified for the UE in subclause 8.2.2.3, for any new radio bearers that are established.

For radio bearers using RLC-AM or RLC-UM, UTRAN should:

- use the old ciphering configuration for received RLC PDUs with RLC sequence number less than the RLC sequence number indicated in the IE "Radio bearer uplink ciphering activation time info" sent by the UE;
- use the new ciphering configuration for received RLC PDUs with RLC sequence number greater than or equal to the RLC sequence number indicated in the IE "Radio bearer uplink ciphering activation time info" sent by the UE;
- if an RLC reset or re-establishment occurs after this response message has been received by UTRAN before the activation time for the new ciphering configuration has been reached:
 - ignore the activation time; and
 - apply the new ciphering configuration immediately after the RLC reset or RLC re-establishment.

For radio bearers using RLC-TM:

- use the new ciphering configuration and only begin incrementing the COUNT-C at the CFN as indicated in:
 - the IE "Ciphering activation time for DPCH" in the IE "Ciphering mode info", if included in the message that triggered the radio bearer control procedure; or
 - the IE "COUNT-C activation time", if included in the response message for this procedure.

The procedure ends on the UTRAN side.

8.2.2.6 Unsupported configuration in the UE

If the UTRAN instructs the UE to use a configuration, which it does not support and/or if the received message causes the variable UNSUPPORTED_CONFIGURATION to be set to TRUE, the UE shall:

- transmit a failure response as specified in subclause 8.2.2.9, setting the information elements as specified below:
 - include the IE "RRC transaction identifier"; and
 - set it to the value of "RRC transaction identifier" in the entry for the received message in the table "Accepted transactions" in the variable TRANSACTIONS; and

- clear that entry;
- set the IE "failure cause" to "configuration unsupported";
- set the variable UNSUPPORTED_CONFIGURATION to FALSE;
- continue with any ongoing processes and procedures as if the reconfiguration message was not received.

The procedure ends.

8.2.2.7 Physical channel failure

A physical channel failure occurs in case the criteria defined in subclause 8.5.4 are not fulfilled.

If the received message caused the UE to be in CELL_DCH state and the UE failed to establish the dedicated physical channel(s) indicated in the received message the UE shall:

- revert to the configuration prior to the reception of the message (old configuration);
- if the old configuration includes dedicated physical channels (CELL_DCH state) and the UE is unable to revert to the old configuration:
 - select a suitable UTRA cell according to [4];
 - initiate a cell update procedure according to subclause 8.3.1, using the cause "radio link failure";
 - after the cell update procedure has completed successfully:
 - proceed as below;
- if the old configuration does not include dedicated physical channels (CELL_FACH state):
 - select a suitable UTRA cell according to [4];
 - if the UE selects another cell than the cell the UE camped on upon reception of the reconfiguration message:
 - initiate a cell update procedure according to subclause 8.3.1, using the cause "Cell reselection";
 - after the cell update procedure has completed successfully:
 - proceed as below;
- transmit a failure response message as specified in subclause 8.2.2.9, setting the information elements as specified below:
 - include the IE "RRC transaction identifier"; and
 - set it to the value of "RRC transaction identifier" in the entry for the received message in the table "Accepted transactions" in the variable TRANSACTIONS; and
 - clear that entry;
 - set the IE "failure cause" to "physical channel failure";
- set the variable ORDERED_RECONFURATION to FALSE;
- continue with any ongoing processes and procedures as if the reconfiguration message was not received;

The procedure ends.

8.2.2.8 Cell re-selection

If the UE performs cell re-selection during the reconfiguration procedure, the UE shall:

- initiate a cell update procedure, as specified in subclause 8.3.1;
- continue with the reconfiguration procedure.

8.2.2.9 Transmission of a response message by the UE, failure case

The UE shall:

- in case of reception of a RADIO BEARER SETUP message:
 - if the radio bearer establishment procedure affects several radio bearers:
 - (may) include the identities of the radio bearers for which the procedure would have been successful into the RADIO BEARER SETUP FAILURE message;
 - transmit a RADIO BEARER SETUP FAILURE as response message on the DCCH using AM RLC;
 - in case of reception of a RADIO BEARER RECONFIGURATION message:
 - if the radio bearer reconfiguration procedure affects several radio bearers:
 - (may) include the identities of the radio bearers for which the procedure would have been successful into the RADIO BEARER RECONFIGURATION FAILURE message;
 - transmit a RADIO BEARER RECONFIGURATION FAILURE as response message on the DCCH using AM RLC;
 - in case of reception of a RADIO BEARER RELEASE message:
 - if the radio bearer release procedure affects several radio bearers:
 - (may) include the identities of the radio bearers for which the procedure would have been successful into the RADIO BEARER RELEASE FAILURE message;
 - transmit a RADIO BEARER RELEASE FAILURE as response message on the DCCH using AM RLC;
- in case of reception of a TRANSPORT CHANNEL RECONFIGURATION message:
- transmit a TRANSPORT CHANNEL RECONFIGURATION FAILURE as response message on the DCCH using AM RLC;
- in case of reception of a PHYSICAL CHANNEL RECONFIGURATION message:
- transmit a PHYSICAL CHANNEL RECONFIGURATION FAILURE as response message on the DCCH using AM RLC;
- when the response message has been submitted to lower layers for transmission:
 - continue with any ongoing processes and procedures as if no reconfiguration attempt had occurred.

8.2.2.10 Reception of a response message by the UTRAN, failure case

When the UTRAN has received

- the RADIO BEARER SETUP FAILURE message; or
- the RADIO BEARER RECONFIGURATION FAILURE message; or
- the RADIO BEARER RELEASE FAILURE message; or
- the TRANSPORT CHANNEL RECONFIGURATION FAILURE message; or
- the PHYSICAL CHANNEL RECONFIGURATION FAILURE message;

the UTRAN may restore the old and delete the new configuration. Upper layers should be notified of the failure.

The procedure ends on the UTRAN side.

8.2.2.11 Invalid configuration

If the variable INVALID_CONFIGURATION is set to TRUE the UE shall:

- keep the configuration existing before the reception of the message;
- transmit a failure response message as specified in subclause 8.2.2.9, setting the information elements as specified below:
 - include the IE "RRC transaction identifier"; and
 - set it to the value of "RRC transaction identifier" in the entry for the received message in the table "Accepted transactions" in the variable TRANSACTIONS; and
 - clear that entry;
 - set the IE "failure cause" to "invalid configuration";
- set the variable INVALID_CONFIGURATION to FALSE;
- continue with any ongoing processes and procedures as if the reconfiguration message was not received;

The procedure ends.

8.2.2.12 Incompatible simultaneous reconfiguration

If the table "Rejected transactions" in the variable TRANSACTIONS is set due to the received message and the variable PROTOCOL_ERROR_REJECT is set to FALSE, the UE shall:

- not apply the configuration contained in the received reconfiguration message;
- transmit a failure response message as specified in subclause 8.2.2.9, setting the information elements as specified below:
 - include the IE "RRC transaction identifier"; and
 - set it to the value of "RRC transaction identifier" in the entry for the received message in the table "Rejected transactions" in the variable TRANSACTIONS; and
 - clear that entry;
 - set the IE "failure cause" to "incompatible simultaneous reconfiguration";
- continue with any ongoing processes and procedures as if the reconfiguration message was not received;

The procedure ends.

8.2.2.12a Incompatible simultaneous security reconfiguration

If the variable INCOMPATIBLE_SECURITY_RECONFIGURATION is set to TRUE due to the received reconfiguration message, the UE shall:

- transmit a failure response message as specified in subclause 8.2.2.9, setting the information elements as specified below:
 - include the IE "RRC transaction identifier"; and
 - set it to the value of "RRC transaction identifier" in the entry for the received message in the table "Accepted transactions" in the variable TRANSACTIONS; and
 - clear that entry;
 - set the IE "failure cause" to the cause value "incompatible simultaneous reconfiguration";
- set the variable INCOMPATIBLE_SECURITY_RECONFIGURATION to FALSE;
- continue with any ongoing processes and procedures as if the reconfiguration message was not received.

The procedure ends.

8.2.2.12b Cell update procedure during security reconfiguration

If:

- a cell update procedure according to subclause 8.3.1 is initiated; and
- the received reconfiguration message causes either,
 - the IE "Reconfiguration" in the variable CIPHERING_STATUS to be set to TRUE; and/or
 - the IE "Reconfiguration" in the variable INTEGRITY_PROTECTION_INFO to be set to TRUE;

the UE shall:

- abort the ongoing integrity and/or ciphering reconfiguration;
- resume data transmission on any suspended radio bearer and signalling radio bearer mapped on RLC-AM or RLC-UM;
- transmit a failure response message as specified in subclause 8.2.2.9, setting the information elements as specified below:
 - include the IE "RRC transaction identifier"; and
 - set it to the value of "RRC transaction identifier" in the entry for the received message in the table "Accepted transactions" in the variable TRANSACTIONS; and
 - clear that entry;
 - set the IE "failure cause" to the cause value "cell update occurred";
 - if the received reconfiguration message contained the IE "Ciphering mode info":
 - set the IE "Reconfiguration" in the variable CIPHERING_STATUS to FALSE; and
 - clear the variable RB_UPLINK_CIPHERING_ACTIVATION_TIME_INFO;
 - if the received reconfiguration message contained the IE "Integrity protection mode info":
 - set the IE "Reconfiguration" in the variable INTEGRITY_PROTECTION_INFO to FALSE; and
 - clear the variable INTEGRITY_PROTECTION_ACTIVATION_INFO;
- continue with any ongoing processes and procedures as if the reconfiguration message was not received.

The procedure ends.

8.2.2.13 Invalid received message

If the received reconfiguration message contains a protocol error causing the variable PROTOCOL_ERROR_REJECT to be set to TRUE according to clause 9, the UE shall perform procedure specific error handling as follows. The UE shall:

- transmit a failure response message as specified in subclause 8.2.2.9, setting the information elements as specified below:
 - include the IE "RRC transaction identifier"; and
 - set it to the value of "RRC transaction identifier" in the entry for the received message in the table "Rejected transactions" in the variable TRANSACTIONS; and
 - clear that entry;
 - set the IE "failure cause" to the cause value "protocol error";
 - include the IE "Protocol error information" with contents set to the value of the variable PROTOCOL_ERROR_INFORMATION.

The procedure ends.

8.2.3 Radio bearer release

See subclause 8.2.2 (Reconfiguration procedures).

8.2.4 Transport channel reconfiguration

See subclause 8.2.2 (Reconfiguration procedures).

8.2.5 Transport format combination control

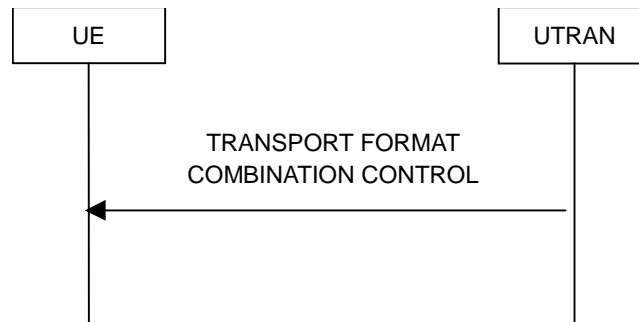

Figure 32: Transport format combination control, normal flow

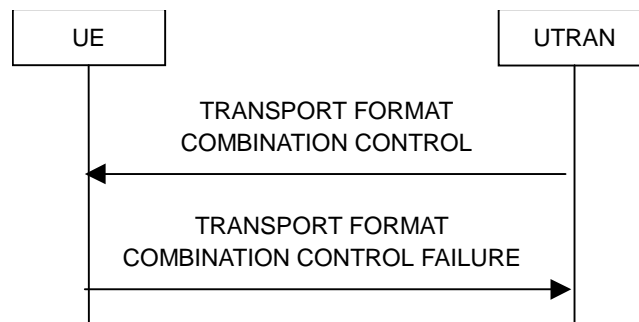

Figure 33: Transport format combination control, failure case

8.2.5.1 General

The transport format combination control procedure is used to control the allowed uplink transport format combinations within the transport format combination set.

8.2.5.2 Initiation

To initiate the transport format combination control procedure, the UTRAN transmits the TRANSPORT FORMAT COMBINATION CONTROL message on the downlink DCCH using AM, UM or TM RLC. When not stated otherwise elsewhere, the UE may initiate the transport format combination control procedure also when another procedure is ongoing, and in that case the state of the latter procedure shall not be affected.

To change the sub-set of allowed transport format combinations, the UTRAN shall:

- set the allowed TFCs in the IE "TFC subset". The network can optionally specify the duration for which a new TFC sub-set applies by using the IE "TFC Control duration" and independently can optionally specify the time at which a new TFC sub-set shall be applied using the IE "Activation Time".

To remove completely the previous restrictions of allowed transport format combinations, the UTRAN shall:

- set the "full transport format combination" in the IE "TFC subset".

8.2.5.3 Reception of a TRANSPORT FORMAT COMBINATION CONTROL message by the UE

Upon reception of the TRANSPORT FORMAT COMBINATION CONTROL message the UE shall:

- act upon all received information elements as specified in 8.6, unless specified otherwise in the following;
- perform the actions for the transport format combination subset specified in the IE "DPCH/PUSCH TFCS in uplink" according to subclause 8.6.5.3;
- if the variable INVALID_CONFIGURATION is set to FALSE:
 - if the IE "TFC Control duration" is included in the message:
 - store the value of the IE "TFC Control duration" in the IE "Duration" in the variable TFC_SUBSET
 - set the IE "Current TFC subset" (or IE "TFCS Id" in case of TDD) in the variable TFC_SUBSET to the value of the IE "Transport format combination subset";
 - apply the transport format combination subset in the IE "Current TFC subset" stored in the variable TFC_SUBSET for the number of (10 ms) frames specified in the IE "TFC Control duration";
 - at the end of the time period defined by the IE "TFC control duration":
 - if the variable TFC_SUBSET has not subsequently been reset by another message:
 - go back to any previous restriction of the transport format combination set defined by the content of the IE "Default TFC subset" in the variable TFC_SUBSET;
 - set the value of the IE "Current TFC subset" in the variable TFC_SUBSET to the value of the IE "Default TFC subset" in the variable TFC_SUBSET;
 - clear the IE "Duration" in the variable TFC_SUBSET;
 - if the IE "TFC Control duration" is not included in the message:
 - set both the IE "Current TFC subset" and the IE "Default TFC subset" (or IE "TFCS Id" in case of TDD) in the variable TFC_SUBSET to the value of the IE "Transport format combination subset";
- if the UE is unable to comply with the reconfiguration due to an invalid activation time:
 - set the variable INVALID_CONFIGURATION to TRUE.

The UE shall:

- clear the entry for the TRANSPORT FORMAT COMBINATION CONTROL message in the table "Accepted transactions" in the variable TRANSACTIONS;
- and the procedure ends.

8.2.5.4 Invalid configuration

If the variable INVALID_CONFIGURATION is set to TRUE due to the received TRANSPORT FORMAT COMBINATION CONTROL message the UE shall:

- if the TRANSPORT FORMAT COMBINATION CONTROL message was received on AM RLC:
 - keep the TFC subset existing before the TRANSPORT FORMAT COMBINATION CONTROL message was received;
 - transmit a TRANSPORT FORMAT COMBINATION CONTROL FAILURE message on the DCCH using AM RLC;
 - set the IE "RRC transaction identifier" in the TRANSPORT FORMAT COMBINATION CONTROL FAILURE message to the value of "RRC transaction identifier" in the entry for the TRANSPORT FORMAT

COMBINATION CONTROL message in the table "Accepted transactions" in the variable TRANSACTIONS; and

- clear that entry;
- set the IE "failure cause" to "invalid configuration";
- when the TRANSPORT FORMAT COMBINATION CONTROL FAILURE message has been submitted to lower layers for transmission the procedure ends.
- if the TRANSPORT FORMAT COMBINATION CONTROL message was received on UM RLC or TM RLC:
 - ignore the TRANSPORT FORMAT COMBINATION CONTROL message.

8.2.5.5 Invalid TRANSPORT FORMAT COMBINATION CONTROL message

If the TRANSPORT FORMAT COMBINATION CONTROL message was received on AM RLC or UM RLC and contains a protocol error causing the variable PROTOCOL_ERROR_REJECT to be set to TRUE according to clause 9, the UE shall perform procedure specific error handling as follows. The UE shall:

- transmit a TRANSPORT FORMAT COMBINATION CONTROL FAILURE message on the uplink DCCH using AM RLC setting the information elements as specified below;
 - set the IE "RRC transaction identifier" in the TRANSPORT FORMAT COMBINATION CONTROL FAILURE message to the value of "RRC transaction identifier" in the entry for the TRANSPORT FORMAT COMBINATION CONTROL message in the table "Rejected transactions" in the variable TRANSACTIONS; and
 - clear that entry;
 - set the IE "failure cause" to the cause value "protocol error";
 - include the IE "Protocol error information" with contents set to the value of the variable PROTOCOL_ERROR_INFORMATION;
- when the TRANSPORT FORMAT COMBINATION CONTROL FAILURE message has been submitted to lower layers for transmission:
 - continue with any ongoing processes and procedures as if the invalid TRANSPORT FORMAT COMBINATION CONTROL message has not been received;
 - and the procedure ends.

If the TRANSPORT FORMAT COMBINATION CONTROL message was received on TM RLC and contains a protocol error causing the variable PROTOCOL_ERROR_REJECT to be set to TRUE according to clause 9, the UE shall perform procedure specific error handling as follows. The UE shall:

- ignore the invalid TRANSPORT FORMAT COMBINATION CONTROL message as if it has not been received;
- the procedure ends.

8.2.6 Physical channel reconfiguration

See subclause 8.2.2 Reconfiguration procedures.

8.2.7 Physical Shared Channel Allocation [TDD only]



Figure 34: Physical Shared Channel Allocation

8.2.7.1 General

The purpose of this procedure is to allocate radio resources to USCH and/or DSCH transport channels in TDD mode, for use by a UE. This procedure can also be used to indicate to the UE, that a PUSCH allocation is pending, in order to prevent further capacity requests from the UE.

UEs are not required to receive FACH and DSCH simultaneously, i.e. if resources are allocated to DSCH the FACH reception may be suspended.

8.2.7.2 Initiation

To initiate the Physical Shared Channel Allocation procedure, the UTRAN sends the "PHYSICAL SHARED CHANNEL ALLOCATION" message on the downlink SHCCH or on the downlink DCCH using UM RLC. The C-RNTI shall be included for UE identification, if the message is sent on the SHCCH.

8.2.7.3 Reception of a PHYSICAL SHARED CHANNEL ALLOCATION message by the UE

Upon reception of a "PHYSICAL SHARED CHANNEL ALLOCATION" message, if the message is received on the downlink SHCCH the UE shall:

- check the C-RNTI to see if the UE is addressed by the message;
- if the UE is addressed by the message, or if the message is received on the downlink DCCH:
 - perform the following actions;
- otherwise:
 - ignore the message;
- act upon all received information elements as specified in subclause 8.6, unless specified otherwise in the following:
- if the IE "ISCP Timeslot list" is included:
 - store the timeslot numbers given there for future Timeslot ISCP measurements and reports;
- if the IE "PDSCH capacity allocation info" is included:
 - configure the physical resources used for the downlink CCTrCH given by the IE "TFCS ID" according to the following:
 - if the CHOICE "Configuration" has the value "Old configuration":
 - if the UE has stored a PDSCH configuration with the identity given by the IE "PDSCH Identity":
 - configure the physical resources according to that configuration;
 - otherwise:
 - ignore the IE "PDSCH capacity allocation info";

- if the CHOICE "Configuration" has the value "New configuration":
 - configure the physical resources according to the information given in IE "PDSCH Info". If IE "Common timeslot info" or IE "PDSCH timeslots and codes" IE are not present in IE "PDSCH Info":
 - reuse the configuration specified in the previous "PHYSICAL SHARED CHANNEL ALLOCATION" message for this CCTrCH;
 - if the IE "PDSCH Identity" is included:
 - store the new configuration using that identity;
- start using the new configuration at the CFN specified by the IE "Allocation activation time", and use that for the duration given by the IE "Allocation duration";
- if the IE "Confirm request" has the value "Confirm PDSCH" and IE "PDSCH Identity" is included in IE "PDSCH capacity allocation info":
 - initiate the PUSCH CAPACITY REQUEST procedure as described in subclause 8.2.8.
- if the IE "PUSCH capacity allocation info" is included:
- stop the timer T310, if running;
- if the CHOICE "PUSCH allocation" has the value "PUSCH allocation pending":
 - start the timer T311;
- if the CHOICE "PUSCH allocation" has the value "PUSCH allocation assignment":
 - stop the timer T311, if running;
- configure the physical resources used for the uplink CCTrCH given by the IE "TFCS ID" according to the following:
 - if the CHOICE "Configuration" has the value "Old configuration":
 - if the UE has stored a PUSCH configuration with the identity given by the IE "PUSCH Identity":
 - configure the physical resources according to that configuration;
 - otherwise:
 - ignore the IE "PUSCH capacity allocation info" ;
 - if the CHOICE "Configuration" has the value "New configuration", the UE shall:
 - configure the physical resources according to the information given in IE "PUSCH Info". If IE "Common timeslot info" or IE "PUSCH timeslots and codes" is not present in IE "PUSCH Info":
 - reuse the configuration specified in the previous "PHYSICAL SHARED CHANNEL ALLOCATION" message for this CCTrCH.
 - if the IE "PUSCH Identity" is included:
 - store the new configuration using that identity;
- start using the new configuration at the CFN specified by the IE "Allocation activation time", and use that for the duration given by the IE "Allocation duration";
- if the IE "Traffic volume report request " is included:
 - initiate the PUSCH CAPACITY REQUEST procedure as described in subclause 8.2.8 at the time indicated by the IE "Traffic volume report request";
- if the IE "Confirm request" has the value "Confirm PUSCH" and IE "PUSCH Identity" is included in IE "PUSCH capacity allocation info":

- initiate the PUSCH CAPACITY REQUEST procedure as described in subclause 8.2.8.
- determine the TFCS subset and hence the TFCI values which are possible given the PUSCH allocation for that CCTrCH;
- configure the MAC-c/sh in the UE with this TFCS restriction if necessary;
- transmit USCH Transport Block Sets as required, within the TFCS limits given by the PUSCH allocation.

NOTE: If the UE has just entered a new cell and System Information Block Type 6 has not yet been scheduled, PUSCH/PDSCH information should be specified in the allocation message.

The UE shall:

- clear the entry for the PHYSICAL SHARED CHANNEL ALLOCATION message in the table "Accepted transactions" in the variable TRANSACTIONS;
- and the procedure ends.

8.2.7.4 Invalid PHYSICAL SHARED CHANNEL ALLOCATION message

If the UE receives a PHYSICAL SHARED CHANNEL ALLOCATION message, which contains a protocol error causing the variable `PROTOCOL_ERROR_REJECT` to be set to `TRUE` according to clause 9, the UE shall perform procedure specific error handling as follows. The UE shall:

- ignore the invalid PHYSICAL SHARED CHANNEL ALLOCATION message;
- submit the PUSCH CAPACITY REQUEST message for transmission on the uplink SHCCH, setting the information elements in the message as specified in subclause 8.2.8.3;
- reset counter `V310`;
- start timer `T310`;
- proceed as described in subclause 8.2.8.

8.2.8 PUSCH capacity request [TDD only]

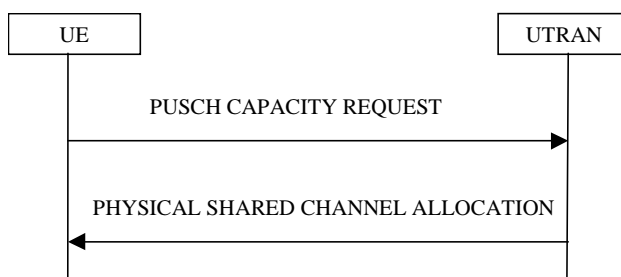

Figure 35: PUSCH Capacity request procedure

8.2.8.1 General

With this procedure, the UE transmits its request for PUSCH resources to the UTRAN. In the normal case, the UTRAN responds with a PHYSICAL SHARED CHANNEL ALLOCATION message, which either allocates the requested PUSCH resources, and/or allocates a PDSCH resource, or may just serve as an acknowledgement, indicating that PUSCH allocation is pending.

This procedure can also be used to acknowledge the reception of a PHYSICAL SHARED CHANNEL ALLOCATION message, or to indicate a protocol error in that message.

With the PUSCH CAPACITY REQUEST message, the UE can request capacity for one or more USCH.

8.2.8.2 Initiation

This procedure is initiated

- in the CELL_FACH or CELL_DCH state,
- and when at least one RB using USCH has been established,
- and when the UE sees the requirement to request physical resources (PUSCH) for an USCH channel or there is the need to reply to a PHYSICAL SHARED CHANNEL ALLOCATION message as described in clause 8.2.7 (i.e. to confirm the reception of a message, if requested to do so, or to indicate a protocol error).

The procedure can be initiated if:

- Timer T311 is not running.
- The timer T310 (capacity request repetition timer) is not running.

The UE shall:

- set the IEs in the PUSCH CAPACITY REQUEST message according to subclause 8.2.8.3;
- if the procedure is triggered to reply to a previous PHYSICAL SHARED CHANNEL ALLOCATION message by the IE "Confirm request" set to "Confirm PUSCH" and the IE "PUSCH capacity allocation info" is not present:
 - transmit the PUSCH CAPACITY REQUEST message on RACH;
- else:
 - transmit the PUSCH CAPACITY REQUEST message on the uplink SHCCH;
- set counter V310 to 1;
- start timer T310.

8.2.8.3 PUSCH CAPACITY REQUEST message contents to set

With one PUSCH CAPACITY REQUEST message, capacity for one or more USCH can be requested. It shall include these information elements:

- C-RNTI to be used as UE identity if the message is sent on RACH;
- Traffic volume measured results for each radio bearer satisfying the reporting criteria as specified in the MEASUREMENT CONTROL procedure (if no radio bearer satisfies the reporting criteria, traffic volume measured results shall not be included). These results shall include:
 - Radio Bearer ID of the Radio Bearer being reported;
 - RLC buffer payload for these radio bearers, as specified by the MEASUREMENT CONTROL procedure;

The UE shall:

- if the initiation of the procedure is triggered by the IE "Traffic volume report request" in a previously received PHYSICAL SHARED CHANNEL ALLOCATION message:
 - report the traffic volume measurement result for the radio bearer mapped on USCH transport channel specified in the received message. These results shall include:
 - Radio Bearer ID of the Radio Bearer being reported;
 - RLC buffer payload for this radio bearer;
- if the initiation of the procedure is triggered by the IE "Confirm request" set to "Confirm PDSCH" in a previously received PHYSICAL SHARED CHANNEL ALLOCATION message and the IE "PUSCH capacity allocation info" is present in this message:

- set the CHOICE "Allocation confirmation" to "PDSCH Confirmation" with the value given in the IE "PDSCH Identity" in the received message;
- if the initiation of the procedure is triggered by the IE "Confirm request" set to "Confirm PUSCH" in a previously received PHYSICAL SHARED CHANNEL ALLOCATION message:
 - set the CHOICE "Allocation confirmation" to "PUSCH Confirmation" with the value given in the IE "PUSCH Identity" in the received message;
- if the variable `PROTOCOL_ERROR_REJECT` is set to TRUE:
 - include the IE "RRC transaction identifier" in the response message transmitted below; and
 - set it to the value of "RRC transaction identifier" in the entry for the PHYSICAL SHARED CHANNEL ALLOCATION message in the table "Rejected transactions" in the variable `TRANSACTIONS`; and
 - clear that entry;
 - set the IE "protocol error indicator" to TRUE;
 - include the IE "Protocol error information" with contents set to the value of the variable `PROTOCOL_ERROR_INFORMATION`;
- if the value of the variable `PROTOCOL_ERROR_REJECT` is FALSE;
 - set the IE "Protocol error indicator" to FALSE;

As an option, the message may include IE "Timeslot ISCP" and IE "Primary CCPCH RSCP".

The timeslots for which "Timeslot ISCP" may be reported shall have been configured with a previous PHYSICAL SHARED CHANNEL ALLOCATION message.

8.2.8.4 Reception of a PUSCH CAPACITY REQUEST message by the UTRAN

Upon receiving a PUSCH CAPACITY REQUEST message with traffic volume measurement included for at least one radio bearer, the UTRAN should initiate the PHYSICAL SHARED CHANNEL ALLOCATION procedure, either for allocating PUSCH or PDSCH resources as required, or just as an acknowledgement, indicating a pending PUSCH allocation, as described in subclause 8.2.7.

8.2.8.5 T310 expiry

Upon expiry of timer T310, the UE shall

- if V310 is smaller than N310:
 - transmit a new PUSCH CAPACITY REQUEST message on the Uplink SHCCH;
 - restart timer T310;
 - increment counter V310;
 - set the IEs in the PUSCH CAPACITY REQUEST message as specified in subclause 8.2.8.3;
- if V310 is greater than or equal to N310:
 - the procedure ends.

8.2.9 Void

8.2.10 Uplink Physical Channel Control [TDD only]

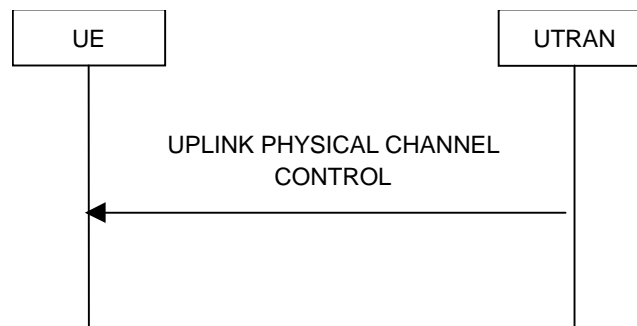

Figure 36: Uplink Physical Channel Control

8.2.10.1 General

The uplink physical channel control procedure is used in TDD to control the uplink outer loop power control and timing advance running in the UE.

8.2.10.2 Initiation

The UTRAN initiates the procedure by transmitting the UPLINK PHYSICAL CHANNEL CONTROL message on the downlink DCCH using AM or UM RLC in order to update parameters for uplink open loop power control in the UE for one CCTrCH or to inform the UE about a new timing advance value to be applied. Especially, uplink interference information measured by the UTRAN can be included for the uplink timeslots used for the CCTrCH.

8.2.10.3 Reception of UPLINK PHYSICAL CHANNEL CONTROL message by the UE

Upon reception of the UPLINK PHYSICAL CHANNEL CONTROL message, the UE shall:

- act upon all received information elements as specified in subclause 8.6.

In 3.84 Mcps TDD, if the IEs "Uplink DPCH Power Control Info", "Constant Value", "Alpha" or IE group "list of UL Timeslot Interference" are transmitted, this information shall be taken into account by the UE for uplink open loop power control as specified in subclause 8.5.7. If the UE is capable of using IPDLs for UE positioning, the IE "IPDL-Alpha" shall be used instead of the IE "Alpha". If the IE "IPDL-Alpha" parameter is not present, the UE shall use IE "Alpha".

If the IE Special Burst Scheduling is transmitted the UE shall:

- use the new value for the UL Special Burst generation period.

The UE shall:

- clear the entry for the UPLINK PHYSICAL CHANNEL CONTROL message in the table "Accepted transactions" in the variable TRANSACTIONS;
- and the procedure ends.

8.2.10.4 Invalid UPLINK PHYSICAL CHANNEL CONTROL message

If the UE receives a UPLINK PHYSICAL CHANNEL CONTROL message, which contains a protocol error causing the variable `PROTOCOL_ERROR_REJECT` to be set to `TRUE` according to clause 9, the UE shall perform procedure specific error handling as follows. The UE shall:

- transmit an RRC STATUS message on the uplink DCCH using AM RLC, setting the information elements as specified below:
 - include the IE "Identification of received message"; and
 - set the IE "Received message type" to UPLINK PHYSICAL CHANNEL CONTROL; and

- set the IE "RRC transaction identifier" to the value of "RRC transaction identifier" in the entry for the UPLINK PHYSICAL CHANNEL CONTROL message in the table "Rejected transactions" in the variable TRANSACTIONS; and
- clear that entry;
- include the IE "Protocol error information" with contents set to the value of the variable PROTOCOL_ERROR_INFORMATION;
- when the RRC STATUS message has been submitted to lower layers for transmission:
- continue with any ongoing processes and procedures as if the invalid UPLINK PHYSICAL CHANNEL CONTROL message has not been received.

8.2.11 Physical channel reconfiguration failure

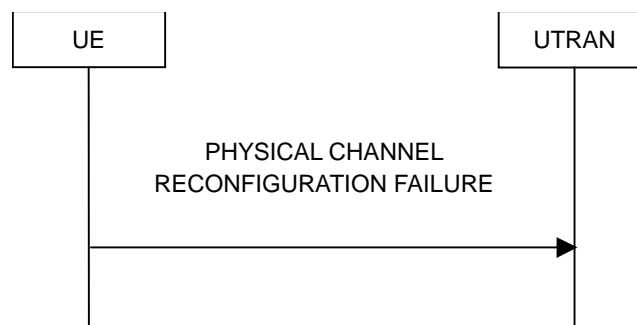

Figure 37: Physical channel reconfiguration failure in case of runtime configuration error

8.2.11.1 General

The physical channel reconfiguration failure procedure is used to indicate to the network a runtime configuration error in the UE.

8.2.11.2 Runtime error due to overlapping compressed mode configurations

When the UE has received from the UTRAN the configurations of several compressed mode transmission gap pattern sequences, and if several of these patterns are to be simultaneously active, the UE shall check to see if these simultaneously active transmission gap pattern sequences create transmission gaps in the same frame. An illegal overlap is created if two or more transmission gap pattern sequences create transmission gaps in the same frame, irrespective of the gaps are created in uplink or downlink.

If the parallel transmission gap pattern sequences create an illegal overlap, the UE shall:

- delete the overlapping transmission gap pattern sequence configuration stored in the variable TGPS_IDENTITY, which is associated with the highest value of IE "TGPSI";
- transmit a PHYSICAL CHANNEL RECONFIGURATION FAILURE message on the DCCH using AM RLC, setting the information elements as specified below:
 - not include the IE "RRC transaction identifier";
 - set the cause value in IE "failure cause" to value "compressed mode runtime error";
- terminate the inter-frequency and/or inter-RAT measurements corresponding to the deleted transmission gap pattern sequence;
- when the PHYSICAL CHANNEL RECONFIGURATION FAILURE message has been submitted to lower layers for transmission:
 - the procedure ends.

8.2.11.3 Runtime error due to overlapping compressed mode configuration and PDSCH reception

If UE is scheduled to receive a PDSCH frame at the same time instant as a compressed mode gap, UE shall perform the measurements according to the measurement purpose of the pattern sequence.

8.3 RRC connection mobility procedures

8.3.1 Cell and URA update procedures

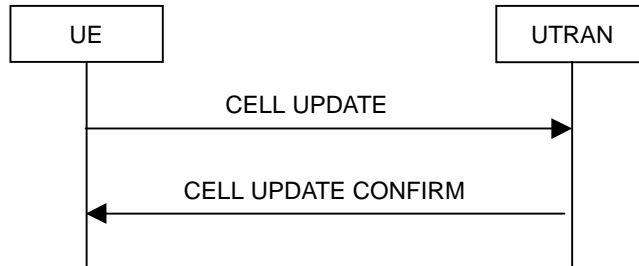

Figure 38: Cell update procedure, basic flow

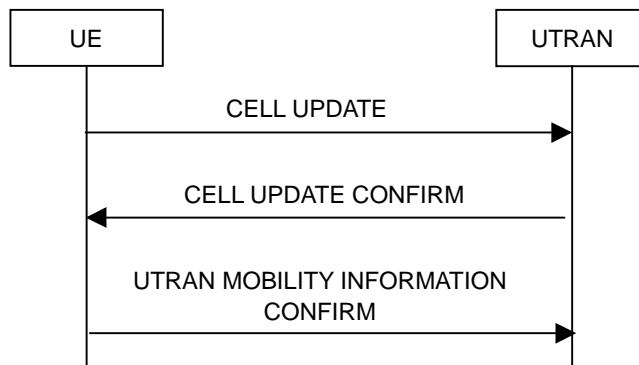

Figure 39: Cell update procedure with update of UTRAN mobility information

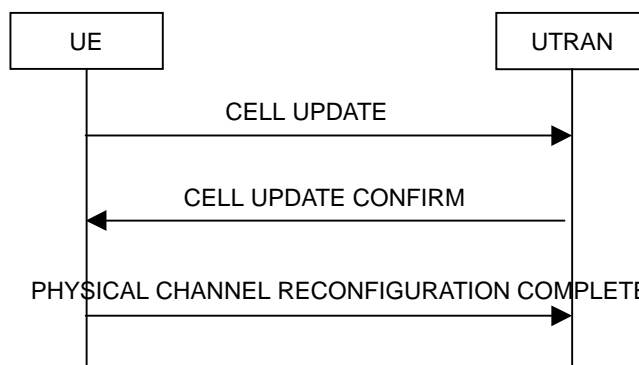

Figure 40: Cell update procedure with physical channel reconfiguration

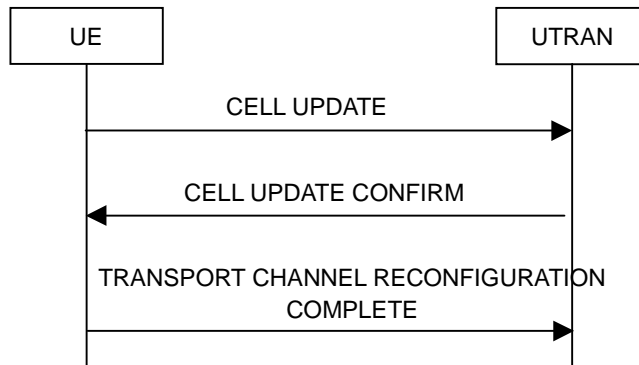

Figure 41: Cell update procedure with transport channel reconfiguration

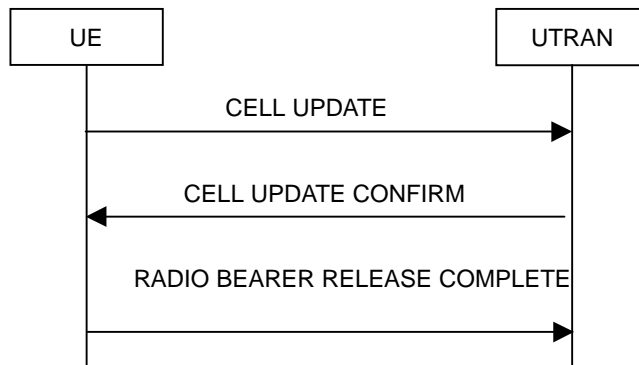

Figure 42: Cell update procedure with radio bearer release

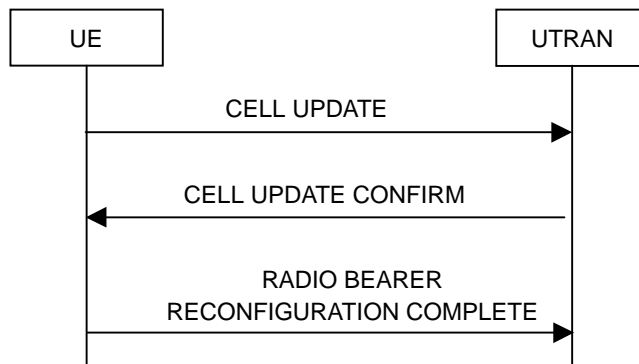

Figure 43: Cell update procedure with radio bearer reconfiguration

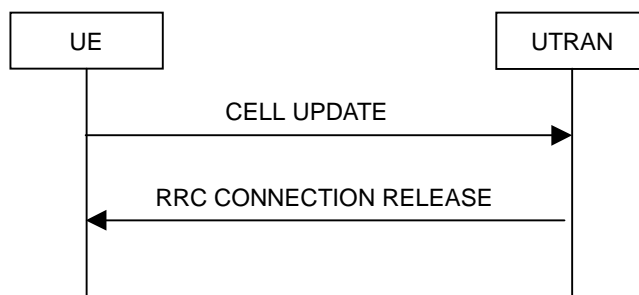

Figure 44: Cell update procedure, failure case

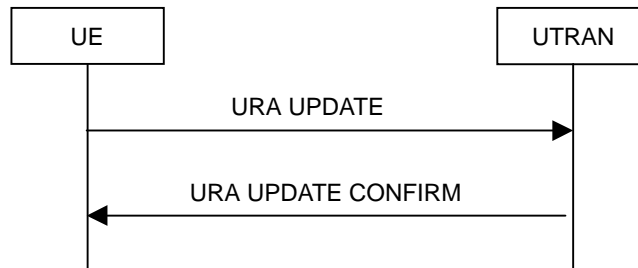

Figure 45: URA update procedure, basic flow

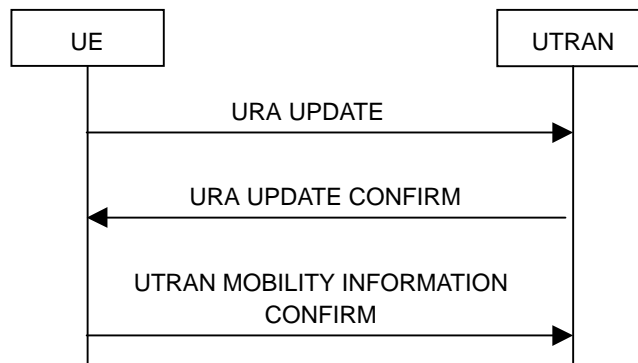

Figure 46: URA update procedure with update of UTRAN mobility information

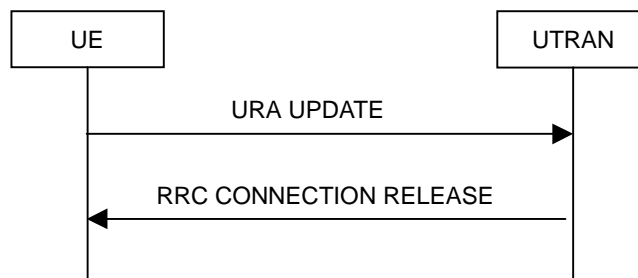

Figure 47: URA update procedure, failure case

8.3.1.1 General

The URA update and cell update procedures serve several main purposes:

- to notify UTRAN after re-entering service area in the URA_PCH or CELL_PCH state;
- to notify UTRAN of an RLC unrecoverable error [16] on an AM RLC entity;
- to be used as a supervision mechanism in the CELL_FACH, CELL_PCH, or URA_PCH state by means of periodical update;

In addition, the URA update procedure also serves the following purpose:

- to retrieve a new URA identity after cell re-selection to a cell not belonging to the current URA assigned to the UE in URA_PCH state;

In addition, the cell update procedure also serves the following purposes:

- to update UTRAN with the current cell the UE is camping on after cell reselection;
- to act on a radio link failure in the CELL_DCH state;
- when triggered in the URA_PCH or CELL_PCH state, to notify UTRAN of a transition to the CELL_FACH state due to the reception of UTRAN originated paging or due to a request to transmit uplink data.

The URA update and cell update procedures may:

- include an update of mobility related information in the UE;
- cause a state transition from the CELL_FACH state to the CELL_DCH, CELL_PCH or URA_PCH states or idle mode.

The cell update procedure may also include:

- a re-establish of AM RLC entities;
- a radio bearer release, radio bearer reconfiguration, transport channel reconfiguration or physical channel reconfiguration;

8.3.1.2 Initiation

A UE shall initiate the cell update procedure in the following cases:

- Uplink data transmission:
 - if the UE is in URA_PCH or CELL_PCH state; and
 - if the UE has uplink RLC data PDU or uplink RLC control PDU on RB1 or upwards to transmit:
 - perform cell update using the cause "uplink data transmission".
- Paging response:
 - if the criteria for performing cell update with the cause specified above in the current subclause is not met; and
 - if the UE in URA_PCH or CELL_PCH state, receives a PAGING TYPE 1 message fulfilling the conditions for initiating a cell update procedure specified in subclause 8.1.2.3:
 - perform cell update using the cause "paging response".
- Re-entering service area:
 - if none of the criteria for performing cell update with the causes specified above in the current subclause is met; and
 - if the UE is in CELL_FACH or CELL_PCH state; and
 - if the UE has been out of service area and re-enters service area before T307 or T317 expires:
 - perform cell update using the cause "re-entering service area".
- Radio link failure:
 - if none of the criteria for performing cell update with the causes specified above in the current subclause is met; and
 - if the UE is in CELL_DCH state; and
 - if the criteria for radio link failure is met as specified in subclause 8.5.6:
 - perform cell update using the cause "radio link failure".
- RLC unrecoverable error:
 - if none of the criteria for performing cell update with the causes specified above in the current subclause is met; and
 - if the UE detects RLC unrecoverable error [16] in an AM RLC entity:
 - perform cell update using the cause "RLC unrecoverable error".

- Cell reselection:
 - if none of the criteria for performing cell update with the causes specified above in the current subclause is met; and
 - if the UE is in CELL_FACH or CELL_PCH state; and
 - if the UE performs cell re-selection or the variable C_RNTI is empty:
 - perform cell update using the cause "cell reselection".
- Periodical cell update:
 - if none of the criteria for performing cell update with the causes specified above in the current subclause is met; and
 - if the UE is in CELL_FACH or CELL_PCH state; and
 - if the timer T305 expires; and
 - if the criteria for "in service area" as specified in subclause 8.5.5.2 is fulfilled; and
 - if periodic updating has been configured by T305 in the IE "UE Timers and constants in connected mode" set to any other value than "infinity":
 - perform cell update using the cause "periodical cell update".

A UE in URA_PCH state shall initiate the URA update procedure in the following cases:

- URA reselection:
 - if the UE detects that the current URA assigned to the UE, stored in the variable URA_IDENTITY, is not present in the list of URA identities in system information block type 2; or
 - if the list of URA identities in system information block type 2 is empty; or
 - if the system information block type 2 can not be found:
 - perform URA update using the cause "change of URA".
- Periodic URA update:
 - if the criteria for performing URA update with the causes as specified above in the current subclause are not met; and
 - if the timer T305 expires while the UE is in the service area; and
 - if periodic updating has been configured by T305 in the IE "UE Timers and constants in connected mode" set to any other value than "infinity":
 - perform URA update using the cause "periodic URA update".

When initiating the URA update or cell update procedure, the UE shall:

- stop timer T305;
- if the UE is in CELL_DCH state:
- in the variable RB_TIMER_INDICATOR, set the IE "T314 expired" and the IE "T315 expired" to FALSE;
- if the stored values of the timer T314 and timer T315 are both equal to zero:
 - release all its radio resources;
 - indicate release (abort) of the established signalling connections (as stored in the variable ESTABLISHED_SIGNALLING_CONNECTIONS) and established radio access bearers (as stored in the variable ESTABLISHED_RABS) to upper layers;

- clear the variable ESTABLISHED_SIGNALLING_CONNECTIONS;
- clear the variable ESTABLISHED_RABS;
- enter idle mode;
- perform other actions when entering idle mode from connected mode as specified in subclause 8.5.2;
- and the procedure ends.
- if the stored value of the timer T314 is equal to zero:
 - release all radio bearers, associated with any radio access bearers for which in the variable ESTABLISHED_RABS the value of the IE "Re-establishment timer" is set to "useT314";
 - in the variable RB_TIMER_INDICATOR set the IE "T314 expired" to TRUE;
- if the stored value of the timer T315 is equal to zero:
 - release all radio bearers associated with any radio access bearers for which in the variable ESTABLISHED_RABS the value of the IE "Re-establishment timer" is set to "useT315";
 - in the variable RB_TIMER_INDICATOR set the IE "T315 expired" to TRUE;
- if the stored value of the timer T314 is greater than zero:
 - re-start timer T314;
- if the stored value of the timer T315 is greater than zero:
 - re-start timer T315;
- for the released radio bearer(s):
 - delete the information about the radio bearer from the variable ESTABLISHED_RABS;
 - when all radio bearers belonging to the same radio access bearer have been released:
 - indicate local end release of the radio access bearer to upper layers using the CN domain identity together with the RAB identity stored in the variable ESTABLISHED_RABS;
 - delete all information about the radio access bearer from the variable ESTABLISHED_RABS;
- set the variables PROTOCOL_ERROR_INDICATOR, FAILURE_INDICATOR, UNSUPPORTED_CONFIGURATION and INVALID_CONFIGURATION to FALSE;
- set the variable CELL_UPDATE_STARTED to TRUE;
- move to CELL_FACH state, if not already in that state;
- if the UE performs cell re-selection:
 - clear the variable C_RNTI; and
 - stop using that C_RNTI just cleared from the variable C_RNTI in MAC;
- set CFN in relation to SFN of current cell according to subclause 8.5.15;
- in case of a cell update procedure:
 - set the contents of the CELL UPDATE message according to subclause 8.3.1.3;
 - submit the CELL UPDATE message for transmission on the uplink CCCH;
- in case of a URA update procedure:
 - set the contents of the URA UPDATE message according to subclause 8.3.1.3;
 - submit the URA UPDATE message for transmission on the uplink CCCH;

- set counter V302 to 1;
- start timer T302 when the MAC layer indicates success or failure in transmitting the message.

8.3.1.3 CELL UPDATE / URA UPDATE message contents to set

In case of cell update procedure the UE shall transmit a CELL UPDATE message.

In case of URA update procedure the UE shall transmit a URA UPDATE message.

The UE shall set the IEs in the CELL UPDATE message as follows:

- set the IE "Cell update cause" corresponding to the cause specified in subclause 8.3.1.2 that is valid when the CELL UPDATE message is submitted to lower layers for transmission;

NOTE: During the time period starting from when a cell update procedure is initiated by the UE until when the procedure ends, additional CELL UPDATE messages may be transmitted by the UE with different causes.

- set the IE "U-RNTI" to the value of the variable U_RNTI;
- if the value of the variable PROTOCOL_ERROR_INDICATOR is TRUE:
 - include the IE "RRC transaction identifier"; and
 - set it to the value of "RRC transaction identifier" in the entry for the CELL UPDATE CONFIRM message in the table "Rejected transactions" in the variable TRANSACTIONS;
 - include and set the IE "failure cause" to the cause value "protocol error";
 - set the IE "Protocol error information" set to the value of the variable PROTOCOL_ERROR_INFORMATION;
- if the value of the variable FAILURE_INDICATOR is TRUE:
 - include the IE "RRC transaction identifier"; and
 - set it to the value of "RRC transaction identifier" in the entry for the CELL UPDATE CONFIRM message in the table "Accepted transactions" in the variable TRANSACTIONS;
 - include and set the IE "failure cause" to the value of the variable FAILURE_CAUSE;
- include the START values for each CN domain, calculated according to subclause 8.5.9;
- if an unrecoverable error [16] in any of the AM RLC entities for the signalling radio bearer RB2 or signalling radio bearer RB3 is detected:
 - set the IE "AM_RLC error indication (RB2 or RB3)" to TRUE;
- otherwise:
 - set the IE "AM_RLC error indication (RB2 or RB3)" to FALSE;
- if an unrecoverable error [16] in any of the AM RLC entities for the RB4 or upward is detected:
 - set the IE "AM_RLC error indication (RB>3)" to TRUE;
- otherwise:
 - set the IE "AM_RLC error indication (RB>3)" to FALSE;
- set the IE "RB Timer indicator" to the value of the variable RB_TIMER_INDICATOR;
- include an intra-frequency measurement report in the IE "Measured results on RACH", as specified in the IE "Intra-frequency reporting quantity for RACH reporting" and the IE "Maximum number of reported cells on RACH" in system information block type 12 (or System Information Block type 11, if System Information Block type 12 is not being broadcast).

The UE shall set the IEs in the URA UPDATE message as follows:

- set the IE "U-RNTI" to the value of the variable U_RNTI;
- set the IE "URA update cause" corresponding to which cause as specified in subclause 8.3.1.2 that is valid when the URA UPDATE message is submitted to lower layers for transmission;

NOTE: During the time period starting from when a URA update procedure is initiated by the UE until when the procedure ends, additional URA UPDATE messages may be transmitted by the UE with different causes, depending on which causes are valid for the respective URA UPDATE message.

- if the value of the variable PROTOCOL_ERROR_INDICATOR is TRUE:
 - include the IE "RRC transaction identifier"; and
 - set it to the value of "RRC transaction identifier" in the entry for the URA UPDATE CONFIRM message in the table "Rejected transactions" in the variable TRANSACTIONS;
 - set the IE "Protocol error indicator" to TRUE;
 - include the IE "Protocol error information" set to the value of the variable PROTOCOL_ERROR_INFORMATION.
- if the value of the variable PROTOCOL_ERROR_INDICATOR is FALSE:
 - if the value of the variable INVALID_CONFIGURATION is TRUE:
 - include the IE "RRC transaction identifier"; and
 - set it to the value of "RRC transaction identifier" in the entry for the URA UPDATE CONFIRM message in the table "Accepted transactions" in the variable TRANSACTIONS;
 - set the IE "Protocol error indicator" to TRUE;
 - include the IE "Protocol error information" set to "Information element value not comprehended";
 - if the value of the variable INVALID_CONFIGURATION is FALSE:
 - set the IE "Protocol error indicator" to FALSE.

8.3.1.4 T305 expiry and the UE detects "out of service area"

When the T305 expires and the UE detects that it is "out of service area" as specified in subclause 8.5.5.1, the UE shall

- start timer T307;
- re-select to a new cell, as described in [4].

8.3.1.4.1 Re-entering "in service area"

If the UE detects "in service area" according to subclause 8.5.5.2 and timer T307 or T317 is running, the UE shall:

- check the value of V302; and
- if V302 is equal to or smaller than N302:
 - in case of a cell update procedure:
 - set the contents of the CELL UPDATE message according to subclause 8.3.1.3;
 - submit the CELL UPDATE message for transmission on the uplink CCCH;
 - in case of a URA update procedure:
 - set the contents of the URA UPDATE message according to subclause 8.3.1.3;
 - submit the URA UPDATE message for transmission on the uplink CCCH;

- increment counter V302;
- restart timer T302 when the MAC layer indicates success or failure to transmit the message.
- if V302 is greater than N302:
 - clear the variable RB_UPLINK_CIPHERING_ACTIVATION_TIME_INFO;
 - clear the variable INTEGRITY_PROTECTION_ACTIVATION_INFO;
 - in case of a cell update procedure:
 - clear the entry for the CELL UPDATE CONFIRM message in the table "Rejected transactions" in the variable TRANSACTIONS;
 - in case of a URA update procedure:
 - clear the entry for the URA UPDATE CONFIRM message in the table "Rejected transactions" in the variable TRANSACTIONS;
 - release all its radio resources;
 - indicate release (abort) of the established signalling connections (as stored in the variable ESTABLISHED_SIGNALLING_CONNECTIONS) and established radio access bearers (as stored in the variable ESTABLISHED_RABS) to upper layers;
 - clear the variable ESTABLISHED_SIGNALLING_CONNECTIONS;
 - clear the variable ESTABLISHED_RABS;
 - enter idle mode;
 - perform other actions when entering idle mode from connected mode as specified in subclause 8.5.2;
 - and the procedure ends.

8.3.1.4.2 Expiry of timer T307

When the T307 expires, the UE shall:

- move to idle mode;
- release all dedicated resources;
- indicate release (abort) of the established signalling connections (as stored in the variable ESTABLISHED_SIGNALLING_CONNECTIONS) and established radio access bearers (as stored in the variable ESTABLISHED_RABS) to upper layers;
- clear the variable ESTABLISHED_SIGNALLING_CONNECTIONS;
- clear the variable ESTABLISHED_RABS;
- perform other actions when entering idle mode from connected mode as specified in subclause 8.5.2;
- and the procedure ends.

8.3.1.5 Reception of an CELL UPDATE/URA UPDATE message by the UTRAN

When the UTRAN receives a CELL UPDATE/URA UPDATE message, it may either:

- in case the procedure was triggered by reception of a CELL UPDATE:
 - update the START value for each CN domain as maintained in UTRAN (refer to subclause 8.5.9) with "START" in the IE "START list" for the CN domain as indicated by "CN domain identity" in the IE "START list";

- if this procedure was triggered while the UE was not in CELL_DCH state, then for each CN domain as indicated by "CN domain identity" in the IE "START list":
 - set the 20 MSB of the MAC-d HFN with the corresponding START value in the IE "START list";
 - set the remaining LSB of the MAC-d HFN to zero;
- transmit a CELL UPDATE CONFIRM message on the downlink DCCH or optionally on the CCCH but only if ciphering is not required; and
- optionally include the IE "RLC re-establish indicator" to request a RLC re-establishment in the UE, in which case the corresponding RLC entities should also be re-established in UTRAN; or
- in case the procedure was triggered by reception of a URA UPDATE:
 - transmit a URA UPDATE CONFIRM message to the lower layers for transmission on the downlink CCCH or DCCH in which case the UTRAN should include the IE "URA identity" in the URA UPDATE CONFIRM message in a cell where multiple URA identifiers are broadcast; or
- initiate an RRC connection release procedure (see subclause 8.1.4) by transmitting an RRC CONNECTION RELEASE message on the downlink CCCH.

8.3.1.6 Reception of the CELL UPDATE CONFIRM/URA UPDATE CONFIRM message by the UE

When the UE receives a CELL UPDATE CONFIRM/URA UPDATE CONFIRM message; and

- if the message is received on the CCCH, and IE "U-RNTI" is present and has the same value as the variable U_RNTI, or;
- if the message is received on DCCH;

the UE shall:

- stop timer T302;
- set the variable CELL_UPDATE_STARTED to FALSE;
- in case of a cell update procedure and the CELL UPDATE CONFIRM message:
 - includes "RB information elements"; and/or
 - includes "Transport channel information elements"; and/or
 - includes "Physical channel information elements"; and
 - if the variable ORDERED_RECONFIGURATION is set to FALSE:
 - set the variable ORDERED_RECONFIGURATION to TRUE;
- act upon all received information elements as specified in subclause 8.6, unless specified otherwise in the following:
 - use the transport channel(s) applicable for the physical channel types that is used; and
 - if the IE "TFS" is neither included nor previously stored in the UE for that transport channel(s):
 - use the TFS given in system information.
 - if none of the TFS stored is compatible with the physical channel:
 - delete the stored TFS;
 - use the TFS given in system information.
- perform the physical layer synchronisation procedure as specified in [29];

- if the CELL UPDATE CONFIRM message includes the IE "RLC re-establish indicator (RB2 and RB3)":
 - re-establish the RLC entities for signalling radio bearer RB2 and signalling radio bearer RB3;
- if the variable CIPHERING_STATUS is set to "Started":
 - set the HFN values for AM RLC entities with RB identity 2 and 3 equal to the START value included in the latest transmitted CELL UPDATE message for the CN domain stored in the variable LATEST_CONFIGURED_CN_DOMAIN;
- if the CELL UPDATE CONFIRM message includes the IE "RLC re-establish indicator (RB>3)":
 - re-establish the AM RLC entities for RB with RB identity equal to or larger than 4;
 - if the variable CIPHERING_STATUS is set to "Started":
 - set the HFN values for AM RLC entities with RB identity equal to or larger than 4 equal to the START value included in the latest transmitted CELL UPDATE message for the CN domain stored in the variable LATEST_CONFIGURED_CN_DOMAIN;
- enter a state according to subclause 8.6.3.3 applied on the CELL UPDATE CONFIRM / URA UPDATE CONFIRM message.

If the UE after state transition enters CELL_DCH state, it shall:

- not prohibit periodical status transmission in RLC.

If the UE after state transition remains in CELL_FACH state, it shall

- start the timer T305 using its initial value if timer T305 is not running and periodical cell update has been configured by T305 in the IE "UE Timers and constants in connected mode" set to any other value than "infinity";
- select PRACH according to subclause 8.5.17;
- select Secondary CCPCH according to subclause 8.5.19;
- not prohibit periodical status transmission in RLC;
- if the IE "UTRAN DRX cycle length coefficient" is included in the same message:
 - ignore that IE and stop using DRX;

If the UE after state transition enters URA_PCH or CELL_PCH state, it shall

- prohibit periodical status transmission in RLC;
- clear the variable C_RNTI;
- stop using that C_RNTI just cleared from the variable C_RNTI in MAC;
- start the timer T305 using its initial value if timer T305 is not running and periodical update has been configured by T305 in the IE "UE Timers and constants in connected mode" set to any other value than "infinity";
- select Secondary CCPCH according to subclause 8.5.19;
- if the IE "UTRAN DRX cycle length coefficient" is included in the same message:
 - use the value in the IE "UTRAN DRX Cycle length coefficient" for calculating Paging Occasion and PICH Monitoring Occasion as specified in 8.6.3.2 in CELL_PCH state.

If the UE after the state transition remains in CELL_FACH state and;

- the contents of the variable C_RNTI are empty;

it shall check the value of V302 and

- If V302 is equal to or smaller than N302:

- if, caused by the received CELL UPDATE CONFIRM or URA UPDATE CONFIRM message,
 - the IE "Reconfiguration" in the variable CIPHERING_STATUS is set to TRUE; and/or
 - the IE "Reconfiguration" in the variable INTEGRITY_PROTECTION_INFO is set to TRUE:
 - abort the ongoing integrity and/or ciphering reconfiguration;
 - if the received CELL UPDATE CONFIRM or URA UPDATE CONFIRM message contained the IE "Ciphering mode info":
 - set the IE "Reconfiguration" in the variable CIPHERING_STATUS to FALSE; and
 - clear the variable RB_UPLINK_CIPHERING_ACTIVATION_TIME_INFO;
 - if the received CELL UPDATE CONFIRM or URA UPDATE CONFIRM message contained the IE "Integrity protection mode info":
 - set the IE "Reconfiguration" in the variable INTEGRITY_PROTECTION_INFO to FALSE; and
 - clear the variable INTEGRITY_PROTECTION_ACTIVATION_INFO;
- in case of a URA update procedure:
 - stop the URA update procedure; and
 - continue with a cell update procedure;
- set the contents of the CELL UPDATE message according to subclause 8.3.1.3, except for the IE "Cell update cause" which shall be set to "cell reselection";
- submit the CELL UPDATE message for transmission on the uplink CCCH;
- increment counter V302;
- restart timer T302 when the MAC layer indicates success or failure to transmit the message;
- If V302 is greater than N302:
 - clear the variable RB_UPLINK_CIPHERING_ACTIVATION_TIME_INFO;
 - clear the variable INTEGRITY_PROTECTION_ACTIVATION_INFO;
 - in case of a cell update procedure:
 - clear the entry for the CELL UPDATE CONFIRM message in the table "Rejected transactions" in the variable TRANSACTIONS;
 - in case of a URA update procedure:
 - clear the entry for the URA UPDATE CONFIRM message in the table "Rejected transactions" in the variable TRANSACTIONS;
 - release all its radio resources;
 - indicate release (abort) of the established signalling connections (as stored in the variable ESTABLISHED_SIGNALLING_CONNECTIONS) and established radio access bearers (as stored in the variable ESTABLISHED_RABS) to upper layers;
 - clear the variable ESTABLISHED_SIGNALLING_CONNECTIONS;
 - clear the variable ESTABLISHED_RABS;
 - enter idle mode;
 - other actions the UE shall perform when entering idle mode from connected mode are specified in subclause 8.5.2;

- and the procedure ends.

If the UE after the state transition remains in CELL_FACH state and

- a C-RNTI is stored in the variable C_RNTI;

or

the UE after the state transition moves to another state than the CELL_FACH state;

the UE shall:

- if the CELL UPDATE CONFIRM / URA UPDATE CONFIRM message contained the IE "Ciphering mode info":
 - include and set the IE "Radio bearer uplink ciphering activation time info" in any response message transmitted below to the value of the variable RB_UPLINK_CIPHERING_ACTIVATION_TIME_INFO.
- if the CELL UPDATE CONFIRM / URA UPDATE CONFIRM message contained the IE "Integrity protection mode info" with the IE "Integrity protection mode command" set to "Modify":
 - include and set the IE "Integrity protection activation info" in any response message transmitted below to the value of the variable INTEGRITY_PROTECTION_ACTIVATION_INFO;
- in case of a cell update procedure:
 - set the IE "RRC transaction identifier" in any response message transmitted below to the value of "RRC transaction identifier" in the entry for the CELL UPDATE CONFIRM message in the table "Accepted transactions" in the variable TRANSACTIONS; and
 - clear that entry.
- in case of a cell update procedure:
 - set the IE "RRC transaction identifier" in any response message transmitted below to the value of "RRC transaction identifier" in the entry for the URA UPDATE CONFIRM message in the table "Accepted transactions" in the variable TRANSACTIONS; and
 - clear that entry;
- if the variable PDCP_SN_INFO is non-empty:
 - include the IE "RB with PDCP information list" in any response message transmitted below and set it to the value of the variable PDCP_SN_INFO;
- if the received CELL UPDATE CONFIRM or URA UPDATE CONFIRM message included the IE "Downlink counter synchronisation info":
 - calculate the START value according to subclause 8.5.9;
 - include the calculated START values for each CN domain in the IE "START list" in the IE "Uplink counter synchronisation info" in any response message transmitted below;
- transmit a response message as specified in subclause 8.3.1.7;
- if the IE "Integrity protection mode info" was present in the CELL UPDATE CONFIRM or URA UPDATE CONFIRM message:
 - start applying the new integrity protection configuration in the uplink for signalling radio bearer RB2 from and including the transmitted response message;
- clear the variable PDCP_SN_INFO;
- if the CELL UPDATE CONFIRM / URA UPDATE CONFIRM message contained the IE "Ciphering mode info":
 - set the IE "Reconfiguration" in the variable CIPHERING_STATUS to FALSE; and

- clear the variable RB_UPLINK_CIPHERING_ACTIVATION_TIME_INFO;
- if the CELL UPDATE CONFIRM / URA UPDATE CONFIRM message contained the IE "Integrity protection mode info":
 - set the IE "Reconfiguration" in the variable INTEGRITY_PROTECTION_INFO to FALSE; and
 - clear the variable INTEGRITY_PROTECTION_ACTIVATION_INFO;
- in case of a cell update procedure:
 - clear the entry for the CELL UPDATE CONFIRM message in the table "Rejected transactions" in the variable TRANSACTIONS;
- in case of a URA update procedure:
 - clear the entry for the URA UPDATE CONFIRM message in the table "Rejected transactions" in the variable TRANSACTIONS;

The procedure ends.

8.3.1.7 Transmission of a response message to UTRAN

If the CELL UPDATE CONFIRM message

- includes the IE "RB information to release list":

the UE shall:

- transmit a RADIO BEARER RELEASE COMPLETE as response message using AM RLC.

If the CELL UPDATE CONFIRM message

- does not include the IE "RB information to release list"; and
- includes the IE "RB information to reconfigure list "; or
- includes the IE "RB information to be affected list ":

the UE shall:

- transmit a RADIO BEARER RECONFIGURATION COMPLETE as response message using AM RLC.

If the CELL UPDATE CONFIRM message

- does not include "RB information elements"; and
- includes "Transport channel information elements":

the UE shall:

- transmit a TRANSPORT CHANNEL RECONFIGURATION COMPLETE as response message using AM RLC.

If the CELL UPDATE CONFIRM message

- does not include "RB information elements"; and
- does not include "Transport channel information elements"; and
- includes "Physical channel information elements":

the UE shall:

- transmit a PHYSICAL CHANNEL RECONFIGURATION COMPLETE as response message using AM RLC.

If the CELL UPDATE CONFIRM message

- does not include "RB information elements"; and
- does not include "Transport channel information elements"; and
- does not include "Physical channel information elements"; and
- includes "CN information elements"; or
- includes the IE "Ciphering mode info"; or
- includes the IE "Integrity protection mode info"; or
- includes the IE "New C-RNTI"; or
- includes the IE "New U-RNTI":

the UE shall:

- transmit a UTRAN MOBILITY INFORMATION CONFIRM as response message using AM RLC.

If the CELL UPDATE CONFIRM message

- does not include "RB information elements"; and
- does not include "Transport channel information elements"; and
- does not include "Physical channel information elements"; and
- does not include "CN information elements"; and
- does not include the IE "Ciphering mode info"; and
- does not include the IE "Integrity protection mode info"; and
- does not include the IE "New C-RNTI"; and
- does not include the IE "New U-RNTI":

the UE shall:

- transmit no response message.

If the URA UPDATE CONFIRM message

- includes "CN information elements"; or
- includes the IE "Ciphering mode info"; or
- includes the IE "Integrity protection mode info"; or
- includes any one or both of the IEs "New C-RNTI" and "New U-RNTI":

the UE shall:

- transmit a UTRAN MOBILITY INFORMATION CONFIRM as response message using AM RLC.

If the URA UPDATE CONFIRM message

- does not include "CN information elements"; and
- does not include the IE "Ciphering mode info"; and
- does not include the IE "Integrity protection mode info"; and
- does not include the IE "New U-RNTI"; and
- does not include the IE "New C-RNTI":

the UE shall:

- transmit no response message.

If the new state is CELL_DCH or CELL_FACH, the response message shall be transmitted using the new configuration after the state transition., and the UE shall:

- if the variable PDCP_SN_INFO is empty:
 - if the CELL UPDATE CONFIRM or URA UPDATE CONFIRM message contained the IE "Ciphering mode info":
 - when RLC has confirmed the successful transmission of the response message:
 - continue with the remainder of the procedure;
 - if the CELL UPDATE CONFIRM or URA UPDATE CONFIRM message did not contain the IE "Ciphering mode info":
 - when RLC has been requested to transmit the response message,
 - continue with the remainder of the procedure;
 - if the variable PDCP_SN_INFO non-empty:
 - when RLC has confirmed the successful transmission of the response message:
 - for each radio bearer in the variable PDCP_SN_INFO:
 - if the IE "RB started" in the variable ESTABLISHED_RABS is set to "started":
 - configure the RLC entity for that radio bearer to "continue";
 - continue with the remainder of the procedure;

If the new state is CELL_PCH or URA_PCH, the response message shall be transmitted in CELL_FACH state, and the UE shall:

- when RLC has confirmed the successful transmission of the response message:
 - for each radio bearer in the variable PDCP_SN_INFO:
 - if the IE "RB started" in the variable ESTABLISHED_RABS is set to "started":
 - configure the RLC entity for that radio bearer to "continue";
 - enter the new state (CELL_PCH or URA_PCH, respectively);
- continue with the remainder of the procedure.

8.3.1.7a Physical channel failure

If the received CELL UPDATE CONFIRM or URA UPDATE CONFIRM message would cause the UE to transit to CELL_DCH state; and

- in case of a received CELL UPDATE CONFIRM message:
 - if the UE failed to establish the physical channel(s) indicated in the received CELL UPDATE CONFIRM message according to the criteria defined in subclause 8.5.4 are not fulfilled; or
 - the received CELL UPDATE CONFIRM message does not contain dedicated physical channels;
- in case of the UE received a URA UPDATE CONFIRM message:

the UE shall:

- if, caused by the received CELL UPDATE CONFIRM or URA UPDATE CONFIRM message
 - the IE "Reconfiguration" in the variable CIPHERING_STATUS is set to TRUE; and/or

- the IE "Reconfiguration" in the variable INTEGRITY_PROTECTION_INFO is set to TRUE:
 - abort the ongoing integrity and/or ciphering reconfiguration;
 - if the received CELL UPDATE CONFIRM or URA UPDATE CONFIRM message contained the IE "Ciphering mode info":
 - set the IE "Reconfiguration" in the variable CIPHERING_STATUS to FALSE; and
 - clear the variable RB_UPLINK_CIPHERING_ACTIVATION_TIME_INFO;
 - if the received CELL UPDATE CONFIRM or URA UPDATE CONFIRM message contained the IE "Integrity protection mode info":
 - set the IE "Reconfiguration" in the variable INTEGRITY_PROTECTION_INFO to FALSE; and
 - clear the variable INTEGRITY_PROTECTION_ACTIVATION_INFO;
- if V302 is equal to or smaller than N302:
 - in case of a URA update procedure:
 - stop the URA update procedure; and
 - continue with a cell update procedure;
 - select a suitable UTRA cell according to [4];
 - set the contents of the CELL UPDATE message according to subclause 8.3.1.3, except for the IE "Cell update cause" which shall be set to "Radio link failure";
 - submit the CELL UPDATE message for transmission on the uplink CCCH;
 - increment counter V302;
 - restart timer T302 when the MAC layer indicates success or failure to transmit the message;
- if V302 is greater than N302:
 - clear the variable RB_UPLINK_CIPHERING_ACTIVATION_TIME_INFO;
 - clear the variable INTEGRITY_PROTECTION_ACTIVATION_INFO;
 - in case of a cell update procedure:
 - clear the entry for the CELL UPDATE CONFIRM message in the table "Rejected transactions" in the variable TRANSACTIONS;
 - in case of a URA update procedure:
 - clear the entry for the URA UPDATE CONFIRM message in the table "Rejected transactions" in the variable TRANSACTIONS;
 - release all its radio resources;
 - indicate release (abort) of the established signalling connections (as stored in the variable ESTABLISHED_SIGNALLING_CONNECTIONS) and established radio access bearers (as stored in the variable ESTABLISHED_RABS) to upper layers;
 - clear the variable ESTABLISHED_SIGNALLING_CONNECTIONS;
 - clear the variable ESTABLISHED_RABS;
 - enter idle mode.

8.3.1.8 Unsupported configuration by the UE

If the UE does not support the configuration in the CELL UPDATE CONFIRM message and/or the variable UNSUPPORTED_CONFIGURATION is set to TRUE, the UE shall:

- if V302 is equal to or smaller than N302, the UE shall:
 - if, caused by the received CELL UPDATE CONFIRM or URA UPDATE CONFIRM message
 - the IE "Reconfiguration" in the variable CIPHERING_STATUS is set to TRUE; and/or
 - the IE "Reconfiguration" in the variable INTEGRITY_PROTECTION_INFO is set to TRUE:
 - abort the ongoing integrity and/or ciphering reconfiguration;
 - if the received CELL UPDATE CONFIRM or URA UPDATE CONFIRM message contained the IE "Ciphering mode info":
 - set the IE "Reconfiguration" in the variable CIPHERING_STATUS to FALSE; and
 - clear the variable RB_UPLINK_CIPHERING_ACTIVATION_TIME_INFO;
 - if the received CELL UPDATE CONFIRM or URA UPDATE CONFIRM message contained the IE "Integrity protection mode info":
 - set the IE "Reconfiguration" in the variable INTEGRITY_PROTECTION_INFO to FALSE; and
 - clear the variable INTEGRITY_PROTECTION_ACTIVATION_INFO;
 - set the variable FAILURE_INDICATOR to TRUE;
 - set the variable FAILURE_CAUSE to "Unsupported configuration";
 - set the content of the CELL UPDATE message according to subclause 8.3.1.3;
 - submit the CELL UPDATE message for transmission on the uplink CCCH;
 - increment counter V302;
 - restart timer T302 when the MAC layer indicates success or failure to transmit the message;
- if V302 is greater than N302, the UE shall:
 - clear the variable RB_UPLINK_CIPHERING_ACTIVATION_TIME_INFO;
 - clear the variable INTEGRITY_PROTECTION_ACTIVATION_INFO;
 - clear the variable PDCP_SN_INFO;
 - clear the entry for the CELL UPDATE CONFIRM message in the table "Rejected transactions" in the variable TRANSACTIONS;
 - release all its radio resources;
 - indicate release (abort) of the established signalling connections (as stored in the variable ESTABLISHED_SIGNALLING_CONNECTIONS) and established radio access bearers (as stored in the variable ESTABLISHED_RABS) to upper layers;
 - clear the variable ESTABLISHED_SIGNALLING_CONNECTIONS;
 - clear the variable ESTABLISHED_RABS;
 - enter idle mode;
 - Other actions the UE shall perform when entering idle mode from connected mode are specified in subclause 8.5.2;
 - and the procedure ends.

8.3.1.9 Invalid configuration

If the variable INVALID_CONFIGURATION is set to TRUE, the UE shall:

- if V302 is equal to or smaller than N302:
 - if, caused by the received CELL UPDATE CONFIRM or URA UPDATE CONFIRM message
 - the IE "Reconfiguration" in the variable CIPHERING_STATUS is set to TRUE; and/or
 - the IE "Reconfiguration" in the variable INTEGRITY_PROTECTION_INFO is set to TRUE:
 - abort the ongoing integrity and/or ciphering reconfiguration;
 - if the received CELL UPDATE CONFIRM or URA UPDATE CONFIRM message contained the IE "Ciphering mode info":
 - set the IE "Reconfiguration" in the variable CIPHERING_STATUS to FALSE; and
 - clear the variable RB_UPLINK_CIPHERING_ACTIVATION_TIME_INFO;
 - if the received CELL UPDATE CONFIRM or URA UPDATE CONFIRM message contained the IE "Integrity protection mode info":
 - set the IE "Reconfiguration" in the variable INTEGRITY_PROTECTION_INFO to FALSE; and
 - clear the variable INTEGRITY_PROTECTION_ACTIVATION_INFO;
 - in case of a cell update procedure:
 - set the variable FAILURE_INDICATOR to TRUE;
 - set the variable FAILURE_CAUSE to "Invalid configuration";
 - set the contents of the CELL UPDATE message according to subclause 8.3.1.3;
 - submit the CELL UPDATE message for transmission on the uplink CCCH;
 - in case of a URA update procedure:
 - set the contents of the URA UPDATE message according to subclause 8.3.1.3;
 - submit the URA UPDATE message for transmission on the uplink CCCH;
 - increment counter V302;
 - restart timer T302 when the MAC layer indicates success or failure to transmit the message;
- if V302 is greater than N302:
 - clear the variable RB_UPLINK_CIPHERING_ACTIVATION_TIME_INFO;
 - clear the variable INTEGRITY_PROTECTION_ACTIVATION_INFO;
 - clear the variable PDCP_SN_INFO;
 - clear the entry for the CELL UPDATE CONFIRM message in the table "Rejected transactions" in the variable TRANSACTIONS;
 - release all its radio resources;
 - indicate release (abort) of the established signalling connections (as stored in the variable ESTABLISHED_SIGNALLING_CONNECTIONS) and established radio access bearers (as stored in the variable ESTABLISHED_RABS) to upper layers;
 - clear the variable ESTABLISHED_SIGNALLING_CONNECTIONS;
 - clear the variable ESTABLISHED_RABS;

- enter idle mode;
- Other actions the UE shall perform when entering idle mode from connected mode are specified in subclause 8.5.2;
- the procedure ends.

8.3.1.9a Incompatible simultaneous reconfiguration

In case of a cell update procedure and if the received CELL UPDATE CONFIRM message

- includes "RB information elements"; and/or
- includes "Transport channel information elements"; and/or
- includes "Physical channel information elements"; and
- the variable ORDERED_RECONFIGURATION is set to TRUE because of an ongoing Reconfiguration procedure;

and/or

- if the variable INCOMPATIBLE_SECURITY_RECONFIGURATION becomes set to TRUE of the received CELL UPDATE CONFIRM message:

the UE shall:

- if V302 is equal to or smaller than N302:
 - if, caused by the received CELL UPDATE CONFIRM or URA UPDATE CONFIRM message
 - the IE "Reconfiguration" in the variable CIPHERING_STATUS is set to TRUE; and/or
 - the IE "Reconfiguration" in the variable INTEGRITY_PROTECTION_INFO is set to TRUE:
 - abort the ongoing integrity and/or ciphering reconfiguration;
 - if the received CELL UPDATE CONFIRM or URA UPDATE CONFIRM message contained the IE "Ciphering mode info":
 - set the IE "Reconfiguration" in the variable CIPHERING_STATUS to FALSE; and
 - clear the variable RB_UPLINK_CIPHERING_ACTIVATION_TIME_INFO;
 - if the received CELL UPDATE CONFIRM or URA UPDATE CONFIRM message contained the IE "Integrity protection mode info":
 - set the IE "Reconfiguration" in the variable INTEGRITY_PROTECTION_INFO to FALSE; and
 - clear the variable INTEGRITY_PROTECTION_ACTIVATION_INFO;
 - set the variable FAILURE_INDICATOR to TRUE;
 - set the variable FAILURE_CAUSE to "Incompatible simultaneous reconfiguration";
 - set the content of the CELL UPDATE message according to subclause 8.3.1.3;
 - submit the CELL UPDATE message for transmission on the uplink CCCH;
 - increment counter V302;
 - restart timer T302 when the MAC layer indicates success or failure to transmit the message;
- if V302 is greater than N302:
 - clear the variable RB_UPLINK_CIPHERING_ACTIVATION_TIME_INFO;
 - clear the variable INTEGRITY_PROTECTION_ACTIVATION_INFO;

- clear the variable PDCP_SN_INFO;
- set the variable INCOMPATIBLE_SECURITY_RECONFIGURATION to FALSE;
- clear the entry for the CELL UPDATE CONFIRM message in the table "Rejected transactions" in the variable TRANSACTIONS;
- release all its radio resources;
- indicate release (abort) of the established signalling connections (as stored in the variable ESTABLISHED_SIGNALLING_CONNECTIONS) and established radio access bearers (as stored in the variable ESTABLISHED_RABS) to upper layers;
- clear the variable ESTABLISHED_SIGNALLING_CONNECTIONS;
- clear the variable ESTABLISHED_RABS;
- enter idle mode;
- Other actions the UE shall perform when entering idle mode from connected mode are specified in subclause 8.5.2;
- the procedure ends.

8.3.1.10 Confirmation error of URA ID list

If the URA UPDATE CONFIRM message causes a confirmation error of URA identity list as specified in subclause 8.6.2.1 the UE shall:

- check the value of V302; and
- if V302 is smaller or equal than N302:
 - if, caused by the received CELL UPDATE CONFIRM or URA UPDATE CONFIRM message
 - the IE "Reconfiguration" in the variable CIPHERING_STATUS is set to TRUE; and/or
 - the IE "Reconfiguration" in the variable INTEGRITY_PROTECTION_INFO is set to TRUE:
 - abort the ongoing integrity and/or ciphering reconfiguration;
 - if the received CELL UPDATE CONFIRM or URA UPDATE CONFIRM message contained the IE "Ciphering mode info":
 - set the IE "Reconfiguration" in the variable CIPHERING_STATUS to FALSE; and
 - clear the variable RB_UPLINK_CIPHERING_ACTIVATION_TIME_INFO;
 - if the received CELL UPDATE CONFIRM or URA UPDATE CONFIRM message contained the IE "Integrity protection mode info"
 - set the IE "Reconfiguration" in the variable INTEGRITY_PROTECTION_INFO to FALSE; and
 - clear the variable INTEGRITY_PROTECTION_ACTIVATION_INFO;
- set the IEs in the URA UPDATE message according to subclause 8.3.1.3;
- submit the URA UPDATE message for transmission on the uplink CCCH;
- increment counter V302;
- restart timer T302 when the MAC layer indicates success or failure to transmit the message;
- if V302 is greater than N302:
 - release all its radio resources;

- clear the variable RB_UPLINK_CIPHERING_ACTIVATION_TIME_INFO;
- clear the variable INTEGRITY_PROTECTION_ACTIVATION_INFO;
- clear the variable PDCP_SN_INFO;
- indicate release (abort) of the established signalling connections (as stored in the variable ESTABLISHED_SIGNALLING_CONNECTIONS) and established radio access bearers (as stored in the variable ESTABLISHED_RABS) to upper layers;
- clear the variable ESTABLISHED_SIGNALLING_CONNECTIONS;
- clear the variable ESTABLISHED_RABS;
- enter idle mode;
- perform the actions specified in subclause 8.5.2 when entering idle mode from connected mode;
- the procedure ends.

8.3.1.11 Invalid CELL UPDATE CONFIRM/URA UPDATE CONFIRM message

If the UE receives an CELL UPDATE CONFIRM/URA UPDATE CONFIRM message, which contains a protocol error causing the variable PROTOCOL_ERROR_REJECT to be set to TRUE according to clause 9, the UE shall perform procedure specific error handling as follows:

- If V302 is equal to or smaller than N302, the UE shall:
 - set the variable PROTOCOL_ERROR_INDICATOR to TRUE;
 - in case of a cell update procedure:
 - set the contents of the CELL UPDATE message according to subclause 8.3.1.3;
 - submit the CELL UPDATE message for transmission on the uplink CCCH;
 - in case of a URA update procedure:
 - set the contents of the URA UPDATE message according to subclause 8.3.1.3;
 - submit the URA UPDATE message for transmission on the uplink CCCH;
 - increment counter V302;
 - restart timer T302 when the MAC layer indicates success or failure to transmit the message;
- if V302 is greater than N302, the UE shall:
 - clear the variable RB_UPLINK_CIPHERING_ACTIVATION_TIME_INFO;
 - in case of a cell update procedure:
 - clear the entry for the CELL UPDATE CONFIRM message in the table "Rejected transactions" in the variable TRANSACTIONS;
 - in case of a URA update procedure:
 - clear the entry for the URA UPDATE CONFIRM message in the table "Rejected transactions" in the variable TRANSACTIONS;
 - indicate release (abort) of the established signalling connections (as stored in the variable ESTABLISHED_SIGNALLING_CONNECTIONS) and established radio access bearers (as stored in the variable ESTABLISHED_RABS) to upper layers;
 - clear the variable ESTABLISHED_SIGNALLING_CONNECTIONS;
 - clear the variable ESTABLISHED_RABS;

- release all its radio resources;
- enter idle mode;
- Other actions the UE shall perform when entering idle mode from connected mode are specified in subclause 8.5.2;
- the procedure ends.

8.3.1.12 T302 expiry or cell reselection

If any or several of the following conditions are true:

- expiry of timer T302;
- reselection to another UTRA cell (including the previously serving cell) before completion of the cell update or URA update procedure;

the UE shall:

- stop T302 if it is running;
- if the UE was in CELL_DCH state prior to the initiation of the procedure; and
 - if timers T314 and T315 have elapsed while T302 was running:
 - enter idle mode.
 - indicate release (abort) of the established signalling connections (as stored in the variable ESTABLISHED_SIGNALLING_CONNECTIONS) and established radio access bearers (as stored in the variable ESTABLISHED_RABS) to upper layers. Other actions the UE shall perform when entering idle mode from connected mode are specified in subclause 8.5.2.
 - and the procedure ends.
 - if timer T314 has elapsed while T302 was running and,
 - if "T314 expired" in the variable RB_TIMER_INDICATOR is set to FALSE and
 - if T315 is still running:
 - release locally all radio bearers which are associated with any radio access bearers for which in the variable ESTABLISHED_RABS the value of the IE "Re-establishment timer" is set to "useT314";
 - indicate release of those radio access bearers to upper layers;
 - delete all information about those radio access bearers from the variable ESTABLISHED_RABS;
 - set "T314 expired" in the variable RB_TIMER_INDICATOR to TRUE;
 - if timer T315 has elapsed while T302 was running and,
 - if "T315 expired" in the variable RB_TIMER_INDICATOR is set to FALSE and,
 - if T314 is still running:
 - release locally all radio bearers which are associated with any radio access bearers for which in the variable ESTABLISHED_RABS the value of the IE "Re-establishment timer" is set to "useT315";
 - indicate release of those radio access bearers to upper layers;
 - delete all information about those radio access bearers from the variable ESTABLISHED_RABS;
 - set "T315 expired" in the variable RB_TIMER_INDICATOR to TRUE;
- check whether it is still in "in service area" (see subclause 8.5.5.2);

- if, caused by the received CELL UPDATE CONFIRM or URA UPDATE CONFIRM message the IE "Reconfiguration" in the variable CIPHERING_STATUS is set to TRUE and/or the IE "Reconfiguration" in the variable INTEGRITY_PROTECTION_INFO is set to TRUE:
 - abort the ongoing integrity and/or ciphering reconfiguration;
 - if the received CELL UPDATE CONFIRM or URA UPDATE CONFIRM message contained the IE "Ciphering mode info":
 - set the IE "Reconfiguration" in the variable CIPHERING_STATUS to FALSE; and
 - clear the variable RB_UPLINK_CIPHERING_ACTIVATION_TIME_INFO;
 - if the received CELL UPDATE CONFIRM or URA UPDATE CONFIRM message contained the IE "Integrity protection mode info":
 - set the IE "Reconfiguration" in the variable INTEGRITY_PROTECTION_INFO to FALSE; and
 - clear the variable INTEGRITY_PROTECTION_ACTIVATION_INFO;
- in case of a cell update procedure:
 - clear any entry for the CELL UPDATE CONFIRM message in the table "Accepted transactions" in the variable TRANSACTIONS;
- in case of a URA update procedure:
 - clear any entry for the URA UPDATE CONFIRM message in the table "Accepted transactions" in the variable TRANSACTIONS;

If the UE detects "in service area" if it has not entered idle mode, and:

- if V302 is equal to or smaller than N302, the UE shall:
 - if the UE performed cell re-selection:
 - delete its C-RNTI;
 - in case of a cell update procedure:
 - set the contents of the CELL UPDATE message according to subclause 8.3.1.3;
 - submit the CELL UPDATE message for transmission on the uplink CCCH;
 - in case of a URA update procedure:
 - set the contents of the URA UPDATE message according to subclause 8.3.1.3;
 - submit the URA UPDATE message for transmission on the uplink CCCH;
 - increment counter V302;
 - restart timer T302 when the MAC layer indicates success or failure to transmit the message;
- if V302 is greater than N302, the UE shall:
 - clear the variable RB_UPLINK_CIPHERING_ACTIVATION_TIME_INFO;
 - clear the variable INTEGRITY_PROTECTION_ACTIVATION_INFO;
 - clear the variable PDCP_SN_INFO;
 - in case of a cell update procedure:
 - clear the entry for the CELL UPDATE CONFIRM message in the table "Rejected transactions" in the variable TRANSACTIONS;
 - in case of a URA update procedure:

- clear the entry for the URA UPDATE CONFIRM message in the table "Rejected transactions" in the variable TRANSACTIONS;
- release all its radio resources;
- indicate release (abort) of the established signalling connections (as stored in the variable ESTABLISHED_SIGNALLING_CONNECTIONS) and established radio access bearers (as stored in the variable ESTABLISHED_RABS) to upper layers;
- clear the variable ESTABLISHED_SIGNALLING_CONNECTIONS;
- clear the variable ESTABLISHED_RABS;
- enter idle mode;
- other actions the UE shall perform when entering idle mode from connected mode are specified in subclause 8.5.2;
- and the procedure ends.

If the UE does not detect "in service area", it shall:

- continue searching for "in service area".

8.3.1.13 T314 expiry

Upon expiry of timer T314 the UE shall:

- if timer T302 is running:
 - continue awaiting response message from UTRAN;
- if timer T302 is not running and timer T315 is running:
 - set IE "T314 expired" in variable RB_TIMER_INDICATOR to TRUE;
 - release locally all radio bearers which are associated with any radio access bearers for which in the variable ESTABLISHED_RABS the value of the IE "Re-establishment timer" is set to "useT314";
 - indicate release of those radio access bearers to upper layers;
 - delete all information about those radio access bearers from the variable ESTABLISHED_RABS;
- if timers T302 and T315 are not running:
 - clear the variable RB_UPLINK_CIPHERING_ACTIVATION_TIME_INFO;
 - clear the variable INTEGRITY_PROTECTION_ACTIVATION_INFO;
 - clear the variable PDCP_SN_INFO;
 - clear the entry for the CELL UPDATE CONFIRM message in the table "Rejected transactions" in the variable TRANSACTIONS;
 - release all its radio resources;
 - indicate release (abort) of the established signalling connections (as stored in the variable ESTABLISHED_SIGNALLING_CONNECTIONS) and established radio access bearers (as stored in the variable ESTABLISHED_RABS) to upper layers;
 - clear the variable ESTABLISHED_SIGNALLING_CONNECTIONS;
 - clear the variable ESTABLISHED_RABS;
 - enter idle mode;

- other actions the UE shall perform when entering idle mode from connected mode are specified in subclause 8.5.2;
- and the procedure ends.

8.3.1.14 T315 expiry

Upon expiry of timer T315 the UE shall:

- if timer T302 is running:
 - continue awaiting response message from UTRAN;
- if timer T302 is not running and timer T314 is running:
 - set IE "T315 expired" in variable RB_TIMER_INDICATOR to TRUE;
 - release locally all radio bearers which are associated with any radio access bearers for which in the variable ESTABLISHED_RABS the value of the IE "Re-establishment timer" is set to "use T315";
 - indicate release of those radio access bearers to upper layers;
 - delete all information about those radio access bearers from the variable ESTABLISHED_RABS;
- if timers T302 and T314 are not running:
 - clear the variable RB_UPLINK_CIPHERING_ACTIVATION_TIME_INFO;
 - clear the variable INTEGRITY_PROTECTION_ACTIVATION_INFO;
 - clear the variable PDCP_SN_INFO;
 - clear the entry for the CELL UPDATE CONFIRM message in the table "Rejected transactions" in the variable TRANSACTIONS;
 - release all its radio resources;
 - indicate release (abort) of the established signalling connections (as stored in the variable ESTABLISHED_SIGNALLING_CONNECTIONS) and established radio access bearers (as stored in the variable ESTABLISHED_RABS) to upper layers;
 - clear the variable ESTABLISHED_SIGNALLING_CONNECTIONS;
 - clear the variable ESTABLISHED_RABS;
 - enter idle mode;
 - other actions the UE shall perform when entering idle mode from connected mode are specified in subclause 8.5.2;
 - and the procedure ends.

8.3.1.15 Reception of the UTRAN MOBILITY INFORMATION CONFIRM message by the UTRAN

See subclause 8.3.3.4.

8.3.2 URA update

See subclause 8.3.1.

8.3.3 UTRAN mobility information

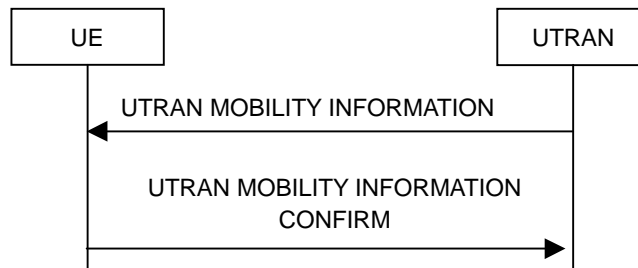

Figure 48: UTRAN mobility information procedure, normal flow

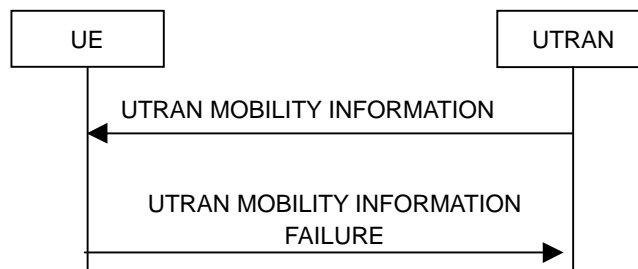

Figure 49: UTRAN mobility information procedure, failure case

8.3.3.1 General

The purpose of this procedure is to allocate any one or a combination of the following to a UE in connected mode:

- a new C-RNTI;
- a new U-RNTI;
- other mobility related information.

8.3.3.2 Initiation

To initiate the procedure UTRAN transmits a UTRAN MOBILITY INFORMATION message to the UE on the downlink DCCH.

8.3.3.3 Reception of UTRAN MOBILITY INFORMATION message by the UE

When the UE receives a UTRAN MOBILITY INFORMATION message, it shall:

- act on received information elements as specified in subclause 8.6;
- if the IE "UE Timers and constants in connected mode" is present:
 - store the values of the IE "UE Timers and constants in connected mode" in the variable TIMERS_AND_CONSTANTS, replacing any previously stored value for each timer and constant; and
 - for each updated timer value:
 - start using the new value next time the timer is started;
 - for each updated constant value:
 - start using the new value directly;
- set the IE "RRC transaction identifier" in the UTRAN MOBILITY INFORMATION CONFIRM message to the value of "RRC transaction identifier" in the entry for the UTRAN MOBILITY INFORMATION message in the table "Accepted transactions" in the variable TRANSACTIONS; and

- clear that entry;
- if the UTRAN MOBILITY INFORMATION message contained the IE "Ciphering mode info":
 - include and set the IE "Radio bearer uplink ciphering activation time info" to the value of the variable RB_UPLINK_CIPHERING_ACTIVATION_TIME_INFO;
- if the UTRAN MOBILITY INFORMATION message contained the IE "Integrity protection mode info" with the IE "Integrity protection mode command" set to "Modify":
 - include and set the IE "Integrity protection activation info" to the value of the variable INTEGRITY_PROTECTION_ACTIVATION_INFO;
- if the variable PDCP_SN_INFO is non-empty:
 - include the IE "RB with PDCP information list" in the UTRAN MOBILITY INFORMATION CONFIRM message and set it to the value of the variable PDCP_SN_INFO;
- if the received UTRAN MOBILITY INFORMATION message included the IE "Downlink counter synchronisation info":
 - calculate the START value according to subclause 8.5.9;
 - include the calculated START values for each CN domain in the IE "START list" in the IE "Uplink counter synchronisation info" in the UTRAN MOBILITY INFORMATION CONFIRM message;
- transmit a UTRAN MOBILITY INFORMATION CONFIRM message on the uplink DCCH using AM RLC;
- if the IE "Integrity protection mode info" was present in the UTRAN MOBILITY INFORMATION message:
 - start applying the new integrity protection configuration in the uplink for signalling radio bearer RB2 from and including the transmitted UTRAN MOBILITY INFORMATION CONFIRM message;
- if the variable PDCP_SN_INFO is empty; and
 - if the UTRAN MOBILITY INFORMATION message contained the IE "Ciphering mode info":
 - when RLC has confirmed the successful transmission of the UTRAN MOBILITY INFORMATION CONFIRM message, perform the actions below;
 - if the UTRAN MOBILITY INFORMATION message did not contain the IE "Ciphering mode info":
 - when RLC has been requested to transmit the UTRAN MOBILITY INFORMATION CONFIRM message, perform the actions below;
- if the variable PDCP_SN_INFO is non-empty:
 - when RLC has confirmed the successful transmission of the UTRAN MOBILITY INFORMATION CONFIRM message:
 - for each radio bearer in the variable PDCP_SN_INFO:
 - if the IE "RB started" in the variable ESTABLISHED_RABS is set to "started":
 - configure the RLC entity for that radio bearer to "continue";
 - clear the variable PDCP_SN_INFO;
- if the UTRAN MOBILITY INFORMATION message contained the IE "Ciphering mode info":
 - set the IE "Reconfiguration" in the variable CIPHERING_STATUS to FALSE; and
 - clear the variable RB_UPLINK_CIPHERING_ACTIVATION_TIME_INFO;
- if the UTRAN MOBILITY INFORMATION message contained the IE "Integrity protection mode info":
 - set the IE "Reconfiguration" in the variable INTEGRITY_PROTECTION_INFO to FALSE; and

- clear the variable INTEGRITY_PROTECTION_ACTIVATION_INFO;

The procedure ends.

8.3.3.4 Reception of an UTRAN MOBILITY INFORMATION CONFIRM message by the UTRAN

When the network receives UTRAN MOBILITY INFORMATION CONFIRM message, UTRAN may delete any old U-RNTI. The procedure ends.

8.3.3.5 Cell re-selection

If the UE performs cell re-selection, the UE shall:

- initiate a cell update procedure according to subclause 8.3.1;
- if the UTRAN MOBILITY INFORMATION message contains the IE "New C-RNTI"; and
- if the UE has not yet submitted the UTRAN MOBILITY INFORMATION CONFIRM message to lower layers for transmission;
 - transmit a UTRAN MOBILITY INFORMATION FAILURE message on the uplink DCCH using AM RLC;
 - set the IE "RRC transaction identifier" in the UTRAN MOBILITY INFORMATION FAILURE message to the value of "RRC transaction identifier" in the entry for the UTRAN MOBILITY INFORMATION message in the table "Accepted transactions" in the variable TRANSACTIONS; and
 - clear that entry.
 - set the IE "failure cause" to the cause value "cell update occurred";
 - when the UTRAN MOBILITY INFORMATION FAILURE message has been submitted to lower layers for transmission:
 - continue with any ongoing processes and procedures as if the invalid UTRAN MOBILITY INFORMATION message has not been received and the procedure ends.
- otherwise:
 - continue the procedure normally.

8.3.3.5a Incompatible simultaneous security reconfiguration

If the variable INCOMPATIBLE_SECURITY_RECONFIGURATION becomes set to TRUE of the received UTRAN MOBILITY INFORMATION message, the UE shall:

- transmit a UTRAN MOBILITY INFORMATION FAILURE message on the uplink DCCH using AM RLC;
- set the IE "RRC transaction identifier" in the UTRAN MOBILITY INFORMATION FAILURE message to the value of "RRC transaction identifier" in the entry for the UTRAN MOBILITY INFORMATION message in the table "Accepted transactions" in the variable TRANSACTIONS; and
- clear that entry;
- set the IE "failure cause" to the cause value "incompatible simultaneous reconfiguration";
- when the UTRAN MOBILITY INFORMATION FAILURE message has been delivered to lower layers for transmission:
 - set the variable INCOMPATIBLE_SECURITY_RECONFIGURATION to FALSE;
 - continue with any ongoing processes and procedures as if the UTRAN MOBILITY INFORMATION message has not been received;
 - and the procedure ends.

8.3.3.6 Invalid UTRAN MOBILITY INFORMATION message

If the UTRAN MOBILITY INFORMATION message contains a protocol error causing the variable `PROTOCOL_ERROR_REJECT` to be set to `TRUE` according to clause 9, the UE shall perform procedure specific error handling as follows. The UE shall:

- transmit a UTRAN MOBILITY INFORMATION FAILURE message on the uplink DCCH using AM RLC;
- set the IE "RRC transaction identifier" in the UTRAN MOBILITY INFORMATION FAILURE message to the value of "RRC transaction identifier" in the entry for the UTRAN MOBILITY INFORMATION message in the table "Rejected transactions" in the variable `TRANSACTIONS`, and;
- clear that entry.
- set the IE "failure cause" to the cause value "protocol error";
- include the IE "Protocol error information" with contents set to the value of the variable `PROTOCOL_ERROR_INFORMATION`;
- when the UTRAN MOBILITY INFORMATION FAILURE message has been submitted to lower layers for transmission:
 - continue with any ongoing processes and procedures as if the invalid UTRAN MOBILITY INFORMATION message has not been received;
 - and the procedure ends.

8.3.4 Active set update

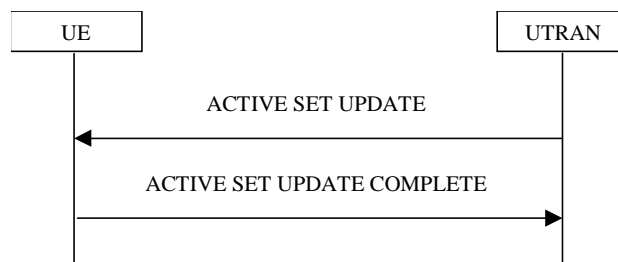

Figure 50: Active Set Update procedure, successful case

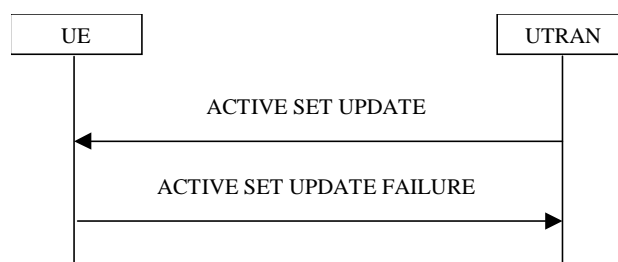

Figure 51: Active Set Update procedure, failure case

8.3.4.1 General

The purpose of the active set update procedure is to update the active set of the connection between the UE and UTRAN. This procedure shall be used in `CELL_DCH` state. The UE should keep on using the old RLs while configuring the new RLs. Also the UE should keep the transmitter turned on during the procedure. This procedure is only used in FDD mode.

8.3.4.2 Initiation

The procedure is initiated when UTRAN orders a UE in CELL_DCH state, to make the following modifications of the active set of the connection:

- a) Radio link addition;
- b) Radio link removal;
- c) Combined radio link addition and removal.

In case a) and c), UTRAN should:

- prepare new additional radio link(s) in the UTRAN prior to the command to the UE.

In all cases, UTRAN should:

- send an ACTIVE SET UPDATE message on downlink DCCH using AM or UM RLC.

UTRAN should include the following information:

- IE "Radio Link Addition Information": Downlink DPCH information and other optional parameters relevant for the radio links to be added along with the IE "Primary CPICH info" used for the reference ID to indicate which radio link to add. This IE is needed in cases a) and c) listed above;
- IE "Radio Link Removal Information": IE "Primary CPICH info" used for the reference ID to indicate which radio link to remove. This IE is needed in cases b) and c) listed above.

8.3.4.3 Reception of an ACTIVE SET UPDATE message by the UE

Upon reception of an ACTIVE SET UPDATE message the UE shall act upon all received information elements as specified in 8.6, unless specified otherwise in the following. The UE shall:

- first add the RLs indicated in the IE "Radio Link Addition Information";
- remove the RLs indicated in the IE "Radio Link Removal Information". If the UE active set is full or becomes full, an RL, which is included in the IE "Radio Link Removal Information" for removal, shall be removed before adding RL, which is included in the IE "Radio Link Addition Information" for addition;
- perform the physical layer synchronisation procedure as specified in [29];
- if the ACTIVE SET UPDATE message contained the IE "Ciphering mode info":
 - include and set the IE "Radio bearer uplink ciphering activation time info" to the value of the variable RB_UPLINK_CIPHERING_ACTIVATION_TIME_INFO;
- if the ACTIVE SET UPDATE message contained the IE "Integrity protection mode info" with the IE "Integrity protection mode command" set to "Modify":
 - include and set the IE "Integrity protection activation info" to the value of the variable INTEGRITY_PROTECTION_ACTIVATION_INFO;
- if the variable PDCP_SN_INFO is non-empty:
 - include the IE "RB with PDCP information list" in the ACTIVE SET UPDATE COMPLETE message; and
 - set it to the value of the variable PDCP_SN_INFO;
- if the ACTIVE SET UPDATE message includes the IE "TFCI combining indicator" associated with a radio link to be added:
 - configure Layer 1 to soft combine TFCI (field 2) of this new link with those links already in the TFCI (field 2) combining set;
- if the received ACTIVE SET UPDATE message included the IE "Downlink counter synchronisation info":
 - calculate the START value according to subclause 8.5.9;

- include the calculated START values for each CN domain in the IE "START list" in the IE "Uplink counter synchronisation info" in the ACTIVE SET UPDATE COMPLETE message;
- set the IE "RRC transaction identifier" in the ACTIVE SET UPDATE COMPLETE message to the value of "RRC transaction identifier" in the entry for the ACTIVE SET UPDATE message in the table "Accepted transactions" in the variable TRANSACTIONS; and
- clear that entry;
- transmit an ACTIVE SET UPDATE COMPLETE message on the uplink DCCH using AM RLC without waiting for the Physical Layer synchronization;
- if the IE "Integrity protection mode info" was present in the ACTIVE SET UPDATE message:
 - start applying the new integrity protection configuration in the uplink for signalling radio bearer RB2 from and including the transmitted ACTIVE SET UPDATE COMPLETE message;
- if the variable PDCP_SN_INFO is empty:
 - if the ACTIVE SET UPDATE message contained the IE "Ciphering mode info":
 - when RLC has confirmed the successful transmission of the ACTIVE SET UPDATE COMPLETE message:
 - perform the actions below;
 - if the ACTIVE SET UPDATE message did not contain the IE "Ciphering mode info":
 - when RLC has been requested to transmit the ACTIVE SET UPDATE COMPLETE message:
 - perform the actions below;
- if the variable PDCP_SN_INFO is non-empty:
 - when RLC has confirmed the successful transmission of the ACTIVE SET UPDATE COMPLETE message:
 - for each radio bearer in the variable PDCP_SN_INFO:
 - if the IE "RB started" in the variable ESTABLISHED_RABS is set to "started":
 - configure the RLC entity for that radio bearer to "continue";
 - clear the variable PDCP_SN_INFO;
- if the ACTIVE SET UPDATE message contained the IE "Ciphering mode info":
 - set the IE "Reconfiguration" in the variable CIPHERING_STATUS to FALSE; and
 - clear the variable RB_UPLINK_CIPHERING_ACTIVATION_TIME_INFO;
- if the ACTIVE SET UPDATE message contained the IE "Integrity protection mode info":
 - set the IE "Reconfiguration" in the variable INTEGRITY_PROTECTION_INFO to FALSE; and
 - clear the variable INTEGRITY_PROTECTION_ACTIVATION_INFO;
- the procedure ends on the UE side.

8.3.4.4 Unsupported configuration in the UE

If UTRAN instructs the UE to use a configuration that it does not support, the UE shall:

- keep the active set as it was before the ACTIVE SET UPDATE message was received;
- transmit an ACTIVE SET UPDATE FAILURE message on the DCCH using AM RLC;

- set the IE "RRC transaction identifier" in the ACTIVE SET UPDATE FAILURE message to the value of "RRC transaction identifier" in the entry for the ACTIVE SET UPDATE message in the table "Accepted transactions" in the variable TRANSACTIONS; and
- clear that entry;
- set the IE "failure cause" to "configuration unsupported";
- when the ACTIVE SET UPDATE FAILURE message has been submitted to lower layers for transmission:
 - the procedure ends on the UE side.

8.3.4.5 Invalid configuration

If any of the following conditions are valid:

- a radio link indicated by the IE "Downlink DPCH info for each RL" in the IE "Radio link addition information" has a different spreading factor than the spreading factor for the radio links in the active set that will be established at the time indicated by the IE "Activation time"; and/or
- a radio link in the IE "Radio link addition information" is also present in the IE "Radio Link Removal Information"; and/or
- the IE "Radio Link Removal Information" contains all the radio links which are part of or will be part of the active set at the time indicated by the IE "Activation time"; and/or
- the variable INVALID_CONFIGURATION is set to TRUE:

the UE shall:

- keep the active set as it was before the ACTIVE SET UPDATE message was received;
- transmit an ACTIVE SET UPDATE FAILURE message on the DCCH using AM RLC;
- set the IE "RRC transaction identifier" in the ACTIVE SET UPDATE FAILURE message to the value of "RRC transaction identifier" in the entry for the ACTIVE SET UPDATE message in the table "Accepted transactions" in the variable TRANSACTIONS; and
- clear that entry;
- set the IE "failure cause" to "Invalid configuration";
- When the ACTIVE SET UPDATE FAILURE message has been submitted to lower layers for transmission:
 - the procedure ends on the UE side.

8.3.4.5a Incompatible simultaneous reconfiguration

If the variable INCOMPATIBLE_SECURITY_RECONFIGURATION becomes set to TRUE due to the received ACTIVE SET UPDATE message, the UE shall:

- transmit a ACTIVE SET UPDATE FAILURE message on the uplink DCCH using AM RLC;
- set the IE "RRC transaction identifier" in the ACTIVE SET UPDATE FAILURE message to the value of "RRC transaction identifier" in the entry for the ACTIVE SET UPDATE message in the table "Accepted transactions" in the variable TRANSACTIONS; and
- clear that entry;
- set the IE "failure cause" to the cause value "incompatible simultaneous reconfiguration";
- when the ACTIVE SET UPDATE FAILURE message has been delivered to lower layers for transmission:
 - set the variable INCOMPATIBLE_SECURITY_RECONFIGURATION to FALSE;

- continue with any ongoing processes and procedures as if the ACTIVE SET UPDATE message has not been received;
- and the procedure ends.

If the variable ORDERED_RECONFIGURATION is set to TRUE; and

- if the activation time for the procedure that has set variable ORDERED_RECONFIGURATION and the activation time for the Active Set Update procedure are within a time window of 5 frames, the UE may:
 - transmit a ACTIVE SET UPDATE FAILURE message on the uplink DCCH using AM RLC;
 - set the IE "RRC transaction identifier" in the ACTIVE SET UPDATE FAILURE message to the value of "RRC transaction identifier" in the entry for the ACTIVE SET UPDATE message in the table "Accepted transactions" in the variable TRANSACTIONS; and
 - clear that entry;
 - set the IE "failure cause" to the cause value "incompatible simultaneous reconfiguration";
- when the ACTIVE SET UPDATE FAILURE message has been delivered to lower layers for transmission:
 - continue with any ongoing processes and procedures as if the ACTIVE SET UPDATE message has not been received;
 - and the procedure ends.

8.3.4.6 Reception of the ACTIVE SET UPDATE COMPLETE message by the UTRAN

When the UTRAN has received the ACTIVE SET UPDATE COMPLETE message,

- the UTRAN may remove radio link(s) that are indicated to remove to the UE in case b) and c); and
- the procedure ends on the UTRAN side.

8.3.4.7 Reception of the ACTIVE SET UPDATE FAILURE message by the UTRAN

When the UTRAN has received the ACTIVE SET UPDATE FAILURE message, the UTRAN may delete radio links that were included in the IE "Radio Link Addition Information" for addition. The procedure ends on the UTRAN side.

8.3.4.8 Invalid ACTIVE SET UPDATE message

If the ACTIVE SET UPDATE message contains a protocol error causing the variable PROTOCOL_ERROR_REJECT to be set to TRUE according to clause 9, the UE shall perform procedure specific error handling as follows. The UE shall:

- transmit a ACTIVE SET UPDATE FAILURE message on the uplink DCCH using AM RLC;
- set the IE "RRC transaction identifier" in the ACTIVE SET UPDATE FAILURE message to the value of "RRC transaction identifier" in the entry for the ACTIVE SET UPDATE message in the table "Rejected transactions" in the variable TRANSACTIONS; and
- clear that entry;
- set the IE "failure cause" to the cause value "protocol error";
- include the IE "Protocol error information" with contents set to the value of the variable PROTOCOL_ERROR_INFORMATION;
- when the ACTIVE SET UPDATE FAILURE message has been delivered to lower layers for transmission:
 - continue with any ongoing processes and procedures as if the invalid ACTIVE SET UPDATE message has not been received;

- and the procedure ends.

8.3.4.9 Reception of an ACTIVE SET UPDATE message in wrong state

If the UE is in another state than CELL_DCH state upon reception of the ACTIVE SET UPDATE message, the UE shall perform procedure specific error handling as follows. The UE shall:

- transmit a ACTIVE SET UPDATE FAILURE message on the uplink DCCH using AM RLC;
- set the IE "RRC transaction identifier" in the ACTIVE SET UPDATE FAILURE message to the value of "RRC transaction identifier" in the entry for the ACTIVE SET UPDATE message in the table "Accepted transactions" in the variable TRANSACTIONS; and
- clear that entry;
- set the IE "failure cause" to the cause value "protocol error";
- include the IE "Protocol error information" with the IE "Protocol error cause" set to "Message not compatible with receiver state";
- when the ACTIVE SET UPDATE FAILURE message has been delivered to lower layers for transmission:
 - continue with any ongoing processes and procedures as if the ACTIVE SET UPDATE message has not been received;
 - and the procedure ends.

8.3.5 Hard handover

8.3.5.1 Timing re-initialised hard handover

8.3.5.1.1 General

The purpose of the timing re-initialised hard handover procedure is to remove all the RL(s) in the active set and establish new RL(s) along with a change in the UL transmission timing and the CFN in the UE according to the SFN of the target cell.(see subclause 8.5.15).

This procedure is initiated when UTRAN does not know the target SFN timing before hard handover.

8.3.5.1.2 Initiation

Timing re-initialised hard handover initiated by the UTRAN is normally performed by using the procedure "Physical channel reconfiguration" (subclause 8.2.6), but may also be performed by using either one of the following procedures:

- "radio bearer establishment" (subclause 8.2.1);
- "Radio bearer reconfiguration" (subclause 8.2.2);
- "Radio bearer release" (subclause 8.2.3); or
- "Transport channel reconfiguration" (subclause 8.2.4).

If IE "Timing indication" has the value "initialise", UE shall:

- execute the Timing Re-initialised hard handover procedure by following the procedure indicated in the subclause relevant to the procedure chosen by the UTRAN.

If the IE "Default DPCH Offset Value" is included:

- UTRAN should:
 - set "Default DPCH Offset Value" and "DPCH frame offset" respecting the following relation

$$(\text{Default DPCH Offset Value}) \bmod 38400 = \text{DPCH frame offset}$$

- where j indicates the first radio link listed in the message and the IE values used are the Actual Values of the IEs as defined in clause 11;
- The UE shall:
 - if the UE receives a message where the above relation between "Default DPCH Offset Value" and "DPCH frame offset" is not respected:
 - set the variable INVALID_CONFIGURATION to true.

If the IE "Default DPCH Offset Value" is not included:

- The UE shall:
 - use the previously received value stored in variable DOFF. If there is no previously received value stored in DOFF, the UE should use the value 0.
- UTRAN should:
 - set "DPCH frame offset" respecting the following relation
 - if UTRAN has previously sent Default DPCH Offset Value to the UE
 - (previously sent Default DPCH Offset Value) mod 38400 = DPCH frame offset _{j}
 - where j indicates the first radio link listed in the message and the IE values used are the Actual Values of the IEs as defined in clause 11.
 - if UTRAN has not previously sent Default DPCH Offset Value to the UE
 - DPCH frame offset _{j} = 0
 - where j indicates the first radio link listed in the message
- The UE shall:
 - if the UE receives a message where the above relations are not respected:
 - set the variable INVALID_CONFIGURATION to true.

8.3.5.2 Timing-maintained hard handover

8.3.5.2.1 General

The purpose of the Timing-maintained hard handover procedure is to remove all the RL(s) in the active set and establish new RL(s) while maintaining the UL transmission timing and the CFN in the UE.

This procedure can be initiated only if UTRAN knows the target SFN timing before hard handover. The target SFN timing can be known by UTRAN in the following 2 cases:

- UE reads SFN when measuring "Cell synchronisation information" and sends it to the UTRAN in MEASUREMENT REPORT message.
- UTRAN internally knows the time difference between the cells.

8.3.5.2.2 Initiation

Timing-maintained hard handover initiated by the network is normally performed by using the procedure "Physical channel reconfiguration" (subclause 8.2.6), but may also be performed by using either one of the following procedures:

- "radio bearer establishment" (subclause 8.2.1);
- "Radio bearer reconfiguration" (subclause 8.2.2);
- "Radio bearer release" (subclause 8.2.3); or

- "Transport channel reconfiguration" (subclause 8.2.4).

If IE "Timing indication" has the value "maintain", UE shall initiate the Timing-maintained hard handover procedure by following the procedure indicated in the subclause relevant to the procedure chosen by the UTRAN.

If the IE "Default DPCH Offset Value" is included:

- UTRAN should:
 - include the same value of IE "Default DPCH Offset Value" as the one currently being used by the UE.

NOTE: The first radio link listed in the message may not be the reference radio link.

- The UE shall:
 - on reception of a message where the value of IE "Default DPCH Offset Value" is not the same as the one currently being used by the UE:
 - set the variable INVALID_CONFIGURATION to true.

8.3.6 Inter-RAT handover to UTRAN

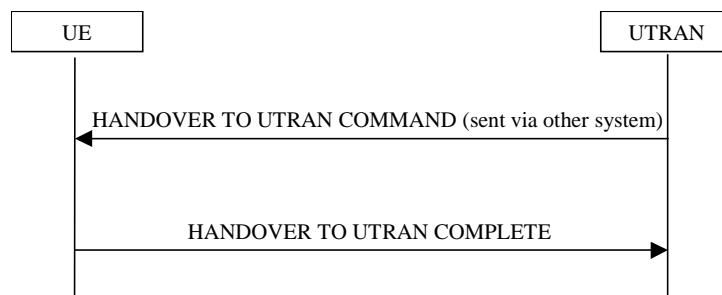

Figure 52: Inter-RAT handover to UTRAN, successful case

8.3.6.1 General

The purpose of the inter-RAT handover procedure is to, under the control of the network, transfer a connection between the UE and another radio access technology (e.g. GSM) to UTRAN.

8.3.6.2 Initiation

The procedure is initiated when a radio access technology other than UTRAN, e.g. GSM, using radio access technology-specific procedures, orders the UE to make a handover to UTRAN.

A HANDOVER TO UTRAN COMMAND message is sent to the UE via the radio access technology from which inter-RAT handover is performed.

In case UTRAN decides to use a predefined or default radio configuration that is stored in the UE, it should include the following information in the HANDOVER TO UTRAN COMMAND message.

- the IE "U-RNTI" to be assigned;
- the IE "Predefined configuration identity", to indicate which pre-defined configuration of RB, transport channel and physical channel parameters shall be used; or
- the IE "Default configuration mode" and IE "Default configuration identity", to indicate which default configuration of RB, transport channel and physical channel parameters shall be used;
- PhyCH information elements.

NOTE 1: When using a predefined or default configuration during handover to UTRAN, UTRAN can only assign values of IEs "U-RNTI" and "scrambling code" that are within the special subranges defined exclusively for this procedure. UTRAN may re-assign other values after completion of the handover procedure.

NOTE 2: When using a predefined or default configuration during handover to UTRAN, fewer IEs are signalled; when using this signalling option some parameters e.g. concerning compressed mode, DSCH, SSdT can not be configured. In this case, the corresponding functionality can not be activated immediately.

In case UTRAN does not use a predefined radio configuration that is stored in the UE, it should include the following information in the HANDOVER TO UTRAN COMMAND message.

- the IE "U-RNTI" to be assigned;
- the complete set of RB, TrCH and PhyCH information elements to be used.

8.3.6.3 Reception of HANDOVER TO UTRAN COMMAND message by the UE

The UE shall be able to receive a HANDOVER TO UTRAN COMMAND message and perform an inter-RAT handover, even if no prior UE measurements have been performed on the target UTRAN cell and/or frequency.

The UE shall act upon all received information elements as specified in subclause 8.6, unless specified otherwise in the following. The UE shall:

- store a U-RNTI value (32 bits), which is derived by the IEs "SRNC identity" (12 bits) and "S-RNTI 2" (10 bits) included in IE "U-RNTI-short". In order to produce a full size U-RNTI value, a full size "S-RNTI" (20 bits) shall be derived by padding the IE "S-RNTI 2" with 10 zero bits in the most significant positions; and
- initialise the variable ESTABLISHED_SIGNALLING_CONNECTIONS with the signalling connections that remains after the handover according to the specifications of the source RAT;
- initialise the variable UE_CAPABILITIES_TRANSFERRED with the UE capabilities that have been transferred to the network up to the point prior to the handover, if any;
- initialise the variable TIMERS_AND_CONSTANTS to the default values and start to use those timer and constants values;
- if IE "Specification mode" is set to "Preconfiguration" and IE "Preconfiguration mode" is set to "Predefined configuration":
 - initiate the radio bearer and transport channel configuration in accordance with the predefined parameters identified by the IE "Predefined configuration identity";
 - initiate the physical channels in accordance with the predefined parameters identified by the IE "Predefined radio configuration identity" and the received physical channel information elements;
 - store information about the established radio access bearers and radio bearers according to the IE "Predefined configuration identity"; and
 - set the IE "RAB Info Post" in the variable ESTABLISHED_RABS and the IE "Re-establishment timer" in the IE "RAB Info" in the variable ESTABLISHED_RABS to "useT314";
- if IE "Specification mode" is set to "Preconfiguration" and IE "Preconfiguration mode" is set to "Default configuration":
 - initiate the radio bearer and transport channel configuration in accordance with the default parameters identified by the IE "Default configuration mode" and IE "Default configuration identity";
 - initiate the physical channels in accordance with the default parameters identified by the IE "Default configuration mode" and IE "Default configuration identity" and the received physical channel information elements;

NOTE IE "Default configuration mode" specifies whether the FDD or TDD version of the default configuration shall be used

- set the IE "RAB Info Post" in the variable ESTABLISHED_RABS and the IE "Re-establishment timer" in the IE "RAB Info" in the variable ESTABLISHED_RABS to "useT314";
- if IE "Specification mode" is set to "Preconfiguration":
 - use the following values for parameters that are neither signalled within the HANDOVER TO UTRAN COMPLETE message nor included within pre-defined or default configuration:
 - 0 dB for the power offset $P_{\text{Pilot-DPDCH}}$ bearer in FDD;
 - calculate the Default DPCH Offset Value using the following formula:
 - in FDD:

$$\text{Default DPCH Offset Value} = (\text{SRNTI} \cdot 2 \bmod 600) * 512$$
 - in TDD:

$$\text{Default DPCH Offset Value} = (\text{SRNTI} \cdot 2 \bmod 7)$$
 - handle the above Default DPCH Offset Value as if an IE with that value was included in the message, as specified in subclause 8.6.6.21;
- if IE "Specification mode" is set to "Complete specification":
 - initiate the radio bearer, transport channel and physical channel configuration in accordance with the received radio bearer, transport channel and physical channel information elements;
 - perform an open loop estimation to determine the UL transmission power according to subclause 8.5.3;
 - if ciphering has been activated and ongoing in the radio access technology from which inter-RAT handover is performed:
 - for the CN domain as in the IE "CN domain identity" which is included in the IE "RAB info" of the IE "RAB information to setup":
 - set the HFN component of the COUNT-C variable for all radio bearers and signalling radio bearers that use RLC-AM and RLC-UM to the START value as stored in the USIM for that CN domain; and
 - set the remaining LSBs of the HFN component of COUNT-C to zero;
 - set the HFN component of the COUNT-C variable for all radio bearers and signalling radio bearers that use the transparent mode of RLC to zero, while not incrementing the value of the HFN component of the COUNT-C variable at each CFN cycle; and
 - set the CFN component of the COUNT-C variable to the value of the CFN as calculated in subclause 8.5.15;
 - set the IE "Status" in the variable CIPHERING_STATUS to "Started";
 - apply the same ciphering (ciphered/unciphered, algorithm) as prior to inter-RAT handover, unless a change of algorithm is requested by means of the IE "Ciphering algorithm";
 - apply ciphering immediately upon reception of the HANDOVER TO UTRAN COMMAND;

If the UE succeeds in establishing the connection to UTRAN, it shall:

- if the IE "Status" in the variable CIPHERING_STATUS is set to "Started" and transparent mode radio bearers have been established by this procedure:
 - include the IE "COUNT-C activation time" in the response message and specify a CFN value other than the default, "Now" for this IE;
 - at the CFN value as indicated in the response message in the IE "COUNT-C activation time":
 - set the HFN component of the COUNT-C variable to the START value as indicated in the IE "START list" of the response message for the relevant CN domain; and

- set the remaining LSBs of the HFN component of COUNT-C to zero;
- increment the HFN component of the COUNT-C variable by one;
- set the CFN component of the COUNT-C to the value of the IE "COUNT-C activation time" of the response message. The HFN component and the CFN component completely initialise the COUNT-C variable;
- step the COUNT-C variable, as normal, at each CFN value. The HFN component is no longer fixed in value but incremented at each CFN cycle;
- transmit a HANDBER TO UTRAN COMPLETE message on the uplink DCCH, using the new ciphering configuration, only if ciphering has been started;
- when the HANDBER TO UTRAN COMPLETE message has been submitted to lower layers for transmission,:
 - if the IE "Transport format combination subset" was not included in the HANDBER TO UTRAN COMMAND message or in the predefined parameters;
 - set the IE "Current TFC subset" in the variable TFS_SUBSET to "Full transport format combination set";
 - set the IE "Status" in the variable CIPHERING_STATUS to "Not started";
 - set the IE "Reconfiguration" in the variable CIPHERING_STATUS to FALSE;
 - set the IE "Status" in the variable INTEGRITY_PROTECTION_INFO to "Not started";
 - set the IE "Historical status" in the variable INTEGRITY_PROTECTION_INFO to "Never been active";
 - set the IE "Reconfiguration" in the variable INTEGRITY_PROTECTION_INFO to FALSE;
 - set the variable CELL_UPDATE_STARTED to FALSE;
 - set the variable CONFIGURATION_INCOMPLETE to FALSE;
 - set the variable ORDERED_RECONFIGURATION to FALSE;
 - set the variable FAILURE_INDICATOR to FALSE;
 - set the variable INCOMPATIBLE_SECURITY_RECONFIGURATION to FALSE;
 - set the variable INVALID_CONFIGURATION to FALSE;
 - set the variable PROTOCOL_ERROR_INDICATOR, TFC_SUBSET to FALSE;
 - set the variable PROTOCOL_ERROR_REJECT to FALSE;
 - set the variable TGSN_REPORTED to FALSE;
 - set the variable UNSUPPORTED_CONFIGURATION to FALSE;
 - clear all optional IEs in all variables, except those optional IEs that are set in this procedure;
- and the procedure ends.

8.3.6.4 Invalid Handover to UTRAN command message

If the UE receives a HANDBER TO UTRAN COMMAND message, which contains a protocol error causing the variable PROTOCOL_ERROR_REJECT to be set to TRUE according to clause 9, the UE shall perform procedure specific error handling according to the source radio access technology. The UE shall:

- if allowed by the source RAT:
 - transmit an RRC STATUS message to the source radio access technology; and
 - include the IE "Protocol error information" with contents set to the value of the variable PROTOCOL_ERROR_INFORMATION;

- Other details may be provided in the specifications related to the source radio access technology.

8.3.6.4a Unsupported configuration in HANDOVER TO UTRAN COMMAND message

If the UE does not support the configuration included in the HANDOVER TO UTRAN COMMAND message, e.g., the message includes a pre-defined configuration that the UE has not stored, the UE shall:

- continue the connection using the other radio access technology; and
- indicate the failure to the other radio access technology.

8.3.6.5 UE fails to perform handover

If the UE does not succeed in establishing the connection to UTRAN, it shall:

- terminate the procedure including release of the associated resources;
- resume the connection used before the handover; and
- indicate the failure to the other radio access technology.

Upon receiving an indication about the failure from the other radio access technology, UTRAN should release the associated resources and the context information concerning this UE.

8.3.6.6 Reception of message HANDOVER TO UTRAN COMPLETE by the UTRAN

Upon receiving a HANDOVER TO UTRAN COMPLETE message, UTRAN should consider the inter-RAT handover procedure as having been completed successfully and indicate this to the Core Network.

8.3.7 Inter-RAT handover from UTRAN

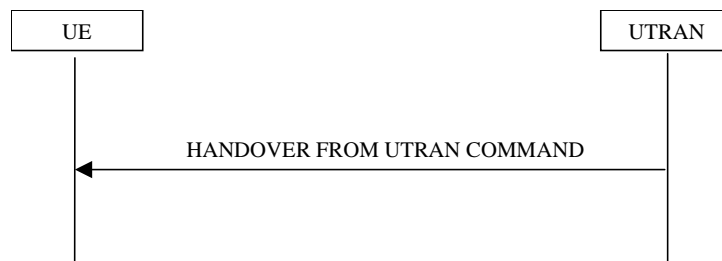

Figure 53: Inter-RAT handover from UTRAN, successful case

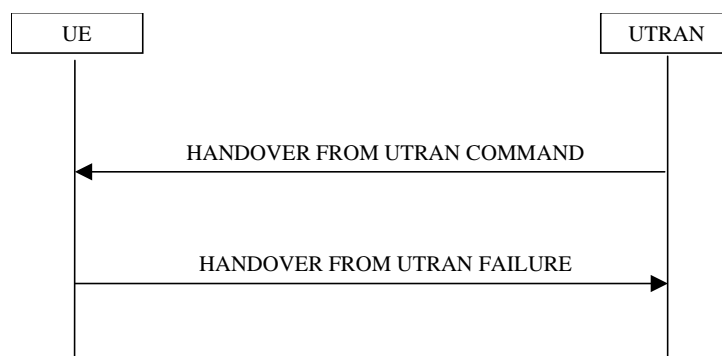

Figure 54: Inter-RAT handover from UTRAN, failure case

8.3.7.1 General

The purpose of the inter-RAT handover procedure is to, under the control of the network, transfer a connection between the UE and UTRAN to another radio access technology (e.g. GSM). This procedure may be used in CELL_DCH state.

NOTE: This procedure is applicable to CS domain service.

8.3.7.2 Initiation

The procedure is initiated when UTRAN orders a UE in CELL_DCH state, to make a handover to a radio access technology other than UTRAN, e.g. GSM.

To initiate the procedure, UTRAN sends a HANDOVER FROM UTRAN COMMAND message.

8.3.7.3 Reception of a HANDOVER FROM UTRAN COMMAND message by the UE

The UE shall be able to receive a HANDOVER FROM UTRAN COMMAND message and perform an inter-RAT handover, even if no prior UE measurements have been performed on the target cell.

The UE shall:

- establish the connection to the target radio access technology, by using the contents of the IE "Inter-RAT message". This IE contains a message specified in another standard, as indicated by the IE "System type", and carries information about the candidate/ target cell identifier(s) and radio parameters relevant for the target radio access technology. The correspondence between the value of the IE "System type", the standard to apply and the message contained within IE "Inter RAT message" is shown in the following:

| Value of the IE "System type" | Standard to apply | Inter RAT Message |
|-------------------------------|--|-------------------|
| GSM | GSM TS 04.18, version 8.5.0 or later | HANDOVER COMMAND |
| cdma2000 | TIA/EIA/IS-2000 or later, TIA/EIA/IS-833 or later, TIA/EIQ/IS-834 or later | |

- if the IE "System type" has the value "GSM":
 - if the IE "Frequency band" has the value "GSM /DCS 1800 band used":
 - set the BAND_INDICATOR [26] to "ARFCN indicates 1800 band";
 - if the IE "Frequency band" has the value " GSM /PCS 1900 band used":
 - set the BAND_INDICATOR [26] to "ARFCN indicates 1900 band";
- apply the "Inter RAT Message" according to the "standard to apply" in the table above.
- in case one or more IEs "RAB info" is included in the HANDOVER FROM UTRAN COMMAND message:
 - connect upper layer entities corresponding to indicated RABs to the radio resources indicated in the inter-RAT message;

NOTE: Requirements concerning the establishment of the radio connection towards the other radio access technology and the signalling procedure are outside the scope of this specification.

8.3.7.4 Successful completion of the inter-RAT handover

Upon successfully completing the handover, UTRAN should:

- release the radio connection; and
- remove all context information for the concerned UE.

Upon successfully completing the handover, the UE shall:

- if the USIM is present:
 - store the current START value for every CN domain in the USIM [50];

- if the "START" stored in the USIM [50] for a CN domain is greater than the value "THRESHOLD" of the variable START_THRESHOLD:
 - delete the ciphering and integrity keys that are stored in the USIM for that CN domain;
 - inform the deletion of these keys to upper layers.

NOTE: The release of the UMTS radio resources is initiated from the target RAT.

8.3.7.5 UE fails to complete requested handover

If the UE does not succeed in establishing the connection to the target radio access technology, it shall:

- revert back to the UTRA configuration;
- establish the UTRA physical channel(s) used at the time for reception of HANDOVER FROM UTRAN COMMAND;
- if the UE does not succeed to establish the UTRA physical channel(s):
 - select a suitable UTRA cell according to [4];
 - perform a cell update procedure according to subclause 8.3.1 with cause "Radio link failure";
 - when the cell update procedure has completed successfully:
 - proceed as below;
- transmit the HANDOVER FROM UTRAN FAILURE message setting the information elements as specified below:
 - include the IE "RRC transaction identifier"; and
 - set it to the value of "RRC transaction identifier" in the entry for the HANDOVER FROM UTRAN COMMAND message in the table "Accepted transactions" in the variable TRANSACTIONS; and
 - clear that entry;
 - set the IE "Inter-RAT change failure" to "physical channel failure";
- When the HANDOVER FROM UTRAN FAILURE message has been submitted to lower layer for transmission:
 - the procedure ends.

8.3.7.6 Invalid HANDOVER FROM UTRAN COMMAND message

If the IE "Inter-RAT message" received within the HANDOVER FROM UTRAN COMMAND message does not include a valid inter RAT handover message in accordance with the protocol specifications for the target RAT, the UE shall perform procedure specific error handling as follows. The UE shall:

- set the IE "failure cause" to the cause value "Inter-RAT protocol error";
- include the IE "Inter-RAT message" in case the target RAT provides further details about the inter RAT protocol error;
- transmit a HANDOVER FROM UTRAN FAILURE message on the uplink DCCH using AM RLC;
- when the transmission of the HANDOVER FROM UTRAN FAILURE message has been confirmed by RLC:
 - continue with any ongoing processes and procedures as if the invalid HANDOVER FROM UTRAN COMMAND message has not been received;
 - and the procedure ends.

If the HANOVER FROM UTRAN COMMAND message contains a protocol error causing the variable PROTOCOL_ERROR_REJECT to be set to TRUE according to clause 9, the UE shall perform procedure specific error handling as follows. The UE shall:

- set the IE "RRC transaction identifier" in the HANOVER FROM UTRAN FAILURE message to the value of "RRC transaction identifier" in the entry for the HANOVER FROM UTRAN COMMAND message in the table "Rejected transactions" in the variable TRANSACTIONS; and
- clear that entry;
- set the IE "failure cause" to the cause value "protocol error";
- include the IE "Protocol error information" with contents set to the value of the variable PROTOCOL_ERROR_INFORMATION;
- transmit a HANOVER FROM UTRAN FAILURE message on the uplink DCCH using AM RLC;
- when the HANOVER FROM UTRAN FAILURE message has been submitted to lower layers for transmission:
 - continue with any ongoing processes and procedures as if the invalid HANOVER FROM UTRAN COMMAND message has not been received;
 - and the procedure ends.

8.3.7.7 Reception of an HANOVER FROM UTRAN FAILURE message by UTRAN

Upon receiving an HANOVER FROM UTRAN FAILURE message, UTRAN may initiate the release the resources in the target radio access technology.

8.3.7.8 Unsupported configuration in HANOVER FROM UTRAN COMMAND message

If the UTRAN instructs the UE to perform a non-supported handover scenario, e.g. multiple RAB or to use a non-supported configuration, the UE shall:

- transmit a HANOVER FROM UTRAN FAILURE message, setting the information elements as specified below:
 - include the IE "RRC transaction identifier"; and
 - set it to the value of "RRC transaction identifier" in the entry for the HANOVER FROM UTRAN COMMAND message in the table "Accepted transactions" in the variable TRANSACTIONS; and
 - clear that entry;
 - set the IE "Inter-RAT change failure" to "configuration unacceptable";
- when the HANOVER FROM UTRAN FAILURE message has been submitted to lower layers for transmission:
 - resume normal operation as if the invalid HANOVER FROM UTRAN COMMAND message has not been received;
 - and the procedure ends.

8.3.7.8a Reception of HANOVER FROM UTRAN COMMAND message by UE in CELL_FACH

If the UE receives HANOVER FROM UTRAN COMMAND while in CELL_FACH, the UE shall:

- transmit a HANOVER FROM UTRAN FAILURE message, setting the information elements as specified below:

- include the IE "RRC transaction identifier"; and
- set it to the value of "RRC transaction identifier" in the entry for the HANOVER FROM UTRAN COMMAND message in the table "Accepted transactions" in the variable TRANSACTIONS; and
- clear that entry;
- set the IE "Inter-RAT change failure" to "protocol error", include IE "Protocol error information"; and
- set the value of IE "Protocol error cause" to "Message not compatible with receiver state";
- when the HANOVER FROM UTRAN FAILURE message has been submitted to lower layers for transmission:
 - resume normal operation as if the invalid HANOVER FROM UTRAN COMMAND message has not been received;
 - and the procedure ends.

8.3.8 Inter-RAT cell reselection to UTRAN

8.3.8.1 General

The purpose of the inter-RAT cell reselection procedure to UTRAN is to transfer, under the control of the UE and to some extent the source radio access technology, a connection between the UE and another radio access technology (e.g. GSM/GPRS, but not UTRAN) to UTRAN.

8.3.8.2 Initiation

When the UE makes an inter-RAT cell reselection to UTRAN according to the criteria specified in [4], it shall initiate this procedure. The inter-RAT cell reselection made by the UE may use system information broadcast from the source radio access technology or UE dedicated information.

The UE shall:

- set the variable ESTABLISHMENT_CAUSE to "Inter-RAT cell reselection";
- initiate an RRC connection establishment procedure as specified in subclause 8.1.3;
- after initiating an RRC connection establishment:
 - release all resources specific to the other radio access technology.

8.3.8.3 UE fails to complete an inter-RAT cell reselection

If the inter-RAT cell reselection fails before the UE has initiated the RRC connection establishment the UE may return back to the other radio access technology.

If the RRC connection establishment fails the UE shall enter idle mode.

8.3.9 Inter-RAT cell reselection from UTRAN

8.3.9.1 General

The purpose of the inter-RAT cell reselection procedure from UTRAN is to transfer, under the control of the UE and to some extent the UTRAN, a connection between the UE and UTRAN to another radio access technology (e.g. GSM/GPRS).

8.3.9.2 Initiation

This procedure is applicable in states CELL_FACH, CELL_PCH or URA_PCH.

When the UE based on received system information makes a cell reselection to a radio access technology other than UTRAN, e.g. GSM/GPRS, according to the criteria specified in [4], the UE shall.

- start timer T309;
- initiate the establishment of a connection to the target radio access technology according to its specifications.

8.3.9.3 Successful cell reselection

When the UE has succeeded in reselecting a cell in the target radio access technology and has initiated the establishment of a connection, it shall stop timer T309 and release all UTRAN specific resources.

UTRAN should release all UE dedicated resources upon indication that the UE has completed a connection establishment to the other radio access technology.

8.3.9.4 Expiry of timer T309

If the timer T309 expires before the UE succeeds in initiating the establishment of a connection to the other radio access technology, the UE shall:

- resume the connection to UTRAN using the resources used before initiating the inter-RAT cell reselection procedure.

8.3.10 Inter-RAT cell change order to UTRAN

8.3.10.1 General

The purpose of the inter-RAT cell change order to UTRAN procedure is to transfer, under the control of the source radio access technology, a connection between the UE and another radio access technology (e.g. GSM/GPRS) to UTRAN.

8.3.10.2 Initiation

The procedure is initiated when a radio access technology other than UTRAN, e.g. GSM/GPRS, using procedures specific for that RAT, orders the UE to change to a UTRAN cell.

NOTE: Within the message used to order the UE to change to a UTRAN cell, the source RAT should specify the identity of the target UTRAN cell as specified in the specifications for that RAT.

The UE shall:

- set the variable ESTABLISHMENT_CAUSE to "Inter-RAT cell reselection";
- initiate an RRC connection establishment procedure as specified in subclause 8.1.3.

8.3.10.3 UE fails to complete an inter-RAT cell change order

If the inter-RAT cell reselection fails the UE shall return to the other radio access technology and proceed as specified in the appropriate specifications for that RAT.

NOTE 3: The cell change was network ordered. Therefore, failure to change to the target cell should not cause the UE to move to UE- controlled cell selection.

8.3.11 Inter-RAT cell change order from UTRAN

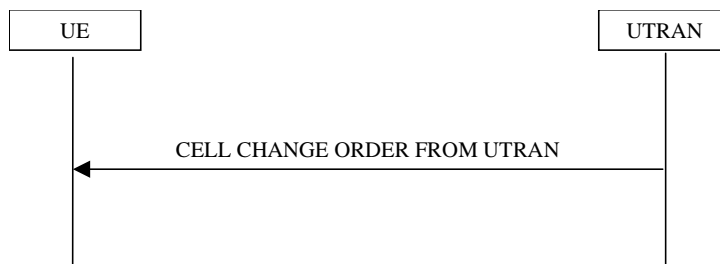

Figure 55: Inter-RAT cell change order from UTRAN

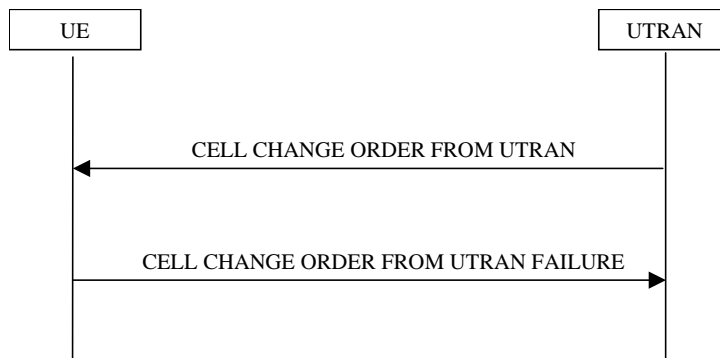

Figure 55a: Inter-RAT cell change order from UTRAN, failure case

8.3.11.1 General

The purpose of the inter-RAT cell change order procedure is to transfer, under the control of the network, a connection between the UE and UTRAN to another radio access technology (e.g. GSM). This procedure may be used in CELL_DCH and CELL_FACH state.

NOTE: This procedure is applicable for services in the PS domain.

8.3.11.2 Initiation

The procedure is initiated when UTRAN orders a UE in CELL_DCH or CELL_FACH state, to make a cell change to a radio access technology other than UTRAN, e.g. GSM.

To initiate the procedure, UTRAN sends a CELL CHANGE ORDER FROM UTRAN message.

8.3.11.3 Reception of an CELL CHANGE ORDER FROM UTRAN message by the UE

The UE shall be able to receive a CELL CHANGE ORDER FROM UTRAN message and perform a cell change order to another RAT, even if no prior UE measurements have been performed on the target cell.

The UE shall:

- start timer T309; and
- establish the connection to the other radio access technology, as specified within IE "Target cell info". This IE specifies the target cell identity, in accordance with the specifications for that other RAT. In case the target cell is a GSM/ GPRS cell, IE "Target cell info" may also include IE "NC mode", which specifies the cell selection mode to be applied in the target cell; and
- if IE "NC mode" is not included in the CELL CHANGE ORDER FROM UTRAN:
 - retrieve it from the target cell as specified in [43];
 - act upon IE "NC mode" as specified in [43].

- if one or more IEs "RAB info" are included in the CELL CHANGE ORDER FROM UTRAN message:
 - connect the upper layer entities corresponding to indicated RABs to the radio resources offered by the target RAT;

NOTE: Requirements concerning the establishment of the radio connection towards the other radio access technology and the signalling procedure are outside the scope of this specification. In case of GSM/GPRS proceed according to the procedure Network control cell reselection procedure as specified in [44].

8.3.11.4 Successful completion of the cell change order

Upon successful completion of the cell change order, the UE shall:

- stop timer T309.

Upon indication of the UE having successfully completed the cell change order, UTRAN should:

- release the radio connection; and
- remove all context information for the concerned UE.

NOTE: The release of the UMTS radio resources is initiated from another RAT.

8.3.11.5 Expiry of timer T309 or UE fails to complete requested cell change order

If:

- timer T309 expires prior to the successful establishment of a connection to the target RAT; or
- if the establishment of the connection to the other RAT failed due to other reasons e.g. (random) access failure, rejection due to lack of resources:

the UE shall:

- if it received the CELL CHANGE ORDER FROM UTRAN message in state CELL_DCH:
 - revert back to the UTRA configuration;
 - establish the UTRA physical channel(s) used at the time for reception of CELL CHANGE ORDER FROM UTRAN;
 - if the UE does not succeed in establishing the UTRA physical channel(s):
 - select a suitable UTRA cell according to [4];
 - perform a cell update procedure according to subclause 8.3.1 with cause "Radio link failure";
 - when the cell update procedure has completed successfully:
 - proceed as below;
 - transmit the CELL CHANGE ORDER FROM UTRAN FAILURE message setting the information elements as specified below:
 - include the IE "RRC transaction identifier"; and
 - set it to the value of "RRC transaction identifier" in the entry for the received message in the table "Accepted transactions" in the variable TRANSACTIONS; and
 - clear that entry;
 - set the IE "Inter-RAT change failure" to "physical channel failure";
 - When the CELL CHANGE ORDER FROM UTRAN FAILURE message has been submitted to lower layer for transmission, the procedure ends.

- if the UE receives the CELL CHANGE ORDER FROM UTRAN message in CELL_FACH state:
 - revert to the cell it was camped on at the reception of the CELL CHANGE ORDER FROM UTRAN message;
 - if the UE is unable to return to this cell:
 - select a suitable UTRA cell according to [4];
 - initiate the cell update procedure according to subclause 8.3.1 using the cause "cell re-selection";
 - when the cell update procedure completed successfully:
 - proceed as below;
 - transmit the CELL CHANGE ORDER FROM UTRAN FAILURE message setting the information elements as specified below:
 - include the IE "RRC transaction identifier"; and
 - set it to the value of "RRC transaction identifier" in the entry for the CELL CHANGE ORDER FROM UTRAN message in the table "Accepted transactions" in the variable TRANSACTIONS; and
 - clear that entry;
 - set the IE "Inter-RAT change failure" to "physical channel failure";
 - When the CELL CHANGE ORDER FROM UTRAN FAILURE message has been submitted to lower layer for transmission:
 - the procedure ends.

8.3.11.6 Unsupported configuration in CELL CHANGE ORDER FROM UTRAN message

If the UTRAN instructs the UE to perform a non-supported cell change order scenario e.g. multiple RAB or to use a non-supported configuration, the UE shall:

- transmit a CELL CHANGE ORDER FROM UTRAN FAILURE message, setting the information elements as specified below:
 - include the IE "RRC transaction identifier"; and
 - set it to the value of "RRC transaction identifier" in the entry for the received message in the table "Accepted transactions" in the variable TRANSACTIONS; and
 - clear that entry;
 - set the IE "Inter-RAT change failure" to "configuration unacceptable";
 - when the CELL CHANGE ORDER FROM UTRAN FAILURE message has been submitted to lower layers for transmission:
 - resume normal operation as if the CELL CHANGE ORDER FROM UTRAN message has not been received;
 - and the procedure ends.

8.3.11.7 Invalid CELL CHANGE ORDER FROM UTRAN message

If the CELL CHANGE ORDER FROM UTRAN message contains a protocol error causing the variable PROTOCOL_ERROR_REJECT to be set to TRUE according to clause 9, the UE shall perform procedure specific error handling as follows. The UE shall:

- set the IE "RRC transaction identifier" in the CELL CHANGE ORDER FROM UTRAN FAILURE message to the value of "RRC transaction identifier" in the entry for the CELL CHANGE ORDER FROM UTRAN message in the table "Rejected transactions" in the variable TRANSACTIONS; and
- clear that entry;
- set the IE "failure cause" to the cause value "protocol error";
- include the IE "Protocol error information" with contents set to the value of the variable PROTOCOL_ERROR_INFORMATION;
- transmit a CELL CHANGE ORDER FROM UTRAN FAILURE message on the uplink DCCH using AM RLC;
- when the CELL CHANGE ORDER FROM UTRAN FAILURE message has been submitted to lower layers for transmission:
 - resume normal operation as if the invalid CELL CHANGE ORDER FROM UTRAN message has not been received;
 - and the procedure ends.

8.4 Measurement procedures

The UE measurements are grouped into 7 different categories, according to what the UE should measure.

The different types of measurements are:

- **Intra-frequency measurements:** measurements on downlink physical channels at the same frequency as the active set. Detailed description is found in subclause 14.1.
- **Inter-frequency measurements:** measurements on downlink physical channels at frequencies that differ from the frequency of the active set. Detailed description is found in subclause 14.2.
- **Inter-RAT measurements:** measurements on downlink physical channels belonging to another radio access technology than UTRAN, e.g. PDC or GSM. Detailed description is found in subclause 14.3.
- **Traffic volume measurements:** measurements on uplink traffic volume. Detailed description is found in subclause 14.4.
- **Quality measurements:** Measurements of quality parameters, e.g. downlink transport block error rate. Detailed description is found in subclause 14.5.
- **UE-internal measurements:** Measurements of UE transmission power and UE received signal level. Detailed description is found in subclause 14.6.
- **UE positioning measurements:** Measurements of UE position. Detailed description is found in subclause 14.7.

The UE shall support a number of measurements running in parallel (the number of parallel measurements to be supported is specified in [19] and [20]). The UE shall also support that each measurement is controlled and reported independently of every other measurement.

Cells that the UE is monitoring (e.g. for handover measurements) are grouped in the UE into three different categories:

1. Cells, which belong to the **active set**. User information is sent from all these cells. In FDD, the cells in the active set are involved in soft handover. In TDD the active set always comprises of one cell only.
2. Cells, which are not included in the active set, but are monitored according to a neighbour list assigned by the UTRAN belong to the **monitored set**.
3. Cells detected by the UE, which are neither included in the active set nor in the monitored set belong to the **detected set**. Reporting of measurements of the detected set is only required for intra-frequency measurements made by UEs in CELL_DCH state.

UTRAN may control a measurement in the UE either by broadcast system information and/or by transmitting a MEASUREMENT CONTROL message. The latter message includes the following measurement control information:

1. **Measurement identity:** A reference number that should be used by the UTRAN when setting up, modifying or releasing the measurement and by the UE in the measurement report.
2. **Measurement command:** One out of three different measurement commands.
 - Setup: Setup a new measurement.
 - Modify: Modify a previously defined measurement, e.g. to change the reporting criteria.
 - Release: Stop a measurement and clear all information in the UE that are related to that measurement.
3. **Measurement type:** One of the types listed above describing what the UE shall measure.
Presence or absence of the following control information depends on the measurement type
4. **Measurement objects:** The objects the UE shall measure, and corresponding object information.
5. **Measurement quantity:** The quantity the UE shall measure. This also includes the filtering of the measurements.
6. **Reporting quantities:** The quantities the UE shall include in the report in addition to the quantities that are mandatory to report for the specific event.
7. **Measurement reporting criteria:** The triggering of the measurement report, e.g. periodical or event-triggered reporting.
8. **Measurement Validity:** Defines in which UE states the measurement is valid.
9. **Measurement reporting mode:** This specifies whether the UE shall transmit the measurement report using AM or UM RLC.
10. **Additional measurement identities:** A list of references to other measurements. When this measurement triggers a measurement report, the UE shall also include the reporting quantities for the measurements referenced by the additional measurement identities.

All these measurement parameters depend on the measurement type and are described in more detail in clause 14.

When the reporting criteria are fulfilled, i.e. a specified event occurred or the time since last report indicated for periodical reporting has elapsed, the UE shall send a MEASUREMENT REPORT message to UTRAN.

In CELL_FACH, CELL_PCH or URA_PCH state, the UE shall perform measurements according to the measurement control information included in System Information Block Type 12 or System Information Block Type 11, according to subclause 8.1.1.6.11. The UE may also be requested to perform traffic volume measurements according to the measurement control information in a MEASUREMENT CONTROL message.

In CELL_DCH state, the UE may be requested to report measurements from any of the measurement types. The UE may also be requested to report cells from the detected set. The triggering event for the UE to send a MEASUREMENT REPORT message for detected set cells is defined in measurement events 1A and 1E for FDD cells and in measurement event 1G for TDD cells in clause 14.

In order to receive information for the immediate establishment of macrodiversity (FDD) or to support the DCA algorithm (TDD), the UTRAN may also indicate to the UE in System Information Block Type 11 or System Information Block Type 12, to append radio link related measurement reports to the following messages when they are sent on common transport channels (i.e., RACH, CPCH, USCH):

- RRC CONNECTION REQUEST message sent to establish an RRC connection;
- INITIAL DIRECT TRANSFER message sent uplink to establish a signalling connection;
- UPLINK DIRECT TRANSFER message to transfer NAS messages for an existing signalling connection;
- CELL UPDATE message sent to respond to a UTRAN originated page;
- MEASUREMENT REPORT message sent to report uplink traffic volume;
- PUSCH CAPACITY REQUEST message sent to request PUSCH capacity (TDD only).

8.4.1 Measurement control



Figure 56: Measurement Control, normal case

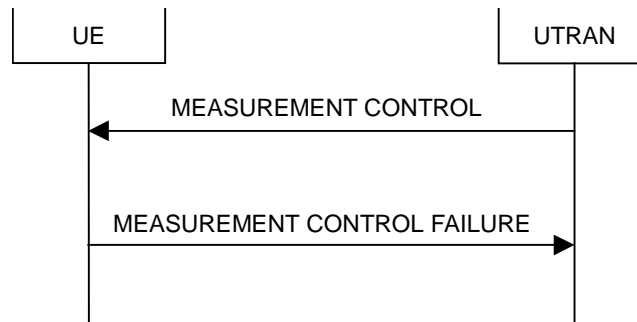

Figure 57: Measurement Control, failure case

8.4.1.1 General

The purpose of the measurement control procedure is to setup, modify or release a measurement in the UE.

8.4.1.2 Initiation

The UTRAN may request a measurement by the UE to be setup, modified or released with a MEASUREMENT CONTROL message, which is transmitted on the downlink DCCH using AM RLC.

The UTRAN should take the UE capabilities into account when a measurement is assigned to the UE.

When a new measurement is initiated, UTRAN should set the IE "Measurement identity" to a value, which is not used for other measurements. UTRAN may use several "Measurement identity" for the same "Measurement type". In case of setting several "Measurement identity" within a same "Measurement type", "Measurement object" can be set differently for each measurement with different "Measurement identity".

When a current measurement is modified or released, UTRAN should set the IE "Measurement identity" to the value, which is used for the measurement being modified or released. In case of modifying IEs within a "Measurement identity", it is not needed for UTRAN to indicate the IEs other than modifying IEs, and the UE continues to use the current values of the IEs that are not modified.

8.4.1.3 Reception of MEASUREMENT CONTROL by the UE

Upon reception of a MEASUREMENT CONTROL message the UE shall perform actions specified in subclause 8.6 unless otherwise specified below.

The UE shall:

- read the IE "Measurement command";
- if the IE "measurement command" has the value "setup":
 - store this measurement in the variable MEASUREMENT_IDENTITY according to the IE "measurement identity", possibly overwriting the measurement previously stored with that identity;
 - for measurement types "inter-RAT measurement" or "inter-frequency measurement":

- if, according to its measurement capabilities, the UE requires compressed mode to perform the measurements and a compressed mode pattern sequence with an appropriate measurement purpose is simultaneously activated by the IE "DPCH compressed mode status info"; or
- if, according to its measurement capabilities, the UE does not require compressed mode to perform the measurements:
 - begin measurements according to the stored control information for this measurement identity;
- for any other measurement type:
 - begin measurements according to the stored control information for this measurement identity.
- if the IE "Measurement command" has the value "modify":
 - for all measurement control present in the MEASUREMENT CONTROL message:
 - if a measurement was stored in the variable MEASUREMENT_IDENTITY associated to the identity by the IE "measurement identity":
 - replace the corresponding information stored in variable MEASUREMENT_IDENTITY associated to the identity indicated by the IE "measurement identity";
 - resume the measurements according to the new stored measurement control information.
 - otherwise:
 - set the variable CONFIGURATION_INCOMPLETE to TRUE;
- if the IE "measurement command" has the value "release":
 - terminate the measurement associated with the identity given in the IE "measurement identity";
 - clear all stored measurement control information related associated to this measurement identity in variable MEASUREMENT_IDENTITY.
- if the IE "DPCH Compressed Mode Status Info" is present,:
 - and if, as the result of this message, UE will have more than one transmission gap pattern sequence with the same measurement purpose active (according to IE "TGMP" in variable TGPS_IDENTITY):
 - set the variable CONFIGURATION_INCOMPLETE to TRUE;
 - if pattern sequence corresponding to IE "TGPSI" is already active (according to "TGPS Status Flag"):
 - deactivate this pattern sequence at the beginning of the frame indicated by IE "TGPS reconfiguration CFN" received in the message;
 - after the time indicated by IE "TGPS reconfiguration CFN" has elapsed:
 - activate the pattern sequence stored in the variable TGPS_IDENTITY corresponding to each IE "TGPSI" for which the "TGPS status flag" is set to "active" at the time indicated by IE "TGCFN"; and
 - begin the inter-frequency and/or inter-RAT measurements corresponding to the pattern sequence measurement purpose of each activated pattern sequence;
 - if the values of IE "TGPS reconfiguration CFN" and IE "TGCFN" are equal:
 - start the concerned pattern sequence immediately at that CFN;
- not alter pattern sequences stored in variable TGPS_IDENTITY, but not identified in IE "TGPSI"
- clear the entry for the MEASUREMENT CONTROL message in the table "Accepted transactions" in the variable TRANSACTIONS;
- and the procedure ends.

8.4.1.4 Unsupported measurement in the UE

If UTRAN instructs the UE to perform a measurement that is not supported by the UE, the UE shall:

- retain the measurement configuration that was valid before the MEASUREMENT CONTROL message was received;
- set the IE "RRC transaction identifier" in the MEASUREMENT CONTROL FAILURE message to the value of "RRC transaction identifier" in the entry for the MEASUREMENT CONTROL message in the table "Accepted transactions" in the variable TRANSACTIONS; and
- clear that entry.
- set the cause value in IE "failure cause" to "unsupported measurement";
- submit the MEASUREMENT CONTROL FAILURE message to lower layers for transmission on the DCCH using AM RLC;
- continue with any ongoing processes and procedures as if the invalid MEASUREMENT CONTROL message has not been received;
- and the procedure ends.

8.4.1.4a Configuration Incomplete

If the variable CONFIGURATION_INCOMPLETE is set to TRUE, the UE shall:

- retain the measurement configuration that was valid before the MEASUREMENT CONTROL message was received;
- set the IE "RRC transaction identifier" in the MEASUREMENT CONTROL FAILURE message to the value of "RRC transaction identifier" in the entry for the MEASUREMENT CONTROL message in the table "Accepted transactions" in the variable TRANSACTIONS and clear that entry;
- clear the variable CONFIGURATION_INCOMPLETE;
- set the cause value in IE "failure cause" to "Configuration incomplete";
- submit the MEASUREMENT CONTROL FAILURE message to lower layers for transmission on the DCCH using AM RLC;
- continue with any ongoing processes and procedures as if the invalid MEASUREMENT CONTROL message has not been received;
- and the procedure ends.

8.4.1.5 Invalid MEASUREMENT CONTROL message

If the MEASUREMENT CONTROL message contains a protocol error causing the variable PROTOCOL_ERROR_REJECT to be set to TRUE according to clause 9, the UE shall perform procedure specific error handling as follows. The UE shall:

- set the IE "RRC transaction identifier" in the MEASUREMENT CONTROL FAILURE message to the value of "RRC transaction identifier" in the entry for the MEASUREMENT CONTROL message in the table "Rejected transactions" in the variable TRANSACTIONS; and
- clear that entry.
- set the IE "failure cause" to the cause value "protocol error";
- include the IE "Protocol error information" with contents set to the value of the variable PROTOCOL_ERROR_INFORMATION;
- submit the MEASUREMENT CONTROL FAILURE message to lower layers for transmission on the DCCH using AM RLC;

- continue with any ongoing processes and procedures as if the invalid MEASUREMENT CONTROL message has not been received;
- and the procedure ends.

8.4.1.6 Measurements after transition from CELL_DCH to CELL_FACH/CELL_PCH/URA_PCH state

The UE shall obey the following rules for different measurement types after transiting from CELL_DCH to CELL_FACH/CELL_PCH/URA_PCH state:

8.4.1.6.1 Intra-frequency measurement

Upon transition from CELL_DCH to CELL_FACH/CELL_PCH/URA_PCH state, the UE shall:

- stop intra-frequency type measurement reporting assigned in a MEASUREMENT CONTROL message;
- begin monitoring cells listed in the IE "intra-frequency cell info" received in System Information Block type 12 (or System Information Block type 11, according to subclause 8.1.1.6.11);
- if the UE receives the IE "Intra-frequency reporting quantity for RACH Reporting" and the IE "Maximum number of Reported cells on RACH" IEs from System Information Block type 12 (or System Information Block type 11, according to subclause 8.1.1.6.11):
 - use this information for reporting measured results in RACH messages.

8.4.1.6.2 Inter-frequency measurement

Upon transition from CELL_DCH to CELL_FACH/ CELL_PCH/URA_PCH state, the UE shall:

- stop the inter-frequency type measurement reporting assigned in a MEASUREMENT CONTROL message;
- begin monitoring cells listed in the IE "inter-frequency cell info" received in System Information Block type 12 (or System Information Block type 11, according to subclause 8.1.1.6.11);
- in CELL_FACH state:
 - perform measurements on other frequencies according to the IE "FACH measurement occasion info".

8.4.1.6.3 Inter-RAT measurement

Upon transition from CELL_DCH to CELL_FACH/CELL_PCH/URA_PCH state, the UE shall:

- stop the inter-RAT type measurement reporting assigned in a MEASUREMENT CONTROL message;
- begin monitoring cells listed in the IE "inter-RAT" cell info" received in System Information Block type 12 (or System Information Block type 11, according to subclause 8.1.1.6.11);
- in CELL_FACH state:
 - perform measurements on other systems according to the IE "FACH measurement occasion info".

8.4.1.6.4 Quality measurement

Upon transition from CELL_DCH to CELL_FACH/CELL_PCH/URA_PCH state, the UE shall:

- stop quality type measurement reporting;
- delete all measurement control information of measurement type "quality" stored in the variable MEASUREMENT_IDENTITY.

8.4.1.6.5 UE internal measurement

Upon transition from CELL_DCH to CELL_FACH/CELL_PCH/URA_PCH state, the UE shall:

- stop UE internal measurement type measurement reporting;
- delete all measurement control information of measurement type "UE internal" stored in the variable MEASUREMENT_IDENTITY.

8.4.1.6.6 Traffic volume measurement

Upon transition from CELL_DCH to CELL_FACH/CELL_PCH/URA_PCH state, the UE shall take the following actions. The UE shall:

- retrieve each set of measurement control information of measurement type "traffic volume" stored in the variable MEASUREMENT_IDENTITY; and
- if the optional IE "measurement validity" for this measurement has not been included:
 - delete the measurement associated with the variable MEASUREMENT_IDENTITY;
- if the IE "measurement validity" for the measurement has been included, and the IE "UE state" has been assigned to value "CELL_DCH":
 - stop measurement reporting;
 - save the measurement associated with the variable MEASUREMENT_IDENTITY to be used after the next transition to CELL_DCH state;
- if the IE "measurement validity" for the measurement has been included, and the IE "UE state" has been assigned to value "all states":
 - continue measurement reporting;
- if the IE "measurement validity" has been included and the IE "UE state" has been assigned to value "all states except CELL_DCH":
 - resume this measurement and associated reporting;
- if no traffic volume type measurements applicable to CELL_FACH/CELL_PCH/URA_PCH states are stored in the variable MEASUREMENT_IDENTITY:
 - store the measurement control information from the IE "Traffic volume measurement system information" received in System Information Block type 12 (or System Information Block type 11, according to subclause 8.1.1.6.11) in the variable MEASUREMENT_IDENTITY;
 - begin traffic volume measurement reporting according to the assigned information;
- if the UE in CELL_FACH state receives a MEASUREMENT CONTROL message, which indicates the same measurement identity as that stored in the variable MEASUREMENT_IDENTITY:
 - update the stored information with the traffic volume measurement control information in variable MEASUREMENT_IDENTITY; and
 - refrain from updating the traffic volume measurement control information associated with this measurement identity received in System Information Block type 12 (or System Information Block type 11, according to 8.1.1.6.11) until this measurement is explicitly released with another MEASUREMENT CONTROL message.

8.4.1.7 Measurements after transition from CELL_FACH to CELL_DCH state

The UE shall obey the following rules for different measurement types after transiting from CELL_FACH to CELL_DCH state:

8.4.1.7.1 Intra-frequency measurement

Upon transition from CELL_FACH to CELL_DCH state, the UE shall:

- retrieve each set of measurement control information of measurement type "intra-frequency" stored in the variable MEASUREMENT_IDENTITY; and
- if the IE "measurement validity" for a measurement has been assigned the value "CELL_DCH";
- if the UE has not performed a cell reselection whilst out of CELL_DCH state:
 - resume the measurement reporting.
- if the UE has performed a cell reselection whilst out of CELL_DCH state and the cell reselection has occurred after the measurement control information was stored:
 - delete the measurement associated with the variable MEASUREMENT_IDENTITY.
- if no intra-frequency measurements applicable to CELL_DCH state are stored in the variable MEASUREMENT_IDENTITY:
 - continue monitoring the list of neighbouring cells assigned in the IE "intra-frequency cell info" in System Information Block type 12 (or System Information Block type 11, according to subclause 8.1.1.6.11);
 - if the IE "intra-frequency measurement reporting criteria" was included in System Information Block type 12 (or System Information Block type 11, according to subclause 8.1.1.6.11):
 - send the MEASUREMENT REPORT message when reporting criteria in IE "Reporting information for CELL_DCH" are fulfilled;

8.4.1.7.2 Inter-frequency measurement

Upon transition from CELL_FACH to CELL_DCH state, the UE shall:

- stop monitoring the list of cells assigned in the IE "inter-frequency cell info" in System Information Block type 12 (or System Information Block type 11, according to subclause 8.1.1.6.11);
- retrieve each set of measurement control information of measurement type "inter-frequency" stored in the variable MEASUREMENT_IDENTITY; and
- if the IE "measurement validity" for a measurement has been assigned the value "CELL_DCH":
 - if the UE has not performed a cell reselection whilst out of CELL_DCH state:
 - resume the measurement reporting;
 - if the UE has performed a cell reselection whilst out of CELL_DCH state and the cell reselection has occurred after the measurement control information was stored:
 - delete the measurement associated with the variable MEASUREMENT_IDENTITY.

8.4.1.7.3 Inter-RAT measurement

The UE shall:

- stop monitoring the list of cells assigned in the IE "inter-frequency system info" in System Information Block type 12 (or System Information Block type 11, according to subclause 8.1.1.6.11).

8.4.1.7.4 Traffic volume measurement

Upon transition from CELL_FACH to CELL_DCH state, the UE shall:

- retrieve each set of measurement control information of measurement type "traffic volume" stored in the variable MEASUREMENT_IDENTITY;
- if the optional IE "measurement validity" for this measurement has not been included:

- delete the measurement associated with the variable MEASUREMENT_IDENTITY;
- if the IE "measurement validity" for the measurement has been included, and the IE "UE state" has been assigned to value "all states except CELL_DCH":
 - stop measurement reporting; and
 - save the measurement associated with the variable MEASUREMENT_IDENTITY to be used after the next transition to CELL_FACH state;
- if the IE "measurement validity" for the measurement has been included, and the IE "UE state" has been assigned to value "all states":
 - continue measurement reporting;
- if the IE "measurement validity" has been included and the IE "UE state" has been assigned to value "CELL_DCH":
 - resume this measurement and associated reporting;
- if no traffic volume type measurement has been assigned to the UE with a MEASUREMENT CONTROL message when transiting to CELL_DCH state:
 - continue an ongoing traffic volume type measurement, assigned in System Information Block type 11 (or System Information Block type 12, according to subclause 8.1.1.6.11);
- if the UE in CELL_DCH state receives a MEASUREMENT CONTROL message, which indicates the same measurement identity as that stored in variable MEASUREMENT_IDENTITY:
 - update the stored information with the traffic volume measurement control information in variable MEASUREMENT_IDENTITY.

8.4.1.8 Measurements after transition from idle mode to CELL_DCH state

The UE shall obey the following rules for different measurement types after transiting from idle mode to CELL_DCH state:

8.4.1.8.1 Intra-frequency measurement

Upon transition from idle mode to CELL_DCH state, the UE shall:

- begin or continue monitoring the list of cells assigned in the IE "intra-frequency cell info" in System Information Block type 12 (or System Information Block type 11, according to subclause 8.1.1.6.11);
- if the "intra-frequency measurement reporting criteria" IE was included in System Information Block type 12 (or System Information Block type 11, according to subclause 8.1.1.6.11):
 - begin measurement reporting according to the IE.

8.4.1.8.2 Inter-frequency measurement

Upon transition from idle mode to CELL_DCH state, the UE shall:

- stop monitoring the list of cells assigned in the IE "inter-frequency cell info" in System Information Block type 12 (or System Information Block type 11, according to subclause 8.1.1.6.11).

8.4.1.8.3 Inter-RAT measurement

Upon transition from idle mode to CELL_DCH state, the UE shall:

- stop monitoring the list of cells assigned in the IE "inter-frequency system info" in System Information Block type 12 (or System Information Block type 11, according to subclause 8.1.1.6.11).

8.4.1.8.4 Traffic volume measurement

Upon transition from idle mode to CELL_DCH state, the UE shall:

- begin a traffic volume type measurement, assigned in System Information Block type 11 (or System Information Block type 12, according to subclause 8.1.1.6.11).

8.4.1.9 Measurements after transition from idle mode to CELL_FACH state

The UE shall obey the follow rules for different measurement types after transiting from idle mode to CELL_FACH state:

8.4.1.9.1 Intra-frequency measurement

Upon transition from idle mode to CELL_FACH state, the UE shall:

- begin or continue monitoring cells listed in the IE "intra-frequency cell info" received in System Information Block type 12 (or System Information Block type 11, according to subclause 8.1.1.6.11);
- if the UE receives the IE "Intra-frequency reporting quantity for RACH Reporting" and IE "Maximum number of Reported cells on RACH" from System Information Block type 12 (or System Information Block type 11, according to subclause 8.1.1.6.11):
 - use this information for reporting measured results in RACH messages.

8.4.1.9.2 Inter-frequency measurement

Upon transition from idle mode to CELL_FACH state, the UE shall:

- begin monitoring cells listed in the IE "inter-frequency cell info" received in System Information Block type 12 (or System Information Block type 11, according to subclause 8.1.1.6.11);
- perform measurements on other frequencies according to the IE "FACH measurement occasion info".

8.4.1.9.3 Inter-RAT measurement

Upon transition from idle mode to CELL_FACH state, the UE shall:

- begin monitoring cells listed in the IE "inter-RAT" cell info" received in System Information Block type 12 (or System Information Block type 11, according to subclause 8.1.1.6.11);
- perform measurements on other systems according to the IE "FACH measurement occasion info".

8.4.1.9.4 Traffic volume measurement

Upon transition from idle mode to CELL_FACH state, the UE shall:

- store the measurement control information from the IE "Traffic volume measurements system information" received in System Information Block type 12 (or System Information Block type 11, according to subclause 8.1.1.6.11) in the variable MEASUREMENT_IDENTITY;
- begin traffic volume measurement reporting according to the assigned information.

8.4.1.9a Measurements after transition from connected mode to idle mode

Upon transition from connected mode to idle mode the UE shall:

- stop measurement reporting for all measurements stored in the variable MEASUREMENT_IDENTITY;
- clear the variable MEASUREMENT_IDENTITY;
- obey the follow rules for different measurement types.

8.4.1.9a.1 Intra-frequency measurement

Upon transition from connected mode to idle mode, the UE shall:

- stop monitoring intra-frequency cells listed in the IE "intra-frequency cell info" received in System Information Block type 12 (if System Information Block type 12 is transmitted in the cell, according to 8.1.1.6.11);
- begin monitoring intra-frequency cells listed in the IE "intra-frequency cell info" received in System Information Block type 11.

8.4.1.9a.2 Inter-frequency measurement

Upon transition from connected mode to idle mode, the UE shall:

- stop monitoring inter-frequency cells listed in the IE "inter-frequency cell info" received in System Information Block type 12 (if System Information Block type 12 is transmitted in the cell, according to 8.1.1.6.11);
- begin monitoring inter-frequency cells listed in the IE "inter-frequency cell info" received in System Information Block type 11.

8.4.1.9a.3 Inter-RAT measurement

Upon transition from connected mode to idle mode, the UE shall:

- stop monitoring inter-RAT cells listed in the IE "inter-RAT cell info" received in System Information Block type 12 (if System Information Block type 12 is transmitted in the cell, according to 8.1.1.6.11);
- begin monitoring inter-RAT cells listed in the IE "inter-RAT cell info" received in System Information Block type 11.

8.4.1.10 Measurements when measurement object is no longer valid

8.4.1.10.1 Traffic volume measurement

If UE is no longer using the transport channel that is specified in "traffic volume measurement object", UE shall ignore any measurements that are assigned to that transport channel. If none of the transport channels that are specified in "traffic volume measurement object" is being used, UE shall release that particular measurement and its measurement ID.

8.4.2 Measurement report



Figure 58: Measurement report, normal case

8.4.2.1 General

The purpose of the measurement reporting procedure is to transfer measurement results from the UE to UTRAN.

8.4.2.2 Initiation

In CELL_DCH state, the UE shall transmit a MEASUREMENT REPORT message on the uplink DCCH when the reporting criteria stored in variable MEASUREMENT_IDENTITY are met for any ongoing measurements that are being performed in the UE.

In CELL_FACH state, the UE shall transmit a MEASUREMENT REPORT message on the uplink DCCH when the reporting criteria stored in variable MEASUREMENT_IDENTITY are met for any ongoing traffic volume measurement that is being performed in the UE.

In TDD, if the Radio Bearer associated with the MEASUREMENT_IDENTITY fulfilling the reporting criteria for an ongoing traffic volume measurement is mapped on transport channel of type USCH, the UE shall initiate the "PUSCH CAPACITY REQUEST" procedure instead of transmitting a MEASUREMENT REPORT (TDD Only).

In CELL_PCH or URA_PCH state, the UE shall first perform the cell update procedure according to subclause 8.3.1, using the cause "uplink data transmission", in order to transit to CELL_FACH state and then transmit a MEASUREMENT REPORT message on the uplink DCCH when the reporting criteria stored in variable MEASUREMENT_IDENTITY are fulfilled for any ongoing traffic volume measurement which is being performed in the UE.

The reporting criteria are fulfilled if either:

- the first measurement has been completed according to the requirements set in [19] or [20] for a newly initiated measurement with periodic reporting; or
- the time period indicated in the stored IE "Periodical reporting criteria" has elapsed since the last measurement report was transmitted for a given measurement; or
- an event in stored IE "Measurement reporting criteria" was triggered. Events and triggering of reports for different measurement types are described in detail in clause 14.

For the measurement, which triggered the MEASUREMENT REPORT message, the UE shall:

- set the IE "measurement identity" to the measurement identity, which is associated with that measurement in variable MEASUREMENT_IDENTITY;
- set the IE "measured results" to include measurements according to the IE "reporting quantity" of that measurement stored in variable MEASUREMENT_IDENTITY; and
- if all the reporting quantities are set to "false":
 - not set the IE "measured results";
- set the IE "Measured results" in the IE "Additional measured results" according to the IE "reporting quantity" for all measurements associated with the measurement identities included in the IE "additional measurements" stored in variable MEASUREMENT_IDENTITY of the measurement that triggered the measurement report; and
- if more than one additional measured results are to be included:
 - sort them in ascending order according to their IE "measurement identity" in the MEASUREMENT REPORT message;
- if the MEASUREMENT REPORT message was triggered by an event (i.e. not a periodical report):
 - set the IE "Event results" according to the event that triggered the report.

The UE shall:

- transmit the MEASUREMENT REPORT message on the uplink DCCH using either AM or UM RLC according to the stored IE "measurement reporting mode" associated with the measurement identity that triggered the report.

When the MEASUREMENT REPORT message has been submitted to lower layers for transmission:

- the procedure ends.

8.4.3 Assistance Data Delivery



Figure 59 Assistance Data Delivery

8.4.3.1 General

The purpose of the assistance data delivery procedure is to transfer UE positioning related assistance data from the UTRAN to the UE.

8.4.3.2 Initiation

The UTRAN may deliver UE positioning related assistance data with a ASSISTANCE DATA DELIVERY message, which is transmitted on the downlink DCCH using AM RLC if RNC is requested to do so by the CN.

8.4.3.3 Reception of ASSISTANCE DATA DELIVERY message by the UE

Upon reception of a ASSISTANCE DATA DELIVERY message the UE shall:

- if IE "UE positioning OTDOA assistance data" is included:
 - store the OTDOA assistance data;
- if IE "UE positioning GPS assistance data" is included:
 - store the GPS assistance data.

8.4.3.4 Invalid ASSISTANCE DATA DELIVERY message

If the UE receives a ASSISTANCE DATA DELIVERY message, which contains a protocol error causing the variable `PROTOCOL_ERROR_REJECT` to be set to TRUE according to clause 9, the UE shall perform procedure specific error handling as follows. The UE shall:

- transmit an RRC STATUS message on the uplink DCCH using AM RLC;
- include the IE "Identification of received message"; and
- set the IE "Received message type" to ASSISTANCE DATA DELIVERY; and
- set the IE "RRC transaction identifier" to the value of "RRC transaction identifier" in the entry for the ASSISTANCE DATA DELIVERY message in the table "Rejected transactions" in the variable TRANSACTIONS; and
- clear that entry;
- include the IE "Protocol error information" with contents set to the value of the variable `PROTOCOL_ERROR_INFORMATION`.
- when the RRC STATUS message has been submitted to lower layers for transmission:
 - continue with any ongoing processes and procedures as if the invalid ASSISTANCE DATA DELIVERY message has not been received.

8.5 General procedures

8.5.1 Selection of initial UE identity

The purpose of the IE "Initial UE identity" is to provide a unique UE identification at the establishment of an RRC connection. The type of identity shall be selected by the UE according to the following.

Upper layers shall set the variable `SELECTED_PLMN`. If the variable `SELECTED_PLMN` in the UE indicates "GSM-MAP", the UE shall choose "UE id type" in the IE "Initial UE identity" with the following priority:

1. TMSI (GSM-MAP): The TMSI (GSM-MAP) shall be chosen if available. The IE "LAI" in the IE "Initial UE identity" shall also be present when TMSI (GSM-MAP) is used, for making it unique.
2. P-TMSI (GSM-MAP): The P-TMSI (GSM-MAP) shall be chosen if available and no TMSI (GSM-MAP) is available. The IE "RAI" in the IE "Initial UE identity" shall in this case also be present when P-TMSI (GSM-MAP) is used, for making it unique.
3. IMSI (GSM-MAP): The IMSI (GSM-MAP) shall be chosen if available and no TMSI (GSM-MAP) or P-TMSI is available.
4. IMEI: The IMEI shall be chosen when none of the above three conditions are fulfilled.

When being used, the IEs "TMSI (GSM-MAP)", "P-TMSI (GSM-MAP)", "IMSI (GSM-MAP)", "LAI" and "RAI" shall be set equal to the values of the corresponding identities stored in the USIM or SIM.

If the variable `SELECTED_PLMN` in the UE indicates "ANSI-41", the UE shall choose "UE id type" in the IE "Initial UE identity" according to the procedure specified in the 3GPP2 document "3GPP2 C.P0004-A".

8.5.2 Actions when entering idle mode from connected mode

When entering idle mode from connected mode, the UE shall:

- attempt to select a suitable cell to camp on.

When leaving connected mode according to [4], the UE shall:

- perform cell selection.

While camping on a cell, the UE shall:

- acquire system information according to the system information procedure in subclause 8.1;
- perform measurements according to the measurement control procedure specified in subclause 8.4; and
- if the UE is registered:
 - be prepared to receive paging messages according to the paging procedure in subclause 8.2.

If IE "PLMN identity" within variable `SELECTED_PLMN` has the value "GSM-MAP", the UE shall:

- delete any NAS system information received in connected mode;
- acquire the NAS system information in system information block type 1; and
- proceed according to subclause 8.6.1.2.

When entering idle mode, the UE shall:

- if the USIM is present:
 - store the current `START` value for every CN domain in the USIM [50];
 - if the "START" stored in the USIM [50] for a CN domain is greater than the value "THRESHOLD" of the variable `START_THRESHOLD`:

- delete the ciphering and integrity keys that are stored in the USIM for that CN domain;
- inform the deletion of these keys to upper layers.

8.5.3 Open loop power control upon establishment of DPCCH

This procedure is used in FDD mode only.

When establishing the first DPCCH the UE shall start the UL inner loop power control at a power level according to:

- $DPCCH_Initial_power = DPCCH_Power_offset - CPICH_RSCP$

Where

$DPCCH_Power_offset$ shall have the value of IE "DPCCH Power offset" in IE "Uplink DPCH power control info"

The value for the $CPICH_RSCP$ shall be measured by the UE.

8.5.4 Physical channel establishment criteria

When a physical dedicated channel establishment is initiated by the UE, the UE shall start a timer T312 and wait for layer 1 to indicate N312 successive "in sync" indications. On receiving N312 successive "in sync" indications, the physical channel is considered established and the timer T312 is stopped and reset.

If the timer T312 expires before the physical channel is established, the UE shall consider this as a "physical channel establishment failure".

8.5.5 Actions in "out of service area" and "in service area"

This subclause specifies the general actions the UE shall perform when it detects "out of service" or "in service" area. The specific UE behaviour when it detects "out of service" or "in service area" and periodical update has been configured by T305 in the IE "UE Timers and constants in connected mode" set to any other value than "infinity" is specified in subclause 8.3.1.

8.5.5.1 Detection of "out of service" area

When a suitable cell is not found based on the description in [4], the UE considers it as having detected "out of service area".

8.5.5.1.1 Actions following detection of "out of service" area in URA_PCH or CELL_PCH state

If the UE detects the "out of service area" and the UE is in URA_PCH or CELL_PCH state it shall perform the following actions:

- start timer T316;
- perform processes described in subclause 7.2.2.

8.5.5.1.2 Actions following detection of "out of service" area in CELL_FACH state

If the UE detects the "out of service area" and the UE is in CELL_FACH state it shall perform the following actions. The UE shall:

- start timer T317 if not already running;
- perform processes described in subclause 7.2.2.

8.5.5.2 Detection of "in service" area

When a suitable cell is found based on the description in [4], the UE considers it as having detected "in service area".

8.5.5.2.1 Actions following Re-entry into "in service area" in URA_PCH or CELL_PCH state

If the UE re-enters "in service area" before T316 expiry the UE shall perform the following actions. The UE shall:

- stop T316;
- perform processes described in subclause 7.2.2.

8.5.5.2.2 Actions following re-entry into "in service area" in CELL_FACH state

If the UE detects "in service area" before T317 expiry the UE shall perform the following actions. If no cell update procedure or URA update procedure is ongoing, the UE shall:

- stop T317;
- initiate the cell update procedure using as cause "Re-entering service area" as specified in subclause 8.3.1;
- perform processes described in subclause 7.2.2.

If an cell update procedure or URA update procedure is ongoing, the UE shall:

- perform the actions as specified in 8.3.1.

8.5.5.3 T316 expiry

On T316 expiry the UE shall perform the following actions. The UE shall:

- if "out of service area" is detected:
 - start timer T317;
 - move to CELL_FACH state;
 - perform processes described in subclause 7.2.2;
- if "in service area" is detected:
 - initiate the cell update procedure using as cause "Re-entering service area" as specified in subclause 8.3.1;
 - perform processes described in subclause 7.2.2.

8.5.5.4 T317 expiry

When the T317 expires, the UE shall:

- move to idle mode;
- release all dedicated resources;
- indicate release (abort) of the established signalling connections (as stored in the variable ESTABLISHED_SIGNALLING_CONNECTIONS) and established radio access bearers (as stored in the variable ESTABLISHED_RABS) to upper layers;
- clear the variable ESTABLISHED_SIGNALLING_CONNECTIONS;
- clear the variable ESTABLISHED_RABS;
- perform actions specified in subclause 8.5.2 when entering idle mode from connected mode.

8.5.6 Radio link failure criteria and actions upon radio link failure

In CELL_DCH State, after receiving N313 consecutive "out of sync" indications from layer 1 for the established DPCH physical channel in FDD, and the DPCH associated with mapped DCCHs in TDD, the UE shall:

- start timer T313;
- upon receiving N315 successive "in sync" indications from layer 1 and upon change of UE state:
 - stop and reset timer T313;
- if T313 expires:
 - consider it as a "Radio link failure";

When a radio link failure occurs, the UE shall:

- clear the dedicated physical channel configuration;
- select a suitable UTRA cell according to [4];
- perform actions as specified for the ongoing procedure;
- if no procedure is ongoing or no actions are specified for the ongoing procedure:
 - select a suitable UTRA cell according to [4];
 - perform a cell update procedure according to subclause 8.3.1 using the cause "radio link failure".

8.5.7 Open loop power control

For FDD and prior to PRACH or PCPCH transmission the UE shall:

- read the IEs "Primary CPICH DL TX power", "UL interference" and "Constant value" in System Information Block type 6 (or System Information Block type 5, if system information block type 6 is not being broadcast) and System Information Block type 7;
- measure the value for the CPICH_RSCP;
- calculate the power for the first preamble as:

$$\text{Preamble_Initial_Power} = \text{Primary CPICH DL TX power} - \text{CPICH_RSCP} + \text{UL interference} + \text{Constant Value}$$

Where,

Primary CPICH DL TX power shall have the value of IE "Primary CPICH DL TX power",

UL interference shall have the value of IE "UL interference"; and

Constant Value shall have the value of IE "Constant Value".

- as long as the physical layer is configured for PRACH or PCPCH transmission:
 - continuously recalculate the Preamble_Initial_Power when any of the broadcast parameters used in the above formula changes; and
 - resubmit to the physical layer the new calculated Preamble_Initial_Power.

For 3.84 Mcps TDD the UE shall:

- if in the IE "Uplink DPCH Power Control" the "CHOICE UL OL PC info" has the value "Broadcast UL OL PC info":
 - acquire Reference Power, Constant Values from System Information Block type 6 (or System Information Block type 5, according to 8.1.1.6.5), and I_{BTS} for all active UL timeslots from System Information Block type 14 on the BCH;

- otherwise:
 - acquire Reference Power, Constant Values and I_{BTS} for all active UL timeslots from the IE "Uplink DPCH Power Control".
- for PUSCH and PRACH power control:
 - acquire Reference Power, Constant Values and I_{BTS} for all active UL timeslots from System Information Block type 6 (or System Information Block type 5, according to 8.1.1.6.5) and System Information Block type 14 on the BCH,

calculate the UL transmit power according to the following formula for the PRACH continuously while the physical channel is active:

$$P_{PRACH} = L_{PCCPCH} + I_{BTS} + RACH \text{ Constant value,}$$

- 3dB shall be added to RACH Constant Value in the above equation for the case where RACH Spreading Factor = 8
- calculate the UL transmit power according to the following formula for the DPCH continuously while the physical channel is active:

$$P_{DPCH} = \alpha L_{PCCPCH} + (1-\alpha)L_0 + I_{BTS} + SIR_{TARGET} + DPCH \text{ Constant value}$$

- calculate the UL transmit power according to the following formula for the PUSCH continuously while the physical channel is active:

$$P_{USCH} = \alpha L_{PCCPCH} + (1-\alpha)L_0 + I_{BTS} + SIR_{TARGET} + USCH \text{ Constant value}$$

Where, for all the above equations for TDD the following apply:

- P_{PRACH} , P_{DPCH} , & P_{USCH} : Transmitter power level in dBm;
- Pathloss values:
 - L_{PCCPCH} : Measurement representing path loss in dB based on beacon channels (the reference transmit power is signalled as the value of the IE "Primary CCPCH Tx Power" on BCH in System Information Block type 6 (or System Information Block type 5, according to 8.1.1.6.5), or individually signalled in the IE "Uplink DPCH Power Control").
 - L_0 : Long term average of path loss in dB;
 - If the midamble is used in the evaluation of L_{PCCPCH} and L_0 , and the Tx diversity scheme used for the P-CCPCH involves the transmission of different midambles from the diversity antennas, the received power of the different midambles from the different antennas shall be combined prior to evaluation of the variables.
- I_{BTS} : Interference signal power level at cell's receiver in dBm. I_{BTS} shall have the value of the IE "UL Timeslot Interference" (IE "UL Timeslot Interference" is broadcast on BCH in System Information Block type 14 or individually signalled to each UE in the IE "Uplink DPCH Power Control" for each active uplink timeslot).
- α : α is a weighting parameter, which represents the quality of path loss measurements. α may be a function of the time delay between the uplink time slot and the most recent down link PCCPCH time slot. α is calculated at the UE. α shall be smaller or equal to the value of the IE "Alpha". If the IE "Alpha" is not explicitly signalled to the UE α shall be set to 1. If UE is capable of estimating its position by using the OTDOA IPDL method, the UE shall use the IPDL- α parameter.
- SIR_{TARGET} : Target SNR in dB. This value is individually signalled to UEs in IE "UL target SIR" in IE "UL DPCH Power Control Info" or in IE "PUSCH Power Control Info" respectively.
- RACH Constant value: RACH Constant value shall have the value of the IE "RACH Constant value".
- DPCH Constant value: DPCH Constant value shall have the value of the IE "DPCH Constant value".
- USCH Constant Value: USCH Constant value shall have the value of the IE "USCH Constant value".

- Values received by dedicated signalling shall take precedence over broadcast values.
- If IPDLs are applied, the UE may increase UL Tx power by the value given in the IE "Max power increase". This power increase is only allowed in the slots between an idle slot and the next beacon slot.

For 1.28 Mcps TDD the UE shall:

- calculate the UL transmit power according to the following formula for each UpPCH code transmission:

$$P_{\text{UpPCH}} = L_{\text{PCCPCH}} + \text{PRX}_{\text{UpPCHdes}} + i * P_{\text{wramp}}$$

- calculate the UL transmit power according to the following formula for each PRACH transmission:

$$P_{\text{PRACH}} = L_{\text{PCCPCH}} + \text{PRX}_{\text{PRACHdes}} + i * P_{\text{wramp}}$$

- calculate the initial UL transmit power according to the following formula for the PUSCH. Once the UE receives TPC bits relating to the PUSCH then it transitions to closed loop power control. If successive PUSCH resource allocations are contiguous then no return is made to open loop power control at the beginning of the succeeding resource allocation.

$$P_{\text{USCH}} = \text{SIR}_{\text{TARGET}} + L_{\text{PCCPCH}}$$

- calculate the initial UL transmit power according to the following formula for the DPCH. Once the UE receives TPC bits relating to the uplink DPCH then it transitions to closed loop power control.

$$P_{\text{DPCH}} = \text{SIR}_{\text{TARGET}} + L_{\text{PCCPCH}}$$

Where:

- P_{UpPCH} , P_{PRACH} , P_{DPCH} , & P_{USCH} : Transmitter power level in dBm,
- L_{PCCPCH} : Measurement representing path loss in dB (reference transmit power "Primary CCPCH Tx Power" is broadcast on BCH in System Information Block type 5 and System Information Block type 6, or individually signalled to each UE in the IE "Uplink DPCH Power Control").
- $\text{SIR}_{\text{TARGET}}$: Target SIR in dB. This value is individually signalled to UEs in IEs "UL DPCH Power Control Info" and "PUSCH Power Control Info".
- i is the number of transmission attempts on UpPCH
- $\text{PRX}_{\text{PRACHdes}}$: Desired PRACH RX power at the cell's receiver in dBm signalled to the UE by the network in the FPACH response to the UE's successful SYNC_UL transmission.
- $\text{PRX}_{\text{UpPCHdes}}$: Desired UpPCH RX power at the cell's receiver in dBm. The value is broadcast on BCH and shall be read on System Information Block type 5 and System Information Block type 6. It can also be signalled directly to the UE in a protocol message triggering a hard handover.
- P_{wramp} : The UE shall increase its transmission power by the value of the IE "Power Ramp step" by every UpPCH transmission.

8.5.8 Maintenance of Hyper Frame Numbers

The MSBs of both the ciphering sequence numbers (COUNT-C) and integrity sequence numbers (COUNT-I), for the ciphering and integrity protection algorithms, respectively [40], are called the Hyper Frame Numbers (HFN).

For integrity protection, the UE shall:

- maintain COUNT-I as specified in subclause 8.5.10.

The following hyper frame numbers types are defined:

MAC-d HFN:
24 MSB of COUNT-C for data sent over RLC TM

RLC UM HFN:
25 MSB of COUNT-C for data sent over RLC UM

RLC AM HFN:
20 MSB of COUNT-C for data sent over RLC AM

RRC HFN:
28 MSB of COUNT-I

For non-transparent mode RLC radio bearers, the UE shall:

- maintain one uplink and one downlink COUNT-C per radio bearer and one uplink and one downlink COUNT-I per signalling radio bearer.

For all transparent mode RLC radio bearers of the same CN domain, the UE shall:

- maintain one COUNT-C, common for all radio bearers in uplink and downlink;
- maintain one uplink and one downlink COUNT-I per signalling radio bearer.

NOTE: In this release of the specification there is only an uplink transparent mode COUNT-I, which is used for signalling radio bearer RB0.

COUNT-C and COUNT-I are defined in [40], with the following supplement for COUNT-C: for transparent mode RLC radio bearers with a transmission time interval of x radio frames ($x = 2, 4, 8$), the MAC PDU is carried by L1 in x consecutive radio frames due to radio frame segmentation. In this case, the CFN of the first segment of the MAC PDU is used as the CFN component of COUNT-C.

8.5.9 START value calculation

In connected mode, the START value for CN domain 'X' is calculated as

Let $START_X$ = the START value for CN domain 'X' prior to the calculation below:

$START_X' = MSB_{20} (MAX \{ COUNT-C, COUNT-I \mid \text{radio bearers and signalling radio bearers with } CK_X \text{ and } IK_X \}) + 1$.

- if $START_X' =$ the maximum value = 1048575 then $START_X = START_X'$;
- if the current $START_X < START_X'$ then $START_X = START_X'$, otherwise $START_X$ is unchanged.

8.5.10 Integrity protection

If the "Status" in the variable INTEGRITY_PROTECTION_INFO has the value "Started" then the UE and UTRAN shall:

- perform integrity protection (and integrity checking) on all RRC messages, with the following exceptions:

HANDOVER TO UTRAN COMPLETE

PAGING TYPE 1

PUSCH CAPACITY REQUEST

PHYSICAL SHARED CHANNEL ALLOCATION

RRC CONNECTION REQUEST

RRC CONNECTION SETUP

RRC CONNECTION SETUP COMPLETE

RRC CONNECTION REJECT

RRC CONNECTION RELEASE (CCCH only)

SYSTEM INFORMATION

SYSTEM INFORMATION CHANGE INDICATION

TRANSPORT FORMAT COMBINATION CONTROL (TM DCCH only)

If the "Status" in the variable INTEGRITY_PROTECTION_INFO has the value "Not started" then integrity protection (and integrity checking) shall not be performed on any RRC message.

For each signalling radio bearer, the UE shall use two RRC hyper frame numbers:

- "Uplink RRC HFN";
- "Downlink RRC HFN".

and two message sequence numbers:

- "Uplink RRC Message sequence number";
- "Downlink RRC Message sequence number".

The above information is stored in the variable INTEGRITY_PROTECTION_INFO per signalling radio bearer (RB0-RB4).

Upon the first activation of integrity protection for an RRC connection, UE and UTRAN initialise the "Uplink RRC Message sequence number" and "Downlink RRC Message sequence number" for all signalling radio bearers as specified in subclauses 8.6.3.5 and 8.5.10.1.

As a general rule, the RRC message sequence number (RRC SN) is incremented for every integrity protected RRC message. In cases when there are exceptions, these are stated for those procedures.

8.5.10.1 Integrity protection in downlink

If the UE receives an RRC message on signalling radio bearer with RB identity n, the "Status" in the variable INTEGRITY_PROTECTION_INFO has the value "Started" and the IE 'Integrity check info' is present the UE shall:

- perform the actions in subclause 8.6.3.5; and
- apply the new integrity protection configuration;
- check the value of the IE "RRC message sequence number" included in the IE "Integrity check info";
 - if the "Downlink RRC Message sequence number" is not present in the variable INTEGRITY_PROTECTION_INFO:
 - initialise the "Downlink RRC Message sequence number" in the variable INTEGRITY_PROTECTION_INFO with the value of the IE "RRC message sequence number" included in the IE "Integrity check info" of the received message;
 - if the "Downlink RRC Message sequence number" is present in the variable INTEGRITY_PROTECTION_INFO:
 - if the RRC message sequence number is lower than the "Downlink RRC Message sequence number" for signalling radio bearer RBn in the variable INTEGRITY_PROTECTION_INFO:
 - increment "Downlink RRC HFN" for signalling radio bearer RBn in the variable INTEGRITY_PROTECTION_INFO with one;
 - if the RRC message sequence number is equal to the "Downlink RRC Message sequence number" for signalling radio bearer RBn in the variable INTEGRITY_PROTECTION_INFO:
 - discard the message;
- calculate an expected message authentication code in accordance with subclause 8.5.10.3;
- compare the expected message authentication code with the value of the received IE "message authentication code" contained in the IE "Integrity check info";

- if the expected message authentication code and the received message authentication code are the same, the integrity check is successful:
 - update the "Downlink RRC Message sequence number" for signalling radio bearer RBn in the variable INTEGRITY_PROTECTION_INFO with the value of the IE "RRC message sequence number" included in the IE "Integrity check info" of the received RRC message;
- if the calculated expected message authentication code and the received message authentication code differ:
 - if the IE "RRC message sequence number" included in the IE "Integrity check info" is lower than the "Downlink RRC Message sequence number" for signalling radio bearer RBn in the variable INTEGRITY_PROTECTION_INFO (in this case the "Downlink RRC HFN" for signalling radio bearer RBn in the variable INTEGRITY_PROTECTION_INFO was incremented by one, as stated above):
 - decrement "Downlink RRC HFN" for signalling radio bearer RBn in the variable INTEGRITY_PROTECTION_INFO by one;
 - discard the message.

If the UE receives an RRC message on signalling radio bearer with identity n, the "Status" in the variable INTEGRITY_PROTECTION_INFO has the value "Started" and the IE 'Integrity check info' is not present the UE shall:

- discard the message.

8.5.10.2 Integrity protection in uplink

Upon transmitting an RRC message using the signalling radio bearer with radio bearer identity n, and the "Status" in the variable INTEGRITY_PROTECTION_INFO has the value "Started" the UE shall:

- increment "Uplink RRC Message sequence number" for signalling radio bearer RBn in the variable INTEGRITY_PROTECTION_INFO with 1. When "Uplink RRC Message sequence number" for signalling radio bearer RBn in the variable INTEGRITY_PROTECTION_INFO becomes 0, the UE shall increment "Uplink RRC HFN" for signalling radio bearer RBn in the variable INTEGRITY_PROTECTION_INFO with 1
- calculate the message authentication code in accordance with subclause 8.5.10.3
- replace the "Message authentication code" in the IE "Integrity check info" in the message with the calculated message authentication code.
- replace the "RRC Message sequence number" in the IE "Integrity check info" in the message with contents set to the new value of the "Uplink RRC Message sequence number" for signalling radio bearer RBn in the variable INTEGRITY_PROTECTION_INFO

During an ongoing reconfiguration of the integrity protection, UTRAN should, for all signalling radio bearers, apply the old configuration (that is, the configuration that was applied before the reconfiguration) for the integrity protection. In the response message for the procedure ordering the reconfiguration, the UE indicates the activation time, for each signalling radio bearer except RB2, when the new configuration is to be applied in uplink. UTRAN should then start to apply the new configuration according to the activation time for each signalling radio bearer (for signalling radio bearer RB2 the new configuration is applied starting from reception of the response message).

8.5.10.3 Calculation of message authentication code

The UE shall calculate the message authentication code in accordance with [40]. The input parameter MESSAGE [40] for the integrity algorithm shall be constructed by:

- setting the "Message authentication code" in the IE "Integrity check info" in the message to the radio bearer identity for the signalling radio bearer;
- setting the "RRC Message sequence number" in the IE "Integrity check info" in the message to zero;
- encoding the message;
- appending RRC padding (if any) as a bitstring to the encoded bitstring as the least significant bits.

For usage on an RRC message transmitted or received on the radio bearer with identity n, the UE shall:

- construct the input parameter COUNT-I [40] by appending the following IEs from the IE "Signalling radio bearer specific integrity protection information" for radio bearer n in the variable INTEGRITY_PROTECTION_INFO:
 - for uplink:
 - "Uplink RRC HFN", as the MSB, and "Uplink RRC Message sequence number", as LSB;
 - for downlink:
 - "Downlink RRC HFN", as the MSB, and "Downlink RRC Message sequence number", as LSB.

8.5.11 FACH measurement occasion calculation

When in CELL_FACH state and when the variable C_RNTI is non-empty the UE in FDD mode shall perform inter-frequency and inter system measurements during the frame(s) with the SFN value fulfilling the following equation:

$$\text{SFN div } N = \text{C_RNTI mod } M_REP + n * M_REP$$

where

- N is the TTI (in number of 10ms frames) of the FACH having the largest TTI on the SCCPCH monitored by UE
- C_RNTI is the C-RNTI value of the UE stored in the variable C_RNTI
- M_REP is the Measurement Occasion cycle length. According to the equation above, a FACH Measurement Occasion of N frames will be repeated every $N * M_REP$ frame, and $M_REP = 2^k$.

where,

- k is the FACH Measurement occasion cycle length coefficient.
The value of the FACH Measurement occasion cycle length coefficient is read in system information in "System Information Block type 11" or "System Information Block type 12" in the IE "FACH measurement occasion info".
- n = 0,1,2... as long as SFN is below its maximum value

The UE is allowed to measure on other occasions in case the UE moves "out of service" area or in case it can simultaneously perform the ordered measurements.

A UE in TDD mode shall use the frame(s) with the SFN value fulfilling the above equation for neighbour cells measurements.

8.5.12 Establishment of Access Service Classes

The PRACH resources (i.e. access slots and preamble signatures for FDD), timeslot (with specific frame allocation and channelisation code for 3.84Mcps TDD and SYNC_UL codes (with specific frame allocation) for 1.28Mcps TDD) may be divided between different Access Service Classes in order to provide different priorities of RACH usage. It is possible for more than one ASC or for all ASCs to be assigned to the same access slot/signature space in FDD or frame allocation/channelisation codes in 3.84Mcps TDD or frame allocation/SYNC_UL codes in 1.28Mcps TDD.

Access Service Classes shall be numbered in the range $0 \leq i \leq \text{NumASC} \leq 7$ (i.e. the maximum number of ASCs is "NumASC+1" = 8). An ASC is defined by an identifier, i , that defines a certain partition of the PRACH resources (SYNC_UL resources in 1.28Mcps TDD) and an associated persistence value P_i . A set of ASC parameters consists of "NumASC+1" such parameters (i, P_i), $i = 0, \dots, \text{NumASC}$.

PRACH partitions shall be established using the information element "PRACH partition". The persistence values P_i to be associated with each ASC shall be derived from the dynamic persistence level $N = 1, \dots, 8$ which is broadcast in SIB 7, and the persistence scaling factors s_i , broadcast in System Information Block Type 5 and possibly also in System Information Block Type 6, as follows:

$$P(N) = 2^{-(N-1)}$$

| ASC # i | 0 | 1 | 2 | 3 | 4 | 5 | 6 | 7 |
|-----------|---|--------|------------|------------|------------|------------|------------|------------|
| P_i | 1 | $P(N)$ | $s_2 P(N)$ | $s_3 P(N)$ | $s_4 P(N)$ | $s_5 P(N)$ | $s_6 P(N)$ | $s_7 P(N)$ |

Scaling factors s_i are provided optionally for $i = 2, \dots, \text{NumASC}$, where $\text{NumASC}+1$ is the number of ASCs as defined by PRACH partitioning. If no scaling factors are broadcast, default value 1 shall be used if $\text{NumASC} \geq 2$.

If $k \geq 1$ scaling factors are broadcast and $\text{NumASC} \geq k+2$ then the last scaling factor s_{k+1} shall be used as default for the ASCs where $i > k+1$.

The set of ASC parameters is provided to MAC with the CMAC-Config-REQ primitive (see [15]), the PRACH partitioning is provided to PHY using the CPHY-TrCH-Config-REQ primitive (see [34]).

The ASC enumeration shall be such that it corresponds to the order of priority (ASC 0 = highest priority, ASC 7 = lowest priority). ASC 0 shall be used in case of Emergency Call or for reasons with equivalent priority.

At radio bearer setup/reconfiguration each involved logical channel is assigned a MAC Logical channel Priority (MLP) in the range 1, ..., 8. When the MAC sublayer is configured for RACH transmission in the UE, these MLP levels shall be employed for ASC selection on MAC.

8.5.13 Mapping of Access Classes to Access Service Classes

Access Classes shall only be applied at initial access, i.e. when sending an RRC CONNECTION REQUEST message. A mapping between Access Class (AC) and Access Service Class (ASC) shall be indicated by the information element "AC-to-ASC mapping" in System Information Block type 5. The correspondence between AC and ASC shall be indicated as follows.

| AC | 0 - 9 | 10 | 11 | 12 | 13 | 14 | 15 |
|-----|--------------------|--------------------|--------------------|--------------------|--------------------|--------------------|--------------------|
| ASC | 1 st IE | 2 nd IE | 3 rd IE | 4 th IE | 5 th IE | 6 th IE | 7 th IE |

In the table, "nth IE" designates an ASC number i in the range 0 - 7 to AC.

For the random access, the parameters implied by the respective ASC shall be employed. In case the UE is member of several ACs it shall select the ASC for the highest AC number. In connected mode, AC shall not be applied.

8.5.14 PLMN Type Selection

The UE shall perform PLMN selection and reselection as stated in [4] and store the identifier of the chosen PLMN in the variable SELECTED_PLMN as follows. The UE shall:

- if a GSM-MAP type of PLMN is selected:
 - set the "PLMN Type" in the variable SELECTED_PLMN to "GSM-MAP";
 - and store the PLMN identity of that PLMN.
- if an ANSI-41 type of PLMN is selected:
 - set the "PLMN Type" in the variable SELECTED_PLMN to "ANSI-41";
 - and store the System identification (SID) of that PLMN.

8.5.14a Neighbour cells list narrowing for cell reselection

A UE having performed the PLMN identification of the neighbour cells as specified in 8.1.1.6.18 may narrow the cell list to be used for cell reselection ([4]) to those cells that do satisfy one of the following criteria:

- the PLMN identity of the neighbour cell is the identity of the selected PLMN;
- the PLMN identity of the neighbour cell is indicated by higher layers to be equivalent to the identity of the selected PLMN.

8.5.15 CFN calculation

8.5.15.1 Initialisation for CELL_DCH state after state transition

When the UE receives any of the messages causing the UE to perform a state transition to CELL_DCH, the UE shall set the CFN in relation to the SFN of the first radio link listed in the IE "Downlink information per radio link list" included in that message according to the following formula:

- for FDD:

$$\text{CFN} = ((\text{SFN} * 38400 - \text{DOFF}) \text{ div } 38400) \text{ mod } 256$$

- for TDD:

$$\text{CFN} = (\text{SFN} - \text{DOFF}) \text{ mod } 256$$

8.5.15.2 Initialisation in CELL_DCH state at hard handover

When the UE is in CELL_DCH state and receives any of the messages causing the UE to perform a hard handover, the UE shall check the IE "Timing indication" in that message and:

- if IE "Timing indication" has the value "initialise" (i.e. timing re-initialised hard handover):
 - read SFN on target cell identified by the first radio link listed in the IE "Downlink information per radio link list" included in that message;
 - set the CFN according to the following formula:
 - for FDD:
 - $\text{CFN} = ((\text{SFN} * 38400 - \text{DOFF}) \text{ div } 38400) \text{ mod } 256;$
 - for TDD:
 - $\text{CFN} = (\text{SFN} - \text{DOFF}) \text{ mod } 256;$
- if IE "Timing indication" has the value "maintain" (i.e. timing-maintained hard handover), the UE shall keep CFN with no change due to the hard handover, and only increase CFN (mod 256) by 1 every frame.

8.5.15.3 Initialisation for CELL_FACH

When the UE performs cell selection, re-selection or changes to CELL_FACH state the UE shall set CFN for all common or shared channels according to:

- $\text{CFN} = \text{SFN} \text{ mod } 256$

After the initialisation, the CFN in the UE is increased (mod 256) by 1 every frame.

8.5.15.4 Initialisation after intersystem handover to UTRAN

Upon inter RAT handover to UTRAN the UE shall, regardless of the value received within IE "Timing indication" (if received):

- read SFN on target cell and set the CFN according to the following formula:
 - for FDD:

$$\text{CFN} = ((\text{SFN} * 38400 - \text{DOFF}) \text{ div } 38400) \text{ mod } 256$$

- for TDD:

$$\text{CFN} = (\text{SFN} - \text{DOFF}) \text{ mod } 256$$

8.5.16 Configuration of CTCH occasions

The CTCH, carrying CBS data is mapped onto only one S-CCPCH. If more than one CTCH is defined, the first CTCH that is configured in the list of S-CCPCHs is the one that is used for CBS data.

The CTCH occasions are identified by the first radio frame of the TTI that can contain CTCH data. The CTCH occasions are fixed on the system frame number cycle 0 .. 4095 (i.e. no modulo calculation) and thus repeated cyclically.

The CTCH occasions are determined by a set of parameters.

M_{TTI} : number of radio frames within the TTI of the FACH used for CTCH

N: period of CTCH allocation on S-CCPCH, integer number of radio frames,
 $M_{TTI} \leq N \leq \text{MaxSFN} - K$, where N is a multiple of M_{TTI} (see [27] and [31]).

MaxSFN: maximum system frame number = 4095 (see [10]).

K: CBS frame offset, integer number of radio frames $0 \leq K \leq N-1$ where K is a multiple of M_{TTI} .

The CTCH occasions are calculated as follows:

$$\text{SFN} = (K + m N), m = 0, 1, \dots, M, \text{ with } M \text{ chosen that } K + MN \leq \text{MaxSFN}.$$

The parameters N and K are broadcast as system information.

8.5.17 PRACH selection

For this version of the specification, when a UE selects a cell, the uplink frequency to be used for the initial PRACH transmission shall have a default duplex frequency spacing offset from the downlink frequency that the cell was selected on. The default duplex frequency separation to be used by the UE is specified in [35] (for FDD only).

The UE shall select a "PRACH system information" according to the following rule. The UE shall:

- select a default "PRACH system information" from the ones indicated in the IE "PRACH system information list" in System Information Block type 5 (applicable in Idle Mode and Connected Mode) or System Information Block type 6 (applicable in Connected Mode only), as follows:
 - if both RACH with 10 ms and 20 ms TTI are indicated in System Information Block type 5 or System Information Block type 6:
 - select the appropriate TTI based on power requirements, as specified in subclause 8.5.18;
 - select a "PRACH system information" randomly from the ones listed in System Information Block type 5 or System Information Block type 6 as follows:

$$\text{"Index of selected PRACH"} = \text{floor}(\text{rand} * K)$$

where K is equal to the number of listed PRACH system informations that carry an RACH with the above selected TTI, "rand" is a random number uniformly distributed in the range 0,...,1, and "floor" refers to rounding down to nearest integer. PRACH system informations carrying RACHs with 10 and 20 ms TTI shall be counted separately. These PRACH system informations shall be indexed from 0 to K-1 in the order of their occurrence in System Information Block type 5 or System Information Block type 6. The random number generator is left to implementation. The scheme shall be implemented such that one of the available PRACH system informations is randomly selected with uniform probability. At start-up of the random number generator in the UE the seed shall be dependent on the IMSI of the UE or time, thereby avoiding that all UEs select the same RACH;

- in Connected mode:
 - select the PRACH according to the following preference:
 - if System Information Block type 6 is defined and PRACH info is included:
 - select PRACH from the PRACHs listed in System Information Block type 6;

- if System Information Block type 6 is defined and no PRACH info is included:
 - select PRACH from the PRACHs listed in System Information Block type 5;
- if no System Information Block type 6 is defined:
 - select PRACH from the PRACHs listed in System Information Block type 5.
- reselect the default PRACH system information when a new cell is selected. RACH reselection may also be performed after each transmission of a Transport Block Set on RACH;
- for emergency call, the UE is allowed to select any of the available PRACH system informations.

After selecting a PRACH system information, the RRC in the UE shall configure the MAC and the physical layer for the RACH access according to the parameters included in the selected "PRACH system information" IE.

8.5.18 Selection of RACH TTI

8.5.18.1 FDD Mode

In FDD mode, a RACH may employ either 10 or 20 ms TTI. The supported TTI is indicated as a semi-static parameter of the RACH Transport Format in system information. If in one cell RACHs for both 10 and 20 ms TTI are supported, the UE shall select an appropriate RACH according to the following rule:

The UE shall first check whether a RACH Transport Format is available which is suitable for the transmission of the current transport Block Set for both 10 and 20 ms TTI. The UE shall:

- if the required transport format is available only for one particular TTI:
 - select this TTI;
 - identify the corresponding RACHs;
 - proceed with RACH selection as specified in subclause 8.5.17.
- if the required transport format is available on both types of RACH, 10 and 20 ms TTI:
 - perform TTI selection as follows:
 - when the UE calculates the initial preamble transmit power ("Preamble_Initial_Power") as specified in subclause 8.5.7:
 - calculate a transmit power margin,

$$\text{Margin} = \{ \min(\text{Maximum allowed UL tx power, P_MAX}) - \max(\text{Preamble_Initial_Power, Preamble_Initial_Power} + \Delta P_{p-m} + 10 \cdot \log_{10}(1 + (\beta_d / \beta_c)^2)) \}$$

where "Maximum allowed UL tx power" is the maximum allowed uplink transmit power indicated in system information (in dBm), and P_MAX is the maximum RF output power of the UE (dBm). The margin shall be calculated for 10 ms TTI RACH message gain factors β_d and β_c .

NOTE: the expression $\text{Preamble_Initial_Power} + \Delta P_{p-m} + 10 \cdot \log_{10}(1 + (\beta_d / \beta_c)^2)$ represents the total RACH message power if the message would be sent after the initial preamble.

- if the value of "Margin" calculated for RACH with 10 ms TTI is less than 6 dB:
 - select RACH with 20 ms TTI, and proceed as specified in subclause 8.5.17.
- perform reselection of the RACH TTI only after successful transmission of one Transport Block Set. However in case L1 message transmission on PRACH has failed at least once while using 10 ms TTI, the UE may use the 20 ms TTI RACH for the retransmission. Handling of RACH Message transmission failure is part of general error handling procedure.

8.5.18.2 1.28Mcps TDD

In 1.28Mcps TDD, a RACH may be assigned a 5, 10 or 20 ms TTI. If, in one cell, more than one RACH is defined a UE shall select the RACH that is to be used for each transmission according to the following rule:

- if only one RACH is assigned a transport format that is suitable for the transmission of the transport block set:
 - select this RACH and the RACH's TTI;
- if more than one RACH is assigned a transport format that is suitable for the transmission of the transport block set:
 - select that which has the largest TTI;
 - if two or more RACH having the same TTI fulfil this criteria:
 - select randomly between them as follows:

$$\text{"Index of selected PRACH"} = \text{floor}(\text{rand} * K)$$

where K is equal to the number of listed PRACH system informations that carry an RACH with the above selected TTI and criteria, "rand" is a random number uniformly distributed in the range 0,...,1, and "floor" refers to rounding down to nearest integer. PRACH system informations carrying RACHs with 5, 10 and 20 ms TTI shall be counted separately. These PRACH system informations shall be indexed from 0 to K-1 in the order of their occurrence in SIB 5 or SIB 6. The random number generator is left to implementation. The scheme shall be implemented such that one of the available PRACH system informations is randomly selected with uniform probability. At start-up of the random number generator in the UE the seed shall be dependent on the IMSI of the UE or time, thereby avoiding that all UEs select the same RACH.

8.5.19 Secondary CCPCH selection

In UTRAN Connected mode, the UE shall select the Secondary CCPCH according to the following rules:

- in Cell_DCH state:
 - select Secondary CCPCH according to subclause 8.6.6.4;
- in Cell_FACH state:
 - select an SCCPCH from the SCCPCHs listed in SIB 5 or SIB 6 based on U-RNTI as follows:

$$\text{"Index of selected SCCPCH"} = \text{U-RNTI mod } K,$$

where K is equal to the number of listed SCCPCHs that carry a FACH (i.e., SCCPCHs carrying PCH only shall not be counted). These SCCPCHs shall be indexed from 0 to K-1 in the order of their occurrence in SIB 5 or SIB 6. "Index of selected SCCPCH" identifies the selected SCCPCH.

- if SIB 6 is defined and SCCPCH info is included:
 - select SCCPCH from the SCCPCHs listed in SIB 6;
- if SIB 6 is defined and no SCCPCH info is included:
 - select SCCPCH from the SCCPCHs listed in SIB 5;
- if no SIB 6 is defined:
 - select SCCPCH from the SCCPCHs listed in SIB 5.
- in Cell_PCH and URA_PCH states:
 - select an SCCPCH from the SCCPCHs listed in SIB 5 or SIB 6 based on U-RNTI as follows:

$$\text{"Index of selected SCCPCH"} = \text{U-RNTI mod } K,$$

where K is equal to the number of listed SCCPCHs that carry a PCH (i.e., SCCPCHs carrying FACH only shall not be counted). These SCCPCHs shall be indexed in the order of their occurrence in system information from 0 to K-1, and "Index of selected SCCPCH" identifies the selected SCCPCH.

- if SIB 6 is defined and SCCPCH info is included:
 - select SCCPCH from the SCCPCHs listed in SIB 6;
- if SIB 6 is defined and no SCCPCH info is included:
 - select SCCPCH from the SCCPCHs listed in SIB 5;
- if no SIB 6 is defined:
 - select SCCPCH from the SCCPCHs listed in SIB 5.

UE shall set CFN in relation to SFN of current cell according to subclause 8.5.15.

The UE shall support reception of all transport formats on all FACHs multiplexed on the selected S-CCPCH.

8.6 Generic actions on receipt and absence of an information element

8.6.1 CN information elements

8.6.1.1 Void

8.6.1.2 CN information info

If the IE "CN information info" is present in a message, the UE shall:

- if present, forward the content of the IE "PLMN identity" to upper layers;
- if present, forward the content of the IE "CN common GSM-MAP NAS system information" to upper layers;
- if the IE "CN domain related information" is present:
 - forward each occurrence of the IE "CN domain specific GSM-MAP NAS system info" together with the IE "CN domain identity" to upper layers;
 - if an IE "CN domain specific GSM-MAP NAS system info" is not present for a particular CN domain:
 - indicate to upper layers that no CN system information is available for that CN domain.

8.6.1.3 Signalling connection release indication

If the IE "Signalling Connection release indication" is present in a message, the UE shall:

- if all radio access bearers for the CN domain identified with the value of the IE "Signalling Connection release indication" would have been released in the variable ESTABLISHED_RABS after processing of the received message:
 - indicate release of the signalling connection identified with the value of the IE "Signalling Connection release indication" to the upper layers;
 - remove the signalling connection identified with the value of the IE "Signalling Connection release indication" from the variable ESTABLISHED_SIGNALLING_CONNECTIONS;
- if radio access bearers for the CN domain identified with the value of the IE "Signalling Connection release indication" would remain in the variable ESTABLISHED_RABS after processing of the received message:

- set the variable INVALID_CONFIGURATION to TRUE.

8.6.2 UTRAN mobility information elements

8.6.2.1 URA identity

The UE shall:

- if the IE "URA identity" is included in a received message:
 - if the IE "RRC State Indicator" is included and set to "URA_PCH":
 - store this URA identity in the variable URA_IDENTITY;
 - after sending a possible message to UTRAN and entering URA_PCH state as specified elsewhere, read system information block type 2 in the selected cell;
 - if the stored URA identity in the variable URA_IDENTITY is not included in the list of URA identities in System Information Block type 2 in the selected cell, the list of URA identities in system information block type 2 is empty or if the system information block type 2 can not be found, a confirmation error of URA identity list has occurred:
 - if no URA update procedure is ongoing:
 - initiate a URA update procedure after entering URA_PCH state; see subclause 8.3.1.2;
 - if a URA update procedure is ongoing:
 - take actions as specified in subclause 8.3.1.10;
 - if the IE "URA identity" is not included in a received message:
 - the IE "RRC State Indicator" is included and set to " URA_PCH":
 - after sending a possible message to UTRAN and entering URA_PCH state as specified elsewhere, read System Information Block type 2 in the selected cell;
 - if System Information Block type 2 in the selected cell contains a single URA identity:
 - store this URA identity in the variable URA_IDENTITY;
 - if System Information Block type 2 of the selected cell contains more than one URA identity, the list of URA identities in system information block type 2 is empty or if the system information block type 2 can not be found, a confirmation error of URA identity list has occurred:
 - if no URA update procedure is ongoing:
 - initiate a URA update procedure after entering URA_PCH state, see subclause 8.3.1.2;
 - if a URA update procedure is ongoing:
 - take actions as specified in subclause 8.3.1.10.

8.6.2.2 Mapping info

If the IE "Mapping info" is received, the UE shall in this version of the specification:

- ignore the contents of this IE.

8.6.3 UE information elements

8.6.3.1 Activation time

If the UE receives a message in which presence is needed for the IE "Activation time", and the value is other than the default value "Now", the UE shall:

- if the frame boundary immediately before the frame with the CFN (Connection Frame Number) value indicated by the IE "Activation Time" is at the TTI boundary common to all the transport channels that are multiplexed onto the same CCTrCh including any transport channel which is added, reconfigured or has been removed:
 - select that frame boundary as the activation time T;
- else:
 - select the next TTI boundary, which is common to all the transport channels that are multiplexed onto the same CCTrCh including any transport channel which is added, reconfigured or has been removed, after the frame with the CFN (Connection Frame Number) value indicated by the IE "Activation Time", as the activation time T;
- at the activation time T:
 - for a physical channel reconfiguration caused by the received message:
 - release the physical channel configuration, which was present before T;
 - initiate the establishment of the physical channel configuration as specified for the physical channel information elements in the received message as specified elsewhere;
 - for actions, other than a physical channel reconfiguration, caused by the received message:
 - perform the actions for the information elements in the received message as specified elsewhere.

If the UE receives a message in which presence is needed for the IE "Activation time", and the value is the default value "Now", the UE shall:

- choose an activation time T as soon as possible after the reception of the message, respecting the performance requirements in subclause 13.5;
- at the activation time T:
 - perform the actions for the information elements in the received message as specified elsewhere.

8.6.3.1a CN domain specific DRX cycle length coefficient

The UE updates CN domain specific DRX cycle length coefficient as specified in [4]. The UE shall use it to calculate the CN domain specific DRX cycle length, according to the following:

- set k to the value of the IE "CN domain specific DRX cycle length coefficient".
- store the result of $\text{MAX}(2^k, \text{PBP})$, where PBP is the Paging Block Periodicity, as the CN domain specific DRX cycle length for the CN domain indicated by the IE "CN domain identity". For FDD PBP=1.

The UE shall determine its idle mode paging occasions and PICH monitoring occasions for that CN domain, according to [4], based on the stored CN domain specific DRX cycle length, when using DRX in idle mode.

8.6.3.2 UTRAN DRX Cycle length coefficient

If the IE "UTRAN DRX cycle length coefficient" is present, the UE shall use it to calculate the UTRAN DRX cycle length, according to the following:

- set k to the value of the IE "UTRAN DRX cycle length coefficient";
- store the result of $\text{MAX}(2^k \cdot \text{PBP})$, where PBP is the Paging Block Periodicity, as the DRX cycle length.

The UE shall determine its connected mode paging occasions and PICH monitoring occasions in the same way as for idle mode, according to [4].

The DRX cycle length to use in connected mode is the shorter of the following two parameters:

- UTRAN DRX cycle length;

- CN domain specific DRX cycle length stored for any CN domain, when using Discontinuous Reception (DRX) in CELL_PCH and URA_PCH state.

The CN domain specific DRX cycle length stored for any CN domain is only used in Cell_PCH state and URA_PCH state if the UE is registered to that CN domain and no signalling connection stored in the variable ESTABLISHED_SIGNALLING_CONNECTIONS exists to that CN domain.

8.6.3.3 Generic state transition rules depending on received information elements

The IE "RRC State Indicator" indicates the state the UE shall enter. The UE shall enter the state indicated by the IE "RRC State Indicator" even if the received message includes other IEs relevant only for states other than indicated by the IE "RRC State Indicator". E.g. if the RRC state indicator is set to CELL_FACH while other IEs provide information about a configuration including dedicated channels, the UE shall enter CELL_FACH state. If however the UE has no information about the configuration corresponding to the state indicated by the IE "RRC State Indicator", it shall consider the requested configuration as invalid.

The UE shall, if the IE "RRC State Indicator" in the received message has the value:

- "CELL_FACH":
 - enter CELL_FACH state as dictated by the procedure governing the message received;
- "CELL_DCH":
 - if neither DPCH is assigned in the message nor is the UE is CELL_DCH:
 - set the variable INVALID_CONFIGURATION to TRUE;
 - else:
 - enter CELL_DCH state as dictated by the procedure governing the message received;
- "CELL_PCH":
 - if the received message is RRC CONNECTION SETUP and IE "RRC State Indicator" is set to CELL_PCH:
 - set the variable INVALID_CONFIGURATION to TRUE;
 - else:
 - enter CELL_PCH state as dictated by the procedure governing the message received;
- "URA_PCH":
 - if the received message is RRC CONNECTION SETUP and IE "RRC State Indicator" is set to URA_PCH:
 - set the variable INVALID_CONFIGURATION to TRUE;
 - else:
 - enter URA_PCH state as dictated by the procedure governing the message received.

8.6.3.4 Cipherng mode info

The IE "Cipherng mode info" defines the new cipherng configuration. If the IE "Cipherng mode info" is present and if the IE "Reconfiguration" in the variable CIPHERING_STATUS is set to FALSE, the UE shall check the IE "Cipherng mode command" as part of the IE "Cipherng mode info", and perform the following. The UE shall:

- if the IE "Status" in the variable CIPHERING_STATUS has the value "Not Started", and if the IE "Cipherng mode command" has the value "stop":
 - ignore this attempt to change the cipherng configuration; and
 - set the variable INVALID_CONFIGURATION to TRUE;
- else:

- set the IE "Reconfiguration" in the variable CIPHERING_STATUS to TRUE;
- if IE "Ciphering mode command" has the value "start/restart":
 - start or restart ciphering in lower layers for all established radio bearers in the variable ESTABLISHED_RABS, using the ciphering algorithm (UEA [40]) indicated by the IE "Ciphering algorithm" as part of the new ciphering configuration. For each radio bearer, the value of the IE "RB identity" in the variable ESTABLISHED_RABS minus one shall be used as the value of BEARER in the ciphering algorithm. The new ciphering configuration shall be applied as specified below;
 - set the IE "Status" in the variable CIPHERING_STATUS to "Started";
- if the IE "Ciphering mode command" has the value "stop", the UE shall:
 - stop ciphering and stop incrementing COUNT-C values for all signalling radio bearers and also for transparent RLC mode radio bearers, only at the new ciphering configuration that shall be applied as specified below;
 - set the IE "Status" in the variable CIPHERING_STATUS to "Not started";
- in case the IE "Ciphering mode command" has the value "start/restart" or "stop", the new ciphering configuration shall be applied as follows:
 - store the (oldest currently used) ciphering configuration until activation times have elapsed for the new ciphering configuration to be applied on all signalling radio bearers and radio bearers;
 - if there are pending activation times set for ciphering by a previous procedure changing the ciphering configuration:
 - apply the ciphering configuration at this pending activation time as indicated in this procedure;
 - only need to store at most two different ciphering configurations at any given time for all signalling radio bearers and radio bearers, the old and latest ciphering configurations, per CN domain;
 - if the IE "Ciphering activation time for DPCH" is present in the IE "Ciphering mode info":
 - apply the new configuration at that time for radio bearers using RLC-TM. If the IE "Ciphering mode info" is present in a message reconfiguring RB, transport channel or physical channel, the indicated time in IE "Activation time for DPCH" corresponds to a CFN after that reconfiguration;
 - if the IE "Radio bearer downlink ciphering activation time info" is present in the IE "Ciphering mode info":
 - apply the following procedure for each radio bearer using RLC-AM and RLC-UM indicated by the IE "RB identity":
 - suspend data transmission on the radio bearer;
 - select an "RLC send sequence number" at which (activation) time the new ciphering configuration shall be applied in uplink for that radio bearer according to the following:
 - for each radio bearer and signalling radio bearer that has no pending ciphering activation time as set by a previous procedure changing the security configuration:
 - set a suitable value that would ensure a minimised delay in the change to the latest security configuration;
 - for each radio bearer and signalling radio bearer that has a pending ciphering activation time as set by a previous procedure changing the security configuration:
 - set the same value as the pending ciphering activation time;
 - consider this activation time to be elapsed when the selected activation time (as above) is equal to the "RLC send sequence number";
 - store the selected "RLC send sequence number" for that radio bearer in the entry for the radio bearer in the variable RB_UPLINK_CIPHERING_ACTIVATION_TIME_INFO;

- when the data transmission of that radio bearer is resumed:
 - switch to the new ciphering configuration according to the following:
 - use the old ciphering configuration for the transmitted and received RLC PDUs with RLC sequence numbers smaller than the corresponding RLC sequence numbers indicated in the IE "Radio bearer uplink ciphering activation time info" sent to UTRAN and in the received IE "Radio bearer downlink ciphering activation time info" received from UTRAN, respectively;
 - use the new ciphering configuration for the transmitted and received RLC PDUs with RLC sequence numbers greater than or equal to the corresponding RLC sequence numbers indicated in the IE "Radio bearer uplink ciphering activation time info" sent to UTRAN and in the received IE "Radio bearer downlink ciphering activation time info" received from UTRAN, respectively;
 - for a radio bearer using RLC-AM, when the RLC sequence number indicated in the IE "Radio bearer downlink ciphering activation time info" falls below the RLC receiving window and the RLC sequence number indicated in the IE "Radio bearer uplink ciphering activation time info" falls below the RLC transmission window, the UE may release the old ciphering configuration for that radio bearer;
 - if an RLC reset or re-establishment occurs before the activation time for the new ciphering configuration has been reached, ignore the activation time and apply the new ciphering configuration immediately after the RLC reset or RLC re-establishment.

If the IE "Ciphering mode info" is present and if the IE "Reconfiguration" in the variable CIPHERING_STATUS is set to TRUE, the UE shall:

- ignore this second attempt to change the ciphering configuration; and
- set the variable INCOMPATIBLE_SECURITY_RECONFIGURATION to TRUE.

If the IE "Ciphering mode info" is not present, the UE shall not change the ciphering configuration.

8.6.3.5 Integrity protection mode info

The IE "Integrity protection mode info" defines the new integrity protection configuration. If the IE "Integrity protection mode info" is present and if the IE "Reconfiguration" in the variable INTEGRITY_PROTECTION_STATUS is set to FALSE, the UE shall check the IE "Integrity protection mode command" as part of the IE "Integrity protection mode info", and perform the following. The UE shall:

- if the IE "Integrity protection mode command" has the value "Modify" and the IE "Status" in the variable INTEGRITY_PROTECTION_INFO has the value "Not Started":
 - ignore this attempt to change the integrity protection configuration; and
 - set the variable INVALID_CONFIGURATION to TRUE;
- else:
 - set the IE "Reconfiguration" in the variable INTEGRITY_PROTECTION_STATUS to TRUE;
 - if IE "Integrity protection mode command" has the value "start" and the IE "Status" in the variable INTEGRITY_PROTECTION_INFO has the value "Not started":
 - if the IE "Historical status" in the variable INTEGRITY_PROTECTION_INFO has the value "Never been active":
 - initialise the information for all signalling radio bearers in the variable INTEGRITY_PROTECTION_INFO according to the following:
 - calculate the START value as specified in subclauses 8.5.9 for the CN domain as indicated in the variable LATEST_CONFIGURED_CN_DOMAIN;
 - set the 20 MSB of the "Uplink RRC HFN" and "Downlink RRC HFN" with the START value as calculated above;

- set the remaining LSB of the "Uplink RRC HFN" and "Downlink RRC HFN" to zero;
- set the IE "Uplink RRC Message sequence number" to zero;
- do not include the IE "Downlink RRC Message sequence number";
- set the IE "Historical status" in the variable INTEGRITY_PROTECTION_INFO to the value "Has been active";
- set the IE "Status" in the variable INTEGRITY_PROTECTION_INFO to the value "Started";
- perform integrity protection on the received message as described in subclause 8.5.10.1;
- use the algorithm (UIA [40]) indicated by the IE "Integrity protection algorithm" contained in the IE "Integrity protection mode info";
- use the IE "Integrity protection initialisation number", contained in the IE "Integrity protection mode info" as the value of FRESH [40];
- if IE "Integrity protection mode command" has the value "start" and the IE "Status" in the variable INTEGRITY_PROTECTION_INFO has the value "Started":

NOTE: This case is used in SRNS relocation

- perform integrity protection on the received message as described in subclause 8.5.10.1;
- use the algorithm (UIA [40]) indicated by the IE "Integrity protection algorithm" contained in the IE "Integrity protection mode info";
- use the IE "Integrity protection initialisation number", contained in the IE "Integrity protection mode info" as the value of FRESH [40];
- if IE "Integrity protection mode command" has the value "modify" and the IE "Status" in the variable INTEGRITY_PROTECTION_INFO has the value "Started":
 - store the (oldest currently used) integrity protection configuration until activation times have elapsed for the new integrity protection configuration to be applied on all signalling radio bearers;
 - if there are pending activation times set for integrity protection by a previous procedure changing the integrity protection configuration:
 - apply the integrity protection configuration at this pending activation time as indicated in this procedure;
 - only need to store at most two different integrity protection configurations at any given time for all signalling radio bearers, the old and newest integrity protection configurations, per CN domain;
 - start applying the new integrity protection configuration in the downlink at the RRC sequence number, for each radio bearer n, indicated by the entry for radio bearer n in the "RRC message sequence number list" in the IE "Downlink integrity protection activation info", included in the IE "Integrity protection mode info";
 - perform integrity protection on the received message as described in subclause 8.5.10.1;
 - if present, use the algorithm indicated by the IE "Integrity protection algorithm" (UIA [40]);
 - set the content of the variable INTEGRITY_PROTECTION_ACTIVATION_INFO according to the following:
 - for each established signalling radio bearer, stored in the variable ESTABLISHED_RABS:
 - select a value of the RRC sequence number at which (activation) time the new integrity protection configuration shall be applied in uplink for that signalling radio bearer according to the following:
 - for each signalling radio bearer that has no pending activation time as set for integrity protection by a previous procedure changing the integrity protection configuration:

- set a suitable value that would ensure a minimised delay in the change to the latest integrity protection configuration;
- for signalling radio bearer that has a pending activation time as set for integrity protection by a previous procedure changing the integrity protection configuration:
 - set the same value as the pending activation time for integrity protection;
- consider this activation time to be elapsed when the selected activation time (as above) is equal to the next RRC sequence number to be used;
- for signalling radio bearer RB0:
 - set the value of the included RRC sequence number to greater than or equal to the current value of the RRC sequence number for signalling radio bearer RB0 in the variable INTEGRITY_PROTECTION_INFO, plus the value of the constant N302 plus one;
- let RBm be the signalling radio bearer on which the message containing the IE "integrity protection mode info" was received;
- start applying the new integrity protection configuration in the uplink at the RRC sequence number, for each RBn, except for signalling radio bearer RBm, indicated by the entry for radio bearer n in the "RRC message sequence number list" in the IE "Uplink integrity protection activation info", included in the variable INTEGRITY_PROTECTION_ACTIVATION_INFO;
- start applying the new integrity protection configuration in the uplink at the RRC sequence number for signalling radio bearer RBm, as specified for the procedure initiating the integrity protection reconfiguration;

If the IE "Integrity protection mode info" is present and if the IE "Reconfiguration" in the variable INTEGRITY_PROTECTION_STATUS is set to TRUE, the UE shall:

- ignore this second attempt to change the integrity protection configuration; and
- set the variable INCOMPATIBLE_SECURITY_RECONFIGURATION to TRUE.

If the IE "Integrity protection mode info" is not present, the UE shall not change the integrity protection configuration.

8.6.3.6 Void

8.6.3.7 Void

8.6.3.8 Integrity check info

If the IE "Integrity check info" is present the UE shall:

- act as described in subclause 8.5.10.1.

8.6.3.9 New C-RNTI

If the IE "New C-RNTI" is included, the UE shall:

- store the value in the variable C_RNTI, replacing any old stored value;
- use that C-RNTI when using common transport channels of type RACH, FACH and CPCH in the current cell.

8.6.3.10 New U-RNTI

If the IE "New U-RNTI" is included in a received message, the UE shall:

- store the value in the variable U_RNTI, replacing any old stored value.

8.6.3.11 RRC transaction identifier

The IE "RRC transaction identifier" may be used, together with the message type, for identification of an invocation of a downlink procedure (transaction). The UE behaviour for accepting or rejecting transactions based on the message type and the IE "RRC transaction identifier" is specified below.

If the IE "RRC transaction identifier" is included in a received message, the UE shall perform the actions below. The UE shall:

If the received message is any of the messages:

- RADIO BEARER SETUP; or
- RADIO BEARER RECONFIGURATION; or
- RADIO BEARER RELEASE; or
- TRANSPORT CHANNEL RECONFIGURATION; or
- PHYSICAL CHANNEL RECONFIGURATION:

the UE shall:

- if the variable ORDERED_RECONFIGURATION is set to FALSE; and
- if the variable CELL_UPDATE_STARTED is set to FALSE; and
- if the received message does not contain a protocol error according to clause 9 and the variable PROTOCOL_ERROR_REJECT is set to FALSE:
 - accept the transaction; and
 - store the IE "Message type" and the IE "RRC transaction identifier" of the received message in the table "Accepted transactions" in the variable TRANSACTIONS;
- else:
 - if the variable ORDERED_RECONFIGURATION is set to TRUE; or
 - if the variable CELL_UPDATE_STARTED is set to TRUE; or
 - if the table "Accepted transactions" in the variable TRANSACTIONS contains an entry with an IE "Message Type" set to ACTIVE SET UPDATE; or
 - if the received message contains a protocol error according to clause 9 causing the variable PROTOCOL_ERROR_REJECT to be set to TRUE:
 - if the IE "RRC transaction identifier" of the received message is identical to the "RRC transaction identifier" stored for the same "Message Type" as the received message in the table "Accepted transactions" in the variable TRANSACTIONS:
 - ignore the transaction; and
 - continue with any ongoing processes and procedures as the message was not received;
 - and end the procedure;
 - else:
 - reject the transaction; and
 - if the IE "Message Type" of the received message is not present in the table "Rejected transactions" in the variable TRANSACTIONS:

- store the IE "Message type" and the IE "RRC transaction identifier" of the received message in the table "Rejected transactions" in the variable TRANSACTIONS.

Else:

If the received message is any of the messages:

- RRC CONNECTION SETUP; or
- CELL UPDATE CONFIRM; or
- URA UPDATE CONFIRM:

the UE shall:

- if the IE "Message Type" of the received message is not present in the table "Accepted transactions" in the variable TRANSACTIONS:
 - if the received message does not contain a protocol error according to clause 9 and the variable PROTOCOL_ERROR_REJECT is set to FALSE:
 - accept the transaction; and
 - store the IE "Message type" and the IE "RRC transaction identifier" of the received message in the table "Accepted transactions" in the variable TRANSACTIONS;
 - else:
 - if the received message contains a protocol error according to clause 9 causing the variable PROTOCOL_ERROR_REJECT to be set to TRUE:
 - reject the transaction; and
 - if the IE "Message Type" of the received message is not present in the table "Rejected transactions" in the variable TRANSACTIONS:
 - store the IE "Message type" and the IE "RRC transaction identifier" of the received message in the table "Rejected transactions" in the variable TRANSACTIONS.
 - else:
 - if the IE "Message Type" of the received message is present in the table "Accepted transactions" in the variable TRANSACTIONS:
 - if the IE "RRC transaction identifier" of the received message is identical to the "RRC transaction identifier" stored for the "Message Type" in the table "Accepted transactions" in the variable TRANSACTIONS:
 - ignore the transaction; and
 - continue with any ongoing processes and procedures as the message was not received; and
 - end the procedure;
 - else:
 - if the IE "RRC transaction identifier" of the received message is different from the "RRC transaction identifier" stored for the "Message Type" in the table "Accepted transactions" in the variable TRANSACTIONS:
 - if the received message does not contain a protocol error according to clause 9 and the variable PROTOCOL_ERROR_REJECT is set to FALSE:
 - ignore the once accepted transaction and instead accept the new transaction; and
 - store the IE "Message type" and the IE "RRC transaction identifier" of the received message in the table "Accepted transactions" in the variable TRANSACTIONS, replacing the previous entry;
 - else:

- if the received message contains a protocol error according to clause 9 causing the variable `PROTOCOL_ERROR_REJECT` to be set to `TRUE`:
 - reject the transaction; and
 - if the IE "Message Type" of the received message is not present in the table "Rejected transactions" in the variable `TRANSACTIONS`:
 - store the IE "Message type" and the IE "RRC transaction identifier" of the received message in the table "Rejected transactions" in the variable `TRANSACTIONS`.

Else:

If the received message is any other message, the UE shall:

- if the IE "Message Type" of the received message is not present in the table "Accepted transactions" in the variable `TRANSACTIONS`:
 - if the received message does not contain a protocol error according to clause 9 and the variable `PROTOCOL_ERROR_REJECT` is set to `FALSE`:
 - accept the transaction; and
 - store the IE "Message type" and the IE "RRC transaction identifier" of the received message in the table "Accepted transactions" in the variable `TRANSACTIONS`;
 - else:
 - if the received message contains a protocol error according to clause 9 causing the variable `PROTOCOL_ERROR_REJECT` to be set to `TRUE`:
 - reject the transaction; and
 - store the IE "Message type" and the IE "RRC transaction identifier" of the received message in the table "Rejected transactions" in the variable `TRANSACTIONS`.
 - else:
 - if the IE "Message Type" of the received message is present in the table "Accepted transactions" in the variable `TRANSACTIONS`:
 - if the IE "RRC transaction identifier" of the received message is identical to the "RRC transaction identifier" stored in any entry for the "Message Type" in the table "Accepted transactions" in the variable `TRANSACTIONS`:
 - ignore the transaction; and
 - continue with any ongoing processes and procedures as the message was not received; and
 - end the procedure;
 - else:
 - if the IE "RRC transaction identifier" of the received message is different from the "RRC transaction identifier" stored in all entries for the "Message Type" in the table "Accepted transactions" in the variable `TRANSACTIONS`:
 - if the received message does not contain a protocol error according to clause 9 and the variable `PROTOCOL_ERROR_REJECT` is set to `FALSE`:
 - accept the additional transaction; and
 - store the IE "Message type" and the IE "RRC transaction identifier" of the received message in the table "Accepted transactions" in the variable `TRANSACTIONS`, in addition to the already existing entries;
 - else:

- if the received message contains a protocol error according to clause 9 causing the variable `PROTOCOL_ERROR_REJECT` to be set to `TRUE`:
 - reject the transaction; and
 - store the IE "Message type" and the IE "RRC transaction identifier" of the received message in the table "Rejected transactions" in the variable `TRANSACTIONS`.

8.6.3.12 Capability Update Requirement

If the IE "Capability Update Requirement" is included the UE shall:

- if the IE "UE radio access FDD capability update requirement" has the value `TRUE`:
 - if the UE supports FDD mode:
 - store its UTRA FDD capabilities and its UTRA capabilities common to FDD and TDD in the IE "UE radio access capability" and the IE "UE radio access capability extension" in variable `UE_CAPABILITY_REQUESTED` as specified below:
 - if the UE supports multiple UTRA FDD Frequency Bands; or
 - if the UE supports a single UTRA FDD Frequency Band different from 2100 MHz:
 - store the IE "UE radio access capability", excluding IEs "RF capability FDD" and "Measurement capability";
 - store the IE "UE radio access capability extension", including the IEs "RF capability FDD extension" and the "Measurement capability extension" associated with each supported UTRA FDD frequency band indicated in the IE "Frequency band";
 - else:
 - store the IE "UE radio access capability", including the IEs "RF capability FDD" and "Measurement capability" associated with the 2100 MHz UTRA FDD frequency band;
- if the IE "UE radio access 3.84Mcps TDD capability update requirement" has the value `TRUE`:
 - if the UE supports 3.84Mcps TDD mode:
 - store its UTRAN-specific 3.84Mcps TDD capabilities and its UTRAN-specific capabilities common to FDD and TDD in the variable `UE_CAPABILITY_REQUESTED`;
- if the IE "UE radio access 1.28Mcps TDD capability update requirement" has the value `TRUE`:
 - if the UE supports 1.28Mcps TDD mode:
 - store its UTRAN-specific 1.28Mcps TDD capabilities and its UTRAN-specific capabilities common to FDD and TDD in the variable `UE_CAPABILITY_REQUESTED`;
- if the IE "System specific capability update requirement list" is present:
 - for each of the RAT requested in the IE "UE system specific capability"
 - if the UE supports the listed RAT:
 - include its inter-RAT radio access capabilities for the listed RAT in the IE "UE system specific capability" from the variable `UE_CAPABILITY_REQUESTED`.

If the IE "Capability update requirement" is not present, the UE shall:

- assume the default values as specified in subclause 10.3.3.2 and act in accordance with the above.

8.6.4 Radio bearer information elements

8.6.4.1 Signalling RB information to setup list

If the IE "Signalling RB information to setup list" is included the UE shall:

- use the same START value to initialise the COUNT-C and COUNT-I variables for all the signalling radio bearers in the list;
- for each occurrence of the IE "Signalling RB information to setup":
 - use the value of the IE "RB identity" as the identity of the signalling radio bearer to setup;
 - if the value "STATUS" of the variable "CIPHERING_STATUS" is "Started":
 - if the IE "Uplink RLC mode" or the IE "Downlink RLC mode" in the IE "RLC info" is set to "AM RLC" or "UM RLC":
 - initialise the 20 MSB of the hyper frame number component of COUNT-C for this signalling radio bearer with the START value for the CN domain as indicated in the variable "LATEST_CONFIGURED_CN_DOMAIN";
 - set the remaining LSB of the hyper frame number component of COUNT-C for this signalling radio bearer to zero;
 - if the IE "Uplink RLC mode" and the IE "Downlink RLC mode" in the IE "RLC info" is set to "TM RLC":
 - if no other transparent mode RLC radio bearers or signalling radio bearers in the variable "ESTABLISHED_RABS" exist:
 - initialise the 20 MSB of the hyper frame number component of COUNT-C for this signalling radio bearer with the START value for the CN domain as indicated in the IE "CN domain identity" in the IE "RAB info" part of the IE "RAB information to setup";
 - set the remaining LSB of the hyper frame number component of COUNT-C for this signalling radio bearer to zero;
 - if at least one transparent mode RLC radio bearers or signalling radio bearers in the variable "ESTABLISHED_RABS" exist:
 - use, for this signalling radio bearer, the COUNT-C for transparent mode radio bearers and signalling radio bearers that is common (refer to subclause 8.5.8), for the CN domain as indicated in the IE "CN domain identity" in the IE "RAB info" part of the IE "RAB information to setup";
 - if the value "Historical status" of the variable "INTEGRITY_PROTECTION_INFO" is "Started":
 - initialise the 20 MSB of the hyper frame number component of COUNT-I for this signalling radio bearer with the START value for the CN domain as indicated in the variable LATEST_CONFIGURED_CN_DOMAIN;
 - set the remaining LSB of the hyper frame number component of COUNT-I for this signalling radio bearer to zero;
 - perform the actions for the IE "RLC info" as specified in subclause 8.6.4.9, applied for that signalling radio bearer;
 - perform the actions for the IE "RB mapping info" as specified in subclause 8.6.4.8, applied for that signalling radio bearer;
- apply a default value of the IE "RB identity" equal to 1 for the first IE "Signalling RB information to setup"; and
- increase the default value by 1 for each occurrence.

8.6.4.2 RAB information for setup

If the IE "RAB information for setup" is included, the procedure is used to establish radio bearers belonging to a radio access bearer, and the UE shall:

- if several IEs "RAB information for setup" are included and the included IEs "CN domain identity" in the IE "RAB info" does not all have the same value:
 - set the variable INVALID_CONFIGURATION to TRUE;
- if the radio access bearer identified with the IE "RAB info" does not exist in the variable ESTABLISHED_RABS:
 - create a new entry for the radio access bearer in the variable ESTABLISHED_RABS;
 - store the content of the IE "RAB info" in the entry for the radio access bearer in the variable ESTABLISHED_RABS;
 - indicate the establishment of the radio access bearer to the upper layer entity using the IE "CN domain identity", forwarding the content of the IE "RAB identity";
 - calculate the START value only once during this procedure (the same START value shall be used on all new radio bearers created for this radio access bearer) according to subclause 8.5.9 for the CN domain as indicated in the IE "CN domain identity" in the IE "RAB info" part of the IE "RAB information to setup";
 - store the calculated START value in the variable START_VALUE_TO_TRANSMIT;
- for each radio bearer in the IE "RB information to setup":
 - if the radio bearer identified with the IE "RB identity" does not exist in the variable ESTABLISHED_RABS for another radio access bearer than the one identified with the IE "RAB info":
 - perform the actions specified in subclause 8.6.4.3;
 - store information about the new radio bearer in the entry for the radio access bearer identified by "RAB info" in the variable ESTABLISHED_RABS;
 - if the radio bearer identified with the IE "RB identity" does not exist in the variable ESTABLISHED_RABS for the radio access bearer identified with the IE "RAB info":
 - create a new RAB subflow for the radio access bearer;
 - number the RAB subflow in ascending order, assigning the smallest number to the RAB subflow corresponding to the first radio bearer in the list;
 - if the radio bearer identified with the IE "RB identity" already exists in the variable ESTABLISHED_RABS for another radio access bearer than the one identified with the IE "RAB info":
 - set the variable INVALID_CONFIGURATION to TRUE.

8.6.4.2a RAB information to reconfigure

If the IE "RAB information to reconfigure" is included then the UE shall:

- if the entry for the radio access bearer identified by the IE "CN domain identity" together with the IE "RAB Identity" in the variable ESTABLISHED_RABS already exists:
 - perform the action for the IE "NAS Synchronization Indicator", according to subclause 8.6.4.12;
- else:
 - set the variable INVALID_CONFIGURATION to TRUE.

8.6.4.3 RB information to setup

If the IE "RB information to setup" is included, the UE shall apply the following actions on the radio bearer identified with the value of the IE "RB identity". The UE shall:

- use the same START value to initialise the hyper frame number components of COUNT-C and COUNT-I variables for all the new radio bearers to setup;
- perform the actions for the IE "PDCP info", if present, according to subclause 8.6.4.10, applied for the radio bearer;
- perform the actions for the IE "RLC info", according to subclause 8.6.4.9, applied for the radio bearer;
- perform the actions for the IE "RB mapping info", according to subclause 8.6.4.8, applied for the radio bearer;
- if the IE "Downlink RLC mode" in the IE "RLC info" is set to "TM RLC":
 - configure delivery of erroneous SDUs in lower layers according to indication from upper layer [5].
- if the variable CIPHERING_STATUS is set to "Started"; and
 - if the IE "Uplink RLC mode" or the IE "Downlink RLC mode" in the IE "RLC info" is set to "AM RLC" or "UM RLC":
 - initialise the 20 MSB of the hyper frame number component of COUNT-C for this radio bearer with the START value for the CN domain as indicated in the IE "CN domain identity" in the IE "RAB info" part of the IE "RAB information to setup";
 - set the remaining LSB of the hyper frame number component of COUNT-C for this radio bearer to zero;
 - if the IE "Uplink RLC mode" and the IE "Downlink RLC mode" in the IE "RLC info" is set to "TM RLC":
 - if no other transparent mode RLC radio bearers exist in the variable ESTABLISHED_RABS:
 - initialise the 20 MSB of the hyper frame number component of COUNT-C for this radio bearer with the START value for the CN domain as indicated in the IE "CN domain identity" in the IE "RAB info" part of the IE "RAB information to setup";
 - set the remaining LSB of the hyper frame number component of COUNT-C for this radio bearer to zero;
 - if at least one transparent mode RLC radio bearers or signalling radio bearers exist in the variable ESTABLISHED_RABS:
 - set the MAC-d HFN component of the COUNT-C for this radio bearer with the MAC-d HFN that is common (refer to subclause 8.5.8) for the CN domain as indicated in the IE "CN domain identity" in the IE "RAB info" part of the IE "RAB information to setup";
- start to perform ciphering on the radio bearer in lower layers, using the value of the IE "RB identity" minus one as the value of BEARER in the ciphering algorithm.

8.6.4.4 RB information to be affected

If the IE "RB information to be affected" is included, the UE shall apply the following actions on the radio bearer identified with the value of the IE "RB identity". The UE shall:

- perform the actions for the IE "RB mapping info", according to subclause 8.6.4.8, applied for the radio bearer.

8.6.4.5 RB information to reconfigure

If the IE "RB information to reconfigure" is included, the UE shall apply the following actions on the radio bearer identified with the value of the IE "RB identity". The UE shall:

- perform the actions for the IE "PDCP info", if present, according to subclause 8.6.4.10, applied for the radio bearer;

- perform the actions for the IE "RLC info", according to subclause 8.6.4.9, applied for the radio bearer;
- perform the actions for the IE "RB mapping info", according to subclause 8.6.4.8, applied for the radio bearer;
- if the IE "Downlink RLC mode" in the IE "RLC info" is set to "TM RLC":
 - configure delivery of erroneous SDUs in lower layers according to indication from upper layer [5].
- if the IE "PDCP SN info" is included:
 - perform the actions as specified in 8.6.4.11 applied for the radio bearer;
- if the IE "RB stop/continue" is included; and
 - if the "RB identity" has a value greater than 2; and
 - if the value of the IE "RB stop/continue" is "stop":
 - configure the RLC entity for the radio bearer to stop;
 - set the IE "RB started" in the variable ESTABLISHED_RABS to "stopped" for that radio bearer;
 - if the value of the IE "RB stop/continue" is "continue":
 - configure the RLC entity for the radio bearer to continue;
 - set the IE "RB started" in the variable ESTABLISHED_RABS to "started" for that radio bearer;
 - if the IE "RB identity" is set to a value less than 2:
 - set the variable INVALID_CONFIGURATION to TRUE.

8.6.4.6 RB information to release

If the IE "RB information to release" is included, the UE shall apply the following actions on the radio bearer identified with the value of the IE "RB identity". The UE shall:

- release the entities in lower layers dedicated for that radio bearer;
- if the information about the radio bearer is stored in the variable ESTABLISHED_RABS:
 - indicate release of the RAB subflow associated with the radio bearer to upper layers;
 - delete the information about the radio bearer from the variable ESTABLISHED_RABS;
- when all radio bearers belonging to the same radio access bearer have been released:
 - indicate release of the radio access bearer to upper layers providing the "CN domain identity" together with the "RAB identity" stored in the variable ESTABLISHED_RABS;
 - delete all information about the radio access bearer from the variable ESTABLISHED_RABS.

8.6.4.7 RB with PDCP information

If the IE "RB with PDCP information" is included, the UE shall apply the following actions on the radio bearer identified with the value of the IE "RB identity". The UE shall:

- for the IE "PDCP SN info":
 - perform the actions as specified in subclause 8.6.4.11.

8.6.4.8 RB mapping info

If the IE "RB mapping info" is included, the UE shall, for each multiplexing option of that RB:

- if the value of the IE "RLC size list" is set to "Explicit list":

- if a "Transport format set" for that transport channel is included in the same message, and the value (index) of any IE "RLC size index" in the IE "RLC size index list" does not correspond to an "RLC size" in the IE transport format set of that transport channel given in the message; or
- if a "Transport format set" for that transport channel is not included in the same message, and the value (index) of any IE "RLC size index" in the IE "RLC size index list" does not correspond to an "RLC size" in the stored transport format set of that transport channel; or
- if a "Transport format set" for that transport channel is included in the same message, and the value of any IE "Logical channel list" in the transport format set is not set to "Configured"; or
- if a "Transport format set" for that transport channel is included in the same message, and the value of any IE "Logical channel list" in the stored transport format set of that transport channel is not set to "Configured":
 - set the variable INVALID_CONFIGURATION to TRUE;
- if the value of the IE "RLC size list" is set to "All":
 - if a "Transport format set" for that transport channel is included in the same message, and the value of any IE "Logical channel list" in the transport format set is not set to "Configured"; or
 - if a "Transport format set" for that transport channel is included in the same message, and the value of any IE "Logical channel list" in the stored transport format set of that transport channel is not set to "Configured":
 - set the variable INVALID_CONFIGURATION to TRUE;
- if the value of the IE "RLC size list" is set to "Configured":
 - if a "Transport format set" for that transport channel is included in the same message, and the IE "Logical channel list" in the transport format set indicates that no "RLC size" is applicable for that RB; or
 - if a "Transport format set" for that transport channel is included in the same message, and the IE "Logical channel list" in the stored transport format set of that transport channel indicates that no "RLC size" is applicable for that RB:
 - set the variable INVALID_CONFIGURATION to TRUE;
- if that RB is using TM and the IE "Segmentation indication" is set to TRUE and, based on the multiplexing configuration resulting from this message, it is mapped onto the same transport channel as another RB:
 - set the variable INVALID_CONFIGURATION to true;
- else:
 - delete all previously stored multiplexing options for that radio bearer;
 - store each new multiplexing option for that radio bearer;
 - select and configure the multiplexing options applicable for the transport channels to be used;
 - if the IE "Uplink transport channel type" is set to the value "RACH":
 - refer the IE "RLC size index" to the RACH Transport Format Set of the first PRACH received in the IE "PRACH system information list" received in SIB5 or SIB6;
 - determine the sets of RLC sizes that apply to the logical channels used by that RB, based on the "RLC size list" and/or the "Logical Channel List" included in the applicable "Transport format set" (either the one received in the same message or the one stored if none were received);
 - if that RB is using AM and the set of RLC sizes applicable to the logical channel transferring data PDUs has more than one element:
 - set the variable INVALID_CONFIGURATION to true;
 - if that RB is using AM and the RLC size applicable to the logical channel transporting data PDUs is different from the one derived from the previously stored configuration:

- re-establish the corresponding RLC entity;
- configure the corresponding RLC entity with the new RLC size;
- if the variable CIPHERING_STATUS is set to "Started":
 - if this IE was included in system information:
 - set the HFN values for the corresponding RLC entity equal to the value of the IE "START" for the CN domain stored in the variable LATEST_CONFIGURED_CN_DOMAIN that will be included in the CELL UPDATE message that will be sent before the next transmission;
 - if this IE was included in CELL UPDATE CONFIRM:
 - set the HFN values for the corresponding RLC entity equal to the value of the IE "START" included in the latest transmitted CELL UPDATE message for the CN domain stored in the variable LATEST_CONFIGURED_CN_DOMAIN;
 - if this IE was included in a reconfiguration message:
 - set the HFN values for the corresponding RLC entity equal to the value of the IE "START" that will be included in the reconfiguration complete message for the CN domain stored in the variable LATEST_CONFIGURED_CN_DOMAIN;
- if that RB is using UM, indicate the largest applicable RLC size to the corresponding RLC entity;
- configure MAC multiplexing according to the selected multiplexing option;
- configure the MAC with the logical channel priorities according to selected multiplexing option;
- configure the MAC with the set of applicable RLC Sizes for each of the logical channels used for that RB;
- if a transport channel that would not exist as a result of the message is referred to:
 - set the variable INVALID_CONFIGURATION to TRUE;
- if a multiplexing option that maps a logical channel corresponding to a TM-RLC entity onto RACH, CPCH, FACH or DSCH is included:
 - set the variable INVALID_CONFIGURATION to TRUE;
- if a multiplexing option is included that realises the radio bearer on the uplink (resp. on the downlink) using two logical channels with different values of the IE "Uplink transport channel type" (resp. of the IE "Downlink transport channel type"):
 - set the variable INVALID_CONFIGURATION to TRUE;
- if there is no multiplexing option applicable for the transport channels to be used:
 - set the variable INVALID_CONFIGURATION to TRUE;
- if there is more than one multiplexing option applicable for the transport channels to be used:
 - set the variable INVALID_CONFIGURATION to TRUE.

In case IE "RB mapping info" includes IE "Downlink RLC logical channel info" but IE "Number of downlink RLC logical channels" is absent, the parameter values are exactly the same as for the corresponding UL logical channels. In case two multiplexing options are specified for the UL, the first options shall be used as default for the DL. As regards the IE "Channel type", the following rule should be applied to derive the DL channel type from the UL channel included in the IE:

| Channel used in UL | DL channel type implied by "same as" |
|--------------------|--------------------------------------|
| DCH | DCH |
| RACH | FACH |
| CPCH | FACH |
| USCH | DSCH |

8.6.4.9 RLC Info

If the IE "RLC Info" is included, the UE shall:

- configure the transmitting and receiving RLC entities in the UE for that radio bearer accordingly.

If the IE "Transmission RLC discard" is not included for UM RLC or TM RLC, RLC discard procedure shall not be used for that radio bearer.

8.6.4.10 PDCP Info

For RFC 3095:

- the chosen MAX_CID shall not be greater than the value "Maximum number of ROHC context sessions" as indicated in the IE "PDCP Capability";
- the configuration for the PACKET_SIZES_ALLOWED is FFS.

If IE "PDCP info" is included, the UE shall:

- configure the PDCP entity for that radio bearer accordingly;
- configure the RLC entity for that radio bearer according to the value of the IE "Support for lossless SRNS relocation".

8.6.4.11 PDCP SN Info

If the IE "PDCP SN Info" is included, the UE shall:

- transfer the sequence number to the PDCP entity for the radio bearer;
- configure the RLC entity for the radio bearer to stop;
- include the current PDCP receive sequence number and the radio bearer identity for the radio bearer in the variable PDCP_SN_INFO.

8.6.4.12 NAS Synchronisation Indicator

If the IE "NAS Synchronisation Indicator" is present in a message, the UE shall:

- forward the content to upper layers along with the IE "CN domain identity" of the associated RAB stored in the variable ESTABLISHED_RABS at the CFN indicated in the IE "Activation time" in order to synchronise actions in NAS and AS.

8.6.5 Transport channel information elements

8.6.5.1 Transport Format Set

If the IE "Transport format set" is included, the UE shall:

- if the transport format set is a RACH TFS received in System Information Block type 5 or 6, and CHOICE "Logical Channel List" has the value "Explicit List":
- ignore that System Information Block;

- if the transport format set for a downlink transport channel is received in a System Information Block, and CHOICE "Logical Channel List" has a value different from 'ALL':
 - ignore that System Information Block;
- if the transport format set for a downlink transport channel is received in a message on a DCCH, and CHOICE "Logical Channel List" has a value different from 'ALL':
 - keep the transport format set if this exists for that transport channel;
 - set the variable INVALID_CONFIGURATION to TRUE;
- if the value of any IE "RB identity" (and "Logical Channel" for RBs using two UL logical channels) in the IE "Logical channel list" does not correspond to a logical channel indicated to be mapped onto this transport channel in any RB multiplexing option (either included in the same message or previously stored and not changed by this message):
 - keep the transport format set if this exists for that transport channel;
 - set the variable INVALID_CONFIGURATION to TRUE;
- if the total number of configured transport formats for the transport channel exceeds maxTF:
 - keep the transport format set if this exists for that transport channel;
 - set the variable INVALID_CONFIGURATION to TRUE;
- if the IE "Transport format set" is considered as valid according to the rules above:
 - remove a previously stored transport format set if this exists for that transport channel;
 - store the transport format set for that transport channel;
 - consider the first instance of the parameter *Number of TBs and TTI List* within the *Dynamic transport format information* to correspond to transport format 0 for this transport channel, the second to transport format 1 and so on;
 - if the IE "Transport format Set" has the choice "Transport channel type" set to "Dedicated transport channel":
 - calculate the transport block size for all transport formats in the TFS using the following

$$\text{TB size} = \text{RLC size} + \text{MAC header size},$$
 where:
 - MAC header size is calculated according to [15] if MAC multiplexing is used. Otherwise it is 0 bits;
 - 'RLC size' reflects the RLC PDU size.
 - if the IE "Transport format Set" has the choice "Transport channel type" set to "Common transport channel":
 - calculate the transport block size for all transport formats in the TFS using the following:

$$\text{TB size} = \text{RLC size}$$
 - if the IE "Number of Transport blocks" $\neq 0$ and IE "RLC size" = 0, no RLC PDU data exists but only parity bits exist for that transport format;
 - if the IE "Number of Transport blocks" = 0, neither RLC PDU neither data nor parity bits exist for that transport format;
 - configure the MAC with the new transport format set (with computed transport block sizes) for that transport channel;
 - if the RB multiplexing option for a RB mapped onto that transport channel (based on the stored RB multiplexing option) is not modified by this message:

- determine the sets of RLC sizes that apply to the logical channels used by that RB, based on the IE "Logical Channel List" and/or the IE "RLC Size List" from the previously stored RB multiplexing option;
- if that RB is using AM and the set of RLC sizes applicable to the logical channel transferring data PDUs has more than one element:
 - set the variable INVALID_CONFIGURATION to true;
- if that RB is using AM and the RLC size applicable to the logical channel transporting data PDUs is different from the one derived from the previously stored configuration:
 - re-establish the corresponding RLC entity;
 - configure the corresponding RLC entity with the new RLC size;
 - if this IE was included in system information and if the variable CIPHERING_STATUS is set to "Started":
 - set the HFN values for the corresponding RLC entity equal to the value of the IE "START" for the CN domain stored in the variable LATEST_CONFIGURED_CN_DOMAIN that will be included in the CELL UPDATE message that will be sent before the next transmission;
 - if this IE was included in CELL UPDATE CONFIRM and if the variable CIPHERING_STATUS is set to "Started":
 - set the HFN values for the corresponding RLC entity equal to the value of the IE "START" included in the latest transmitted CELL UPDATE message for the CN domain stored in the variable LATEST_CONFIGURED_CN_DOMAIN;
 - if this IE was included in a reconfiguration message and if the variable CIPHERING_STATUS is set to "Started":
 - set the HFN values for the corresponding RLC entity equal to the value of the IE "START" that will be included in the reconfiguration complete message for the CN domain stored in the variable LATEST_CONFIGURED_CN_DOMAIN;
 - if this IE was included in ACTIVE SET UPDATE and if the variable CIPHERING_STATUS is set to "Started":
 - set the HFN values for the corresponding RLC entity equal to the value of the IE "START" that will be included in the ACTIVE SET UPDATE COMPLETE message for the CN domain stored in the variable LATEST_CONFIGURED_CN_DOMAIN;
- if that RB is using UM:
 - indicate the largest applicable RLC size to the corresponding RLC entity;
 - configure MAC with the set of applicable RLC Sizes for each of the logical channels used for that RB.

For configuration restrictions on Blind Transport Format Detection, see [27].

8.6.5.2 Transport format combination set

If the IE "Transport format combination set" is included, the UE shall for that direction (uplink or downlink):

- store the new transport format combination set, or (if this exists) modify a previously stored transport format combination set according to IEs included in IE "Transport format combination set";
- start to respect those transport format combinations;
- if IE "Transport format combination subset" is received in this message:
 - perform the actions as specified in subsection 8.6.5.3;
- if IE "Transport format combination subset" is not received in this message:

- clear the IE "Duration" in the variable TFC_SUBSET;
- set both the IE "Current TFC subset" and the IE "Default TFC subset" in the variable TFC_SUBSET to the value indicating "full transport format combination set".

If the IE "Transport format combination set" is not included and if there is no addition, removal or reconfiguration of transport channels, the UE shall for that direction (uplink or downlink):

- use a previously stored transport format combination set if this exists.

If the IE "Transport format combination set" is not included; and

- if no transport format combination set is stored in the UE; or
- if transport channels are added or removed in the message; or
- if any transport channel is reconfigured in the message such that the size of the transport format set is changed:

the UE shall:

- set the variable INVALID_CONFIGURATION to TRUE.

The UTRAN should include in the TFCS, for each transport channel, a TFC with one transport block for this transport channel and empty TFs (see [34]) for all the others. Similarly, the UTRAN should include, for each AM logical channel, a TFC with a minimum size compatible TF for the corresponding transport channel and empty TFs for all other transport channels. Finally, the UTRAN should include, for each TM logical channel and for each SDU size associated with it, a TFC with a minimum size compatible TF for the corresponding transport channel and empty TFs for all other transport channels. For TDD, the TFCS of a CCTrCH should include those of the above combinations, which include a TF with one transport block for a transport channel used in that CCTrCH.

For AM-RLC logical channels, the minimum size compatible TF includes one transport block with "Configured RLC Size" equal to the RLC PDU size. For non-segmented mode TM-RLC logical channels, the minimum size compatible TF includes one transport block with "Configured RLC Size" equal to the RLC SDU size considered. For segmented mode TM-RLC, the minimum size compatible TF is any TF such that the number of transport blocks multiplied by the "Configured RLC Size" is equal to the RLC SDU size considered.

NOTE: The "Configured RLC Size" is defined as the transport block size minus the MAC header size.

Finally, UTRAN should include in the TFCS an "empty" TFC (see [34]). For TDD, the "empty" TFC should be included in the TFCS of every CCTrCH.

8.6.5.3 Transport format combination subset

If the IE "Transport format combination subset" ("TFC subset") is included, the UE shall:

- if the IE "Minimum allowed Transport format combination index" is included; and
 - if the value of the IE "Minimum allowed Transport format combination index" is greater than the highest TFCI value in the current transport format combination set:
 - consider the TFC subset to be incompatible with the current transport format combination set;
- if the IE "Allowed transport format combination list" is included; and
 - if the value of any of the IEs "Allowed transport format combination" included in the IE "Allowed transport format combination list" does not match a TFCI value in the current transport format combination set:
 - consider the TFC subset to be incompatible with the current transport format combination set;

if the IE "Non-allowed transport format combination list" is included; and

- if the value of any of the IEs "Non-allowed transport format combination" included in the IE "Non-allowed transport format combination list" does not match a TFCI value in the current transport format combination set:
 - consider the TFC subset to be incompatible with the current transport format combination set;

- if the IE "Restricted TrCH information" is included:
 - if the value of any of the IEs "Uplink transport channel type" and "Restricted UL TrCH identity" included in the IE "Restricted TrCH information" do not correspond to any of the transport channels for which the current transport format combination set is valid:
 - consider the TFC subset to be incompatible with the current transport format combination set;
 - if the IE "Allowed TFIs" is included; and
 - if the value of each of the IEs "Allowed TFI" included in the IE "Allowed TFIs" corresponds to a transport format for that transport channel within the current transport format combination set:
 - allow all transport format combinations that include these transport formats for the transport channel;
 - restrict all other transport format combinations;
 - else
 - consider the TFC subset to be incompatible with the current transport format combination set;
 - if the IE "Allowed TFIs" is not included:
 - restrict all transport format combinations where the transport channel has a transport format of non-zero rate;
- if the UE considers the TFC subset to be incompatible with the current Transport format combination set according to the above:
 - keep any previous restriction of the transport format combination set;
 - set the variable INVALID_CONFIGURATION to TRUE;
- if the UE does not consider the TFC subset to be incompatible with the current Transport format combination set according to the above:
 - restrict the transport format combination set in the uplink to the value of the IE "Transport format combination subset" (in case of TDD for the uplink CCTrCH specified by the IE "TFCS Id");
 - clear the IE "Duration" in the variable TFC_SUBSET;
- if the transport format combination subset indicates the "full transport format combination set":
 - any restriction on transport format combination set is released and the UE may use the full transport format combination set.

8.6.5.4 DCH quality target

At physical channel establishment, the UE sets an initial downlink target SIR value based on the received IEs "DCH quality target". The IE "DCH quality target" for a given DCH shall be used by the UE to set the target SIR for the downlink power control in case BLER measurement is possible for this DCH, i.e. CRC exists in all transport formats in downlink TFS.

8.6.5.5 Added or Reconfigured UL TrCH information

If the IE "Added or Reconfigured UL TrCH information" is included then the UE shall:

- for the transport channel identified by the IE "UL Transport Channel Identity":
 - perform the actions for the IE "Transport Format Set" as specified in subclause 8.6.5.1.

8.6.5.6 Added or Reconfigured DL TrCH information

If the IE "Added or Reconfigured DL TrCH information" is included then for the transport channel identified by the IE "DL Transport Channel Identity" the UE shall:

- if the choice "DL parameters" is set to 'independent':
 - perform the actions for the IE "Transport Format Set" as specified in subclause 8.6.5.1;
- if the choice "DL parameters" is set to 'same as uplink':
 - if the IE "UL Transport Channel Identity" indicates an existing or a new UL Transport Channel:
 - store as transport format for this transport channel the transport format associated with the transport channel identified by the IE "UL Transport Channel Identity";
 - else:
 - set the variable INVALID_CONFIGURATION to TRUE;
- if the IE "DCH quality target" is included:
 - perform the actions specified in subclause 8.6.5.4;
- if the IE "Transparent mode signalling info" is included:
 - consider the messages received on this transport channel to have the message type according to the value of the IE "Type of message";
 - if the choice "Transparent signalling mode" is set to "Mode 1":
 - consider the messages received on this transport channel affect all established DCHs;
 - if the choice "Transparent signalling mode" is set to "Mode 2":
 - consider the messages received on this transport channel affect the DCHs identified with the IE "UL controlled transport channels" in the IE "Controlled transport channels list";
 - if any of the DCHs identified with the IE "UL controlled transport channels" in the IE "Controlled transport channels list" does not exist:
 - set the variable INVALID_CONFIGURATION to TRUE.

8.6.5.7 Deleted UL TrCH information

If the IE "Deleted UL TrCH information" is included the UE shall:

- delete any information about the transport channel identified by the IE "UL TrCH identity".

8.6.5.8 Deleted DL TrCH information

If the IE "Deleted DL TrCH information" is included the UE shall:

- delete any information about the transport channel identified by the IE "DL TrCH identity".

8.6.5.9 UL Transport channel information common for all transport channels

If the IE "UL Transport channel information common for all transport channels" is included the UE shall:

- perform actions for the IE "TFC subset" as specified in subclause 8.6.5.3;
- if the IE "PRACH TFCS" is included:
 - set the variable INVALID_CONFIGURATION to TRUE;
- if the IE has the choice "mode" set to FDD:
 - perform actions for the IE "UL DCH TFCS" as specified in subclause 8.6.5.2;
- if the IE has the choice "mode" set to TDD:

- if the IE "Individual UL CcTrCH information" is included:
 - for each TFCS identified by IE "UL TFCS id":
 - perform actions for the IE "UL TFCS" as specified in subclause 8.6.5.2.

8.6.5.10 DL Transport channel information common for all transport channels

If the IE "DL Transport channel information common for all transport channels" is included the UE shall:

- if the IE "SCCPCH TFCS" is included:
 - perform actions for the TFCS of the selected SCCPCH as specified in subclause 8.6.5.2;
- if the IE choice "mode" is set to FDD:
 - if the choice "DL parameters" is set to 'Independent':
 - if the IE "DL DCH TFCS" is included:
 - if the IE "SCCPCH TFCS" is included and the state the UE enters after handling the received information is other than CELL_DCH:
 - ignore the received IE "DL DCH TFCS";

NOTE: the IE "DL Transport channel information common for all transport channels" always includes a DL DCH TFCS configuration, either by including the IE "DL DCH TFCS" or by specifying that the TFCS is the same as in UL. If UTRAN does not require the reconfiguration of the concerned parameters, UTRAN may replace one TFC with the value that is already assigned for this IE.

- else:
 - perform actions as specified in subclause 8.6.5.2;
- if the IE choice "mode" is set to TDD:
 - if the IE "Individual DL CcTrCH information" is included:
 - for each DL TFCS identified by the IE "DL TFCS identity":
 - if the IE choice "DL parameters" is set to 'independent':
 - perform actions for the IE "DL TFCS" as specified in subclause 8.6.5.2;
 - if the IE choice "DL parameters" is set to 'same as UL':
 - if the IE "UL DCH TFCS identity" indicates an existing or a new UL TFCS:
 - store for that DL TFCS the TFCS identified by the IE "UL DCH TFCS identity";
 - else:
 - set the variable INVALID_CONFIGURATION to TRUE.

8.6.5.11 DRAC static information

If the IE "DRAC static information" is included the UE shall:

- store the content of the IE "Transmission Time Validity";
- store the content of the IE "Time duration before retry";
- store the content of the IE "DRAC Class identity".

8.6.5.12 TFCS Reconfiguration/Addition Information

If the IE "TFCS Reconfiguration/Addition Information" is included the UE shall:

- store the TFCs to be reconfigured/added indicated in the IE "CTFC information" as specified below;
- if the IE "Power offset information" is included:
 - perform actions as specified in [29].

In order to identify the TFCs included in this IE the UE shall calculate the CTFC as specified in subclause 14.10 and

- if the IE "TFCS Reconfiguration/Addition Information" was included in the IE "TFCI Field 1 Information":
 - ignore for the CTFC calculation any DSCH transport channel that may be assigned;
- if the IE "TFCS Reconfiguration/Addition Information" was included in the IE "TFCI Field 2 Information":
 - ignore for the CTFC calculation any DCH transport channel that may be assigned.

If the IE "TFCS Reconfiguration/Addition Information" is used in case of TFCS "Complete reconfiguration" the UE shall:

- remove a previously stored transport format combination set if this exists;
- consider the first instance of the IE "CTFC information" as Transport Format Combination 0 in FDD (TFCI=0) and 1 in TDD (TFCI=1), the second instance as Transport Format Combination 1 in FDD (TFCI=1) and 2 in TDD (TFCI=2) and so on. In TDD the TFCI value = 0 is reserved for physical layer use.

If the IE "TFCS Reconfiguration/Addition Information" is used in case of TFCS "Addition" the UE shall insert the new additional(s) TFC into the first available position(s) in ascending TFCI order in the TFCS.

8.6.5.13 TFCS Removal Information

If the IE "TFCS Removal Information" is included the UE shall:

- remove the TFC indicated by the IE "TFCI" from the current TFCS, and regard this position (TFCI) in the TFCS as vacant.

8.6.5.14 TFCI Field 2 Information

If the IE "TFCI Field 2 Information" is included the UE shall:

- if the IE choice "Signalling method" is set to 'TFCI range':
 - for the first group in the IE "TFCI(field 2) range":
 - apply the Transport Format Combination indicated by the value of the IE "TFCS Information for DSCH (TFCI range method)" to the group of values of TFCI(field 2) between 0 and the IE "Max TFCI(field2) value";
 - for the following groups in the IE "TFCI(field 2) range":
 - apply the Transport Format Combination indicated by the value of the IE "TFCS Information for DSCH (TFCI range method)" to the group of values of TFCI(field 2) between the largest value reached in the previous group plus one and the IE "Max TFCI(field2) value";
- if the IE choice "Signalling method" is set to 'Explicit':
 - perform actions for the IE "TFCS explicit configuration" as specified in subclause 8.6.5.15.

8.6.5.15 TFCS Explicit Configuration

If the IE "TFCS Explicit Configuration" is included the UE shall:

- if the IE choice "TFCS representation" is set to 'complete reconfiguration':
 - perform the actions for the IE "TFCS Reconfiguration/Addition Information" as specified in subclause 8.6.5.12;
- if the IE choice "TFCS representation" is set to 'addition':
 - perform the actions for the IE "TFCS Reconfiguration/Addition Information" as specified in subclause 8.6.5.12;
- if the IE choice "TFCS representation" is set to 'removal':
 - perform the actions for the IE "TFCS Removal Information" as specified in subclause 8.6.5.13;
- if the IE choice "TFCS representation" is set to 'replace':
 - perform first the actions for the IE "TFCS Removal Information" as specified in subclause 8.6.5.13; and then
 - perform the actions for the IE "TFCS Reconfiguration/Addition Information" as specified in subclause 8.6.5.12.

8.6.6 Physical channel information elements

This section specifies the actions upon reception and/or non-reception of the physical channel information elements. The combination of the values of those information elements included in a given message shall follow the compatibility rules that are specified in the physical layer specifications. In case those rules are not followed, the UE shall set the variable INVALID_CONFIGURATION to TRUE.

8.6.6.1 Frequency info

If the IE "Frequency info" is included the UE shall:

- store that frequency as the active frequency; and
- tune to that frequency.

If the IE "Frequency info" is not included and the UE has a stored active frequency, the UE shall:

- continue to use the stored active frequency.

8.6.6.2 Void

8.6.6.2a PNBSCH allocation

The UE shall consider the frame numbers fulfilling the following equation as "PRACH blocked frames" as specified in [33].

- $SFN = \lfloor k * \text{Repetition period} \rfloor$

for an integer k with $k \in \{0, 1, 2, 3, 4, \dots, \text{value of IE "Number of repetitions per SFN period"} - 1\}$, where:

Repetition period is: $4096 / \text{value of IE "Number of repetitions per SFN period"}$.

The UE shall configure the physical layer for the physical random access procedure accordingly.

8.6.6.3 Void

8.6.6.4 Downlink information for each radio link

If the IE "Downlink information for each radio link" is included in a received message, the UE shall:

- if the UE would enter CELL_DCH state according to subclause 8.6.3.3 applied on the received message:
 - if the IE "SCCPCH Information for FACH" is included; and
 - if the UE is in FDD mode and is not capable of simultaneous reception of DPCH and Secondary CCPCH:
 - set the variable UNSUPPORTED_CONFIGURATION to TRUE;
 - if the UE is in FDD mode and is capable of simultaneous reception of DPCH and SCCPCH:
 - start to receive the indicated Secondary CCPCH;
 - if the UE is in TDD mode and shared transport channels are assigned to the UE:
 - start to receive the indicated Secondary CCPCH;
 - if the UE is in TDD mode and no shared transport channels are assigned to the UE:
 - set the variable UNSUPPORTED_CONFIGURATION to TRUE;
- act on the other IEs contained in the IE "Downlink information for each radio link" as specified in subclause 8.6 applied on this radio link;
- if the UE would enter either the CELL_FACH, CELL_PCH or URA_PCH state according to subclause 8.6.3.3 applied on the received message:
 - if the received message is CELL UPDATE CONFIRM:
 - set the variable INVALID_CONFIGURATION to TRUE;
 - if the received message is any other message than CELL UPDATE CONFIRM; and
 - if other IEs than the IE "Primary CPICH info" (for FDD) or the IE "Primary CCPCH info" (for TDD) are included in the IE "Downlink information for each radio link":
 - set the variable INVALID_CONFIGURATION to TRUE;
- act on the other IEs contained in the IE "Downlink information for each radio link" as specified in subclause 8.6 applied on this radio link.

8.6.6.5 Void

8.6.6.6 Uplink DPCH info

If the IE "Uplink DPCH info" is included, the UE shall:

- release any active uplink physical channels and activate the given physical channels.

8.6.6.7 Void

8.6.6.8 Maximum allowed UL TX power

If the IE "Maximum allowed UL TX power" is included, the UE shall:

- keep the UE uplink transmit power below the indicated power value;
- if the current UE uplink transmit power is above the indicated power value:

- decrease the power to a level below the power value.

The maximum UE transmitter power is defined as the lower of the maximum output power of the UE power class and the maximum allowed UL TX power indicated in this IE. The maximum UE transmitter power shall not be exceeded.

8.6.6.9 PDSCH with SHO DCH Info (FDD only)

If the IE "PDSCH with SHO DCH Info" is included, the UE shall:

- configure itself to receive the PDSCH from the specified radio link within the active set identified by the IE "DSCH radio link identifier";
- if the TFCI has a 'hard' split:
 - if the IE "TFCI(field2) combining set" is included:
 - configure the Layer 1 to combine soft only the DPCCH TFCI(field 2) of the radio links within the active set which are identified by the IE "Radio link identifier" in the IE "TFCI(field2) Combining set";
 - if the IE "TFCI combining set" is not included:
 - configure the L1 to combine soft the DPCCH TFCI(field 2) of all radio links within the active set.

8.6.6.10 PDSCH code mapping (FDD only)

If the IE "PDSCH code mapping" is included, the UE shall:

- use the scrambling code defined by the IE "DL Scrambling Code" to receive the PDSCH;
- if the IE choice "signalling method" is set to 'code range':
 - map the TFCI(field2) values to PDSCH codes in the following way:
 - for the first group of the IE "PDSCH code mapping":
 - if the value of the IE "multi-code info" equals 1:
 - map the TFCI(field 2) = 0 to the PDSCH code specified by the IE "Spreading factor" and the code number given by the IE "Code number (for PDSCH code) start";
 - map TFCI(field 2) = 1 to the PDSCH code specified by the IE "Spreading factor" and the code number given by the IE "Code number (for PDSCH code) start"+1;
 - continue this process with unit increments in the value of TFCI(field 2) mapped to unit increments in code number until the code number equals the value of the IE "Code number (for PDSCH code) stop";
 - if the value of the IE "multi-code info" is greater than 1:
 - if the value of the difference between the IE "Code number (for PDSCH code) start" and the IE "Code number (for PDSCH code) stop" + 1 is not a multiple of the value of the IE "multi-code info":
 - set the variable INVALID_CONFIGURATION to TRUE;
 - map TFCI (field 2)=0 to a set of PDSCH contiguous codes. This code set is specified by the IE "Spreading factor" and code numbers between 'code number start' denoted by the IE "Code number (for PDSCH code) start" and 'code number stop' given by IE "Code number (for PDSCH code) start" - 1 + the value of the IE "multi-code info";
 - continue this process with unit increments in the value of TFCI(field 2) mapped to a set of contiguous codes. This code set is specified by the IE "Spreading factor" and code numbers between 'code number start' = 'code number stop' +1 of the previous TFCI(field2) and 'code number stop'='code number start' - 1 + the value of the IE "multi-code info";
 - stop this process when the 'code number stop' associated to the last TFCI(field2) equals the value of the IE "Code number (for PDSCH code) stop";

- for each of the next groups included in the IE "PDSCH code mapping":
 - continue the process in the same way as for the first group with the TFCI(field 2) value used by the UE to construct its mapping table starting at the largest TFCI(field 2) value reached in the previous group plus one;
 - if the value of the IE "Code number (for PDSCH code) start" equals the value of the IE "Code number (for PDSCH code) stop" (as may occur when mapping the PDSCH root code to a TFCI (field 2) value):
 - consider this as defining the mapping between the channelisation code and a single TFCI (i.e., TFCI(field 2) shall not be incremented twice);
- if the IE choice "signalling method" is set to "TFCI range":
 - map the TFCI(field2) values to PDSCH codes in the following way:
 - for the first group of the IE "DSCH mapping":
 - map each of the TFCI(field 2) between 0 and the value of the IE "Max TFCI(field2)" to the PDSCH code specified by the IE "Spreading factor (for PDSCH code)" and the code number given by the IE "Code number (for PDSCH code)";
 - for each of the next groups included in the IE "DSCH mapping":
 - map each of the TFCI(field 2) between the IE "Max TFCI(field2) value" specified in the last group plus one and the specified IE "Max TFCI(field2)" in the current group to the PDSCH code specified by the IE "Spreading factor (for PDSCH code)" and the code number given by the IE "Code number (for PDSCH code)";
 - if the value of the IE "multi-code info" is greater than 1:
 - map each value of TFCI (field 2) to a set of PDSCH contiguous codes starting at the channelisation code denoted by the 'code number' parameter and including all codes with code numbers up to and including 'code number' - 1 + the value of the IE "multi-code info";
- if the IE choice "signalling method" is set to 'Explicit'
 - map the TFCI(field2) values to PDSCH codes in the following way:
 - for the first instance on the IE "PDSCH code info":
 - apply the PDSCH code specified by the IE "Spreading factor (for PDSCH code)" and the code number given by the IE "Code number (for PDSCH code)" for TFCI(field2)=0;
 - for the second instance of the IE "PDSCH code info":
 - apply the PDSCH code specified by the IE "Spreading factor (for PDSCH code)" and the code number given by the IE "Code number (for PDSCH code)" for TFCI(field2)=1;
 - continue in a similar way for each next instance of the IE "PDSCH code info";
 - if the value of the IE "multi-code info" is greater than 1, then
 - map each value of TFCI (field 2) to a set of PDSCH contiguous codes starting at the channelisation code denoted by the 'code number' parameter and including all codes with code numbers up to and including 'code number' - 1 + the value of the IE "multi-code info";
- if the IE choice "signalling method" is set to 'Replace':
 - map the TFCI(field2) values to PDSCH codes in the following way:
 - for each instance of the IE "Replaced PDSCH code":
 - replace the corresponding PDSCH code for the TFCI(field2) identified by the IE "TFCI(field2)" with the new code specified by the IE "Spreading factor (for PDSCH code)" and the code number given by the IE "Code number (for PDSCH code)";

- if the value of the IE "multi-code info" is greater than 1:
 - map each value of TFCI (field 2) to a set of PDSCH contiguous codes starting at the channelisation code denoted by the 'code number' parameter and including all codes with code numbers up to and including 'code number' - 1 + the value of the IE "multi-code info".

8.6.6.11 Uplink DPCH power control info

The UE shall:

- in FDD:
 - if the IE "Uplink DPCH power control info" is included:
 - calculate and set an initial uplink transmission power;
 - start inner loop power control as specified in subclause 8.5.3;
 - for the UL inner loop power control:
 - use the parameters specified in the IE;
 - in 3.84 Mcps TDD:
 - if the IE "Uplink DPCH power control info" is included:
 - use the parameters specified in the IE for open loop power control as defined in subclause 8.5.7;
 - in 1.28 Mcps TDD:
 - if the IE "Uplink DPCH power control info" is included:
 - calculate and set an initial uplink transmission power;
 - start inner loop power control;
 - for the UL inner loop power control:
 - use the parameter specified in the IE;
 - both in FDD and TDD;
 - if the IE "Uplink DPCH power control info" is not included:
 - use the current uplink transmission power.

8.6.6.12 Secondary CPICH info

If the IE Secondary CPICH info is included, the UE:

- may use the channelisation code according to IE "channelisation code", with scrambling code according to IE "DL scrambling code" in the IE "Secondary CPICH info", for channel estimation of that radio link;
- may use the pilot bits on DPCCH for channel estimation.

8.6.6.13 Primary CPICH usage for channel estimation

If the IE "Primary CPICH usage for channel estimation" is included and has the value "Primary CPICH may be used" the UE:

- may use the Primary CPICH for channel estimation;
- may use the pilot bits on DPCCH for channel estimation.

If the IE "Primary CPICH usage for channel estimation" is included and has the value "Primary CPICH shall not be used" the UE:

- shall not use the Primary CPICH for channel estimation;
- may use the Secondary CPICH for channel estimation;
- may use the pilot bits on DPCCH for channel estimation.

8.6.6.14 DPCH frame offset

If "DPCH frame offset" is included in a message that instructs the UE to enter CELL_DCH state:

- UTRAN should:
 - if only one Radio Link is included in the message:
 - set "Default DPCH Offset Value" and "DPCH frame offset" respecting the following relation:

$$(\text{Default DPCH Offset Value}) \bmod 38400 = \text{DPCH frame offset}$$
 - where the IE values used are the Actual Values of the IEs as defined in clause 11;
 - if more than one Radio Link are included in the message:
 - set "Default DPCH Offset Value" and "DPCH frame offset" respecting the following relation:

$$(\text{Default DPCH Offset Value}) \bmod 38400 = \text{DPCH frame offset}_j$$
 - where j indicates the first radio link listed in the message and the IE values used are the Actual Values of the IEs as defined in clause 11;
- The UE shall:
 - on reception of a message where the above relation between "Default DPCH Offset Value" and "DPCH frame offset" is not respected:
 - set the variable INVALID_CONFIGURATION to true.

If the IE "DPCH frame offset" is included the UE shall:

- use its value to determine the beginning of the DPCH frame.

8.6.6.15 DPCH Compressed mode info

If the IE "DPCH compressed mode info" is included, and if the IE group "transmission gap pattern sequence configuration parameters" is included, the UE shall for each transmission gap pattern sequence perform the following consistency checks:

- if UE, according to its measurement capabilities, and for the measurement purpose indicated by IE "TGMP", requires UL compressed mode for measurements on any of the cells to be measured according to UE variable CELL_INFO_LIST, and CHOICE 'UL/DL mode' indicates 'DL only':
 - set the variable INVALID_CONFIGURATION to TRUE;
- if UE, according to its measurement capabilities, and for the measurement purpose indicated by IE "TGMP", requires DL compressed mode for measurements on any of the cells to be measured according to UE variable CELL_INFO_LIST, and CHOICE 'UL/DL mode' indicates 'UL only':
 - set the variable INVALID_CONFIGURATION to TRUE;
- if UE already has an active transmission gap pattern sequence that, according to IE "TGMP", has the same measurement purpose, and both patterns will be active after the new configuration has been taken into use:
 - set the variable INVALID_CONFIGURATION to TRUE.

If variable INVALID_CONFIGURATION has value FALSE after UE has performed the checks above, the UE shall:

- if pattern sequence corresponding to IE "TGPSI" is already active (according to "TGPS Status Flag"):

- deactivate this pattern sequence at the beginning of the frame, indicated by IE "Activation time"(see subclause 8.6.3.1) received in this message, when the new configuration received in this message is taken into use;
- update each pattern sequence to the variable TGPS_IDENTITY according to the IE "TGPSI";
- update into the variable TGPS_IDENTITY the configuration information defined by IE group "transmission gap pattern sequence configuration parameters ";
- after the new configuration has been taken into use:
 - activate the stored pattern sequence corresponding to each IE "TGPSI" for which the "TGPS status flag" is set to "activate" at the time indicated by IE "TGCFN"; and
 - begin the inter-frequency and/or inter-RAT measurements corresponding to the pattern sequence measurement purpose of each activated pattern sequence;
 - if the new configuration is taken into use at the same CFN as indicated by IE "TGCFN":
 - start the concerned pattern sequence immediately at that CFN;
- monitor if the parallel transmission gap pattern sequences create an illegal overlap, and in case of overlap, take actions as specified in subclause 8.2.11.2;

If the IE "DPCH compressed mode info" is included, and if the IE group "transmission gap pattern sequence configuration parameters" is not included, the UE shall:

- if pattern sequence corresponding to IE "TGPSI" is already active (according to "TGPS Status Flag"):
 - deactivate this pattern sequence at the beginning of the frame, indicated by IE "Activation time"(see subclause 8.6.3.1) received in this message, when the new configuration received in this message is taken into use;
- after the new configuration has been taken into use:
 - activate, at the time indicated by IE "TGCFN", the stored pattern sequence corresponding to each IE "TGPSI" for which the "TGPS status flag" is set to "activate"; and
 - begin the inter-frequency and/or inter-RAT measurements corresponding to the pattern sequence measurement purpose of each activated pattern sequence;
 - if the new configuration is taken into use at the same CFN as indicated by IE "TGCFN":
 - start the concerned pattern sequence immediately at that CFN;

For transmission gap pattern sequences stored in variable TGPS_IDENTITY, but not identified in IE "TGPSI", the UE shall:

- if the received message implies a timing re-initialised hard handover (see subclause 8.3.5.1):
 - deactivate such transmission gap pattern sequences at the beginning of the frame, indicated by IE "Activation time" (see subclause 8.6.3.1) received in this message; and
 - set IE "TGPS Status Flag" in corresponding UE variable TGPS_IDENTITY to 'inactive';
- if the received message not implies a timing re-initialised hard handover (see subclause 8.3.5.1):
 - continue such transmission gap pattern sequence according to IE "TGPS Status Flag" in corresponding UE variable TGPS_IDENTITY.

Uplink and downlink compressed mode methods are described in [27]. For UL "higher layer scheduling" compressed mode method and transport format combination selection, see [15].

8.6.6.16 Repetition period, Repetition length, Offset (TDD only)

In case the physical allocations of different channels overlap the following priority rules shall apply for common channels and shall be taken into account by the UE:

- PICH takes precedence over Primary CCPCH;
- PICH takes precedence over Secondary CCPCH;
- Secondary CCPCH takes precedence over Primary CCPCH.

The frame allocation can be derived by following rules:

If no IE "Offset" is explicitly given, the parameter "Offset" to be used is calculated by the following equation:

$$\text{Activation time mod Repetition period} = \text{Offset.}$$

Frames from CFN CFN_{off} to $CFN_{\text{off}} + \text{Repetition length}$ belong to the allocation with CFN_{off} fulfilling the following equation:

$$CFN_{\text{off}} \text{ mod Repetition period} = \text{Offset.}$$

Repetition length is always a multiple of the largest TTI within the CCTrCH fulfilling the following equation:

$$(\text{largest TTI within CCTrCH}) * X = \text{Repetition Length}$$

Example of usage:

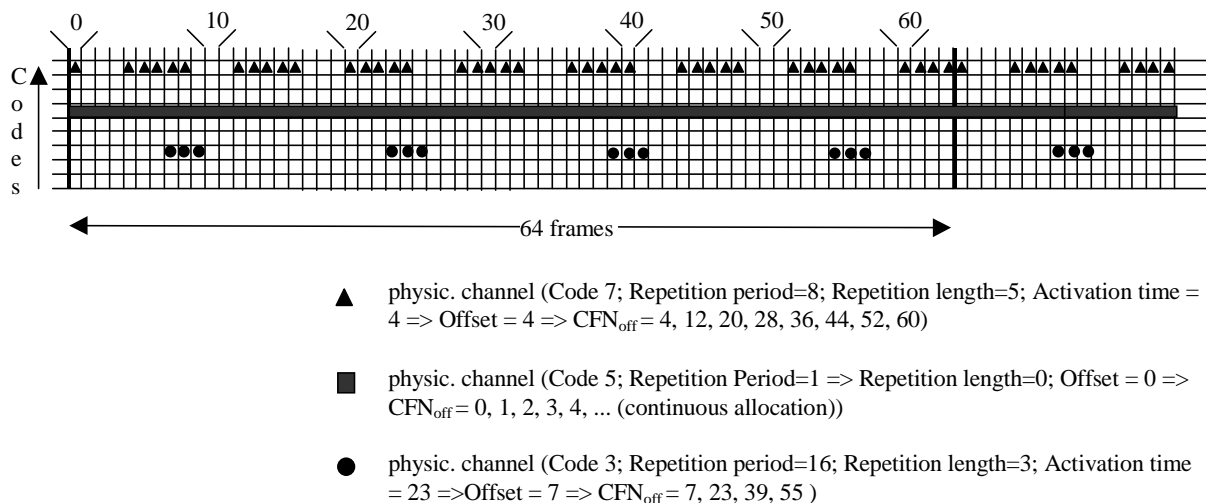

Figure 60: Examples for frame allocations in TDD

8.6.6.17 Primary CCPCH info

If the IE "Primary CCPCH info" is included, the UE shall:

- use the information elements in this IE.

8.6.6.18 Primary CPICH info

If the IE "Primary CPICH info" in FDD is included, the UE shall:

- use the value of this IE as the primary scrambling code for the downlink radio link.

8.6.6.19 CPCH SET Info (FDD only)

If the UE has the capability to use CPCH, the UE shall use the following general procedures:

- if an IE "CPCH SET Info" is included in a dedicated message:
 - read the "CPCH set ID" included in the IE;
 - store the IE using the "CPCH set ID" as an address tag;
 - release any active dedicated physical channels in the uplink;
 - let the PCPCHs listed in the CPCH set be the default in the uplink for CPCH;
- if an IE "CPCH SET Info" is included in a System Information message:
 - read the "CPCH set ID" included in the IE;
 - store the IE using the "CPCH set ID" as an address tag.

8.6.6.20 CPCH set ID (FDD only)

If the UE has the capability to use CPCH, the UE shall use the following general procedures. The UE shall:

- if an IE "CPCH set ID" is included in a dedicated message and not as part of IE "CPCH SET Info":
 - use the IE as an address tag to retrieve the corresponding stored "CPCH SET Info";
 - release any active dedicated physical channels in the uplink;
 - let the PCPCHs listed in the CPCH set be the default in the uplink for CPCH;
- if an IE "CPCH set ID" is included in a dedicated message and not as part of IE "CPCH SET Info", and if there is no corresponding stored "CPCH SET Info":
 - release any active dedicated physical channels in the uplink;
 - let the last assigned PRACH be the default in the uplink for RACH;
 - obtain current System Information on SCCPCH to obtain and store the "CPCH SET info" IE(s);
 - upon receipt of a "CPCH SET Info" which corresponds to the "CPCH set ID" IE:
 - let the PCPCHs listed in that CPCH set be the default in the uplink for CPCH.

8.6.6.21 Default DPCH Offset Value

The UE shall:

- if the IE "Default DPCH Offset Value" is included:
 - use its value to determine Frame Offset and Chip Offset from the SFN timing in a cell;
 - store the received value in variable DOFF;
- if the IE "Default DPCH Offset Value" is not included:
 - use the previously received value stored in variable DOFF. If there is no previously received value stored in DOFF, the UE should use the value 0.

After transition from CELL_DCH state to other states, the UE shall:

- erase the value stored in variable DOFF.

8.6.6.22 Secondary Scrambling Code, Code Number

The following description applies to FDD.

Code Number can be assigned by following rules:

- When more than one DL DPDCH is assigned per RL, the segmented physical channel shall be mapped on to DL DPDCHs according to [27]. When p number of DL DPDCHs are assigned to each RL, the first pair of Secondary Scrambling Code and Code Number corresponds to "*PhCH number 1*", the second to "*PhCH number 2*", and so on until the p th to "*PhCH number p*".

8.6.6.23 PDSCH Power Control info

The UE shall:

- if the IE "PDSCH Power Control info" is included:
 - configure PDSCH power control with the received values;
- if the IE "PDSCH Power Control info" is not included:
 - continue to use the stored values.

8.6.6.24 Tx Diversity Mode

If the IE "Tx Diversity Mode" is included the UE shall:

- configure the Layer 1 to use the Tx diversity mode indicated in the IE.

8.6.6.25 SSDT Information

If the IE "SSDT Information" is included the UE shall:

- configure the size of the S-field in the FBI field on the uplink DPCCCH to the value indicated in the IE "S-field";
- use the length of the temporary cell ID code for SSDT indicated in the IE "Code Word Length".

8.6.6.26 UL Timing Advance Control (TDD only)

If the IE "UL Timing Advance Control" is present, the UE shall:

- if IE "Uplink Timing Advance Control" has the value "disabled":
 - reset timing advance to 0;
 - disable calculated timing advance following handover;
 - in case of handover:
 - start uplink transmissions in the target cell without applying timing advance;
- if IE "Uplink Timing Advance Control" has the value "enabled":
 - in case of no cell change:
 - evaluate and apply the timing advance value for uplink transmission as indicated in IE "Uplink Timing Advance" at the CFN indicated in the IE "Activation Time";
 - in case of cell change:
 - use the IE "Uplink Timing Advance" as TA_{old} and apply TA_{new} for uplink transmission in the target cell at the CFN indicated in the IE "Activation Time" as specified in [33];
 - include the value of the applied timing advance in the IE "Timing Advance" in the COMPLETE message.

8.6.6.26a Uplink synchronisation parameters

The UE shall apply uplink synchronisation using the values of the IEs "Uplink synchronisation step size" and "Uplink synchronisation frequency" as specified in [33].

8.6.6.27 Downlink information common for all radio links

If the IE "Downlink information common for all radio links " is included the UE shall:

- if the IE "Downlink DPCH info common for all radio links " is included:
 - perform actions as specified in subclause 8.6.6.28;
- if the IE choice "mode" is set to 'FDD':
 - perform actions for the IE "DPCH compressed mode info" as specified in subclause 8.6.6.15;
 - perform actions for the IE "Tx Diversity mode" as specified in subclause 8.6.6.24;
 - if the IE "SSDT information" is included:
 - perform actions as specified in subclause 8.6.6.25;
- if the IE "Default DPCH Offset value" is included:
 - perform actions as specified in the subclause 8.6.6.21.

8.6.6.28 Downlink DPCH info common for all radio links

If the IE "Downlink DPCH info common for all radio links" is included the UE shall:

- perform actions for the IE "Timing indicator" as specified in subclause 8.5.15.2;
- ignore the value received in IE "CFN-targetSFN frame offset";
- if the IE "Downlink DPCH power control information" is included:
 - perform actions for the IE "DPC Mode" according to [29];
- if the IE choice "mode" is set to 'FDD':
 - if the IE "Downlink rate matching restriction information" is included:
 - perform downlink rate matching based on the TFCs composed of 'all the TFIs of the non-restricted Transport channel' and 'allowed TFIs in the restricted Transport channel' within given TFCS;
 - if the IE "Downlink rate matching restriction information" is not included:
 - cancel all the transport format restrictions if any and initiate the downlink rate matching based on all the TFCs in given TFCS;
 - perform actions for the IE "spreading factor";
 - perform actions for the IE "Fixed or Flexible position";
 - perform actions for the IE "TFCI existence";
 - if the IE choice "SF" is set to 256:
 - store the value of the IE "Number of bits for pilot bits";
 - if the IE choice "SF" set to 128:
 - store the value of the IE "Number of bits for pilot bits";
- if the IE choice "mode" is set to 'TDD':
 - perform actions for the IE "Common timeslot info".

If the IE "Downlink DPCH info common for all radio links " is included in a message used to perform a Timing re-initialised hard handover, and ciphering is active for any radio bearer using RLC-TM, the UE shall, after having activated the dedicated physical channels indicated by that IE:

- increment HFN for RLC-TM by '1'.

8.6.6.29 ASC setting

If the IE "ASC setting" is included, the UE shall:

- establish the available signatures for this ASC as specified in the following:
 - renumber the list of available signatures specified in the IE "Available signature" included in the IE "PRACH info" from signature index 0 to signature index N-1, where N is the number of available signatures, starting with the lowest available signature number and continuing in sequence, in the order of increasing signature numbers;
 - consider as available signatures for this ASC the signatures included in this renumbered list from the index specified by the IE "Available signature Start Index" to the index specified by the IE "Available signature End Index";
- establish the available access slot sub-channels for this ASC as specified in the following:
 - if the IE "AICH transmission timing" included in the IE "AICH Info" is set to '0':
 - ignore the leftmost (most significant) bit (bit b3) of the bitstring specified by the IE "Assigned Sub-Channel Number";
 - repeat 4 times the 3 rightmost (least significant) bits (bits b2-b0) of the bitstring specified by the IE "Assigned Sub-Channel Number" to form a resulting bitstring 'b2 b1 b0 b2 b1 b0 b2 b1 b0 b2 b1 b0' of length 12 bits, where the leftmost bit is the most significant;
 - if the IE "AICH transmission timing" included in the IE "AICH Info" is set to '1':
 - repeat 3 times the bitstring (bits b3-b0) specified by the IE "Assigned Sub-Channel Number" to form a bitstring 'b3 b2 b1 b0 b3 b2 b1 b0 b3 b2 b1 b0' of length 12 bits, where the leftmost bit is the most significant;
 - perform in both cases, for the resulting bitstring (that includes the repetitions) bit-wise logical AND operation with the IE "Available Sub Channel number" included in IE "PRACH info (for RACH)";
 - consider as available sub-channels for this ASC the available sub-channels indicated in the resulting bitstring, after logical AND operation i.e. each bit set to 1 or 0 indicates availability or non-availability, respectively, of sub-channel number x , with x from 0 to 11, for the respective ASC.

NOTE 1: In FDD, the list of available signatures is renumbered from signature index 0 to signature index N-1, where N is the number of available signatures, starting with the lowest available signature number and continuing in sequence, in the order of increasing signature numbers.

- List of available signatures: 16 or fewer signatures are available.
- Example: only signatures 0, 5, 10 and 15 are available, then :
 - Signature 0 is: available signature index 0
 - Signature 5 is: available signature index 1
 - Signature 10 is: available signature index 2
 - Signature 15 is: available signature index 3

NOTE 2: In TDD, the list of available channelisation codes (defined in PRACH info) is renumbered from channelisation code index 0 to channelisation code index N-1, where N is the number of available channelisation codes, starting with the lowest available channelisation code number and continuing in sequence, in the order of increasing channelisation code numbers

List of available channelisation codes : 8 or less channelisation codes are available.

The i-th bit of the bitmap defined in the IE "Available Channelisation Code indices" defines whether the channelisation code with the available channelisation code index i is to be used for this ASC (bit set means used, bit unset means not used). Only the low N bits shall be used in the bitmap, where N is the number of available channelisation codes defined in PRACH info.

Ex : spreading factor 16, channelisation codes 16/1, 16/2, 16/5, 16/10 are available :

Channelisation code 16/1 is: available channelisation code index 0
 Channelisation code 16/2 is: available channelisation code index 1
 Channelisation code 16/5 is: available channelisation code index 2
 Channelisation code 16/10 is: available channelisation code index 3

Available Channelisation Code indices has the value '1100' means: Channelisation Codes 16/5 and 16/10 are available for this ASC.

NOTE 3: In TDD, the subchannel description is found in [33].

8.6.6.30 SRB delay, PC preamble

When the IE "SRB delay" and IE "PC preamble" is received in a message that results in a configuration of uplink DPCH, the UE shall:

- after the establishment of the uplink physical channel, send DPCCCH and no DPDCH according to [26] during the number of frames indicated in the IE "PC preamble"; and
- then not send any data on signalling radio bearers RB0 to RB4 during the number of frames indicated in the IE "SRB delay".

8.6.6.31 FPACH/PRACH Selection (1.28 Mcps TDD only)

Where more than one FPACH is defined, the FPACH that a UE should receive following a UpPCH transmission is defined by the UpPCH signature (SYNC_UL) code that the UE used. The FPACH/PRACH number = $N \bmod M$ where N denotes the signature number (0..7) and M denotes the number of FPACH/PRACH combinations that have been defined. The FPACH/PRACH number indicates the position of the FPACH/PRACH description in the IE "PRACH info".

The PRACH that should be used is selected out of the ones associated with the FPACH in the IE "PRACH info" according to [33].

8.6.7 Measurement information elements

8.6.7.1 Measurement validity

If the optional IE "measurement validity" for a given measurement has not been included in measurement control information, the UE shall delete the measurement associated with the variable MEASUREMENT_IDENTITY after the UE makes a transition to a new state.

If the IE "measurement validity" for this measurement has been included in measurement control information, the UE shall save the measurement associated with the variable MEASUREMENT_IDENTITY. The IE "UE state" defines the scope of resuming the measurement.

If the "UE state" is defined as "all states", the UE shall continue the measurement after making a transition to a new state. This scope is assigned only for traffic volume type measurements and can only be applied by the UE if the IE "traffic volume measurement object" has been included in measurement control information. If the IE "traffic volume

measurement object" has not been included in measurement control information, the UE shall not save the measurement control information in variable MEASUREMENT_IDENTITY, but shall send a MEASUREMENT CONTROL FAILURE message to the UTRAN with failure cause "Configuration incomplete".

If the "UE state" is defined as "all states except CELL_DCH", the UE shall store the measurement to be resumed after a subsequent transition from CELL_DCH state to any of the other states in connected mode. This scope is assigned only for traffic volume type measurements.

If the "UE state" is defined as "CELL_DCH", the UE shall store the measurement to be resumed after a subsequent transition to CELL_DCH state. After cell re-selection, the UE shall delete any ongoing intra-frequency or inter-frequency and inter-RAT type measurement associated with the variable MEASUREMENT_IDENTITY. Other measurement types shall, however, be continued regardless of cell reselection.

8.6.7.2 Filter coefficient

If the IE "Filter coefficient" is received the UE shall apply filtering of the measurements for that measurement quantity according to the formula below. This filtering shall be performed by the UE before UE event evaluation. The UE shall also filter the measurements reported in the IE "Measured results". The filtering shall not be performed for the measurements reported in the IE "Measured results on RACH" and for cell-reselection in connected or idle mode.

The filtering shall be performed according to the following formula.

$$F_n = (1 - a) \cdot F_{n-1} + a \cdot M_n$$

The variables in the formula are defined as follows:

F_n is the updated filtered measurement result

F_{n-1} is the old filtered measurement result

M_n is the latest received measurement result from physical layer measurements, the unit used for M_n is the same unit as the reported unit in the MEASUREMENT REPORT message or the unit used in the event evaluation.

$a = 1/2^{(k/2)}$, where k is the parameter received in the IE "Filter coefficient".

NOTE: if k is set to 0 that will mean no layer 3 filtering.

In order to initialise the averaging filter, F_0 is set to M_1 when the first measurement result from the physical layer measurement is received.

The physical layer measurement results are sampled once every measurement period. The measurement period and the accuracy for a certain measurement is defined in [19] and [20].

8.6.7.3 Intra-frequency/Inter-frequency/Inter-RAT cell info list

If the IE "Intra-frequency cell info list" is received in System Information Block Type 11, the UE shall update the variable CELL_INFO_LIST accordingly and in the following order. The UE shall:

- if the IE "Removed Intra-frequency cells" is received:
 - ignore the IE;
- if the IE "Remove all intra-frequency cells" is received:
 - ignore the IE;
- if the IE "New Intra-frequency cells" is received, for each cell, and in the same order as the cells appear in the IE:
 - update the variable CELL_INFO_LIST as follows:
 - if the IE "Intra-frequency cell id" is received:
 - store received cell information at this position in the Intra-frequency cell info list in the variable CELL_INFO_LIST, possibly overwriting any existing information in this position; and

- mark the position "occupied";
- if the IE "Intra-frequency cell id" is not received:
 - store the received cell information at the first vacant position in ascending order in the Intra-frequency cell info list in the variable CELL_INFO_LIST; and
 - mark the position as "occupied";
- if the IE "Cells for measurement" is received:
 - ignore the IE.

If the IE "Intra-frequency cell info list" is received in System Information Block Type 12, the UE shall update the variable CELL_INFO_LIST accordingly and in the following order. The UE shall:

- if the IE "Removed Intra-frequency cells" is received:
 - at the position indicated by the IE "Intra-frequency cell id" clear the cell information stored in the variable CELL_INFO_LIST; and
 - mark the position "vacant";
- if the IE "Remove all intra-frequency cells" is received:
 - for each position referring to an intra frequency cell in the variable CELL_INFO_LIST:
 - mark the position "vacant";
- if the IE "New Intra-frequency cells" is received, for each cell, and in the same order as the cells appear in the IE:
 - update the variable CELL_INFO_LIST as follows:
 - if the IE "Intra-frequency cell id" is received:
 - store received cell information at this position in the Intra-frequency cell info list in the variable CELL_INFO_LIST, possibly overwriting any existing information in this position; and
 - mark the position "occupied";
 - if the IE "Intra-frequency cell id" is not received:
 - store the received cell information at the first vacant position in ascending order in the Intra-frequency cell info list in the variable CELL_INFO_LIST; and
 - mark the position as "occupied";
- if the IE "Cells for measurement" is received:
 - ignore the IE.

If the IE "Intra-frequency cell info list" is received in a MEASUREMENT CONTROL message, the UE shall update the variable CELL_INFO_LIST accordingly and in the following order. The UE shall:

- if the IE "Removed Intra-frequency cells" is received, at the position indicated by the IE "Intra-frequency cell id":
 - clear the cell information stored in the variable CELL_INFO_LIST; and
 - mark the position "vacant";
- if the IE "Remove all intra-frequency cells" is received:
 - for each position referring to an intra frequency cell in the variable CELL_INFO_LIST:
 - mark the position "vacant";

- if the IE "New Intra-frequency cells" is received, for each cell, and in the same order as the cells appear in the IE:
 - update the variable CELL_INFO_LIST as follows:
 - if the IE "Intra-frequency cell id" is received:
 - store received cell information at this position in the Intra-frequency cell info list in the variable CELL_INFO_LIST, possibly overwriting any existing information in this position; and
 - mark the position "occupied";
 - if the IE "Intra-frequency cell id" is not received:
 - store the received cell information at the first vacant position in ascending order in the Intra-frequency cell info list in the variable CELL_INFO_LIST; and
 - mark the position as "occupied";
 - if the IE "Cells for measurement" is received, in the measurement configured by this message only:
 - consider Intra-frequency cells whose cell information is stored at the position indicated by the IE "Intra-frequency cell id" in the variable CELL_INFO_LIST;
 - if the IE "Cells for measurement" is not received, in the measurement configured by this message:
 - consider all Intra-frequency cells whose cell information is stored in CELL_INFO_LIST.

If the IE "Inter-frequency cell info list" is received in System Information Block Type 11 update the variable CELL_INFO_LIST accordingly and in the following order. The UE shall:

- if the IE "Removed Inter-frequency cells" is received:
 - ignore the IE;
- if the IE "Remove all inter-frequency cells" is received:
 - ignore the IE;
- if the IE "New Inter-frequency cells" is received, for each cell, and in the same order as the cells appear in the IE:
 - update the variable CELL_INFO_LIST as follows:
 - if the IE "Inter-frequency cell id" is received:
 - store received cell information at this position in the Inter-frequency cell info list in the variable CELL_INFO_LIST, possibly overwriting any existing information in this position; and
 - mark the position "occupied";
 - if the IE "Inter-frequency cell id" is not received:
 - store the received cell information at the first vacant position in ascending order in the Inter-frequency cell info list in the variable CELL_INFO_LIST; and
 - mark the position as "occupied";
 - if the IE "Cells for measurement" is received:
 - ignore the IE.

If the IE "Inter-frequency cell info list" is received in System Information Block Type 12, the UE shall update the variable CELL_INFO_LIST accordingly and in the following order. The UE shall:

- if the IE "Removed Inter-frequency cells" is received, at the position indicated by the IE "Inter-frequency cell id":

- clear the cell information stored in the variable CELL_INFO_LIST; and
- mark the position "vacant";
- if the IE "Remove all inter-frequency cells" is received:
 - for each position referring to an inter-frequency cell in the variable CELL_INFO_LIST:
 - clear the cell information stored in the variable CELL_INFO_LIST; and
 - mark the position "vacant";
- if the IE "New Inter-frequency cells" is received, for each cell, and in the same order as the cells appear in the IE:
 - update the variable CELL_INFO_LIST as follows:
 - if the IE "Inter-frequency cell id" is received:
 - store received cell information at this position in the Inter-frequency cell info list in the variable CELL_INFO_LIST, possibly overwriting any existing information in this position; and
 - mark the position "occupied";
 - if the IE "Inter-frequency cell id" is not received:
 - store the received cell information at the first vacant position in ascending order in the Inter-frequency cell info list in the variable CELL_INFO_LIST; and
 - mark the position as "occupied";
- if the IE "Cells for measurement" is received:
 - ignore the IE.

If the IE "Inter-frequency cell info list" is received in a MEASUREMENT CONTROL message, the UE shall update the variable CELL_INFO_LIST accordingly and in the following order:

- if the IE "Removed Inter-frequency cells" is received, at the position indicated by the IE "Inter-frequency cell id":
 - clear the cell information stored in the variable CELL_INFO_LIST; and
 - mark the position "vacant";
- if the IE "Remove all inter-frequency cells" is received:
 - for each position referring to an inter-frequency cell in the variable CELL_INFO_LIST:
 - clear the cell information stored in the variable CELL_INFO_LIST; and
 - mark the position "vacant";
- if the IE "New Inter-frequency cells" is received, for each cell, and in the same order as the cells appear in the IE:
 - update the variable CELL_INFO_LIST as follows:
 - if the IE "Inter-frequency cell id" is received:
 - store received cell information at this position in the Inter-frequency cell info list in the variable CELL_INFO_LIST, possibly overwriting any existing information in this position; and
 - mark the position "occupied";
 - if the IE "Inter-frequency cell id" is not received:

- store the received cell information at the first vacant position in ascending order in the Inter-frequency cell info list in the variable CELL_INFO_LIST; and
- mark the position as "occupied";
- if the IE "Cells for measurement" is received, in the measurement configured by this message only:
 - consider Inter-frequency cells whose cell information is stored at the position indicated by the IE "Inter-frequency cell id" in the variable CELL_INFO_LIST;
- if the IE "Cells for measurement" is not received, in the measurement configured by this message:
 - consider all Inter-frequency cells whose cell information is stored in CELL_INFO_LIST.

If the IE "Inter-RAT cell info list" is received in System Information Block Type 11, the UE shall update the variable CELL_INFO_LIST accordingly and in the following order. The UE shall:

- if the IE "Removed Inter-RAT cells" is received:
 - ignore the IE;
- if the IE "Remove all inter-RAT cells" is received:
 - ignore the IE;
- if the IE "New Inter-RAT cells" is received, for each cell, and in the same order as the cells appear in the IE:
 - update the variable CELL_INFO_LIST as follows:
 - if the IE "Inter-RAT cell id" is received:
 - store received cell information at this position in the Inter-RAT cell info list in the variable CELL_INFO_LIST, possibly overwriting any existing information in this position; and
 - mark the position "occupied";
 - if the IE "Inter-RAT cell id" is not received:
 - store the received cell information at the first vacant position in ascending order in the Inter-RAT cell info list in the variable CELL_INFO_LIST; and
 - mark the position as "occupied";
- if the IE "Cells for measurement" is received:
 - ignore the IE;

If the IE "Inter-RAT cell info list" is received in System Information Block Type 12, the UE shall update the variable CELL_INFO_LIST accordingly and in the following order. The UE shall:

- if the IE "Removed Inter-RAT cells" is received, at the position indicated by the IE "Inter-RAT cell id":
 - clear the cell information stored in the variable CELL_INFO_LIST; and
 - mark the position "vacant";
- if the IE "Remove all inter-RAT cells" is received:
 - for each position referring to an inter-RAT cell in the variable CELL_INFO_LIST:
 - clear the cell information stored in the variable CELL_INFO_LIST; and
 - mark the position "vacant";
- if the IE "New Inter-RAT cells" is received, for each cell, and in the same order as the cells appear in the IE:
 - update the variable CELL_INFO_LIST as follows:

- if the IE "Inter-RAT cell id" is received:
 - store received cell information at this position in the Inter-RAT cell info list in the variable CELL_INFO_LIST, possibly overwriting any existing information in this position; and
 - mark the position "occupied";
- if the IE "Inter-RAT cell id" is not received:
 - store the received cell information at the first vacant position in ascending order in the Inter-RAT cell info list in the variable CELL_INFO_LIST; and
 - mark the position as "occupied";
- if the IE "Cells for measurement" is received:
 - ignore the IE.

If the IE "Inter-RAT cell info list" is received in a MEASUREMENT CONTROL message, the UE shall update the variable CELL_INFO_LIST accordingly and in the following order. The UE shall:

- if the IE "Removed Inter-RAT cells" is received, at the position indicated by the IE "Inter-RAT cell id":
 - clear the cell information stored in the variable CELL_INFO_LIST; and
 - mark the position "vacant";
- if the IE "Remove all inter-RAT cells" is received:
 - for each position referring to an inter-RAT cell in the variable CELL_INFO_LIST:
 - clear the cell information stored in the variable CELL_INFO_LIST; and
 - mark the position "vacant";
- if the IE "New Inter-RAT cells" is received, for each cell, and in the same order as the cells appear in the IE:
 - update the variable CELL_INFO_LIST as follows:
 - if the IE "Inter-RAT cell id" is received:
 - store received cell information at this position in the Inter-RAT cell info list in the variable CELL_INFO_LIST, possibly overwriting any existing information in this position; and
 - mark the position "occupied";
 - if the IE "Inter-RAT cell id" is not received:
 - store the received cell information at the first vacant position in ascending order in the Inter-RAT cell info list in the variable CELL_INFO_LIST; and
 - mark the position as "occupied";
- if the IE "Cells for measurement" is received, in the measurement configured by this message only:
 - consider Inter-RAT cells whose cell information is stored at the position indicated by the IE "Inter-RAT cell id" in the variable CELL_INFO_LIST;
- if the IE "Cells for measurement" is not received, in the measurement configured by this message:
 - consider all Inter-RAT cells whose cell information is stored in CELL_INFO_LIST;
- if the IE "Cell selection and re-selection info for SIB11/12" is present:
 - ignore the IE.

8.6.7.4 Intra-frequency measurement quantity

If the IE "Intra-frequency measurement quantity" is received in a MEASUREMENT CONTROL message, the UE shall:

- if the IE "Measurement quantity" is set to "pathloss"; and
- for any intra-frequency cell indicated by the IE "Cells for measurement", the IE "Primary CPICH Tx power" in FDD or the IE "Primary CCPCH TX Power" in TDD in the intra frequency cell info list in the variable CELL_INFO_LIST is not present:
 - set the variable CONFIGURATION_INCOMPLETE to TRUE;
- else:
 - configure the measurement quantity accordingly.

8.6.7.5 Inter-RAT measurement quantity

If the IE "Inter-RAT measurement quantity" is received in a MEASUREMENT CONTROL message and CHOICE system is GSM, the UE shall:

- if IE "BSIC verification required" is set to "required", for cells that match any of the BCCH ARFCN and BSIC combinations in the list of inter-RAT cells that the UE has received in IE "Inter-RAT cell info list", and that has a "verified" BSIC:
 - report measurement quantities according to IE "inter-RAT reporting quantity" taking into account the restrictions defined in subclause 8.6.7.6;
 - trigger inter-RAT events according to IE "inter-RAT measurement reporting criteria"; and
 - perform event evaluation for event-triggered reporting after BSIC has been verified for a GSM cell as defined in [19]; and
 - trigger periodical reports according to the given "Reporting interval" even if the BSIC of GSM cell has not been verified; and
 - indicate non-verified BSIC for a GSM cell in the "Inter-RAT measured results list" IE as defined in subclause 8.6.7.6;
- if IE "BSIC verification required" is set to "not required", for cells that match any of the BCCH ARFCN in the list of inter-RAT cells that the UE has received in IE "Inter-RAT cell info list", regardless if the BSIC is "verified" or "non-verified":
 - report measurement quantities according to IE "inter-RAT reporting quantity";
 - trigger inter-RAT events according to IE "inter-RAT measurement reporting criteria";
- if the IE "Measurement quantity" is set to "pathloss":
 - set the variable CONFIGURATION_INCOMPLETE to TRUE.

NOTE: The requirements for a cell to be considered "verified" or "non-verified" can be found in [19].

8.6.7.6 Inter-RAT reporting quantity

If the IE "Inter-RAT reporting quantity" is received by the UE, the UE shall:

- store the content of the IE to the variable MEASUREMENT_IDENTITY.

If the IE "Inter-RAT measurement quantity" is received and CHOICE system is GSM, the UE shall check each quantity in the GSM choice. The UE shall include measured results in MEASUREMENT REPORT as specified in the IE "Inter-RAT reporting quantity" with the following restrictions:

- if the UE has not confirmed the BSIC of the measured cell:

- if no compressed mode pattern sequence specified with measurement purpose "Initial BSIC identification" is active, the UE is not required to include the "inter-RAT cell id" nor "Observed time difference to GSM cell" in the IE "Inter-RAT measured results list", when a MEASUREMENT REPORT is triggered.
- if the UE has confirmed the BSIC of the measured cell, then:
 - if no compressed mode pattern sequence specified with measurement purpose "Initial BSIC identification" nor "BSIC re-confirmation" is active, the UE is not required to include the "inter-RAT cell id" nor "Observed time difference to GSM cell" in the IE "Inter-RAT measured results", when a MEASUREMENT REPORT is triggered. If no compressed mode pattern sequence with measurement purpose "GSM carrier RSSI measurements" is active, the UE may include "inter-RAT cell id" or "Observed time difference to GSM cell" in MEASUREMENT REPORT without "GSM carrier RSSI" even if it is defined in the IE "Inter-RAT reporting quantity".
- if IE "Pathloss" is set to "TRUE":
 - set the variable CONFIGURATION_INCOMPLETE to TRUE;
- if IE "Observed time difference to GSM cell" is set to "TRUE":
 - include optional IE "Observed time difference to GSM cell" with the value set to the time difference to that GSM cell for the GSM cells that have a BSIC that is "verified", and that match any of the BCCH ARFCN and BSIC combinations in the list of inter-RAT cells that the UE has received in IE "Inter-RAT cell info list". Observed time difference to GSM cells with "non-verified" BSIC shall not be included;
- if IE "GSM Carrier RSSI" is set to "TRUE":
 - include optional IE "GSM Carrier RSSI" with a value set to the measured RXLEV to that GSM cell in IE "Inter-RAT measured results list". If no compressed mode pattern sequence specified with measurement purpose "GSM carrier RSSI measurements" is active, the UE is not required to include the "GSM carrier RSSI" in the IE "Inter-RAT measured results list", when a MEASUREMENT REPORT is triggered;
- if the BSIC of reported GSM cell is "verified":
 - set the CHOICE BSIC to "Verified BSIC" and IE "inter-RAT cell id" to the value that GSM cell had in the IE "Inter-RAT cell info list";
- if the BSIC of reported GSM cell is "non-verified":
 - set the CHOICE BSIC to "Non verified BSIC" and the IE "BCCH ARFCN" to the value of that GSM cells ARFCN;

The requirements for a cell to be considered "verified" or "non-verified" can be found in [19].

8.6.7.7 Cell Reporting Quantities

If the IE "Cell Reporting Quantities" is received by the UE, the UE shall store the content of the IE "Cell Reporting Quantities" to the variable MEASUREMENT_IDENTITY.

The UE shall include measured results in MEASUREMENT REPORT as specified in the IE "Cell Reporting Quantities", except for the following cases:

If the IE "Cell Identity" is set to TRUE, the UE shall in this version of the specification:

- treat the IE as if the IE "Cell Identity" is set to FALSE.

If the IE "Cell synchronisation information reporting indicator" is set to TRUE, the UE shall:

- include the IE "Cell synchronisation information" in MEASUREMENT REPORT as specified in the IE "Cell Reporting Quantities":
 - if the measurement is performed on another frequency:
 - a UE may omit the information group "COUNT-C-SFN frame difference" in the IE "Cell synchronisation information".

- if the measurement is performed on the same frequency and no RLC Transparent Mode COUNT-C exists in the UE:
 - set the IE "COUNT-C-SFN high" to 0.
- otherwise:
 - include the information group "COUNT-C-SFN frame difference".

If the IE "Proposed TGSN Reporting required" is set to TRUE, the UE shall:

- if compressed mode was used to monitor a TDD cell and the variable TGSN_REPORTED is set to FALSE:
 - report the IE "Proposed TGSN" indicating the TGSN that suits best to the measured cell;
 - set the variable TGSN_REPORTED to TRUE.
- otherwise
 - omit the IE "Proposed TGSN".

8.6.7.8 Periodical Reporting Criteria

If the IE "Periodical Reporting Criteria" is received by the UE, the UE shall:

- store the contents of the IE "Amount of Reporting" and IE "Reporting interval" in the variable MEASUREMENT_IDENTITY.

The UE shall:

- send the first MEASUREMENT REPORT message, omitting parts of the configured measurements that are not available according to the variable MEASUREMENT_IDENTITY, as soon as the first measurement has been completed according to the requirements and the measurement capabilities set in [19] and [20]; and then
- send the next MEASUREMENT REPORT messages with intervals specified by the IE "Reporting interval", omitting parts of the configured measurements that are not available according to the variable MEASUREMENT_IDENTITY, and omitting measurement results that were reported in a previous MEASUREMENT REPORT and were not subsequently updated.

After the UE has sent a total number of MEASUREMENT REPORT messages, which equal the value indicated in the IE "Amount of reporting", the UE shall:

- terminate measurement reporting; and
- delete all measurement information linked with the "Measurement identity" of the ongoing measurement from the variable MEASUREMENT_IDENTITY.

8.6.7.9 Reporting Cell Status

If the IE "Reporting Cell Status" is received, the UE shall set the IE "Measured Results" in MEASUREMENT REPORT as follows. The UE shall:

- for intra-frequency measurement and inter-frequency measurement:
 - include the IE "Cell Measured Results" for cells that satisfy the condition (such as "Report cells within active set") specified in "Reporting Cell Status", in descending order by the measurement quantity;
 - the maximum number of the IE "Cell Measured Results" to be included in the IE "Measured Results" is the number specified in "Reporting Cell Status".

If the IE "Reporting Cell Status" is not received for intra-frequency or inter-frequency measurement, the UE shall:

- exclude the IE "cell measured results" for any cell in MEASUREMENT REPORT.

8.6.7.10 Traffic Volume Measurement

If the IE "Traffic Volume Measurement" is received by the UE, the UE shall:

- store the content of the IE to the variable MEASUREMENT_IDENTITY.

If the IE "Traffic volume measurement Object" is not included, the UE shall:

- apply the measurement reporting criteria to all uplink transport channels.

If IE "Traffic volume measurement" is received by the UE in a MEASUREMENT CONTROL message, where IE "measurement command" has the value "setup", and if the IE "traffic volume reporting quantity" is included, the UE shall:

- report the measured quantities specified in the IE "traffic volume reporting quantity";
- if the parameter "Average of RLC Buffer Payload for each RB" or the parameter "Variance of RLC Buffer payload for each RB" is set:
 - if the IE "Traffic volume measurement quantity" is not included:
 - set the variable CONFIGURATION_INCOMPLETE to TRUE;
 - if the IE "Traffic volume measurement quantity" is included:
 - if the parameter "time interval to take an average or a variance" is included:
 - use the time specified in the parameter "time interval to take an average or a variance" to calculate the average and/or variance of RLC Buffer Payload according to the IE "traffic volume reporting quantity";
 - if the parameter "time interval to take an average or a variance" is not included:
 - set the variable CONFIGURATION_INCOMPLETE to TRUE.

If IE "Traffic volume measurement" is received by the UE in a MEASUREMENT CONTROL message, where IE "measurement command" has the value "setup", but IE "Traffic volume measurement quantity" or IE "Traffic volume reporting quantity" is not received, the UE shall:

- clear all stored measurement control information related associated to this measurement identity in variable MEASUREMENT_IDENTITY;
- set the variable CONFIGURATION_INCOMPLETE to TRUE.

8.6.7.11 Traffic Volume Measurement Reporting Criteria

If the IE "Traffic Volume Measurement Reporting Criteria" is received by the UE, the UE shall:

- store the content of the IE "Traffic Volume Measurement Reporting Criteria" to the variable MEASUREMENT_IDENTITY.

If the IE "UL transport channel id" is not included, the UE shall:

- apply the measurement reporting criteria to all uplink transport channels indicated in the "Traffic volume measurement Object";
- if the UTRAN has not specified a traffic volume measurement object for a given measurement identity:
 - apply the measurement reporting criteria to all uplink transport channels that are configured for the current UE state.

If the IE "Tx interruption after trigger" is included, the UE shall:

- block DTCH transmissions on the RACH during the time specified in the IE after a measurement report is transmitted.

8.6.7.12 FACH measurement occasion info

IE "FACH measurement occasion info" is used to control UE measurement activities in inter-frequency and inter-RAT cells in CELL_FACH state.

If IE "FACH measurement occasion info" is received, UE shall, when in CELL_FACH state:

- if IE "FACH Measurement occasion length coefficient" is included:
 - if, according to its measurement capabilities, UE is not able to perform some of the indicated measurements in this IE simultaneously as receiving the SCCPCH of serving cell:
 - perform those measurements during FACH measurement occasions, see subclause 8.5.12;
 - if, according to its measurement capabilities, UE is able to perform some of the indicated measurements in this IE simultaneously as receiving the SCCPCH of serving cell:
 - UE may perform measurements also on other occasions;
 - if, according to its measurement capabilities, UE is able to perform the measurements and indicated in this IE simultaneously as receiving the SCCPCH of serving cell:
 - perform the measurements simultaneously as receiving the SCCPCH of serving cell;
- if IE "FACH Measurement occasion length coefficient" is not included:
 - perform those indicated measurements indicated in this IE that UE, according to its measurement capabilities, is able to perform simultaneously as receiving the SCCPCH of serving cell;
- if IE "Inter-frequency FDD measurement indicator" is set to TRUE:
 - perform measurements and evaluate cell re-selection criteria according to [4] on inter-frequency FDD cells listed in IE "Measurement control system information" in "System Information Block type 11" or "System Information Block type 12";
- if IE "Inter-frequency FDD measurement indicator" is set to FALSE:
 - neither perform measurements nor evaluate cell re-selection criteria on inter-frequency FDD cells;
- if IE "Inter-frequency TDD measurement indicator" is set to TRUE:
 - perform measurements and evaluate cell re-selection criteria according to [4] on inter-frequency TDD cells listed in IE "Measurement control system information" in "System Information Block type 11" or "System Information Block type 12";
- if IE "Inter-frequency TDD measurement indicator" is set to FALSE:
 - neither perform measurements nor evaluate cell re-selection criteria on inter-frequency TDD cells;
- if IE "Inter-RAT measurement indicators" is included:
 - perform measurements and evaluate cell re-selection criteria according to [4] on those cells of listed Inter-RAT types that are present in IE "Measurement control system information" in "System Information Block type 11" or "System Information Block type 12".

8.6.7.13 Measurement Reporting Mode

If IE "Measurement Reporting Mode" is received by the UE, the UE shall:

- store the contents of the IE "Measurement Report Transfer Mode" in the variable MEASUREMENT_IDENTITY;
- use the indicated RLC mode when sending MEASUREMENT REPORT message(s) related to this measurement;
- ignore IE "Periodical Reporting / Event Trigger Reporting Mode".

If IE "Measurement Reporting Mode" is not received by the UE in MEASUREMENT CONTROL message, where IE "measurement command" has the value "setup", the UE shall:

- clear all stored measurement control information related associated to this measurement identity in variable MEASUREMENT_IDENTITY;
- set the variable CONFIGURATION_INCOMPLETE to TRUE.

8.6.7.14 Inter-frequency measurement

If IE "Inter-frequency measurement" is received by the UE in a MEASUREMENT CONTROL message, where IE "measurement command" has the value "setup", but IE "Inter-frequency measurement quantity", IE "Inter-frequency reporting quantity" or "CHOICE Report criteria" is not received, the UE shall:

- clear all stored measurement control information related associated to this measurement identity in variable MEASUREMENT_IDENTITY;
- set the variable CONFIGURATION_INCOMPLETE to TRUE.

8.6.7.15 Inter-RAT measurement

If IE "Inter-RAT measurement" is received by the UE in a MEASUREMENT CONTROL message, where IE "measurement command" has the value "setup", but IE "Inter-RAT measurement quantity", IE "Inter-RAT reporting quantity" or "CHOICE Report criteria" is not received, the UE shall:

- clear all stored measurement control information related associated to this measurement identity in variable MEASUREMENT_IDENTITY;
- set the variable CONFIGURATION_INCOMPLETE to TRUE.

8.6.7.16 Intra-frequency measurement

If IE "Intra-frequency measurement" is received by the UE in a MEASUREMENT CONTROL message, where IE "measurement command" has the value "setup", but IE "Intra-frequency measurement quantity", IE "Intra-frequency reporting quantity" or "CHOICE Report criteria" is not received, the UE shall:

- clear all stored measurement control information related associated to this measurement identity in variable MEASUREMENT_IDENTITY;
- set the variable CONFIGURATION_INCOMPLETE to TRUE.

8.6.7.17 Quality measurement

If IE "Quality measurement" is received by the UE in a MEASUREMENT CONTROL message, where IE "measurement command" has the value "setup", but IE "Quality reporting quantity" is not received, the UE shall:

- clear all stored measurement control information related associated to this measurement identity in variable MEASUREMENT_IDENTITY;
- set the variable CONFIGURATION_INCOMPLETE to TRUE.

8.6.7.18 UE internal measurement

If IE "UE internal measurement" is received by the UE in a MEASUREMENT CONTROL message, where IE "measurement command" has the value "setup", but IE "UE internal measurement quantity" or IE "UE internal reporting quantity" is not received, the UE shall:

- clear all stored measurement control information related associated to this measurement identity in variable MEASUREMENT_IDENTITY;
- set the variable CONFIGURATION_INCOMPLETE to TRUE.

8.6.7.19 UE positioning GPS real-time integrity

The GPS real-time integrity information element specified in 10.3.7.95 is primarily intended for non-differential applications. The real-time integrity of the satellite constellation is of importance as there is no differential correction data by which the UE can determine the soundness of each satellite signal. The Real-Time GPS Satellite Integrity data communicates the health of the constellation to the mobile via a list of bad satellites. The UE shall consider the data associated with the satellites identified in this IE as invalid.

8.6.7.20 UE positioning OTDOA neighbour cell info

If IE "UE positioning OTDOA neighbour cell info" is received with UE based PositioningMode selected, the UE shall:

- if "Relative North", "Relative East", or "Relative Altitude" IEs are transmitted:
 - store the corresponding values into UE variable "CELL_POSITION" defined in subclause 13.4.00;
- use the values stored in CELL_POSITION (either from the current or previously processed IEs) as "Relative North", "Relative East" and "Relative Altitude".

8.6.8 Void

9 Handling of unknown, unforeseen and erroneous protocol data

9.1 General

This subclause specifies procedures for the handling of unknown, unforeseen, and erroneous protocol data by the receiving entity. These procedures are called "error handling procedures", but in addition to provide recovery mechanisms for error situations they define a compatibility mechanism for future extensions of the protocol.

The error handling procedures specified in this subclause shall apply to all RRC messages. When there is a specific handling for messages received on different logical channels this is specified.

For system information received on the BCCH, the error handling procedures are applied on the BCCH message SYSTEM INFORMATION, the re-assembled system information segments as well as the system information blocks (including the master information block and the scheduling blocks), with specific error handling as specified below.

When the UE receives an RRC message, it shall set the variable PROTOCOL_ERROR_REJECT to FALSE and then perform the checks in the order as defined below.

The procedures specified in clause 8 are applied only for the messages passing the checks as defined below, except when procedure specific handling is used to recover from the error.

In certain error cases, as specified in the following, default values apply. In this case, the default values specified within the ASN.1, the tabular and the procedure specifications apply.

9.2 ASN.1 violation or encoding error

If the UE receives an RRC message on the DCCH for which the encoded message does not result in any valid abstract syntax value [49] (or "encoding error"), it shall perform the following. The UE shall:

- set the variable PROTOCOL_ERROR_REJECT to TRUE;
- transmit an RRC STATUS message on the uplink DCCH. The IE "Protocol error information" shall contain an IE "Protocol error cause" set to "ASN.1 violation or encoding error";
- when RRC STATUS message has been submitted to lower layers for transmission:

- continue with any ongoing processes and procedures as if the invalid message had not been received.

If the UE receives an RRC message sent to the UE in an RRC information container via a radio access technology other than UTRAN, for which the encoded message does not result in any valid abstract syntax, the UE shall:

- set the variable `PROTOCOL_ERROR_REJECT` to TRUE;
- set the IE "Protocol error cause" in the variable `PROTOCOL_ERROR_INFORMATION` to "ASN.1 violation or encoding error";
- perform procedure specific error handling according to clause 8.

If a reassembled set of system information segments received in messages on the BCCH does not result in any valid abstract syntax value, the UE shall:

- ignore the reassembled set of system information segments;
- treat the rest of each message containing the ignored system information segments as if those segments were not present.

If the UE receives an RRC message on the BCCH, PCCH, CCCH or SHCCH for which the encoded message does not result in any valid abstract syntax value, it shall ignore the message.

9.3 Unknown or unforeseen message type

If a UE receives an RRC message on the DCCH with a message type not defined for the DCCH it shall:

- set the variable `PROTOCOL_ERROR_REJECT` to TRUE;
- transmit an RRC STATUS message on the uplink DCCH. The IE "Protocol error information" shall contain an IE "Protocol error cause" set to "Message type non-existent or not implemented";
- when the RRC STATUS message has been submitted to lower layers for transmission:
 - continue with any ongoing processes and procedures as if the invalid message had not been received.

If the UE receives an RRC message on the BCCH, PCCH, CCCH or SHCCH with a message type not defined for the logical channel type the message was received on, it shall ignore the message.

9.3a Unsolicited received message

If the UE receives any of the following messages:

- an RRC CONNECTION SETUP message addressed to the UE on the CCCH; or
- an RRC CONNECTION REJECT message addressed to the UE on the CCCH; or
- a UE CAPABILITY INFORMATION CONFIRM message on the DCCH; or
- a CELL UPDATE CONFIRM message addressed to the UE on the CCCH or on the DCCH; or
- a URA UPDATE CONFIRM message addressed to the UE on the CCCH or on the DCCH

and no procedure is ongoing according to clause 8 which expects the message to be received:

the UE shall:

- ignore the received message.

9.3b Unexpected critical message extension

If the UE receives an RRC message on the DCCH, or addressed to the UE on the CCCH or on the SHCCH, or sent to the UE in an RRC information container via a radio access technology other than UTRAN, containing an undefined critical message extension, the UE shall:

- set the variable `PROTOCOL_ERROR_REJECT` to `TRUE`;
- set the IE "Protocol error cause" in the variable `PROTOCOL_ERROR_INFORMATION` to "Message extension not comprehended";
- if the IE "Message Type" of the received message is not present in the table "Rejected transactions" in the variable `TRANSACTIONS`:
 - store the IE "Message type" of the received message in the table "Rejected transactions" in the variable `TRANSACTIONS`; and
 - set the IE "RRC transaction identifier" to zero in that table entry;
- perform procedure specific error handling according to clause 8.

If the UE receives an RRC message on the BCCH or PCCH, containing an undefined critical message extension, the UE shall:

- ignore the message.

9.4 Unknown or unforeseen information element value, mandatory information element

If the UE receives an RRC message on the DCCH, or addressed to the UE on the CCCH or on the SHCCH, or sent to the UE in an RRC information container via a radio access technology other than UTRAN, with a mandatory IE having a value, including choice, reserved for future extension (spare) or when the encoded IE does not result in any valid abstract syntax value [49] for this IE, the UE shall:

- if a default value of the IE is defined:
 - treat the rest of the message using the default value of the IE;
- if no default value of the IE is defined:
 - set the variable `PROTOCOL_ERROR_REJECT` to `TRUE`;
 - set the IE "Protocol error cause" in the variable `PROTOCOL_ERROR_INFORMATION` to "Information element value not comprehended";
 - perform procedure specific error handling according to clause 8.

If the UE receives a system information block on the BCCH with a mandatory IE having a value reserved for future extension (spare) or when the encoded IE does not result in any valid abstract syntax value for this IE, the UE shall:

- if a default value of the IE is defined:
 - treat the rest of the system information block using the default value of the IE;
- if no default value of the IE is defined:
 - ignore the system information block.

If the UE receives an RRC message on the BCCH or PCCH with a mandatory IE having a value reserved for future extension (spare) or when the encoded IE does not result in any valid abstract syntax value for this IE, it shall

- if a default value of the IE is defined:
 - treat the rest of the message using the default value of the IE.

- if no default value of the IE is defined:
 - ignore the message.

9.5 Conditional information element error

If the UE receives an RRC message on the DCCH, BCCH, PCCH, or addressed to the UE on the CCCH or on the SHCCH, or sent to the UE in an RRC information container via a radio access technology other than UTRAN, for which the specified conditions for absence of a conditional IE are met and that IE is present, the UE shall:

- ignore the IE;
- treat the rest of the message as if the IE was not present.

If the UE receives an RRC message on the DCCH, or addressed to the UE on the CCCH or on the SHCCH, or sent to the UE via a radio access technology other than UTRAN, for which the specified conditions for presence of a conditional IE are met and that IE is absent, the UE shall:

- set the variable `PROTOCOL_ERROR_REJECT` to `TRUE`;
- set the IE "Protocol error cause" in the variable `PROTOCOL_ERROR_INFORMATION` to "Conditional information element error";
- perform procedure specific error handling according to clause 8.

If the UE receives a system information block on the BCCH for which the specified conditions for presence of a conditional IE are met and that IE is absent, the UE shall:

- ignore the system information block.

If the UE receives an RRC message on the BCCH or PCCH for which the specified conditions for presence of a conditional IE are met and that IE is absent, the UE shall:

- ignore the message.

9.6 Unknown or unforeseen information element value, conditional information element

If the UE receives an RRC message on the DCCH, or addressed to the UE on the CCCH or on the SHCCH, or sent to the UE in an RRC information container via a radio access technology other than UTRAN, for which the specified conditions for presence of a conditional IE are met, that IE is present, and that IE has a value, including choice, reserved for future extension (spare) or when the encoded IE does not result in any valid abstract syntax value [49] for this IE, the UE shall:

- if a default value of the IE is defined:
 - treat the rest of the message using the default value of the IE;
- if no default value of the IE is defined:
 - set the variable `PROTOCOL_ERROR_REJECT` to `TRUE`;
 - set the IE "Protocol error cause" in the variable `PROTOCOL_ERROR_INFORMATION` to "Information element value not comprehended";
 - perform procedure specific error handling according to clause 8.

If the UE receives a system information block on the BCCH for which the specified conditions for presence of a conditional IE are met, that IE is present, and that IE has a value, including choice, reserved for future extension (spare) or when the encoded IE does not result in any valid abstract syntax value for this IE, the UE shall:

- if a default value of the IE is defined:

- treat the rest of the system information block using the default value of the IE;
- if no default value of the IE is defined:
 - ignore the system information block.

If the UE receives an RRC message on the BCCH or PCCH for which the specified conditions for presence of a conditional IE are met, that IE is present, and that IE has a value, including choice, reserved for future extension (spare) or when the encoded IE does not result in any valid abstract syntax value for this IE, the UE shall:

- if a default value of the IE is defined:
 - treat the rest of the message using the default value of the IE;
- if no default value of the IE is defined:
 - ignore the message.

9.7 Unknown or unforeseen information element value, optional information element

If the UE receives an RRC message on the DCCH, or addressed to the UE on the CCCH or on the SHCCH, or sent to the UE in an RRC information container via a radio access technology other than UTRAN, with an optional IE having a value, including choice, reserved for future extension (spare) or when the encoded IE does not result in any valid abstract syntax value [49] for this IE, it shall:

- ignore the value of the IE;
- treat the rest of the message as if the IE was not present.

If the UE receives a system information block on the BCCH with an optional IE having a value, including choice, reserved for future extension (spare) or when the encoded IE does not result in any valid abstract syntax value for this IE, it shall:

- ignore the value of the IE;
- treat the rest of the system information block as if the IE was not present.

If the UE receives an RRC message on the BCCH or PCCH with an optional IE having a value, including choice, reserved for future extension (spare) or when the encoded IE does not result in any valid abstract syntax value for this IE, it shall:

- ignore the value of the IE;
- treat the rest of the message as if the IE was not present.

9.8 Unexpected non-critical message extension

If the UE receives an RRC message on the DCCH, or addressed to the UE on the CCCH or on the SHCCH, or sent to the UE in an RRC information container via a radio access technology other than UTRAN, containing an undefined non-critical message extension, the UE shall:

- ignore the content of the extension and the message contents after the extension, but treat the parts of the message up to the extension normally.

If the UE receives a system information block on the BCCH containing an undefined non-critical message extension, the UE shall:

- ignore the content of the extension and the system information block contents after the extension, but treat the parts of the system information block up to the extension normally.

If the UE receives an RRC message on the BCCH or PCCH, containing an undefined non-critical message extension, the UE shall:

- ignore the content of the extension and the message contents after the extension, but treat the parts of the message up to the extension normally.

10 Message and information element functional definition and content

10.1 General

The function of each Radio Resource Control message together with message contents in the form of a list of information elements is defined in subclause 10.2.

Functional definitions of the information elements are then described in subclause 10.3.

Information elements are marked as either MP - Mandatory present, MD - Mandatory with default value, OP - Optional, CV - Conditional on value or CH - Conditional on history (see Table 10.1 with information extracted from [14]).

Table 10.1: Meaning of abbreviations used in RRC messages and information elements

| Abbreviation | Meaning |
|--------------|--|
| MP | <p>Mandatory present</p> <p>A value for that information is always needed, and no information is provided about a particular default value. If ever the transfer syntax allows absence (e.g., due to extension), then absence leads to an error diagnosis.</p> |
| MD | <p>Mandatory with default value</p> <p>A value for that information is always needed, and a particular default value is mentioned (in the 'Semantical information' column). This opens the possibility for the transfer syntax to use absence or a special pattern to encode the default value.</p> |
| CV | <p>Conditional on value</p> <p>A value for that information is needed (presence needed) or unacceptable (absence needed) when some conditions are met that can be evaluated on the sole basis of the content of the message.</p> <p>If conditions for presence needed are specified, the transfer syntax must allow for the presence of the information. If the transfer syntax allows absence, absence when the conditions for presence are met leads to an error diagnosis.</p> <p>If conditions for absence needed are specified, the transfer syntax must allow to encode the absence. If the information is present and the conditions for absence are met, an error is diagnosed.</p> <p>When neither conditions for presence or absence are met, the information is treated as optional, as described for 'OP'.</p> |
| CH | <p>Conditional on history</p> <p>A value for that information is needed (presence needed) or unacceptable (absence needed) when some conditions are met that must be evaluated on the basis of information obtained in the past (e.g., from messages received in the past from the other party).</p> <p>If conditions for presence needed are specified, the transfer syntax must allow for the presence of the information. If the transfer syntax allows absence, absence when the conditions for presence are met leads to an error diagnosis.</p> <p>If conditions for absence needed are specified, the transfer syntax must allow to encode the absence. If the information is present and the conditions for absence are met, an error is diagnosed.</p> <p>When neither conditions for presence or absence are met, the information is treated as optional, as described for 'OP'.</p> |
| OP | <p>Optional</p> <p>The presence or absence is significant and modifies the behaviour of the receiver. However whether the information is present or not does not lead to an error diagnosis.</p> |

10.1.1 Protocol extensions

RRC messages may be extended in future versions of this protocol, either by adding values for choices, enumerated and size constrained types or by adding information elements. An important aspect concerns the behaviour of a UE, conforming to this revision of the standard, upon receiving a not comprehended future extension. The details of this error handling behaviour are provided in clause 9.

NOTE 1: By avoiding the need for partial decoding (skipping uncomprehended IEs to continue decoding the remainder of the message), the RRC protocol extension mechanism also avoids the overhead of length determinants for extensions.

Two kinds of protocol extensions are distinguished: non-critical and critical extensions. In general, a receiver shall process a message including not comprehended non-critical extensions as if the extensions were absent. However, a receiver shall entirely reject a message including not comprehended critical extensions (there is no partial rejection) and notify the sender, as specified in clause 9.

The general mechanism for adding critical extensions is by defining a new version of the message, which is indicated at the beginning of the message.

The UE shall always comprehend the complete transfer syntax specified for the protocol version it supports; if the UE comprehends the transfer syntax defined within protocol version A for message 1, it shall also comprehend the transfer syntax defined within protocol version A for message 2.

The following table shows for which messages only non-critical extensions may be added while for others both critical and non-critical extensions may be added.

NOTE 2: Critical extensions can only be added to certain downlink messages.

| Extensions | Message |
|--------------------------------------|---|
| Critical and non-critical extensions | ACTIVE SET UPDATE 10.2.1 ASSISTANCE DATA DELIVERY 10.2.4 CELL CHANGE ORDER FROM UTRAN 10.2.5 CELL UPDATE CONFIRM 10.2.8 COUNTER CHECK 10.2.9 DOWNLINK DIRECT TRANSFER 10.2.11 HANDOVER TO UTRAN COMMAND 10.2.12 HANDOVER FROM UTRAN COMMAND 10.2.15 MEASUREMENT CONTROL 10.2.17 PHYSICAL CHANNEL RECONFIGURATION 10.2.22 PHYSICAL SHARED CHANNEL ALLOCATION 10.2.25 RADIO BEARER RECONFIGURATION 10.2.27 RADIO BEARER RELEASE 10.2.30 RADIO BEARER SETUP 10.2.33 RRC CONNECTION REJECT 10.2.36 RRC CONNECTION RELEASE 10.2.37 RRC CONNECTION SETUP 10.2.40 SECURITY MODE COMMAND 10.2.43 SIGNALLING CONNECTION RELEASE 10.2.46 TRANSPORT CHANNEL RECONFIGURATION 10.2.50 TRANSPORT FORMAT COMBINATION CONTROL 10.2.53 UE CAPABILITY ENQUIRY 10.2.55 UE CAPABILITY INFORMATION CONFIRM 10.2.57 UPLINK PHYSICAL CHANNEL CONTROL 10.2.59 URA UPDATE CONFIRM 10.2.61 UTRAN MOBILITY INFORMATION 10.2.62 |
| Non-critical extensions only | ACTIVE SET UPDATE COMPLETE 10.2.2 ACTIVE SET UPDATE FAILURE 10.2.3 CELL CHANGE ORDER FROM UTRAN FAILURE 10.2.6 CELL UPDATE 10.2.7 COUNTER CHECK RESPONSE 10.2.10 HANDOVER TO UTRAN COMPLETE 10.2.13 INITIAL DIRECT TRANSFER 10.2.14 HANDOVER FROM UTRAN FAILURE 10.2.16 MEASUREMENT CONTROL FAILURE 10.2.18 MEASUREMENT REPORT 10.2.19 PAGING TYPE 1 10.2.20 PAGING TYPE 2 10.2.21 PHYSICAL CHANNEL RECONFIGURATION COMPLETE 10.2.23 PHYSICAL CHANNEL RECONFIGURATION FAILURE 10.2.24 PUSCH CAPACITY REQUEST 10.2.26 RADIO BEARER RECONFIGURATION COMPLETE 10.2.28 RADIO BEARER RECONFIGURATION FAILURE 10.2.29 RADIO BEARER RELEASE COMPLETE 10.2.31 RADIO BEARER RELEASE FAILURE 10.2.32 RADIO BEARER SETUP COMPLETE 10.2.34 RADIO BEARER SETUP FAILURE 10.2.35 RRC CONNECTION RELEASE COMPLETE 10.2.38 RRC CONNECTION REQUEST 10.2.39 RRC CONNECTION SETUP COMPLETE 10.2.41 RRC STATUS 10.2.42 SECURITY MODE COMPLETE 10.2.44 SECURITY MODE FAILURE 10.2.45 SIGNALLING CONNECTION RELEASE REQUEST 10.2.47 Master Information Block 10.2.48.8.1 System Information Block type 1 to System Information Block type 17 10.2.48.8.2 to 10.2.48.8.19 SYSTEM INFORMATION CHANGE INDICATION 10.2.49 TRANSPORT CHANNEL RECONFIGURATION COMPLETE 10.2.51 TRANSPORT CHANNEL RECONFIGURATION FAILURE 10.2.52 TRANSPORT FORMAT COMBINATION CONTROL FAILURE 10.2.54 UE CAPABILITY INFORMATION 10.2.56 UPLINK DIRECT TRANSFER 10.2.58 URA UPDATE 10.2.60 UTRAN MOBILITY INFORMATION CONFIRM 10.2.63 UTRAN MOBILITY INFORMATION FAILURE 10.2.64 |
| No extensions | SYSTEM INFORMATION 10.2.48 |

| Extensions | Message |
|------------|--|
| | First Segment 10.2.48.1 Subsequent or last Segment 10.2.48.3 Complete SIB 10.2.48.5 SIB content 10.2.48.8.1 |

NOTE: For the SYSTEM INFORMATION message protocol extensions are only possible at the level of system information blocks.

10.1.1.1 Non-critical extensions

10.1.1.1.1 Extension of an information element with additional values or choices

In future versions of this protocol, non-critical values may be added to choices, enumerated and size constrained types.

For choices, enumerated and size constrained types it is possible to indicate how many non-critical spare values need to be reserved for future extension. The number of spare values is specified within the ASN.1 type definitions; the tabular format only indicates that at least one spare value is needed. This kind of extension is allowed only for items with need set to OP or MD, and the receiver shall interpret the reception of a spare as absence of the IE and as reception of the default value respectively.

Information elements applicable to choices reserved for future releases of the protocol shall be added to the end of the message.

10.1.1.1.2 Extension of a message with additional information elements

In future versions of this protocol, non-critical information elements may be added to RRC messages. These additional information elements shall be appended at the end of the message; the transfer syntax specified in this revision of the standard facilitates this. A receiver conformant to this revision of the standard shall accept such extension, and proceed as if it was not included.

10.1.1.2 Critical extensions

10.1.1.2.1 Extension of an information element with additional values or choices

In versions of this protocol, choices, enumerated and size constrained types may be extended with critical values. For extension with critical values the general critical extension mechanism is used, i.e. for this no spare values are reserved since backward compatibility is not required.

10.1.1.2.2 Extension of a message with additional information elements

In future versions of this protocol, RRC messages may be extended with new information elements. Since messages including critical extensions are rejected by receivers not comprehending them, these messages may be modified completely, e.g. IEs may be inserted at any place and IEs may be removed or redefined.

10.2 Radio Resource Control messages

10.2.1 ACTIVE SET UPDATE

NOTE: Only for FDD.

This message is used by UTRAN to add, replace or delete radio links in the active set of the UE.

RLC-SAP: AM or UM

Logical channel: DCCH

Direction: UTRAN → UE

| Information Element/Group name | Need | Multi | Type and reference | Semantics description |
|---------------------------------------|------|----------------------|--|---|
| Message Type | MP | | Message Type | |
| UE information elements | | | | |
| RRC transaction identifier | MP | | RRC transaction identifier 10.3.3.36 | |
| Integrity check info | CH | | Integrity check info 10.3.3.16 | |
| Integrity protection mode info | OP | | Integrity protection mode info 10.3.3.19 | |
| Ciphering mode info | OP | | Ciphering mode info 10.3.3.5 | |
| Activation time | MD | | Activation time 10.3.3.1 | Default value is "now". |
| New U-RNTI | OP | | U-RNTI 10.3.3.47 | |
| CN information elements | | | | |
| CN Information info | OP | | CN Information info 10.3.1.3 | |
| RB information elements | | | | |
| Downlink counter synchronisation info | OP | | | |
| >RB with PDCP information list | OP | 1 to <maxRBall RABs> | | This IE is needed for each RB having PDCP in the case of lossless SRNS relocation |
| >>RB with PDCP information | MP | | RB with PDCP information 10.3.4.22 | |
| Phy CH information elements | | | | |
| Uplink radio resources | | | | |
| Maximum allowed UL TX power | MD | | Maximum allowed UL TX power 10.3.6.39 | Default value is the existing "maximum UL TX power." |
| Downlink radio resources | | | | |
| Radio link addition information | OP | 1 to <maxRL-1> | | Radio link addition information required for each RL to add |
| >Radio link addition information | MP | | Radio link addition information 10.3.6.68 | |
| Radio link removal information | OP | 1 to <maxRL> | | Radio link removal information required for each RL to remove |
| >Radio link removal information | MP | | Radio link removal information 10.3.6.69 | |
| TX Diversity Mode | MD | | TX Diversity Mode 10.3.6.86 | Default value is the existing TX diversity mode. |
| SSDT information | OP | | SSDT information 10.3.6.77 | |

10.2.2 ACTIVE SET UPDATE COMPLETE

NOTE: For FDD only.

This message is sent by UE when active set update has been completed.

RLC-SAP: AM

Logical channel: DCCH

Direction: UE→UTRAN

| Information Element/Group name | Need | Multi | Type and reference | Semantics description |
|--|------|----------------------|---|---|
| Message Type | MP | | Message Type | |
| UE information elements | | | | |
| RRC transaction identifier | MP | | RRC transaction identifier 10.3.3.36 | |
| Integrity check info | CH | | Integrity check info 10.3.3.16 | |
| Uplink integrity protection activation info | OP | | Integrity protection activation info 10.3.3.17 | |
| RB Information elements | | | | |
| Radio bearer uplink ciphering activation time info | OP | | RB activation time info 10.3.4.13 | |
| Uplink counter synchronisation info | OP | | | |
| >RB with PDCP information list | OP | 1 to <maxRBall RABs> | | This IE is needed for each RB having PDCP in the case of lossless SRNS relocation |
| >>RB with PDCP information | MP | | RB with PDCP information 10.3.4.22 | |
| >START list | MP | 1 to <maxCNdo mains> | | START [40] values for all CN domains. |
| >>CN domain identity | MP | | CN domain identity 10.3.1.1 | |
| >>START | MP | | START 10.3.3.38 | START value to be used in this CN domain. |

10.2.3 ACTIVE SET UPDATE FAILURE

NOTE: Only for FDD.

This message is sent by UE if the update of the active set has failed, e.g. because the radio link is not a part of the active set.

RLC-SAP: AM

Logical channel: DCCH

Direction: UE→UTRAN

| Information Element/Group name | Need | Multi | Type and reference | Semantics description |
|--------------------------------|------|-------|---|-----------------------|
| Message Type | MP | | Message Type | |
| UE information elements | | | | |
| RRC transaction identifier | MP | | RRC transaction identifier 10.3.3.36 | |
| Integrity check info | CH | | Integrity check info 10.3.3.16 | |
| Failure cause | MP | | Failure cause and error information 10.3.3.14 | |

10.2.4 ASSISTANCE DATA DELIVERY

This message is sent by UTRAN to convey UE positioning assistance data to the UE.

RLC-SAP: AM

Logical channel: DCCH

Direction: UTRAN→UE

| Information Element/Group name | Need | Multi | Type and reference | Semantics description |
|---|------|-------|---|-----------------------|
| Message Type | MP | | Message Type | |
| UE information elements | | | | |
| RRC transaction identifier | MP | | RRC transaction identifier 10.3.3.36 | |
| Integrity check info | CH | | Integrity check info 10.3.3.16 | |
| Measurement Information elements | | | | |
| UE positioning OTDOA assistance data | OP | | UE positioning OTDOA assistance data 10.3.7.103 | |
| UE positioning GPS assistance data | OP | | UE positioning GPS assistance data 10.3.7.90 | |

10.2.5 CELL CHANGE ORDER FROM UTRAN

This message is used to order a cell change from UTRA to another radio access technology, e.g., GSM.

RLC-SAP: AM

Logical channel: DCCH

Direction: UTRAN→UE

| Information Element/Group name | Need | Multi | Type and reference | Semantics description |
|--|------|---------------------|---|--|
| Message Type | MP | | Message Type | |
| UE information elements | | | | |
| RRC transaction identifier | MP | | RRC transaction identifier 10.3.3.36 | |
| Integrity check info | CH | | Integrity check info 10.3.3.16 | |
| Activation time | MD | | Activation time 10.3.3.1 | Default value is "now" |
| RB Information elements | | | | |
| RAB information list | OP | 1 to <maxRABs etup> | | For each RAB to be handed over |
| >RAB info | MP | | RAB info 10.3.4.8 | |
| Other information elements | | | | |
| Target cell description | MP | | | |
| >CHOICE <i>Radio Access Technology</i> | MP | | | At least one spare choice, Criticality: Reject, is needed. |
| >>GSM | | | | |
| >>>BSIC | MP | | BSIC 10.3.8.2 | |
| >>>Band Indicator | MP | | Enumerated (DCS 1800 band used, PCS 1900 band used) | Indicates how to interpret the BCCH ARFCN |
| >>>BCCH ARFCN | MP | | Integer (0..1023) | [45] |
| >>>NC mode | OP | | Bitstring(3) | [43] |
| >>IS-2000 | | | | |

10.2.6 CELL CHANGE ORDER FROM UTRAN FAILURE

This message is sent on the RRC connection used before the Cell change order from UTRAN was executed. The message indicates that the UE has failed to seize the new channel in the other radio access technology.

RLC-SAP: AM

Logical channel: DCCH

Direction: UE→UTRAN

| Information Element/Group name | Need | Multi | Type and reference | Semantics description |
|-----------------------------------|------|-------|---|-----------------------|
| Message Type | MP | | Message Type | |
| UE information elements | | | | |
| RRC transaction identifier | MP | | RRC transaction identifier 10.3.3.36 | |
| Integrity check info | CH | | Integrity check info 10.3.3.16 | |
| Other information elements | | | | |
| Inter-RAT change failure | MP | | Inter-RAT change failure 10.3.8.5 | |

10.2.7 CELL UPDATE

This message is used by the UE to initiate a cell update procedure.

RLC-SAP: TM

Logical channel: CCCH

Direction: UE→UTRAN

| Information Element/Group name | Need | Multi | Type and reference | Semantics description |
|---|-------------------|----------------------|--|---|
| Message Type | MP | | Message Type | |
| UE information elements | | | | |
| U-RNTI | MP | | U-RNTI 10.3.3.47 | |
| RRC transaction identifier | <i>CV-Failure</i> | | RRC transaction identifier 10.3.3.36 | |
| Integrity check info | CH | | Integrity check info 10.3.3.16 | |
| START list | MP | 1 to <maxCNdo mains> | | START [40] values for all CN domains. |
| >CN domain identity | MP | | CN domain identity 10.3.1.1 | |
| >START | MP | | START 10.3.3.38 | START value to be used in this CN domain. |
| AM_RLC error indication(RB2 or RB3) | MP | | Boolean | TRUE indicates AM_RLC unrecoverable error [16] occurred on RB2 or RB3 in the UE |
| AM_RLC error indication(RB>3) | MP | | Boolean | TRUE indicates AM_RLC unrecoverable error [16] occurred on RB>3 in the UE |
| Cell update cause | MP | | Cell update cause 10.3.3.3 | |
| Failure cause | OP | | Failure cause and error information 10.3.3.14 | |
| RB timer indicator | MP | | RB timer indicator 10.3.3.28 | |
| Measurement information elements | | | | |
| Measured results on RACH | OP | | Measured results on RACH 10.3.7.45 | |

| Condition | Explanation |
|----------------|--|
| <i>Failure</i> | This IE is mandatory if the IE "Failure cause" is present. Otherwise it is absent. |

10.2.8 CELL UPDATE CONFIRM

This message confirms the cell update procedure and can be used to reallocate new RNTI information for the UE valid in the new cell.

RLC-SAP: UM

Logical channel: CCCH or DCCH

Direction: UTRAN→UE

| Information Element/Group name | Need | Multi | Type and reference | Semantics description |
|--|---------|--------------|--|--|
| Message Type | MP | | Message Type | |
| UE Information Elements | | | | |
| U-RNTI | CV-CCCH | | U-RNTI 10.3.3.47 | |
| RRC transaction identifier | MP | | RRC transaction identifier 10.3.3.36 | |
| Integrity check info | CH | | Integrity check info 10.3.3.16 | |
| Integrity protection mode info | OP | | Integrity protection mode info 10.3.3.19 | |
| Ciphering mode info | OP | | Ciphering mode info 10.3.3.5 | |
| Activation time | MD | | Activation time 10.3.3.1 | Default value is "now" |
| New U-RNTI | OP | | U-RNTI 10.3.3.47 | |
| New C-RNTI | OP | | C-RNTI 10.3.3.8 | |
| RRC State Indicator | MP | | RRC State Indicator 10.3.3.10 | |
| UTRAN DRX cycle length coefficient | MD | | UTRAN DRX cycle length coefficient 10.3.3.49 | Default value is the existing DRX cycle length coefficient |
| RLC re-establish indicator (RB2 and RB3) | MP | | RLC re-establish indicator 10.3.3.35 | |
| RLC re-establish indicator (RB4 and upwards) | MP | | RLC re-establish indicator 10.3.3.35 | |
| CN Information Elements | | | | |
| CN Information info | OP | | CN Information info 10.3.1.3 | |
| UTRAN Information Elements | | | | |
| URA identity | OP | | URA identity 10.3.2.6 | |
| RB information elements | | | | |
| RB information to release list | OP | 1 to <maxRB> | | |
| >RB information to release | MP | | RB information to release 10.3.4.19 | |
| RB information to reconfigure list | OP | 1 to <maxRB> | | |
| >RB information to reconfigure | MP | | RB information to reconfigure 10.3.4.18 | |
| RB information to be affected list | OP | 1 to <maxRB> | | |
| >RB information to be affected | MP | | RB information | |

| Information Element/Group name | Need | Multi | Type and reference | Semantics description |
|--|------|----------------------|---|---|
| | | | to be affected 10.3.4.17 | |
| Downlink counter synchronisation info | OP | | | |
| >RB with PDCP information list | OP | 1 to <maxRBall RABs> | | This IE is needed for each RB having PDCP in the case of lossless SRNS relocation |
| >>RB with PDCP information | MP | | RB with PDCP information 10.3.4.22 | |
| TrCH Information Elements | | | | |
| Uplink transport channels | | | | |
| UL Transport channel information common for all transport channels | OP | | UL Transport channel information common for all transport channels 10.3.5.24 | |
| Deleted TrCH information list | OP | 1 to <maxTrCH > | | |
| >Deleted UL TrCH information | MP | | Deleted UL TrCH information 10.3.5.5 | |
| Added or Reconfigured TrCH information list | OP | 1 to <maxTrCH > | | |
| >Added or Reconfigured UL TrCH information | MP | | Added or Reconfigured UL TrCH information 10.3.5.2 | |
| CHOICE <i>mode</i> | MP | | | |
| >FDD | | | | |
| >>CPCH set ID | OP | | CPCH set ID 10.3.5.3 | |
| >>Added or Reconfigured TrCH information for DRAC list | OP | 1 to <maxTrCH > | | |
| >>>DRAC static information | MP | | DRAC static information 10.3.5.7 | |
| >TDD | | | | (no data) |
| Downlink transport channels | | | | |
| DL Transport channel information common for all transport channels | OP | | DL Transport channel information common for all transport channels 10.3.5.6 | |
| Deleted TrCH information list | OP | 1 to <maxTrCH > | | |
| >Deleted DL TrCH information | MP | | Deleted DL TrCH information 10.3.5.4 | |
| Added or Reconfigured TrCH information list | OP | 1 to <maxTrCH > | | |

| Information Element/Group name | Need | Multi | Type and reference | Semantics description |
|---|------|--------------|---|--|
| >Added or Reconfigured DL TrCH information | MP | | Added or Reconfigured DL TrCH information 10.3.5.1 | |
| PhyCH information elements | | | | |
| Frequency info | MD | | Frequency info 10.3.6.36 | Default value is the existing value of frequency information |
| Uplink radio resources | | | | |
| Maximum allowed UL TX power | MD | | Maximum allowed UL TX power 10.3.6.39 | Default value is the existing maximum UL TX power |
| CHOICE channel requirement | | | | |
| >Uplink DPCH info | | | Uplink DPCH info 10.3.6.88. | |
| >CPCH SET Info | | | CPCH SET Info 10.3.6.13 | |
| Downlink radio resources | | | | |
| CHOICE mode | MP | | | |
| >FDD | | | | |
| >>Downlink PDSCH information | OP | | Downlink PDSCH information 10.3.6.30 | |
| >TDD | | | | (no data) |
| Downlink information common for all radio links | OP | | Downlink information common for all radio links 10.3.6.24 | |
| Downlink information per radio link list | OP | 1 to <maxRL> | | Send downlink information for each radio link to be set-up |
| >Downlink information for each radio link | MP | | Downlink information for each radio link 10.3.6.27 | |

| Condition | Explanation |
|-----------|---|
| CCCH | This IE is mandatory when CCCH is used and ciphering is not required. Otherwise it is absent. |

10.2.9 COUNTER CHECK

This message is used by the UTRAN to indicate the current COUNT-C MSB values associated to each radio bearer utilising UM or AM RLC mode and to request the UE to compare these to its COUNT-C MSB values and to report the comparison results to UTRAN.

RLC-SAP: AM

Logical channel: DCCH

Direction: UTRAN→UE

| Information Element/Group name | Presence | Multi | IE type and reference | Semantics description |
|--------------------------------|----------|------------------------|---|--|
| Message Type | MP | | | |
| UE information elements | | | | |
| RRC transaction identifier | MP | | RRC transaction identifier 10.3.3.36 | |
| Integrity check info | MP | | Integrity check info 10.3.3.16 | |
| RB information elements | | | | |
| RB COUNT-C MSB information | MP | 1 to < maxRBallR ABs > | | For each RB (excluding signalling radio bearers) using UM or AM RLC. |
| >RB COUNT-C MSB information | MP | | RB COUNT-C MSB information 10.3.4.14 | |

10.2.10 COUNTER CHECK RESPONSE

This message is used by the UE to respond to a COUNTER CHECK message.

RLC-SAP: AM

Logical channel: DCCH

Direction: UE→UTRAN

| Information Element/Group name | Presence | Multi | IE type and reference | Semantics description |
|--------------------------------|----------|------------------------|---|-----------------------|
| Message Type | MP | | | |
| UE information elements | | | | |
| RRC transaction identifier | MP | | RRC transaction identifier 10.3.3.36 | |
| Integrity check info | MP | | Integrity check info 10.3.3.16 | |
| RB information elements | | | | |
| RB COUNT-C information | OP | 1 to < maxRBallR ABs > | | |
| >RB COUNT-C information | MP | | RB COUNT-C information 10.3.4.15 | |

10.2.11 DOWNLINK DIRECT TRANSFER

This message is sent by UTRAN to transfer higher layer messages.

RLC-SAP: AM

Logical channel: DCCH

Direction: UTRAN -> UE

| Information Element/Group name | Need | Multi | Type and reference | Semantics description |
|--------------------------------|------|-------|--|-----------------------|
| Message Type | MP | | Message Type | |
| UE information elements | | | | |
| RRC transaction identifier | MP | | RRC transaction identifier 10.3.3.36 | |
| Integrity check info | CH | | Integrity check info 10.3.3.16 | |
| CN information elements | | | | |
| CN Domain Identity | MP | | Core Network Domain Identity 10.3.1.1 | |
| NAS message | MP | | NAS message 10.3.1.8 | |

10.2.12 HANDOVER TO UTRAN COMMAND

This message is sent to the UE via other system to make a handover to UTRAN.

RLC-SAP: N/A (Sent through a different RAT)

Logical channel: N/A (Sent through a different RAT)

Direction: UTRAN → UE

| Information Element/Group name | Need | Multi | Type and reference | Semantics description |
|--|------|---------------------|---|--|
| New U-RNTI | MP | | U-RNTI Short 10.3.3.48 | |
| Ciphering algorithm | OP | | Ciphering algorithm 10.3.3.4 | |
| CHOICE <i>specification mode</i> | MP | | | |
| >Complete specification | | | | |
| RB information elements | | | | |
| >>Signalling RB information to setup list | MP | 1 to <maxSRBs etup> | | For each signalling radio bearer established |
| >>>Signalling RB information to setup | MP | | Signalling RB information to setup 10.3.4.24 | |
| >>RAB information to setup list | OP | 1 to <maxRABs etup> | | For each RAB established |
| >>>RAB information for setup | MP | | RAB information for setup 10.3.4.10 | |
| Uplink transport channels | | | | |
| >>UL Transport channel information common for all transport channels | MP | | UL Transport channel information common for all transport channels 10.3.5.24 | |
| >>Added or Reconfigured TrCH information | MP | 1 to <maxTrCH > | | |
| >>>Added or Reconfigured UL TrCH information | MP | | Added or Reconfigured UL TrCH information 10.3.5.2 | |
| Downlink transport channels | | | | |
| >>DL Transport channel information common for all transport channels | MP | | DL Transport channel information common for all transport channels 10.3.5.6 | |
| >>Added or Reconfigured TrCH information | MP | 1 to <maxTrCH > | | |
| >>>Added or Reconfigured DL TrCH information | MP | | Added or Reconfigured DL TrCH information 10.3.5.1 | |
| Uplink radio resources | | | | |
| >>Uplink DPCH info | MP | | Uplink DPCH info 10.3.6.88 | |
| >>CHOICE <i>mode</i> | MP | | | |
| >>>FDD | | | | |
| >>>>CPCH SET Info | OP | | CPCH SET Info 10.3.6.13 | |

| Information Element/Group name | Need | Multi | Type and reference | Semantics description |
|---|------|--------------|---|---|
| Downlink radio resources | | | | |
| >>>Downlink PDSCH information | OP | | Downlink PDSCH information 10.3.6.30 | |
| >>>TDD | | | | (no data) |
| >>Downlink information common for all radio links | MP | | Downlink information common for all radio links 10.3.6.24 | |
| >>Downlink information per radio link | MP | 1 to <maxRL> | | |
| >>>Downlink information for each radio link | MP | | Downlink information for each radio link 10.3.6.27 | |
| >Preconfiguration | | | | |
| >>CHOICE <i>Preconfiguration mode</i> | MP | | | |
| >>>Predefined configuration | MP | | Predefined configuration identity 10.3.4.5 | |
| >>>Default configuration | | | | |
| >>>>Default configuration mode | MP | | Enumerated (FDD, TDD) | Indicates whether the FDD or TDD version of the default configuration shall be used |
| >>>>Default configuration identity | MP | | Default configuration identity 10.3.4.0 | |
| >>RAB info | OP | | RAB info Post 10.3.4.9 | One RAB is established |
| >>Uplink DPCH info | MP | | Uplink DPCH info Post 10.3.6.89 | |
| Downlink radio resources | | | | |
| >>Downlink information common for all radio links | MP | | Downlink information common for all radio links Post 10.3.6.25 | |
| >>Downlink information per radio link | MP | 1 to <maxRL> | | Send downlink information for each radio link to be set-up. In TDD MaxRL is 1. |
| >>>Downlink information for each radio link | MP | | Downlink information for each radio link Post 10.3.6.28 | |
| >>CHOICE <i>mode</i> | MP | | | |
| >>>FDD | | | | (no data) |
| >>>TDD | | | | |
| >>>>Primary CCPCH Tx Power | MP | | Primary CCPCH Tx Power 10.3.6.59 | |
| Frequency info | MP | | Frequency info | |

| Information Element/Group name | Need | Multi | Type and reference | Semantics description |
|--------------------------------|------|-------|---|-----------------------|
| Maximum allowed UL TX power | MP | | 10.3.6.36 Maximum allowed UL TX power 10.3.6.39 | |

10.2.13 HANDOVER TO UTRAN COMPLETE

This message is sent by the UE when a handover to UTRAN has been completed.

RLC-SAP: AM

Logical channel: DCCH

Direction: UE → UTRAN

| Information Element/Group name | Need | Multi | Type and reference | Semantics description |
|--------------------------------|------|----------------------|--------------------------------|---|
| Message Type | MP | | Message Type | |
| UE Information elements | | | | |
| START list | CH | 1 to <maxCNdo mains> | | START [40] values for all CN domains. The IE is mandatory if it has not been transferred prior to the handover. |
| >CN domain identity | MP | | CN domain identity 10.3.1.1 | |
| >START | MP | | START 10.3.3.38 | |
| RB Information elements | | | | |
| COUNT-C activation time | OP | | Activation time 10.3.3.1 | Used for radio bearers mapped on RLC-TM. |

10.2.14 INITIAL DIRECT TRANSFER

This message is used to initiate a signalling connection based on indication from the upper layers, and to transfer a NAS message.

RLC-SAP: AM

Logical channel: DCCH

Direction: UE -> UTRAN

| Information Element/Group name | Need | Multi | Type and reference | Semantics description |
|---|------|-------|--|-----------------------|
| Message Type | MP | | Message Type | |
| UE information elements | | | | |
| Integrity check info | CH | | Integrity check info 10.3.3.16 | |
| CN information elements | | | | |
| CN domain identity | MP | | CN domain identity 10.3.1.1 | |
| Intra Domain NAS Node Selector | MP | | Intra Domain NAS Node Selector 10.3.1.6 | |
| NAS message | MP | | NAS message 10.3.1.8 | |
| Measurement information elements | | | | |
| Measured results on RACH | OP | | Measured results on RACH 10.3.7.45 | |

10.2.15 HANDOVER FROM UTRAN COMMAND

This message is used for handover from UMTS to another system e.g. GSM. One or several messages from the other system can be included in the Inter-RAT message information element in this message. These messages are structured and coded according to that systems specification.

RLC-SAP: AM

Logical channel: DCCH

Direction: UTRAN→UE

| Information Element/Group name | Need | Multi | Type and reference | Semantics description |
|-----------------------------------|------|------------------------------|--|---|
| Message Type | MP | | Message Type | |
| UE information elements | | | | |
| RRC transaction identifier | MP | | RRC transaction identifier 10.3.3.36 | |
| Integrity check info | CH | | Integrity check info 10.3.3.16 | |
| Activation time | MD | | Activation time 10.3.3.1 | Default value is "now" |
| RB information elements | | | | |
| RAB information list | OP | 1 to <maxRABs etup> | | For each RAB to be handed over. In this version, the maximum size of the list of 1 shall be applied for all system types. |
| >RAB info | MP | | RAB info 10.3.4.8 | |
| Other information elements | | | | |
| CHOICE <i>System type</i> | MP | | | This IE indicates which specification to apply, to decode the transported messages |
| >GSM | | | | |
| >>Frequency band | MP | | Enumerated (GSM/DCS 1800 band used), GSM/PCS 1900 band used) | |
| >>GSM message | | | | |
| >>>Single GSM message | MP | | Bitstring (no explicit size constraint) | Formatted and coded according to GSM specifications The first bit of the bitstring contains the first bit of the GSM message. |
| >>>GSM message List | MP | 1.to.<maxl nterSysMe ssages> | Bitstring (1..512) | Formatted and coded according to GSM specifications. The first bit of the bitstring contains the first bit of the GSM message. |
| >cdma2000 | | | | |
| >>cdma2000MessageList | MP | 1.to.<maxl nterSysMe ssages> | | |
| >>>MSG_TYPE(s) | MP | | Bitstring (8) | Formatted and coded according to cdma2000 specifications. The MSG_TYPE bits are numbered b0 to b7, where b0 is the least significant bit. |
| >>>cdma2000Messagepayload(s) | MP | | Bitstring (1..512) | Formatted and coded according to cdma2000 specifications. The first bit of the bitstring contains the first bit of the cdma2000 message. |

10.2.16 HANDOVER FROM UTRAN FAILURE

This message is sent on the RRC connection used before the Inter-RAT Handover was executed. The message indicates that the UE has failed to seize the new channel in the other system.

RLC-SAP: AM

Logical channel: DCCH

Direction: UE→UTRAN

| Information Element/Group name | Need | Multi | Type and reference | Semantics description |
|-----------------------------------|------|----------------------------|---|---|
| Message Type | MP | | Message Type | |
| UE information elements | | | | |
| RRC transaction identifier | MP | | RRC transaction identifier 10.3.3.36 | |
| Integrity check info | CH | | Integrity check info 10.3.3.16 | |
| Other information elements | | | | |
| Inter-RAT handover failure | OP | | Inter-RAT handover failure 10.3.8.6 | |
| CHOICE <i>System type</i> | MP | | | This IE indicates which specification to apply to decode the transported messages |
| >GSM | | | | |
| >GSM message List | MP | 1.to.<maxlnterSysMessages> | Bitstring (1..512) | Formatted and coded according to GSM specifications. The first bit of the bitstring contains the first bit of the GSM message. |
| >cdma2000 | | | | |
| >>cdma2000MessageList | MP | 1.to.<maxlnterSysMessages> | | |
| >>>MSG_TYPE(s) | MP | | Bitstring (8) | Formatted and coded according to cdma2000 specifications. The MSG_TYPE bits are numbered b0 to b7, where b0 is the least significant bit. |
| >>>cdma2000Messagepayload(s) | MP | | Bitstring (1..512) | Formatted and coded according to cdma2000 specifications. The first bit of the bitstring contains the first bit of the cdma2000 message. |

10.2.17 MEASUREMENT CONTROL

This message is sent by UTRAN to setup, modify or release a measurement in the UE.

RLC-SAP: AM

Logical channel: DCCH

Direction: UTRAN→UE

| Information Element/Group name | Need | Multi | Type and reference | Semantics description |
|--|------------|-------|--|-----------------------|
| Message Type | MP | | Message Type | |
| UE information elements | | | | |
| RRC transaction identifier | MP | | RRC transaction identifier 10.3.3.36 | |
| Integrity check info | CH | | Integrity check info 10.3.3.16 | |
| Measurement Information elements | | | | |
| Measurement Identity | MP | | Measurement Identity 10.3.7.48 | |
| Measurement Command | MP | | Measurement Command 10.3.7.46 | |
| Measurement Reporting Mode | OP | | Measurement Reporting Mode 10.3.7.49 | |
| Additional measurements list | OP | | Additional measurements list 10.3.7.1 | |
| CHOICE <i>Measurement type</i> | CV-command | | | |
| >Intra-frequency measurement | | | Intra-frequency measurement 10.3.7.36 | |
| >Inter-frequency measurement | | | Inter-frequency measurement 10.3.7.16 | |
| >Inter-RAT measurement | | | Inter-RAT measurement 10.3.7.27 | |
| >UE positioning measurement | | | UE positioning measurement 10.3.7.100 | |
| >Traffic Volume measurement | | | Traffic Volume measurement 10.3.7.68 | |
| >Quality measurement | | | Quality measurement 10.3.7.56 | |
| >UE internal measurement | | | UE internal measurement 10.3.7.77 | |
| Physical channel information elements | | | | |
| DPCH compressed mode status info | OP | | DPCH compressed mode status info 10.3.6.34 | |

| Condition | Explanation |
|----------------|---|
| <i>Command</i> | The IE is mandatory if the "Measurement command" IE is set to "Setup", optional if the "Measurement command" IE is set to "modify", otherwise the IE is not needed. |

10.2.18 MEASUREMENT CONTROL FAILURE

This message is sent by UE, if it cannot initiate a measurement as instructed by UTRAN.

RLC-SAP: AM

Logical channel: DCCH

Direction: UE→UTRAN

| Information Element/Group name | Need | Multi | Type and reference | Semantics description |
|--------------------------------|------|-------|--|-----------------------|
| Message Type | MP | | Message Type | |
| UE information elements | | | | |
| RRC transaction identifier | MP | | RRC transaction identifier 10.3.3.36 | |
| Integrity check info | CH | | Integrity check info 10.3.3.16 | |
| Failure cause | MP | | Failure cause and error information 10.3.3.14 | |

10.2.19 MEASUREMENT REPORT

This message is used by UE to transfer measurement results to the UTRAN.

RLC-SAP: AM or UM

Logical channel: DCCH

Direction: UE→UTRAN

| Information Element/Group name | Need | Multi | Type and reference | Semantics description |
|---|------|--------------------------|---------------------------------------|-----------------------|
| Message Type | MP | | Message Type | |
| UE information elements | | | | |
| Integrity check info | CH | | Integrity check info 10.3.3.16 | |
| Measurement Information Elements | | | | |
| Measurement identity | MP | | Measurement identity 10.3.7.48 | |
| Measured Results | OP | | Measured Results 10.3.7.44 | |
| Measured Results on RACH | OP | | Measured Results on RACH 10.3.7.45 | |
| Additional Measured results | OP | 1 to <maxAdditionalMeas> | | |
| >Measured Results | MP | | Measured Results 10.3.7.44 | |
| Event results | OP | | Event results 10.3.7.7 | |

10.2.20 PAGING TYPE 1

This message is used to send information on the paging channel. One or several UEs, in idle or connected mode, can be paged in one message, which also can contain other information.

RLC-SAP: TM

Logical channel: PCCH

Direction: UTRAN → UE

| Information Element/Group name | Need | Multi | Type and reference | Semantics description |
|-----------------------------------|------|------------------|---------------------------------|-----------------------|
| Message Type | MP | | Message Type | |
| UE Information elements | | | | |
| Paging record list | OP | 1 to <maxPage 1> | | |
| >Paging record | MP | | Paging record 10.3.3.23 | |
| Other information elements | | | | |
| BCCH modification info | OP | | BCCH modification info 10.3.8.1 | |

If the encoded message does not fill a transport block, the RRC layer shall add padding according to subclause 12.1.

10.2.21 PAGING TYPE 2

This message is used to page an UE in connected mode, when using the DCCH for CN originated paging.

RLC-SAP: AM

Logical channel: DCCH

Direction: UTRAN → UE

| Information Element/Group name | Need | Multi | Type and reference | Semantics description |
|--------------------------------|------|-------|---|-----------------------|
| Message Type | MP | | Message Type | |
| UE information elements | | | | |
| RRC transaction identifier | MP | | RRC transaction identifier 10.3.3.36 | |
| Integrity check info | CH | | Integrity check info 10.3.3.16 | |
| Paging cause | MP | | Paging cause 10.3.3.22 | |
| CN Information elements | | | | |
| CN domain identity | MP | | CN domain identity 10.3.1.1 | |
| Paging Record Type Identifier | MP | | Paging Record Type Identifier 10.3.1.10 | |

10.2.22 PHYSICAL CHANNEL RECONFIGURATION

This message is used by UTRAN to assign, replace or release a set of physical channels used by a UE.

RLC-SAP: AM or UM

Logical channel: DCCH

Direction: UTRAN → UE

| Information Element/Group name | Need | Multi | Type and reference | Semantics description |
|--|------|----------------------|---|---|
| Message Type | MP | | Message Type | |
| UE Information Elements | | | | |
| RRC transaction identifier | MP | | RRC transaction identifier 10.3.3.36 | |
| Integrity check info | CH | | Integrity check info 10.3.3.16 | |
| Integrity protection mode info | OP | | Integrity protection mode info 10.3.3.19 | |
| Ciphering mode info | OP | | Ciphering mode info 10.3.3.5 | |
| Activation time | MD | | Activation time 10.3.3.1 | Default value is "now" |
| New U-RNTI | OP | | U-RNTI 10.3.3.47 | |
| New C-RNTI | OP | | C-RNTI 10.3.3.8 | |
| RRC State Indicator | MP | | RRC State Indicator 10.3.3.10 | |
| UTRAN DRX cycle length coefficient | MD | | UTRAN DRX cycle length coefficient 10.3.3.49 | Default value is the existing value of UTRAN DRX cycle length coefficient |
| CN Information Elements | | | | |
| CN Information info | OP | | CN Information info 10.3.1.3 | |
| UTRAN mobility information elements | | | | |
| URA identity | OP | | URA identity 10.3.2.6 | |
| RB information elements | | | | |
| Downlink counter synchronisation info | OP | | | |
| >RB with PDCP information list | OP | 1 to <maxRBall RABs> | | This IE is needed for each RB having PDCP in the case of lossless SRNS relocation |
| >>RB with PDCP information | MP | | RB with PDCP information 10.3.4.22 | |
| PhyCH information elements | | | | |
| Frequency info | MD | | Frequency info 10.3.6.36 | Default value is the existing value of frequency information |
| Uplink radio resources | | | | |
| Maximum allowed UL TX power | MD | | Maximum allowed UL TX power 10.3.6.39 | Default value is the existing value of the maximum allowed UL TX power |
| <i>CHOICE channel requirement</i> | | | | |
| >Uplink DPCH info | | | Uplink DPCH info 10.3.6.88 | |
| >CPCH SET Info | | | CPCH SET Info 10.3.6.13 | |
| >CPCH set ID | | | CPCH set ID | |

| Information Element/Group name | Need | Multi | Type and reference | Semantics description |
|---|------|-----------------|--|---|
| | | | 10.3.5.3 | |
| Downlink radio resources | | | | |
| CHOICE <i>mode</i> | MP | | | |
| >FDD | | | | |
| >>Downlink PDSCH information | OP | | Downlink PDSCH information 10.3.6.30 | |
| >TDD | | | | (no data) |
| Downlink information common for all radio links | OP | | Downlink information common for all radio links 10.3.6.24 | |
| Downlink information per radio link list | OP | 1 to <maxRL> | | Send downlink information for each radio link |
| >Downlink information for each radio link | MP | | Downlink information for each radio link 10.3.6.27 | |

10.2.23 PHYSICAL CHANNEL RECONFIGURATION COMPLETE

This message is sent from the UE when a physical channel reconfiguration has been done.

RLC-SAP: AM

Logical channel: DCCH

Direction: UE → UTRAN

| Information Element/Group name | Need | Multi | Type and reference | Semantics description | Version |
|--|------|----------------------|---|---|---------|
| Message Type | MP | | Message Type | | |
| UE information elements | | | | | |
| RRC transaction identifier | MP | | RRC transaction identifier 10.3.3.36 | | |
| Integrity check info | CH | | Integrity check info 10.3.3.16 | | |
| Uplink integrity protection activation info | OP | | Integrity protection activation info 10.3.3.17 | | |
| CHOICE <i>mode</i> | MP | | | | |
| >FDD | | | | (no data) | |
| >TDD | | | | | |
| >>CHOICE <i>TDD option</i> | MP | | | | REL-4 |
| >>>3.84 Mcps TDD | MP | | | | REL-4 |
| >>>>Uplink Timing Advance | OP | | Uplink Timing Advance 10.3.6.95 | | |
| >>>1.28 Mcps TDD | | | | (no data) | REL-4 |
| RB Information elements | | | | | |
| COUNT-C activation time | OP | | Activation time 10.3.3.1 | Used for radio bearers mapped on RLC-TM. | |
| Radio bearer uplink ciphering activation time info | OP | | RB activation time info 10.3.4.13 | | |
| Uplink counter synchronisation info | OP | | | | |
| >RB with PDCP information list | OP | 1 to <maxRBall RABs> | | | |
| >>RB with PDCP information | MP | | RB with PDCP information 10.3.4.22 | | |
| >START list | MP | 1 to <maxCNdo mains> | | START [40] values for all CN domains. | |
| >>CN domain identity | MP | | CN domain identity 10.3.1.1 | | |
| >>START | MP | | START 10.3.3.38 | START value to be used in this CN domain. | |

10.2.24 PHYSICAL CHANNEL RECONFIGURATION FAILURE

This message is sent by UE if the configuration given by UTRAN is unacceptable or if the UE failed to assign, replace or release a set of physical channel(s).

RLC-SAP: AM

Logical channel: DCCH

Direction: UE→UTRAN

| Information Element/Group name | Need | Multi | Type and reference | Semantics description |
|--------------------------------|------|-------|--|-----------------------|
| Message type | MP | | Message type | |
| UE information elements | | | | |
| RRC transaction identifier | OP | | RRC transaction identifier 10.3.3.36 | |
| Integrity check info | CH | | Integrity check info 10.3.3.16 | |
| Failure cause | MP | | Failure cause and error information 10.3.3.14 | |

10.2.25 PHYSICAL SHARED CHANNEL ALLOCATION

NOTE: Only for TDD.

This message is used by UTRAN to assign physical resources to USCH/DSCH transport channels in TDD, for temporary usage by the UE.

RLC-SAP: UM on SHCCH, UM on DCCH

Logical channel: SHCCH or DCCH

Direction: UTRAN → UE

| Information Element/Group name | Need | Multi | Type and reference | Semantics description |
|--------------------------------|------|------------|---|--|
| Message Type | MP | | Message type | |
| C-RNTI | OP | | C-RNTI 10.3.3.8 | |
| RRC transaction identifier | MP | | RRC transaction identifier 10.3.3.36 | |
| Uplink timing advance Control | MD | | Uplink Timing Advance Control 10.3.6.96 | Default value is the existing value for uplink timing advance |
| PUSCH capacity allocation info | OP | | PUSCH Capacity Allocation info 10.3.6.64 | |
| PDSCH capacity allocation info | OP | | PDSCH Capacity Allocation info 10.3.6.42 | |
| Confirm request | MD | | Enumerated(No Confirm, Confirm PDSCH, Confirm PUSCH) | Default value is No Confirm |
| Traffic volume report request | OP | | Integer (0 .. 255) | Indicates the number of frames between start of the allocation period and sending measurement report. The value should be less than the value for Allocation Duration. |
| ISCP Timeslot list | OP | 1 to maxTS | | |
| >Timeslot number | MP | | Timeslot number 10.3.6.84 | Timeslot numbers, for which the UE shall report the timeslot ISCP in PUSCH CAPACITY REQUEST message. |

10.2.26 PUSCH CAPACITY REQUEST

NOTE: Only for TDD.

This message is used by the UE for request of PUSCH resources to the UTRAN.

RLC-SAP: TM

Logical channel: SHCCH

Direction: UE → UTRAN

| Information Element/Group name | Need | Multi | Type and reference | Semantics description |
|--------------------------------|------------|------------|--|------------------------|
| Message Type | MP | | Message Type | |
| C-RNTI | OP | | C-RNTI 10.3.3.8 | |
| RRC transaction identifier | CV-ProtErr | | RRC transaction identifier 10.3.3.36 | |
| Traffic Volume | OP | | Traffic Volume, measured results list 10.3.7.67 | |
| Timeslot list | OP | 1 to maxTS | | |
| >Timeslot number | MP | | Timeslot number 10.3.6.84 | |
| >Timeslot ISCP | MP | | Timeslot ISCP info 10.3.7.65 | |
| Primary CCPCH RSCP | OP | | Primary CCPCH RSCP info 10.3.7.54 | |
| CHOICE Allocation confirmation | OP | | | |
| >PDSCH Confirmation | | | Integer(1..Hi PDSCHIdentities) | |
| >PUSCH Confirmation | | | Integer(1..Hi PUSCHIdentities) | |
| Protocol error indicator | MD | | Protocol error indicator 10.3.3.27 | Default value is FALSE |
| Protocol error information | CV-ProtErr | | Protocol error information 10.3.8.12 | |

| Condition | Explanation |
|----------------|---|
| <i>ProtErr</i> | This IE is mandatory if the IE "Protocol error indicator" has the value "TRUE". Otherwise it is not needed. |

10.2.27 RADIO BEARER RECONFIGURATION

This message is sent from UTRAN to reconfigure parameters related to a change of QoS. This procedure can also change the multiplexing of MAC, reconfigure transport channels and physical channels.

RLC-SAP: AM or UM

Logical channel: DCCH

Direction: UTRAN → UE

| Information Element/Group name | Need | Multi | Type and reference | Semantics description |
|--|------|-------------------------|---|---|
| Message Type | MP | | Message Type | |
| UE Information elements | | | | |
| RRC transaction identifier | MP | | RRC transaction identifier 10.3.3.36 | |
| Integrity check info | CH | | Integrity check info 10.3.3.16 | |
| Integrity protection mode info | OP | | Integrity protection mode info 10.3.3.19 | |
| Ciphering mode info | OP | | Ciphering mode info 10.3.3.5 | |
| Activation time | MD | | Activation time 10.3.3.1 | Default value is "now" |
| New U-RNTI | OP | | U-RNTI 10.3.3.47 | |
| New C-RNTI | OP | | C-RNTI 10.3.3.8 | |
| RRC State Indicator | MP | | RRC State Indicator 10.3.3.10 | |
| UTRAN DRX cycle length coefficient | MD | | UTRAN DRX cycle length coefficient 10.3.3.49 | Default value is the existing value of UTRAN DRX cycle length coefficient |
| CN information elements | | | | |
| CN Information info | OP | | CN Information info 10.3.1.3 | |
| UTRAN mobility information elements | | | | |
| URA identity | OP | | URA identity 10.3.2.6 | |
| RB information elements | | | | |
| RAB information to reconfigure list | OP | 1 to <maxRABse tup > | | |
| >RAB information to reconfigure | MP | | RAB information to reconfigure 10.3.4.11 | |
| RB information to reconfigure list | MP | 1to <maxRB> | | Although this IE is not always required, need is MP to align with ASN.1 |
| >RB information to reconfigure | MP | | RB information to reconfigure 10.3.4.18 | |
| RB information to be affected list | OP | 1 to <maxRB> | | |
| >RB information to be affected | MP | | RB information to be affected 10.3.4.17 | |
| TrCH Information Elements | | | | |
| Uplink transport channels | | | | |
| UL Transport channel | OP | | UL Transport | |

| Information Element/Group name | Need | Multi | Type and reference | Semantics description |
|--|------|-----------------|---|--|
| information common for all transport channels | | | channel information common for all transport channels 10.3.5.24 | |
| Deleted TrCH information list | OP | 1 to <maxTrCH > | | |
| >Deleted UL TrCH information | MP | | Deleted UL TrCH information 10.3.5.5 | |
| Added or Reconfigured TrCH information list | OP | 1 to <maxTrCH > | | |
| >Added or Reconfigured UL TrCH information | MP | | Added or Reconfigured UL TrCH information 10.3.5.2 | |
| CHOICE <i>mode</i> | OP | | | |
| >FDD | | | | |
| >>CPCH set ID | OP | | CPCH set ID 10.3.5.3 | |
| >>Added or Reconfigured TrCH information for DRAC list | OP | 1 to <maxTrCH > | | |
| >>>DRAC static information | MP | | DRAC static information 10.3.5.7 | |
| >TDD | | | | (no data) |
| Downlink transport channels | | | | |
| DL Transport channel information common for all transport channels | OP | | DL Transport channel information common for all transport channels 10.3.5.6 | |
| Deleted TrCH information list | OP | 1 to <maxTrCH > | | |
| >Deleted DL TrCH information | MP | | Deleted DL TrCH information 10.3.5.4 | |
| Added or Reconfigured TrCH information list | OP | 1 to <maxTrCH > | | |
| >Added or Reconfigured DL TrCH information | MP | | Added or Reconfigured DL TrCH information 10.3.5.1 | |
| PhyCH information elements | | | | |
| Frequency info | MD | | Frequency info 10.3.6.36 | Default value is the existing value of frequency information |
| Uplink radio resources | | | | |
| Maximum allowed UL TX power | MD | | Maximum allowed UL TX power 10.3.6.39 | Default value is the existing maximum UL TX power |
| CHOICE <i>channel requirement</i> | OP | | | |

| Information Element/Group name | Need | Multi | Type and reference | Semantics description |
|---|------|--------------|--|---|
| >Uplink DPCH info | | | Uplink DPCH info 10.3.6.88 | |
| >CPCH SET Info | | | CPCH SET Info 10.3.6.13 | |
| Downlink radio resources | | | | |
| CHOICE <i>mode</i> | MP | | | |
| >FDD | | | | |
| >>Downlink PDSCH information | OP | | Downlink PDSCH information 10.3.6.30 | |
| >TDD | | | | (no data) |
| Downlink information common for all radio links | OP | | Downlink information common for all radio links 10.3.6.24 | |
| Downlink information per radio link list | MP | 1 to <maxRL> | | Although this IE is not always required, need is MP to align with ASN.1 |
| >Downlink information for each radio link | MP | | Downlink information for each radio link 10.3.6.27 | |

10.2.28 RADIO BEARER RECONFIGURATION COMPLETE

This message is sent from the UE when a RB and signalling link reconfiguration has been done.

RLC-SAP: AM

Logical channel: DCCH

Direction: UE → UTRAN

| Information Element/Group name | Need | Multi | Type and reference | Semantics description | Version |
|--|------|----------------------|---|---|---------|
| Message Type | MP | | Message Type | | |
| UE information elements | | | | | |
| RRC transaction identifier | MP | | RRC transaction identifier 10.3.3.36 | | |
| Integrity check info | CH | | Integrity check info 10.3.3.16 | | |
| Uplink integrity protection activation info | OP | | Integrity protection activation info 10.3.3.17 | | |
| CHOICE <i>mode</i> | MP | | | | |
| >FDD | | | | (no data) | |
| >TDD | | | | | |
| >>CHOICE <i>TDD option</i> | MP | | | | REL-4 |
| >>>3.84 Mcps TDD | | | | | REL-4 |
| >>>>Uplink Timing Advance | OP | | Uplink Timing Advance 10.3.6.95 | | |
| >>>1.28 Mcps TDD | | | | (no data) | REL-4 |
| RB Information elements | | | | | |
| COUNT-C activation time | OP | | Activation time 10.3.3.1 | Used for radio bearers mapped on RLC-TM. | |
| Radio bearer uplink ciphering activation time info | OP | | RB activation time info 10.3.4.13 | | |
| Uplink counter synchronisation info | OP | | | | |
| >RB with PDCP information list | OP | 1 to <maxRBall RABs> | | | |
| >>RB with PDCP information | MP | | RB with PDCP information 10.3.4.22 | | |
| >START list | MP | 1 to <maxCNdo mains> | | START [40] values for all CN domains. | |
| >>CN domain identity | MP | | CN domain identity 10.3.1.1 | | |
| >>START | MP | | START 10.3.3.38 | START value to be used in this CN domain. | |

10.2.29 RADIO BEARER RECONFIGURATION FAILURE

This message is sent by UE if the configuration given by UTRAN is unacceptable or if the UE failed to establish the physical channel(s).

RLC-SAP: AM

Logical channel: DCCH

Direction: UE→UTRAN

| Information Element/Group name | Need | Multi | Type and reference | Semantics description |
|---|------|--------------|--|-----------------------|
| Message Type | MP | | Message Type | |
| UE information elements | | | | |
| RRC transaction identifier | MP | | RRC transaction identifier 10.3.3.36 | |
| Integrity check info | CH | | Integrity check info 10.3.3.16 | |
| Failure cause | MP | | Failure cause and error information 10.3.3.14 | |
| RB information elements | | | | |
| Radio bearers for which reconfiguration would have succeeded List | OP | 1 to <maxRB> | | |
| >Radio bearer for which reconfiguration would have succeeded | MP | | RB identity, 10.3.4.16 | |

10.2.30 RADIO BEARER RELEASE

This message is used by UTRAN to release a radio bearer. It can also include modifications to the configurations of transport channels and/or physical channels. It can simultaneously indicate release of a signalling connection when UE is connected to more than one CN domain.

RLC-SAP: AM or UM

Logical channel: DCCH

Direction: UTRAN → UE

| Information Element/Group name | Need | Multi | Type and reference | Semantics description |
|--|------|----------------------|---|---|
| Message Type | MP | | Message Type | |
| UE Information Elements | | | | |
| RRC transaction identifier | MP | | RRC transaction identifier 10.3.3.36 | |
| Integrity check info | CH | | Integrity check info 10.3.3.16 | |
| Integrity protection mode info | OP | | Integrity protection mode info 10.3.3.19 | |
| Ciphering mode info | OP | | Ciphering mode info 10.3.3.5 | |
| Activation time | MD | | Activation time 10.3.3.1 | Default value is "now" |
| New U-RNTI | OP | | U-RNTI 10.3.3.47 | |
| New C-RNTI | OP | | C-RNTI 10.3.3.8 | |
| RRC State Indicator | MP | | RRC State Indicator 10.3.3.10 | |
| UTRAN DRX cycle length coefficient | MD | | UTRAN DRX cycle length coefficient 10.3.3.49 | Default value is the existing value of UTRAN DRX cycle length coefficient |
| CN Information Elements | | | | |
| CN Information info | OP | | CN Information info 10.3.1.3 | |
| Signalling Connection release indication | OP | | CN domain identity 10.3.1.1 | |
| UTRAN mobility information elements | | | | |
| URA identity | OP | | URA identity 10.3.2.6 | |
| RB Information Elements | | | | |
| RAB information to reconfigure list | OP | 1 to <maxRABse tup > | | |
| >RAB information to reconfigure | MP | | RAB information to reconfigure 10.3.4.11 | |
| RB information to release list | MP | 1 to <maxRB> | | |
| >RB information to release | MP | | RB information to release 10.3.4.19 | |
| RB information to be affected list | OP | 1 to <maxRB> | | |
| >RB information to be affected | MP | | RB information to be affected 10.3.4.17 | |
| Downlink counter synchronisation info | OP | | | |

| Information Element/Group name | Need | Multi | Type and reference | Semantics description |
|--|------|----------------------|--|---|
| >RB with PDCP information list | OP | 1 to <maxRBall RABs> | | This IE is needed for each RB having PDCP in the case of lossless SRNS relocation |
| >>RB with PDCP information | MP | | RB with PDCP information 10.3.4.22 | |
| TrCH Information Elements | | | | |
| Uplink transport channels | | | | |
| UL Transport channel information common for all transport channels | OP | | UL Transport channel information common for all transport channels 10.3.5.24 | |
| Deleted TrCH information list | OP | 1 to <maxTrCH > | | |
| >Deleted UL TrCH information | MP | | Deleted UL TrCH information 10.3.5.5 | |
| Added or Reconfigured TrCH information list | OP | 1 to <maxTrCH > | | |
| >Added or Reconfigured UL TrCH information | MP | | Added or Reconfigured UL TrCH information 10.3.5.2 | |
| CHOICE <i>mode</i> | OP | | | |
| >FDD | | | | |
| >>CPCH set ID | OP | | CPCH set ID 10.3.5.3 | |
| >>>Added or Reconfigured TrCH information for DRAC list | OP | 1 to <maxTrCH > | | |
| >>>>DRAC static information | MP | | DRAC static information 10.3.5.7 | |
| >TDD | | | | (no data) |
| Downlink transport channels | | | | |
| DL Transport channel information common for all transport channels | OP | | DL Transport channel information common for all transport channels 10.3.5.6 | |
| Deleted TrCH information list | OP | 1 to <maxTrCH > | | |
| >Deleted DL TrCH information | MP | | Deleted DL TrCH information 10.3.5.4 | |
| Added or Reconfigured TrCH information list | OP | 1 to <maxTrCH > | | |
| >Added or Reconfigured DL TrCH information | MP | | Added or Reconfigured DL TrCH information 10.3.5.1 | |

| Information Element/Group name | Need | Multi | Type and reference | Semantics description |
|---|------|--------------|--|--|
| PhyCH information elements | | | | |
| Frequency info | MD | | Frequency info 10.3.6.36 | Default value is the existing value of frequency information |
| Uplink radio resources | | | | |
| Maximum allowed UL TX power | MD | | Maximum allowed UL TX power 10.3.6.39 | Default value is the existing maximum UL TX power |
| <i>CHOICE channel requirement</i> | | | | |
| >Uplink DPCH info | | | Uplink DPCH info 10.3.6.88 | |
| >CPCH SET Info | | | CPCH SET Info 10.3.6.13 | |
| Downlink radio resources | | | | |
| <i>CHOICE mode</i> | | | | |
| >FDD | MP | | | |
| >>Downlink PDSCH information | OP | | Downlink PDSCH information 10.3.6.30 | |
| >TDD | | | | (no data) |
| Downlink information common for all radio links | OP | | Downlink information common for all radio links 10.3.6.24 | |
| Downlink information per radio link list | OP | 1 to <maxRL> | | Send downlink information for each radio link to be set-up |
| >Downlink information for each radio link | MP | | Downlink information for each radio link 10.3.6.27 | |

10.2.31 RADIO BEARER RELEASE COMPLETE

This message is sent from the UE when radio bearer release has been completed.

RLC-SAP: AM

Logical channel: DCCH

Direction: UE → UTRAN

| Information Element/Group name | Need | Multi | Type and reference | Semantics description | Version |
|--|------|----------------------|---|--|---------|
| Message Type | MP | | Message Type | | |
| UE information elements | | | | | |
| RRC transaction identifier | MP | | RRC transaction identifier 10.3.3.36 | | |
| Integrity check info | CH | | Integrity check info 10.3.3.16 | Integrity check info is included if integrity protection is applied | |
| Uplink integrity protection activation info | OP | | Integrity protection activation info 10.3.3.17 | | |
| CHOICE <i>mode</i> | MP | | | | |
| >FDD | | | | (no data) | |
| >TDD | | | | | |
| >>CHOICE <i>TDD option</i> | MP | | | | REL-4 |
| >>>3.84 Mcps TDD | | | | | REL-4 |
| >>>>Uplink Timing Advance | OP | | Uplink Timing Advance 10.3.6.95 | This information element shall be present in case of handover procedure if timing advance is enabled. Calculated timing advance value for the new cell after handover in a synchronous TDD network | |
| >>>1.28 Mcps TDD | | | | (no data) | REL-4 |
| RB Information elements | | | | | |
| COUNT-C activation time | OP | | Activation time 10.3.3.1 | Used for radio bearers mapped on RLC-TM. | |
| Radio bearer uplink ciphering activation time info | OP | | RB activation time info 10.3.4.13 | | |
| Uplink counter synchronisation info | OP | | | | |
| >RB with PDCP information list | OP | 1 to <maxRBall RABs> | | This IE is needed for each RB having PDCP in the case of lossless SRNS relocation | |
| >>RB with PDCP information | MP | | RB with PDCP information 10.3.4.22 | | |
| >START list | MP | 1 to <maxCNdo mains> | | START [40] values for all CN domains. | |
| >>CN domain identity | MP | | CN domain identity 10.3.1.1 | | |
| >>START | MP | | START 10.3.3.38 | START value to be used in this CN domain. | |

10.2.32 RADIO BEARER RELEASE FAILURE

This message is sent by UE if the configuration given by UTRAN is unacceptable or if radio bearer cannot be released.

RLC-SAP: AM

Logical channel: DCCH

Direction: UE→UTRAN

| Information Element/Group name | Need | Multi | Type and reference | Semantics description |
|---|------|--------------|--|-----------------------|
| Message Type | MP | | Message Type | |
| UE information elements | | | | |
| RRC transaction identifier | MP | | RRC transaction identifier 10.3.3.36 | |
| Integrity check info | CH | | Integrity check info 10.3.3.16 | |
| Failure cause | MP | | Failure cause and error information 10.3.3.14 | |
| RB information elements | | | | |
| Radio bearers for which reconfiguration would have succeeded | OP | 1 to <maxRB> | | |
| >Radio bearer for which reconfiguration would have been succeeded | MP | | RB identity, 10.3.4.16 | |

10.2.33 RADIO BEARER SETUP

This message is sent by UTRAN to the UE to establish new radio bearer(s). It can also include modifications to the configurations of transport channels and/or physical channels.

RLC-SAP: AM or UM

Logical channel: DCCH

Direction: UTRAN → UE

| Information Element/Group name | Need | Multi | Type and reference | Semantics description |
|--|------|---------------------|---|---|
| Message Type | MP | | Message Type | |
| UE Information Elements | | | | |
| RRC transaction identifier | MP | | RRC transaction identifier 10.3.3.36 | |
| Integrity check info | CH | | Integrity check info 10.3.3.16 | |
| Integrity protection mode info | OP | | Integrity protection mode info 10.3.3.19 | |
| Ciphering mode info | OP | | Ciphering mode info 10.3.3.5 | |
| Activation time | MD | | Activation time 10.3.3.1 | Default value is "now" |
| New U-RNTI | OP | | U-RNTI 10.3.3.47 | |
| New C-RNTI | OP | | C-RNTI 10.3.3.8 | |
| RRC State Indicator | MP | | RRC State Indicator 10.3.3.10 | |
| UTRAN DRX cycle length coefficient | MD | | UTRAN DRX cycle length coefficient 10.3.3.49 | Default value is the existing value of UTRAN DRX cycle length coefficient |
| CN Information Elements | | | | |
| CN Information info | OP | | CN Information info 10.3.1.3 | |
| UTRAN mobility information elements | | | | |
| URA identity | OP | | URA identity 10.3.2.6 | |
| RB Information Elements | | | | |
| Signalling RB information to setup list | OP | 1 to <maxSRBs etup> | | For each signalling radio bearer established |
| >Signalling RB information to setup | MP | | Signalling RB information to setup 10.3.4.24 | |
| RAB information to setup list | OP | 1 to <maxRABs etup> | | For each RAB established |
| >RAB information for setup | MP | | RAB information for setup 10.3.4.10 | |
| RB information to be affected list | OP | 1 to <maxRB> | | |
| >RB information to be affected | MP | | RB information to be affected 10.3.4.17 | |
| Downlink counter synchronisation info | OP | | | |
| >RB with PDCP information list | OP | 1 to <maxRBall | | This IE is needed for each RB having PDCP in the case of |

| Information Element/Group name | Need | Multi | Type and reference | Semantics description |
|--|------|-----------------|--|-------------------------------|
| | | RABs> | | lossless SRNS relocation |
| >>RB with PDCP information | MP | | RB with PDCP information 10.3.4.22 | |
| TrCH Information Elements | | | | |
| Uplink transport channels | | | | |
| UL Transport channel information common for all transport channels | OP | | UL Transport channel information common for all transport channels 10.3.5.24 | |
| Deleted TrCH information list | OP | 1 to <maxTrCH > | | |
| >Deleted UL TrCH information | MP | | Deleted UL TrCH information 10.3.5.5 | |
| Added or Reconfigured TrCH information list | OP | 1 to <maxTrCH > | | |
| >Added or Reconfigured UL TrCH information | MP | | Added or Reconfigured UL TrCH information 10.3.5.2 | |
| CHOICE <i>mode</i> | OP | | | |
| >FDD | | | | |
| >>CPCH set ID | OP | | CPCH set ID 10.3.5.3 | |
| >>Added or Reconfigured TrCH information for DRAC list | OP | 1 to <maxTrCH > | | |
| >>>DRAC static information | MP | | DRAC static information 10.3.5.7 | |
| >TDD | | | | (no data) |
| Downlink transport channels | | | | |
| DL Transport channel information common for all transport channels | OP | | DL Transport channel information common for all transport channels 10.3.5.6 | |
| Deleted TrCH information list | OP | 1 to <maxTrCH > | | |
| >Deleted DL TrCH information | MP | | Deleted DL TrCH information 10.3.5.4 | |
| Added or Reconfigured TrCH information list | OP | 1 to <maxTrCH > | | |
| >Added or Reconfigured DL TrCH information | MP | | Added or Reconfigured DL TrCH information 10.3.5.1 | |
| PhyCH information elements | | | | |
| Frequency info | MD | | Frequency | Default value is the existing |

| Information Element/Group name | Need | Multi | Type and reference | Semantics description |
|---|------|--------------|--|---|
| | | | info 10.3.6.36 | value of frequency information |
| Uplink radio resources | | | | |
| Maximum allowed UL TX power | MD | | Maximum allowed UL TX power 10.3.6.39 | Default value is the existing maximum UL TX power |
| CHOICE <i>channel requirement</i> | OP | | | |
| >Uplink DPCH info | | | Uplink DPCH info 10.3.6.88 | |
| >CPCH SET Info | | | CPCH SET Info 10.3.6.13 | |
| Downlink radio resources | | | | |
| CHOICE <i>mode</i> | MP | | | |
| >FDD | | | | |
| >>Downlink PDSCH information | OP | | Downlink PDSCH information 10.3.6.30 | |
| >TDD | | | | (no data) |
| Downlink information common for all radio links | OP | | Downlink information common for all radio links 10.3.6.24 | |
| Downlink information per radio link list | OP | 1 to <maxRL> | | Send downlink information for each radio link |
| >Downlink information for each radio link | MP | | Downlink information for each radio link 10.3.6.27 | |

10.2.34 RADIO BEARER SETUP COMPLETE

This message is sent by UE to confirm the establishment of the radio bearer.

RLC-SAP: AM

Logical channel: DCCH

Direction: UE → UTRAN

| Information Element/Group name | Need | Multi | Type and reference | Semantics description | Version |
|--|------|----------------------|---|--|---------|
| Message Type | MP | | Message Type | | |
| UE information elements | | | | | |
| RRC transaction identifier | MP | | RRC transaction identifier 10.3.3.36 | | |
| Integrity check info | CH | | Integrity check info 10.3.3.16 | | |
| Uplink integrity protection activation info | OP | | Integrity protection activation info 10.3.3.17 | | |
| CHOICE <i>mode</i> | OP | | | | |
| >FDD | | | | (no data) | |
| >TDD | | | | | |
| >>CHOICE <i>TDD option</i> | MP | | | | REL-4 |
| >>>3.84 Mcps TDD | | | | | REL-4 |
| >>>>Uplink Timing Advance | OP | | Uplink Timing Advance 10.3.6.95 | This information element shall be present in case of handover procedure if timing advance is enabled. Calculated timing advance value for the new cell after handover in a synchronous TDD network | |
| >>>1.28 Mcps TDD | | | | (No data) | REL-4 |
| START | OP | | START 10.3.3.38 | This information element is not needed for transparent mode RBs | |
| RB Information elements | | | | | |
| COUNT-C activation time | OP | | Activation time 10.3.3.1 | Used for radio bearers mapped on RLC-TM. | |
| Radio bearer uplink ciphering activation time info | OP | | RB activation time info 10.3.4.13 | | |
| Uplink counter synchronisation info | OP | | | | |
| >RB with PDCP information list | OP | 1 to <maxRBall RABs> | | This IE is needed for each RB having PDCP in the case of lossless SRNS relocation | |
| >>RB with PDCP information | MP | | RB with PDCP information 10.3.4.22 | | |
| >START list | MP | 1 to <maxCNdo mains> | | START [40] values for all CN domains. | |
| >>CN domain identity | MP | | CN domain identity 10.3.1.1 | | |

| | | | | | |
|---------|----|--|--------------------|---|--|
| >>START | MP | | START 10.3.3.38 | START value to be used in this CN domain. | |
|---------|----|--|--------------------|---|--|

10.2.35 RADIO BEARER SETUP FAILURE

This message is sent by UE, if it does not support the configuration given by UTRAN.

RLC-SAP: AM

Logical channel: DCCH

Direction: UE→UTRAN

| Information Element/Group name | Need | Multi | Type and reference | Semantics description |
|--|------|--------------|--|-----------------------|
| Message Type | MP | | Message Type | |
| UE information elements | | | | |
| RRC transaction identifier | MP | | RRC transaction identifier 10.3.3.36 | |
| Integrity check info | CH | | Integrity check info 10.3.3.16 | |
| Failure cause | MP | | Failure cause and error information 10.3.3.14 | |
| RB information elements | | | | |
| Radio bearers for which reconfiguration would have succeeded | OP | 1 to <maxRB> | | |
| >Radio bearer for which reconfiguration would have succeeded | MP | | RB identity, 10.3.4.16 | |

10.2.36 RRC CONNECTION REJECT

The network transmits this message when the requested RRC connection cannot be accepted.

RLC-SAP: UM

Logical channel: CCCH

Direction: UTRAN → UE

| Information Element/Group name | Need | Multi | Type and reference | Semantics description |
|--------------------------------|------|-------|---|-----------------------|
| Message Type | MP | | Message Type | |
| UE information elements | | | | |
| RRC transaction identifier | MP | | RRC transaction identifier 10.3.3.36 | |
| Initial UE identity | MP | | Initial UE identity 10.3.3.15 | |
| Rejection cause | MP | | Rejection cause 10.3.3.31 | |
| Wait time | MP | | Wait time 10.3.3.50 | |
| Redirection info | OP | | Redirection info 10.3.3.29 | |

10.2.37 RRC CONNECTION RELEASE

This message is sent by UTRAN to release the RRC connection. The message also releases the signalling connection and all radio bearers between the UE and UTRAN.

RLC-SAP: UM

Logical channel: CCCH or DCCH

Direction: UTRAN→UE

| Information Element/Group name | Need | Multi | Type and reference | Semantics description |
|-----------------------------------|--------------------|-------|---|---|
| Message Type | MP | | Message Type | |
| UE information elements | | | | |
| U-RNTI | <i>CV-CCCH</i> | | U-RNTI 10.3.3.47 | |
| RRC transaction identifier | MP | | RRC transaction identifier 10.3.3.36 | |
| Integrity check info | <i>CV-DCCH</i> | | Integrity check info 10.3.3.16 | Integrity check info is included if integrity protection is applied |
| N308 | <i>CH-Cell_DCH</i> | | Integer(1..8) | |
| Release cause | MP | | Release cause 10.3.3.32 | |
| Other information elements | | | | |
| Rplmn information | OP | | Rplmn information 10.3.8.15 | |

| Condition | Explanation |
|-----------------|--|
| <i>CCCH</i> | This IE is only sent when CCCH is used. |
| <i>DCCH</i> | This IE is only sent when DCCH is used. |
| <i>Cell_DCH</i> | This IE is present when UE is in CELL_DCH state. |

10.2.38 RRC CONNECTION RELEASE COMPLETE

This message is sent by UE to confirm that the RRC connection has been released.

RLC-SAP: AM or UM

Logical channel: DCCH

Direction: UE → UTRAN

| Information Element/Group name | Need | Multi | Type and reference | Semantics description |
|--------------------------------|------|-------|--|-----------------------|
| Message Type | MP | | Message Type | |
| UE information elements | | | | |
| RRC transaction identifier | MP | | RRC transaction identifier 10.3.3.36 | |
| Integrity check info | CH | | Integrity check info 10.3.3.16 | |
| Error indication | OP | | Failure cause and error information 10.3.3.14 | |

10.2.39 RRC CONNECTION REQUEST

RRC Connection Request is the first message transmitted by the UE when setting up an RRC Connection to the network.

RLC-SAP: TM

Logical channel: CCCH

Direction: UE → UTRAN

| Information Element/Group name | Need | Multi | Type and reference | Semantics description |
|---|------|-------|---------------------------------------|------------------------|
| Message Type | MP | | Message Type | |
| UE information elements | | | | |
| Initial UE identity | MP | | Initial UE identity 10.3.3.15 | |
| Establishment cause | MP | | Establishment cause 10.3.3.11 | |
| Protocol error indicator | MD | | Protocol error indicator 10.3.3.27 | Default value is FALSE |
| Measurement information elements | | | | |
| Measured results on RACH | OP | | Measured results on RACH 10.3.7.45 | |

If the encoded message does not fill a transport block, the RRC layer shall insert padding according to subclause 12.1.

10.2.40 RRC CONNECTION SETUP

This message is used by the network to accept the establishment of an RRC connection for an UE, including assignment of signalling link information, transport channel information and optionally physical channel information.

RLC-SAP: UM

Logical channel: CCCH

Direction: UTRAN → UE

| Information Element/Group name | Need | Multi | Type and reference | Semantics description |
|--|------|-----------------|---|--|
| Message Type | MP | | Message Type | |
| UE Information Elements | | | | |
| Initial UE identity | MP | | Initial UE identity 10.3.3.15 | |
| RRC transaction identifier | MP | | RRC transaction identifier 10.3.3.36 | |
| Activation time | MD | | Activation time 10.3.3.1 | Default value is "now" |
| New U-RNTI | MP | | U-RNTI 10.3.3.47 | |
| New C-RNTI | OP | | C-RNTI 10.3.3.8 | |
| RRC State Indicator | MP | | RRC State Indicator 10.3.3.10 | |
| UTRAN DRX cycle length coefficient | MP | | UTRAN DRX cycle length coefficient 10.3.3.49 | |
| Capability update requirement | MD | | Capability update requirement 10.3.3.2 | Default value is defined in subclause 10.3.3.2 |
| RB Information Elements | | | | |
| Signalling RB information to setup list | MP | 3 to 4 | | Information for signalling radio bearers, in the order RB1 up to RB4. |
| >Signalling RB information to setup | MP | | Signalling RB information to setup 10.3.4.24 | |
| TrCH Information Elements | | | | |
| Uplink transport channels | | | | |
| UL Transport channel information common for all transport channels | OP | | UL Transport channel information common for all transport channels 10.3.5.24 | |
| Added or Reconfigured TrCH information list | MP | 1 to <maxTrCH > | | Although this IE is not required when the IE "RRC state indicator" is set to "CELL_FACH", need is MP to align with ASN.1 |
| >Added or Reconfigured UL TrCH information | MP | | Added or Reconfigured UL TrCH information 10.3.5.2 | |
| Downlink transport channels | | | | |
| DL Transport channel information common for all transport channels | OP | | DL Transport channel information common for all transport channels 10.3.5.6 | |
| Added or Reconfigured TrCH information list | MP | 1 to <maxTrCH > | | Although this IE is not required when the IE "RRC state |

| Information Element/Group name | Need | Multi | Type and reference | Semantics description |
|---|------|--------------|---|--|
| | | > | | indicator" is set to "CELL_FACH", need is MP to align with ASN.1 |
| >Added or Reconfigured DL TrCH information | MP | | Added or Reconfigured DL TrCH information 10.3.5.1 | |
| PhyCH information elements | | | | |
| Frequency info | MD | | Frequency info 10.3.6.36 | Default value is the existing value of frequency information |
| Uplink radio resources | | | | |
| Maximum allowed UL TX power | MD | | Maximum allowed UL TX power 10.3.6.39 | Default value is the existing maximum UL TX power |
| <i>CHOICE channel requirement</i> | | | | |
| >Uplink DPCH info | | | Uplink DPCH info 10.3.6.88 | |
| >CPCH SET Info | | | CPCH SET Info 10.3.6.13 | |
| Downlink radio resources | | | | |
| Downlink information common for all radio links | OP | | Downlink information common for all radio links 10.3.6.24 | |
| Downlink information per radio link list | OP | 1 to <MaxRL> | | Send downlink information for each radio link to be set-up |
| >Downlink information for each radio link | MP | | Downlink information for each radio link 10.3.6.27 | |

10.2.41 RRC CONNECTION SETUP COMPLETE

This message confirms the establishment of the RRC Connection by the UE.

RLC-SAP: AM

Logical channel: DCCH

Direction: UE → UTRAN

| Information Element/Group name | Need | Multi | Type and reference | Semantics description |
|---------------------------------------|------|-----------------------------|--|---|
| Message Type | MP | | Message Type | |
| UE Information Elements | | | | |
| RRC transaction identifier | MP | | RRC transaction identifier 10.3.3.36 | |
| START list | MP | 1 to <maxCNdo mains> | | START [40] values for all CN domains. |
| >CN domain identity | MP | | CN domain identity 10.3.1.1 | |
| >START | MP | | START 10.3.3.38 | START value to be used in this CN domain. |
| UE radio access capability | OP | | UE radio access capability 10.3.3.42 | |
| UE radio access capability extension | OP | | UE radio access capability extension 10.3.3.42a | |
| Other information elements | | | | |
| UE system specific capability | OP | 1 to <maxInter SysMessages> | | |
| >Inter-RAT UE radio access capability | MP | | Inter-RAT UE radio access capability 10.3.8.7 | |

10.2.42 RRC STATUS

This message is sent to indicate a protocol error.

RLC-SAP: AM

Logical channel: DCCH

Direction: UE→UTRAN

| Information Element/Group name | Need | Multi | Type and reference | Semantics description |
|------------------------------------|----------------------------------|-------|---|---|
| Message Type | MP | | Message Type | |
| UE information elements | | | | |
| Integrity check info | CH | | Integrity check info 10.3.3.16 | Integrity check info is included if integrity protection is applied |
| Identification of received message | CV- <i>Message identified</i> | | | |
| >Received message type | MP | | Message Type | |
| >RRC transaction identifier | MP | | RRC transaction identifier 10.3.3.36 | |
| Other information elements | | | | |
| Protocol error information | MP | | Protocol error information 10.3.8.12 | |

| Condition | Explanation |
|---------------------------|---|
| <i>Message identified</i> | This IE is mandatory if the IE "Protocol error cause" in the IE "Protocol error information" has any other value than "ASN.1 violation or encoding error" or "Message type non-existent or not implemented" |

10.2.43 SECURITY MODE COMMAND

This message is sent by UTRAN to start or reconfigure ciphering and/or integrity protection parameters.

RLC-SAP: AM

Logical channel: DCCH

Direction: UTRAN to UE

| Information Element/Group name | Need | Multi | Type and reference | Semantics description |
|--|------|-----------------------------|---|--|
| Message Type | MP | | Message Type | |
| UE information elements | | | | |
| RRC transaction identifier | MP | | RRC transaction identifier 10.3.3.36 | |
| Integrity check info | MP | | Integrity check info 10.3.3.16 | |
| Security capability | MP | | Security capability 10.3.3.37 | |
| Ciphering mode info | OP | | Ciphering mode info 10.3.3.5 | Only present if ciphering shall be controlled |
| Integrity protection mode info | OP | | Integrity protection mode info 10.3.3.19 | Only present if integrity protection shall be controlled |
| CN Information elements | | | | |
| CN domain identity | MP | | CN domain identity 10.3.1.1 | Indicates which cipher and integrity protection keys are applicable |
| Other information elements | | | | |
| UE system specific security capability | CH | 1 to <maxInter SysMessages> | | This IE is included if the IE "Inter-RAT UE radio access capability" was included in RRC CONNECTION SETUP COMPLETE message |
| >Inter-RAT UE security capability | MP | | Inter-RAT UE security capability 10.3.8.8a | |

10.2.44 SECURITY MODE COMPLETE

This message is sent by UE to confirm the reconfiguration of ciphering and/or integrity protection.

RLC-SAP: AM

Logical channel: DCCH

Direction: UE to UTRAN

| Information Element/Group name | Need | Multi | Type and reference | Semantics description |
|--|------|-------|---|-----------------------|
| Message Type | MP | | Message Type | |
| UE information elements | | | | |
| RRC transaction identifier | MP | | RRC transaction identifier 10.3.3.36 | |
| Integrity check info | MP | | Integrity check info 10.3.3.16 | |
| Uplink integrity protection activation info | OP | | Integrity protection activation info 10.3.3.17 | |
| RB Information elements | | | | |
| Radio bearer uplink ciphering activation time info | OP | | RB activation time info 10.3.4.13 | |

10.2.45 SECURITY MODE FAILURE

This message is sent to indicate a failure to act on a received SECURITY MODE CONTROL message.

RLC-SAP: AM

Logical channel: DCCH

Direction: UE→UTRAN

| Information Element/Group name | Need | Multi | Type and reference | Semantics description |
|--------------------------------|------|-------|--|-----------------------|
| Message Type | MP | | Message Type | |
| UE information elements | | | | |
| RRC transaction identifier | MP | | RRC transaction identifier 10.3.3.36 | |
| Integrity check info | CH | | Integrity check info 10.3.3.16 | |
| Failure cause | MP | | Failure cause and error information 10.3.3.14 | |

10.2.46 SIGNALLING CONNECTION RELEASE

This message is used to notify the UE that its ongoing signalling connection to a CN domain has been released.

RLC-SAP: AM

Logical channel: DCCH

Direction: UTRAN→UE

| Information Element/Group name | Need | Multi | Type and reference | Semantics description |
|--------------------------------|------|-------|---|---|
| Message Type | MP | | Message Type | |
| UE information elements | | | | |
| RRC transaction identifier | MP | | RRC transaction identifier 10.3.3.36 | |
| Integrity check info | CH | | Integrity check info 10.3.3.16 | Integrity check info is included if integrity protection is applied |
| CN information elements | | | | |
| CN domain identity | MP | | CN domain identity 10.3.1.1 | |

10.2.47 SIGNALLING CONNECTION RELEASE REQUEST

This message is used by the UE to request for the release of an existing signalling connection.

RLC-SAP: AM

Logical channel: DCCH

Direction: UE→UTRAN

| Information Element/Group name | Need | Multi | IE type and reference | Semantics description |
|--------------------------------|------|-------|-----------------------------------|-----------------------|
| Message Type | MP | | Message type | |
| UE Information Elements | | | | |
| Integrity check info | CH | | Integrity check info 10.3.3.16 | |
| CN information elements | | | | |
| CN domain identity | MP | | CN domain identity 10.3.1.1 | |

10.2.48 SYSTEM INFORMATION

| Information Element/Group name | Need | Multi | Type and reference | Semantics description |
|-----------------------------------|------------|---------------------|----------------------------------|---|
| Message type | OP | | Message type | The message type is mandatory on the FACH, and absent on the BCH |
| SFNprime | CV-channel | | Integer(0..4094 by step of 2) | SFN=SFNprime (for first 10ms frame of 20ms TTI), SFN=SFNprime+1 (for last 10ms frame of 20ms TTI) |
| <i>CHOICE Segment combination</i> | MP | | | |
| >Combination 1 | | | | (no data) |
| >Combination 2 | | | | |
| >>First Segment | MP | | First Segment, 10.2.48.1 | |
| >Combination 3 | | | | |
| >>Subsequent Segment | MP | | Subsequent Segment, 10.2.48.3 | |
| >Combination 4 | | | | |
| >>Last segment | MP | | Last segment (short), 10.2.48.5 | |
| >Combination 5 | | | | |
| >>Last segment | MP | | Last Segment (short) 10.2.48.5 | |
| >>First Segment | MP | | First Segment (short), 10.2.48.2 | |
| >Combination 6 | | | | |
| >>Last Segment | MP | | Last Segment (short), 10.2.48.5 | |
| >>Complete list | MP | 1 to maxSIBper Msg | | Note 1 |
| >>>Complete | MP | | Complete SIB (short), 10.2.48.7 | |
| >Combination 7 | | | | |
| >>Last Segment | MP | | Last Segment (short), 10.2.48.5 | |
| >>Complete list | MP | 1..< maxSIBper Msg> | | Note 1 |
| >>>Complete | MP | | Complete SIB (short), 10.2.48.7 | |
| >>First Segment | MP | | First Segment (short), 10.2.48.2 | |
| >Combination 8 | | | | |
| >>Complete list | MP | 1 to maxSIBper Msg | | Note 1 |

| | | | | |
|------------------------------------|----|------------------|----------------------------------|--------|
| >>>Complete | MP | | Complete SIB (short),10.2.48.7 | |
| >Combination 9 | | | | |
| >>Complete list | MP | 1..MaxSIB perMsg | | Note 1 |
| >>>Complete | MP | | Complete SIB (short),10.2.48.7 | |
| >>First Segment | MP | | First Segment (short), 10.2.48.2 | |
| >Combination 10 | | | | |
| >>>Complete SIB of size 215 to 226 | MP | | Complete SIB,10.2.48.6 | |
| >Combination 11 | | | | |
| >>Last segment of size 215 to 222 | MP | | Last segment,10.2.48.4 | |

| Condition | Explanation |
|----------------|---|
| <i>channel</i> | This IE is mandatory if the channel is BCH, otherwise it is absent. |

If the encoded message does not fill a transport block, the RRC layer shall insert padding according to subclause 12.1. Padding is needed e.g. if the remaining space is insufficient to start a new First Segment (which requires several bits for SIB type, SEG_COUNT and SIB data).

NOTE 1: If Combination 6 - 9 contains a Master information block Master information shall be located as the first IE in the list.

10.2.48.1 First Segment

This segment type is used to transfer the first segment of a segmented system information block. The IE is used when the first segment fills the entire transport block (Combination 2).

| Information Element/Group name | Need | Multi | Type and reference | Semantics description |
|-----------------------------------|------|-------|---------------------------|-----------------------|
| Other information elements | | | | |
| SIB type | MP | | SIB Type, 10.3.8.21 | |
| SEG_COUNT | MP | | SEG COUNT, 10.3.8.17 | |
| SIB data fixed | MP | | SIB data fixed, 10.3.8.19 | |

10.2.48.2 First Segment (short)

This segment type is used to transfer the first segment of a segmented system information block. The IE is used when the first segment is concatenated after other segments in a transport block (Combination 5, 7 and 9).

| Information Element/Group name | Need | Multi | Type and reference | Semantics description |
|-----------------------------------|------|-------|------------------------------|-----------------------|
| Other information elements | | | | |
| SIB type | MP | | SIB Type, 10.3.8.21 | |
| SEG_COUNT | MP | | SEG COUNT, 10.3.8.17 | |
| SIB data variable | MP | | SIB data variable, 10.3.8.20 | |

10.2.48.3 Subsequent Segment

This segment type is used to transfer a subsequent segment of a segmented system information block.

| Information Element/Group name | Need | Multi | Type and reference | Semantics description |
|-----------------------------------|------|-------|---------------------------|-----------------------|
| Other information elements | | | | |
| SIB type | MP | | SIB Type, 10.3.8.21 | |
| Segment index | MP | | Segment Index, 10.3.8.18 | |
| SIB data fixed | MP | | SIB data fixed, 10.3.8.19 | |

10.2.48.4 Last Segment

This segment type is used to transfer the last segment of a segmented system information block. The IE is used when the last segment has a length, excluding length denominator, from 215 through 222 (Combination 11).

| Information Element/Group name | Need | Multi | Type and reference | Semantics description |
|-----------------------------------|------|-------|---------------------------|--|
| Other information elements | | | | |
| SIB type | MP | | SIB Type, 10.3.8.21 | |
| Segment index | MP | | Segment Index, 10.3.8.18 | |
| SIB data fixed | MP | | SIB data fixed, 10.3.8.19 | In case the SIB data is less than 222 bits, padding shall be used. The same padding bits shall be used as defined in clause 12.1 |

10.2.48.5 Last Segment (short)

This segment type is used to transfer the last segment of a segmented system information block. The IE is used when the last segment has a length, excluding length denominator, of upto 214 bits (Combination 4, 5, 6 and 7).

| Information Element/Group name | Need | Multi | Type and reference | Semantics description |
|-----------------------------------|------|-------|------------------------------|-----------------------|
| Other information elements | | | | |
| SIB type | MP | | SIB Type, 10.3.8.21 | |
| Segment index | MP | | Segment Index, 10.3.8.18 | |
| SIB data variable | MP | | SIB data variable, 10.3.8.20 | |

10.2.48.6 Complete SIB

This segment type is used to transfer a non-segmented system information block. The IE is used when the complete SIB has a length, excluding length denominator, from 215 through 226 (Combination 10).

| Information Element/Group name | Need | Multi | Type and reference | Semantics description |
|-----------------------------------|------|-------|---------------------|--|
| Other information elements | | | | |
| SIB type | MP | | SIB Type, 10.3.8.21 | |
| SIB data fixed | MP | | Bit string (226) | In case the SIB data is less than 226 bits, padding shall be used. The same padding bits shall be used as defined in clause 12.1 |

10.2.48.7 Complete SIB (short)

This segment type is used to transfer a non-segmented system information block. The IE is used when the complete SIB has a length, excluding length denominator, of upto 214 bits (Combination 6, 7, 8 and 9).

| Information Element/Group name | Need | Multi | Type and reference | Semantics description |
|-----------------------------------|------|-------|------------------------------|-----------------------|
| Other information elements | | | | |
| SIB type | MP | | SIB Type, 10.3.8.21 | |
| SIB data variable | MP | | SIB data variable, 10.3.8.20 | |

10.2.48.8 System Information Blocks

The IE "SIB data" within the IEs, "First Segment", "Subsequent or last Segment" and "Complete SIB" contains either complete system information block or a segment of a system information block. The actual system information blocks are defined in the following clauses.

10.2.48.8.1 Master Information Block

| Information Element/Group name | Need | Multi | Type and reference | Semantics description |
|---|------------|-------|---|-----------------------|
| Other information elements | | | | |
| MIB Value tag | MP | | MIB Value tag 10.3.8.9 | |
| CN information elements | | | | |
| Supported PLMN types | MP | | PLMN Type 10.3.1.12 | |
| PLMN Identity | CV-GSM | | PLMN Identity 10.3.1.11 | |
| ANSI-41 information elements | | | | |
| ANSI-41 Core Network Information | CV-ANSI-41 | | ANSI-41 Core Network Information 10.3.9.1 | |
| References to other system information blocks and scheduling blocks | MP | | References to other system information blocks and scheduling blocks 10.3.8.14 | |

| Condition | Explanation |
|-----------|---|
| GSM | The IE is mandatory if the IE "Supported PLMN Types" is set to 'GSM-MAP' or 'GSM-MAP AND ANSI-41', and not needed otherwise |
| ANSI-41 | The IE is mandatory if the IE "Supported PLMN Types" is set to 'ANSI-41' or 'GSM-MAP AND ANSI-41', and not needed otherwise |

10.2.48.8.2 Scheduling Block 1

| Information Element/Group name | Need | Multi | Type and reference | Semantics description |
|---|------|-------|---|-----------------------|
| References to other system information blocks | MP | | References to other system information blocks 10.3.8.13 | |

10.2.48.8.3 Scheduling Block 2

| Information Element/Group name | Need | Multi | Type and reference | Semantics description |
|---|------|-------|---|-----------------------|
| References to other system information blocks | MP | | References to other system information blocks 10.3.8.13 | |

10.2.48.8.4 System Information Block type 1

The system information block type 1 contains NAS system information as well as UE timers and counters to be used in idle mode and in connected mode.

| Information Element/Group name | Need | Multi | Type and reference | Semantics description |
|---|------|---------------------|---|---|
| CN information elements | | | | |
| CN common GSM-MAP NAS system information | MP | | NAS system information (GSM-MAP) 10.3.1.9 | |
| CN domain system information list | MP | 1 to <maxCNdomains> | | Send CN information for each CN domain. |
| >CN domain system information | MP | | CN domain system information 10.3.1.2 | |
| UE information | | | | |
| UE Timers and constants in idle mode | MD | | UE Timers and constants in idle mode 10.3.3.44 | Default value means that for all timers and constants - For parameters with need MD, the defaults specified in 10.3.3.44 apply and - For parameters with need OP, the parameters are absent |
| UE Timers and constants in connected mode | MD | | UE Timers and constants in connected mode 10.3.3.43 | Default value means that for all timers and constants - For parameters with need MD, the defaults specified in 10.3.3.43 apply and - For parameters with need OP, the parameters are absent |

10.2.48.8.5 System Information Block type 2

The system information block type 2 contains the URA identity.

| Information Element/Group name | Need | Multi | Type and reference | Semantics description |
|--|------|--------------|-----------------------|-----------------------|
| UTRAN mobility information elements | | | | |
| URA identity list | MP | 1 ..<maxURA> | | |
| >URA identity | MP | | URA identity 10.3.2.6 | |

10.2.48.8.6 System Information Block type 3

The system information block type 3 contains parameters for cell selection and re-selection.

| Information Element/Group name | Need | Multi | Type and reference | Semantics description |
|--|------|-------|--|--|
| SIB4 Indicator | MP | | Boolean | TRUE indicates that SIB4 is broadcast in the cell. |
| UTRAN mobility information elements | | | | |
| Cell identity | MP | | Cell identity 10.3.2.2 | |
| Cell selection and re-selection info | MP | | Cell selection and re-selection info for SIB3/4 10.3.2.3 | |
| Cell Access Restriction | MP | | Cell Access Restriction 10.3.2.1 | |

10.2.48.8.7 System Information Block type 4

The system information block type 4 contains parameters for cell selection and re-selection to be used in connected mode.

| Information Element/Group name | Need | Multi | Type and reference | Semantics description |
|--|------|-------|--|-----------------------|
| UTRAN mobility information elements | | | | |
| Cell identity | MP | | Cell identity 10.3.2.2 | |
| Cell selection and re-selection info | MP | | Cell selection and re-selection info for SIB3/4 10.3.2.3 | |
| Cell Access Restriction | MP | | Cell Access Restriction 10.3.2.1 | |

10.2.48.8.8 System Information Block type 5

The system information block type 5 contains parameters for the configuration of the common physical channels in the cell.

| Information Element/Group name | Need | Multi | Type and reference | Semantics description |
|------------------------------------|---------|-------|---|---|
| SIB6 Indicator | MP | | Boolean | TRUE indicates that SIB6 is broadcast in the cell. |
| PhyCH information elements | | | | |
| PICH Power offset | MP | | PICH Power offset 10.3.6.50 | |
| CHOICE <i>mode</i> | MP | | | |
| >FDD | | | | |
| >>AICH Power offset | MP | | AICH Power offset 10.3.6.3 | This AICH Power offset also indicates the power offset for AP-AICH and for CD/CA-ICH. |
| >TDD | | | | |
| >>PUSCH system information | OP | | PUSCH system information 10.3.6.66 | |
| >>PDSCH system information | OP | | PDSCH system information 10.3.6.46 | |
| >>TDD open loop power control | MP | | TDD open loop power control 10.3.6.79 | |
| Primary CCPCH info | OP | | Primary CCPCH info 10.3.6.57 | Note 1 |
| PRACH system information list | MP | | PRACH system information list 10.3.6.55 | |
| Secondary CCPCH system information | MP | | Secondary CCPCH system information 10.3.6.72 | |
| CBS DRX Level 1 information | CV-CTCH | | CBS DRX Level 1 information 10.3.8.3 | |

NOTE 1: DL scrambling code of the Primary CCPCH is the same as the one for Primary CPICH (FDD only).

| Condition | Explanation |
|-----------|--|
| CTCH | The IE is mandatory if the IE "CTCH indicator" is equal to TRUE for at least one FACH, otherwise the IE is not needed in the message |

10.2.48.8.9 System Information Block type 6

The system information block type 6 contains parameters for the configuration of the common and shared physical channels to be used in connected mode.

| Information Element/Group name | Need | Multi | Type and reference | Semantics description |
|------------------------------------|---------|-------|---|---|
| PhyCH information elements | | | | |
| PICH Power offset | MP | | PICH Power offset 10.3.6.50 | |
| CHOICE <i>mode</i> | MP | | | |
| >FDD | | | | |
| >>AICH Power offset | MP | | AICH Power offset 10.3.6.3 | This AICH Power offset also indicates the power offset for AP-AICH and for CD/CA-ICH. |
| >TDD | | | | |
| >>PUSCH system information | OP | | PUSCH system information 10.3.6.66 | |
| >>PDSCH system information | OP | | PDSCH system information 10.3.6.46 | |
| >>TDD open loop power control | MP | | TDD open loop power control 10.3.6.79 | |
| Primary CCPCH info | OP | | Primary CCPCH info 10.3.6.57 | Note 1 |
| PRACH system information list | OP | | PRACH system information list 10.3.6.55 | |
| Secondary CCPCH system information | OP | | Secondary CCPCH system information 10.3.6.72 | |
| CBS DRX Level 1 information | CV-CTCH | | CBS DRX Level 1 information 10.3.8.3 | |

NOTE 1: DL scrambling code of the Primary CCPCH is the same as the one for Primary CPICH (FDD only).

| Condition | Explanation |
|-----------|---|
| CTCH | The IE is mandatory if the IE "CTCH indicator" is equal to TRUE for at least one FACH, otherwise the IE is not needed |

10.2.48.8.10 System Information Block type 7

The system information block type 7 contains the fast changing parameters UL interference and Dynamic persistence level.

| Information Element/Group name | Need | Multi | Type and reference | Semantics description |
|--|------|------------------|--|--|
| CHOICE <i>mode</i> | MP | | | |
| >FDD | | | | |
| >>UL interference | MP | | UL interference 10.3.6.87 | |
| >TDD | | | | (no data) |
| PhyCH information elements | | | | |
| PRACHs listed in system information block type 5 | MP | 1 to <maxPRACH> | | The order of the PRACHs is the same as in system information block type 5. |
| >Dynamic persistence level | MP | | Dynamic persistence level 10.3.6.35 | |
| PRACHs listed in system information block type 6 | OP | 1 to <maxPRA CH> | | The order of the PRACHs is the same as in system information block type 6. |
| >Dynamic persistence level | MP | | Dynamic persistence level 10.3.6.35 | |
| Expiration Time Factor | MD | | Expiration Time Factor 10.3.3.12 | Default is 1. |

10.2.48.8.11 System Information Block type 8

NOTE: Only for FDD.

The system information block type 8 contains static CPCH information to be used in the cell.

| Information Element/Group name | Need | Multi | Type and reference | Semantics description |
|-----------------------------------|------|---------------------|---------------------------------|-----------------------|
| UE information | | | | |
| CPCH parameters | MP | | CPCH parameters 10.3.3.7 | |
| PhyCH information elements | | | | |
| CPCH set info list | MP | 1 to <maxCPC Hsets> | | |
| >CPCH set info | MP | | CPCH set info 10.3.6.13 | |
| CSICH Power offset | MP | | CSICH Power offset 10.3.6.15 | |

10.2.48.8.12 System Information Block type 9

NOTE: Only for FDD.

The system information block type 9 contains CPCH information to be used in the cell.

| Information Element/Group name | Need | Multi | Type and reference | Semantics description |
|-----------------------------------|------|-----------------------|-----------------------------------|-----------------------|
| PhyCH information elements | | | | |
| CPCH set persistence levels list | MP | ..1 to <maxCPC Hsets> | | |
| >CPCH set persistence levels | MP | | CPCH persistence levels 10.3.6.12 | |

10.2.48.8.13 System Information Block type 10

NOTE: Only for FDD.

The system information block type 10 contains information to be used by UEs having their DCH controlled by a DRAC procedure.

| Information Element/Group name | Need | Multi | Type and reference | Semantics description |
|--------------------------------|------|-------|----------------------------------|---|
| UE information | | | | |
| DRAC system information | MP | | DRAC system information 10.3.3.9 | DRAC information is sent for each class of terminal |

10.2.48.8.14 System Information Block type 11

The system information block type 11 contains measurement control information to be used in the cell.

| Information Element/Group name | Need | Multi | Type and reference | Semantics description |
|---|------|-------|--|---|
| SIB12 Indicator | MP | | Boolean | TRUE indicates that SIB12 is broadcast in the cell. |
| Measurement information elements | | | | |
| FACH measurement occasion info | OP | | FACH measurement occasion info 10.3.7.8 | |
| Measurement control system information | MP | | Measurement control system information 10.3.7.47 | |

10.2.48.8.15 System Information Block type 12

The system information block type 12 contains measurement control information to be used in connected mode.

| Information Element/Group name | Need | Multi | Type and reference | Semantics description |
|---|------|-------|--|-----------------------|
| Measurement information elements | | | | |
| FACH measurement occasion info | OP | | FACH measurement occasion info 10.3.7.8 | |
| Measurement control system information | MP | | Measurement control system information 10.3.7.47 | |

10.2.48.8.16 System Information Block type 13

The system information block type 13 contains ANSI-41 system information.

| Information Element/Group name | Need | Multi | Type and reference | Semantics description |
|--------------------------------------|------|---------------------|--|--|
| Other information elements | | | | |
| CN Information Elements | | | | |
| CN Domain system information list | MP | 1 to <maxCNdomains> | | Send CN information for each CN domain. |
| >CN Domain system information | MP | | CN Domain system information 10.3.1.2 | |
| UE Information | | | | |
| UE timers and constants in idle mode | OP | | UE timers and constants in idle mode 10.3.3.44 | |
| Capability update requirement | MD | | Capability update requirement 10.3.3.2 | Default value is defined in subclause 10.3.3.2 |

10.2.48.8.16.1 System Information Block type 13.1

The system information block type 13.1 contains the ANSI-41 RAND information.

| Information Element/Group name | Need | Multi | Type and reference | Semantics description |
|-------------------------------------|------|-------|-----------------------------------|-----------------------|
| ANSI-41 information elements | | | | |
| ANSI-41 RAND information | MP | | ANSI-41 RAND information 10.3.9.6 | |

10.2.48.8.16.2 System Information Block type 13.2

The system information block type 13.2 contains the ANSI-41 User Zone Identification information.

| Information Element/Group name | Need | Multi | Type and reference | Semantics description |
|--|------|-------|---|-----------------------|
| ANSI-41 information elements | | | | |
| ANSI-41 User Zone Identification information | MP | | ANSI-41 User Zone Identification information 10.3.9.7 | |

10.2.48.8.16.3 System Information Block type 13.3

The system information block type 13.3 contains the ANSI-41 Private Neighbour List information.

| Information Element/Group name | Need | Multi | Type and reference | Semantics description |
|--|------|-------|---|-----------------------|
| ANSI-41 information elements | | | | |
| ANSI-41 Private Neighbour List information | MP | | ANSI-41 Private Neighbour List information 10.3.9.5 | |

10.2.48.8.16.4 System Information Block type 13.4

The system information block type 13.4 contains the ANSI-41 Global Service Redirection information.

| Information Element/Group name | Need | Multi | Type and reference | Semantics description |
|--|------|-------|---|-----------------------|
| ANSI-41 information elements | | | | |
| ANSI-41 Global Service Redirection information | MP | | ANSI-41 Global Service Redirection information 10.3.9.2 | |

10.2.48.8.17 System Information Block type 14

NOTE: Only for TDD.

The system information block type 14 contains parameters for common and dedicated physical channel uplink outer loop power control information to be used in both idle and connected mode.

| Information Element/Group name | Need | Multi | Type and reference | Semantics description |
|---------------------------------------|------|--------------|--|-----------------------|
| PhyCH information elements | | | | |
| Individual Timeslot interference list | MP | 1 to <maxTS> | | |
| >Individual Timeslot interference | MP | | Individual Timeslot interference 10.3.6.38 | |
| Expiration Time Factor | MD | | Expiration Time Factor 10.3.3.12 | Default is 1. |

10.2.48.8.18 System Information Block type 15

The system information block type 15 contains information useful for UE-based or UE-assisted positioning methods.

| Information Element/Group name | Need | Multi | Type and Reference | Semantics description |
|--------------------------------|------|---------------|---|--|
| GPS Data ciphering info | OP | | UE positioning Cipher info 10.3.7.86 | If this IE is present then the SIB types 15.1, 15.2 & 15.3 are ciphered in accordance with the Data Assistance Ciphering Algorithm specified in [18] |
| Reference position | MP | | Ellipsoid point with altitude and uncertainty ellipsoid 10.3.8.4c | approximate position where the UE is located |
| GPS Reference Time | MP | | UE positioning GPS reference time 10.3.7.96 | |
| Satellite information | OP | 1 to <maxSat> | | This IE is present whenever bad (failed/failing) satellites are detected by UTRAN [18]. |
| >BadSatID | MP | | Enumerated(0..63) | |

10.2.48.8.18.1 System Information Block type 15.1

The system information block type 15.1 contains information useful for UE positioning DGPS Corrections. The DGPS Corrections message contents are based on a Type-1 message of DGPS specified in [13].

| Information Element/Group name | Need | Multi | Type and Reference | Semantics description |
|--------------------------------|------|-------|---|-----------------------|
| DGPS corrections | MP | | UE positioning GPS DGPS corrections 10.3.7.91 | |

10.2.48.8.18.2 System Information Block type 15.2

The system information block type 15.2 contains information useful for GPS Navigation Model. These IE fields are based on information extracted from the subframes 1 to 3 of the GPS navigation message [12].

| Information Element/Group name | Need | Multi | Type and Reference | Semantics description |
|---|------|-------|---|--|
| Transmission TOW | MP | | Integer (0..604799) | The approximate GPS time-of-week when the message is broadcast. in seconds |
| SatID | MP | | Enumerated(0..63) | Satellite ID |
| GPS Ephemeris and Clock Correction Parameters | MP | | UE positioning GPS Ephemeris and Clock Correction parameters 10.3.7.90a | |

10.2.48.8.18.3 System Information Block type 15.3

The system information block type 15.3 contains information useful for ionospheric delay, UTC offset, and Almanac. These IEs contain information extracted from the subframes 4 and 5 of the GPS navigation message, [12].

| Information Element/Group name | Need | Multi | Type and Reference | Semantics description |
|----------------------------------|-----------------------|-------|--|--|
| Transmission TOW | MP | | Integer (0..604799) | The approximate GPS time-of-week when the message is broadcast. in seconds |
| GPS Almanac and Satellite Health | OP | | UE positioning GPS almanac 10.3.7.89 | |
| GPS ionospheric model | OP | | UE positioning GPS ionospheric model 10.3.7.92 | |
| GPS UTC model | OP | | UE positioning GPS UTC model 10.3.7.97 | |
| SatMask | CV- <i>Almanac</i> | | Bitstring(1..32) | indicates the satellites that contain the pages being broadcast in this data set |
| LSB TOW | CV- <i>Almanac</i> | | Bit string(8) | |

| Condition | Explanation |
|----------------|--|
| <i>Almanac</i> | This IE is present if the IE "GPS Almanac and Satellite Health" is present |

10.2.48.8.18.4 System Information Block type 15.4

The system information block type 15.4 contains information useful for OTDOA based UE Positioning method.

| Information Element/Group name | Need | Multi | Type and Reference | Semantics description |
|--------------------------------|------|-------|---|--|
| OTDOA Data ciphering info | OP | | UE positioning Ciphering info 10.3.7.86 | If this IE is present then the IE "OTDOA Assistance Data" is ciphered in accordance with the Data Assistance Ciphering Algorithm specified in [18] |
| OTDOA assistance data | MP | | UE positioning OTDOA assistance data 10.3.7.103 | |

10.2.48.8.19 System Information Block type 16

The system information block type 16 contains radio bearer, transport channel and physical channel parameters to be stored by UE in idle and connected mode for use during handover to UTRAN.

| Information Element/Group name | Need | Multi | Type and Reference | Semantics description |
|-----------------------------------|------|-------|--|-----------------------|
| RB information elements | | | | |
| Predefined RB configuration | MP | | Predefined RB configuration 10.3.4.7 | |
| TrCH Information Elements | | | | |
| Predefined TrCH configuration | MP | | Predefined TrCH configuration 10.3.5.9 | |
| PhyCH Information Elements | | | | |
| Predefined PhyCH configuration | MP | | Predefined PhyCH configuration 10.3.6.56 | |

10.2.48.8.20 System Information Block type 17

NOTE: Only for TDD.

The system information block type 17 contains fast changing parameters for the configuration of the shared physical channels to be used in connected mode.

| Information Element/Group name | Need | Multi | Type and reference | Semantics description |
|-----------------------------------|------|-------|------------------------------------|-----------------------|
| PhyCH information elements | | | | |
| PUSCH system information | OP | | PUSCH system information 10.3.6.66 | |
| PDSCH system information | OP | | PDSCH system information 10.3.6.46 | |

10.2.48.8.21 System Information Block type 18

The System Information Block type 18 contains PLMN identities of neighbouring cells to be considered in idle mode as well as in connected mode.

| Information Element/Group name | Need | Multi | Type and reference | Semantics description |
|--------------------------------|------|-------|---|-----------------------|
| Idle mode PLMN identities | OP | | PLMN identities of neighbour cells 10.3.7.53a | |
| Connected mode PLMN identities | OP | | PLMN identities of neighbour cells 10.3.7.53a | |

10.2.49 SYSTEM INFORMATION CHANGE INDICATION

This message is used to send information on FACH to the UEs in state CELL_FACH about coming modification of the system information.

RLC-SAP: TM

Logical channel: BCCH

Direction: UTRAN → UE

| Information Element/Group name | Need | Multi | Type and reference | Semantics description |
|-----------------------------------|------|-------|---------------------------------|-----------------------|
| Message Type | MP | | Message Type | |
| Other information elements | | | | |
| BCCH modification info | MP | | BCCH modification info 10.3.8.1 | |

If the encoded message does not fill a transport block, the RRC layer shall insert padding according to subclause 12.1.

10.2.50 TRANSPORT CHANNEL RECONFIGURATION

This message is used by UTRAN to configure the transport channel of a UE. This also includes a possible reconfiguration of physical channels. The message can also be used to assign a TFC subset and reconfigure physical channel.

RLC-SAP: AM or UM

Logical channel: DCCH

Direction: UTRAN → UE

| Information Element/Group name | Need | Multi | Type and reference | Semantics description |
|--|------|----------------------|---|---|
| Message Type | MP | | Message Type | |
| UE Information Elements | | | | |
| RRC transaction identifier | MP | | RRC transaction identifier 10.3.3.36 | |
| Integrity check info | CH | | Integrity check info 10.3.3.16 | |
| Integrity protection mode info | OP | | Integrity protection mode info 10.3.3.19 | |
| Ciphering mode info | OP | | Ciphering mode info 10.3.3.5 | |
| Activation time | MD | | Activation time 10.3.3.1 | Default value is "now" |
| New U-RNTI | OP | | U-RNTI 10.3.3.47 | |
| New C-RNTI | OP | | C-RNTI 10.3.3.8 | |
| RRC State Indicator | MP | | RRC State Indicator 10.3.3.10 | |
| UTRAN DRX cycle length coefficient | MD | | UTRAN DRX cycle length coefficient 10.3.3.49 | Default value is the existing value of UTRAN DRX cycle length coefficient |
| CN Information Elements | | | | |
| CN Information info | OP | | CN Information info 10.3.1.3 | |
| UTRAN mobility information elements | | | | |
| URA identity | OP | | URA identity 10.3.2.6 | |
| RB information elements | | | | |
| Downlink counter synchronisation info | OP | | | |
| >RB with PDCP information list | OP | 1 to <maxRBall RABs> | | This IE is needed for each RB having PDCP in the case of lossless SRNS relocation |
| >>RB with PDCP information | MP | | RB with PDCP information 10.3.4.22 | |
| TrCH Information Elements | | | | |
| Uplink transport channels | | | | |
| UL Transport channel information common for all transport channels | OP | | UL Transport channel information common for all transport channels 10.3.5.24 | |
| Added or Reconfigured TrCH information list | OP | 1 to <maxTrCH > | | |
| >Added or Reconfigured UL TrCH information | MP | | Added or Reconfigured UL TrCH information 10.3.5.2 | |

| Information Element/Group name | Need | Multi | Type and reference | Semantics description |
|--|------|-----------------------|--|--|
| CHOICE <i>mode</i> | OP | | | |
| >FDD | | | | |
| >>CPCH set ID | OP | | CPCH set ID 10.3.5.3 | |
| >>>Added or Reconfigured TrCH information for DRAC list | OP | 1 to <maxTrCH > | | |
| >>>DRAC static information | MP | | DRAC static information 10.3.5.7 | |
| >TDD | | | | (no data) |
| Downlink transport channels | | | | |
| DL Transport channel information common for all transport channels | OP | | DL Transport channel information common for all transport channels 10.3.5.6 | |
| Added or Reconfigured TrCH information list | OP | 1 to <maxTrCH > | | |
| >Added or Reconfigured DL TrCH information | MP | | Added or Reconfigured DL TrCH information 10.3.5.1 | |
| PhyCH information elements | | | | |
| Frequency info | MD | | Frequency info 10.3.6.36 | Default value is the existing value of frequency information |
| Uplink radio resources | | | | |
| Maximum allowed UL TX power | MD | | Maximum allowed UL TX power 10.3.6.39 | Default value is the existing maximum UL TX power |
| CHOICE <i>channel requirement</i> | OP | | | |
| >Uplink DPCH info | | | Uplink DPCH info 10.3.6.88 | |
| >CPCH SET Info | | | CPCH SET Info 10.3.6.13 | |
| Downlink radio resources | | | | |
| CHOICE <i>mode</i> | MP | | | |
| >FDD | | | | |
| >>Downlink PDSCH information | OP | | Downlink PDSCH information 10.3.6.30 | |
| >TDD | | | | (no data) |
| Downlink information common for all radio links | OP | | Downlink information common for all radio links 10.3.6.24 | |
| Downlink information per radio link list | OP | 1 to <maxRL> | | Send downlink information for each radio link |
| >Downlink information for each radio link | MP | | Downlink information for each radio link 10.3.6.27 | |

10.2.51 TRANSPORT CHANNEL RECONFIGURATION COMPLETE

This message is sent from the UE when a transport channel reconfiguration has been done.

RLC-SAP: AM

Logical channel: DCCH

Direction: UE → UTRAN

| Information Element/Group name | Need | Multi | Type and reference | Semantics description | Version |
|--|------|----------------------|---|--|---------|
| Message Type | MP | | Message Type | | |
| UE information elements | | | | | |
| RRC transaction identifier | MP | | RRC transaction identifier 10.3.3.36 | | |
| Integrity check info | CH | | Integrity check info 10.3.3.16 | | |
| Uplink integrity protection activation info | OP | | Integrity protection activation info 10.3.3.17 | | |
| CHOICE <i>mode</i> | OP | | | | |
| >FDD | | | | (no data) | |
| >TDD | | | | | |
| >>CHOICE <i>TDD option</i> | MP | | | | REL-4 |
| >>>3.84 Mcps TDD | | | | | REL-4 |
| >>>>Uplink Timing Advance | OP | | Uplink Timing Advance 10.3.6.95 | | |
| >>>1.28 Mcps TDD | | | | (no data) | REL-4 |
| RB Information elements | | | | | |
| COUNT-C activation time | OP | | Activation time 10.3.3.1 | Used for radio bearers mapped on RLC-TM. Only applicable if the UE is moving to CELL_DCH state due to this procedure | |
| Radio bearer uplink ciphering activation time info | OP | | RB activation time info 10.3.4.13 | | |
| Uplink counter synchronisation info | OP | | | | |
| >RB with PDCP information list | OP | 1 to <maxRBall RABs> | | | |
| >>RB with PDCP information | MP | | RB with PDCP information 10.3.4.22 | | |
| >START list | MP | 1 to <maxCNdo mains> | | START [40] values for all CN domains. | |
| >>CN domain identity | MP | | CN domain identity 10.3.1.1 | | |
| >>>START | MP | | START 10.3.3.38 | START value to be used in this CN domain. | |

10.2.52 TRANSPORT CHANNEL RECONFIGURATION FAILURE

This message is sent by UE if the configuration given by UTRAN is unacceptable or if the UE failed to establish the physical channel(s).

RLC-SAP: AM

Logical channel: DCCH

Direction: UE→UTRAN

| Information Element/Group name | Need | Multi | Type and reference | Semantics description |
|--------------------------------|------|-------|--|-----------------------|
| Message Type | MP | | Message Type | |
| UE information elements | | | | |
| RRC transaction identifier | MP | | RRC transaction identifier 10.3.3.36 | |
| Integrity check info | CH | | Integrity check info 10.3.3.16 | |
| Failure cause | MP | | Failure cause and error information 10.3.3.14 | |

10.2.53 TRANSPORT FORMAT COMBINATION CONTROL

This message is sent by UTRAN to control the uplink transport format combination within the allowed transport format combination set.

RLC-SAP: TM, AM or UM

Logical channel: DCCH

Direction: UTRAN→UE

| Information Element/Group name | Need | Multi | Type and reference | Semantics description |
|----------------------------------|---------------------|-------|--|------------------------|
| Message Type | CV- <i>notTM</i> | | Message Type | |
| UE information elements | | | | |
| RRC transaction identifier | CV- <i>notTM</i> | | RRC transaction identifier 10.3.3.36 | |
| Integrity check info | CV- <i>notTM</i> | | Integrity check info 10.3.3.16 | |
| TrCH information elements | | | | |
| CHOICE <i>mode</i> | MP | | | |
| >FDD | | | | (no data) |
| >TDD | | | | |
| >>TFCS Id | OP | | Transport Format Combination Set Identity 10.3.5.21 | |
| DPCH/PUSCH TFCS in uplink | MP | | Transport Format Combination subset 10.3.5.22 | |
| Activation time for TFC subset | CV- <i>notTMMD</i> | | Activation time 10.3.3.1 | Default value is "now" |
| TFC Control duration | CV- <i>notTMopt</i> | | TFC Control duration 10.3.6.80 | |

| Condition | Explanation |
|-----------------|--|
| <i>NotTM</i> | The message type is not included when transmitting the message on the transparent mode signalling DCCH |
| <i>NotTMopt</i> | The information element is not included when transmitting the message on the transparent mode signalling DCCH and is optional otherwise. |
| <i>NotTMMD</i> | The information element is not included when transmitting the message on the transparent mode signalling DCCH and is Mandatory with default otherwise. |

If transparent mode signalling is used and the encoded message does not fill a transport block, the RRC layer shall insert padding according to subclause 12.1.

10.2.54 TRANSPORT FORMAT COMBINATION CONTROL FAILURE

This message is sent to indicate that a received TRANSPORT FORMAT COMBINATION CONTROL message could not be handled by the UE.

RLC-SAP: AM

Logical channel: DCCH

Direction: UE→UTRAN

| Information Element/Group name | Need | Multi | Type and reference | Semantics description |
|--------------------------------|------|-------|--|-----------------------|
| Message Type | MP | | Message Type | |
| UE information elements | | | | |
| RRC transaction identifier | MP | | RRC transaction identifier 10.3.3.36 | |
| Integrity check info | CH | | Integrity check info 10.3.3.16 | |
| Failure cause | MP | | Failure cause and error information 10.3.3.14 | |

10.2.55 UE CAPABILITY ENQUIRY

The UE CAPABILITY ENQUIRY is used by the UTRAN to enquire inter-RAT classmarks from the UE.

RLC-SAP: AM or UM

Logical channel: DCCH

Direction: UTRAN → UE

| Information Element/Group name | Need | Multi | Type and reference | Semantics description |
|--------------------------------|------|-------|---|---|
| Message Type | MP | | Message Type | |
| UE information elements | | | | |
| RRC transaction identifier | MP | | RRC transaction identifier 10.3.3.36 | |
| Integrity check info | CH | | Integrity check info 10.3.3.16 | Integrity check info is included if integrity protection is applied |
| Capability update requirement | MP | | Capability update requirement 10.3.3.2 | |

10.2.56 UE CAPABILITY INFORMATION

This message is sent by UE to convey UE specific capability information to the UTRAN.

RLC-SAP: AM

Logical channel: DCCH

Direction: UE → UTRAN

| Information Element/Group name | Need | Multi | Type and reference | Semantics description |
|---------------------------------------|------|-----------------------------|--|---|
| Message Type | MP | | Message Type | |
| UE information elements | | | | |
| RRC transaction identifier | OP | | RRC transaction identifier 10.3.3.36 | |
| Integrity check info | CH | | Integrity check info 10.3.3.16 | Integrity check info is included if integrity protection is applied |
| UE radio access capability | OP | | UE radio access capability 10.3.3.42 | |
| UE radio access capability extension | OP | | UE radio access capability extension 10.3.3.42a | |
| Other information elements | | | | |
| UE system specific capability | OP | 1 to <maxInter SysMessages> | | |
| >Inter-RAT UE radio access capability | MP | | Inter-RAT UE radio access capability 10.3.8.7 | |

10.2.57 UE CAPABILITY INFORMATION CONFIRM

This message is sent by UTRAN to confirm that UE capability information has been received.

RLC-SAP: AM or UM

Logical channel: DCCH

Direction: UTRAN → UE

| Information Element/Group name | Need | Multi | Type and reference | Semantics description |
|--------------------------------|------|-------|---|---|
| Message Type | MP | | Message Type | |
| UE information elements | | | | |
| RRC transaction identifier | MP | | RRC transaction identifier 10.3.3.36 | |
| Integrity check info | CH | | Integrity check info 10.3.3.16 | Integrity check info is included if integrity protection is applied |

10.2.58 UPLINK DIRECT TRANSFER

This message is used to transfer NAS messages for an existing signalling connection.

RLC-SAP: AM

Logical channel: DCCH

Direction: UE → UTRAN

| Information Element/Group name | Need | Multi | Type and reference | Semantics description |
|---|------|-------|---------------------------------------|---|
| Message Type | MP | | Message Type | |
| UE information elements | | | | |
| Integrity check info | CH | | Integrity check info 10.3.3.16 | Integrity check info is included if integrity protection is applied |
| CN information elements | | | | |
| CN domain identity | MP | | CN domain identity 10.3.1.1 | |
| NAS message | MP | | NAS message 10.3.1.8 | |
| Measurement information elements | | | | |
| Measured results on RACH | OP | | Measured results on RACH 10.3.7.45 | |

10.2.59 UPLINK PHYSICAL CHANNEL CONTROL

NOTE: Only for TDD.

This message is used to transfer uplink physical channel parameters to the UE.

RLC-SAP: AM or UM

Logical channel: DCCH

Direction: UTRAN→UE

| Information Element/Group name | Need | Multi | Type and Reference | Semantics description | Version |
|-------------------------------------|-----------------|-------|---|--|---------|
| Message Type | MP | | Message Type | | |
| UE information elements | | | | | |
| RRC transaction identifier | MP | | RRC transaction identifier 10.3.3.36 | | |
| Integrity check info | OP | | Integrity check info 10.3.3.16 | | |
| PhyCH information elements | | | | | |
| CCTrCH power control info | OP | | CCTrCH power control info 10.3.6.8 | Power control information for one CCTrCH | |
| CHOICE <i>TDD option</i> | MP | | | | REL-4 |
| >3.84Mcps TDD | | | | | REL-4 |
| >>Alpha | OP | | Alpha 10.3.6.5 | | |
| >>Special Burst Scheduling | OP | | Special Burst Scheduling 10.3.6.75a | UL Special Burst generation period in radio frames | |
| >>Timing Advance Control | OP | | UL Timing Advance Control 10.3.6.96 | | |
| >>PRACH Constant Value | OP | | Constant value 10.3.6.11 | Operator controlled PRACH Margin | |
| >>PUSCH Constant Value | OP | | Constant value 10.3.6.11 | Operator controlled PUSCH Margin | |
| >1.28 Mcps TDD | | | | | REL-4 |
| >>Uplink synchronisation parameters | MD | | | Default: Uplink synchronisation step size 1. Uplink synchronisation frequency 1. | REL-4 |
| >>>Uplink synchronisation step size | MP | | Integer(1..8) | This parameter specifies the step size to be used for the adjustment of the uplink transmission timing | REL-4 |
| >>>Uplink synchronisation frequency | MP | | Integer(1..8) | This parameter specifies the frequency of the adjustment of the uplink transmission timing | REL-4 |
| UE positioning related parameters | <i>CV-IPDLs</i> | | | | REL-4 |
| >IPDL-Alpha | MP | | Alpha 10.3.6.5 | | REL-4 |
| >Max power increase | MP | | Integer (0..3) | In db | REL-4 |

| Condition | Explanation |
|--------------|---|
| <i>IPDLs</i> | This IE is present only if idle periods are applied |

10.2.60 URA UPDATE

This message is used by the UE to initiate a URA update procedure.

RLC-SAP: TM

Logical channel: CCCH

Direction: UE→UTRAN

| Information Element/Group name | Need | Multi | Type and reference | Semantics description |
|-----------------------------------|--------------------|-------|---|------------------------|
| Message Type | MP | | Message Type | |
| UE information elements | | | | |
| U-RNTI | MP | | U-RNTI 10.3.3.47 | |
| RRC transaction identifier | CV- <i>ProtErr</i> | | RRC transaction identifier 10.3.3.36 | |
| Integrity check info | CH | | Integrity check info 10.3.3.16 | |
| URA update cause | MP | | URA update cause 10.3.3.46 | |
| Protocol error indicator | MD | | Protocol error indicator 10.3.3.27 | Default value is FALSE |
| Other information elements | | | | |
| Protocol error information | CV- <i>ProtErr</i> | | Protocol error information 10.3.8.12 | |

| Condition | Explanation |
|----------------|---|
| <i>ProtErr</i> | If the IE "Protocol error indicator" has the value "TRUE" |

10.2.61 URA UPDATE CONFIRM

This message confirms the URA update procedure and can be used to reallocate new RNTI information for the UE valid after the URA update.

RLC-SAP: UM

Logical channel: CCCH or DCCH

Direction: UTRAN→UE

| Information Element/Group name | Need | Multi | Type and reference | Semantics description |
|--|---------|----------------------|--|---|
| Message Type | MP | | Message Type | |
| UE information elements | | | | |
| U-RNTI | CV-CCCH | | U-RNTI 10.3.3.47 | |
| RRC transaction identifier | MP | | RRC transaction identifier 10.3.3.36 | |
| Integrity check info | CH | | Integrity check info 10.3.3.16 | Integrity check info is included if integrity protection is applied |
| Integrity protection mode info | OP | | Integrity protection mode info 10.3.3.19 | |
| Ciphering mode info | OP | | Ciphering mode info 10.3.3.5 | |
| New U-RNTI | OP | | U-RNTI 10.3.3.47 | |
| New C-RNTI | OP | | C-RNTI 10.3.3.8 | |
| RRC State Indicator | MP | | RRC State Indicator 10.3.3.10 | |
| UTRAN DRX cycle length coefficient | MD | | UTRAN DRX cycle length coefficient 10.3.3.49 | Default value is the existing value of UTRAN DRX cycle length coefficient |
| CN Information Elements | | | | |
| CN Information info | OP | | CN Information info 10.3.1.3 | |
| UTRAN mobility information elements | | | | |
| URA identity | OP | | URA identity 10.3.2.6 | |
| RB information elements | | | | |
| Downlink counter synchronisation info | OP | | | |
| >RB with PDCP information list | OP | 1 to <maxRBall RABs> | | This IE is needed for each RB having PDCP in the case of lossless SRNS relocation |
| >>RB with PDCP information | MP | | RB with PDCP information 10.3.4.22 | |

| Condition | Explanation |
|-----------|--|
| CCCH | This IE is only sent when CCCH is used |

10.2.62 UTRAN MOBILITY INFORMATION

This message is used by UTRAN to allocate a new RNTI and to convey other UTRAN mobility related information to a UE.

RLC-SAP: AM or UM

Logical channel: DCCH

Direction: UTRAN→UE

| Information Element/Group name | Need | Multi | Type and reference | Semantics description |
|---|------|----------------------|--|---|
| Message Type | MP | | Message Type | |
| UE Information Elements | | | | |
| Integrity check info | CH | | Integrity check info 10.3.3.16 | |
| RRC transaction identifier | MP | | RRC transaction identifier 10.3.3.36 | |
| Integrity protection mode info | OP | | Integrity protection mode info 10.3.3.19 | |
| Ciphering mode info | OP | | Ciphering mode info 10.3.3.5 | |
| New U-RNTI | OP | | U-RNTI 10.3.3.47 | |
| New C-RNTI | OP | | C-RNTI 10.3.3.8 | |
| UE Timers and constants in connected mode | OP | | UE Timers and constants in connected mode 10.3.3.43 | |
| CN Information Elements | | | | |
| CN Information info | OP | | CN Information info full 10.3.1.3a | |
| UTRAN Information Elements | | | | |
| URA identity | OP | | URA identity 10.3.2.6 | |
| RB Information elements | | | | |
| Downlink counter synchronisation info | OP | | | |
| >RB with PDCP information list | OP | 1 to <maxRBall RABs> | | This IE is needed for each RB having PDCP in the case of lossless SRNS relocation |
| >>RB with PDCP information | MP | | RB with PDCP information 10.3.4.22 | |

10.2.63 UTRAN MOBILITY INFORMATION CONFIRM

This message is used to confirm the new UTRAN mobility information for the UE.

RLC-SAP: AM

Logical channel: DCCH

Direction: UE→UTRAN

| Information Element/Group name | Need | Multi | Type and reference | Semantics description |
|--|------|----------------------|---|--|
| Message Type | MP | | Message Type | |
| UE information elements | | | | |
| RRC transaction identifier | MP | | RRC transaction identifier 10.3.3.36 | |
| Integrity check info | CH | | Integrity check info 10.3.3.16 | |
| Uplink integrity protection activation info | OP | | Integrity protection activation info 10.3.3.17 | |
| RB Information elements | | | | |
| COUNT-C activation time | OP | | Activation time 10.3.3.1 | Used for radio bearers mapped on RLC-TM. Only applicable if the UE is moving to CELL_DCH state due to this procedure |
| Radio bearer uplink ciphering activation time info | OP | | RB activation time info 10.3.4.13 | |
| Uplink counter synchronisation info | OP | | | |
| >RB with PDCP information list | OP | 1 to <maxRBall RABs> | | This IE is needed for each RB having PDCP in the case of lossless SRNS relocation |
| >>RB with PDCP information | MP | | RB with PDCP information 10.3.4.22 | |
| >START list | MP | 1 to <maxCNdo mains> | | START [40] values for all CN domains. |
| >>CN domain identity | MP | | CN domain identity 10.3.1.1 | |
| >>>START | MP | | START 10.3.3.38 | START value to be used in this CN domain. |

10.2.64 UTRAN MOBILITY INFORMATION FAILURE

This message is sent to indicate a failure to act on a received UTRAN MOBILITY INFORMATION message.

RLC-SAP: AM

Logical channel: DCCH

Direction: UE→UTRAN

| Information Element/Group name | Need | Multi | Type and reference | Semantics description |
|--------------------------------|------|-------|--|-----------------------|
| Message Type | MP | | Message Type | |
| UE information elements | | | | |
| RRC transaction identifier | MP | | RRC transaction identifier 10.3.3.36 | |
| Integrity check info | CH | | Integrity check info 10.3.3.16 | |
| Failure cause | MP | | Failure cause and error information 10.3.3.14 | |

10.3 Information element functional definitions

10.3.1 CN Information elements

10.3.1.1 CN domain identity

Identifies the type of core network domain.

| Information Element/Group name | Need | Multi | Type and reference | Semantics description |
|--------------------------------|------|-------|--------------------------------------|-----------------------|
| CN domain identity | MP | | Enumerated (CS domain, PS domain) | |

10.3.1.2 CN Domain System Information

| Information Element/Group name | Need | Multi | Type and reference | Semantics description |
|---|------|-------|--|-----------------------|
| CN domain identity | MP | | CN domain identity 10.3.1.1 | |
| CHOICE <i>CN Type</i> | MP | | | |
| >GSM-MAP | | | | |
| >>CN domain specific NAS system information | MP | | NAS system information (GSM-MAP) 10.3.1.9 | |
| >ANSI-41 | | | | |
| >>CN domain specific NAS system information | MP | | ANSI-41 NAS system information, 10.3.9.4 | |
| CN domain specific DRX cycle length coefficient | MP | | CN domain specific DRX cycle length coefficient, 10.3.3.6 | |

10.3.1.3 CN Information info

| Information Element/Group name | Need | Multi | Type and reference | Semantics description |
|---|------|---------------------|--|-----------------------|
| PLMN identity | OP | | PLMN identity 10.3.1.11 | |
| CN common GSM-MAP NAS system information | OP | | NAS system information (GSM-MAP) 10.3.1.9 | |
| CN domain related information | OP | 1 to <maxCNdomains> | | |
| >CN domain identity | MP | | CN domain identity 10.3.1.1 | |
| >CN domain specific GSM-MAP NAS system info | MP | | NAS system information (GSM-MAP) 10.3.1.9 | |

NOTE 1: Necessity of PLMN is FFS and for CN domain identity and NAS system information, the confirmation in SA WG2 is needed.

10.3.1.3a CN Information info full

| Information Element/Group name | Need | Multi | Type and reference | Semantics description |
|--|------|---------------------|--|-----------------------|
| PLMN identity | OP | | PLMN identity 10.3.1.11 | |
| CN common GSM-MAP NAS system information | OP | | NAS system information (GSM-MAP) 10.3.1.9 | |
| CN domain related information | OP | 1 to <maxCNdomains> | | |
| >CN domain identity | MP | | CN domain identity 10.3.1.1 | |
| >CN domain specific GSM-MAP NAS system info | MP | | NAS system information (GSM-MAP) 10.3.1.9 | |
| >CN domain specific DRX cycle length coefficient | MP | | CN domain specific DRX cycle length coefficient, 10.3.3.6 | |

10.3.1.4 IMEI

This IE contains an International Mobile Equipment Identity. Setting specified in [11].

| Information Element/Group name | Need | Multi | Type and reference | Semantics description |
|--------------------------------|------|-------|--------------------|--|
| IMEI | MP | 15 | | The first element contains the first IMEI digit, the second element the second IMEI digit and so on. |
| >IMEI digit | MP | | INTEGER(0..15) | |

10.3.1.5 IMSI (GSM-MAP)

This IE contains an International Mobile Subscriber Identity, used towards a GSM-MAP type of PLMN. Setting specified in [11].

| Information Element/Group name | Need | Multi | Type and reference | Semantics description |
|--------------------------------|------|---------|--------------------|--|
| IMSI | MP | 6 to 15 | | The first element contains the first IMSI digit, the second element the second IMSI digit and so on. |
| >IMSI digit | MP | | INTEGER(0..9) | |

10.3.1.6 Intra Domain NAS Node Selector

This IE carries information to be used to route the establishment of a signalling connection to a CN node within a CN domain.

| Information Element/Group name | Need | Multi | Type and reference | Semantics description |
|---|------|-------|--------------------|---|
| CHOICE <i>version</i> | MP | | | |
| >R99 | | | | |
| >>CHOICE <i>CN type</i> | MP | | | |
| >>>GSM-MAP | | | | |
| >>>>CHOICE <i>Routing basis</i> | MP | | | |
| >>>>>local (P)TMSI | | | | TMSI allocated in the current LA or PTMSI allocated in the current RA |
| >>>>>>Routing parameter | MP | | Bitstring (10) | The TMSI/ PTMSI consists of 4 octets (32bits). The bits are numbered from b0 to b31, with bit b0 being the least significant The "Routing parameter" bitstring consists of bits b14 through b23 of the TMSI/ PTMSI where bit b14 is the least significant. |
| >>>>>(P)TMSI of same PLMN, different (RA)LA | | | | TMSI allocated in another LA of this PLMN or PTMSI allocated in another RA this PLMN |
| >>>>>>Routing parameter | MP | | Bitstring (10) | The TMSI/ PTMSI consists of 4 octets (32bits). The bits are numbered from b0 to b31, with bit b0 being the least significant The "Routing parameter" bitstring consists of bits b14 through b23 of the TMSI/ PTMSI where bit b14 is the least significant. |
| >>>>>(P)TMSI of different PLMN | | | | TMSI or a PTMSI allocated in another PLMN |
| >>>>>>>Routing parameter | MP | | Bitstring (10) | The TMSI/ PTMSI consists of 4 octets (32bits). The bits are numbered from b0 to b31, with bit b0 being the least significant The "Routing parameter" bitstring consists of bits b14 through b23 of the TMSI/ PTMSI where bit b14 is the least significant. |
| >>>>>>>IMSI(response to IMSI paging) | | | | NAS identity is IMSI |
| >>>>>>>>Routing parameter | MP | | Bitstring (10) | The "Routing parameter" bitstring consists of DecimalToBinary [(IMSI div 10) mod 1000]. The bits of the result are numbered from b0 to b9, with bit b0 being the least significant. |
| >>>>>>>>IMSI(cause UE initiated event) | | | | NAS identity is IMSI |
| >>>>>>>>>Routing parameter | MP | | Bitstring (10) | The "Routing parameter" bitstring consists of DecimalToBinary [(IMSI div 10) mod 1000]. The bits of the result are numbered from b0 to b9, with bit b0 being the least significant. |
| >>>>>>>>>>IMEI | | | | NAS parameter is IMEI |

| | | | | |
|------------------------|----|--|----------------|---|
| >>>>>Routing parameter | MP | | Bitstring (10) | The "Routing parameter" bitstring consists of DecimalToBinary [(IMEI div 10) mod 1000]. The bits of the result are numbered from b0 to b9, with bit b0 being the least significant. |
| >>>>>Spare 1 | | | Bitstring (10) | This choice shall not be used in this version |
| >>>>>Spare 2 | | | Bitstring (10) | This choice shall not be used in this version |
| >>>>Entered parameter | MP | | Boolean | Entered parameter shall be set to TRUE if the most significant byte of the current LAI/RAI is different compared to the most significant byte of the LAI/RAI stored on the SIM; Entered parameter shall be set to FALSE otherwise |
| >>>ANSI-41 | | | Bitstring (14) | All bits shall be set to 0 |
| >Later | | | Bitstring(15) | This bitstring shall not be sent by mobiles that are compliant to this version of the protocol. |

10.3.1.7 Location Area Identification

Identifies uniquely a location area for a GSM-MAP type of PLMN. Setting specified in [5].

| Information Element/Group name | Need | Multi | Type and reference | Semantics description |
|--------------------------------|------|-------|----------------------------|--|
| PLMN identity | MP | | PLMN identity 10.3.1.11 | |
| LAC | MP | | Bit string(16) | The LAC bits are numbered b0-b15, where b0 is the least significant bit. |

10.3.1.8 NAS message

A non-access stratum message to be transferred transparently through UTRAN.

| Information Element/Group name | Need | Multi | Type and reference | Semantics description |
|--------------------------------|------|-------|---------------------------|---|
| NAS message | MP | | Octet string (1..4095) | The first octet contains octet 1 [17] of the NAS message, the second octet contains octet 2 of the NAS message and so on. |

10.3.1.9 NAS system information (GSM-MAP)

This information element contains system information that belongs to the non-access stratum for a GSM-MAP type of PLMN. This information is transparent to RRC. It may contain either information specific to one CN domain (CS or PS) or information common for both CN domains.

| Information Element/Group name | Need | Multi | Type and reference | Semantics description |
|--------------------------------|------|-------|---------------------|---|
| GSM-MAP NAS system information | MP | | Octet string(1..8) | The first octet contains octet 1 [17] of the NAS system information element, the second octet contains octet 2 of the NAS system information element and so on. |

10.3.1.10 Paging record type identifier

| Information Element/Group name | Need | Multi | Type and reference | Semantics description |
|--------------------------------|------|-------|---|-----------------------|
| Paging record type identifier | MP | | Enumerated (IMSI (GSM-MAP), TMSI (GSM-MAP)/ P-TMSI, IMSI (DS-41), TMSI (DS-41)) | |

10.3.1.11 PLMN identity

This information element identifies a Public Land Mobile Network for a GSM-MAP type of PLMN. Setting of digits is defined in [11].

| Information Element/Group name | Need | Multi | Type and reference | Semantics description |
|--------------------------------|------|--------|--------------------|--|
| MCC | MP | 3 | | The first element contains the first MCC digit, the second element the second MCC digit and so on. |
| >MCC digit | MP | | INTEGER(0..9) | |
| MNC | MP | 2 to 3 | | The first element contains the first MNC digit, the second element the second MNC digit and so on. |
| >MNC digit | MP | | INTEGER(0..9) | |

10.3.1.12 PLMN Type

Identifies the type of Public Land Mobile Network (PLMN). This IE shall be used to control the interpretation of network dependent messages and information elements in the RRC protocol.

| Information Element/Group name | Need | Multi | Type and reference | Semantics description |
|--------------------------------|------|-------|--|-----------------------|
| PLMN Type | MP | | Enumerated (GSM-MAP, ANSI-41, GSM-MAP and ANSI-41) | |

10.3.1.13 P-TMSI (GSM-MAP)

This IE contains a Packet Temporary Mobile Subscriber Identity, used towards a GSM-MAP type of PLMN.

| Information Element/Group name | Need | Multi | Type and reference | Semantics description |
|--------------------------------|------|-------|--------------------|--|
| P-TMSI | MP | | Bit string (32) | Setting specified in [11]. The P-TMSI bits are numbered b0-b31, where b0 is the least significant bit. |

10.3.1.14 RAB identity

This information element uniquely identifies a radio access bearer within a CN domain.

| Information Element/Group name | Need | Multi | Type and reference | Semantics description |
|---------------------------------|------|-------|--------------------|---|
| CHOICE <i>RAB identity type</i> | MP | | | |
| >RAB identity (GSM-MAP) | | | Bit string (8) | Formatted according to [5]. The bits are numbered b1-b8, where b1 is the least significant bit. |
| >RAB identity (ANSI-41) | | | Bit string (8) | The bits are numbered b1-b8, where b1 is the least significant bit. |

| CHOICE <i>NAS binding info type</i> | Condition under which the given <i>RAB identity type</i> is chosen |
|-------------------------------------|--|
| RAB identity (GSM-MAP) | PLMN is of type GSM-MAP |
| RAB identity (ANSI-41) | PLMN is of type ANSI-41 |

10.3.1.15 Routing Area Code

Identifies a routing area within a location area for a GSM-MAP type of PLMN.

| Information Element/Group name | Need | Multi | Type and reference | Semantics description |
|--------------------------------|------|-------|--------------------|---|
| Routing Area Code | MP | | Bit string(8) | Setting specified in [11]. The Routing Area Code bits are numbered b0 to b7, where b0 is the least significant bit. |

10.3.1.16 Routing Area Identification

Identifies uniquely a routing area for a GSM-MAP type of PLMN. Setting specified in [11].

| Information Element/Group name | Need | Multi | Type and reference | Semantics description |
|--------------------------------|------|-------|---------------------------------------|-----------------------|
| LAI | MP | | Location area identification 10.3.1.7 | |
| RAC | MP | | Routing area code 10.3.1.15 | |

10.3.1.17 TMSI (GSM-MAP)

This IE contains a Temporary Mobile Subscriber Identity, used towards a GSM-MAP type of PLMN.

| Information Element/Group name | Need | Multi | Type and reference | Semantics description |
|--------------------------------|------|-------|--------------------|--|
| TMSI (GSM-MAP) | MP | | Bit string (32) | Setting specified in [11]. The TMSI bits are numbered b0-b31, where b0 is the least significant bit. |

10.3.2 UTRAN mobility Information elements

10.3.2.1 Cell Access Restriction

Indicates the restrictions to cell access.

| Information Element/Group name | Need | Multi | Type and reference | Semantics description |
|---|------------------|-------|--|--|
| Cell Barred | MP | | Enumerated(not barred, barred) | |
| Intra-frequency cell re-selection indicator | <i>CV-Barred</i> | | Enumerated(not allowed, allowed) | |
| T_{barred} | <i>CV-Barred</i> | | Integer (10,20,40,80,160,320,640,1280) | [4] |
| Cell Reserved for operator use | MP | | Enumerated(reserved, not reserved) | |
| Cell Reservation Extension | MP | | Enumerated(reserved, not reserved) | |
| Access Class Barred list | MD | maxAC | | Default is no access class barred is applied. The first instance of the parameter corresponds to Access Class 0, the second to Access Class 1 and so on up to Access Class 15. UE reads this IE of its access class stored in SIM. |
| >Access Class Barred | MP | | Enumerated(not barred, barred) | |

| Condition | Explanation |
|---------------|---|
| <i>Barred</i> | Presence is mandatory if the IE "Cell Barred" has the value "Barred"; otherwise the element is not needed in the message. |

10.3.2.2 Cell identity

This information element identifies a cell unambiguously within a PLMN.

| Information Element/Group name | Need | Multi | Type and reference | Semantics description |
|--------------------------------|------|-------|--------------------|-----------------------|
| Cell identity | MP | | bit string(28) | |

10.3.2.3 Cell selection and re-selection info for SIB3/4

| Information Element/Group name | Need | Multi | Type and reference | Semantics description |
|--|------|---------------------|--------------------------------------|---|
| Mapping Info | OP | | Mapping info 10.3.2.5 | |
| Cell_selection_and_reselection_quality_measure | MP | | Enumerated (CPICH Ec/N0, CPICH RSCP) | Choice of measurement (CPICH Ec/N0 or CPICH RSCP) to use as quality measure Q for FDD cells. |
| CHOICE mode | MP | | | |
| >FDD | | | | |
| >>S _{intrasearch} | OP | | Integer (-32..20 by step of 2) | [4] [dB] |
| >>S _{intersearch} | OP | | Integer (-32..20 by step of 2) | [4] [dB] |
| >>S _{searchHCS} | OP | | Integer (-105..91 by step of 2) | [4] [dB] |
| >>>RAT List | OP | 1 to <maxOther RAT> | | |
| >>>RAT identifier | MP | | Enumerated (GSM, cdma2000) | |
| >>>S _{search,RAT} | MP | | Integer (-32..20 by step of 2) | In case the value 20 is received the UE shall consider this IE as if it was absent according to [4] [dB] |
| >>>S _{HCS,RAT} | OP | | Integer (-105..91 by step of 2) | [4] [dB] |
| >>>S _{limit,SearchRAT} | OP | | Integer (-32..20 by step of 2) | [4] [dB] |
| >>Qqualmin | MP | | Integer (-24..0) | Ec/N0, [dB] |
| >>Qrxlevmin | MP | | Integer (-115..-25 by step of 2) | RSCP, [dBm] |
| >TDD | | | | |
| >>S _{intrasearch} | OP | | Integer (-105..91 by step of 2) | [4] [dB] |
| >>S _{intersearch} | OP | | Integer (-105..91 by step of 2) | [4] [dB] |
| >>S _{searchHCS} | OP | | Integer (-105..91 by step of 2) | [4] [dB] |
| >>>RAT List | OP | 1 to <maxOther RAT> | | |
| >>>RAT identifier | MP | | Enumerated (GSM, cdma2000) | |
| >>>S _{search,RAT} | MP | | Integer (-105..91 by step of 2) | In case the value 91 is received the UE shall consider this IE as if it was absent according to [4] [dB] |
| >>>S _{HCS,RAT} | OP | | Integer (- | [4] |

| | | | | |
|---------------------------------|-------------------------------|--|---|---|
| | | | 105..91 by step of 2) | [dB] |
| >>>S _{limit,SearchRAT} | MP | | Integer (-105..91 by step of 2) | [4] [dB] |
| >>Q _{rxlevmin} | MP | | Integer (-115..-25 by step of 2) | RSCP, [dBm] |
| Q _{hyst1s} | MP | | Integer (0..40 by step of 2) | [4] [dB] |
| Q _{hyst2s} | <i>CV-FDD-Quality-Measure</i> | | Integer (0..40 by step of 2) | Default value is Q _{hyst1s} [4] [dB] |
| T _{reselections} | MP | | Integer (0..31) | [s] |
| HCS Serving cell Information | OP | | HCS Serving cell information 10.3.7.12 | |
| Maximum allowed UL TX power | MP | | Maximum allowed UL TX power 10.3.6.39 | [dBm] UE_TXPWR_MAX_RACH in [4]. |

| Condition | Explanation |
|----------------------------|---|
| <i>FDD-Quality-Measure</i> | Presence is not allowed if the IE "Cell_selection_and_reselection_quality_measure" has the value CPICH RSCP, otherwise the IE is mandatory and has a default value. |

10.3.2.4 Cell selection and re-selection info for SIB11/12

| Information Element/Group name | Need | Multi | Type and reference | Semantics description |
|-----------------------------------|------------------------|-------|---|---|
| Qoffset1 _{s,n} | MD | | Integer(-50..50) | Default value is 0. [dB] |
| Qoffset2 _{s,n} | CV-FDD-Quality-Measure | | Integer(-50..50) | Default value is 0. [dB] |
| Maximum allowed UL TX power | MD | | Maximum allowed UL TX power 10.3.6.39 | [dBm] UE_TXPWR_MAX_RACH in [4]. Default is the Maximum allowed UL TX power for the serving cell |
| HCS neighbouring cell information | OP | | HCS Neighbouring cell information 10.3.7.11 | |
| CHOICE mode | MP | | | |
| >FDD | | | | |
| >>Qqualmin | MD | | Integer (-24..0) | Ec/NO, [dB] Default value is Qqualmin for the serving cell |
| >>Qrxlevmin | MD | | Integer (-115..-25 by step of 2) | RSCP, [dBm] Default value is Qrxlevmin for the serving cell |
| >TDD | | | | |
| >>Qrxlevmin | MD | | Integer (-115..-25 by step of 2) | RSCP, [dBm] Default value is Qrxlevmin for the serving cell |
| >GSM | | | | |
| >>Qrxlevmin | MD | | Integer (-115..-25 by step of 2) | RXLEV, [dBm] Default value is Qrxlevmin for the serving cell |

| Condition | Explanation |
|---------------------|---|
| FDD-Quality-Measure | This IE is mandatory and has a default value for Intra/Inter Frequency Cells if the IE "Cell_selection_and_reselection_quality_measure" has the value CPICH Ec/No. Otherwise the IE is Optional |

10.3.2.5 Mapping Info

| Information Element/Group name | Need | Multi | Type and Reference | Semantics description | Version |
|----------------------------------|-----------|--------------------------|--|---|---|
| Mapping List | MP | 1 to <MaxRAT> | | | |
| >RAT | MP | | Enumerated (UTRA FDD, UTRA TDD 3.84 Mcps, UTRA TDD 1.28 Mcps, GSM, cdma2000) | | UTRA TDD 1.28 Mcps is included for REL-4. |
| >Mapping Function Parameter List | MP | 1 to <maxMeas Intervals> | | | |
| >>Function type | MP | | Enumerated (linear, function type 2, function type 3, function type 4) | Type of the function within the interval. | |
| >>Map_parameter_1 | MD | | Integer (0..99) | Parameter describing the mapping function between the quality measurement and the representing quality value, see [4]. Default value is zero for the first interval or otherwise the value of Map_parameter_2 of the interval before. | |
| >>Map_parameter_2 | MP | | Integer (0..99) | Parameter describing the mapping function between the quality measurement and the representing quality value, see [4]. | |
| >>Upper_limit | CV-MaxInt | | Integer (1..MaxMeas) | Upper limit of interval for which the Map_parameter_1 and Map_parameter_2 are valid. MaxMeas = 25 if RAT = UTRA FDD / CPICH Ec/N0, MaxMeas = 91 if RAT = UTRA TDD 3.84 Mcps or if RAT = UTRA TDD 1.28 Mcps or if RAT = UTRA | UTRA TDD 1.28 Mcps is included for REL-4. |

| | | | | | |
|--|--|--|--|--|--|
| | | | | FDD/ CPICH RSCP, MaxMeas = 63 if RAT = GSM. | |
|--|--|--|--|--|--|

| Condition | Explanation |
|---------------|--|
| <i>MaxInt</i> | This information is only sent if Mapping Function Parameter List has not reached maxMeasIntervals. |

10.3.2.6 URA identity

Gives the identity of the UTRAN Registration Area. It can be used to indicate to the UE which URA it shall use in case of overlapping URAs.

| Information Element/Group name | Need | Multi | Type and reference | Semantics description |
|--------------------------------|------|-------|--------------------|-----------------------|
| URA identity | MP | | bit string(16) | |

10.3.3 UE Information elements

10.3.3.1 Activation time

Activation Time defines the frame number/time at which the operation/changes caused by the related message shall take effect. Values between 0 and 255 indicate the absolute value of CFN (Connection Frame Number) of that frame number/time.

| Information Element/Group name | Need | Multi | Type and reference | Semantics description |
|--------------------------------|------|-------|--------------------|-----------------------|
| Activation time | MP | | Integer(0..255) | CFN [10] |

10.3.3.2 Capability Update Requirement

This IE indicates to the UE which specific capabilities to transfer to the network.

| Information Element/Group name | Need | Multi | Type and reference | Semantics description | Version |
|--|------|----------------------------|--------------------|--|-----------------------|
| UE radio access FDD capability update requirement | MP | | Boolean | TRUE indicates update required | |
| UE radio access 3.84Mcps TDD capability update requirement | MP | | Boolean | TRUE indicates update required | Name changed in REL-4 |
| UE radio access 1.28Mcps TDD capability update requirement | MP | | Boolean | TRUE indicates update required | REL-4 |
| System specific capability update requirement list | OP | 1 to <maxSystemCapability> | | In this version, a maximum size of 4 of the list shall be applied and any items after the 4 th item in the list shall be ignored. | |
| >System specific capability update requirement | MP | | Enumerated (GSM) | | |

Default value is:

"UE radio capability FDD update requirement" = false

"UE radio capability 3.84Mcps TDD update requirement" = false
 "UE radio capability 1.28Mcps TDD update requirement" = false
 "System specific capability update requirement" not present.

10.3.3.3 Cell update cause

Indicates the cause for cell update.

| Information Element/Group name | Need | Multi | Type and reference | Semantics description |
|--------------------------------|------|-------|---|----------------------------------|
| Cell update cause | MP | | Enumerated (cell reselection, periodical cell update, uplink data transmission , paging response, re-entered service area, radio link failure, RLC unrecoverable error) | At least one spare value needed. |

10.3.3.4 Cipherring Algorithm

| Information Element/Group name | Need | Multi | Type and reference | Semantics description |
|--------------------------------|------|-------|-------------------------|-----------------------|
| Cipherring algorithm | MP | | Enumerated (UEA0, UEA1) | |

10.3.3.5 Cipherring mode info

This information element contains the cipherring specific security mode control information.

| Information Element/Group name | Need | Multi | Type and reference | Semantics description |
|---|--------------------|-------|------------------------------------|---|
| Cipherring mode command | MP | | Enumerated (start/restart, stop) | |
| Cipherring algorithm | CV- <i>notStop</i> | | Cipherring algorithm 10.3.3.4 | |
| Cipherring activation time for DPCH | OP | | Activation time 10.3.3.1 | Used for radio bearers mapped on RLC-TM. Only applicable if the UE is already in CELL_DCH state |
| Radio bearer downlink cipherring activation time info | OP | | RB activation time info, 10.3.4.13 | Used for radio bearers mapped on RLC-AM or RLC-UM |

| Condition | Explanation |
|----------------|---|
| <i>notStop</i> | The IE is mandatory if the IE "Cipherring mode command" has the value "start/restart", otherwise the IE is not needed in the message. |

10.3.3.6 CN domain specific DRX cycle length coefficient

A coefficient in the formula to count the paging occasions to be used by a specific UE (specified in [4]) .

| Information Element/Group name | Need | Multi | Type and reference | Semantics description |
|---|------|-------|--------------------|--|
| CN domain specific DRX cycle length coefficient | MP | | Integer(6...9) | Refers to 'k' in the formula as specified in [4], Discontinuous reception |

10.3.3.7 CPCH Parameters

NOTE: Only for FDD.

These parameters are used by any UE using any CPCH set allocated to the cell that is broadcasting this system information.

| Information Element/Group name | Need | Multi | Type and reference | Semantics description |
|--------------------------------|---------|-------------|---------------------------------------|---|
| Initial Priority Delay | OP | 1 to maxASC | | Initial delays for ASC priority. |
| >NS_IP | MP | | Integer (0...28) | Number of slots for initial fixed delay for each ASC priority level |
| Backoff control parameters | MP | | | |
| >N_ap_retrans_max | MP | | Integer (1...64) | Max number of AP transmissions without AP-AICH response, a PHY parameter. |
| >N_access_fails | MP | | Integer (1...64) | Max number of preamble ramping cycles when NAK response received, a MAC parameter. |
| >NF_bo_no_aich | MP | | Integer (0...31) | Number of frames for UE backoff after N _{ap_retrans_max} unsuccessful AP access attempts, a MAC parameter. |
| >NS_bo_busy | MP | | Integer (0...63) | Number of slots for UE fixed backoff after access attempt to busy CPCH, a MAC parameter. |
| >NF_bo_all_busy | MP | | Integer (0...31) | Max number of frames for UE backoff after access attempt to last busy CPCH, a MAC parameter. UE randomly selects backoff value from range (0..NF_bo_all_busy) |
| >NF_bo_mismatch | MP | | Integer (0...127) | Max number of frames for the UE backoff after received mismatch on CD/CA-ICH, a MAC parameter. UE randomly selects backoff value from range (0..NF_bo_mismatch) |
| >T_CPCH | MP | | Enumerated (0, 1) | CPCH channel timing used to determine Tau, a PHY parameter |
| Power Control Algorithm | MP | | Enumerated (algorithm 1, algorithm 2) | Specifies algorithm to be used by UE to interpret TPC commands |
| TPC step size | CV-algo | | Integer (1, 2) | In dB |
| DL DPCCH BER | MP | | Integer (0..63) | The BER quality value shall be set in the range $0 \leq \text{DPCCH BER} \leq 1$ in the unit BER_dB where: BER_dB_0: DPCCH BER = 0 BER_dB_1: $-\infty < \text{Log}_{10}(\text{DPCCH BER}) < -4.03$ BER_dB_2: $-4.03 \leq \text{Log}_{10}(\text{DPCCH BER}) < -3.965$ BER_dB_3: $-3.965 \leq \text{Log}_{10}(\text{DPCCH BER}) < -3.9$... BER_dB_61: $-0.195 \leq \text{Log}_{10}(\text{DPCCH BER}) < -0.13$ BER_dB_62: $-0.13 \leq$ |

| | | | | |
|--|--|--|--|--|
| | | | | Log10(DPCCH BER) < -0.065 BER_dB_63: -0.065 ≤ Log10(DPCCH BER) ≤ 0 |
|--|--|--|--|--|

| Condition | Explanation |
|-------------|--|
| <i>algo</i> | The IE is mandatory if "Power Control Algorithm" is set to "algorithm 1", otherwise the IE is not needed |

10.3.3.8 C-RNTI

The cell RNTI (C-RNTI) identifies an UE having a RRC connection within a cell.

| Information Element/Group name | Need | Multi | Type and reference | Semantics description |
|--------------------------------|------|-------|--------------------|-----------------------|
| C-RNTI | MP | | bit string(16) | |

10.3.3.9 DRAC system information

| Information element | Need | Multi | Type and reference | Semantics description |
|---------------------------|------|------------------------|---------------------------------------|---|
| DRAC system information | MP | 1 to <maxDRA Cclasses> | | DRAC information is sent for each class of terminal |
| >Transmission probability | MP | | Transmission probability 10.3.3.39 | |
| >Maximum bit rate | MP | | Maximum bit rate 10.3.3.20 | |

10.3.3.10 RRC State Indicator

Indicates to a UE the RRC state to be entered.

| Information Element/Group name | Need | Multi | Type and reference | Semantics description |
|--------------------------------|------|-------|---|-----------------------|
| RRC State indicator | MP | | Enumerated(CELL_DCH, CELL_FACH, CELL_PCH, URA_PCH) | |

10.3.3.11 Establishment cause

Cause for an RRC connection establishment request.

| Information Element/Group name | Need | Multi | Type and reference | Semantics description |
|--------------------------------|------|-------|---|----------------------------------|
| Establishment cause | MP | | Enumerated(Originating Conversational Call, Originating Streaming Call, Originating Interactive Call, Originating Background Call, Originating Subscribed traffic Call, Terminating Conversational Call, Terminating Streaming Call, Terminating Interactive Call, Terminating Background Call, Emergency Call, Inter-RAT cell re-selection, Inter-RAT cell change order, Registration, Detach, Originating High Priority Signalling, Originating Low Priority Signalling, Call re-establishment, Terminating High Priority Signalling, Terminating Low Priority Signalling, Terminating – cause unknown) | At least one spare value needed. |

10.3.3.12 Expiration Time Factor

| Information Element/Group name | Need | Multi | Type and reference | Semantics description |
|--------------------------------|------|-------|--|-----------------------|
| Expiration Time Factor | MP | | Enumerated(2times, 4times, 8times, 16times, 32times, 64times, 128times, 256times) | |

10.3.3.13 Failure cause

Cause for failure to perform the requested procedure.

| Information Element/Group name | Need | Multi | Type and reference | Semantics description |
|--------------------------------|------|-------|--|----------------------------------|
| Failure cause | MP | | Enumerated (configuration unsupported, physical channel failure, incompatible simultaneous reconfiguration, protocol error, compressed mode runtime error, cell update occurred, invalid configuration, configuration incomplete, unsupported measurement) | At least one spare value needed. |

10.3.3.14 Failure cause and error information

Cause for failure to perform the requested procedure.

| Information Element/Group name | Need | Multi | Type and reference | Semantics description |
|--------------------------------|----------------|-------|--------------------------------------|-----------------------|
| Failure cause | MP | | Failure cause 10.3.3.13 | |
| Protocol error information | CV-ProtErr | | Protocol error information 10.3.8.12 | |
| Deleted TGPSI | CV-CompModeErr | | TGPSI 10.3.6.82 | |

| Condition | Explanation |
|--------------------|--|
| <i>ProtErr</i> | Presence is mandatory if the IE "Failure cause" has the value "Protocol error"; otherwise the element is not needed in the message. |
| <i>CompModeErr</i> | Presence is mandatory if the IE "Failure cause" has the value "Compressed mode runtime error"; otherwise the element is not needed in the message. |

10.3.3.15 Initial UE identity

This information element identifies the UE at a request of an RRC connection.

| Information Element/Group name | Need | Multi | Type and reference | Semantics description |
|--------------------------------|------|-------|--|-----------------------|
| CHOICE <i>UE id type</i> | MP | | | |
| >IMSI (GSM-MAP) | | | IMSI (GSM-MAP) 10.3.1.5 | |
| >TMSI and LAI (GSM-MAP) | | | | |
| >>TMSI (GSM-MAP) | MP | | TMSI (GSM-MAP) 10.3.1.17 | |
| >>LAI (GSM-MAP) | MP | | Location Area Identification 10.3.1.7 | |
| >P-TMSI and RAI (GSM-MAP) | | | | |
| >>P-TMSI (GSM-MAP) | MP | | P-TMSI (GSM-MAP) 10.3.1.13 | |
| >>RAI (GSM-MAP) | MP | | Routing Area Identification 10.3.1.16 | |
| >IMEI | | | IMEI 10.3.1.4 | |
| >ESN (DS-41) | | | bitstring (SIZE (32)) | TIA/EIA/IS-2000-4 |
| >IMSI (DS-41) | | | octetstring (SIZE (5..7)) | TIA/EIA/IS-2000-4 |
| >IMSI and ESN (DS-41) | | | | TIA/EIA/IS-2000-4 |
| >>IMSI (DS-41) | MP | | octetstring (SIZE (5..7)) | TIA/EIA/IS-2000-4 |
| >>ESN (DS-41) | MP | | bitstring (SIZE (32)) | TIA/EIA/IS-2000-4 |
| >TMSI (DS-41) | | | octetstring (SIZE (2..12)) | TIA/EIA/IS-2000-4 |

10.3.3.16 Integrity check info

The Integrity check info contains the RRC message sequence number needed in the calculation of XMAC-I [40] and the calculated MAC-I.

| Information Element/Group name | Need | Multi | Type and reference | Semantics description |
|--------------------------------|------|-------|--------------------|---|
| Message authentication code | MP | | bit string(32) | MAC-I [40]. The Message Authentication Code bits are numbered b0-b31, where b0 is the least significant bit. The 27 MSB of the IE shall be set to zero and the 5 LSB of the IE shall be set to the used signalling radio bearer identity when the encoded RRC message is used as the MESSAGE parameter in the integrity protection algorithm. |
| RRC Message sequence number | MP | | Integer (0..15) | The local RRC hyper frame number (RRC HFN) is concatenated with the RRC message sequence number to form the input parameter COUNT-I for the integrity protection algorithm. The IE value shall be set to zero when the encoded RRC message is used as the MESSAGE parameter in the integrity protection algorithm. |

10.3.3.17 Integrity protection activation info

This IE contains the time, in terms of RRC sequence numbers, when a new integrity protection configuration shall be activated for the signalling radio bearers.

| Information Element/Group name | Need | Multi | Type and reference | Semantics description |
|----------------------------------|------|--------|--------------------|--|
| RRC message sequence number list | MP | 4 to 5 | | The RRC sequence number when a new integrity protection configuration shall be applied, for CCCH (=RB0) and signalling radio bearers in the order RB0, RB1, RB2, RB3, RB4. The value for RB1 shall be ignored if this IE was included in a RRC message sent on RB1. The value for RB2 shall be ignored if this IE was included in a RRC message sent on RB2. |
| >RRC message sequence number | MP | | Integer (0..15) | |

10.3.3.18 Integrity protection Algorithm

| Information Element/Group name | Need | Multi | Type and reference | Semantics description |
|--------------------------------|------|-------|--------------------|-----------------------|
| Integrity protection algorithm | MP | | Enumerated (UIA1) | |

10.3.3.19 Integrity protection mode info

| Information Element/Group name | Need | Multi | Type and reference | Semantics description |
|---|------------------|-------|---|-----------------------|
| Integrity protection mode command | MP | | Enumerated(start, modify) | |
| Downlink integrity protection activation info | <i>CV-modify</i> | | Integrity protection activation info 10.3.3.17 | |
| Integrity protection algorithm | OP | | Integrity protection algorithm 10.3.3.18 | |
| Integrity protection initialisation number | <i>CV-start</i> | | Bitstring(32) | FRESH [40] |

| Condition | Explanation |
|---------------|--|
| <i>Start</i> | The IE is mandatory if the IE "Integrity protection mode command" has the value "start ", otherwise it is not needed in the message. |
| <i>Modify</i> | The IE is only present if the IE "Integrity protection mode command" has the value "modify" |

10.3.3.20 Maximum bit rate

NOTE: Only for FDD.

Indicates the maximum user bit rate allowed on a DCH controlled by DRAC procedure for the transmission period (Transmission time validity).

| Information Element/Group name | Need | Multi | Type and reference | Semantics description |
|--------------------------------|------|-------|-------------------------------|-----------------------|
| Maximum bit rate | MP | | integer(0..512 by step of 16) | =kbit/s |

10.3.3.21 Measurement capability

| Information Element/Group name | Need | Multi | Type and reference | Semantics description | Version |
|-----------------------------------|-----------------------------|-------|--------------------|--|-----------------------|
| Need for downlink compressed mode | | | | | |
| FDD measurements | MP | | Boolean | TRUE means that the UE requires DL compressed mode in order to perform measurements on FDD | |
| 3.84Mcps TDD measurements | CV- 3.84Mcps_ tdd_sup | | Boolean | TRUE means that the UE requires DL compressed mode in order to perform measurements on 3.84Mcps TDD | Name changed in REL-4 |
| 1.28Mcps TDD measurements | CV- 1.28Mcps_ tdd_sup | | Boolean | TRUE means that the UE requires DL compressed mode in order to perform measurements on 1.28Mcps TDD | REL-4 |
| GSM 900 | CV- Gsm900_ supM | | Boolean | TRUE means that the UE requires DL compressed mode in order to perform measurements on GSM 900 | |
| DCS 1800 | CV- Gsm1800_ sup | | Boolean | TRUE means that the UE requires DL compressed mode in order to perform measurements on DCS 1800 | |
| GSM 1900 | CV- Gsm1900_ sup | | Boolean | TRUE means that the UE requires DL compressed mode in order to perform measurements on GSM 1900 | |
| Multi-carrier measurement | CV- mc_sup | | Boolean | TRUE means that the UE requires DL compressed mode in order to perform measurements on multi-carrier | |
| Need for uplink compressed mode | | | | | |
| FDD measurements | MP | | Boolean | TRUE means that the UE requires UL compressed mode in order to perform measurements on FDD | |
| 3.84Mcps TDD measurements | CV- 3.84Mcps_ tdd_sup | | Boolean | TRUE means that the UE requires UL compressed mode in order to | Name changed in REL-4 |

| | | | | | |
|---------------------------|---------------------|--|---------|--|-------|
| | | | | perform measurements on 3.84Mcps TDD | |
| 1.28Mcps TDD measurements | CV-1.28Mcps_tdd_sup | | Boolean | TRUE means that the UE requires DL compressed mode in order to perform measurements on 1.28Mcps TDD | REL-4 |
| GSM 900 | CV-Gsm900_sup | | Boolean | TRUE means that the UE requires UL compressed mode in order to perform measurements on GSM 900 | |
| DCS 1800 | CV-Gsm1800_sup | | Boolean | TRUE means that the UE requires UL compressed mode in order to perform measurements on DCS 1800 | |
| GSM 1900 | CV-Gsm1900_sup | | Boolean | TRUE means that the UE requires UL compressed mode in order to perform measurements on GSM 1900 | |
| Multi-carrier measurement | CV-mc_sup | | Boolean | TRUE means that the UE requires UL compressed mode in order to perform measurements on multi-carrier | |

| Condition | Explanation |
|------------------|---|
| 3.84Mcps_tdd_sup | Presence is mandatory if an IE "TDD RF capability" is present with the IE "Chip rate capability" set to "3.84Mcps". Otherwise this field is not needed in the message. |
| 1.28Mcps_tdd_sup | Presence is mandatory if an IE "TDD RF capability" is present with the IE "Chip rate capability" set to "1.28Mcps". Otherwise this field is not needed in the message. |
| Gsm900_sup | Presence is needed if the IE "Inter-RAT UE radio access capability" indicates support for GSM900. Absence is needed if the IE "Inter-RAT UE radio access capability" indicates no support for GSM900. |
| Gsm1800_sup | Presence is needed if the IE "Inter-RAT UE radio access capability" indicates support for GSM1800. Absence is needed if the IE "Inter-RAT UE radio access capability" indicates no support for GSM1800. |
| Gsm1900_sup | Presence is needed if the IE "Inter-RAT UE radio access capability" indicates support for GSM1900. Absence is needed if the IE "Inter-RAT UE radio access capability" indicates no support for GSM1900. |
| mc_sup | Presence is mandatory if IE Support of multi-carrier has the value TRUE. Otherwise this field is not needed in the message. |

10.3.3.21a Measurement capability extension

This IE may be used to replace the measurement capability information provided within IE "Measurement capability".

| Information Element/Group name | Need | Multi | Type and reference | Semantics description |
|--------------------------------|--------------------|--------------------------|--|--|
| FDD measurements | MP | 1 to <maxFreq BandsFDD > | | |
| >FDD Frequency band | MD | | Enumerated(FDD2100, FDD1900) | The default value is the same as indicated in the IE "Frequency band" included in the IE " UE radio access capability extension". At least one spare value is needed |
| >Need for DL compressed mode | MP | | Boolean | TRUE means that the UE requires DL compressed mode in order to perform measurements on the FDD frequency band indicated by the IE "FDD Frequency band" |
| >Need for UL compressed mode | MP | | Boolean | TRUE means that the UE requires UL compressed mode in order to perform measurements on the FDD frequency band indicated by the IE "FDD Frequency band" |
| TDD measurements | CV- <i>tdd_sup</i> | 1 to <maxFreq BandsTDD > | | |
| >TDD Frequency band | MP | | Enumerated(a, b, c) | |
| >Need for DL compressed mode | MP | | Boolean | TRUE means that the UE requires DL compressed mode in order to perform measurements on TDD frequency band indicated by the IE "TDD Frequency band" |
| >Need for UL compressed mode | MP | | Boolean | TRUE means that the UE requires UL compressed mode in order to perform measurements on TDD frequency band indicated by the IE "TDD Frequency band" |
| GSM measurements | CV- <i>gsm_sup</i> | 1 to <maxFreq BandsGS M> | | |
| >GSM Frequency band | MP | | Enumerated(GSM450, GSM480, GSM850, GSM900P, GSM900E, GSM1800, GSM1900) | as defined in [45] at least one spare value |
| >Need for DL compressed mode | MP | | Boolean | TRUE means that the UE requires DL compressed mode in order to perform measurements on GSM frequency band indicated by the IE "GSM Frequency band" |
| >Need for UL compressed mode | MP | | Boolean | TRUE means that the UE requires UL compressed mode in order to perform measurements on GSM frequency band indicated by the IE "GSM Frequency band" |

| | | | | |
|------------------------------|----------------------|--|---------|--|
| Multi-carrier measurement | CV- <i>mc_sup</i> | | | |
| >Need for DL compressed mode | MP | | Boolean | TRUE means that the UE requires DL compressed mode in order to perform measurements on multi-carrier |
| >Need for UL compressed mode | MP | | Boolean | TRUE means that the UE requires UL compressed mode in order to perform measurements on multi-carrier |

| Condition | Explanation |
|----------------|--|
| <i>tdd_sup</i> | Presence is mandatory if IE Multi-mode capability has the value "TDD" or "FDD/TDD". Otherwise this field is not needed in the message. |
| <i>gsm_sup</i> | Presence is mandatory if IE Support of GSM has the value TRUE. Otherwise this field is not needed in the message. |
| <i>mc_sup</i> | Presence is mandatory if IE Support of multi-carrier has the value TRUE. Otherwise this field is not needed in the message. |

10.3.3.22 Paging cause

Cause for a CN originated page.

| Information Element/Group name | Need | Multi | Type and reference | Semantics description |
|--------------------------------|------|-------|--|-----------------------|
| Paging cause | MP | | Enumerated(Terminating Conversational Call, Terminating Streaming Call, Terminating Interactive Call, Terminating Background Call, Terminating High Priority Signalling, Terminating Low Priority Signalling, Terminating – cause unknown) | |

10.3.3.23 Paging record

| Information Element/Group name | Need | Multi | Type and reference | Semantics description |
|--|------|-------|--|-----------------------|
| CHOICE <i>Used paging identity</i> | MP | | | |
| >CN identity | | | | |
| >>Paging cause | MP | | Paging cause 10.3.3.22 | |
| >>>CN domain identity | MP | | CN domain identity 10.3.1.1 | |
| >>>>CHOICE <i>UE Identity</i> | MP | | | |
| >>>>>IMSI (GSM-MAP) | | | IMSI (GSM-MAP) 10.3.1.5 | |
| >>>>>TMSI (GSM-MAP) | | | TMSI (GSM-MAP) 10.3.1.17 | |
| >>>>>P-TMSI (GSM-MAP) | | | P-TMSI (GSM-MAP) 10.3.1.13 | |
| >>>>>IMSI (DS-41) | | | TIA/EIA/IS-2000-4 | |
| >>>>>TMSI (DS-41) | | | TIA/EIA/IS-2000-4 | |
| >UTRAN identity | | | | |
| >>U-RNTI | MP | | U-RNTI 10.3.3.47 | |
| >>>CN originated page to connected mode UE | OP | | | |
| >>>>Paging cause | MP | | Paging cause 10.3.3.22 | |
| >>>>>CN domain identity | MP | | CN domain identity 10.3.1.1 | |
| >>>>>>Paging record type identifier | MP | | Paging record type identifier 10.3.1.10 | |

| Condition | Explanation |
|---|--|
| CHOICE <i>Used paging identity</i> | Condition under which the given <i>used paging identity</i> is chosen |
| CN identity | For CN originating pages (for idle mode UEs) |
| UTRAN identity | For UTRAN originating pages (for connected mode UEs) |

10.3.3.24 PDCP capability

Indicates which algorithms and which value range of their parameters are supported by the UE.

| Information Element/Group name | Need | Multi | Type and reference | Semantics description | Version |
|--|------|-------|---|---|---------|
| Support for lossless SRNS relocation | MP | | Boolean | TRUE means supported | |
| Support for RFC2507 | MP | | Boolean | TRUE means supported | |
| >Max HC context space | | | Integer(512, 1024, 2048, 4096, 8192) | | |
| Support for RFC 3095 | MP | | Boolean | TRUE means supported | REL-4 |
| >Maximum number of ROHC context sessions | MD | | Integer(2, 4, 8, 12, 16, 24, 32, 48, 64, 128, 256, 512, 1024, 16384) | Default value is 16. | REL-4 |
| >Reverse decompression depth | MD | | Integer (0..65535) | Default value is 0 (reverse decompression shall not be used). | REL-4 |

10.3.3.25 Physical channel capability

| Information Element/Group name | Need | Multi | Type and Reference | Semantics description | Version |
|---|--|-------|--|---|-----------------------|
| Downlink physical channel capability information elements | | | | | |
| FDD downlink physical channel capability | CH- <i>fdd_req_su p</i> | | | | |
| >Max no DPCH/PDSCH codes | MP | | Integer (1..8) | Maximum number of DPCH/PDSCH codes to be simultaneously received | |
| >Max no physical channel bits received | MP | | Integer (600, 1200, 2400, 3600, 4800, 7200, 9600, 14400, 19200, 28800, 38400, 48000, 57600, 67200, 76800) | Maximum number of physical channel bits received in any 10 ms interval (DPCH, PDSCH, S-CCPCH) | |
| >Support for SF 512 | MP | | Boolean | TRUE means supported | |
| >Support of PDSCH | MP | | Boolean | TRUE means supported | |
| >Simultaneous reception of SCCPCH and DPCH | MP | | Boolean | TRUE means supported | |
| >Simultaneous reception of SCCPCH, DPCH and PDSCH | CV- <i>if_sim_rec _pdsch _sup</i> | | Boolean | TRUE means supported | |
| >Max no of S-CCPCH RL | CV- <i>if_sim_rec</i> | | Integer(1) | Maximum number of simultaneous S-CCPCH radio links | |
| 3.84Mcps TDD downlink physical channel capability | CH- <i>3.84Mcps_ tdd_req_su p</i> | | | | Name changed in REL-4 |
| >Maximum number of timeslots per frame | MP | | Integer (1..14) | | |
| >Maximum number of physical channels per frame | MP | | Integer (1..224) | | |
| >Minimum SF | MP | | Integer (1, 16) | | |
| >Support of PDSCH | MP | | Boolean | TRUE means supported | |
| >Maximum number of physical channels per timeslot | MP | | Integer (1..16) | | |
| 1.28Mcps TDD downlink physical channel capability | CH- <i>1.28Mcps_ tdd_req_su p</i> | | | | REL-4 |
| >Maximum number of timeslots per subframe | MP | | Integer (1..6) | | REL-4 |
| >Maximum number of physical channels per subframe | MP | | Integer (1..96) | | REL-4 |
| >Minimum SF | MP | | Integer (1, 16) | | REL-4 |
| >Support of PDSCH | MP | | Boolean | TRUE means supported | REL-4 |
| >Maximum number of physical | MP | | Integer | | REL-4 |

| | | | | | |
|--|--|--|--|----------------------|-----------------------|
| channels per timeslot | | | (1..16) | | |
| >Support of 8PSK | MP | | Boolean | TRUE means supported | REL-4 |
| Uplink physical channel capability information elements | | | | | |
| FDD uplink physical channel capability | CH- <i>fdd_req_su p</i> | | | | |
| >Maximum number of DPDCH bits transmitted per 10 ms | MP | | Integer (600, 1200, 2400, 4800, 9600, 19200, 28800, 38400, 48000, 57600) | | |
| >Support of PCPCH | MP | | Boolean | TRUE means supported | |
| 3.84Mcps TDD uplink physical channel capability | CH- <i>3.84Mcps_ tdd_req_su p</i> | | | | Name changed in REL-4 |
| >Maximum Number of timeslots per frame | MP | | Integer (1..14) | | |
| >Maximum number of physical channels per timeslot | MP | | Integer (1, 2) | | |
| >Minimum SF | MP | | Integer (1, 2, 4, 8, 16) | | |
| >Support of PUSCH | MP | | Boolean | TRUE means supported | |
| 1.28Mcps TDD uplink physical channel capability | CH- <i>1.28Mcps_ tdd_req_su p</i> | | | | REL-4 |
| >Maximum Number of timeslots per subframe | MP | | Integer (1..6) | | REL-4 |
| >Maximum number of physical channels per timeslot | MP | | Integer (1, 2) | | REL-4 |
| >Minimum SF | MP | | Integer (1, 2, 4, 8, 16) | | REL-4 |
| >Support of PUSCH | MP | | Boolean | TRUE means supported | REL-4 |
| >Support of 8PSK | MP | | Boolean | TRUE means supported | REL-4 |

| Condition | Explanation |
|-----------------------------|--|
| <i>if_sim_rec_pdsch_sup</i> | Presence is mandatory if IE Simultaneous reception of SCCPCH and DPCH = True and IE Support of PDSCH = True. Otherwise this field is not needed in the message. |
| <i>if_sim_rec</i> | Presence is mandatory if IE capability Simultaneous reception of SCCPCH and DPCH = True. Otherwise this field is not needed in the message. |
| <i>3.84Mcps_tdd_req_sup</i> | Presence is mandatory if an IE "TDD RF capability" is present with the IE "Chip rate capability" set to "3.84Mcps" and a 3.84Mcps TDD capability update has been requested in a previous message. Otherwise this field is not needed in the message. |
| <i>1.28Mcps_tdd_req_sup</i> | Presence is mandatory if an IE "TDD RF capability" is present with the IE "Chip rate capability" set to "1.28Mcps" and a 1.28Mcps TDD capability update has been requested in a previous message. Otherwise this field is not needed in the message. |
| <i>fdd_req_sup</i> | Presence is mandatory if IE Multi-mode capability has the value "FDD" or "FDD/TDD" and a FDD capability update has been requested in a previous message. Otherwise this field is not needed in the message. |

10.3.3.26 Protocol error cause

This IE indicates the cause for a message or information that was not comprehended.

| Information Element/Group name | Need | Multi | Type and reference | Semantics description |
|--------------------------------|------|-------|---|----------------------------------|
| Protocol error cause | MP | | Enumerated (ASN.1 violation or encoding error, Message type non-existent or not implemented, Message not compatible with receiver state, Information element value not comprehended, Conditional information element error, Message extension not comprehended) | At least one spare value needed. |

10.3.3.27 Protocol error indicator

This IE indicates whether a message was transmitted due to a protocol error or not.

| Information Element/Group name | Need | Multi | Type and Reference | Semantics description |
|--------------------------------|------|-------|--------------------|---|
| Protocol error indicator | MP | | Boolean | TRUE means a protocol error occurred. FALSE means a protocol error did not occur. |

10.3.3.28 RB timer indicator

This IE is used to indicate to UTRAN if the timers T314 or T315 has expired in the UE.

| Information Element/Group name | Need | Multi | Type and reference | Semantics description |
|--------------------------------|------|-------|--------------------|---|
| T314 expired | MP | | Boolean | TRUE means that the timer has expired or the stored value is zero. FALSE means that the timer has not expired. |
| T315 expired | MP | | Boolean | TRUE means that the timer has expired or the stored value is zero. FALSE means that the timer has not expired. |

10.3.3.29 Redirection info

This IE is used to redirect the UE to another frequency or other system.

| Information Element/Group name | Need | Multi | Type and reference | Semantics description |
|---------------------------------------|------|-------|-----------------------------|-----------------------|
| <i>CHOICE Redirection Information</i> | MP | | | |
| >Frequency info | | | Frequency info 10.3.6.36 | |
| >Inter-RAT info | | | Inter-RAT info 10.3.7.25 | |

10.3.3.30 Re-establishment timer

This information element indicates which timer to associate with RAB.

| Information Element/Group name | Need | Multi | Type and reference | Semantics description |
|--------------------------------|------|-------|------------------------------|-----------------------|
| Re-establishment timer | MP | | Enumerated(useT314, useT315) | |

10.3.3.31 Rejection cause

Cause for rejection of RRC connection establishment request.

| Information Element/Group name | Need | Multi | Type and reference | Semantics description |
|--------------------------------|------|-------|-------------------------------------|-----------------------|
| Rejection cause | MP | | Enumerated(congestion, unspecified) | |

10.3.3.32 Release cause

Cause for release of RRC connection.

| Information Element/Group name | Need | Multi | Type and reference | Semantics description |
|--------------------------------|------|-------|---|-----------------------|
| Release cause | MP | | Enumerated (normal event, unspecified, pre-emptive release, congestion, re-establishment reject, user inactivity), directed signalling connection re-establishment) | |

10.3.3.33 RF capability FDD

| Information Element/Group name | Need | Multi | Type and Reference | Semantics description | Version |
|--------------------------------|------|-------|---|---|---------|
| UE power class | MP | | Enumerated(1..4) | as defined in [21] | |
| Tx/Rx frequency separation | MP | | Enumerated(190, 174.8-205.2, 134.8-245.2) | In MHz as defined in [21]. NOTE: Not applicable if UE is not operating in frequency band a (as defined in [21]). | |

10.3.3.33a RF capability FDD extension

| Information Element/Group name | Need | Multi | Type and Reference | Semantics description |
|--------------------------------|------|-------|---|---|
| UE power class extension | MP | | Enumerated(1..4) | as defined in [21]. At least one spare value is needed |
| Tx/Rx frequency separation | MP | | Enumerated(190, 174.8-205.2, 134.8-245.2) | In MHz as defined in [21]. NOTE: Not applicable if UE is not operating in frequency band a (as defined in [21]). |

10.3.3.33b RF capability TDD

| Information Element/Group name | Need | Multi | Type and Reference | Semantics description |
|--------------------------------|------|-------|---|-----------------------|
| UE power class | MP | | Enumerated (1..4) | as defined in [22] |
| Radio frequency bands | MP | | Enumerated(a, b, c, a+b, a+c, b+c, a+b+c) | as defined in [22] |
| Chip rate capability | MP | | Enumerated(3.84Mcps, 1.28Mcps) | as defined in [22] |

10.3.3.34 RLC capability

| Information Element/Group name | Need | Multi | Type and Reference | Semantics description |
|--------------------------------|------|-------|------------------------------------|---|
| Total RLC AM buffer size | MP | | Integer (2,10,50,100,150,500,1000) | Total receiving and transmitting RLC AM buffer capability in kBytes |
| Maximum RLC AM Window Size | MP | | Integer(2047,4095) | Maximum supported RLC TX and RX window in UE |
| Maximum number of AM entities | MP | | Integer (3,4,5,6,8,16,30) | |

10.3.3.35 RLC re-establish indicator

This IE is used to re-configure AM RLC on c-plane and u-plane.

| Information Element/Group name | Need | Multi | Type and reference | Semantics description |
|--------------------------------|------|-------|--------------------|---|
| RLC re-establish indicator | MP | | Boolean | TRUE means re-establish required FALSE means re-establish not required |

10.3.3.36 RRC transaction identifier

This IE contains an identification of the RRC procedure transaction local for the type of the message this IE was included within.

| Information Element/Group name | Need | Multi | Type and reference | Semantics description |
|--------------------------------|------|-------|--------------------|-----------------------|
| RRC transaction identifier | MP | | Integer (0..3) | |

10.3.3.37 Security capability

| Information Element/Group name | Need | Multi | Type and reference | Semantics description |
|---|------|-------|--------------------|---|
| Ciphering algorithm capability | MP | | | |
| >UEA0 | MP | | Boolean | The value TRUE means that an unciphered connection after the Security mode control procedure is accepted by the UE. |
| >UEA1 | MP | | Boolean | The value TRUE means that UEA1, Kasumi, is supported |
| >Spare | MP | 14 | Boolean | Shall be set to FALSE by UEs complying with this version of the protocol. |
| Integrity protection algorithm capability | MP | | | |
| >UIA1 | MP | | Boolean | The value TRUE means that UIA1, Kasumi, is supported |
| >Spare | MP | 15 | Boolean | Shall be set to FALSE by UEs complying with this version of the protocol. |

NOTE: The UE shall support at least one UEAx other than UEA0 and one UIAx.

10.3.3.38 START

There is a START value per CN domain. The START is used to initialise the 20 MSBs of all hyper frame numbers (MAC-d HFN, RLC UM HFN, RLC AM HFN, RRC HFN) for a CN domain.

| Information Element/Group name | Need | Multi | Type and Reference | Semantics description |
|--------------------------------|------|-------|--------------------|---|
| START | MP | | Bit string (20) | The START [40] bits are numbered b0-b19, where b0 is the least significant bit. |

10.3.3.39 Transmission probability

NOTE: Only for FDD.

Indicates the probability for a mobile to be allowed to transmit on a DCH controlled by DRAC procedure.

| Information Element/Group name | Need | Multi | Type and reference | Semantics description |
|--------------------------------|------|-------|------------------------------------|-----------------------|
| Transmission probability | MP | | Real(0.125.. 1.0 by step of 0.125) | probability |

10.3.3.40 Transport channel capability

| Information Element/Group name | Need | Multi | Type and Reference | Semantics description |
|---|----------------------|-------|--|--|
| Downlink transport channel capability information elements | | | | |
| Max no of bits received | MP | | Integer(640, 1280, 2560, 3840, 5120, 6400, 7680, 8960, 10240, 20480, 40960, 81920, 163840) | Maximum sum of number of bits of all transport blocks received at an arbitrary time instant |
| Max convolutionally coded bits received | MP | | Integer(640, 1280, 2560, 3840, 5120, 6400, 7680, 8960, 10240, 20480, 40960, 81920, 163840) | Maximum sum of number of bits of all convolutionally coded transport blocks received at an arbitrary time instant |
| Max turbo coded bits received | CV- turbo_dec_sup | | Integer(640, 1280, 2560, 3840, 5120, 6400, 7680, 8960, 10240, 20480, 40960, 81920, 163840) | Maximum sum of number of bits of all turbo coded transport blocks received at an arbitrary time instant |
| Maximum number of simultaneous transport channels | MP | | Integer(4, 8, 16, 32) | |
| Maximum number of simultaneous CCTrCH | MP | | Integer (1..8) | |
| Max no of received transport blocks | MP | | Integer(4, 8, 16, 32, 48, 64, 96, 128, 256, 512) | Maximum total number of transport blocks received within TTIs that end at within the same 10ms interval |
| Maximum number of TFC in the TFCS | MP | | Integer(16, 32, 48, 64, 96, 128, 256, 512, 1024) | |
| Maximum number of TF | MP | | Integer(32, 64, 128, 256, 512, 1024) | |
| Support for turbo decoding | MP | | Boolean | TRUE means supported |
| Uplink transport channel capability information elements | | | | |
| Max no of bits transmitted | MP | | Integer(640, 1280, 2560, 3840, 5120, 6400, 7680, 8960, 10240, 20480, 40960, 81920, 163840) | Maximum sum of number of bits of all transport blocks transmitted at an arbitrary time instant |
| Max convolutionally coded bits transmitted | MP | | Integer(640, 1280, 2560, 3840, 5120, 6400, 7680, 8960, 10240, 20480, | Maximum sum of number of bits of all convolutionally coded transport blocks transmitted at an arbitrary time instant |

| | | | | |
|---|------------------|--|--|--|
| | | | 40960, 81920, 163840) | |
| Max turbo coded bits transmitted | CV-turbo_enc_sup | | Integer(640, 1280, 2560, 3840, 5120, 6400, 7680, 8960, 10240, 20480, 40960, 81920, 163840) | Maximum sum of number of bits of all turbo coded transport blocks transmitted at an arbitrary time instant |
| Maximum number of simultaneous transport channels | MP | | Integer(2, 4, 8, 16, 32) | |
| Maximum number of simultaneous CCTrCH of DCH type | CH-tdd_req_sup | | Integer (1..8) | |
| Max no of transmitted transport blocks | MP | | Integer(2, 4, 8, 16, 32, 48, 64, 96, 128, 256, 512) | Maximum total number of transport blocks transmitted within TTIs that start at the same time |
| Maximum number of TFC in the TFCS | MP | | Integer(4, 8, 16, 32, 48, 64, 96, 128, 256, 512, 1024) | |
| Maximum number of TF | MP | | Integer(32, 64, 128, 256, 512, 1024) | |
| Support for turbo encoding | MP | | Boolean | TRUE means supported |

| Condition | Explanation |
|----------------------|---|
| <i>turbo_dec_sup</i> | Presence is mandatory if IE Support of turbo decoding = True. Otherwise this field is not needed in the message. |
| <i>turbo_enc_sup</i> | Presence is mandatory if IE Support of turbo encoding = True. Otherwise this field is not needed in the message. |
| <i>tdd_req_sup</i> | Presence is mandatory if IE Multi-mode capability has the value "TDD" or "FDD/TDD" and a TDD capability update has been requested in a previous message. Otherwise this field is not needed in the message. |

10.3.3.41 UE multi-mode/multi-RAT capability

| Information Element/Group name | Need | Multi | Type and Reference | Semantics description |
|--------------------------------|------|-------|--------------------------------|-----------------------|
| Multi-RAT capability | | | | |
| Support of GSM | MP | | Boolean | |
| Support of multi-carrier | MP | | Boolean | |
| Multi-mode capability | MP | | Enumerated (TDD, FDD, FDD/TDD) | |

10.3.3.42 UE radio access capability

| Information Element/Group name | Need | Multi | Type and reference | Semantics description | Version |
|------------------------------------|---------------------------|--------|--|--|------------------------------|
| ICS version | MP | | Enumerated(R99, REL-4) | Indicates the release version of [42]-2 (Implementation Conformance Statement (ICS) proforma specification) that is applicable for the UE. | Value REL-4 added in REL-4 |
| PDCP capability | MP | | PDCP capability 10.3.3.24 | | |
| RLC capability | MP | | RLC capability 10.3.3.34 | | |
| Transport channel capability | MP | | Transport channel capability 10.3.3.40 | | |
| RF capability FDD | OP | | RF capability FDD 10.3.3.33 | | |
| RF capability TDD | OP | 1 to 2 | RF capability TDD 10.3.3.33b | One "TDD RF capability" entity shall be included for every Chip rate capability supported. | Multi=2 is included in REL-4 |
| Physical channel capability | MP | | Physical channel capability 10.3.3.25 | | |
| UE multi-mode/multi-RAT capability | MP | | UE multi-mode/multi-RAT capability 10.3.3.41 | | |
| Security capability | MP | | Security capability 10.3.3.37 | | |
| UE positioning capability | MP | | UE positioning capability 10.3.3.45 | | |
| Measurement capability | CH- <i>fdd_req_sup</i> | | Measurement capability 10.3.3.21 | | |

| Condition | Explanation |
|--------------------|---|
| <i>fdd_req_sup</i> | Presence is mandatory if IE Multi-mode capability has the value "FDD" or "FDD/TDD" and a FDD capability update has been requested in a previous message. Otherwise this field is not needed in the message. |

10.3.3.42a UE radio access capability extension

| Information Element/Group name | Need | Multi | Type and reference | Semantics description |
|---|------|------------------------|---|---|
| Frequency band specific capability list | MP | 1 to <maxFreqbandsFDD> | | |
| >Frequency band | MP | | Enumerated(FDD2100, FDD1900) | At least one spare value is needed |
| >RF capability FDD extension | MD | | RF capability FDD extension 10.3.3.33a | the default values are the same values as in the immediately preceding IE "RF capability FDD extension"; the first occurrence is MP |
| >Measurement capability extension | MP | | Measurement capability extension 10.3.3.21a | |

10.3.3.43 UE Timers and Constants in connected mode

This information element specifies timer- and constants values used by the UE in connected mode.

| Information Element/Group name | Need | Multi | Type and reference | Semantics description |
|--------------------------------|------|-------|--|---|
| T301 | MD | | Integer(100, 200 .. 2000 by step of 200, 3000, 4000, 6000, 8000) | Value in milliseconds. Default value is 2000. This IE should not be used by the UE in this release of the protocol. |
| N301 | MD | | Integer(0..7) | Default value is 2. This IE should not be used by the UE in this release of the protocol. |
| T302 | MD | | Integer(100, 200... 2000 by step of 200, 3000, 4000, 6000, 8000) | Value in milliseconds. Default value is 4000. |
| N302 | MD | | Integer(0..7) | Default value is 3. |
| T304 | MD | | Integer(100, 200, 400, 1000, 2000) | Value in milliseconds. Default value is 2000. At least one spare value is needed. Note 1. |
| N304 | MD | | Integer(0..7) | Default value is 2. Note 1. |
| T305 | MD | | Integer(5, 10, 30, 60, 120, 360, 720, infinity) | Value in minutes. Default value is 30. Infinity means no update |
| T307 | MD | | Integer(5, 10, 15, 20, 30, 40, 50) | Value in seconds. Default value is 30. |
| T308 | MD | | Integer(40, 80, 160, 320) | Value in milliseconds. Default value is 160. Note 1. |
| T309 | MD | | Integer(1...8) | Value in seconds. Default value is 5. Note 1. |
| T310 | MD | | Integer(40 .. 320 by step of 40) | Value in milliseconds. Default value is 160. Note 1. |
| N310 | MD | | Integer(0 .. 7) | Default value is 4. Note 1. |
| T311 | MD | | Integer(250 .. 2000 by step of 250) | Value in milliseconds. Default value is 2000. Note 1. |
| T312 | MD | | Integer (0..15) | Value in seconds. Default value is 1. |
| N312 | MD | | Integer (1, 50, 100, 200, 400, 600, 800, 1000) | Default value is 1. |
| T313 | MD | | Integer (0..15) | Value in seconds. Default value is 3. Note 1. |
| N313 | MD | | Integer (1, 2, 4, 10, 20, 50, 100, 200) | Default value is 20. Note 1. |
| T314 | MD | | Integer(0, 2, 4, 6, 8, 12, 16, 20) | Value in seconds. Default value is 12. Note 1. |
| T315 | MD | | Integer | Value in seconds. Default |

| | | | | |
|------|----|--|--|---|
| | | | (0,10, 30, 60, 180, 600, 1200, 1800) | value is 180. Note 1. |
| N315 | MD | | Integer (1, 50, 100, 200, 400, 600, 800, 1000) | Default value is 1. Note 1. |
| T316 | MD | | Integer(0, 10, 20, 30, 40, 50, infinity) | Value in seconds. Default value is 30. |
| T317 | MD | | Integer (0,10, 30, 60, 180, 600, 1200, 1800) | Value in seconds Default value is 180. |

NOTE 1: If the value of SIB1 changes, the UE shall re-read SIB1 and use the new value of the parameter, if modified.

10.3.3.44 UE Timers and Constants in idle mode

This information element specifies timer- and constant values used by the UE in idle mode.

| Information Element/Group name | Need | Multi | Type and reference | Semantics description |
|--------------------------------|------|-------|---|---|
| T300 | MP | | Integer(10 0, 200... 2000 by step of 200, 3000, 4000, 6000, 8000) | Value in milliseconds. Default value is 1000. |
| N300 | MP | | Integer(0.. 7) | Default value is 3. |
| T312 | MP | | Integer(0 .. 15) | Value in seconds. Default value is 1. |
| N312 | MP | | Integer (1, 50, 100, 200, 400, 600, 800, 1000) | Default value is 1. |

10.3.3.45 UE positioning capability

| Information Element/Group name | Need | Multi | Type and reference | Semantics description |
|---|------|-------|--|---|
| Standalone location method(s) supported | MP | | Boolean | Defines if a UE can measure its location by some means unrelated to UTRAN TRUE means supported |
| UE based OTDOA supported | MP | | Boolean | TRUE means supported |
| Network Assisted GPS support | MP | | Enumerated ('Network based', 'UE based', 'Both', 'None') | Defines if the UE supports network based or UE based GPS methods. |
| GPS reference time capable | MP | | Boolean | Defines if a UE has the capability to measure GPS reference time as defined in [7]. TRUE means capable |
| Support for IPDL | MP | | Boolean | Defines if a UE has the capability to use IPDL to enhance its 'SFN-SFN observed time difference –type 2' measurement. TRUE means supported |

10.3.3.46 URA update cause

Indicates the cause for s URA update.

| Information Element/Group name | Need | Multi | Type and reference | Semantics description |
|--------------------------------|------|-------|--|----------------------------------|
| URA update cause | MP | | Enumerated(cha nge of URA, periodic URA update, re-entered service area) | At least one spare value needed. |

10.3.3.47 U-RNTI

The U-RNTI (UTRAN Radio Network Temporary Identity) is allocated to an UE having a RRC connection and identifies the UE within UTRAN.

| Information Element/Group name | Need | Multi | Type and reference | Semantics description |
|--------------------------------|------|-------|--------------------|-----------------------|
| SRNC identity | MP | | bit string(12) | |
| S-RNTI | MP | | bit string(20) | |

10.3.3.48 U-RNTI Short

The U-RNTI (UTRAN Radio Network Temporary Identity) is allocated to an UE having a RRC connection and identifies the UE within UTRAN.

| Information Element/Group name | Need | Multi | Type and reference | Semantics description |
|--------------------------------|------|-------|--------------------|-----------------------|
| SRNC identity | MP | | bit string(12) | |
| S-RNTI 2 | MP | | bit string(10) | |

10.3.3.49 UTRAN DRX cycle length coefficient

A coefficient in the formula to count the paging occasions to be used by a specific UE (specified in [4]).

| Information Element/Group name | Need | Multi | Type and reference | Semantics description |
|--------------------------------|------|-------|--------------------|--|
| DRX cycle length coefficient | MP | | Integer(3..9) | Refers to 'k' in the formula as specified in [4], Discontinuous reception |

10.3.3.50 Wait time

Wait time defines the time period the UE has to wait before repeating the rejected procedure.

| Information Element/Group name | Need | Multi | Type and reference | Semantics description |
|--------------------------------|------|-------|--------------------|---|
| Wait time | MP | | Integer(0..15) | Wait time in seconds The value 0 indicates that repetition is not allowed. |

10.3.4 Radio Bearer Information elements

10.3.4.0 Default configuration identity

This information element identifies a default radio parameter configuration.

| Information Element/Group name | Need | Multi | Type and reference | Semantics description |
|--------------------------------|------|-------|--------------------|--|
| Default configuration identity | MP | | Integer (0..9) | The corresponding default configurations are specified in 13.7 |

10.3.4.1 Downlink RLC STATUS info

| Information Element/Group name | Need | Multi | Type and reference | Semantics description |
|--------------------------------|------|-------|--|--|
| Timer_Status_Prohibit | OP | | Integer(10..50 by step of 10, 550..1000 by step of 50) | Minimum time in ms between STATUS reports |
| Timer_EPC | OP | | Integer(50, 60, 70, 80, 90, 100, 120, 140, 160, 180, 200, 300, 400, 500, 700, 900) | Time in ms |
| Missing PDU Indicator | MP | | Boolean | Value true indicates that UE should send a STATUS report for each missing PDU that is detected |
| Timer_STATUS_periodic | OP | | Integer(100, 200, 300, 400, 500, 750, 1000, 2000) | Time in milliseconds |

10.3.4.2 PDCP info

The purpose of the PDCP info IE is to indicate which algorithms shall be established and to configure the parameters of each of the algorithms.

| Information Element/Group name | Need | Multi | Type and reference | Semantics description | Version |
|--------------------------------------|--------------------------------|-----------------------------------|--|---|---------|
| Support for lossless SRNS relocation | CV- <i>LosslessCriteria</i> | | Boolean | TRUE means support | |
| Max PDCP SN window size | CV- <i>Lossless</i> | | Enumerated(sn255, sn65535) | Maximum PDCP sequence number window size. The handling of sequence number when the Max PDCP SN window size is 255 is specified in [23]. | |
| PDCP PDU header | MD | | Enumerated (present, absent) | Whether a PDCP PDU header is existent or not. Default value is "present" | |
| Header compression information | OP | 1 to <maxPDC PAlgoType > | | | |
| >CHOICE <i>algorithm type</i> | MP | | | | |
| >>RFC 2507 | | | | Header compression according to IETF standard RFC 2507 | |
| >>>F_MAX_PERIOD | MD | | Integer (1..65535) | Largest number of compressed non-TCP headers that may be sent without sending a full header. Default value is 256. | |
| >>>F_MAX_TIME | MD | | Integer (1..255) | Compressed headers may not be sent more than F_MAX_TIME seconds after sending last full header. Default value is 5. | |
| >>>MAX_HEADER | MD | | Integer (60..65535) | The largest header size in octets that may be compressed. Default value is 168. | |
| >>>TCP_SPACE | MD | | Integer (3..255) | Maximum CID value for TCP connections. Default value is 15. | |
| >>>NON_TCP_SPACE | MD | | Integer (3..65535) | Maximum CID value for non-TCP connections. Default value is 15. | |
| >>>EXPECT_REORDERING | MD | | Enumerated (reordering not expected, reordering expected) | Whether the algorithm shall reorder PDCP SDUs or not. Default value is "reordering not expected". | |

| | | | | | |
|--------------------------------|----|-----------------------------|----------------------|--|-------|
| >>RFC 3095 | | | | Header compression according to IETF standard RFC 3095 | REL-4 |
| >>>Max_CID | MD | | Integer (1..16383) | Highest context ID number to be used by the compressor. Default value is 15. | REL-4 |
| >>>Profiles | MP | 1 to <maxROHC-Profiles> | | Profiles supported by the decompressor. | REL-4 |
| >>>>Profile instance | MP | | Integer(1 .. 3) | Supported profile types. At least four spare values. | REL-4 |
| >>>MRRU | MD | | Integer (0 .. 65535) | Maximum reconstructed reception unit. Default value is 0 (no segmentation). | REL-4 |
| >>>Packet_Sizes_Allowed | OP | 1 to <maxROHC-PacketSize s> | | List of packet sizes that are allowed to be produced by RFC 3095. | REL-4 |
| >>>>Packet size | MP | | Integer (2 .. 1500) | Packet size as defined in RFC 3095. | REL-4 |
| >>>Reverse-Decompression_Depth | MD | | Integer (0..65535) | Determines whether reverse decompression should be used or not and the maximum number of packets that can be reverse decompressed by the decompressor. Default value is 0 (reverse decompression shall not be used). | REL-4 |

| Condition | Explanation |
|-------------------------|--|
| <i>LosslessCriteria</i> | This IE is present only if the IE "RLC mode" is "Acknowledged" and the IE "In-sequence delivery" is "True". |
| <i>Lossless</i> | This IE shall be present if the IE "Support for lossless SRNS relocation" is TRUE, otherwise it shall be absent. |

10.3.4.3 PDCP SN info

| Information Element/Group name | Need | Multi | Type and Reference | Semantics description |
|--------------------------------|------|-------|--------------------|---|
| Receive PDCP sequence number | MP | | Integer(0..65535) | The PDCP sequence number, which the sender of the message is expecting next to be received. |

10.3.4.4 Polling info

| Information Element/Group name | Need | Multi | Type and reference | Semantics description |
|--------------------------------|------|-------|--|---|
| Timer_poll_prohibit | OP | | Integer(10..50 by step of 10, 600..1000 by step of 50) | Minimum time between polls in ms |
| Timer_poll | OP | | Integer(10..50 by step of 10, 600..1000 by step of 50) | Time in ms. |
| Poll_PDU | OP | | Integer(1,2,4,8,16,32,64,128) | Number of PDUs, interval between pollings |
| Poll_SDU | OP | | Integer(1,4,16,64) | Number of SDUs, interval between pollings |
| Last transmission PDU poll | MP | | Boolean | TRUE indicates that poll is made at last PDU in transmission buffer |
| Last retransmission PDU poll | MP | | Boolean | TRUE indicates that poll is made at last PDU in retransmission buffer |
| Poll_Window | OP | | Integer(50,60,70,80,85,90,95,99) | Percentage of transmission window, threshold for polling |
| Timer_poll_periodic | OP | | Integer(100, 200, 300, 400, 500, 750, 1000, 2000) | Time in milliseconds Timer for periodic polling. |

10.3.4.5 Predefined configuration identity

This information element identifies a pre- defined radio parameter configuration.

| Information Element/Group name | Need | Multi | Type and reference | Semantics description |
|---|------|-------|--------------------|-----------------------|
| Predefined radio configuration identity | MP | | Integer (0..15) | |

10.3.4.6 Predefined configuration value tag

This information element is used to identify different versions of a radio bearer configuration as may be used within one PLMN e.g. to support different UTRAN implementations.

| Information Element/Group name | Need | Multi | Type and Reference | Semantics description |
|------------------------------------|------|-------|--------------------|-----------------------|
| Predefined configuration value tag | MP | | Integer(0..15) | |

10.3.4.7 Predefined RB configuration

This information element concerns a pre- defined configuration of radio bearer parameters

| Information Element/Group name | Need | Multi | Type and Reference | Semantics description |
|--|------|----------------------|---|----------------------------------|
| UE information elements | | | | |
| Re-establishment timer | MP | | Re-establishment timer 10.3.3.30 | Only one RAB supported |
| Signalling radio bearer information | | | | |
| Signalling RB information to setup List | MP | 1 to <maxSRBs setup> | | For each signalling radio bearer |
| >Signalling RB information to setup | MP | | Signalling RB information to setup 10.3.4.24 | |
| RB information | | | | |
| RB information to setup list | MP | 1 to <maxRBperRAB> | | Only one RAB supported |
| >RB information to setup | MP | | RB information to setup 10.3.4.20 | |

10.3.4.8 RAB info

This IE contains information used to uniquely identify a radio access bearer.

| Information Element/Group name | Need | Multi | Type and reference | Semantics description |
|--------------------------------|------|-------|--|-----------------------|
| RAB identity | MP | | RAB identity 10.3.1.14 | |
| CN domain identity | MP | | CN domain identity 10.3.1.1 | |
| NAS Synchronization Indicator | OP | | NAS Synchronization indicator 10.3.4.12 | |
| Re-establishment timer | MP | | Re-establishment timer 10.3.3.30 | |

10.3.4.9 RAB info Post

This IE contains information used to uniquely identify a radio access bearer.

| Information Element/Group name | Need | Multi | Type and reference | Semantics description |
|--------------------------------|------|-------|--|-----------------------|
| RAB identity | MP | | RAB identity 10.3.1.14 | |
| CN domain identity | MP | | CN domain identity 10.3.1.1 | |
| NAS Synchronization Indicator | OP | | NAS Synchronization indicator 10.3.4.12 | |

10.3.4.10 RAB information for setup

| Information Element/Group name | Need | Multi | Type and reference | Semantics description |
|--------------------------------|------|---------------------------|--|-----------------------|
| RAB info | MP | | RAB info 10.3.4.8 | |
| RB information to setup list | MP | 1 to <maxRBpe rRAB> | | |
| >RB information to setup | MP | | RB information to setup 10.3.4.20 | |

10.3.4.11 RAB information to reconfigure

| Information Element/Group name | Need | Multi | Type and reference | Semantics description |
|--------------------------------|------|-------|--|-----------------------|
| RAB identity | MP | | RAB Identity 10.3.1.14 | |
| CN domain identity | MP | | CN domain identity 10.3.1.1 | |
| NAS synchronization indicator | MP | | NAS Synchronizat ion info 10.3.4.12 | |

10.3.4.12 NAS Synchronization indicator

A container for non-access stratum information to be transferred transparently through UTRAN.

| Information Element/Group name | Need | Multi | Type and reference | Semantics description |
|--------------------------------|------|-------|--------------------|---|
| NAS Synchronization indicator | MP | | Bitstring(4) | The bits are numbered b1-b4, where b1 is the least significant bit. |

10.3.4.13 RB activation time info

This IE contains the time, in terms of RLC sequence numbers, when a certain configuration shall be activated, for a number of radio bearers.

| Information Element/Group name | Need | Multi | Type and reference | Semantics description |
|--------------------------------|------|-----------------|--------------------------|--|
| Radio bearer activation time | MP | 1 to <maxRB> | | |
| >RB identity | MP | | RB identity 10.3.4.16 | |
| >RLC sequence number | MP | | Integer (0.. 4095) | RLC SN [16] . Used for radio bearers mapped on RLC AM and UM |

10.3.4.14 RB COUNT-C MSB information

The MSB of the COUNT-C values of the radio bearer.

| Information Element/Group name | Needed | Multi | Type and reference | Semantics description |
|--------------------------------|--------|-------|---------------------------|--|
| RB identity | MP | | RB identity 10.3.4.16 | |
| COUNT-C-MSB-uplink | MP | | Integer (0.. $2^{25}-1$) | 25 MSBs from COUNT-C associated to this RB |
| COUNT-C-MSB-downlink | MP | | Integer (0.. $2^{25}-1$) | 25 MSBs from COUNT-C associated to this RB |

10.3.4.15 RB COUNT-C information

The COUNT-C values of the radio bearer.

| Information Element/Group name | Needed | Multi | Type and reference | Semantics description |
|--------------------------------|--------|-------|---------------------------|-----------------------|
| RB identity | MP | | RB identity 10.3.4.16 | |
| COUNT-C-uplink | MP | | Integer (0.. $2^{32}-1$) | |
| COUNT-C-downlink | MP | | Integer (0.. $2^{32}-1$) | |

10.3.4.16 RB identity

An identification number for the radio bearer affected by a certain message.

| Information Element/Group name | Need | Multi | Type and reference | Semantics description |
|--------------------------------|------|-------|--------------------|--|
| RB identity | MP | | Integer(1..32) | Values 1-4 shall only be used for signalling radio bearers. The IE value minus one shall be used as BEARER in the ciphering algorithm. |

10.3.4.17 RB information to be affected

| Information Element/Group name | Need | Multi | Type and reference | Semantics description |
|--------------------------------|------|-------|---------------------------|-----------------------|
| RB identity | MP | | RB identity 10.3.4.16 | |
| RB mapping info | MP | | RB mapping info 10.3.4.21 | |

10.3.4.18 RB information to reconfigure

| Information Element/Group name | Need | Multi | Type and reference | Semantics description |
|--------------------------------|------|-------|-----------------------------|---|
| RB identity | MP | | RB identity 10.3.4.16 | |
| PDCP info | OP | | PDCP info 10.3.4.2 | |
| PDCP SN info | OP | | PDCP SN info 10.3.4.3 | PDCP sequence number info from the network. Present only in case of lossless SRNS relocation. |
| RLC info | OP | | RLC info 10.3.4.23 | |
| RB mapping info | OP | | RB mapping info 10.3.4.21 | |
| RB stop/continue | OP | | Enumerated(stop, continue) | |

10.3.4.19 RB information to release

| Information Element/Group name | Need | Multi | Type and reference | Semantics description |
|--------------------------------|------|-------|-----------------------|-----------------------|
| RB identity | MP | | RB identity 10.3.4.16 | |

10.3.4.20 RB information to setup

| Information Element/Group name | Need | Multi | Type and reference | Semantics description |
|--------------------------------|------|-------|---------------------------|---|
| RB identity | MP | | RB identity 10.3.4.16 | |
| PDCP info | OP | | PDCP info 10.3.4.2 | |
| CHOICE <i>RLC info type</i> | MP | | | |
| >RLC info | | | RLC info 10.3.4.23 | |
| >Same as RB | | | RB identity 10.3.4.16 | Identity of RB with exactly the same RLC info IE values |
| RB mapping info | MP | | RB mapping info 10.3.4.21 | |

NOTE This information element is included within IE "Predefined RB configuration"

10.3.4.21 RB mapping info

A multiplexing option for each possible transport channel this RB can be multiplexed on.

| Information Element/Group name | Need | Multi | Type and reference | Semantics description |
|---|--------------------------|------------------------|---|---|
| Information for each multiplexing option | MP | 1 to <maxRBMuxOptions> | | |
| >RLC logical channel mapping indicator | CV-UL-RLCLogicalChannels | | Boolean | TRUE indicates that the first logical channel shall be used for data PDUs and the second logical channel shall be used for control PDUs. FALSE indicates that control and data PDUs can be sent on either of the two logical channels. This parameter is not used in this release and shall be set to TRUE. |
| >Number of uplink RLC logical channels | CV-UL-RLC info | 1 to MaxLoCHperRLC | | 1 or 2 logical channels per RLC entity or radio bearer RLC [16] |
| >>Uplink transport channel type | MP | | Enumerated(DCH,RACH, CPCH,USCH) | CPCH is FDD only USCH is TDD only |
| >>ULTransport channel identity | CV-UL-DCH/USCH | | Transport channel identity 10.3.5.18 | This is the ID of a DCH or USCH (TDD only) that this RB could be mapped onto. |
| >>Logical channel identity | OP | | Integer(1..15) | This parameter is used to distinguish logical channels multiplexed by MAC on a transport channel. |
| >>CHOICE RLC size list | MP | | | The RLC sizes that are allowed for this logical channel For radio bearers mapped to RACH, "Explicit list" is the only valid choice. The UE shall regard all other choices as undefined IE values and handle these as specified in clause 9. |
| >>>All | | | Null | All RLC sizes listed in the <i>Transport Format Set</i> . 10.3.5.23 |
| >>>Configured | | | Null | The RLC sizes configured for this logical channel in the <i>Transport Format Set</i> . 10.3.5.23 if present in this message or in the previously stored configuration otherwise |
| >>>Explicit List | | 1 to <maxTF> | | Lists the RLC sizes that are valid for the logical channel. |
| >>>>RLC size index | MP | | Integer(1..maxTF) | The integer number is a reference to the <i>RLC size</i> which arrived at that position in the <i>Transport Format Set</i> 10.3.5.23 |
| >>MAC logical channel priority | MP | | Integer(1..8) | This is priority between a user's different RBs (or logical channels). [15] |
| >Downlink RLC logical channel info | CV-DL-RLC info | | | |
| >>Number of downlink RLC logical channels | MD | 1 to MaxLoCHperRLC | | 1 or 2 logical channels per RLC entity or radio bearer RLC [16] Default value is that parameter values for DL are exactly the same as for corresponding UL |

| | | | | |
|---------------------------------------|------------|--|--------------------------------------|---|
| | | | | logical channel. In case two multiplexing options are specified for the UL, the first options shall be used as default for the DL. As regards to the IE "Channel type", rule is specified in 8.6.4.8. |
| >>>Downlink transport channel type | MP | | Enumerated(DCH,FACH, DSCH,DCH+DSCH) | |
| >>>DL DCH Transport channel identity | CV-DL-DCH | | Transport channel identity 10.3.5.18 | |
| >>>DL DSCH Transport channel identity | CV-DL-DSCH | | Transport channel identity 10.3.5.18 | |
| >>>Logical channel identity | OP | | Integer(1..15) | 16 is reserved |

| Condition | Explanation |
|------------------------------|---|
| <i>UL-RLC info</i> | If "CHOICE <i>Uplink RLC mode</i> " in IE "RLC info" is present this IE is MP. Otherwise the IE is not needed. |
| <i>DL-RLC info</i> | If "CHOICE <i>Downlink RLC mode</i> " in IE "RLC info" is present this IE is MP. Otherwise the IE is not needed. |
| <i>UL-RLCLogicalChannels</i> | If "Number of uplink RLC logical channels" in IE "RB mapping info" is 2, then this is present. Otherwise this IE is not needed. |
| <i>UL-DCH/USCH</i> | If IE "Uplink transport channel type" is equal to "DCH" or "USCH" (TDD only) this IE is MP. Otherwise the IE is not needed. |
| <i>DL-DCH</i> | If IE "Downlink transport channel type" is equal to "DCH" or "DCH+DSCH" this IE is MP. Otherwise the IE is not needed. |
| <i>DL-DSCH</i> | If IE "Downlink transport channel type" is equal to "DSCH" or "DCH+DSCH" this IE is MP. Otherwise the IE is not needed. |

10.3.4.22 RB with PDCP information

| Information Element/Group name | Need | Multi | Type and reference | Semantics description |
|--------------------------------|------|-------|-----------------------|--|
| RB identity | MP | | RB identity 10.3.4.16 | |
| PDCP SN info | MP | | PDCP SN info 10.3.4.3 | PDCP sequence number info from the sender of the message for lossless SRNS relocation. |

10.3.4.23 RLC info

| Information Element/Group name | Need | Multi | Type and reference | Semantics description |
|---------------------------------|------|-------|---|---|
| CHOICE <i>Uplink RLC mode</i> | OP | | | Indicates if Acknowledged, Unacknowledged or Transparent mode RLC shall be used. |
| >AM RLC | | | | |
| >>Transmission RLC discard | MP | | Transmission RLC discard 10.3.4.25 | |
| >>Transmission window size | MP | | Integer(1,8,16,32,64,128,256,512,768,1024,1536,2047,2560,3072,3584,4095) | Maximum number of RLC PUs sent without getting them acknowledged. This parameter is needed if acknowledged mode is used. UE shall also assume that the UTRAN receiver window is equal to this value. |
| >>Timer_RST | MP | | Integer(50, 100, 150, 200, 250, 300, 350, 400, 450, 500, 550, 600, 700, 800, 900, 1000) | Elapsed time in milliseconds. It is used to trigger the retransmission of RESET PDU. |
| >>Max_RST | MP | | Integer(1, 4, 6, 8, 12, 16, 24, 32) | The maximum number of retransmission of RESET PDU |
| >>Polling info | OP | | Polling info 10.3.4.4 | |
| >UM RLC | | | | |
| >>Transmission RLC discard | OP | | Transmission RLC discard 10.3.4.25 | |
| >TM RLC | | | | |
| >>Transmission RLC discard | OP | | Transmission RLC discard 10.3.4.25 | |
| >>Segmentation indication | MP | | Boolean | TRUE indicates that segmentation is performed. |
| CHOICE <i>Downlink RLC mode</i> | OP | | | Indicates if Acknowledged, Unacknowledged or Transparent mode RLC shall be used |
| >AM RLC | | | | |
| >>In-sequence delivery | MP | | Boolean | TRUE indicates that RLC shall preserve the order of higher layer PDUs when these are delivered. FALSE indicates that receiving RLC entity could allow SDUs to be delivered to the higher layer in different order than submitted to RLC sublayer at the transmitting side. |
| >>Receiving window size | MP | | Integer(1,8,16,32,64,128,256,512,768,1024,1536,2047,2560,3072,3584,4095) | Maximum number of RLC PUs allowed to be received. This parameter is needed if acknowledged mode is used. UE shall also assume that the UTRAN transmitter window is equal to this value |
| >>Downlink RLC status Info | MP | | Downlink RLC status info 10.3.4.1 | |
| >UM RLC | | | | (No data) |
| >TM RLC | | | | |

| | | | | |
|---------------------------|----|--|---------|--|
| >>Segmentation indication | MP | | Boolean | TRUE indicates that segmentation is performed. |
|---------------------------|----|--|---------|--|

NOTE This information element is included within IE "Predefined RB configuration"

10.3.4.24 Signalling RB information to setup

| Information Element/Group name | Need | Multi | Type and reference | Semantics description |
|--------------------------------|------|-------|------------------------------|---|
| RB identity | MD | | RB identity 10.3.4.16 | Default value is specified in subclause 8.6.4.1 |
| <i>CHOICE RLC info type</i> | MP | | | |
| >RLC info | | | RLC info 10.3.4.23 | |
| >Same as RB | | | RB identity 10.3.4.16 | Identity of RB with exactly the same RLC info IE values |
| RB mapping info | MP | | RB mapping info 10.3.4.21 | |

NOTE This information element is included within IE "Predefined RB configuration"

10.3.4.25 Transmission RLC Discard

| Information Element/Group name | Need | Multi | Type and reference | Semantics description |
|--------------------------------|------|-------|---|--|
| CHOICE <i>SDU Discard Mode</i> | MP | | | Different modes for discharge the RLC buffer on the transmitter side; "Timer based with explicit signalling", "Timer based without explicit signalling", "Discard after Max_DAT retransmissions" or "No_discard". For unacknowledged mode and transparent mode, only Timer based without explicit signalling is applicable. If "No_discard" is used, reset procedure shall be done after Max_DAT retransmissions |
| >Timer based explicit | | | | |
| >>Timer_MRW | MP | | Integer(50,60, 70, 80, 90, 100, 120, 140, 160, 180, 200, 300, 400, 500, 700, 900) | Elapsed time in milliseconds. It is used to trigger the retransmission of a STATUS PDU containing an MRW SUFI field |
| >>Timer_discard | MP | | Integer(100, 250, 500, 750, 1000, 1250, 1500, 1750, 2000, 2500, 3000, 3500, 4000, 4500, 5000, 7500) | Elapsed time in milliseconds before a SDU is discarded. |
| >>MaxMRW | MP | | Integer(1, 4, 6, 8, 12, 16, 24, 32) | It is the maximum value for the number of retransmissions of a MRW command |
| >Timer based no explicit | | | | |
| >>Timer_discard | MP | | Integer(10,20,30,40,50,60,70,80,90,100) | Elapsed time in milliseconds before a SDU is discarded. |
| >Max DAT retransmissions | | | | |
| >>Max_DAT | MP | | Integer(1, 2, 3, 4, 5, 6, 7, 8, 9, 10, 15, 20, 25, 30, 35, 40) | Number of retransmissions of a PDU before a SDU is discarded. |
| >>Timer_MRW | MP | | Integer(50, 60, 70, 80, 90, 100, 120, 140, 160, 180, 200, 300, 400, 500, 700, 900) | Elapsed time in milliseconds. It is used to trigger the retransmission of a STATUS PDU containing an MRW SUFI field |
| >>MaxMRW | MP | | Integer(1, 4, 6, 8, 12, 16, 24, 32) | It is the maximum value for the number of retransmissions of a MRW command |
| >No discard | | | | |
| >>Max_DAT | MP | | Integer(1, 2, 3, 4, 5, 6, 7, 8, 9, 10, 15, 20, 25, 30, | Number of retransmissions of a PDU before the RLC entity is reset. |

| | | | | |
|--|--|--|---------|--|
| | | | 35, 40) | |
|--|--|--|---------|--|

| CHOICE SDU Discard Mode | Condition under which the given SDU Discard Mode is chosen |
|--------------------------------|---|
| Timer based explicit | If the modes for discharge of the RLC buffer on the transmitter side is "Timer based with explicit signalling" |
| Timer based no explicit | If the modes for discharge of the RLC buffer on the transmitter side is "Timer based without explicit signalling" For unacknowledged mode, only Timer based without explicit signalling is applicable. |
| Max DAT retransmissions | If the modes for discharge of the RLC buffer on the transmitter side is "Discard after Max_DAT retransmissions" |
| No discard | If the modes for discharge the of RLC buffer on the transmitter side is "Reset procedure shall be done after Max_DAT retransmissions" |

10.3.5 Transport CH Information elements

10.3.5.1 Added or Reconfigured DL TrCH information

| Information Element/Group name | Need | Multi | Type and reference | Semantics description |
|---------------------------------------|--------------------|--------------|--|--|
| Downlink transport channel type | MP | | Enumerated(DCH,DSCH) | |
| DL Transport channel identity | MP | | Transport channel identity 10.3.5.18 | |
| CHOICE DL parameters | | | | |
| >Explicit | | | | |
| >>TFS | MP | | Transport Format Set 10.3.5.23 | |
| >SameAsUL | | | | |
| >>Uplink transport channel type | MP | | Enumerated(DCH,USCH) | USCH is TDD only |
| >>UL TrCH identity | MP | | Transport channel identity 10.3.5.18 | Same TFS applies as specified for indicated UL TrCH |
| DCH quality target | OP | | Quality target 10.3.5.10 | |
| Transparent mode signalling info | CV- MessageType | | Transparent mode signalling info 10.3.5.17 | This IE is not used in RB RELEASE message nor RB RECONFIGURATION message |

| Condition | Explanation |
|------------------|---|
| MessageType | This IE is absent in Radio Bearer Release message and Radio Bearer Reconfiguration message. Otherwise it is OPTIONAL. |

10.3.5.2 Added or Reconfigured UL TrCH information

| Information Element/Group name | Need | Multi | Type and reference | Semantics description |
|--------------------------------|------|-------|---|-----------------------|
| Uplink transport channel type | MP | | Enumerated(DCH,USCH) | USCH is TDD only |
| UL Transport channel identity | MP | | Transport channel identity 10.3.5.18 | |
| TFS | MP | | Transport Format Set 10.3.5.23 | |

NOTE This information element is included within IE "Predefined RB configuration"

10.3.5.3 CPCH set ID

NOTE: Only for FDD.

This information element indicates that this transport channel may use any of the Physical CPCH channels defined in the CPCH set info, which contains the same CPCH set ID. The CPCH set ID associates the transport channel with a set of PCPCH channels defined in a CPCH set info IE and a set of CPCH persistency values. The CPCH set info IE(s) and the CPCH persistency values IE(s) each include the CPCH set ID and are part of the SYSTEM INFORMATION message

| Information Element/Group name | Need | Multi | Type and reference | Semantics description |
|--------------------------------|------|-------|--------------------------|--|
| CPCH set ID | MP | | Integer(1...maxCPCHsets) | Identifier for CPCH set info and CPCH persistency value messages |

10.3.5.4 Deleted DL TrCH information

| Information Element/Group name | Need | Multi | Type and reference | Semantics description |
|---------------------------------|------|-------|---|-----------------------|
| Downlink transport channel type | MP | | Enumerated(DCH,DSCH) | |
| DL Transport channel identity | MP | | Transport channel identity 10.3.5.18 | |

10.3.5.5 Deleted UL TrCH information

| Information Element/Group name | Need | Multi | Type and reference | Semantics description |
|--------------------------------|------|-------|---|-----------------------|
| Uplink transport channel type | MP | | Enumerated(DCH,USCH) | USCH is TDD only |
| UL Transport channel identity | MP | | Transport channel identity 10.3.5.18 | |

10.3.5.6 DL Transport channel information common for all transport channels

| Information Element/Group name | Need | Multi | Type and reference | Semantics description |
|------------------------------------|------|------------------|---|---|
| SCCPCH TFCS | OP | | Transport Format Combination Set 10.3.5.20 | This IE should be absent within IE "Predefined RB configuration" |
| CHOICE <i>mode</i> | MP | | | Although this IE is not always required, need is MP to align with ASN.1 |
| >FDD | | | | |
| >>CHOICE <i>DL parameters</i> | OP | | | |
| >>>Explicit | | | | |
| >>>>DL DCH TFCS | MP | | Transport Format Combination Set 10.3.5.20 | Although this IE is not always required, need is MP to align with ASN.1 |
| >>>SameAsUL | | | | (no data) |
| >TDD | | | | |
| >>Individual DL CCTrCH information | OP | 1 to <maxCCTrCH> | | |
| >>>DL TFCS Identity | MP | | Transport format combination set identity 10.3.5.21 | Identifies a special CCTrCH for shared or dedicated channels. |
| >>>CHOICE <i>DL parameters</i> | MP | | | |
| >>>>Independent | | | | |
| >>>>>DL TFCS | MP | | Transport format combination set 10.3.5.20 | |
| >>>>SameAsUL | | | | |
| >>>>>UL DCH TFCS Identity | MP | | Transport format combination set identity 10.3.5.21 | Same TFCS applies as specified for the indicated UL DCH TFCS identity except for information applicable for UL only |

NOTE This information element is included within IE "Predefined TrCh configuration"

10.3.5.7 DRAC Static Information

NOTE: Only for FDD.

Contains static parameters used by the DRAC procedure. Meaning and use is described in subclause 14.8.

| Information Element/Group name | Need | Multi | Type and reference | Semantics description |
|--------------------------------|------|-------|----------------------------|--|
| Transmission Time Validity | MP | | Integer(1..256) | number of frames |
| Time duration before retry | MP | | Integer(1..256) | number of frames |
| DRAC Class Identity | MP | | Integer(1..maxDRACclasses) | Indicates the class of DRAC parameters to use in SIB10 message |

10.3.5.8 Power Offset Information

| Information Element/Group name | Need | Multi | Type and reference | Semantics description |
|---------------------------------|------|-------|--------------------|---|
| CHOICE <i>Gain Factors</i> | MP | | | |
| >Signalled Gain Factors | | | | |
| >>CHOICE <i>mode</i> | | | | |
| >>>FDD | | | | |
| >>>>Gain Factor β_c | MP | | Integer (0.. 15) | For UL DPCCH or control part of PRACH or PCPCH |
| >>>TDD | | | | (no data) |
| >>Gain Factor β_d | MP | | Integer (0..15) | For UL DPDCH or data part of PRACH or PCPCH in FDD and all uplink channels in TDD |
| >>Reference TFC ID | OP | | Integer (0..3) | If this TFC is a reference TFC, indicates the reference ID. |
| >Computed Gain Factors | | | | |
| >>Reference TFC ID | MP | | Integer (0.. 3) | Indicates the reference TFC Id of the TFC to be used to calculate the gain factors for this TFC. In case of using computed gain factors, at least one signalled gain factor is necessary for reference. |
| CHOICE <i>mode</i> | MP | | | |
| >FDD | | | | |
| >>Power offset P _{p-m} | OP | | Integer(-5..10) | In dB. Power offset between the last transmitted preamble and the control part of the message (added to the preamble power to receive the power of the message control part) Needed only for PRACH |
| >TDD | | | | (no data) |

| CHOICE <i>Gain Factors</i> | Condition under which the way to signal the <i>Gain Factors</i> is chosen |
|-------------------------------|---|
| <i>Signalled Gain Factors</i> | The values for gain factors β_c (only in FDD mode) and β_d are signalled directly for a TFC. |
| <i>Computed Gain Factors</i> | The gain factors β_c (only in FDD mode) and β_d are computed for a TFC, based on the signalled settings for the associated reference TFC. |

10.3.5.9 Predefined TrCH configuration

This information element concerns a pre- defined configuration of transport channel parameters.

| Information Element/Group name | Need | Multi | Type and Reference | Semantics description |
|--|------|------------------------|---|-----------------------|
| UL Transport channel information common for all transport channels | MP | | UL Transport channel information common for all transport channels 10.3.5.24 | |
| Added or Reconfigured TrCH information | | | | |
| Added or Reconfigured UL TrCH information | MP | 1 to <maxTrCH preconf> | | |
| >Added or Reconfigured UL TrCH information | MP | | Added or Reconfigured UL TrCH information 10.3.5.2 | |
| DL Transport channel information common for all transport channels | MP | | DL Transport channel information common for all transport channels 10.3.5.6 | |
| Downlink transport channels | | | | |
| Added or Reconfigured DL TrCH information | MP | 1 to <maxTrCH preconf> | | |
| >Added or Reconfigured DL TrCH information | MP | | Added or Reconfigured DL TrCH information 10.3.5.1 | |

10.3.5.10 Quality Target

| Information Element/Group name | Need | Multi | Type and reference | Semantics description |
|--------------------------------|------|-------|-------------------------------|---|
| BLER Quality value | MP | | Real(-6.3 ..0 by step of 0.1) | Signalled value is Log10(Transport channel BLER quality target) |

10.3.5.11 Semi-static Transport Format Information

| Information Element/Group name | Need | Multi | Type and reference | Semantics description | Version |
|--------------------------------|------------------|-------|---|--|---------|
| Transmission time interval | MP | | Integer(5, 10, 20, 40, 80, dynamic) | In ms. The value dynamic is only used in TDD mode. 5 is only applicable for the RACH in 1.28 Mcps TDD | REL-4 |
| Type of channel coding | MP | | Enumerated(No coding, Convolutional, Turbo) | | |
| Coding Rate | <i>CV-Coding</i> | | Enumerated(1/2, 1/3) | | |
| Rate matching attribute | MP | | Integer(1..hi RM) | | |
| CRC size | MP | | Integer(0, 8, 12, 16, 24) | in bits | |

| Condition | Explanation |
|---------------|---|
| <i>Coding</i> | This IE is only present if IE "Type of channel coding" is "Convolutional" |

10.3.5.12 TFCI Field 2 Information

This IE is used for signalling the mapping between TFCI (field 2) values and the corresponding TFC.

| Information Element/Group name | Need | Multi | IE type and reference | Semantics description |
|--|------|------------------------------|---|--|
| CHOICE <i>Signalling method</i> | MP | | | |
| >TFCI range | | | | |
| >>TFCI(field 2) range | MP | 1 to <maxPDS CH-TFCI groups> | | |
| >>>Max TFCI(field2) value | MP | | Integer(1..1023) | This is the Maximum value in the range of TFCI(field2) values for which the specified CTFC(field2) applies |
| >>>TFCS Information for DSCH (TFCI range method) | MP | | TFCS Information for DSCH (TFCI range method) 10.3.5.14 | |
| >Explicit | | | | |
| >>TFCS explicit configuration | MP | | TFCS explicit configuration 10.3.5.13 | |

10.3.5.13 TFCS Explicit Configuration

| Information Element/Group name | Need | Multi | IE type and reference | Semantics description |
|---|------|-------|---|-----------------------|
| CHOICE <i>TFCS representation</i> | MP | | | |
| >Complete reconfiguration | | | | |
| >>TFCS complete reconfiguration information | MP | | TFCS Reconfiguration/Addition information 10.3.5.15 | |
| >Addition | | | | |
| >>TFCS addition information | MP | | TFCS Reconfiguration/Addition information 10.3.5.15 | |
| >Removal | | | | |
| >>TFCS removal information | MP | | TFCS Removal Information 10.3.5.16 | |
| >Replace | | | | |
| >>TFCS removal information | MP | | TFCS Removal Information 10.3.5.16 | |
| >>TFCS addition information | MP | | TFCS Reconfiguration/Addition information 10.3.5.15 | |

10.3.5.14 TFCS Information for DSCH (TFCI range method)

| Information Element/Group name | Need | Multi | IE type and reference | Semantics description |
|--------------------------------|------|-------|-----------------------|-----------------------|
| CHOICE <i>CTFC Size</i> | MP | | | |
| >2 bit CTFC | | | | |
| >>2bit CTFC | MP | | Integer(0..3) | |
| >4 bit CTFC | | | | |
| >>4bit CTFC | MP | | Integer(0..15) | |
| >6 bit CTFC | | | | |
| >>6 bit CTFC | MP | | Integer(0..63) | |
| >8 bit CTFC | | | | |
| >>8 bit CTFC | MP | | Integer(0..255) | |
| >12 bit CTFC | | | | |
| >>12 bit CTFC | MP | | Integer(0..4095) | |
| >16 bit CTFC | | | | |
| >>16 bit CTFC | MP | | Integer(0..65535) | |
| >24 bit CTFC | | | | |
| >>24 bit CTFC | MP | | Integer(0..16777215) | |

10.3.5.15 TFCS Reconfiguration/Addition Information

| Information Element/Group name | Need | Multi | IE type and reference | Semantics description |
|--------------------------------|------|---------------|-----------------------------------|---|
| CHOICE <i>CTFC Size</i> | MP | | | |
| >2 bit CTFC | | | | |
| >>CTFC information | MP | 1 to <maxTFC> | | |
| >>>2bit CTFC | MP | | Integer(0..3) | |
| >>>Power offset Information | OP | | Power Offset Information 10.3.5.8 | Needed only for uplink physical channels. |
| >4 bit CTFC | | | | |
| >>CTFC information | MP | 1 to <maxTFC> | | |
| >>>4bit CTFC | MP | | Integer(0..15) | |
| >>>Power offset Information | OP | | Power Offset Information 10.3.5.8 | Needed only for uplink physical channels. |
| >6 bit CTFC | | | | |
| >>CTFC information | MP | 1 to <maxTFC> | | |
| >>>6 bit CTFC | MP | | Integer(0..63) | |
| >>>Power offset Information | OP | | Power Offset Information 10.3.5.8 | Needed only for uplink physical channels. |
| >8 bit CTFC | | | | |
| >>CTFC information | MP | 1 to <MaxTFC> | | |
| >>>8 bit CTFC | MP | | Integer(0..255) | |
| >>>Power offset Information | OP | | Power Offset Information 10.3.5.8 | Needed only for uplink physical channels. |
| >12 bit CTFC | | | | |
| >>CTFC information | MP | 1 to <maxTFC> | | |
| >>>12 bit CTFC | MP | | Integer(0..4095) | |
| >>>Power offset Information | OP | | Power Offset Information 10.3.5.8 | Needed only for uplink physical channels. |
| >16 bit CTFC | | | | |
| >>CTFC information | MP | 1 to <maxTFC> | | |
| >>>16 bit CTFC | MP | | Integer(0..65535) | |
| >>>Power offset Information | OP | | Power Offset Information 10.3.5.8 | Needed only for uplink physical channels. |
| >24 bit CTFC | | | | |
| >>CTFC information | MP | 1 to <MaxTFC> | | |
| >>>24 bit CTFC | MP | | Integer(0..16777215) | |
| >>>Power offset Information | OP | | Power Offset Information 10.3.5.8 | Needed only for uplink physical channels. |

10.3.5.16 TFCS Removal Information

| Information Element/Group name | Need | Multi | IE type and reference | Semantics description |
|--------------------------------|------|---------------|---|------------------------------|
| Removal TFCI information | MP | 1 to <maxTFC> | | |
| >TFCI | MP | | Transport Format Combination (TFC) 10.3.5.19 | In TDD 0 is a reserved value |

10.3.5.17 Transparent mode signalling info

| Information Element | Need | Multi | Type and reference | Semantics description |
|---|------|----------------|---|--|
| Type of message | MP | | Enumerated (TRANSPORT FORMAT COMBINATION CONTROL) | Indicates which type of message sent on the transparent mode signalling DCCH |
| CHOICE <i>Transparent signalling mode</i> | MP | | | |
| >Mode 1 | | | | (no data) |
| >Mode 2 | | | | |
| >>Controlled transport channels list | MP | 1 to <maxTrCH> | | The transport channels that are effected by the rate control commands sent on this transparent mode DCCH |
| >>>UL Controlled transport channels | MP | | Transport channel identity, 10.3.5.18 | transport channel type = DCH |

10.3.5.18 Transport channel identity

This information element is used to distinguish transport channels. Transport channels of different type (RACH, CPCH, USCH, FACH/PCH, DSCH or DCH) have separate series of identities. This also holds for uplink and downlink transport channel identities (i.e. for DCH). Depending on in which context a transport channel identity n that is sent, it will have different meaning

| Information Element/Group name | Need | Multi | Type and reference | Semantics description |
|--------------------------------|------|-------|--------------------|-----------------------|
| Transport channel identity | MP | | Integer(1..32) | |

10.3.5.19 Transport Format Combination (TFC)

| Information Element/Group name | Need | Multi | Type and reference | Semantics description |
|--------------------------------|------|-------|--------------------|-----------------------|
| Transport format combination | MP | | Integer (0..1023) | |

10.3.5.20 Transport Format Combination Set

Indicates the allowed combinations of already defined Transport formats and the mapping between these allowed TFCs and the corresponding TFCI values.

For TDD, different coded composite transport channels have independent transport format combination sets and thus independent TFCI values.

For FDD, Where the UE is assigned access to one or more DSCH transport channels, a TFCI(field2) is used to signal the transport format combination for the DSCH. The following two cases exist:

- Case 1:
Using one TFCI-word on the physical layer. A logical split determines the available number of transport format combinations for DCH and DSCH.
- Case 2:
Using split TFCI on the physical layer. Two TFCI-words, each having a static length of five bits, are used.

| Information Element/Group name | Need | Multi | IE type and reference | Semantics description |
|--------------------------------|------|-------|---------------------------------------|---|
| CHOICE <i>TFCI signalling</i> | MP | | | 'Normal' : meaning no split in the TFCI field (either 'Logical' or 'Hard') 'Split' : meaning there is a split in the TFCI field (either 'Logical' or 'Hard'). This value is only valid for FDD downlink when using DSCH. |
| >Normal | | | | |
| >>TFCI Field 1 Information | MP | | TFCS explicit Configuration 10.3.5.13 | |
| >Split | | | | |
| >>Split type | OP | | Enumerated ('Hard', 'Logical') | 'Hard' : meaning that TFCI (field 1) and TFCI (field 2) are each 5 bits long and each field is block coded separately. 'Logical' : meaning that on the physical layer TFCI (field 1) and TFCI (field 2) are concatenated, field 1 taking the most significant bits and field 2 taking the least significant bits). The whole is then encoded with a single block code. |
| >>Length of TFCI(field2) | OP | | Integer (1..10) | This IE indicates the length measured in number of bits of TFCI(field2) |
| >>TFCI Field 1 Information | OP | | TFCS explicit Configuration 10.3.5.13 | |
| >>TFCI Field 2 Information | OP | | TFCI field 2 information 10.3.5.12 | |

| CHOICE <i>TFCI signalling</i> | Condition under which <i>TFCI signalling type</i> is chosen |
|-------------------------------|---|
| Normal | It is chosen when no split in the TFCI field. |
| Split | It is chosen when split in the TFCI field. This value is only valid for FDD downlink when using DSCH. |

10.3.5.21 Transport Format Combination Set Identity

NOTE: Only for TDD.

| Information Element/Group name | Need | Multi | Type and reference | Semantics description |
|--------------------------------|------|-------|--------------------|---|
| TFCS ID | MD | | Integer (1..8) | Indicates the identity of every TFCS within a UE. Default value is 1. |
| Shared Channel Indicator | MP | | Boolean | TRUE indicates the use of shared channels. Default is false. |

10.3.5.22 Transport Format Combination Subset

Indicates which Transport format combinations in the already defined Transport format combination set are allowed.

| Information Element/Group name | Need | Multi | Type and reference | Semantics description |
|---|------|-----------------|--|-----------------------|
| <i>CHOICE Subset representation</i> | MP | | | |
| >Minimum allowed Transport format combination index | | | Transport format combination 10.3.5.19 | |
| >Allowed transport format combination list | | 1 to <maxTFC> | | |
| >>Allowed transport format combination | MP | | Transport format combination 10.3.5.19 | |
| >Non-allowed transport format combination list | | 1 to <maxTFC> | | |
| >>Non-allowed transport format combination | MP | | Transport format combination 10.3.5.19 | |
| >Restricted TrCH information | | 1 to <maxTrCH > | | |
| >>Uplink transport channel type | MP | | Enumerated(DCH, USCH) | USCH is TDD only |
| >>Restricted UL TrCH identity | MP | | Transport channel identity 10.3.5.18 | |
| >>Allowed TFIs | OP | 1 to <maxTF> | | |
| >>>Allowed TFI | MP | | Integer(0..31) | |
| >Full transport format combination set | | | | (No data) |

10.3.5.23 Transport Format Set

| Information Element/Group name | Need | Multi | Type and reference | Semantics description |
|---|----------------------------------|--------------|--|---|
| CHOICE <i>Transport channel type</i> >Dedicated transport channels | MP | | | The transport channel that is configured with this TFS is of type DCH |
| >>Dynamic Transport Format Information | MP | 1 to <maxTF> | | |
| >>>RLC Size | MP | | Integer(0..4992) | Unit is bits |
| >>>Number of TBs and TTI List | MP | 1 to <maxTF> | | Present for every valid number of TB's (and TTI) for this RLC Size. |
| >>>>Transmission Time Interval | CV- <i>dynamicTTI</i> | | Integer(10,20,40,80) | Unit is ms. |
| >>>>Number of Transport blocks | MP | | Integer(0..512) | |
| >>>CHOICE <i>Logical Channel List</i> | MP | | | The logical channels that are allowed to use this RLC Size |
| >>>>ALL | | | Null | All logical channels mapped to this transport channel. |
| >>>>Configured | | | Null | The logical channels configured to use this RLC size in the <i>RB mapping info</i> . 10.3.4.21 if present in this message or in the previously stored configuration otherwise |
| >>>>Explicit List | | 1 to 15 | | Lists the logical channels that are allowed to use this RLC size. |
| >>>>>RB Identity | MP | | RB identity 10.3.4.16 | |
| >>>>>LogicalChannel | CH-UL- <i>RLCLogicalChannels</i> | | Integer(0..1) | Indicates the relevant UL logical channel for this RB. "0" corresponds to the first, "1" corresponds to the second UL logical channel configured for this RB in the IE "RB mapping info". |
| >>Semi-static Transport Format Information | MP | | Semi-static Transport Format Information 10.3.5.11 | |
| >Common transport channels | | | | The transport channel that is configured with this TFS is of a type not equal to DCH |
| >>Dynamic Transport Format Information | MP | 1 to <maxTF> | | Note |
| >>>RLC Size | MP | | Integer(0..4992) | Unit is bits |
| >>>Number of TBs and TTI List | MP | 1 to <maxTF> | | Present for every valid number of TB's (and TTI) for this RLC Size. |
| >>>>Number of Transport blocks | MP | | Integer(0..512) | |
| >>>>CHOICE <i>mode</i> | MP | | | |
| >>>>>FDD | | | | (no data) |
| >>>>>TDD | | | | |
| >>>>>>Transmission Time Interval | CV- <i>dynamicTTI</i> | | Integer(10,20,40,80) | Unit is ms. |

| Information Element/Group name | Need | Multi | Type and reference | Semantics description |
|--|---------------------------------|---------|--|---|
| | / | | | |
| >>>CHOICE <i>Logical Channel List</i> | MP | | | The logical channels that are allowed to use this RLC Size. For radio bearers mapped to RACH, the UE shall regard "Explicit list" as an undefined IE value and handle these as specified in clause 9. |
| >>>>ALL | | | Null | All logical channels mapped to this transport channel. |
| >>>>Configured | | | Null | The logical channels configured to use this RLC size in the <i>RB mapping info</i> . 10.3.4.21 if present in this message or in the previously stored configuration otherwise |
| >>>>Explicit List | | 1 to 15 | | Lists the logical channels that are allowed to use this RLC size. |
| >>>>>RB Identity | MP | | RB identity 10.3.4.16 | |
| >>>>>LogicalChannel | <i>CV-UL-RLCLogicalChannels</i> | | Integer(0..1) | Indicates the relevant UL logical channel for this RB. "0" corresponds to the first, "1" corresponds to the second UL logical channel configured for this RB in the IE "RB mapping info". |
| >>Semi-static Transport Format Information | MP | | Semi-static Transport Format Information 10.3.5.11 | |

| Condition | Explanation |
|------------------------------|--|
| <i>dynamicTTI</i> | This IE is included if dynamic TTI usage is indicated in IE Transmission Time Interval in Semi-static Transport Format Information. Otherwise it is not needed. |
| <i>UL-RLCLogicalChannels</i> | If "Number of uplink RLC logical channels" in IE "RB mapping info" in this message is 2 or the IE "RB mapping info" is not present in this message and 2 UL logical channels are configured for this RB, then this IE is present. Otherwise this IE is not needed. |

NOTE: The parameter "rate matching attribute" is in line with the RAN WG1 specifications. However, it is not currently in line with the description in [34].

10.3.5.24 UL Transport channel information common for all transport channels

| Information Element/Group name | Need | Multi | Type and reference | Semantics description |
|------------------------------------|------|------------------|---|---|
| PRACH TFCS | OP | | Transport format combination set 10.3.5.20 | This IE should not be included in this version of the protocol. |
| CHOICE <i>mode</i> | OP | | | |
| >FDD | | | | |
| >>TFC subset | MD | | Transport Format Combination Subset 10.3.5.22 | Default value is the complete existing set of transport format combinations |
| >>UL DCH TFCS | MP | | Transport formation combination set 10.3.5.20 | |
| >TDD | | | | |
| >>Individual UL CCTrCH information | OP | 1 to <maxCCTrCH> | | |
| >>>UL TFCS Identity | MP | | Transport format combination set identity 10.3.5.21 | Identifies a special CCTrCH for shared or dedicated channels. |
| >>>UL TFCS | MP | | Transport format combination set 10.3.5.20 | |
| >>>TFC subset | MD | | Transport Format Combination Subset 10.3.5.22 | Default value is the complete existing set of transport format combinations |

NOTE This information element is included within IE "Predefined TrCh configuration"

10.3.6 Physical CH Information elements

10.3.6.1 AC-to-ASC mapping

| Information Element/Group name | Need | Multi | Type and reference | Semantics description |
|--------------------------------|------|-----------|--------------------|---|
| AC-to-ASC mapping table | MP | maxASCmap | | |
| >AC-to-ASC mapping | MP | | Integer(0...7) | Mapping of Access Classes to Access Service Classes (see subclause 8.5.13.) |

10.3.6.2 AICH Info

NOTE: Only for FDD.

| Information Element/Group name | Need | Multi | Type and reference | Semantics description |
|--------------------------------|------|-------|-----------------------------|--|
| Channelisation code | MP | | Integer(0..255) | SF is fixed and equal to 256 |
| STTD indicator | MP | | STTD Indicator 10.3.6.78 | |
| AICH transmission timing | MP | | Enumerated (0, 1) | See parameter AICH_Transmission_Timing in [26] |

10.3.6.3 AICH Power offset

NOTE: Only for FDD.

This parameter is used to indicate the power level of AICH, AP-AICH and CD/CA-ICH channels. This is the power per transmitted Acquisition Indicator, AP Acquisition Indicator or CD/CA Indicator minus power of the Primary CPICH.

| Information Element/Group name | Need | Multi | Type and reference | Semantics description |
|--------------------------------|------|-------|--------------------|-----------------------|
| AICH Power offset | MP | | Integer(-22..+5) | Offset in dB |

10.3.6.4 Allocation period info

NOTE: Only for TDD.

Parameters used by UE to determine period of shared channel allocation.

| Information Element/Group name | Need | Multi | Type and reference | Semantics description |
|--------------------------------|------|-------|---------------------|---|
| Allocation Activation Time | MP | | Integer (0..255) | Start the allocation period at the given CFN. |
| Allocation Duration | MP | | Integer (1..256) | Total number of frames for the allocation period. |

10.3.6.5 Alpha

| Information Element/Group name | Need | Multi | Type and reference | Semantics description |
|--------------------------------|------|-------|---|-----------------------|
| Alpha Value | MP | | Enumerated(0, 1/8, 2/8, 3/8, 4/8, 5/8, 6/8, 7/8, 1) | |

10.3.6.6 ASC setting

| Information Element/Group name | Need | Multi | Type and reference | Semantics description | Version |
|--|------|-------|--------------------|--|---------|
| CHOICE <i>mode</i> | MP | | | | |
| >FDD | | | | | |
| >>Available signature Start Index | MP | | Integer(0..15) | | |
| >>Available signature End Index | MP | | Integer(0..15) | | |
| >>Assigned Sub-Channel Number | MP | | Bitstring(4) | This IE defines the subchannel assignment as specified in 8.6.6.29. The bits are numbered b0 to b3, where b0 is the least significant bit. | |
| >TDD | | | | | |
| >>CHOICE <i>TDD option</i> | MP | | | | REL-4 |
| >>>3.84 Mcps TDD | | | | | REL-4 |
| >>>>Available Channelisation codes indices | MD | | Bitstring(8) | Each bit indicates availability of a channelisation code index, where the channelisation code indices are numbered "channelisation code index 0" to "channelisation code index 7". The value 1 of a bit indicates that the channelisation code index is available for the ASC this IE is associated to. The value 0 of a bit indicates that the channelisation code index is not available for the ASC this IE is associated to. Default is that all channelisation codes defined in PRACH Info are available. | |
| >>>>1.28 Mcps TDD | | | | | REL-4 |
| >>>>Available SYNC_UL codes indices | MD | | Bitstring(8) | Each bit indicates availability of a SYNC_UL code index, where the SYNC_UL code indices are numbered "SYNC_UL code index 0" to "SYNC_UL code index 7". The value 1 of a bit indicates that the SYNC_UL code index is available for the ASC this IE is | REL-4 |

| | | | | | |
|---------------------------------|----|--|---------------|---|--|
| | | | | associated to. The value 0 of a bit indicates that the SYNC_UL code index is not available for the ASC this IE is associated to. Default is that all SYNC_UL codes defined in SYNC_UL Info are available. | |
| >>CHOICE <i>subchannel size</i> | MP | | | | |
| >>>Size1 | | | | | |
| >>>>Available Subchannels | MP | | null | Indicates that all Subchannels are available | |
| >>>Size2 | | | | | |
| >>>>Available Subchannels | MD | | Bitstring (2) | NOTE 1 | |
| >>>Size4 | | | | | |
| >>>>Available Subchannels | MD | | Bitstring (4) | NOTE 1 | |
| >>>Size8 | | | | | |
| >>>>Available Subchannels | MD | | Bitstring (8) | NOTE 1 | |

NOTE 1: Each bit indicates availability of a subchannel, where the subchannels are numbered subchannel 0, subchannel 1 etc. The value 1 of a bit indicates that the subchannel is available for the ASC this IE is associated with. The value 0 of a bit indicates that the subchannel is not available for the ASC this IE is associated with. Default value of the IE is that all subchannels within the size are available for the ASC this IE is associated with.

10.3.6.7 Block STTD indicator

NOTE: Only for TDD

| Information Element/Group name | Need | Multi | Type and reference | Semantics description |
|--------------------------------|------|-------|--------------------|--|
| Block STTD indicator | MP | | Boolean | TRUE indicates that block STTD is used |

10.3.6.8 CCTrCH power control info

Parameters used by UE to set the SIR target value for uplink open loop power control in TDD.

| Information Element/Group name | Need | Multi | Type and Reference | Semantics description |
|--------------------------------|------|-------|---|---|
| TFCS Identity | OP | | Transport Format Combination Set Identity 10.3.5.21 | TFCS Identity of this CCTrCH. Default value is 1. |
| Uplink DPCH power control info | MP | | Uplink DPCH power control info 10.3.6.91 | |

10.3.6.8a Cell and Channel Identity info

NOTE: Only for TDD.

| Information Element/Group name | Need | Multi | Type and Reference | Semantics description |
|--------------------------------|------|-------|--------------------------------|---|
| Burst type | MP | | Enumerated (Type1, Type2) | Identifies the channel in combination with the Midamble shift and slot number |
| Midamble Shift | MP | | Integer (0...15) | |
| Time Slot | OP | | Timeslot number 10.3.6.84 | This IE is present only if no IPDL scheme is configured in the reference cell. Otherwise the slot is defined by the IPDL configuration. |
| Cell parameters ID | MP | | Cell parameters ID 10.3.6.9 | Identifies the cell |

10.3.6.9 Cell parameters Id

| Information Element/Group name | Need | Multi | Type and Reference | Semantics description |
|--------------------------------|------|-------|--------------------|-----------------------|
| Cell parameter Id | MP | | Integer(0..127) | |

10.3.6.10 Common timeslot info

| Information Element/Group name | Need | Multi | Type and reference | Semantics description |
|-----------------------------------|------|-------|-----------------------------------|---|
| 2 nd interleaving mode | MD | | Enumerated (Frame, Timeslot) | Frame timeslot related interleaving. Default value is "Frame" |
| TFCI coding | MD | | Integer(4,8,16,32) | Describes the amount of bits for the TFCI bits code word as described in [31]. Defaults is no TFCI bit: In case of 8 PSK in 1.28Mcps TDD: 4 corresponds to 6 TFCI code word bits. 8 corresponds to 12 TFCI code word bits. 16 corresponds to 24 TFCI code word bits. 32 corresponds to 48 TFCI code word bits. |
| Puncturing limit | MP | | Real(0.40..1.0 by step of 0.04) | |
| Repetition period | MD | | Integer(1, 2,4,8,16,32,64) | Default is continuous allocation. Value 1 indicate continuous |
| Repetition length | MP | | Integer(1..Repetition period -1) | Note that this is empty if repetition period is set to 1 |

10.3.6.11 Constant value

This constant value is used by the UE to calculate the initial output power on PRACH according to the Open loop power control procedure. In TDD constant values are used for open loop power control of PRACH, USCH and UL DPCH as defined in subclause 8.5.7.

| Information Element/Group name | Need | Multi | Type and reference | Semantics description |
|--------------------------------|------|-------|--------------------|-----------------------|
| Constant value | MP | | Integer (-35..-10) | |

10.3.6.12 CPCH persistence levels

NOTE: Only for FDD.

This IE is dynamic and is used by RNC for load balancing and congestion control. This is broadcast often in the system information message.

| Information Element/Group name | Need | Multi | Type and reference | Semantics description |
|--------------------------------|------|-------------------|-------------------------------------|---|
| CPCH set ID | MP | | Integer (1 .. <maxCPCHs ets>) | Identifier for CPCH set info. |
| Dynamic persistence level | MP | 1 to <maxTF-CPCH> | | |
| >Dynamic persistence level | MP | | Dynamic persistence level 10.3.6.35 | Persistence level for transport format. |

10.3.6.13 CPCH set info

NOTE: Only for FDD.

This IE may be broadcast in the System Information message or assigned by SRNC. It is pseudo-static in a cell.

| Information Element/Group name | Need | Multi | Type and reference | Semantics description |
|-------------------------------------|---------------------|--------------------------------|---|--|
| CPCH set ID | MP | | CPCH set ID 10.3.5.3 | Indicates the ID number for a particular CPCH set allocated to a cell. |
| TFS | MP | | Transport Format Set 10.3.5.23 | Transport Format Set Information allocated to this CPCH set. |
| TFCS | MP | | Transport Format Combination Set 10.3.5.20 | Transport Format Set Information allocated to this CPCH set |
| AP preamble scrambling code | MP | | Integer (0..79) | Preamble scrambling code for AP in UL |
| AP-AICH channelisation code | MP | | Integer(0..255) | Channelisation code for AP-AICH in DL |
| CD preamble scrambling code | MP | | Integer (0..79) | Preamble scrambling code for CD in UL |
| CD/CA-ICH channelisation code | MP | | Integer (0..255) | Channelisation code for CD/CA-ICH in DL |
| Available CD access slot subchannel | CV- CDSigPresent | 1 to <maxPCPCH- CDsubCh> | | Lists the set of subchannels to be used for CD access preambles. Note: if not present, all subchannels are to be used without access delays. |
| >CD access slot subchannel | MP | | Integer (0..11) | |
| Available CD signatures | OP | 1 to <maxPCPCH- CDsig> | | Signatures for CD preamble in UL. Note: if not present, all signatures are available for use. |
| >CD signatures | MP | | Integer (0..15) | |
| DeltaPp-m | MP | | Integer (-10..10) | In dB. Power offset between the transmitted CD preamble and UL DPCCH of the power control preamble or message part (added to the preamble power to calculate the power of the UL DPCCH) |
| UL DPCCH Slot Format | MP | | Enumerated (0,1,2) | Slot format for UL DPCCH in power control preamble and in message part |
| N_start_message | MP | | Integer (1..8) | Number of Frames for start of message indication |
| N_EOT | MP | | Integer(0..7) | Actual number of appended EOT indicators is $T_EOT = N_TTI * \text{ceil}(N_EOT/N_TTI)$, where N_TTI is the number of frames per TTI and "ceil" refers to rounding up to nearest integer. |
| Channel Assignment Active | OP | | Boolean | When present, indicates that Node B send a CA message and VCAM mapping rule (14.11) shall be used. |
| CPCH status indication mode | MP | | CPCH status indication mode 10.3.6.14 | |
| PCPCH Channel Info. | MP | 1 to <maxPCPCHs> | | |
| >UL scrambling code | MP | | Integer (0..79) | For PCPCH message part |

| | | | | |
|--|---------|--------------------------|-------------------------------------|---|
| >DL channelisation code | MP | | Integer (0...511) | For DL DPCCH for PCPCH message part |
| >DL scrambling code | MD | | Secondary Scrambling Code 10.3.6.74 | Default is the same scrambling code as for the primary CPICH. |
| >PCP length | MP | | Enumerated (0, 8) | Indicates length of power control preamble, 0slots (no preamble used) or 8 slots |
| >UCSM Info | CV-NCAA | | | |
| >>Minimum Spreading Factor | MP | | Integer (4,8,16,32,64,128,256) | The UE may use this PCPCH at any Spreading Factor equal to or greater than the indicated minimum Spreading Factor. The Spreading Factor for initial access is the minimum Spreading Factor. |
| >>NF_max | MP | | Integer (1..64) | Maximum number of frames for PCPCH message part |
| >>Channel request parameters for UCSM | MP | | | Required in UE channel selection mode. |
| >>>Available AP signature | MP | 1 to <maxPCP CH-APsig> | | AP preamble signature codes for selection of this PCPCH channel. |
| >>>>AP signature | MP | | Integer (0..15) | |
| >>>Available AP access slot subchannel | OP | 1 to <maxPCP CH-APsubCh> | | Lists the set of subchannels to be used for AP access preambles in combination with the above AP signature(s). Note: if not present, all subchannels are to be used without access delays. |
| >>>>AP access slot subchannel | MP | | Integer (0..11) | |
| VCAM info | CV-CAA | | | |
| >Available Minimum Spreading Factor | MP | 1 to <maxPCP CH-SF> | | |
| >>Minimum Spreading Factor | MP | | Enumerated (4,8,16,32,64,128,256) | |
| >>NF_max | MP | | Integer (1..64) | Maximum number of frames for PCPCH message part |
| >>Maximum available number of PCPCH | MP | | Integer (1..64) | Maximum available number of PCPCH for the indicated Spreading Factor. |
| >>Available AP signatures | MP | 1 to <maxPCP CH-APsig> | | Signatures for AP preamble in UL. |
| >>>AP signature | | | Integer (0..15) | |
| >>Available AP sub-channel | OP | 1 to <maxPCP CH-APsubCh> | | AP sub-channels for the given AP signature in UL. Note: if not present, all subchannels are to be used without access delays. |
| >>>AP sub-channel | MP | | Integer (0..11) | |

| Condition | Explanation |
|---------------------|--|
| <i>CDSigPresent</i> | This IE may be included if IE "Available CD signatures" is present. |
| <i>NCAA</i> | This IE is included if IE "Channel Assignment Active" is not present |
| <i>CAA</i> | This IE is included if IE ""Channel Assignment Active" is present. |

10.3.6.14 CPCH Status Indication mode

NOTE: Only for FDD.

| Information Element/Group name | Need | Multi | Type and reference | Semantics description |
|--------------------------------|------|-------|-----------------------------------|---|
| CPCH Status Indication mode | MP | | Enumerated (PA mode, PAMASF mode) | Defines the status information type broadcast on the CPCH Status Indication Channel (CSICH) |

CPCH Status Indication mode defines the structure of the CSICH information that is broadcast by Node B on the CSICH channel. CSICH mode can take 2 values: PCPCH Availability (PA) mode and PCPCH Availability with Minimum Available Spreading Factor (PAMASF) mode. PAMASF mode is used when Channel Assignment is active. PA mode is used when Channel Assignment is not active (UE Channel Selection is active). [26] defines the structure of the CSICH information for both CSICH modes.

10.3.6.15 CSICH Power offset

NOTE: Only for FDD.

This is the power per transmitted CSICH Indicator minus power of the Primary CPICH.

| Information Element/Group name | Need | Multi | Type and reference | Semantics description |
|--------------------------------|------|-------|--------------------|-----------------------------------|
| CSICH Power offset | MP | | Integer(-10..+5) | Offset in dB, granularity of 1 dB |

10.3.6.16 Default DPCH Offset Value

Indicates the default offset value within interleaving size at a resolution of 512chip (1/5 slot) in FDD and a resolution of one frame in TDD to offset CFN in the UE. This is used to distribute discontinuous transmission periods in time and also to distribute NodeB-RNC transmission traffics in time. Even though the CFN is offset by DOFF, the start timing of the interleaving will be the timing that "CFN mod (interleaving size)"=0 (e.g. interleaving size: 2,4,8) in both UE and SRNC.

| Information Element/Group name | Need | Multi | Type and reference | Semantics description |
|------------------------------------|------|-------|------------------------------------|---|
| <i>CHOICE mode</i> | | | | |
| >FDD | | | | |
| >>Default DPCH Offset Value (DOFF) | MP | | Integer (0..306688 by step of 512) | Number of chips= 0 to 599 time 512 chips, see [10]. |
| >TDD | | | | |
| >>Default DPCH Offset Value (DOFF) | MP | | Integer(0..7) | Number of frames; See [10] |

10.3.6.17 Downlink channelisation codes

NOTE: Only for TDD

| Information Element/Group name | Need | Multi | Type and reference | Semantics description |
|------------------------------------|------|-------|---------------------------------|--|
| CHOICE <i>codes representation</i> | MP | | | |
| >Consecutive codes | | | | |
| >>First channelisation code | MP | | Enumerated ((16/1)...(16/16)) | The codes from First channelisation code to Last channelisation code shall be used in that order by the physical layer in this timeslot. If a TFCI exists in this timeslot, it is mapped in the First channelisation code. |
| >>Last channelisation code | MP | | Enumerated ((16/1)...(16/16)) | If this is the same as First channelisation code, only one code is used by the physical layer. |
| >Bitmap | | | | |
| >>Channelisation codes bitmap | MP | | Bitstring(16) | Each bit indicates the availability of a channelisation code for SF16, where the channelisation codes are numbered as channelisation code 1 (SF16) to channelisation code 16 (SF16). (For SF 16, a 1 in the bitmap means that the corresponding code is used, a 0 means that the corresponding code is not used.) If all bits are set to zero, SF 1 shall be used. |

10.3.6.18 Downlink DPCH info common for all RL

| Information Element/Group name | Need | Multi | Type and reference | Semantics description |
|---|-------------------|-------|--|--|
| Timing Indication | MP | | Enumerated(Initialise, Maintain) | Note 1 |
| CFN-targetSFN frame offset | CV- <i>TimInd</i> | | Integer(0..255) | In frame |
| Downlink DPCH power control information | OP | | Downlink DPCH power control information 10.3.6.23 | |
| CHOICE <i>mode</i> | MP | | | |
| >FDD | | | | |
| >>Power offset $P_{\text{Pilot-DPCH}}$ | MP | | Integer(0..24) | Power offset equals $P_{\text{Pilot}} - P_{\text{DPDCH}}$, range 0..6 dB, in steps of 0.25 dB |
| >>>Downlink rate matching restriction information | OP | | Downlink rate matching restriction information 10.3.6.31 | If this IE is set to "absent", no Transport CH is restricted in TFI. |
| >>>Spreading factor | MP | | Integer(4, 8, 16, 32, 64, 128, 256, 512) | |
| >>>Fixed or Flexible Position | MP | | Enumerated (Fixed, Flexible) | |
| >>TFCI existence | MP | | Boolean | TRUE indicates that TFCI exists |
| >>CHOICE <i>SF</i> | MP | | | |
| >>>SF = 256 | | | | |
| >>>>Number of bits for Pilot bits | MP | | Integer (2,4,8) | In bits |
| >>>>SF = 128 | | | | |
| >>>>Number of bits for Pilot bits | MP | | Integer(4,8) | In bits |
| >>>>Otherwise | | | | (no data). In ASN.1 choice "Otherwise" is not explicitly available as all values are available, it is implied by the use of any value other than 128 or 256. |
| >TDD | | | | |
| >>Common timeslot info | MD | | Common Timeslot Info 10.3.6.10 | Default is the current Common timeslot info |

| CHOICE <i>SF</i> | Condition under which the given <i>SF</i> is chosen |
|------------------|--|
| SF=128 | "Spreading factor" is set to 128 |
| SF=256 | "Spreading factor" is set to 256 |
| Otherwise | "Spreading factor" is set to a value distinct from 128 and 256 |

| Condition | Explanation |
|---------------|---|
| <i>TimInd</i> | This IE is OPTIONAL if the IE "Timing Indication" is set to "Initialise". Otherwise it is absent. |

NOTE 1: Within the HANDOVER TO UTRAN COMMAND message, only value "initialise" is applicable.

10.3.6.19 Downlink DPCH info common for all RL Post

| Information Element/Group name | Need | Multi | Type and reference | Semantics description |
|---|------|-------|--|-----------------------|
| Downlink DPCH power control information | OP | | Downlink DPCH power control information 10.3.6.23 | |

10.3.6.20 Downlink DPCH info common for all RL Pre

| Information Element/Group name | Need | Multi | Type and reference | Semantics description |
|-----------------------------------|------|-------|--|---|
| CHOICE <i>mode</i> | MP | | | |
| >FDD | | | | |
| >>Spreading factor | MP | | Integer(4, 8, 16, 32, 64, 128, 256, 512) | Defined in CHOICE SF512-Andpilot with "number of its for pilot bits" in ASN.1 |
| >>Fixed or Flexible Position | MP | | Enumerated (Fixed, Flexible) | |
| >>TFCI existence | MP | | Boolean | TRUE indicates that TFCI exists |
| >>CHOICE <i>SF</i> | MP | | | |
| >>>SF = 256 | | | | |
| >>>>Number of bits for Pilot bits | MP | | Integer (2,4,8) | In bits |
| >>>SF = 128 | | | | |
| >>>>Number of bits for Pilot bits | MP | | Integer(4,8) | In bits |
| >>>Otherwise | | | | (no data) |
| >TDD | | | | |
| >>Common timeslot info | MP | | Common Timeslot Info 10.3.6.10 | |

| CHOICE <i>SF</i> | Condition under which the given <i>SF</i> is chosen |
|------------------|--|
| SF=128 | "Spreading factor" is set to 128 |
| SF=256 | "Spreading factor" is set to 256 |
| Otherwise | "Spreading factor" is set to a value distinct from 128 and 256 |

10.3.6.21 Downlink DPCH info for each RL

| Information Element/Group name | Need | Multi | Type and reference | Semantics description |
|--|---------------------|------------------------------|---|--|
| CHOICE <i>mode</i> | MP | | | |
| >FDD | | | | |
| >>Primary CPICH usage for channel estimation | MP | | Primary CPICH usage for channel estimation 10.3.6.62 | |
| >>DPCH frame offset | MP | | Integer(0..381 44 by step of 256) | Offset (in number of chips) between the beginning of the P-CCPCH frame and the beginning of the DPCH frame This is called $\tau_{DPCH,n}$ in [26] |
| >>Secondary CPICH info | OP | | Secondary CPICH info 10.3.6.73 | |
| >>DL channelisation code | MP | 1 to <maxDPC H-DLchan> | | For the purpose of physical channel mapping [27] the DPCHs are numbered, starting from DPCH number 1, according to the order that they are contained in this IE. |
| >>>Secondary scrambling code | MD | | Secondary scrambling code 10.3.6.74 | Default is the same scrambling code as for the Primary CPICH |
| >>>Spreading factor | MP | | Integer(4, 8, 16, 32, 64, 128, 256, 512) | Defined in CHOICE SF512-AndCodenum with "code number" in ASN.1 |
| >>>Code number | MP | | Integer(0..Spreading factor - 1) | |
| >>>Scrambling code change | CH-SF/2 | | Enumerated (code change, no code change) | Indicates whether the alternative scrambling code is used for compressed mode method 'SF/2'. |
| >>TPC combination index | MP | | TPC combination index 10.3.6.85 | |
| >>SSDT Cell Identity | OP | | SSDT Cell Identity 10.3.6.76 | |
| >>Closed loop timing adjustment mode | CH-TxDiversity Mode | | Integer(1, 2) | It is present if current TX Diversity Mode in UE is "closed loop mode 1" or "closed loop mode 2". Value in slots |
| >TDD | | | | |
| >>DL CCTrCh List | MP | 1..<maxCC TrCH> | | |
| >>>TFCS ID | MD | | Integer(1..8) | Identity of this CCTrCh. Default value is 1 |
| >>>Time info | MP | | Time Info 10.3.6.83 | |
| >>>Downlink DPCH timeslots and codes | MD | | Downlink Timeslots and Codes 10.3.6.32 | Default is to use the old timeslots and codes. |
| >>>UL CCTrCH TPC List | MD | 0..<maxCC TrCH> | | UL CCTrCH identities for TPC commands associated with this DL CCTrCH. Default is previous list or all defined UL CCTrCHs |

| Information Element/Group name | Need | Multi | Type and reference | Semantics description |
|--------------------------------|------|-------|---|-----------------------|
| >>>>UL TPC TFCS Identity | MP | | Transport Format Combination Set Identity 10.3.5.21 | |

| Condition | Explanation |
|-------------------------|--|
| <i>SF/2</i> | The information element is mandatory if the UE has an active compressed mode pattern sequence, which is using compressed mode method "SF/2". Otherwise the IE is not needed. |
| <i>TxDiversity Mode</i> | This IE is present if current TX Diversity Mode in UE is "closed loop mode 1" or "closed loop mode 2". Otherwise the IE is not needed. |

10.3.6.22 Downlink DPCH info for each RL Post

| Information Element/Group name | Need | Multi | Type and reference | Semantics description |
|--|---------|-------|--|--|
| CHOICE <i>mode</i> | MP | | | |
| >FDD | | | | |
| >>Primary CPICH usage for channel estimation | MP | | Primary CPICH usage for channel estimation 10.3.6.62 | |
| >>Secondary scrambling code | MD | | Secondary scrambling code 10.3.6.74 | Default is the same scrambling code as for the Primary CPICH |
| >>CHOICE <i>Spreading factor</i> | MP | | Integer(4, 8, 16, 32, 64, 128, 256, 512) | Defined in CHOICE SF512-AndCodenumbr with "code number" in ASN.1 |
| >>Code number | MP | | Integer(0.. Spreading factor - 1) | |
| >>Scrambling code change | CH-SF/2 | | Enumerated (code change, no code change) | Indicates whether the alternative scrambling code is used for compressed mode method 'SF/2'. |
| >>>TPC combination index | MP | | TPC combination index 10.3.6.85 | |
| >TDD | | | | |
| >>Downlink DPCH timeslots and codes | MP | | Downlink Timeslots and Codes 10.3.6.32 | |

10.3.6.23 Downlink DPCH power control information

| Information Element/Group name | Need | Multi | Type and reference | Semantics description |
|--------------------------------|------|-------|--|---|
| CHOICE <i>mode</i> | MP | | | |
| >FDD | | | | |
| >>DPC Mode | MP | | Enumerated (Single TPC, TPC triplet in soft) | "Single TPC" is DPC_Mode=0 and "TPC triplet in soft" is DPC_mode=1 in [29]. |
| >TDD | | | | |
| >>TPC Step Size | OP | | Integer (1, 2, 3) | In dB |

10.3.6.24 Downlink information common for all radio links

| Information Element/Group name | Need | Multi | Type and reference | Semantics description | Version |
|--------------------------------------|------|-------|--|---|---------|
| Downlink DPCH info common for all RL | OP | | Downlink DPCH info common for all RL 10.3.6.18 | | |
| CHOICE <i>mode</i> | MP | | | | |
| >FDD | | | | | |
| >>DPCH compressed mode info | MD | | DPCH compressed mode info 10.3.6.33 | Default value is the existing value of DPCH compressed mode information | |
| >>TX Diversity Mode | MD | | TX Diversity Mode 10.3.6.86 | Default value is the existing value of TX Diversity mode | |
| >>>SSDT information | OP | | SSDT information 10.3.6.77 | | |
| >TDD | | | | (no data) | |
| >>CHOICE <i>TDD option</i> | MP | | | | REL-4 |
| >>>3.84 Mcps TDD | | | | (no data) | REL-4 |
| >>>1.28 Mcps TDD | | | | | REL-4 |
| >>>>TSTD indicator | MP | | TSTD indicator 10.3.6.85a | | REL-4 |
| Default DPCH Offset Value | OP | | Default DPCH Offset Value, 10.3.6.16 | | |

10.3.6.25 Downlink information common for all radio links Post

| Information Element/Group name | Need | Multi | Type and reference | Semantics description |
|--------------------------------------|------|-------|---|-----------------------|
| Downlink DPCH info common for all RL | MP | | Downlink DPCH info common for all RL Post 10.3.6.19 | |

10.3.6.26 Downlink information common for all radio links Pre

| Information Element/Group name | Need | Multi | Type and reference | Semantics description |
|--------------------------------------|------|-------|--|-----------------------|
| Downlink DPCH info common for all RL | MP | | Downlink DPCH info common for all RL Pre 10.3.6.20 | |

10.3.6.27 Downlink information for each radio link

| Information Element/Group name | Need | Multi | Type and reference | Semantics description |
|--------------------------------|------|-------|--|-----------------------|
| Choice mode | MP | | | |
| >FDD | | | | |
| >>Primary CPICH info | MP | | Primary CPICH info 10.3.6.60 | |
| >>PDSCH with SHO DCH Info | OP | | PDSCH with SHO DCH Info 10.3.6.47 | |
| >>PDSCH code mapping | OP | | PDSCH code mapping 10.3.6.43 | |
| >TDD | | | | |
| >>Primary CCPCH info | MP | | Primary CCPCH info 10.3.6.57 | |
| Downlink DPCH info for each RL | OP | | Downlink DPCH info for each RL 10.3.6.21 | |
| SCCPCH Information for FACH | OP | | SCCPCH Information for FACH 10.3.6.70 | |

10.3.6.28 Downlink information for each radio link Post

| Information Element/Group name | Need | Multi | Type and reference | Semantics description |
|--------------------------------|------|-------|---|-----------------------|
| Choice mode | MP | | | |
| >FDD | | | | |
| >>Primary CPICH info | MP | | Primary CPICH info 10.3.6.60 | |
| >TDD | | | | |
| >>Primary CCPCH info | MP | | Primary CCPCH info post 10.3.6.58 | |
| Downlink DPCH info for each RL | MP | | Downlink DPCH info for each RL Post 10.3.6.22 | |

10.3.6.29 Void

10.3.6.30 Downlink PDSCH information

NOTE: Only for FDD.

| Information Element/Group name | Need | Multi | Type and reference | Semantics description |
|--------------------------------|------|-------|--------------------------------------|-----------------------|
| PDSCH with SHO DCH Info | OP | | PDSCH with SHO DCH Info 10.3.6.47 | |
| PDSCH code mapping | OP | | PDSCH code mapping 10.3.6.43 | |

10.3.6.31 Downlink rate matching restriction information

This IE indicates which TrCH is restricted in TFI.

| Information Element/Group name | Need | Multi | Type and reference | Semantics description |
|----------------------------------|------|-----------------|---|-----------------------|
| Restricted TrCH information | OP | 1 to <maxTrCH > | | |
| >Downlink transport channel type | MP | | Enumerated(DCH,DSCH) | |
| >Restricted DL TrCH identity | MP | | Transport channel identity 10.3.5.18 | |
| >Allowed TFIs | MP | 1 to <maxTF> | | |
| >>Allowed TFI | MP | | Integer(0..31) | |

10.3.6.32 Downlink Timeslots and Codes

NOTE: Only for TDD

| Information Element/Group name | Need | Multi | Type and reference | Semantics description |
|-------------------------------------|------|----------------|---|--|
| First Individual timeslot info | MP | | Individual timeslot info 10.3.6.37 | Individual timeslot info for the first timeslot used by the physical layer. |
| First timeslot channelisation codes | MP | | Downlink channelisation codes 10.3.6.17 | These codes shall be used by the physical layer in the timeslot given in First Individual timeslot info. |
| CHOICE <i>more timeslots</i> | MP | | | |
| >No more timeslots | | | | (no data) |
| >Consecutive timeslots | | | | |
| >>Number of additional timeslots | MP | | Integer(1..maxTS-1) | The timeslots used by the physical layer shall be timeslots: N mod maxTS (N+1) mod maxTS ... (N+k) mod maxTS in that order, where N is the timeslot number in the First individual timeslot info and k the Number of additional timeslots. The additional timeslots shall use the same parameters (e.g. channelisation codes, midamble shifts etc.) as the first timeslot. |
| >Timeslot list | | | | |
| >>Additional timeslot list | MP | 1 to <maxTS-1> | | The first instance of this parameter corresponds to the timeslot that shall be used second by the physical layer, the second to the timeslot that shall be used third and so on. |
| >>>CHOICE <i>parameters</i> | MP | | | |
| >>>>Same as last | | | | |
| >>>>>Timeslot number | MP | | Timeslot Number 10.3.6.84 | The physical layer shall use the same parameters (e.g. channelisation codes, midamble shifts etc.) for this timeslot as for the last one. |
| >>>>New parameters | | | | |
| >>>>>Individual timeslot info | MP | | Individual timeslot info 10.3.6.37 | |
| >>>>>Channelisation codes | MP | | Downlink channelisation codes 10.3.6.17 | |

10.3.6.33 DPCH compressed mode info

NOTE: Only for FDD.

This information element indicates the parameters of the compressed mode to be used by the UE in order to perform inter-frequency and inter-RAT measurements.

| Information Element/Group name | Need | Multi | Type and reference | Semantics description |
|-----------------------------------|------|-----------------|--------------------|-----------------------|
| Transmission gap pattern sequence | MP | 1 to <maxTGP S> | | |
| >TGPSI | MP | | TGPSI | |

| Information Element/Group name | Need | Multi | Type and reference | Semantics description |
|---|-----------|-------|---|--|
| >TGPS Status Flag | MP | | 10.3.6.82 Enumerated(active, inactive) | This flag indicates the current status of the Transmission Gap Pattern Sequence, whether it shall be activated or deactivated. |
| >TGCFN | CV-Active | | Integer (0..255) | Connection Frame Number of the first frame of the first pattern within the Transmission Gap Pattern Sequence. |
| >Transmission gap pattern sequence configuration parameters | OP | | | |
| >>TGMP | MP | | Enumerated(TDD measurement, FDD measurement, GSM carrier RSSI measurement, GSM Initial BSIC identification, GSM BSIC re-confirmation, Multi-carrier measurement) | Transmission Gap pattern sequence Measurement Purpose. |
| >>TGPRC | MP | | Integer (1..511, Infinity) | The number of transmission gap patterns within the Transmission Gap Pattern Sequence. |
| >>TGSN | MP | | Integer (0..14) | Transmission Gap Starting Slot Number The slot number of the first transmission gap slot within the TGCFN. |

| Information Element/Group name | Need | Multi | Type and reference | Semantics description |
|-------------------------------------|------|-------|--|--|
| >>TGL1 | MP | | Integer(1..14) | The length of the first Transmission Gap within the transmission gap pattern expressed in number of slots |
| >>TGL2 | MD | | Integer (1..14) | The length of the second Transmission Gap within the transmission gap pattern. If omitted, then TGL2=TGL1. |
| >>TGD | MP | | Integer(15..269, undefined) | Transmission gap distance indicates the number of slots between starting slots of two consecutive transmission gaps within a transmission gap pattern. If there is only one transmission gap in the transmission gap pattern, this parameter shall be set to zero. |
| >>TGPL1 | MP | | Integer (1..144) | The duration of transmission gap pattern 1. |
| >>TGPL2 | MD | | Integer (1..144) | The duration of transmission gap pattern 2. If omitted, then TGPL2=TGPL1. |
| >>RPP | MP | | Enumerated (mode 0, mode 1). | Recovery Period Power control mode during the frame after the transmission gap within the compressed frame. Indicates whether normal PC mode or compressed PC mode is applied |
| >>ITP | MP | | Enumerated (mode 0, mode 1). | Initial Transmit Power is the uplink power control method to be used to compute the initial transmit power after the compressed mode gap. |
| >>CHOICE <i>UL/DL mode</i> | MP | | | |
| >>>DL only | | | | Compressed mode used in DL only |
| >>>>Downlink compressed mode method | MP | | Enumerated (puncturing, SF/2, higher layer scheduling) | Method for generating downlink compressed mode gap |
| >>>UL only | | | | Compressed mode used in UL only |
| >>>>Uplink compressed mode method | MP | | Enumerated (SF/2, higher layer scheduling) | Method for generating uplink compressed mode gap |
| >>>UL and DL | | | | Compressed mode used in UL and DL |
| >>>>Downlink compressed mode method | MP | | Enumerated (puncturing, SF/2, higher layer scheduling) | Method for generating downlink compressed mode gap |
| >>>>Uplink compressed mode method | MP | | Enumerated (SF/2, higher layer scheduling) | Method for generating uplink compressed mode gap |
| >>Downlink frame type | MP | | Enumerated (A, B) | |
| >>DeltaSIR1 | MP | | Real(0..3 by step of 0.1) | Delta in DL SIR target value to be set in the UE during the frame containing the start of the first transmission gap in |

| Information Element/Group name | Need | Multi | Type and reference | Semantics description |
|--------------------------------|--------------------|-------|--------------------------------|---|
| | | | | the transmission gap pattern (without including the effect of the bit-rate increase) |
| >>DeltaSIRafter1 | MP | | Real(0..3 by step of 0.1) | Delta in DL SIR target value to be set in the UE one frame after the frame containing the start of the first transmission gap in the transmission gap pattern. |
| >>DeltaSIR2 | OP | | Real(0..3 by step of 0.1) | Delta in DL SIR target value to be set in the UE during the frame containing the start of the second transmission gap in the transmission gap pattern (without including the effect of the bit-rate increase) When omitted, DeltaSIR2 = DeltaSIR1. |
| >>DeltaSIRafter2 | OP | | Real(0..3 by step of 0.1) | Delta in DL SIR target value to be set in the UE one frame after the frame containing the start of the second transmission gap in the transmission gap pattern. When omitted, DeltaSIRafter2 = DeltaSIRafter1. |
| >>N Identify abort | CV-Initial BSIC | | Integer(1..128) | Indicates the maximum number of repeats of patterns that the UE shall use to attempt to decode the unknown BSIC of the GSM cell in the initial BSIC identification procedure |
| >>T Reconfirm abort | CV-Re-confirm BSIC | | Real(0.5..10.0 by step of 0.5) | Indicates the maximum time allowed for the re-confirmation of the BSIC of one GSM cell in the BSIC re-confirmation procedure. The time is given in steps of 0.5 seconds. |

| Condition | Explanation |
|-----------------|--|
| Active | This information element is only sent when the value of the "TGPS Status Flag" IE is "Active". |
| Initial BSIC | This information element is only sent when the value of the IE "TGMP" is set to "GSM Initial BSIC identification". |
| Re-confirm BSIC | This information element is only sent when the value of the IE "TGMP" is set to "GSM BSIC re-confirmation". |

10.3.6.34 DPCH Compressed Mode Status Info

This information element indicates status information of the compressed mode used by the UE in order to perform inter-frequency and inter-RAT measurements.

| Information Element/Group name | Need | Multi | Type and reference | Semantics description |
|--------------------------------|------|-------|--------------------|---|
| TGPS reconfiguration CFN | MP | | Integer (0..255) | Connection Frame Number of the frame where already active Transmission Gap Pattern Sequences shall be deactivated |
| Transmission gap pattern | MP | 1 to | | |

| Information Element/Group name | Need | Multi | Type and reference | Semantics description |
|--------------------------------|-----------|------------|-------------------------------------|--|
| sequence | | <maxTGP S> | | |
| >TGPSI | MP | | TGPSI 10.3.6.82 | Transmission Gap Pattern Sequence Identifier |
| >TGPS Status Flag | MP | | Enumerated(active, inactive) | This flag indicates the current status of the Transmission Gap Pattern Sequence, whether it shall be active or inactive. |
| >TGCFN | CV-Active | | Integer (0..255) | Connection Frame Number of the first frame of the first pattern within the Transmission Gap Pattern Sequence. |

| Condition | Explanation |
|-----------|--|
| Active | This information element is only sent when the value of the "TGPS Status Flag" IE is "Active". |

10.3.6.35 Dynamic persistence level

| Information Element/Group name | Need | Multi | Type and reference | Semantics description |
|--------------------------------|------|-------|--------------------|---|
| Dynamic persistence level | MP | | Integer(1..8) | Level shall be mapped to a dynamic persistence value in the range 0 .. 1. |

10.3.6.35a FPACH info

NOTE: Only for 1.28 Mcps TDD.

| Information Element/Group name | Need | Multi | Type and reference | Semantics description | Version |
|--------------------------------|------|-------|--|---|---------|
| Timeslot number | MP | | Integer(1..6) | | REL-4 |
| Channelisation code | MP | | Enumerated((16/1)..(16/1 6) | | REL-4 |
| Midamble Shift and burst type | MP | | Midamble shift and burst type 10.3.6.41 | | REL-4 |
| WT | MP | | Integer(1..4) | The number of sub-frames, following the sub-frame in which the SYNC UL is transmitted, in which the FPACH can be transmitted. | REL-4 |

10.3.6.36 Frequency info

| Information Element/Group name | Need | Multi | Type and reference | Semantics description |
|--------------------------------|------|-------|---------------------|--|
| CHOICE <i>mode</i> | MP | | | |
| >FDD | | | | |
| >>UARFCN uplink (Nu) | OP | | Integer(0..16383) | [21] If IE not present, default duplex distance of 190 MHz shall be used. |
| >>UARFCN downlink (Nd) | MP | | Integer(0 .. 16383) | [21] |
| >TDD | | | | |
| >>UARFCN (Nt) | MP | | Integer(0 .. 16383) | [22] |

10.3.6.37 Individual timeslot info

| Information Element/Group name | Need | Multi | Type and reference | Semantics description | Version |
|--------------------------------|------|-------|--|--|---------|
| Timeslot number | MP | | Timeslot number 10.3.6.84 | Timeslot within a frame | |
| TFCI existence | MP | | Boolean | TRUE indicates that the TFCI exists. It shall be coded in the first physical channel of this timeslot. | |
| Midamble Shift and burst type | MP | | Midamble shift and burst type 10.3.6.41 | | |
| CHOICE <i>TDD option</i> | MP | | | | REL-4 |
| >3.84 Mcps TDD | | | | (no data) | REL-4 |
| >1.28 Mcps TDD | | | | | REL-4 |
| >>Modulation | MP | | Enumerated(QPSK, 8PSK) | | REL-4 |
| >>SS-TPC Symbols | MP | | Enumerated(0, 1, 16/SF) | Denotes amount of SS and TPC bits send in this timeslot | REL-4 |

10.3.6.38 Individual Timeslot interference

Parameters used by the UE for uplink open loop power control in TDD.

| Information element | Need | Multi | Type and reference | Semantics description |
|--------------------------|------|-------|------------------------------|-----------------------|
| Timeslot number | MP | | Timeslot number 10.3.6.84 | |
| UL Timeslot Interference | MP | | UL Interference 10.3.6.87 | |

10.3.6.39 Maximum allowed UL TX power

This information element indicates the maximum allowed uplink transmit power.

| Information Element | Need | Multi | Type and reference | Semantics description |
|-----------------------------|------|-------|--------------------|-----------------------|
| Maximum allowed UL TX power | MP | | Integer(-50..33) | In dBm |

10.3.6.40 Void

10.3.6.41 Midamble shift and burst type

NOTE: Only for TDD.

This information element indicates burst type and midamble allocation. Three different midamble allocation schemes exist:

- Default midamble: the midamble shift is selected by layer 1 depending on the associated channelisation code (DL and UL)
- Common midamble: the midamble shift is chosen by layer 1 depending on the number of channelisation codes (possible in DL only)
- UE specific midamble: a UE specific midamble is explicitly assigned (DL and UL).

| Information Element/Group name | Need | Multi | Type and reference | Semantics description | Version |
|---|-------|-------|--|--|---------|
| CHOICE <i>TDD option</i> | MP | | | | REL-4 |
| >3.84 Mcps TDD | | | | | REL-4 |
| >>CHOICE <i>Burst Type</i> | MP | | | | |
| >>>Type 1 | | | | | |
| >>>>Midamble Allocation Mode | MP | | Enumerated (Default midamble, Common midamble, UE specific midamble) | | |
| >>>>Midamble configuration burst type 1 and 3 | MP | | Integer(4, 8, 16) | As defined in [30] | |
| >>>>Midamble Shift | CV-UE | | Integer(0..15) | | |
| >>>>Type 2 | | | | | |
| >>>>Midamble Allocation Mode | MP | | Enumerated (Default midamble, Common midamble, UE specific midamble) | | |
| >>>>Midamble configuration burst type 2 | MP | | Integer(3, 6) | As defined in [30] | |
| >>>>Midamble Shift | CV-UE | | Integer(0..5) | | |
| >>>>Type 3 | | | | | |
| >>>>Midamble Allocation Mode | MP | | Enumerated (Default midamble, UE specific midamble) | | |
| >>>>Midamble configuration burst type 1 and 3 | MP | | Integer(4, 8, 16) | As defined in [30] | |
| >>>>Midamble Shift | CV-UE | | Integer (0..15) | NOTE: Burst Type 3 is only used in uplink. | |
| >1.28 Mcps TDD | | | | | REL-4 |
| >>Midamble Allocation Mode | MP | | Enumerated (Default midamble, UE specific midamble) | | REL-4 |
| >>Midamble configuration | MP | | Integer(2, 4, 6, 8, 10, 12, 14, 16) | As defined in [30] | REL-4 |
| >>Midamble Shift | CV-UE | | Integer (0..15) | | REL-4 |

| Condition | Explanation |
|-----------|--|
| UE | This information element is only sent when the value of the "Midamble Allocation Mode" IE is "UE-specific midamble". |

10.3.6.42 PDSCH Capacity Allocation info

NOTE: Only for TDD.

| Information Element/Group name | Need | Multi | Type and reference | Semantics description |
|--------------------------------|------|-------|------------------------------------|-----------------------|
| PDSCH allocation period info | MP | | Allocation Period Info 10.3.6.4 | |
| TFCS ID | MD | | Integer(1..8) | Default is 1. |
| CHOICE <i>Configuration</i> | MP | | | |
| >Old configuration | | | | |
| >>PDSCH Identity | MP | | Integer(1..Hi PDSCHIdentities) | |
| >New configuration | | | | |
| >>PDSCH Info | MP | | PDSCH Info 10.3.6.44 | |
| >>PDSCH Identity | OP | | Integer(1..Hi PDSCHIdentities) | |
| >>PDSCH power control info | OP | | PDSCH power control info 10.3.6.45 | |

10.3.6.43 PDSCH code mapping

NOTE: Only for FDD.

This IE indicates the association between each possible value of TFCI(field 2) and the corresponding PDSCH channelisation code(s). The following signalling methods are specified:

- 'code range': the mapping is described in terms of a number of groups, each group associated with a given spreading factor;
- 'TFCI range': the mapping is described in terms of a number of groups, each group corresponding to a given PDSCH channelisation code;
- 'Explicit': the mapping between TFCI(field 2) value and PDSCH channelisation code is spelt out explicitly for each value of TFCI (field2);
- 'Removal': replace individual entries in the TFCI(field 2) to PDSCH code mapping table with new PDSCH code values.

| Information Element/Group name | Need | Multi | Type and reference | Semantics description |
|---------------------------------------|------|-------------------------------|--|--|
| DL Scrambling Code | MD | | Secondary scrambling code 10.3.6.74 | Scrambling code on which PDSCH is transmitted. Default is the same scrambling code as for the Primary CPICH |
| <i>Choice signalling method</i> | MP | | | |
| >code range | | | | |
| >>PDSCH code mapping | MP | 1 to < maxPDSC H-TFCIgroups > | | |
| >>>Spreading factor | MP | | Integer(4, 8, 16, 32, 64, 128, 256) | |
| >>>multi-code info | MP | | Integer(1..16) | |
| >>>Code number (for PDSCH code) start | MP | | Integer(0..Spreading factor-1) | |
| >>>Code number (for PDSCH code) stop | MP | | Integer(0..Spreading factor-1) | |
| >TFCI range | | | | |
| >>DSCH mapping | MP | 1 to < maxPDSC H-TFCIgroups > | | |
| >>>Max TFCI(field2) value | MP | | Integer(1..1023) | This is the maximum value in the range of TFCI(field 2) values for which the specified PDSCH code applies |
| >>>Spreading factor (for PDSCH code) | MP | | Integer(4, 8, 16, 32, 64, 128, 256) | |
| >>>Code number (for PDSCH code) | MP | | Integer(0..Spreading factor-1) | |
| >>>multi-code info | MP | | Integer(1..16) | |
| >Explicit | | | | |
| >>PDSCH code info | MP | 1 to < maxTFCI-2-Combs > | | The first instance of the parameter <i>PDSCH code</i> corresponds to TFCI (field2) = 0, the second to TFCI(field 2) = 1 and so on. |
| >>>Spreading factor (for PDSCH code) | MP | | Integer(4, 8, 16, 32, 64, 128, 256) | |
| >>>Code number (for PDSCH code) | MP | | Integer(0..Spreading factor-1) | |
| >>>multi-code info | MP | | Integer(1..16) | |
| >Replace | | | | This choice is made if the PDSCH code(s) associated with a given value of TFCI(field 2) is to be replaced. |
| >>Replaced PDSCH code | MP | 1 to < maxTFCI-2-Combs > | | Identity of the PDSCH code(s) to be used for the specified value of TFCI(field 2). These code identity(s) replace any that had been specified before |
| >>>TFCI (field 2) | MP | | Integer | Value of TFCI(field 2) for |

| Information Element/Group name | Need | Multi | Type and reference | Semantics description |
|--------------------------------------|------|-------|-------------------------------------|--|
| | | | (0..1023) | which PDSCH code mapping will be changed |
| >>>Spreading factor (for PDSCH code) | MP | | Integer(4, 8, 16, 32, 64, 128, 256) | |
| >>>Code number (for PDSCH code) | MP | | Integer(0..Spreading factor-1) | |
| >>>multi-code info | MP | | Integer(1..16) | |

10.3.6.44 PDSCH info

NOTE: Only for TDD.

| Information Element/Group name | Need | Multi | Type and reference | Semantics description |
|--------------------------------|------|-------|--|--|
| TFCS ID | MD | | Integer(1..8) | TFCS to be used. Default value is 1. |
| Common timeslot info | OP | | Common timeslot info 10.3.6.10 | |
| PDSCH timeslots and codes | OP | | Downlink Timeslots and Codes 10.3.6.32 | Default is to use the old timeslots and codes. |

10.3.6.45 PDSCH Power Control info

NOTE: Only for TDD.

| Information Element/Group name | Need | Multi | Type and reference | Semantics description |
|--------------------------------|------|-----------------|---|--|
| TPC Step Size | OP | | Integer (1, 2, 3) | In dB |
| UL CCTrCH TPC List | OP | 1..<maxCC TrCH> | | UL CCTrCH identities for TPC commands associated with this DL CCTrCH |
| >UL TPC TFCS Identity | MP | | Transport Format Combination Set Identity 10.3.5.21 | |

10.3.6.46 PDSCH system information

NOTE: Only for TDD.

| Information Element/Group name | Need | Multi | Type and reference | Semantics description |
|--------------------------------|------------|-----------------|--|-----------------------|
| PDSCH information | MP | 1 to <maxPDSCH> | | |
| >PDSCH Identity | MP | | Integer(1..Hi PDSCHIdentities) | |
| >PDSCH info | MP | | PDSCH info 10.3.6.44 | |
| >SFN Time Info | CH-Block17 | | SFN Time Info 10.3.6.75 | |
| >DSCH TFS | OP | | Transport format set 10.3.5.23 | |
| >DSCH TFCS | OP | | Transport Format Combination Set 10.3.5.20 | |

| Condition | Explanation |
|-----------|---|
| Block17 | This IE is absent in System Information Block 17. Otherwise it is optional. |

10.3.6.47 PDSCH with SHO DCH Info

NOTE: Only for FDD

| Information Element/Group name | Need | Multi | Type and reference | Semantics description |
|--------------------------------|------|--------------|------------------------------|---|
| DSCH radio link identifier | MP | | Primary CPICH info 10.3.6.60 | This parameter indicates on which radio link the user will be allocated resource on the DSCH. |
| TFCI(field2) Combining set | OP | 1 to <maxRL> | | This is used to indicate which of the downlink TFCI(field 2) transmissions made on the DPCCs within the active set should be soft combined on the physical layer. This parameter may only be sent if there is a 'hard' split of the TFCI field and in this case the sending of the parameter is optional. |
| >Radio link identifier | MP | | Primary CPICH info 10.3.6.60 | |

10.3.6.48 Persistence scaling factors

This IE defines scaling factors associated with ASC 2 – ASC 7 to be applied to the dynamic persistence value.

| Information Element/Group name | Need | Multi | Type and reference | Semantics description |
|--------------------------------|------|--------------------|--------------------------------|--|
| Access Service Class | MP | 1 to maxASCpersist | | multiplicity corresponds to the number of PRACH partitions minus 2 |
| >Persistence scaling factor | MP | | Real(0.9..0.2, by step of 0.1) | Scaling factors in the range 0,...,1 |

10.3.6.49 PICH Info

| Information Element/Group name | Need | Multi | Type and reference | Semantics description | Version |
|------------------------------------|------|-------|---|---|---------|
| CHOICE <i>mode</i> | MP | | | | |
| >FDD | | | | | |
| >>Channelisation code | MP | | Integer(0..255) | SF is fixed and equal to 256 | |
| >>>Number of PI per frame | MP | | Integer (18, 36, 72, 144) | | |
| >>>>STTD indicator | MP | | STTD Indicator 10.3.6.78 | | |
| >TDD | | | | | |
| >>Timeslot number | MD | | Timeslot number 10.3.6.84 | Default value is the timeslot used by the SCCPCH carrying the associated PCH. | |
| >>>>CHOICE <i>TDD option</i> | MP | | | | REL-4 |
| >>>>>3.84 Mcps TDD | | | | | REL-4 |
| >>>>>>Channelisation code | MD | | Enumerated ((16/1)...(16/16)) | Default value is the channelisation code used by the SCCPCH carrying the associated PCH. | |
| >>>>>CHOICE <i>Burst Type</i> | MP | | | | |
| >>>>>>Type 1 | | | | | |
| >>>>>>>Midamble Shift | MP | | Integer(0..15) | | |
| >>>>>>>Type 2 | | | | | |
| >>>>>>>>Midamble Shift | MP | | Integer(0..5) | | |
| >>>>1.28 Mcps TDD | | | | | REL-4 |
| >>>>>Midamble shift and burst type | MP | | Midamble shift and burst type 10.3.6.41 | | REL-4 |
| >>>Repetition period/length | MD | | Enumerated((4/2),(8/2), (8/4),(16/2), (16/4), (32/2),(32/4), (64/2),(64/4)) | Default value is "(64/2)". | |
| >>>Offset | MP | | Integer (0...Repetition period -1) | SFN mod Repetitionperiod = Offset. | |
| >>>Paging indicator length | MD | | Integer (4, 8, 16) | Indicates the length of one paging indicator in Bits. Default value is 4. | |
| >>>N _{GAP} | MD | | Integer(2, 4, 8) | Number of frames between the last frame carrying PICH for this Paging Occasion and the first frame carrying paging messages for this Paging Occasion. Default value is 4. | |
| >>>N _{PCH} | MD | | Integer(1 .. 8) | Number of paging groups. Default value is 2. | |

10.3.6.50 PICH Power offset

This is the power transmitted on the PICH minus power of the Primary CPICH in FDD and Primary CCPCH Tx Power in TDD.

| Information Element/Group name | Need | Multi | Type and reference | Semantics description |
|--------------------------------|------|-------|--------------------|-----------------------|
| PICH Power offset | MP | | Integer(-10 .. +5) | Offset in dB |

10.3.6.51 PRACH Channelisation Code List

NOTE: Only for 3.84Mcps TDD.

| Information Element/Group name | Need | Multi | Type and reference | Semantics description | Version |
|--------------------------------|------|--------|------------------------------|---|---------|
| CHOICE SF | MP | | | | |
| >SF16 | | | | | |
| >>Channelisation Code List | MP | 1 to 8 | | | |
| >>>Channelisation code | MP | | Enumerated ((16/1)..(16/16)) | 1:1 mapping between spreading code and midamble shift | |
| >SF8 | | | | | |
| >>Channelisation Code List | MP | 1 to 8 | | | |
| >>>Channelisation Code | MP | | Enumerated((8/1)..(8/8)) | | |

10.3.6.51a PRACH Channelisation Code 1.28Mcps TDD

NOTE: Only for 1.28Mcps TDD.

| Information Element/Group name | Need | Multi | Type and reference | Semantics description | Version |
|--------------------------------|------|--------|--|-----------------------|---------|
| Channelisation Code List | MP | 1 to 4 | | | REL-4 |
| >Channelisation Code | MP | | Enumerated((4/1)..(4/4),(8/1)..(8/8),(16/1)..(16/16)) | | REL-4 |

10.3.6.52 PRACH info (for RACH)

| Information Element/Group name | Need | Multi | Type and reference | Semantics description | Version |
|------------------------------------|------|-----------|---|---|---------|
| CHOICE <i>mode</i> | MP | | | | |
| >FDD | | | | | |
| >>Available Signature | MP | | Bitstring(16) | Each bit indicates availability for a signature, where the signatures are numbered "signature 0" up to "signature 15". The value 1 of a bit indicates that the corresponding signature is available and the value 0 that it is not available. | |
| >>Available SF | MP | | Integer (32,64,128,256) | In chips per symbol Defines the minimum allowed SF (i.e. the maximum rate) | |
| >>Preamble scrambling code number | MP | | Integer (0 .. 15) | Identification of scrambling code see [28] | |
| >>Puncturing Limit | MP | | Real(0.40..1.00 by step of 0.04) | | |
| >>Available Sub Channel Number | MP | | Bitstring(12) | Each bit indicates availability for a subchannel, where the subchannels are numbered "subchannel 0" to "subchannel 11". The value 1 of a bit indicates that the corresponding subchannel is available and the value 0 indicates that it is not available. | |
| >TDD | | | | | |
| >>CHOICE <i>TDD option</i> | MP | | | | REL-4 |
| >>>3.84 Mcps TDD | | | | | REL-4 |
| >>>>Timeslot number | MP | | Timeslot number 10.3.6.84 | | |
| >>>>PRACH Channelisation Code List | MP | | PRACH Channelisation Code List 10.3.6.51 | | |
| >>>>PRACH Midamble | MP | | Enumerated (Direct, Direct/Inverted) | Direct or direct and inverted midamble are used for PRACH | |
| >>>1.28 Mcps TDD | | | | | REL-4 |
| >>>>SYNC_UL info | MP | | SYNC_UL info 10.3.6.78a | | REL-4 |
| >>>>PRACH Definition | MP | 1..<maxPR | | | REL-4 |

| Information Element/Group name | Need | Multi | Type and reference | Semantics description | Version |
|------------------------------------|------|----------------|---|--|---------|
| | | ACH_FPA CH> | | | |
| >>>>>Timeslot number | MP | | Timeslot number 10.3.6.84 | | REL-4 |
| >>>>>PRACH Channelisation Code | MP | | PRACH Channelisation Code 1.28Mcps TDD 10.3.6.51a | | REL-4 |
| >>>>>Midamble Shift and burst type | MP | | Midamble shift and burst type 10.3.6.41 | | REL-4 |
| >>>>>FPACH info | MP | | FPACH info 10.3.6.35a | | REL-4 |
| >>PNBSCH allocation | OP | | PNBSCH allocation 10.3.8.10a | Identifies frames used for cell synchronisation purposes | REL-4 |

10.3.6.53 PRACH partitioning

| Information Element/Group name | Need | Multi | Type and reference | Semantics description |
|--------------------------------|------|-------------|-------------------------|---|
| Access Service class | MP | 1 to maxASC | | |
| ASC Setting | MD | | ASC setting 10.3.6.6 | The default values are same as the previous ASC. If the "default" is used for the first ASC, the default values are all available signatures and "all available sub-channels" for FDD and "all available channelisation codes" and "all available subchannels" with "subchannel size=Size 1" in TDD. |

10.3.6.54 PRACH power offset

NOTE: Only for FDD.

| Information Element/Group name | Need | Multi | Type and reference | Semantics description |
|--------------------------------|------|-------|--------------------|--|
| Power Ramp Step | MP | | Integer (1..8) | Power step when no acquisition indicator is received in dB |
| Preamble Retrans Max | MP | | Integer (1..64) | Maximum number of preambles in one preamble ramping cycle |

10.3.6.55 PRACH system information list

| Information element | Need | Multi | Type and reference | Semantics description |
|------------------------------------|------|------------------------|--|--|
| PRACH system information | MP | 1 .. <maxPRA CH> | | |
| >PRACH info | MP | | PRACH info (for RACH) 10.3.6.52 | |
| >Transport channel identity | MP | | Transport channel identity 10.3.5.18 | |
| >RACH TFS | MD | | Transport format set 10.3.5.23 | Default value is the value of "RACH TFS" for the previous PRACH in the list NOTE: The first occurrence is then MP) NOTE: For TDD in this release there is a single TF within the RACH TFS. |
| >RACH TFCS | MD | | Transport Format Combination Set 10.3.5.20 | Default value is the value of "RACH TFCS" for the previous PRACH in the list. NOTE: The first occurrence is then MP). NOTE: For TDD in this release there is no TFCS required. |
| >PRACH partitioning | MD | | PRACH partitioning 10.3.6.53 | Default value is the value of "PRACH partitioning" for the previous PRACH in the list (note : the first occurrence is then MP) |
| >Persistence scaling factors | OP | | Persistence scaling factors 10.3.6.48 | This IE shall not be present if only ASC 0 and ASC 1 are defined. If this IE is absent, value is the value of "Persistence scaling factors" for the previous PRACH in the list if value exists |
| >AC-to-ASC mapping | OP | | AC-to-ASC mapping 10.3.6.1 | Only present in SIB 5 If this IE is absent, value is the value of "AC-to-ASC mapping" for the previous PRACH in the list if value exists |
| >CHOICE <i>mode</i> | MP | | | |
| >>FDD | | | | |
| >>>Primary CPICH TX power | MD | | Primary CPICH TX power 10.3.6.61 | Default value is the value of "Primary CPICH TX power" for the previous PRACH in the list (note : the first occurrence is then MP) |
| >>>Constant value | MD | | Constant value 10.3.6.11 | Default value is the value of "Constant value" for the previous PRACH in the list (note : the first occurrence is then MP) |
| >>>PRACH power offset | MD | | PRACH power offset 10.3.6.54 | Default value is the value of "PRACH power offset" for the previous PRACH in the list (note : the first occurrence is then MP) |
| >>>RACH transmission parameters | MD | | RACH transmission parameters | Default value is the value of "RACH transmission parameters" for the previous |

| | | | | |
|--------------|----|--|-----------------------|---|
| | | | 10.3.6.67 | PRACH in the list (note : the first occurrence is then MP) |
| >>>AICH info | MD | | AICH info 10.3.6.2 | Default value is the value of "AICH info" for the previous PRACH in the list (note : the first occurrence is then MP) |
| >>TDD | | | | (no data) |

NOTE: If the setting of the PRACH information results in that a combination of a signature, preamble scrambling code and subchannel corresponds to a RACH with different TFS and/or TFCS, then for that combination only the TFS/TFCS of the PRACH listed first is valid, where PRACHs listed in System Information Block type 5 shall be counted first.

10.3.6.56 Predefined PhyCH configuration

This information element concerns a pre- defined configuration of physical channel parameters.

| Information Element/Group name | Need | Multi | Type and Reference | Semantics description |
|---|------|-------|---|-----------------------|
| Uplink radio resources | | | | |
| Uplink DPCH info | MP | | Uplink DPCH info Pre 10.3.6.90 | |
| Downlink radio resources | | | | |
| Downlink information common for all radio links | OP | | Downlink information common for all radio links Pre 10.3.6.26 | |

10.3.6.57 Primary CCPCH info

| Information Element/Group name | Need | Multi | Type and reference | Semantics description | Version |
|--------------------------------|------|-------|----------------------------------|--|---------|
| CHOICE <i>mode</i> | MP | | | | |
| >FDD | | | | | |
| >>TX Diversity indicator | MP | | Boolean | | |
| >TDD | | | | | |
| >>CHOICE <i>TDD option</i> | MP | | | | REL-4 |
| >>>3.84 Mcps TDD | | | | | REL-4 |
| >>>>CHOICE <i>SyncCase</i> | OP | | | | |
| >>>>>Sync Case 1 | | | | | |
| >>>>>>Timeslot | MP | | Integer (0...14) | PCCPCH timeslot | |
| >>>>>>>Sync Case 2 | | | | | |
| >>>>>>>>Timeslot | MP | | Integer(0..6) | | |
| >>>>1.28 Mcps TDD | | | | | REL-4 |
| >>>>TSTD indicator | MP | | TSTD indicator 10.3.6.85a | | REL-4 |
| >>Cell parameters ID | OP | | Cell parameters Id 10.3.6.9 | The Cell parameters ID is described in [32]. | |
| >>Block STTD indicator | MP | | Block STTD indicator 10.3.6.7 | | |

10.3.6.58 Primary CCPCH info post

NOTE: Only for TDD

| Information Element/Group name | Need | Multi | Type and reference | Semantics description | Version |
|--------------------------------|------|-------|-------------------------------|--|---------|
| CHOICE <i>TDD option</i> | MP | | | | REL-4 |
| >3.84 Mcps TDD | | | | | REL-4 |
| >>CHOICE <i>SyncCase</i> | MP | | | | |
| >>>Sync Case 1 | | | | | |
| >>>>Timeslot | MP | | Integer (0...14) | PCCPCH timeslot | |
| >>>>Sync Case 2 | | | | | |
| >>>>Timeslot | MP | | Integer(0..6) | | |
| >1.28 Mcps TDD | | | | | REL-4 |
| >>TSTD indicator | MP | | TSTD indicator 10.3.6.85a | | REL-4 |
| Cell parameters ID | MP | | Cell parameters Id 10.3.6.9 | The Cell parameters ID is described in [32]. | |
| Block STTD indicator | MP | | Block STTD indicator 10.3.6.7 | | |

10.3.6.59 Primary CCPCH TX Power

NOTE: Only for TDD.

| Information Element/group name | Need | Multi | Type and reference | Semantics description |
|--------------------------------|------|-------|--------------------|-----------------------|
| Primary CCPCH Tx Power | MP | | Integer(6..43) | In dBm |

10.3.6.60 Primary CPICH info

NOTE: Only for FDD.

| Information Element/Group name | Need | Multi | Type and reference | Semantics description |
|--------------------------------|------|-------|--------------------|-----------------------|
| Primary scrambling code | MP | | Integer(0..511) | |

10.3.6.61 Primary CPICH Tx power

NOTE: Only for FDD.

| Information Element/Group name | Need | Multi | Type and reference | Semantics description |
|--------------------------------|------|-------|--------------------|-----------------------|
| Primary CPICH Tx Power | MP | | Integer(-10..50) | Power in dBm. |

10.3.6.62 Primary CPICH usage for channel estimation

NOTE: Only for FDD.

| Information Element/Group name | Need | Multi | Type and Reference | Semantics description |
|--|------|-------|---|-----------------------|
| Primary CPICH usage for channel estimation | MP | | Enumerated(Primary CPICH may be used, Primary CPICH shall not be used) | |

10.3.6.63 PUSCH info

NOTE: Only for TDD.

| Information Element/Group name | Need | Multi | Type and reference | Semantics description |
|--------------------------------|------|-------|--------------------------------------|-----------------------|
| TFCS ID | MD | | Integer(1..8) | Default value is 1 |
| Common timeslot info | OP | | Common timeslot info 10.3.6.10 | |
| PUSCH timeslots and codes | OP | | Uplink Timeslots and Codes 10.3.6.94 | |

10.3.6.64 PUSCH Capacity Allocation info

NOTE: Only for TDD.

| Information Element/Group name | Need | Multi | Type and reference | Semantics description |
|--------------------------------|------|-------|------------------------------------|-----------------------|
| CHOICE <i>PUSCH allocation</i> | MP | | | |
| >PUSCH allocation pending | | | | (no data) |
| >PUSCH allocation assignment | | | | |
| >>PUSCH allocation period info | MP | | Allocation Period Info 10.3.6.4 | |
| >>PUSCH power control info | OP | | PUSCH power control info 10.3.6.65 | |
| >>TFCS ID | MD | | Integer(1..8) | Default is 1. |
| >>CHOICE <i>Configuration</i> | MP | | | |
| >>>Old configuration | | | | |
| >>>>PUSCH Identity | MP | | Integer(1..Hi PUSCHIdentities) | |
| >>>New configuration | | | | |
| >>>>PUSCH info | MP | | PUSCH info 10.3.6.63 | |
| >>>>PUSCH Identity | OP | | Integer(1..HiPUSCHIdentities) | |

10.3.6.65 PUSCH power control info

NOTE: Only for TDD.

Interference level measured for a frequency at the UTRAN access point used by UE to set PUSCH output power.

| Information Element/Group name | Need | Multi | Type and reference | Semantics description | Version |
|--------------------------------|------|-----------------|---|--|---------|
| UL target SIR | MP | | Real (-11 .. 20 by step of 0.5) | in dB | |
| CHOICE <i>TDD option</i> | MP | | | | REL-4 |
| >3.84 Mcps TDD | | | | (no data) | REL-4 |
| >1.28 Mcps TDD | | | | | REL-4 |
| >>TPC Step Size | OP | | Integer (1, 2, 3) | In dB | REL-4 |
| >>DL CCTrCH TPC List | OP | 0..<maxCC TrCH> | | DL CCTrCH identities for TPC commands associated with this UL CCTrCH | REL-4 |
| >>>DL TPC TFCS Identity | MP | | Transport Format Combination Set Identity 10.3.5.21 | | REL-4 |

10.3.6.66 PUSCH system information

NOTE: Only for TDD.

| Information Element/Group name | Need | Multi | Type and reference | Semantics description |
|--------------------------------|------------|-----------------|--|-----------------------|
| PUSCH information | MP | 1 to <maxPUSCH> | | |
| >PUSCH Identity | MP | | Integer(1..Hi PUSCHIdentities) | |
| >PUSCH info | MP | | PUSCH info 10.3.6.63 | |
| >SFN Time Info | CH-Block17 | | SFN Time Info 10.3.6.75 | |
| >USCH TFS | OP | | Transport format set 10.3.5.23 | |
| >USCH TFCS | MP | | Transport Format Combination Set 10.3.5.20 | |

| Condition | Explanation |
|-----------|---|
| Block17 | This IE is absent in System Information Block 17. Otherwise it is optional. |

10.3.6.67 RACH transmission parameters

NOTE: Only for FDD.

| Information Element/Group name | Need | Multi | Type and reference | Semantics description |
|--------------------------------|------|-------|--------------------|--------------------------------------|
| Mmax | MP | | Integer(1..32) | Maximum number of preamble cycles |
| NB01min | MP | | Integer(0..50) | Sets lower bound for random back-off |
| NB01max | MP | | Integer(0..50) | Sets upper bound for random back-off |

10.3.6.68 Radio link addition information

| Information Element/Group name | Need | Multi | Type and reference | Semantics description |
|--------------------------------|------|-------|--|-----------------------|
| Primary CPICH info | MP | | Primary CPICH info 10.3.6.60 | |
| Downlink DPCH info for each RL | MP | | Downlink DPCH info for each RL 10.3.6.21 | |
| TFCI combining indicator | OP | | TFCI combining indicator 10.3.6.81 | |
| SCCPCH Information for FACH | OP | | SCCPCH Information for FACH 10.3.6.70 | Note 1 |

NOTE 1: These IEs are present when the UE needs to listen to system information on FACH in CELL_DCH state.

10.3.6.69 Radio link removal information

| Information Element/Group name | Need | Multi | Type and reference | Semantics description |
|--------------------------------|------|-------|------------------------------|-----------------------|
| Primary CPICH info | MP | | Primary CPICH info 10.3.6.60 | |

10.3.6.70 SCCPCH Information for FACH

| Information Element/Group name | Need | Multi | Type and reference | Semantics description |
|---|------|---------------------|--|---|
| Secondary CCPCH info | MP | | Secondary CCPCH info 10.3.6.71 | |
| TFCS | MP | | Transport format combination set 10.3.5.20 | For FACHs and PCH |
| FACH/PCH information | MP | 1 to <maxFACH/HPCH> | | |
| >TFS | MP | | Transport format set 10.3.5.23 | For each FACHs and PCH |
| >Transport channel identity | MP | | Transport channel identity 10.3.5.18 | |
| >CTCH indicator | MP | | Boolean | The value "TRUE" indicates that a CTCH is mapped on the FACH, and "FALSE" that no CTCH is mapped. |
| CHOICE mode | | | | |
| >FDD | | | | |
| >>References to system information blocks | MP | 1 to <maxSIB-FACH> | | |
| >>>Scheduling information | MP | | Scheduling information 10.3.8.16 | |
| >>>SIB type SIBs only | MP | | SIB Type SIBs only, 10.3.8.22 | |
| >TDD | | | | (No data) |

NOTE: TFS for PCH shall be the first "FACH/PCH information" in the list if a PCH exists for the respective secondary CCPCH.

10.3.6.71 Secondary CCPCH info

| Information Element/Group name | Need | Multi | Type and reference | Semantics description |
|--|------|---------|--|---|
| CHOICE <i>mode</i> | MP | | | |
| >FDD | | | | |
| >>Primary CPICH usage for channel estimation | MP | | Primary CPICH usage for channel estimation 10.3.6.62 | |
| >>Secondary CPICH info | OP | | Secondary CPICH info 10.3.6.73 | May only be sent for SCCPCH channels not carrying the PCH. |
| >>Secondary scrambling code | OP | | Secondary scrambling code 10.3.6.74 | May only be sent for SCCPCH channels not carrying the PCH. |
| >>STTD indicator | MD | | STTD Indicator 10.3.6.78 | Default value is "TRUE" |
| >>Spreading factor | MP | | Integer(4, 8, 16, 32, 64, 128, 256) | |
| >>Code number | MP | | Integer(0..Spreading factor - 1) | |
| >>Pilot symbol existence | MD | | Boolean | TRUE means the existence. Default value is "TRUE" |
| >>TFCI existence | MD | | Boolean | TRUE means the existence. Default value is "TRUE" |
| >>Fixed or Flexible Position | MD | | Enumerated (Fixed, Flexible) | Default value is "Flexible" |
| >>Timing Offset | MD | | Integer(0..38144 by step of 256) | Chip Delay of the Secondary CCPCH relative to the Primary CCPCH. Default value is 0. |
| >TDD | | | | |
| >>Offset | MP | | Integer (0..Repetition Period -1) | SFN modulo Repetition period = offset. Repetition period is the one indicated in the accompanying Common timeslot info IE |
| >>Common timeslot info | MP | | Common timeslot info 10.3.6.10 | |
| >>Individual timeslot info | MP | | Individual timeslot info 10.3.6.37 | |
| >>Code List | MP | 1 to 16 | | |
| >>>Channelisation Code | MP | | Enumerated((16/1)..(16/16)) | |

10.3.6.72 Secondary CCPCH system information

| Information element | Need | Multi | Type and reference | Semantics description |
|------------------------------------|------|--------------------|--|---|
| Secondary CCPCH system information | MP | 1 to <maxSCC PCH> | | |
| >Secondary CCPCH info | MP | | Secondary CCPCH info 10.3.6.71 | Note 1 |
| >TFCS | MD | | Transport format combination set 10.3.5.20 | For FACHs and PCH Default value is the value of "TFCS" for the previous SCCPCH in the list (note : the first occurrence is then MP) |
| >FACH/PCH information | MD | 1 to <maxFACH PCH> | | Default value is the value of "FACH/PCH" for the previous SCCPCH in the list (note : the first occurrence is then MP) |
| >>TFS | MP | | Transport format set 10.3.5.23 | For each FACH and PCH Note 2 |
| >>Transport channel identity | MP | | Transport channel identity 10.3.5.18 | |
| >>CTCH indicator | MP | | Boolean | The value "TRUE" indicates that a CTCH is mapped on the FACH, and "FALSE" that no CTCH is mapped. |
| >PICH info | OP | | PICH info 10.3.6.49 | PICH info is present only when PCH is multiplexed on Secondary CCPCH |

NOTE 1: The secondary CCPCHs carrying a PCH shall be listed first.

NOTE 2: TFS for PCH shall be the first "FACH/PCH information" in the list if a PCH exists for the respective secondary CCPCH.

10.3.6.73 Secondary CPICH info

NOTE: Only for FDD.

| Information Element/Group name | Need | Multi | Type and reference | Semantics description |
|--------------------------------|------|-------|-------------------------------------|--|
| Secondary scrambling code | MD | | Secondary scrambling code 10.3.6.74 | Default is the same scrambling code as for the Primary CPICH |
| Channelisation code | MP | | Integer(0..255) | SF=256 |

10.3.6.74 Secondary scrambling code

| Information Element/Group name | Need | Multi | Type and reference | Semantics description |
|--------------------------------|------|-------|--------------------|-----------------------|
| Secondary scrambling code | MP | | Integer(1..15) | |

10.3.6.75 SFN Time info

| Information Element/Group name | Need | Multi | Type and reference | Semantics description |
|--------------------------------|------|-------|--------------------|--|
| Activation time SFN | MP | | Integer (0..4095) | System frame number start of the physical channel existence. |
| Duration | MP | | Integer(1..4096) | Total number of frames the physical channel will exist. |

10.3.6.75a Special Burst Scheduling

NOTE: Only for TDD.

| Information Element/Group name | Need | Multi | Type and reference | Semantics description |
|---------------------------------|------|-------|---|-----------------------|
| Special Burst Generation Period | MP | | Integer (2, 4, 8, 16, 32, 64, 128, 256) | Value in radio frames |

10.3.6.76 SSDD cell identity

NOTE: Only for FDD.

This IE is used to associate a cell identity with a given radio link.

| Information Element/Group name | Need | Multi | Type and reference | Semantics description |
|--------------------------------|------|-------|-------------------------------------|-----------------------|
| SSDD cell id | MP | | Enumerated (a, b, c, d, e, f, g, h) | |

10.3.6.77 SSDD information

NOTE: Only for FDD.

This information element indicates the status (e.g. initiated/terminated) of the Site Selection.

Diversity Transmit power control (SSDD). It is used to change the SSDD status. The parameter 'code word set' indicates how cell identities are coded (using many bits or few, values are long, medium, or short).

| Information Element/Group name | Need | Multi | Type and reference | Semantics description | Version |
|--------------------------------|------|-------|--|-----------------------|---------|
| S field | MP | | Integer (1, 2) | In bits | |
| Code Word Set | MP | | Enumerated (long, medium, shortSSDD off) | | |
| SSDD UL | OP | | Enumerated (UL, ULandDL) | | REL-4 |

NOTE: These parameters shall be set optionally associated with DL DPCH info but not for each RL.

10.3.6.78 STTD indicator

Indicates whether STTD is used or not.

| Information Element/Group name | Need | Multi | Type and reference | Semantics description |
|--------------------------------|------|-------|--------------------|------------------------------|
| STTD Indicator | MP | | Boolean | TRUE means that STTD is used |

10.3.6.78a SYNC_UL info

NOTE: Only for 1.28 Mcps TDD.

| Information Element/ Group name | Need | Multi | Type and reference | Semantics description | Version |
|---------------------------------|------|-------|--------------------------------|---|---------|
| SYNC_UL codes bitmap | MP | | Bitstring(8) | 00000001 indicates code 0 can be used, 10000001 indicates that codes 0 and 7 can be used. | REL-4 |
| UL Target SIR | MP | | Real(-11 .. 20 by step of 0.5) | In dB | REL-4 |
| Power Ramping Step | MP | | Integer(0,1,2,3) | In dB | REL-4 |
| Max SYNC_UL Transmissions | MP | | Integer(1,2,4,8) | Maximum numbers of SYNC_UL transmissions in a power ramping sequence. | REL-4 |
| Mmax | MP | | Integer(1..32) | Maximum number of synchronisation attempts. | REL-4 |

10.3.6.79 TDD open loop power control

This information element contains parameters for open loop power control setting for TDD.

| Information Element/Group name | Need | Multi | Type and reference | Semantics description | Version |
|-------------------------------------|----------|-------|-------------------------------------|------------------------------------|---------|
| Primary CCPCH Tx Power | MP | | Primary CCPCH Tx Power 10.3.6.59 | For path loss calculation | |
| <i>CHOICE TDD option</i> | MP | | | | REL-4 |
| >3.84 Mcps TDD | | | | | REL-4 |
| >>Alpha | OP | | Alpha 10.3.6.5 | | |
| >>PRACH Constant Value | MP | | Constant Value 10.3.6.11 | Operator controlled PRACH Margin | |
| >>DPCH Constant Value | MP | | Constant Value 10.3.6.11 | Operator controlled UL DPCH Margin | |
| >>PUSCH Constant Value | OP | | Constant Value 10.3.6.11 | Operator controlled PUSCH Margin | |
| >>UE positioning related parameters | CV-IPDLs | | | | REL-4 |
| >>>IPDL-Alpha | MP | | Alpha 10.3.6.5 | | REL-4 |
| >>>Max power increase | MP | | Integer (0..3) | In db | REL-4 |
| >1.28 Mcps TDD | | | | (no data) | REL-4 |

| Condition | Explanation |
|--------------|---|
| <i>IPDLs</i> | This IE is present only if idle periods are applied |

10.3.6.80 TFC Control duration

| Information Element/Group name | Need | Multi | Type and reference | Semantics description |
|--------------------------------|------|-------|--|---|
| TFC Control duration | MP | | Integer (1, 2, 4, 8, 16, 24, 32, 48, 64, 128, 192, 256, 512) | Defines the period in multiples of 10 ms frames for which the defined TFC sub-set is to be applied. |

10.3.6.81 TFCI Combining Indicator

NOTE: Only for FDD.

This IE indicates whether the TFCI (field 2), which will be transmitted on the DPCCCH of a newly added radio link, should be soft-combined with the others in the TFCI (field 2) combining set. This IE can only be sent when the UE is in CELL_DCH state with a DSCH transport channel assigned and when there is a 'hard' split in the TFCI field (such that TFCI1 and TFCI2 have their own separate block coding).

| Information Element/Group name | Need | Multi | Type and reference | Semantics description |
|--------------------------------|------|-------|--------------------|----------------------------------|
| TFCI combining indicator | MP | | Boolean | TRUE means that TFCI is combined |

10.3.6.82 TGPSI

| Information Element/Group name | Need | Multi | Type and reference | Semantics description |
|--------------------------------|------|-------|---------------------|--|
| TGPSI | MP | | Integer(1..MaxTGPS) | Transmission Gap Pattern Sequence Identifier Establish a reference to the compressed mode pattern sequence. Up to <MaxTGPS> simultaneous compressed mode pattern sequences can be used. |

10.3.6.83 Time info

| Information Element/Group name | Need | Multi | Type and reference | Semantics description |
|--------------------------------|------|-------|----------------------------|--|
| Activation time | MD | | Activation time 10.3.3.1 | Frame number start of the physical channel existence. Default value is "Now" |
| Duration | MD | | Integer(1..4096, infinite) | Total number of frames the physical channel will exist. Default value is "infinite". |

10.3.6.84 Timeslot number

| Information Element/Group name | Need | Multi | Type and reference | Semantics description | Version |
|--------------------------------|------|-------|--------------------|----------------------------|---------|
| CHOICE <i>TDD option</i> | MP | | | | REL-4 |
| >3.84 Mcps TDD | | | | | REL-4 |
| >>Timeslot number | MP | | Integer(0..14) | Timeslot within a frame | |
| >1.28 Mcps TDD | | | | | REL-4 |
| >>Timeslot number | MP | | Integer(0..6) | Timeslot within a subframe | REL-4 |

10.3.6.85 TPC combination index

NOTE: Only for FDD.

| Information Element/Group name | Need | Multi | Type and reference | Semantics description |
|--------------------------------|------|-------|--------------------|---|
| TPC combination index | MP | | Integer(0..5) | Radio links with the same index have TPC bits, which for the UE are known to be the same. |

10.3.6.85a TSTD indicator

NOTE: Only for 1.28Mcps TDD.

| Information Element/Group name | Need | Multi | Type and reference | Semantics description | Version |
|--------------------------------|------|-------|--------------------|-------------------------|---------|
| TSTD indicator | MD | | Boolean | Default value is "TRUE" | REL-4 |

10.3.6.86 TX Diversity Mode

NOTE: Only for FDD.

| Information Element/Group name | Need | Multi | Type and reference | Semantics description |
|--------------------------------|------|-------|---|-----------------------|
| Tx diversity Mode | MP | | Enumerated (none, STTD, closed loop mode1, closed loop mode2) | |

10.3.6.87 UL interference

| Information Element/Group name | Need | Multi | Type and reference | Semantics description |
|--------------------------------|------|-------|---------------------|-----------------------|
| UL interference | MP | | Integer (-110..-70) | In dBm |

NOTE: In TDD, this IE is a timeslot specific value.

10.3.6.88 Uplink DPCH info

| Information Element/Group name | Need | Multi | Type and reference | Semantics description |
|------------------------------------|------|------------------|--|--|
| Uplink DPCH power control info | OP | | Uplink DPCH power control info 10.3.6.91 | |
| <i>CHOICE mode</i> | MP | | | |
| >FDD | | | | |
| >>Scrambling code type | MP | | Enumerated(short, long) | |
| >>Scrambling code number | MP | | Integer(0..16 777215) | |
| >>Number of DPDCH | MD | | Integer(2..maxDPDCH) | Default value is 1. Number of DPDCH is 1 in HANDOVER TO UTRAN COMMAND |
| >>Spreading factor | MP | | Integer(4, 8, 16, 32, 64, 128, 256) | Minimum allowed SF of the channelisation code for data part |
| >>TFCI existence | MD | | Boolean | TRUE means existence. Default value is "TRUE" |
| >>Number of FBI bits | CH | | Integer (1, 2) | In bits. Number of FBI bits is needed if SSdT or FB Mode Transmit Signalling is supported. |
| >>Puncturing Limit | MP | | Real(0.40 ..1 by step of 0.04) | |
| >TDD | | | | |
| >>Uplink Timing Advance Control | OP | | Uplink Timing Advance Control 10.3.6.96 | |
| >>UL CCTrCH List | MP | 1 to <maxCCTrCH> | | |
| >>>TFCS ID | MD | | Integer(1..8) | Default value is 1. |
| >>>Time info | MP | | Time info 10.3.6.83 | |
| >>>Common timeslot info | MD | | Common timeslot info 10.3.6.10 | Default is the current Common timeslot info |
| >>>Uplink DPCH timeslots and codes | MD | | Uplink Timeslots and Codes 10.3.6.94 | Default is to use the old timeslots and codes. |

| Condition | Explanation |
|-----------|--|
| Single | This IE is included if IE "Number of DPDCH" is "1" |

10.3.6.89 Uplink DPCH info Post

| Information Element/Group name | Need | Multi | Type and reference | Semantics description |
|-----------------------------------|------|-------|--|--|
| Uplink DPCH power control info | MP | | Uplink DPCH power control info Post 10.3.6.92 | |
| CHOICE <i>mode</i> | MP | | | |
| >FDD | | | | |
| >>Scrambling code type | MP | | Enumerated(short, long) | |
| >>Reduced scrambling code number | MP | | Integer(0..8191) | Sub-range of values for initial use upon handover to UTRAN. |
| >>Spreading factor | MP | | Integer(4, 8, 16, 32, 64, 128, 256) | SF of the channelisation code for data part There is only one DPDCH for this case |
| >TDD | | | | |
| >>Uplink Timing Advance Control | OP | | Uplink Timing Advance Control 10.3.6.96 | |
| >>Uplink DPCH timeslots and codes | MP | | Uplink Timeslots and Codes 10.3.6.94 | |

10.3.6.90 Uplink DPCH info Pre

| Information Element/Group name | Need | Multi | Type and reference | Semantics description |
|--------------------------------|------|-------|---|--|
| Uplink DPCH power control info | OP | | Uplink DPCH power control info Pre 10.3.6.93 | |
| CHOICE <i>mode</i> | MP | | | |
| >FDD | | | | |
| >>TFCI existence | MP | | Boolean | TRUE means existence. Default value is "TRUE" |
| >>Puncturing Limit | MP | | Real(0.40 ..1 by step of 0.04) | |
| >TDD | | | | |
| >>Common timeslot info | MP | | Common Timeslot Info 10.3.6.10 | |

| Condition | Explanation |
|---------------|--|
| <i>Single</i> | This IE is included if IE "Number of DPDCH" is "1" |

10.3.6.91 Uplink DPCH power control info

Parameters used by UE to set DPCH initial output power and to use for closed-loop power control in FDD and 1.28Mcps TDD and parameters for uplink open loop power control in 3.84Mcps TDD.

| Information Element/Group name | Need | Multi | Type and reference | Semantics description | Version |
|--|----------------|--------------|--|--|---------|
| CHOICE <i>mode</i> | MP | | | | |
| >FDD | | | | | |
| >>DPCCH Power offset | MP | | Integer(-164,..-6 by step of 2) | In dB | |
| >>>PC Preamble | MP | | Integer (0..7) | In number of frames | |
| >>>>SRB delay | MP | | Integer(0..7) | In number of frames | |
| >>>>>Power Control Algorithm | MP | | Enumerated (algorithm 1, algorithm 2) | Specifies algorithm to be used by UE to interpret TPC commands | |
| >>>>>>TPC step size | <i>CV-algo</i> | | Integer (1, 2) | In dB | |
| >TDD | | | | | |
| >>>UL target SIR | MP | | Real (-11 .. 20 by step of 0.5dB) | In dB | |
| >>>>CHOICE <i>UL OL PC info</i> | MP | | | | |
| >>>>>Broadcast UL OL PC info | | | Null | No data | |
| >>>>>>Individually Signalled | OP | | | | |
| >>>>>>>CHOICE <i>TDD option</i> | MP | | | | REL-4 |
| >>>>>>>>3.84Mcps TDD | | | | | REL-4 |
| >>>>>>>>>Individual timeslot interference info | MP | 1 to <maxTS> | | | |
| >>>>>>>>>>Individual timeslot interference | MP | | Individual timeslot interference 10.3.6.38 | | |
| >>>>>>>>>>>DPCH Constant Value | OP | | Constant Value 10.3.6.11 | Quality Margin | |
| >>>>>>>>>>>>1.28 Mcps TDD | | | | | REL-4 |
| >>>>>>>>>>>>>TPC step size | MP | | Integer(1,2,3) | | REL-4 |
| >>>>>>>>>>>>>>Primary CCPCH Tx Power | OP | | Primary CCPCH Tx Power 10.3.6.59 | For Pathloss Calculation | |

| Condition | Explanation |
|-------------|--|
| <i>algo</i> | The IE is mandatory if "Power Control Algorithm" is set to "algorithm 1", otherwise the IE is not needed |

10.3.6.92 Uplink DPCH power control info Post

Parameters used by UE to set DPCH initial output power and to use for closed-loop power control.

| Information Element/Group name | Need | Multi | Type and reference | Semantics description | Version |
|--------------------------------|------|-------|-----------------------------------|-----------------------|---------|
| CHOICE <i>mode</i> | MP | | | | |
| >FDD | | | | | |
| >>DPCCH Power offset | MP | | Integer(-110..-50 by step of 4) | In dB | |
| >>PC Preamble | MP | | Integer (0..7) | in number of frames | |
| >>SRB delay | MP | | Integer (0..7) | In number of frames | |
| >TDD | | | | | |
| >>UL target SIR | MP | | Real (-11 .. 20 by step of 0.5dB) | In dB | |
| >>CHOICE <i>TDD option</i> | MP | | | | REL-4 |
| >>>3.84Mcps TDD | | | | | REL-4 |
| >>>>UL Timeslot Interference | MP | | UL Interference 10.3.6.87 | | |
| >>>1.28Mcps TDD | | | | (no data) | REL-4 |

| Condition | Explanation |
|-------------|--|
| <i>algo</i> | The IE is mandatory if "Power Control Algorithm" is set to "algorithm 1", otherwise the IE is not needed |

10.3.6.93 Uplink DPCH power control info Pre

Parameters used by UE to set DPCH initial output power and to use for closed-loop power control in FDD and parameters for uplink open loop power control in 3.84 Mcps TDD.

| Information Element/Group name | Need | Multi | Type and reference | Semantics description | Version |
|--------------------------------|----------------|-------|---------------------------------------|--|---------|
| CHOICE <i>mode</i> | MP | | | | |
| >FDD | | | | | |
| >>Power Control Algorithm | MP | | Enumerated (algorithm 1, algorithm 2) | Specifies algorithm to be used by UE to interpret TPC commands | |
| >>TPC step size | <i>CV-algo</i> | | Integer (1, 2) | In dB | |
| >TDD | | | | (No data) | |
| >>CHOICE <i>TDD option</i> | MP | | | | REL-4 |
| >>>3.84Mcps TDD | | | | | REL-4 |
| >>DPCH Constant Value | MP | | Constant Value 10.3.6.11 | Quality Margin | |
| >>>1.28Mcps TDD | | | | (no data) | REL-4 |

| Condition | Explanation |
|-------------|--|
| <i>Algo</i> | The IE is mandatory if "Power Control Algorithm" is set to "algorithm 1", otherwise the IE is not needed |

10.3.6.94 Uplink Timeslots and Codes

NOTE: Only for TDD

| Information Element/Group name | Need | Multi | Type and reference | Semantics description |
|----------------------------------|------|----------------|---|--|
| Dynamic SF usage | MP | | Boolean | |
| First Individual timeslot info | MP | | Individual timeslot info 10.3.6.37 | Individual timeslot info for the first timeslot used by the physical layer. |
| First timeslot Code List | MP | 1..2 | | Code list used in the timeslot. given in First individual timeslot info. |
| >Channelisation Code | MP | | Enumerated((1/1),(2/1),(2/2),(4/1)..(4/4),(8/1)..(8/8),(16/1)..(16/16)) | |
| CHOICE <i>more timeslots</i> | MP | | | |
| >No more timeslots | | | | (no data) |
| >Consecutive timeslots | | | | |
| >>Number of additional timeslots | MP | | Integer(1..maxTS-1) | The timeslots used by the physical layer shall be timeslots: N mod maxTS (N+1) mod maxTS ... (N+k) mod maxTS in that order, where N is the timeslot number in the First individual timeslot info and k the Number of additional timeslots. The additional timeslots shall use the same parameters (e.g. channelisation codes, midamble shifts etc.) as the first timeslot. |
| >Timeslot list | | | | |
| >>Additional timeslot list | MP | 1 to <maxTS-1> | | The first instance of this parameter corresponds to the timeslot that shall be used second by the physical layer, the second to the timeslot that shall be used third and so on. |
| >>>CHOICE <i>parameters</i> | MP | | | |
| >>>>Same as last | | | | |
| >>>>>Timeslot number | MP | | Timeslot Number 10.3.6.84 | This physical layer shall use the same parameters (e.g. channelisation codes, midamble shifts etc.) for this timeslot as for the last one. |
| >>>>>New parameters | | | | |
| >>>>>>Individual timeslot info | MP | | Individual timeslot info 10.3.6.37 | |
| >>>>>>Code List | MP | 1..2 | | |
| >>>>>>>Channelisation Code | MP | | Enumerated((1/1),(2/1),(2/2),(4/1)..(4/4),(8/1)..(8/8),(16/1)..(16/16)) | |

10.3.6.95 Uplink Timing Advance

NOTE: Only for 3.84 Mcps TDD.

| Information Element/Group name | Need | Multi | Type and reference | Semantics description | Version |
|--------------------------------|------|-------|--------------------|---|---------|
| UL Timing Advance | MP | | Integer (0..63) | Absolute timing advance value to be used to avoid large delay spread at the NodeB | |

10.3.6.96 Uplink Timing Advance Control

NOTE: Only for TDD

| Information Element/Group name | Need | Multi | Type and reference | Semantics description | Version |
|--------------------------------------|------|-------|------------------------------------|---|---------|
| CHOICE <i>Timing Advance</i> | MP | | | | |
| >Disabled | | | Null | Indicates that no timing advance is applied | |
| >Enabled | | | | | |
| >>CHOICE <i>TDD option</i> | MP | | | | REL-4 |
| >>>3.84 Mcps TDD | | | | | REL-4 |
| >>>>UL Timing Advance | MD | | Uplink Timing Advance 10.3.6.95 | Absolute timing advance value to be used to avoid large delay spread at the NodeB. Default value is the existing value for uplink timing advance. | |
| >>>>Activation Time | OP | | Activation Time 10.3.3.1 | Frame number timing advance is to be applied. This IE is required when a new UL Timing Advance adjustment is specified and Activation Time is not otherwise specified in the RRC message. | |
| >>1.28 Mcps TDD | | | | (no data) | REL-4 |
| >>>Uplink synchronisation parameters | MD | | | Default: Uplink synchronisation parameters is 1. Uplink synchronisation frequency is 1. | REL-4 |
| >>>>Uplink synchronisation step size | MP | | Integer(1..8) | This parameter specifies the step size to be used for the adjustment of the uplink transmission timing | REL-4 |
| >>>>Uplink synchronisation frequency | MP | | Integer(1..8) | This parameter specifies the frequency of the adjustment of the uplink transmission timing | REL-4 |
| >>>Synchronization parameters | OP | | | | |
| >>>>SYNC_UL codes bitmap | MD | | Bitstring(8) | 00000001 indicates code 0 can be used, 10000001 indicates that codes 0 and 7 can be used. Default: all SYNC_UL codes can be used | REL-4 |
| >>>>FPACH info | MP | | FPACH info 10.3.6.? | | REL-4 |
| >>>>SYNC_UL procedure | MD | | | Default is: Max SYNC_UL Transmission is 2. Power Ramping | REL-4 |

| | | | | | |
|-------------------------------|----|--|------------------|---|-------|
| | | | | Step is 2. | |
| >>>>Max SYNC_UL Transmissions | MP | | Integer(1,2,4,8) | Maximum numbers of SYNC_UL transmissions in a power ramping sequence. | REL-4 |
| >>>>Power Ramping Step | MP | | Integer(0,1,2,3) | In dB | REL-4 |

10.3.7 Measurement Information elements

10.3.7.1 Additional measurements list

| Information Element/Group name | Need | Multi | Type and reference | Semantics description |
|----------------------------------|------|--------------------------|--------------------------------|-----------------------|
| Additional measurements | MP | 1 to <MaxAdditionalMeas> | | |
| >Additional measurement identity | MP | | Measurement identity 10.3.7.48 | |

10.3.7.2 Cell info

Includes non-frequency related cell info used in the IE "inter-frequency cell info list" and "intra frequency cell info list".

| Information Element/Group name | Need | Multi | Type and reference | Semantics description | Version |
|--------------------------------------|-------------------|--------------|--|---|---------|
| Cell individual offset | MD | | Real(-10..10 by step of 0.5) | In dB Default value is 0 dB Used to offset measured quantity value | |
| Reference time difference to cell | OP | | Reference time difference to cell 10.3.7.60 | In chips. This IE is absent for serving cell. | |
| Read SFN indicator | MP | | Boolean | TRUE indicates that read of SFN is requested for the target cell | |
| CHOICE <i>mode</i> | MP | | | | |
| >FDD | | | | | |
| >>Primary CPICH info | OP | | Primary CPICH info 10.3.6.60 | This IE is absent only if measuring RSSI only (broadband measurement.) | |
| >>Primary CPICH Tx power | OP | | Primary CPICH Tx power 10.3.6.61 | Required if calculating pathloss. | |
| >>TX Diversity Indicator | MP | | Boolean | | |
| >TDD | | | | | |
| >>Primary CCPCH info | MP | | Primary CCPCH info 10.3.6.57 | | |
| >>Primary CCPCH TX power | OP | | Primary CCPCH TX power 10.3.6.59 | | |
| >>Timeslot list | OP | 1 to <maxTS> | | The UE shall report Timeslot ISCP values according the order of the listed Timeslot numbers | |
| >>>CHOICE <i>TDD option</i> | MP | | | | REL-4 |
| >>>>3.84 Mcps TDD | | | | | REL-4 |
| >>>>>Timeslot number | MP | | Integer (0...14) | Timeslot numbers, for which the UE shall report Timeslot ISCP | |
| >>>>>Burst Type | MD | | Enumerated (Type1, Type2) | Use for Timeslot ISCP measurements only. Default value is "Type1" | |
| >>>>>1.28Mcps TDD | | | | | REL-4 |
| >>>>>>Timeslot number | MP | | Integer (1...6) | Timeslot numbers, for which the UE shall report Timeslot ISCP | REL-4 |
| Cell Selection and Re-selection Info | CV- <i>BCHopt</i> | | Cell Selection and Re-selection for SIB11/12Info 10.3.2.4 | This IE is absent for serving cell. For neighbouring cell, if HCS is not used and all the parameters in cell selection and re-selection info are | |

| Information Element/Group name | Need | Multi | Type and reference | Semantics description | Version |
|--------------------------------|------|-------|--------------------|-----------------------------------|---------|
| | | | | default value, this IE is absent. | |

| Condition | Explanation |
|---------------|--|
| <i>BCHopt</i> | This IE is Optional when sent in SYSTEM INFORMATION, Otherwise, the IE is not needed |

10.3.7.3 Cell measured results

Includes non-frequency related measured results for a cell.

| Information Element/Group name | Need | Multi | Type and reference | Semantics description |
|----------------------------------|------|--------------|---|---|
| Cell Identity | OP | | Cell Identity 10.3.2.2 | |
| SFN-SFN observed time difference | OP | | SFN-SFN observed time difference 10.3.7.63 | |
| Cell synchronisation information | OP | | Cell synchronisation information 10.3.7.6 | |
| <i>CHOICE mode</i> | MP | | | |
| >FDD | | | | |
| >>Primary CPICH info | MP | | Primary CPICH info 10.3.6.60 | |
| >>CPICH Ec/N0 | OP | | Integer(0..50) | According to CPICH_Ec/No in [19] and [20] |
| >>CPICH RSCP | OP | | Integer(0..91) | According to CPICH_RSCP in [19] and [20] |
| >>Pathloss | OP | | Integer(46..158) | In dB |
| >TDD | | | | |
| >>Cell parameters Id | MP | | Cell parameters Id 10.3.6.9 | |
| >>Proposed TGSN | OP | | Integer (0..14) | Proposal for the next TGSN |
| >>Primary CCPCH RSCP | OP | | Primary CCPCH RSCP info 10.3.7.54 | |
| >>Pathloss | OP | | Integer(46..158) | In dB |
| >>Timeslot list | OP | 1 to <maxTS> | | |
| >>>Timeslot ISCP | MP | | Timeslot ISCP Info 10.3.7.65 | The UE shall report the Timeslot ISCP in the same order as indicated in the cell info |

10.3.7.4 Cell measurement event results

Includes non-frequency related cell reporting quantities.

| Information Element/Group name | Need | Multi | Type and reference | Semantics description |
|--------------------------------|------|----------------------|------------------------------|-----------------------|
| CHOICE <i>mode</i> | MP | | | |
| >FDD | | | | |
| >>Primary CPICH info | MP | 1 to <maxCellIM eas> | Primary CPICH info 10.3.6.60 | |
| >TDD | | | | |
| >>Primary CCPCH info | MP | 1 to <maxCellIM eas> | Primary CCPCH info 10.3.6.57 | |

10.3.7.5 Cell reporting quantities

Includes non-frequency related cell reporting quantities.

For all boolean types TRUE means inclusion in the report is requested.

| Information Element/Group name | Need | Multi | Type and reference | Semantics description |
|--|------|-------|--|-----------------------|
| SFN-SFN observed time difference reporting indicator | MP | | Enumerated(No report, type 1, type 2) | |
| Cell synchronisation information reporting indicator | MP | | Boolean | |
| Cell Identity reporting indicator | MP | | Boolean | |
| CHOICE <i>mode</i> | MP | | | |
| >FDD | | | | |
| >>CPICH Ec/N0 reporting indicator | MP | | Boolean | |
| >>CPICH RSCP reporting indicator | MP | | Boolean | |
| >>Pathloss reporting indicator | MP | | Boolean | |
| >TDD | | | | |
| >>Timeslot ISCP reporting indicator | MP | | Boolean | |
| >>Proposed TGSN Reporting required | MP | | Boolean | |
| >>Primary CCPCH RSCP reporting indicator | MP | | Boolean | |
| >>Pathloss reporting indicator | MP | | Boolean | |

10.3.7.6 Cell synchronisation information

The IE "Cell synchronisation information" contains the OFF and Tm as defined in [7] and [8] and the four most significant bits of the difference between the 12 least significant bits of the RLC Transparent Mode COUNT-C in the UE and the SFN of the measured cell. It is notified to SRNC by Measurement Report message or Measurement Information Element in other RRC messages

| Information Element/Group name | Need | Multi | Type and reference | Semantics description |
|--------------------------------|------|-------|---------------------------------|-----------------------|
| CHOICE <i>mode</i> | MP | | | |
| >FDD | | | | |
| >>COUNT-C-SFN frame difference | OP | | | |
| >>>COUNT-C-SFN high | MP | | Integer(0..3840 by step of 256) | in frames |
| >>>OFF | MP | | Integer(0..255) | in frames |
| >>Tm | MP | | Integer(0..38399) | in chips |
| >TDD | | | | |
| >>COUNT-C-SFN frame difference | OP | | | |
| >>>COUNT-C-SFN high | MP | | Integer(0..3840 by step of 256) | in frames |
| >>>OFF | MP | | Integer(0..255) | in frames |

NOTE: This measurement is only used in TDD when cells are not SFN synchronised

10.3.7.7 Event results

| Information Element/Group name | Need | Multi | Type and reference | Semantics description |
|--|------|-------|---|--|
| CHOICE <i>event result</i> | MP | | | |
| >Intra-frequency measurement event results | | | Intra-frequency measurement event results 10.3.7.37 | |
| >Inter-frequency measurement event results | | | Inter-frequency measurement event results 10.3.7.17 | |
| >Inter-RAT measurement event results | | | Inter-RAT measurement event results 10.3.7.28 | For IS-2000 results, include fields of the <i>Pilot Strength Measurement Message</i> from subclause 2.7.2.3.2.5 of TIA/EIA/IS-2000.5 |
| >Traffic volume measurement event results | | | Traffic volume measurement event results 10.3.7.69 | |
| >Quality measurement event results | | | Quality measurement event results 10.3.7.57 | |
| >UE internal measurement event results | | | UE internal measurement event results 10.3.7.78 | |
| >UE positioning measurement event results | | | UE positioning measurement event results 10.3.7.101 | |

| CHOICE <i>event result</i> | Condition under which the given <i>event result</i> is chosen |
|---|---|
| Intra-frequency measurement event results | If measurement type = intra-frequency measurement |
| Inter-frequency measurement event results | If measurement type = inter-frequency measurement |
| Inter-RAT measurement event results | If measurement type = inter-RAT measurement |
| Traffic volume measurement event results | If measurement type = traffic volume measurement |
| Quality measurement event results | If measurement type = Quality measurement |
| UE internal measurement event results | If measurement type = UE internal measurement |
| UE positioning measurement event results | If measurement type = UE positioning measurement |

10.3.7.8 FACH measurement occasion info

| Information Element/Group name | Need | Multi | Type and reference | Semantics description | Version |
|---|------|---------------------|-------------------------|---|---------|
| FACH Measurement occasion cycle length coefficient | OP | | Integer(1..12) | | |
| Inter-frequency FDD measurement indicator | MP | | Boolean | TRUE means that measurements are required | |
| Inter-frequency TDD 3.84 Mcps measurement indicator | MP | | Boolean | TRUE means that measurements are required | REL-4 |
| Inter-frequency TDD 1.28 Mcps measurement indicator | MP | | Boolean | TRUE means that measurements are required | |
| Inter-RAT measurement indicators | OP | 1 to <maxOther RAT> | | | |
| >RAT type | MP | | Enumerated(GSM, IS2000) | | |

10.3.7.9 Filter coefficient

| Information Element/Group name | Need | Multi | Type and reference | Semantics description |
|--------------------------------|------|-------|---|-----------------------|
| Filter coefficient | MD | | Integer(0, 1, 2, 3, 4, 5, 6, 7, 8, 9, 11, 13, 15, 17, 19) | Default value is 0 |

10.3.7.10 HCS Cell re-selection information

| Information Element/Group name | Need | Multi | Type and reference | Semantics description |
|--------------------------------|-------------------------------|-------|---|---|
| Penalty_time | MD | | Integer(0, 10, 20, 30, 40, 50, 60) | Default value is 0 which means = not used In seconds |
| Temporary_offsets | <i>CV-Penalty used</i> | | | |
| >Temporary_offset1 | MP | | Integer(10, 20, 30, 40, 50, 60, 70, infinity) | [dB] |
| >Temporary_offset2 | <i>CV-FDD-Quality-Measure</i> | | Integer(10, 20, 30, 40, 50, 60, 70, infinity) | [dB] |

| Condition | Explanation |
|----------------------------|--|
| <i>Penalty used</i> | Not allowed if IE Penalty time equals 'not used' else MP |
| <i>FDD-Quality-Measure</i> | Presence is not allowed if the IE "Cell_selection_and_reselection_quality_measure" has the value CPICH RSCP, otherwise the IE is mandatory. This conditional presence is implemented in ASN.1 by the use of a specific RSCP and EcN0 variant of 10.3.7.10. |

10.3.7.11 HCS neighbouring cell information

| Information Element/Group name | Need | Multi | Type and reference | Semantics description |
|-----------------------------------|------|-------|--|-----------------------|
| HCS_PRIO | MD | | Integer (0..7) | Default value = 0 |
| Qhcs | MD | | Qhcs 10.3.7.54a | Default value = 0 |
| HCS Cell Re-selection Information | MP | | HCS Cell Re-selection Information 10.3.7.10 | |

10.3.7.12 HCS Serving cell information

| Information Element/Group name | Need | Multi | Type and Reference | Semantics description |
|--------------------------------|-----------------------------|-------|---|----------------------------------|
| HCS_PRIO | MD | | Integer (0..7) | Default value = 0 |
| Qhcs | MD | | Qhcs 10.3.7.54a | Default value = 0 |
| T _{CRmax} | MD | | Enumerated(not used, 30, 60, 120, 180, 240) | [s] Default value is not used |
| N _{CR} | <i>CV-UE speed detector</i> | | Integer(1..16) | Default value = 8 |
| T _{CRmaxHyst} | <i>CV-UE speed detector</i> | | Enumerated(not used, 10, 20, 30, 40, 50, 60, 70) | [s] |

| Condition | Explanation |
|--------------------------|--|
| <i>UE Speed detector</i> | Not allowed if T _{CRmax} equals 'not used' else Mandatory |

10.3.7.13 Inter-frequency cell info list

Contains the measurement object information for an inter-frequency measurement.

| Information Element/Group name | Need | Multi | Type and reference | Semantics description |
|--|-------------------|--------------------|-------------------------------|--|
| CHOICE <i>Inter-frequency cell removal</i> | OP | | | |
| >Remove all inter-frequency cells | | | | No data |
| >Remove some inter-frequency cells | | | | |
| >>Removed inter-frequency cells | MP | 1 .. <maxCellMeas> | | |
| >>>Inter-frequency cell id | MP | | Integer(0 .. <maxCellMeas>-1) | |
| >No inter-frequency cells removed | | | | No data |
| New inter-frequency cells | OP | 1 to <maxCellMeas> | | |
| >Inter-frequency cell id | MD | | Integer(0 .. <maxCellMeas>-1) | |
| >Frequency info | MD | | Frequency info 10.3.6.36 | Default value is the value of the previous "frequency info" in the list (note : the first occurrence is then MP) |
| >Cell info | MP | | Cell info 10.3.7.2 | |
| Cell for measurement | CV- <i>BCHopt</i> | 1 to <maxCellMeas> | | |
| >Inter-frequency cell id | MP | | Integer(0 .. <maxCellMeas>-1) | |

| Condition | Explanation |
|---------------|--|
| <i>BCHopt</i> | This IE is not needed when sent in SYSTEM INFORMATION. Otherwise, the IE is Optional |

10.3.7.14 Inter-frequency event identity

| Information Element/Group name | Need | Multi | Type and reference | Semantics description |
|--------------------------------|------|-------|------------------------------------|-----------------------|
| Inter-frequency event identity | MP | | Enumerated(2a, 2b, 2c, 2d, 2e, 2f) | |

10.3.7.15 Inter-frequency measured results list

| Information Element/Group name | Need | Multi | Type and reference | Semantics description |
|---|------|--------------------|-----------------------------------|--|
| Inter-frequency measurement results | OP | 1 to <maxFreq> | | |
| >Frequency info | MD | | Frequency info 10.3.6.36 | Default value is the value of the previous "frequency info" in the list (note : the first occurrence is then MP) |
| >UTRA carrier RSSI | OP | | Integer(0..76) | According to UTRA_carrier_RSSI_LEV in [19] and [20] |
| >Inter-frequency cell measurement results | OP | 1 to <maxCellMeas> | | |
| >>Cell measured results | MP | | Cell measured results 10.3.7.3 | |

10.3.7.16 Inter-frequency measurement

| Information Element/Group name | Need | Multi | Type and reference | Semantics description |
|---|--------------|-------|--|---|
| Inter-frequency cell info list | MP | | Inter-frequency cell info list 10.3.7.13 | Measurement object |
| Inter-frequency measurement quantity | OP | | Inter-frequency measurement quantity 10.3.7.18 | |
| Inter-frequency reporting quantity | OP | | Inter-frequency reporting quantity 10.3.7.21 | |
| Reporting cell status | CV-reporting | | Reporting cell status 10.3.7.61 | |
| Measurement validity | OP | | Measurement validity 10.3.7.51 | |
| Inter-frequency set update | OP | | Inter-frequency set update 10.3.7.22 | |
| <i>CHOICE report criteria</i> | MP | | | |
| >Intra-frequency measurement reporting criteria | | | Intra-frequency measurement reporting criteria 10.3.7.39 | |
| >Inter-frequency measurement reporting criteria | | | Inter-frequency measurement reporting criteria 10.3.7.19 | |
| >Periodical reporting criteria | | | Periodical reporting criteria 10.3.7.53 | |
| >No reporting | | | | (no data) Chosen when this measurement only is used as additional measurement to another measurement |

| Condition | Explanation |
|------------------|--|
| <i>reporting</i> | This IE is optional if the CHOICE " <i>report criteria</i> " is equal to "periodical reporting criteria" or "No reporting", otherwise the IE is not needed |

10.3.7.17 Inter-frequency measurement event results

This IE contains the measurement event results that are reported to UTRAN for inter-frequency measurements.

| Information Element/Group name | Need | Multi | Type and reference | Semantics description |
|--|------|-------------------|---|-----------------------|
| Inter-frequency event identity | MP | | Inter-frequency event identity 10.3.7.14 | |
| Inter-frequency cells | OP | 1 to <maxFreq> | | |
| >Frequency info | MP | | Frequency info 10.3.6.36 | |
| >Non frequency related measurement event results | MP | | Cell measurement event results 10.3.7.4 | |

10.3.7.18 Inter-frequency measurement quantity

The quantity the UE shall measure in case of inter-frequency measurement. It also includes the filtering of the measurements.

| Information Element/Group name | Need | Multi | Type and reference | Semantics description |
|---|------|-------|---|-----------------------|
| CHOICE <i>reporting criteria</i> | MP | | | |
| >Intra-frequency reporting criteria | | | | |
| >>Intra-frequency measurement quantity | MP | | Intra-frequency measurement quantity 10.3.7.38 | |
| >Inter-frequency reporting criteria | | | | |
| >>Filter coefficient | MP | | Filter coefficient 10.3.7.9 | |
| >>>CHOICE <i>mode</i> | MP | | | |
| >>>>FDD | | | | |
| >>>>Measurement quantity for frequency quality estimate | MP | | Enumerated(CPICH Ec/N0, CPICH RSCP) | |
| >>>>TDD | | | | |
| >>>>Measurement quantity for frequency quality estimate | MP | | Enumerated(Primary CCPCH RSCP) | |

10.3.7.19 Inter-frequency measurement reporting criteria

The triggering of the event-triggered reporting for an inter-frequency measurements. All events concerning inter-frequency measurements are labelled 2x where x is a,b,c..

Event 2a: Change of best frequency.

Event 2b: The estimated quality of the currently used frequency is below a certain threshold **and** the estimated quality of a non-used frequency is above a certain threshold.

Event 2c: The estimated quality of a non-used frequency is above a certain threshold.

Event 2d: The estimated quality of the currently used frequency is below a certain threshold.

Event 2e: The estimated quality of a non-used frequency is below a certain threshold.

Event 2f: The estimated quality of the currently used frequency is above a certain threshold.

| Information Element/Group name | Need | Multi | Type and reference | Semantics description |
|--|-------------|----------------------|---|--|
| Parameters required for each event | OP | 1 to <maxMeas Event> | | |
| >Inter-frequency event identity | MP | | Inter-frequency event identity 10.3.7.14 | |
| >Threshold used frequency | CV-clause 0 | | Integer(-115..0) | Ranges used depend on measurement quantity. CPICH Ec/No -24..0dB CPICH/Primary CCPCH RSCP -115..-25dBm |
| >W used frequency | CV-clause 0 | | Real(0, 0.1..2.0 by step of 0.1) | |
| >Hysteresis | MP | | Real(0, 0.5..14.5 by step of 0.5) | In event 2a, 2b, 2c, 2d, 2e, 2f |
| >Time to trigger | MP | | Time to trigger 10.3.7.64 | Indicates the period of time between the timing of event detection and the timing of sending Measurement Report. Time in ms. |
| >Reporting cell status | OP | | Reporting cell status 10.3.7.61 | |
| >Parameters required for each non-used frequency | OP | 1 to <maxFreq > | | |
| >>Threshold non used frequency | CV-clause 1 | | Integer(-115..0) | Ranges used depend on measurement quantity. CPICH Ec/No -24..0dB CPICH/Primary CCPCH RSCP -115..-25dBm |
| >>W non-used frequency | CV-clause 1 | | Real(0, 0.1..2.0 by step of 0.1) | |

| Condition | Explanation |
|-----------|---|
| Clause 0 | 2a,2b, 2d, or 2f, otherwise the IE is not needed |
| Clause 1 | The IE is mandatory in if "inter frequency event identity" is set to 2a, 2b, 2c or 2e, otherwise the IE is not needed |

10.3.7.20 Inter-frequency measurement system information

| Information Element/Group name | Need | Multi | Type and reference | Semantics description |
|--------------------------------|------|-------|---|-----------------------|
| Inter-frequency cell info list | OP | | Inter-frequency cell info list 10.3.7.13 | |

10.3.7.21 Inter-frequency reporting quantity

| Information Element/Group name | Need | Multi | Type and reference | Semantics description |
|---|------|-------|------------------------------------|-------------------------------------|
| UTRA Carrier RSSI | MP | | Boolean | TRUE means report is requested |
| Frequency quality estimate | MP | | Boolean | TRUE means that report is requested |
| Non frequency related cell reporting quantities | MP | | Cell reporting quantities 10.3.7.5 | |

10.3.7.22 Inter-frequency SET UPDATE

NOTE: Only for FDD.

Contains the changes of the active set associated with a non-used frequency. This information makes it possible to use events defined for Intra-frequency measurement within the same non-used frequency for Inter-frequency measurement reporting criteria. This information also controls if the UE should use autonomous updating of the active set associated with a non-used frequency.

| Information Element/group name | Need | Multi | Type and reference | Semantics description |
|----------------------------------|------------------|--------------|--|---|
| UE autonomous update mode | MP | | Enumerated (On, On with no reporting, Off) | |
| Non autonomous update mode | <i>CV-Update</i> | | | |
| >Radio link addition information | OP | 1 to <maxRL> | | Radio link addition information required for each RL to add |
| >>Primary CPICH info | MP | | Primary CPICH info 10.3.6.60 | Note 1 |
| >Radio link removal information | OP | 1 to <MaxRL> | | Radio link removal information required for each RL to remove |
| >>Primary CPICH info | MP | | Primary CPICH info 10.3.6.60 | Note 1 |

| Condition | Explanation |
|---------------|---|
| <i>Update</i> | The IE is mandatory if IE"UE autonomous update mode" is set to "Off", otherwise the IE is not needed. |

NOTE 1: If it is assumed that CPICH downlink scrambling code is always allocated with sufficient reuse distances, CPICH downlink scrambling code will be enough for designating the different radio links.

10.3.7.23 Inter-RAT cell info list

Contains the measurement object information for an inter-RAT measurement.

| Information Element/Group name | Need | Multi | Type and reference | Semantics description |
|---|------|--------------------|--|---|
| CHOICE <i>Inter-RAT cell removal</i> | MP | | | |
| >Remove all inter-RAT cells | | | | No data |
| >Remove some inter-RAT cells | | | | |
| >>Removed inter-RAT cells | MP | 1 to <maxCellMeas> | | |
| >>>Inter-RAT cell id | MP | | Integer(0 .. <maxCellMeas> - 1) | |
| >Remove no inter-RAT cells | | | | |
| New inter-RAT cells | OP | 1 to <maxCellMeas> | | |
| >Inter-RAT cell id | OP | | Integer(0 .. <maxCellMeas> - 1) | |
| >CHOICE <i>Radio Access Technology</i> | MP | | | |
| >>GSM | | | | |
| >>>Cell individual offset | MP | | Integer (-50..50) | In dB Used to offset measured quantity value |
| >>>Cell selection and re-selection info | OP | | Cell selection and re-selection info for SIB11/12 10.3.2.4 | see 8.6.7.3 If HCS is not used and all the parameters in cell selection and re-selection info are default values, this IE is absent. |
| >>>BSIC | MP | | BSIC 10.3.8.2 | |
| >>>Band indicator | MP | | Enumerated (DCS 1800 band used, PCS 1900 band used) | Indicates how to interpret the BCCH ARFCN |
| >>>BCCH ARFCN | MP | | Integer (0..1023) | [45] |
| >>IS-2000 | | | | |
| >>>System specific measurement info | | | enumerated (frequency, timeslot, colour code, output power, PN offset) | For IS-2000, use fields from TIA/EIA/IS-2000.5, Subclause 3. 7.3.3.2.27, <i>Candidate Frequency Neighbour List Message</i> |
| Cell for measurement | OP | 1 to <maxCellMeas> | | |
| >Inter-RAT cell id | MP | | Integer(0 .. <maxCellMeas> -1) | |

10.3.7.24 Inter-RAT event identity

| Information Element/Group name | Need | Multi | Type and reference | Semantics description |
|--------------------------------|------|-------|-----------------------------|-----------------------|
| Inter-RAT event identity | MP | | Enumerated (3a, 3b, 3c, 3d) | |

10.3.7.25 Inter-RAT info

Inter-RAT info defines the target system for redirected cell selection.

| Information Element/Group name | Need | Multi | Type and reference | Semantics description |
|--------------------------------|------|-------|--------------------|-----------------------|
| Inter-RAT info | MP | | Enumerated (GSM) | |

10.3.7.26 Inter-RAT measured results list

| Information Element/Group name | Need | Multi | Type and reference | Semantics description |
|--|------|----------------------------|--|--|
| Inter-RAT measurement results | OP | 1 to <maxOther RAT> | | |
| >CHOICE <i>system</i> | MP | | | At least one spare value needed |
| >>GSM | | | | |
| >>>Measured GSM cells | MP | 1 to <maxReportedGSMCells> | | |
| >>>>GSM carrier RSSI | OP | | bit string(6) | RXLEV, [46]. The RSSI bits are numbered b0 to b5, where b0 is the least significant bit. |
| >>>>Pathloss | OP | | Integer(46..158) | In dB |
| >>>>CHOICE <i>BSIC</i> | MP | | | |
| >>>>>Verified BSIC | | | | |
| >>>>>>inter-RAT cell id | MP | | Integer(0..<maxCellMeasurements>-1) | |
| >>>>>>Non verified BSIC | | | | |
| >>>>>>>BCCH ARFCN | MP | | Integer (0..1023) | [45] |
| >>>>>>>>Observed time difference to GSM cell | OP | | Observed time difference to GSM cell 10.3.7.52 | |

10.3.7.27 Inter-RAT measurement

| Information Element/Group name | Need | Multi | Type and reference | Semantics description |
|---|--------------|-------|--|---|
| Inter-RAT cell info list | OP | | Inter-RAT cell info list 10.3.7.23 | Measurement object |
| Inter-RAT measurement quantity | OP | | Inter-RAT measurement quantity 10.3.7.29 | |
| Inter-RAT reporting quantity | OP | | Inter-RAT reporting quantity 10.3.7.32 | |
| Reporting cell status | CV-reporting | | Reporting cell status 10.3.7.61 | |
| <i>CHOICE report criteria</i> | MP | | | |
| >Inter-RAT measurement reporting criteria | | | Inter-RAT measurement reporting criteria 10.3.7.30 | |
| >Periodical reporting criteria | | | Periodical reporting criteria 10.3.7.53 | |
| >No reporting | | | | (no data) Chosen when this measurement only is used as additional measurement to another measurement |

| Condition | Explanation |
|------------------|--|
| <i>reporting</i> | This IE is optional if the CHOICE " <i>report criteria</i> " is equal to "periodical reporting criteria" or "No reporting", otherwise the IE is not needed |

10.3.7.28 Inter-RAT measurement event results

This IE contains the measurement event results that are reported to UTRAN for inter-RAT measurements.

| Information Element/Group name | Need | Multi | Type and reference | Semantics description |
|--------------------------------|------|--------------------|------------------------------------|-----------------------|
| Inter-RAT event identity | MP | | Inter-RAT event identity 10.3.7.24 | |
| Cells to report | MP | 1 to <maxCellMeas> | | |
| >CHOICE <i>BSIC</i> | MP | | | |
| >>Verified <i>BSIC</i> | | | | |
| >>>inter-RAT cell id | MP | | Integer(0..<maxCellMeas>-1) | |
| >>Non verified <i>BSIC</i> | | | | |
| >>>BCCH ARFCN | MP | | Integer (0..1023) | [45] |

10.3.7.29 Inter-RAT measurement quantity

The quantity the UE shall measure in case of inter-RAT measurement. It also includes the filtering of the measurements.

| Information Element/Group name | Need | Multi | Type and reference | Semantics description |
|---|------|-------|---|---|
| Measurement quantity for UTRAN quality estimate | OP | | Intra-frequency measurement quantity 10.3.7.38 | |
| CHOICE system | MP | | | |
| >GSM | | | | |
| >>Measurement quantity | MP | | Enumerated(GSM Carrier RSSI, Pathloss) | |
| >>Filter coefficient | MP | | Filter coefficient 10.3.7.9 | |
| >>BSIC verification required | MP | | Enumerated(required, not required) | |
| >IS2000 | | | | |
| >>TADD E_c/I_0 | MP | | Integer(0..63) | Admission criteria for neighbours, see subclause 2.6.6.2.6 of TIA/EIA/IS-2000.5 |
| >>TCOMP E_c/I_0 | MP | | Integer(0..15) | Admission criteria for neighbours, see subclause 2.6.6.2.5.2 of TIA/EIA/IS-2000.5 |
| >>SOFT SLOPE | OP | | Integer(0..63) | Admission criteria for neighbours, see subclause 2.6.6.2.3 and 2.6.6.2.5.2 of TIA/EIA/IS-2000.5 |
| >>ADD_INTERCEPT | OP | | Integer(0..63) | Admission criteria for neighbours, see subclause 2.6.6.2.5.2 of TIA/EIA/IS-2000.5 |

Also, this IE must be set to "required" if IE "Observed time difference to GSM cell" in IE "Inter-RAT reporting quantity" is set to "true".

10.3.7.30 Inter-RAT measurement reporting criteria

The triggering of the event-triggered reporting for an inter-RAT measurement. All events concerning inter-RAT measurements are labelled 3x where x is a,b,c..

Event 3a: The estimated quality of the currently used UTRAN frequency is below a certain threshold **and** the estimated quality of the other system is above a certain threshold.

Event 3b: The estimated quality of other system is below a certain threshold.

Event 3c: The estimated quality of other system is above a certain threshold.

Event 3d: Change of best cell in other system.

| Information Element/Group name | Need | Multi | Type and reference | Semantics description |
|------------------------------------|-------------|----------------------|---------------------------------------|--|
| Parameters required for each event | OP | 1 to <maxMeas Event> | | |
| >Inter-RAT event identity | MP | | Inter-RAT event identity 10.3.7.24 | |
| >Threshold own system | CV-clause 0 | | Integer (-115..0) | |
| >W | CV-clause 0 | | Real(0, 0.1..2.0 by step of 0.1) | In event 3a |
| >Threshold other system | CV-clause 1 | | Integer (-115..0) | In event 3a, 3b, 3c |
| >Hysteresis | MP | | Integer (0..15) | |
| >Time to trigger | MP | | Time to trigger 10.3.7.64 | Indicates the period of time between the timing of event detection and the timing of sending Measurement Report. |
| >Reporting cell status | OP | | Reporting cell status 10.3.7.61 | |

| Condition | Explanation |
|-----------|---|
| Clause 0 | The IE is mandatory if " Inter-RAT event identity" is set to "3a", otherwise the IE is not needed |
| Clause 1 | The IE is mandatory if " Inter-RAT event identity" is set to 3a, 3b or 3c, otherwise the IE is not needed |

10.3.7.31 Inter-RAT measurement system information

| Information Element/Group name | Need | Multi | Type and reference | Semantics description |
|--------------------------------|------|-------|---------------------------------------|-----------------------|
| Inter-RAT cell info list | OP | | Inter-RAT cell info list 10.3.7.23 | |

10.3.7.32 Inter-RAT reporting quantity

For all boolean types TRUE means inclusion in the report is requested.

| Information Element/Group name | Need | Multi | Type and reference | Semantics description |
|--|------|-------|--------------------|-----------------------|
| UTRAN estimated quality | MP | | Boolean | |
| CHOICE <i>system</i> | MP | | | |
| >GSM | | | | |
| >>Pathloss | MP | | Boolean | |
| >>Observed time difference to GSM cell | MP | | Boolean | |
| >>GSM Carrier RSSI | MP | | Boolean | |

10.3.7.33 Intra-frequency cell info list

Contains the measurement object information for an intra-frequency measurement.

| Information Element/Group name | Need | Multi | Type and reference | Semantics description |
|--|-------------------|--------------------|---------------------------------|--|
| CHOICE <i>Intra-frequency cell removal</i> | OP | | | |
| >Remove all intra-frequency cells | | | | No data |
| >Remove some intra-frequency cells | | | | |
| >>Removed intra-frequency cells | MP | 1 to <maxCellMeas> | | |
| >>>Intra-frequency cell id | MP | | Integer(0 .. <maxCellMeas> - 1) | |
| >Remove no intra-frequency cells | | | | |
| New intra-frequency cell | OP | 1 to <maxCellMeas> | | This information element must be present when "Intra-frequency cell info list" is included in the system information |
| >Intra-frequency cell id | MD | | Integer(0 .. <maxCellMeas> - 1) | |
| >Cell info | MP | | Cell info 10.3.7.2 | |
| Cell for measurement | CV- <i>BCHopt</i> | 1 to <maxCellMeas> | | |
| >Intra-frequency cell id | MP | | Integer(0 .. <maxCellMeas>-1) | |

| Condition | Explanation |
|---------------|--|
| <i>BCHopt</i> | This IE is not needed when sent in SYSTEM INFORMATION. Otherwise, the IE is Optional |

10.3.7.34 Intra-frequency event identity

| Information Element/Group name | Need | Multi | Type and reference | Semantics description |
|--------------------------------|------|-------|--|-----------------------|
| Intra-frequency event identity | MP | | Enumerated (1a,1b,1c,1d, 1e,1f,1g,1h,1i) | |

10.3.7.35 Intra-frequency measured results list

| Information Element/Group name | Need | Multi | Type and reference | Semantics description |
|-------------------------------------|------|--------------------|--------------------------------|-----------------------|
| Intra-frequency measurement results | OP | 1 to <maxCellMeas> | | |
| >Cell measured results | MP | | Cell measured results 10.3.7.3 | |

10.3.7.36 Intra-frequency measurement

| Information Element/Group name | Need | Multi | Type and reference | Semantics description |
|---|--------------|-------|---|---|
| Intra-frequency cell info list | OP | | Intra-frequency cell info list 10.3.7.33 | Measurement object |
| Intra-frequency measurement quantity | OP | | Intra-frequency measurement quantity 10.3.7.38 | |
| Intra-frequency reporting quantity | OP | | Intra-frequency reporting quantity 10.3.7.41 | |
| Reporting cell status | CV-reporting | | Reporting cell status 10.3.7.61 | |
| Measurement validity | OP | | Measurement validity 10.3.7.51 | |
| <i>CHOICE report criteria</i> | OP | | | |
| >Intra-frequency measurement reporting criteria | | | Intra-frequency measurement reporting criteria 10.3.7.39 | |
| >Periodical reporting criteria | | | Periodical reporting criteria 10.3.7.53 | |
| >No reporting | | | | (no data) Chosen when this measurement only is used as additional measurement to another measurement |

| Condition | Explanation |
|------------------|--|
| <i>reporting</i> | This IE is optional if the CHOICE " <i>report criteria</i> " is equal to "periodical reporting criteria" or "No reporting", otherwise the IE is not needed |

10.3.7.37 Intra-frequency measurement event results

This IE contains the measurement event results that are reported to UTRAN for intra-frequency measurements.

| Information Element/Group name | Need | Multi | Type and reference | Semantics description |
|--------------------------------|------|-------|---|-----------------------|
| Intra-frequency event identity | MP | | Intra-frequency event identity 10.3.7.34 | |
| Cell measurement event results | MP | | Cell measurement event results 10.3.7.4 | |

10.3.7.38 Intra-frequency measurement quantity

The quantity the UE shall measure in case of intra-frequency measurement. It also includes the filtering of the measurements.

| Information Element/Group name | Need | Multi | Type and reference | Semantics description |
|--------------------------------|------|--------|---|--|
| Filter coefficient | MP | | Filter coefficient 10.3.7.9 | |
| CHOICE <i>mode</i> | MP | | | |
| >FDD | | | | |
| >>Measurement quantity | MP | | Enumerated(C PICH Ec/N0, CPICH RSCP, Pathloss, UTRA Carrier RSSI) | If used in Inter system measurement quantity only Ec/N0 and RSCP is allowed. If used in inter-frequency measurement quantity RSSI is not allowed. |
| >TDD | | | | |
| >>Measurement quantity list | MP | 1 to 4 | | |
| >>>Measurement quantity | MP | | Enumerated(Pr imary CCPCH RSCP, Pathloss, Timeslot ISCP, UTRA Carrier RSSI) | If used in inter-frequency measurement quantity RSSI is not allowed. |

10.3.7.39 Intra-frequency measurement reporting criteria

The triggering of the event-triggered reporting for an intra-frequency measurement. All events concerning intra-frequency measurements are labelled 1x where x is a, b, c....

Event 1a: A Primary CPICH enters the Reporting Range (FDD only).

Event 1b: A Primary CPICH leaves the Reporting Range (FDD only).

Event 1c: A Non-active Primary CPICH becomes better than an active Primary CPICH (FDD only).

Event 1d: Change of best cell [Note 1] (FDD only).

Event 1e: A Primary CPICH becomes better than an absolute threshold (FDD only).

Event 1f: A Primary CPICH becomes worse than an absolute threshold (FDD only).

Event 1g: Change of best cell in TDD.

Event 1h: Timeslot ISCP below a certain threshold (TDD only).

Event 1i: Timeslot ISCP above a certain threshold (TDD only).

| Information Element/Group name | Need | Multi | Type and reference | Semantics description |
|--|-------------|----------------------|---|---|
| Parameters required for each event | OP | 1 to <maxMeas Event> | | |
| >Intra-frequency event identity | MP | | Intra-frequency event identity 10.3.7.34 | |
| >Triggering condition 1 | CV-clause 0 | | Enumerated(Active set cells, Monitored set cells, Active set cells and monitored set cells) | Indicates which cells can trigger the event |
| >Triggering condition 2 | CV-clause 6 | | Enumerated(Active set cells, Monitored set cells, Active set cells and monitored set cells, Detected set cells, Detected set cells and monitored set cells) | Indicates which cells can trigger the event |
| >Reporting Range Constant | CV-clause 2 | | Real(0..14.5 by step of 0.5) | In dB. In event 1a,1b. |
| >Cells forbidden to affect Reporting range | CV-clause 1 | 1 to <maxCellMeas> | | In event 1a,1b |
| >>CHOICE mode | MP | | | |
| >>>FDD | | | | |
| >>>>Primary CPICH info | MP | | Primary CPICH info 10.3.6.60 | |
| >>>TDD | | | | |
| >>>>Primary CCPCH info | MP | | Primary CCPCH info 10.3.6.57 | |
| >W | CV-clause 2 | | Real(0.0..2.0 by step of 0.1) | |
| >Hysteresis | MP | | Real(0..7.5 by step of 0.5) | In dB. |
| >Threshold used frequency | CV-clause 3 | | Integer (-115..165) | Range used depend on measurement quantity. CPICH RSCP -115..-25 dBm CPICH Ec/No -24..0 dB Pathloss 30..165dB ISCP -115..-25 dBm |
| >Reporting deactivation threshold | CV-clause 4 | | Integer(0, 1, 2, 3, 4, 5, 6, 7) | In event 1a Indicates the maximum number of cells allowed in the active set in order for event 1a to occur. 0 means not applicable |

| Information Element/Group name | Need | Multi | Type and reference | Semantics description |
|-----------------------------------|-------------|-------|---|---|
| >Replacement activation threshold | CV-clause 5 | | Integer(0, 1, 2, 3, 4, 5, 6, 7) | In event 1c Indicates the minimum number of cells allowed in the active set in order for event 1c to occur. 0 means not applicable |
| >Time to trigger | MP | | Time to trigger 10.3.7.64 | Indicates the period of time between the timing of event detection and the timing of sending Measurement Report. Time in ms |
| >Amount of reporting | CV-clause 7 | | Integer(1, 2, 4, 8, 16, 32, 64, Infinity) | |
| >Reporting interval | CV-clause 7 | | Integer(0, 250, 500, 1000, 2000, 4000, 8000, 16000) | Indicates the interval of periodical reporting when such reporting is triggered by an event. Interval in milliseconds. 0 means no periodical reporting |
| >Reporting cell status | OP | | Reporting cell status 10.3.7.61 | |

| Condition | Explanation |
|-----------|--|
| Clause 0 | The IE is mandatory if "Intra-frequency event identity" is set to "1b" or "1f", otherwise the IE is not needed |
| Clause 1 | The IE is optional if "Intra-frequency event identity" is set to "1a" or "1b", otherwise the IE is not needed |
| Clause 2 | The IE is mandatory if "Intra-frequency event identity" is set to "1a" or "1b", otherwise the IE is not needed |
| Clause 3 | The IE is mandatory if "Intra-frequency event identity" is set to , "1e", "1f", "1h" or "1i", otherwise the IE is not needed |
| Clause 4 | The IE is mandatory if "Intra-frequency event identity" is set to "1a", otherwise the IE is not needed |
| Clause 5 | The IE is mandatory if "Intra-frequency event identity" is set to "1c", otherwise the IE is not needed |
| Clause 6 | The IE is mandatory if "Intra-frequency event identity" is set to "1a" or "1e". |
| Clause 7 | The IE is mandatory if "Intra-frequency event identity" is set to "1a" or "1c". |

10.3.7.40 Intra-frequency measurement system information

| Information Element/Group name | Need | Multi | Type and reference | Semantics description |
|---|------|-------|---|---|
| Intra-frequency measurement identity | MD | | Measurement identity 10.3.7.48 | The intra-frequency measurement identity has default value 1. |
| Intra-frequency cell info list | OP | | Intra-frequency cell info list 10.3.7.33 | |
| Intra-frequency measurement quantity | OP | | Intra-frequency measurement quantity 10.3.7.38 | |
| Intra-frequency reporting quantity for RACH Reporting | OP | | Intra-frequency reporting quantity for RACH Reporting 10.3.7.42 | |
| Maximum number of reported cells on RACH | OP | | Maximum number of reported cells on RACH 10.3.7.43 | |
| Reporting information for state CELL_DCH | OP | | Reporting information for state CELL_DCH 10.3.7.62 | Note 1 |

NOTE 1: The reporting of intra-frequency measurements is activated when state CELL_DCH is entered.

10.3.7.41 Intra-frequency reporting quantity

Contains the reporting quantity information for an intra-frequency measurement.

| Information Element/Group name | Need | Multi | Type and reference | Semantics description |
|--|------|-------|------------------------------------|-----------------------|
| Reporting quantities for active set cells | MP | | Cell reporting quantities 10.3.7.5 | |
| Reporting quantities for monitored set cells | MP | | Cell reporting quantities 10.3.7.5 | |
| Reporting quantities for detected set cells | OP | | Cell reporting quantities 10.3.7.5 | |

10.3.7.42 Intra-frequency reporting quantity for RACH reporting

Contains the reporting quantity information for an intra-frequency measurement report, which is sent on the RACH.

| Information Element/Group name | Need | Multi | Type and reference | Semantics description |
|--|------|--------|---|-----------------------|
| SFN-SFN observed time difference reporting indicator | MP | | Enumerated(No report, type 1, type 2) | |
| CHOICE <i>mode</i> | MP | | | |
| >FDD | | | | |
| >>Reporting quantity | MP | | Enumerated(CPICH Ec/No, CPICH RSCP, Pathloss, No report) | |
| >TDD | | | | |
| >>Reporting quantity list | MP | 1 to 2 | | |
| >>>Reporting quantity | MP | | Enumerated(Timeslot ISCP, Primary CCPCH RSCP, No report) | |

10.3.7.43 Maximum number of reported cells on RACH

| Information Element/Group name | Need | Multi | Type and reference | Semantics description |
|----------------------------------|------|-------|--|-----------------------|
| Maximum number of reported cells | MP | | Enumerated (no report, current cell, current cell + best neighbour, current cell+2 best neighbours, ..., current cell+6 best neighbours) | |

10.3.7.44 Measured results

Contains the measured results of the quantity indicated optionally by Reporting Quantity in Measurement Control. "Measured results" can be used for both event trigger mode and periodical reporting mode. The list should be in the order of the value of the measurement quality (the first cell should be the best cell). The "best" FDD cell has the largest value when the measurement quantity is "Ec/No" or "RSCP". On the other hand, the "best" cell has the smallest value when the measurement quantity is "Pathloss". The "best" TDD cell has the largest value when measurement quantity is "Primary CCPCH RSCP".

| Information Element/Group name | Need | Multi | Type and reference | Semantics description |
|--|------|-------|--|-----------------------|
| CHOICE <i>Measurement</i> | MP | | | |
| >Intra-frequency measured results list | | | Intra-frequency measured results list 10.3.7.35 | |
| >Inter-frequency measured results list | | | Inter-frequency measured results list 10.3.7.15 | |
| >Inter-RAT measured results list | | | Inter-RAT measured results list 10.3.7.26 | |
| >Traffic volume measured results list | | | Traffic volume measured results list 10.3.7.67 | |
| >Quality measured results list | | | Quality measured results list 10.3.7.55 | |
| >UE Internal measured results | | | UE Internal measured results 10.3.7.76 | |
| >UE positioning measured results | | | UE positioning measured results 10.3.7.99 | |

10.3.7.45 Measured results on RACH

Contains the measured results on RACH of the quantity indicated optionally by Reporting Quantity in the system information broadcast on BCH. The list should be in the order of the value of the measurement quality (the first cell should be the best cell). The "best" FDD cell has the largest value when the measurement quantity is "Ec/No" or "RSCP". On the other hand, the "best" cell has the smallest value when the measurement quantity is "Pathloss". The "best" TDD cell has the largest value when measurement quantity is "Primary CCPCH RSCP".

| Information Element/group name | Need | Multi | Type and reference | Semantics description | Version |
|---|------|---------|--|---|---------|
| Measurement result for current cell | | | | | |
| CHOICE <i>mode</i> | MP | | | | |
| >FDD | | | | | |
| >>CHOICE <i>measurement quantity</i> | MP | | | | |
| >>>CPICH Ec/N0 | | | Integer(0..50) | In dB. According to CPICH_Ec/No in [19] | |
| >>>CPICH RSCP | | | Integer(0..91) | In dBm. According to CPICH_RSCP_LEV in [19] | |
| >>>Pathloss | | | Integer(46..158) | In dB | |
| >TDD | | | | | |
| >>CHOICE <i>TDD option</i> | MP | | | | REL-4 |
| >>>3.84 Mcps TDD | | | | | REL-4 |
| >>>>Timeslot List | OP | 1 to 14 | | | |
| >>>>>Timeslot ISCP | MP | | Timeslot ISCP info 10.3.7.65 | The UE shall report the Timeslot ISCP in the same order as indicated in the cell info | |
| >>>>1.28 Mcps TDD | | | | | REL-4 |
| >>>>>Timeslot List | OP | 1 to 6 | | | REL-4 |
| >>>>>>Timeslot ISCP | MP | | Timeslot ISCP info 10.3.7.65 | The UE shall report the Timeslot ISCP in the same order as indicated in the cell info | REL-4 |
| >>Primary CCPCH RSCP | OP | | Primary CCPCH RSCP info 10.3.7.54 | | |
| Measurement results for monitored cells | OP | 1 to 7 | | | |
| >SFN-SFN observed time difference | OP | | SFN-SFN observed time difference 10.3.7.63 | It is absent for current cell | |
| >CHOICE <i>mode</i> | MP | | | | |
| >>FDD | | | | | |
| >>>Primary CPICH info | MP | | Primary CPICH info 10.3.6.60 | | |
| >>>CHOICE <i>measurement quantity</i> | OP | | | It is absent for current cell | |
| >>>>CPICH Ec/N0 | | | Integer(0..50) | In dB. According to CPICH_Ec/No in [19]. | |
| >>>>CPICH RSCP | | | Integer(0..91) | In dBm. According to CPICH_RSCP_LEV in [19]. | |
| >>>>Pathloss | | | Integer(46..158) | In dB | |
| >>TDD | | | | | |
| >>>Cell parameters Id | MP | | Cell parameters Id 10.3.6.9 | | |
| >>>Primary CCPCH RSCP | MP | | Primary | | |

| | | | | | |
|--|--|--|---------------------------------|--|--|
| | | | CCPCH RSCP info 10.3.7.54 | | |
|--|--|--|---------------------------------|--|--|

NOTE 1: Monitored cells consist of current cell and neighbouring cells.

10.3.7.46 Measurement Command

| Information Element/Group name | Need | Multi | Type and reference | Semantics description |
|--------------------------------|------|-------|------------------------------------|-----------------------|
| Measurement command | MP | | Enumerated(Setup, Modify, Release) | |

10.3.7.47 Measurement control system information

| Information element/Group name | Need | Multi | Type and reference | Semantics description |
|--|------|-------|--|--|
| Use of HCS | MP | | Enumerated (Not used, used) | Indicates if the serving cell belongs to a HCS structure |
| Cell_selection_and_reselection_quality_measure | MP | | Enumerated (CPICH Ec/N0, CPICH RSCP) | Choice of measurement (CPICH Ec/N0 or CPICH RSCP) to use as quality measure Q. |
| Intra-frequency measurement system information | OP | | Intra-frequency measurement system information 10.3.7.40 | |
| Inter-frequency measurement system information | OP | | Inter-frequency measurement system information 10.3.7.20 | |
| Inter-RAT measurement system information | OP | | Inter-RAT measurement system information 10.3.7.31 | |
| Traffic volume measurement system information | OP | | Traffic volume measurement system information 10.3.7.73 | |
| UE Internal measurement system information | OP | | UE Internal measurement system information 10.3.7.81 | |

10.3.7.48 Measurement Identity

A reference number that is used by the UTRAN at modification and release of the measurement, and by the UE in the measurement report.

| Information Element/Group name | Need | Multi | Type and reference | Semantics description |
|--------------------------------|------|-------|--------------------|-----------------------|
| Measurement identity | MP | | Integer(1..16) | |

10.3.7.49 Measurement reporting mode

Contains the type of Measurement Report transfer mode and the indication of periodical/event trigger.

| Information Element/Group name | Need | Multi | Type and reference | Semantics description |
|---|------|-------|---|-----------------------|
| Measurement Report Transfer Mode | MP | | enumerated (Acknowledged mode RLC, Unacknowledged mode RLC) | |
| Periodical Reporting / Event Trigger Reporting Mode | MP | | Enumerated (Periodical reporting, Event trigger) | |

10.3.7.50 Measurement Type

| Information Element/Group name | Need | Multi | Type and reference | Semantics description |
|--------------------------------|------|-------|---|-----------------------|
| Measurement Type | MP | | Enumerated(Intra-frequency, Inter-frequency, Inter-RAT, Traffic volume, Quality, UE internal, UE positioning) | |

10.3.7.51 Measurement validity

| Information Element/Group name | Need | Multi | Type and reference | Semantics description |
|--------------------------------|------|-------|--|---|
| UE state | MP | | Enumerated(CELL_DCH, all states except CELL_DCH, all states) | Indicates the states, in which measurement reporting shall be conducted. The values 'all states except CELL_DCH' and 'all states' are used for measurement type 'traffic volume reporting'. |

10.3.7.52 Observed time difference to GSM cell

| Information Element/Group name | Need | Multi | Type and reference | Semantics description |
|--------------------------------------|------|-------|--------------------|--|
| Observed time difference to GSM cell | OP | | Integer(0,,4095) | According to GSM_TIME in [19] and [20] |

10.3.7.53 Periodical reporting criteria

Contains the periodical reporting criteria information. It is necessary only in the periodical reporting mode.

| Information Element/Group name | Need | Multi | Type and reference | Semantics description |
|--------------------------------|------|-------|--|--|
| Amount of reporting | MD | | Integer(1, 2, 4, 8, 16, 32, 64, Infinity) | The default value is infinity. |
| Reporting interval | MP | | Integer(250, 500, 1000, 2000, 3000, 4000, 6000, 8000, 12000, 16000, 20000, 24000, 28000, 32000, 64000) | Indicates the interval of periodical report. Interval in milliseconds |

10.3.7.53a PLMN identities of neighbour cells

This IE contains the PLMN identities of neighbour cells.

| Information Element/Group name | Need | Multi | Type and reference | Semantics description |
|-------------------------------------|------|---------------------|-------------------------|--|
| PLMNs of intra-frequency cells list | OP | 1 to <maxCellM eas> | | |
| >PLMN identity | MD | | PLMN identity 10.3.1.11 | Default value is the previous "PLMN identity" in the list. The default value for the first PLMN in the list is the identity of the selected PLMN if the "PLMN type" in the variable SELECTED_PLMN has the value "GSM-MAP"; otherwise, the first occurrence is MP. |
| PLMNs of inter-frequency cells list | OP | 1 to <maxCellM eas> | | |
| >PLMN identity | MD | | PLMN identity 10.3.1.11 | Default value is the previous "PLMN identity" in the list. The default value for the first PLMN in the list is the identity of the selected PLMN if the "PLMN type" in the variable SELECTED_PLMN has the value "GSM-MAP"; otherwise, the first occurrence is MP. |
| PLMNs of inter-RAT cells list | OP | 1 to <maxCellM eas> | | |
| >PLMN identity | MD | | PLMN identity 10.3.1.11 | Default value is the previous "PLMN identity" in the list. The default value for the first PLMN in the list is the identity of the selected PLMN if the "PLMN type" in the variable SELECTED_PLMN has the value "GSM-MAP"; otherwise, the first occurrence is MP. |

10.3.7.54 Primary CCPCH RSCP info

NOTE: Only for TDD

| Information Element/Group name | Need | Multi | IE type and reference | Semantics description |
|--------------------------------|------|-------|-----------------------|--|
| Primary CCPCH RSCP | MP | | Integer(0..91) | According to P-CCPCH_RSCP_LEV in [19] and [20] |

10.3.7.54a Qhcs

| Information Element/Group name | Need | Multi | Type and Reference | Semantics description |
|--------------------------------|------|-------|--------------------|---|
| Qhcs | MP | | Integer(0..99) | Qhcs, mapped from CPICH Ec/No (FDD), see [4] [dB] 0: -24 1: -23.5 2: -23 3: -22.5 ... 45: -1.5 46: -1 47: -0.5 48: 0 49: (spare) ... 98: (spare) 99: (spare) |
| | | | | Qhcs, mapped from CPICH RSCP (FDD), see [4] [dBm] 0: -115 1: -114 2: -113 : 88: -27 89: -26 90: -(spare) 91: -(spare) : 98: -(spare) 99: -(spare) |
| | | | | Qhcs, mapped from PCCPCH RSCP (TDD), see [4] [dBm] 0: -115 1: -114 2: -113 : 88: -27 89: -26 90: -(spare) 91: -(spare) : 98: -(spare) 99: -(spare) |

| | | | |
|--|--|--|---|
| | | | Qhcs level, mapped from Averaged received signal level RXLEV (GSM), see [4] [dBm] 0: -110 1: -109 2: -108 : 61: -49 62: -48 63: -47 64: -46 65: -45 66: -44 67: -43 68: -42 69: -41 70: -40 71: -39 72: -38 73: -37 74: -(spare) : 98: -(spare) 99: -(spare) |
|--|--|--|---|

10.3.7.55 Quality measured results list

| Information Element/Group name | Need | Multi | Type and reference | Semantics description |
|--------------------------------|------|-------------------|--------------------------------------|---|
| BLER measurement results | OP | 1 to <maxTrCH > | | |
| >DL Transport channel identity | MP | | Transport channel identity 10.3.5.18 | transport channel type = DCH |
| >DL Transport Channel BLER | OP | | Integer (0..63) | According to BLER_LOG in [19] and [20] |
| CHOICE <i>mode</i> | MP | | | |
| >FDD | | | | No data |
| >TDD | | | | |
| >>SIR measurement results | OP | 1 to <MaxCCTrCH > | | SIR measurements for DL CCTrCH |
| >>>TFCS ID | MP | | Integer(1...8) | |
| >>>Timeslot list | MP | 1 to <maxTS> | | for all timeslot on which the CCTrCH is mapped on |
| >>>>SIR | MP | | Integer(0..63) | According to UE_SIR in [20] |

10.3.7.56 Quality measurement

| Information Element/Group name | Need | Multi | Type and reference | Semantics description |
|---|------|-------|---|---|
| Quality reporting quantity | OP | | Quality reporting quantity 10.3.7.59 | |
| <i>CHOICE report criteria</i> | MP | | | |
| >Quality measurement reporting criteria | | | Quality measurement reporting criteria 10.3.7.58 | |
| >Periodical reporting criteria | | | Periodical reporting criteria 10.3.7.53 | |
| >No reporting | | | | (no data) Chosen when this measurement only is used as additional measurement to another measurement |

10.3.7.57 Quality measurement event results

| Information Element/Group name | Need | Multi | Type and reference | Semantics description |
|--------------------------------------|------|-----------------|---|------------------------------|
| Transport channels causing the event | OP | 1 to <maxTrCH > | | |
| >DL Transport channel identity | MP | | Transport channel identity 10.3.5.18 | transport channel type = DCH |

10.3.7.58 Quality measurement reporting criteria

Event 5a: Number of bad CRCs on a certain transport channel exceeds a threshold.

| Information Element/Group name | Need | Multi | Type and reference | Semantics description |
|--|------|-----------------|---|------------------------------|
| Parameters sent for each transport channel | OP | 1 to <maxTrCH > | | |
| >DL Transport channel identity | MP | | Transport channel identity 10.3.5.18 | transport channel type = DCH |
| >Total CRC | MP | | Integer(1..512) | Number of CRCs |
| >Bad CRC | MP | | Integer(1..512) | Number of CRCs |
| >Pending after trigger | MP | | Integer(1..512) | Number of CRCs |

10.3.7.59 Quality reporting quantity

| Information Element/Group name | Need | Multi | Type and reference | Semantics description |
|---------------------------------------|--------------------------|-------------------|--------------------------------------|---|
| DL Transport Channel BLER | MP | | Boolean | TRUE means report requested |
| Transport channels for BLER reporting | <i>CV-BLER reporting</i> | 1 to <maxTrCH > | | The default, if no transport channel identities are present, is that the BLER is reported for all downlink transport channels |
| >DL Transport channel identity | MP | | Transport channel identity 10.3.5.18 | transport channel type = DCH |
| CHOICE <i>mode</i> | MP | | | |
| >FDD | | | | No data |
| >TDD | | | | |
| >>SIR measurement list | OP | 1 to <maxCCTr CH> | | SIR measurements shall be reported for all listed TFCS IDs |
| >>>TFCS ID | MP | | Integer(1..8) | |

| Condition | Explanation |
|-----------------------|---|
| <i>BLER reporting</i> | This information element is absent if 'DL Transport Channel BLER' is 'False' and optional, if 'DL Transport Channel BLER' is 'True' |

10.3.7.60 Reference time difference to cell

In the System Information message, the reference time difference to cell indicates the timing difference between the primary CCPCH of the current cell and the primary CCPCH of a neighbouring cell..

In the Measurement Control message, the reference time difference to cell indicates the timing difference between UE uplink transmission timing and the primary CCPCH of a neighbouring cell.

| Information Element/Group name | Need | Multi | Type and reference | Semantics description |
|--------------------------------|------|-------|-----------------------------------|-----------------------|
| CHOICE <i>accuracy</i> | MP | | | |
| >40 chips | | | | |
| >>Reference time difference | MP | | Integer(0..38400 by step of 40) | In chips |
| >256 chips | | | | |
| >>Reference time difference | MP | | Integer(0..38400 by step of 256) | In chips |
| >2560 chips | | | | |
| >>Reference time difference | MP | | Integer(0..38400 by step of 2560) | In chips |

10.3.7.61 Reporting Cell Status

Indicates maximum allowed number of cells to report and whether active set cells and/or virtual active set cells and/or monitored set cells on and/or detected set cells used frequency and/or monitored set cells on non used frequency should/should not be included in the IE "Measured results".

| Information Element/Group name | Need | Multi | Type and reference | Semantics description |
|---|------|-------|--|-----------------------|
| CHOICE <i>reported cell</i> | MP | | | |
| >Report cells within active set | | | | |
| >>Maximum number of reported cells | MP | | Enumerated(e1..e6) | |
| >Report cells within monitored set cells on used frequency | | | | |
| >>Maximum number of reported cells | MP | | Enumerated(e1..e6) | |
| >Report cells within active set and/or monitored set cells on used frequency | | | | |
| >>Maximum number of reported cells | MP | | Enumerated(e1..e6) | |
| >Report cells within detected set on used frequency | | | | |
| >>Maximum number of reported cells | MP | | Enumerated(e1..e6) | |
| >Report cells within monitored set and/or detected set on used frequency | | | | |
| >>Maximum number of reported cells | MP | | Enumerated(e1..e6) | |
| >Report all active set cells + cells within monitored set on used frequency | | | | |
| >>Maximum number of reported cells | MP | | Enumerated (virtual/active set cells+1, virtual/active set cells+2, ..., virtual/active set cells+6) | |
| >Report all active set cells + cells within detected set on used frequency | | | | |
| >>Maximum number of reported cells | MP | | Enumerated (virtual/active set cells+1, virtual/active set cells+2, ..., virtual/active set cells+6) | |
| >Report all active set cells + cells within monitored set and/or detected set on used frequency | | | | |
| >>Maximum number of reported cells | MP | | Enumerated (virtual/active set cells+1, virtual/active set cells+2, ..., virtual/active set cells+6) | |

| | | | | |
|--|----|--|--|--|
| >Report cells within virtual active set | | | | |
| >>Maximum number of reported cells | MP | | Integer(1..6) | |
| >Report cells within monitored set on non-used frequency | | | | |
| >>Maximum number of reported cells | MP | | Integer(1..6) | |
| >Report cells within monitored and/or active set on non-used frequency | | | | |
| >>Maximum number of reported cells | MP | | Integer(1..6) | |
| >Report all virtual active set cells + cells within monitored set on non-used frequency | | | | |
| >>Maximum number of reported cells | MP | | Enumerated (virtual/active set cells+1, virtual/active set cells+2, ..., virtual/active set cells+6) | |
| >Report cells within active set or within virtual active set | | | | |
| >>Maximum number of reported cells | MP | | Integer (1..12) | |
| >Report cells within active and/or monitored set on used frequency or within active and/or monitored set on non-used frequency | | | | |
| >>Maximum number of reported cells | MP | | Integer(1..12) | |

10.3.7.62 Reporting information for state CELL_DCH

| Information Element/Group name | Need | Multi | Type and reference | Semantics description |
|---|------|-------|--|-----------------------|
| Intra-frequency reporting quantity | MP | | Intra-frequency reporting quantity 10.3.7.41 | |
| Measurement Reporting Mode | MP | | Measurement Reporting Mode 10.3.7.49 | |
| CHOICE <i>report criteria</i> | MP | | | |
| >Intra-frequency measurement reporting criteria | | | Intra-frequency measurement reporting criteria 10.3.7.39 | |
| >Periodical reporting criteria | | | Periodical reporting criteria 10.3.7.53 | |

10.3.7.63 SFN-SFN observed time difference

| Information Element/Group name | Need | Multi | Type and reference | Semantics description |
|--------------------------------|------|-------|---------------------|---|
| CHOICE <i>type</i> | MP | | | |
| >Type 1 | | | Integer(0..9830399) | According to T1_SFN-SFN_TIME in [19] and [20] |
| >Type 2 | | | Integer(0..40961) | According to T2_SFN-SFN_TIME in [19] and [20] |

10.3.7.64 Time to trigger

| Information Element/Group name | Need | Multi | Type and reference | Semantics description |
|--------------------------------|------|-------|---|-----------------------|
| Time to trigger | MP | | Integer(0, 10, 20, 40, 60, 80, 100, 120, 160, 200, 240, 320, 640, 1280, 2560, 5000) | Time in ms |

10.3.7.65 Timeslot ISCP info

NOTE: Only for TDD

| Information Element/Group name | Need | Multi | IE type and reference | Semantics description |
|--------------------------------|------|-------|-----------------------|-------------------------------------|
| Timeslot ISCP | MP | | Integer (0..91) | According to UE_TS_ISCP_LEV in [20] |

10.3.7.66 Traffic volume event identity

| Information Element/Group name | Need | Multi | Type and reference | Semantics description |
|--------------------------------|------|-------|--------------------|-----------------------|
| Traffic volume event identity | MP | | Enumerated(4a, 4b) | |

10.3.7.67 Traffic volume measured results list

| Information Element/Group name | Need | Multi | Type and reference | Semantics description |
|------------------------------------|------|---------------|--|---|
| Traffic volume measurement results | OP | 1 to <maxRB > | | |
| >RB Identity | MP | | RB Identity 10.3.4.16 | |
| >RLC Buffers Payload | OP | | Enumerated(0, 4, 8, 16, 32, 64, 128, 256, 512, 1024, 2K, 4K, 8K, 16K, 32K, 64K, 128K, 256K, 512K, 1024K) | In bytes And N Kbytes = N*1024 bytes |
| >Average of RLC Buffer Payload | OP | | Enumerated(0, 4, 8, 16, 32, 64, 128, 256, 512, 1024, 2K, 4K, 8K, 16K, 32K, 64K, 128K, 256K, 512K, 1024K) | In bytes And N Kbytes = N*1024 bytes |
| >Variance of RLC Buffer Payload | OP | | Enumerated(0, 4, 8, 16, 32, 64, 128, 256, 512, 1024, 2K, 4K, 8K, 16K) | In bytes And N Kbytes = N*1024 bytes |

10.3.7.68 Traffic volume measurement

| Information Element/Group name | Need | Multi | Type and reference | Semantics description |
|--|------|-------|--|---|
| Traffic volume measurement Object | OP | | Traffic volume measurement Object 10.3.7.70 | |
| Traffic volume measurement quantity | OP | | Traffic volume measurement quantity 10.3.7.71 | |
| Traffic volume reporting quantity | OP | | Traffic volume reporting quantity 10.3.7.74 | |
| Measurement validity | OP | | Measurement validity 10.3.7.51 | |
| <i>CHOICE report criteria</i> | MP | | | |
| >Traffic volume measurement reporting criteria | | | Traffic volume measurement reporting criteria 10.3.7.72 | |
| >Periodical reporting criteria | | | Periodical reporting criteria 10.3.7.53 | |
| >No reporting | | | | (no data) Chosen when this measurement only is used as additional measurement to another measurement |

10.3.7.69 Traffic volume measurement event results

Contains the event result for a traffic volume measurement.

| Information Element/Group name | Need | Multi | Type and reference | Semantics description |
|---|-----------------------|-------|--|-----------------------|
| Uplink transport channel type causing the event | MP | | Enumerated(DCH,RACH,USCH) | USCH is TDD only |
| UL Transport Channel identity | <i>CV-UL-DCH/USCH</i> | | Transport channel identity 10.3.5.18 | |
| Traffic volume event identity | MP | | Traffic volume event identity 10.3.7.66 | |

| Condition | Explanation |
|--------------------|---|
| <i>UL-DCH/USCH</i> | If IE "Uplink transport channel type" is equal to "DCH" or "USCH" (TDD only) this IE is MP. Otherwise the IE is not needed. |

10.3.7.70 Traffic volume measurement object

Contains the measurement object information for a traffic volume measurement.

| Information Element/Group name | Need | Multi | Type and reference | Semantics description |
|------------------------------------|----------------|-----------------|--------------------------------------|-----------------------|
| Traffic volume measurement objects | MP | 1 to <maxTrCH > | | |
| >Uplink transport channel type | MP | | Enumerated(DCH,RACH, USCH) | USCH is TDD only |
| >UL Target Transport Channel ID | CV-UL-DCH/USCH | | Transport channel identity 10.3.5.18 | |

| Condition | Explanation |
|-------------|---|
| UL-DCH/USCH | If IE "Uplink transport channel type" is equal to "DCH" or "USCH" (TDD only) this IE is MP. Otherwise the IE is not needed. |

10.3.7.71 Traffic volume measurement quantity

Contains the measurement quantity information for a traffic volume measurement.

| Information Element/Group name | Need | Multi | Type and reference | Semantics description |
|--|--------|-------|--|---|
| Measurement quantity | MP | | Enumerated(RLC buffer payload, Average RLC buffer payload, Variance of RLC buffer payload) | The use of this parameter is described in section 8.6.7.10. |
| Time Interval to take an average or a variance | CV-A/V | | Integer(20, 40, ..260, by steps of 20) | In ms |

| Condition | Explanation |
|-----------|---|
| A/V | This IE is present when "Average RLC buffer" or "Variance of RLC buffer payload" is chosen. |

10.3.7.72 Traffic volume measurement reporting criteria

Contains the measurement reporting criteria information for a traffic volume measurement.

Event 4a: Transport Channel Traffic Volume [15] exceeds an absolute threshold.

Event 4b: Transport Channel Traffic Volume [15] becomes smaller than an absolute threshold.

| Information Element/Group name | Need | Multi | Type and reference | Semantics description |
|--|----------------|-------------------------|--|---|
| Parameters sent for each transport channel | OP | 1 to <maxTrCH > | | |
| >Uplink transport channel type | OP | | Enumerated(DCH,RACH,USCH) | USCH is TDD only |
| >UL Transport Channel ID | CV-UL-DCH/USCH | | Transport channel identity 10.3.5.18 | |
| >Parameters required for each Event | OP | 1 to <maxMeas perEvent> | | |
| >>Traffic volume event identity | MP | | Traffic volume event identity 10.3.7.66 | |
| >>Reporting Threshold | MP | | Enumerated(8,16,32,64,128,256,512,1024,2K,3K,4K,6K,8K,12K,16K,24K,32K,48K,64K,96K,128K,192K,256K,384K,512K,768K) | Threshold in bytes And N Kbytes = N*1024 bytes |
| >>Time to trigger | OP | | Time to trigger 10.3.7.64 | Indicates the period of time between the timing of event detection and the timing of sending Measurement Report. Time in ms |
| >>Pending time after trigger | OP | | Integer(250, 500, 1000, 2000, 4000, 8000, 16000) | Indicates the period of time during which it is forbidden to send any new measurement reports with the same Traffic volume event identity even if the triggering condition is fulfilled. Time in milliseconds |
| >>Tx interruption after trigger | OP | | Integer (250, 500, 1000, 2000, 4000, 8000, 16000) | Time in milliseconds. Indicates how long the UE shall block DTCH transmissions on the RACH after a measurement report is triggered. |

| Condition | Explanation |
|-------------|---|
| UL-DCH/USCH | If IE "Uplink transport channel type" is equal to "DCH" or "USCH" (TDD only) this IE is OP. Otherwise the IE is not needed. |

10.3.7.73 Traffic volume measurement system information

| Information Element/Group name | Need | Multi | Type and reference | Semantics description |
|-------------------------------------|------|-------|-----------------------------------|--|
| Traffic volume measurement identity | MD | | Measurement identity 10.3.7.48 | The traffic volume measurement identity has default value 4. |
| Traffic volume measurement object | OP | | Traffic volume measurement object | |

| | | | | |
|--|----|--|--|--|
| | | | 10.3.7.70 | |
| Traffic volume measurement quantity | OP | | Traffic volume measurement quantity 10.3.7.71 | |
| Traffic volume reporting quantity | OP | | Traffic volume reporting quantity 10.3.7.74 | |
| Measurement validity | OP | | Measurement validity 10.3.7.51 | |
| Measurement Reporting Mode | MP | | Measurement Reporting Mode 10.3.7.49 | |
| <i>CHOICE reporting criteria</i> | MP | | | |
| >Traffic volume measurement reporting criteria | | | Traffic volume measurement reporting criteria 10.3.7.72 | |
| >Periodical reporting criteria | | | Periodical reporting criteria 10.3.7.53 | |

10.3.7.74 Traffic volume reporting quantity

Contains the reporting quantity information for a traffic volume measurement.

For all boolean types TRUE means inclusion in the report is requested.

| Information Element/Group name | Need | Multi | Type and reference | Semantics description |
|--|------|-------|--------------------|-----------------------|
| RLC Buffer Payload for each RB | MP | | Boolean | |
| Average of RLC Buffer Payload for each RB | MP | | Boolean | |
| Variance of RLC Buffer Payload for each RB | MP | | Boolean | |

10.3.7.75 UE internal event identity

| Information Element/Group name | Need | Multi | Type and reference | Semantics description |
|--------------------------------|------|-------|------------------------------------|-----------------------|
| UE internal event identity | MP | | Enumerated(6a,6b,6c,6d,6e, 6f, 6g) | |

10.3.7.76 UE internal measured results

| Information Element/Group name | Need | Multi | Type and reference | Semantics description | Version |
|------------------------------------|------|--------------|--|---|---------|
| CHOICE <i>mode</i> | MP | | | | |
| >FDD | | | | | |
| >>UE Transmitted Power | OP | | UE Transmitted Power info 10.3.7.85 | | |
| >>UE Rx-Tx report entries | OP | 1 to <maxRL> | | | |
| >>>Primary CPICH info | MP | | Primary CPICH info 10.3.6.60 | Primary CPICH info for each cell included in the active set | |
| >>>UE Rx-Tx time difference type 1 | MP | | UE Rx-Tx time difference type 1 10.3.7.83 | UE Rx-Tx time difference in chip for each RL included in the active set | |
| >TDD | | | | | |
| >>UE Transmitted Power list | OP | 1 to <maxTS> | | UE Transmitted Power for each used uplink timeslot in ascending timeslot number order | |
| >>>UE Transmitted Power | MP | | UE Transmitted Power info 10.3.7.85 | | |
| >>CHOICE <i>TDD option</i> | MP | | | | REL-4 |
| >>>3.84 Mcps TDD | | | | | REL-4 |
| >>>>Applied TA | OP | | Uplink Timing Advance 10.3.6.95 | Uplink timing advance applied by the UE | |
| >>>>1.28 Mcps TDD | | | | | REL-4 |
| >>>> UpPCH _{ADV} | OP | | UpPCH _{ADV} 10.3.7.112 | | REL-4 |

10.3.7.77 UE internal measurement

| Information Element/Group name | Need | Multi | Type and reference | Semantics description |
|---|------|-------|---|---|
| UE internal measurement quantity | OP | | UE internal measurement quantity 10.3.7.79 | |
| UE internal reporting quantity | OP | | UE internal reporting quantity 10.3.7.82 | |
| <i>CHOICE report criteria</i> | MP | | | |
| >UE internal measurement reporting criteria | | | UE internal measurement reporting criteria 10.3.7.80 | |
| >Periodical reporting criteria | | | Periodical reporting criteria 10.3.7.53 | |
| >No reporting | | | | (no data) Chosen when this measurement only is used as additional measurement to another measurement |

| <i>CHOICE report criteria</i> | Condition under which the given <i>report criteria</i> is chosen |
|--|--|
| UE internal measurement reporting criteria | Chosen when UE internal measurement event triggering is required |
| Periodical reporting criteria | Chosen when periodical reporting is required |
| No reporting | Chosen when this measurement only is used as additional measurement to another measurement |

10.3.7.78 UE internal measurement event results

This IE contains the measurement event results that are reported to UTRAN for UE internal measurements.

| Information Element/Group name | Need | Multi | Type and reference | Semantics description |
|--------------------------------|--------------------|-------|---|-----------------------|
| UE internal event identity | MP | | UE internal event identity 10.3.7.75 | |
| <i>CHOICE mode</i> | MP | | | |
| >FDD | | | | |
| >Primary CPICH info | <i>CV-clause 1</i> | | Primary CPICH info 10.3.6.60 | |
| >TDD | | | | (no data) |

| Condition | Explanation |
|-----------------|---|
| <i>Clause 1</i> | This IE is mandatory if "UE internal event identity" is set to "6f" or "6g", otherwise the IE is not needed |

10.3.7.79 UE internal measurement quantity

The quantity the UE shall measure in case of UE internal measurement.

| Information Element/Group name | Need | Multi | Type and reference | Semantics description |
|--------------------------------|------|-------|---|-----------------------|
| CHOICE <i>mode</i> | MP | | | |
| >FDD | | | | |
| >>Measurement quantity | MP | | Enumerated(UE Transmitted Power, UTRA Carrier RSSI, UE Rx-Tx time difference) | |
| >TDD | | | | |
| >>Measurement quantity | MP | | Enumerated(UE Transmitted Power, UTRA Carrier RSSI) | |
| Filter coefficient | MP | | Filter coefficient 10.3.7.9 | |

10.3.7.80 UE internal measurement reporting criteria

The triggering of the event-triggered reporting for a UE internal measurement. All events concerning UE internal measurements are labelled 6x where x is a, b, c.... In TDD, the events 6a - 6d are measured and reported on timeslot basis.

Event 6a: The UE Transmitted Power becomes larger than an absolute threshold

Event 6b: The UE Transmitted Power becomes less than an absolute threshold

Event 6c: The UE Transmitted Power reaches its minimum value

Event 6d: The UE Transmitted Power reaches its maximum value

Event 6e: The UE RSSI reaches the UEs dynamic receiver range

Event 6f: The UE Rx-Tx time difference for a RL included in the active set becomes larger than an absolute threshold

Event 6g: The UE Rx-Tx time difference for a RL included in the active set becomes less than an absolute threshold

| Information Element/Group name | Need | Multi | Type and reference | Semantics description |
|--|---------------------|----------------------|---|--|
| Parameters sent for each UE internal measurement event | OP | 1 to <maxMeas Event> | | |
| >UE internal event identity | MP | | UE internal event identity 10.3.7.75 | |
| >Time-to-trigger | MP | | Integer(0, 10, 20, 40, 60, 80, 100, 120, 160, 200, 240, 320, 640, 1280, 2560, 5000) | Time in ms. Indicates the period of time between the timing of event detection and the timing of sending Measurement Report. |
| >UE Transmitted Power Tx power threshold | CV- <i>clause 1</i> | | Integer(-50..33) | Power in dBm. In event 6a, 6b. |
| >UE Rx-Tx time difference threshold | CV- <i>clause 2</i> | | Integer(768..1280) | Time difference in chip. In event 6f, 6g. |

| Condition | Explanation |
|-----------------|--|
| <i>Clause 1</i> | The IE is mandatory if "UE internal event identity" is set to "6a" or "6b", otherwise the IE is not needed |
| <i>Clause 2</i> | The IE is mandatory if "UE internal event identity" is set to "6f" or "6g", otherwise the IE is not needed |

10.3.7.81 UE internal measurement system information

| Information Element/Group name | Need | Multi | Type and reference | Semantics description |
|----------------------------------|------|-------|---|---|
| UE internal measurement identity | MD | | Measurement identity 10.3.7.48 | The UE internal measurement identity has default value 5. |
| UE internal measurement quantity | MP | | UE internal measurement quantity 10.3.7.79 | |

10.3.7.82 UE Internal reporting quantity

For all boolean types TRUE means inclusion in the report is requested.

| Information Element/Group name | Need | Multi | Type and reference | Semantics description | Version |
|--------------------------------|------|-------|--------------------|-----------------------|---------|
| UE Transmitted Power | MP | | Boolean | | |
| CHOICE <i>mode</i> | MP | | | | |
| >FDD | | | | | |
| >>UE Rx-Tx time difference | MP | | Boolean | | |
| >TDD | | | | | |
| >>CHOICE <i>TDD option</i> | | | | | REL-4 |
| >>>3.84 Mcps TDD | | | | (no data) | REL-4 |
| >>Applied TA | MP | | Boolean | | |
| >>>1.28 Mcps TDD | | | | | REL-4 |
| >>>> UpPCH _{ADV} | MP | | Boolean | | REL-4 |

10.3.7.83 UE Rx-Tx time difference type 1

The difference in time between the UE uplink DPCCH/DPDCH frame transmission and the first detected path (in time), of the downlink DPCH frame from the measured radio link. This measurement is for FDD only.

| Information Element/Group name | Need | Multi | Type and reference | Semantics description |
|---------------------------------|------|-------|--------------------|-----------------------|
| UE Rx-Tx time difference type 1 | MP | | Integer(768..1280) | In chips. |

10.3.7.84 UE Rx-Tx time difference type 2

The difference in time between the UE uplink DPCCH/DPDCH frame transmission and the first detected path (in time), of the downlink DPCH frame from the measured radio link.

| Information Element/Group name | Need | Multi | Type and reference | Semantics description |
|---------------------------------|------|-------|--|-------------------------------|
| UE Rx-Tx time difference type 2 | MP | | Real(768.0..1279.9375 by step of 0.0625) | Resolution of 1/16 of a chip. |

10.3.7.85 UE Transmitted Power info

| Information Element/Group name | Need | Multi | IE type and reference | Semantics description |
|--------------------------------|------|-------|-----------------------|---|
| UE Transmitted Power | MP | | Integer (0..104) | According to UE_TX_POWER in [19] and [20] |

10.3.7.86 UE positioning Ciphering info

This IE contains information for the ciphering of UE positioning assistance data broadcast in System Information.

| Information Element/Group name | Need | Multi | Type and Reference | Semantics description |
|--------------------------------|------|-------|--------------------|---|
| Ciphering Key Flag | MP | | Bitstring(1) | See note 1 |
| Ciphering Serial Number | MP | | Integer(0..65535) | The serial number used in the DES ciphering algorithm |

NOTE 1: The UE always receives two (2) cipher keys during the location update procedure. One of the keys is time-stamped to be current one and the other is time-stamped to be the next one. Thus, the UE always has two cipher keys in memory. The Cipher Key Change Indicator in this broadcast message instructs the UE whether to use current or next cipher key for deciphering the received broadcast message. The UE shall interpret this IE as follows:

- **Ciphering Key Flag**(previous message) = **Ciphering Key Flag**(this message) => Deciphering Key not changed
- **Ciphering Key Flag**(previous message) <> **Ciphering Key Flag**(this message) => Deciphering Key changed

10.3.7.87 UE positioning Error

| Information Element/Group name | Need | Multi | Type and Reference | Semantics description |
|--|------|-------|--|-----------------------|
| Error reason | MP | | Enumerated(ER1, ER2, ER3, ER4, ER5, ER6, ER7, ER8) | Note 1 |
| GPS Additional Assistance Data Request | OP | | UE positioning GPS Additional Assistance Data Request 10.3.7.88a | |

NOTE 1: The following table gives the mapping of the IE "Error reason"

| Value | Indication |
|-------|---|
| ER1 | There were not enough cells to be received when performing mobile-based OTDOA-IPDL. |
| ER2 | There were not enough GPS satellites to be received, when performing UE-based GPS location. |
| ER3 | Location calculation assistance data missing. |
| ER4 | Requested method not supported. |
| ER5 | Undefined error. |
| ER6 | Location request denied by the user. |
| ER7 | Location request not processed by the user and timeout |
| ER8 | Reference cell for GPS is not the serving cell |

10.3.7.88 UE positioning GPS acquisition assistance

This IE contains parameters that enable fast acquisition of the GPS signals in UE-assisted GPS positioning.

| Information Element/Group name | Need | Multi | Type and Reference | Semantics description |
|---|------|---------------|--|--|
| CHOICE <i>Reference Time</i> >UTRAN reference time | MP | | | GPS Time of Week counted in microseconds, given as GPS TOW in milliseconds and GPS TOW remainder in microseconds, UTRAN reference time = 1000 * GPS TOW msec + GPS TOW rem usec |
| >>GPS TOW msec | MP | | Integer(0..6.048*10 ⁸ -1) | GPS Time of Week in milliseconds (rounded down to the nearest millisecond unit) |
| >>GPS TOW rem usec | MP | | Integer(0..999) | GPS Time of Week in microseconds MOD 1000. |
| >>CHOICE <i>mode</i> | | | | |
| >>>FDD | | | | |
| >>>>Primary CPICH Info | OP | | Primary CPICH Info 10.3.6.60 | Identifies the reference cell for the GPS TOW-SFN relationship |
| >>>TDD | | | | |
| >>>>cell parameters id | OP | | Cell parameters id 10.3.6.9 | Identifies the reference cell for the GPS TOW-SFN relationship |
| >>SFN | MP | | Integer(0..4095) | |
| >GPS reference time only | | | | |
| >>GPS TOW msec | MP | | Integer(0..6.048*10 ⁸ -1) | GPS Time of Week in milliseconds (rounded down to the nearest millisecond unit). |
| Satellite information | MP | 1 to <maxSat> | | |
| >SatID | MP | | Integer (0..63) | |
| >Doppler (0 th order term) | MP | | Real(-5120..51175 by step of 2.5) | Hz |
| >Extra Doppler | OP | | | |
| >>Doppler (1 st order term) | MP | | Real (0.966..0.483 by step of 0.023) | Scaling factor 1/42 |
| >>Doppler Uncertainty | MP | | Enumerated (12.5,25,50,100,200) | Hz |
| >Code Phase | MP | | Integer(0..1022) | Chips, specifies the centre of the search window |
| >Integer Code Phase | MP | | Integer(0..19) | 1023 chip segments |
| >GPS Bit number | MP | | Integer(0..3) | Specifies GPS bit number (20 1023 chip segments) |
| >Code Phase Search Window | MP | | Integer(1023,1,2,3,4,6,8,12,16,24,32,48,64,96,128,192) | Specifies the width of the search window. |
| >Azimuth and Elevation | OP | | | |
| >>Azimuth | MP | | Real(0..348.75 by step of 11.25) | Degrees |
| >>Elevation | MP | | Real(0..78.75 by step of 11.25) | Degrees |

| CHOICE Reference time | Condition under which the given reference time is chosen |
|------------------------------|--|
| UTRAN reference time | The reference time is relating GPS time to UTRAN time (SFN) |
| GPS reference time only | The time gives the time for which the location estimate is valid |

10.3.7.88a UE positioning GPS Additional Assistance Data Request

| Information Element/Group name | Need | Multi | Type and Reference | Semantics description |
|---------------------------------------|--------------------------------|---------------|---------------------------|---|
| Almanac | MP | | Boolean | TRUE means requested |
| UTC Model | MP | | Boolean | TRUE means requested |
| Ionospheric model | MP | | Boolean | TRUE means requested |
| Navigation Model | MP | | Boolean | TRUE means requested |
| DGPS Corrections | MP | | Boolean | TRUE means requested |
| Reference Location | MP | | Boolean | TRUE means requested |
| Reference Time | MP | | Boolean | TRUE means requested |
| Acquisition Assistance | MP | | Boolean | TRUE means requested |
| Real-Time Integrity | MP | | Boolean | TRUE means requested |
| Navigation Model Additional data | CV- <i>Navigation Model</i> | | | this IE is present only if "Navigation Model" is set to TRUE otherwise it is absent |
| >GPS Week | MP | | Integer (0..1023) | |
| >GPS_Toe | MP | | Integer (0..167) | GPS time of ephemeris in hours of the latest ephemeris set contained by the UE |
| >T-Toe limit | MP | | Integer (0..10) | ephemeris age tolerance of the UE to UTRAN in hours |
| >Satellites list related data | MP | 0 to <maxSat> | | |
| >>SatID | MP | | Integer (0..63) | |
| >>IODE | MP | | Integer (0..255) | Issue of Data Ephemeris for SatID |

10.3.7.89 UE positioning GPS almanac

This IE contains a reduced-precision subset of the ephemeris and clock correction parameters.

| Information Element/Group name | Need | Multi | Type and Reference | Semantics description |
|--------------------------------|------|---------------|--------------------|--|
| WN _a | MP | | Bit string(8) | |
| Satellite information | MP | 1 to <maxSat> | | |
| >DataID | MP | | Integer(0..3) | See [12] |
| >SatID | MP | | Enumerated(0..63) | Satellite ID |
| >e | MP | | Bit string(16) | Eccentricity [12] |
| >t _{oa} | MP | | Bit string(8) | Reference Time Ephemeris [12] |
| >δi | MP | | Bit string(16) | |
| >OMEGADOT | MP | | Bit string(16) | Longitude of Ascending Node of Orbit Plane at Weekly Epoch (semi-circles/sec) [12] |
| >SV Health | MP | | Bit string(8) | |
| >A ^{1/2} | MP | | Bit string(24) | Semi-Major Axis (meters) ^{1/2} [12] |
| >OMEGA ₀ | MP | | Bit string(24) | Longitude of Ascending Node of Orbit Plane at Weekly Epoch (semi-circles) [12] |
| >M ₀ | MP | | Bit string(24) | Mean Anomaly at Reference Time (semi-circles) [12] |
| >ω | MP | | Bit string(24) | Argument of Perigee (semi-circles) [12] |
| >af ₀ | MP | | Bit string(11) | apparent clock correction [12] |
| >af ₁ | MP | | Bit string(11) | apparent clock correction [12] |
| SV Global Health | OP | | Bit string(364) | This enables GPS time recovery and possibly extended GPS correlation intervals. It is specified in page 25 of subframes 4 and 5 [12] |

10.3.7.90 UE positioning GPS assistance data

This IE contains GPS assistance data.

| Information Element/Group name | Need | Multi | Type and Reference | Semantics description |
|---|------|-------|--|--|
| UE positioning GPS reference time | OP | | UE positioning GPS reference time 10.3.7.96 | |
| UE positioning GPS reference UE position | OP | | Ellipsoid point with altitude and uncertainty ellipsoid 10.3.8.4c | A priori knowledge of UE 3-D position. |
| UE positioning GPS DGPS corrections | OP | | UE positioning GPS DGPS corrections 10.3.7.91 | |
| UE positioning GPS navigation model | OP | | UE positioning GPS navigation model 10.3.7.94 | |
| UE positioning GPS ionospheric model | OP | | UE positioning GPS ionospheric model 10.3.7.92 | |
| UE positioning GPS UTC model | OP | | UE positioning GPS UTC model 10.3.7.97 | |
| UE positioning GPS almanac | OP | | UE positioning GPS almanac 10.3.7.89 | |
| UE positioning GPS acquisition assistance | OP | | UE positioning GPS acquisition assistance 10.3.7.88 | |
| UE positioning GPS real-time integrity | OP | | UE positioning GPS real-time integrity 10.3.7.95 | |

10.3.7.90a UE positioning GPS Ephemeris and Clock Correction parameters

This IE contains information for GPS ephemeris and clock correction.

| Information Element/Group name | Need | Multi | Type and Reference | Semantics description |
|--------------------------------|------|-------|--------------------|---|
| C/A or P on L2 | MP | | Bit string(2) | Code(s) on L2 Channel [12] |
| URA Index | MP | | Bit string(4) | User Range Accuracy [12] |
| SV Health | MP | | Bit string(6) | [12] |
| IODC | MP | | Bit string(10) | Issue of Data, Clock [12] |
| L2 P Data Flag | MP | | Bit string(1) | [12] |
| SF 1 Reserved | MP | | Bit string(87) | [12] |
| TGD | MP | | Bit string(8) | Estimated group delay differential [12] |
| t_{oc} | MP | | Bit string(16) | apparent clock correction [12] |
| af_2 | MP | | Bit string(8) | apparent clock correction [12] |
| af_1 | MP | | Bit string(16) | apparent clock correction [12] |
| af_0 | MP | | Bit string(22) | apparent clock correction [12] |
| C_{rs} | MP | | Bit string(16) | Amplitude of the Sine Harmonic Correction Term to the Orbit Radius (meters) [12] |
| Δn | MP | | Bit string(16) | Mean Motion Difference From Computed Value (semi-circles/sec) [12] |
| M_0 | MP | | Bit string(32) | Mean Anomaly at Reference Time (semi-circles) [12] |
| C_{uc} | MP | | Bit string(16) | Amplitude of the Cosine Harmonic Correction Term To The Argument Of Latitude (radians) [12] |
| e | MP | | Bit string(32) | c |
| C_{us} | MP | | Bit string(16) | Amplitude of the Sine Harmonic Correction Term To The Argument Of Latitude (radians) [12] |
| $(A)^{1/2}$ | MP | | Bit string(32) | Semi-Major Axis (meters) ^{1/2} [12] |
| t_{oe} | MP | | Bit string(16) | Reference Time Ephemeris [12] |
| Fit Interval Flag | MP | | Bit string(1) | [12] |
| AODO | MP | | Bit string(5) | Age Of Data Offset [12] |
| C_{ic} | MP | | Bit string(16) | Amplitude of the Cosine Harmonic Correction Term To The Angle Of Inclination (radians) [12] |
| OMEGA_0 | MP | | Bit string(32) | Longitude of Ascending Node of Orbit Plane at Weekly Epoch (semi-circles) [12] |
| C_{is} | MP | | Bit string(16) | Amplitude of the Sine Harmonic Correction Term To The Angle Of Inclination (radians) [12] |
| i_0 | MP | | Bit string(32) | Inclination Angle at Reference Time (semi-circles) [12] |
| C_{rc} | MP | | Bit string(16) | Amplitude of the Cosine Harmonic Correction Term to the Orbit Radius (meters) [12] |
| ω | MP | | Bit string(32) | Argument of Perigee (semi-circles) [12] |
| OMEGA_{dot} | MP | | Bit string(24) | Longitude of Ascending Node of Orbit Plane at Weekly Epoch (semi-circles/sec) [12] |
| i_{dot} | MP | | Bit string(14) | Rate of Inclination Angle (semi-circles/sec) [12] |

10.3.7.91 UE positioning GPS DGPS corrections

This IE contains DGPS corrections to be used by the UE.

| Information Element/Group name | Need | Multi | Type and Reference | Semantics description |
|--------------------------------|----------------------|---------------|--|---|
| GPS TOW sec | MP | | Integer(0..604799) | seconds GPS time-of-week when the DGPS corrections were calculated |
| Status/Health | MP | | Enumerated(UDRE scale 1.0, UDRE scale 0.75, UDRE scale 0.5, UDRE scale 0.3, UDRE scale 0.2, UDRE scale 0.1, no data, invalid data) | |
| DPGS information | CV- Status/Health | 1 to <maxSat> | | If the Cipher information is included these fields are ciphered. |
| >SatID | MP | | Enumerated (0..63) | |
| >IODE | MP | | Integer(0..255) | |
| >UDRE | MP | | Enumerated(UDRE ≤ 1.0 m, 1.0m < UDRE ≤ 4.0m, 4.0m < UDRE ≤ 8.0m, 8.0m < UDRE) | The value in this field shall be multiplied by the UDRE Scale Factor in the IE Status/Health to determine the final UDRE estimate for the particular satellite. |
| >PRC | MP | | Real(-655.04..655.04 by step of 0.32) | meters (different from [13]) |
| >RRC | MP | | Real(-4.064..4.064 by step of 0.032) | meters/sec (different from [13]) |
| >Delta PRC2 | MP | | Integer(-127..127) | meters |
| >Delta RRC2 | MP | | Real(-0.224..0.224 by step of 0.032) | meters/sec |
| >Delta PRC3 | CV-DCCH | | Integer(-127..127) | meters |
| >Delta RRC3 | CV-DCCH | | Real(-0.224..0.224 by step of 0.032) | meters/sec |

| Condition | Explanation |
|---------------|--|
| Status/Health | This IE is mandatory if "status" is not equal to "no data" or "invalid data", otherwise the IE is not needed |
| DCCH | This IE is mandatory present if the IE " UE positioning GPS DGPS corrections" it is included in the point-to-point message otherwise it is optional if the IE "UE positioning GPS DGPS corrections" is included in the broadcast message |

10.3.7.92 UE positioning GPS ionospheric model

The IE contains fields needed to model the propagation delays of the GPS signals through the ionosphere.

| Information Element/Group name | Need | Multi | Type and Reference | Semantics description |
|--------------------------------|------|-------|--------------------|-----------------------|
| α_0 | MP | | Bit string(8) | Note 1 |
| α_1 | MP | | Bit string(8) | Note 1 |
| α_2 | MP | | Bit string(8) | Note 1 |
| α_3 | MP | | Bit string(8) | Note 1 |
| β_0 | MP | | Bit string(8) | Note 2 |
| β_1 | MP | | Bit string(8) | Note 2 |
| β_2 | MP | | Bit string(8) | Note 2 |
| β_3 | MP | | Bit string(8) | Note 2 |

NOTE 1: The parameters α_n are the coefficients of a cubic equation representing the amplitude of the vertical delay [12].

NOTE 2: The parameters β_n are the coefficients of a cubic equation representing the period of the ionospheric model [12].

10.3.7.93 UE positioning GPS measured results

| Information Element/Group name | Need | Multi | Type and Reference | Semantics description |
|--------------------------------|--------------------------------------|---------------|---|---|
| CHOICE <i>mode</i> | | | | |
| >FDD | | | | |
| >>Primary CPICH Info | OP | | Primary CPICH Info 10.3.6.60 | Identifies the reference cell for the GPS TOW-SFN relationship |
| >TDD | | | | |
| >>cell parameters id | OP | | Cell parameters id 10.3.6.9 | Identifies the reference cell for the GPS TOW-SFN relationship |
| Reference SFN | OP | | Integer(0..4095) | The SFN for which the location is valid |
| GPS TOW msec | MP | | Integer(0..6.048*10 ⁸ -1) | GPS Time of Week in milliseconds (rounded down to the nearest millisecond unit). This time is the GPS TOW measured by the UE. If the Reference SFN field is present it is the ms flank closest to the beginning of that frame. GPS Time of Week in microseconds = 1000 * GPS TOW msec + GPS TOW rem usec |
| GPS TOW rem usec | CV- <i>capability and request</i> | | Integer(0..999) | GPS Time of Week in microseconds MOD 1000. |
| Measurement Parameters | MP | 1 to <maxSat> | | |
| >Satellite ID | MP | | Enumerated(0..63) | |
| >C/N ₀ | MP | | Integer(0..63) | the estimate of the carrier-to-noise ratio of the received signal from the particular satellite used in the measurement. It is given in whole dBs. Typical levels observed by UE-based GPS units will be in the range of 20 – 50 dB. |
| >Doppler | MP | | Integer(-32768..32768) | Hz, scale factor 0.2. |
| >Whole GPS Chips | MP | | Integer(0..1023) | Unit in GPS chips |
| >Fractional GPS Chips | MP | | Integer(0..(2 ¹⁰ -1)) | Scale factor 2 ⁻¹⁰ |
| >Multipath Indicator | MP | | Enumerated(NM, low, medium, high) | See note 1 |
| >Pseudorange RMS Error | MP | | Enumerated(range index 0..range index 63) | See note 2 |

| Condition | Explanation |
|-------------------------------|--|
| <i>Capability and request</i> | This field is included only if the UE has this capability and if it was requested in the UE positioning reporting quantity |

NOTE 1: The following table gives the mapping of the multipath indicator field.

| Value | Multipath Indication |
|--------|----------------------|
| NM | Not measured |
| Low | MP error < 5m |
| Medium | 5m < MP error < 43m |
| High | MP error > 43m |

NOTE 2: The following table gives the bitmapping of the Pseudorange RMS Error field.

| Range Index | Mantissa | Exponent | Floating-Point value, x_i | Pseudorange value, P |
|-------------|----------|----------|-----------------------------|------------------------|
| 0 | 000 | 000 | 0.5 | $P < 0.5$ |
| 1 | 001 | 000 | 0.5625 | $0.5 \leq P < 0.5625$ |
| I | X | Y | $0.5 * (1 + x/8) * 2^y$ | $x_{i-1} \leq P < x_i$ |
| 62 | 110 | 111 | 112 | $104 \leq P < 112$ |
| 63 | 111 | 111 | -- | $112 \leq P$ |

10.3.7.94 UE positioning GPS navigation model

This IE contain information required to manage the transfer of precise navigation data to the GPS-capable UE.

| Information Element/Group name | Need | Multi | Type and Reference | Semantics description |
|--|---------------------|----------------|---|-----------------------|
| Satellite information | MP | 1 to <maxSat > | | |
| >SatID | MP | | Enumerated(0..63) | Satellite ID |
| >Satellite Status | MP | | Enumerated(NS_NN, ES_SN, ES_NN, REVD) | See note 1 |
| >GPS Ephemeris and Clock Correction parameters | CV-Satellite status | | UE positioning GPS Ephemeris and Clock Correction parameters 10.3.7.90a | |

NOTE 1: The UE shall interpret enumerated symbols as follows.

| Value | Indication |
|-------|---|
| NS_NN | New satellite, new Navigation Model |
| ES_SN | Existing satellite, same Navigation Model |
| ES_NN | Existing satellite, new Navigation Model |
| REVD | Reserved |

| Condition | Explanation |
|------------------|---|
| Satellite status | The IE is present unless IE "Satellite status" is ES_SN |

10.3.7.95 UE positioning GPS real-time integrity

This IE contains parameters that describe the real-time status of the GPS constellation.

| Information Element/Group name | Need | Multi | Type and Reference | Semantics description |
|--------------------------------|------|----------------|--------------------|-----------------------|
| Satellite information | MP | 1 to <maxSat > | | |
| >BadSatID | MP | | Enumerated(0..63) | |

10.3.7.96 UE positioning GPS reference time

| Information Element/Group name | Need | Multi | Type and Reference | Semantics description |
|--------------------------------|------|----------------|---|---|
| GPS Week | MP | | Integer(0..1023) | |
| GPS TOW msec | MP | | Integer(0..6.048*10 ⁸ -1) | GPS Time of Week in milliseconds (rounded down to the nearest millisecond unit). |
| GPS TOW rem usec | OP | | Integer(0..999) | GPS Time of Week in microseconds MOD 1000. GPS Time of Week in microseconds = 1000 * GPS TOW msec + GPS TOW rem usec |
| <i>CHOICE mode</i> | | | | |
| >FDD | | | | |
| >>Primary CPICH Info | OP | | Primary CPICH Info 10.3.6.60 | Identifies the reference cell for the GPS TOW-SFN relationship |
| >TDD | | | | |
| >>cell parameters id | OP | | Cell parameters id 10.3.6.9 | Identifies the reference cell for the GPS TOW-SFN relationship |
| SFN | OP | | Integer(0..4095) | The SFN which the GPS TOW time stamps. SFN and GPS TOW msec and GPS TOW rem usec are included if relation GPS TOW/SFN is known to at least 10 μs. |
| SFN-TOW Uncertainty | OP | | Enumerated (lessThan10, moreThan10) | This field indicates the uncertainty of the relation GPS TOW/SFN. lessThan10 means the relation is accurate to at least 10 ms. |
| Node B Clock Drift | OP | | Real(-0.09375..0.09375 by step of 0.0125) | μsec/sec (ppm) |
| GPS TOW Assist | OP | 1 to <maxSat > | | |
| >SatID | MP | | Enumerated(0..63) | |
| >TLM Message | MP | | Bit string(14) | |
| >TLM Reserved | MP | | Bit string(2) | |
| >Alert | MP | | Boolean | |
| >Anti-Spoof | MP | | Boolean | |

10.3.7.97 UE positioning GPS UTC model

The UTC Model field contains a set of parameters needed to relate GPS time to Universal Time Coordinate (UTC).

| Information Element/Group name | Need | Multi | Type and Reference | Semantics description |
|--------------------------------|------|-------|--------------------|-----------------------|
| A ₁ | MP | | Bit string(24) | sec/sec [12] |
| A ₀ | MP | | Bit string(32) | seconds [12] |
| t _{tot} | MP | | Bit string(8) | seconds [12] |
| Δt _{LS} | MP | | Bit string(8) | seconds [12] |
| WN _t | MP | | Bit string(8) | weeks [12] |
| WN _{LSF} | MP | | Bit string(8) | weeks [12] |
| DN | MP | | Bit string(8) | days [12] |
| Δt _{LSF} | MP | | Bit string(8) | seconds [12] |

10.3.7.98 UE positioning IPDL parameters

This IE contains parameters for the IPDL mode. The use of this parameters is described in [29].

| Information Element/Group name | Need | Multi | Type and Reference | Semantics description | Version |
|--------------------------------|------------|-------|--------------------------------|--|---------|
| CHOICE <i>mode</i> | | | | | REL-4 |
| >FDD | | | | | REL-4 |
| >>IP spacing | MP | | Integer(5,7,10,15,20,30,40,50) | See [29] | |
| >>IP length | MP | | Integer(5,10) | See [29] | |
| >>IP offset | MP | | Integer(0..9) | Relates the BFN and SFN, should be same as T _{cell} defined in [10]; See [29] | |
| >>Seed | MP | | Integer(0..63) | See [29] | |
| >TDD | | | | | REL-4 |
| >>IP spacing | MP | | Integer(30,40,50,70,100) | See [33] | REL-4 |
| >>IP_Start | MP | | Integer(0..4095) | See [33] | REL-4 |
| >>IP_Slot | MP | | Integer(0..14) | See [33] | REL-4 |
| >>IP_PCCPCH | CV-channel | | Boolean | See [33] | REL-4 |
| Burst mode parameters | OP | | | | |
| >Burst Start | MP | | Integer(0..15) | See [29] and [33] | |
| >Burst Length | MP | | Integer(10..25) | See [29] and [33] | |
| >Burst freq | MP | | Integer(1..16) | See [29] and [33] | |

| Condition | Explanation |
|----------------|---|
| <i>channel</i> | This IE is present only if the idle slot carries the PCCPCH |

10.3.7.99 UE positioning measured results

| Information Element/Group name | Need | Multi | Type and reference | Semantics description |
|---------------------------------------|------|-------|---|---|
| UE positioning OTDOA measured results | OP | | UE positioning OTDOA measured results 10.3.7.105 | |
| UE positioning Position estimate info | OP | | UE positioning Position estimate info 10.3.7.109 | |
| UE positioning GPS measured results | OP | | UE positioning GPS measured results 10.3.7.93 | |
| UE positioning error | OP | | UE positioning error 10.3.7.87 | Included if UE positioning error occurred |

10.3.7.100 UE positioning measurement

| Information Element/Group name | Need | Multi | Type and reference | Semantics description |
|--------------------------------------|--------------|-------|--|---|
| UE positioning reporting quantity | MP | | UE positioning reporting quantity 10.3.7.111 | |
| <i>CHOICE reporting criteria</i> | MP | | | |
| >UE positioning reporting criteria | | | UE positioning reporting criteria 10.3.7.110 | |
| >Periodical reporting criteria | | | Periodical reporting criteria 10.3.7.53 | |
| >No reporting | | | | (no data) Chosen when this measurement only is used as additional measurement to another measurement |
| UE positioning OTDOA assistance data | CV- OTDOA | | UE positioning OTDOA assistance data 10.3.7.103 | |
| UE positioning GPS assistance data | OP | | UE positioning GPS assistance data 10.3.7.90 | |

| Condition | Explanation |
|-----------|--|
| OTDOA | This IE is mandatory if the IE "Positioning method" is set to "OTDOA" or "OTDOA or GPS". |

10.3.7.101 UE positioning measurement event results

This IE contains the measurement event results that are reported to UTRAN for UE positioning measurements.

| Information Element/Group name | Need | Multi | Type and Reference | Semantics description |
|---|------|-------|--|-----------------------|
| CHOICE <i>Event ID</i> | MP | | | |
| >7a | | | | |
| >>UE positioning Position estimate info | MP | | UE positioning Position estimate info 10.3.7.109 | |
| >7b | | | | |
| >>UE positioning OTDOA measurement | MP | | UE positioning OTDOA measurement 10.3.7.105 | |
| >7c | | | | |
| >>UE positioning GPS measurement | MP | | UE positioning GPS measurement 10.3.7.93 | |

10.3.7.102 Void

10.3.7.103 UE positioning OTDOA assistance data

| Information Element/Group name | Need | Multi | Type and Reference | Semantics description |
|---|------|--------------------|---|-----------------------|
| UE positioning OTDOA reference cell info | OP | | UE positioning OTDOA reference cell info 10.3.7.108 | |
| UE positioning OTDOA neighbour cell list | OP | 1 to <maxCellMeas> | | |
| >UE positioning OTDOA neighbour cell info | MP | | UE positioning OTDOA neighbour cell info 10.3.7.106 | |

10.3.7.104 Void

10.3.7.105 UE positioning OTDOA measurement

The purpose of the OTDOA Measurement Information element is to provide OTDOA measurements of signals sent from the reference and neighbour cells.

| Information Element/Group name | Need | Multi | Type and Reference | Semantics description |
|--|------|--------------------|--|--|
| SFN | MP | | Integer(0..4095) | SFN during which the last measurement was performed |
| CHOICE <i>mode</i> | | | | |
| >FDD | | | | |
| >>Reference cell id | MP | | Primary CPICH info 10.3.6.60 | |
| >>>UE Rx-Tx time difference type 2 | MP | | UE Rx-Tx time difference type 2 10.3.7.84 | |
| >TDD | | | | (no data) |
| >>Reference cell id | MP | | Cell parameters ID 10.3.6.9 | |
| Neighbours | MP | 0 to <maxCellMeas> | | |
| >CHOICE <i>mode</i> | MP | | | |
| >>FDD | | | | |
| >>>Neighbour Identity | MD | | Primary CPICH info 10.3.6.60 | Default value is the same as in the first set of multiple sets. |
| >>>>UE Rx-Tx time difference type 2 | OP | | UE Rx-Tx time difference type 2 10.3.7.84 | Included if the neighbour is in the active set |
| >>TDD | | | | |
| >>>>Cell and Channel ID | MD | | Cell and Channel Identity info 10.3.6.8a | Default value is the same as in the first set of multiple sets. |
| >UE positioning OTDOA quality | MP | | UE positioning OTDOA quality 10.3.7.107 | Quality of the measurement from the neighbour cell. |
| >SFN-SFN observed time difference type 2 | MP | | SFN-SFN observed time difference 10.3.7.63 | Gives the timing relative to the reference cell. Only type 2 is allowed. |

10.3.7.106 UE positioning OTDOA neighbour cell info

This IE gives approximate cell timing in order to decrease the search window, as well as the cell locations and fine cell timing for UE based OTDOA.

| Information Element/Group name | Need | Multi | Type and Reference | Semantics description |
|----------------------------------|----------|-------|---|---|
| CHOICE <i>mode</i> | MP | | | |
| >FDD | | | | |
| >>Primary CPICH info | MP | | Primary CPICH info 10.3.6.60 | |
| >TDD | | | | |
| >>cell and channel ID | MP | | Cell and Channel Identity info 10.3.6.8a | Identifies the channel to be measured on. |
| Frequency info | MD | | Frequency info 10.3.6.36 | Default value is the existing value of frequency information |
| IPDL parameters | CV-IPDLs | | UE positioning IPDL parameters 10.3.7.98 | |
| SFN offset | CV-IPDLs | | Integer (0 .. 4095) | Define Tref as the time of beginning of system frame number SFNref of the reference cell. Define Tnc as the beginning of a frame from the neighbour cell occurring immediately after the time Tref. Let the corresponding system frame number be SFNnc. Then SFNnc = SFNref-SFN offset modulo 4096. |
| SFN-SFN relative time difference | MP | | Integer(0.. 38399) | Gives the relative timing compared to the reference cell Equal to $(Tnc-Tref)/(3.84 \cdot 10^6)$ where $\lfloor \cdot \rfloor$ denotes rounding to the nearest lower integer. in chips. |
| SFN-SFN drift | OP | | Real(0,+0.33,+0.66,+1,+1.33,+1.66,+2,+2.5,+3,+4,+5,+7,+9,+11,+13,+15,-0.33,-0.66,-1,-1.33,-1.66,-2,-2.5,-3,-4,-5,-7,-9,-11,-13,-15) | meters/sec |
| Search Window Size | MP | | Integer(20, 40, 80, 160, 320, 640, 1280, infinity) | in chips. If the value is X then the expected SFN-SFN observed time difference is in the range [RTD-X, RTD+X] where RTD is the value of the field SFN-SFN relative time difference. Infinity means that the uncertainty is larger than 1280 chips. |
| CHOICE <i>PositioningMode</i> | MP | | | |
| >UE based | | | | |
| >>Cell Position | MD | | | Default is the same as previous cell |
| >>>Relative North | OP | | Integer(-20000..20000) | Seconds, scale factor 0.03. Relative position compared to reference cell. |

| | | | | |
|----------------------|----|--|---|---|
| >>>Relative East | OP | | Integer(-20000..20000) | Seconds, scale factor 0.03. Relative position compared to reference cell. |
| >>>Relative Altitude | OP | | Integer(-4000..4000) | Relative altitude in meters compared to ref. cell. |
| >>Fine SFN-SFN | MP | | Real(0..0.9375 in steps of 0.0625) | Gives finer resolution |
| >>Round Trip Time | OP | | Real(876.00 .. 2923.875) in steps of 0.0625 | In chips. Included if cell is in active set. |
| >UE assisted | | | | (no data) |

| Condition | Explanation |
|-----------|---|
| IPDLs | This IE is present only if IPDLs are applied. |

10.3.7.107 UE positioning OTDOA quality

| Information Element/Group name | Need | Multi | Type and Reference | Semantics description |
|--------------------------------|------|-------|--------------------|---|
| Std Resolution | MP | | Bit string(2) | Std Resolution field includes the resolution used in Std of OTDOA Measurements field. Encoding on two bits as follows: '00' 10 meters '01' 20 meters '10' 30 meters '11' Reserved |
| Number of OTDOA Measurements | MP | | Bit string(3) | Number of measurements field is used together with Std of OTDOA Measurements field to define quality of a reported OTDOA measurement. The field indicates how many OTDOA measurements have been used in the UE to define the standard deviation of the measurements. Following 3 bit encoding is used: '000' 0-4 '001' 5-9 '010' 10-14 '011' 15-24 '100' 25-34 '101' 35-44 '110' 45-54 '111' 55 or more |
| Std of OTDOA Measurements | MP | | Bit string(5) | Std of OTDOA Measurements field includes standard deviation of OTDOA measurements. Following linear 5 bit encoding is used: '00000' 0 - (R*1-1) meters '00001' R*1 - (R*2-1) meters '00010' R*2 - (R*3-1) meters ... '11111' R*31 meters or more where R is the resolution defined by Std Resolution field. E.g. R=20 m corresponds to 0-19 m, 20-39 m,...,620+ m. |

10.3.7.108 UE positioning OTDOA reference cell info

This IE defines the cell used for time references in all OTDOA measurements.

| Information Element/Group name | Need | Multi | Type and Reference | Semantics description |
|-----------------------------------|------|-------|---|--|
| SFN | OP | | Integer (0..4095) | Time stamp (SFN of Reference Cell) of the SFN-SFN relative time differences and SFN-SFN drift rates. Included if any SFN-SFN drift value is included in IE UE positioning OTDOA neighbour cell info. |
| CHOICE <i>mode</i> | MP | | | |
| >FDD | | | | |
| >>Primary CPICH info | MP | | Primary CPICH info 10.3.6.60 | |
| >TDD | | | | |
| >>cell and channel ID | MP | | Cell and Channel Identity info 10.3.6.8a | Identifies the channel to be measured on. |
| Frequency info | MD | | Frequency info 10.3.6.36 | Default value is the existing value of frequency information. |
| CHOICE <i>PositioningMode</i> | MP | | | |
| >UE based | | | | |
| >>CHOICE <i>Cell Position</i> | OP | | | The position of the antenna that defines the cell. Used for the UE based method. |
| >>>Ellipsoid | | | | |
| >>>>Ellipsoid point | MP | | Ellipsoid point 10.3.8.4a | |
| >>>Ellipsoid with altitude | | | | |
| >>>>Ellipsoid point with altitude | MP | | Ellipsoid point with altitude 10.3.8.4b | |
| >>Round Trip Time | OP | | Real(876.00 .. 2923.875) in steps of 0.0625 | In chips. |
| >UE assisted | | | | (no data) |
| IPDL parameters | OP | | UE positioning IPDL parameters 10.3.7.98 | If this element is not included there are no idle periods present |

10.3.7.109 UE positioning position estimate info

The purpose of this IE is to provide the position estimate from the UE to the network, if the UE is capable of determining its own position.

| Information Element/Group name | Need | Multi | Type and Reference | Semantics description |
|--|--------------------------------------|-------|--|--|
| CHOICE <i>mode</i> | | | | |
| >FDD | | | | |
| >>Primary CPICH Info | OP | | Primary CPICH Info 10.3.6.60 | Identifies the reference cell for the GPS TOW-SFN relationship |
| >TDD | | | | |
| >>cell parameters id | OP | | Cell parameters id 10.3.6.9 | Identifies the reference cell for the GPS TOW-SFN relationship |
| Reference SFN | MP | | Integer(0..4095) | The SFN for which the location is valid |
| GPS TOW msec | CV- <i>Capability and request</i> | | Integer(0..6.048*10 ⁸ -1) | GPS Time of Week in milliseconds (rounded down to the nearest millisecond unit). This time-stamps the beginning of the frame defined in Reference SFN GPS Time of Week in microseconds = 1000 * GPS TOW msec + GPS TOW rem usec |
| GPS TOW rem usec | CV- <i>Capability and request</i> | | Integer(0..999) | GPS Time of Week in microseconds MOD 1000. |
| CHOICE <i>Position estimate</i> | MP | | | |
| >Ellipsoid Point | | | Ellipsoid Point; 10.3.8.4a | |
| >Ellipsoid point with uncertainty circle | | | Ellipsoid point with uncertainty circle 10.3.8.4d | |
| >Ellipsoid point with uncertainty ellipse | | | Ellipsoid point with uncertainty ellipse 10.3.8.4e | |
| >Ellipsoid point with altitude | | | Ellipsoid point with altitude 10.3.8.4b | |
| >Ellipsoid point with altitude and uncertainty ellipsoid | | | Ellipsoid point with altitude and uncertainty ellipsoid 10.3.8.4c | |

| Condition | Explanation |
|-------------------------------|--|
| <i>Capability and request</i> | This field is included only if the UE has this capability <i>and</i> if it was requested in the UE positioning reporting quantity and if the method was UE-based GPS |

10.3.7.110 UE positioning reporting criteria

The triggering of the event-triggered reporting for an UE positioning measurement.

| Information Element/Group name | Need | Multi | Type and Reference | Semantics description |
|------------------------------------|------|----------------------|---|--|
| Parameters required for each event | OP | 1 to <maxMeas Event> | | |
| >Amount of reporting | MP | | Integer(1, 2, 4, 8, 16, 32, 64,infinite) | |
| >Report first fix | MP | | Boolean | If true the UE reports the position once the measurement control is received, and then each time an event is triggered. |
| >Measurement interval | MP | | Integer(5,15, 60,300,900,1 800,3600,72 00) | Indicates how often the UE should make the measurement In seconds |
| >CHOICE <i>Event ID</i> | MP | | | |
| >>7a | | | | |
| >>>Threshold Position Change | MP | | Integer(10,2 0,30,40,50,1 00,200,300,5 00,1000,200 0,5000,1000 0,20000,500 00,100000) | Indicated how much the position should change compared to last reported position fix in order to trigger the event. |
| >>7b | | | | |
| >>>Threshold SFN-SFN change | MP | | Real(0.25,0. 5,1,2,3,4,5,1 0,20,50,100, 200,500,100 0,2000,5000) | Chips. Indicates how much the SFN-SFN measurement of ANY measured cell is allowed to change before the event is triggered. |
| >>7c | | | | |
| >>>Threshold SFN-GPS TOW | MP | | Integer(1,2,3 ,5, 10,20,50,1 00) | Time in ms. When the GPS TOW and SFN timer has drifted apart more than the specified value the event is triggered) |

10.3.7.111 UE positioning reporting quantity

The purpose of the element is to express the allowed/required location method(s), and to provide information required QoS.

| Information Element/Group name | Need | Multi | Type and Reference | Semantics description |
|------------------------------------|--------------------------|-------|--|---|
| Method Type | MP | | Enumerated(UE assisted, UE based, UE based is preferred but UE assisted is allowed, UE assisted is preferred but UE based is allowed) | |
| Positioning Methods | MP | | Enumerated(OTDOA, GPS, OTDOA or GPS) | |
| Response Time | MP | | Integer(1,2,4, 8, 16, 32, 64, 128) | in seconds |
| Accuracy | CV- <i>MethodType</i> | | Bitstring(7) | The uncertainty is derived from the "uncertainty code" k by $r = 10 * (1.1^k - 1)$ |
| GPS timing of Cell wanted | MP | | Boolean | If true the SRNC wants the UE to report the SFN-GPS timing of the reference cell. This is however optional in the UE. |
| Multiple Sets | MP | | Boolean | TRUE indicates that the UE is requested to send multiple <i>OTDOA/GPS Measurement Information Sets</i> . UE is expected to include the current measurement set. |
| Additional Assistance Data Request | MP | | Boolean | TRUE indicates that the UE is requested to send the IE "Additional assistance Data Request" when the IE "UE positioning Error" is present in the UE positioning measured results. |
| Environment Characterisation | OP | | Enumerated(possibly heavy multipath and NLOS conditions, no or light multipath and usually LOS conditions, not defined or mixed environment) | |

| Condition | Explanation |
|--------------------|--|
| <i>Method Type</i> | The IE is optional if the IE "Method Type" is 'UE assisted'; otherwise it is mandatory |

10.3.7.112 UpPCH_{ADV}

NOTE: Only for 1.28Mcps TDD.

UpPCH_{ADV} indicates the difference between the Rx timing and initial Tx timing of a UE.

| Information Element/group name | Need | Multi | Type and reference | Semantics description | Version |
|--------------------------------|------|-------|--------------------|-----------------------|---------|
| UpPCH _{ADV} | MP | | Integer (0..352) | In chips | REL-4 |

10.3.8 Other Information elements

10.3.8.1 BCCH modification info

Indicates modification of the System Information on BCCH.

| Information Element/Group name | Need | Multi | Type and reference | Semantics description |
|--------------------------------|------|-------|--------------------------------|--|
| MIB Value tag | MP | | MIB Value tag 10.3.8.9 | |
| BCCH modification time | OP | | Integer (0..4088 in step of 8) | All SFN values in which MIB may be mapped are allowed. |

10.3.8.2 BSIC

| Information Element/Group name | Need | Multi | Type and reference | Semantics description |
|---|------|-------|--------------------|-----------------------|
| Base transceiver Station Identity Code (BSIC) | MP | | | [11] |
| >Network Colour Code (NCC) | MP | | bit string(3) | |
| >Base Station Colour Code (BCC) | MP | | bit string(3) | |

10.3.8.3 CBS DRX Level 1 information

This information element contains the CBS discontinuous reception information to be broadcast for CBS DRX Level 1 calculations in the UE.

| Information Element/Group name | Need | Multi | Type and reference | Semantics description |
|--------------------------------|------|-------|--------------------|---|
| Period of CTCH allocation (N) | MP | | Integer (1..256) | $M_{TTI} \leq N \leq 4096 - K$, N multiple of M_{TTI} |
| CBS frame offset (K) | MP | | Integer (0..255) | $0 \leq K \leq N-1$, K multiple of M_{TTI} |

10.3.8.4 Cell Value tag

| Information Element/Group name | Need | Multi | Type and reference | Semantics description |
|--------------------------------|------|-------|--------------------|-----------------------|
| Cell Value tag | MP | | Integer (1..4) | |

10.3.8.4a Ellipsoid point

This IE contains the description of an ellipsoid point as in [24].

| Information Element/Group name | Need | Multi | Type and Reference | Semantics description |
|--------------------------------|------|-------|--|---|
| Latitude sign | MP | | Enumerated (North, South) | |
| Degrees Of Latitude | MP | | Integer (0...2 ²³ -1) | The IE value (N) is derived by this formula: $N \leq 2^{23} X / 90 < N+1$ X being the latitude in degree (0°.. 90°) |
| Degrees Of Longitude | MP | | Integer (-2 ²³ ...2 ²³ -1) | The IE value (N) is derived by this formula: $N \leq 2^{24} X / 360 < N+1$ X being the longitude in degree (-180°..+180°) |

10.3.8.4b Ellipsoid point with Altitude

This IE contains the description of an ellipsoid point with altitude as in [24].

| Information Element/Group name | Need | Multi | Type and Reference | Semantics description |
|--------------------------------|------|-------|--|---|
| Latitude sign | MP | | Enumerated (North, South) | |
| Degrees Of Latitude | MP | | Integer (0...2 ²³ -1) | The IE value (N) is derived by this formula: $N \leq 2^{23} X / 90 < N+1$ X being the latitude in degree (0°.. 90°) |
| Degrees Of Longitude | MP | | Integer (-2 ²³ ...2 ²³ -1) | The IE value (N) is derived by this formula: $N \leq 2^{24} X / 360 < N+1$ X being the longitude in degree (-180°..+180°) |
| Altitude Direction | MP | | Enumerated (Height, Depth) | |
| Altitude | MP | | Integer (0..2 ¹⁵ -1) | The IE value (N) is derived by this formula: $N \leq a < N+1$ a being the altitude in metres |

10.3.8.4c Ellipsoid point with Altitude and uncertainty ellipsoid

This IE contains the description of an ellipsoid point with altitude and uncertainty ellipsoid as in [24].

| Information Element/Group name | Need | Multi | Type and Reference | Semantics description |
|--------------------------------|------|-------|--|--|
| Latitude sign | MP | | Enumerated (North, South) | |
| Degrees Of Latitude | MP | | Integer (0...2 ²³ -1) | The IE value (<i>N</i>) is derived by this formula: $N \leq 2^{23} X / 90 < N+1$ <i>X</i> being the latitude in degree (0°.. 90°) |
| Degrees Of Longitude | MP | | Integer (-2 ²³ ...2 ²³ -1) | The IE value (<i>N</i>) is derived by this formula: $N \leq 2^{24} X / 360 < N+1$ <i>X</i> being the longitude in degree (-180°..+180°) |
| Altitude Direction | MP | | Enumerated (Height, Depth) | |
| Altitude | MP | | Integer (0..2 ¹⁵ -1) | The IE value (<i>N</i>) is derived by this formula: $N \leq a < N+1$ <i>a</i> being the altitude in metres |
| Uncertainty semi-major | MP | | Integer (0...127) | The uncertainty <i>r</i> is derived from the "uncertainty code" <i>k</i> by $r = 10x(1.1^k - 1)$ |
| Uncertainty semi-minor | MP | | Integer (0...127) | The uncertainty <i>r</i> is derived from the "uncertainty code" <i>k</i> by $r = 10x(1.1^k - 1)$ |
| Orientation of major axis | MP | | Integer (0..179 by step of 2) | The IE value (<i>N</i>) is derived by this formula: $N \leq a / 2 < N+1$ <i>a</i> being the orientation in degree (0°.. 360°) |
| Uncertainty Altitude | MP | | Integer(0..127) | The uncertainty in altitude, <i>h</i> , expressed in metres is mapped from the IE value (<i>K</i>), with the following formula: $h = C \left((1 + x)^K - 1 \right)$ with <i>C</i> = 45 and <i>x</i> = 0.025. |
| Confidence | MP | | Integer (0..100) | in percentage |

10.3.8.4d Ellipsoid point with uncertainty Circle

This IE contains the description of an ellipsoid point with an uncertainty circle as in [24].

| Information Element/Group name | Need | Multi | Type and Reference | Semantics description |
|--------------------------------|------|-------|--|---|
| Latitude sign | MP | | Enumerated (North, South) | |
| Degrees Of Latitude | MP | | Integer (0...2 ²³ -1) | The IE value (N) is derived by this formula: $N \leq 2^{23} X / 90 < N+1$ X being the latitude in degree (0°.. 90°) |
| Degrees Of Longitude | MP | | Integer (-2 ²³ ...2 ²³ -1) | The IE value (N) is derived by this formula: $N \leq 2^{24} X / 360 < N+1$ X being the longitude in degree (-180°..+180°) |
| Uncertainty Code | MP | | Integer (0...127) | The uncertainty r is derived from the "uncertainty code" k by $r = 10x(1.1^k - 1)$ |

10.3.8.4e Ellipsoid point with uncertainty Ellipse

This IE contains the description of an ellipsoid point with an uncertainty ellipse as in [24].

| Information Element/Group name | Need | Multi | Type and Reference | Semantics description |
|--------------------------------|------|-------|--|---|
| Latitude sign | MP | | Enumerated (North, South) | |
| Degrees Of Latitude | MP | | Integer (0...2 ²³ -1) | The IE value (N) is derived by this formula: $N \leq 2^{23} X / 90 < N+1$ X being the latitude in degree (0°.. 90°) |
| Degrees Of Longitude | MP | | Integer (-2 ²³ ...2 ²³ -1) | The IE value (N) is derived by this formula: $N \leq 2^{24} X / 360 < N+1$ X being the longitude in degree (-180°..+180°) |
| Uncertainty semi-major | MP | | Integer (0...127) | The uncertainty r is derived from the "uncertainty code" k by $r = 10x(1.1^k - 1)$ |
| Uncertainty semi-minor | MP | | Integer (0...127) | The uncertainty r is derived from the "uncertainty code" k by $r = 10x(1.1^k - 1)$ |
| Orientation of major axis | MP | | Integer (0..179 by step of 2) | The IE value (N) is derived by this formula: $N \leq a / 2 < N+1$ a being the orientation in degree (0°.. 360°) |
| Confidence | MP | | Integer (0..100) | in percentage |

10.3.8.5 Inter-RAT change failure

| Information Element/Group name | Need | Multi | Type and reference | Semantics description |
|--------------------------------|------|-------|----------------------------|---|
| Inter-RAT change failure cause | MP | | Enumerated(C onfiguration) | At least 3 spare values, criticality = default, are |

| | | | | |
|----------------------------|-------------------|--|---|----------|
| | | | unacceptable, physical channel failure, protocol error) | required |
| Protocol error information | <i>CV-ProtErr</i> | | Protocol error information 10.3.8.12 | |

| Condition | Explanation |
|----------------|---|
| <i>ProtErr</i> | If the IE "Inter-RAT handover failure cause" has the value "Protocol error" |

10.3.8.6 Inter-RAT handover failure

| Information Element/Group name | Need | Multi | Type and reference | Semantics description |
|----------------------------------|-------------------|-------|---|--|
| Inter-RAT handover failure cause | MD | | Enumerated(Configuration unacceptable, physical channel failure, protocol error, inter-RAT protocol error, unspecified) | Default value is "unspecified". At least one spare value needed |
| Protocol error information | <i>CV-ProtErr</i> | | Protocol error information 10.3.8.12 | |

| Condition | Explanation |
|----------------|---|
| <i>ProtErr</i> | If the IE "Inter-RAT handover failure cause" has the value "Protocol error" |

10.3.8.7 Inter-RAT UE radio access capability

This Information Element contains the inter-RAT UE radio access capability that is structured and coded according to the specification used for the corresponding system type.

| Information Element/Group name | Need | Multi | Type and reference | Semantics description |
|--------------------------------|------|----------------------------|----------------------|--|
| CHOICE <i>system</i> | MP | | | |
| >GSM | | | | |
| >>Mobile Station Classmark 2 | MP | | Octet string (5) | Defined in [5] |
| >>Mobile Station Classmark 3 | MP | | Octet string (1..32) | Defined in [5] |
| >cdma2000 | | | | |
| >>cdma2000Message | MP | 1.to.<maxInterSysMessages> | | |
| >>>MSG_TYPE(s) | MP | | Bitstring (8) | Formatted and coded according to cdma2000 specifications |
| >>>cdma2000Messagepayload(s) | MP | | Bitstring (1..512) | Formatted and coded according to cdma2000 specifications |

10.3.8.8 Void

10.3.8.8a Inter-RAT UE security capability

| Information Element/Group name | Need | Multi | Type and reference | Semantics description |
|--------------------------------|------|-------|--------------------|---|
| CHOICE <i>system</i> | MP | | | |
| >GSM | | | | |
| >>GSM security capability | MP | | | The value TRUE means that the indicated ciphering algorithm is supported. |
| >>>A5/7 supported | MP | | Boolean | |
| >>>A5/6 supported | MP | | Boolean | |
| >>>A5/5 supported | MP | | Boolean | |
| >>>A5/4 supported | MP | | Boolean | |
| >>>A5/3 supported | MP | | Boolean | |
| >>>A5/2 supported | MP | | Boolean | |
| >>>A5/1 supported | MP | | Boolean | |

10.3.8.9 MIB Value tag

| Information Element/Group name | Need | Multi | Type and reference | Semantics description |
|--------------------------------|------|-------|--------------------|-----------------------|
| MIB Value tag | MP | | Integer (1..8) | |

10.3.8.10 PLMN Value tag

| Information Element/Group name | Need | Multi | Type and reference | Semantics description |
|--------------------------------|------|-------|--------------------|-----------------------|
| PLMN Value tag | MP | | Integer (1..256) | |

10.3.8.10a PNBSCH allocation

UTRAN may use this IE to provide silent periods in the cell that may be used for cell synchronisation purposes.

| Information Element/Group name | Need | Multi | Type and reference | Semantics description | Version |
|--------------------------------------|------|-------|---|-----------------------|---------|
| Number of repetitions per SFN period | MP | | Integer(2, 3, 4, 5, 6, 7, 8, 9, 10, 12, 14, 16, 18, 20, 24, 28, 32, 36, 40, 48, 56, 64, 72, 80) | | REL-4 |

10.3.8.11 Predefined configuration identity and value tag

| Information Element/Group name | Need | Multi | Type and reference | Semantics description |
|------------------------------------|------|-------|--|-----------------------|
| Predefined configuration identity | MP | | Predefined configuration identity 10.3.4.5 | |
| Predefined configuration value tag | MP | | Predefined configuration value tag 10.3.4.6 | |

10.3.8.12 Protocol error information

This information element contains diagnostics information returned by the receiver of a message that was not completely understood.

| Information Element/Group name | Need | Multi | Type and reference | Semantics description |
|--------------------------------|------|-------|-----------------------------------|--------------------------------------|
| CHOICE <i>diagnostics type</i> | MP | | | At least one spare choice is needed. |
| >Protocol error cause | | | Protocol error cause 10.3.3.26 | |

10.3.8.13 References to other system information blocks

| Information element/Group name | Need | Multi | Type and reference | Semantics description |
|---|------|------------------|--------------------------------------|---|
| References to other system information blocks | MP | 1 to <maxSIB> | | System information blocks for which multiple occurrences are used, may appear more than once in this list |
| >Scheduling information | MP | | Scheduling information, 10.3.8.16 | |
| >SIB type SIBs only | MP | | SIB Type SIBs only, 10.3.8.22 | |

10.3.8.14 References to other system information blocks and scheduling blocks

| Information element/Group name | Need | Multi | Type and reference | Semantics description |
|---|------|------------------|--------------------------------------|---|
| References to other system information blocks | MP | 1 to <maxSIB> | | System information blocks for which multiple occurrences are used, may appear more than once in this list |
| >Scheduling information | MP | | Scheduling information, 10.3.8.16 | |
| >SIB type | MP | | SIB Type, 10.3.8.21 | |

10.3.8.15 Rplmn information

Contains information to provide faster RPLMN selection in the UE.

| Information Element/Group name | Need | Multi | Type and reference | Semantics description | Version |
|-----------------------------------|------|--------------------------|---------------------|--|---------|
| GSM BA Range | OP | 1 to maxNumGSMFreqRanges | | GSM BA Range | |
| >GSM Lower Range (UARFCN) | MP | | Integer(0..16383) | Lower bound for range of GSM BA freqs | |
| >GSM Upper Range (UARFCN) | MP | | Integer(0..16383) | Upper bound for range of GSM BA freqs | |
| FDD UMTS Frequency list | OP | 1 to maxNumFDDFreqs | | | |
| >UARFCN (Nlow) | MP | | Integer(0..16383) | [21] | |
| >UARFCN (Nupper) | OP | | Integer(0..16383) | [21] This IE is only needed when the FDD frequency list is specifying a range. | |
| 3.84 Mcps TDD UMTS Frequency list | OP | 1 to maxNumTDDFreqs | | | |
| >UARFCN | MP | | Integer(0..16383) | [22] | |
| 1.28 Mcps TDD UMTS Frequency list | OP | 1 to maxNumTDDFreqs | | | REL-4 |
| >UARFCN | MP | | Integer(0..16383) | [22] | REL-4 |
| CDMA2000 UMTS Frequency list | OP | 1 to maxNumCDMA2000Freqs | | | |
| >BAND_CLASS | MP | | Bitstring(5 bits) | TIA/EIA/IS-2000 The BAND_CLASS bits are numbered b0 to b4, where b0 is the least significant bit. | |
| >CDMA_FREQ | MP | | Bitstring (11 bits) | TIA/EIA/IS-2000 The CDMA_FREQ bits are numbered b0 to b10, where b0 is the least significant bit. | |

10.3.8.16 Scheduling information

| Information Element/Group name | Need | Multi | Type and reference | Semantics description |
|--|------|-------|---|--|
| CHOICE Value tag >PLMN Value tag | OP | | PLMN Value tag 10.3.8.10 | This IE is included if the following conditions are fulfilled: the area scope for the system information block is set to "PLMN" in table 8.1.1. a value tag is used to indicate changes in the system information block. the SIB type does not equal system information block type 16 |
| >Predefined configuration identity and value tag | | | Predefined configuration identity and value tag 10.3.8.11 | This IE is included if the following conditions are fulfilled: the SIB type equals system information block type 16 |
| >Cell Value tag | | | Cell Value tag 10.3.8.4 | This IE is included if the following conditions are fulfilled: the area scope for the system information block is set to "cell" in table 8.1.1. a value tag is used to indicate changes in the system information block. |
| >SIB occurrence identity and value tag | | | SIB occurrence identity and value tag 10.3.8.20b | This IE is included if the following conditions are fulfilled: the SIB type equals system information block types 15.2 and 15.3 |
| Scheduling | MP | | | |
| >SEG_COUNT | MD | | SEG COUNT 10.3.8.17 | Default value is 1 |
| >SIB_REP | MP | | Integer (4, 8, 16, 32, 64, 128, 256, 512, 1024, 2048, 4096) | Repetition period for the SIB in frames |
| >SIB_POS | MP | | Integer (0 ..Rep-2 by step of 2) | Position of the first segment Rep is the value of the SIB_REP IE |
| >SIB_POS offset info | MD | 1..15 | | see below for default value |
| >>SIB_OFF | MP | | Integer(2..32 by step of 2) | Offset of subsequent segments |

| Field | Default value |
|---------------------|--|
| SIB_POS offset info | The default value is that all segments are consecutive, i.e., that the SIB_OFF = 2 for all segments except when MIB segment/complete MIB is scheduled to be transmitted in between segments from same SIB. In that case, SIB_OFF=4 in between segments which are scheduled to be transmitted at SFNprime = 8 *n-2 and 8*n + 2, and SIB_OFF=2 for the rest of the segments. |

10.3.8.17 SEG COUNT

| Information Element/Group name | Need | Multi | Type and reference | Semantics description |
|--------------------------------|------|-------|--------------------|--|
| SEG_COUNT | MP | | Integer (1..16) | Number of segments in the system information block |

10.3.8.18 Segment index

Each system information segment has an individual segment index.

| Information Element/Group name | Need | Multi | Type and reference | Semantics description |
|--------------------------------|------|-------|--------------------|--|
| Segment index | MP | | Integer (1..15) | Segments of a system information block are numbered starting with 0 for the first segment and 1 for the next segment, which can be the first subsequent segment or a last segment. |

10.3.8.19 SIB data fixed

Contains the result of a master information block or a system information block after encoding and segmentation. The IE is used for segments with fixed length (segments filling an entire transport block).

| Information Element/Group name | Need | Multi | Type and reference | Semantics description |
|--------------------------------|------|-------|--------------------|--|
| SIB data fixed | MP | | Bit string (222) | The first bit contains the first bit of the segment. |

10.3.8.20 SIB data variable

Contains either a complete system information block or a segment of a system information block. Contains the result of a master information block or a system information block after encoding and segmentation. The IE is used for segments with variable length. The system information blocks are defined in clauses 10.2.48.8.1 to 10.2.48.8.18.

| Information Element/Group name | Need | Multi | Type and reference | Semantics description |
|--------------------------------|------|-------|---------------------|--|
| SIB data variable | MP | | Bit string (1..214) | The first bit contains the first bit of the segment. |

10.3.8.20a SIB occurrence identity

This information element identifies a SIB occurrence for System Information Block types 15.2 and 15.3. For System Information Block type 15.2, this identity is assigned to the visible satellite only. Unused identities are claimed by newly rising satellites.

| Information Element/Group name | Need | Multi | Type and reference | Semantics description |
|--------------------------------|------|-------|--------------------|-----------------------|
| SIB occurrence identity | MP | | Integer (0..15) | |

10.3.8.20b SIB occurrence identity and value tag

| Information Element/Group name | Need | Multi | Type and reference | Semantics description |
|--------------------------------|------|-------|--|-----------------------|
| SIB occurrence identity | MP | | SIB occurrence identity 10.3.8.20a | |
| SIB occurrence value tag | MP | | SIB occurrence value tag 10.3.8.20c | |

10.3.8.20c SIB occurrence value tag

This information element is used to identify different versions of SIB occurrence for System Information Block types 15.2 and 15.3.

| Information Element/Group name | Need | Multi | Type and Reference | Semantics description |
|--------------------------------|------|-------|--------------------|-----------------------|
| SIB occurrence value tag | MP | | Integer(0..15) | |

10.3.8.21 SIB type

The SIB type identifies a specific system information block.

| Information Element/Group name | Need | Multi | Type and reference | Semantics description |
|--------------------------------|------|-------|-----------------------|-----------------------|
| SIB type | MP | | Enumerated, see below | |

The list of values to encode is:

- Master information block,
- System Information Type 1,
- System Information Type 2,
- System Information Type 3,
- System Information Type 4,
- System Information Type 5,
- System Information Type 6,
- System Information Type 7,
- System Information Type 8,
- System Information Type 9,
- System Information Type 10,
- System Information Type 11,
- System Information Type 12,
- System Information Type 13,
- System Information Type 13.1,

System Information Type 13.2,
 System Information Type 13.3,
 System Information Type 13.4,
 System Information Type 14,
 System Information Type 15,
 System Information Type 15.1,
 System Information Type 15.2,
 System Information Type 15.3,
 System Information Type 15.4,
 System Information Type 16,
 System Information Type 17,
 System Information Type 18,
 Scheduling Block 1,
 Scheduling Block 2.

In addition, at least one spare value, criticality: ignore, is needed.

10.3.8.22 SIB type SIBs only

The SIB type identifies a specific system information block.

| Information Element/Group name | Need | Multi | Type and reference | Semantics description |
|--------------------------------|------|-------|-----------------------|-----------------------|
| SIB type SIBs only | MP | | Enumerated, see below | |

The list of values to encode is:

System Information Type 1,
 System Information Type 2,
 System Information Type 3,
 System Information Type 4,
 System Information Type 5,
 System Information Type 6,
 System Information Type 7,
 System Information Type 8,
 System Information Type 9,
 System Information Type 10,
 System Information Type 11,
 System Information Type 12,
 System Information Type 13,

System Information Type 13.1,
 System Information Type 13.2,
 System Information Type 13.3,
 System Information Type 13.4,
 System Information Type 14,
 System Information Type 15,
 System Information Type 15.1,
 System Information Type 15.2,
 System Information Type 15.3,
 System Information Type 15.4,
 System Information Type 16,
 System Information Type 17,
 System Information Type 18.

In addition, at least one spare value, criticality: ignore, is needed.

10.3.9 ANSI-41 Information elements

10.3.9.1 ANSI 41 Core Network Information

| Information element/Group name | Need | Multi | Type and reference | Semantics description |
|--------------------------------|------|-------|-----------------------|-----------------------|
| P_REV | MP | | P_REV 10.3.9.10 | |
| MIN_P_REV | MP | | MIN_P_REV 10.3.9.8 | |
| SID | MP | | SID 10.3.9.11 | |
| NID | MP | | NID 10.3.9.9 | |

10.3.9.2 ANSI-41 Global Service Redirection information

This Information Element contains ANSI-41 Global Service Redirection information.

| Information Element/Group name | Need | Multi | Type and reference | Semantics description |
|--|------|-------|---------------------------------|--|
| ANSI-41 Global Service Redirection information | MP | | ANSI-41 NAS parameter, 10.3.9.3 | Formatted and coded according to the 3GPP2 document "G3G CDMA DS on ANSI-41" |

10.3.9.3 ANSI-41 NAS parameter

This Information Element contains ANSI-41 User Zone Identification information.

| Information Element/Group name | Need | Multi | Type and reference | Semantics description |
|--------------------------------|------|-------|-----------------------------|--|
| ANSI-41 NAS parameter | MP | | Bit string (size (1..2048)) | The first bit contains the first bit of the ANSI-41 information. |

10.3.9.4 ANSI-41 NAS system information

This Information Element contains ANSI-41 system information.

| Information Element/Group name | Need | Multi | Type and reference | Semantics description |
|----------------------------------|------|-------|---------------------------------|--|
| NAS (ANSI-41) system information | MP | | ANSI-41 NAS parameter, 10.3.9.3 | Formatted and coded according to the 3GPP2 document "G3G CDMA DS on ANSI-41" |

10.3.9.5 ANSI-41 Private Neighbour List information

This Information Element contains ANSI-41 Private Neighbour List information.

| Information Element/Group name | Need | Multi | Type and reference | Semantics description |
|--|------|-------|---------------------------------|--|
| ANSI-41 Private Neighbour List information | MP | | ANSI-41 NAS parameter, 10.3.9.3 | Formatted and coded according to the 3GPP2 document "G3G CDMA DS on ANSI-41" |

10.3.9.6 ANSI-41 RAND information

This Information Element contains ANSI-41 RAND information.

| Information Element/Group name | Need | Multi | Type and reference | Semantics description |
|--------------------------------|------|-------|---------------------------------|--|
| ANSI-41 RAND information | MP | | ANSI-41 NAS parameter, 10.3.9.3 | Formatted and coded according to the 3GPP2 document "G3G CDMA DS on ANSI-41" |

10.3.9.7 ANSI-41 User Zone Identification information

This Information Element contains ANSI-41 User Zone Identification information.

| Information Element/Group name | Need | Multi | Type and reference | Semantics description |
|--|------|-------|---------------------------------|--|
| ANSI-41 User Zone Identification information | MP | | ANSI-41 NAS parameter, 10.3.9.3 | Formatted and coded according to the 3GPP2 document "G3G CDMA DS on ANSI-41" |

10.3.9.8 MIN_P_REV

This Information Element contains minimum protocol revision level.

| Information Element/Group name | Need | Multi | Type and reference | Semantics description |
|--------------------------------|------|-------|--------------------|---|
| MIN_P_REV | MP | | Bitstring (8) | Minimum protocol revision level. The MIN_P_REV bits are numbered b0 to b7, where b0 is the least significant bit. |

10.3.9.9 NID

This Information Element contains Network identification.

| Information Element/Group name | Need | Multi | Type and reference | Semantics description |
|--------------------------------|------|-------|--------------------|---|
| NID | MP | | Bitstring (16) | Network identification. The NID bits are numbered b0 to b15, where b0 is the least significant bit. |

10.3.9.10 P_REV

This Information Element contains protocol revision level.

| Information Element/Group name | Need | Multi | Type and reference | Semantics description |
|--------------------------------|------|-------|--------------------|---|
| P_REV | MP | | Bitstring (8) | Protocol revision level. The P_REV bits are numbered b0 to b7, where b0 is the least significant bit. |

10.3.9.11 SID

This Information Element contains System identification.

| Information Element/Group name | Need | Multi | Type and reference | Semantics description |
|--------------------------------|------|-------|--------------------|--|
| SID | MP | | Bitstring (15) | System identification. The SID bits are numbered b0 to b14, where b0 is the least significant bit. |

10.3.10 Multiplicity values and type constraint values

The following table includes constants that are either used as multi bounds (name starting with "max") or as high or low value in a type specification (name starting with "lo" or "hi"). Constants are specified only for values appearing more than once in the RRC specification. In case a constant is related to one or more other constants, an expression is included in the "value" column instead of the actual value.

| Constant | Explanation | Value |
|-----------------------------------|--|-----------------|
| CN information | | |
| maxCNdomains | Maximum number of CN domains | 4 |
| UTRAN mobility information | | |
| maxRAT | Maximum number of Radio Access Technologies | maxOtherRAT + 1 |
| maxOtherRAT | Maximum number of other Radio Access Technologies | 15 |
| maxURA | Maximum number of URAs in a cell | 8 |
| maxInterSysMessages | Maximum number of Inter System Messages | 4 |
| maxRABsetup | Maximum number of RABs to be established | 16 |
| UE information | | |
| maxtransactions | Maximum number of parallel RRC transactions in downlink | 25 |
| maxPDCPalgoType | Maximum number of PDCP algorithm types | 8 |
| maxDRACclasses | Maximum number of UE classes which would require different DRAC parameters | 8 |
| maxFreqBandsFDD | Maximum number of frequency bands supported by the UE as defined in [21] | 8 |
| maxFreqBandsTDD | Maximum number of frequency bands supported by the UE as defined in [22] | 4 |
| maxFreqBandsGSM | Maximum number of frequency bands supported by the UE as defined in [45] | 16 |
| maxPage1 | Number of UEs paged in the Paging Type 1 message | 8 |
| maxSystemCapability | Maximum number of system specific capabilities that can be requested in one message. | 16 |
| RB information | | |
| maxPredefConfig | Maximum number of predefined configurations | 16 |
| maxRB | Maximum number of RBs | 32 |
| maxSRBsetup | Maximum number of signalling RBs to be established | 8 |
| maxRBperRAB | Maximum number of RBs per RAB | 8 |
| maxRBAIRABs | Maximum number of non signalling RBs | 27 |
| maxRBMuxOptions | Maximum number of RB multiplexing options | 8 |
| maxLoCHperRLC | Maximum number of logical channels per RLC entity | 2 |
| MaxROHC-PacketSizes | Maximum number of packet sizes that are allowed to be produced by ROHC. | 16 |
| MaxROHC-Profiles | Maximum number of profiles supported by ROHC on a given RB. | 8 |
| TrCH information | | |
| maxTrCH | Maximum number of transport channels used in one direction (UL or DL) | 32 |
| maxTrCHpreconf | Maximum number of preconfigured Transport channels, per direction | 16 |
| maxCCTrCH | Maximum number of CCTrCHs | 8 |
| maxTF | Maximum number of different transport formats that can be included in the Transport format set for one transport channel | 32 |
| maxTF-CPCH | Maximum number of TFs in a CPCH set | 16 |
| maxTFC | Maximum number of Transport Format Combinations | 1024 |
| maxTFCl-1-Combs | Maximum number of TFCI (field 1) combinations | 512 |
| maxTFCl-2-Combs | Maximum number of TFCI (field 2) combinations | 512 |
| maxCPCHsets | Maximum number of CPCH sets per cell | 16 |
| maxSIBperMsg | Maximum number of complete system information blocks per SYSTEM INFORMATION message | 16 |
| maxSIB | Maximum number of references to other system information blocks. | 32 |
| maxSIB-FACH | Maximum number of references to system information blocks on the FACH | 8 |
| PhyCH information | | |
| maxSubCh | Maximum number of sub-channels on PRACH | 12 |
| maxPCPCH-APsubCH | Maximum number of available sub-channels for AP signature on PCPCH | 12 |
| maxPCPCH-CDsubCH | Maximum number of available sub-channels for CD signature on PCPCH | 12 |
| maxSig | Maximum number of signatures on PRACH | 16 |
| maxPCPCH-APsig | Maximum number of available signatures for AP on PCPCH | 16 |
| maxPCPCH-CDsig | Maximum number of available signatures for CD on PCPCH | 16 |

| | | |
|--------------------------------|---|---|
| maxAC | Maximum number of access classes | 16 |
| maxASC | Maximum number of access service classes | 8 |
| maxASCmap | Maximum number of access class to access service classes mappings | 7 |
| maxASCpersist | Maximum number of access service classes for which persistence scaling factors are specified | 6 |
| maxPRACH | Maximum number of PRACHs in a cell | 16 |
| MaxPRACH_FPACH | Maximum number of PRACH / FPACH pairs in a cell (1.28 Mcps TDD) | 8 |
| maxFACHPCH | Maximum number of FACHs and PCHs mapped onto one secondary CCPCHs | 8 |
| maxRL | Maximum number of radio links | 8 |
| maxSCCPCH | Maximum number of secondary CCPCHs per cell | 16 |
| maxDPDCH-UL | Maximum number of DPDCHs per cell | 6 |
| maxDPCH-DLchan | Maximum number of channelisation codes used for DL DPCH | 8 |
| maxDPCHcodesPerTS | Maximum number of codes for one timeslots (TDD) | 16 |
| maxPUSCH | Maximum number of PUSCHs | (8) |
| maxPDSCH | Maximum number of PDSCHs | 8 |
| maxPDSCHcodes | Maximum number of codes for PDSCH | 16 |
| maxPDSCH-TFCIgroups | Maximum number of TFCI groups for PDSCH | 256 |
| maxPDSCHcodeGroups | Maximum number of code groups for PDSCH | 256 |
| maxPCPCHs | Maximum number of PCPCH channels in a CPCH Set | 64 |
| maxPCPCH-SF | Maximum number of available SFs on PCPCH | 7 |
| maxTS | Maximum number of timeslots used in one direction (UL or DL) | 6 (1.28 Mcps TDD) 14 (3.84 Mcps TDD) |
| HiPUSCHIdentities | Maximum number of PDSCH Identities | 64 |
| HiPDSCHIdentities | Maximum number of PDSCH Identities | 64 |
| Measurement information | | |
| maxTGPS | Maximum number of transmission gap pattern sequences | 6 |
| maxAdditionalMeas | Maximum number of additional measurements for a given measurement identity | 4 |
| maxMeasEvent | Maximum number of events that can be listed in measurement reporting criteria | 8 |
| maxMeasParEvent | Maximum number of measurement parameters (e.g. thresholds) per event | 2 |
| maxMeasIntervals | Maximum number of intervals that define the mapping function between the measurements for the cell quality Q of a cell and the representing quality value | 1 |
| maxCellMeas | Maximum number of cells to measure | 32 |
| maxReportedGSMCells | Maximum number of GSM cells to be reported | 6 |
| maxFreq | Maximum number of frequencies to measure | 8 |
| maxSat | Maximum number of satellites to measure | 16 |
| HiRM | Maximum number that could be set as rate matching attribute for a transport channel | 256 |
| Frequency information | | |
| maxFDDFreqList | Maximum number of FDD carrier frequencies to be stored in USIM | 4 |
| maxTDDFreqList | Maximum number of TDD carrier frequencies to be stored in USIM | 4 |
| maxFDDFreqCellList | Maximum number of neighbouring FDD cells to be stored in USIM | 32 |
| maxTDDFreqCellList | Maximum number of neighbouring TDD cells to be stored in USIM | 32 |
| maxGSMCellList | Maximum number of GSM cells to be stored in USIM | 32 |
| Other information | | |
| maxNumGSMFreqRanges | Maximum number of GSM Frequency Ranges to store | 32 |
| maxNumFDDFreqs | Maximum number of FDD centre frequencies to store | 8 |
| maxNumTDDFreqs | Maximum number of TDD centre frequencies to store | 8 |
| maxNumCDMA200Freqs | Maximum number of CDMA2000 centre frequencies to store | 8 |

11 Message and Information element abstract syntax (with ASN.1)

This clause contains definitions for RRC PDUs and IEs using a subset of ASN.1 as specified in [14]. PDU and IE definitions are grouped into separate ASN.1 modules.

11.0 General

If the abstract syntax of an IE is defined using the ASN.1 type "BIT STRING", and this IE corresponds to a functional IE definition in tabular format, in which the significance of bits is semantically defined, the following general rule shall be applied:

The bits in the ASN.1 bit string shall represent the semantics of the functional IE definition in decreasing order of bit significance;

- with the first (or leftmost) bit in the bit string representing the most significant bit; and
- with the last (or rightmost) bit in the bit string representing the least significant bit.

11.1 General message structure

```
Class-definitions DEFINITIONS AUTOMATIC TAGS ::=
```

```
BEGIN
```

```
IMPORTS
```

```
    ActiveSetUpdate,  
    ActiveSetUpdateComplete,  
    ActiveSetUpdateFailure,  
    AssistanceDataDelivery,  
    CellChangeOrderFromUTRAN,  
    CellChangeOrderFromUTRANFailure,  
    CellUpdate,  
    CellUpdateConfirm-CCCH,  
    CellUpdateConfirm,  
    CounterCheck,  
    CounterCheckResponse,  
    DownlinkDirectTransfer,  
    HandoverToUTRANComplete,  
    InitialDirectTransfer,  
    HandoverFromUTRANCommand-GSM,  
    HandoverFromUTRANCommand-CDMA2000,  
    HandoverFromUTRANFailure,  
    MeasurementControl,  
    MeasurementControlFailure,  
    MeasurementReport,  
    PagingType1,  
    PagingType2,  
    PhysicalChannelReconfiguration,  
    PhysicalChannelReconfigurationComplete,  
    PhysicalChannelReconfigurationFailure,  
    PhysicalSharedChannelAllocation,  
    PUSCHCapacityRequest,  
    RadioBearerReconfiguration,  
    RadioBearerReconfigurationComplete,  
    RadioBearerReconfigurationFailure,  
    RadioBearerRelease,  
    RadioBearerReleaseComplete,  
    RadioBearerReleaseFailure,  
    RadioBearerSetup,  
    RadioBearerSetupComplete,  
    RadioBearerSetupFailure,  
    RRCConnectionReject,  
    RRCConnectionRelease,  
    RRCConnectionRelease-CCCH,  
    RRCConnectionReleaseComplete,  
    RRCConnectionRequest,
```

```

    RRCConnectionSetup,
    RRCConnectionSetupComplete,
    RRCStatus,
    SecurityModeCommand,
    SecurityModeComplete,
    SecurityModeFailure,
    SignallingConnectionRelease,
    SignallingConnectionReleaseRequest,
    SystemInformation-BCH,
    SystemInformation-FACH,
    SystemInformationChangeIndication,
    TransportChannelReconfiguration,
    TransportChannelReconfigurationComplete,
    TransportChannelReconfigurationFailure,
    TransportFormatCombinationControl,
    TransportFormatCombinationControlFailure,
    UECapabilityEnquiry,
    UECapabilityInformation,
    UECapabilityInformationConfirm,
    UplinkDirectTransfer,
    UplinkPhysicalChannelControl,
    URAUpdate,
    URAUpdateConfirm,
    URAUpdateConfirm-CCCH,
    UTRANMobilityInformation,
    UTRANMobilityInformationConfirm,
    UTRANMobilityInformationFailure
FROM PDU-definitions

-- User Equipment IEs :
    IntegrityCheckInfo
FROM InformationElements;

--*****
--
-- Downlink DCCH messages
--
--*****

DL-DCCH-Message ::= SEQUENCE {
    integrityCheckInfo      IntegrityCheckInfo      OPTIONAL,
    message                 DL-DCCH-MessageType
}

DL-DCCH-MessageType ::= CHOICE {
    activeSetUpdate                ActiveSetUpdate,
    assistanceDataDelivery         AssistanceDataDelivery,
    cellChangeOrderFromUTRAN      CellChangeOrderFromUTRAN,
    cellUpdateConfirm              CellUpdateConfirm,
    counterCheck                   CounterCheck,
    downlinkDirectTransfer         DownlinkDirectTransfer,
    handoverFromUTRANCommand-GSM   HandoverFromUTRANCommand-GSM,
    handoverFromUTRANCommand-CDMA2000 HandoverFromUTRANCommand-CDMA2000,
    measurementControl             MeasurementControl,
    pagingType2                    PagingType2,
    physicalChannelReconfiguration PhysicalChannelReconfiguration,
    physicalSharedChannelAllocation PhysicalSharedChannelAllocation,
    radioBearerReconfiguration     RadioBearerReconfiguration,
    radioBearerRelease             RadioBearerRelease,
    radioBearerSetup               RadioBearerSetup,
    rrcConnectionRelease           RRCConnectionRelease,
    securityModeCommand            SecurityModeCommand,
    signallingConnectionRelease    SignallingConnectionRelease,
    transportChannelReconfiguration TransportChannelReconfiguration,
    transportFormatCombinationControl TransportFormatCombinationControl,
    ueCapabilityEnquiry            UECapabilityEnquiry,
    ueCapabilityInformationConfirm  UECapabilityInformationConfirm,
    uplinkPhysicalChannelControl    UplinkPhysicalChannelControl,
    uraUpdateConfirm               URAUpdateConfirm,
    utranMobilityInformation        UTRANMobilityInformation,
    extension                       NULL
}

--*****
--
-- Uplink DCCH messages
--
--*****

```

```

UL-DCCH-Message ::= SEQUENCE {
    integrityCheckInfo    IntegrityCheckInfo    OPTIONAL,
    message                UL-DCCH-MessageType
}

UL-DCCH-MessageType ::= CHOICE {
    activeSetUpdateComplete      ActiveSetUpdateComplete,
    activeSetUpdateFailure       ActiveSetUpdateFailure,
    cellChangeOrderFromUTRANFailure CellChangeOrderFromUTRANFailure,
    counterCheckResponse         CounterCheckResponse,
    handoverToUTRANComplete      HandoverToUTRANComplete,
    initialDirectTransfer        InitialDirectTransfer,
    handoverFromUTRANFailure      HandoverFromUTRANFailure,
    measurementControlFailure     MeasurementControlFailure,
    measurementReport            MeasurementReport,
    physicalChannelReconfigurationComplete PhysicalChannelReconfigurationComplete,
    physicalChannelReconfigurationFailure PhysicalChannelReconfigurationFailure,
    radioBearerReconfigurationComplete RadioBearerReconfigurationComplete,
    radioBearerReconfigurationFailure RadioBearerReconfigurationFailure,
    radioBearerReleaseComplete    RadioBearerReleaseComplete,
    radioBearerReleaseFailure     RadioBearerReleaseFailure,
    radioBearerSetupComplete      RadioBearerSetupComplete,
    radioBearerSetupFailure       RadioBearerSetupFailure,
    rrcConnectionReleaseComplete  RRCConnectionReleaseComplete,
    rrcConnectionSetupComplete    RRCConnectionSetupComplete,
    rrcStatus                     RRCStatus,
    securityModeComplete          SecurityModeComplete,
    securityModeFailure           SecurityModeFailure,
    signallingConnectionReleaseRequest SignallingConnectionReleaseRequest,
    transportChannelReconfigurationComplete TransportChannelReconfigurationComplete,
    transportChannelReconfigurationFailure TransportChannelReconfigurationFailure,
    transportFormatCombinationControlFailure TransportFormatCombinationControlFailure,
    ueCapabilityInformation        UECapabilityInformation,
    uplinkDirectTransfer           UplinkDirectTransfer,
    utranMobilityInformationConfirm UTRANMobilityInformationConfirm,
    utranMobilityInformationFailure UTRANMobilityInformationFailure,
    extension                      NULL
}

--*****
--
-- Downlink CCCH messages
--
--*****

DL-CCCH-Message ::= SEQUENCE {
    integrityCheckInfo    IntegrityCheckInfo    OPTIONAL,
    message                DL-CCCH-MessageType
}

DL-CCCH-MessageType ::= CHOICE {
    cellUpdateConfirm      CellUpdateConfirm-CCCH,
    rrcConnectionReject    RRCConnectionReject,
    rrcConnectionRelease   RRCConnectionRelease-CCCH,
    rrcConnectionSetup     RRCConnectionSetup,
    uraUpdateConfirm       URAUpdateConfirm-CCCH,
    extension              NULL
}

--*****
--
-- Uplink CCCH messages
--
--*****

UL-CCCH-Message ::= SEQUENCE {
    integrityCheckInfo    IntegrityCheckInfo    OPTIONAL,
    message                UL-CCCH-MessageType
}

UL-CCCH-MessageType ::= CHOICE {
    cellUpdate            CellUpdate,

```

```

    rrcConnectionRequest      RRCConnectionRequest,
    uraUpdate                  URAUpdate,
    extension                  NULL
}

--*****
--
-- PCCH messages
--
--*****

PCCH-Message ::= SEQUENCE {
    message          PCCH-MessageType
}

PCCH-MessageType ::= CHOICE {
    pagingType1     PagingType1,
    extension       NULL
}

--*****
--
-- Downlink SHCCH messages
--
--*****

DL-SHCCH-Message ::= SEQUENCE {
    message          DL-SHCCH-MessageType
}

DL-SHCCH-MessageType ::= CHOICE {
    physicalSharedChannelAllocation PhysicalSharedChannelAllocation,
    extension             NULL
}

--*****
--
-- Uplink SHCCH messages
--
--*****

UL-SHCCH-Message ::= SEQUENCE {
    message          UL-SHCCH-MessageType
}

UL-SHCCH-MessageType ::= CHOICE {
    puschCapacityRequest PUSCHCapacityRequest,
    extension            NULL
}

--*****
--
-- BCCH messages sent on FACH
--
--*****

BCCH-FACH-Message ::= SEQUENCE {
    message          BCCH-FACH-MessageType
}

BCCH-FACH-MessageType ::= CHOICE {
    systemInformation          SystemInformation-FACH,
    systemInformationChangeIndication SystemInformationChangeIndication,
    extension                 NULL
}

--*****
--
-- BCCH messages sent on BCH
--
--*****

BCCH-BCH-Message ::= SEQUENCE {
    message          SystemInformation-BCH
}

END

```

11.2 PDU definitions

```

--*****
--
-- TABULAR: The message type and integrity check info are not
-- visible in this module as they are defined in the class module.
-- Also, all FDD/TDD specific choices have the FDD option first
-- and TDD second, just for consistency.
--
--*****

PDU-definitions DEFINITIONS AUTOMATIC TAGS ::=

BEGIN

--*****
--
-- IE parameter types from other modules
--
--*****

IMPORTS

-- Core Network IEs :
  CN-DomainIdentity,
  CN-InformationInfo,
  CN-InformationInfoFull,
  NAS-Message,
  PagingRecordTypeID,
-- UTRAN Mobility IEs :
  URA-Identity,
-- User Equipment IEs :
  ActivationTime,
  C-RNTI,
  CapabilityUpdateRequirement,
  CapabilityUpdateRequirement-r4,
  CapabilityUpdateRequirement-r4-ext,
  CellUpdateCause,
  CipheringAlgorithm,
  CipheringModeInfo,
  EstablishmentCause,
  FailureCauseWithProtErr,
  FailureCauseWithProtErrTrId,
  InitialUE-Identity,
  IntegrityProtActivationInfo,
  IntegrityProtectionModeInfo,
  N-308,
  PagingCause,
  PagingRecordList,
  ProtocolErrorIndicator,
  ProtocolErrorIndicatorWithMoreInfo,
  Rb-timer-indicator,
  Re-EstablishmentTimer,
  RedirectionInfo,
  RejectionCause,
  ReleaseCause,
  RRC-StateIndicator,
  RRC-TransactionIdentifier,
  SecurityCapability,
  START-Value,
  STARTList,
  U-RNTI,
  U-RNTI-Short,
  UE-RadioAccessCapability,
  UE-RadioAccessCapability-r4-ext,
  UE-RadioAccessCapability-v370ext,
  UE-ConnTimersAndConstants,
  URA-UpdateCause,
  UTRAN-DRX-CycleLengthCoefficient,
  WaitTime,
-- Radio Bearer IEs :
  DefaultConfigIdentity,
  DefaultConfigMode,
  DL-CounterSynchronisationInfo,
  PredefinedConfigIdentity,
  RAB-Info,
  RAB-Info-Post,

```

```
RAB-InformationList,
RAB-InformationReconfigList,
RAB-InformationSetupList,
RAB-InformationSetupList-r4,
RB-ActivationTimeInfo,
RB-ActivationTimeInfoList,
RB-COUNT-C-InformationList,
RB-COUNT-C-MSB-InformationList,
RB-IdentityList,
RB-InformationAffectedList,
RB-InformationReconfigList,
RB-InformationReconfigList-r4,
RB-InformationReleaseList,
RB-InformationSetupList,
RB-InformationSetupList-r4,
RB-WithPDCP-InfoList,
SRB-InformationSetupList,
SRB-InformationSetupList2,
UL-CounterSynchronisationInfo,
-- Transport Channel IEs:
CPCH-SetID,
DL-AddReconfTransChInfo2List,
DL-AddReconfTransChInfoList,
DL-CommonTransChInfo,
DL-CommonTransChInfo-r4,
DL-DeletedTransChInfoList,
DRAC-StaticInformationList,
TFC-Subset,
TFCS-Identity,
UL-AddReconfTransChInfoList,
UL-CommonTransChInfo,
UL-DeletedTransChInfoList,
-- Physical Channel IEs :
AllocationPeriodInfo,
Alpha,
CCTrCH-PowerControlInfo,
CCTrCH-PowerControlInfo-r4,
ConstantValue,
CPCH-SetInfo,
DL-CommonInformation,
DL-CommonInformation-r4,
DL-CommonInformationPost,
DL-InformationPerRL,
DL-InformationPerRL-List,
DL-InformationPerRL-List-r4,
DL-InformationPerRL-ListPostFDD,
DL-InformationPerRL-PostTDD,
DL-InformationPerRL-PostTDD-LCR-r4,
DL-DPCH-PowerControlInfo,
DL-PDSCH-Information,
DPCH-CompressedModeStatusInfo,
FrequencyInfo,
FrequencyInfoFDD,
FrequencyInfoTDD,
IndividualTS-InterferenceList,
MaxAllowedUL-TX-Power,
OpenLoopPowerControl-IPDL-TDD-r4,
PDSCH-CapacityAllocationInfo,
PDSCH-CapacityAllocationInfo-r4,
PDSCH-Identity,
PDSCH-Info,
PDSCH-Info-r4,
PRACH-RACH-Info,
PRACH-RACH-Info-LCR-r4,
PrimaryCCPCH-TX-Power,
PUSCH-CapacityAllocationInfo,
PUSCH-CapacityAllocationInfo-r4,
PUSCH-Identity,
RL-AdditionInformationList,
RL-RemovalInformationList,
SpecialBurstScheduling,
SSDT-Information,
TFC-ControlDuration,
SSDT-UL-r4,
TimeslotList,
TimeslotList-r4,
TX-DiversityMode,
UL-ChannelRequirement,
```

```

UL-ChannelRequirement-r4,
UL-ChannelRequirementWithCPCH-SetID,
UL-ChannelRequirementWithCPCH-SetID-r4,
UL-DPCH-Info,
UL-DPCH-Info-r4,
UL-DPCH-InfoPostFDD,
UL-DPCH-InfoPostTDD,
UL-DPCH-InfoPostTDD-LCR-r4,
UL-SynchronisationParameters-r4,
UL-TimingAdvance,
UL-TimingAdvanceControl,
UL-TimingAdvanceControl-r4,
-- Measurement IEs :
AdditionalMeasurementID-List,
Frequency-Band,
EventResults,
InterFreqEventResults-LCR-r4-ext,
InterRAT-TargetCellDescription,
MeasuredResults,
MeasuredResultsList,
MeasuredResultsList-LCR-r4-ext,
MeasuredResultsOnRACH,
MeasurementCommand,
MeasurementCommand-r4,
MeasurementIdentity,
MeasurementReportingMode,
PrimaryCCPCH-RSCP,
TimeslotListWithISCP,
TrafficVolumeMeasuredResultsList,
UE-Positioning-GPS-AssistanceData,
UE-Positioning-OTDOA-AssistanceData,
UP-IPDL-Parameters-TDD-r4-ext,
-- Other IEs :
BCCH-ModificationInfo,
CDMA2000-MessageList,
GSM-MessageList,
InterRAT-ChangeFailureCause,
InterRAT-HO-FailureCause,
InterRAT-UE-RadioAccessCapabilityList,
InterRAT-UE-SecurityCapList,
InterRATMessage,
IntraDomainNasNodeSelector,
ProtocolErrorInformation,
ProtocolErrorMoreInformation,
Rplmn-Information,
Rplmn-Information-r4,
SegCount,
SegmentIndex,
SFN-Prime,
SIB-Data-fixed,
SIB-Data-variable,
SIB-Type
FROM InformationElements

maxSIBperMsg,
maxSystemCapability
FROM Constant-definitions;

-- *****
--
-- ACTIVE SET UPDATE (FDD only)
--
-- *****

ActiveSetUpdate ::= CHOICE {
    r3                               SEQUENCE {
        activeSetUpdate-r3           ActiveSetUpdate-r3-IEs,
        nonCriticalExtensions        SEQUENCE {
            activeSetUpdate-r4-ext   ActiveSetUpdate-r4-ext-IEs,
            nonCriticalExtensions    SEQUENCE {} OPTIONAL
        } OPTIONAL
    },
    later-than-r3                    SEQUENCE {
        rrc-TransactionIdentifier    RRC-TransactionIdentifier,
        criticalExtensions           SEQUENCE {}
    }
}

ActiveSetUpdate-r3-IEs ::= SEQUENCE {

```

```

-- User equipment IEs
  rrc-TransactionIdentifier      RRC-TransactionIdentifier,
  integrityProtectionModeInfo    IntegrityProtectionModeInfo    OPTIONAL,
  cipheringModeInfo              CipheringModeInfo                  OPTIONAL,
  activationTime                 ActivationTime                      OPTIONAL,
  newU-RNTI                      U-RNTI                          OPTIONAL,
-- Core network IEs
  cn-InformationInfo             CN-InformationInfo              OPTIONAL,
-- Radio bearer IEs
  dl-CounterSynchronisationInfo DL-CounterSynchronisationInfo  OPTIONAL,
-- Physical channel IEs
  maxAllowedUL-TX-Power          MaxAllowedUL-TX-Power          OPTIONAL,
  rl-AdditionInformationList      RL-AdditionInformationList      OPTIONAL,
  rl-RemovalInformationList       RL-RemovalInformationList       OPTIONAL,
  tx-DiversityMode               TX-DiversityMode               OPTIONAL,
  ssdt-Information               SSDT-Information               OPTIONAL
}

ActiveSetUpdate-r4-ext-IEs ::= SEQUENCE {
  -- Physical channel IEs
  -- The following IE extends SSDT-Information. FDD only.
  ssdt-UL                        SSDT-UL-r4                          OPTIONAL
}

-- *****
--
-- ACTIVE SET UPDATE COMPLETE (FDD only)
--
-- *****

ActiveSetUpdateComplete ::= SEQUENCE {
  -- User equipment IEs
  rrc-TransactionIdentifier      RRC-TransactionIdentifier,
  ul-IntegProtActivationInfo      IntegrityProtActivationInfo      OPTIONAL,
  -- Radio bearer IEs
  rb-UL-CiphActivationTimeInfo    RB-ActivationTimeInfoList       OPTIONAL,
  ul-CounterSynchronisationInfo    UL-CounterSynchronisationInfo    OPTIONAL,
  -- Extension mechanism for non- release99 information
  nonCriticalExtensions           SEQUENCE {} OPTIONAL
}

-- *****
--
-- ACTIVE SET UPDATE FAILURE (FDD only)
--
-- *****

ActiveSetUpdateFailure ::= SEQUENCE {
  -- User equipment IEs
  rrc-TransactionIdentifier      RRC-TransactionIdentifier,
  failureCause                   FailureCauseWithProtErr,
  -- Extension mechanism for non- release99 information
  nonCriticalExtensions           SEQUENCE {} OPTIONAL
}

-- *****
--
-- Assistance Data Delivery
--
-- *****

AssistanceDataDelivery ::= CHOICE {
  r3                               SEQUENCE {
    assistanceDataDelivery-r3      AssistanceDataDelivery-r3-IEs,
    nonCriticalExtensions           SEQUENCE {
      assistanceDataDelivery-r3-r4-ext
      AssistanceDataDelivery-r3-r4-ext-IEs,
    } OPTIONAL
  },
  later-than-r3                   SEQUENCE {
    rrc-TransactionIdentifier      RRC-TransactionIdentifier,
    criticalExtensions             SEQUENCE {}
  }
}

AssistanceDataDelivery-r3-IEs ::= SEQUENCE {

```

```

-- User equipment IEs
rrc-TransactionIdentifier      RRC-TransactionIdentifier,
-- Measurement Information Elements
ue-positioning-GPS-AssistanceData      UE-Positioning-GPS-AssistanceData
OPTIONAL,
ue-positioning-OTDOA-AssistanceData      UE-Positioning-OTDOA-AssistanceData      OPTIONAL
}

AssistanceDataDelivery-r3-r4-ext-IEs ::= SEQUENCE {
-- In case of TDD, the following IE is included instead of the IE
-- up-IPDL-Parameters in up-OTDOA-AssistanceData
up-IPDL-Parameters-TDD      UP-IPDL-Parameters-TDD-r4-ext      OPTIONAL
}

-- *****
--
-- CELL CHANGE ORDER FROM UTRAN
--
-- *****

CellChangeOrderFromUTRAN ::= CHOICE {
  r3      SEQUENCE {
    cellChangeOrderFromUTRAN-IEs      CellChangeOrderFromUTRAN-r3-IEs,
    nonCriticalExtensions      SEQUENCE {} OPTIONAL
  },
  later-than-r3      SEQUENCE {
    rrc-TransactionIdentifier      RRC-TransactionIdentifier,
    criticalExtensions      SEQUENCE {}
  }
}

CellChangeOrderFromUTRAN-r3-IEs ::= SEQUENCE {
-- User equipment IEs
rrc-TransactionIdentifier      RRC-TransactionIdentifier,
-- not used in this release of the specification
dummy      IntegrityProtectionModeInfo      OPTIONAL,
activationTime      ActivationTime      OPTIONAL,
rab-InformationList      RAB-InformationList      OPTIONAL,
interRAT-TargetCellDescription      InterRAT-TargetCellDescription
}

-- *****
--
-- CELL CHANGE ORDER FROM UTRAN FAILURE
--
-- *****

CellChangeOrderFromUTRANFailure ::= CHOICE {
  r3      SEQUENCE {
    cellChangeOrderFromUTRANFailure-r3
    nonCriticalExtensions      SEQUENCE {} OPTIONAL
  },
  later-than-r3      SEQUENCE {
    rrc-TransactionIdentifier      RRC-TransactionIdentifier,
    criticalExtensions      SEQUENCE {}
  }
}

CellChangeOrderFromUTRANFailure-r3-IEs ::= SEQUENCE {
-- User equipment IEs
rrc-TransactionIdentifier      RRC-TransactionIdentifier,
-- not used in this release of the specification
dummy      IntegrityProtectionModeInfo      OPTIONAL,
interRAT-ChangeFailureCause      InterRAT-ChangeFailureCause
}

-- *****
--
-- CELL UPDATE
--
-- *****

CellUpdate ::= SEQUENCE {
-- User equipment IEs
u-RNTI      U-RNTI,
startList      STARTList,
am-RLC-ErrorIndicationRb2or3      BOOLEAN,

```

```

    am-RLC-ErrorIndicationRb4orAbove    BOOLEAN,
    cellUpdateCause                      CellUpdateCause,
    failureCause                          FailureCauseWithProtErrTrId    OPTIONAL,
    -- TABULAR: RRC transaction identifier is nested in FailureCauseWithProtErrTrId
    rb-timer-indicator                    Rb-timer-indicator,
    -- Measurement IEs
    measuredResultsOnRACH                  MeasuredResultsOnRACH          OPTIONAL,
    -- Extension mechanism for non- release99 information
    nonCriticalExtensions                   SEQUENCE {} OPTIONAL
}

-- *****
--
-- CELL UPDATE CONFIRM
--
-- *****

CellUpdateConfirm ::= CHOICE {
    r3                                     SEQUENCE {
        cellUpdateConfirm-r3              CellUpdateConfirm-r3-IEs,
        nonCriticalExtensions              SEQUENCE {
            cellUpdateConfirm-r3-r4-ext    CellUpdateConfirm-r3-r4-ext-IEs,
            nonCriticalExtensions          SEQUENCE {} OPTIONAL
        }
        OPTIONAL
    },
    later-than-r3                          SEQUENCE {
        rrc-TransactionIdentifier          RRC-TransactionIdentifier,
        criticalExtensions                  CHOICE {
            r4                              SEQUENCE {
                cellUpdateConfirm-r4        CellUpdateConfirm-r4-IEs,
                nonCriticalExtensions        SEQUENCE {} OPTIONAL
            },
            criticalExtensions              SEQUENCE {}
        }
    }
}

CellUpdateConfirm-r3-IEs ::= SEQUENCE {
    -- User equipment IEs
    rrc-TransactionIdentifier              RRC-TransactionIdentifier,
    integrityProtectionModeInfo            IntegrityProtectionModeInfo    OPTIONAL,
    cipheringModeInfo                      CipheringModeInfo              OPTIONAL,
    activationTime                          ActivationTime                  OPTIONAL,
    new-U-RNTI                              U-RNTI                        OPTIONAL,
    new-C-RNTI                              C-RNTI                        OPTIONAL,
    rrc-StateIndicator                      RRC-StateIndicator,
    utran-DRX-CycleLengthCoeff              UTRAN-DRX-CycleLengthCoefficient OPTIONAL,
    rlc-Re-establishIndicatorRb2or3          BOOLEAN,
    rlc-Re-establishIndicatorRb4orAbove      BOOLEAN,
    -- CN information elements
    cn-InformationInfo                      CN-InformationInfo            OPTIONAL,
    -- UTRAN mobility IEs
    ura-Identity                            URA-Identity                  OPTIONAL,
    -- Radio bearer IEs
    rb-InformationReleaseList                RB-InformationReleaseList      OPTIONAL,
    rb-InformationReconfigList              RB-InformationReconfigList     OPTIONAL,
    rb-InformationAffectedList              RB-InformationAffectedList     OPTIONAL,
    dl-CounterSynchronisationInfo           DL-CounterSynchronisationInfo  OPTIONAL,
    -- Transport channel IEs
    ul-CommonTransChInfo                    UL-CommonTransChInfo          OPTIONAL,
    ul-deletedTransChInfoList              UL-DeletedTransChInfoList     OPTIONAL,
    ul-AddReconfTransChInfoList            UL-AddReconfTransChInfoList   OPTIONAL,
    modeSpecificTransChInfo                 CHOICE {
        fdd                                  SEQUENCE {
            cpch-SetID                       CPCH-SetID                    OPTIONAL,
            addReconfTransChDRAC-Info         DRAC-StaticInformationList    OPTIONAL
        },
        tdd                                  NULL
    },
    dl-CommonTransChInfo                    DL-CommonTransChInfo          OPTIONAL,
    dl-DeletedTransChInfoList              DL-DeletedTransChInfoList     OPTIONAL,
    dl-AddReconfTransChInfoList            DL-AddReconfTransChInfoList   OPTIONAL,
    -- Physical channel IEs
    frequencyInfo                          FrequencyInfo                   OPTIONAL,
    maxAllowedUL-TX-Power                   MaxAllowedUL-TX-Power         OPTIONAL,
    ul-ChannelRequirement                   UL-ChannelRequirement         OPTIONAL,
    modeSpecificPhysChInfo                   CHOICE {
        fdd                                  SEQUENCE {
            dl-PDSCH-Information              DL-PDSCH-Information          OPTIONAL
        }
    }
}

```

```

    },
    tdd
  },
  dl-CommonInformation          DL-CommonInformation          OPTIONAL,
  dl-InformationPerRL-List     DL-InformationPerRL-List     OPTIONAL
}

CellUpdateConfirm-r3-r4-ext-IEs ::= SEQUENCE {
  -- Physical channel IEs
  -- The following IE extends SSDT-Information, which is included in
  -- DL-CommonInformation. FDD only.
  ssdt-UL                      SSDT-UL-r4                      OPTIONAL
}

CellUpdateConfirm-r4-IEs ::= SEQUENCE {
  -- User equipment IEs
  integrityProtectionModeInfo  IntegrityProtectionModeInfo  OPTIONAL,
  cipheringModeInfo           CipheringModeInfo             OPTIONAL,
  activationTime               ActivationTime                  OPTIONAL,
  new-U-RNTI                   U-RNTI                       OPTIONAL,
  new-C-RNTI                   C-RNTI                       OPTIONAL,
  rrc-StateIndicator           RRC-StateIndicator,
  utran-DRX-CycleLengthCoeff   UTRAN-DRX-CycleLengthCoefficient  OPTIONAL,
  rlc-ResetIndicatorC-Plane    BOOLEAN,
  rlc-ResetIndicatorU-Plane    BOOLEAN,
  -- CN information elements
  cn-InformationInfo           CN-InformationInfo           OPTIONAL,
  -- UTRAN mobility IEs
  ura-Identity                 URA-Identity                 OPTIONAL,
  -- Radio bearer IEs
  rb-InformationReleaseList     RB-InformationReleaseList     OPTIONAL,
  rb-InformationReconfigList    RB-InformationReconfigList-r4  OPTIONAL,
  rb-InformationAffectedList    RB-InformationAffectedList     OPTIONAL,
  rb-WithPDCP-InfoList         RB-WithPDCP-InfoList         OPTIONAL,
  -- Transport channel IEs
  ul-CommonTransChInfo         UL-CommonTransChInfo         OPTIONAL,
  ul-deletedTransChInfoList     UL-DeletedTransChInfoList     OPTIONAL,
  ul-AddReconfTransChInfoList   UL-AddReconfTransChInfoList   OPTIONAL,
  modeSpecificTransChInfo       CHOICE {
    fdd                          SEQUENCE {
      cpch-SetID                 CPCH-SetID                   OPTIONAL,
      addReconfTransChDRAC-Info  DRAC-StaticInformationList   OPTIONAL
    },
    tdd                          NULL
  },
  dl-CommonTransChInfo         DL-CommonTransChInfo-r4      OPTIONAL,
  dl-DeletedTransChInfoList     DL-DeletedTransChInfoList     OPTIONAL,
  dl-AddReconfTransChInfoList   DL-AddReconfTransChInfoList   OPTIONAL,
  -- Physical channel IEs
  frequencyInfo                FrequencyInfo                  OPTIONAL,
  maxAllowedUL-TX-Power         MaxAllowedUL-TX-Power        OPTIONAL,
  ul-ChannelRequirement         UL-ChannelRequirement-r4     OPTIONAL,
  modeSpecificPhysChInfo        CHOICE {
    fdd                          SEQUENCE {
      dl-PDSCH-Information       DL-PDSCH-Information         OPTIONAL
    },
    tdd                          NULL
  },
  dl-CommonInformation          DL-CommonInformation-r4      OPTIONAL,
  dl-InformationPerRL-List     DL-InformationPerRL-List-r4  OPTIONAL
}

-- *****
--
-- CELL UPDATE CONFIRM for CCCH
--
-- *****

CellUpdateConfirm-CCCH ::= CHOICE {
  r3                            SEQUENCE {
    -- User equipment IEs
    u-RNTI                      U-RNTI,
    -- The rest of the message is identical to the one sent on DCCH.
    cellUpdateConfirm-r3        CellUpdateConfirm-r3-IEs,
    nonCriticalExtensions       SEQUENCE {
      cellUpdateConfirm-r3-r4-ext CellUpdateConfirm-r3-r4-ext-IEs,
      nonCriticalExtensions      SEQUENCE {} OPTIONAL
    } OPTIONAL
  }
}

```

```

    },
    later-than-r3          SEQUENCE {
        u-RNTI             U-RNTI,
        rrc-TransactionIdentifier RRC-TransactionIdentifier,
        criticalExtensions CHOICE {
            r4              SEQUENCE {
                -- The rest of the message is identical to the one sent on DCCH.
                cellUpdateConfirm-r4      CellUpdateConfirm-r4-IEs,
                nonCriticalExtensions     SEQUENCE {} OPTIONAL
            },
            criticalExtensions SEQUENCE {}
        }
    }
}

-- *****
--
-- COUNTER CHECK
--
-- *****

CounterCheck ::= CHOICE {
    r3          SEQUENCE {
        counterCheck-r3      CounterCheck-r3-IEs,
        nonCriticalExtensions SEQUENCE {} OPTIONAL
    },
    later-than-r3          SEQUENCE {
        rrc-TransactionIdentifier RRC-TransactionIdentifier,
        criticalExtensions SEQUENCE {}
    }
}

CounterCheck-r3-IEs ::= SEQUENCE {
    -- User equipment IEs
    rrc-TransactionIdentifier RRC-TransactionIdentifier,
    -- Radio bearer IEs
    rb-COUNT-C-MSB-InformationList RB-COUNT-C-MSB-InformationList
}

-- *****
--
-- COUNTER CHECK RESPONSE
--
-- *****

CounterCheckResponse ::= SEQUENCE {
    -- User equipment IEs
    rrc-TransactionIdentifier RRC-TransactionIdentifier,
    -- Radio bearer IEs
    rb-COUNT-C-InformationList RB-COUNT-C-InformationList OPTIONAL,
    -- Extension mechanism for non-release99 information
    nonCriticalExtensions SEQUENCE {} OPTIONAL
}

-- *****
--
-- DOWNLINK DIRECT TRANSFER
--
-- *****

DownlinkDirectTransfer ::= CHOICE {
    r3          SEQUENCE {
        downlinkDirectTransfer-r3      DownlinkDirectTransfer-r3-IEs,
        nonCriticalExtensions SEQUENCE {} OPTIONAL
    },
    later-than-r3          SEQUENCE {
        rrc-TransactionIdentifier RRC-TransactionIdentifier,
        criticalExtensions SEQUENCE {}
    }
}

DownlinkDirectTransfer-r3-IEs ::= SEQUENCE {
    -- User equipment IEs
    rrc-TransactionIdentifier RRC-TransactionIdentifier,
    -- Core network IEs
    cn-DomainIdentity CN-DomainIdentity,
    nas-Message NAS-Message
}

```



```

-- *****
--
-- HANDOVER TO UTRAN COMMAND
--
-- *****

HandoverToUTRANCommand ::= CHOICE {
  r3 SEQUENCE {
    handoverToUTRANCommand-r3 HandoverToUTRANCommand-r3-IEs,
    nonCriticalExtensions SEQUENCE {
      handoverToUTRANCommand-r3-r4-ext
      nonCriticalExtensions HandoverToUTRANCommand-r3-r4-ext-IEs,
    } OPTIONAL
  },
  criticalExtensions CHOICE {
    r4 SEQUENCE {
      handoverToUTRANCommand-r4 HandoverToUTRANCommand-r4-IEs,
      nonCriticalExtensions SEQUENCE {} OPTIONAL
    },
    criticalExtensions SEQUENCE {}
  }
}

HandoverToUTRANCommand-r3-IEs ::= SEQUENCE {
  -- User equipment IEs
  new-U-RNTI U-RNTI-Short,
  dummy ActivationTime OPTIONAL,
  cipheringAlgorithm CipheringAlgorithm OPTIONAL,
  -- Radio bearer IEs
  -- Specification mode information
  specificationMode CHOICE {
    complete SEQUENCE {
      srb-InformationSetupList SRB-InformationSetupList,
      rab-InformationSetupList RAB-InformationSetupList OPTIONAL,
      ul-CommonTransChInfo UL-CommonTransChInfo,
      ul-AddReconfTransChInfoList UL-AddReconfTransChInfoList,
      dl-CommonTransChInfo DL-CommonTransChInfo,
      dl-AddReconfTransChInfoList DL-AddReconfTransChInfoList,
      ul-DPCH-Info UL-DPCH-Info,
      modeSpecificInfo CHOICE {
        fdd SEQUENCE {
          dl-PDSCH-Information DL-PDSCH-Information OPTIONAL,
          cpch-SetInfo CPCH-SetInfo OPTIONAL
        },
        tdd NULL
      },
      dl-CommonInformation DL-CommonInformation,
      dl-InformationPerRL-List DL-InformationPerRL-List,
      frequencyInfo FrequencyInfo
    },
    preconfiguration SEQUENCE {
      predefinedConfigIdentity PredefinedConfigIdentity,
      defaultConfig SEQUENCE {
        defaultConfigMode DefaultConfigMode,
        defaultConfigIdentity DefaultConfigIdentity
      }
    },
    rab-Info RAB-Info-Post OPTIONAL,
    modeSpecificInfo CHOICE {
      fdd SEQUENCE {
        ul-DPCH-Info UL-DPCH-InfoPostFDD,
        dl-CommonInformationPost DL-CommonInformationPost,
        dl-InformationPerRL-List DL-InformationPerRL-ListPostFDD,
        frequencyInfo FrequencyInfoFDD
      },
      tdd SEQUENCE {
        ul-DPCH-Info UL-DPCH-InfoPostTDD,
        dl-CommonInformationPost DL-CommonInformationPost,
        dl-InformationPerRL-List DL-InformationPerRL-ListPostTDD,
        frequencyInfo FrequencyInfoTDD,
        primaryCCPCH-TX-Power PrimaryCCPCH-TX-Power
      }
    }
  }
}

```

```

    }
  }
},
-- Physical channel IEs
maxAllowedUL-TX-Power          MaxAllowedUL-TX-Power
}

HandoverToUTRANCommand-r3-r4-ext-IEs ::= SEQUENCE {
-- Physical channel IEs
-- The following IE extends SSdT-Information, which is included in
-- DL-CommonInformation. FDD only.
ssdt-UL                          SSdT-UL-r4                      OPTIONAL
}

HandoverToUTRANCommand-r4-IEs ::= SEQUENCE {
-- User equipment IEs
new-U-RNTI                        U-RNTI-Short,
activationTime                    ActivationTime              OPTIONAL,
cipheringAlgorithm                CipheringAlgorithm        OPTIONAL,
-- Radio bearer IEs
rab-Info                          RAB-Info-Post,
-- Specification mode information
specificationMode                 CHOICE {
complete                          SEQUENCE {
srb-InformationSetupList          SRB-InformationSetupList,
rab-InformationSetupList          RAB-InformationSetupList-r4    OPTIONAL,
ul-CommonTransChInfo             UL-CommonTransChInfo,
ul-AddReconfTransChInfoList      UL-AddReconfTransChInfoList,
dl-CommonTransChInfo             DL-CommonTransChInfo,
dl-AddReconfTransChInfoList      DL-AddReconfTransChInfoList,
ul-DPCH-Info                     UL-DPCH-Info-r4,
modeSpecificInfo                 CHOICE {
fdd                               SEQUENCE {
dl-PDSCH-Information             DL-PDSCH-Information OPTIONAL,
cpch-SetInfo                    CPCH-SetInfo              OPTIONAL
},
tdd                               NULL
},
dl-CommonInformation             DL-CommonInformation-r4,
dl-InformationPerRL-List         DL-InformationPerRL-List-r4,
frequencyInfo                    FrequencyInfo
},
preconfiguration                 SEQUENCE {
-- All IEs that include an FDD/TDD choice are split in two IEs for this message,
-- one for the FDD only elements and one for the TDD only elements, so that one
-- FDD/TDD choice in this level is sufficient.
predefinedConfigIdentity         PredefinedConfigIdentity,
rab-Info                          RAB-Info-Post              OPTIONAL,
modeSpecificInfo                 CHOICE {
fdd                               SEQUENCE {
ul-DPCH-Info                    UL-DPCH-InfoPostFDD,
dl-CommonInformationPost         DL-CommonInformationPost,
dl-InformationPerRL-List         DL-InformationPerRL-ListPostFDD,
frequencyInfo                    FrequencyInfoFDD
},
tdd                               CHOICE {
tdd384                           SEQUENCE {
ul-DPCH-Info                    UL-DPCH-InfoPostTDD,
dl-InformationPerRL              DL-InformationPerRL-PostTDD,
frequencyInfo                    FrequencyInfoTDD,
primaryCCPCH-TX-Power            PrimaryCCPCH-TX-Power
},
tdd128                           SEQUENCE {
ul-DPCH-Info                    UL-DPCH-InfoPostTDD-LCR-r4,
dl-InformationPerRL              DL-InformationPerRL-PostTDD-LCR-r4,
frequencyInfo                    FrequencyInfoTDD,
primaryCCPCH-TX-Power            PrimaryCCPCH-TX-Power
}
}
},
},
-- Physical channel IEs
maxAllowedUL-TX-Power          MaxAllowedUL-TX-Power
}

```

```

-- *****
--
-- HANDOVER TO UTRAN COMPLETE
--
-- *****

HandoverToUTRANComplete ::= SEQUENCE {
  --TABULAR: Integrity protection shall not be performed on this message.
  -- User equipment IEs
  -- TABULAR: the IE below is conditional on history.
  startList          STARTList          OPTIONAL,
  -- Radio bearer IEs
  count-C-ActivationTime  ActivationTime  OPTIONAL,
  -- Extension mechanism for non- release99 information
  nonCriticalExtensions  SEQUENCE {}     OPTIONAL
}

-- *****
--
-- INITIAL DIRECT TRANSFER
--
-- *****

InitialDirectTransfer ::= SEQUENCE {
  -- Core network IEs
  cn-DomainIdentity      CN-DomainIdentity,
  intraDomainNasNodeSelector  IntraDomainNasNodeSelector,
  nas-Message            NAS-Message,
  -- Measurement IEs
  measuredResultsOnRACH  MeasuredResultsOnRACH  OPTIONAL,
  -- Extension mechanism for non- release99 information
  nonCriticalExtensions  SEQUENCE {}     OPTIONAL
}

-- *****
--
-- HANDOVER FROM UTRAN COMMAND
--
-- *****

HandoverFromUTRANCommand-GSM ::= CHOICE {
  r3          SEQUENCE {
    handoverFromUTRANCommand-GSM-r3
    nonCriticalExtensions          SEQUENCE {} OPTIONAL
  },
  later-than-r3          SEQUENCE {
    rrc-TransactionIdentifier      RRC-TransactionIdentifier,
    criticalExtensions            SEQUENCE {}
  }
}

HandoverFromUTRANCommand-GSM-r3-IEs ::= SEQUENCE {
  -- User equipment IEs
  rrc-TransactionIdentifier      RRC-TransactionIdentifier,
  activationTime                ActivationTime          OPTIONAL,
  -- Radio bearer IEs
  toHandover-Info              RAB-Info              OPTIONAL,
  -- Measurement IEs
  frequency-band               Frequency-Band,
  -- Other IEs
  gsm-message                   CHOICE {
    single-GSM-Message          SEQUENCE {},
    -- In this case, what follows the basic production is a variable length bit string
    -- with no length field, containing the GSM message including GSM padding up to end
    -- of container, to be analysed according to GSM specifications
    gsm-MessageList            SEQUENCE {
      gsm-Messages              GSM-MessageList
    }
  }
}

HandoverFromUTRANCommand-CDMA2000 ::= CHOICE {
  r3          SEQUENCE {
    handoverFromUTRANCommand-CDMA2000-r3
    nonCriticalExtensions          SEQUENCE {} OPTIONAL
  },
}

```

```

    later-than-r3
      rrc-TransactionIdentifier      RRC-TransactionIdentifier,
      criticalExtensions              SEQUENCE {}
    }
  }

HandoverFromUTRANCommand-CDMA2000-r3-IEs ::= SEQUENCE {
  -- User equipment IEs
  rrc-TransactionIdentifier      RRC-TransactionIdentifier,
  activationTime                  ActivationTime                OPTIONAL,
  -- Radio bearer IEs
  toHandover-Info                RAB-Info                    OPTIONAL,
  -- Other IEs
  cdma2000-MessageList            CDMA2000-MessageList
}

-- *****
--
-- HANDOVER FROM UTRAN FAILURE
--
-- *****

HandoverFromUTRANFailure ::= SEQUENCE {
  -- User equipment IEs
  rrc-TransactionIdentifier      RRC-TransactionIdentifier,
  -- Other IEs
  interRAT-HO-FailureCause       InterRAT-HO-FailureCause    OPTIONAL,
  -- Extension mechanism for non- release99 information
  nonCriticalExtensions           SEQUENCE {}                OPTIONAL
}

-- *****
--
-- MEASUREMENT CONTROL
--
-- *****

MeasurementControl ::= CHOICE {
  r3
    SEQUENCE {
      measurementControl-r3      MeasurementControl-r3-IEs,
      nonCriticalExtensions       SEQUENCE {
        measurementControl-r3-r4-ext  MeasurementControl-r3-r4-ext-IEs,
        nonCriticalExtensions         SEQUENCE {}
      }
    },
  criticalExtensions             CHOICE {
    r4
      SEQUENCE {
        measurementControl-r4      MeasurementControl-r4-IEs,
        nonCriticalExtensions       SEQUENCE {}                OPTIONAL
      },
    criticalExtensions           SEQUENCE {}
  }
}

MeasurementControl-r3-IEs ::= SEQUENCE {
  -- User equipment IEs
  rrc-TransactionIdentifier      RRC-TransactionIdentifier,
  -- Measurement IEs
  measurementIdentity            MeasurementIdentity,
  measurementCommand             MeasurementCommand,
  -- TABULAR: The measurement type is included in MeasurementCommand.
  measurementReportingMode       MeasurementReportingMode    OPTIONAL,
  additionalMeasurementList      AdditionalMeasurementID-List  OPTIONAL,
  -- Physical channel IEs
  dpch-CompressedModeStatusInfo  DPCH-CompressedModeStatusInfo  OPTIONAL
}

MeasurementControl-r3-r4-ext-IEs ::= SEQUENCE {
  -- In case of TDD, the following IE is included instead of the IE
  -- up-IPDL-Parameters in up-OTDOA-AssistanceData
  up-IPDL-Parameters-TDD        UP-IPDL-Parameters-TDD-r4-ext  OPTIONAL
}

MeasurementControl-r4-IEs ::= SEQUENCE {
  -- User equipment IEs
  rrc-TransactionIdentifier      RRC-TransactionIdentifier,
  -- Measurement IEs
  measurementIdentity            MeasurementIdentity,

```

```

        measurementCommand      MeasurementCommand-r4,
        -- TABULAR: The measurement type is included in MeasurementCommand.
        measurementReportingMode MeasurementReportingMode      OPTIONAL,
        additionalMeasurementList AdditionalMeasurementID-List  OPTIONAL,
    -- Physical channel IEs
        dpch-CompressedModeStatusInfo DPCH-CompressedModeStatusInfo  OPTIONAL
    }

-- *****
--
-- MEASUREMENT CONTROL FAILURE
--
-- *****

MeasurementControlFailure ::= SEQUENCE {
    -- User equipment IEs
        rrc-TransactionIdentifier      RRC-TransactionIdentifier,
        failureCause                    FailureCauseWithProtErr,
    -- Extension mechanism for non- release99 information
        nonCriticalExtensions          SEQUENCE {}      OPTIONAL
    }

-- *****
--
-- MEASUREMENT REPORT
--
-- *****

MeasurementReport ::= SEQUENCE {
    -- Measurement IEs
        measurementIdentity      MeasurementIdentity,
        measuredResults            MeasuredResults      OPTIONAL,
        measuredResultsOnRACH      MeasuredResultsOnRACH  OPTIONAL,
        additionalMeasuredResults  MeasuredResultsList  OPTIONAL,
        eventResults                EventResults        OPTIONAL,
    -- Extension mechanism for non- release99 information
        nonCriticalExtensions      SEQUENCE {
            measurementReport-r3-r4-ext  MeasurementReport-r3-r4-ext-IEs,
            nonCriticalExtensions        SEQUENCE {}      OPTIONAL
        }
    }

MeasurementReport-r3-r4-ext-IEs ::= SEQUENCE {
        interFreqEventResults-LCR      InterFreqEventResults-LCR-r4-ext  OPTIONAL,
        additionalMeasuredResults-LCR  MeasuredResultsList-LCR-r4-ext  OPTIONAL
    }

-- *****
--
-- PAGING TYPE 1
--
-- *****

PagingType1 ::= SEQUENCE {
    -- User equipment IEs
        pagingRecordList            PagingRecordList      OPTIONAL,
    -- Other IEs
        bcch-ModificationInfo        BCCH-ModificationInfo  OPTIONAL,
    -- Extension mechanism for non- release99 information
        nonCriticalExtensions        SEQUENCE {}      OPTIONAL
    }

-- *****
--
-- PAGING TYPE 2
--
-- *****

PagingType2 ::= SEQUENCE {
    -- User equipment IEs
        rrc-TransactionIdentifier      RRC-TransactionIdentifier,
        pagingCause                    PagingCause,
    -- Core network IEs
        cn-DomainIdentity              CN-DomainIdentity,
        pagingRecordTypeID              PagingRecordTypeID,
    -- Extension mechanism for non- release99 information
        nonCriticalExtensions          SEQUENCE {}      OPTIONAL
    }

```

```

-- *****
--
-- PHYSICAL CHANNEL RECONFIGURATION
--
-- *****

PhysicalChannelReconfiguration ::= CHOICE {
  r3
    SEQUENCE {
      physicalChannelReconfiguration-r3
      nonCriticalExtensions
        SEQUENCE {
          physicalChannelReconfiguration-r3-r4-ext
            PhysicalChannelReconfiguration-r3-r4-ext-
IEs,
            nonCriticalExtensions
              SEQUENCE {} OPTIONAL
        } OPTIONAL
    },
  later-than-r3
    SEQUENCE {
      rrc-TransactionIdentifier
        RRC-TransactionIdentifier,
      criticalExtensions
        CHOICE {
          r4
            SEQUENCE {
              physicalChannelReconfiguration-r4
              nonCriticalExtensions
                SEQUENCE {} OPTIONAL
            },
          criticalExtensions
            SEQUENCE {}
        }
    }
}

PhysicalChannelReconfiguration-r3-IEs ::= SEQUENCE {
  -- User equipment IEs
  rrc-TransactionIdentifier
    RRC-TransactionIdentifier,
  integrityProtectionModeInfo
    IntegrityProtectionModeInfo
    OPTIONAL,
  cipheringModeInfo
    CipheringModeInfo
    OPTIONAL,
  activationTime
    ActivationTime
    OPTIONAL,
  new-U-RNTI
    U-RNTI
    OPTIONAL,
  new-C-RNTI
    C-RNTI
    OPTIONAL,
  rrc-StateIndicator
    RRC-StateIndicator,
  utran-DRX-CycleLengthCoeff
    UTRAN-DRX-CycleLengthCoefficient
    OPTIONAL,
  -- Core network IEs
  cn-InformationInfo
    CN-InformationInfo
    OPTIONAL,
  -- UTRAN mobility IEs
  ura-Identity
    URA-Identity
    OPTIONAL,
  -- Radio bearer IEs
  dl-CounterSynchronisationInfo
    DL-CounterSynchronisationInfo
    OPTIONAL,
  -- Physical channel IEs
  frequencyInfo
    FrequencyInfo
    OPTIONAL,
  maxAllowedUL-TX-Power
    MaxAllowedUL-TX-Power
    OPTIONAL,
  ul-ChannelRequirement
    UL-ChannelRequirementWithCPCH-SetID
    OPTIONAL,
  -- TABULAR: UL-ChannelRequirementWithCPCH-SetID contains the choice
  -- between UL DPCH info, CPCH SET info and CPCH set ID.
  modeSpecificInfo
    CHOICE {
      fdd
        SEQUENCE {
          dl-PDSCH-Information
            DL-PDSCH-Information
            OPTIONAL
        },
      tdd
        NULL
    },
  dl-CommonInformation
    DL-CommonInformation
    OPTIONAL,
  dl-InformationPerRL-List
    DL-InformationPerRL-List
    OPTIONAL
}

PhysicalChannelReconfiguration-r3-r4-ext-IEs ::= SEQUENCE {
  -- Physical channel IEs
  -- The following IE extends SSdT-Information, which is included in
  -- DL-CommonInformation. FDD only.
  ssdt-UL
    SSdT-UL-r4
    OPTIONAL
}

PhysicalChannelReconfiguration-r4-IEs ::= SEQUENCE {
  -- User equipment IEs
  integrityProtectionModeInfo
    IntegrityProtectionModeInfo
    OPTIONAL,
  cipheringModeInfo
    CipheringModeInfo
    OPTIONAL,
  activationTime
    ActivationTime
    OPTIONAL,
  new-U-RNTI
    U-RNTI
    OPTIONAL,
  new-C-RNTI
    C-RNTI
    OPTIONAL,
  rrc-StateIndicator
    RRC-StateIndicator,
  utran-DRX-CycleLengthCoeff
    UTRAN-DRX-CycleLengthCoefficient
    OPTIONAL,

```

```

-- Core network IEs
cn-InformationInfo          CN-InformationInfo          OPTIONAL,
-- UTRAN mobility IEs
ura-Identity                URA-Identity                OPTIONAL,
-- Radio bearer IEs
rb-WithPDCP-InfoList       RB-WithPDCP-InfoList       OPTIONAL,
-- Physical channel IEs
frequencyInfo               FrequencyInfo           OPTIONAL,
maxAllowedUL-TX-Power       MaxAllowedUL-TX-Power     OPTIONAL,
ul-ChannelRequirement       UL-ChannelRequirementWithCPCH-SetID-r4  OPTIONAL,
-- TABULAR: UL-ChannelRequirementWithCPCH-SetID-r4 contains the choice
-- between UL DPCH info, CPCH SET info and CPCH set ID.
modeSpecificInfo           CHOICE {
    fdd                      SEQUENCE {
        dl-PDSCH-Information    DL-PDSCH-Information    OPTIONAL
    },
    tdd                      NULL
},
dl-CommonInformation        DL-CommonInformation-r4    OPTIONAL,
dl-InformationPerRL-List    DL-InformationPerRL-List-r4  OPTIONAL
}

-- *****
--
-- PHYSICAL CHANNEL RECONFIGURATION COMPLETE
--
-- *****

PhysicalChannelReconfigurationComplete ::= SEQUENCE {
-- User equipment IEs
rrc-TransactionIdentifier    RRC-TransactionIdentifier,
ul-IntegProtActivationInfo    IntegrityProtActivationInfo    OPTIONAL,
-- TABULAR: UL-TimingAdvance is applicable for TDD mode only.
ul-TimingAdvance             UL-TimingAdvance             OPTIONAL,
-- Radio bearer IEs
count-C-ActivationTime       ActivationTime               OPTIONAL,
rb-UL-CiphActivationTimeInfo  RB-ActivationTimeInfoList     OPTIONAL,
ul-CounterSynchronisationInfo  UL-CounterSynchronisationInfo  OPTIONAL,
-- Extension mechanism for non- release99 information
nonCriticalExtensions         SEQUENCE {}                 OPTIONAL
}

-- *****
--
-- PHYSICAL CHANNEL RECONFIGURATION FAILURE
--
-- *****

PhysicalChannelReconfigurationFailure ::= SEQUENCE {
-- User equipment IEs
rrc-TransactionIdentifier    RRC-TransactionIdentifier    OPTIONAL,
failureCause                 FailureCauseWithProtErr,
-- Extension mechanism for non- release99 information
nonCriticalExtensions         SEQUENCE {}                 OPTIONAL
}

-- *****
--
-- PHYSICAL SHARED CHANNEL ALLOCATION (TDD only)
--
-- *****

PhysicalSharedChannelAllocation ::= CHOICE {
    r3                         SEQUENCE {
        physicalSharedChannelAllocation-r3
        nonCriticalExtensions    PhysicalSharedChannelAllocation-r3-IEs,
        SEQUENCE {}             OPTIONAL
    },
    later-than-r3              SEQUENCE {
        c-RNTI                  C-RNTI                        OPTIONAL,
        rrc-TransactionIdentifier  RRC-TransactionIdentifier,
        criticalExtensions         CHOICE {
            r4                   SEQUENCE {
                physicalSharedChannelAllocation-r4
                nonCriticalExtensions    PhysicalSharedChannelAllocation-r4-IEs,
                SEQUENCE {}             OPTIONAL
            },
            criticalExtensions     SEQUENCE {}
        }
    }
}

```

```

    }
  }
}

PhysicalSharedChannelAllocation-r3-IEs ::= SEQUENCE {
  -- TABULAR: Integrity protection shall not be performed on this message.
  -- User equipment IEs
    c-RNTI                               C-RNTI                               OPTIONAL,
    rrc-TransactionIdentifier             RRC-TransactionIdentifier,
  -- Physical channel IEs
    ul-TimingAdvance                     UL-TimingAdvanceControl              OPTIONAL,
    pusch-CapacityAllocationInfo         PUSCH-CapacityAllocationInfo        OPTIONAL,
    pdsch-CapacityAllocationInfo         PDSCH-CapacityAllocationInfo        OPTIONAL,
    confirmRequest                        ENUMERATED {
                                          confirmPDSCH, confirmPUSCH } OPTIONAL,
  -- TABULAR: If the above value is not present, the default value "No Confirm"
  -- shall be used as specified in 10.2.25.
    trafficVolumeReportRequest           INTEGER (0..255)                      OPTIONAL,
    iscpTimeslotList                     TimeslotList                          OPTIONAL
}

PhysicalSharedChannelAllocation-r4-IEs ::= SEQUENCE {
  -- TABULAR: Integrity protection shall not be performed on this message.
  -- Physical channel IEs
    ul-TimingAdvance                     UL-TimingAdvanceControl-r4          OPTIONAL,
    pusch-CapacityAllocationInfo         PUSCH-CapacityAllocationInfo-r4    OPTIONAL,
    pdsch-CapacityAllocationInfo         PDSCH-CapacityAllocationInfo-r4    OPTIONAL,
    confirmRequest                        ENUMERATED {
                                          confirmPDSCH, confirmPUSCH } OPTIONAL,
  -- TABULAR: If the above value is not present, the default value "No Confirm"
  -- shall be used as specified in 10.2.25.
    iscpTimeslotList                     TimeslotList-r4                      OPTIONAL
}

-- *****
--
-- PUSCH CAPACITY REQUEST (TDD only)
--
-- *****

PUSCHCapacityRequest ::= SEQUENCE {
  -- User equipment IEs
    c-RNTI                               C-RNTI                               OPTIONAL,
  -- Measurement IEs
    trafficVolume                         TrafficVolumeMeasuredResultsList,
    timeslotListWithISCP                  TimeslotListWithISCP                 OPTIONAL,
    primaryCCPCH-RSCP                     PrimaryCCPCH-RSCP                     OPTIONAL,
    allocationConfirmation                 CHOICE {
      pdschConfirmation                   PDSCH-Identity,
      puschConfirmation                    PUSCH-Identity
    } OPTIONAL,
    protocolErrorIndicator                 ProtocolErrorIndicatorWithMoreInfo,
  -- Extension mechanism for non- release99 information
    nonCriticalExtensions                  SEQUENCE {} OPTIONAL
}

-- *****
--
-- RADIO BEARER RECONFIGURATION
--
-- *****

RadioBearerReconfiguration ::= CHOICE {
  r3                                       SEQUENCE {
    radioBearerReconfiguration-r3         RadioBearerReconfiguration-r3-IEs,
    nonCriticalExtensions                  SEQUENCE {
      radioBearerReconfiguration-r3-r4-ext
    } OPTIONAL,
    nonCriticalExtensions                  RadioBearerReconfiguration-r3-r4-ext-IEs,
    nonCriticalExtensions                  SEQUENCE {} OPTIONAL
  },
  later-than-r3                             SEQUENCE {
    rrc-TransactionIdentifier             RRC-TransactionIdentifier,
    criticalExtensions                     CHOICE {
      r4                                   SEQUENCE {
        radioBearerReconfiguration-r4     RadioBearerReconfiguration-r4-IEs,
        nonCriticalExtensions              SEQUENCE {} OPTIONAL
      }
    }
  },
}

```



```

        criticalExtensions          SEQUENCE {}
    }
}

RadioBearerReconfiguration-r3-IEs ::= SEQUENCE {
    -- User equipment IEs
    rrc-TransactionIdentifier      RRC-TransactionIdentifier,
    integrityProtectionModeInfo    IntegrityProtectionModeInfo    OPTIONAL,
    cipheringModeInfo              CipheringModeInfo              OPTIONAL,
    activationTime                  ActivationTime                  OPTIONAL,
    new-U-RNTI                      U-RNTI                      OPTIONAL,
    new-C-RNTI                      C-RNTI                      OPTIONAL,
    rrc-StateIndicator              RRC-StateIndicator,
    utran-DRX-CycleLengthCoeff     UTRAN-DRX-CycleLengthCoefficient OPTIONAL,
    -- Core network IEs
    cn-InformationInfo              CN-InformationInfo              OPTIONAL,
    -- UTRAN mobility IEs
    ura-Identity                    URA-Identity                    OPTIONAL,
    -- Radio bearer IEs
    rab-InformationReconfigList     RAB-InformationReconfigList     OPTIONAL,
    rb-InformationReconfigList      RB-InformationReconfigList,
    -- NOTE: IE rb-InformationReconfigList should be optional in later versions of this message
    rb-InformationAffectedList      RB-InformationAffectedList      OPTIONAL,
    -- Transport channel IEs
    ul-CommonTransChInfo           UL-CommonTransChInfo           OPTIONAL,
    ul-deletedTransChInfoList      UL-DeletedTransChInfoList      OPTIONAL,
    ul-AddReconfTransChInfoList    UL-AddReconfTransChInfoList    OPTIONAL,
    modeSpecificTransChInfo        CHOICE {
        fdd                          SEQUENCE {
            cpch-SetID                CPCH-SetID                OPTIONAL,
            addReconfTransChDRAC-Info DRAC-StaticInformationList OPTIONAL
        },
        tdd                          NULL
    }
    dl-CommonTransChInfo           DL-CommonTransChInfo           OPTIONAL,
    dl-DeletedTransChInfoList      DL-DeletedTransChInfoList      OPTIONAL,
    dl-AddReconfTransChInfoList    DL-AddReconfTransChInfo2List   OPTIONAL,
    -- Physical channel IEs
    frequencyInfo                  FrequencyInfo                  OPTIONAL,
    maxAllowedUL-TX-Power          MaxAllowedUL-TX-Power          OPTIONAL,
    ul-ChannelRequirement          UL-ChannelRequirement          OPTIONAL,
    modeSpecificPhysChInfo         CHOICE {
        fdd                          SEQUENCE {
            dl-PDSCH-Information      DL-PDSCH-Information      OPTIONAL
        },
        tdd                          NULL
    },
    dl-CommonInformation           DL-CommonInformation           OPTIONAL,
    dl-InformationPerRL-List       DL-InformationPerRL-List
    -- NOTE: IE dl-InformationPerRL-List should be optional in later versions of this message
}

RadioBearerReconfiguration-r3-r4-ext-IEs ::= SEQUENCE {
    -- Physical channel IEs
    -- The following IE extends SSdT-Information, which is included in
    -- DL-CommonInformation. FDD only.
    ssdt-UL                        SSdT-UL-r4                      OPTIONAL
}

RadioBearerReconfiguration-r4-IEs ::= SEQUENCE {
    -- User equipment IEs
    integrityProtectionModeInfo    IntegrityProtectionModeInfo    OPTIONAL,
    cipheringModeInfo              CipheringModeInfo              OPTIONAL,
    activationTime                  ActivationTime                  OPTIONAL,
    new-U-RNTI                      U-RNTI                      OPTIONAL,
    new-C-RNTI                      C-RNTI                      OPTIONAL,
    rrc-StateIndicator              RRC-StateIndicator,
    utran-DRX-CycleLengthCoeff     UTRAN-DRX-CycleLengthCoefficient OPTIONAL,
    -- Core network IEs
    cn-InformationInfo              CN-InformationInfo              OPTIONAL,
    -- UTRAN mobility IEs
    ura-Identity                    URA-Identity                    OPTIONAL,
    -- Radio bearer IEs
    rab-InformationReconfigList     RAB-InformationReconfigList     OPTIONAL,
    rb-InformationReconfigList      RB-InformationReconfigList-r4   OPTIONAL,
    rb-InformationAffectedList      RB-InformationAffectedList      OPTIONAL,
    -- Transport channel IEs

```

```

    ul-CommonTransChInfo          UL-CommonTransChInfo          OPTIONAL,
    ul-deletedTransChInfoList     UL-DeletedTransChInfoList     OPTIONAL,
    ul-AddReconfTransChInfoList   UL-AddReconfTransChInfoList   OPTIONAL,
    modeSpecificTransChInfo       CHOICE {
        fdd                        SEQUENCE {
            cpch-SetID             CPCH-SetID             OPTIONAL,
            addReconfTransChDRAC-Info DRAC-StaticInformationList OPTIONAL
        },
        tdd                        NULL
    }
    dl-CommonTransChInfo          DL-CommonTransChInfo-r4       OPTIONAL,
    dl-DeletedTransChInfoList     DL-DeletedTransChInfoList     OPTIONAL,
    dl-AddReconfTransChInfoList   DL-AddReconfTransChInfo2List  OPTIONAL,
-- Physical channel IEs
    frequencyInfo                 FrequencyInfo                 OPTIONAL,
    maxAllowedUL-TX-Power         MaxAllowedUL-TX-Power        OPTIONAL,
    ul-ChannelRequirement         UL-ChannelRequirement-r4     OPTIONAL,
    modeSpecificPhysChInfo       CHOICE {
        fdd                        SEQUENCE {
            dl-PDSCH-Information   DL-PDSCH-Information   OPTIONAL
        },
        tdd                        NULL
    },
    dl-CommonInformation         DL-CommonInformation-r4       OPTIONAL,
    dl-InformationPerRL-List     DL-InformationPerRL-List-r4   OPTIONAL
}

-- *****
--
-- RADIO BEARER RECONFIGURATION COMPLETE
--
-- *****

RadioBearerReconfigurationComplete ::= SEQUENCE {
-- User equipment IEs
    rrc-TransactionIdentifier     RRC-TransactionIdentifier,
    ul-IntegProtActivationInfo    IntegrityProtActivationInfo    OPTIONAL,
    -- TABULAR: UL-TimingAdvance is applicable for TDD mode only.
    ul-TimingAdvance             UL-TimingAdvance             OPTIONAL,
-- Radio bearer IEs
    count-C-ActivationTime       ActivationTime                 OPTIONAL,
    rb-UL-CiphActivationTimeInfo  RB-ActivationTimeInfoList     OPTIONAL,
    ul-CounterSynchronisationInfo UL-CounterSynchronisationInfo OPTIONAL,
-- Extension mechanism for non- release99 information
    nonCriticalExtensions        SEQUENCE {} OPTIONAL
}

-- *****
--
-- RADIO BEARER RECONFIGURATION FAILURE
--
-- *****

RadioBearerReconfigurationFailure ::= SEQUENCE {
-- User equipment IEs
    rrc-TransactionIdentifier     RRC-TransactionIdentifier,
    failureCause                 FailureCauseWithProtErr,
-- Radio bearer IEs
    potentiallySuccessfulBearerList RB-IdentityList             OPTIONAL,
-- Extension mechanism for non- release99 information
    nonCriticalExtensions        SEQUENCE {} OPTIONAL
}

-- *****
--
-- RADIO BEARER RELEASE
--
-- *****

RadioBearerRelease ::= CHOICE {
    r3                            SEQUENCE {
        radioBearerRelease-r3     RadioBearerRelease-r3-IEs,
        nonCriticalExtensions     SEQUENCE {
            radioBearerRelease-r3-r4-ext RadioBearerRelease-r3-r4-ext-IEs,
            nonCriticalExtensions     SEQUENCE {} OPTIONAL
        } OPTIONAL
    },
    later-than-r3                 SEQUENCE {

```

```

rrc-TransactionIdentifier      RRC-TransactionIdentifier,
criticalExtensions             CHOICE {
    r4                         SEQUENCE {
        radioBearerRelease-r4  RadioBearerRelease-r4-IEs,
        nonCriticalExtensions  SEQUENCE {} OPTIONAL
    },
    criticalExtensions         SEQUENCE {}
}
}
}

RadioBearerRelease-r3-IEs ::= SEQUENCE {
-- User equipment IEs
rrc-TransactionIdentifier      RRC-TransactionIdentifier,
integrityProtectionModeInfo   IntegrityProtectionModeInfo   OPTIONAL,
cipheringModeInfo             CipheringModeInfo             OPTIONAL,
activationTime                 ActivationTime                 OPTIONAL,
new-U-RNTI                    U-RNTI                       OPTIONAL,
new-C-RNTI                    C-RNTI                       OPTIONAL,
rrc-StateIndicator            RRC-StateIndicator,
utran-DRX-CycleLengthCoeff    UTRAN-DRX-CycleLengthCoefficient OPTIONAL,
-- Core network IEs
cn-InformationInfo            CN-InformationInfo            OPTIONAL,
signallingConnectionRelIndication CN-DomainIdentity            OPTIONAL,
-- UTRAN mobility IEs
ura-Identity                  URA-Identity                  OPTIONAL,
-- Radio bearer IEs
rab-InformationReconfigList   RAB-InformationReconfigList   OPTIONAL,
rb-InformationReleaseList     RB-InformationReleaseList,
rb-InformationAffectedList    RB-InformationAffectedList    OPTIONAL,
dl-CounterSynchronisationInfo DL-CounterSynchronisationInfo OPTIONAL,
-- Transport channel IEs
ul-CommonTransChInfo         UL-CommonTransChInfo         OPTIONAL,
ul-deletedTransChInfoList     UL-DeletedTransChInfoList     OPTIONAL,
ul-AddReconfTransChInfoList  UL-AddReconfTransChInfoList  OPTIONAL,
modeSpecificTransChInfo      CHOICE {
    fdd                       SEQUENCE {
        cpch-SetID           CPCH-SetID           OPTIONAL,
        addReconfTransChDRAC-Info DRAC-StaticInformationList OPTIONAL
    },
    tdd                       NULL
}
dl-CommonTransChInfo         DL-CommonTransChInfo         OPTIONAL,
dl-DeletedTransChInfoList    DL-DeletedTransChInfoList    OPTIONAL,
dl-AddReconfTransChInfoList  DL-AddReconfTransChInfo2List OPTIONAL,
-- Physical channel IEs
frequencyInfo                 FrequencyInfo                 OPTIONAL,
maxAllowedUL-TX-Power         MaxAllowedUL-TX-Power         OPTIONAL,
ul-ChannelRequirement         UL-ChannelRequirement         OPTIONAL,
modeSpecificPhysChInfo       CHOICE {
    fdd                       SEQUENCE {
        dl-PDSCH-Information DL-PDSCH-Information    OPTIONAL
    },
    tdd                       NULL
},
dl-CommonInformation         DL-CommonInformation         OPTIONAL,
dl-InformationPerRL-List     DL-InformationPerRL-List     OPTIONAL
}

RadioBearerRelease-r3-r4-ext-IEs ::= SEQUENCE {
-- Physical channel IEs
-- The following IE extends SSdT-Information, which is included in
-- DL-CommonInformation. FDD only.
ssdt-UL                       SSdT-UL-r4                       OPTIONAL
}

RadioBearerRelease-r4-IEs ::= SEQUENCE {
-- User equipment IEs
integrityProtectionModeInfo   IntegrityProtectionModeInfo   OPTIONAL,
cipheringModeInfo             CipheringModeInfo             OPTIONAL,
activationTime                 ActivationTime                 OPTIONAL,
new-U-RNTI                    U-RNTI                       OPTIONAL,
new-C-RNTI                    C-RNTI                       OPTIONAL,
rrc-StateIndicator            RRC-StateIndicator,
utran-DRX-CycleLengthCoeff    UTRAN-DRX-CycleLengthCoefficient OPTIONAL,
-- Core network IEs
cn-InformationInfo            CN-InformationInfo            OPTIONAL,
signallingConnectionRelIndication CN-DomainIdentity            OPTIONAL,
}

```

```

-- UTRAN mobility IEs
  ura-Identity          URA-Identity          OPTIONAL,
-- Radio bearer IEs
  rab-InformationReconfList  RAB-InformationReconfList  OPTIONAL,
  rb-InformationReleaseList  RB-InformationReleaseList,
  rb-InformationAffectedList  RB-InformationAffectedList  OPTIONAL,
  rb-WithPDCP-InfoList      RB-WithPDCP-InfoList      OPTIONAL,
-- Transport channel IEs
  ul-CommonTransChInfo      UL-CommonTransChInfo      OPTIONAL,
  ul-deletedTransChInfoList  UL-DeletedTransChInfoList  OPTIONAL,
  ul-AddReconfTransChInfoList  UL-AddReconfTransChInfoList  OPTIONAL,
  modeSpecificTransChInfo    CHOICE {
    fdd                      SEQUENCE {
      cpch-SetID            CPCH-SetID            OPTIONAL,
      addReconfTransChDRAC-Info  DRAC-StaticInformationList  OPTIONAL
    },
    tdd                      NULL
  }
  dl-CommonTransChInfo      DL-CommonTransChInfo-r4    OPTIONAL,
  dl-DeletedTransChInfoList  DL-DeletedTransChInfoList  OPTIONAL,
  dl-AddReconfTransChInfoList  DL-AddReconfTransChInfo2List  OPTIONAL,
-- Physical channel IEs
  frequencyInfo            FrequencyInfo            OPTIONAL,
  maxAllowedUL-TX-Power    MaxAllowedUL-TX-Power    OPTIONAL,
  ul-ChannelRequirement    UL-ChannelRequirement-r4  OPTIONAL,
  modeSpecificPhysChInfo    CHOICE {
    fdd                      SEQUENCE {
      dl-PDSCH-Information    DL-PDSCH-Information    OPTIONAL
    },
    tdd                      NULL
  },
  dl-CommonInformation      DL-CommonInformation-r4    OPTIONAL,
  dl-InformationPerRL-List  DL-InformationPerRL-List-r4  OPTIONAL
}

-- *****
--
-- RADIO BEARER RELEASE COMPLETE
--
-- *****

RadioBearerReleaseComplete ::= SEQUENCE {
-- User equipment IEs
  rrc-TransactionIdentifier  RRC-TransactionIdentifier,
  ul-IntegProtActivationInfo  IntegrityProtActivationInfo  OPTIONAL,
  -- TABULAR: UL-TimingAdvance is applicable for TDD mode only.
  ul-TimingAdvance          UL-TimingAdvance          OPTIONAL,
-- Radio bearer IEs
  count-C-ActivationTime    ActivationTime            OPTIONAL,
  rb-UL-CiphActivationTimeInfo  RB-ActivationTimeInfoList  OPTIONAL,
  ul-CounterSynchronisationInfo  UL-CounterSynchronisationInfo  OPTIONAL,
-- Extension mechanism for non- release99 information
  nonCriticalExtensions      SEQUENCE {}            OPTIONAL
}

-- *****
--
-- RADIO BEARER RELEASE FAILURE
--
-- *****

RadioBearerReleaseFailure ::= SEQUENCE {
-- User equipment IEs
  rrc-TransactionIdentifier  RRC-TransactionIdentifier,
  failureCause              FailureCauseWithProtErr,
-- Radio bearer IEs
  potentiallySuccessfulBearerList  RB-IdentityList          OPTIONAL,
-- Extension mechanism for non- release99 information
  nonCriticalExtensions      SEQUENCE {}            OPTIONAL
}

-- *****
--
-- RADIO BEARER SETUP
--
-- *****

RadioBearerSetup ::= CHOICE {

```

```

r3
  radioBearerSetup-r3          SEQUENCE {
    nonCriticalExtensions      RadioBearerSetup-r3-IEs,
    radioBearerSetup-r3-r4-ext SEQUENCE {
      nonCriticalExtensions   RadioBearerSetup-r3-r4-ext-IEs,
    } OPTIONAL
  },
  later-than-r3               SEQUENCE {
    rrc-TransactionIdentifier  RRC-TransactionIdentifier,
    criticalExtensions         CHOICE {
      r4                       SEQUENCE {
        radioBearerSetup-r4    RadioBearerSetup-r4-IEs,
        nonCriticalExtensions   SEQUENCE {} OPTIONAL
      },
      criticalExtensions       SEQUENCE {}
    }
  }
}

RadioBearerSetup-r3-IEs ::= SEQUENCE {
  -- User equipment IEs
  rrc-TransactionIdentifier      RRC-TransactionIdentifier,
  integrityProtectionModeInfo   IntegrityProtectionModeInfo   OPTIONAL,
  cipheringModeInfo             CipheringModeInfo                 OPTIONAL,
  activationTime                 ActivationTime                     OPTIONAL,
  new-U-RNTI                     U-RNTI                             OPTIONAL,
  new-C-RNTI                     C-RNTI                             OPTIONAL,
  rrc-StateIndicator            RRC-StateIndicator,
  utran-DRX-CycleLengthCoeff    UTRAN-DRX-CycleLengthCoefficient OPTIONAL,
  -- UTRAN mobility IEs
  ura-Identity                   URA-Identity                       OPTIONAL,
  -- Core network IEs
  cn-InformationInfo            CN-InformationInfo                 OPTIONAL,
  -- Radio bearer IEs
  srb-InformationSetupList      SRB-InformationSetupList     OPTIONAL,
  rab-InformationSetupList      RAB-InformationSetupList     OPTIONAL,
  rb-InformationAffectedList    RB-InformationAffectedList   OPTIONAL,
  dl-CounterSynchronisationInfo DL-CounterSynchronisationInfo OPTIONAL,
  -- Transport channel IEs
  ul-CommonTransChInfo         UL-CommonTransChInfo         OPTIONAL,
  ul-deletedTransChInfoList     UL-DeletedTransChInfoList     OPTIONAL,
  ul-AddReconfTransChInfoList  UL-AddReconfTransChInfoList  OPTIONAL,
  modeSpecificTransChInfo      CHOICE {
    fdd                         SEQUENCE {
      cpch-SetID               CPCH-SetID                 OPTIONAL,
      addReconfTransChDRAC-Info DRAC-StaticInformationList OPTIONAL
    },
    tdd                         NULL
  } OPTIONAL,
  dl-CommonTransChInfo         DL-CommonTransChInfo         OPTIONAL,
  dl-DeletedTransChInfoList     DL-DeletedTransChInfoList     OPTIONAL,
  dl-AddReconfTransChInfoList  DL-AddReconfTransChInfoList  OPTIONAL,
  -- Physical channel IEs
  frequencyInfo                 FrequencyInfo                     OPTIONAL,
  maxAllowedUL-TX-Power         MaxAllowedUL-TX-Power         OPTIONAL,
  ul-ChannelRequirement         UL-ChannelRequirement         OPTIONAL,
  modeSpecificPhysChInfo       CHOICE {
    fdd                         SEQUENCE {
      dl-PDSCH-Information     DL-PDSCH-Information     OPTIONAL
    },
    tdd                         NULL
  },
  dl-CommonInformation         DL-CommonInformation         OPTIONAL,
  dl-InformationPerRL-List     DL-InformationPerRL-List     OPTIONAL
}

RadioBearerSetup-r3-r4-ext-IEs ::= SEQUENCE {
  -- Physical channel IEs
  -- The following IE extends SSDT-Information, which is included in
  -- DL-CommonInformation. FDD only.
  ssdt-UL                       SSDT-UL-r4                       OPTIONAL
}

RadioBearerSetup-r4-IEs ::= SEQUENCE {
  -- User equipment IEs
  integrityProtectionModeInfo   IntegrityProtectionModeInfo   OPTIONAL,
  cipheringModeInfo             CipheringModeInfo                 OPTIONAL,
  activationTime                 ActivationTime                     OPTIONAL,

```

```

    new-U-RNTI                U-RNTI                OPTIONAL,
    new-C-RNTI                C-RNTI                OPTIONAL,
    rrc-StateIndicator        RRC-StateIndicator,
    utran-DRX-CycleLengthCoeff  UTRAN-DRX-CycleLengthCoefficient  OPTIONAL,
-- UTRAN mobility IEs
    ura-Identity              URA-Identity              OPTIONAL,
-- Core network IEs
    cn-InformationInfo        CN-InformationInfo        OPTIONAL,
-- Radio bearer IEs
    srb-InformationSetupList  SRB-InformationSetupList  OPTIONAL,
    rab-InformationSetupList  RAB-InformationSetupList-r4  OPTIONAL,
    rb-InformationAffectedList  RB-InformationAffectedList  OPTIONAL,
-- Transport channel IEs
    ul-CommonTransChInfo      UL-CommonTransChInfo      OPTIONAL,
    ul-deletedTransChInfoList  UL-DeletedTransChInfoList  OPTIONAL,
    ul-AddReconfTransChInfoList  UL-AddReconfTransChInfoList  OPTIONAL,
    modeSpecificTransChInfo     CHOICE {
        fdd                    SEQUENCE {
            cpch-SetID          CPCH-SetID          OPTIONAL,
            addReconfTransChDRAC-Info  DRAC-StaticInformationList  OPTIONAL
        },
        tdd                    NULL
    }
    dl-CommonTransChInfo      DL-CommonTransChInfo-r4    OPTIONAL,
    dl-DeletedTransChInfoList  DL-DeletedTransChInfoList  OPTIONAL,
    dl-AddReconfTransChInfoList  DL-AddReconfTransChInfoList  OPTIONAL,
-- Physical channel IEs
    frequencyInfo             FrequencyInfo             OPTIONAL,
    maxAllowedUL-TX-Power      MaxAllowedUL-TX-Power     OPTIONAL,
    ul-ChannelRequirement      UL-ChannelRequirement-r4  OPTIONAL,
    modeSpecificPhysChInfo     CHOICE {
        fdd                    SEQUENCE {
            dl-PDSCH-Information  DL-PDSCH-Information  OPTIONAL
        },
        tdd                    NULL
    },
    dl-CommonInformation       DL-CommonInformation-r4    OPTIONAL,
    dl-InformationPerRL-List   DL-InformationPerRL-List-r4  OPTIONAL
}

-- *****
--
-- RADIO BEARER SETUP COMPLETE
--
-- *****

RadioBearerSetupComplete ::= SEQUENCE {
-- User equipment IEs
    rrc-TransactionIdentifier  RRC-TransactionIdentifier,
    ul-IntegProtActivationInfo  IntegrityProtActivationInfo  OPTIONAL,
-- TABULAR: UL-TimingAdvance is applicable for TDD mode only.
    ul-TimingAdvance           UL-TimingAdvance           OPTIONAL,
    start-Value                 START-Value                 OPTIONAL,
-- Radio bearer IEs
    count-C-ActivationTime      ActivationTime              OPTIONAL,
    rb-UL-CiphActivationTimeInfo  RB-ActivationTimeInfoList  OPTIONAL,
    ul-CounterSynchronisationInfo  UL-CounterSynchronisationInfo  OPTIONAL,
-- Extension mechanism for non- release99 information
    nonCriticalExtensions        SEQUENCE {}                OPTIONAL
}

-- *****
--
-- RADIO BEARER SETUP FAILURE
--
-- *****

RadioBearerSetupFailure ::= SEQUENCE {
-- User equipment IEs
    rrc-TransactionIdentifier  RRC-TransactionIdentifier,
    failureCause               FailureCauseWithProtErr,
-- Radio bearer IEs
    potentiallySuccessfulBearerList  RB-IdentityList            OPTIONAL,
-- Extension mechanism for non- release99 information
    nonCriticalExtensions        SEQUENCE {}                OPTIONAL
}

-- *****

```

```

--
-- RRC CONNECTION REJECT
--
-- *****

RRCCConnectionReject ::= CHOICE {
    r3
        rrcConnectionReject-r3
        nonCriticalExtensions
    },
    later-than-r3
        initialUE-Identity
        rrc-TransactionIdentifier
        criticalExtensions
}

RRCCConnectionReject-r3-IEs ::= SEQUENCE {
    -- TABULAR: Integrity protection shall not be performed on this message.
    -- User equipment IEs
    initialUE-Identity
    rrc-TransactionIdentifier
    rejectionCause
    waitTime
    redirectionInfo
}

-- *****
--
-- RRC CONNECTION RELEASE
--
-- *****

RRCCConnectionRelease ::= CHOICE {
    r3
        rrcConnectionRelease-r3
        nonCriticalExtensions
    },
    later-than-r3
        rrc-TransactionIdentifier
        criticalExtensions
        r4
            rrcConnectionRelease-r4
            nonCriticalExtensions
        },
        criticalExtensions
}

RRCCConnectionRelease-r3-IEs ::= SEQUENCE {
    -- User equipment IEs
    rrc-TransactionIdentifier
    n-308
    -- The IE above is conditional on the UE state.
    releaseCause
    rplmn-information
}

RRCCConnectionRelease-r4-IEs ::= SEQUENCE {
    -- User equipment IEs
    n-308
    -- The IE above is conditional on the UE state.
    releaseCause
    rplmn-information
}

-- *****
--
-- RRC CONNECTION RELEASE for CCCH
--
-- *****

RRCCConnectionRelease-CCCH ::= CHOICE {
    r3
        rrcConnectionRelease-CCCH-r3
        nonCriticalExtensions
    },
}

```

```

later-than-r3          SEQUENCE {
  u-RNTI                U-RNTI,
  rrc-TransactionIdentifier RRC-TransactionIdentifier,
  criticalExtensions     CHOICE {
    r4                   SEQUENCE {
      rrcConnectionRelease-CCCH-r4 RRCConnectionRelease-CCCH-r4-IEs,
      nonCriticalExtensions         SEQUENCE {} OPTIONAL
    },
    criticalExtensions             SEQUENCE {}
  }
}
}

RRCConnectionRelease-CCCH-r3-IEs ::= SEQUENCE {
  -- User equipment IES
  u-RNTI                U-RNTI,
  -- The rest of the message is identical to the one sent on DCCH.
  rrcConnectionRelease RRCConnectionRelease-r3-IEs
}

RRCConnectionRelease-CCCH-r4-IEs ::= SEQUENCE {
  -- The rest of the message is identical to the one sent on DCCH.
  rrcConnectionRelease RRCConnectionRelease-r4-IEs
}

-- *****
--
-- RRC CONNECTION RELEASE COMPLETE
--
-- *****

RRCConnectionReleaseComplete ::= SEQUENCE {
  -- User equipment IES
  rrc-TransactionIdentifier RRC-TransactionIdentifier,
  errorIndication           FailureCauseWithProtErr           OPTIONAL,
  -- Extension mechanism for non- release99 information
  nonCriticalExtensions     SEQUENCE {} OPTIONAL
}

-- *****
--
-- RRC CONNECTION REQUEST
--
-- *****

RRCConnectionRequest ::= SEQUENCE {
  -- TABULAR: Integrity protection shall not be performed on this message.
  -- User equipment IES
  initialUE-Identity        InitialUE-Identity,
  establishmentCause        EstablishmentCause,
  protocolErrorIndicator    ProtocolErrorIndicator,
  -- The IE above is MD, but for compactness reasons no default value
  -- has been assigned to it.
  -- Measurement IES
  measuredResultsOnRACH     MeasuredResultsOnRACH           OPTIONAL,
  -- Extension mechanism for non- release99 information
  nonCriticalExtensions     SEQUENCE {} OPTIONAL
}

-- *****
--
-- RRC CONNECTION SETUP
--
-- *****

RRCConnectionSetup ::= CHOICE {
  r3                   SEQUENCE {
    rrcConnectionSetup-r3 RRCConnectionSetup-r3-IEs,
    nonCriticalExtensions SEQUENCE {
      rrcConnectionSetup-r3-r4-ext RRCConnectionSetup-r3-r4-ext-IEs,
      -- Extension mechanism for non- release99 information
      nonCriticalExtensions         SEQUENCE {} OPTIONAL
    } OPTIONAL
  },
  later-than-r3       SEQUENCE {
    initialUE-Identity        InitialUE-Identity,
    rrc-TransactionIdentifier RRC-TransactionIdentifier,
    criticalExtensions        CHOICE {

```



```

    r4
      rrcConnectionSetup-r4          SEQUENCE {
        nonCriticalExtensions        RRCConnectionSetup-r4-IEs,
                                     SEQUENCE {} OPTIONAL
      },
      criticalExtensions              SEQUENCE {}
    }
  }
}

RRCConnectionSetup-r3-IEs ::= SEQUENCE {
  -- TABULAR: Integrity protection shall not be performed on this message.
  -- User equipment IEs
  initialUE-Identity                InitialUE-Identity,
  rrc-TransactionIdentifier          RRC-TransactionIdentifier,
  activationTime                     ActivationTime                OPTIONAL,
  new-U-RNTI                        U-RNTI,
  new-c-RNTI                        C-RNTI                    OPTIONAL,
  rrc-StateIndicator                RRC-StateIndicator,
  utran-DRX-CycleLengthCoeff        UTRAN-DRX-CycleLengthCoefficient,
  capabilityUpdateRequirement        CapabilityUpdateRequirement  OPTIONAL,
  -- TABULAR: If the IE is not present, the default value defined in 10.3.3.2 shall
  -- be used.
  -- Radio bearer IEs
  srb-InformationSetupList           SRB-InformationSetupList2,
  -- Transport channel IEs
  ul-CommonTransChInfo              UL-CommonTransChInfo        OPTIONAL,
  ul-AddReconfTransChInfoList       UL-AddReconfTransChInfoList,
  -- NOTE: IE ul-AddReconfTransChInfoList should be optional in later versions of this message
  dl-CommonTransChInfo              DL-CommonTransChInfo        OPTIONAL,
  dl-AddReconfTransChInfoList       DL-AddReconfTransChInfoList,
  -- NOTE: IE dl-AddReconfTransChInfoList should be optional in later versions of this message
  -- Physical channel IEs
  frequencyInfo                     FrequencyInfo                OPTIONAL,
  maxAllowedUL-TX-Power              MaxAllowedUL-TX-Power      OPTIONAL,
  ul-ChannelRequirement              UL-ChannelRequirement      OPTIONAL,
  dl-CommonInformation               DL-CommonInformation        OPTIONAL,
  dl-InformationPerRL-List           DL-InformationPerRL-List   OPTIONAL
}

RRCConnectionSetup-r3-r4-ext-IEs ::= SEQUENCE {
  capabilityUpdateRequirement-r4-ext CapabilityUpdateRequirement-r4-ext  OPTIONAL,
  -- Physical channel IEs
  -- The following IE extends SSDT-Information, which is included in
  -- DL-CommonInformation. FDD only.
  ssdt-UL                            SSDT-UL-r4                    OPTIONAL
}

RRCConnectionSetup-r4-IEs ::= SEQUENCE {
  -- TABULAR: Integrity protection shall not be performed on this message.
  activationTime                     ActivationTime                OPTIONAL,
  new-U-RNTI                        U-RNTI,
  new-c-RNTI                        C-RNTI                    OPTIONAL,
  rrc-StateIndicator                RRC-StateIndicator,
  utran-DRX-CycleLengthCoeff        UTRAN-DRX-CycleLengthCoefficient,
  capabilityUpdateRequirement        CapabilityUpdateRequirement-r4  OPTIONAL,
  -- TABULAR: If the IE is not present, the default value defined in 10.3.3.2 shall
  -- be used.
  -- Radio bearer IEs
  srb-InformationSetupList           SRB-InformationSetupList2,
  -- Transport channel IEs
  ul-CommonTransChInfo              UL-CommonTransChInfo        OPTIONAL,
  ul-AddReconfTransChInfoList       UL-AddReconfTransChInfoList  OPTIONAL,
  dl-CommonTransChInfo              DL-CommonTransChInfo-r4      OPTIONAL,
  dl-AddReconfTransChInfoList       DL-AddReconfTransChInfoList  OPTIONAL,
  -- Physical channel IEs
  frequencyInfo                     FrequencyInfo                OPTIONAL,
  maxAllowedUL-TX-Power              MaxAllowedUL-TX-Power      OPTIONAL,
  ul-ChannelRequirement              UL-ChannelRequirement-r4    OPTIONAL,
  dl-CommonInformation               DL-CommonInformation-r4     OPTIONAL,
  dl-InformationPerRL-List           DL-InformationPerRL-List-r4  OPTIONAL
}

-- *****
--
-- RRC CONNECTION SETUP COMPLETE
--
-- *****

```

```

RRCConnectionSetupComplete ::= SEQUENCE {
  -- TABULAR: Integrity protection shall not be performed on this message.
  -- User equipment IEs
  rrc-TransactionIdentifier      RRC-TransactionIdentifier,
  startList                      STARTList,
  ue-RadioAccessCapability      UE-RadioAccessCapability          OPTIONAL,
  -- Other IEs
  ue-RATSpecificCapability      InterRAT-UE-RadioAccessCapabilityList  OPTIONAL,
  -- Non critical extensions
  v370NonCriticalExtensions      SEQUENCE {
    rrcConnectionSetupComplete-v370ext  RRCConnectionSetupComplete-v370ext,
    -- Reserved for future non critical extension
    v4NonCriticalExtensions          SEQUENCE {
      rrcConnectionSetupComplete-r3-r4-ext
      nonCriticalExtensions-r4      SEQUENCE {}          OPTIONAL
    }
  }
  OPTIONAL
}

RRCConnectionSetupComplete-v370ext ::= SEQUENCE {
  -- User equipment IEs
  ue-RadioAccessCapability-v370ext  UE-RadioAccessCapability-v370ext  OPTIONAL
}

RRCConnectionSetupComplete-r3-r4-ext-IEs ::= SEQUENCE {
  -- User equipment IEs
  ue-RadioAccessCapability-r4-ext  UE-RadioAccessCapability-r4-ext  OPTIONAL
}

-- *****
--
-- RRC STATUS
--
-- *****

RRCStatus ::= SEQUENCE {
  -- Other IEs
  protocolErrorInformation      ProtocolErrorMoreInformation,
  -- TABULAR: Identification of received message is nested in
  -- ProtocolErrorMoreInformation
  -- Extension mechanism for non- release99 information
  nonCriticalExtensions          SEQUENCE {}          OPTIONAL
}

SecurityModeCommand ::= CHOICE {
  r3                              SEQUENCE {
    securityModeCommand-r3      SecurityModeCommand-r3-IEs,
    nonCriticalExtensions        SEQUENCE {}          OPTIONAL
  },
  later-than-r3                  SEQUENCE {
    rrc-TransactionIdentifier    RRC-TransactionIdentifier,
    criticalExtensions           SEQUENCE {}
  }
}

-- *****
--
-- SECURITY MODE COMMAND
--
-- *****

SecurityModeCommand-r3-IEs ::= SEQUENCE {
  -- TABULAR: Integrity protection shall always be performed on this message.
  -- User equipment IEs
  rrc-TransactionIdentifier      RRC-TransactionIdentifier,
  securityCapability             SecurityCapability,
  cipheringModeInfo             CipheringModeInfo          OPTIONAL,
  integrityProtectionModeInfo    IntegrityProtectionModeInfo  OPTIONAL,
  -- Core network IEs
  cn-DomainIdentity             CN-DomainIdentity,
  -- Other IEs
  ue-SystemSpecificSecurityCap  InterRAT-UE-SecurityCapList  OPTIONAL
}

-- *****
--
-- SECURITY MODE COMPLETE

```

```

--
-- *****
SecurityModeComplete ::= SEQUENCE {
-- TABULAR: Integrity protection shall always be performed on this message.
    -- User equipment IEs
    rrc-TransactionIdentifier      RRC-TransactionIdentifier,
    ul-IntegProtActivationInfo     IntegrityProtActivationInfo      OPTIONAL,
    -- Radio bearer IEs
    rb-UL-CiphActivationTimeInfo   RB-ActivationTimeInfoList        OPTIONAL,
    -- Extension mechanism for non- release99 information
    nonCriticalExtensions           SEQUENCE {}          OPTIONAL
}
-- *****
--
-- SECURITY MODE FAILURE
--
-- *****

SecurityModeFailure ::= SEQUENCE {
    -- User equipment IEs
    rrc-TransactionIdentifier      RRC-TransactionIdentifier,
    failureCause                   FailureCauseWithProtErr,
    -- Extension mechanism for non- release99 information
    nonCriticalExtensions           SEQUENCE {}          OPTIONAL
}
-- *****
--
-- SIGNALLING CONNECTION RELEASE
--
-- *****

SignallingConnectionRelease ::= CHOICE {
    r3                             SEQUENCE {
        signallingConnectionRelease-r3 SignallingConnectionRelease-r3-IEs,
        nonCriticalExtensions           SEQUENCE {}          OPTIONAL
    },
    later-than-r3                   SEQUENCE {
        rrc-TransactionIdentifier      RRC-TransactionIdentifier,
        criticalExtensions              SEQUENCE {}
    }
}

SignallingConnectionRelease-r3-IEs ::= SEQUENCE {
    -- User equipment IEs
    rrc-TransactionIdentifier      RRC-TransactionIdentifier,
    -- Core network IEs
    cn-DomainIdentity              CN-DomainIdentity
}
-- *****
--
-- SIGNALLING CONNECTION RELEASE REQUEST
--
-- *****

SignallingConnectionReleaseRequest ::= SEQUENCE {
    -- Core network IEs
    cn-DomainIdentity              CN-DomainIdentity,
    -- Extension mechanism for non- release99 information
    nonCriticalExtensions           SEQUENCE {}          OPTIONAL
}
-- *****
--
-- SYSTEM INFORMATION for BCH
--
-- *****

SystemInformation-BCH ::= SEQUENCE {
    -- Other information elements
    sfn-Prime                       SFN-Prime,
    payload                          CHOICE {
        noSegment                     NULL,
        firstSegment                   FirstSegment,
}

```

```

subsequentSegment          SubsequentSegment,
lastSegmentShort           LastSegmentShort,
lastAndFirst               SEQUENCE {
    lastSegmentShort       LastSegmentShort,
    firstSegment           FirstSegmentShort
},
lastAndComplete            SEQUENCE {
    lastSegmentShort       LastSegmentShort,
    completeSIB-List       CompleteSIB-List
},
lastAndCompleteAndFirst   SEQUENCE {
    lastSegmentShort       LastSegmentShort,
    completeSIB-List       CompleteSIB-List,
    firstSegment           FirstSegmentShort
},
completeSIB-List          CompleteSIB-List,
completeAndFirst          SEQUENCE {
    completeSIB-List       CompleteSIB-List,
    firstSegment           FirstSegmentShort
},
completeSIB                CompleteSIB,
lastSegment                LastSegment
}

```

```

-- *****
--
-- SYSTEM INFORMATION for FACH
--
-- *****

```

```

SystemInformation-FACH ::= SEQUENCE {
    -- Other information elements
    payload                CHOICE {
        noSegment           NULL,
        firstSegment        FirstSegment,
        subsequentSegment   SubsequentSegment,
        lastSegmentShort    LastSegmentShort,
        lastAndFirst        SEQUENCE {
            lastSegmentShort LastSegmentShort,
            firstSegment      FirstSegmentShort
        },
        lastAndComplete     SEQUENCE {
            lastSegmentShort LastSegmentShort,
            completeSIB-List CompleteSIB-List
        },
        lastAndCompleteAndFirst SEQUENCE {
            lastSegmentShort LastSegmentShort,
            completeSIB-List CompleteSIB-List,
            firstSegment      FirstSegmentShort
        },
        completeSIB-List    CompleteSIB-List,
        completeAndFirst    SEQUENCE {
            completeSIB-List CompleteSIB-List,
            firstSegment      FirstSegmentShort
        },
        completeSIB         CompleteSIB,
        lastSegment         LastSegment
    }
}

```

```

-- *****
--
-- First segment
--
-- *****

```

```

FirstSegment ::= SEQUENCE {
    -- Other information elements
    sib-Type          SIB-Type,
    seg-Count         SegCount,
    sib-Data-fixed    SIB-Data-fixed
}

```

```

-- *****
--
-- First segment (short)
--

```

```

-- *****
FirstSegmentShort ::=                               SEQUENCE {
  -- Other information elements
  sib-Type                SIB-Type,
  seg-Count               SegCount,
  sib-Data-variable      SIB-Data-variable
}
-- *****
--
-- Subsequent segment
--
-- *****

SubsequentSegment ::=                               SEQUENCE {
  -- Other information elements
  sib-Type                SIB-Type,
  segmentIndex           SegmentIndex,
  sib-Data-fixed         SIB-Data-fixed
}
-- *****
--
-- Last segment
--
-- *****

LastSegment ::=                                     SEQUENCE {
  -- Other information elements
  sib-Type                SIB-Type,
  segmentIndex           SegmentIndex,
  sib-Data-fixed         SIB-Data-fixed
  -- In case the SIB data is less than 222 bits, padding shall be used
  -- The same padding bits shall be used as defined in clause 12.1
}
-- *****

LastSegmentShort ::=                               SEQUENCE {
  -- Other information elements
  sib-Type                SIB-Type,
  segmentIndex           SegmentIndex,
  sib-Data-variable      SIB-Data-variable
}
-- *****
--
-- Complete SIB
--
-- *****

CompleteSIB-List ::=                               SEQUENCE (SIZE (1..maxSIBperMsg)) OF
  CompleteSIBshort

CompleteSIB ::=                                     SEQUENCE {
  -- Other information elements
  sib-Type                SIB-Type,
  sib-Data-fixed         BIT STRING (SIZE (226))
  -- In case the SIB data is less than 226 bits, padding shall be used
  -- The same padding bits shall be used as defined in clause 12.1
}
-- *****

CompleteSIBshort ::=                               SEQUENCE {
  -- Other information elements
  sib-Type                SIB-Type,
  sib-Data-variable      SIB-Data-variable
}
-- *****
--
-- SYSTEM INFORMATION CHANGE INDICATION
--
-- *****

SystemInformationChangeIndication ::=              SEQUENCE {
  -- Other IEs
  bcch-ModificationInfo  BCCH-ModificationInfo,
  -- Extension mechanism for non- release99 information
  nonCriticalExtensions  SEQUENCE {} OPTIONAL
}

```

```

}
-- *****
--
-- TRANSPORT CHANNEL RECONFIGURATION
--
-- *****

TransportChannelReconfiguration ::= CHOICE {
  r3 SEQUENCE {
    transportChannelReconfiguration-r3
    nonCriticalExtensions SEQUENCE {
      transportChannelReconfiguration-r3-r4-ext
      nonCriticalExtensions SEQUENCE {} OPTIONAL
    } OPTIONAL
  },
  later-than-r3 SEQUENCE {
    rrc-TransactionIdentifier RRC-TransactionIdentifier,
    criticalExtensions CHOICE {
      r4 SEQUENCE {
        transportChannelReconfiguration-r4
        nonCriticalExtensions SEQUENCE {} OPTIONAL
      },
      criticalExtensions SEQUENCE {}
    }
  }
}

TransportChannelReconfiguration-r3-IEs ::= SEQUENCE {
  -- User equipment IEs
  rrc-TransactionIdentifier RRC-TransactionIdentifier,
  integrityProtectionModeInfo IntegrityProtectionModeInfo OPTIONAL,
  cipheringModeInfo CipheringModeInfo OPTIONAL,
  activationTime ActivationTime OPTIONAL,
  new-U-RNTI U-RNTI OPTIONAL,
  new-C-RNTI C-RNTI OPTIONAL,
  rrc-StateIndicator RRC-StateIndicator,
  utran-DRX-CycleLengthCoeff UTRAN-DRX-CycleLengthCoefficient OPTIONAL,
  -- Core network IEs
  cn-InformationInfo CN-InformationInfo OPTIONAL,
  -- UTRAN mobility IEs
  ura-Identity URA-Identity OPTIONAL,
  -- Radio bearer IEs
  dl-CounterSynchronisationInfo DL-CounterSynchronisationInfo OPTIONAL,
  -- Transport channel IEs
  ul-CommonTransChInfo UL-CommonTransChInfo OPTIONAL,
  ul-AddReconfTransChInfoList UL-AddReconfTransChInfoList OPTIONAL,
  modeSpecificTransChInfo CHOICE {
    fdd SEQUENCE {
      cpch-SetID CPCH-SetID OPTIONAL,
      addReconfTransChDRAC-Info DRAC-StaticInformationList OPTIONAL
    },
    tdd NULL
  } OPTIONAL,
  dl-CommonTransChInfo DL-CommonTransChInfo OPTIONAL,
  dl-AddReconfTransChInfoList DL-AddReconfTransChInfoList OPTIONAL,
  -- Physical channel IEs
  frequencyInfo FrequencyInfo OPTIONAL,
  maxAllowedUL-TX-Power MaxAllowedUL-TX-Power OPTIONAL,
  ul-ChannelRequirement UL-ChannelRequirement OPTIONAL,
  modeSpecificPhysChInfo CHOICE {
    fdd SEQUENCE {
      dl-PDSCH-Information DL-PDSCH-Information OPTIONAL
    },
    tdd NULL
  },
  dl-CommonInformation DL-CommonInformation OPTIONAL,
  dl-InformationPerRL-List DL-InformationPerRL-List OPTIONAL
}

TransportChannelReconfiguration-r3-r4-ext-IEs ::= SEQUENCE {
  -- Physical channel IEs
  -- The following IE extends SSdT-Information, which is included in
  -- DL-CommonInformation. FDD only.
  ssdt-UL SSdT-UL-r4 OPTIONAL
}

```

```

}
TransportChannelReconfiguration-r4-IEs ::= SEQUENCE {
  -- User equipment IEs
  integrityProtectionModeInfo    IntegrityProtectionModeInfo    OPTIONAL,
  cipheringModeInfo              CipheringModeInfo                OPTIONAL,
  activationTime                  ActivationTime                    OPTIONAL,
  new-U-RNTI                      U-RNTI                          OPTIONAL,
  new-C-RNTI                      C-RNTI                          OPTIONAL,
  rrc-StateIndicator              RRC-StateIndicator,
  utran-DRX-CycleLengthCoeff      UTRAN-DRX-CycleLengthCoefficient OPTIONAL,
  -- Core network IEs
  cn-InformationInfo              CN-InformationInfo              OPTIONAL,
  -- UTRAN mobility IEs
  ura-Identity                    URA-Identity                    OPTIONAL,
  -- Radio bearer IEs
  rb-WithPDCP-InfoList           RB-WithPDCP-InfoList           OPTIONAL,
  -- Transport channel IEs
  ul-CommonTransChInfo           UL-CommonTransChInfo           OPTIONAL,
  ul-AddReconfTransChInfoList    UL-AddReconfTransChInfoList    OPTIONAL,
  modeSpecificTransChInfo        CHOICE {
    fdd                            SEQUENCE {
      cpch-SetID                  CPCH-SetID                      OPTIONAL,
      addReconfTransChDRAC-Info   DRAC-StaticInformationList      OPTIONAL
    },
    tdd                            NULL
  }
  dl-CommonTransChInfo           DL-CommonTransChInfo-r4        OPTIONAL,
  dl-AddReconfTransChInfoList    DL-AddReconfTransChInfoList    OPTIONAL,
  -- Physical channel IEs
  frequencyInfo                  FrequencyInfo                    OPTIONAL,
  maxAllowedUL-TX-Power           MaxAllowedUL-TX-Power           OPTIONAL,
  ul-ChannelRequirement           UL-ChannelRequirement-r4        OPTIONAL,
  modeSpecificPhysChInfo         CHOICE {
    fdd                            SEQUENCE {
      dl-PDSCH-Information        DL-PDSCH-Information            OPTIONAL
    },
    tdd                            NULL
  },
  dl-CommonInformation           DL-CommonInformation-r4        OPTIONAL,
  dl-InformationPerRL-List       DL-InformationPerRL-List-r4    OPTIONAL
}

```

```

-- *****
--
-- TRANSPORT CHANNEL RECONFIGURATION COMPLETE
--
-- *****

```

```

TransportChannelReconfigurationComplete ::= SEQUENCE {
  -- User equipment IEs
  rrc-TransactionIdentifier       RRC-TransactionIdentifier,
  ul-IntegProtActivationInfo      IntegrityProtActivationInfo      OPTIONAL,
  -- TABULAR: UL-TimingAdvance is applicable for TDD mode only.
  ul-TimingAdvance                UL-TimingAdvance                OPTIONAL,
  -- Radio bearer IEs
  count-C-ActivationTime          ActivationTime                    OPTIONAL,
  rb-UL-CiphActivationTimeInfo    RB-ActivationTimeInfoList        OPTIONAL,
  ul-CounterSynchronisationInfo  UL-CounterSynchronisationInfo   OPTIONAL,
  -- Extension mechanism for non- release99 information
  nonCriticalExtensions           SEQUENCE {}                      OPTIONAL
}

```

```

-- *****
--
-- TRANSPORT CHANNEL RECONFIGURATION FAILURE
--
-- *****

```

```

TransportChannelReconfigurationFailure ::= SEQUENCE {
  -- User equipment IEs
  rrc-TransactionIdentifier       RRC-TransactionIdentifier,
  failureCause                    FailureCauseWithProtErr,
  -- Extension mechanism for non- release99 information
  nonCriticalExtensions           SEQUENCE {}                      OPTIONAL
}

```

```

-- *****

```

```

--
-- TRANSPORT FORMAT COMBINATION CONTROL
--
-- *****

TransportFormatCombinationControl ::= SEQUENCE {
  -- TABULAR: Integrity protection shall not be performed on this message when transmitting this
  message
  -- on the transparent mode signalling DCCH.
  rrc-TransactionIdentifier      RRC-TransactionIdentifier      OPTIONAL,
  -- The information element is not included when transmitting the message
  -- on the transparent mode signalling DCCH
  modeSpecificInfo              CHOICE {
    fdd                          NULL,
    tdd                          SEQUENCE {
      tfcs-ID                    TFCS-Identity      OPTIONAL
    }
  },
  dpch-TFCS-InUplink            TFC-Subset,
  activationTimeForTFCSsubset   ActivationTime              OPTIONAL,
  tfc-ControlDuration           TFC-ControlDuration            OPTIONAL,
  -- The information element is not included when transmitting the message
  -- on the transparent mode signalling DCCH and is optional otherwise
  -- Extension mechanism for non- release99 information
  nonCriticalExtensions         SEQUENCE {}      OPTIONAL
}

-- *****
--
-- TRANSPORT FORMAT COMBINATION CONTROL FAILURE
--
-- *****

TransportFormatCombinationControlFailure ::= SEQUENCE {
  -- User equipment IEs
  rrc-TransactionIdentifier      RRC-TransactionIdentifier,
  failureCause                   FailureCauseWithProtErr,
  -- Extension mechanism for non- release99 information
  nonCriticalExtensions         SEQUENCE {}      OPTIONAL
}

-- *****
--
-- UE CAPABILITY ENQUIRY
--
-- *****

UECapabilityEnquiry ::= CHOICE {
  r3                             SEQUENCE {
    ueCapabilityEnquiry-r3       UECapabilityEnquiry-r3-IEs,
    nonCriticalExtensions        SEQUENCE {
      ueCapabilityEnquiry-r3-r4-ext UECapabilityEnquiry-r3-r4-ext-IEs,
      nonCriticalExtensions       SEQUENCE {}      OPTIONAL
    }
  },
  later-than-r3                 SEQUENCE {
    rrc-TransactionIdentifier     RRC-TransactionIdentifier,
    criticalExtensions            SEQUENCE {}
  }
}

UECapabilityEnquiry-r3-IEs ::= SEQUENCE {
  -- User equipment IEs
  rrc-TransactionIdentifier      RRC-TransactionIdentifier,
  capabilityUpdateRequirement   CapabilityUpdateRequirement
}

UECapabilityEnquiry-r3-r4-ext-IEs ::= SEQUENCE {
  capabilityUpdateRequirement-r4-ext CapabilityUpdateRequirement-r4-ext
}

-- *****
--
-- UE CAPABILITY INFORMATION
--
-- *****

UECapabilityInformation ::= SEQUENCE {

```



```

-- User equipment IEs
  rrc-TransactionIdentifier      RRC-TransactionIdentifier      OPTIONAL,
  ue-RadioAccessCapability      UE-RadioAccessCapability      OPTIONAL,
-- Other IEs
  ue-RATSpecificCapability      InterRAT-UE-RadioAccessCapabilityList
OPTIONAL,
  v370NonCriticalExtensions      SEQUENCE {
    ueCapabilityInformation-v370ext UECapabilityInformation-v370ext,
    -- Reserved for future non critical extension
    v4NonCriticalExtensions      SEQUENCE {
      ueCapabilityInformation-r3-r4-ext
      ueCapabilityInformation-r3-r4-ext,
      UECapabilityInformation-r3-r4-ext,
      nonCriticalExtensions-r4    SEQUENCE {}      OPTIONAL
    }
  }      OPTIONAL
}
}

UECapabilityInformation-v370ext ::= SEQUENCE {
  -- User equipment IEs
  ue-RadioAccessCapability-v370ext      UE-RadioAccessCapability-v370ext      OPTIONAL
}

UECapabilityInformation-r3-r4-ext ::= SEQUENCE {
  -- User equipment IEs
  ue-RadioAccessCapability-r4-ext      UE-RadioAccessCapability-r4-ext      OPTIONAL
}

-- *****
--
-- UE CAPABILITY INFORMATION CONFIRM
--
-- *****

UECapabilityInformationConfirm ::= CHOICE {
  r3      SEQUENCE {
    ueCapabilityInformationConfirm-r3
    UECapabilityInformationConfirm-r3-IEs,
    nonCriticalExtensions      SEQUENCE {}      OPTIONAL
  },
  later-than-r3      SEQUENCE {
    rrc-TransactionIdentifier      RRC-TransactionIdentifier,
    criticalExtensions      SEQUENCE {}
  }
}

UECapabilityInformationConfirm-r3-IEs ::= SEQUENCE {
  -- User equipment IEs
  rrc-TransactionIdentifier      RRC-TransactionIdentifier
}

-- *****
--
-- UPLINK DIRECT TRANSFER
--
-- *****

UplinkDirectTransfer ::= SEQUENCE {
  -- Core network IEs
  cn-DomainIdentity      CN-DomainIdentity,
  nas-Message      NAS-Message,
  -- Measurement IEs
  measuredResultsOnRACH      MeasuredResultsOnRACH      OPTIONAL,
  -- Extension mechanism for non- release99 information
  nonCriticalExtensions      SEQUENCE {}      OPTIONAL
}

-- *****
--
-- UPLINK PHYSICAL CHANNEL CONTROL
--
-- *****

UplinkPhysicalChannelControl ::= CHOICE {
  r3      SEQUENCE {
    uplinkPhysicalChannelControl-r3 UplinkPhysicalChannelControl-r3-IEs,
    nonCriticalExtensions      SEQUENCE {
      -- In case of TDD, the following IE is included instead of the IE
      -- up-IPDL-Parameters in up-OTDOA-AssistanceData
    }
  }
}

```

```

        openLoopPowerControl-IPDL-TDD  OpenLoopPowerControl-IPDL-TDD-r4  OPTIONAL,
        -- Extension mechanism for non- release4 information
        noncriticalExtensions          SEQUENCE {}                          OPTIONAL
    },
    later-than-r3                      SEQUENCE {
        rrc-TransactionIdentifier      RRC-TransactionIdentifier,
        criticalExtensions              CHOICE {
            r4                          SEQUENCE {
                uplinkPhysicalChannelControl-r4 UplinkPhysicalChannelControl-r4-IEs,
                nonCriticalExtensions          SEQUENCE {} OPTIONAL
            },
            criticalExtensions          SEQUENCE {}
        }
    }
}

UplinkPhysicalChannelControl-r3-IEs ::= SEQUENCE {
    -- User equipment IEs
    rrc-TransactionIdentifier      RRC-TransactionIdentifier,
    -- Physical channel IEs
    ccTrCH-PowerControlInfo      CCTrCH-PowerControlInfo          OPTIONAL,
    timingAdvance                 UL-TimingAdvanceControl        OPTIONAL,
    alpha                         Alpha                          OPTIONAL,
    specialBurstScheduling        SpecialBurstScheduling        OPTIONAL,
    prach-ConstantValue           ConstantValue                OPTIONAL,
    pusch-ConstantValue           ConstantValue                OPTIONAL
}

UplinkPhysicalChannelControl-r4-IEs ::= SEQUENCE {
    -- Physical channel IEs
    ccTrCH-PowerControlInfo      CCTrCH-PowerControlInfo-r4    OPTIONAL,
    tddOption                    CHOICE {
        tdd384                    SEQUENCE {
            timingAdvance          UL-TimingAdvanceControl-r4  OPTIONAL,
            alpha                  Alpha                          OPTIONAL,
            prach-ConstantValue     ConstantValue                OPTIONAL,
            pusch-ConstantValue     ConstantValue                OPTIONAL,
            openLoopPowerControl-IPDL-TDD  OpenLoopPowerControl-IPDL-TDD-r4  OPTIONAL
        },
        tdd128                    SEQUENCE {
            ul-SynchronisationParameters  UL-SynchronisationParameters-r4  OPTIONAL
        }
    }
}

-- *****
--
-- URA UPDATE
--
-- *****

URAUUpdate ::= SEQUENCE {
    -- User equipment IEs
    u-RNTI                        U-RNTI,
    ura-UpdateCause               URA-UpdateCause,
    protocolErrorIndicator        ProtocolErrorIndicatorWithMoreInfo,
    -- Extension mechanism for non- release99 information
    nonCriticalExtensions         SEQUENCE {}          OPTIONAL
}

-- *****
--
-- URA UPDATE CONFIRM
--
-- *****

URAUUpdateConfirm ::= CHOICE {
    r3                            SEQUENCE {
        uraUpdateConfirm-r3      URAUpdateConfirm-r3-IEs,
        nonCriticalExtensions     SEQUENCE {}          OPTIONAL
    },
    later-than-r3                SEQUENCE {
        rrc-TransactionIdentifier  RRC-TransactionIdentifier,
        criticalExtensions         SEQUENCE {}
    }
}

```

```

URAUUpdateConfirm-r3-IEs ::= SEQUENCE {
  -- User equipment IEs
  rrc-TransactionIdentifier      RRC-TransactionIdentifier,
  integrityProtectionModeInfo    IntegrityProtectionModeInfo    OPTIONAL,
  cipheringModeInfo              CipheringModeInfo                    OPTIONAL,
  new-U-RNTI                      U-RNTI                            OPTIONAL,
  new-C-RNTI                      C-RNTI                            OPTIONAL,
  rrc-StateIndicator              RRC-StateIndicator,
  utran-DRX-CycleLengthCoeff      UTRAN-DRX-CycleLengthCoefficient  OPTIONAL,
  -- CN information elements
  cn-InformationInfo              CN-InformationInfo                OPTIONAL,
  -- UTRAN mobility IEs
  ura-Identity                    URA-Identity                      OPTIONAL,
  -- Radio bearer IEs
  dl-CounterSynchronisationInfo  DL-CounterSynchronisationInfo    OPTIONAL
}

-- *****
--
-- URA UPDATE CONFIRM for CCCH
--
-- *****

URAUUpdateConfirm-CCCH ::= CHOICE {
  r3                               SEQUENCE {
    uraUpdateConfirm-CCCH-r3      URAUpdateConfirm-CCCH-r3-IEs,
    nonCriticalExtensions          SEQUENCE {}          OPTIONAL
  },
  later-than-r3                   SEQUENCE {
    u-RNTI                        U-RNTI,
    rrc-TransactionIdentifier      RRC-TransactionIdentifier,
    criticalExtensions             SEQUENCE {}
  }
}

URAUUpdateConfirm-CCCH-r3-IEs ::= SEQUENCE {
  -- User equipment IEs
  u-RNTI                          U-RNTI,
  -- The rest of the message is identical to the one sent on DCCH.
  uraUpdateConfirm                URAUpdateConfirm-r3-IEs
}

-- *****
--
-- UTRAN MOBILITY INFORMATION
--
-- *****

UTRANMobilityInformation ::= CHOICE {
  r3                               SEQUENCE {
    utranMobilityInformation-r3    UTRANMobilityInformation-r3-IEs,
    nonCriticalExtensions          SEQUENCE {}          OPTIONAL
  },
  later-than-r3                   SEQUENCE {
    rrc-TransactionIdentifier      RRC-TransactionIdentifier,
    criticalExtensions             SEQUENCE {}
  }
}

UTRANMobilityInformation-r3-IEs ::= SEQUENCE {
  -- User equipment IEs
  rrc-TransactionIdentifier      RRC-TransactionIdentifier,
  integrityProtectionModeInfo    IntegrityProtectionModeInfo    OPTIONAL,
  cipheringModeInfo              CipheringModeInfo                    OPTIONAL,
  new-U-RNTI                      U-RNTI                            OPTIONAL,
  new-C-RNTI                      C-RNTI                            OPTIONAL,
  ue-ConnTimersAndConstants      UE-ConnTimersAndConstants        OPTIONAL,
  -- CN information elements
  cn-InformationInfo              CN-InformationInfoFull            OPTIONAL,
  -- UTRAN mobility IEs
  ura-Identity                    URA-Identity                      OPTIONAL,
  -- Radio bearer IEs
  dl-CounterSynchronisationInfo  DL-CounterSynchronisationInfo    OPTIONAL,
  -- Extension mechanism for non- release99 information
  nonCriticalExtensions          SEQUENCE {}          OPTIONAL
}

-- *****

```

```

--
-- UTRAN MOBILITY INFORMATION CONFIRM
--
-- *****
UTRANMobilityInformationConfirm ::= SEQUENCE {
  -- User equipment IEs
  rrc-TransactionIdentifier      RRC-TransactionIdentifier,
  ul-IntegProtActivationInfo     IntegrityProtActivationInfo      OPTIONAL,
  -- Radio bearer IEs
  count-C-ActivationTime        ActivationTime                        OPTIONAL,
  rb-UL-CiphActivationTimeInfo  RB-ActivationTimeInfoList      OPTIONAL,
  ul-CounterSynchronisationInfo UL-CounterSynchronisationInfo  OPTIONAL,
  -- Extension mechanism for non- release99 information
  nonCriticalExtensions         SEQUENCE {}      OPTIONAL
}

-- *****
--
-- UTRAN MOBILITY INFORMATION FAILURE
--
-- *****

UTRANMobilityInformationFailure ::= SEQUENCE {
  -- UE information elements
  rrc-TransactionIdentifier      RRC-TransactionIdentifier,
  failureCause                   FailureCauseWithProtErr,
  -- Extension mechanism for non- release99 information
  nonCriticalExtensions         SEQUENCE {}      OPTIONAL
}

END

```

11.3 Information element definitions

```

InformationElements DEFINITIONS AUTOMATIC TAGS ::=
-- *****
--
-- CORE NETWORK INFORMATION ELEMENTS (10.3.1)
--
-- *****

BEGIN

IMPORTS

  hiPDSCHidentities,
  hiPUSCHidentities,
  hiRM,
  maxAC,
  maxAdditionalMeas,
  maxASC,
  maxASCmap,
  maxASCpersist,
  maxCCTrCH,
  maxCellMeas,
  maxCellMeas-1,
  maxCNdomains,
  maxCPCHsets,
  maxDPCH-DLchan,
  maxDPCHcodesPerTS,
  maxDPDCH-UL,
  maxDRACclasses,
  maxFACHPCH,
  maxFreq,
  maxFreqBandsFDD,
  maxFreqBandsTDD,
  maxFreqBandsGSM,
  maxInterSysMessages,
  maxLoCHperRLC,
  maxMeasEvent,
  maxMeasIntervals,
  maxMeasParEvent,
  maxNumCDMA2000Freqs,
  maxNumFDDFreqs,
  maxNumGSMFreqRanges,
  maxNumTDDFreqs,

```

```

maxOtherRAT,
maxPage1,
maxPCPCH-APsig,
maxPCPCH-APsubCh,
maxPCPCH-CDsig,
maxPCPCH-CDsubCh,
maxPCPCH-SF,
maxPCPCHs,
maxPDCPAlgoType,
maxPDSCH,
maxPDSCH-TFCIgroups,
maxPRACH,
maxPRACH-FPACH,
maxPUSCH,
maxRABsetup,
maxRAT,
maxRB,
maxRBallRABs,
maxRBMuxOptions,
maxRBperRAB,
maxReportedGSMCells,
maxSRBsetup,
maxRL,
maxRL-1,
maxROHC-PacketSizes-r4,
maxROHC-Profile-r4,
maxSCCPCH,
maxSat,
maxSIB,
maxSIB-FACH,
maxSig,
maxSubCh,
maxSystemCapability,
maxTF,
maxTF-CPCH,
maxTFC,
maxTFCI-2-Combs,
maxTGPS,
maxTrCH,
maxTS,
maxTS-1,
maxTS-LCR,
maxTS-LCR-1,
maxURA
FROM Constant-definitions;

Ansi-41-IDNNS ::= BIT STRING (SIZE (14))

CN-DomainIdentity ::= ENUMERATED {
    cs-domain,
    ps-domain }

CN-DomainInformation ::= SEQUENCE {
    cn-DomainIdentity
    cn-DomainSpecificNAS-Info
    NAS-SystemInformationGSM-MAP
}

CN-DomainInformationFull ::= SEQUENCE {
    cn-DomainIdentity
    cn-DomainSpecificNAS-Info
    cn-DRX-CycleLengthCoeff
    NAS-SystemInformationGSM-MAP,
    CN-DRX-CycleLengthCoefficient
}

CN-DomainInformationList ::= SEQUENCE (SIZE (1..maxCNdomains)) OF
    CN-DomainInformation

CN-DomainInformationListFull ::= SEQUENCE (SIZE (1..maxCNdomains)) OF
    CN-DomainInformationFull

CN-DomainSysInfo ::= SEQUENCE {
    cn-DomainIdentity
    cn-Type
        gsm-MAP
        ansi-41
    },
    cn-DRX-CycleLengthCoeff
    CN-DRX-CycleLengthCoefficient
}

CN-DomainSysInfoList ::= SEQUENCE (SIZE (1..maxCNdomains)) OF

```

```

CN-DomainSysInfo
CN-InformationInfo ::=
  plmn-Identity
  cn-CommonGSM-MAP-NAS-SysInfo
  cn-DomainInformationList
}
SEQUENCE {
  PLMN-Identity OPTIONAL,
  NAS-SystemInformationGSM-MAP OPTIONAL,
  CN-DomainInformationList OPTIONAL
}

CN-InformationInfoFull ::=
  plmn-Identity
  cn-CommonGSM-MAP-NAS-SysInfo
  cn-DomainInformationListFull
}
SEQUENCE {
  PLMN-Identity OPTIONAL,
  NAS-SystemInformationGSM-MAP OPTIONAL,
  CN-DomainInformationListFull OPTIONAL
}

Digit ::=
INTEGER (0..9)

Gsm-map-IDNNS ::=
  routingbasis
  localPTMSI
  routingparameter
},
  tMSIofsamePLMN
  routingparameter
},
  tMSIofdifferentPLMN
  routingparameter
},
  iMSIresponsetopaging
  routingparameter
},
  iMSIUEinitiatedEvent
  routingparameter
},
  iMEI
  routingparameter
},
  spare1
  routingparameter
},
  spare2
  routingparameter
},
  enteredparameter
}
SEQUENCE {
  CHOICE {
    SEQUENCE {
      RoutingParameter
    }
    SEQUENCE {
      RoutingParameter
    }
    SEQUENCE {
      RoutingParameter
    }
    SEQUENCE {
      RoutingParameter
    }
    SEQUENCE {
      RoutingParameter
    }
    SEQUENCE {
      RoutingParameter
    }
    SEQUENCE {
      RoutingParameter
    }
  }
  BOOLEAN
}

IMEI ::=
SEQUENCE (SIZE (15)) OF
  IMEI-Digit

IMEI-Digit ::=
INTEGER (0..15)

IMSI-GSM-MAP ::=
SEQUENCE (SIZE (6..15)) OF
  Digit

IntraDomainNasNodeSelector ::=
  version
  release99
  cn-Type
  gsm-Map-IDNNS
  ansi-41-IDNNS
},
  later
  futurecoding
}
SEQUENCE {
  CHOICE {
    SEQUENCE {
      CHOICE {
        Gsm-map-IDNNS,
        Ansi-41-IDNNS
      }
    }
    SEQUENCE {
      BIT STRING (SIZE (15))
    }
  }
}

LAI ::=
  plmn-Identity
  lac
}
SEQUENCE {
  PLMN-Identity,
  BIT STRING (SIZE (16))
}

MCC ::=
SEQUENCE (SIZE (3)) OF
  Digit

MNC ::=
SEQUENCE (SIZE (2..3)) OF
  Digit

```

```

NAS-Message ::= OCTET STRING (SIZE (1..4095))

NAS-Synchronisation-Indicator ::= BIT STRING(SIZE(4))

NAS-SystemInformationGSM-MAP ::= OCTET STRING (SIZE (1..8))

P-TMSI-GSM-MAP ::= BIT STRING (SIZE (32))

PagingRecordTypeID ::= ENUMERATED {
    imsi-GSM-MAP,
    tmsi-GSM-MAP-P-TMSI,
    imsi-DS-41,
    tmsi-DS-41 }

PLMN-Identity ::= SEQUENCE {
    mcc MCC,
    mnc MNC
}

PLMN-Type ::= CHOICE {
    gsm-MAP SEQUENCE {
        plmn-Identity
    },
    ansi-41 SEQUENCE {
        p-REV,
        min-P-REV,
        sid,
        nid
    },
    gsm-MAP-and-ANSI-41 SEQUENCE {
        plmn-Identity,
        p-REV,
        min-P-REV,
        sid,
        nid
    }
}

RAB-Identity ::= CHOICE {
    gsm-MAP-RAB-Identity,
    ansi-41-RAB-Identity
}

RAI ::= SEQUENCE {
    lai LAI,
    rac RoutingAreaCode
}

RoutingAreaCode ::= BIT STRING (SIZE (8))

RoutingParameter ::= BIT STRING (SIZE (10))

TMSI-GSM-MAP ::= BIT STRING (SIZE (32))

-- *****
--
-- UTRAN MOBILITY INFORMATION ELEMENTS (10.3.2)
--
-- *****

AccessClassBarred ::= ENUMERATED {
    barred, notBarred }

AccessClassBarredList ::= SEQUENCE (SIZE (maxAC)) OF
    AccessClassBarred

AllowedIndicator ::= ENUMERATED {
    allowed, notAllowed }

CellAccessRestriction ::= SEQUENCE {
    cellBarred CellBarred,
    cellReservedForOperatorUse ReservedIndicator,
    cellReservationExtension ReservedIndicator,
    accessClassBarredList AccessClassBarredList OPTIONAL
}

CellBarred ::= CHOICE {

```

```

    barred                               SEQUENCE {
      intraFreqCellReselectionInd      AllowedIndicator,
      t-Barred                          T-Barred
    },
    notBarred                            NULL
  }

CellIdentity ::=                          BIT STRING (SIZE (28))

CellSelectReselectInfoSIB-3-4 ::= SEQUENCE {
  mappingInfo                            MappingInfo                               OPTIONAL,
  cellSelectQualityMeasure               CHOICE {
    cpich-Ec-N0                          SEQUENCE {
      q-HYST-2-S                          Q-Hyst-S                               OPTIONAL
      -- Default value for q-HYST-2-S is q-HYST-1-S
    },
    cpich-RSCP                            NULL
  },
  modeSpecificInfo                       CHOICE {
    fdd                                    SEQUENCE {
      s-Intrasearch                       S-SearchQual                           OPTIONAL,
      s-Intersearch                       S-SearchQual                           OPTIONAL,
      s-SearchHCS                         S-SearchRXLEV                          OPTIONAL,
      rat-List                            RAT-FDD-InfoList                       OPTIONAL,
      q-QualMin                           Q-QualMin,
      q-RxlevMin                          Q-RxlevMin
    },
    tdd                                    SEQUENCE {
      s-Intrasearch                       S-SearchRXLEV                          OPTIONAL,
      s-Intersearch                       S-SearchRXLEV                          OPTIONAL,
      s-SearchHCS                         S-SearchRXLEV                          OPTIONAL,
      rat-List                            RAT-TDD-InfoList                       OPTIONAL,
      q-RxlevMin                          Q-RxlevMin
    }
  },
  q-Hyst-1-S                             Q-Hyst-S,
  t-Reselection-S                       T-Reselection-S,
  hcs-ServingCellInformation             HCS-ServingCellInformation             OPTIONAL,
  maxAllowedUL-TX-Power                  MaxAllowedUL-TX-Power
}

MapParameter ::=                          INTEGER (0..99)

Mapping ::=                               SEQUENCE {
  rat                                     RAT,
  mappingFunctionParameterList           MappingFunctionParameterList
}

Mapping-LCR-r4 ::=                       SEQUENCE {
  mappingFunctionParameterList           MappingFunctionParameterList
}

MappingFunctionParameter ::=             SEQUENCE {
  functionType                           MappingFunctionType,
  mapParameter1                          MapParameter                               OPTIONAL,
  mapParameter2                          MapParameter,
  upperLimit                              UpperLimit                               OPTIONAL
  -- The parameter is conditional on the number of repetition
}

MappingFunctionParameterList ::=         SEQUENCE (SIZE (1..maxMeasIntervals)) OF
  MappingFunctionParameter

MappingFunctionType ::=                  ENUMERATED {
  linear,
  functionType2,
  functionType3,
  functionType4 }

-- In this list, mapping for FDD and 3.84Mcps TDD is defined. For 1.28Mcps TDD, Mapping-LCR-r4
-- is used instead.
MappingInfo ::=                          SEQUENCE (SIZE (1..maxRAT)) OF
  Mapping

-- Actual value = IE value * 2
Q-Hyst-S ::=                             INTEGER (0..20)

RAT ::=                                  ENUMERATED {

```



```

        ultra-FDD,
        ultra-TDD,
        gsm,
        cdma2000 }

RAT-FDD-Info ::=
    rat-Identifier
    s-SearchRAT
    s-HCS-RAT
    s-Limit-SearchRAT
    SEQUENCE {
        RAT-Identifier,
        S-SearchQual,
        S-SearchRXLEV
        S-SearchQual
    }
    OPTIONAL,

RAT-FDD-InfoList ::=
    SEQUENCE (SIZE (1..maxOtherRAT)) OF
        RAT-FDD-Info

RAT-Identifier ::=
    ENUMERATED {
        gsm, cdma2000 }

RAT-TDD-Info ::=
    rat-Identifier
    s-SearchRAT
    s-HCS-RAT
    s-Limit-SearchRAT
    SEQUENCE {
        RAT-Identifier,
        S-SearchRXLEV,
        S-SearchRXLEV
        S-SearchRXLEV
    }
    OPTIONAL,

RAT-TDD-InfoList ::=
    SEQUENCE (SIZE (1..maxOtherRAT)) OF
        RAT-TDD-Info

ReservedIndicator ::=
    ENUMERATED {
        reserved,
        notReserved }

-- Actual value = IE value * 2
S-SearchQual ::=
    INTEGER (-16..10)

-- Actual value = (IE value * 2) + 1
S-SearchRXLEV ::=
    INTEGER (-53..45)

T-Barred ::=
    ENUMERATED {
        s10, s20, s40, s80,
        s160, s320, s640, s1280 }

T-Reselection-S ::=
    INTEGER (0..31)

-- The used range depends on the RAT used.
UpperLimit ::=
    INTEGER (1..91)

URA-Identity ::=
    BIT STRING (SIZE (16))

URA-IdentityList ::=
    SEQUENCE (SIZE (1..maxURA)) OF
        URA-Identity

-- *****
--
--     USER EQUIPMENT INFORMATION ELEMENTS (10.3.3)
--
-- *****

ActivationTime ::=
    INTEGER (0..255)
-- TABULAR : value 'now' always appear as default, and is encoded by absence of the field

BackoffControlParams ::=
    n-AP-RetransMax
    n-AccessFails
    nf-BO-NoAICH
    ns-BO-Busy
    nf-BO-AllBusy
    nf-BO-Mismatch
    t-CPCH
    SEQUENCE {
        N-AP-RetransMax,
        N-AccessFails,
        NF-BO-NoAICH,
        NS-BO-Busy,
        NF-BO-AllBusy,
        NF-BO-Mismatch,
        T-CPCH
    }

C-RNTI ::=
    BIT STRING (SIZE (16))

CapabilityUpdateRequirement ::=
    ue-RadioCapabilityFDDUpdateRequirement-FDD BOOLEAN,
    -- The following is for 3.84Mcps TDD update requirement
    ue-RadioCapabilityTDDUpdateRequirement-TDD BOOLEAN,
    systemSpecificCapUpdateReqList
    SystemSpecificCapUpdateReqList
    OPTIONAL

```

```

}

CapabilityUpdateRequirement-r4-ext ::= SEQUENCE {
    ue-RadioCapabilityUpdateRequirement-TDD128    BOOLEAN
}

CapabilityUpdateRequirement-r4 ::= SEQUENCE {
    ue-RadioCapabilityFDDUpdateRequirement-FDD    BOOLEAN,
    ue-RadioCapabilityTDDUpdateRequirement-TDD384    BOOLEAN,
    ue-RadioCapabilityTDDUpdateRequirement-TDD128    BOOLEAN,
    systemSpecificCapUpdateReqList                SystemSpecificCapUpdateReqList    OPTIONAL
}

CellUpdateCause ::=
    ENUMERATED {
        cellReselection,
        periodicalCellUpdate,
        uplinkDataTransmission,
        utran-pagingResponse,
        re-enteredServiceArea,
        radiolinkFailure,
        rlc-unrecoverableError,
        spare1 }

ChipRateCapability ::=
    ENUMERATED {
        mcps3-84, mcps1-28 }

CipheringAlgorithm ::=
    ENUMERATED {
        uea0, uea1 }

CipheringModeCommand ::=
    CHOICE {
        startRestart                CipheringAlgorithm,
        stopCiphering                NULL
    }

CipheringModeInfo ::=
    SEQUENCE {
        cipheringModeCommand        CipheringModeCommand,
        -- TABULAR: The ciphering algorithm is included in
        -- the CipheringModeCommand.
        activationTimeForDPCH        ActivationTime                OPTIONAL,
        rb-DL-CiphActivationTimeInfo  RB-ActivationTimeInfoList    OPTIONAL
    }

CN-DRX-CycleLengthCoefficient ::= INTEGER (6..9)

CN-PagedUE-Identity ::=
    CHOICE {
        imsi-GSM-MAP                IMSI-GSM-MAP,
        tmsi-GSM-MAP                TMSI-GSM-MAP,
        p-TMSI-GSM-MAP              P-TMSI-GSM-MAP,
        imsi-DS-41                  IMSI-DS-41,
        tmsi-DS-41                  TMSI-DS-41
    }

CompressedModeMeasCapability ::= SEQUENCE {
    fdd-Measurements                BOOLEAN,
    -- TABULAR: The IEs below are made optional since they are conditional based
    -- on another information element. Their absence corresponds to the case where
    -- the condition is not true.
    -- tdd-Measurements indicates need for compressed mode for 3.84Mcps TDD measurements
    tdd-Measurements                BOOLEAN                OPTIONAL,
    gsm-Measurements                GSM-Measurements        OPTIONAL,
    multiCarrierMeasurements        BOOLEAN                OPTIONAL
}

CompressedModeMeasCapability-LCR-r4 ::= SEQUENCE {
    tdd128-Measurements                BOOLEAN                OPTIONAL
}

CompressedModeMeasCapabFDDList ::= SEQUENCE (SIZE (1..maxFreqBandsFDD)) OF
    CompressedModeMeasCapabFDD

CompressedModeMeasCapabFDD ::= SEQUENCE {
    radioFrequencyBandFDD            RadioFrequencyBandFDD    OPTIONAL,
    dl-MeasurementsFDD                BOOLEAN,
    ul-MeasurementsFDD                BOOLEAN
}

CompressedModeMeasCapabTDDList ::= SEQUENCE (SIZE (1..maxFreqBandsTDD)) OF
    CompressedModeMeasCapabTDD

```

```

CompressedModeMeasCapabTDD ::= SEQUENCE {
    radioFrequencyBandTDD      RadioFrequencyBandTDD,
    dl-MeasurementsTDD         BOOLEAN,
    ul-MeasurementsTDD         BOOLEAN
}

CompressedModeMeasCapabGSMList ::= SEQUENCE (SIZE (1..maxFreqBandsGSM)) OF
    CompressedModeMeasCapabGSM

CompressedModeMeasCapabGSM ::= SEQUENCE {
    radioFrequencyBandGSM      RadioFrequencyBandGSM,
    dl-MeasurementsGSM         BOOLEAN,
    ul-MeasurementsGSM         BOOLEAN
}

CompressedModeMeasCapabMC ::= SEQUENCE {
    dl-MeasurementsMC          BOOLEAN,
    ul-MeasurementsMC          BOOLEAN
}

CPCH-Parameters ::= SEQUENCE {
    initialPriorityDelayList    InitialPriorityDelayList           OPTIONAL,
    backoffControlParams        BackoffControlParams,
    powerControlAlgorithm        PowerControlAlgorithm,
    -- TABULAR: TPC step size nested inside PowerControlAlgorithm
    dl-DPCCH-BER                DL-DPCCH-BER
}

DL-DPCCH-BER ::= INTEGER (0..63)

DL-PhysChCapabilityFDD ::= SEQUENCE {
    maxNoDPCH-PDSCH-Codes        INTEGER (1..8),
    maxNoPhysChBitsReceived      MaxNoPhysChBitsReceived,
    supportForSF-512              BOOLEAN,
    supportOfPDSCH                BOOLEAN,
    simultaneousSCCPCH-DPCH-Reception SimultaneousSCCPCH-DPCH-Reception
}

DL-PhysChCapabilityTDD ::= SEQUENCE {
    maxTS-PerFrame                MaxTS-PerFrame,
    maxPhysChPerFrame              MaxPhysChPerFrame,
    minimumSF                      MinimumSF-DL,
    supportOfPDSCH                BOOLEAN,
    maxPhysChPerTS                MaxPhysChPerTS
}

DL-PhysChCapabilityTDD-LCR-r4 ::= SEQUENCE {
    maxTS-PerSubFrame              MaxTS-PerSubFrame-r4,
    maxPhysChPerSubFrame-r4        MaxPhysChPerSubFrame-r4,
    minimumSF                      MinimumSF-DL,
    supportOfPDSCH                BOOLEAN,
    maxPhysChPerTS                MaxPhysChPerTS,
    supportOf8PSK                  BOOLEAN
}

DL-TransChCapability ::= SEQUENCE {
    maxNoBitsReceived              MaxNoBits,
    maxConvCodeBitsReceived        MaxNoBits,
    turboDecodingSupport            TurboSupport,
    maxSimultaneousTransChs        MaxSimultaneousTransChsDL,
    maxSimultaneousCCTrCH-Count    MaxSimultaneousCCTrCH-Count,
    maxReceivedTransportBlocks     MaxTransportBlocksDL,
    maxNumberOfTFC-InTFCS          MaxNumberOfTFC-InTFCS-DL,
    maxNumberOfTF                  MaxNumberOfTF
}

DRAC-SysInfo ::= SEQUENCE {
    transmissionProbability        TransmissionProbability,
    maximumBitRate                 MaximumBitRate
}

DRAC-SysInfoList ::= SEQUENCE (SIZE (1..maxDRACclasses)) OF
    DRAC-SysInfo

ESN-DS-41 ::= BIT STRING (SIZE (32))

EstablishmentCause ::= ENUMERATED {

```

```

originatingConversationalCall,
originatingStreamingCall,
originatingInteractiveCall,
originatingBackgroundCall,
originatingSubscribedTrafficCall,
terminatingConversationalCall,
terminatingStreamingCall,
terminatingInteractiveCall,
terminatingBackgroundCall,
emergencyCall,
interRAT-CellReselection,
interRAT-CellChangeOrder,
registration,
detach,
originatingHighPrioritySignalling,
originatingLowPrioritySignalling,
callRe-establishment,
terminatingHighPrioritySignalling,
terminatingLowPrioritySignalling,
terminatingCauseUnknown,
spare1 }

FailureCauseWithProtErr ::= CHOICE {
    configurationUnsupported          NULL,
    physicalChannelFailure           NULL,
    incompatibleSimultaneousReconfiguration
                                     NULL,
    compressedModeRuntimeError      TGPSI,
    protocolError                   ProtocolErrorInformation,
    cellUpdateOccurred              NULL,
    invalidConfiguration             NULL,
    configurationIncomplete          NULL,
    unsupportedMeasurement           NULL,
    spare1                           NULL,
    spare2                           NULL,
    spare3                           NULL,
    spare4                           NULL,
    spare5                           NULL,
    spare6                           NULL,
    spare7                           NULL
}

FailureCauseWithProtErrTrId ::= SEQUENCE {
    rrc-TransactionIdentifier        RRC-TransactionIdentifier,
    failureCause                     FailureCauseWithProtErr
}

GSM-Measurements ::= SEQUENCE {
    gsm900                           BOOLEAN,
    dcs1800                           BOOLEAN,
    gsm1900                           BOOLEAN
}

-- If ICS-Version-r4 is included, the following IE shall be ignored.
ICS-Version ::= ENUMERATED {
    r99 }

ICS-Version-r4 ::= ENUMERATED {
    rel-4 }

IMSI-and-ESN-DS-41 ::= SEQUENCE {
    imsi-DS-41                       IMSI-DS-41,
    esn-DS-41                         ESN-DS-41
}

IMSI-DS-41 ::= OCTET STRING (SIZE (5..7))

InitialPriorityDelayList ::= SEQUENCE (SIZE (1..maxASC)) OF
    NS-IP

InitialUE-Identity ::= CHOICE {
    imsi                               IMSI-GSM-MAP,
    tmsi-and-LAI                       TMSI-and-LAI-GSM-MAP,
    p-TMSI-and-RAI                     P-TMSI-and-RAI-GSM-MAP,
    imei                                IMEI,
    esn-DS-41                           ESN-DS-41,
    imsi-DS-41                           IMSI-DS-41,

```

```

imsi-and-ESN-DS-41      IMSI-and-ESN-DS-41,
tmsi-DS-41             TMSI-DS-41
}

IntegrityCheckInfo ::= SEQUENCE {
    messageAuthenticationCode      MessageAuthenticationCode,
    rrc-MessageSequenceNumber      RRC-MessageSequenceNumber
}

IntegrityProtActivationInfo ::= SEQUENCE {
    rrc-MessageSequenceNumberList   RRC-MessageSequenceNumberList
}

IntegrityProtectionAlgorithm ::= ENUMERATED {
    uia1 }

IntegrityProtectionModeCommand ::= CHOICE {
    startIntegrityProtection      SEQUENCE {
        integrityProtInitNumber   IntegrityProtInitNumber
    },
    modify                        SEQUENCE {
        dl-IntegrityProtActivationInfo IntegrityProtActivationInfo
    }
}

IntegrityProtectionModeInfo ::= SEQUENCE {
    integrityProtectionModeCommand IntegrityProtectionModeCommand,
    -- TABULAR: DL integrity protection activation info and Integrity
    -- protection intialisation number have been nested inside
    -- IntegrityProtectionModeCommand.
    integrityProtectionAlgorithm   IntegrityProtectionAlgorithm   OPTIONAL
}

IntegrityProtInitNumber ::= BIT STRING (SIZE (32))

MaxHcContextSpace ::= ENUMERATED {
    by512, by1024, by2048, by4096,
    by8192 }

MaxROHC-ContextSessions-r4 ::= ENUMERATED {
    s2, s4, s8, s12, s16, s24, s32, s48,
    s64, s128, s256, s512, s1024, s16384 }

MaximumAM-EntityNumberRLC-Cap ::= ENUMERATED {
    am3, am4, am5, am6,
    am8, am16, am30 }

-- Actual value = IE value * 16
MaximumBitRate ::= INTEGER (0..32)

MaximumRLC-WindowSize ::= ENUMERATED { mws2047, mws4095 }

MaxNoDPDCH-BitsTransmitted ::= ENUMERATED {
    b600, b1200, b2400, b4800,
    b9600, b19200, b28800, b38400,
    b48000, b57600 }

MaxNoBits ::= ENUMERATED {
    b640, b1280, b2560, b3840, b5120,
    b6400, b7680, b8960, b10240,
    b20480, b40960, b81920, b163840 }

MaxNoPhysChBitsReceived ::= ENUMERATED {
    b600, b1200, b2400, b3600,
    b4800, b7200, b9600, b14400,
    b19200, b28800, b38400, b48000,
    b57600, b67200, b76800 }

MaxNoSCCPCH-RL ::= ENUMERATED {
    r11 }

MaxNumberOfTF ::= ENUMERATED {
    tf32, tf64, tf128, tf256,
    tf512, tf1024 }

MaxNumberOfTFC-InTFCS-DL ::= ENUMERATED {

```

```

        tfc16, tfc32, tfc48, tfc64, tfc96,
        tfc128, tfc256, tfc512, tfc1024 }

MaxNumberOfTFC-InTFCS-UL ::=      ENUMERATED {
        tfc4, tfc8, tfc16, tfc32, tfc48, tfc64,
        tfc96, tfc128, tfc256, tfc512, tfc1024 }

MaxPhysChPerFrame ::=            INTEGER (1..224)

MaxPhysChPerSubFrame-r4 ::=      INTEGER (1..96)

MaxPhysChPerTimeslot ::=         ENUMERATED {
        ts1, ts2 }

MaxPhysChPerTS ::=              INTEGER (1..16)

MaxSimultaneousCCTrCH-Count ::=  INTEGER (1..8)

MaxSimultaneousTransChsDL ::=    ENUMERATED {
        e4, e8, e16, e32 }

MaxSimultaneousTransChsUL ::=    ENUMERATED {
        e2, e4, e8, e16, e32 }

MaxTransportBlocksDL ::=         ENUMERATED {
        tb4, tb8, tb16, tb32, tb48,
        tb64, tb96, tb128, tb256, tb512 }

MaxTransportBlocksUL ::=         ENUMERATED {
        tb2, tb4, tb8, tb16, tb32, tb48,
        tb64, tb96, tb128, tb256, tb512 }

MaxTS-PerFrame ::=              INTEGER (1..14)

MaxTS-PerSubFrame-r4 ::=         INTEGER (1..6)

-- TABULAR: This IE contains dependencies to UE-MultiModeRAT-Capability,
-- the conditional fields have been left mandatory for now.
MeasurementCapability ::=        SEQUENCE {
        downlinkCompressedMode      CompressedModeMeasCapability,
        uplinkCompressedMode        CompressedModeMeasCapability
}

MeasurementCapability-v370 ::=   SEQUENCE{
        compressedModeMeasCapabFDDList      CompressedModeMeasCapabFDDList,
        compressedModeMeasCapabTDDList     CompressedModeMeasCapabTDDList OPTIONAL,
        compressedModeMeasCapabGSMList     CompressedModeMeasCapabGSMList OPTIONAL,
        compressedModeMeasCapabMC         CompressedModeMeasCapabMC         OPTIONAL
}

MeasurementCapability-r4-ext ::= SEQUENCE {
        downlinkCompressedMode-LCR         CompressedModeMeasCapability-LCR-r4,
        uplinkCompressedMode-LCR          CompressedModeMeasCapability-LCR-r4
}

MessageAuthenticationCode ::=   BIT STRING (SIZE (32))

MinimumSF-DL ::=                ENUMERATED {
        sf1, sf16 }

MinimumSF-UL ::=               ENUMERATED {
        sf1, sf2, sf4, sf8, sf16 }

MultiModeCapability ::=         ENUMERATED {
        tdd, fdd, fdd-tdd }

MultiRAT-Capability ::=         SEQUENCE {
        supportOfGSM                    BOOLEAN,
        supportOfMulticarrier            BOOLEAN
}

N-300 ::=                      INTEGER (0..7)

N-301 ::=                      INTEGER (0..7)

N-302 ::=                      INTEGER (0..7)

N-304 ::=                      INTEGER (0..7)

```

```

N-308 ::= INTEGER (1..8)
N-310 ::= INTEGER (0..7)
N-312 ::= ENUMERATED {
    s1, s50, s100, s200, s400,
    s600, s800, s1000 }
N-313 ::= ENUMERATED {
    s1, s2, s4, s10, s20,
    s50, s100, s200 }
N-315 ::= ENUMERATED {
    s1, s50, s100, s200, s400,
    s600, s800, s1000 }
N-AccessFails ::= INTEGER (1..64)
N-AP-RetransMax ::= INTEGER (1..64)
NetworkAssistedGPS-Supported ::= ENUMERATED {
    networkBased,
    ue-Based,
    bothNetworkAndUE-Based,
    noNetworkAssistedGPS }
NF-BO-AllBusy ::= INTEGER (0..31)
NF-BO-NoAICH ::= INTEGER (0..31)
NF-BO-Mismatch ::= INTEGER (0..127)
NS-BO-Busy ::= INTEGER (0..63)
NS-IP ::= INTEGER (0..28)
P-TMSI-and-RAI-GSM-MAP ::= SEQUENCE {
    p-TMSI
    rai
}
PagingCause ::= ENUMERATED {
    terminatingConversationalCall,
    terminatingStreamingCall,
    terminatingInteractiveCall,
    terminatingBackgroundCall,
    terminatingHighPrioritySignalling,
    terminatingLowPrioritySignalling,
    terminatingCauseUnknown
}
PagingRecord ::= CHOICE {
    cn-Identity SEQUENCE {
        pagingCause
        cn-DomainIdentity
        cn-pagedUE-Identity
    },
    utran-Identity SEQUENCE {
        u-RNTI
        cn-OriginatedPage-connectedMode-UE SEQUENCE {
            pagingCause
            cn-DomainIdentity
            pagingRecordTypeID
        }
    }
} OPTIONAL
PagingRecordList ::= SEQUENCE (SIZE (1..maxPage1)) OF
    PagingRecord
PDCP-Capability ::= SEQUENCE {
    losslessSRNS-RelocationSupport
    supportForRfc2507
    notSupported
    supported
}

```

```

PDCP-Capability-r4-ext ::=          SEQUENCE {
    supportForRfc3095                CHOICE {
        notSupported                  NULL,
        supported                     SEQUENCE {
            maxROHC-ContextSessions   MaxROHC-ContextSessions-r4  DEFAULT s16,
            reverseCompressionDepth   INTEGER (0..65535)         DEFAULT 0
        }
    }
}

PhysicalChannelCapability ::=        SEQUENCE {
    fddPhysChCapability              SEQUENCE {
        downlinkPhysChCapability      DL-PhysChCapabilityFDD,
        uplinkPhysChCapability        UL-PhysChCapabilityFDD
    } OPTIONAL,
    -- The following describes the 3.84Mcps TDD physical channel capability
    tddPhysChCapability              SEQUENCE {
        downlinkPhysChCapability      DL-PhysChCapabilityTDD,
        uplinkPhysChCapability        UL-PhysChCapabilityTDD
    } OPTIONAL
}

-- The following describes the 1.28Mcps TDD physical channel capability
PhysicalChannelCapability-LCR-r4 ::= SEQUENCE {
    tdd128-PhysChCapability          SEQUENCE {
        downlinkPhysChCapability      DL-PhysChCapabilityTDD-LCR-r4,
        uplinkPhysChCapability        UL-PhysChCapabilityTDD-LCR-r4
    } OPTIONAL
}

PNBSCH-Allocation-r4 ::=            SEQUENCE {
    numberOfRepetitionsPerSFNPeriod  ENUMERATED {
        c2, c3, c4, c5, c6, c7, c8, c9, c10,
        c12, c14, c16, c18, c20, c24, c28, c32,
        c36, c40, c48, c56, c64, c72, c80 }
}

ProtocolErrorCause ::=              ENUMERATED {
    asn1-ViolationOrEncodingError,
    messageTypeNonexistent,
    messageNotCompatibleWithReceiverState,
    ie-ValueNotComprehended,
    conditionalInformationElementError,
    messageExtensionNotComprehended,
    spare1, spare2 }

ProtocolErrorIndicator ::=           ENUMERATED {
    noError, errorOccurred }

ProtocolErrorIndicatorWithMoreInfo ::= CHOICE {
    noError                          NULL,
    errorOccurred                     SEQUENCE {
        rrc-TransactionIdentifier     RRC-TransactionIdentifier,
        protocolErrorInformation      ProtocolErrorInformation
    }
}

ProtocolErrorMoreInformation ::=     SEQUENCE {
    diagnosticsType                  CHOICE {
        type1                         CHOICE {
            asn1-ViolationOrEncodingError  NULL,
            messageTypeNonexistent         NULL,
            messageNotCompatibleWithReceiverState
                IdentificationOfReceivedMessage,
            ie-ValueNotComprehended        IdentificationOfReceivedMessage,
            conditionalInformationElementError
                IdentificationOfReceivedMessage,
            messageExtensionNotComprehended
                IdentificationOfReceivedMessage,
            spare1                        NULL,
            spare2                        NULL
        },
        spare                          NULL
    }
}

RadioFrequencyBandFDD ::=           ENUMERATED {
    fdd2100,
}

```



```

        fdd1900,
        spare1, spare2, spare3, spare4, spare5, spare6}

RadioFrequencyBandTDDList ::=      ENUMERATED {
        a, b, c, ab, ac, bc, abc }

RadioFrequencyBandTDD ::=          ENUMERATED {a, b, c, spare}

RadioFrequencyBandGSM ::=          ENUMERATED {
        gsm450,
        gsm480,
        gsm850,
        gsm900P,
        gsm900E,
        gsm1800,
        gsm1900,
        spare1, spare2, spare3, spare4, spare5,
        spare6, spare7, spare8, spare9}

Rb-timer-indicator ::=             SEQUENCE {
        t314-expired                BOOLEAN,
        t315-expired                BOOLEAN }

Re-EstablishmentTimer ::=          ENUMERATED {
        useT314, useT315
}

RedirectionInfo ::=                CHOICE {
        frequencyInfo              FrequencyInfo,
        interRATInfo               InterRATInfo
}

RejectionCause ::=                ENUMERATED {
        congestion,
        unspecified }

ReleaseCause ::=                   ENUMERATED {
        normalEvent,
        unspecified,
        pre-emptiveRelease,
        congestion,
        re-establishmentReject,
        directedsignallingconnectionre-establishment,
        userInactivity }

RF-Capability ::=                  SEQUENCE {
        fddRF-Capability            SEQUENCE {
            ue-PowerClass           UE-PowerClass,
            txRxFrequencySeparation TxRxFrequencySeparation
        }
        tddRF-Capability            SEQUENCE {
            ue-PowerClass           UE-PowerClass,
            radioFrequencyBandTDDList RadioFrequencyBandTDDList,
            chipRateCapability       ChipRateCapability
        }
        OPTIONAL
}

RF-Capability-r4-ext ::=           SEQUENCE {
        tddRF-Capability            SEQUENCE {
            ue-PowerClass           UE-PowerClass,
            radioFrequencyBandTDDList RadioFrequencyBandTDDList,
            chipRateCapability       ChipRateCapability
        }
        OPTIONAL
}

RLC-Capability ::=                 SEQUENCE {
        totalRLC-AM-BufferSize      TotalRLC-AM-BufferSize,
        maximumRLC-WindowSize       MaximumRLC-WindowSize,
        maximumAM-EntityNumber      MaximumAM-EntityNumberRLC-Cap
}

RRC-MessageSequenceNumber ::=      INTEGER (0..15)

RRC-MessageSequenceNumberList ::=  SEQUENCE (SIZE (4..5)) OF
        RRC-MessageSequenceNumber

```

```

RRC-StateIndicator ::=          ENUMERATED {
                                cell-DCH, cell-FACH, cell-PCH, ura-PCH }

RRC-TransactionIdentifier ::=   INTEGER (0..3)

S-RNTI ::=                      BIT STRING (SIZE (20))

S-RNTI-2 ::=                    BIT STRING (SIZE (10))

SecurityCapability ::=          SEQUENCE {
    cipheringAlgorithmCap
                                BIT STRING {
                                    spare15(0),
                                    spare14(1),
                                    spare13(2),
                                    spare12(3),
                                    spare11(4),
                                    spare10(5),
                                    spare9(6),
                                    spare8(7),
                                    spare7(8),
                                    spare6(9),
                                    spare5(10),
                                    spare4(11),
                                    spare3(12),
                                    spare2(13),
                                    ueal(14),
                                    uea0(15)
                                } (SIZE (16)),
    integrityProtectionAlgorithmCap BIT STRING {
                                    spare15(0),
                                    spare14(1),
                                    spare13(2),
                                    spare12(3),
                                    spare11(4),
                                    spare10(5),
                                    spare9(6),
                                    spare8(7),
                                    spare7(8),
                                    spare6(9),
                                    spare5(10),
                                    spare4(11),
                                    spare3(12),
                                    spare2(13),
                                    uial(14),
                                    spare0(15)
                                } (SIZE (16))
    }

SimultaneousSCCPCH-DPCH-Reception ::= CHOICE {
    notSupported                NULL,
    supported                   SEQUENCE {
        maxNoSCCPCH-RL          MaxNoSCCPCH-RL,
        simultaneousSCCPCH-DPCH-DPDCH-Reception
                                BOOLEAN
        -- The IE above is applicable only if IE Support of PDSCH = TRUE
    }
}

SRNC-Identity ::=              BIT STRING (SIZE (12))

START-Value ::=                BIT STRING (SIZE (20))

STARTList ::=                  SEQUENCE (SIZE (1..maxCNdomains)) OF
                                STARTSingle

STARTSingle ::=                SEQUENCE {
    cn-DomainIdentity           CN-DomainIdentity,
    start-Value                 START-Value
}

SystemSpecificCapUpdateReq ::=  ENUMERATED {
                                gsm }

SystemSpecificCapUpdateReqList ::= SEQUENCE (SIZE (1..maxSystemCapability)) OF
                                    SystemSpecificCapUpdateReq

```

```

T-300 ::=
    ENUMERATED {
        ms100, ms200, ms400, ms600, ms800,
        ms1000, ms1200, ms1400, ms1600,
        ms1800, ms2000, ms3000, ms4000,
        ms6000, ms8000 }

T-301 ::=
    ENUMERATED {
        ms100, ms200, ms400, ms600, ms800,
        ms1000, ms1200, ms1400, ms1600,
        ms1800, ms2000, ms3000, ms4000,
        ms6000, ms8000 }

T-302 ::=
    ENUMERATED {
        ms100, ms200, ms400, ms600, ms800,
        ms1000, ms1200, ms1400, ms1600,
        ms1800, ms2000, ms3000, ms4000,
        ms6000, ms8000 }

T-304 ::=
    ENUMERATED {
        ms100, ms200, ms400,
        ms1000, ms2000, spare1, spare2, spare3 }

T-305 ::=
    ENUMERATED {
        noUpdate, m5, m10, m30,
        m60, m120, m360, m720 }

T-307 ::=
    ENUMERATED {
        s5, s10, s15, s20,
        s30, s40, s50 }

T-308 ::=
    ENUMERATED {
        ms40, ms80, ms160, ms320 }

T-309 ::=
    INTEGER (1..8)

T-310 ::=
    ENUMERATED {
        ms40, ms80, ms120, ms160,
        ms200, ms240, ms280, ms320 }

T-311 ::=
    ENUMERATED {
        ms250, ms500, ms750, ms1000,
        ms1250, ms1500, ms1750, ms2000 }

T-312 ::=
    INTEGER (0..15)

T-313 ::=
    INTEGER (0..15)

T-314 ::=
    ENUMERATED {
        s0, s2, s4, s6, s8,
        s12, s16, s20 }

T-315 ::=
    ENUMERATED {
        s0, s10, s30, s60, s180,
        s600, s1200, s1800 }

T-316 ::=
    ENUMERATED {
        s0, s10, s20, s30, s40,
        s50, s-inf }

T-317 ::=
    ENUMERATED {
        s0, s10, s30, s60, s180,
        s600, s1200, s1800 }

T-CPCH ::=
    ENUMERATED {
        ct0, ct1 }

TMSI-and-LAI-GSM-MAP ::=
    SEQUENCE {
        tmsi
        lai
    }

TMSI-DS-41 ::=
    OCTET STRING (SIZE (2..12))

TotalRLC-AM-BufferSize ::=
    ENUMERATED {
        kb2, kb10, kb50, kb100,
        kb150, kb500, kb1000 }

```

-- Actual value = IE value * 0.125

```

TransmissionProbability ::=          INTEGER (1..8)

TransportChannelCapability ::=       SEQUENCE {
    dl-TransChCapability             DL-TransChCapability,
    ul-TransChCapability             UL-TransChCapability
}

TurboSupport ::=                    CHOICE {
    notSupported                     NULL,
    supported                         MaxNoBits
}

TxRxFrequencySeparation ::=         ENUMERATED {
    mhz190, mhz174-8-205-2,
    mhz134-8-245-2 }

U-RNTI ::=                          SEQUENCE {
    srnc-Identity                   SRNC-Identity,
    s-RNTI                          S-RNTI
}

U-RNTI-Short ::=                   SEQUENCE {
    srnc-Identity                   SRNC-Identity,
    s-RNTI-2                        S-RNTI-2
}

UE-ConnTimersAndConstants ::=       SEQUENCE {
-- Optional is used also for parameters for which the default value is the last one read in SIB1
-- t-301 and n-301 should not be used by the UE in this release of the protocol
    t-301                            T-301                DEFAULT ms2000,
    n-301                            N-301                DEFAULT 2,
    t-302                            T-302                DEFAULT ms4000,
    n-302                            N-302                DEFAULT 3,
    t-304                            T-304                DEFAULT ms2000,
    n-304                            N-304                DEFAULT 2,
    t-305                            T-305                DEFAULT m30,
    t-307                            T-307                DEFAULT s30,
    t-308                            T-308                DEFAULT ms160,
    t-309                            T-309                DEFAULT 5,
    t-310                            T-310                DEFAULT ms160,
    n-310                            N-310                DEFAULT 4,
    t-311                            T-311                DEFAULT ms2000,
    t-312                            T-312                DEFAULT 1,
    n-312                            N-312                DEFAULT s1,
    t-313                            T-313                DEFAULT 3,
    n-313                            N-313                DEFAULT s20,
    t-314                            T-314                DEFAULT s12,
    t-315                            T-315                DEFAULT s180,
    n-315                            N-315                DEFAULT s1,
    t-316                            T-316                DEFAULT s30,
    t-317                            T-317                DEFAULT s180
}

UE-IdleTimersAndConstants ::=       SEQUENCE {
    t-300                            T-300,
    n-300                            N-300,
    t-312                            T-312,
    n-312                            N-312
}

UE-MultiModeRAT-Capability ::=      SEQUENCE {
    multiRAT-CapabilityList          MultiRAT-Capability,
    multiModeCapability              MultiModeCapability
}

UE-PowerClass ::=                   INTEGER (1..4)

UE-PowerClass-v370 ::=              ENUMERATED {class1, class2, class3, class4,
    spare1, spare2, spare3, spare4}

UE-RadioAccessCapability ::=        SEQUENCE {
    ics-Version                       ICS-Version,
    pdcp-Capability                  PDCP-Capability,
    rlc-Capability                   RLC-Capability,
    transportChannelCapability        TransportChannelCapability,
    rf-Capability                    RF-Capability,
    physicalChannelCapability         PhysicalChannelCapability,
    ue-MultiModeRAT-Capability        UE-MultiModeRAT-Capability,

```

```

securityCapability                SecurityCapability,
ue-positioning-Capability        UE-Positioning-Capability,
measurementCapability            MeasurementCapability        OPTIONAL
}

UE-RadioAccessCapability-v370ext ::= SEQUENCE {
  ue-RadioAccessCapabBandFDDList UE-RadioAccessCapabBandFDDList
}

UE-RadioAccessCapabBandFDDList ::= SEQUENCE (SIZE (1..maxFreqBandsFDD)) OF
  UE-RadioAccessCapabBandFDD

UE-RadioAccessCapabBandFDD ::= SEQUENCE{
  radioFrequencyBandFDD          RadioFrequencyBandFDD,
  fddRF-Capability              SEQUENCE {
    ue-PowerClass                UE-PowerClass-v370,
    txRxFrequencySeparation      TxRxFrequencySeparation
  }
  measurementCapability          MeasurementCapability-v370        OPTIONAL,
}

UE-RadioAccessCapability-r4-ext ::= SEQUENCE {
  pdcp-Capability-r4-ext        PDCP-Capability-r4-ext,
  ics-Version-r4                ICS-Version-r4,
  rf-Capability                 RF-Capability-r4-ext,
  physicalChannelCapability-LCR  PhysicalChannelCapability-LCR-r4,
  measurementCapability-r4-ext  MeasurementCapability-r4-ext        OPTIONAL
}

UL-PhysChCapabilityFDD ::= SEQUENCE {
  maxNoDPDCH-BitsTransmitted    MaxNoDPDCH-BitsTransmitted,
  supportOfPCPCH                BOOLEAN
}

UL-PhysChCapabilityTDD ::= SEQUENCE {
  maxTS-PerFrame                MaxTS-PerFrame,
  maxPhysChPerTimeslot          MaxPhysChPerTimeslot,
  minimumSF                     MinimumSF-UL,
  supportOfPUSCH                BOOLEAN
}

UL-PhysChCapabilityTDD-LCR-r4 ::= SEQUENCE {
  maxTS-PerSubFrame             MaxTS-PerSubFrame-r4,
  maxPhysChPerTimeslot          MaxPhysChPerTimeslot,
  minimumSF                     MinimumSF-UL,
  supportOfPUSCH                BOOLEAN,
  supportOf8PSK                 BOOLEAN
}

UL-TransChCapability ::= SEQUENCE {
  maxNoBitsTransmitted          MaxNoBits,
  maxConvCodeBitsTransmitted    MaxNoBits,
  turboDecodingSupport          TurboSupport,
  maxSimultaneousTransChs       MaxSimultaneousTransChsUL,
  modeSpecificInfo              CHOICE {
    fdd                          NULL,
    tdd                          SEQUENCE {
      maxSimultaneousCCTrCH-Count MaxSimultaneousCCTrCH-Count
    }
  },
  maxTransmittedBlocks          MaxTransportBlocksUL,
  maxNumberOfTFC-InTFCS         MaxNumberOfTFC-InTFCS-UL,
  maxNumberOfTF                 MaxNumberOfTF
}

UE-Positioning-Capability ::= SEQUENCE {
  standaloneLocMethodsSupported BOOLEAN,
  ue-BasedOTDOA-Supported       BOOLEAN,
  networkAssistedGPS-Supported  NetworkAssistedGPS-Supported,
  gps-ReferenceTimeCapable      BOOLEAN,
  supportForIPDL                BOOLEAN
}

URA-UpdateCause ::= ENUMERATED {
  changeOfURA,
  periodicURAUpdate,
  re-enteredServiceArea,
  spare1 }

```

```

UTRAN-DRX-CycleLengthCoefficient ::= INTEGER (3..9)

WaitTime ::=
    INTEGER (0..15)

-- *****
--
--     RADIO BEARER INFORMATION ELEMENTS (10.3.4)
--
-- *****

AlgorithmSpecificInfo ::=
    CHOICE {
        rfc2507-Info          RFC2507-Info
    }

AlgorithmSpecificInfo-r4 ::=
    CHOICE {
        rfc2507-Info          RFC2507-Info,
        rfc3095-Info          RFC3095-Info-r4
    }

-- Upper limit is 2^32 - 1
COUNT-C ::=
    INTEGER (0..4294967295)

-- Upper limit is 2^25 - 1
COUNT-C-MSB ::=
    INTEGER (0..33554431)

DefaultConfigIdentity ::=
    INTEGER (0..9)

DefaultConfigMode ::=
    ENUMERATED {
        fdd,
        tdd }

DL-AM-RLC-Mode ::=
    SEQUENCE {
        inSequenceDelivery    BOOLEAN,
        receivingWindowSize    ReceivingWindowSize,
        dl-RLC-StatusInfo     DL-RLC-StatusInfo
    }

DL-CounterSynchronisationInfo ::=
    SEQUENCE {
        rB-WithPDCP-InfoList    RB-WithPDCP-InfoList    OPTIONAL
    }

DL-LogicalChannelMapping ::=
    SEQUENCE {
        -- TABULAR: DL-TransportChannelType contains TransportChannelIdentity as well.
        dl-TransportChannelType    DL-TransportChannelType,
        logicalChannelIdentity      LogicalChannelIdentity    OPTIONAL
    }

DL-LogicalChannelMappingList ::=
    SEQUENCE (SIZE (1..maxLoCHperRLC)) OF
        DL-LogicalChannelMapping

DL-RLC-Mode ::=
    CHOICE {
        dl-AM-RLC-Mode          DL-AM-RLC-Mode,
        dl-UM-RLC-Mode          NULL,
        dl-TM-RLC-Mode          DL-TM-RLC-Mode
    }

DL-RLC-StatusInfo ::=
    SEQUENCE {
        timerStatusProhibit      TimerStatusProhibit    OPTIONAL,
        timerEPC                  TimerEPC                    OPTIONAL,
        missingPDU-Indicator      BOOLEAN,
        timerStatusPeriodic      TimerStatusPeriodic          OPTIONAL
    }

DL-TM-RLC-Mode ::=
    SEQUENCE {
        segmentationIndication    BOOLEAN
    }

DL-TransportChannelType ::=
    CHOICE {
        dch                      TransportChannelIdentity,
        fach                      NULL,
        dsch                      TransportChannelIdentity,
        dch-and-dsch              TransportChannelIdentityDCHandDSCH
    }

ExpectReordering ::=
    ENUMERATED {
        reorderingNotExpected,
        reorderingExpected }

```

```

ExplicitDiscard ::=
    timerMRW
    timerDiscard
    maxMRW
}
SEQUENCE {
    TimerMRW,
    TimerDiscard,
    MaxMRW
}

HeaderCompressionInfo ::=
    algorithmSpecificInfo
}
SEQUENCE {
    AlgorithmSpecificInfo
}

HeaderCompressionInfoList ::=
SEQUENCE (SIZE (1..maxPDCPALgoType)) OF
    HeaderCompressionInfo

HeaderCompressionInfo-r4 ::=
    algorithmSpecificInfo
}
SEQUENCE {
    AlgorithmSpecificInfo-r4
}

HeaderCompressionInfoList-r4 ::=
SEQUENCE (SIZE (1..maxPDCPALgoType)) OF
    HeaderCompressionInfo-r4

LogicalChannelIdentity ::=
INTEGER (1..15)

LosslessSRNS-RelocSupport ::=
    supported
    notSupported
}
CHOICE {
    MaxPDCP-SN-WindowSize,
    NULL
}

MAC-LogicalChannelPriority ::=
INTEGER (1..8)

MaxDAT ::=
ENUMERATED {
    dat1, dat2, dat3, dat4, dat5, dat6,
    dat7, dat8, dat9, dat10, dat15, dat20,
    dat25, dat30, dat35, dat40 }

MaxDAT-Retransmissions ::=
    maxDAT
    timerMRW
    maxMRW
}
SEQUENCE {
    MaxDAT,
    TimerMRW,
    MaxMRW
}

MaxMRW ::=
ENUMERATED {
    mm1, mm4, mm6, mm8, mm12, mm16,
    mm24, mm32 }

MaxPDCP-SN-WindowSize ::=
ENUMERATED {
    sn255, sn65535 }

MaxRST ::=
ENUMERATED {
    rst1, rst4, rst6, rst8, rst12,
    rst16, rst24, rst32 }

NoExplicitDiscard ::=
ENUMERATED {
    dt10, dt20, dt30, dt40, dt50,
    dt60, dt70, dt80, dt90, dt100 }

PDCP-Info ::=
    losslessSRNS-RelocSupport
    pdcp-PDU-Header
    -- TABULAR: The IE above is MD in the tabular format and it can be encoded
    -- in one bit, so the OPTIONAL is removed for compactness.
    headerCompressionInfoList
}
SEQUENCE {
    LosslessSRNS-RelocSupport OPTIONAL,
    PDCP-PDU-Header,
    HeaderCompressionInfoList OPTIONAL
}

PDCP-Info-r4 ::=
    losslessSRNS-RelocSupport
    pdcp-PDU-Header
    -- TABULAR: The IE above is MD in the tabular format and it can be encoded
    -- in one bit, so the OPTIONAL is removed for compactness.
    headerCompressionInfoList
}
SEQUENCE {
    LosslessSRNS-RelocSupport OPTIONAL,
    PDCP-PDU-Header,
    HeaderCompressionInfoList-r4 OPTIONAL
}

PDCP-InfoReconfig ::=
    pdcp-Info
    -- dummy is not used in this version of the protocol
    dummy
}
SEQUENCE {
    PDCP-Info,
    INTEGER (0..65535)
}

```

```

PDCP-InfoReconfig-r4 ::= SEQUENCE {
    pdcp-Info          PDCP-Info-r4,
    pdcp-SN-Info      PDCP-SN-Info
}

PDCP-PDU-Header ::= ENUMERATED {
    present, absent }

PDCP-SN-Info ::= INTEGER (0..65535)

Poll-PDU ::= ENUMERATED {
    pdu1, pdu2, pdu4, pdu8, pdu16,
    pdu32, pdu64, pdu128 }

Poll-SDU ::= ENUMERATED {
    sdu1, sdu4, sdu16, sdu64 }

PollingInfo ::= SEQUENCE {
    timerPollProhibit    TimerPollProhibit          OPTIONAL,
    timerPoll            TimerPoll                OPTIONAL,
    poll-PDU             Poll-PDU                 OPTIONAL,
    poll-SDU             Poll-SDU                 OPTIONAL,
    lastTransmissionPDU-Poll    BOOLEAN,
    lastRetransmissionPDU-Poll  BOOLEAN,
    pollWindow           PollWindow               OPTIONAL,
    timerPollPeriodic    TimerPollPeriodic        OPTIONAL
}

PollWindow ::= ENUMERATED {
    pw50, pw60, pw70, pw80, pw85,
    pw90, pw95, pw99 }

PredefinedConfigIdentity ::= INTEGER (0..15)

PredefinedConfigValueTag ::= INTEGER (0..15)

PredefinedRB-Configuration ::= SEQUENCE {
    re-EstablishmentTimer    Re-EstablishmentTimer,
    srb-InformationList       SRB-InformationSetupList,
    rb-InformationList        RB-InformationSetupList
}

PreDefRadioConfiguration ::= SEQUENCE {
    -- Radio bearer IEs
    predefinedRB-Configuration    PredefinedRB-Configuration,
    -- Transport channel IEs
    preDefTransChConfiguration    PreDefTransChConfiguration,
    -- Physical channel IEs
    preDefPhyChConfiguration      PreDefPhyChConfiguration
}

RAB-Info ::= SEQUENCE {
    rab-Identity          RAB-Identity,
    cn-DomainIdentity     CN-DomainIdentity,
    nas-Synchronisation-Indicator    NAS-Synchronisation-Indicator    OPTIONAL,
    re-EstablishmentTimer    Re-EstablishmentTimer
}

RAB-InformationList ::= SEQUENCE (SIZE (1..maxRABsetup)) OF
    RAB-Info

RAB-InformationReconfigList ::= SEQUENCE (SIZE (1.. maxRABsetup)) OF
    RAB-InformationReconfig

RAB-InformationReconfig ::= SEQUENCE {
    rab-Identity          RAB-Identity,
    cn-DomainIdentity     CN-DomainIdentity,
    nas-Synchronisation-Indicator    NAS-Synchronisation-Indicator
}

RAB-Info-Post ::= SEQUENCE {
    rab-Identity          RAB-Identity,
    cn-DomainIdentity     CN-DomainIdentity,
    nas-Synchronisation-Indicator    NAS-Synchronisation-Indicator    OPTIONAL
}

RAB-InformationSetup ::= SEQUENCE {
    rab-Info              RAB-Info,
    rb-InformationSetupList    RB-InformationSetupList
}

```



```

}
RAB-InformationSetup-r4 ::= SEQUENCE {
    rab-Info
    rb-InformationSetupList
}
RAB-InformationSetupList ::= SEQUENCE (SIZE (1..maxRABsetup)) OF
    RAB-InformationSetup
RAB-InformationSetupList-r4 ::= SEQUENCE (SIZE (1..maxRABsetup)) OF
    RAB-InformationSetup-r4
RB-ActivationTimeInfo ::= SEQUENCE {
    rb-Identity
    rlc-SequenceNumber
}
RB-ActivationTimeInfoList ::= SEQUENCE (SIZE (1..maxRB)) OF
    RB-ActivationTimeInfo
RB-COUNT-C-Information ::= SEQUENCE {
    rb-Identity
    count-C-UL
    count-C-DL
}
RB-COUNT-C-InformationList ::= SEQUENCE (SIZE (1..maxRBallRABs)) OF
    RB-COUNT-C-Information
RB-COUNT-C-MSB-Information ::= SEQUENCE {
    rb-Identity
    count-C-MSB-UL
    count-C-MSB-DL
}
RB-COUNT-C-MSB-InformationList ::= SEQUENCE (SIZE (1..maxRBallRABs)) OF
    RB-COUNT-C-MSB-Information
RB-Identity ::= INTEGER (1..32)
RB-IdentityList ::= SEQUENCE (SIZE (1..maxRB)) OF
    RB-Identity
RB-InformationAffected ::= SEQUENCE {
    rb-Identity
    rb-MappingInfo
}
RB-InformationAffectedList ::= SEQUENCE (SIZE (1..maxRB)) OF
    RB-InformationAffected
RB-InformationReconfig ::= SEQUENCE {
    rb-Identity
    pdcp-Info
    pdcp-SN-Info
    rlc-Info
    rb-MappingInfo
    rb-StopContinue
}
RB-InformationReconfig-r4 ::= SEQUENCE {
    rb-Identity
    pdcp-Info
    rlc-Info
    rb-MappingInfo
    rb-StopContinue
}
RB-InformationReconfigList ::= SEQUENCE (SIZE (1..maxRB)) OF
    RB-InformationReconfig
RB-InformationReconfigList-r4 ::= SEQUENCE (SIZE (1..maxRB)) OF
    RB-InformationReconfig-r4
RB-InformationReleaseList ::= SEQUENCE (SIZE (1..maxRB)) OF
    RB-Identity

```

```

RB-InformationSetup ::= SEQUENCE {
    rb-Identity          RB-Identity,
    pdcp-Info           PDCP-Info           OPTIONAL,
    rlc-InfoChoice      RLC-InfoChoice,
    rb-MappingInfo      RB-MappingInfo
}

RB-InformationSetup-r4 ::= SEQUENCE {
    rb-Identity          RB-Identity,
    pdcp-Info           PDCP-Info-r4       OPTIONAL,
    rlc-Info            RLC-Info,
    rb-MappingInfo      RB-MappingInfo
}

RB-InformationSetupList ::= SEQUENCE (SIZE (1..maxRBperRAB)) OF
    RB-InformationSetup

RB-InformationSetupList-r4 ::= SEQUENCE (SIZE (1..maxRBperRAB)) OF
    RB-InformationSetup-r4

RB-MappingInfo ::= SEQUENCE (SIZE (1..maxRBMuxOptions)) OF
    RB-MappingOption

RB-MappingOption ::= SEQUENCE {
    ul-LogicalChannelMappings UL-LogicalChannelMappings OPTIONAL,
    dl-LogicalChannelMappingList DL-LogicalChannelMappingList OPTIONAL
}

RB-StopContinue ::= ENUMERATED {
    stopRB, continueRB }

RB-WithPDCP-Info ::= SEQUENCE {
    rb-Identity          RB-Identity,
    pdcp-SN-Info        PDCP-SN-Info
}

RB-WithPDCP-InfoList ::= SEQUENCE (SIZE (1..maxRBallRABs)) OF
    RB-WithPDCP-Info

ReceivingWindowSize ::= ENUMERATED {
    rw1, rw8, rw16, rw32, rw64, rw128, rw256,
    rw512, rw768, rw1024, rw1536, rw2047,
    rw2560, rw3072, rw3584, rw4095 }

RFC2507-Info ::= SEQUENCE {
    f-MAX-PERIOD        INTEGER (1..65535)           DEFAULT 256,
    f-MAX-TIME          INTEGER (1..255)           DEFAULT 5,
    max-HEADER          INTEGER (60..65535)        DEFAULT 168,
    tcp-SPACE           INTEGER (3..255)           DEFAULT 15,
    non-TCP-SPACE       INTEGER (3..65535)         DEFAULT 15,
    expectReordering    ExpectReordering
    -- TABULAR: The IE above has only two possible values, so using Optional or Default
    -- would be wasteful
}

RFC3095-Info-r4 ::= SEQUENCE {
    max-CID             INTEGER (1..16383)          DEFAULT 15,
    rohcProfileList     ROHC-ProfileList-r4,
    mrru               INTEGER (0..65535)          DEFAULT 0,
    rohcPacketSizeList ROHC-PacketSizeList-r4,
    reverseDecompressionDepth INTEGER (0..65535)     DEFAULT 0
}

RLC-Info ::= SEQUENCE {
    ul-RLC-Mode        UL-RLC-Mode           OPTIONAL,
    dl-RLC-Mode        DL-RLC-Mode           OPTIONAL
}

RLC-InfoChoice ::= CHOICE {
    rlc-Info           RLC-Info,
    same-as-RB         RB-Identity
}

RLC-SequenceNumber ::= INTEGER (0..4095)

RLC-SizeInfo ::= SEQUENCE {
    rlc-SizeIndex      INTEGER (1..maxTF)
}

```

```

RLC-SizeExplicitList ::= SEQUENCE (SIZE (1..maxTF)) OF
                          RLC-SizeInfo

ROHC-Profile-r4 ::= INTEGER (1..3)

ROHC-ProfileList-r4 ::= SEQUENCE (SIZE (1..maxROHC-Profile-r4)) OF
                          ROHC-Profile-r4

ROHC-PacketSize-r4 ::= INTEGER (2..1500)

ROHC-PacketSizeList-r4 ::= SEQUENCE (SIZE (1..maxROHC-PacketSizes-r4)) OF
                             ROHC-PacketSize-r4

SRB-InformationSetup ::= SEQUENCE {
  rb-Identity                RB-Identity                OPTIONAL,
  -- The default value for the IE above is the smallest value not used yet.
  rlc-InfoChoice             RLC-InfoChoice,
  rb-MappingInfo            RB-MappingInfo
}

SRB-InformationSetupList ::= SEQUENCE (SIZE (1..maxSRBsetup)) OF
                              SRB-InformationSetup

SRB-InformationSetupList2 ::= SEQUENCE (SIZE (3..4)) OF
                               SRB-InformationSetup

TimerDiscard ::= ENUMERATED {
  td0-1, td0-25, td0-5, td0-75,
  td1, td1-25, td1-5, td1-75,
  td2, td2-5, td3, td3-5, td4,
  td4-5, td5, td7-5 }

TimerEPC ::= ENUMERATED {
  te50, te60, te70, te80, te90,
  te100, te120, te140, te160, te180,
  te200, te300, te400, te500, te700,
  te900 }

TimerMRW ::= ENUMERATED {
  te50, te60, te70, te80, te90, te100,
  te120, te140, te160, te180, te200,
  te300, te400, te500, te700, te900 }

TimerPoll ::= ENUMERATED {
  tp10, tp20, tp30, tp40, tp50,
  tp60, tp70, tp80, tp90, tp100,
  tp110, tp120, tp130, tp140, tp150,
  tp160, tp170, tp180, tp190, tp200,
  tp210, tp220, tp230, tp240, tp250,
  tp260, tp270, tp280, tp290, tp300,
  tp310, tp320, tp330, tp340, tp350,
  tp360, tp370, tp380, tp390, tp400,
  tp410, tp420, tp430, tp440, tp450,
  tp460, tp470, tp480, tp490, tp500,
  tp510, tp520, tp530, tp540, tp550,
  tp600, tp650, tp700, tp750, tp800,
  tp850, tp900, tp950, tp1000 }

TimerPollPeriodic ::= ENUMERATED {
  tper100, tper200, tper300, tper400,
  tper500, tper750, tper1000, tper2000 }

TimerPollProhibit ::= ENUMERATED {
  tpp10, tpp20, tpp30, tpp40, tpp50,
  tpp60, tpp70, tpp80, tpp90, tpp100,
  tpp110, tpp120, tpp130, tpp140, tpp150,
  tpp160, tpp170, tpp180, tpp190, tpp200,
  tpp210, tpp220, tpp230, tpp240, tpp250,
  tpp260, tpp270, tpp280, tpp290, tpp300,
  tpp310, tpp320, tpp330, tpp340, tpp350,
  tpp360, tpp370, tpp380, tpp390, tpp400,
  tpp410, tpp420, tpp430, tpp440, tpp450,
  tpp460, tpp470, tpp480, tpp490, tpp500,
  tpp510, tpp520, tpp530, tpp540, tpp550,
  tpp600, tpp650, tpp700, tpp750, tpp800,
  tpp850, tpp900, tpp950, tpp1000 }

```

```

TimerRST ::=
    ENUMERATED {
        tr50, tr100, tr150, tr200, tr250, tr300,
        tr350, tr400, tr450, tr500, tr550,
        tr600, tr700, tr800, tr900, tr1000 }

TimerStatusPeriodic ::=
    ENUMERATED {
        tsp100, tsp200, tsp300, tsp400, tsp500,
        tsp750, tsp1000, tsp2000 }

TimerStatusProhibit ::=
    ENUMERATED {
        tsp10, tsp20, tsp30, tsp40, tsp50,
        tsp60, tsp70, tsp80, tsp90, tsp100,
        tsp110, tsp120, tsp130, tsp140, tsp150,
        tsp160, tsp170, tsp180, tsp190, tsp200,
        tsp210, tsp220, tsp230, tsp240, tsp250,
        tsp260, tsp270, tsp280, tsp290, tsp300,
        tsp310, tsp320, tsp330, tsp340, tsp350,
        tsp360, tsp370, tsp380, tsp390, tsp400,
        tsp410, tsp420, tsp430, tsp440, tsp450,
        tsp460, tsp470, tsp480, tsp490, tsp500,
        tsp510, tsp520, tsp530, tsp540, tsp550,
        tsp600, tsp650, tsp700, tsp750, tsp800,
        tsp850, tsp900, tsp950, tsp1000 }

TransmissionRLC-Discard ::=
    timerBasedExplicit
    timerBasedNoExplicit
    maxDAT-Retransmissions
    noDiscard
    CHOICE {
        ExplicitDiscard,
        NoExplicitDiscard,
        MaxDAT-Retransmissions,
        MaxDAT
    }

TransmissionWindowSize ::=
    ENUMERATED {
        tw1, tw8, tw16, tw32, tw64, tw128, tw256,
        tw512, tw768, tw1024, tw1536, tw2047,
        tw2560, tw3072, tw3584, tw4095 }

UL-AM-RLC-Mode ::=
    transmissionRLC-Discard
    transmissionWindowSize
    timerRST
    max-RST
    pollingInfo
    SEQUENCE {
        TransmissionRLC-Discard,
        TransmissionWindowSize,
        TimerRST,
        MaxRST,
        PollingInfo
    } OPTIONAL

UL-CounterSynchronisationInfo ::=
    rB-WithPDCP-InfoList
    startList
    SEQUENCE {
        RB-WithPDCP-InfoList
        STARTList
    } OPTIONAL

UL-LogicalChannelMapping ::=
    -- TABULAR: UL-TransportChannelType contains TransportChannelIdentity as well.
    ul-TransportChannelType
    logicalChannelIdentity
    rlc-SizeList
    allSizes
    configured
    explicitList
    },
    mac-LogicalChannelPriority
    SEQUENCE {
        UL-TransportChannelType,
        LogicalChannelIdentity
    } OPTIONAL,
    CHOICE {
        NULL,
        NULL,
        RLC-SizeExplicitList
    }
    MAC-LogicalChannelPriority

UL-LogicalChannelMappingList ::=
    rlc-LogicalChannelMappingIndicator
    ul-LogicalChannelMapping
    SEQUENCE {
        BOOLEAN,
        SEQUENCE (SIZE (maxLoCHperRLC)) OF
        UL-LogicalChannelMapping
    }
    -- NOTE: This parameter shall be set to TRUE in
    this release

UL-LogicalChannelMappings ::=
    oneLogicalChannel
    twoLogicalChannels
    CHOICE {
        UL-LogicalChannelMapping,
        UL-LogicalChannelMappingList
    }

UL-RLC-Mode ::=
    ul-AM-RLC-Mode
    ul-UM-RLC-Mode
    ul-TM-RLC-Mode
    spare
    CHOICE {
        UL-AM-RLC-Mode,
        UL-UM-RLC-Mode,
        UL-TM-RLC-Mode,
        NULL
    }

```

```

}

UL-TM-RLC-Mode ::=
    transmissionRLC-Discard      SEQUENCE {
    segmentationIndication      BOOLEAN
    }
    OPTIONAL,

UL-UM-RLC-Mode ::=
    transmissionRLC-Discard      SEQUENCE {
    }
    OPTIONAL

UL-TransportChannelType ::=
    dch                          CHOICE {
    rach                          TransportChannelIdentity,
    cpch                          NULL,
    usch                          TransportChannelIdentity
    }

-- *****
--
-- TRANSPORT CHANNEL INFORMATION ELEMENTS (10.3.5)
--
-- *****

AllowedTFC-List ::=
    SEQUENCE (SIZE (1..maxTFC)) OF
    TFC-Value

AllowedTFI-List ::=
    SEQUENCE (SIZE (1..maxTF)) OF
    INTEGER (0..31)

BitModeRLC-SizeInfo ::=
    CHOICE {
    sizeType1                    INTEGER (0..127),
    sizeType2                    SEQUENCE {
    part1                        INTEGER (0..15),
    part2                        INTEGER (1..7)
    -- Actual size = (part1 * 8) + 128 + part2
    },
    sizeType3                    SEQUENCE {
    part1                        INTEGER (0..47),
    part2                        INTEGER (1..15)
    -- Actual size = (part1 * 16) + 256 + part2
    },
    sizeType4                    SEQUENCE {
    part1                        INTEGER (0..62),
    part2                        INTEGER (1..63)
    -- Actual size = (part1 * 64) + 1024 + part2
    }
    }
    }
-- Actual value = IE value * 0.1
BLER-QualityValue ::=
    INTEGER (-63..0)

ChannelCodingType ::=
    CHOICE {
    noCoding                      NULL,
    convolutional                 CodingRate,
    turbo                         NULL
    }

CodingRate ::=
    ENUMERATED {
    half,
    third
    }

CommonDynamicTF-Info ::=
    SEQUENCE {
    rlc-Size                      CHOICE {
    fdd                          SEQUENCE {
    octetModeRLC-SizeInfoType2  OctetModeRLC-SizeInfoType2
    },
    tdd                          SEQUENCE {
    commonTDD-Choice            CHOICE {
    bitModeRLC-SizeInfo        BitModeRLC-SizeInfo,
    octetModeRLC-SizeInfoType1 OctetModeRLC-SizeInfoType1
    }
    }
    },
    numberOfTbSizeList           SEQUENCE (SIZE (1..maxTF)) OF
    NumberOfTransportBlocks,
    logicalChannelList           LogicalChannelList
    }

```

```

CommonDynamicTF-Info-DynamicTTI ::= SEQUENCE {
    commonTDD-Choice          CHOICE {
        bitModeRLC-SizeInfo      BitModeRLC-SizeInfo,
        octetModeRLC-SizeInfoType1 OctetModeRLC-SizeInfoType1
    },
    numberOfTbSizeAndTTIList    NumberOfTbSizeAndTTIList,
    logicalChannelList          LogicalChannelList
}

CommonDynamicTF-InfoList ::= SEQUENCE (SIZE (1..maxTF)) OF
    CommonDynamicTF-Info

CommonDynamicTF-InfoList-DynamicTTI ::= SEQUENCE (SIZE (1..maxTF)) OF
    CommonDynamicTF-Info-DynamicTTI

CommonTransChTFS ::= SEQUENCE {
    tti          CHOICE {
        tti10      CommonDynamicTF-InfoList,
        tti20      CommonDynamicTF-InfoList,
        tti40      CommonDynamicTF-InfoList,
        tti80      CommonDynamicTF-InfoList,
        dynamic    CommonDynamicTF-InfoList-DynamicTTI
    },
    semistaticTF-Information SemistaticTF-Information
}

CommonTransChTFS-LCR ::= SEQUENCE {
    tti          CHOICE {
        tti5      CommonDynamicTF-InfoList,
        tti10     CommonDynamicTF-InfoList,
        tti20     CommonDynamicTF-InfoList,
        tti40     CommonDynamicTF-InfoList,
        tti80     CommonDynamicTF-InfoList,
        dynamic   CommonDynamicTF-InfoList-DynamicTTI
    },
    semistaticTF-Information SemistaticTF-Information
}

CPCH-SetID ::= INTEGER (1..maxCPCHsets)

CRC-Size ::= ENUMERATED {
    crc0, crc8, crc12, crc16, crc24 }

DedicatedDynamicTF-Info ::= SEQUENCE {
    rlc-Size          CHOICE {
        bitMode      BitModeRLC-SizeInfo,
        octetModeType1 OctetModeRLC-SizeInfoType1
    },
    numberOfTbSizeList SEQUENCE (SIZE (1..maxTF)) OF
    NumberOfTransportBlocks,
    logicalChannelList LogicalChannelList
}

DedicatedDynamicTF-Info-DynamicTTI ::= SEQUENCE {
    rlc-Size          CHOICE {
        bitMode      BitModeRLC-SizeInfo,
        octetModeType1 OctetModeRLC-SizeInfoType1
    },
    numberOfTbSizeAndTTIList    NumberOfTbSizeAndTTIList,
    logicalChannelList          LogicalChannelList
}

DedicatedDynamicTF-InfoList ::= SEQUENCE (SIZE (1..maxTF)) OF
    DedicatedDynamicTF-Info

DedicatedDynamicTF-InfoList-DynamicTTI ::= SEQUENCE (SIZE (1..maxTF)) OF
    DedicatedDynamicTF-Info-DynamicTTI

DedicatedTransChTFS ::= SEQUENCE {
    tti          CHOICE {
        tti10      DedicatedDynamicTF-InfoList,
        tti20      DedicatedDynamicTF-InfoList,
        tti40      DedicatedDynamicTF-InfoList,
        tti80      DedicatedDynamicTF-InfoList,
        dynamic    DedicatedDynamicTF-InfoList-DynamicTTI
    },
    semistaticTF-Information SemistaticTF-Information
}

```

```

}

DL-AddReconfTransChInfo2List ::= SEQUENCE (SIZE (1..maxTrCH)) OF
    DL-AddReconfTransChInformation2

DL-AddReconfTransChInfoList ::= SEQUENCE (SIZE (1..maxTrCH)) OF
    DL-AddReconfTransChInformation

-- ASN.1 for IE "Added or Reconfigured DL TrCH information"
-- in case of messages other than: Radio Bearer Release message and
-- Radio Bearer Reconfiguration message
DL-AddReconfTransChInformation ::= SEQUENCE {
    dl-TransportChannelType      DL-TrCH-Type,
    dl-transportChannelIdentity  TransportChannelIdentity,
    tfs-SignallingMode          CHOICE {
        explicit                TransportFormatSet,
        sameAsULTrCH           UL-TransportChannelIdentity
    },
    dch-QualityTarget           QualityTarget                OPTIONAL,
    tm-SignallingInfo           TM-SignallingInfo           OPTIONAL
}

-- ASN.1 for IE "Added or Reconfigured DL TrCH information"
-- in case of Radio Bearer Release message and
-- Radio Bearer Reconfiguration message
DL-AddReconfTransChInformation2 ::= SEQUENCE {
    dl-TransportChannelType      DL-TrCH-Type,
    transportChannelIdentity     TransportChannelIdentity,
    tfs-SignallingMode          CHOICE {
        explicit                TransportFormatSet,
        sameAsULTrCH           UL-TransportChannelIdentity
    },
    qualityTarget               QualityTarget                OPTIONAL
}

DL-CommonTransChInfo ::= SEQUENCE {
    sccpch-TFCS                 TFCS                    OPTIONAL,
    modeSpecificInfo            CHOICE {
        fdd                     SEQUENCE {
            dl-Parameters        CHOICE {
                dl-DCH-TFCS      TFCS,
                sameAsUL         NULL
            }
        },
        tdd                     SEQUENCE {
            individualDL-CCTrCH-InfoList IndividualDL-CCTrCH-InfoList OPTIONAL
        }
    }
}

-- NOTE: CHOICE modeSpecificInfo should be optional. A new version of this IE
-- should be defined to be used in later versions of messages using this IE

DL-CommonTransChInfo-r4 ::= SEQUENCE {
    sccpch-TFCS                 TFCS                    OPTIONAL,
    modeSpecificInfo            CHOICE {
        fdd                     SEQUENCE {
            dl-Parameters        CHOICE {
                dl-DCH-TFCS      SEQUENCE {
                    tfcs          TFCS                    OPTIONAL
                },
                sameAsUL         NULL
            }
        },
        tdd                     SEQUENCE {
            individualDL-CCTrCH-InfoList IndividualDL-CCTrCH-InfoList OPTIONAL
        }
    }
}

DL-DeletedTransChInfoList ::= SEQUENCE (SIZE (1..maxTrCH)) OF
    DL-TransportChannelIdentity

DL-TransportChannelIdentity ::= SEQUENCE {
    dl-TransportChannelType      DL-TrCH-Type,
    dl-TransportChannelIdentity  TransportChannelIdentity
}

```

```

DL-TrCH-Type ::= ENUMERATED {dch, dsch}

DRAC-ClassIdentity ::= INTEGER (1..maxDRACclasses)

DRAC-StaticInformation ::= SEQUENCE {
    transmissionTimeValidity    TransmissionTimeValidity,
    timeDurationBeforeRetry     TimeDurationBeforeRetry,
    drac-ClassIdentity          DRAC-ClassIdentity
}

DRAC-StaticInformationList ::= SEQUENCE (SIZE (1..maxTrCH)) OF
    DRAC-StaticInformation

ExplicitTFCS-Configuration ::= CHOICE {
    complete                    TFCS-ReconfAdd,
    addition                    TFCS-ReconfAdd,
    removal                     TFCS-RemovalList,
    replacement                 SEQUENCE {
        tfcsRemoval            TFCS-RemovalList,
        tfcsAdd                 TFCS-ReconfAdd
    }
}

GainFactor ::= INTEGER (0..15)

GainFactorInformation ::= CHOICE {
    signalledGainFactors        SignalledGainFactors,
    computedGainFactors         ReferenceTFC-ID
}

IndividualDL-CCTrCH-Info ::= SEQUENCE {
    dl-TFCS-Identity            TFCS-Identity,
    tfcs-SignallingMode        CHOICE {
        explicit                TFCS,
        sameAsUL                TFCS-Identity
    }
}

IndividualDL-CCTrCH-InfoList ::= SEQUENCE (SIZE (1..maxCCTrCH)) OF
    IndividualDL-CCTrCH-Info

IndividualUL-CCTrCH-Info ::= SEQUENCE {
    ul-TFCS-Identity            TFCS-Identity,
    ul-TFCS                     TFCS,
    tfc-Subset                  TFC-Subset
}

IndividualUL-CCTrCH-InfoList ::= SEQUENCE (SIZE (1..maxCCTrCH)) OF
    IndividualUL-CCTrCH-Info

LogicalChannelByRB ::= SEQUENCE {
    rb-Identity                 RB-Identity,
    logChOfRb                   INTEGER (0..1)
}

LogicalChannelList ::= CHOICE {
    allSizes                     NULL,
    configured                   NULL,
    explicitList                 SEQUENCE (SIZE (1..15)) OF
        LogicalChannelByRB
}

NumberOfTbSizeAndTTIList ::= SEQUENCE (SIZE (1..maxTF)) OF SEQUENCE {
    numberOfTransportBlocks      NumberOfTransportBlocks,
    transmissionTimeInterval     TransmissionTimeInterval
}

MessType ::= ENUMERATED {
    transportFormatCombinationControl
}

Non-allowedTFC-List ::= SEQUENCE (SIZE (1..maxTFC)) OF
    TFC-Value

NumberOfTransportBlocks ::= CHOICE {
    zero                         NULL,
    one                          NULL,
    small                        INTEGER (2..17),
}

```



```

    large                INTEGER (18..512)
  }

OctetModeRLC-SizeInfoType1 ::= CHOICE {
  sizeType1              INTEGER (0..31),
  -- Actual size = (8 * sizeType1) + 16
  sizeType2              SEQUENCE {
    part1                INTEGER (0..23),
    part2                INTEGER (1..3)                OPTIONAL
  },
  -- Actual size = (32 * part1) + 272 + (part2 * 8)
  sizeType3              SEQUENCE {
    part1                INTEGER (0..61),
    part2                INTEGER (1..7)                OPTIONAL
  },
  -- Actual size = (64 * part1) + 1040 + (part2 * 8)
}

OctetModeRLC-SizeInfoType2 ::= CHOICE {
  sizeType1              INTEGER (0..31),
  -- Actual size = (sizeType1 * 8) + 48
  sizeType2              INTEGER (0..63),
  -- Actual size = (sizeType2 * 16) + 312
  sizeType3              INTEGER (0..56),
  -- Actual size = (sizeType3 * 64) + 1384
}

PowerOffsetInformation ::= SEQUENCE {
  gainFactorInformation  GainFactorInformation,
  -- PowerOffsetPp-m is always absent in TDD
  powerOffsetPp-m       PowerOffsetPp-m                OPTIONAL
}

PowerOffsetPp-m ::= INTEGER (-5..10)

PreDefTransChConfiguration ::= SEQUENCE {
  ul-CommonTransChInfo  UL-CommonTransChInfo,
  ul-AddReconfTrChInfoList UL-AddReconfTransChInfoList,
  dl-CommonTransChInfo  DL-CommonTransChInfo,
  dl-TrChInfoList       DL-AddReconfTransChInfoList
}

QualityTarget ::= SEQUENCE {
  bler-QualityValue     BLER-QualityValue
}

RateMatchingAttribute ::= INTEGER (1..hiRM)

ReferenceTFC-ID ::= INTEGER (0..3)

RestrictedTrChInfo ::= SEQUENCE {
  ul-TransportChannelType UL-TrCH-Type,
  restrictedTrChIdentity  TransportChannelIdentity,
  allowedTFI-List        AllowedTFI-List                OPTIONAL
}

RestrictedTrChInfoList ::= SEQUENCE (SIZE (1..maxTrCH)) OF
  RestrictedTrChInfo

SemistaticTF-Information ::= SEQUENCE {
  -- TABULAR: Transmission time interval has been included in the IE CommonTransChTFS.
  channelCodingType      ChannelCodingType,
  rateMatchingAttribute  RateMatchingAttribute,
  crc-Size               CRC-Size
}

SignalledGainFactors ::= SEQUENCE {
  modeSpecificInfo      CHOICE {
    fdd                  SEQUENCE {
      gainFactorBetaC    GainFactor
    },
    tdd                  NULL
  },
  gainFactorBetaD        GainFactor,
  referenceTFC-ID        ReferenceTFC-ID                OPTIONAL
}

```

```

SplitTFCI-Signalling ::=
    splitType
    tfci-Field2-Length
    tfci-Field1-Information
    tfci-Field2-Information
}

SplitType ::=
    ENUMERATED {
        hardSplit, logicalSplit }

TFC-Subset ::=
    minimumAllowedTFC-Number
    allowedTFC-List
    non-allowedTFC-List
    restrictedTrChInfoList
    fullTFCS
}

TFC-Value ::=
    INTEGER (0..1023)

TFCI-Field2-Information ::=
    tfci-Range
    explicit
}

TFCI-Range ::=
    maxTFCIField2Value
    tfcs-InfoForDSCH
}

TFCI-RangeList ::=
    SEQUENCE (SIZE (1..maxPDSCH-TFCIgroups)) OF
        TFCI-Range

TFCS ::=
    normalTFCI-Signalling
    splitTFCI-Signalling
}

TFCS-Identity ::=
    tfcs-ID
    sharedChannelIndicator
}

TFCS-IdentityPlain ::=
    INTEGER (1..8)

TFCS-InfoForDSCH ::=
    ctfc2bit
    ctfc4bit
    ctfc6bit
    ctfc8bit
    ctfc12bit
    ctfc16bit
    ctfc24bit
}

TFCS-ReconfAdd ::=
    ctfcSize
    ctfc2Bit
        ctfc2
        powerOffsetInformation
    },
    ctfc4Bit
        ctfc4
        powerOffsetInformation
    },
    ctfc6Bit
        ctfc6
        powerOffsetInformation
    },
    ctfc8Bit
        ctfc8
        powerOffsetInformation
    },
    ctfc12Bit
        ctfc12
        powerOffsetInformation
    },
    ctfc16Bit
}

SEQUENCE {
    SplitType
    INTEGER (1..10)
    ExplicitTFCS-Configuration
    TFCI-Field2-Information
    OPTIONAL,
    OPTIONAL,
    OPTIONAL,
    OPTIONAL
}

CHOICE {
    TFC-Value,
    AllowedTFC-List,
    Non-allowedTFC-List,
    RestrictedTrChInfoList,
    NULL
}

CHOICE {
    TFCI-RangeList,
    ExplicitTFCS-Configuration
}

SEQUENCE {
    INTEGER (1..1023),
    TFCS-InfoForDSCH
}

SEQUENCE (SIZE (1..maxPDSCH-TFCIgroups)) OF
    TFCI-Range

CHOICE {
    ExplicitTFCS-Configuration,
    SplitTFCI-Signalling
}

SEQUENCE {
    TFCS-IdentityPlain
    BOOLEAN
    DEFAULT 1,
}

INTEGER (1..8)

CHOICE {
    INTEGER (0..3),
    INTEGER (0..15),
    INTEGER (0..63),
    INTEGER (0..255),
    INTEGER (0..4095),
    INTEGER (0..65535),
    INTEGER (0..16777215)
}

SEQUENCE{
    CHOICE{
        SEQUENCE (SIZE (1..maxTFC)) OF SEQUENCE {
            INTEGER (0..3),
            PowerOffsetInformation
            OPTIONAL
        },
        SEQUENCE (SIZE (1..maxTFC)) OF SEQUENCE {
            INTEGER (0..15),
            PowerOffsetInformation
            OPTIONAL
        },
        SEQUENCE (SIZE (1..maxTFC)) OF SEQUENCE {
            INTEGER (0..63),
            PowerOffsetInformation
            OPTIONAL
        },
        SEQUENCE (SIZE (1..maxTFC)) OF SEQUENCE {
            INTEGER (0..255),
            PowerOffsetInformation
            OPTIONAL
        },
        SEQUENCE (SIZE (1..maxTFC)) OF SEQUENCE {
            INTEGER (0..4095),
            PowerOffsetInformation
            OPTIONAL
        },
        SEQUENCE (SIZE (1..maxTFC)) OF SEQUENCE {
}

```

```

        ctfc16                INTEGER(0..65535),
        powerOffsetInformation PowerOffsetInformation    OPTIONAL
    },
    ctfc24Bit                SEQUENCE (SIZE (1..maxTFC)) OF SEQUENCE {
        ctfc24                INTEGER(0..16777215),
        powerOffsetInformation PowerOffsetInformation    OPTIONAL
    }
}

TFCS-Removal ::= SEQUENCE {
    tfci                INTEGER (0..1023)
}

TFCS-RemovalList ::= SEQUENCE (SIZE (1..maxTFC)) OF
    TFCS-Removal

TimeDurationBeforeRetry ::= INTEGER (1..256)

TM-SignallingInfo ::= SEQUENCE {
    messType            MessType,
    tm-SignallingMode   CHOICE {
        model            NULL,
        mode2            SEQUENCE {
            --TrCH-Type is always DCH
            ul-controlledTrChList    UL-ControlledTrChList
        }
    }
}

TransmissionTimeInterval ::= ENUMERATED {
    tti10, tti20, tti40, tti80 }

TransmissionTimeValidity ::= INTEGER (1..256)

TransportChannelIdentity ::= INTEGER (1..32)

TransportChannelIdentityDCHandDSCH ::= SEQUENCE {
    dch-transport-ch-id    TransportChannelIdentity,
    dsch-transport-ch-id    TransportChannelIdentity
}

TransportFormatSet ::= CHOICE {
    dedicatedTransChTFS    DedicatedTransChTFS,
    commonTransChTFS        CommonTransChTFS
}

TransportFormatSet-LCR ::= CHOICE {
    dedicatedTransChTFS    DedicatedTransChTFS,
    commonTransChTFS-LCR    CommonTransChTFS-LCR
}

UL-AddReconfTransChInfoList ::= SEQUENCE (SIZE (1..maxTrCH)) OF
    UL-AddReconfTransChInformation

UL-AddReconfTransChInformation ::= SEQUENCE {
    ul-TransportChannelType    UL-TrCH-Type,
    transportChannelIdentity    TransportChannelIdentity,
    transportFormatSet          TransportFormatSet
}

UL-CommonTransChInfo ::= SEQUENCE {
    -- TABULAR: this tfc-subset IE is applicable to FDD only, TDD specifies tfc-subset in individual
    -- CTrCH Info.
    tfc-Subset                TFC-Subset                OPTIONAL,
    prach-TFCS                TFCS                    OPTIONAL,
    modeSpecificInfo          CHOICE {
        fdd                    SEQUENCE {
            ul-TFCS            TFCS
        },
        tdd                    SEQUENCE {
            individualUL-CCTrCH-InfoList    IndividualUL-CCTrCH-InfoList
        }
    }
}
}
OPTIONAL
OPTIONAL
OPTIONAL

```

```

-- TrCH-Type is always DCH
UL-ControlledTrChList ::= SEQUENCE (SIZE (1..maxTrCH)) OF
                           TransportChannelIdentity

UL-DeletedTransChInfoList ::= SEQUENCE (SIZE (1..maxTrCH)) OF
                               UL-TransportChannelIdentity

UL-TransportChannelIdentity ::= SEQUENCE {
    ul-TransportChannelType    UL-TrCH-Type,
    ul-TransportChannelIdentity TransportChannelIdentity
}

UL-TrCH-Type ::= ENUMERATED {dch, usch}

-- *****
--
--     PHYSICAL CHANNEL INFORMATION ELEMENTS (10.3.6)
--
-- *****

AC-To-ASC-Mapping ::= INTEGER (0..7)

AC-To-ASC-MappingTable ::= SEQUENCE (SIZE (maxASCmap)) OF
                            AC-To-ASC-Mapping

AccessServiceClass-FDD ::= SEQUENCE {
    availableSignatureStartIndex    INTEGER (0..15),
    availableSignatureEndIndex      INTEGER (0..15),

    assignedSubChannelNumber        BIT STRING {
                                    b3(0),
                                    b2(1),
                                    b1(2),
                                    b0(3)
                                    } (SIZE(4))
}

AccessServiceClass-TDD ::= SEQUENCE {
    channelisationCodeIndices       BIT STRING {
                                    chCodeIndex0(0),
                                    chCodeIndex1(1),
                                    chCodeIndex2(2),
                                    chCodeIndex3(3),
                                    chCodeIndex4(4),
                                    chCodeIndex5(5),
                                    chCodeIndex6(6),
                                    chCodeIndex7(7)
                                    } (SIZE(8)) OPTIONAL,

    subchannelSize                  CHOICE {
        size1                        NULL,
        size2                        SEQUENCE {
            subchannels              ENUMERATED { subch0, subch1 } OPTIONAL
        },
        size4                        SEQUENCE {
            subchannels              BIT STRING {
                                    subCh3(0),
                                    subCh2(1),
                                    subCh1(2),
                                    subCh0(3)
                                    } (SIZE(4)) OPTIONAL
            },
        size8                        SEQUENCE {
            subchannels              BIT STRING {
                                    subCh7(0),
                                    subCh6(1),
                                    subCh5(2),
                                    subCh4(3),
                                    subCh3(4),
                                    subCh2(5),
                                    subCh1(6),
                                    subCh0(7)
                                    } (SIZE(8)) OPTIONAL
            }
        }
}

AccessServiceClass-TDD-LCR-r4 ::= SEQUENCE {

```

```

availableSYNC-UlCodesIndics      BIT STRING {
                                   sulCodeIndex0(0),
                                   sulCodeIndex1(1),
                                   sulCodeIndex2(2),
                                   sulCodeIndex3(3),
                                   sulCodeIndex4(4),
                                   sulCodeIndex5(5),
                                   sulCodeIndex6(6),
                                   sulCodeIndex7(7)
                                   } (SIZE(8))                                OPTIONAL,

subchannelSize                    CHOICE {
  size1                            NULL,
-- in size2, subch0 means bitstring '01' in the tabular, subch1 means bitsring '10'.
  size2                            SEQUENCE {
    subchannels                     ENUMERATED { subch0, subch1 } OPTIONAL
  },
  size4                            SEQUENCE {
    subchannels                     BIT STRING {
                                   subCh3(0),
                                   subCh2(1),
                                   subCh1(2),
                                   subCh0(3)
                                   } (SIZE(4))                                OPTIONAL
  },
  size8                            SEQUENCE {
    subchannels                     BIT STRING {
                                   subCh7(0),
                                   subCh6(1),
                                   subCh5(2),
                                   subCh4(3),
                                   subCh3(4),
                                   subCh2(5),
                                   subCh1(6),
                                   subCh0(7)
                                   } (SIZE(8))                                OPTIONAL
  }
}

}

AICH-Info ::=                      SEQUENCE {
  channelisationCode256             ChannelisationCode256,
  sttd-Indicator                    BOOLEAN,
  aich-TransmissionTiming           AICH-TransmissionTiming
}

AICH-PowerOffset ::=              INTEGER (-22..5)

AICH-TransmissionTiming ::=       ENUMERATED {
  e0, e1 }

AllocationPeriodInfo ::=          SEQUENCE {
  allocationActivationTime           INTEGER (0..255),
  allocationDuration                 INTEGER (1..256)
}
-- Actual value = IE value * 0.125
Alpha ::=                          INTEGER (0..8)

AP-AICH-ChannelisationCode ::=    INTEGER (0..255)

AP-PreambleScramblingCode ::=     INTEGER (0..79)

AP-Signature ::=                  INTEGER (0..15)

AP-Signature-VCAM ::=             SEQUENCE {
  ap-Signature                      AP-Signature,
  availableAP-SubchannelList         AvailableAP-SubchannelList OPTIONAL
}

AP-Subchannel ::=                 INTEGER (0..11)

ASCSetting-FDD ::=                SEQUENCE {
  -- TABULAR: This is MD in tabular description
  -- Default value is previous ASC
  -- If this is the first ASC, the default value is all available signature and sub-channels
  accessServiceClass-FDD            AccessServiceClass-FDD OPTIONAL
}

```

```

ASCSetting-TDD ::=
    -- TABULAR: This is MD in tabular description
    -- Default value is previous ASC
    -- If this is the first ASC, the default value is all available channelisation codes and
    -- all available sub-channels with subchannelSize=size1.
    accessServiceClass-TDD
    AccessServiceClass-TDD OPTIONAL
}

ASCSetting-TDD-LCR-r4 ::=
    -- TABULAR: This is MD in tabular description
    -- Default value is previous ASC
    -- If this is the first ASC, the default value is all available SYNC_UL codes and
    -- all available sub-channels with subchannelSize=size1.
    accessServiceClass-TDD-LCR
    AccessServiceClass-TDD-LCR-r4 OPTIONAL
}

AvailableAP-Signature-VCAMList ::= SEQUENCE (SIZE (1..maxPCPCH-APsig)) OF
    AP-Signature-VCAM

AvailableAP-SignatureList ::= SEQUENCE (SIZE (1..maxPCPCH-APsig)) OF
    AP-Signature

AvailableAP-SubchannelList ::= SEQUENCE (SIZE (1..maxPCPCH-APsubCh)) OF
    AP-Subchannel

AvailableMinimumSF-ListVCAM ::= SEQUENCE (SIZE (1..maxPCPCH-SF)) OF
    AvailableMinimumSF-VCAM

AvailableMinimumSF-VCAM ::= SEQUENCE {
    minimumSpreadingFactor MinimumSpreadingFactor,
    nf-Max NF-Max,
    maxAvailablePCPCH-Number MaxAvailablePCPCH-Number,
    availableAP-Signature-VCAMList AvailableAP-Signature-VCAMList
}

AvailableSignatures ::= BIT STRING {
    signature15(0),
    signature14(1),
    signature13(2),
    signature12(3),
    signature11(4),
    signature10(5),
    signature9(6),
    signature8(7),
    signature7(8),
    signature6(9),
    signature5(10),
    signature4(11),
    signature3(12),
    signature2(13),
    signature1(14),
    signature0(15)
} (SIZE(16))

AvailableSubChannelNumbers ::= BIT STRING {
    subCh11(0),
    subCh10(1),
    subCh9(2),
    subCh8(3),
    subCh7(4),
    subCh6(5),
    subCh5(6),
    subCh4(7),
    subCh3(8),
    subCh2(9),
    subCh1(10),
    subCh0(11)
} (SIZE(12))

BurstType ::= ENUMERATED {
    short1, long2 }

CCTrCH-PowerControlInfo ::= SEQUENCE {
    tfcs-Identity TFCS-Identity OPTIONAL,
    ul-DPCH-PowerControlInfo UL-DPCH-PowerControlInfo
}

CCTrCH-PowerControlInfo-r4 ::= SEQUENCE {

```

```

    tfcs-Identity                TFCS-Identity                OPTIONAL,
    ul-DPCH-PowerControlInfo    UL-DPCH-PowerControlInfo-r4
}

CD-AccessSlotSubchannel ::=      INTEGER (0..11)

CD-AccessSlotSubchannelList ::= SEQUENCE (SIZE (1..maxPCPCH-CDsubCh)) OF
    CD-AccessSlotSubchannel

CD-CA-ICH-ChannelisationCode ::= INTEGER (0..255)

CD-PreambleScramblingCode ::=   INTEGER (0..79)

CD-SignatureCode ::=            INTEGER (0..15)

CD-SignatureCodeList ::=        SEQUENCE (SIZE (1..maxPCPCH-CDsig)) OF
    CD-SignatureCode

CellAndChannelIdentity ::=      SEQUENCE {
    burstType                    BurstType,
    midambleShift                MidambleShiftLong,
    timeslot                    TimeslotNumber,
    cellParametersID            CellParametersID
}

CellParametersID ::=            INTEGER (0..127)

Cfntargetsfnframeoffset ::=     INTEGER(0..255)

ChannelAssignmentActive ::=     CHOICE {
    notActive                    NULL,
    isActive                    AvailableMinimumSF-ListVCAM
}

ChannelisationCode256 ::=       INTEGER (0..255)

ChannelReqParamsForUCSM ::=     SEQUENCE {
    availableAP-SignatureList    AvailableAP-SignatureList,
    availableAP-SubchannelList  AvailableAP-SubchannelList        OPTIONAL
}

ClosedLoopTimingAdjMode ::=     ENUMERATED {
    slot1, slot2 }

CodeNumberDSCH ::=             INTEGER (0..255)

CodeRange ::=                   SEQUENCE {
    pdsch-CodeMapList           PDSCH-CodeMapList
}

CodeWordSet ::=                 ENUMERATED {
    longCWS,
    mediumCWS,
    shortCWS,
    ssdtOff }

CommonTimeslotInfo ::=          SEQUENCE {
    -- TABULAR: The IE below is MD, but since it can be encoded in a single
    -- bit it is not defined as OPTIONAL.
    secondInterleavingMode      SecondInterleavingMode,
    tfci-Coding                  TFCI-Coding                OPTIONAL,
    puncturingLimit             PuncturingLimit,
    repetitionPeriodAndLength    RepetitionPeriodAndLength    OPTIONAL
}

CommonTimeslotInfoSCCPCH ::=    SEQUENCE {
    -- TABULAR: The IE below is MD, but since it can be encoded in a single
    -- bit it is not defined as OPTIONAL.
    secondInterleavingMode      SecondInterleavingMode,
    tfci-Coding                  TFCI-Coding                OPTIONAL,
    puncturingLimit             PuncturingLimit,
    repetitionPeriodLengthAndOffset RepetitionPeriodLengthAndOffset    OPTIONAL
}

ConstantValue ::=               INTEGER (-35..-10)

CPCH-PersistenceLevels ::=      SEQUENCE {
    cpch-SetID                  CPCH-SetID,
}

```

```

dynamicPersistenceLevelTF-List      DynamicPersistenceLevelTF-List
}

CPCH-PersistenceLevelsList ::=      SEQUENCE (SIZE (1..maxCPCHsets)) OF
                                     CPCH-PersistenceLevels

CPCH-SetInfo ::=                    SEQUENCE {
  cpch-SetID                         CPCH-SetID,
  transportFormatSet                 TransportFormatSet,
  tfcs                               TFCS,
  ap-PreambleScramblingCode         AP-PreambleScramblingCode,
  ap-AICH-ChannelisationCode        AP-AICH-ChannelisationCode,
  cd-PreambleScramblingCode         CD-PreambleScramblingCode,
  cd-CA-ICH-ChannelisationCode      CD-CA-ICH-ChannelisationCode,
  cd-AccessSlotSubchannelList      CD-AccessSlotSubchannelList      OPTIONAL,
  cd-SignatureCodeList             CD-SignatureCodeList              OPTIONAL,
  deltaPp-m                         DeltaPp-m,
  ul-DPCCH-SlotFormat              UL-DPCCH-SlotFormat,
  n-StartMessage                   N-StartMessage,
  n-EOT                             N-EOT,
  channelAssignmentActive           ChannelAssignmentActive,
  -- TABULAR: VCAM info has been nested inside ChannelAssignmentActive,
  -- which in turn is mandatory since it's only a binary choice.
  cpch-StatusIndicationMode        CPCH-StatusIndicationMode,
  pcpcch-ChannelInfoList           PCPCH-ChannelInfoList
}

CPCH-SetInfoList ::=                SEQUENCE (SIZE (1..maxCPCHsets)) OF
                                     CPCH-SetInfo

CPCH-StatusIndicationMode ::=      ENUMERATED {
  pa-mode,
  pamsf-mode }

CSICH-PowerOffset ::=              INTEGER (-10..5)

-- DefaultDPCH-OffsetValueFDD and DefaultDPCH-OffsetValueTDD corresponds to
-- IE "Default DPCH Offset Value" depending on the mode.
-- Actual value = IE value * 512
DefaultDPCH-OffsetValueFDD ::=      INTEGER (0..599)

DefaultDPCH-OffsetValueTDD ::=      INTEGER (0..7)

DeltaPp-m ::=                       INTEGER (-10..10)

-- Actual value = IE value * 0.1
DeltaSIR ::=                        INTEGER (0..30)

DL-CCTrCh ::=                      SEQUENCE {
  tfcs-ID                           TFCS-IdentityPlain                DEFAULT 1,
  timeInfo                          TimeInfo,
  dl-CCTrCH-TimeslotsCodes          DownlinkTimeslotsCodes          OPTIONAL,
  ul-CCTrChTPCList                 UL-CCTrChTPCList                OPTIONAL
}

DL-CCTrCh-r4 ::=                   SEQUENCE {
  tfcs-ID                           TFCS-IdentityPlain                DEFAULT 1,
  timeInfo                          TimeInfo,
  tddOption                         CHOICE {
    tdd384                          SEQUENCE {
      dl-CCTrCH-TimeslotsCodes      DownlinkTimeslotsCodes          OPTIONAL
    },
    tdd128                          SEQUENCE {
      dl-CCTrCH-TimeslotsCodes      DownlinkTimeslotsCodes-LCR-r4   OPTIONAL
    }
  },
  ul-CCTrChTPCList                 UL-CCTrChTPCList                OPTIONAL
}

DL-CCTrChList ::=                  SEQUENCE (SIZE (1..maxCCTrCH)) OF
                                     DL-CCTrCh

DL-CCTrChList-r4 ::=               SEQUENCE (SIZE (1..maxCCTrCH)) OF
                                     DL-CCTrCh-r4

DL-CCTrChTPCList ::=                SEQUENCE (SIZE (0..maxCCTrCH)) OF
                                     TFCS-Identity

```



```

DL-ChannelisationCode ::= SEQUENCE {
    secondaryScramblingCode          OPTIONAL,
    sf-AndCodeNumber                 SF512-AndCodeNumber,
    scramblingCodeChange              ScramblingCodeChange          OPTIONAL
}

DL-ChannelisationCodeList ::= SEQUENCE (SIZE (1..maxDPCH-DLchan)) OF
    DL-ChannelisationCode

DL-CommonInformation ::= SEQUENCE {
    dl-DPCH-InfoCommon              DL-DPCH-InfoCommon          OPTIONAL,
    modeSpecificInfo                 CHOICE {
        fdd                           SEQUENCE {
            defaultDPCH-OffsetValue    DefaultDPCH-OffsetValueFDD  OPTIONAL,
            dpch-CompressedModeInfo     DPCH-CompressedModeInfo    OPTIONAL,
            tx-DiversityMode            TX-DiversityMode           OPTIONAL,
            ssdt-Information             SSDT-Information           OPTIONAL
        },
        tdd                           SEQUENCE {
            defaultDPCH-OffsetValue     DefaultDPCH-OffsetValueTDD  OPTIONAL
        }
    }
}

DL-CommonInformation-r4 ::= SEQUENCE {
    dl-DPCH-InfoCommon              DL-DPCH-InfoCommon          OPTIONAL,
    modeSpecificInfo                 CHOICE {
        fdd                           SEQUENCE {
            defaultDPCH-OffsetValue     DefaultDPCH-OffsetValueFDD  OPTIONAL,
            dpch-CompressedModeInfo     DPCH-CompressedModeInfo    OPTIONAL,
            tx-DiversityMode            TX-DiversityMode           OPTIONAL,
            ssdt-Information             SSDT-Information-r4        OPTIONAL
        },
        tdd                           SEQUENCE {
            tddOption                   CHOICE {
                tdd384                  NULL,
                tdd128                  SEQUENCE {
                    tstd-Indicator      BOOLEAN
                }
            },
            defaultDPCH-OffsetValue     DefaultDPCH-OffsetValueTDD  OPTIONAL
        }
    }
}

DL-CommonInformationPost ::= SEQUENCE {
    dl-DPCH-InfoCommon              DL-DPCH-InfoCommonPost
}

DL-CommonInformationPredef ::= SEQUENCE {
    dl-DPCH-InfoCommon              DL-DPCH-InfoCommonPredef  OPTIONAL
}

DL-CompressedModeMethod ::= ENUMERATED {
    puncturing, sf-2,
    higherLayerScheduling }

DL-DPCH-InfoCommon ::= SEQUENCE {
    cfnHandling                       CHOICE {
        maintain                       NULL,
        initialise                       SEQUENCE {
            cfntargetsfnsframeoffset    Cfntargetsfnsframeoffset    OPTIONAL
        }
    },
    modeSpecificInfo                 CHOICE {
        fdd                           SEQUENCE {
            dl-DPCH-PowerControlInfo    DL-DPCH-PowerControlInfo    OPTIONAL,
            powerOffsetPilot-pdpdch     PowerOffsetPilot-pdpdch,
            dl-rate-matching-restriction Dl-rate-matching-restriction  OPTIONAL,
            spreadingFactorAndPilot     SF512-AndPilot,
            -- TABULAR: The number of pilot bits is nested inside the spreading factor.
            positionFixedOrFlexible     PositionFixedOrFlexible,
            tfci-Existence              BOOLEAN
        },
        tdd                           SEQUENCE {
            dl-DPCH-PowerControlInfo    DL-DPCH-PowerControlInfo    OPTIONAL,
            commonTimeslotInfo          CommonTimeslotInfo           OPTIONAL
        }
    }
}

```

```

    }
}

DL-DPCH-InfoCommonPost ::=          SEQUENCE {
    dl-DPCH-PowerControlInfo          DL-DPCH-PowerControlInfo          OPTIONAL
}

DL-DPCH-InfoCommonPredef ::=        SEQUENCE {
    modeSpecificInfo                  CHOICE {
        fdd                            SEQUENCE {
            spreadingFactorAndPilot    SF512-AndPilot,
            -- TABULAR: The number of pilot bits is nested inside the spreading factor.
            positionFixedOrFlexible    PositionFixedOrFlexible,
            tfci-Existence              BOOLEAN
        },
        tdd                            SEQUENCE {
            commonTimeslotInfo         CommonTimeslotInfo
        }
    }
}

DL-DPCH-InfoPerRL ::=               CHOICE {
    fdd                                SEQUENCE {
        pCPICH-UsageForChannelEst      PCPICH-UsageForChannelEst,
        dpch-FrameOffset               DPCH-FrameOffset,
        secondaryCPICH-Info            SecondaryCPICH-Info          OPTIONAL,
        dl-ChannelisationCodeList      DL-ChannelisationCodeList,
        tpc-CombinationIndex           TPC-CombinationIndex,
        ssdt-CellIdentity              SSDT-CellIdentity          OPTIONAL,
        closedLoopTimingAdjMode        ClosedLoopTimingAdjMode    OPTIONAL
    },
    tdd                                DL-CCTrChList
}

DL-DPCH-InfoPerRL-r4 ::=            CHOICE {
    fdd                                SEQUENCE {
        pCPICH-UsageForChannelEst      PCPICH-UsageForChannelEst,
        dpch-FrameOffset               DPCH-FrameOffset,
        secondaryCPICH-Info            SecondaryCPICH-Info          OPTIONAL,
        dl-ChannelisationCodeList      DL-ChannelisationCodeList,
        tpc-CombinationIndex           TPC-CombinationIndex,
        ssdt-CellIdentity              SSDT-CellIdentity          OPTIONAL,
        closedLoopTimingAdjMode        ClosedLoopTimingAdjMode    OPTIONAL
    },
    tdd                                DL-CCTrChList-r4
}

DL-DPCH-InfoPerRL-PostFDD ::=       SEQUENCE {
    pCPICH-UsageForChannelEst          PCPICH-UsageForChannelEst,
    dl-ChannelisationCode             DL-ChannelisationCode,
    tpc-CombinationIndex              TPC-CombinationIndex
}

DL-DPCH-InfoPerRL-PostTDD ::=       SEQUENCE {
    dl-DPCH-TimeslotsCodes            DownlinkTimeslotsCodes
}

DL-DPCH-InfoPerRL-PostTDD-LCR-r4 ::= SEQUENCE {
    dl-CCTrCH-TimeslotsCodes          DownlinkTimeslotsCodes-LCR-r4
}

DL-DPCH-PowerControlInfo ::=        SEQUENCE {
    modeSpecificInfo                  CHOICE {
        fdd                            SEQUENCE {
            dpc-Mode                   DPC-Mode
        },
        tdd                            SEQUENCE {
            tpc-StepSizeTDD            TPC-StepSizeTDD          OPTIONAL
        }
    }
}

DL-FrameType ::=                    ENUMERATED {
    dl-FrameTypeA, dl-FrameTypeB }

DL-InformationPerRL ::=              SEQUENCE {
    modeSpecificInfo                  CHOICE {
        fdd                            SEQUENCE {

```

| | | |
|---|---|--|
| <pre> primaryCPICH-Info pdsch-SHO-DCH-Info pdsch-CodeMapping }, tdd }, dl-DPCH-InfoPerRL sccpch-InfoForFACH } </pre> | <pre> PrimaryCPICH-Info, PDSCH-SHO-DCH-Info PDSCH-CodeMapping }, PrimaryCCPCH-Info DL-DPCH-InfoPerRL SCCPCH-InfoForFACH </pre> | <pre> OPTIONAL, OPTIONAL OPTIONAL, OPTIONAL </pre> |
| <pre> DL-InformationPerRL-r4 ::= modeSpecificInfo fdd primaryCPICH-Info pdsch-SHO-DCH-Info pdsch-CodeMapping }, tdd }, dl-DPCH-InfoPerRL secondaryCCPCH-Info } </pre> | <pre> SEQUENCE { CHOICE { SEQUENCE { PrimaryCPICH-Info, PDSCH-SHO-DCH-Info PDSCH-CodeMapping } PrimaryCCPCH-Info-r4 } DL-DPCH-InfoPerRL-r4 SecondaryCCPCH-Info-r4 } </pre> | <pre> OPTIONAL, OPTIONAL OPTIONAL, OPTIONAL </pre> |
| <pre> DL-InformationPerRL-List ::= </pre> | <pre> SEQUENCE (SIZE (1..maxRL)) OF DL-InformationPerRL </pre> | |
| <pre> DL-InformationPerRL-List-r4 ::= </pre> | <pre> SEQUENCE (SIZE (1..maxRL)) OF DL-InformationPerRL-r4 </pre> | |
| <pre> DL-InformationPerRL-ListPostFDD ::= </pre> | <pre> SEQUENCE (SIZE (1..maxRL)) OF DL-InformationPerRL-PostFDD </pre> | |
| <pre> DL-InformationPerRL-PostFDD ::= primaryCPICH-Info dl-DPCH-InfoPerRL } </pre> | <pre> PrimaryCPICH-Info, DL-DPCH-InfoPerRL-PostFDD </pre> | |
| <pre> DL-InformationPerRL-PostTDD ::= primaryCCPCH-Info dl-DPCH-InfoPerRL } </pre> | <pre> PrimaryCCPCH-InfoPost, DL-DPCH-InfoPerRL-PostTDD </pre> | |
| <pre> DL-InformationPerRL-PostTDD-LCR-r4 ::= primaryCCPCH-Info dl-DPCH-InfoPerRL } </pre> | <pre> SEQUENCE { PrimaryCCPCH-InfoPostTDD-LCR-r4, DL-DPCH-InfoPerRL-PostTDD-LCR-r4 } </pre> | |
| <pre> DL-PDSCH-Information ::= pdsch-SHO-DCH-Info pdsch-CodeMapping } </pre> | <pre> SEQUENCE { PDSCH-SHO-DCH-Info PDSCH-CodeMapping } </pre> | <pre> OPTIONAL, OPTIONAL </pre> |
| <pre> DL-rate-matching-restriction ::= restrictedTrCH-InfoList } </pre> | <pre> SEQUENCE { RestrictedTrCH-InfoList } </pre> | <pre> OPTIONAL </pre> |
| <pre> DL-TS-ChannelisationCode ::= </pre> | <pre> ENUMERATED { cc16-1, cc16-2, cc16-3, cc16-4, cc16-5, cc16-6, cc16-7, cc16-8, cc16-9, cc16-10, cc16-11, cc16-12, cc16-13, cc16-14, cc16-15, cc16-16 } </pre> | |
| <pre> DL-TS-ChannelisationCodesShort ::= codesRepresentation consecutive firstChannelisationCode lastChannelisationCode }, bitmap </pre> | <pre> SEQUENCE { CHOICE { SEQUENCE { DL-TS-ChannelisationCode, DL-TS-ChannelisationCode } BIT STRING { chCode16-SF16(0), chCode15-SF16(1), chCode14-SF16(2), chCode13-SF16(3), chCode12-SF16(4), chCode11-SF16(5), chCode10-SF16(6), chCode9-SF16(7), chCode8-SF16(8), </pre> | |

```

        chCode7-SF16(9),
        chCode6-SF16(10),
        chCode5-SF16(11),
        chCode4-SF16(12),
        chCode3-SF16(13),
        chCode2-SF16(14),
        chCode1-SF16(15)
    } (SIZE (16))
}
}

DownlinkAdditionalTimeslots ::= SEQUENCE {
    parameters CHOICE {
        sameAsLast SEQUENCE {
            timeslotNumber TimeslotNumber
        },
        newParameters SEQUENCE {
            individualTimeslotInfo IndividualTimeslotInfo,
            dl-TS-ChannelisationCodesShort DL-TS-ChannelisationCodesShort
        }
    }
}

DownlinkAdditionalTimeslots-LCR-r4 ::= SEQUENCE {
    parameters CHOICE {
        sameAsLast SEQUENCE {
            timeslotNumber TimeslotNumber-LCR-r4
        },
        newParameters SEQUENCE {
            individualTimeslotInfo IndividualTimeslotInfo-LCR-r4,
            dl-TS-ChannelisationCodesShort DL-TS-ChannelisationCodesShort
        }
    }
}

DownlinkTimeslotsCodes ::= SEQUENCE {
    firstIndividualTimeslotInfo IndividualTimeslotInfo,
    dl-TS-ChannelisationCodesShort DL-TS-ChannelisationCodesShort,
    moreTimeslots CHOICE {
        noMore NULL,
        additionalTimeslots CHOICE {
            consecutive INTEGER (1..maxTS-1),
            timeslotList SEQUENCE (SIZE (1..maxTS-1)) OF
                DownlinkAdditionalTimeslots
        }
    }
}

DownlinkTimeslotsCodes-LCR-r4 ::= SEQUENCE {
    firstIndividualTimeslotInfo IndividualTimeslotInfo-LCR-r4,
    dl-TS-ChannelisationCodesShort DL-TS-ChannelisationCodesShort,
    moreTimeslots CHOICE {
        noMore NULL,
        additionalTimeslots CHOICE {
            consecutive INTEGER (1..maxTS-LCR-1),
            timeslotList SEQUENCE (SIZE (1..maxTS-LCR-1)) OF
                DownlinkAdditionalTimeslots-LCR-r4
        }
    }
}

DPC-Mode ::= ENUMERATED {
    singleTPC,
    tpcTripletInSoft }

-- The actual value of DPCCH power offset is the value of this IE * 2.
DPCCH-PowerOffset ::= INTEGER (-82..-3)

-- The actual value of DPCCH power offset is the value of this (2 + IE * 4).
DPCCH-PowerOffset2 ::= INTEGER (-28..-13)

DPCH-CompressedModeInfo ::= SEQUENCE {
    tgp-SequenceList TGP-SequenceList
}

DPCH-CompressedModeStatusInfo ::= SEQUENCE {
    tgps-Reconfiguration-CFN TGPS-Reconfiguration-CFN,

```

```

    tgp-SequenceShortList                SEQUENCE (SIZE (1..maxTGPS)) OF
}                                          TGP-SequenceShort

-- TABULAR: Actual value = IE value * 256
DPCH-FrameOffset ::=                    INTEGER (0..149)

DSCH-Mapping ::=                        SEQUENCE {
    maxTFCI-Field2Value                  MaxTFCI-Field2Value,
    spreadingFactor                      SF-PDSCH,
    codeNumber                           CodeNumberDSCH,
    multiCodeInfo                        MultiCodeInfo
}

DSCH-MappingList ::=                    SEQUENCE (SIZE (1..maxPDSCH-TFCIgroups)) OF
                                          DSCH-Mapping

DSCH-RadioLinkIdentifier ::=            INTEGER (0..511)

DurationTimeInfo ::=                    INTEGER (1..4096)

-- TABULAR : value [Duration = infinite] is the value by default,
-- and is encoded by absence of the full sequence. If the sequence is present,
-- thefield is absent, the default is respectivelyinfinite. Presence of the
-- field absent should not be used, but shall be understood as if the
-- sequence was absent.

DynamicPersistenceLevel ::=              INTEGER (1..8)

DynamicPersistenceLevelList ::=          SEQUENCE (SIZE (1..maxPRACH)) OF
                                          DynamicPersistenceLevel

DynamicPersistenceLevelTF-List ::=       SEQUENCE (SIZE (1..maxTF-CPCH)) OF
                                          DynamicPersistenceLevel

FACH-PCH-Information ::=                 SEQUENCE {
    transportFormatSet                   TransportFormatSet,
    transportChannelIdentity             TransportChannelIdentity,
    ctch-Indicator                       BOOLEAN
}

FACH-PCH-InformationList ::=             SEQUENCE (SIZE (1..maxFACHPCH)) OF
                                          FACH-PCH-Information

FPACH-Info-r4 ::=                       SEQUENCE {
    timeslot                             TimeslotNumber-PRACH-LCR-r4,
    channelisationCode                   TDD-FPACH-CCode16-r4,
    midambleShiftAndBurstType            MidambleShiftAndBurstType-LCR-r4,
    wi                                    Wi-LCR
}

FrequencyInfo ::=                       SEQUENCE {
    modeSpecificInfo                     CHOICE {
        fdd                               FrequencyInfoFDD,
        tdd                               FrequencyInfoTDD    }
}

FrequencyInfoFDD ::=                    SEQUENCE {
    uarfcn-UL                            UARFCN                OPTIONAL,
    uarfcn-DL                            UARFCN
}

FrequencyInfoTDD ::=                    SEQUENCE {
    uarfcn-Nt                            UARFCN
}

IndividualTimeslotInfo ::=               SEQUENCE {
    timeslotNumber                       TimeslotNumber,
    tfci-Existence                       BOOLEAN,
    midambleShiftAndBurstType            MidambleShiftAndBurstType
}

IndividualTimeslotInfo-LCR-r4 ::=         SEQUENCE {
    timeslotNumber                       TimeslotNumber-LCR-r4,
    tfci-Existence                       BOOLEAN,
    midambleShiftAndBurstType            MidambleShiftAndBurstType-LCR-r4,
    modulation                           ENUMERATED { mod-QPSK, mod-8PSK },
    ss-TPC-Symbols                       ENUMERATED { zero, one, sixteenOverSF }
}

```

```

}

IndividualTimeslotInfo-LCR-r4-ext ::= SEQUENCE {
-- timeslotNumber and tfci-Existence is taken from IndividualTimeslotInfo.
-- midambleShiftAndBurstType in IndividualTimeslotInfo shall be ignored.
  midambleShiftAndBurstType      MidambleShiftAndBurstType-LCR-r4,
  modulation                      ENUMERATED { mod-QPSK, mod-8PSK },
  ss-TPC-Symbols                  ENUMERATED { zero, one, sixteenOverSF }
}

IndividualTS-Interference ::= SEQUENCE {
  timeslot                        TimeslotNumber,
  ul-TimeslotInterference        UL-Interference
}

IndividualTS-Interference-LCR-r4 ::= SEQUENCE {
  timeslot                        TimeslotNumber-LCR-r4,
  ul-TimeslotInterference        UL-Interference
}

IndividualTS-InterferenceList ::= SEQUENCE (SIZE (1..maxTS)) OF
  IndividualTS-Interference

IndividualTS-InterferenceList-r4 ::= CHOICE {
  tdd384                          SEQUENCE (SIZE (1..maxTS)) OF
    IndividualTS-Interference,
  tdd128                          SEQUENCE (SIZE (1..maxTS-LCR)) OF
    IndividualTS-Interference-LCR-r4
}

ITP ::= ENUMERATED {
  mode0, mode1 }

NidentifyAbort ::= INTEGER (1..128)

MaxAllowedUL-TX-Power ::= INTEGER (-50..33)

MaxAvailablePCPCH-Number ::= INTEGER (1..64)

MaxPowerIncrease-r4 ::= INTEGER (0..3)

MaxTFCI-Field2Value ::= INTEGER (1..1023)

MidambleConfigurationBurstTypeLand3 ::= ENUMERATED {ms4, ms8, ms16}

MidambleConfigurationBurstType2 ::= ENUMERATED {ms3, ms6}

MidambleShiftAndBurstType ::= SEQUENCE {
  burstType                       CHOICE {
    type1                          SEQUENCE {
      midambleConfigurationBurstTypeLand3 MidambleConfigurationBurstTypeLand3,
      midambleAllocationMode             CHOICE {
        defaultMidamble             NULL,
        commonMidamble              NULL,
        ueSpecificMidamble          SEQUENCE {
          midambleShift              MidambleShiftLong
        }
      }
    },
    type2                          SEQUENCE {
      midambleConfigurationBurstType2   MidambleConfigurationBurstType2,
      midambleAllocationMode             CHOICE {
        defaultMidamble             NULL,
        commonMidamble              NULL,
        ueSpecificMidamble          SEQUENCE {
          midambleShift              MidambleShiftShort
        }
      }
    },
    type3                          SEQUENCE {
      midambleConfigurationBurstTypeLand3 MidambleConfigurationBurstTypeLand3,
      midambleAllocationMode             CHOICE {
        defaultMidamble             NULL,
        ueSpecificMidamble          SEQUENCE {
          midambleShift              MidambleShiftLong
        }
      }
    }
  }
}

```

```

}
}
MidambleShiftAndBurstType-LCR-r4 ::= SEQUENCE {
    midambleAllocationMode CHOICE {
        defaultMidamble NULL,
        ueSpecificMidamble SEQUENCE {
            midambleShift INTEGER (0..15)
        }
    },
    midambleConfiguration INTEGER (1..8) -- Actual value = IE value * 2
}

MidambleShiftLong ::= INTEGER (0..15)

MidambleShiftShort ::= INTEGER (0..5)

MinimumSpreadingFactor ::= ENUMERATED {
    sf4, sf8, sf16, sf32,
    sf64, sf128, sf256 }

MultiCodeInfo ::= INTEGER (1..16)

N-EOT ::= INTEGER (0..7)

N-GAP ::= ENUMERATED {
    f2, f4, f8 }

N-PCH ::= INTEGER (1..8)

N-StartMessage ::= INTEGER (1..8)

NB01 ::= INTEGER (0..50)

NF-Max ::= INTEGER (1..64)

NumberOfDPDCH ::= INTEGER (1..maxDPDCH-UL)

NumberOfFBI-Bits ::= INTEGER (1..2)

OpenLoopPowerControl-TDD ::= SEQUENCE {
    primaryCCPCH-TX-Power PrimaryCCPCH-TX-Power,
    -- The following IEs shall be ignored in 1.28Mcps TDD mode.
    alpha Alpha OPTIONAL,
    prach-ConstantValue ConstantValue,
    dpch-ConstantValue ConstantValue,
    pusch-ConstantValue ConstantValue OPTIONAL
}

OpenLoopPowerControl-IPDL-TDD-r4 ::= SEQUENCE {
    ipdl-alpha Alpha,
    maxPowerIncrease MaxPowerIncrease-r4
}

PagingIndicatorLength ::= ENUMERATED {
    pi4, pi8, pi16 }

PC-Preamble ::= INTEGER (0..7)

PCP-Length ::= ENUMERATED {
    as0, as8 }

PCPCH-ChannelInfo ::= SEQUENCE {
    pcpch-UL-ScramblingCode INTEGER (0..79),
    pcpch-DL-ChannelisationCode INTEGER (0..511),
    pcpch-DL-ScramblingCode SecondaryScramblingCode OPTIONAL,
    pcp-Length PCP-Length,
    ucsM-Info UCSM-Info OPTIONAL
}

PCPCH-ChannelInfoList ::= SEQUENCE (SIZE (1..maxPCPCHs)) OF
    PCPCH-ChannelInfo

PCPICH-UsageForChannelEst ::= ENUMERATED {
    mayBeUsed,
    shallNotBeUsed }

```

```

PDSCH-CapacityAllocationInfo ::= SEQUENCE {
  pdsch-PowerControlInfo      PDSCH-PowerControlInfo      OPTIONAL,
  -- pdsch-PowerControlInfo is conditional on new-configuration branch below, if this
  -- selected the IE is OPTIONAL otherwise it should not be sent
  pdsch-AllocationPeriodInfo  AllocationPeriodInfo,
  tfcs-ID                      TFCS-IdentityPlain          DEFAULT 1,
  configuration                CHOICE {
    old-Configuration          SEQUENCE {
      pdsch-Identity          PDSCH-Identity
    },
    new-Configuration          SEQUENCE {
      pdsch-Info              PDSCH-Info,
      pdsch-Identity          PDSCH-Identity          OPTIONAL
    }
  }
}

PDSCH-CapacityAllocationInfo-r4 ::= SEQUENCE {
  pdsch-PowerControlInfo      PDSCH-PowerControlInfo      OPTIONAL,
  -- pdsch-PowerControlInfo is conditional on new-configuration branch below, if this
  -- selected the IE is OPTIONAL otherwise it should not be sent
  pdsch-AllocationPeriodInfo  AllocationPeriodInfo,
  tfcs-ID                      TFCS-IdentityPlain          DEFAULT 1,
  configuration                CHOICE {
    old-Configuration          SEQUENCE {
      pdsch-Identity          PDSCH-Identity
    },
    new-Configuration          SEQUENCE {
      pdsch-Info              PDSCH-Info-r4,
      pdsch-Identity          PDSCH-Identity          OPTIONAL
    }
  }
}

PDSCH-CodeInfo ::= SEQUENCE {
  spreadingFactor              SF-PDSCH,
  codeNumber                   CodeNumberDSCH,
  multiCodeInfo                MultiCodeInfo
}

PDSCH-CodeInfoList ::= SEQUENCE (SIZE (1..maxTFCI-2-Combs)) OF
  PDSCH-CodeInfo

PDSCH-CodeMap ::= SEQUENCE {
  spreadingFactor              SF-PDSCH,
  multiCodeInfo                MultiCodeInfo,
  codeNumberStart              CodeNumberDSCH,
  codeNumberStop                CodeNumberDSCH
}

PDSCH-CodeMapList ::= SEQUENCE (SIZE (1..maxPDSCH-TFCIgroups)) OF
  PDSCH-CodeMap

PDSCH-CodeMapping ::= SEQUENCE {
  dl-ScramblingCode            SecondaryScramblingCode      OPTIONAL,
  signallingMethod              CHOICE {
    codeRange                    CodeRange,
    tfci-Range                    DSCH-MappingList,
    explicit                       PDSCH-CodeInfoList,
    replace                       ReplacedPDSCH-CodeInfoList
  }
}

PDSCH-Identity ::= INTEGER (1..hiPDSCHidentities)

PDSCH-Info ::= SEQUENCE {
  tfcs-ID                      TFCS-IdentityPlain          DEFAULT 1,
  commonTimeslotInfo            CommonTimeslotInfo          OPTIONAL,
  pdsch-TimeslotsCodes          DownlinkTimeslotsCodes      OPTIONAL
}

PDSCH-Info-r4 ::= SEQUENCE {
  tfcs-ID                      TFCS-IdentityPlain          DEFAULT 1,
  commonTimeslotInfo            CommonTimeslotInfo          OPTIONAL,
  tddOption                     CHOICE {
    tdd384                       SEQUENCE {

```

| | |
|---|--|
| <pre> pdsch-TimeslotsCodes }, tdd128 pdsch-TimeslotsCodes } } } </pre> | <pre> DownlinkTimeslotsCodes OPTIONAL SEQUENCE { DownlinkTimeslotsCodes-LCR-r4 OPTIONAL } </pre> |
| <pre> PDSCH-Info-LCR-r4 ::= tfcs-ID commonTimeslotInfo pdsch-TimeslotsCodes } </pre> | <pre> SEQUENCE { TFCS-IdentityPlain DEFAULT 1, CommonTimeslotInfo OPTIONAL, DownlinkTimeslotsCodes-LCR-r4 OPTIONAL } </pre> |
| <pre> PDSCH-PowerControlInfo ::= tpc-StepSizeTDD ul-CCTrChTPCList } </pre> | <pre> SEQUENCE { TPC-StepSizeTDD OPTIONAL, UL-CCTrChTPCList OPTIONAL } </pre> |
| <pre> PDSCH-SHO-DCH-Info ::= dsch-RadioLinkIdentifier rl-IdentifierList } </pre> | <pre> SEQUENCE { DSCH-RadioLinkIdentifier, RL-IdentifierList OPTIONAL } </pre> |
| <pre> PDSCH-SysInfo ::= pdsch-Identity pdsch-Info dsch-TFS dsch-TFCS } </pre> | <pre> SEQUENCE { PDSCH-Identity, PDSCH-Info, TransportFormatSet OPTIONAL, TFCS OPTIONAL } </pre> |
| <pre> PDSCH-SysInfo-LCR-r4 ::= pdsch-Identity pdsch-Info dsch-TFS dsch-TFCS } </pre> | <pre> SEQUENCE { PDSCH-Identity, PDSCH-Info-LCR-r4, TransportFormatSet OPTIONAL, TFCS OPTIONAL } </pre> |
| <pre> PDSCH-SysInfoList ::= </pre> | <pre> SEQUENCE (SIZE (1..maxPDSCH)) OF PDSCH-SysInfo </pre> |
| <pre> PDSCH-SysInfoList-LCR-r4 ::= </pre> | <pre> SEQUENCE (SIZE (1..maxPDSCH)) OF PDSCH-SysInfo-LCR-r4 </pre> |
| <pre> PDSCH-SysInfoList-SFN ::= pdsch-SysInfo sfm-TimeInfo } </pre> | <pre> SEQUENCE (SIZE (1..maxPDSCH)) OF SEQUENCE { PDSCH-SysInfo, SFN-TimeInfo OPTIONAL } </pre> |
| <pre> PDSCH-SysInfoList-SFN-LCR-r4 ::= pdsch-SysInfo sfm-TimeInfo } </pre> | <pre> SEQUENCE (SIZE (1..maxPDSCH)) OF SEQUENCE { PDSCH-SysInfo-LCR-r4, SFN-TimeInfo OPTIONAL } </pre> |
| <pre> PersistenceScalingFactor ::= </pre> | <pre> ENUMERATED { psf0-9, psf0-8, psf0-7, psf0-6, psf0-5, psf0-4, psf0-3, psf0-2 } </pre> |
| <pre> PersistenceScalingFactorList ::= </pre> | <pre> SEQUENCE (SIZE (1..maxASCPersist)) OF PersistenceScalingFactor </pre> |
| <pre> PI-CountPerFrame ::= </pre> | <pre> ENUMERATED { e18, e36, e72, e144 } </pre> |
| <pre> PICH-Info ::= fdd channelisationCode256 pi-CountPerFrame sttd-Indicator }, tdd channelisationCode timeslot burstType type-1 type-2 </pre> | <pre> CHOICE { SEQUENCE { ChannelisationCode256, PI-CountPerFrame, BOOLEAN }, SEQUENCE { TDD-PICH-CCode OPTIONAL, TimeslotNumber OPTIONAL, CHOICE { MidambleShiftLong, MidambleShiftShort } } } </pre> |

```

    }
    repetitionPeriodLengthOffset      RepPerLengthOffset-PICH      OPTIONAL,
    pagingIndicatorLength             PagingIndicatorLength      OPTIONAL,
    n-GAP                             N-GAP                     DEFAULT pi4,
    n-PCH                             N-PCH                     DEFAULT f4,
    }
    }
    }

PICH-Info-LCR-r4 ::=
    timeslot                          SEQUENCE {
    midambleShiftAndBurstType          TimeslotNumber-LCR-r4      OPTIONAL,
    repetitionPeriodLengthOffset      MidambleShiftAndBurstType-LCR-r4,
    pagingIndicatorLength              RepPerLengthOffset-PICH   OPTIONAL,
    n-GAP                             PagingIndicatorLength     DEFAULT pi4,
    n-PCH                             N-GAP                     DEFAULT f4,
    }
    }

PICH-PowerOffset ::=
    INTEGER (-10..5)

PilotBits128 ::=
    ENUMERATED {
        pb4, pb8 }

PilotBits256 ::=
    ENUMERATED {
        pb2, pb4, pb8 }

PositionFixedOrFlexible ::=
    ENUMERATED {
        fixed,
        flexible }

PowerControlAlgorithm ::=
    CHOICE {
        algorithm1      TPC-StepSizeFDD,
        algorithm2      NULL
    }

PowerOffsetPilot-pdpdch ::=
    INTEGER (0..24)

PowerRampStep ::=
    INTEGER (1..8)

PRACH-ChanCodes-LCR-r4 ::=
    SEQUENCE (SIZE (1..4)) OF
        TDD-PRACH-CCode-LCR-r4

PRACH-Definition-LCR-r4 ::=
    SEQUENCE {
        timeslot          TimeslotNumber-PRACH-LCR-r4,
        prach-ChanCodes-LCR
        midambleShiftAndBurstType-LCR-r4,
        fpach-Info       FPACH-Info-r4
    }

PRACH-Midamble ::=
    ENUMERATED {
        direct,
        direct-Inverted }

PRACH-Partitioning ::=
    CHOICE {
        fdd          SEQUENCE (SIZE (1..maxASC)) OF
                    ASCSetting-FDD,
        tdd          SEQUENCE (SIZE (1..maxASC)) OF
                    ASCSetting-TDD
    }

PRACH-Partitioning-LCR-r4 ::=
    SEQUENCE (SIZE (1..maxASC)) OF
        ASCSetting-TDD-LCR-r4

PRACH-PowerOffset ::=
    SEQUENCE {
        powerRampStep      PowerRampStep,
        preambleRetransMax PreambleRetransMax
    }

PRACH-RACH-Info ::=
    SEQUENCE {
        modeSpecificInfo  CHOICE {
            fdd          SEQUENCE {
                availableSignatures      AvailableSignatures,
                availableSF              SF-PRACH,
                preambleScramblingCodeWordNumber
                PreambleScramblingCodeWordNumber,
                puncturingLimit          PuncturingLimit,
                availableSubChannelNumbers
                AvailableSubChannelNumbers
            },
            tdd          SEQUENCE {
                timeslot          TimeslotNumber,
    }

```

```

        channelisationCodeList          TDD-PRACH-CCodeList,
        prach-Midamble                  PRACH-Midamble
    }
}

PRACH-RACH-Info-LCR-r4 ::=              SEQUENCE {
    sync-UL-Info                        SYNC-UL-Info-r4,
    prach-DefinitionList                SEQUENCE (SIZE (1..maxPRACH-FPACH)) OF
                                        PRACH-Definition-LCR-r4
}

PRACH-SystemInformation ::=            SEQUENCE {
    prach-RACH-Info                    PRACH-RACH-Info,
    transportChannelIdentity            TransportChannelIdentity,
    rach-TransportFormatSet            TransportFormatSet                OPTIONAL,
    rach-TFCS                          TFCS                            OPTIONAL,
    prach-Partitioning                 PRACH-Partitioning                OPTIONAL,
    persistenceScalingFactorList       PersistenceScalingFactorList        OPTIONAL,
    ac-To-ASC-MappingTable             AC-To-ASC-MappingTable            OPTIONAL,
    modeSpecificInfo                   CHOICE {
        fdd                             SEQUENCE {
            primaryCPICH-TX-Power        PrimaryCPICH-TX-Power            OPTIONAL,
            constantValue                ConstantValue                    OPTIONAL,
            prach-PowerOffset            PRACH-PowerOffset              OPTIONAL,
            rach-TransmissionParameters  RACH-TransmissionParameters    OPTIONAL,
            aich-Info                    AICH-Info                      OPTIONAL
        },
        tdd                             NULL
    }
}

PRACH-SystemInformationList ::=        SEQUENCE (SIZE (1..maxPRACH)) OF
                                        PRACH-SystemInformation

PreambleRetransMax ::=                INTEGER (1..64)

PreambleScramblingCodeWordNumber ::=  INTEGER (0..15)

PreDefPhyChConfiguration ::=          SEQUENCE {
    ul-DPCH-InfoPredef                 UL-DPCH-InfoPredef,
    dl-CommonInformationPredef         DL-CommonInformationPredef    OPTIONAL
}

PrimaryCCPCH-Info ::=                 CHOICE {
    fdd                                 SEQUENCE {
        tx-DiversityIndicator           BOOLEAN
    },
    tdd                                 SEQUENCE {
        -- syncCase should be absent for 1.28Mcps TDD mode
        syncCase                        CHOICE {
            syncCase1                   SEQUENCE {
                timeslot                 TimeslotNumber
            },
            syncCase2                   SEQUENCE {
                timeslotSync2           TimeslotSync2
            }
        }
    }
}
cellParametersID                      CellParametersID                OPTIONAL,
blockSTTD-Indicator                   BOOLEAN                          OPTIONAL
}

PrimaryCCPCH-Info-r4 ::=               CHOICE {
    fdd                                 SEQUENCE {
        tx-DiversityIndicator           BOOLEAN
    },
    tdd                                 SEQUENCE {
        tddOption                       CHOICE {
            tdd384                       SEQUENCE {
                syncCase                 CHOICE {
                    syncCase1            SEQUENCE {
                        timeslot          TimeslotNumber
                    },
                    syncCase2            SEQUENCE {
                        timeslotSync2     TimeslotSync2
                    }
                }
            }
        }
    }
}
OPTIONAL

```

```

        },
        tdd128
            tstd-Indicator
        }
    },
    cellParametersID
    blockSTTD-Indicator
}

}

PrimaryCCPCH-Info-LCR-r4 ::= SEQUENCE {
    tstd-Indicator          BOOLEAN,
    cellParametersID      CellParametersID          OPTIONAL,
    blockSTTD-Indicator    BOOLEAN
}

-- For 1.28Mcps TDD, the following IE includes elements for the PCCPCH Info additional to those
-- in PrimaryCCPCH-Info
PrimaryCCPCH-Info-LCR-r4-ext ::= SEQUENCE {
    tstd-Indicator          BOOLEAN
}

PrimaryCCPCH-InfoPost ::= SEQUENCE {
    syncCase                CHOICE {
        syncCase1           SEQUENCE {
            timeslot        TimeslotNumber
        },
        syncCase2           SEQUENCE {
            timeslotSync2   TimeslotSync2
        }
    },
    cellParametersID      CellParametersID,
    blockSTTD-Indicator    BOOLEAN
}

PrimaryCCPCH-InfoPostTDD-LCR-r4 ::= SEQUENCE {
    tstd-Indicator          BOOLEAN,
    cellParametersID      CellParametersID,
    blockSTTD-Indicator    BOOLEAN
}

PrimaryCCPCH-TX-Power ::= INTEGER (6..43)

PrimaryCPICH-Info ::= SEQUENCE {
    primaryScramblingCode  PrimaryScramblingCode
}

PrimaryCPICH-TX-Power ::= INTEGER (-10..50)

PrimaryScramblingCode ::= INTEGER (0..511)

PuncturingLimit ::= ENUMERATED {
    p10-40, p10-44, p10-48, p10-52, p10-56,
    p10-60, p10-64, p10-68, p10-72, p10-76,
    p10-80, p10-84, p10-88, p10-92, p10-96, p11 }

PUSCH-CapacityAllocationInfo ::= SEQUENCE {
    pusch-Allocation        CHOICE {
        pusch-AllocationPending    NULL,
        pusch-AllocationAssignment SEQUENCE {
            pdsch-AllocationPeriodInfo AllocationPeriodInfo,
            pusch-PowerControlInfo     UL-TargetSIR          OPTIONAL,
            tfcs-ID                    TFCS-IdentityPlain    DEFAULT 1,
            configuration              CHOICE {
                old-Configuration      SEQUENCE {
                    pusch-Identity     PUSCH-Identity
                },
                new-Configuration     SEQUENCE {
                    pusch-Info         PUSCH-Info,
                    pusch-Identity     PUSCH-Identity    OPTIONAL
                }
            }
        }
    }
}

}

}

PUSCH-CapacityAllocationInfo-r4 ::= SEQUENCE {
    pusch-Allocation        CHOICE {

```

```

    pusch-AllocationPending          NULL,
    pusch-AllocationAssignment       SEQUENCE {
        pdsch-AllocationPeriodInfo  AllocationPeriodInfo,
        pusch-PowerControlInfo       PUSCH-PowerControlInfo-r4  OPTIONAL,
        tfcs-Identity                 TFCS-IdentityPlain         OPTIONAL,
        configuration                  CHOICE {
            old-Configuration         SEQUENCE {
                pusch-Identity       PUSCH-Identity
            },
            new-Configuration         SEQUENCE {
                pusch-Info            PUSCH-Info-r4,
                pusch-Identity       PUSCH-Identity  OPTIONAL
            }
        }
    }
}

PUSCH-Identity ::=
    INTEGER (1..hiPUSCHidentities)

PUSCH-Info ::=
    SEQUENCE {
        tfcs-ID                       TFCS-IdentityPlain         DEFAULT 1,
        commonTimeslotInfo            CommonTimeslotInfo        OPTIONAL,
        pusch-TimeslotsCodes          UplinkTimeslotsCodes        OPTIONAL
    }

PUSCH-Info-r4 ::=
    SEQUENCE {
        tfcs-ID                       TFCS-IdentityPlain         DEFAULT 1,
        commonTimeslotInfo            CommonTimeslotInfo        OPTIONAL,
        tddOption                     CHOICE {
            tdd384                    SEQUENCE {
                pusch-TimeslotsCodes  UplinkTimeslotsCodes        OPTIONAL
            },
            tdd128                    SEQUENCE {
                pusch-TimeslotsCodes  UplinkTimeslotsCodes-LCR-r4  OPTIONAL
            }
        }
    }

PUSCH-Info-LCR-r4 ::=
    SEQUENCE {
        tfcs-ID                       TFCS-IdentityPlain         DEFAULT 1,
        commonTimeslotInfo            CommonTimeslotInfo        OPTIONAL,
        pusch-TimeslotsCodes          UplinkTimeslotsCodes-LCR-r4  OPTIONAL
    }

PUSCH-PowerControlInfo-r4 ::=
    SEQUENCE {
        ul-TargetSIR                  UL-TargetSIR,
        tddOption                     CHOICE {
            tdd384                    NULL,
            tdd128                    SEQUENCE {
                tpc-StepSize           TPC-StepSizeTDD            OPTIONAL,
                dl-CCTrChTPCList      DL-CCTrChTPCList         OPTIONAL
            }
        }
    }

PUSCH-SysInfo ::=
    SEQUENCE {
        pusch-Identity                PUSCH-Identity,
        pusch-Info                    PUSCH-Info,
        usch-TFS                      TransportFormatSet        OPTIONAL,
        usch-TFCS                     TFCS                     OPTIONAL
    }

PUSCH-SysInfo-LCR-r4 ::=
    SEQUENCE {
        pusch-Identity                PUSCH-Identity,
        pusch-Info                    PUSCH-Info-LCR-r4,
        usch-TFS                      TransportFormatSet        OPTIONAL,
        usch-TFCS                     TFCS                     OPTIONAL
    }

PUSCH-SysInfoList ::=
    SEQUENCE (SIZE (1..maxPUSCH)) OF
        PUSCH-SysInfo

PUSCH-SysInfoList-LCR-r4 ::=
    SEQUENCE (SIZE (1..maxPUSCH)) OF
        PUSCH-SysInfo-LCR-r4

PUSCH-SysInfoList-SFN ::=
    SEQUENCE (SIZE (1..maxPUSCH)) OF

```

```

    pusch-SysInfo
    sfn-TimeInfo
}
SEQUENCE {
    PUSCH-SysInfo,
    SFN-TimeInfo
} OPTIONAL

PUSCH-SysInfoList-SFN-LCR-r4 ::=
    SEQUENCE (SIZE (1..maxPDSCH)) OF
    SEQUENCE {
        pusch-SysInfo
        sfn-TimeInfo
        PUSCH-SysInfo-LCR-r4,
        SFN-TimeInfo
    } OPTIONAL

RACH-TransmissionParameters ::=
    SEQUENCE {
        mmax
        nb01Min
        nb01Max
        INTEGER (1..32),
        NB01,
        NB01
    }

ReducedScramblingCodeNumber ::=
    INTEGER (0..8191)

RepetitionPeriodAndLength ::=
    CHOICE {
        repetitionPeriod1
        repetitionPeriod2
        -- repetitionPeriod2 could just as well be NULL also.
        repetitionPeriod4
        repetitionPeriod8
        repetitionPeriod16
        repetitionPeriod32
        repetitionPeriod64
        NULL,
        INTEGER (1..1),
        INTEGER (1..3),
        INTEGER (1..7),
        INTEGER (1..15),
        INTEGER (1..31),
        INTEGER (1..63)
    }

RepetitionPeriodLengthAndOffset ::= CHOICE {
    repetitionPeriod1
    repetitionPeriod2
    length
    offset
    NULL,
    SEQUENCE {
        NULL,
        INTEGER (0..1)
    },
    repetitionPeriod4
    length
    offset
    SEQUENCE {
        INTEGER (1..3),
        INTEGER (0..3)
    },
    repetitionPeriod8
    length
    offset
    SEQUENCE {
        INTEGER (1..7),
        INTEGER (0..7)
    },
    repetitionPeriod16
    length
    offset
    SEQUENCE {
        INTEGER (1..15),
        INTEGER (0..15)
    },
    repetitionPeriod32
    length
    offset
    SEQUENCE {
        INTEGER (1..31),
        INTEGER (0..31)
    },
    repetitionPeriod64
    length
    offset
    SEQUENCE {
        INTEGER (1..63),
        INTEGER (0..63)
    }
}

ReplacedPDSCH-CodeInfo ::=
    SEQUENCE {
        tfci-Field2
        spreadingFactor
        codeNumber
        multiCodeInfo
        MaxTFCI-Field2Value,
        SF-PDSCH,
        CodeNumberDSCH,
        MultiCodeInfo
    }

ReplacedPDSCH-CodeInfoList ::=
    SEQUENCE (SIZE (1..maxTFCI-2-Combs)) OF
    ReplacedPDSCH-CodeInfo

RepPerLengthOffset-PICH ::=
    CHOICE {
        rpp4-2
        rpp8-2
        rpp8-4
        rpp16-2
        rpp16-4
        rpp32-2
        rpp32-4
        rpp64-2
        rpp64-4
        INTEGER (0..3),
        INTEGER (0..7),
        INTEGER (0..7),
        INTEGER (0..15),
        INTEGER (0..15),
        INTEGER (0..31),
        INTEGER (0..31),
        INTEGER (0..63),
        INTEGER (0..63)
    }

```

```

}

RestrictedTrCH ::= SEQUENCE {
    dl-restrictedTrCh-Type DL-TrCH-Type,
    restrictedDL-TrCH-Identity TransportChannelIdentity,
    allowedTFIList AllowedTFI-List
}

RestrictedTrCH-InfoList ::= SEQUENCE (SIZE(1..maxTrCH)) OF
    RestrictedTrCH

RL-AdditionInformation ::= SEQUENCE {
    primaryCPICH-Info PrimaryCPICH-Info,
    dl-DPCH-InfoPerRL DL-DPCH-InfoPerRL,
    tfci-CombiningIndicator BOOLEAN,
    sccpch-InfoForFACH SCCPCH-InfoForFACH OPTIONAL
}

RL-AdditionInformationList ::= SEQUENCE (SIZE (1..maxRL-1)) OF
    RL-AdditionInformation

RL-IdentifierList ::= SEQUENCE (SIZE (1..maxRL)) OF
    PrimaryCPICH-Info

RL-RemovalInformationList ::= SEQUENCE (SIZE (1..maxRL)) OF
    PrimaryCPICH-Info

RPP ::= ENUMERATED {
    mode0, mode1 }

S-Field ::= ENUMERATED {
    e1bit, e2bits }

SCCPCH-ChannelisationCode ::= ENUMERATED {
    ccl6-1, ccl6-2, ccl6-3, ccl6-4,
    ccl6-5, ccl6-6, ccl6-7, ccl6-8,
    ccl6-9, ccl6-10, ccl6-11, ccl6-12,
    ccl6-13, ccl6-14, ccl6-15, ccl6-16 }

SCCPCH-ChannelisationCodeList ::= SEQUENCE (SIZE (1..16)) OF
    SCCPCH-ChannelisationCode

SCCPCH-InfoForFACH ::= SEQUENCE {
    secondaryCCPCH-Info SecondaryCCPCH-Info,
    tfcs TFCS,
    modeSpecificInfo CHOICE {
        fdd SEQUENCE {
            fach-PCH-InformationList FACH-PCH-InformationList,
            sib-ReferenceListFACH SIB-ReferenceListFACH
        },
        tdd NULL
    }
}

SCCPCH-SystemInformation ::= SEQUENCE {
    secondaryCCPCH-Info SecondaryCCPCH-Info,
    tfcs TFCS OPTIONAL,
    fach-PCH-InformationList FACH-PCH-InformationList OPTIONAL,
    pich-Info PICH-Info OPTIONAL
}

SCCPCH-SystemInformation-LCR-r4-ext ::= SEQUENCE {
    secondaryCCPCH-LCR-Extensions SecondaryCCPCH-Info-LCR-r4-ext,
    -- pich-Info in the SCCPCH-SystemInformation IE shall be absent, and instead the following used.
    pich-Info PICH-Info-LCR-r4 OPTIONAL
}

SCCPCH-SystemInformationList ::= SEQUENCE (SIZE (1..maxSCCPCH)) OF
    SCCPCH-SystemInformation

-- The following list includes elements additional to those in
-- SCCPCH-SystemInformationList for the 1.28Mcps TDD. The order of the IEs
-- indicates which SCCPCH-SystemInformation-LCR-r4-ext IE extends which
-- SCCPCH-SystemInformation IE.
SCCPCH-SystemInformationList-LCR-r4-ext ::= SEQUENCE (SIZE (1..maxSCCPCH)) OF
    SCCPCH-SystemInformation-LCR-r4-ext

ScramblingCodeChange ::= ENUMERATED {

```

```

        codeChange, noCodeChange }

ScramblingCodeType ::=
    ENUMERATED {
        shortSC,
        longSC }

SecondaryCCPCH-Info ::=
    modeSpecificInfo
        fdd
            PCPICH-UsageForChannelEst      PCPICH-UsageForChannelEst,
            secondaryCPICH-Info             SecondaryCPICH-Info           OPTIONAL,
            secondaryScramblingCode         SecondaryScramblingCode       OPTIONAL,
            sttd-Indicator                  BOOLEAN,
            sf-AndCodeNumber                 SF256-AndCodeNumber,
            pilotSymbolExistence            BOOLEAN,
            tfci-Existence                  BOOLEAN,
            positionFixedOrFlexible         PositionFixedOrFlexible,
            timingOffset                    TimingOffset                 DEFAULT 0
        },
        tdd
            -- TABULAR: the offset is included in CommonTimeslotInfoSCCPCH
            commonTimeslotInfo              CommonTimeslotInfoSCCPCH,
            individualTimeslotInfo          IndividualTimeslotInfo,
            channelisationCode              SCCPCH-ChannelisationCodeList
        }
    }

SecondaryCCPCH-Info-r4 ::=
    modeSpecificInfo
        fdd
            PCPICH-UsageForChannelEst      PCPICH-UsageForChannelEst,
            secondaryCPICH-Info             SecondaryCPICH-Info           OPTIONAL,
            secondaryScramblingCode         SecondaryScramblingCode       OPTIONAL,
            sttd-Indicator                  BOOLEAN,
            sf-AndCodeNumber                 SF256-AndCodeNumber,
            pilotSymbolExistence            BOOLEAN,
            tfci-Existence                  BOOLEAN,
            positionFixedOrFlexible         PositionFixedOrFlexible,
            timingOffset                    TimingOffset                 DEFAULT 0
        },
        tdd
            -- TABULAR: the offset is included in CommonTimeslotInfoSCCPCH
            commonTimeslotInfo              CommonTimeslotInfoSCCPCH,
            tddOption                       CHOICE {
                tdd384                      SEQUENCE {
                    individualTimeslotInfo    IndividualTimeslotInfo
                },
                tdd128                      SEQUENCE {
                    individualTimeslotInfo    IndividualTimeslotInfo-LCR-r4
                }
            },
            channelisationCode              SCCPCH-ChannelisationCodeList
        }
    }

SecondaryCCPCH-Info-LCR-r4-ext ::=
    SEQUENCE {
        individualTimeslotLCR-Ext          IndividualTimeslotInfo-LCR-r4-ext
    }

SecondaryCPICH-Info ::=
    secondaryDL-ScramblingCode            SecondaryScramblingCode           OPTIONAL,
    channelisationCode                    ChannelisationCode256
}

SecondaryScramblingCode ::=
    INTEGER (1..15)

SecondInterleavingMode ::=
    ENUMERATED {
        frameRelated, timeslotRelated }

-- SF256-AndCodeNumber encodes both "Spreading factor" and "Code Number"
SF256-AndCodeNumber ::=
    CHOICE {
        sf4                                INTEGER (0..3),
        sf8                                INTEGER (0..7),
        sf16                               INTEGER (0..15),
        sf32                               INTEGER (0..31),
        sf64                               INTEGER (0..63),
    }

```



```

    sf128                INTEGER (0..127),
    sf256                INTEGER (0..255)
}

-- SF512-AndCodeNumber encodes both "Spreading factor" and "Code Number"
SF512-AndCodeNumber ::= CHOICE {
    sf4                  INTEGER (0..3),
    sf8                  INTEGER (0..7),
    sf16                 INTEGER (0..15),
    sf32                 INTEGER (0..31),
    sf64                 INTEGER (0..63),
    sf128                INTEGER (0..127),
    sf256                INTEGER (0..255),
    sf512                INTEGER (0..511)
}

-- SF512-AndPilot encodes both "Spreading factor" and "Number of bits for Pilot bits"
SF512-AndPilot ::= CHOICE {
    sfd4                 NULL,
    sfd8                 NULL,
    sfd16                NULL,
    sfd32                NULL,
    sfd64                NULL,
    sfd128               PilotBits128,
    sfd256               PilotBits256,
    sfd512               NULL
}

SF-PDSCH ::= ENUMERATED {
    sfp4, sfp8, sfp16, sfp32,
    sfp64, sfp128, sfp256 }

SF-PRACH ::= ENUMERATED {
    sfpr32, sfpr64, sfpr128, sfpr256 }

SFN-TimeInfo ::= SEQUENCE {
    activationTimeSFN    INTEGER (0..4095),
    physChDuration       DurationTimeInfo
}

SpecialBurstScheduling ::= INTEGER (0..7)

SpreadingFactor ::= ENUMERATED {
    sf4, sf8, sf16, sf32,
    sf64, sf128, sf256 }

SRB-delay ::= INTEGER (0..7)

SSDT-CellIdentity ::= ENUMERATED {
    ssdt-id-a, ssdt-id-b, ssdt-id-c,
    ssdt-id-d, ssdt-id-e, ssdt-id-f,
    ssdt-id-g, ssdt-id-h }

SSDT-Information ::= SEQUENCE {
    s-Field              S-Field,
    codeWordSet          CodeWordSet
}

SSDT-Information-r4 ::= SEQUENCE {
    s-Field              S-Field,
    codeWordSet          CodeWordSet,
    ssdt-UL              SSDT-UL-r4
}

-- The following information element is used to extend the
-- SSDT-Information IE from Release 4 onwards.
SSDT-UL-r4 ::= ENUMERATED {
    ul, ul-AndDL }

SynchronisationParameters-r4 ::= SEQUENCE {
    sync-UL-CodesBitmap  BIT STRING (SIZE (8))
    fpack-Info           FPACH-Info-r4,
    sync-UL-Procedure    SYNC-UL-Procedure-r4
}

SYNC-UL-Procedure-r4 ::= SEQUENCE {
    max-SYNC-UL-Transmissions
    powerRampingStep     ENUMERATED { tr1, tr2, tr4, tr8 },
    INTEGER (0..3)
}

```

```

SYNC-UL-Info-r4 ::=
  sync-UL-Codes-Bitmap
  ul-TargetSIR
  powerRampingStep
  max-SYNC-UL-Transmissions
  mmax
}

SEQUENCE {
  BIT STRING ( SIZE (8)),
  UL-TargetSIR,
  INTEGER (0..3),
  ENUMERATED { tr1, tr2, tr4, tr8 } ,
  INTEGER(1..32)
}

TDD-FPACH-CCode16-r4 ::=
  ENUMERATED {
    cc16-1, cc16-2, cc16-3, cc16-4,
    cc16-5, cc16-6, cc16-7, cc16-8,
    cc16-9, cc16-10, cc16-11, cc16-12,
    cc16-13, cc16-14, cc16-15, cc16-16 }

TDD-PICH-CCode ::=
  ENUMERATED {
    cc16-1, cc16-2, cc16-3, cc16-4,
    cc16-5, cc16-6, cc16-7, cc16-8,
    cc16-9, cc16-10, cc16-11, cc16-12,
    cc16-13, cc16-14, cc16-15, cc16-16 }

TDD-PRACH-CCode8 ::=
  ENUMERATED {
    cc8-1, cc8-2, cc8-3, cc8-4,
    cc8-5, cc8-6, cc8-7, cc8-8 }

TDD-PRACH-CCode16 ::=
  ENUMERATED {
    cc16-1, cc16-2, cc16-3, cc16-4,
    cc16-5, cc16-6, cc16-7, cc16-8,
    cc16-9, cc16-10, cc16-11, cc16-12,
    cc16-13, cc16-14, cc16-15, cc16-16 }

TDD-PRACH-CCode-LCR-r4 ::=
  ENUMERATED {
    cc4-1, cc4-2, cc4-3, cc4-4,
    cc8-1, cc8-2, cc8-3, cc8-4,
    cc8-5, cc8-6, cc8-7, cc8-8,
    cc16-1, cc16-2, cc16-3, cc16-4,
    cc16-5, cc16-6, cc16-7, cc16-8,
    cc16-9, cc16-10, cc16-11, cc16-12,
    cc16-13, cc16-14, cc16-15, cc16-16 }

TDD-PRACH-CCodeList ::=
  sf8
  sf16
}

CHOICE {
  SEQUENCE (SIZE (1..8)) OF
    TDD-PRACH-CCode8,
  SEQUENCE (SIZE (1..8)) OF
    TDD-PRACH-CCode16
}

TFC-ControlDuration ::=
  ENUMERATED {
    tfc-cd1, tfc-cd2, tfc-cd4, tfc-cd8,
    tfc-cd16, tfc-cd24, tfc-cd32,
    tfc-cd48, tfc-cd64, tfc-cd128,
    tfc-cd192, tfc-cd256, tfc-cd512 }

TFCI-Coding ::=
  ENUMERATED {
    tfci-bits-4, tfci-bits-8,
    tfci-bits-16, tfci-bits-32 }

TGCFN ::=
  INTEGER (0..255)

-- The value 270 represents "undefined" in the tabular description.
TGD ::=
  INTEGER (15..270)

TGL ::=
  INTEGER (1..14)

TGMP ::=
  ENUMERATED {
    tdd-Measurement, fdd-Measurement,
    gsm-CarrierRSSIMeasurement,
    gsm-initialBSICIdentification, gsmBSICReconfirmation,
    multi-carrier }

TGP-Sequence ::=
  tgpsi
  tgps-Status
    activate
      tgcfn
    },
  deactivate
}

SEQUENCE {
  TGPSI,
  CHOICE {
    SEQUENCE {
      TGCFN
    },
    NULL
  }
}

```

```

    tgps-ConfigurationParams          TGPS-ConfigurationParams          OPTIONAL
}
TGPS-Reconfiguration-CFN ::=          INTEGER (0..255)
TGP-SequenceList ::=                  SEQUENCE (SIZE (1..maxTGPS)) OF
                                        TGP-Sequence
TGP-SequenceShort ::=                  SEQUENCE {
    tgpsi                               TGPSI,
    tgps-Status                           CHOICE {
        activate                           SEQUENCE {
            tgcfm                           TGCFM
        },
        deactivate                           NULL
    }
}
TGPL ::=                               INTEGER (1..144)
-- TABULAR: The value 0 represents "infinity" in the tabular description.
TGPRC ::=                               INTEGER (0..511)
TGPS-ConfigurationParams ::=           SEQUENCE {
    tgmpp                                TGMP,
    tgprc                                TGPRC,
    tgsn                                  TGSN,
    tgl1                                  TGL,
    tgl2                                  TGL                                OPTIONAL,
    tgd                                    TGD,
    tgpl1                                 TGPL,
    tgpl2                                 TGPL                                OPTIONAL,
    rpp                                    RPP,
    itp                                    ITP,
    ul-DL-Mode                            UL-DL-Mode,
    -- TABULAR: Compressed mode method is nested inside UL-DL-Mode
    dl-FrameType                           DL-FrameType,
    deltaSIR1                               DeltaSIR,
    deltaSIRAfter1                          DeltaSIR,
    deltaSIR2                               DeltaSIR                                OPTIONAL,
    deltaSIRAfter2                          DeltaSIR                                OPTIONAL,
    nidentifyAbort                          NidentifyAbort                        OPTIONAL,
    treconfirmAbort                          TreconfirmAbort                        OPTIONAL
}
TGPSI ::=                               INTEGER (1..maxTGPS)
TGSN ::=                               INTEGER (0..14)
TimeInfo ::=                             SEQUENCE {
    activationTime                           ActivationTime                            OPTIONAL,
    durationTimeInfo                          DurationTimeInfo                           OPTIONAL
}
TimeslotList ::=                          SEQUENCE (SIZE (1..maxTS)) OF
                                        TimeslotNumber
TimeslotList-r4 ::=                       CHOICE {
    tdd384                                    SEQUENCE (SIZE (1..maxTS)) OF
                                                TimeslotNumber,
    tdd128                                    SEQUENCE (SIZE (1..maxTS-LCR)) OF
                                                TimeslotNumber-LCR-r4
}
-- If TimeslotNumber is included for a 1.28Mcps TDD description, it shall take values from 0..6
TimeslotNumber ::=                         INTEGER (0..14)
TimeslotNumber-LCR-r4 ::=                  INTEGER (0..6)
TimeslotNumber-PRACH-LCR-r4 ::=            INTEGER (1..6)
TimeslotSync2 ::=                          INTEGER (0..6)
-- Actual value = IE value * 256
TimingOffset ::=                           INTEGER (0..149)
TPC-CombinationIndex ::=                   INTEGER (0..5)

```

```

TPC-StepSizeFDD ::= INTEGER (0..1)

TPC-StepSizeTDD ::= INTEGER (1..3)

-- Actual value = IE value * 0.5 seconds
TreconfirmAbort ::= INTEGER (1..20)

TX-DiversityMode ::= ENUMERATED {
    noDiversity,
    sttd,
    closedLoopModel1,
    closedLoopMode2 }

UARFCN ::= INTEGER (0..16383)

UCSM-Info ::= SEQUENCE {
    minimumSpreadingFactor MinimumSpreadingFactor,
    nf-Max NF-Max,
    channelReqParamsForUCSM ChannelReqParamsForUCSM
}

UL-CCTrCH ::= SEQUENCE {
    tfcs-ID TFCS-IdentityPlain DEFAULT 1,
    timeInfo TimeInfo,
    commonTimeslotInfo CommonTimeslotInfo OPTIONAL,
    ul-CCTrCH-TimeslotsCodes UplinkTimeslotsCodes OPTIONAL
}

UL-CCTrCH-r4 ::= SEQUENCE {
    tfcs-ID TFCS-IdentityPlain DEFAULT 1,
    timeInfo TimeInfo,
    commonTimeslotInfo CommonTimeslotInfo OPTIONAL,
    tddOption CHOICE {
        tdd384 SEQUENCE {
            ul-CCTrCH-TimeslotsCodes UplinkTimeslotsCodes OPTIONAL
        },
        tdd128 SEQUENCE {
            ul-CCTrCH-TimeslotsCodes UplinkTimeslotsCodes-LCR-r4 OPTIONAL
        }
    }
}

UL-CCTrCHList ::= SEQUENCE (SIZE (1..maxCCTrCH)) OF
    UL-CCTrCH

UL-CCTrCHList-r4 ::= SEQUENCE (SIZE (1..maxCCTrCH)) OF
    UL-CCTrCH-r4

UL-CCTrChTPCList ::= SEQUENCE (SIZE (0..maxCCTrCH)) OF
    TFCS-Identity

UL-ChannelRequirement ::= CHOICE {
    ul-DPCH-Info UL-DPCH-Info,
    cpch-SetInfo CPCH-SetInfo
}

UL-ChannelRequirement-r4 ::= CHOICE {
    ul-DPCH-Info UL-DPCH-Info-r4,
    cpch-SetInfo CPCH-SetInfo
}

UL-ChannelRequirementWithCPCH-SetID ::= CHOICE {
    ul-DPCH-Info UL-DPCH-Info,
    cpch-SetInfo CPCH-SetInfo,
    cpch-SetID CPCH-SetID
}

UL-ChannelRequirementWithCPCH-SetID-r4 ::= CHOICE {
    ul-DPCH-Info UL-DPCH-Info-r4,
    cpch-SetInfo CPCH-SetInfo,
    cpch-SetID CPCH-SetID
}

UL-CompressedModeMethod ::= ENUMERATED {
    sf-2,
    higherLayerScheduling }

UL-DL-Mode ::= CHOICE {

```

```

    ul          UL-CompressedModeMethod,
    dl          DL-CompressedModeMethod,
    ul-and-dl   SEQUENCE {
        ul      UL-CompressedModeMethod,
        dl      DL-CompressedModeMethod
    }}

UL-DPCCH-SlotFormat ::=          ENUMERATED {
    slf0, slf1, slf2 }

UL-DPCH-Info ::=                SEQUENCE {
    ul-DPCH-PowerControlInfo     UL-DPCH-PowerControlInfo          OPTIONAL,
    modeSpecificInfo             CHOICE {
        fdd                      SEQUENCE {
            scramblingCodeType    ScramblingCodeType,
            scramblingCode        UL-ScramblingCode,
            numberOfDPDCH         NumberOfDPDCH              DEFAULT 1,
            spreadingFactor       SpreadingFactor,
            tfci-Existence        BOOLEAN,
            numberOfFBI-Bits      NumberOfFBI-Bits          OPTIONAL,
            -- The IE above is conditional based on history
            puncturingLimit       PuncturingLimit
        },
        tdd                      SEQUENCE {
            ul-TimingAdvance      UL-TimingAdvanceControl    OPTIONAL,
            ul-CCTrCHList         UL-CCTrCHList
        }
    }
}

UL-DPCH-Info-r4 ::=            SEQUENCE {
    ul-DPCH-PowerControlInfo     UL-DPCH-PowerControlInfo-r4      OPTIONAL,
    modeSpecificInfo             CHOICE {
        fdd                      SEQUENCE {
            scramblingCodeType    ScramblingCodeType,
            scramblingCode        UL-ScramblingCode,
            numberOfDPDCH         NumberOfDPDCH              DEFAULT 1,
            spreadingFactor       SpreadingFactor,
            tfci-Existence        BOOLEAN,
            numberOfFBI-Bits      NumberOfFBI-Bits          OPTIONAL,
            -- The IE above is conditional based on history
            puncturingLimit       PuncturingLimit
        },
        tdd                      SEQUENCE {
            ul-TimingAdvance      UL-TimingAdvanceControl-r4  OPTIONAL,
            ul-CCTrCHList         UL-CCTrCHList-r4
        }
    }
}

UL-DPCH-InfoPostFDD ::=       SEQUENCE {
    ul-DPCH-PowerControlInfo     UL-DPCH-PowerControlInfoPostFDD,
    scramblingCodeType           ScramblingCodeType,
    reducedScramblingCodeNumber  ReducedScramblingCodeNumber,
    spreadingFactor              SpreadingFactor
}

UL-DPCH-InfoPostTDD ::=       SEQUENCE {
    ul-DPCH-PowerControlInfo     UL-DPCH-PowerControlInfoPostTDD,
    ul-TimingAdvance             UL-TimingAdvanceControl          OPTIONAL,
    ul-CCTrCH-TimeslotsCodes     UplinkTimeslotsCodes
}

UL-DPCH-InfoPostTDD-LCR-r4 ::= SEQUENCE {
    ul-DPCH-PowerControlInfo     UL-DPCH-PowerControlInfoPostTDD-LCR-r4,
    ul-TimingAdvance             UL-TimingAdvanceControl-LCR-r4      OPTIONAL,
    ul-CCTrCH-TimeslotsCodes     UplinkTimeslotsCodes-LCR-r4
}

UL-DPCH-InfoPredef ::=        SEQUENCE {
    ul-DPCH-PowerControlInfo     UL-DPCH-PowerControlInfoPredef,
    modeSpecificInfo             CHOICE {
        fdd                      SEQUENCE {
            tfci-Existence        BOOLEAN,
            puncturingLimit       PuncturingLimit
        },
        tdd                      SEQUENCE {

```

```

        commonTimeslotInfo          CommonTimeslotInfo
    }
}

UL-DPCH-PowerControlInfo ::=      CHOICE {
    fdd                             SEQUENCE {
        dpcch-PowerOffset           DPCCH-PowerOffset,
        pc-Preamble                 PC-Preamble,
        srb-delay                   SRB-delay,
        powerControlAlgorithm       PowerControlAlgorithm
        -- TABULAR: TPC step size nested inside PowerControlAlgorithm
    },
    tdd                             SEQUENCE {
        ul-TargetSIR                UL-TargetSIR,
        ul-OL-PC-Signalling         CHOICE {
            broadcast-UL-OL-PC-info  NULL,
            handoverGroup            SEQUENCE {
                individualTS-InterferenceList  IndividualTS-InterferenceList,
                dpch-ConstantValue           ConstantValue,
                primaryCCPCH-TX-Power       PrimaryCCPCH-TX-Power
            }
        }
    }
}
OPTIONAL

UL-DPCH-PowerControlInfo-r4 ::=    CHOICE {
    fdd                             SEQUENCE {
        dpcch-PowerOffset           DPCCH-PowerOffset,
        pc-Preamble                 PC-Preamble,
        powerControlAlgorithm       PowerControlAlgorithm
        -- TABULAR: TPC step size nested inside PowerControlAlgorithm
    },
    tdd                             SEQUENCE {
        ul-TargetSIR                UL-TargetSIR,
        ul-OL-PC-Signalling         CHOICE {
            broadcast-UL-OL-PC-info  NULL,
            handoverGroup            SEQUENCE {
                tddOption            CHOICE {
                    tdd384          SEQUENCE {
                        individualTS-InterferenceList  IndividualTS-InterferenceList,
                        dpch-ConstantValue           ConstantValue
                    },
                    tdd128          SEQUENCE {
                        tpc-StepSize  TPC-StepSizeTDD
                    }
                }
            },
            primaryCCPCH-TX-Power  PrimaryCCPCH-TX-Power
        }
    }
}

UL-DPCH-PowerControlInfoPostFDD ::= SEQUENCE {
    dpcch-PowerOffset2           DPCCH-PowerOffset2, -- smaller range to save bits
    pc-Preamble                 PC-Preamble,
    srb-delay                   SRB-delay
}

UL-DPCH-PowerControlInfoPostTDD ::= SEQUENCE {
    ul-TargetSIR                UL-TargetSIR,
    ul-TimeslotInterference      UL-Interference
}

UL-DPCH-PowerControlInfoPostTDD-LCR-r4 ::= SEQUENCE {
    ul-TargetSIR                UL-TargetSIR
}

UL-DPCH-PowerControlInfoPredef ::= CHOICE {
    fdd                             SEQUENCE {
        powerControlAlgorithm       PowerControlAlgorithm
        -- TABULAR: TPC step size nested inside PowerControlAlgorithm
    },
    tdd                             SEQUENCE {
        -- The following IE shall be ignored if in 1.28Mcps TDD mode.
        dpch-ConstantValue          ConstantValue
    }
}

```

```

UL-Interference ::= INTEGER (-110..-70)

UL-ScramblingCode ::= INTEGER (0..16777215)

UL-SynchronisationParameters-r4 ::= SEQUENCE {
    stepSize          INTEGER (1..8),
    frequency         INTEGER (1..8)
}

-- Actual value = (IE value * 0.5) - 11
UL-TargetSIR ::= INTEGER (0..62)

UL-TimingAdvance ::= INTEGER (0..63)

UL-TimingAdvanceControl ::= CHOICE {
    disabled          NULL,
    enabled           SEQUENCE {
        ul-TimingAdvance          UL-TimingAdvance          OPTIONAL,
        activationTime            ActivationTime            OPTIONAL
    }
}

UL-TimingAdvanceControl-r4 ::= CHOICE {
    disabled          NULL,
    enabled           SEQUENCE {
        tddOption      CHOICE {
            tdd384      SEQUENCE {
                ul-TimingAdvance          UL-TimingAdvance          OPTIONAL,
                activationTime            ActivationTime            OPTIONAL
            },
            tdd128      SEQUENCE {
                ul-SynchronisationParameters          UL-SynchronisationParameters-r4 OPTIONAL,
                synchronisationParameters            SynchronisationParameters-r4 OPTIONAL
            }
        }
    }
}

UL-TimingAdvanceControl-LCR-r4 ::= CHOICE {
    disabled          NULL,
    enabled           SEQUENCE {
        ul-SynchronisationParameters          UL-SynchronisationParameters-r4 OPTIONAL,
        synchronisationParameters            SynchronisationParameters-r4 OPTIONAL
    }
}

UL-TS-ChannelisationCode ::= ENUMERATED {
    cc1-1, cc2-1, cc2-2,
    cc4-1, cc4-2, cc4-3, cc4-4,
    cc8-1, cc8-2, cc8-3, cc8-4,
    cc8-5, cc8-6, cc8-7, cc8-8,
    cc16-1, cc16-2, cc16-3, cc16-4,
    cc16-5, cc16-6, cc16-7, cc16-8,
    cc16-9, cc16-10, cc16-11, cc16-12,
    cc16-13, cc16-14, cc16-15, cc16-16 }

UL-TS-ChannelisationCodeList ::= SEQUENCE (SIZE (1..2)) OF
    UL-TS-ChannelisationCode

UplinkAdditionalTimeslots ::= SEQUENCE {
    parameters      CHOICE {
        sameAsLast  SEQUENCE {
            timeslotNumber          TimeslotNumber
        },
        newParameters SEQUENCE {
            individualTimeslotInfo          IndividualTimeslotInfo,
            ul-TS-ChannelisationCodeList    UL-TS-ChannelisationCodeList
        }
    }
}

UplinkAdditionalTimeslots-LCR-r4 ::= SEQUENCE {
    parameters      CHOICE {
        sameAsLast  SEQUENCE {
            timeslotNumber          TimeslotNumber
        },

```

```

        newParameters                SEQUENCE {
            individualTimeslotInfo    IndividualTimeslotInfo-LCR-r4,
            ul-TS-ChannelisationCodeList  UL-TS-ChannelisationCodeList
        }
    }
}

UplinkTimeslotsCodes ::=          SEQUENCE {
    dynamicSFusage                 BOOLEAN,
    firstIndividualTimeslotInfo    IndividualTimeslotInfo,
    ul-TS-ChannelisationCodeList  UL-TS-ChannelisationCodeList,
    moreTimeslots                  CHOICE {
        noMore                     NULL,
        additionalTimeslots        CHOICE {
            consecutive             SEQUENCE {
                numAdditionalTimeslots  INTEGER (1..maxTS-1)
            },
            timeslotList           SEQUENCE (SIZE (1..maxTS-1)) OF
                UplinkAdditionalTimeslots
        }
    }
}

UplinkTimeslotsCodes-LCR-r4 ::=  SEQUENCE {
    dynamicSFusage                 BOOLEAN,
    firstIndividualTimeslotInfo    IndividualTimeslotInfo-LCR-r4,
    ul-TS-ChannelisationCodeList  UL-TS-ChannelisationCodeList,
    moreTimeslots                  CHOICE {
        noMore                     NULL,
        additionalTimeslots        CHOICE {
            consecutive             SEQUENCE {
                numAdditionalTimeslots  INTEGER (1..maxTS-LCR-1)
            },
            timeslotList           SEQUENCE (SIZE (1..maxTS-LCR-1)) OF
                UplinkAdditionalTimeslots-LCR-r4
        }
    }
}

Wi-LCR ::=                        INTEGER(1..4)

-- *****
--
--     MEASUREMENT INFORMATION ELEMENTS (10.3.7)
--
-- *****

AcquisitionSatInfo ::=          SEQUENCE {
    satID                          SatID,
    -- Actual value = IE value * 2.5
    doppler0thOrder                INTEGER (-2048..2047),
    extraDopplerInfo               ExtraDopplerInfo                OPTIONAL,
    codePhase                      INTEGER (0..1022),
    integerCodePhase               INTEGER (0..19),
    gps-BitNumber                  INTEGER (0..3),
    codePhaseSearchWindow          CodePhaseSearchWindow,
    azimuthAndElevation            AzimuthAndElevation                OPTIONAL
}

AcquisitionSatInfoList ::=      SEQUENCE (SIZE (1..maxSat)) OF
    AcquisitionSatInfo

AdditionalMeasurementID-List ::= SEQUENCE (SIZE (1..maxAdditionalMeas)) OF
    MeasurementIdentity

AlmanacSatInfo ::=             SEQUENCE {
    dataID                        INTEGER (0..3),
    satID                          SatID,
    e                              BIT STRING (SIZE (16)),
    t-oa                          BIT STRING (SIZE (8)),
    deltaI                        BIT STRING (SIZE (16)),
    omegaDot                      BIT STRING (SIZE (16)),
    satHealth                     BIT STRING (SIZE (8)),
    a-Sqrt                        BIT STRING (SIZE (24)),
    omega0                        BIT STRING (SIZE (24)),
    m0                            BIT STRING (SIZE (24)),
    omega                         BIT STRING (SIZE (24)),
}

```



```

    af0          BIT STRING (SIZE (11)),
    af1          BIT STRING (SIZE (11))
}

AlmanacSatInfoList ::= SEQUENCE (SIZE (1..maxSat)) OF
                        AlmanacSatInfo

AverageRLC-BufferPayload ::= ENUMERATED {
    pla0, pla4, pla8, pla16, pla32,
    pla64, pla128, pla256, pla512,
    pla1024, pla2k, pla4k, pla8k, pla16k,
    pla32k, pla64k, pla128k, pla256k,
    pla512k, pla1024k }

AzimuthAndElevation ::= SEQUENCE {
    -- Actual value = IE value * 11.25
    azimuth      INTEGER (0..31),
    -- Actual value = IE value * 11.25
    elevation    INTEGER (0..7)
}

BadSatList ::= SEQUENCE (SIZE (1..maxSat)) OF
               INTEGER (0..63)

Frequency-Band ::= ENUMERATED {
    dcs1800BandUsed, pcs1900BandUsed }

BCCH-ARFCN ::= INTEGER (0..1023)

BLER-MeasurementResults ::= SEQUENCE {
    transportChannelIdentity      TransportChannelIdentity,
    dl-TransportChannelBLER      DL-TransportChannelBLER           OPTIONAL
}

BLER-MeasurementResultsList ::= SEQUENCE (SIZE (1..maxTrCH)) OF
                                  BLER-MeasurementResults

BLER-TransChIdList ::= SEQUENCE (SIZE (1..maxTrCH)) OF
                        TransportChannelIdentity

BSIC-VerificationRequired ::= ENUMERATED {
    required, notRequired }

BSICReported ::= CHOICE {
    -- Value maxCellMeas is not allowed for verifiedBSIC
    verifiedBSIC      INTEGER (0..maxCellMeas),
    nonVerifiedBSIC  BCCH-ARFCN
}

BurstModeParameters ::= SEQUENCE {
    burstStart      INTEGER (0..15),
    burstLength    INTEGER (10..25),
    burstFreq      INTEGER (1..16)
}

CellDCH-ReportCriteria ::= CHOICE {
    intraFreqReportingCriteria      IntraFreqReportingCriteria,
    periodicalReportingCriteria      PeriodicalReportingCriteria
}

CellDCH-ReportCriteria-LCR-r4 ::= CHOICE {
    intraFreqReportingCriteria      IntraFreqReportingCriteria-LCR-r4,
    periodicalReportingCriteria      PeriodicalReportingCriteria
}

-- Actual value = IE value * 0.5
CellIndividualOffset ::= INTEGER (-20..20)

CellInfo ::= SEQUENCE {
    cellIndividualOffset      CellIndividualOffset           DEFAULT 0,
    referenceTimeDifferenceToCell      ReferenceTimeDifferenceToCell      OPTIONAL,
    modeSpecificInfo          CHOICE {
        fdd                  SEQUENCE {
            primaryCPICH-Info      PrimaryCPICH-Info           OPTIONAL,
            primaryCPICH-TX-Power    PrimaryCPICH-TX-Power      OPTIONAL,
            readSFN-Indicator        BOOLEAN,
            tx-DiversityIndicator    BOOLEAN
        }
    }
}

```

```

    },
    tdd
        primaryCCPCH-Info
        primaryCCPCH-TX-Power
        timeslotInfoList
        readSFN-Indicator
    }
}

CellInfo-r4 ::=
    cellIndividualOffset
    referenceTimeDifferenceToCell
    modeSpecificInfo
    fdd
        primaryCPICH-Info
        primaryCPICH-TX-Power
        readSFN-Indicator
        tx-DiversityIndicator
    },
    tdd
        primaryCCPCH-Info
        primaryCCPCH-TX-Power
        timeslotInfoList
    }
}

CellInfoSI-RSCP ::=
    cellIndividualOffset
    referenceTimeDifferenceToCell
    modeSpecificInfo
    fdd
        primaryCPICH-Info
        primaryCPICH-TX-Power
        readSFN-Indicator
        tx-DiversityIndicator
    },
    tdd
        primaryCCPCH-Info
        primaryCCPCH-TX-Power
        timeslotInfoList
        readSFN-Indicator
    }
},
cellSelectionReselectionInfo
}

CellInfoSI-RSCP-LCR-r4 ::=
    cellIndividualOffset
    referenceTimeDifferenceToCell
    primaryCCPCH-Info
    primaryCCPCH-TX-Power
    timeslotInfoList
    cellSelectionReselectionInfo
}

CellInfoSI-ECN0 ::=
    cellIndividualOffset
    referenceTimeDifferenceToCell
    modeSpecificInfo
    fdd
        primaryCPICH-Info
        primaryCPICH-TX-Power
        readSFN-Indicator
        tx-DiversityIndicator
    },
    tdd
        primaryCCPCH-Info
        primaryCCPCH-TX-Power
        timeslotInfoList
        readSFN-Indicator
    }
},
cellSelectionReselectionInfo
}

CellInfoSI-ECN0-LCR-r4 ::=

```

SEQUENCE {

PrimaryCCPCH-Info, OPTIONAL,

PrimaryCCPCH-TX-Power OPTIONAL,

TimeslotInfoList OPTIONAL,

BOOLEAN

SEQUENCE {

CellIndividualOffset DEFAULT 0,

ReferenceTimeDifferenceToCell OPTIONAL,

CHOICE {

SEQUENCE {

PrimaryCPICH-Info OPTIONAL,

PrimaryCPICH-TX-Power OPTIONAL,

BOOLEAN,

BOOLEAN

SEQUENCE {

PrimaryCCPCH-Info-r4, OPTIONAL,

PrimaryCCPCH-TX-Power OPTIONAL,

TimeslotInfoList-r4

SEQUENCE {

CellIndividualOffset DEFAULT 0,

ReferenceTimeDifferenceToCell OPTIONAL,

CHOICE {

SEQUENCE {

PrimaryCPICH-Info OPTIONAL,

PrimaryCPICH-TX-Power OPTIONAL,

BOOLEAN,

BOOLEAN

SEQUENCE {

PrimaryCCPCH-Info, OPTIONAL,

PrimaryCCPCH-TX-Power OPTIONAL,

TimeslotInfoList OPTIONAL,

BOOLEAN

CellSelectReselectInfoSIB-11-12-RSCP OPTIONAL

SEQUENCE {

CellIndividualOffset DEFAULT 0,

ReferenceTimeDifferenceToCell OPTIONAL,

PrimaryCCPCH-Info-LCR-r4, OPTIONAL,

PrimaryCCPCH-TX-Power OPTIONAL,

TimeslotInfoList-LCR-r4 OPTIONAL,

CellSelectReselectInfoSIB-11-12-RSCP OPTIONAL

SEQUENCE {

CellIndividualOffset DEFAULT 0,

ReferenceTimeDifferenceToCell OPTIONAL,

CHOICE {

SEQUENCE {

PrimaryCPICH-Info OPTIONAL,

PrimaryCPICH-TX-Power OPTIONAL,

BOOLEAN,

BOOLEAN

SEQUENCE {

PrimaryCCPCH-Info, OPTIONAL,

PrimaryCCPCH-TX-Power OPTIONAL,

TimeslotInfoList OPTIONAL,

BOOLEAN

CellSelectReselectInfoSIB-11-12-ECN0 OPTIONAL

SEQUENCE {

```

cellIndividualOffset          CellIndividualOffset          DEFAULT 0,
referenceTimeDifferenceToCell ReferenceTimeDifferenceToCell OPTIONAL,
primaryCCPCH-Info            PrimaryCCPCH-Info-LCR-r4,
primaryCCPCH-TX-Power        PrimaryCCPCH-TX-Power          OPTIONAL,
timeslotInfoList             TimeslotInfoList-LCR-r4       OPTIONAL,
cellSelectionReselectionInfo CellSelectReselectInfoSIB-11-12-ECN0 OPTIONAL
}

CellInfoSI-HCS-RSCP ::=
cellIndividualOffset          CellIndividualOffset          DEFAULT 0,
referenceTimeDifferenceToCell ReferenceTimeDifferenceToCell OPTIONAL,
modeSpecificInfo              CHOICE {
    fdd                        SEQUENCE {
        primaryCPICH-Info      PrimaryCPICH-Info            OPTIONAL,
        primaryCPICH-TX-Power  PrimaryCPICH-TX-Power        OPTIONAL,
        readSFN-Indicator      BOOLEAN,
        tx-DiversityIndicator  BOOLEAN
    },
    tdd                        SEQUENCE {
        primaryCCPCH-Info      PrimaryCCPCH-Info,
        primaryCCPCH-TX-Power PrimaryCCPCH-TX-Power        OPTIONAL,
        timeslotInfoList       TimeslotInfoList             OPTIONAL,
        readSFN-Indicator      BOOLEAN
    }
},
cellSelectionReselectionInfo CellSelectReselectInfoSIB-11-12-HCS-RSCP OPTIONAL
}

CellInfoSI-HCS-RSCP-LCR-r4 ::=
cellIndividualOffset          CellIndividualOffset          DEFAULT 0,
referenceTimeDifferenceToCell ReferenceTimeDifferenceToCell OPTIONAL,
primaryCCPCH-Info            PrimaryCCPCH-Info-LCR-r4,
primaryCCPCH-TX-Power        PrimaryCCPCH-TX-Power          OPTIONAL,
timeslotInfoList             TimeslotInfoList-LCR-r4       OPTIONAL,
cellSelectionReselectionInfo CellSelectReselectInfoSIB-11-12-HCS-RSCP OPTIONAL
}

CellInfoSI-HCS-ECN0 ::=
cellIndividualOffset          CellIndividualOffset          DEFAULT 0,
referenceTimeDifferenceToCell ReferenceTimeDifferenceToCell OPTIONAL,
modeSpecificInfo              CHOICE {
    fdd                        SEQUENCE {
        primaryCPICH-Info      PrimaryCPICH-Info            OPTIONAL,
        primaryCPICH-TX-Power  PrimaryCPICH-TX-Power        OPTIONAL,
        readSFN-Indicator      BOOLEAN,
        tx-DiversityIndicator  BOOLEAN
    },
    tdd                        SEQUENCE {
        primaryCCPCH-Info      PrimaryCCPCH-Info,
        primaryCCPCH-TX-Power PrimaryCCPCH-TX-Power        OPTIONAL,
        timeslotInfoList       TimeslotInfoList             OPTIONAL,
        readSFN-Indicator      BOOLEAN
    }
},
cellSelectionReselectionInfo CellSelectReselectInfoSIB-11-12-HCS-ECN0 OPTIONAL
}

CellInfoSI-HCS-ECN0-LCR-r4 ::=
cellIndividualOffset          CellIndividualOffset          DEFAULT 0,
referenceTimeDifferenceToCell ReferenceTimeDifferenceToCell OPTIONAL,
primaryCCPCH-Info            PrimaryCCPCH-Info-LCR-r4,
primaryCCPCH-TX-Power        PrimaryCCPCH-TX-Power          OPTIONAL,
timeslotInfoList             TimeslotInfoList-LCR-r4       OPTIONAL,
cellSelectionReselectionInfo CellSelectReselectInfoSIB-11-12-HCS-ECN0 OPTIONAL
}

CellMeasuredResults ::=
cellIdentity                  CellIdentity                    OPTIONAL,
sfm-SFM-ObsTimeDifference    SFM-SFM-ObsTimeDifference        OPTIONAL,
cellSynchronisationInfo     CellSynchronisationInfo          OPTIONAL,
modeSpecificInfo              CHOICE {
    fdd                        SEQUENCE {
        primaryCPICH-Info      PrimaryCPICH-Info,
        cpich-Ec-N0            CPICH-Ec-N0                    OPTIONAL,
        cpich-RSCP              CPICH-RSCP                      OPTIONAL,
        pathloss                Pathloss                          OPTIONAL
    },
    tdd                        SEQUENCE {

```

```

        cellParametersID          CellParametersID,
        proposedTGSN              TGSN                                OPTIONAL,
        primaryCCPCH-RSCP         PrimaryCCPCH-RSCP                 OPTIONAL,
        pathloss                  Pathloss                          OPTIONAL,
        timeslotISCP-List         TimeslotISCP-List                 OPTIONAL
    }
}

CellMeasurementEventResults ::= CHOICE {
    fdd          SEQUENCE (SIZE (1..maxCellMeas)) OF
                PrimaryCPICH-Info,
    tdd          SEQUENCE (SIZE (1..maxCellMeas)) OF
                PrimaryCCPCH-Info
}

CellMeasurementEventResults-LCR-r4 ::= SEQUENCE (SIZE (1..maxCellMeas)) OF
    PrimaryCCPCH-Info-LCR-r4

CellPosition ::= SEQUENCE {
    relativeNorth    INTEGER (-32767..32767),
    relativeEast     INTEGER (-32767..32767),
    relativeAltitude INTEGER (-4095..4095)
}

CellReportingQuantities ::= SEQUENCE {
    sfn-SFN-OTD-Type          SFN-SFN-OTD-Type,
    cellIdentity-reportingIndicator    BOOLEAN,
    cellSynchronisationInfoReportingIndicator    BOOLEAN,
    modeSpecificInfo          CHOICE {
        fdd          SEQUENCE {
            cpich-Ec-N0-reportingIndicator    BOOLEAN,
            cpich-RSCP-reportingIndicator      BOOLEAN,
            pathloss-reportingIndicator        BOOLEAN
        },
        tdd          SEQUENCE {
            timeslotISCP-reportingIndicator    BOOLEAN,
            proposedTGSN-ReportingRequired    BOOLEAN,
            primaryCCPCH-RSCP-reportingIndicator    BOOLEAN,
            pathloss-reportingIndicator        BOOLEAN
        }
    }
}

CellSelectReselectInfoSIB-11-12 ::= SEQUENCE {
    q-Offset1S-N          Q-OffsetS-N          DEFAULT 0,
    q-Offset2S-N          Q-OffsetS-N          OPTIONAL,
    maxAllowedUL-TX-Power    MaxAllowedUL-TX-Power    OPTIONAL,
    hcs-NeighbouringCellInformation-RSCP    HCS-NeighbouringCellInformation-RSCP
    OPTIONAL,
    modeSpecificInfo          CHOICE {
        fdd          SEQUENCE {
            q-QualMin          Q-QualMin          OPTIONAL,
            q-RxlevMin         Q-RxlevMin         OPTIONAL
        },
        tdd          SEQUENCE {
            q-RxlevMin         Q-RxlevMin         OPTIONAL
        },
        gsm          SEQUENCE {
            q-RxlevMin         Q-RxlevMin         OPTIONAL
        }
    }
}

CellSelectReselectInfoSIB-11-12-RSCP ::= SEQUENCE {
    q-OffsetS-N          Q-OffsetS-N          DEFAULT 0,
    maxAllowedUL-TX-Power    MaxAllowedUL-TX-Power    OPTIONAL,
    modeSpecificInfo          CHOICE {
        fdd          SEQUENCE {
            q-QualMin          Q-QualMin          OPTIONAL,
            q-RxlevMin         Q-RxlevMin         OPTIONAL
        },
        tdd          SEQUENCE {
            q-RxlevMin         Q-RxlevMin         OPTIONAL
        },
        gsm          SEQUENCE {
            q-RxlevMin         Q-RxlevMin         OPTIONAL
        }
    }
}

```

```

}
}
CellSelectReselectInfoSIB-11-12-ECNO ::= SEQUENCE {
  q-Offset1S-N          Q-OffsetS-N          DEFAULT 0,
  q-Offset2S-N          Q-OffsetS-N          DEFAULT 0,
  maxAllowedUL-TX-Power MaxAllowedUL-TX-Power OPTIONAL,
  modeSpecificInfo     CHOICE {
    fdd                 SEQUENCE {
      q-QualMin         Q-QualMin           OPTIONAL,
      q-RxlevMin        Q-RxlevMin          OPTIONAL
    },
    tdd                 SEQUENCE {
      q-RxlevMin        Q-RxlevMin          OPTIONAL
    },
    gsm                 SEQUENCE {
      q-RxlevMin        Q-RxlevMin          OPTIONAL
    }
  }
}

CellSelectReselectInfoSIB-11-12-HCS-RSCP ::= SEQUENCE {
  q-OffsetS-N           Q-OffsetS-N           DEFAULT 0,
  maxAllowedUL-TX-Power MaxAllowedUL-TX-Power OPTIONAL,
  hcs-NeighbouringCellInformation-RSCP HCS-NeighbouringCellInformation-RSCP
  OPTIONAL,
  modeSpecificInfo     CHOICE {
    fdd                 SEQUENCE {
      q-QualMin         Q-QualMin           OPTIONAL,
      q-RxlevMin        Q-RxlevMin          OPTIONAL
    },
    tdd                 SEQUENCE {
      q-RxlevMin        Q-RxlevMin          OPTIONAL
    },
    gsm                 SEQUENCE {
      q-RxlevMin        Q-RxlevMin          OPTIONAL
    }
  }
}

CellSelectReselectInfoSIB-11-12-HCS-ECNO ::= SEQUENCE {
  q-Offset1S-N          Q-OffsetS-N          DEFAULT 0,
  q-Offset2S-N          Q-OffsetS-N          DEFAULT 0,
  maxAllowedUL-TX-Power MaxAllowedUL-TX-Power OPTIONAL,
  hcs-NeighbouringCellInformation-ECNO HCS-NeighbouringCellInformation-ECNO
  OPTIONAL,
  modeSpecificInfo     CHOICE {
    fdd                 SEQUENCE {
      q-QualMin         Q-QualMin           OPTIONAL,
      q-RxlevMin        Q-RxlevMin          OPTIONAL
    },
    tdd                 SEQUENCE {
      q-RxlevMin        Q-RxlevMin          OPTIONAL
    },
    gsm                 SEQUENCE {
      q-RxlevMin        Q-RxlevMin          OPTIONAL
    }
  }
}

CellsForInterFreqMeasList ::= SEQUENCE (SIZE (1..maxCellMeas)) OF
  InterFreqCellID
CellsForInterRATMeasList ::= SEQUENCE (SIZE (1..maxCellMeas)) OF
  InterRATCellID
CellsForIntraFreqMeasList ::= SEQUENCE (SIZE (1..maxCellMeas)) OF
  IntraFreqCellID

CellSynchronisationInfo ::= SEQUENCE {
  modeSpecificInfo     CHOICE {
    fdd                 SEQUENCE {
      countC-SFN-Frame-difference CountC-SFN-Frame-difference OPTIONAL,
      tm                 INTEGER(0..38399)
    },
    tdd                 SEQUENCE {
      countC-SFN-Frame-difference CountC-SFN-Frame-difference OPTIONAL
    }
  }
}

```

```

CellToMeasure ::=
    sfm-sfm-Drift                INTEGER (0..30)                OPTIONAL,
    primaryCPICH-Info            PrimaryCPICH-Info,
    frequencyInfo                FrequencyInfo                OPTIONAL,
    sfm-SFM-ObservedTimeDifference SFM-SFM-ObsTimeDifference1,
    fineSFM-SFM                  FineSFM-SFM,
    cellPosition                  CellPosition                OPTIONAL
}

CellToMeasureInfoList ::= SEQUENCE (SIZE (1..maxCellMeas)) OF
    CellToMeasure

CellToReport ::= SEQUENCE {
    bsicReported                 BSICReported
}

CellToReportList ::= SEQUENCE (SIZE (1..maxCellMeas)) OF
    CellToReport

CodePhaseSearchWindow ::= ENUMERATED {
    w1023, w1, w2, w3, w4, w6, w8,
    w12, w16, w24, w32, w48, w64,
    w96, w128, w192 }

CountC-SFM-Frame-difference ::= SEQUENCE {
    countC-SFM-High              INTEGER(0..15),                -- Actual value = IE value * 256
    off                           INTEGER(0..255)
}

CPICH-Ec-NO ::= INTEGER (0..50)

CPICH-RSCP ::= INTEGER (0..91)

DeltaPRC ::= INTEGER (-127..127)

-- Actual value = IE value * 0.032
DeltaRRC ::= INTEGER (-7..7)

DGPS-CorrectionSatInfo ::= SEQUENCE {
    satID                         SatID,
    iode                           IODE,
    udre                           UDRE,
    prc                             PRC,
    rrc                             RRC,
    deltaPRC2                       DeltaPRC,
    deltaRRC2                       DeltaRRC,
    deltaPRC3                       DeltaPRC                OPTIONAL,
    deltaRRC3                       DeltaRRC                OPTIONAL
}

DGPS-CorrectionSatInfoList ::= SEQUENCE (SIZE (1..maxSat)) OF
    DGPS-CorrectionSatInfo

DiffCorrectionStatus ::= ENUMERATED {
    udre-1-0, udre-0-75, udre-0-5, udre-0-3,
    udre-0-2, udre-0-1, noData, invalidData }

-- Actual value = IE value * 0.02
DL-PhysicalChannelBER ::= INTEGER (0..255)

DL-TransportChannelBLER ::= INTEGER (0..63)

DopplerUncertainty ::= ENUMERATED {
    hz12-5, hz25, hz50, hz100, hz200 }

EllipsoidPoint ::= SEQUENCE {
    latitudeSign                   ENUMERATED { north, south },
    latitude                       INTEGER (0..8388607),
    longitude                       INTEGER (-8388608..8388607)
}

EllipsoidPointAltitude ::= SEQUENCE {
    latitudeSign                   ENUMERATED { north, south },
    latitude                       INTEGER (0..8388607),
    longitude                       INTEGER (-8388608..8388607),

```

```

altitudeDirection  ENUMERATED {height, depth},
altitude           INTEGER (0..32767)
}

EllipsoidPointAltitudeEllipsoide ::= SEQUENCE {
latitudeSign      ENUMERATED { north, south },
latitude          INTEGER (0..8388607),
longitude         INTEGER (-8388608..8388607),
altitudeDirection ENUMERATED {height, depth},
altitude          INTEGER (0..32767),
uncertaintySemiMajor  INTEGER (0..127),
uncertaintySemiMinor  INTEGER (0..127),
orientationMajorAxis  INTEGER (0..89),
uncertaintyAltitude   INTEGER (0..127),
confidence         INTEGER (0..100)
}

EllipsoidPointUncertCircle ::= SEQUENCE {
latitudeSign      ENUMERATED { north, south },
latitude          INTEGER (0..8388607),
longitude         INTEGER (-8388608..8388607),
uncertaintyCode   INTEGER (0..127)
}

EllipsoidPointUncertEllipse ::= SEQUENCE {
latitudeSign      ENUMERATED { north, south },
latitude          INTEGER (0..8388607),
longitude         INTEGER (-8388608..8388607),
uncertaintySemiMajor  INTEGER (0..127),
uncertaintySemiMinor  INTEGER (0..127),
orientationMajorAxis  INTEGER (0..89),
confidence         INTEGER (0..100)
}

EnvironmentCharacterisation ::= ENUMERATED {
possibleHeavyMultipathNLOS,
lightMultipathLOS,
notDefined }

Event1a ::= SEQUENCE {
triggeringCondition  TriggeringCondition2,
reportingRange       ReportingRange,
forbiddenAffectCellList  ForbiddenAffectCellList      OPTIONAL,
w                    W,
reportDeactivationThreshold  ReportDeactivationThreshold,
reportingAmount       ReportingAmount,
reportingInterval     ReportingInterval
}

Event1a-r4 ::= SEQUENCE {
triggeringCondition  TriggeringCondition2,
reportingRange       ReportingRange,
forbiddenAffectCellList  ForbiddenAffectCellList-r4      OPTIONAL,
w                    W,
reportDeactivationThreshold  ReportDeactivationThreshold,
reportingAmount       ReportingAmount,
reportingInterval     ReportingInterval
}

Event1a-LCR-r4 ::= SEQUENCE {
triggeringCondition  TriggeringCondition2,
reportingRange       ReportingRange,
forbiddenAffectCellList  ForbiddenAffectCellList-LCR-r4      OPTIONAL,
w                    W,
reportDeactivationThreshold  ReportDeactivationThreshold,
reportingAmount       ReportingAmount,
reportingInterval     ReportingInterval
}

Event1b ::= SEQUENCE {
triggeringCondition  TriggeringCondition1,
reportingRange       ReportingRange,
forbiddenAffectCellList  ForbiddenAffectCellList      OPTIONAL,
w                    W
}

```

```

}

Event1b-r4 ::=
    triggeringCondition
    reportingRange
    forbiddenAffectCellList
    w
}

SEQUENCE {
    TriggeringCondition1,
    ReportingRange,
    ForbiddenAffectCellList-r4
    w
    OPTIONAL,
}

Event1b-LCR-r4 ::=
    triggeringCondition
    reportingRange
    forbiddenAffectCellList
    w
}

SEQUENCE {
    TriggeringCondition1,
    ReportingRange,
    ForbiddenAffectCellList-LCR-r4
    w
    OPTIONAL,
}

Event1c ::=
    replacementActivationThreshold
    reportingAmount
    reportingInterval
}

SEQUENCE {
    ReplacementActivationThreshold,
    ReportingAmount,
    ReportingInterval
}

Event1e ::=
    triggeringCondition
    thresholdUsedFrequency
}

SEQUENCE {
    TriggeringCondition2,
    ThresholdUsedFrequency
}

Event1f ::=
    triggeringCondition
    thresholdUsedFrequency
}

SEQUENCE {
    TriggeringCondition1,
    ThresholdUsedFrequency
}

Event2a ::=
    usedFreqThreshold
    usedFreqW
    hysteresis
    timeToTrigger
    reportingCellStatus
    nonUsedFreqParameterList
}

SEQUENCE {
    Threshold,
    W,
    HysteresisInterFreq,
    TimeToTrigger,
    ReportingCellStatus
    NonUsedFreqParameterList
    OPTIONAL,
    OPTIONAL
}

Event2b ::=
    usedFreqThreshold
    usedFreqW
    hysteresis
    timeToTrigger
    reportingCellStatus
    nonUsedFreqParameterList
}

SEQUENCE {
    Threshold,
    W,
    HysteresisInterFreq,
    TimeToTrigger,
    ReportingCellStatus
    NonUsedFreqParameterList
    OPTIONAL,
    OPTIONAL
}

Event2c ::=
    hysteresis
    timeToTrigger
    reportingCellStatus
    nonUsedFreqParameterList
}

SEQUENCE {
    HysteresisInterFreq,
    TimeToTrigger,
    ReportingCellStatus
    NonUsedFreqParameterList
    OPTIONAL,
    OPTIONAL
}

Event2d ::=
    usedFreqThreshold
    usedFreqW
    hysteresis
    timeToTrigger
    reportingCellStatus
}

SEQUENCE {
    Threshold,
    W,
    HysteresisInterFreq,
    TimeToTrigger,
    ReportingCellStatus
    OPTIONAL
}

Event2e ::=
    hysteresis
    timeToTrigger
    reportingCellStatus
    nonUsedFreqParameterList
}

SEQUENCE {
    HysteresisInterFreq,
    TimeToTrigger,
    ReportingCellStatus
    NonUsedFreqParameterList
    OPTIONAL,
    OPTIONAL
}

Event2f ::=
    usedFreqThreshold
    usedFreqW
    hysteresis
    timeToTrigger
    reportingCellStatus
}

SEQUENCE {
    Threshold,
    W,
    HysteresisInterFreq,
    TimeToTrigger,
    ReportingCellStatus
    OPTIONAL
}

```



```

}

Event3a ::=
    thresholdOwnSystem
    w
    thresholdOtherSystem
    hysteresis
    timeToTrigger
    reportingCellStatus
    SEQUENCE {
        Threshold,
        W,
        Threshold,
        Hysteresis,
        TimeToTrigger,
        ReportingCellStatus
    } OPTIONAL

Event3b ::=
    thresholdOtherSystem
    hysteresis
    timeToTrigger
    reportingCellStatus
    SEQUENCE {
        Threshold,
        Hysteresis,
        TimeToTrigger,
        ReportingCellStatus
    } OPTIONAL

Event3c ::=
    thresholdOtherSystem
    hysteresis
    timeToTrigger
    reportingCellStatus
    SEQUENCE {
        Threshold,
        Hysteresis,
        TimeToTrigger,
        ReportingCellStatus
    } OPTIONAL

Event3d ::=
    hysteresis
    timeToTrigger
    reportingCellStatus
    SEQUENCE {
        Hysteresis,
        TimeToTrigger,
        ReportingCellStatus
    } OPTIONAL

EventIDInterFreq ::=
    ENUMERATED {
        e2a, e2b, e2c, e2d, e2e, e2f }

EventIDInterRAT ::=
    ENUMERATED {
        e3a, e3b, e3c, e3d }

EventIDIntraFreq ::=
    ENUMERATED {
        e1a, e1b, e1c, e1d, e1e,
        e1f, e1g, e1h, e1i }

EventResults ::=
    intraFreqEventResults
    interFreqEventResults
    interRATEventResults
    trafficVolumeEventResults
    qualityEventResults
    ue-InternalEventResults
    ue-positioning-MeasurementEventResults
    CHOICE {
        IntraFreqEventResults,
        InterFreqEventResults,
        InterRATEventResults,
        TrafficVolumeEventResults,
        QualityEventResults,
        UE-InternalEventResults,
        UE-Positioning-MeasurementEventResults
    }

ExtraDopplerInfo ::=
    -- Actual value = IE value * 0.023
    doppler1stOrder
    dopplerUncertainty
    SEQUENCE {
        INTEGER (-42..21),
        DopplerUncertainty
    }

FACH-MeasurementOccasionInfo ::=
    fACH-meas-occasion-coeff
    inter-freq-FDD-meas-ind
    -- The following IE is for 3.84Mcps TDD. For 1.28Mcps TDD, the IE in
    -- FACH-MeasurementOccasionInfo-LCR-r4-ext is used.
    inter-freq-TDD-meas-ind
    inter-RAT-meas-ind
    SEQUENCE {
        INTEGER (1..12)
        BOOLEAN,
        SEQUENCE (SIZE (1..maxOtherRAT)) OF
            RAT-Type
    } OPTIONAL

FACH-MeasurementOccasionInfo-LCR-r4-ext ::= SEQUENCE {
    inter-freq-TDD128-meas-ind
    BOOLEAN
}

FilterCoefficient ::=
    fc0, fc1, fc2, fc3, fc4, fc5,
    fc6, fc7, fc8, fc9, fc11, fc13,
    fc15, fc17, fc19, spare1 }
    ENUMERATED {

-- Actual value = IE value * 0.0625

```

```

FineSFN-SFN ::= INTEGER (0..15)

ForbiddenAffectCell ::= CHOICE {
    fdd PrimaryCPICH-Info,
    tdd PrimaryCCPCH-Info
}

ForbiddenAffectCell-r4 ::= CHOICE {
    fdd PrimaryCPICH-Info,
    tdd PrimaryCCPCH-Info-r4
}

ForbiddenAffectCell-LCR-r4 ::= SEQUENCE {
    tdd PrimaryCCPCH-Info-LCR-r4
}

ForbiddenAffectCellList ::= SEQUENCE (SIZE (1..maxCellMeas)) OF
    ForbiddenAffectCell

ForbiddenAffectCellList-r4 ::= SEQUENCE (SIZE (1..maxCellMeas)) OF
    ForbiddenAffectCell-r4

ForbiddenAffectCellList-LCR-r4 ::= SEQUENCE (SIZE (1..maxCellMeas)) OF
    ForbiddenAffectCell-LCR-r4

FreqQualityEstimateQuantity-FDD ::= ENUMERATED {
    cpich-Ec-N0,
    cpich-RSCP }

FreqQualityEstimateQuantity-TDD ::= ENUMERATED {
    primaryCCPCH-RSCP }

GPS-MeasurementParam ::= SEQUENCE {
    satelliteID INTEGER (0..63),
    c-N0 INTEGER (0..63),
    doppler INTEGER (-32768..32768),
    wholeGPS-Chips INTEGER (0..1023),
    fractionalGPS-Chips INTEGER (0..1023),
    multipathIndicator MultipathIndicator,
    pseudorangeRMS-Error INTEGER (0..63)
}

GPS-MeasurementParamList ::= SEQUENCE (SIZE (1..maxSat)) OF
    GPS-MeasurementParam

GSM-CarrierRSSI ::= BIT STRING (SIZE (6))

GSM-MeasuredResults ::= SEQUENCE {
    gsm-CarrierRSSI GSM-CarrierRSSI OPTIONAL,
    pathloss Pathloss OPTIONAL,
    bsicReported BSICReported,
    observedTimeDifferenceToGSM ObservedTimeDifferenceToGSM OPTIONAL
}

GSM-MeasuredResultsList ::= SEQUENCE (SIZE (1..maxReportedGSMCells)) OF
    GSM-MeasuredResults

GPS-TOW-1msec ::= INTEGER (0..604799999)

GPS-TOW-Assist ::= SEQUENCE {
    satID SatID,
    tlm-Message BIT STRING (SIZE (14)),
    tlm-Reserved BIT STRING (SIZE (2)),
    alert BOOLEAN,
    antiSpoof BOOLEAN
}

GPS-TOW-AssistList ::= SEQUENCE (SIZE (1..maxSat)) OF
    GPS-TOW-Assist

GPS-TOW-rem-usec ::= INTEGER (0..999)

HCS-CellReselectInformation-RSCP ::= SEQUENCE {
    penaltyTime PenaltyTime-RSCP
    -- TABULAR: The default value is "notUsed", temporary offset is nested inside PenaltyTime
}

```

```

HCS-CellReselectInformation-ECNO ::= SEQUENCE {
    penaltyTime PenaltyTime-ECNO
    -- TABULAR: The default value is "notUsed", temporary offset is nested inside PenaltyTime
}

HCS-NeighbouringCellInformation-RSCP ::= SEQUENCE {
    hcs-PRIO HCS-PRIO DEFAULT 0,
    q-HCS Q-HCS DEFAULT 0,
    hcs-CellReselectInformation HCS-CellReselectInformation-RSCP
}

HCS-NeighbouringCellInformation-ECNO ::= SEQUENCE {
    hcs-PRIO HCS-PRIO DEFAULT 0,
    q-HCS Q-HCS DEFAULT 0,
    hcs-CellReselectInformation HCS-CellReselectInformation-ECNO
}

HCS-PRIO ::= INTEGER (0..7)

HCS-ServingCellInformation ::= SEQUENCE {
    hcs-PRIO HCS-PRIO DEFAULT 0,
    q-HCS Q-HCS DEFAULT 0,
    t-CR-Max T-CRMax OPTIONAL
}

-- Actual value = IE value * 0.5
Hysteresis ::= INTEGER (0..15)

-- Actual value = IE value * 0.5
HysteresisInterFreq ::= INTEGER (0..29)

InterFreqCell ::= SEQUENCE {
    frequencyInfo FrequencyInfo,
    nonFreqRelatedEventResults CellMeasurementEventResults
}

InterFreqCell-LCR-r4 ::= SEQUENCE {
    frequencyInfo FrequencyInfo,
    nonFreqRelatedEventResults CellMeasurementEventResults-LCR-r4
}

InterFreqCellID ::= INTEGER (0..maxCellMeas-1)

InterFreqCellInfoList ::= SEQUENCE {
    removedInterFreqCellList RemovedInterFreqCellList OPTIONAL,
    newInterFreqCellList NewInterFreqCellList OPTIONAL,
    cellsForInterFreqMeasList CellsForInterFreqMeasList OPTIONAL
}

InterFreqCellInfoList-r4 ::= SEQUENCE {
    removedInterFreqCellList RemovedInterFreqCellList OPTIONAL,
    newInterFreqCellList NewInterFreqCellList-r4 OPTIONAL
}

InterFreqCellInfoSI-List-RSCP ::= SEQUENCE {
    removedInterFreqCellList RemovedInterFreqCellList OPTIONAL,
    newInterFreqCellList NewInterFreqCellSI-List-RSCP OPTIONAL
}

InterFreqCellInfoSI-List-ECNO ::= SEQUENCE {
    removedInterFreqCellList RemovedInterFreqCellList OPTIONAL,
    newInterFreqCellList NewInterFreqCellSI-List-ECNO OPTIONAL
}

InterFreqCellInfoSI-List-HCS-RSCP ::= SEQUENCE {
    removedInterFreqCellList RemovedInterFreqCellList OPTIONAL,
    newInterFreqCellList NewInterFreqCellSI-List-HCS-RSCP OPTIONAL
}

InterFreqCellInfoSI-List-HCS-ECNO ::= SEQUENCE {
    removedInterFreqCellList RemovedInterFreqCellList OPTIONAL,
    newInterFreqCellList NewInterFreqCellSI-List-HCS-ECNO OPTIONAL
}

InterFreqCellInfoSI-List-RSCP-LCR ::= SEQUENCE {
    removedInterFreqCellList RemovedInterFreqCellList OPTIONAL,
    newInterFreqCellList NewInterFreqCellSI-List-RSCP-LCR-r4 OPTIONAL
}

```

```

InterFreqCellInfoSI-List-ECN0-LCR ::= SEQUENCE {
    removedInterFreqCellList RemovedInterFreqCellList OPTIONAL,
    newInterFreqCellList NewInterFreqCellSI-List-ECN0-LCR-r4 OPTIONAL
}

InterFreqCellInfoSI-List-HCS-RSCP-LCR ::= SEQUENCE {
    removedInterFreqCellList RemovedInterFreqCellList OPTIONAL,
    newInterFreqCellList NewInterFreqCellSI-List-HCS-RSCP-LCR-r4 OPTIONAL
}

InterFreqCellInfoSI-List-HCS-ECN0-LCR ::= SEQUENCE {
    removedInterFreqCellList RemovedInterFreqCellList OPTIONAL,
    newInterFreqCellList NewInterFreqCellSI-List-HCS-ECN0-LCR-r4 OPTIONAL
}

InterFreqCellList ::= SEQUENCE (SIZE (1..maxFreq)) OF
    InterFreqCell

InterFreqCellList-LCR-r4-ext ::= SEQUENCE (SIZE (1..maxFreq)) OF
    InterFreqCell-LCR-r4

InterFreqCellMeasuredResultsList ::= SEQUENCE (SIZE (1..maxCellMeas)) OF
    CellMeasuredResults

InterFreqEvent ::= CHOICE {
    event2a Event2a,
    event2b Event2b,
    event2c Event2c,
    event2d Event2d,
    event2e Event2e,
    event2f Event2f
}

InterFreqEventList ::= SEQUENCE (SIZE (1..maxMeasEvent)) OF
    InterFreqEvent

InterFreqEventResults ::= SEQUENCE {
    eventID EventIDInterFreq,
    interFreqCellList InterFreqCellList OPTIONAL
}

InterFreqEventResults-LCR-r4-ext ::= SEQUENCE {
    eventID EventIDInterFreq,
    interFreqCellList InterFreqCellList-LCR-r4-ext OPTIONAL
}

InterFreqMeasQuantity ::= SEQUENCE {
    reportingCriteria CHOICE {
        intraFreqReportingCriteria SEQUENCE {
            intraFreqMeasQuantity IntraFreqMeasQuantity
        },
        interFreqReportingCriteria SEQUENCE {
            filterCoefficient FilterCoefficient DEFAULT fc0,
            modeSpecificInfo CHOICE {
                fdd SEQUENCE {
                    freqQualityEstimateQuantity-FDD FreqQualityEstimateQuantity-FDD
                },
                tdd SEQUENCE {
                    freqQualityEstimateQuantity-TDD FreqQualityEstimateQuantity-TDD
                }
            }
        }
    }
}

InterFreqMeasuredResults ::= SEQUENCE {
    frequencyInfo FrequencyInfo OPTIONAL,
    ultra-CarrierRSSI UTRA-CarrierRSSI OPTIONAL,
    interFreqCellMeasuredResultsList InterFreqCellMeasuredResultsList OPTIONAL
}

InterFreqMeasuredResultsList ::= SEQUENCE (SIZE (1..maxFreq)) OF
    InterFreqMeasuredResults

InterFreqMeasurementSysInfo-RSCP ::= SEQUENCE {
    interFreqCellInfoSI-List InterFreqCellInfoSI-List-RSCP OPTIONAL
}

```

```

InterFreqMeasurementSysInfo-ECN0 ::= SEQUENCE {
    interFreqCellInfoSI-List          InterFreqCellInfoSI-List-ECN0          OPTIONAL
}

InterFreqMeasurementSysInfo-HCS-RSCP ::= SEQUENCE {
    interFreqCellInfoSI-List          InterFreqCellInfoSI-List-HCS-RSCP      OPTIONAL
}

InterFreqMeasurementSysInfo-HCS-ECN0 ::= SEQUENCE {
    interFreqCellInfoSI-List          InterFreqCellInfoSI-List-HCS-ECN0    OPTIONAL
}

InterFreqMeasurementSysInfo-RSCP-LCR-r4 ::= SEQUENCE {
    interFreqCellInfoSI-List          InterFreqCellInfoSI-List-RSCP-LCR    OPTIONAL
}

InterFreqMeasurementSysInfo-ECN0-LCR-r4 ::= SEQUENCE {
    interFreqCellInfoSI-List          InterFreqCellInfoSI-List-ECN0-LCR    OPTIONAL
}

InterFreqMeasurementSysInfo-HCS-RSCP-LCR-r4 ::= SEQUENCE {
    interFreqCellInfoSI-List          InterFreqCellInfoSI-List-HCS-RSCP-LCR  OPTIONAL
}

InterFreqMeasurementSysInfo-HCS-ECN0-LCR-r4 ::= SEQUENCE {
    interFreqCellInfoSI-List          InterFreqCellInfoSI-List-HCS-ECN0-LCR  OPTIONAL
}

InterFreqReportCriteria ::= CHOICE {
    intraFreqReportingCriteria
    interFreqReportingCriteria
    periodicalReportingCriteria
    noReporting
}

InterFreqReportCriteria-r4 ::= CHOICE {
    intraFreqReportingCriteria-r4
    interFreqReportingCriteria
    periodicalReportingCriteria
    noReporting
}

InterFreqReportingCriteria ::= SEQUENCE {
    interFreqEventList
}

InterFreqReportingQuantity ::= SEQUENCE {
    ultra-Carrier-RSSI
    frequencyQualityEstimate
    nonFreqRelatedQuantities
}

InterFrequencyMeasurement ::= SEQUENCE {
    interFreqCellInfoList
    interFreqMeasQuantity
    interFreqReportingQuantity
    measurementValidity
    interFreqSetUpdate
    reportCriteria
}

InterFrequencyMeasurement-r4 ::= SEQUENCE {
    interFreqCellInfoList
    interFreqMeasQuantity
    interFreqReportingQuantity
    measurementValidity
    interFreqSetUpdate
    reportCriteria
}

InterRAT-TargetCellDescription ::= SEQUENCE {
    technologySpecificInfo
    gsm
    bsic
    frequency-band
    bcch-ARFCN
    ncMode
}

```

```

    },
    is-2000
    spare
  }
}

InterRATCellID ::=                INTEGER (0..maxCellMeas-1)

InterRATCellInfoList ::=          SEQUENCE {
  removedInterRATCellList        RemovedInterRATCellList,
  newInterRATCellList            NewInterRATCellList,
  cellsForInterRATMeasList      CellsForInterRATMeasList          OPTIONAL
}

InterRATCellInfoList-B ::=       SEQUENCE {
  removedInterRATCellList        RemovedInterRATCellList,
  newInterRATCellList            NewInterRATCellList-B
}

InterRATCellIndividualOffset ::=  INTEGER (-50..50)

InterRATEvent ::=                CHOICE {
  event3a                        Event3a,
  event3b                        Event3b,
  event3c                        Event3c,
  event3d                        Event3d
}

InterRATEventList ::=            SEQUENCE (SIZE (1..maxMeasEvent)) OF
  InterRATEvent

InterRATEventResults ::=         SEQUENCE {
  eventID                        EventIDInterRAT,
  cellToReportList              CellToReportList
}

InterRATInfo ::=                 ENUMERATED {
  gsm
}

InterRATMeasQuantity ::=         SEQUENCE {
  measQuantityUTRAN-QualityEstimate  IntraFreqMeasQuantity          OPTIONAL,
  ratSpecificInfo                  CHOICE {
    gsm                             SEQUENCE {
      measurementQuantity            MeasurementQuantityGSM,
      filterCoefficient              FilterCoefficient          DEFAULT fc0,
      bsic-VerificationRequired      BSIC-VerificationRequired
    },
    is-2000                          SEQUENCE {
      tadd-EcIo                      INTEGER (0..63),
      tcomp-EcIo                     INTEGER (0..15),
      softSlope                       INTEGER (0..63)          OPTIONAL,
      addIntercept                    INTEGER (0..63)          OPTIONAL
    }
  }
}

InterRATMeasuredResults ::=      CHOICE {
  gsm                              GSM-MeasuredResultsList,
  spare                             NULL
}

InterRATMeasuredResultsList ::=  SEQUENCE (SIZE (1..maxOtherRAT)) OF
  InterRATMeasuredResults

InterRATMeasurement ::=         SEQUENCE {
  interRATCellInfoList            InterRATCellInfoList          OPTIONAL,
  interRATMeasQuantity            InterRATMeasQuantity          OPTIONAL,
  interRATReportingQuantity        InterRATReportingQuantity      OPTIONAL,
  reportCriteria                   InterRATReportCriteria
}

InterRATMeasurementSysInfo ::=  SEQUENCE {
  interRATCellInfoList            InterRATCellInfoList          OPTIONAL
}

InterRATMeasurementSysInfo-B ::= SEQUENCE {
  interRATCellInfoList            InterRATCellInfoList-B        OPTIONAL
}

```

```

InterRATReportCriteria ::= CHOICE {
    interRATReportingCriteria    InterRATReportingCriteria,
    periodicalReportingCriteria  PeriodicalWithReportingCellStatus,
    noReporting                  ReportingCellStatusOpt
}

InterRATReportingCriteria ::= SEQUENCE {
    interRATEventList            InterRATEventList            OPTIONAL
}

InterRATReportingQuantity ::= SEQUENCE {
    utran-EstimatedQuality      BOOLEAN,
    ratSpecificInfo             CHOICE {
        gsm                     SEQUENCE {
            pathloss             BOOLEAN,
            observedTimeDifferenceGSM  BOOLEAN,
            gsm-Carrier-RSSI     BOOLEAN
        }
    }
}

IntraFreqCellID ::= INTEGER (0..maxCellMeas-1)

IntraFreqCellInfoList ::= SEQUENCE {
    removedIntraFreqCellList    RemovedIntraFreqCellList    OPTIONAL,
    newIntraFreqCellList        NewIntraFreqCellList        OPTIONAL,
    cellsForIntraFreqMeasList    CellsForIntraFreqMeasList    OPTIONAL
}

IntraFreqCellInfoList-r4 ::= SEQUENCE {
    removedIntraFreqCellList    RemovedIntraFreqCellList    OPTIONAL,
    newIntraFreqCellList        NewIntraFreqCellList-r4        OPTIONAL
}

IntraFreqCellInfoSI-List-RSCP ::= SEQUENCE {
    removedIntraFreqCellList    RemovedIntraFreqCellList    OPTIONAL,
    newIntraFreqCellList        NewIntraFreqCellSI-List-RSCP
}

IntraFreqCellInfoSI-List-ECN0 ::= SEQUENCE {
    removedIntraFreqCellList    RemovedIntraFreqCellList    OPTIONAL,
    newIntraFreqCellList        NewIntraFreqCellSI-List-ECN0
}

IntraFreqCellInfoSI-List-HCS-RSCP ::= SEQUENCE {
    removedIntraFreqCellList    RemovedIntraFreqCellList    OPTIONAL,
    newIntraFreqCellList        NewIntraFreqCellSI-List-HCS-RSCP
}

IntraFreqCellInfoSI-List-HCS-ECN0 ::= SEQUENCE {
    removedIntraFreqCellList    RemovedIntraFreqCellList    OPTIONAL,
    newIntraFreqCellList        NewIntraFreqCellSI-List-HCS-ECN0
}

IntraFreqCellInfoSI-List-RSCP-LCR-r4 ::= SEQUENCE {
    removedIntraFreqCellList    RemovedIntraFreqCellList    OPTIONAL,
    newIntraFreqCellList        NewIntraFreqCellSI-List-RSCP-LCR-r4
}

IntraFreqCellInfoSI-List-ECN0-LCR-r4 ::= SEQUENCE {
    removedIntraFreqCellList    RemovedIntraFreqCellList    OPTIONAL,
    newIntraFreqCellList        NewIntraFreqCellSI-List-ECN0-LCR-r4
}

IntraFreqCellInfoSI-List-HCS-RSCP-LCR-r4 ::= SEQUENCE {
    removedIntraFreqCellList    RemovedIntraFreqCellList    OPTIONAL,
    newIntraFreqCellList        NewIntraFreqCellSI-List-HCS-RSCP-LCR-r4
}

IntraFreqCellInfoSI-List-HCS-ECN0-LCR-r4 ::= SEQUENCE {
    removedIntraFreqCellList    RemovedIntraFreqCellList    OPTIONAL,
    newIntraFreqCellList        NewIntraFreqCellSI-List-HCS-ECN0-LCR-r4
}

IntraFreqEvent ::= CHOICE {
    e1a                          Event1a,
    e1b                          Event1b,
}

```

```

    e1c                Event1c,
    e1d                NULL,
    e1e                Event1e,
    e1f                Event1f,
    e1g                NULL,
    e1h                ThresholdUsedFrequency,
    e1i                ThresholdUsedFrequency
}

IntraFreqEvent-r4 ::= CHOICE {
    e1a                Event1a-r4,
    e1b                Event1b-r4,
    e1c                Event1c,
    e1d                NULL,
    e1e                Event1e,
    e1f                Event1f,
    e1g                NULL,
    e1h                ThresholdUsedFrequency,
    e1i                ThresholdUsedFrequency
}

IntraFreqEvent-LCR-r4 ::= CHOICE {
    e1a                Event1a-LCR-r4,
    e1b                Event1b-LCR-r4,
    e1c                Event1c,
    e1d                NULL,
    e1e                Event1e,
    e1f                Event1f,
    e1g                NULL,
    e1h                ThresholdUsedFrequency,
    e1i                ThresholdUsedFrequency
}

IntraFreqEventCriteria ::= SEQUENCE {
    event              IntraFreqEvent,
    hysteresis         Hysteresis,
    timeToTrigger     TimeToTrigger,
    reportingCellStatus ReportingCellStatus OPTIONAL
}

IntraFreqEventCriteria-r4 ::= SEQUENCE {
    event              IntraFreqEvent-r4,
    hysteresis         Hysteresis,
    timeToTrigger     TimeToTrigger,
    reportingCellStatus ReportingCellStatus OPTIONAL
}

IntraFreqEventCriteria-LCR-r4 ::= SEQUENCE {
    event              IntraFreqEvent-LCR-r4,
    hysteresis         Hysteresis,
    timeToTrigger     TimeToTrigger,
    reportingCellStatus ReportingCellStatus OPTIONAL
}

IntraFreqEventCriteriaList ::= SEQUENCE (SIZE (1..maxMeasEvent)) OF
    IntraFreqEventCriteria

IntraFreqEventCriteriaList-r4 ::= SEQUENCE (SIZE (1..maxMeasEvent)) OF
    IntraFreqEventCriteria-r4

IntraFreqEventCriteriaList-LCR-r4 ::= SEQUENCE (SIZE (1..maxMeasEvent)) OF
    IntraFreqEventCriteria-LCR-r4

IntraFreqEventResults ::= SEQUENCE {
    eventID           EventIDIntraFreq,
    cellMeasurementEventResults CellMeasurementEventResults
}

IntraFreqMeasQuantity ::= SEQUENCE {
    filterCoefficient FilterCoefficient DEFAULT fc0,
    modeSpecificInfo  CHOICE {
        fdd            SEQUENCE {
            intraFreqMeasQuantity-FDD IntraFreqMeasQuantity-FDD
        },
        tdd            SEQUENCE {
            intraFreqMeasQuantity-TDDList IntraFreqMeasQuantity-TDDList
        }
    }
}

```



```

}

IntraFreqMeasQuantity-FDD ::=      ENUMERATED {
    cpich-Ec-N0,
    cpich-RSCP,
    pathloss,
    ultra-CarrierRSSI }

IntraFreqMeasQuantity-TDD ::=      ENUMERATED {
    primaryCCPCH-RSCP,
    pathloss,
    timeslotISCP,
    ultra-CarrierRSSI }

IntraFreqMeasQuantity-TDDList ::=  SEQUENCE (SIZE (1..4)) OF
    IntraFreqMeasQuantity-TDD

IntraFreqMeasuredResultsList ::=   SEQUENCE (SIZE (1..maxCellMeas)) OF
    CellMeasuredResults

IntraFreqMeasurementSysInfo-RSCP ::= SEQUENCE {
    intraFreqMeasurementID          MeasurementIdentity          DEFAULT 1,
    intraFreqCellInfoSI-List        IntraFreqCellInfoSI-List-RSCP OPTIONAL,
    intraFreqMeasQuantity            IntraFreqMeasQuantity          OPTIONAL,
    intraFreqReportingQuantityForRACH IntraFreqReportingQuantityForRACH OPTIONAL,
    maxReportedCellsOnRACH          MaxReportedCellsOnRACH        OPTIONAL,
    reportingInfoForCellDCH          ReportingInfoForCellDCH        OPTIONAL
}

IntraFreqMeasurementSysInfo-ECN0 ::= SEQUENCE {
    intraFreqMeasurementID          MeasurementIdentity          DEFAULT 1,
    intraFreqCellInfoSI-List        IntraFreqCellInfoSI-List-ECN0 OPTIONAL,
    intraFreqMeasQuantity            IntraFreqMeasQuantity          OPTIONAL,
    intraFreqReportingQuantityForRACH IntraFreqReportingQuantityForRACH OPTIONAL,
    maxReportedCellsOnRACH          MaxReportedCellsOnRACH        OPTIONAL,
    reportingInfoForCellDCH          ReportingInfoForCellDCH        OPTIONAL
}

IntraFreqMeasurementSysInfo-HCS-RSCP ::= SEQUENCE {
    intraFreqMeasurementID          MeasurementIdentity          DEFAULT 1,
    intraFreqCellInfoSI-List        IntraFreqCellInfoSI-List-HCS-RSCP OPTIONAL,
    intraFreqMeasQuantity            IntraFreqMeasQuantity          OPTIONAL,
    intraFreqReportingQuantityForRACH IntraFreqReportingQuantityForRACH OPTIONAL,
    maxReportedCellsOnRACH          MaxReportedCellsOnRACH        OPTIONAL,
    reportingInfoForCellDCH          ReportingInfoForCellDCH        OPTIONAL
}

IntraFreqMeasurementSysInfo-HCS-ECN0 ::= SEQUENCE {
    intraFreqMeasurementID          MeasurementIdentity          DEFAULT 1,
    intraFreqCellInfoSI-List        IntraFreqCellInfoSI-List-HCS-ECN0 OPTIONAL,
    intraFreqMeasQuantity            IntraFreqMeasQuantity          OPTIONAL,
    intraFreqReportingQuantityForRACH IntraFreqReportingQuantityForRACH OPTIONAL,
    maxReportedCellsOnRACH          MaxReportedCellsOnRACH        OPTIONAL,
    reportingInfoForCellDCH          ReportingInfoForCellDCH        OPTIONAL
}

IntraFreqMeasurementSysInfo-RSCP-LCR-r4 ::= SEQUENCE {
    intraFreqMeasurementID          MeasurementIdentity          DEFAULT 1,
    intraFreqCellInfoSI-List        IntraFreqCellInfoSI-List-RSCP-LCR-r4 OPTIONAL,
    intraFreqMeasQuantity            IntraFreqMeasQuantity          OPTIONAL,
    intraFreqReportingQuantityForRACH IntraFreqReportingQuantityForRACH OPTIONAL,
    maxReportedCellsOnRACH          MaxReportedCellsOnRACH        OPTIONAL,
    reportingInfoForCellDCH          ReportingInfoForCellDCH-LCR-r4 OPTIONAL
}

IntraFreqMeasurementSysInfo-ECN0-LCR-r4 ::= SEQUENCE {
    intraFreqMeasurementID          MeasurementIdentity          DEFAULT 1,
    intraFreqCellInfoSI-List        IntraFreqCellInfoSI-List-ECN0-LCR-r4 OPTIONAL,
    intraFreqMeasQuantity            IntraFreqMeasQuantity          OPTIONAL,
    intraFreqReportingQuantityForRACH IntraFreqReportingQuantityForRACH OPTIONAL,
    maxReportedCellsOnRACH          MaxReportedCellsOnRACH        OPTIONAL,
    reportingInfoForCellDCH          ReportingInfoForCellDCH-LCR-r4 OPTIONAL
}

IntraFreqMeasurementSysInfo-HCS-RSCP-LCR-r4 ::= SEQUENCE {
    intraFreqMeasurementID          MeasurementIdentity          DEFAULT 1,
    intraFreqCellInfoSI-List        IntraFreqCellInfoSI-List-HCS-RSCP-LCR-r4 OPTIONAL,
    intraFreqMeasQuantity            IntraFreqMeasQuantity          OPTIONAL,

```

```

    intraFreqReportingQuantityForRACH    IntraFreqReportingQuantityForRACH    OPTIONAL,
    maxReportedCellsOnRACH              MaxReportedCellsOnRACH              OPTIONAL,
    reportingInfoForCellDCH              ReportingInfoForCellDCH-LCR-r4      OPTIONAL
}

IntraFreqMeasurementSysInfo-HCS-ECNO-LCR-r4 ::= SEQUENCE {
    intraFreqMeasurementID              MeasurementIdentity                DEFAULT 1,
    intraFreqCellInfoSI-List           IntraFreqCellInfoSI-List-HCS-ECNO-LCR-r4    OPTIONAL,
    intraFreqMeasQuantity              IntraFreqMeasQuantity            OPTIONAL,
    intraFreqReportingQuantityForRACH  IntraFreqReportingQuantityForRACH    OPTIONAL,
    maxReportedCellsOnRACH              MaxReportedCellsOnRACH            OPTIONAL,
    reportingInfoForCellDCH            ReportingInfoForCellDCH-LCR-r4      OPTIONAL
}

IntraFreqReportCriteria ::= CHOICE {
    intraFreqReportingCriteria          IntraFreqReportingCriteria,
    periodicalReportingCriteria         PeriodicalWithReportingCellStatus,
    noReporting                         ReportingCellStatusOpt
}

IntraFreqReportCriteria-r4 ::= CHOICE {
    intraFreqReportingCriteria-r4      IntraFreqReportingCriteria-r4,
    periodicalReportingCriteria-r4     PeriodicalWithReportingCellStatus,
    noReporting                         ReportingCellStatusOpt
}

IntraFreqReportingCriteria ::= SEQUENCE {
    eventCriteriaList                  IntraFreqEventCriteriaList        OPTIONAL
}

IntraFreqReportingCriteria-r4 ::= SEQUENCE {
    eventCriteriaList-r4               IntraFreqEventCriteriaList-r4     OPTIONAL
}

IntraFreqReportingCriteria-LCR-r4 ::= SEQUENCE {
    eventCriteriaList-LCR-r4           IntraFreqEventCriteriaList-LCR-r4  OPTIONAL
}

IntraFreqReportingQuantity ::= SEQUENCE {
    activeSetReportingQuantities       CellReportingQuantities,
    monitoredSetReportingQuantities    CellReportingQuantities,
    detectedSetReportingQuantities     CellReportingQuantities            OPTIONAL
}

IntraFreqReportingQuantityForRACH ::= SEQUENCE {
    sfn-SFN-OTD-Type                  SFN-SFN-OTD-Type,
    modeSpecificInfo                   CHOICE {
        fdd                            SEQUENCE {
            intraFreqRepQuantityRACH-FDD    IntraFreqRepQuantityRACH-FDD
        },
        tdd                             SEQUENCE {
            intraFreqRepQuantityRACH-TDDList    IntraFreqRepQuantityRACH-TDDList
        }
    }
}

IntraFreqRepQuantityRACH-FDD ::= ENUMERATED {
    cpich-EcN0, cpich-RSCP,
    pathloss, noReport }

IntraFreqRepQuantityRACH-TDD ::= ENUMERATED {
    timeslotISCP,
    primaryCCPCH-RSCP,
    noReport }

IntraFreqRepQuantityRACH-TDDList ::= SEQUENCE (SIZE (1..2)) OF
    IntraFreqRepQuantityRACH-TDD

IntraFrequencyMeasurement ::= SEQUENCE {
    intraFreqCellInfoList              IntraFreqCellInfoList            OPTIONAL,
    intraFreqMeasQuantity              IntraFreqMeasQuantity            OPTIONAL,
    intraFreqReportingQuantity         IntraFreqReportingQuantity        OPTIONAL,
    measurementValidity                MeasurementValidity                OPTIONAL,
    reportCriteria                     IntraFreqReportCriteria           OPTIONAL
}

IntraFrequencyMeasurement-r4 ::= SEQUENCE {
    intraFreqCellInfoList-r4           IntraFreqCellInfoList-r4         OPTIONAL,
}

```

```

    intraFreqMeasQuantity          IntraFreqMeasQuantity          OPTIONAL,
    intraFreqReportingQuantity     IntraFreqReportingQuantity    OPTIONAL,
    measurementValidity            MeasurementValidity            OPTIONAL,
    reportCriteria                 IntraFreqReportCriteria-r4    OPTIONAL
}

IODE ::= INTEGER (0..255)

IP-Length ::= ENUMERATED {
    ip15, ip110 }

IP-PCCPCH-r4 ::= BOOLEAN

IP-Spacing ::= ENUMERATED {
    e5, e7, e10, e15, e20,
    e30, e40, e50 }

IP-Spacing-TDD ::= ENUMERATED {
    e30, e40, e50, e70, e100}

IS-2000SpecificMeasInfo ::= ENUMERATED {
    frequency, timeslot, colourcode,
    outputpower, pn-Offset }

MaxNumberOfReportingCellsType1 ::= ENUMERATED {
    e1, e2, e3, e4, e5, e6}

MaxNumberOfReportingCellsType2 ::= ENUMERATED {
    e1, e2, e3, e4, e5, e6, e7, e8, e9, e10, e11, e12}

MaxNumberOfReportingCellsType3 ::= ENUMERATED {
    viactCellsPlus1,
    viactCellsPlus2,
    viactCellsPlus3,
    viactCellsPlus4,
    viactCellsPlus5,
    viactCellsPlus6 }

MaxReportedCellsOnRACH ::= ENUMERATED {
    noReport,
    currentCell,
    currentAnd-1-BestNeighbour,
    currentAnd-2-BestNeighbour,
    currentAnd-3-BestNeighbour,
    currentAnd-4-BestNeighbour,
    currentAnd-5-BestNeighbour,
    currentAnd-6-BestNeighbour }

MeasuredResults ::= CHOICE {
    intraFreqMeasuredResultsList    IntraFreqMeasuredResultsList,
    interFreqMeasuredResultsList    InterFreqMeasuredResultsList,
    interRATMeasuredResultsList     InterRATMeasuredResultsList,
    trafficVolumeMeasuredResultsList TrafficVolumeMeasuredResultsList,
    qualityMeasuredResults           QualityMeasuredResults,
    ue-InternalMeasuredResults       UE-InternalMeasuredResults,
    ue-positioning-MeasuredResults    UE-Positioning-MeasuredResults
}

MeasuredResults-LCR-r4 ::= CHOICE {
    intraFreqMeasuredResultsList    IntraFreqMeasuredResultsList,
    interFreqMeasuredResultsList    InterFreqMeasuredResultsList,
    interRATMeasuredResultsList     InterRATMeasuredResultsList,
    trafficVolumeMeasuredResultsList TrafficVolumeMeasuredResultsList,
    qualityMeasuredResults           QualityMeasuredResults,
    ue-InternalMeasuredResults       UE-InternalMeasuredResults-LCR-r4,
    ue-positioning-MeasuredResults    UE-Positioning-MeasuredResults
}

MeasuredResultsList ::= SEQUENCE (SIZE (1..maxAdditionalMeas)) OF
    MeasuredResults

MeasuredResultsList-LCR-r4-ext ::= SEQUENCE (SIZE (1..maxAdditionalMeas)) OF
    MeasuredResults-LCR-r4

MeasuredResultsOnRACH ::= SEQUENCE {
    currentCell                     SEQUENCE {
        modeSpecificInfo           CHOICE {
            fdd                     SEQUENCE {

```

```

        measurementQuantity          CHOICE {
            cpich-Ec-N0
            cpich-RSCP
            pathloss
        }
    },
    tdd                               SEQUENCE {
        timeslotISCP                 TimeslotISCP-List      OPTIONAL,
        primaryCCPCH-RSCP           PrimaryCCPCH-RSCP      OPTIONAL
    }
},
monitoredCells                      MonitoredCellRACH-List      OPTIONAL
}

MeasurementCommand ::=              CHOICE {
    setup                            MeasurementType,
    modify                            SEQUENCE {
        measurementType              MeasurementType          OPTIONAL
    },
    release                            NULL
}

MeasurementCommand-r4 ::=           CHOICE {
    setup                            MeasurementType-r4,
    modify                            SEQUENCE {
        measurementType              MeasurementType-r4      OPTIONAL
    },
    release                            NULL
}

MeasurementControlSysInfo ::=       SEQUENCE {
    use-of-HCS                       CHOICE {
        hcs-not-used                 SEQUENCE {
            cellSelectQualityMeasure CHOICE {
                cpich-RSCP           SEQUENCE {
                    intraFreqMeasurementSysInfo      IntraFreqMeasurementSysInfo-RSCP
                }
            },
            interFreqMeasurementSysInfo              InterFreqMeasurementSysInfo-RSCP  OPTIONAL
        },
        cpich-Ec-N0                     SEQUENCE {
            intraFreqMeasurementSysInfo              IntraFreqMeasurementSysInfo-ECN0
            interFreqMeasurementSysInfo              InterFreqMeasurementSysInfo-ECN0  OPTIONAL
        }
    },
    interRATMeasurementSysInfo          InterRATMeasurementSysInfo-B      OPTIONAL
},
    hcs-used                            SEQUENCE {
        cellSelectQualityMeasure        CHOICE {
            cpich-RSCP                 SEQUENCE {
                intraFreqMeasurementSysInfo          IntraFreqMeasurementSysInfo-HCS-RSCP
            }
        },
        interFreqMeasurementSysInfo      InterFreqMeasurementSysInfo-HCS-RSCP
    },
    cpich-Ec-N0                         SEQUENCE {
        intraFreqMeasurementSysInfo          IntraFreqMeasurementSysInfo-HCS-ECN0
        interFreqMeasurementSysInfo          InterFreqMeasurementSysInfo-HCS-ECN0
    }
},
    interRATMeasurementSysInfo          InterRATMeasurementSysInfo        OPTIONAL
},
},
trafficVolumeMeasSysInfo              TrafficVolumeMeasSysInfo          OPTIONAL,
ue-InternalMeasurementSysInfo          UE-InternalMeasurementSysInfo     OPTIONAL
}

MeasurementControlSysInfo-LCR-r4-ext ::= SEQUENCE {
-- The following CHOICE shall have the same value as the use-of-HCS in MeasurementControlSysInfo
    use-of-HCS                          CHOICE {
        hcs-not-used                     SEQUENCE {
-- The following CHOICE shall have the same value as the cellSelectQualityMeasure in
-- MeasurementControlSysInfo
            cellSelectQualityMeasure      CHOICE {
                cpich-RSCP                 SEQUENCE {

```

```

        intraFreqMeasurementSysInfo IntraFreqMeasurementSysInfo-RSCP-LCR-r4 OPTIONAL,
        interFreqMeasurementSysInfo InterFreqMeasurementSysInfo-RSCP-LCR-r4 OPTIONAL
    },
    cpich-Ec-N0 SEQUENCE {
        intraFreqMeasurementSysInfo IntraFreqMeasurementSysInfo-ECN0-LCR-r4 OPTIONAL,
        interFreqMeasurementSysInfo InterFreqMeasurementSysInfo-ECN0-LCR-r4 OPTIONAL
    }
},
hcs-used SEQUENCE {
-- The following CHOICE shall have the same value as the cellSelectQualityMeasure in
-- MeasurementControlSysInfo
    cellSelectQualityMeasure CHOICE {
        cpich-RSCP SEQUENCE {
            intraFreqMeasurementSysInfo IntraFreqMeasurementSysInfo-HCS-RSCP-LCR-r4
OPTIONAL,
            interFreqMeasurementSysInfo InterFreqMeasurementSysInfo-HCS-RSCP-LCR-r4 OPTIONAL
        },
        cpich-Ec-N0 SEQUENCE {
            intraFreqMeasurementSysInfo IntraFreqMeasurementSysInfo-HCS-ECN0-LCR-r4
OPTIONAL,
            interFreqMeasurementSysInfo InterFreqMeasurementSysInfo-HCS-ECN0-LCR-r4 OPTIONAL
        }
    }
}
}
}
}
}

MeasurementIdentity ::= INTEGER (1..16)

MeasurementQuantityGSM ::= ENUMERATED {
    gsm-CarrierRSSI,
    pathloss }

MeasurementReportingMode ::= SEQUENCE {
    measurementReportTransferMode TransferMode,
    periodicalOrEventTrigger PeriodicalOrEventTrigger
}

MeasurementType ::= CHOICE {
    intraFrequencyMeasurement IntraFrequencyMeasurement,
    interFrequencyMeasurement InterFrequencyMeasurement,
    interRATMeasurement InterRATMeasurement,
    ue-positioning-Measurement UE-Positioning-Measurement,
    trafficVolumeMeasurement TrafficVolumeMeasurement,
    qualityMeasurement QualityMeasurement,
    ue-InternalMeasurement UE-InternalMeasurement
}

MeasurementType-r4 ::= CHOICE {
    intraFrequencyMeasurement IntraFrequencyMeasurement-r4,
    interFrequencyMeasurement InterFrequencyMeasurement-r4,
    interRATMeasurement InterRATMeasurement,
    up-Measurement UE-Positioning-Measurement-r4,
    trafficVolumeMeasurement TrafficVolumeMeasurement,
    qualityMeasurement QualityMeasurement,
    ue-InternalMeasurement UE-InternalMeasurement-r4
}

MeasurementValidity ::= SEQUENCE {
    ue-State ENUMERATED {
        cell-DCH, all-But-Cell-DCH, all-States }
}

MonitoredCellRACH-List ::= SEQUENCE (SIZE (1..7)) OF
    MonitoredCellRACH-Result

MonitoredCellRACH-Result ::= SEQUENCE {
    sfn-SFN-ObsTimeDifference SFN-SFN-ObsTimeDifference OPTIONAL,
    modeSpecificInfo CHOICE {
        fdd SEQUENCE {
            primaryCPICH-Info PrimaryCPICH-Info,
            measurementQuantity CHOICE {
                cpich-Ec-N0 CPICH-Ec-N0,
                cpich-RSCP CPICH-RSCP,
                pathloss Pathloss
            }
        },
    } OPTIONAL
},

```

```

        tdd
        cellParametersID
        primaryCCPCH-RSCP
    }
}

MultipathIndicator ::=
    ENUMERATED {
        nm,
        low,
        medium,
        high }

N-CR-T-CRMaxHyst ::=
    SEQUENCE {
        n-CR
        t-CRMaxHyst
    }
    DEFAULT 8,

NavigationModelSatInfo ::=
    SEQUENCE {
        satID
        satelliteStatus
        ephemerisParameter
    }
    OPTIONAL

NavigationModelSatInfoList ::=
    SEQUENCE (SIZE (1..maxSat)) OF
        NavigationModelSatInfo

EphemerisParameter ::=
    SEQUENCE {
        codeOnL2
        uraIndex
        satHealth
        iodc
        l2Pflag
        sflRevD
        t-GD
        t-oc
        af2
        af1
        af0
        c-rs
        delta-n
        m0
        c-uc
        e
        c-us
        a-Sqrt
        t-oe
        fitInterval
        aodo
        c-ic
        omega0
        c-is
        i0
        c-rc
        omega
        omegaDot
        iDot
    }

NC-Mode ::=
    BIT STRING (SIZE (3))

Neighbour ::=
    SEQUENCE {
        modeSpecificInfo
        fdd
            neighbourIdentity
            ue-RX-TX-TimeDifferenceType2
        },
        tdd
            neighbourAndChannelIdentity
        },
        neighbourQuality
        sfn-SFN-ObsTimeDifference2
    }
    CHOICE {
        SEQUENCE {
            PrimaryCPICH-Info
            UE-RX-TX-TimeDifferenceType2
        }
        SEQUENCE {
            CellAndChannelIdentity
        }
        NeighbourQuality,
        SFN-SFN-ObsTimeDifference2
    }
    OPTIONAL,
    OPTIONAL,
    OPTIONAL

NeighbourList ::=
    SEQUENCE (SIZE (1..maxCellMeas)) OF
        Neighbour

NeighbourQuality ::=
    SEQUENCE {
        ue-Positioning-OTDOA-Quality
        UE-Positioning-OTDOA-Quality
    }

```

```

}

NewInterFreqCell ::=
    interFreqCellID
    frequencyInfo
    cellInfo
}

NewInterFreqCell-r4 ::=
    interFreqCellID
    frequencyInfo
    cellInfo
}

NewInterFreqCellList ::=
    SEQUENCE (SIZE (1..maxCellMeas)) OF
        NewInterFreqCell

NewInterFreqCellList-r4 ::=
    SEQUENCE (SIZE (1..maxCellMeas)) OF
        NewInterFreqCell-r4

NewInterFreqCellSI-RSCP ::=
    interFreqCellID
    frequencyInfo
    cellInfo
}

NewInterFreqCellSI-ECN0 ::=
    interFreqCellID
    frequencyInfo
    cellInfo
}

NewInterFreqCellSI-HCS-RSCP ::=
    interFreqCellID
    frequencyInfo
    cellInfo
}

NewInterFreqCellSI-HCS-ECN0 ::=
    interFreqCellID
    frequencyInfo
    cellInfo
}

NewInterFreqCellSI-RSCP-LCR-r4 ::=
    interFreqCellID
    frequencyInfo
    cellInfo
}

NewInterFreqCellSI-ECN0-LCR-r4 ::=
    interFreqCellID
    frequencyInfo
    cellInfo
}

NewInterFreqCellSI-HCS-RSCP-LCR-r4 ::=
    interFreqCellID
    frequencyInfo
    cellInfo
}

NewInterFreqCellSI-HCS-ECN0-LCR-r4 ::=
    interFreqCellID
    frequencyInfo
    cellInfo
}

NewInterFreqCellSI-List-ECN0 ::=
    SEQUENCE (SIZE (1..maxCellMeas)) OF
        NewInterFreqCellSI-ECN0

NewInterFreqCellSI-List-HCS-RSCP ::=
    SEQUENCE (SIZE (1..maxCellMeas)) OF
        NewInterFreqCellSI-HCS-RSCP

NewInterFreqCellSI-List-HCS-ECN0 ::=
    SEQUENCE (SIZE (1..maxCellMeas)) OF
        NewInterFreqCellSI-HCS-ECN0

NewInterFreqCellSI-List-RSCP ::=
    SEQUENCE (SIZE (1..maxCellMeas)) OF

```

```

NewInterFreqCellSI-RSCP
NewInterFreqCellSI-List-ECNO-LCR-r4 ::= SEQUENCE (SIZE (1..maxCellMeas)) OF
NewInterFreqCellSI-ECNO-LCR-r4
NewInterFreqCellSI-List-HCS-RSCP-LCR-r4 ::= SEQUENCE (SIZE (1..maxCellMeas)) OF
NewInterFreqCellSI-HCS-RSCP-LCR-r4
NewInterFreqCellSI-List-HCS-ECNO-LCR-r4 ::= SEQUENCE (SIZE (1..maxCellMeas)) OF
NewInterFreqCellSI-HCS-ECNO-LCR-r4
NewInterFreqCellSI-List-RSCP-LCR-r4 ::= SEQUENCE (SIZE (1..maxCellMeas)) OF
NewInterFreqCellSI-RSCP-LCR-r4

NewInterRATCell ::= SEQUENCE {
    interRATCellID InterRATCellID OPTIONAL,
    technologySpecificInfo CHOICE {
        gsm SEQUENCE {
            cellSelectionReselectionInfo CellSelectReselectInfoSIB-11-12 OPTIONAL,
            interRATCellIndividualOffset InterRATCellIndividualOffset,
            bsic BSIC,
            frequency-band Frequency-Band,
            bcch-ARFCN BCCH-ARFCN,
            dummy NULL OPTIONAL
        },
        is-2000 SEQUENCE {
            is-2000SpecificMeasInfo IS-2000SpecificMeasInfo
        },
        spare1 NULL,
        spare2 NULL
    }
}

NewInterRATCell-B ::= SEQUENCE {
    interRATCellID InterRATCellID OPTIONAL,
    technologySpecificInfo CHOICE {
        gsm SEQUENCE {
            cellSelectionReselectionInfo CellSelectReselectInfoSIB-11-12 OPTIONAL,
            interRATCellIndividualOffset InterRATCellIndividualOffset,
            bsic BSIC,
            frequency-band Frequency-Band,
            bcch-ARFCN BCCH-ARFCN,
            dummy NULL OPTIONAL
        },
        is-2000 SEQUENCE {
            is-2000SpecificMeasInfo IS-2000SpecificMeasInfo
        },
        spare1 NULL,
        spare2 NULL
    }
}

NewInterRATCellList ::= SEQUENCE (SIZE (1..maxCellMeas)) OF
NewInterRATCell

NewInterRATCellList-B ::= SEQUENCE (SIZE (1..maxCellMeas)) OF
NewInterRATCell-B

NewIntraFreqCell ::= SEQUENCE {
    intraFreqCellID IntraFreqCellID OPTIONAL,
    cellInfo CellInfo
}

NewIntraFreqCell-r4 ::= SEQUENCE {
    intraFreqCellID IntraFreqCellID OPTIONAL,
    cellInfo-r4 CellInfo-r4
}

NewIntraFreqCellList ::= SEQUENCE (SIZE (1..maxCellMeas)) OF
NewIntraFreqCell

NewIntraFreqCellList-r4 ::= SEQUENCE (SIZE (1..maxCellMeas)) OF
NewIntraFreqCell-r4

NewIntraFreqCellSI-RSCP ::= SEQUENCE {
    intraFreqCellID IntraFreqCellID OPTIONAL,
    cellInfo CellInfoSI-RSCP
}

```



```

NewIntraFreqCellSI-ECNO ::= SEQUENCE {
    intraFreqCellID          IntraFreqCellID          OPTIONAL,
    cellInfo                  CellInfoSI-ECNO
}
NewIntraFreqCellSI-HCS-RSCP ::= SEQUENCE {
    intraFreqCellID          IntraFreqCellID          OPTIONAL,
    cellInfo                  CellInfoSI-HCS-RSCP
}
NewIntraFreqCellSI-HCS-ECNO ::= SEQUENCE {
    intraFreqCellID          IntraFreqCellID          OPTIONAL,
    cellInfo                  CellInfoSI-HCS-ECNO
}
NewIntraFreqCellSI-RSCP-LCR-r4 ::= SEQUENCE {
    intraFreqCellID          IntraFreqCellID          OPTIONAL,
    cellInfo                  CellInfoSI-RSCP-LCR-r4
}
NewIntraFreqCellSI-ECNO-LCR-r4 ::= SEQUENCE {
    intraFreqCellID          IntraFreqCellID          OPTIONAL,
    cellInfo                  CellInfoSI-ECNO-LCR-r4
}
NewIntraFreqCellSI-HCS-RSCP-LCR-r4 ::= SEQUENCE {
    intraFreqCellID          IntraFreqCellID          OPTIONAL,
    cellInfo                  CellInfoSI-HCS-RSCP-LCR-r4
}
NewIntraFreqCellSI-HCS-ECNO-LCR-r4 ::= SEQUENCE {
    intraFreqCellID          IntraFreqCellID          OPTIONAL,
    cellInfo                  CellInfoSI-HCS-ECNO-LCR-r4
}
NewIntraFreqCellSI-List-RSCP ::= SEQUENCE (SIZE (1..maxCellMeas)) OF
    NewIntraFreqCellSI-RSCP
NewIntraFreqCellSI-List-ECNO ::= SEQUENCE (SIZE (1..maxCellMeas)) OF
    NewIntraFreqCellSI-ECNO
NewIntraFreqCellSI-List-HCS-RSCP ::= SEQUENCE (SIZE (1..maxCellMeas)) OF
    NewIntraFreqCellSI-HCS-RSCP
NewIntraFreqCellSI-List-HCS-ECNO ::= SEQUENCE (SIZE (1..maxCellMeas)) OF
    NewIntraFreqCellSI-HCS-ECNO
NewIntraFreqCellSI-List-RSCP-LCR-r4 ::= SEQUENCE (SIZE (1..maxCellMeas)) OF
    NewIntraFreqCellSI-RSCP-LCR-r4
NewIntraFreqCellSI-List-ECNO-LCR-r4 ::= SEQUENCE (SIZE (1..maxCellMeas)) OF
    NewIntraFreqCellSI-ECNO-LCR-r4
NewIntraFreqCellSI-List-HCS-RSCP-LCR-r4 ::= SEQUENCE (SIZE (1..maxCellMeas)) OF
    NewIntraFreqCellSI-HCS-RSCP-LCR-r4
NewIntraFreqCellSI-List-HCS-ECNO-LCR-r4 ::= SEQUENCE (SIZE (1..maxCellMeas)) OF
    NewIntraFreqCellSI-HCS-ECNO-LCR-r4
-- Actual value = IE value * 0.0125 - 0.09375
NodeB-ClockDrift ::= INTEGER (0..15)
NonUsedFreqParameter ::= SEQUENCE {
    nonUsedFreqThreshold    Threshold,
    nonUsedFreqW            W
}
NonUsedFreqParameterList ::= SEQUENCE (SIZE (1..maxFreq)) OF
    NonUsedFreqParameter
ObservedTimeDifferenceToGSM ::= INTEGER (0..4095)
OTDOA-SearchWindowSize ::= ENUMERATED {
    c20, c40, c80, c160, c320,
    c640, c1280, moreThan1280 }
Pathloss ::= INTEGER (46..158)
PenaltyTime-RSCP ::= CHOICE {

```

```

    notUsed          NULL,
    pt10             TemporaryOffset,
    pt20             TemporaryOffset,
    pt30             TemporaryOffset,
    pt40             TemporaryOffset,
    pt50             TemporaryOffset,
    pt60             TemporaryOffset
}

PenaltyTime-ECNO ::= CHOICE {
    notUsed          NULL,
    pt10             TemporaryOffsetList,
    pt20             TemporaryOffsetList,
    pt30             TemporaryOffsetList,
    pt40             TemporaryOffsetList,
    pt50             TemporaryOffsetList,
    pt60             TemporaryOffsetList
}

PendingTimeAfterTrigger ::= ENUMERATED {
    ptat0-25, ptat0-5, ptat1,
    ptat2, ptat4, ptat8, ptat16 }

PeriodicalOrEventTrigger ::= ENUMERATED {
    periodical,
    eventTrigger }

PeriodicalReportingCriteria ::= SEQUENCE {
    reportingAmount      ReportingAmount          DEFAULT ra-Infinity,
    reportingInterval    ReportingIntervalLong
}

PeriodicalWithReportingCellStatus ::= SEQUENCE {
    periodicalReportingCriteria    PeriodicalReportingCriteria,
    reportingCellStatus            ReportingCellStatus          OPTIONAL
}

PLMNIdentitiesOfNeighbourCells ::= SEQUENCE {
    plmnsOfIntraFreqCellsList     PLMNsOfIntraFreqCellsList    OPTIONAL,
    plmnsOfInterFreqCellsList     PLMNsOfInterFreqCellsList    OPTIONAL,
    plmnsOfInterRATCellsList      PLMNsOfInterRATCellsList     OPTIONAL
}

PLMNsOfInterFreqCellsList ::= SEQUENCE (SIZE (1..maxCellMeas)) OF
    SEQUENCE {
        plmn-Identity            PLMN-Identity          OPTIONAL
    }

PLMNsOfIntraFreqCellsList ::= SEQUENCE (SIZE (1..maxCellMeas)) OF
    SEQUENCE {
        plmn-Identity            PLMN-Identity          OPTIONAL
    }

PLMNsOfInterRATCellsList ::= SEQUENCE (SIZE (1..maxCellMeas)) OF
    SEQUENCE {
        plmn-Identity            PLMN-Identity          OPTIONAL
    }

PositionEstimate ::= CHOICE {
    ellipsoidPoint              EllipsoidPoint,
    ellipsoidPointUncertCircle  EllipsoidPointUncertCircle,
    ellipsoidPointUncertEllipse EllipsoidPointUncertEllipse,
    ellipsoidPointAltitude      EllipsoidPointAltitude,
    ellipsoidPointAltitudeEllipse EllipsoidPointAltitudeEllipsoide
}

PositioningMethod ::= ENUMERATED {
    otdoa,
    gps,
    otdoaOrGPS }

-- Actual value = IE value * 0.32
PRC ::= INTEGER (-2047..2047)

PrimaryCCPCH-RSCP ::= INTEGER (0..91)

Q-HCS ::= INTEGER (0..99)

```

```

Q-OffsetS-N ::= INTEGER (-50..50)

Q-QualMin ::= INTEGER (-24..0)

-- Actual value = (IE value * 2) + 1
Q-RxlevMin ::= INTEGER (-58..-13)

QualityEventResults ::= SEQUENCE (SIZE (1..maxTrCH)) OF
    TransportChannelIdentity

QualityMeasuredResults ::= SEQUENCE {
    blerMeasurementResultsList BLER-MeasurementResultsList OPTIONAL,
    modeSpecificInfo CHOICE {
        fdd NULL,
        tdd SEQUENCE {
            sir-MeasurementResults SIR-MeasurementList OPTIONAL
        }
    }
}

QualityMeasurement ::= SEQUENCE {
    qualityReportingQuantity QualityReportingQuantity OPTIONAL,
    reportCriteria QualityReportCriteria
}

QualityReportCriteria ::= CHOICE {
    qualityReportingCriteria QualityReportingCriteria,
    periodicalReportingCriteria PeriodicalReportingCriteria,
    noReporting NULL
}

QualityReportingCriteria ::= SEQUENCE (SIZE (1..maxTrCH)) OF
    QualityReportingCriteriaSingle

QualityReportingCriteriaSingle ::= SEQUENCE {
    transportChannelIdentity TransportChannelIdentity,
    totalCRC INTEGER (1..512),
    badCRC INTEGER (1..512),
    pendingAfterTrigger INTEGER (1..512)
}

QualityReportingQuantity ::= SEQUENCE {
    dl-TransChBLER BOOLEAN,
    bler-dl-TransChIdList BLER-TransChIdList OPTIONAL,
    modeSpecificInfo CHOICE {
        fdd NULL,
        tdd SEQUENCE {
            sir-TFCS-List SIR-TFCS-List OPTIONAL
        }
    }
}

QualityType ::= ENUMERATED {
    std-10, std-50, cpich-Ec-N0 }

RAT-Type ::= ENUMERATED {
    gsm, is2000 }

ReferenceCellPosition ::= CHOICE {
    ellipsoidPoint EllipsoidPoint,
    ellipsoidPointWithAltitude EllipsoidPointAltitude
}

-- As defined in 23.032
ReferenceLocation ::= SEQUENCE {
    ellipsoidPointAltitudeEllipsoide EllipsoidPointAltitudeEllipsoide
}

ReferenceSFN ::= INTEGER (0..4095)

ReferenceTimeDifferenceToCell ::= CHOICE {
    -- Actual value = IE value * 40
    accuracy40 INTEGER (0..960),
    -- Actual value = IE value * 256
    accuracy256 INTEGER (0..150),
    -- Actual value = IE value * 2560
    accuracy2560 INTEGER (0..15)
}

```

```

}

RemovedInterFreqCellList ::= CHOICE {
    removeAllInterFreqCells      NULL,
    removeSomeInterFreqCells    SEQUENCE (SIZE (1..maxCellMeas)) OF
                                InterFreqCellID,
    removeNoInterFreqCells      NULL
}

RemovedInterRATCellList ::= CHOICE {
    removeAllInterRATCells      NULL,
    removeSomeInterRATCells    SEQUENCE (SIZE (1..maxCellMeas)) OF
                                InterRATCellID,
    removeNoInterRATCells      NULL
}

RemovedIntraFreqCellList ::= CHOICE {
    removeAllIntraFreqCells     NULL,
    removeSomeIntraFreqCells   SEQUENCE (SIZE (1..maxCellMeas)) OF
                                IntraFreqCellID,
    removeNoIntraFreqCells     NULL
}

ReplacementActivationThreshold ::= ENUMERATED {
    notApplicable, t1, t2,
    t3, t4, t5, t6, t7 }

ReportDeactivationThreshold ::= ENUMERATED {
    notApplicable, t1, t2,
    t3, t4, t5, t6, t7 }

ReportingAmount ::= ENUMERATED {
    ra1, ra2, ra4, ra8, ra16, ra32,
    ra64, ra-Infinity }

ReportingCellStatus ::= CHOICE{
    withinActiveSet              MaxNumberOfReportingCellsType1,
    withinMonitoredSetUsedFreq   MaxNumberOfReportingCellsType1,
    withinActiveAndOrMonitoredUsedFreq MaxNumberOfReportingCellsType1,
    withinDetectedSetUsedFreq   MaxNumberOfReportingCellsType1,
    withinMonitoredAndOrDetectedUsedFreq
                                MaxNumberOfReportingCellsType1,
    allActiveplusMonitoredSet    MaxNumberOfReportingCellsType3,
    allActivePlusDetectedSet     MaxNumberOfReportingCellsType3,
    allActivePlusMonitoredAndOrDetectedSet
                                MaxNumberOfReportingCellsType3,
    withinVirtualActSet          MaxNumberOfReportingCellsType1,
    withinMonitoredSetNonUsedFreq MaxNumberOfReportingCellsType1,
    withinMonitoredAndOrActiveSetNonUsedFreq
                                MaxNumberOfReportingCellsType1,
    allVirtualActSetplusMonitoredSetNonUsedFreq
                                MaxNumberOfReportingCellsType3,
    withinActSetOrVirtualActSet  MaxNumberOfReportingCellsType2,
    withinActSetAndOrMonitoredUsedFreqOrMonitoredNonUsedFreq
                                MaxNumberOfReportingCellsType2
}

ReportingCellStatusOpt ::= SEQUENCE {
    reportingCellStatus          ReportingCellStatus          OPTIONAL
}

ReportingInfoForCellDCH ::= SEQUENCE {
    intraFreqReportingQuantity  IntraFreqReportingQuantity,
    measurementReportingMode    MeasurementReportingMode,
    reportCriteria              CellDCH-ReportCriteria
}

ReportingInfoForCellDCH-LCR-r4 ::= SEQUENCE {
    intraFreqReportingQuantity  IntraFreqReportingQuantity,
    measurementReportingMode    MeasurementReportingMode,
    reportCriteria              CellDCH-ReportCriteria-LCR-r4
}

ReportingInterval ::= ENUMERATED {
    noPeriodicalreporting, ri0-25,
    ri0-5, ri1, ri2, ri4, ri8, ri16 }

```

```

ReportingIntervalLong ::=          ENUMERATED {
                                     ril0, ril0-25, ril0-5, ril1,
                                     ril2, ril3, ril4, ril6, ril8,
                                     ril12, ril16, ril20, ril24,
                                     ril28, ril32, ril64 }

-- Actual value = IE value * 0.5
ReportingRange ::=                INTEGER (0..29)

RL-AdditionInfoList ::=          SEQUENCE (SIZE (1..maxRL)) OF
                                   PrimaryCPICH-Info

RL-InformationLists ::=          SEQUENCE {
                                   rl-AdditionInfoList          OPTIONAL,
                                   rl-RemovalInfoList           OPTIONAL,
                                   }

RL-RemovalInfoList ::=           SEQUENCE (SIZE (1..maxRL)) OF
                                   PrimaryCPICH-Info

RLC-BuffersPayload ::=           ENUMERATED {
                                   pl0, pl4, pl8, pl16, pl32, pl64, pl128,
                                   pl256, pl512, pl1024, pl2k, pl4k,
                                   pl8k, pl16k, pl32k, pl64k, pl128k,
                                   pl256k, pl512k, pl1024k }

-- Actual value = IE value * 0.032
RRC ::=                            INTEGER (-127..127)

SatData ::=                       SEQUENCE{
                                   satID,
                                   iode
                                   }

SatDataList ::=                   SEQUENCE (SIZE (0..maxSat)) OF
                                   SatData

SatelliteStatus ::=              ENUMERATED {
                                   ns-NN-U,
                                   es-SN,
                                   es-NN-U,
                                   rev2,
                                   rev }

SatID ::=                         INTEGER (0..63)

SFN-SFN-Drift ::=                ENUMERATED {no-drift, sfnsfndrift0-33, sfnsfndrift0-66,
                                             sfnsfndrift1, sfnsfndrift1-33, sfnsfndrift1-66,
                                             sfnsfndrift2, sfnsfndrift2-5, sfnsfndrift3,
                                             sfnsfndrift4, sfnsfndrift5, sfnsfndrift7,
                                             sfnsfndrift9, sfnsfndrift11, sfnsfndrift13,
                                             sfnsfndrift15, sfnsfndrift-0-33, sfnsfndrift-0-66,
                                             sfnsfndrift-1, sfnsfndrift-1-33, sfnsfndrift-1-66,
                                             sfnsfndrift-2, sfnsfndrift-2-5, sfnsfndrift-3,
                                             sfnsfndrift-4, sfnsfndrift-5, sfnsfndrift-7,
                                             sfnsfndrift-9, sfnsfndrift-11, sfnsfndrift-13,
                                             sfnsfndrift-15}

SFN-SFN-ObsTimeDifference ::=     CHOICE {
                                   type1
                                   SFN-SFN-ObsTimeDifference1,
                                   type2
                                   SFN-SFN-ObsTimeDifference2
                                   }

SFN-SFN-ObsTimeDifference1 ::=    INTEGER (0..9830399)

SFN-SFN-ObsTimeDifference2 ::=    INTEGER (0..40961)

SFN-SFN-OTD-Type ::=             ENUMERATED {
                                   noReport,
                                   type1,
                                   type2 }

SFN-SFN-RelTimeDifference1 ::=    SEQUENCE {
                                   sfn-Offset
                                   INTEGER (0 .. 4095),
                                   sfn-sfn-Reltimedifference
                                   INTEGER (0.. 38399)
                                   }

SFN-TOW-Uncertainty ::=          ENUMERATED {

```

```

        lessThan10,
        moreThan10 }

SIR ::=
    INTEGER (0..63)

SIR-MeasurementList ::=
    SEQUENCE (SIZE (1..maxCCTrCH)) OF
        SIR-MeasurementResults

SIR-MeasurementResults ::=
    SEQUENCE {
        tfcs-ID
        sir-TimeslotList
    }

SIR-TFCS ::=
    TFCS-IdentityPlain

SIR-TFCS-List ::=
    SEQUENCE (SIZE (1..maxCCTrCH)) OF
        SIR-TFCS

SIR-TimeslotList ::=
    SEQUENCE (SIZE (1..maxTS)) OF
        SIR

-- Reserved bits in subframe 1 of the GPS navigation message
SubFrame1Reserved ::=
    SEQUENCE {
        reserved1
        reserved2
        reserved3
        reserved4
    }

T-CRMax ::=
    CHOICE {
        notUsed
        t30
        t60
        t120
        t180
        t240
    }

T-CRMaxHyst ::=
    ENUMERATED {
        notUsed, t10, t20, t30,
        t40, t50, t60, t70 }

TemporaryOffset ::=
    ENUMERATED {
        to10, to20, to30, to40, to50,
        to60, to70, infinite }

TemporaryOffsetList ::=
    SEQUENCE {
        temporaryOffset1
        temporaryOffset2
    }

Threshold ::=
    INTEGER (-115..0)

ThresholdPositionChange ::=
    ENUMERATED {
        pc10, pc20, pc30, pc40, pc50,
        pc100, pc200, pc300, pc500,
        pc1000, pc2000, pc5000, pc10000,
        pc20000, pc50000, pc100000 }

ThresholdSFN-GPS-TOW ::=
    ENUMERATED {
        ms1, ms2, ms3, ms5, ms10,
        ms20, ms50, ms100 }

ThresholdSFN-SFN-Change ::=
    ENUMERATED {
        c0-25, c0-5, c1, c2, c3, c4, c5,
        c10, c20, c50, c100, c200, c500,
        c1000, c2000, c5000 }

ThresholdUsedFrequency ::=
    INTEGER (-115..165)

-- Actual value = IE value * 20.
TimeInterval ::=
    INTEGER (1..13)

```

```

TimeslotInfo ::=
    timeslotNumber
    burstType
}

TimeslotInfo-LCR-r4 ::=
    timeslotNumber
    burstType
}

TimeslotInfoList ::=
    SEQUENCE (SIZE (1..maxTS)) OF
        TimeslotInfo

TimeslotInfoList-LCR-r4 ::=
    SEQUENCE (SIZE (1..maxTS-LCR)) OF
        TimeslotInfo-LCR-r4

TimeslotInfoList-r4 ::=
    tdd384
    tdd128
}

TimeslotISCP ::=
    INTEGER (0..91)

-- The following list shall not include more than 6 elements in 1.28Mcps TDD mode.
TimeslotISCP-List ::=
    SEQUENCE (SIZE (1..maxTS)) OF
        TimeslotISCP

TimeslotListWithISCP ::=
    SEQUENCE (SIZE (1..maxTS)) OF
        TimeslotWithISCP

TimeslotWithISCP ::=
    timeslot
    timeslotISCP
}

TimeToTrigger ::=
    ENUMERATED {
        ttt0, ttt10, ttt20, ttt40, ttt60,
        ttt80, ttt100, ttt120, ttt160,
        ttt200, ttt240, ttt320, ttt640,
        ttt1280, ttt2560, ttt5000 }

TrafficVolumeEventParam ::=
    eventID
    reportingThreshold
    timeToTrigger
    pendingTimeAfterTrigger
    tx-InterruptionAfterTrigger
}

TrafficVolumeEventResults ::=
    ul-transportChannelCausingEvent
    trafficVolumeEventIdentity
}

TrafficVolumeEventType ::=
    ENUMERATED {
        e4a,
        e4b }

TrafficVolumeMeasQuantity ::=
    rlc-BufferPayload
    averageRLC-BufferPayload
    varianceOfRLC-BufferPayload
}

TrafficVolumeMeasSysInfo ::=
    trafficVolumeMeasurementID
    trafficVolumeMeasurementObjectList
    trafficVolumeMeasQuantity
    trafficVolumeReportingQuantity
    trafficVolumeMeasRepCriteria
    measurementValidity
    measurementReportingMode
    reportCriteriaSysInf
}

SEQUENCE {
    TimeslotNumber,
    BurstType
}

SEQUENCE {
    TimeslotNumber-LCR-r4,
    BurstType
}

SEQUENCE (SIZE (1..maxTS)) OF
    TimeslotInfo

SEQUENCE (SIZE (1..maxTS-LCR)) OF
    TimeslotInfo-LCR-r4

CHOICE {
    SEQUENCE (SIZE (1..maxTS)) OF
        TimeslotInfo,
    SEQUENCE (SIZE (1..maxTS-LCR)) OF
        TimeslotInfo-LCR-r4
}

INTEGER (0..91)

SEQUENCE (SIZE (1..maxTS)) OF
    TimeslotISCP

SEQUENCE (SIZE (1..maxTS)) OF
    TimeslotWithISCP

SEQUENCE {
    TimeslotNumber,
    TimeslotISCP
}

ENUMERATED {
    ttt0, ttt10, ttt20, ttt40, ttt60,
    ttt80, ttt100, ttt120, ttt160,
    ttt200, ttt240, ttt320, ttt640,
    ttt1280, ttt2560, ttt5000 }

SEQUENCE {
    TrafficVolumeEventType,
    TrafficVolumeThreshold,
    TimeToTrigger
    PendingTimeAfterTrigger
    TX-InterruptionAfterTrigger
    OPTIONAL,
    OPTIONAL,
    OPTIONAL
}

SEQUENCE {
    UL-TrCH-Identity,
    TrafficVolumeEventType
}

ENUMERATED {
    e4a,
    e4b }

CHOICE {
    NULL,
    TimeInterval,
    TimeInterval
}

SEQUENCE {
    MeasurementIdentity
    TrafficVolumeMeasurementObjectList
    TrafficVolumeMeasQuantity
    TrafficVolumeReportingQuantity
    TrafficVolumeReportingCriteria
    MeasurementValidity
    MeasurementReportingMode,
    TrafficVolumeReportCriteriaSysInfo
    DEFAULT 4,
    OPTIONAL,
    OPTIONAL,
    OPTIONAL,
    OPTIONAL,
    OPTIONAL,
}

```

```

TrafficVolumeMeasuredResults ::= SEQUENCE {
    rb-Identity                RB-Identity,
    rlc-BuffersPayload         RLC-BuffersPayload           OPTIONAL,
    averageRLC-BufferPayload   AverageRLC-BufferPayload   OPTIONAL,
    varianceOfRLC-BufferPayload VarianceOfRLC-BufferPayload   OPTIONAL
}

TrafficVolumeMeasuredResultsList ::= SEQUENCE (SIZE (1..maxRB)) OF
    TrafficVolumeMeasuredResults

TrafficVolumeMeasurement ::= SEQUENCE {
    trafficVolumeMeasurementObjectList TrafficVolumeMeasurementObjectList OPTIONAL,
    trafficVolumeMeasQuantity          TrafficVolumeMeasQuantity   OPTIONAL,
    trafficVolumeReportingQuantity     TrafficVolumeReportingQuantity OPTIONAL,
    measurementValidity                MeasurementValidity         OPTIONAL,
    reportCriteria                     TrafficVolumeReportCriteria
}

TrafficVolumeMeasurementObjectList ::= SEQUENCE (SIZE (1..maxTrCH)) OF
    UL-TrCH-Identity

TrafficVolumeReportCriteria ::= CHOICE {
    trafficVolumeReportingCriteria TrafficVolumeReportingCriteria,
    periodicalReportingCriteria    PeriodicalReportingCriteria,
    noReporting                     NULL
}

TrafficVolumeReportCriteriaSysInfo ::= CHOICE {
    trafficVolumeReportingCriteria TrafficVolumeReportingCriteria,
    periodicalReportingCriteria    PeriodicalReportingCriteria
}

TrafficVolumeReportingCriteria ::= SEQUENCE {
    transChCriteriaList          TransChCriteriaList           OPTIONAL
}

TrafficVolumeReportingQuantity ::= SEQUENCE {
    rlc-RB-BufferPayload         BOOLEAN,
    rlc-RB-BufferPayloadAverage  BOOLEAN,
    rlc-RB-BufferPayloadVariance BOOLEAN
}

TrafficVolumeThreshold ::= ENUMERATED {
    th8, th16, th32, th64, th128,
    th256, th512, th1024, th2k, th3k,
    th4k, th6k, th8k, th12k, th16k,
    th24k, th32k, th48k, th64k, th96k,
    th128k, th192k, th256k, th384k,
    th512k, th768k }

TransChCriteria ::= SEQUENCE {
    ul-transportChannelID        UL-TrCH-Identity           OPTIONAL,
    eventSpecificParameters      SEQUENCE (SIZE (1..maxMeasParEvent)) OF
        TrafficVolumeEventParam   OPTIONAL
}

TransChCriteriaList ::= SEQUENCE (SIZE (1..maxTrCH)) OF
    TransChCriteria

TransferMode ::= ENUMERATED {
    acknowledgedModeRLC,
    unacknowledgedModeRLC }

TransmittedPowerThreshold ::= INTEGER (-50..33)

TriggeringCondition1 ::= ENUMERATED {
    activeSetCellsOnly,
    monitoredSetCellsOnly,
    activeSetAndMonitoredSetCells }

TriggeringCondition2 ::= ENUMERATED {
    activeSetCellsOnly,
    monitoredSetCellsOnly,
    activeSetAndMonitoredSetCells,
    detectedSetCellsOnly,
    detectedSetAndMonitoredSetCells }

```



```

TX-InterruptionAfterTrigger ::=      ENUMERATED {
                                        txiat0-25, txiat0-5, txiat1,
                                        txiat2, txiat4, txiat8, txiat16 }

UDRE ::=                              ENUMERATED {
                                        lessThan1,
                                        between1-and-4,
                                        between4-and-8,
                                        over8 }

UE-6AB-Event ::=                     SEQUENCE {
    timeToTrigger                      TimeToTrigger,
    transmittedPowerThreshold          TransmittedPowerThreshold
}

UE-6FG-Event ::=                     SEQUENCE {
    timeToTrigger                      TimeToTrigger,
    ue-RX-TX-TimeDifferenceThreshold   UE-RX-TX-TimeDifferenceThreshold
}

UE-AutonomousUpdateMode ::=         CHOICE {
    on                                  NULL,
    onWithNoReporting                 NULL,
    off                                RL-InformationLists
}

UE-InternalEventParam ::=           CHOICE {
    event6a                           UE-6AB-Event,
    event6b                           UE-6AB-Event,
    event6c                           TimeToTrigger,
    event6d                           TimeToTrigger,
    event6e                           TimeToTrigger,
    event6f                           UE-6FG-Event,
    event6g                           UE-6FG-Event
}

UE-InternalEventParamList ::=       SEQUENCE (SIZE (1..maxMeasEvent)) OF
    UE-InternalEventParam

UE-InternalEventResults ::=         CHOICE {
    event6a                           NULL,
    event6b                           NULL,
    event6c                           NULL,
    event6d                           NULL,
    event6e                           NULL,
    event6f                           PrimaryCPICH-Info,
    event6g                           PrimaryCPICH-Info
}

UE-InternalMeasQuantity ::=         SEQUENCE {
    measurementQuantity                UE-MeasurementQuantity,
    filterCoefficient                  FilterCoefficient                DEFAULT fc0
}

UE-InternalMeasuredResults ::=      SEQUENCE {
    modeSpecificInfo                  CHOICE {
        fdd                          SEQUENCE {
            ue-TransmittedPowerFDD    UE-TransmittedPower            OPTIONAL,
            ue-RX-TX-ReportEntryList  UE-RX-TX-ReportEntryList        OPTIONAL
        },
        tdd                          SEQUENCE {
            ue-TransmittedPowerTDD-List UE-TransmittedPowerTDD-List    OPTIONAL,
            appliedTA                  UL-TimingAdvance                OPTIONAL
        }
    }
}

UE-InternalMeasuredResults-LCR-r4 ::= SEQUENCE {
    ue-TransmittedPowerTDD-List        UE-TransmittedPowerTDD-List    OPTIONAL,
    upPCH-ADV                          INTEGER (0..352)                OPTIONAL
}

UE-InternalMeasurement ::=         SEQUENCE {
    ue-InternalMeasQuantity            UE-InternalMeasQuantity        OPTIONAL,
    ue-InternalReportingQuantity        UE-InternalReportingQuantity    OPTIONAL,
    reportCriteria                      UE-InternalReportCriteria
}

```

```

UE-InternalMeasurement-r4 ::= SEQUENCE {
    ue-InternalMeasQuantity          UE-InternalMeasQuantity          OPTIONAL,
    ue-InternalReportingQuantity-r4  UE-InternalReportingQuantity-r4  OPTIONAL,
    reportCriteria                    UE-InternalReportCriteria
}

UE-InternalMeasurementSysInfo ::= SEQUENCE {
    ue-InternalMeasurementID          MeasurementIdentity          DEFAULT 5,
    ue-InternalMeasQuantity          UE-InternalMeasQuantity
}

UE-InternalReportCriteria ::= CHOICE {
    ue-InternalReportingCriteria      UE-InternalReportingCriteria,
    periodicalReportingCriteria      PeriodicalReportingCriteria,
    noReporting                        NULL
}

UE-InternalReportingCriteria ::= SEQUENCE {
    ue-InternalEventParamList        UE-InternalEventParamList        OPTIONAL
}

UE-InternalReportingQuantity ::= SEQUENCE {
    ue-TransmittedPower              BOOLEAN,
    modeSpecificInfo                 CHOICE {
        fdd                          SEQUENCE {
            ue-RX-TX-TimeDifference  BOOLEAN
        },
        tdd                          SEQUENCE {
            appliedTA                BOOLEAN
        }
    }
}

UE-InternalReportingQuantity-r4 ::= SEQUENCE {
    ue-TransmittedPower              BOOLEAN,
    modeSpecificInfo                 CHOICE {
        fdd                          SEQUENCE {
            ue-RX-TX-TimeDifference  BOOLEAN
        },
        tdd                          SEQUENCE {
            tddOption                CHOICE {
                tdd384                SEQUENCE {
                    appliedTA          BOOLEAN
                },
                tdd128                SEQUENCE {
                    upPTS-ADV          BOOLEAN
                }
            }
        }
    }
}

-- TABULAR: For TDD only the first two values are used.
UE-MeasurementQuantity ::= ENUMERATED {
    ue-TransmittedPower,
    ultra-Carrier-RSSI,
    ue-RX-TX-TimeDifference }

UE-RX-TX-ReportEntry ::= SEQUENCE {
    primaryCPICH-Info                PrimaryCPICH-Info,
    ue-RX-TX-TimeDifferenceType1      UE-RX-TX-TimeDifferenceType1
}

UE-RX-TX-ReportEntryList ::= SEQUENCE (SIZE (1..maxRL)) OF
    UE-RX-TX-ReportEntry

UE-RX-TX-TimeDifferenceType1 ::= INTEGER (768..1280)

-- Actual value = IE value * 0.0625 + 768
UE-RX-TX-TimeDifferenceType2 ::= INTEGER (0..8191)

UE-RX-TX-TimeDifferenceThreshold ::= INTEGER (768..1280)

UE-TransmittedPower ::= INTEGER (0..104)

UE-TransmittedPowerTDD-List ::= SEQUENCE (SIZE (1..maxTS)) OF
    UE-TransmittedPower

```

```

UL-TrCH-Identity ::=
    dch
    rach
    usch
}
CHOICE {
    TransportChannelIdentity,
    NULL,
    TransportChannelIdentity
}

UE-Positioning-Accuracy ::=
    BIT STRING (SIZE (7))

UE-Positioning-CipherParameters ::=
    cipheringKeyFlag
    cipheringSerialNumber
}
SEQUENCE {
    BIT STRING (SIZE (1)),
    INTEGER (0..65535)
}

UE-Positioning-Error ::=
    errorReason
    ue-positioning-GPS-additionalAssistanceDataRequest
    AdditionalAssistanceDataRequest OPTIONAL
}
SEQUENCE {
    UE-Positioning-ErrorCause,
    UE-Positioning-GPS-
}

UE-Positioning-ErrorCause ::=
    notEnoughOTDOA-Cells,
    notEnoughGPS-Satellites,
    assistanceDataMissing,
    methodNotSupported,
    undefinedError,
    requestDeniedByUser,
    notProcessedAndTimeout ,
    referenceCellNotServingCell }
ENUMERATED {

UE-Positioning-EventID ::=
    e7a, e7b, e7c }
ENUMERATED {

UE-Positioning-EventParam ::=
    reportingAmount
    reportFirstFix
    measurementInterval
    eventSpecificInfo
}
SEQUENCE {
    ReportingAmount,
    BOOLEAN,
    UE-Positioning-MeasurementInterval,
    UE-Positioning-EventSpecificInfo
}

UE-Positioning-EventParamList ::=
    SEQUENCE (SIZE (1..maxMeasEvent)) OF
    UE-Positioning-EventParam

UE-Positioning-EventSpecificInfo ::=
    e7a
    e7b
    e7c
}
CHOICE {
    ThresholdPositionChange,
    ThresholdSFN-SFN-Change,
    ThresholdSFN-GPS-TOW
}

UE-Positioning-GPS-AcquisitionAssistance ::=
    referenceTime
    utran-ReferenceTime
    gps-ReferenceTimeOnly
    },
    satelliteInformationList
}
SEQUENCE {
    CHOICE {
        UTRAN-ReferenceTime,
        INTEGER (0..60479999)
    },
    AcquisitionSatInfoList
}

UE-Positioning-GPS-AdditionalAssistanceDataRequest ::=
    almanacRequest
    utcModelRequest
    ionosphericModelRequest
    navigationModelRequest
    dgpsCorrectionsRequest
    referenceLocationRequest
    referenceTimeRequest
    aquisitionAssistanceRequest
    realTimeIntegrityRequest
    navModelAddDataRequest
}
SEQUENCE {
    BOOLEAN,
    BOOLEAN,
    BOOLEAN,
    BOOLEAN,
    BOOLEAN,
    BOOLEAN,
    BOOLEAN,
    BOOLEAN,
    BOOLEAN,
    UE-Positioning-GPS-NavModelAddDataReq
    OPTIONAL
}

UE-Positioning-GPS-Almanac ::=
    wn-a
    almanacSatInfoList
    sv-GlobalHealth
}
SEQUENCE {
    BIT STRING (SIZE (8)),
    AlmanacSatInfoList,
    BIT STRING (SIZE (364))
    OPTIONAL
}

UE-Positioning-GPS-AssistanceData ::=
    SEQUENCE {

```

```

ue-positioning-GPS-ReferenceTime          UE-Positioning-GPS-ReferenceTime
OPTIONAL,
ue-positioning-GPS-ReferenceLocation      ReferenceLocation          OPTIONAL,
ue-positioning-GPS-DGPS-Corrections      UE-Positioning-GPS-DGPS-Corrections
OPTIONAL,
ue-positioning-GPS-NavigationModel       UE-Positioning-GPS-NavigationModel
OPTIONAL,
ue-positioning-GPS-IonosphericModel      UE-Positioning-GPS-IonosphericModel
OPTIONAL,
ue-positioning-GPS-UTC-Model             UE-Positioning-GPS-UTC-Model
OPTIONAL,
ue-positioning-GPS-Almanac               UE-Positioning-GPS-Almanac
OPTIONAL,
ue-positioning-GPS-AcquisitionAssistance UE-Positioning-GPS-AcquisitionAssistance
OPTIONAL,
ue-positioning-GPS-Real-timeIntegrity    BadSatList                  OPTIONAL
}

UE-Positioning-GPS-DGPS-Corrections ::= SEQUENCE {
  gps-TOW          INTEGER (0..604799),
  statusHealth    DiffCorrectionStatus,
  dgps-CorrectionSatInfoList DGPS-CorrectionSatInfoList
}

UE-Positioning-GPS-IonosphericModel ::= SEQUENCE {
  alfa0          BIT STRING (SIZE (8)),
  alfa1          BIT STRING (SIZE (8)),
  alfa2          BIT STRING (SIZE (8)),
  alfa3          BIT STRING (SIZE (8)),
  beta0          BIT STRING (SIZE (8)),
  beta1          BIT STRING (SIZE (8)),
  beta2          BIT STRING (SIZE (8)),
  beta3          BIT STRING (SIZE (8))
}

UE-Positioning-GPS-MeasurementResults ::= SEQUENCE {
  modeSpecificInfo CHOICE {
    fdd             SEQUENCE {
      referenceIdentity PrimaryCPICH-Info          OPTIONAL
    },
    tdd             SEQUENCE {
      referenceIdentity CellParametersID          OPTIONAL
    }
  },
  referenceSFN     ReferenceSFN                  OPTIONAL,
  gps-TOW-lmsec   GPS-TOW-lmsec,
  gps-TOW-rem-usec GPS-TOW-rem-usec              OPTIONAL,
  gps-MeasurementParamList GPS-MeasurementParamList
}

UE-Positioning-GPS-NavigationModel ::= SEQUENCE {
  navigationModelSatInfoList NavigationModelSatInfoList
}

UE-Positioning-GPS-NavModelAddDataReq ::= SEQUENCE {
  gps-Week        INTEGER (0..1023),
  gps-Toe         INTEGER (0..167),
  tToeLimit       INTEGER (0..10),
  satDataList     SatDataList
}

UE-Positioning-GPS-ReferenceTime ::= SEQUENCE {
  gps-Week        INTEGER (0..1023),
  gps-tow-lmsec   GPS-TOW-lmsec,
  gps-tow-rem-usec GPS-TOW-rem-usec              OPTIONAL,
  modeSpecificInfo CHOICE {
    fdd             SEQUENCE {
      referenceIdentity PrimaryCPICH-Info          OPTIONAL
    },
    tdd             SEQUENCE {
      referenceIdentity CellParametersID          OPTIONAL
    }
  },
  sfn             INTEGER (0..4095)              OPTIONAL,
  sfn-tow-Uncertainty SFN-TOW-Uncertainty          OPTIONAL,
  nodeBClockDrift NodeB-ClockDrift              OPTIONAL,
  gps-TOW-AssistList GPS-TOW-AssistList          OPTIONAL
}

```

```

UE-Positioning-GPS-UTC-Model ::=
    a1
    a0
    t-ot
    wn-t
    delta-t-LS
    wn-lsf
    dn
    delta-t-LSF
    SEQUENCE {
        BIT STRING (SIZE (24)),
        BIT STRING (SIZE (32)),
        BIT STRING (SIZE (8)),
        BIT STRING (SIZE (8)),
        BIT STRING (SIZE (8)),
        BIT STRING (SIZE (8)),
        BIT STRING (SIZE (8)),
        BIT STRING (SIZE (8))
    }

UE-Positioning-IPDL-Parameters ::=
    ip-Spacing
    ip-Length
    ip-Offset
    seed
    burstModeParameters
    SEQUENCE {
        IP-Spacing,
        IP-Length,
        INTEGER (0..9),
        INTEGER (0..63),
        BurstModeParameters OPTIONAL
    }

UE-Positioning-IPDL-Parameters-r4 ::=
    modeSpecificInfo
    fdd
        ip-Spacing
        ip-Length
        ip-Offset
        seed
    },
    tdd
        ip-Spacing-TDD
        ip-slot
        ip-Start
        ip-PCCPCG
    },
    burstModeParameters
    SEQUENCE {
        CHOICE {
            SEQUENCE {
                IP-Spacing,
                IP-Length,
                INTEGER (0..9),
                INTEGER (0..63)
            },
            SEQUENCE {
                IP-Spacing-TDD,
                INTEGER (0..14),
                INTEGER (0..4095),
                IP-PCCPCH-r4 OPTIONAL
            }
        }
        BurstModeParameters
    }

UP-IPDL-Parameters-TDD-r4-ext ::= SEQUENCE {
    ip-Spacing
    ip-slot
    ip-Start
    ip-PCCPCG
    burstModeParameters
    IP-Spacing-TDD,
    INTEGER (0..14),
    INTEGER (0..4095),
    IP-PCCPCH-r4 OPTIONAL,
    BurstModeParameters
}

UE-Positioning-MeasuredResults ::=
    ue-positioning-OTDOA-Measurement
    OPTIONAL,
    ue-positioning-PositionEstimateInfo
    OPTIONAL,
    ue-positioning-GPS-Measurement
    OPTIONAL,
    ue-positioning-Error
    OPTIONAL
    SEQUENCE {
        UE-Positioning-OTDOA-Measurement
        UE-Positioning-PositionEstimateInfo
        UE-Positioning-GPS-MeasurementResults
        UE-Positioning-Error
    }

UE-Positioning-Measurement ::=
    ue-positioning-ReportingQuantity
    reportCriteria
    ue-positioning-OTDOA-AssistanceData
    OPTIONAL,
    ue-positioning-GPS-AssistanceData
    OPTIONAL
    SEQUENCE {
        UE-Positioning-ReportingQuantity,
        UE-Positioning-ReportCriteria,
        UE-Positioning-OTDOA-AssistanceData
        UE-Positioning-GPS-AssistanceData
    }

UE-Positioning-Measurement-r4 ::=
    ue-positioning-ReportingQuantity
    reportCriteria
    ue-positioning-OTDOA-AssistanceData
    OPTIONAL,
    ue-positioning-GPS-AssistanceData
    OPTIONAL
    SEQUENCE {
        UE-Positioning-ReportingQuantity,
        UE-Positioning-ReportCriteria,
        UE-Positioning-OTDOA-AssistanceData-r4
        UE-Positioning-GPS-AssistanceData
    }

UE-Positioning-MeasurementEventResults ::=
    event7a
    event7b
    CHOICE {
        UE-Positioning-PositionEstimateInfo,
        UE-Positioning-OTDOA-Measurement,
    }

```

```

    event7c                UE-Positioning-GPS-MeasurementResults
  }

UE-Positioning-MeasurementInterval ::=
    ENUMERATED {
        e5, e15, e60, e300,
        e900, e1800, e3600, e7200 }

UE-Positioning-MethodType ::=
    ENUMERATED {
        ue-Assisted,
        ue-Based,
        ue-BasedPreferred,
        ue-AssistedPreferred }

UE-Positioning-OTDOA-AssistanceData ::= SEQUENCE {
    ue-positioning-OTDOA-ReferenceCellInfo    UE-Positioning-OTDOA-ReferenceCellInfo
    OPTIONAL,
    ue-positioning-OTDOA-NeighbourCellList    UE-Positioning-OTDOA-NeighbourCellList
    OPTIONAL
}

UE-Positioning-OTDOA-AssistanceData-r4 ::= SEQUENCE {
    ue-positioning-OTDOA-ReferenceCellInfo    UE-Positioning-OTDOA-ReferenceCellInfo-r4
    OPTIONAL,
    ue-positioning-OTDOA-NeighbourCellList    UE-Positioning-OTDOA-NeighbourCellList-r4
    OPTIONAL
}

UE-Positioning-OTDOA-Measurement ::= SEQUENCE {
    sfn                INTEGER (0..4095),
    modeSpecificInfo   CHOICE {
        fdd             SEQUENCE {
            referenceCellIdentity    PrimaryCPICH-Info,
            ue-RX-TX-TimeDifferenceType2 UE-RX-TX-TimeDifferenceType2
        },
        tdd             SEQUENCE {
            referenceCellIdentity    CellParametersID
        }
    },
    neighbourList      NeighbourList                OPTIONAL
}

UE-Positioning-OTDOA-NeighbourCellInfo ::= SEQUENCE {
    modeSpecificInfo   CHOICE {
        fdd             SEQUENCE {
            primaryCPICH-Info        PrimaryCPICH-Info
        },
        tdd             SEQUENCE {
            cellAndChannelIdentity    CellAndChannelIdentity
        }
    },
    frequencyInfo      FrequencyInfo                OPTIONAL,
    ue-positioning-IPDL-Parameters    UE-Positioning-IPDL-Parameters
    OPTIONAL,
    sfn-SFN-RelTimeDifference    SFN-SFN-RelTimeDifference1,
    sfn-SFN-Drift                SFN-SFN-Drift                OPTIONAL,
    searchWindowSize            OTDOA-SearchWindowSize,
    positioningMode            CHOICE {
        ueBased          SEQUENCE {
            relativeNorth    INTEGER (-20000..20000)    OPTIONAL,
            relativeEast     INTEGER (-20000..20000)    OPTIONAL,
            relativeAltitude  INTEGER (-4000..4000)     OPTIONAL,
            fineSFN-SFN       FineSFN-SFN,
            -- actual value = (IE value * 0.0625) + 876
            roundTripTime     INTEGER (0.. 32766)        OPTIONAL
        },
        ueAssisted          SEQUENCE {}
    }
}

UE-Positioning-OTDOA-NeighbourCellInfo-r4 ::= SEQUENCE {
    modeSpecificInfo   CHOICE {
        fdd             SEQUENCE {
            primaryCPICH-Info        PrimaryCPICH-Info
        },
        tdd             SEQUENCE {
            cellAndChannelIdentity    CellAndChannelIdentity
        }
    },
}

```

```

frequencyInfo                                FrequencyInfo                                OPTIONAL,
ue-positioning-IPDL-Parameters                UE-Positioning-IPDL-Parameters-r4
OPTIONAL,
sfn-SFN-RelTimeDifference                     SFN-SFN-RelTimeDifference1,
sfn-SFN-Drift                                 INTEGER (0..30),
searchWindowSize                             OTDOA-SearchWindowSize,
positioningMode CHOICE{
  ueBased                                     SEQUENCE {
    relativeNorth                           INTEGER (-20000..20000)                OPTIONAL,
    relativeEast                             INTEGER (-20000..20000)                OPTIONAL,
    relativeAltitude                         INTEGER (-4000..4000)                 OPTIONAL,
    fineSFN-SFN                             FineSFN-SFN                          OPTIONAL,
    -- actual value = (IE value * 0.0625) + 876
    roundTripTime                           INTEGER (0.. 32766)                   OPTIONAL
  },
  ueAssisted                                 SEQUENCE {}
}
}

UE-Positioning-OTDOA-NeighbourCellList ::= SEQUENCE (SIZE (1..maxCellMeas)) OF
UE-Positioning-OTDOA-NeighbourCellInfo

UE-Positioning-OTDOA-NeighbourCellList-r4 ::= SEQUENCE (SIZE (1..maxCellMeas)) OF
UE-Positioning-OTDOA-NeighbourCellInfo-r4

UE-Positioning-OTDOA-Quality ::= SEQUENCE {
  stdResolution                             BIT STRING (SIZE (2)),
  numberOfOTDOA-Measurements                BIT STRING (SIZE (3)),
  stdOfOTDOA-Measurements                   BIT STRING (SIZE (5))
}

UE-Positioning-OTDOA-ReferenceCellInfo ::= SEQUENCE {
  sfn                                        INTEGER (0..4095)
  OPTIONAL,
  modeSpecificInfo CHOICE {
    fdd                                     SEQUENCE {
      primaryCPICH-Info                    PrimaryCPICH-Info
    },
    tdd                                     SEQUENCE{
      cellAndChannelIdentity                CellAndChannelIdentity
    }
  },
  frequencyInfo                             FrequencyInfo                                OPTIONAL,
  positioningMode CHOICE {
    ueBased                                 SEQUENCE {
      cellPosition                           ReferenceCellPosition  OPTIONAL,
      -- actual value = (IE value * 0.0625) + 876
      roundTripTime                         INTEGER (0..32766)      OPTIONAL
    },
    ueAssisted                               SEQUENCE {}
  },
  ue-positioning-IPDL-Parameters            UE-Positioning-IPDL-Parameters  OPTIONAL
}

UE-Positioning-OTDOA-ReferenceCellInfo-r4 ::= SEQUENCE {
  sfn                                        INTEGER (0..4095)
  OPTIONAL,
  modeSpecificInfo CHOICE {
    fdd                                     SEQUENCE {
      primaryCPICH-Info                    PrimaryCPICH-Info
    },
    tdd                                     SEQUENCE{
      cellAndChannelIdentity                CellAndChannelIdentity
    }
  },
  frequencyInfo                             FrequencyInfo                                OPTIONAL,
  positioningMode CHOICE {
    ueBased                                 SEQUENCE {
      cellPosition                           ReferenceCellPosition  OPTIONAL,
      -- actual value = (IE value * 0.0625) + 876
      roundTripTime                         INTEGER (0..32766)      OPTIONAL
    },
    ueAssisted                               SEQUENCE {}
  },
  ue-positioning-IPDL-Parameters            UE-Positioning-IPDL-Parameters-r4  OPTIONAL
}

UE-Positioning-PositionEstimateInfo ::= SEQUENCE {

```

```

modeSpecificInfo          CHOICE {
  fdd                      SEQUENCE {
    referenceIdentity      PrimaryCPICH-Info          OPTIONAL
  },
  tdd                      SEQUENCE {
    referenceIdentity      CellParametersID          OPTIONAL
  }
},
referenceSFN              ReferenceSFN,
gps-tow-lmsec             GPS-TOW-lmsec          OPTIONAL,
gps-tow-rem-usec         GPS-TOW-rem-usec        OPTIONAL,
positionEstimate         PositionEstimate

}

UE-Positioning-ReportCriteria ::=
  ue-positioning-ReportingCriteria
  periodicalReportingCriteria
  noReporting
                                CHOICE {
                                  UE-Positioning-EventParamList,
                                  PeriodicalReportingCriteria,
                                  NULL
                                }

UE-Positioning-ReportingQuantity ::=
  methodType
  positioningMethod
  responseTime
  accuracy
  gps-TimingOfCellWanted
  multipleSets
  additionalAssistanceDataReq
  environmentCharacterisation
                                SEQUENCE {
                                  UE-Positioning-MethodType,
                                  PositioningMethod,
                                  UE-Positioning-ResponseTime,
                                  UE-Positioning-Accuracy          OPTIONAL,
                                  BOOLEAN,
                                  BOOLEAN,
                                  BOOLEAN,
                                  EnvironmentCharacterisation    OPTIONAL
                                }

UE-Positioning-ResponseTime ::=
  ENUMERATED {
    s1, s2, s4, s8, s16,
    s32, s64, s128 }

UTRA-CarrierRSSI ::=
  INTEGER (0..76)

UTRAN-ReferenceTime ::=
  gps-tow-lmsec
  gps-tow-rem-usec
  modeSpecificInfo
  fdd
    referenceIdentity
  },
  tdd
    referenceIdentity
  },
  sfn
                                SEQUENCE {
                                  GPS-TOW-lmsec,
                                  GPS-TOW-rem-usec,
                                  CHOICE {
                                    SEQUENCE {
                                      PrimaryCPICH-Info          OPTIONAL
                                    },
                                    SEQUENCE {
                                      CellParametersID          OPTIONAL
                                    }
                                  }
                                }
                                INTEGER (0..4095)

VarianceOfRLC-BufferPayload ::=
  ENUMERATED {
    plv0, plv4, plv8, plv16, plv32, plv64,
    plv128, plv256, plv512, plv1024,
    plv2k, plv4k, plv8k, plv16k }

-- Actual value = IE value * 0.1
W ::=
  INTEGER (0..20)

-- *****
--
--   OTHER INFORMATION ELEMENTS (10.3.8)
--
-- *****

BCC ::=
  INTEGER (0..7)

BCCH-ModificationInfo ::=
  mib-ValueTag
  bcch-ModificationTime
                                SEQUENCE {
                                  MIB-ValueTag,
                                  BCCH-ModificationTime          OPTIONAL
                                }

-- Actual value = IE value * 8
BCCH-ModificationTime ::=
  INTEGER (0..511)

BSIC ::=
  ncc
                                SEQUENCE {
                                  NCC,

```



```

    bcc                BCC
}

CBS-DRX-Level1Information ::= SEQUENCE {
    ctch-AllocationPeriod    INTEGER (1..256),
    cbs-FrameOffset          INTEGER (0..255)
}

CDMA2000-Message ::= SEQUENCE {
    msg-Type                BIT STRING (SIZE (8)),
    payload                 BIT STRING (SIZE (1..512))
}

CDMA2000-MessageList ::= SEQUENCE (SIZE (1..maxInterSysMessages)) OF
    CDMA2000-Message

CDMA2000-UMTS-Frequency-List ::= SEQUENCE (SIZE (1..maxNumCDMA2000Freqs)) OF
    FrequencyInfoCDMA2000

CellValueTag ::= INTEGER (1..4)

--Actual value = 2^(IE value)
ExpirationTimeFactor ::= INTEGER (1..8)

FDD-UMTS-Frequency-List ::= SEQUENCE (SIZE (1..maxNumFDDFreqs)) OF
    FrequencyInfoFDD

FrequencyInfoCDMA2000 ::= SEQUENCE {
    band-Class             BIT STRING (SIZE (5)),
    cdma-Freq             BIT STRING (SIZE(11))
}

GSM-BA-Range ::= SEQUENCE {
    gsmLowRangeUARFCN     UARFCN,
    gsmUpRangeUARFCN     UARFCN
}

GSM-BA-Range-List ::= SEQUENCE (SIZE (1..maxNumGSMFreqRanges)) OF
    GSM-BA-Range

GSM-Classmark2 ::= OCTET STRING (SIZE (5))

GSM-Classmark3 ::= OCTET STRING (SIZE (1..32))

GSM-MessageList ::= SEQUENCE (SIZE (1..maxInterSysMessages)) OF
    BIT STRING (SIZE (1..512))

GsmSecurityCapability ::= BIT STRING {
    a5-7(0),
    a5-6(1),
    a5-5(2),
    a5-4(3),
    a5-3(4),
    a5-2(5),
    a5-1(6)
} (SIZE (7))

IdentificationOfReceivedMessage ::= SEQUENCE {
    rrc-TransactionIdentifier    RRC-TransactionIdentifier,
    receivedMessageType          ReceivedMessageType
}

InterRAT-ChangeFailureCause ::= CHOICE {
    configurationUnacceptable    NULL,
    physicalChannelFailure       NULL,
    protocolError                ProtocolErrorInformation,
    unspecified                  NULL,
    spare1                       NULL,
    spare2                       NULL,
    spare3                       NULL
}

InterRAT-UE-RadioAccessCapability ::= CHOICE {
    gsm                SEQUENCE {
        gsm-Classmark2    GSM-Classmark2,
        gsm-Classmark3    GSM-Classmark3
    },
    cdma2000            SEQUENCE {

```

```

        cdma2000-MessageList          CDMA2000-MessageList
    }
}

InterRAT-UE-RadioAccessCapabilityList ::= SEQUENCE (SIZE(1..maxInterSysMessages)) OF
                                           InterRAT-UE-RadioAccessCapability

InterRAT-UE-SecurityCapability ::= CHOICE {
    gsm                               SEQUENCE {
        gsmSecurityCapability          GsmSecurityCapability
    }
}

InterRAT-UE-SecurityCapList ::= SEQUENCE (SIZE(1..maxInterSysMessages)) OF
                                InterRAT-UE-SecurityCapability

InterRAT-HO-FailureCause ::= CHOICE {
    configurationUnacceptable          NULL,
    physicalChannelFailure             NULL,
    protocolError                     ProtocolErrorInformation,
    interRAT-ProtocolError            NULL,
    unspecified                        NULL,
    spare1                             NULL,
    spare2                             NULL,
    spare3                             NULL,
    spare4                             NULL
}

InterRATMessage ::= CHOICE {
    gsm                               SEQUENCE {
        gsm-MessageList               GSM-MessageList
    },
    cdma2000                          SEQUENCE {
        cdma2000-MessageList          CDMA2000-MessageList
    }
}

MasterInformationBlock ::= SEQUENCE {
    mib-ValueTag                      MIB-ValueTag,
    plmn-Type                          PLMN-Type,
    -- TABULAR: The PLMN identity and ANSI-41 core network information
    -- are included in PLMN-Type.
    sibSb-ReferenceList               SIBSb-ReferenceList,
    -- Extension mechanism for non-release99 information
    nonCriticalExtensions              SEQUENCE {} OPTIONAL
}

MIB-ValueTag ::= INTEGER (1..8)

NCC ::= INTEGER (0..7)

PLMN-ValueTag ::= INTEGER (1..256)

PredefinedConfigIdentityAndValueTag ::= SEQUENCE {
    predefinedConfigIdentity           PredefinedConfigIdentity,
    predefinedConfigValueTag           PredefinedConfigValueTag
}

ProtocolErrorInformation ::= SEQUENCE {
    diagnosticsType                   CHOICE {
        type1                          SEQUENCE {
            protocolErrorCause          ProtocolErrorCause
        },
        spare                           NULL
    }
}

ReceivedMessageType ::= ENUMERATED {
    activeSetUpdate,
    cellChangeOrderFromUTRAN,
    cellUpdateConfirm,
    counterCheck,
    downlinkDirectTransfer,
    interRATHandoverCommand,
    measurementControl,
    pagingType2,
    physicalChannelReconfiguration,
}

```

```

        physicalSharedChannelAllocation,
        radioBearerReconfiguration,
        radioBearerRelease,
        radioBearerSetup,
        rrcConnectionRelease,
        rrcConnectionReject,
        rrcConnectionSetup,
        securityModeCommand,
        signallingConnectionRelease,
        transportChannelReconfiguration,
        transportFormatCombinationControl,
        ueCapabilityEnquiry,
        ueCapabilityInformationConfirm,
        uplinkPhysicalChannelControl,
        uraUpdateConfirm,
        utranMobilityInformation,
        assistanceDataDelivery,
        spare1, spare2, spare3, spare4,
        spare5
    }
}

Rplmn-Information ::= SEQUENCE {
    gsm-BA-Range-List          GSM-BA-Range-List          OPTIONAL,
    fdd-UMTS-Frequency-List   FDD-UMTS-Frequency-List
    OPTIONAL,
    tdd-UMTS-Frequency-List   FDD-UMTS-Frequency-List
    OPTIONAL,
    cdma2000-UMTS-Frequency-List   CDMA2000-UMTS-Frequency-
List          OPTIONAL
}

Rplmn-Information-r4 ::= SEQUENCE {
    gsm-BA-Range-List          GSM-BA-Range-List          OPTIONAL,
    fdd-UMTS-Frequency-List   FDD-UMTS-Frequency-List   OPTIONAL,
    tdd384-UMTS-Frequency-List TDD-UMTS-Frequency-List   OPTIONAL,
    tdd128-UMTS-Frequency-List TDD-UMTS-Frequency-List   OPTIONAL,
    cdma2000-UMTS-Frequency-List CDMA2000-UMTS-Frequency-List   OPTIONAL
}

SchedulingInformation ::= SEQUENCE {
    scheduling                  SEQUENCE {
        segCount                SegCount                DEFAULT 1,
        sib-Pos                 CHOICE {
            -- The element name indicates the repetition period and the value
            -- (multiplied by two) indicates the position of the first segment.
            rep4                 INTEGER (0..1),
            rep8                 INTEGER (0..3),
            rep16                INTEGER (0..7),
            rep32                INTEGER (0..15),
            rep64                INTEGER (0..31),
            rep128               INTEGER (0..63),
            rep256               INTEGER (0..127),
            rep512               INTEGER (0..255),
            rep1024              INTEGER (0..511),
            rep2048              INTEGER (0..1023),
            rep4096              INTEGER (0..2047)
        },
        sib-PosOffsetInfo       SibOFF-List                OPTIONAL
    }
}

SchedulingInformationSIB ::= SEQUENCE {
    sib-Type                   SIB-TypeAndTag,
    scheduling                  SchedulingInformation
}

SchedulingInformationSIBSb ::= SEQUENCE {
    sibSb-Type                 SIBSb-TypeAndTag,
    scheduling                  SchedulingInformation
}

SegCount ::= INTEGER (1..16)

SegmentIndex ::= INTEGER (1..15)

-- Actual value = 2 * IE value
SFN-Prime ::= INTEGER (0..2047)

```

```

SIB-Data-fixed ::=                               BIT STRING (SIZE (222))

SIB-Data-variable ::=                           BIT STRING (SIZE (1..214))

SIBOccurIdentity ::=                            INTEGER (0..15)

SIBOccurrenceIdentityAndValueTag ::=           SEQUENCE {
    sibOccurIdentity                            SIBOccurIdentity,
    sibOccurValueTag                            SIBOccurValueTag
}

SIBOccurValueTag ::=                            INTEGER (0..15)

SIB-ReferenceList ::=                           SEQUENCE (SIZE (1..maxSIB)) OF
    SchedulingInformationSIB

SIBSb-ReferenceList ::=                         SEQUENCE (SIZE (1..maxSIB)) OF
    SchedulingInformationSIBSb

SIB-ReferenceListFACH ::=                       SEQUENCE (SIZE (1..maxSIB-FACH)) OF
    SchedulingInformationSIB

SIB-Type ::=                                    ENUMERATED {
    masterInformationBlock,
    systemInformationBlockType1,
    systemInformationBlockType2,
    systemInformationBlockType3,
    systemInformationBlockType4,
    systemInformationBlockType5,
    systemInformationBlockType6,
    systemInformationBlockType7,
    systemInformationBlockType8,
    systemInformationBlockType9,
    systemInformationBlockType10,
    systemInformationBlockType11,
    systemInformationBlockType12,
    systemInformationBlockType13,
    systemInformationBlockType13-1,
    systemInformationBlockType13-2,
    systemInformationBlockType13-3,
    systemInformationBlockType13-4,
    systemInformationBlockType14,
    systemInformationBlockType15,
    systemInformationBlockType15-1,
    systemInformationBlockType15-2,
    systemInformationBlockType15-3,
    systemInformationBlockType16,
    systemInformationBlockType17,
    systemInformationBlockType15-4,
    systemInformationBlockType18,
    schedulingBlock1,
    schedulingBlock2,
    spare1, spare2, spare3 }

SIB-TypeAndTag ::=                              CHOICE {
    sysInfoType1                                PLMN-ValueTag,
    sysInfoType2                                CellValueTag,
    sysInfoType3                                CellValueTag,
    sysInfoType4                                CellValueTag,
    sysInfoType5                                CellValueTag,
    sysInfoType6                                CellValueTag,
    sysInfoType7                                NULL,
    sysInfoType8                                CellValueTag,
    sysInfoType9                                NULL,
    sysInfoType10                               NULL,
    sysInfoType11                               CellValueTag,
    sysInfoType12                               CellValueTag,
    sysInfoType13                               CellValueTag,
    sysInfoType13-1                             CellValueTag,
    sysInfoType13-2                             CellValueTag,
    sysInfoType13-3                             CellValueTag,
    sysInfoType13-4                             CellValueTag,
    sysInfoType14                               NULL,
    sysInfoType15                               CellValueTag,
    sysInfoType16                               PredefinedConfigIdentityAndValueTag,
    sysInfoType17                               NULL,

```

```

sysInfoType15-1      CellValueTag,
sysInfoType15-2      SIBOccurrenceIdentityAndValueTag,
sysInfoType15-3      SIBOccurrenceIdentityAndValueTag,
sysInfoType15-4      CellValueTag,
sysInfoType18        CellValueTag
}

SIBSb-TypeAndTag ::= CHOICE {
  sysInfoType1        PLMN-ValueTag,
  sysInfoType2        CellValueTag,
  sysInfoType3        CellValueTag,
  sysInfoType4        CellValueTag,
  sysInfoType5        CellValueTag,
  sysInfoType6        CellValueTag,
  sysInfoType7        NULL,
  sysInfoType8        CellValueTag,
  sysInfoType9        NULL,
  sysInfoType10       NULL,
  sysInfoType11       CellValueTag,
  sysInfoType12       CellValueTag,
  sysInfoType13       CellValueTag,
  sysInfoType13-1     CellValueTag,
  sysInfoType13-2     CellValueTag,
  sysInfoType13-3     CellValueTag,
  sysInfoType13-4     CellValueTag,
  sysInfoType14       NULL,
  sysInfoType15       CellValueTag,
  sysInfoType16       PredefinedConfigIdentityAndValueTag,
  sysInfoType17       NULL,
  sysInfoTypeSB1      CellValueTag,
  sysInfoTypeSB2      CellValueTag,
  sysInfoType15-1     CellValueTag,
  sysInfoType15-2     SIBOccurrenceIdentityAndValueTag,
  sysInfoType15-3     SIBOccurrenceIdentityAndValueTag,
  sysInfoType15-4     CellValueTag,
  sysInfoType18       CellValueTag
}

SibOFF ::= ENUMERATED {
  so2, so4, so6, so8, so10,
  so12, so14, so16, so18,
  so20, so22, so24, so26,
  so28, so30, so32 }

SibOFF-List ::= SEQUENCE (SIZE (1..15)) OF
  SibOFF

SysInfoType1 ::= SEQUENCE {
  -- Core network IEs
  cn-CommonGSM-MAP-NAS-SysInfo  NAS-SystemInformationGSM-MAP,
  cn-DomainSysInfoList          CN-DomainSysInfoList,
  -- User equipment IEs
  ue-ConnTimersAndConstants      UE-ConnTimersAndConstants      OPTIONAL,
  ue-IdleTimersAndConstants      UE-IdleTimersAndConstants      OPTIONAL,
  -- Extension mechanism for non- release99 information
  nonCriticalExtensions          SEQUENCE {}                      OPTIONAL
}

SysInfoType2 ::= SEQUENCE {
  -- UTRAN mobility IEs
  ura-IdentityList              URA-IdentityList,
  -- Extension mechanism for non- release99 information
  nonCriticalExtensions          SEQUENCE {}                      OPTIONAL
}

SysInfoType3 ::= SEQUENCE {
  sib4indicator                  BOOLEAN,
  -- UTRAN mobility IEs
  cellIdentity                   CellIdentity,
  cellSelectReselectInfo         CellSelectReselectInfoSIB-3-4,
  cellAccessRestriction         CellAccessRestriction,
  -- Extension mechanism for non- release99 information
  nonCriticalExtensions          SEQUENCE {
    sysInfoType3-r3-r4-ext      SysInfoType3-r3-r4-ext-IEs,
    nonCriticalExtensions       SEQUENCE {}                      OPTIONAL
  }
}

```

```

SysInfoType3-r3-r4-ext-IEs ::= SEQUENCE {
    mapping-LCR                               Mapping-LCR-r4                               OPTIONAL
}

SysInfoType4 ::=
    -- UTRAN mobility IEs
    cellIdentity                               CellIdentity,
    cellSelectReselectInfo                     CellSelectReselectInfoSIB-3-4,
    cellAccessRestriction                     CellAccessRestriction,
    -- Extension mechanism for non- release99 information
    nonCriticalExtensions                      SEQUENCE {
        sysInfoType4-r3-r4-ext                SysInfoType4-r3-r4-ext-IEs,
        nonCriticalExtensions                  SEQUENCE {}
    }
    OPTIONAL

SysInfoType4-r3-r4-ext-IEs ::= SEQUENCE {
    mapping-LCR                               Mapping-LCR-r4                               OPTIONAL
}

SysInfoType5 ::=
    sib6indicator                             BOOLEAN,
    -- Physical channel IEs
    pich-PowerOffset                           PICH-PowerOffset,
    modeSpecificInfo                           CHOICE {
        fdd                                     SEQUENCE {
            aich-PowerOffset                    AICH-PowerOffset
        },
        tdd                                     SEQUENCE {
            -- If PDSCH/PUSCH is configured for 1.28Mcps TDD, the following IEs should be absent
            -- and the info included in the tdd128SpecificInfo instead.
            pusch-SysInfoList-SFN              PUSCH-SysInfoList-SFN                OPTIONAL,
            pdsch-SysInfoList-SFN              PDSCH-SysInfoList-SFN                OPTIONAL,
            openLoopPowerControl-TDD            OpenLoopPowerControl-TDD
        }
    },
    primaryCCPCH-Info                          PrimaryCCPCH-Info                        OPTIONAL,
    prach-SystemInformationList                 PRACH-SystemInformationList,
    sCCPCH-SystemInformationList                SCCPCH-SystemInformationList,
    cbs-DRX-Level1Information                   CBS-DRX-Level1Information                OPTIONAL,
    -- Conditional on any of the CTCH indicator IEs in
    -- sCCPCH-SystemInformationList
    -- Extension mechanism for non- release99 information
    nonCriticalExtensions                      SEQUENCE {
        sysInfoType5-r3-r4-ext                SysInfoType5-r3-r4-ext-IEs,
        -- Extension mechanism for non- rel-4 information
        nonCriticalExtensions                  SEQUENCE {}
    }
    OPTIONAL

SysInfoType5-r3-r4-ext-IEs ::= SEQUENCE {
    pNBSCH-Allocation-r4                       PNBSCH-Allocation-r4                    OPTIONAL,
    -- In case of TDD, the following IE is included instead of the
    -- IE up-IPDL-Parameter in up-OTDOA-AssistanceData.
    openLoopPowerControl-IPDL-TDD              OpenLoopPowerControl-IPDL-TDD-r4        OPTIONAL,
    -- If SysInfoType5 is sent to describe a 1.28Mcps TDD cell, the IE PRACH-RACH-Info included in
    -- PRACH-SystemInformationList shall be ignored, and the following IE shall describe
    -- the PRACH-RACH-Information.
    prach-RACH-Info-LCR                        PRACH-RACH-Info-LCR-r4                  OPTIONAL,
    -- If SysInfoType5 is sent to describe a 1.28Mcps TDD cell, the IE PRACH-Partitioning in
    -- PRACH-SystemInformationList shall be absent, and the following IE shall describe
    -- the PRACH-Partitioning.
    prach-Partitioning-LCR                     PRACH-Partitioning-LCR-r4                OPTIONAL,
    -- If SysInfoType5 is sent to describe a 1.28Mcps TDD cell, the IE rach-TransportFormatSet in
    -- PRACH-SystemInformationList shall be absent, and the following IE shall describe
    -- the rach-TransportFormatSet.
    rach-TransportFormatSet-LCR                TransportFormatSet-LCR                    OPTIONAL,
    tdd128SpecificInfo                          SEQUENCE {
        pusch-SysInfoList-SFN                  PUSCH-SysInfoList-SFN-LCR-r4            OPTIONAL,
        pdsch-SysInfoList-SFN                  PDSCH-SysInfoList-SFN-LCR-r4            OPTIONAL,
        pCCPCH-LCR-Extensions                  PrimaryCCPCH-Info-LCR-r4-ext            OPTIONAL,
        sCCPCH-LCR-ExtensionsList              SCCPCH-SystemInformationList-LCR-r4-ext
    }
    OPTIONAL
}

SysInfoType6 ::=
    -- Physical channel IEs
    pich-PowerOffset                           PICH-PowerOffset,

```

```

modeSpecificInfo          CHOICE {
  fdd                      SEQUENCE {
    aich-PowerOffset      AICH-PowerOffset,
    dummy                  CSICH-PowerOffset      OPTIONAL
    -- This parameter dummy is not to be sent in the current version of the specification.
  },
  tdd                      SEQUENCE {
-- If PDSCH/PUSCH is configured for 1.28Mcps TDD, the following IEs should be absent
-- and the info included in the tddl28SpecificInfo instead.
    pusch-SysInfoList-SFN  PUSCH-SysInfoList-SFN      OPTIONAL,
    pdsch-SysInfoList-SFN  PDSCH-SysInfoList-SFN      OPTIONAL,
    openLoopPowerControl-TDD OpenLoopPowerControl-TDD
  }
},
primaryCCPCH-Info        PrimaryCCPCH-Info          OPTIONAL,
prach-SystemInformationList PRACH-SystemInformationList  OPTIONAL,
sCCPCH-SystemInformationList SCCPCH-SystemInformationList  OPTIONAL,
cbs-DRX-Level1Information CBS-DRX-Level1Information  OPTIONAL,
-- Conditional on any of the CTCH indicator IEs in
-- sCCPCH-SystemInformationList
-- Extension mechanism for non- release99 information
nonCriticalExtensions    SEQUENCE {
  sysInfoType6-r3-r4-ext SysInfoType6-r3-r4-ext-IEs,
-- Extension mechanism for non- rel-4 information
  nonCriticalExtensions  SEQUENCE {}          OPTIONAL
}
}

SysInfoType6-r3-r4-ext-IEs ::= SEQUENCE {
-- This IE is present only if IPDLs are applied for TDD
  openLoopPowerControl-IPDL-TDD OpenLoopPowerControl-IPDL-TDD-r4  OPTIONAL,
-- If SysInfoType6 is sent to describe a 1.28Mcps TDD cell, the IE PRACH-RACH-Info included in
-- PRACH-SystemInformationList shall be ignored, and the following IE shall describe
-- the PRACH-RACH-Information.
  prach-RACH-Info-LCR          PRACH-RACH-Info-LCR-r4          OPTIONAL,
-- If SysInfoType6 is sent to describe a 1.28Mcps TDD cell, the IE PRACH-Partitioning in
-- PRACH-SystemInformationList shall be absent, and the following IE shall describe
-- the PRACH-Partitioning.
  prach-Partitioning-LCR      PRACH-Partitioning-LCR-r4      OPTIONAL,
-- If SysInfoType6 is sent to describe a 1.28Mcps TDD cell, the IE rach-TransportFormatSet in
-- PRACH-SystemInformationList shall be absent, and the following IE shall describe
-- the rach-TransportFormatSet.
  rach-TransportFormatSet-LCR  TransportFormatSet-LCR      OPTIONAL,
  tddl28SpecificInfo          SEQUENCE {
    pusch-SysInfoList-SFN      PUSCH-SysInfoList-SFN-LCR-r4  OPTIONAL,
    pdsch-SysInfoList-SFN      PDSCH-SysInfoList-SFN-LCR-r4  OPTIONAL,
    pCCPCH-LCR-Extensions      PrimaryCCPCH-Info-LCR-r4-ext  OPTIONAL,
    sCCPCH-LCR-ExtensionsList  SCCPCH-SystemInformationList-LCR-r4-ext  OPTIONAL
  }
}

SysInfoType7 ::= SEQUENCE {
-- Physical channel IEs
  modeSpecificInfo          CHOICE {
    fdd                      SEQUENCE {
      ul-Interference        UL-Interference
    },
    tdd                      NULL
  },
  prach-Information-SIB5-List DynamicPersistenceLevelList,
  prach-Information-SIB6-List DynamicPersistenceLevelList  OPTIONAL,
  expirationTimeFactor      ExpirationTimeFactor  OPTIONAL,
-- Extension mechanism for non- release99 information
  nonCriticalExtensions    SEQUENCE {}          OPTIONAL
}

SysInfoType8 ::= SEQUENCE {
-- User equipment IEs
  cpch-Parameters          CPCH-Parameters,
-- Physical channel IEs
  cpch-SetInfoList         CPCH-SetInfoList,
  csich-PowerOffset        CSICH-PowerOffset,
-- Extension mechanism for non- release99 information
  nonCriticalExtensions    SEQUENCE {}          OPTIONAL
}

SysInfoType9 ::= SEQUENCE {
-- Physical channel IEs

```

```

    cpch-PersistenceLevelsList      CPCH-PersistenceLevelsList,
-- Extension mechanism for non- release99 information
    nonCriticalExtensions           SEQUENCE {}                                OPTIONAL
}

SysInfoType10 ::=                   SEQUENCE {
-- User equipment IEs
    drac-SysInfoList               DRAC-SysInfoList,
-- Extension mechanism for non- release99 information
    nonCriticalExtensions           SEQUENCE {}                                OPTIONAL
}

SysInfoType11 ::=                   SEQUENCE {
    sib12indicator                 BOOLEAN,
-- Measurement IEs
    fach-MeasurementOccasionInfo    FACH-MeasurementOccasionInfo    OPTIONAL,
    measurementControlSysInfo       MeasurementControlSysInfo,
-- Extension mechanism for non- release99 information
    nonCriticalExtensions           SEQUENCE {
        sysInfoType11-r3-r4-ext     SysInfoType11-r3-r4-ext-IEs,
        nonCriticalExtensions       SEQUENCE {}                                OPTIONAL
    }
}

SysInfoType11-r3-r4-ext-IEs ::= SEQUENCE {
    fach-MeasurementOccasionInfo-LCR-Ext    FACH-MeasurementOccasionInfo-LCR-r4-ext    OPTIONAL,
    measurementControlSysInfo-LCR          MeasurementControlSysInfo-LCR-r4-ext
}

SysInfoType12 ::=                   SEQUENCE {
-- Measurement IEs
    fach-MeasurementOccasionInfo    FACH-MeasurementOccasionInfo    OPTIONAL,
    measurementControlSysInfo       MeasurementControlSysInfo,
-- Extension mechanism for non- release99 information
    nonCriticalExtensions           SEQUENCE {
        sysInfoType12-r3-r4-ext     SysInfoType12-r3-r4-ext-IEs,
        nonCriticalExtensions       SEQUENCE {}                                OPTIONAL
    }
}

SysInfoType12-r3-r4-ext-IEs ::= SEQUENCE {
    fach-MeasurementOccasionInfo-LCR-Ext    FACH-MeasurementOccasionInfo-LCR-r4-ext    OPTIONAL,
    measurementControlSysInfo-LCR          MeasurementControlSysInfo-LCR-r4-ext
}

SysInfoType13 ::=                   SEQUENCE {
-- Core network IEs
    cn-DomainSysInfoList           CN-DomainSysInfoList,
-- User equipment IEs
    ue-IdleTimersAndConstants       UE-IdleTimersAndConstants    OPTIONAL,
    capabilityUpdateRequirement      CapabilityUpdateRequirement    OPTIONAL,
-- Extension mechanism for non- release99 information
    nonCriticalExtensions           SEQUENCE {
        sysInfoType13-r3-r4-ext     SysInfoType13-r3-r4-ext-IEs,
        -- Extension mechanism for non- release99 information
        nonCriticalExtensions       SEQUENCE {}                                OPTIONAL
    }
}

SysInfoType13-r3-r4-ext-IEs ::= SEQUENCE {
    capabilityUpdateRequirement-r4Ext    CapabilityUpdateRequirement-r4-ext    OPTIONAL
}

SysInfoType13-1 ::=                 SEQUENCE {
-- ANSI-41 IEs
    ansi-41-RAND-Information         ANSI-41-RAND-Information,
-- Extension mechanism for non- release99 information
    nonCriticalExtensions           SEQUENCE {}                                OPTIONAL
}

SysInfoType13-2 ::=                 SEQUENCE {
-- ANSI-41 IEs
    ansi-41-UserZoneID-Information    ANSI-41-UserZoneID-Information,
-- Extension mechanism for non- release99 information
    nonCriticalExtensions           SEQUENCE {}                                OPTIONAL
}

SysInfoType13-3 ::=                 SEQUENCE {

```



```

-- ANSI-41 IEs
ansi-41-PrivateNeighbourListInfo ANSI-41-PrivateNeighbourListInfo,
-- Extension mechanism for non- release99 information
nonCriticalExtensions SEQUENCE {} OPTIONAL
}

SysInfoType13-4 ::= SEQUENCE {
-- ANSI-41 IEs
ansi-41-GlobalServiceRedirectInfo
ANSI-41-GlobalServiceRedirectInfo,
-- Extension mechanism for non- release99 information
nonCriticalExtensions SEQUENCE {} OPTIONAL
}

SysInfoType14 ::= SEQUENCE {
-- Physical channel IEs
individualTS-InterferenceList IndividualTS-InterferenceList,
expirationTimeFactor ExpirationTimeFactor OPTIONAL,
-- Extension mechanism for non- release99 information
nonCriticalExtensions SEQUENCE {} OPTIONAL
}

SysInfoType15 ::= SEQUENCE {
-- Measurement IEs

ue-positioning-GPS-CipherParameters UE-Positioning-CipherParameters OPTIONAL,
ue-positioning-GPS-ReferenceLocation ReferenceLocation,
ue-positioning-GPS-ReferenceTime UE-Positioning-GPS-ReferenceTime,

ue-positioning-GPS-Real-timeIntegrity BadSatList OPTIONAL,
-- Extension mechanism for non- release99 information
nonCriticalExtensions SEQUENCE {
sysInfoType15-r3-r4-ext SysInfoType15-r3-r4-ext-IEs,
-- Extension mechanism for non- release4 information
nonCriticalExtensions SEQUENCE {} OPTIONAL
} OPTIONAL
}

SysInfoType15-r3-r4-ext-IEs ::= SEQUENCE {
up-IPDL-Parameters-TDD UP-IPDL-Parameters-TDD-r4-ext OPTIONAL
}

SysInfoType15-1 ::= SEQUENCE {
-- DGPS corrections
ue-positioning-GPS-DGPS-Corrections UE-Positioning-GPS-DGPS-Corrections,

-- Extension mechanism for non- release99 information
nonCriticalExtensions SEQUENCE {} OPTIONAL
}

SysInfoType15-2 ::= SEQUENCE {
-- Ephemeris and clock corrections
transmissionTOW INTEGER (0..604799),
satID SatID,
ephemerisParameter EphemerisParameter,

-- Extension mechanism for non- release99 information
nonCriticalExtensions SEQUENCE {} OPTIONAL
}

SysInfoType15-3 ::= SEQUENCE {
-- Almanac and other data
transmissionTOW INTEGER (0.. 604799),
ue-positioning-GPS-Almanac UE-Positioning-GPS-Almanac
OPTIONAL,
ue-positioning-GPS-IonosphericModel UE-Positioning-GPS-IonosphericModel
OPTIONAL,
ue-positioning-GPS-UTC-Model UE-Positioning-GPS-UTC-Model
OPTIONAL,
satMask BIT STRING (SIZE (1..32)) OPTIONAL,
lsbTOW BIT STRING (SIZE (8)) OPTIONAL,
-- Extension mechanism for non- release99 information
nonCriticalExtensions SEQUENCE {} OPTIONAL
}

SysInfoType15-4 ::= SEQUENCE {
-- Measurement IEs
ue-positioning-OTDOA-CipherParameters UE-Positioning-CipherParameters OPTIONAL,

```

```

        ue-positioning-OTDOA-AssistanceData    UE-Positioning-OTDOA-AssistanceData,
-- Extension mechanism for non- release99 information
        nonCriticalExtensions                SEQUENCE {}                                OPTIONAL
}

SysInfoType16 ::=                               SEQUENCE {
-- Radio bearer IEs
    preDefinedRadioConfiguration            PreDefRadioConfiguration,
-- Extension mechanism for non- release99 information
        nonCriticalExtensions                SEQUENCE {}                                OPTIONAL
}

SysInfoType17 ::=                               SEQUENCE {
-- Physical channel IEs
-- If PDSCH/PUSCH is configured for 1.28Mcps TDD, the following IEs should be absent
-- and the info included in the tdd128SpecificInfo instead.
    pusch-SysInfoList                       PUSCH-SysInfoList                        OPTIONAL,
    pdsch-SysInfoList                       PDSCH-SysInfoList                        OPTIONAL,
-- Extension mechanism for non- release99 information
        nonCriticalExtensions                SEQUENCE {
            sysInfoType17-r3-r4-ext          SysInfoType17-r3-r4-ext-IEs,
            nonCriticalExtensions            SEQUENCE {}                                OPTIONAL
        }
}

SysInfoType17-r3-r4-ext-IEs ::= SEQUENCE {
    tdd128SpecificInfo                       SEQUENCE {
        pusch-SysInfoList                   PUSCH-SysInfoList-LCR-r4                OPTIONAL,
        pdsch-SysInfoList                   PDSCH-SysInfoList-LCR-r4                OPTIONAL
    }
}

SysInfoType18 ::=                               SEQUENCE {
    idleModePLMNIdentities                   PLMNIdentitiesOfNeighbourCells            OPTIONAL,
    connectedModePLMNIdentities              PLMNIdentitiesOfNeighbourCells            OPTIONAL,
-- Extension mechanism for non- release99 information
        nonCriticalExtensions                SEQUENCE {}                                OPTIONAL
}

SysInfoTypeSB1 ::=                             SEQUENCE {
-- Other IEs
    sib-ReferenceList                        SIB-ReferenceList,
-- Extension mechanism for non- release99 information
        nonCriticalExtensions                SEQUENCE {}                                OPTIONAL
}

SysInfoTypeSB2 ::=                             SEQUENCE {
-- Other IEs
    sib-ReferenceList                        SIB-ReferenceList,
-- Extension mechanism for non- release99 information
        nonCriticalExtensions                SEQUENCE {}                                OPTIONAL
}

TDD-UMTS-Frequency-List ::=                   SEQUENCE (SIZE (1..maxNumTDDFreqs)) OF
                                                FrequencyInfoTDD

-- *****
--
-- ANSI-41 INFORMATION ELEMENTS (10.3.9)
--
-- *****

ANSI-41-GlobalServiceRedirectInfo ::=         ANSI-41-NAS-Parameter
ANSI-41-PrivateNeighbourListInfo ::=         ANSI-41-NAS-Parameter
ANSI-41-RAND-Information ::=                 ANSI-41-NAS-Parameter
ANSI-41-UserZoneID-Information ::=           ANSI-41-NAS-Parameter
ANSI-41-NAS-Parameter ::=                   BIT STRING (SIZE (1..2048))

Min-P-REV ::=                                 BIT STRING (SIZE (8))

NAS-SystemInformationANSI-41 ::=             ANSI-41-NAS-Parameter
NID ::=                                      BIT STRING (SIZE (16))

P-REV ::=                                    BIT STRING (SIZE (8))

SID ::=                                       BIT STRING (SIZE (15))

END

```

11.4 Constant definitions

Constant-definitions DEFINITIONS AUTOMATIC TAGS ::=

BEGIN

```

hipDSCHidentities          INTEGER ::= 64
hiPUSCHidentities          INTEGER ::= 64
hiRM                        INTEGER ::= 256
maxAC                       INTEGER ::= 16
maxAdditionalMeas           INTEGER ::= 4
maxASC                      INTEGER ::= 8
maxASCmap                   INTEGER ::= 7
maxASCpersist              INTEGER ::= 6
maxCCTrCH                  INTEGER ::= 8
maxCellMeas                INTEGER ::= 32
maxCellMeas-1              INTEGER ::= 31
maxCNDomains               INTEGER ::= 4
maxCPCHsets                INTEGER ::= 16
maxDPCH-DLchan             INTEGER ::= 8
maxDPCHcodesPerTS         INTEGER ::= 16
-- **TODO**
maxDPDCH-UL                INTEGER ::= 6
maxDRACclasses             INTEGER ::= 8
-- **TODO**
maxFACHPCH                 INTEGER ::= 8
maxFreq                    INTEGER ::= 8
maxFreqBandsFDD            INTEGER ::= 8
maxFreqBandsTDD           INTEGER ::= 4
maxFreqBandsGSM           INTEGER ::= 16
maxInterSysMessages        INTEGER ::= 4
maxLoCHperRLC              INTEGER ::= 2
maxMeasEvent               INTEGER ::= 8
maxMeasIntervals           INTEGER ::= 3
maxMeasParEvent            INTEGER ::= 2
maxNumCDMA2000Freqs        INTEGER ::= 8
maxNumGSMFreqRanges        INTEGER ::= 32
maxNumFDDFreqs             INTEGER ::= 8
maxNumTDDFreqs             INTEGER ::= 8
maxNoOfMeas                INTEGER ::= 16
maxOtherRAT                INTEGER ::= 15
maxPagel                   INTEGER ::= 8
maxPCPCH-APsig             INTEGER ::= 16
maxPCPCH-APsubCh           INTEGER ::= 12
maxPCPCH-CDsig             INTEGER ::= 16
maxPCPCH-CDSUBch           INTEGER ::= 12
maxPCPCH-SF                INTEGER ::= 7
maxPCPCHs                  INTEGER ::= 64
maxPDCPAlgoType            INTEGER ::= 8
maxPDSCH                   INTEGER ::= 8
maxPDSCH-TFCIgroups        INTEGER ::= 256
maxPRACH                   INTEGER ::= 16
maxPRACH-FPACH             INTEGER ::= 8
maxPredefConfig            INTEGER ::= 16
maxPUSCH                   INTEGER ::= 8
maxRABsetup                INTEGER ::= 16
maxRAT                     INTEGER ::= 16
maxRB                       INTEGER ::= 32
maxRBallRABs               INTEGER ::= 27
maxRBMuxOptions            INTEGER ::= 8
maxRBperRAB                INTEGER ::= 8
maxReportedGSMCells        INTEGER ::= 6
maxRL                       INTEGER ::= 8
maxRL-1                    INTEGER ::= 7
maxROHC-PacketSizes-r4     INTEGER ::= 16
maxROHC-Profile-r4         INTEGER ::= 8
maxSat                      INTEGER ::= 16
maxSCCPCH                  INTEGER ::= 16
maxSIB                     INTEGER ::= 32
-- **TODO**
maxSIB-FACH                INTEGER ::= 8
maxSIBperMsg               INTEGER ::= 16
maxSig                      INTEGER ::= 16
maxSRBsetup                INTEGER ::= 8
maxSubCh                   INTEGER ::= 12
maxSystemCapability         INTEGER ::= 16
maxTF                       INTEGER ::= 32

```

```

maxTF-CPCH          INTEGER ::= 16
maxTFC              INTEGER ::= 1024
maxTFCI-2-Combs    INTEGER ::= 512
maxTGPS            INTEGER ::= 6
maxTrCH            INTEGER ::= 32
maxTrCHpreconf     INTEGER ::= 16
maxTS              INTEGER ::= 14
maxTS-1            INTEGER ::= 13
maxTS-LCR          INTEGER ::= 6
maxTS-LCR-1       INTEGER ::= 5
maxURA            INTEGER ::= 8

```

END

11.5 RRC information between network nodes

Internode-definitions DEFINITIONS AUTOMATIC TAGS ::=

BEGIN

IMPORTS

```

    HandoverToUTRANCommand,
    MeasurementReport,
    PhysicalChannelReconfiguration,
    RadioBearerReconfiguration,
    RadioBearerRelease,
    RadioBearerSetup,
    TransportChannelReconfiguration,
    UECapabilityInformation

```

FROM PDU-definitions

```

-- Core Network IEs :
    CN-DomainIdentity,
    CN-DomainInformationList,
    NAS-SystemInformationGSM-MAP,
-- UTRAN Mobility IEs :
    CellIdentity,
    URA-Identity,
-- User Equipment IEs :
    C-RNTI,
    FailureCauseWithProtErr,
    RRC-MessageSequenceNumber,
    STARTList,
    U-RNTI,
    UE-RadioAccessCapability,
-- Radio Bearer IEs :
    PDCP-InfoReconfig,
    PredefinedConfigValueTag,
    RAB-InformationSetupList,
    RB-Identity,
    RB-MappingInfo,
    RLC-Info,
    SRB-InformationSetupList,
-- Transport Channel IEs :
    CPCH-SetID,
    DL-CommonTransChInfo,
    DL-AddReconfTransChInfoList,
    DRAC-StaticInformationList,
    UL-CommonTransChInfo,
    UL-AddReconfTransChInfoList,
-- Measurement IEs :
    MeasurementIdentity,
    MeasurementReportingMode,
    MeasurementType,
    MeasurementType-r4,
    AdditionalMeasurementID-List,
    PositionEstimate,
    UP-IPDL-Parameters-TDD-r4-ext,
-- Other IEs :
InterRAT-UE-RadioAccessCapabilityList
FROM InformationElements

    maxCNdomains,
    maxNoOfMeas,
    maxPredefConfig,
    maxRABsetup,

```

```

    maxRB,
    maxSRBsetup,
    maxTrCH
FROM Constant-definitions;

-- Part 1: Class definitions similar to what has been defined in 11.1 for RRC messages
-- Information that is transferred in the same direction and across the same path is grouped
-- *****
--
-- RRC information, to target RNC
--
-- *****
-- RRC Information to target RNC sent either from source RNC or from another RAT

ToTargetRNC-Container ::= CHOICE {
    handoverToUTRAN          HandoverToUTRANInfo-r3,
    srncRelocation          SRNC-RelocationInfo-r3,
    extension                NULL
}

-- *****
--
-- RRC information, target RNC to source RNC
--
-- *****

Target-RNC-ToSourceRNC-Container ::= CHOICE {
    radioBearerSetup        RadioBearerSetup,
    radioBearerReconfiguration RadioBearerReconfiguration,
    radioBearerRelease      RadioBearerRelease,
    transportChannelReconfiguration TransportChannelReconfiguration,
    physicalChannelReconfiguration PhysicalChannelReconfiguration,
    rrc-InformationContainerFailureInfo RRC-InformationContainerFailureInfo-r3,
    extension                NULL
}

-- *****
--
-- RRC information, target RNC to source RAT
--
-- *****

TargetRNC-ToSourceRAT-Container ::= CHOICE {
    handoverToUTRAN          HandoverToUTRANCommand,
    rrc-InformationContainerFailureInfo RRC-InformationContainerFailureInfo-r3,
    extension                NULL
}

-- Part 2: Container definitions, similar to the PDU definitions in 11.2 for RRC messages
-- In alphabetical order
-- *****
--
-- Handover to UTRAN information
--
-- *****

HandoverToUTRANInfo-r3 ::= CHOICE {
    r3                      SEQUENCE {
        handoverToUTRANInfo-r3          HandoverToUTRANInfo-r3-IEs,
        nonCriticalExtensions            SEQUENCE {} OPTIONAL
    },
    criticalExtensions                SEQUENCE {}
}

HandoverToUTRANInfo-r3-IEs ::= SEQUENCE {
    -- User equipment IEs
    ue-RadioAccessCapability          UE-RadioAccessCapability          OPTIONAL,
    startList                          STARTList                          OPTIONAL,
    -- Other IEs
    ue-RATSpecificCapability          InterRAT-UE-RadioAccessCapabilityList OPTIONAL,
    predefinedConfigStatusList        PredefinedConfigStatusList    OPTIONAL
}

-- *****

```

```

--
-- RRC information container failure info
--
-- *****
RRC-InformationContainerFailureInfo-r3 ::= CHOICE {
    r3
        rRC-InformationContainerFailureInfo-r3      SEQUENCE {
            nonCriticalExtensions                    RRC-InformationContainerFailureInfo-r3-IEs,
                                                    SEQUENCE {} OPTIONAL
        },
        criticalExtensions                          SEQUENCE {}
    }
}

RRC-InformationContainerFailureInfo-r3-IEs ::= SEQUENCE {
    -- Non-RRC IEs
    failureCauseWithProtErr                        FailureCauseWithProtErr
}

-- *****
--
-- SRNC Relocation information
--
-- *****

SRNC-RelocationInfo-r3 ::= CHOICE {
    r3
        sRNC-RelocationInfo-r3                    SRNC-RelocationInfo-r3-IEs,
            nonCriticalExtensions                    SEQUENCE {} OPTIONAL
        },
        criticalExtensions                          SEQUENCE {}
    }
}

SRNC-RelocationInfo-r3-IEs ::= SEQUENCE {
    -- Non-RRC IEs
    stateOfRRC                                    StateOfRRC,
    stateOfRRC-Procedure                          StateOfRRC-Procedure,
    cipheringStatus                               CipheringStatus,
    calculationTimeForCiphering                   CalculationTimeForCiphering      OPTIONAL,
    cipheringInfoPerRB-List                       CipheringInfoPerRB-List         OPTIONAL,
    count-C-List                                  COUNT-C-List                    OPTIONAL,
    integrityProtectionStatus                     IntegrityProtectionStatus,
    srb-SpecificIntegrityProtInfo                 SRB-SpecificIntegrityProtInfoList,
    implementationSpecificParams                  ImplementationSpecificParams    OPTIONAL,
    -- User equipment IEs
    u-RNTI                                         U-RNTI,
    c-RNTI                                         C-RNTI                          OPTIONAL,
    ue-RadioAccessCapability                     UE-RadioAccessCapability,
    ue-Positioning-LastKnownPos                  UE-Positioning-LastKnownPos     OPTIONAL,
    -- Other IEs
    ue-RATSpecificCapability                     InterRAT-UE-RadioAccessCapabilityList  OPTIONAL,
    -- UTRAN mobility IEs
    ura-Identity                                  URA-Identity                    OPTIONAL,
    -- Core network IEs
    cn-CommonGSM-MAP-NAS-SysInfo                 NAS-SystemInformationGSM-MAP,
    cn-DomainInformationList                       CN-DomainInformationList        OPTIONAL,
    -- Measurement IEs
    ongoingMeasRepList                            OngoingMeasRepList             OPTIONAL,
    -- Radio bearer IEs
    predefinedConfigStatusList                   PredefinedConfigStatusList,
    srb-InformationList                           SRB-InformationSetupList,
    rab-InformationList                           RAB-InformationSetupList        OPTIONAL,
    -- Transport channel IEs
    ul-CommonTransChInfo                         UL-CommonTransChInfo           OPTIONAL,
    ul-TransChInfoList                           UL-AddReconfTransChInfoList    OPTIONAL,
    modeSpecificInfo                              CHOICE {
        fdd
            cpch-SetID                             CPCH-SetID                     OPTIONAL,
            transChDRAC-Info                       DRAC-StaticInformationList     OPTIONAL
        },
        tdd
            NULL
    },
    dl-CommonTransChInfo                         DL-CommonTransChInfo           OPTIONAL,
    dl-TransChInfoList                           DL-AddReconfTransChInfoList    OPTIONAL,
    -- Measurement report
    measurementReport                             MeasurementReport               OPTIONAL,
    nonCriticalExtensions                         SEQUENCE {
        -- In case of TDD only this IE is present otherwise this IE is absent
        up-IpdL-Parameters-TDD                     UP-IPDL-Parameters-TDD-r4-ext  OPTIONAL,
    }
}

```

```

-- Extension mechanism for non- release4 information
    nonCriticalExtensions      SEQUENCE {}          OPTIONAL
  }
}

SRNC-RelocationInfo-r4 ::=          SEQUENCE {
  -- Non-RRC IEs
  stateOfRRC                    StateOfRRC,
  stateOfRRC-Procedure          StateOfRRC-Procedure,
  cipheringStatus              CipheringStatus,
  calculationTimeForCiphering  CalculationTimeForCiphering  OPTIONAL,
  cipheringInfoPerRB-List      CipheringInfoPerRB-List      OPTIONAL,
  integrityProtectionStatus    IntegrityProtectionStatus,
  srb-SpecificIntegrityProtInfo SRB-SpecificIntegrityProtInfoList,
  implementationSpecificParams ImplementationSpecificParams  OPTIONAL,
  -- User equipment IEs
  u-RNTI                        U-RNTI,
  c-RNTI                        C-RNTI                    OPTIONAL,
  ue-RadioAccessCapability     UE-RadioAccessCapability,
  ue-Positioning-LastKnownPos  UE-Positioning-LastKnownPos  OPTIONAL,
  -- Other IEs
  ue-RATSpecificCapability     InterRAT-UE-RadioAccessCapabilityList  OPTIONAL,
  -- UTRAN mobility IEs
  ura-Identity                 URA-Identity                    OPTIONAL,
  -- Core network IEs
  cn-CommonGSM-MAP-NAS-SysInfo NAS-SystemInformationGSM-MAP,
  cn-DomainInformationList     CN-DomainInformationList      OPTIONAL,
  -- Measurement IEs
  ongoingMeasRepList          OngoingMeasRepList-r4        OPTIONAL,
  -- Radio bearer IEs
  predefinedConfigStatusList   PredefinedConfigStatusList,
  srb-InformationList         SRB-InformationSetupList,
  rab-InformationList         RAB-InformationSetupList      OPTIONAL,
  -- Transport channel IEs
  ul-CommonTransChInfo        UL-CommonTransChInfo          OPTIONAL,
  ul-TransChInfoList          UL-AddReconfTransChInfoList  OPTIONAL,
  modeSpecificInfo            CHOICE {
    fdd                        SEQUENCE {
      cpch-SetID              CPCH-SetID                    OPTIONAL,
      transChDRAC-Info        DRAC-StaticInformationList  OPTIONAL
    },
    tdd                        NULL
  },
  dl-CommonTransChInfo        DL-CommonTransChInfo          OPTIONAL,
  dl-TransChInfoList          DL-AddReconfTransChInfoList  OPTIONAL,
  -- Measurement report
  measurementReport           MeasurementReport                OPTIONAL,
  nonCriticalExtensions        SEQUENCE {
    -- In case of TDD only this IE is present otherwise this IE is absent
    up-IpdL-Parameters-TDD    UP-IPDL-Parameters-TDD-r4-ext  OPTIONAL,
    -- Extension mechanism for non- release4 information
    nonCriticalExtensions      SEQUENCE {}          OPTIONAL
  }
}

-- IE definitions

CalculationTimeForCiphering ::=          SEQUENCE {
  cell-Id                     CellIdentity,
  sfn                          INTEGER (0..4095)
}

CipheringInfoPerRB ::=          SEQUENCE {
  dl-HFN                       BIT STRING (SIZE (20..25)),
  ul-HFN                       BIT STRING (SIZE (20..25))
}

-- TABULAR: Multiplicity value numberOfRadioBearers has been replaced
-- with maxRB.
CipheringInfoPerRB-List ::=          SEQUENCE (SIZE (1..maxRB)) OF
  CipheringInfoPerRB

CipheringStatus ::=          ENUMERATED {
  started, notStarted }

COUNT-C-List ::=          SEQUENCE (SIZE (1..maxCNdomains)) OF
  COUNT-CSingle

```

```

COUNT-CSingle ::=
    cn-DomainIdentity
    count-C
}
SEQUENCE {
    CN-DomainIdentity,
    BIT STRING (SIZE (32))
}

ImplementationSpecificParams ::= BIT STRING (SIZE (1..512))

IntegrityProtectionStatus ::= ENUMERATED {
    started, notStarted }

MeasurementCommandWithType ::= CHOICE {
    setup MeasurementType,
    modify NULL,
    release NULL
}

MeasurementCommandWithType-r4 ::= CHOICE {
    setup MeasurementType-r4,
    modify NULL,
    release NULL
}

OngoingMeasRep ::= SEQUENCE {
    measurementIdentity MeasurementIdentity,
    measurementCommandWithType MeasurementCommandWithType,
    -- TABULAR: The CHOICE Measurement in the tabular description is included
    -- in the IE above.
    measurementReportingMode MeasurementReportingMode OPTIONAL,
    additionalMeasurementID-List AdditionalMeasurementID-List OPTIONAL
}

OngoingMeasRep-r4 ::= SEQUENCE {
    measurementIdentity MeasurementIdentity,
    measurementCommandWithType-r4 MeasurementCommandWithType-r4,
    -- TABULAR: The CHOICE Measurement in the tabular description is included
    -- in the IE above.
    measurementReportingMode MeasurementReportingMode OPTIONAL,
    additionalMeasurementID-List AdditionalMeasurementID-List OPTIONAL
}

OngoingMeasRepList ::= SEQUENCE (SIZE (1..maxNoOfMeas)) OF
    OngoingMeasRep

OngoingMeasRepList-r4 ::= SEQUENCE (SIZE (1..maxNoOfMeas)) OF
    OngoingMeasRep-r4

PredefinedConfigStatusList ::= SEQUENCE (SIZE (16)) OF
    PredefinedConfigStatusInfo

PredefinedConfigStatusInfo ::= SEQUENCE {
    predefinedConfigValueTag PredefinedConfigValueTag OPTIONAL
    -- Absence of the IE indicates that the UE has not stored the corresponding preconfiguration
}

SRB-SpecificIntegrityProtInfo ::= SEQUENCE {
    ul-RRC-HFN BIT STRING (SIZE (28)),
    dl-RRC-HFN BIT STRING (SIZE (28)),
    ul-RRC-SequenceNumber RRC-MessageSequenceNumber,
    dl-RRC-SequenceNumber RRC-MessageSequenceNumber
}

SRB-SpecificIntegrityProtInfoList ::= SEQUENCE (SIZE (4..maxSRBsetup)) OF
    SRB-SpecificIntegrityProtInfo

StateOfRRC ::= ENUMERATED {
    cell-DCH, cell-FACH,
    cell-PCH, ura-PCH }

StateOfRRC-Procedure ::= ENUMERATED {
    awaitNoRRC-Message,
    awaitRRC-ConnectionRe-establishmentComplete,
    awaitRB-SetupComplete,
    awaitRB-ReconfigurationComplete,
    awaitTransportCH-ReconfigurationComplete,
    awaitPhysicalCH-ReconfigurationComplete,
    awaitActiveSetUpdateComplete,
    awaitHandoverComplete,
}

```



```

        sendCellUpdateConfirm,
        sendUraUpdateConfirm,
        sendRrcConnectionReestablishment,
        otherStates
    }
UE-Positioning-LastKnownPos ::= SEQUENCE {
    sfn                INTEGER (0..4095),
    cell-id            CellIdentity,
    positionEstimate   PositionEstimate
}
END

```

11.6 RRC information between UE and other RATs

```

UEtoOtherRAT-definitions DEFINITIONS AUTOMATIC TAGS ::=
BEGIN

IMPORTS

-- User Equipment IEs :
    START-Value,
    UE-RadioAccessCapability,
    UE-RadioAccessCapability-v370ext,
-- Radio Bearer IEs :
    PredefinedConfigValueTag
FROM InformationElements

    maxPredefConfig
FROM Constant-definitions;

-- Part 1: Class definitions similar to what has been defined in 11.1 for RRC messages
-- Information that is tranferred in the same direction and across the same path is grouped
-- *****
--
-- RRC information, to target RNC
--
-- *****
-- RRC Information to target RNC sent either from source RNC or from another RAT

-- Currently not used

-- *****
--
-- RRC information, target RNC to source RNC
--
-- *****

-- Currently not used

-- *****
--
-- RRC information, target RNC to source RAT
--
-- *****

-- Currently not used

-- Part 2: Container definitions, similar to the PDU definitions in 11.2 for RRC messages
-- In alphabetical order

-- Currently not used

-- Part 3: Non- extensible IE definitions
-- In alphabetical order

PredefConfigStatusInfo ::= SEQUENCE {
    predefinedConfigValueTag   PredefinedConfigValueTag
}

PredefConfigStatusInfoList ::= SEQUENCE (SIZE (maxPredefConfig)) OF
    PredefConfigStatusInfo

```

```
UE-CapabilityInformation ::=          SEQUENCE {
  ue-RadioAccessCapability           UE-RadioAccessCapability,
  ue-RadioAccessCapabilityExt1      UE-RadioAccessCapability-v370ext
}

UE-SecurityInformation ::=          SEQUENCE {
  start-CS                           START-Value
}

END
```

12 Message transfer syntax

Transfer syntax for RRC PDUs is derived from their ASN.1 definitions by use of Packed Encoding Rules, unaligned as specified in X.691 [49], and with adapted final padding. If special encoding is used, it is indicated in the ECN module defined for each ASN.1 module. The use of special encoding is defined in [14].

12.1 Structure of encoded RRC messages

An RRC PDU, which is the bit string that is exchanged between peer entities/ across the radio interface, is the concatenation of a basic production, an extension and padding, in that order.

RRC PDUs shall be mapped to and from RLC SDUs upon transmission and reception as follows:

- when delivering an RRC PDU as an RLC SDU to the RLC layer for transmission, the first bit of the RRC PDU shall be represented as the first bit in the RLC SDU and onwards; and
- upon reception of an RLC SDU from the RLC layer, the first bit of the RLC SDU shall represent the first bit of the RRC PDU and onwards.

12.1.1 Basic production

The 'basic production' is obtained by applying UNALIGNED PER to the abstract syntax value (the ASN.1 description) as specified in X.691, except for the 0 to 7 bits added at the end to produce a multiple of 8 bits. The basic production can have any positive number of bits, not necessarily a multiple of 8 bits.

12.1.2 Extension

Emitters compliant with this version of the specification of the protocol shall, unless indicated otherwise on a PDU type basis, set the extension part empty. Emitters compliant with a later version might send non-empty extensions.

12.1.3 Padding

Emitters compliant with this version of the specification of the protocol shall, unless indicated otherwise on a PDU type basis, pad the basic production with the smallest number of bits required to meet the size constraints of the lower layers. Padding bits shall be set to 0.

Receivers compliant with this version of the specification have no need to distinguish the extension and padding parts, and shall, unless indicated otherwise on a PDU type basis, accept RRC PDUs with any bit string in the extension and padding parts.

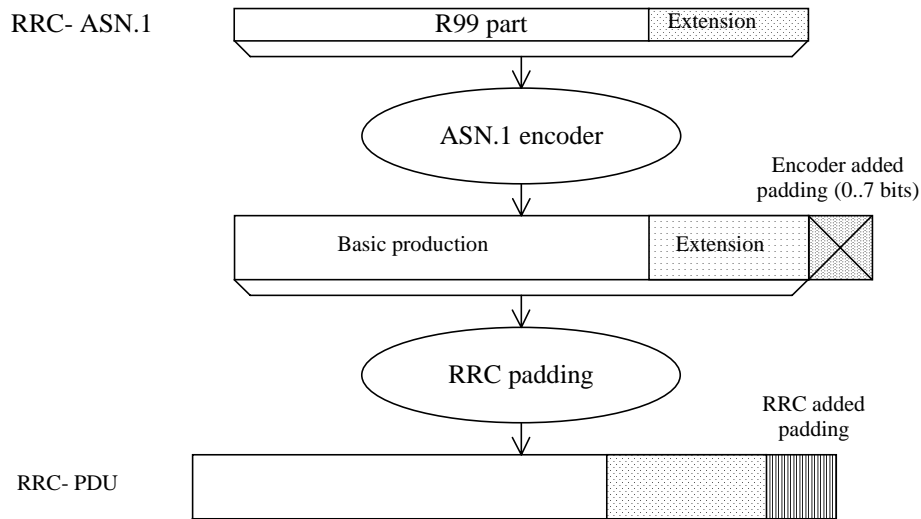

Figure 61: Padding

When using AM or UM mode, RLC requires that the RRC PDU length is a multiple of 8 bits.

When using Tr mode, RLC does neither impose size requirements nor perform padding. This implies that RRC has to take into account the transport format set defined for the transport channel across which the message is to be sent. RRC shall select the smallest transport format that fits the RRC PDU and shall add the lowest number of padding bits required to fit the size specified for the selected transport format.

For system information blocks, building the PDU involves two steps. The first step is the building of the SIBs, in which step padding is not applied (the rules for extension apply). The second step is the building of the RRC PDUs, involving segmentation and concatenation of SIBs, and then padding as described above for Tr mode. The procedure is shown by means of an example as described in Figure 62. The example includes two SIBs, SIBn and SIBn+1, of which only SIBn includes a protocol extension. The two SIBs used in the example don't require segmentation and are concatenated into one SYSTEM INFORMATION message.

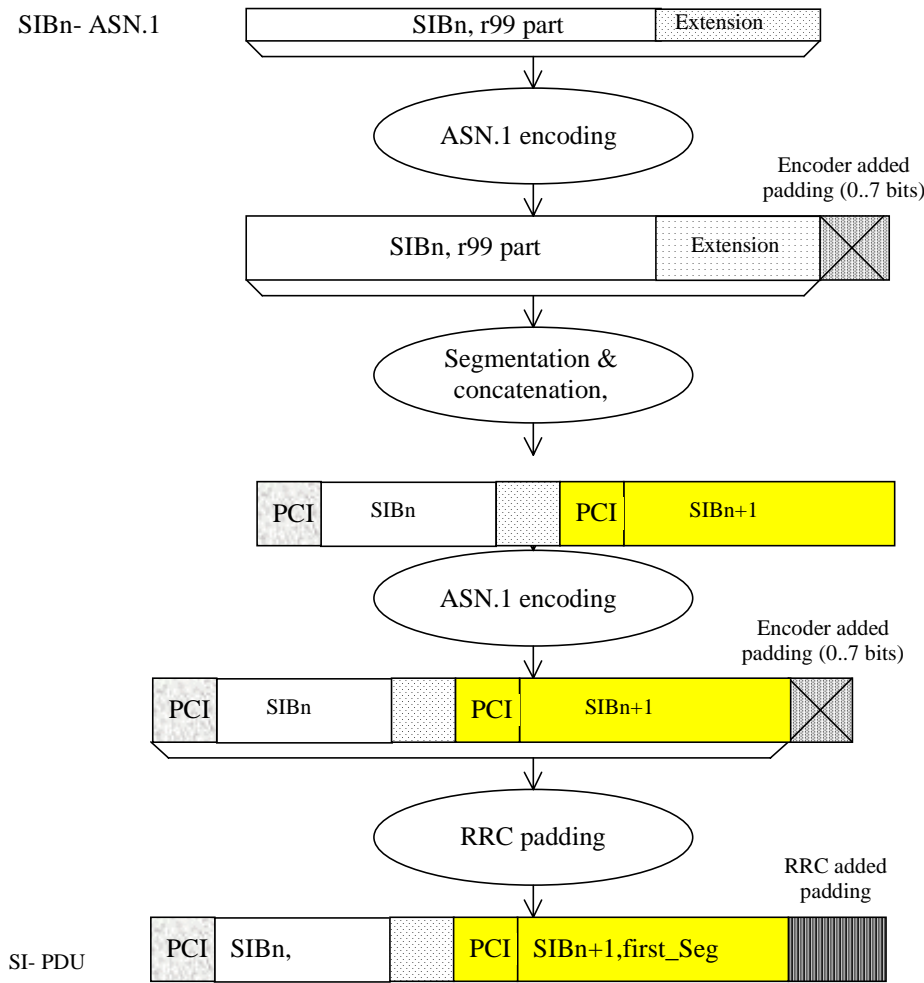

Figure 62: Padding for System Information

PCI: Protocol control information at SYSTEM INFORMATION message level

SI: SYSTEM INFORMATION message

For system information blocks, RRC may also add padding information at the end of IE "SIB data fixed", used both within IE "Last segment" and IE "Complete SIB". The IE "SIB data fixed" has a fixed length i.e. no length denominator used. In case the remaining amount of "SIB data" information is insufficient to fill the IE completely, RRC includes padding bits.

Since no length denominator is included, the receiving RRC cannot remove the padding added by the sender. However, since the padding used is the same as the padding added by the PER encoder to achieve octet alignment, the receiver can handle it.

NOTE 1 The mechanism described above implies that the PDU provided to the ASN.1 decoder may have more than 7 padding bits included. For a complete SIB of length 215 bits, 11 padding bits are added by RRC. Since the decoder requires an octet aligned input, 6 additional bits need to be added. In this (worst) case, a total of 17 padding bits is included.

NOTE 2 For the above cases, use of padding bits is possible and more efficient than including a length denominator.

When using the RRC padding described above, the segment has a fixed length, which completely fills the transport block. Therefore, in this case no RRC padding is added within the SYSTEM INFORMATION message. This is illustrated by means of the following figure.

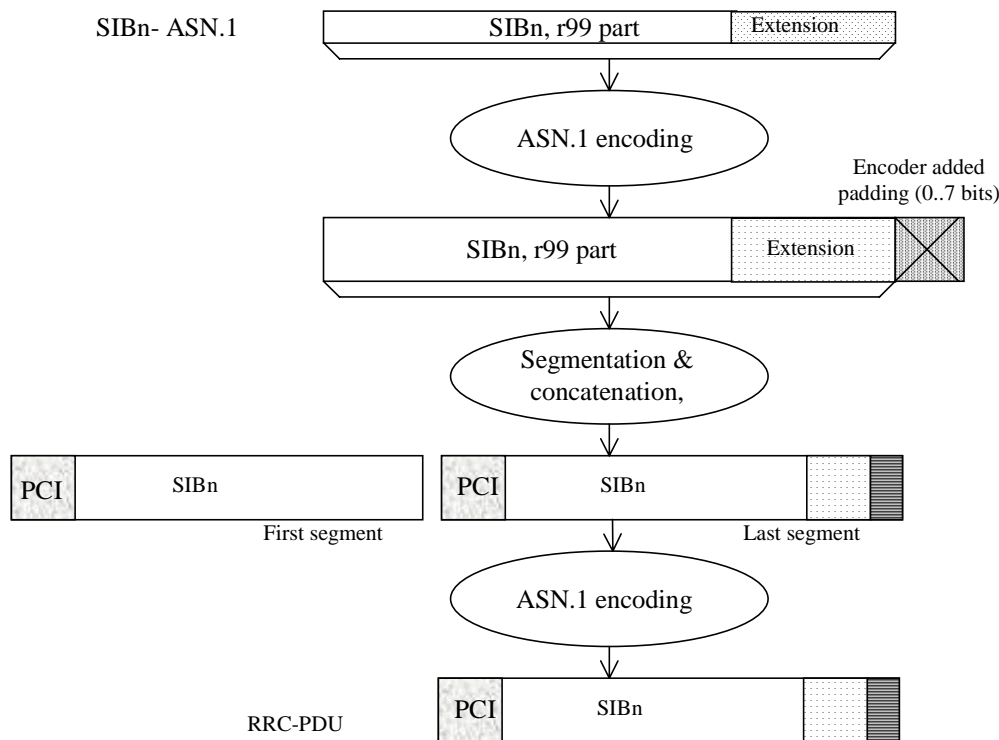

Figure 62a: No RRC padding for System Information

12.2 ECN link module for RRC

```

RRC-ECN-Link-Module LINK-DEFINITIONS ::=
BEGIN

IMPORTS
    RRC-encodings          -- Encoding objects for RRC messages
FROM RRC-Encoding-Definitions;

ENCODE Class-definitions
    WITH RRC-encodings
    COMPLETED BY PER-BASIC-UNALIGNED

ENCODE PDU-definitions
    WITH RRC-encodings
    COMPLETED BY PER-BASIC-UNALIGNED

ENCODE InformationElements
    WITH RRC-encodings
    COMPLETED BY PER-BASIC-UNALIGNED

ENCODE Internode-definitions
    WITH RRC-encodings
    COMPLETED BY PER-BASIC-UNALIGNED

END

```

12.3 ECN modules for RRC

The encoding definition module "RRC-Encoding-Definitions" contains definition of the encoding object set "RRC-encodings". The encoding object set contains all the specialized encoding for RRC.

```

RRC-Encoding-Definitions ENCODING-DEFINITIONS ::=
BEGIN
EXPORTS
  RRC-encodings;
RRC-encodings #ENCODINGS ::= {
  -- Trailing bits
  outer-encoding
}
--*****
--
-- The trailing bits in all RRC messages shall be ignored
-- (including unknown message contents & unknown extensions).
-- This overrides the default PER behaviour which pads the last
-- octet with zero bits.
--
--*****

outer-encoding #OUTER ::= {
  ENCODER-DECODER {
  }
  DECODE AS IF {
    POST-PADDING    encoder-option
  }
}

END

Class-definitions-ECN-Module ENCODING-DEFINITIONS ::=
BEGIN
END

PDU-definitions-ECN-Module ENCODING-DEFINITIONS ::=
BEGIN
END

InformationElements-ECN-Module ENCODING-DEFINITIONS ::=
BEGIN
END

Internode-definitions-ECN-Module ENCODING-DEFINITIONS ::=
BEGIN
END

```

13 Protocol timers, counters, other parameters and default configurations

The information provided in subclauses 13.1 and 13.2 shall be treated as informative. The normative text is specified in the relevant subclauses in clause 8 and clause 8 shall prevail.

13.1 Timers for UE

| Timer | Start | Stop | At expiry |
|-------|---|--|---|
| T300 | Transmission of RRC CONNECTION REQUEST | Reception of RRC CONNECTION SETUP | Retransmit RRC CONNECTION REQUEST if $V300 \leq N300$, else go to Idle mode |
| T302 | Transmission of CELL UPDATE/URA UPDATE | Reception of CELL UPDATE CONFIRM/URA UPDATE CONFIRM | Retransmit CELL UPDATE/URA UPDATE if $V302 \leq N302$, else, go to Idle mode |
| T304 | Transmission of UE CAPABILITY INFORMATION | Reception of UE CAPABILITY INFORMATION CONFIRM | Retransmit UE CAPABILITY INFORMATION if $V304 \leq N304$, else initiate a cell update procedure |
| T305 | Entering CELL_FACH or URA_PCH or CELL_PCH state. Reception of CELL UPDATE CONFIRM/URA UPDATE CONFIRM. | Entering another state. | Transmit CELL UPDATE if T307 is not activated and the UE detects "in service area". Otherwise, if T307 is not active, start T307. |
| T307 | When the timer T305 has expired and the UE detects "out of service area". | When the UE detects "in service area". | Transit to idle mode |
| T308 | Transmission of RRC CONNECTION RELEASE COMPLETE | Not stopped | Transmit RRC CONNECTION RELEASE COMPLETE if $V308 \leq N308$, else go to idle mode. |
| T309 | Upon reselection of a cell belonging to another radio access system from connected mode, or reception of CELL CHANGE ORDER FROM UTRAN message | Successful establishment of a connection in the new cell | Resume the connection to UTRAN |
| T310 | Transmission of PUSCH CAPACITY REQUEST | Reception of PHYSICAL SHARED CHANNEL ALLOCATION | Transmit PUSCH CAPACITY REQUEST if $V310 \leq N310$, else procedure stops. |
| T311 | Reception of PHYSICAL SHARED CHANNEL ALLOCATION message with the CHOICE "PUSCH allocation" set to "PUSCH allocation pending". | Reception of PHYSICAL SHARED CHANNEL ALLOCATION message with CHOICE "PUSCH allocation" set to "PUSCH allocation assignment". | UE may initiate a PUSCH capacity request procedure. |
| T312 | When the UE starts to establish dedicated CH | When the UE detects consecutive $N312$ "in sync" indication from L1. | The criteria for physical channel establishment failure is fulfilled |
| T313 | When the UE detects consecutive $N313$ "out of sync" indication from L1. | When the UE detects consecutive $N315$ "in sync" indication from L1. | The criteria for Radio Link failure is fulfilled |
| T314 | When the criteria for radio link failure are fulfilled. The timer is started only if radio bearer(s) that are associated with T314 exist. | When the Cell Update procedure has been completed. | See subclause 8.3.1.13 |

| Timer | Start | Stop | At expiry |
|-------|--|--|--|
| T315 | When the criteria for radio link failure are fulfilled. The timer is started only if radio bearer(s) that are associated with T315 exist. | When the Cell Update procedure has been completed. | See subclause 8.3.1.14 |
| T316 | When the UE detects "out of service area" in URA_PCH or CELL_PCH state | When the UE detects "in service area". | Initiate cell update procedure if in service area is detected. Otherwise start timer T317, transit to CELL_FACH state and initiate cell update procedure when the UE detects "in service area". |
| T317 | When the T316 expires or when in CELL_FACH state, the UE detects "out of service area". | When the UE detects "in service area". | Transit to idle mode |

13.2 Counters for UE

| Counter | Reset | Incremented | When reaching max value |
|---------|---|----------------------|--|
| V300 | When initiating the procedure RRC connection establishment | Upon expiry of T300. | When V300 > N300, the UE enters idle mode. |
| V302 | When initiating the procedure Cell update or URA update | Upon expiry of T302 | When V302 > N302 the UE enters idle mode. |
| V304 | When sending the first UE CAPABILITY INFORMATION message. | Upon expiry of T304 | When V304 > N304 the UE initiates the Cell update procedure |
| V308 | When sending the first RRC CONNECTION RELEASE COMPLETE message in a RRC connection release procedure. | Upon expiry of T308 | When V308 > N308 the UE stops re-transmitting the RRC CONNECTION RELEASE COMPLETE message. |
| V310 | When sending the first PUSCH CAPACITY REQUEST message in a PUSCH capacity request procedure | Upon expiry of T310 | When V310 > N310 the UE stops re-transmitting the PUSCH CAPACITY REQUEST message. |

13.3 UE constants and parameters

| Constant | Usage |
|----------|---|
| N300 | Maximum number of retransmissions of the RRC CONNECTION REQUEST message |
| N302 | Maximum number of retransmissions of the CELL UPDATE / URA UPDATE message |
| N304 | Maximum number of retransmissions of the UE CAPABILITY INFORMATION message |
| N308 | Maximum number of retransmissions of the RRC CONNECTION RELEASE COMPLETE message |
| N310 | Maximum number of retransmission of the PUSCH CAPACITY REQUEST message |
| N312 | Maximum number of successive "in sync" received from L1. |
| N313 | Maximum number of successive "out of sync" received from L1. |
| N315 | Maximum number of successive "in sync" received from L1 during T313 is activated. |

13.4 UE variables

13.4.0 CELL INFO LIST

This variable contains cell information on intra-frequency, inter-frequency and inter-RAT cells, as received in messages System Information Block Type 11, System Information Block Type 12, and MEASUREMENT CONTROL.

The first position in Intra-frequency cell info list corresponds to Intra-frequency cell id 0, the second to Intra-frequency cell id 1, etc.

The first position in Inter-frequency cell info list corresponds to Inter-frequency cell id 0, the second to Inter-frequency cell id 1, etc.

The first position in Inter-RAT cell info list corresponds to Intra-frequency cell id 0, the second to Inter-RAT cell id 1, etc.

| Information Element/Group name | Need | Multi | Type and reference | Semantics description |
|---|------|------------------|--|--|
| Intra-frequency cell info | MP | 1..<maxCellMeas> | | |
| >CHOICE <i>position status</i> | MP | | | |
| >>Occupied | | | | |
| >>>Cell info | MP | | Cell info 10.3.7.2 | |
| >>Vacant | | | | No data |
| Inter-frequency cell info | MP | 1..<maxCellMeas> | | |
| >CHOICE <i>position status</i> | MP | | | |
| >>Occupied | | | | |
| >>>Frequency info | MP | | Frequency info 10.3.6.36 | |
| >>>Cell info | MP | | Cell info 10.3.7.2 | |
| >>Vacant | | | | No data |
| Inter-RAT cell info | MP | 1..<maxCellMeas> | | |
| >CHOICE <i>position status</i> | MP | | | |
| >>Occupied | | | | |
| >>>CHOICE <i>Radio Access Technology</i> | | | | |
| >>>>GSM | | | | |
| >>>>>Cell selection and re-selection info | MP | | Cell selection and re-selection info for SIB11/12 10.3.2.4 | |
| >>>>>BSIC | MP | | BSIC 10.3.8.2 | |
| >>>>>BCCH ARFCN | MP | | Integer (0..1023) | [43] |
| >>>>>IS-2000 | | | | |
| >>>>>System specific measurement info | | | enumerated (frequency, timeslot, colour code, output power, PN offset) | For IS-2000, use fields from TIA/EIA/IS-2000.5, Subclause 3. 7.3.3.2.27, <i>Candidate Frequency Neighbour List Message</i> |
| >>Vacant | | | | No data |

13.4.00 CELL_POSITION

This variable stores the CELL_POSITION for UE-based OTDOA (10.3.7.106).

| Information Element/Group name | Need | Multi | Type and reference | Semantics description |
|--------------------------------|------|-------|------------------------|---|
| Relative North | OP | | Integer(-20000..20000) | Seconds, scale factor 0.03. Relative position compared to reference cell. |
| Relative East | OP | | Integer(-20000..20000) | Seconds, scale factor 0.03. Relative position compared to reference cell. |
| Relative Altitude | OP | | Integer(-4000..4000) | Relative altitude in meters compared to ref. cell. |

13.4.0a CELL_UPDATE_STARTED

This variable indicates whether a cell update or URA update procedure is in progress.

| Information Element/Group name | Need | Multi | Type and reference | Semantics description |
|--------------------------------|------|-------|--------------------|---|
| Cell update started | MP | | Boolean | TRUE means a cell or URA update procedure is in progress. |

13.4.1 CIPHERING_STATUS

This variable contains information about the current status of ciphering in the UE.

| Information Element/Group name | Need | Multi | Type and reference | Semantics description |
|--------------------------------|------|-------|----------------------------------|---|
| Status | MP | | Enumerated(Not started, Started) | |
| Reconfiguration | MP | | Boolean | TRUE means an RRC procedure performing reconfiguration of ciphering is ongoing. |

13.4.2 Void

13.4.2a CONFIGURATION_INCOMPLETE

This variable indicates whether a received measurement control message contains invalid an incomplete measurement configuration.

| Information Element/Group name | Need | Multi | Type and reference | Semantics description |
|--------------------------------|------|-------|--------------------|---|
| Configuration incomplete | MP | | Boolean | TRUE: An incomplete configuration has been detected |

13.4.3 C_RNTI

This variable stores the assigned C-RNTI for this UE when in CELL_FACH state.

| Information Element/Group name | Need | Multi | Type and reference | Semantics description |
|--------------------------------|------|-------|--------------------|-----------------------|
| C-RNTI | OP | | C-RNTI 10.3.3.8 | |

13.4.4 DOFF

This variable contains the default offset value in the UE. See [10] for details.

| Information Element/Group name | Need | Multi | Type and reference | Semantics description |
|----------------------------------|------|-------|--------------------------------------|-----------------------|
| Default DPCH Offset Value (DOFF) | OP | | Default DPCH Offset Value, 10.3.6.16 | |

13.4.5 ESTABLISHED_RABS

This variable is used to store information about the established radio access bearers and signalling radio bearers in the UE.

| Information Element/Group name | Need | Multi | Type and reference | Semantics description |
|-------------------------------------|------|--------------------|-------------------------------|---|
| RAB information | OP | 1 to <maxRABsetup> | | For each RAB established |
| >RAB info | MP | | RAB info 10.3.4.8 | |
| >RB information | MP | 1 to <maxRBperRAB> | | For each RB belonging to the RAB |
| >>RB identity | MP | | RB identity 10.3.4.16 | |
| >>>Subflow | MP | | Integer(0..<maxSubflowcount>) | Reference to the RAB subflow implemented by this RB |
| >>>RB started | MD | | Enumerated(stopped, started) | Default value is started |
| Signalling radio bearer information | OP | 1 to <maxSRBsetup> | | In the order of RB0 and upwards |
| >RB started | MD | | Enumerated(stopped, started) | Default value is started |

13.4.5a ESTABLISHED_SIGNALLING_CONNECTIONS

This variable is used to store information about established signalling connections.

| Information Element/Group name | Need | Multi | Type and reference | Semantics description |
|---------------------------------|------|---------------------|-----------------------------|--|
| Signalling connection list | OP | 1 to <maxCNdomains> | | For each established signalling connection |
| >Signalling connection identity | MP | | CN domain identity 10.3.1.1 | |

13.4.6 ESTABLISHMENT_CAUSE

This variable is used to store the cause for establishment of a signalling connection received by upper layers, to be used at RRC connection establishment.

| Information Element/Group name | Need | Multi | Type and reference | Semantics description |
|--------------------------------|------|-------|-------------------------------|-----------------------|
| Establishment cause | OP | | Establishment cause 10.3.3.11 | |

13.4.7 FAILURE_CAUSE

This variable contains the cause for failure of a UE initiated procedure, to be reported in a retransmitted message.

| Information Element/Group name | Need | Multi | Type and reference | Semantics description |
|--------------------------------|------|-------|----------------------------|-----------------------|
| Failure cause | OP | | Failure cause 10.3.3.13 | |

13.4.8 FAILURE_INDICATOR

This variable indicates whether the procedure has failed for a UE initiated procedure.

| Information Element/Group name | Need | Multi | Type and reference | Semantics description |
|--------------------------------|------|-------|--------------------|----------------------------|
| Failure indicator | MP | | Boolean | TRUE: Procedure has failed |

13.4.8a INCOMPATIBLE_SECURITY_RECONFIGURATION

This variable indicates whether an incompatible simultaneous reconfiguration of a security function has been received.

| Information Element/Group name | Need | Multi | Type and reference | Semantics description |
|---------------------------------------|------|-------|--------------------|---|
| Incompatible security reconfiguration | MP | | Boolean | TRUE: An incompatible simultaneous security reconfiguration has been detected |

13.4.9 INITIAL_UE_IDENTITY

In this variable the identity used by the UE when establishing an RRC connection is stored.

| Information Element/Group name | Need | Multi | Type and reference | Semantics description |
|--------------------------------|------|-------|----------------------------------|-----------------------|
| Initial UE identity | OP | | Initial UE identity 10.3.3.15 | |

13.4.9a INTEGRITY_PROTECTION_ACTIVATION_INFO

This variable contains information to be sent to UTRAN about when a new integrity protection configuration shall be activated in the uplink for signalling radio bearers in case of modification of integrity protection.

| Information Element/Group name | Need | Multi | Type and reference | Semantics description |
|---|------|-------|---|-----------------------|
| Uplink Integrity protection activation info | OP | | Integrity protection activation info 10.3.3.17 | |

13.4.10 INTEGRITY_PROTECTION_INFO

This variable contains information about the current status of the integrity protection in the UE.

| Information Element/Group name | Need | Multi | Type and reference | Semantics description |
|---|------|--------------------|--|--|
| Historical status | MP | | Enumerated(Never been active, Has been active) | |
| Status | MP | | Enumerated(Not started, Started) | |
| Reconfiguration | MP | | Boolean | TRUE means a reconfiguration of integrity protection is ongoing. |
| Signalling radio bearer specific integrity protection information | MP | 1 to <maxSRBsetup> | | Status information for RB0-RB4 in that order |
| >Uplink RRC HFN | MP | | Bitstring (28) | |
| >Downlink RRC HFN | MP | | Bitstring (28) | |
| >Uplink RRC Message sequence number | MP | | Integer (0..15) | |
| >Downlink RRC Message sequence number | OP | | Integer (0..15) | |

13.4.11 INVALID_CONFIGURATION

This variable indicates whether a received message contained an invalid configuration, by means of invalid values or invalid combinations of information elements.

| Information Element/Group name | Need | Multi | Type and reference | Semantics description |
|--------------------------------|------|-------|--------------------|--|
| Invalid configuration | MP | | Boolean | TRUE: An invalid configuration has been detected |

13.4.11a LATEST_CONFIGURED_CN_DOMAIN

This variable stores the CN-domain that was most recently configured to be used for ciphering and integrity protection.

| Information Element/Group name | Need | Multi | Type and reference | Semantics description |
|--------------------------------|------|-------|-----------------------------|-----------------------|
| Latest configured CN domain | OP | | CN domain identity 10.3.1.1 | |

13.4.12 MEASUREMENT_IDENTITY

This variable stores the measurements configured in the UE. For each configured measurement, the information below shall be stored.

| Information Element/Group name | Need | Multi | Type and reference | Semantics description |
|--------------------------------|------|-------|--|---|
| MEASUREMENT CONTROL | OP | | MEASUREMENT CONTROL 10.2.17, System Information Block type 11 10.2.48.8.1 2, System Information Block type 12 10.2.48.8.1 3 | Information as contained in these messages. |

13.4.13 Void

13.4.14 ORDERED_RECONFIGURATION

This variable stores information about an ongoing Reconfiguration procedure.

| Information Element/Group name | Need | Multi | Type and reference | Semantics description |
|--------------------------------|------|-------|--------------------|---|
| Ordered reconfiguration | MP | | Boolean | TRUE means that a Reconfiguration procedure is ongoing. |

13.4.15 PDCP_SN_INFO

This variable contains PDCP receive sequence numbers for one or several radio bearers to be included in a response message to UTRAN.

| Information Element/Group name | Need | Multi | Type and reference | Semantics description |
|--------------------------------|------|----------------------|---------------------------------------|-----------------------|
| RB with PDCP information list | OP | 1 to <maxRBall RABs> | | |
| >RB with PDCP information | MP | | RB with PDCP information 10.3.4.22 | |

13.4.16 PROTOCOL_ERROR_INDICATOR

This variable indicates whether there exist a protocol error that is to be reported to UTRAN.

| Information Element/Group name | Need | Multi | Type and reference | Semantics description |
|--------------------------------|------|-------|---------------------------------------|-----------------------|
| Protocol error indicator | MP | | Protocol error indicator 10.3.3.27 | |

13.4.17 PROTOCOL_ERROR_INFORMATION

This variable contains diagnostics to be reported to UTRAN for a message that was not completely understood.

| Information Element/Group name | Need | Multi | Type and reference | Semantics description |
|--------------------------------|------|-------|---|-----------------------|
| Protocol error information | OP | | Protocol error information 10.3.8.12 | |

13.4.18 PROTOCOL_ERROR_REJECT

This variable indicates whether there has occurred a severe protocol error causing the ongoing procedure to fail.

| Information Element/Group name | Need | Multi | Type and reference | Semantics description |
|--------------------------------|------|-------|--------------------|--|
| Protocol error reject | MP | | Boolean | TRUE: a severe protocol error has occurred |

13.4.19 RB_TIMER_INDICATOR

This variable contains information to be sent to UTRAN if any of the timers T314 or T315 has expired when the UE sends a cell update with cause RL failure.

| Information Element/Group name | Need | Multi | Type and reference | Semantics description |
|--------------------------------|------|-------|---------------------------------|-----------------------|
| RB timer indicator | OP | | RB timer indicator 10.3.3.28 | |

13.4.20 RB_UPLINK_CIPHERING_ACTIVATION_TIME_INFO

This variable contains information to be sent to UTRAN about when a new ciphering configuration shall be activated in the uplink for radio bearers using RLC-AM or RLC-UM.

| Information Element/Group name | Need | Multi | Type and reference | Semantics description |
|--|------|-------|--------------------------------------|-----------------------|
| RB uplink ciphering activation time info | OP | | RB activation time info 10.3.4.13 | |

13.4.21 SELECTED_PLMN

This variable contains the type of and identity of the selected PLMN.

| Information Element/Group name | Need | Multi | Type and reference | Semantics description |
|--------------------------------|------|-------|----------------------------|-----------------------|
| PLMN Type | MP | | PLMN Type 10.3.1.12 | |
| CHOICE <i>identity type</i> | MP | | | |
| >PLMN identity | | | PLMN identity 10.3.1.11 | |
| >SID | | | SID 10.3.9.11 | |

| CHOICE <i>identity type</i> | Condition under which the given <i>identity type</i> is chosen |
|------------------------------------|---|
| PLMN identity | PLMN Type is "GSM-MAP" |
| SID | PLMN Type is "ANSI-41" |

13.4.22 START_THRESHOLD

This variable contains information about the maximum allowed value of the START for a CN domain.

| Information Element/Group name | Need | Multi | Type and reference | Semantics description |
|---------------------------------------|-------------|--------------|---------------------------|------------------------------|
| THRESHOLD | OP | | Integer (0..1048576) | 20 bits |

13.4.23 START_VALUE_TO_TRANSMIT

This variable contains the value of START for new radio bearer(s) to be transmitted in a response message.

| Information Element/Group name | Need | Multi | Type and reference | Semantics description |
|---------------------------------------|-------------|--------------|---------------------------|------------------------------|
| START | OP | | START 10.3.3.38 | |

13.4.24 TFC_SUBSET

This variable contains information about the TFC subset currently applied.

| Information Element/Group name | Need | Multi | Type and reference | Semantics description |
|--------------------------------|------|---------------------|---|--|
| CHOICE <i>mode</i> | MP | | | |
| >FDD | | | | |
| >>Current TFC subset | MP | | Transport Format Combination Subset 10.3.5.22 | |
| >>Duration | OP | | TFC Control duration 10.3.6.80 | |
| >>Default TFC subset | OP | | Transport Format Combination Subset 10.3.5.22 | The TFC subset to go back to when any temporary limitation is released |
| >TDD | | | | |
| >>TFCS list | | 1 to < maxCCTrC H > | | |
| >>>TFCS identity | MP | | | |
| >>>Current TFC subset | MP | | Transport Format Combination Subset 10.3.5.22 | |
| >>>>Duration | OP | | TFC Control duration 10.3.6.80 | |
| >>>>Default TFC subset | OP | | Transport Format Combination Subset 10.3.5.22 | The TFC subset to go back to when any temporary limitation is released |

13.4.25 TGPS_IDENTITY

This variable contains the configuration parameters of a compressed mode transmission gap pattern sequence

| Information Element/Group name | Need | Multi | Type and reference | Semantics description |
|--------------------------------|------|-------|-------------------------------------|--|
| TGPS_IDENTITY | OP | | DPCH compressed mode info 10.3.6.33 | Information as contained in the IE group "Transmission gap pattern sequence configuration parameters". |
| TGPS Status Flag | MP | | Enumerated(active, inactive) | This flag indicates the current status of the Transmission Gap Pattern Sequence |

13.4.26 TGSN_REPORTED

This variable specifies whether an IE "Proposed TGSN" was reported to the UTRAN

| Information Element/Group name | Need | Multi | Type and reference | Semantics description |
|--------------------------------|------|-------|--------------------|-----------------------|
| Proposed TGSN reported | MP | | Boolean | |

13.4.26a TIMERS_AND_CONSTANTS

This variable contains the values for all timers and constants used in connected mode.

| Information Element/Group name | Need | Multi | Type and reference | Semantics description |
|---|------|-------|---|---|
| UE Timers and constants in connected mode | MD | | UE Timers and constants in connected mode 10.3.3.43 | Default value means that for all timers and constants - For parameters with need MD, the defaults specified in 10.3.3.43 apply and - For parameters with need OP, the parameters are absent |

13.4.27 TRANSACTIONS

This variable stores the identifications of the ongoing RRC procedure transactions.

| Information Element/Group name | Need | Multi | Type and reference | Semantics description |
|--------------------------------|------|------------------------|--------------------------------------|-----------------------|
| Accepted transactions | OP | 1 to <maxtransactions> | | |
| >Message type | MP | | Message Type | |
| >RRC transaction identifier | MP | | RRC transaction identifier 10.3.3.36 | |
| Rejected transactions | OP | 1 to <maxtransactions> | | |
| >Message type | MP | | Message Type | |
| >RRC transaction identifier | MP | | RRC transaction identifier 10.3.3.36 | |

13.4.27a TRIGGERED_1A_EVENTS

This variable contains information about 1a events that have been triggered in the UE.

| Information Element/Group name | Need | Multi | Type and reference | Semantics description |
|--------------------------------|------|----------------------------|------------------------------|---|
| Cells triggered | OP | 1 to <maxCellMeasurements> | | |
| >primary CPICH | MP | | Primary CPICH info 10.3.6.60 | |
| >sent reports | MP | | Integer(1..Infinity) | Number of reports sent to UTRAN in case of event triggered periodical reporting |

13.4.27b TRIGGERED_1B_EVENTS

This variable contains information about 1b events that have been triggered in the UE.

| Information Element/Group name | Need | Multi | Type and reference | Semantics description |
|--------------------------------|------|----------------------|------------------------------|-----------------------|
| Cells triggered | OP | 1 to < maxCellMe as> | | |
| >primary CPICH | MP | | Primary CPICH info 10.3.6.60 | |

13.4.27c TRIGGERED_1C_EVENTS

This variable contains information about 1b events that have been triggered in the UE.

| Information Element/Group name | Need | Multi | Type and reference | Semantics description |
|--------------------------------|------|----------------------|------------------------------|---|
| Cells triggered | OP | 1 to < maxCellMe as> | | |
| >primary CPICH | MP | | Primary CPICH info 10.3.6.60 | |
| >sent reports | MP | | Integer(1..Infinity) | Number of reports sent to UTRAN in case of event triggered periodical reporting |

13.4.27d BEST_CELL_1D_EVENT

This variable contains information about 1d events that have been triggered in the UE.

| Information Element/Group name | Need | Multi | Type and reference | Semantics description |
|--------------------------------|------|-------|------------------------------|-----------------------|
| Best cell | MP | | Primary CPICH info 10.3.6.60 | |

13.4.27e TRIGGERED_1E_EVENTS

This variable contains information about 1e events that have been triggered in the UE.

| Information Element/Group name | Need | Multi | Type and reference | Semantics description |
|--------------------------------|------|----------------------|------------------------------|-----------------------|
| Cells triggered | OP | 1 to < maxCellMe as> | | |
| >primary CPICH | MP | | Primary CPICH info 10.3.6.60 | |

13.4.27f TRIGGERED_1F_EVENTS

This variable contains information about 1f events that have been triggered in the UE.

| Information Element/Group name | Need | Multi | Type and reference | Semantics description |
|--------------------------------|------|--------------------|------------------------------|-----------------------|
| Cells triggered | OP | 1 to <maxCellMeas> | | |
| >primary CPICH | MP | | Primary CPICH info 10.3.6.60 | |

13.4.27g UE_CAPABILITY_REQUESTED

This variable stores information about the UE capabilities that have been requested by UTRAN but that have not yet been transferred to UTRAN.

| Information Element/Group name | Need | Multi | Type and reference | Semantics description |
|---------------------------------------|------|----------------------------|---|------------------------------|
| UE radio access capability | OP | | UE radio access capability 10.3.3.42 | |
| UE radio access capability extension | OP | | UE radio access capability extension 10.3.3.42a | |
| UE system specific capability | OP | 1 to <maxSystemCapability> | Inter-RAT UE radio access capability 10.3.8.7 | Includes inter-RAT classmark |
| >Inter-RAT UE radio access capability | MP | | Inter-RAT UE radio access capability 10.3.8.7 | |

13.4.28 UE_CAPABILITY_TRANSFERRED

This variable stores information about which UE capabilities that have been transferred to UTRAN.

| Information Element/Group name | Need | Multi | Type and reference | Semantics description |
|---------------------------------------|------|----------------------------|---|------------------------------|
| UE radio access capability | OP | | UE radio access capability 10.3.3.42 | |
| UE radio access capability extension | OP | | UE radio access capability extension 10.3.3.42a | |
| UE system specific capability | OP | 1 to <maxSystemCapability> | Inter-RAT UE radio access capability 10.3.8.7 | Includes inter-RAT classmark |
| >Inter-RAT UE radio access capability | MP | | Inter-RAT UE radio access capability 10.3.8.7 | |

13.4.29 UNSUPPORTED_CONFIGURATION

This variable indicates whether a received message contained a configuration that is not supported by the UE.

| Information Element/Group name | Need | Multi | Type and reference | Semantics description |
|--------------------------------|------|-------|--------------------|--|
| Unsupported configuration | MP | | Boolean | TRUE: An unsupported configuration has been detected |

13.4.30 URA_IDENTITY

This variable stores the assigned URA identity for this UE when in URA_PCH state.

| Information Element/Group name | Need | Multi | Type and reference | Semantics description |
|--------------------------------|------|-------|--------------------------|-----------------------|
| URA identity | OP | | URA identity 10.3.2.6 | |

13.4.31 U_RNTI

This variable stores the assigned U-RNTI for this UE.

| Information Element/Group name | Need | Multi | Type and reference | Semantics description |
|--------------------------------|------|-------|---------------------|-----------------------|
| U-RNTI | MP | | U-RNTI 10.3.3.47 | |

13.4.32 VALUE_TAG

This variable contains information about the value tag for the last received system information block of a given type, for all system information blocks using value tags.

| Information Element/Group name | Need | Multi | Type and reference | Semantics description |
|--------------------------------|---------|-------|--------------------------|--|
| MIB value tag | MP | | MIB value tag 10.3.8.9 | Value tag for the master information block |
| SB 1 value tag | MP | | Cell value tag 10.3.8.4 | Value tag for the scheduling block type 1 |
| SB 2 value tag | MP | | Cell value tag 10.3.8.4 | Value tag for the scheduling block type 2 |
| SIB 1 value tag | CV-GSM | | PLMN value tag 10.3.8.10 | Value tag for the system information block type 1 |
| SIB 2 value tag | MP | | Cell value tag 10.3.8.4 | Value tag for the system information block type 2 |
| SIB 3 value tag | MP | | Cell value tag 10.3.8.4 | Value tag for the system information block type 3 |
| SIB 4 value tag | MP | | Cell value tag 10.3.8.4 | Value tag for the system information block type 4 |
| SIB 5 value tag | MP | | Cell value tag 10.3.8.4 | Value tag for the system information block type 5 |
| SIB 6 value tag | MP | | Cell value tag 10.3.8.4 | Value tag for the system information block type 6 |
| CHOICE mode | | | | |
| >FDD | | | | |
| >>SIB 8 value tag | MP | | Cell value tag 10.3.8.4 | Value tag for the system information block type 8 |
| >TDD | | | | (no data) |
| SIB 11 value tag | MP | | Cell value tag 10.3.8.4 | Value tag for the system information block type 11 |
| SIB 12 value tag | MP | | Cell value tag 10.3.8.4 | Value tag for the system information block type 12 |
| SIB 13 value tag | CV-ANSI | | Cell value tag 10.3.8.4 | Value tag for the system information block type 13 |
| SIB 13.1 value tag | CV-ANSI | | Cell value tag 10.3.8.4 | Value tag for the system information block type 13.1 |
| SIB 13.2 value tag | CV-ANSI | | Cell value tag 10.3.8.4 | Value tag for the system information block type 13.2 |
| SIB 13.3 value tag | CV-ANSI | | Cell value tag 10.3.8.4 | Value tag for the system information block type 13.3 |
| SIB 13.4 value tag | CV-ANSI | | Cell value tag 10.3.8.4 | Value tag for the system information block type 13.4 |
| SIB 15 value tag | MP | | Cell value tag 10.3.8.4 | Value tag for the system information block type 15 |
| SIB 15.1 value tag | MP | | Cell value tag 10.3.8.4 | Value tag for the system information block type 15.1 |
| SIB 15.2 value tag | MP | | Cell value tag 10.3.8.4 | Value tag for the system information block type 15.2 |
| SIB 15.3 value tag | MP | | PLMN value tag 10.3.8.10 | Value tag for the system information block type 15.3 |
| SIB 15.4 value tag | MP | | Cell value tag 10.3.8.4 | Value tag for the system information block type 15.4 |
| SIB 16 value tag | MP | | PLMN value tag 10.3.8.10 | Value tag for the system information block type 16 |
| SIB 18 value tag | MP | | Cell value tag 10.3.8.4 | Value tag for the system information block type 18 |

| Condition | Explanation |
|-----------|--|
| GSM | This information is only stored when the PLMN Type in the variable SELECTED_PLMN is "GSM-MAP". |
| ANSI | This information is only stored when the PLMN Type in the variable SELECTED_PLMN is "ANSI-41". |

13.5 UE RRC Procedure Performance

This subclause defines the performance requirements related to RRC procedures in the UE. Where the total delay is impacted by processing of variable length on the physical layer (e.g. physical layer synchronisation), references to appropriate specifications are given.

13.5.1 Definitions

The following definitions of N1 and N2 are valid only for this UE RRC Procedure Performance specification.

N1 = upper limit on the time required to execute modifications in UE after the reception of a UTRAN -> UE message has been completed. Where applicable (e.g. the physical layer transmission is impacted), the changes shall be adopted in the beginning of the next TTI starting after N1. N1 is specified as a multiple of 10 ms.

N2 = number of 10 ms radio frames from end of reception of UTRAN -> UE message on UE physical layer before the transmission of the UE -> UTRAN response message must be ready to start on a transport channel with no access delay other than the TTI alignment (e.g. DCH, therefore excluding delays caused by RACH procedure etc). The UE response message transmission from the physical layer shall begin at the latest $(N2*10)+TTI$ ms after completion of the reception of the last TTI carrying the triggering UTRAN -> UE message. When Target State is CELL_DCH, the UE response message transmission from the physical layer may be additionally delayed by the value of IE "SRB delay".

N1 and N2 are independent (e.g. $N2-N1$ is not restricted to being less than or equal to 10ms).

13.5.2 RRC procedure performance values

NOTE: Times indicated in the table do not include cell reselection.

| Procedure title: | UTRAN -> UE | UE -> UTRAN | N1 | N2 | Notes |
|--|----------------------|-------------------------------|----|----|--|
| RRC Connection Management Procedures | | | | | |
| Broadcast of system information | SYSTEM INFORMATION | | | | N2 is not applicable for any system information messages, because there is no response message from the UE. |
| Master Information Block | SYSTEM INFORMATION | | 5 | NA | No system information data shall be lost due to processing of a MIB received with no detectable errors. This means that the UE shall buffer all system information data received after the MIB until the data can be processed according to the information in the MIB, unless the MIB was received erroneously. |
| System Information Block type 1 | SYSTEM INFORMATION | | 10 | NA | |
| System Information Block type 2 | SYSTEM INFORMATION | | 10 | NA | |
| System Information Block type 3 | SYSTEM INFORMATION | | 10 | NA | |
| System Information Block type 4 | SYSTEM INFORMATION | | 10 | NA | |
| System Information Block type 5 | SYSTEM INFORMATION | | 10 | NA | |
| System Information Block type 6 | SYSTEM INFORMATION | | 10 | NA | |
| System Information Block type 7 | SYSTEM INFORMATION | | 5 | NA | |
| System Information Block type 8 | SYSTEM INFORMATION | | 10 | NA | |
| System Information Block type 9 | SYSTEM INFORMATION | | 5 | NA | |
| System Information Block type 10 | SYSTEM INFORMATION | | 5 | NA | |
| System Information Block type 11 | SYSTEM INFORMATION | | 10 | NA | |
| System Information Block type 12 | SYSTEM INFORMATION | | 10 | NA | |
| System Information Block type 13 | SYSTEM INFORMATION | | 10 | NA | |
| System Information Block type 14 | SYSTEM INFORMATION | | 10 | NA | |
| System Information Block type 15 | SYSTEM INFORMATION | | 10 | NA | |
| System Information Block type 16 | SYSTEM INFORMATION | | 10 | NA | |
| System Information Block type 18 | SYSTEM INFORMATION | | 10 | NA | |
| RRC connection establishment <i>Target state CELL_DCH</i> | RRC CONNECTION SETUP | RRC CONNECTION SETUP COMPLETE | 10 | NA | N1 measures time to the start of tx / rx on DPCH. N2 cannot be specified, because RRC CONNECTION SETUP COMPLETE message is transmitted only after physical layer synchronisation, which also depends on the Node B. The performance of the physical layer synchronisation procedure is specified in [19] and [20] |

| | | | | | |
|--|-------------------------------|---|----|----------|---|
| RRC connection establishment <i>Target state CELL_FACH</i> | RRC CONNECTION SETUP | RRC CONNECTION SETUP COMPLETE | 10 | 11 | N1 and N2 applicable as defined (N2 can be tested from the initiation of the power ramp on RACH). |
| RRC connection release <i>From CELL_DCH state</i> | RRC CONNECTION RELEASE | RRC CONNECTION RELEASE COMPLETE | 5 | 8 | N1 sets the requirement for the time from the completion of the last repetition of the RRC CONNECTION RELEASE COMPLETE message to the release of the physical channel. N2 sets the requirement from the end of successful reception of the RRC CONNECTION RELEASE message to the start of the first transmission of the RRC CONNECTION RELEASE COMPLETE message. |
| RRC connection release <i>From CELL_FACH state</i> | RRC CONNECTION RELEASE | RRC CONNECTION RELEASE COMPLETE | NA | 11 | N1 represents UE internal configuration that cannot be externally observed. |
| Paging | PAGING TYPE 1 | CELL UPDATE | 10 | 11+ T | T is the repetition period of SIB7 (applicable for FDD) and SIB14 (applicable for TDD) |
| UE capability enquiry | UE CAPABILITY ENQUIRY | UE CAPABILITY INFORMATION | NA | 8 | N1 is not applicable because the UE configuration does not change. |
| Security mode control | SECURITY MODE COMMAND | SECURITY MODE COMPLETE | 5 | 8 | |
| Signalling connection release procedure | SIGNALLING CONNECTION RELEASE | | 5 | NA | N2 is not applicable because there is no response message. |
| Counter check | COUNTER CHECK | COUNTER CHECK RESPONSE | NA | 8 | N1 is not applicable because the UE configuration does not change. |
| Radio Bearer control procedures | | | | | |
| Radio bearer establishment <i>Target state CELL_DCH</i> | RADIO BEARER SETUP | RADIO BEARER SETUP COMPLETE / FAILURE | 10 | NA | N2 cannot be specified, because the RADIO BEARER SETUP COMPLETE / FAILURE message is transmitted only after physical layer synchronisation, which depends also on Node B. |
| Radio bearer establishment <i>From state CELL_FACH to state CELL_FACH</i> | RADIO BEARER SETUP | RADIO BEARER SETUP COMPLETE / FAILURE | 10 | 11 | |
| Radio bearer establishment <i>From CELL_DCH to CELL_FACH</i> | RADIO BEARER SETUP | RADIO BEARER SETUP COMPLETE | NA | NA | N1 and N2 cannot be specified, because UE need to read SIBs on BCH before sending RADIO BEARER SETUP COMPLETE |
| Radio bearer reconfiguration <i>Target state CELL_DCH</i> | RADIO BEARER RECONFIGURATION | RADIO BEARER RECONFIGURATION COMPLETE / FAILURE | 10 | NA | N2 cannot be specified, because the RADIO BEARER RECONFIGURATION COMPLETE / FAILURE message is transmitted only after physical layer synchronisation, which depends also on Node B. |

| | | | | | |
|---|--------------------------------------|--|----|----|--|
| Radio bearer reconfiguration <i>From state CELL_FACH to state CELL_FACH</i> | RADIO BEARER RECONFIGURATION | RADIO BEARER RECONFIGURATION COMPLETE / FAILURE | 10 | 11 | |
| Radio bearer reconfiguration <i>From state CELL_DCH to state CELL_FACH</i> | RADIO BEARER RECONFIGURATION | RADIO BEARER RECONFIGURATION COMPLETE | NA | NA | N1 and N2 cannot be specified, because UE need to read SIBs on BCH before sending RADIO BEARER RECONFIGURATION COMPLETE |
| Radio bearer release <i>Target state CELL_DCH</i> | RADIO BEARER RELEASE | RADIO BEARER RELEASE COMPLETE / FAILURE | 10 | 11 | |
| Radio bearer release <i>From state CELL_FACH to state CELL_FACH</i> | RADIO BEARER RELEASE | RADIO BEARER RELEASE COMPLETE / FAILURE | 10 | 11 | |
| Radio bearer release <i>From state CELL_DCH to state CELL_FACH</i> | RADIO BEARER RELEASE | RADIO BEARER RELEASE COMPLETE | NA | NA | N1 and N2 cannot be specified, because UE need to read SIBs on BCH before sending RADIO BEARER RECONFIGURATION COMPLETE |
| Transport channel reconfiguration <i>Target state CELL_DCH</i> | TRANSPORT CHANNEL RECONFIGURATION | TRANSPORT CHANNEL RECONFIGURATION COMPLETE / FAILURE | 10 | NA | N2 cannot be specified, because the TRANSPORT CHANNEL RECONFIGURATION COMPLETE / FAILURE message is transmitted only after physical layer synchronisation, which depends also on Node B. |
| Transport channel reconfiguration <i>From state CELL_FACH to state CELL_FACH</i> | TRANSPORT CHANNEL RECONFIGURATION | TRANSPORT CHANNEL RECONFIGURATION COMPLETE / FAILURE | 10 | 11 | |
| Transport channel reconfiguration <i>From state CELL_DCH to state CELL_FACH</i> | TRANSPORT CHANNEL RECONFIGURATION | TRANSPORT CHANNEL RECONFIGURATION COMPLETE | NA | NA | N1 and N2 cannot be specified, because UE need to read SIBs on BCH before sending TRANSPORT CHANNEL RECONFIGURATION COMPLETE |
| Transport format combination control <i>AM or UM RLC mode</i> | TRANSPORT FORMAT COMBINATION CONTROL | TRANSPORT FORMAT COMBINATION CONTROL FAILURE | 5 | 8 | |
| Transport format combination control <i>Transparent mode</i> | TRANSPORT FORMAT COMBINATION CONTROL | | 5 | NA | N2 is not applicable because no response message is defined. |
| Physical channel reconfiguration <i>Target state CELL_DCH</i> | PHYSICAL CHANNEL RECONFIGURATION | PHYSICAL CHANNEL RECONFIGURATION COMPLETE / FAILURE | 8 | NA | N2 cannot be specified, because the PHYSICAL CHANNEL RECONFIGURATION COMPLETE / FAILURE message is transmitted only after physical layer synchronisation, which depends also on Node B. |

| | | | | | |
|--|------------------------------------|---|----|----|---|
| Physical channel reconfiguration <i>From state CELL_FACH to state CELL_FACH</i> | PHYSICAL CHANNEL RECONFIGURATION | PHYSICAL CHANNEL RECONFIGURATION COMPLETE / FAILURE | 8 | 9 | |
| Physical channel reconfiguration <i>From state CELL_DCH to state CELL_FACH</i> | PHYSICAL CHANNEL RECONFIGURATION | PHYSICAL CHANNEL RECONFIGURATION COMPLETE | NA | NA | N1 and N2 cannot be specified, because UE need to read SIBs on BCH before sending PHYSICAL CHANNEL RECONFIGURATION COMPLETE |
| Physical Shared Channel Allocation [TDD only] | PHYSICAL SHARED CHANNEL ALLOCATION | | 5 | NA | N2 is not applicable because no response message is defined. |
| Uplink Physical Channel Control [TDD only] | UPLINK PHYSICAL CHANNEL CONTROL | | NA | NA | Requirements for outer loop and timing advance adjustments are defined in [22] and [20]. |
| RRC connection mobility procedures | | | | | |
| Cell update | CELL UPDATE CONFIRM | UTRAN MOBILITY INFORMATION CONFIRM | 5 | 8 | |
| | | PHYSICAL CHANNEL RECONFIGURATION COMPLETE <i>Target state CELL_FACH</i> | 8 | 9 | |
| | | PHYSICAL CHANNEL RECONFIGURATION COMPLETE <i>Target state CELL_DCH</i> | 8 | NA | N2 cannot be specified, because the PHYSICAL CHANNEL RECONFIGURATION COMPLETE / FAILURE message is transmitted only after physical layer synchronisation, which depends also on Node B. |
| | | TRANSPORT CHANNEL RECONFIGURATION COMPLETE <i>Target state CELL_FACH</i> | 10 | 11 | |
| | | TRANSPORT CHANNEL RECONFIGURATION COMPLETE <i>Target state CELL_DCH</i> | 10 | NA | N2 cannot be specified, because the PHYSICAL CHANNEL RECONFIGURATION COMPLETE / FAILURE message is transmitted only after physical layer synchronisation, which depends also on Node B. |
| | | RADIO BEARER RECONFIGURATION COMPLETE <i>Target state CELL_FACH</i> | 10 | 11 | |

| | | | | | |
|-------------------------------|--|---|----|----|---|
| | | RADIO BEARER RECONFIGURATION COMPLETE <i>Target state</i> <i>CELL_DCH</i> | 10 | NA | N2 cannot be specified, because the PHYSICAL CHANNEL RECONFIGURATION COMPLETE / FAILURE message is transmitted only after physical layer synchronisation, which depends also on Node B. |
| | | RADIO BEARER RELEASE COMPLETE <i>Target state</i> <i>CELL_DCH</i> | 10 | 11 | |
| URA update | URA UPDATE CONFIRM | UTRAN MOBILITY INFORMATION CONFIRM | 5 | 8 | |
| UTRAN mobility information | UTRAN MOBILITY INFORMATION | UTRAN MOBILITY INFORMATION CONFIRM / FAILURE | 5 | 8 | |
| Active set update | ACTIVE SET UPDATE | ACTIVE SET UPDATE COMPLETE / FAILURE | NA | 8 | The requirements on UE combining and power control performance for both UL and DL are specified by RAN WG4 in [21] and [19]. Also in case of branch addition the COMPLETE / FAILURE message is transmitted without waiting for the new branch to stabilise, therefore N2 is specified. |
| Inter-RAT handover to UTRAN | HANDOVER TO UTRAN COMMAND (other system) | HANDOVER TO UTRAN COMPLETE | NA | NA | The performance of this procedure is specified in 05.10. |
| Inter-RAT handover from UTRAN | HANDOVER FROM UTRAN COMMAND | HANDOVER FROM UTRAN FAILURE | NA | NA | The performance of this procedure is specified in [19] and [20]. |
| Measurement procedures | | | | | |
| Measurement control | MEASUREMENT CONTROL | MEASUREMENT CONTROL FAILURE | 5 | 8 | Response to measurement inquiry depends on physical layer measurement. Response time is defined in [19] and [20]. N1 and N2 only define the processing of the message. |

13.6 RB information parameters for signalling radio bearer RB 0

The following Radio Bearer parameter values apply for signalling radio bearer RB0:

| Information element/ Group name | Value | Comment |
|---------------------------------|---------|---|
| RLC info | | |
| >Uplink RLC mode | TM | |
| >>Transmission RLC discard | omitted | Neither discard is used, nor will there be a reset |
| >>Segmentation indication | FALSE | |
| >Downlink RLC mode | UM | |
| RB mapping info | | Single multiplexing option |
| >Uplink mapping info | | |
| >>UL transport channel | RACH | RACH corresponding with selected PRACH |
| >>RLC size list | N/A | The first TB defined in the Transport Format Set for the transport channel that is used |
| >Downlink mapping info | | |
| >>DL transport channel | FACH | |

13.6a RB information parameters for SHCCH

The following Radio Bearer parameter values apply for SHCCH:

| Information element/ Group name | Value | Comment |
|---------------------------------|---------|---|
| RLC info | | |
| >Uplink RLC mode | TM | |
| >>Transmission RLC discard | omitted | Neither discard is used, nor will there be a reset |
| >>Segmentation indication | FALSE | |
| >Downlink RLC mode | UM | |
| RB mapping info | | |
| >Uplink mapping info | | Option 1 |
| >>UL transport channel | RACH | RACH corresponding with selected PRACH |
| >>RLC size list | N/A | The first TB defined in the Transport Format Set for the transport channel that is used |
| >Downlink mapping info | | |
| >>DL transport channel | FACH | |
| >Uplink mapping info | | Option 2 |
| >>UL transport channel | USCH | |
| >>UL Transport Channel Identity | 1 | |
| >>MAC logical channel priority | 1 | |
| >>RLC size list | N/A | The first TB defined in the Transport Format Set for the transport channel that is used |
| >Downlink mapping info | | |
| >>DL transport channel | DSCH | |
| >>DL Transport Channel Identity | 1 | |

13.6b RB information parameters for BCCH mapped to FACH

The following Radio Bearer parameter values apply for BCCH mapped to FACH:

| Information element/ Group name | Value | Comment |
|---------------------------------|-------|---------|
| Downlink RLC mode | TM | |
| Segmentation indication | FALSE | |

13.6c RB information parameters for PCCH mapped to PCH

The following Radio Bearer parameter values apply for PCCH mapped to PCH:

| Information element/ Group name | Value | Comment |
|---------------------------------|-------|---------|
| Downlink RLC mode | TM | |
| Segmentation indication | FALSE | |

13.6d Parameters for BCCH mapped to BCH

The transport format parameters for BCH are specified in [34].

13.7 Parameter values for default radio configurations

The UE shall support the use of the default radio configurations that are specified in the following.

NOTE 1: These configurations are based on [41] and cover a number of RAB and signalling connection configurations.

In the table that is used to specify the parameter values for these default configurations, the following principles are used:

- Optional IEs that are not used are omitted;
- In case no parameter value is specified in a column, this means the value given the previous (left side) column applies.

NOTE 2: If needed, signalling radio bearer RB4 is established after the completion of handover.

NOTE 3: For each default configuration, the value of both FDD and TDD parameters are specified. All parameters apply to both FDD and TDD modes, unless explicitly stated otherwise. It should be noted that in this respect default configurations differ from pre-defined configurations, which only include parameter values for one mode.

NOTE 4: The transport format sizes, indicated in the following table, concern the RLC PDU size, since all configurations concern dedicated channels. The transport block sizes indicated in TS 34.108 are different since these include the size of the MAC header.

| Configuration | 3.4 kbps signalling | 13.6 kbps signalling | 7.95 kbps speech + 3.4 kbps signalling | 12.2 kbps speech + 3.4 kbps signalling |
|--------------------------------|---------------------------------|---------------------------------|--|--|
| Ref 34.108 | 2 | 3 | 6 | 4 |
| Default configuration identity | 0 | 1 | 2 | 3 |
| RB INFORMATION | | | | |
| rb-Identity | RB1: 1, RB2: 2, RB3: 3 | RB1: 1, RB2: 2, RB3: 3 | RB1: 1, RB2: 2, RB3: 3, RB5: 5, RB6: 6 | RB1: 1, RB2: 2, RB3: 3, RB5: 5, RB6: 6, RB7: 7 |
| rlc-InfoChoice | Rlc-info | Rlc-info | Rlc-info | Rlc-info |
| >ul-RLC-Mode | RB1: UM RB2- RB3: AM | RB1: UM RB2- RB3: AM | RB1: UM RB2- RB3: AM RB5-RB6: TM | RB1: UM RB2- RB3: AM RB5-RB7: TM |
| >>transmissionRLC-DiscardMode | RB1: N/A RB2- RB3: NoDiscard | RB1: N/A RB2- RB3: NoDiscard | RB1: N/A RB2- RB3: NoDiscard RB5- RB6: N/A | RB1: N/A RB2- RB3: NoDiscard RB5- RB7: N/A |
| >>>maxDat | RB1: N/A RB2- RB3: 15 | RB1: N/A RB2- RB3: 15 | RB1: N/A RB2- RB3: 15 RB5- RB6: N/A | RB1: N/A RB2- RB3: 15 RB5- RB7: N/A |
| >>transmissionWindowSize | RB1: N/A RB2- RB3: 128 | RB1: N/A RB2- RB3: 128 | RB1: N/A RB2- RB3: 128 RB5- RB6: N/A | RB1: N/A RB2- RB3: 128 RB5- RB7: N/A |
| >>timerRST | RB1: N/A RB2- RB3: 300 | RB1: N/A RB2- RB3: 300 | RB1: N/A RB2- RB3: 300 RB5- RB6: N/A | RB1: N/A RB2- RB3: 300 RB5- RB7: N/A |
| >>max-RST | RB1: N/A RB2- RB3: 1 | RB1: N/A RB2- RB3: 1 | RB1: N/A RB2- RB3: 1 RB5- RB6: N/A | RB1: N/A RB2- RB3: 1 RB5- RB7: N/A |
| >>pollingInfo | RB1: N/A RB2- RB3: as below | RB1: N/A RB2- RB3: as below | RB1: N/A RB2- RB3: as below RB5- RB6: N/A | RB1: N/A RB2- RB3: as below RB5- RB7: N/A |
| >>>lastTransmissionPUPoll | RB2- RB3: FALSE | RB2- RB3: FALSE | RB2- RB3: FALSE | RB2- RB3: FALSE |
| >>>lastRetransmissionPUPoll | RB2- RB3: FALSE | RB2- RB3: FALSE | RB2- RB3: FALSE | RB2- RB3: FALSE |
| >>>timerPollPeriodic | RB2- RB3: 100 | RB2- RB3: 100 | RB2- RB3: 100 | RB2- RB3: 100 |
| >>segmentationIndication | RB1- RB3: N/A | RB1- RB3: N/A | RB1- RB3: N/A RB5- RB6: FALSE | RB1- RB3: N/A RB5- RB7: FALSE |
| >dl-RLC-Mode | RB1: UM RB2- RB3: AM | RB1: UM RB2- RB3: AM | RB1: UM RB2- RB3: AM RB5- RB6: TM | RB1: UM RB2- RB3: AM RB5- RB7: TM |
| >>inSequenceDelivery | RB1: N/A RB2- RB3: TRUE | RB1: N/A RB2- RB3: TRUE | RB1: N/A RB2- RB3: TRUE RB5- RB6: N/A | RB1: N/A RB2- RB3: TRUE RB5- RB7: N/A |
| >>receivingWindowSize | RB1: N/A RB2- RB3: 128 | RB1: N/A RB2- RB3: 128 | RB1: N/A RB2- RB3: 128 RB5- RB6: N/A | RB1: N/A RB2- RB3: 128 RB5- RB7: N/A |
| >>>dl-RLC-StatusInfo | RB1: N/A RB2- RB3: as below | RB1: N/A RB2- RB3: as below | RB1: N/A RB2- RB3: as below RB5- RB6: N/A | RB1: N/A RB2- RB3: as below RB5- RB7: N/A |
| >>>timerStatusProhibit | RB2- RB3: 100 | RB2- RB3: 100 | RB2- RB3: 100 | RB2- RB3: 100 |
| >>>missingPU-Indicator | RB2- RB3: FALSE | RB2- RB3: FALSE | RB2- RB3: FALSE | RB2- RB3: FALSE |
| >>>timerStatusPeriodic | RB2- RB3: 100 | RB2- RB3: 100 | RB2- RB3: 100 | RB2- RB3: 100 |
| >>segmentationIndication | RB1- RB3: N/A | RB1- RB3: N/A | RB1- RB3: N/A RB5- RB6: FALSE | RB1- RB3: N/A RB5- RB7: FALSE |
| rb-MappingInfo | | | | |
| >UL-LogicalChannelMappings | OneLogicalChannel | OneLogicalChannel | OneLogicalChannel | OneLogicalChannel |
| >>ul-TransportChannelType | Dch | Dch | Dch | Dch |
| >>>transportChannelIdentity | RB1- RB3: 1 | RB1- RB3: 1 | RB1- RB3: 3 RB5: 1, RB6: 2 | RB1- RB3: 4 RB5: 1, RB6: 2, RB7: 3 |

| | | | | |
|-------------------------------|---|---|--|--|
| >>logicalChannelIdentity | RB1: 1, RB2: 2, RB3: 3 | RB1: 1, RB2: 2, RB3: 3 | RB1: 1, RB2: 2, RB3: 3 RB5- RB6: N/A | RB1: 1, RB2: 2, RB3: 3 RB5- RB7: N/A |
| >>rlc-SizeList | RB1- RB3: all | RB1- RB3: all | RB1- RB3: all RB5- RB6: N/A | RB1- RB3: all RB5- RB7: N/A |
| >>mac-LogicalChannelPriority | RB1: 1, RB2: 2, RB3: 3 | RB1: 1, RB2: 2, RB3: 3 | RB1: 1, RB2: 2, RB3: 3 RB5- RB6: 5 | RB1: 1, RB2: 2, RB3: 3 RB5- RB7: 5 |
| >DL-logicalChannelMappingList | | | | |
| >>Mapping option 1 | One mapping option | One mapping option | One mapping option | One mapping option |
| >>>dl-TransportChannelType | Dch | Dch | Dch | Dch |
| >>>>transportChannelIdentity | RB1- RB3: 1 | RB1- RB3: 1 | RB1- RB3: 3 RB5: 1, RB6: 2 | RB1- RB3: 4 RB5: 1, RB6: 2, RB7: 3 |
| >>>>logicalChannelIdentity | RB1: 1, RB2: 2, RB3: 3 | RB1: 1, RB2: 2, RB3: 3 | RB1: 1, RB2: 2, RB3: 3 RB5- RB6: N/A | RB1: 1, RB2: 2, RB3: 3 RB5- RB7: N/A |
| TrCH INFORMATION PER TrCH | | | | |
| UL-AddReconfTransChInfoList | | | | |
| >transportChannelIdentity | TrCH1: 1 | TrCH1: 1 | TrCH1: 1, TrCH2: 2, TrCH3: 3 | TrCH1: 1, TrCH2: 2, TrCH3: 3, TrCH4: 4 |
| >transportFormatSet | DedicatedTransChTFS | DedicatedTransChTFS | DedicatedTransChTFS | DedicatedTransChTFS |
| >>dynamicTF-information | | | | |
| >>>tf0/ tf0,1 | TrCH1: (0x144, 1x144) | TrCH1: (0x144, 1x144) | TrCH1: (0x75) TrCH2: (0x 84 1x84) TrCH3: (0x144, 1x144) | TrCH1: (0x81) TrCH2: (0x 103, 1x103) TrCH3: (0x 60, 1x60) TrCH4: (0x144, 1x144) |
| >>>>rlcSize | BitMode | BitMode | BitMode | BitMode |
| >>>>>sizeType | TrCH1: type 2, part1= 2, part2= 0 (144) | TrCH1: type 2, part1= 2, part2= 0 (144) | TrCH1: type 1: 75 TrCH2: type 1: 84 TrCH3: 2: type 2, part1= 2, part2= 0 (144) | TrCH1: type 1: 81 TrCH2: type 1: 103 TrCH3: type 1: 60 TrCH4: 2: type 2, part1= 2, part2= 0 (144) |
| >>>>>numberOfTbSizeList | TrCH1: Zero, one | TrCH1: Zero, one | TrCH1: Zero TrCH2-3: Zero, one | TrCH1: Zero TrCH2-4: Zero, one |
| >>>>>logicalChannelList | All | All | All | All |
| >>>>tf 1 | N/A | N/A | TrCH1: (1x39) TrCH2- TrCH4: N/A | TrCH1: (1x39) TrCH2- TrCH4: N/A |
| >>>>>numberOfTransportBlocks | | | TrCH1: One | TrCH1: One |
| >>>>>rlc-Size | | | TrCH1: BitMode | TrCH1: BitMode |
| >>>>>>sizeType | | | TrCH1: 1: 39 | TrCH1: 1: 39 |
| >>>>>>numberOfTbSizeList | | | TrCH1: One | TrCH1: One |
| >>>>>>logicalChannelList | | | TrCH1: all | TrCH1: all |
| >>>>>tf 2 | N/A | N/A | TrCH1: (1x75) TrCH2- TrCH3: N/A | TrCH1: (1x81) TrCH2- TrCH4: N/A |
| >>>>>>numberOfTransportBlocks | | | TrCH1: Zero | TrCH1: Zero |
| >>>>>>rlc-Size | | | TrCH1: BitMode | TrCH1: BitMode |
| >>>>>>>sizeType | | | TrCH1: type 1: 75 | TrCH1: type 1: 81 |
| >>>>>>>numberOfTbSizeList | | | TrCH1: One | TrCH1: One |
| >>>>>>>logicalChannelList | | | TrCH1: all | TrCH1: all |
| >>>>tti | TrCH1: 40 | TrCH1: 10 | TrCH1- TrCH2: 20 TrCH3: 40 | TrCH1- TrCH3: 20 TrCH4: 40 |
| >>>>channelCodingType | Convolutional | Convolutional | Convolutional | Convolutional |

| | | | | |
|---|---------------------------|---------------------------|---|---|
| >>>>codingRate | TrCH1: Third | TrCH1: Third | TrCH1- TrCH2: Third TrCH3: Third | TrCH1- TrCH2: Third TrCH3: Half TrCH4: Third |
| >>>rateMatchingAttribute | TrCH1: 160 | TrCH1: 160 | TrCH1: 200 TrCH2: 190 TrCH3: 160 | TrCH1: 200 TrCH2: 190 TrCH3: 235 TrCH4: 160 |
| >>>crc-Size | TrCH1: 16 | TrCH1: 16 | TrCH1: 12 TrCH2: 0 TrCH3: 16 | TrCH1: 12 TrCH2- TrCH3: 0 TrCH4: 16 |
| DL- AddReconfTransChInfoList | | | | |
| >dl- TransportChannelIdentity (should be as for UL) | TrCH1: 1 | TrCH1: 1 | TrCH1: 1, TrCH2: 2, TrCH3: 3 | TrCH1: 1, TrCH2: 2, TrCH3: 3, TrCH4: 4 |
| >tfs-SignallingMode | SameAsUL | SameAsUL | Independent <Only tf0 on TrCH1 is different and shown below> | Independent <Only tf0 on TrCH1 is different and shown below> |
| >>transportFormatSet | | | DedicatedTransChT FS | DedicatedTransChT FS |
| >>>dynamicTF-information | | | | |
| >>>>tf0/ tf0,1 | | | TrCH1: (1x0) | TrCH1: (1x0) |
| >>>>rlcSize | | | BitMode | bitMode |
| >>>>>sizeType | | | TrCH1: type 1: 0 | TrCH1: type 1: 0 |
| >>>>numberOfTbSizeList | | | TrCH1: One | TrCH1: One |
| >>>>logicalChannelList | | | All | All |
| >>ULTrCH-Id | TrCH1: 1 | TrCH1: 1 | TrCH1: 1, TrCH2: 2, TrCH3: 3 | TrCH1: 1, TrCH2: 2, TrCH3: 3, TrCH4: 4 |
| >dch-QualityTarget | | | | |
| >>bler-QualityValue | TrCH1: 5×10^{-2} | TrCH1: 5×10^{-2} | TrCH1: 7×10^{-3} TrCH2- TrCH3: Absent | TrCH1: 7×10^{-3} TrCH2- TrCH4: Absent |
| TrCH INFORMATION, COMMON | | | | |
| ul-CommonTransChInfo | | | | |
| >tfs-ID (TDD only) | 1 | 1 | 1 | 1 |
| >sharedChannelIndicator (TDD only) | FALSE | FALSE | FALSE | FALSE |
| >tfc-Subset | Absent, not required | Absent, not required | Absent, not required | Absent, not required |
| >ul-TFCS | Normal TFCI signalling | Normal TFCI signalling | Normal TFCI signalling | Normal TFCI signalling |
| >>explicitTFCS- ConfigurationMode | Complete | Complete | Complete | Complete |
| >>>ctfcSize | Ctfc2Bit | Ctfc2Bit | Ctfc4Bit | Ctfc6Bit |
| >>>>TFCS representation | Addition | Addition | Addition | Addition |
| >>>>>TFCS list | | | | |
| >>>>>>TFCS 1 | (TF0) | (TF0) | (TF0, TF0, TF0) | (TF0, TF0, TF0, TF0) |
| >>>>>>>ctfc | 0 | 0 | 0 | 0 |
| >>>>>>>gainFactorInform ation | Computed | Computed | Computed | Computed |
| >>>>>>>>referenceTFCId | 0 | 0 | 0 | 0 |
| >>>>>>>>TFCS 2 | (TF1) | (TF1) | (TF1, TF0, TF0) | (TF1, TF0, TF0, TF0) |
| >>>>>>>>ctfc | 1 | 1 | 1 | 1 |
| >>>>>>>>gainFactorInform ation | Signalled | Signalled | Computed | Computed |
| >>>>>>>>> β c (FDD only) | 11 | 11 | N/A | N/A |
| >>>>>>>>> β d | 15 | 15 | N/A | N/A |
| >>>>>>>>>>referenceTFCId | N/A | N/A | 0 | 0 |
| >>>>>>>>>>TFCS 3 | | | (TF2, TF1, TF0) | (TF2, TF1, TF1, TF0) |
| >>>>>>>>>>>ctfc | | | 5 | 11 |

| | | | | |
|-----------------------------|-------------------|-------------------|-------------------|----------------------|
| >>>>>>gainFactorInformation | | | Computed | Computed |
| >>>>>>referenceTFCId | | | 0 | 0 |
| >>>>>>TFCS 4 | | | (TF0, TF0, TF1) | (TF0, TF0, TF0, TF1) |
| >>>>>>ctfc | | | 6 | 12 |
| >>>>>>gainFactorInformation | | | Computed | Computed |
| >>>>>>βc (FDD only) | | | N/A | N/A |
| >>>>>>βd | | | N/A | N/A |
| >>>>>>referenceTFCId | | | 0 | 0 |
| >>>>>>TFCS 5 | | | (TF1, TF0, TF1) | (TF1, TF0, TF0, TF1) |
| >>>>>>ctfc | | | 7 | 13 |
| >>>>>>gainFactorInformation | | | Computed | Computed |
| >>>>>>referenceTFCId | | | 0 | 0 |
| >>>>>>TFCS 6 | | | (TF2, TF1, TF1) | (TF2, TF1, TF1, TF1) |
| >>>>>>ctfc | | | 11 | 23 |
| >>>>>>gainFactorInformation | | | Signalled | Signalled |
| >>>>>>βc (FDD only) | | | 11 | 11 |
| >>>>>>βd | | | 15 | 15 |
| >>>>>>referenceTFCId | | | 0 | 0 |
| dl-CommonTransChInfo | | | | |
| >tfcS-SignallingMode | Same as UL | Same as UL | Same as UL | Same as UL |
| PhyCH INFORMATION FDD | | | | |
| UL-DPCH-InfoPredef | | | | |
| >ul-DPCH-PowerControlInfo | | | | |
| >>powerControlAlgorithm | Algorithm 1 | Algorithm 1 | Algorithm 1 | Algorithm 1 |
| >>>tpcStepSize | 1 | 1 | 1 | 1 |
| >tfcI-Existence | TRUE | TRUE | TRUE | TRUE |
| >puncturingLimit | 1 | 1 | 1 | 0.88 |
| DL-CommonInformationPredef | | | | |
| >dl-DPCH-InfoCommon | | | | |
| >>spreadingFactor | 256 | 128 | 128 | 128 |
| >>pilotBits | 4 | 4 | 4 | 4 |
| >>positionFixed | N/A | N/A | Fixed | Fixed |
| PhyCH INFORMATION TDD | | | | |
| UL-DPCH-InfoPredef | | | | |
| >ul-DPCH-PowerControlInfo | | | | |
| >>dpch-ConstantValue | -20 | -20 | -20 | -20 |
| >commonTimeslotInfo | | | | |
| >>secondInterleavingMode | frameRelated | frameRelated | frameRelated | frameRelated |
| >>tfcI-Coding | 4 | 4 | 16 | 16 |
| >>puncturingLimit | 0.80 | 0.80 | 0.80 | 0.80 |
| >>repetitionPeriodAndLength | repetitionPeriod1 | repetitionPeriod1 | repetitionPeriod1 | repetitionPeriod1 |
| DL-CommonInformationPredef | | | | |
| >dl-DPCH-InfoCommon | | | | |
| >>commonTimeslotInfo | | | | |
| >>>secondInterleavingMode | frameRelated | frameRelated | frameRelated | frameRelated |
| >>>tfcI-Coding | 4 | 4 | 16 | 16 |
| >>>puncturingLimit | 0.74 | 0.74 | 0.80 | 0.80 |

| | | | | |
|------------------------------|-------------------|-------------------|-------------------|-------------------|
| >>>repetitionPeriodAndLength | repetitionPeriod1 | repetitionPeriod1 | repetitionPeriod1 | repetitionPeriod1 |
|------------------------------|-------------------|-------------------|-------------------|-------------------|

| Configuration | 28.8 kbps conv. CS- data + 3.4 kbps signalling | 32 kbps conv. CS- data + 3.4 kbps signalling | 64kbps conv. CS- data + 3.4 kbps signalling | 14.4 kbps streaming CS- data + 3.4 kbps signalling |
|--------------------------------|--|--|---|--|
| Ref 34.108 | 12 | 14 | 13 | 15 |
| Default configuration identity | 4 | 5 | 6 | 7 |
| RB INFORMATION | | | | |
| rb-Identity | RB1: 1, RB2: 2, RB3: 3, RB5: 5 | RB1: 1, RB2: 2, RB3: 3, RB5: 5 | RB1: 1, RB2: 2, RB3: 3, RB5: 5 | RB1: 1, RB2: 2, RB3: 3, RB5: 5 |
| rlc-InfoChoice | Rlc-info | Rlc-info | Rlc-info | Rlc-info |
| >ul-RLC-Mode | RB1: UM RB2- RB3: AM RB5: TM | RB1: UM RB2- RB3: AM RB5: TM | RB1: UM RB2- RB3: AM RB5: TM | RB1: UM RB2- RB3: AM RB5: TM |
| >>transmissionRLC-DiscardMode | RB1: N/A RB2- RB3: NoDiscard RB5: N/A | RB1: N/A RB2- RB3: NoDiscard RB5: N/A | RB1: N/A RB2- RB3: NoDiscard RB5: N/A | RB1: N/A RB2- RB3: NoDiscard RB5: N/A |
| >>>maxDat | RB1: N/A RB2- RB3: 15 RB5: N/A | RB1: N/A RB2- RB3: 15 RB5: N/A | RB1: N/A RB2- RB3: 15 RB5: N/A | RB1: N/A RB2- RB3: 15 RB5: N/A |
| >>transmissionWindowSize | RB1: N/A RB2- RB3: 128 RB5: N/A | RB1: N/A RB2- RB3: 128 RB5: N/A | RB1: N/A RB2- RB3: 128 RB5: N/A | RB1: N/A RB2- RB3: 128 RB5: N/A |
| >>timerRST | RB1: N/A RB2- RB3: 300 RB5: N/A | RB1: N/A RB2- RB3: 300 RB5: N/A | RB1: N/A RB2- RB3: 300 RB5: N/A | RB1: N/A RB2- RB3: 300 RB5: N/A |
| >>max-RST | RB1: N/A RB2- RB3: 1 RB5: N/A | RB1: N/A RB2- RB3: 1 RB5: N/A | RB1: N/A RB2- RB3: 1 RB5: N/A | RB1: N/A RB2- RB3: 1 RB5: N/A |
| >>pollingInfo | RB1: N/A RB2- RB3: as below RB5: N/A | RB1: N/A RB2- RB3: as below RB5: N/A | RB1: N/A RB2- RB3: as below RB5: N/A | RB1: N/A RB2- RB3: as below RB5: N/A |
| >>>lastTransmissionPUPoll | RB2- RB3: FALSE | RB2- RB3: FALSE | RB2- RB3: FALSE | RB2- RB3: FALSE |
| >>>lastRetransmissionPUPoll | RB2- RB3: FALSE | RB2- RB3: FALSE | RB2- RB3: FALSE | RB2- RB3: FALSE |
| >>>timerPollPeriodic | RB2- RB3: 100 | RB2- RB3: 100 | RB2- RB3: 100 | RB2- RB3: 100 |
| >>segmentationIndication | RB1- RB3: N/A RB5: FALSE | RB1- RB3: N/A RB5: FALSE | RB1- RB3: N/A RB5: FALSE | RB1- RB3: N/A RB5: FALSE |
| >dl-RLC-Mode | RB1: UM RB2- RB3: AM RB5: TM | RB1: UM RB2- RB3: AM RB5: TM | RB1: UM RB2- RB3: AM RB5: TM | RB1: UM RB2- RB3: AM RB5: TM |
| >>inSequenceDelivery | RB1: N/A RB2- RB3: TRUE RB5: N/A | RB1: N/A RB2- RB3: TRUE RB5: N/A | RB1: N/A RB2- RB3: TRUE RB5: N/A | RB1: N/A RB2- RB3: TRUE RB5: N/A |
| >>receivingWindowSize | RB1: N/A RB2- RB3: 128 RB5: N/A | RB1: N/A RB2- RB3: 128 RB5: N/A | RB1: N/A RB2- RB3: 128 RB5: N/A | RB1: N/A RB2- RB3: 128 RB5: N/A |
| >>dl-RLC-StatusInfo | RB1: N/A RB2- RB3: as below RB5: N/A | RB1: N/A RB2- RB3: as below RB5: N/A | RB1: N/A RB2- RB3: as below RB5: N/A | RB1: N/A RB2- RB3: as below RB5: N/A |
| >>>timerStatusProhibit | RB2- RB3: 100 | RB2- RB3: 100 | RB2- RB3: 100 | RB2- RB3: 100 |
| >>>missingPUIndicator | RB2- RB3: FALSE | RB2- RB3: FALSE | RB2- RB3: FALSE | RB2- RB3: FALSE |
| >>>timerStatusPeriodic | RB2- RB3: 100 | RB2- RB3: 100 | RB2- RB3: 100 | RB2- RB3: 100 |
| >>segmentationIndication | RB1- RB3: N/A RB5: FALSE | RB1- RB3: N/A RB5: FALSE | RB1- RB3: N/A RB5: FALSE | RB1- RB3: N/A RB5: FALSE |
| rb-MappingInfo | | | | |
| >UL-LogicalChannelMappings | OneLogicalChannel | OneLogicalChannel | OneLogicalChannel | OneLogicalChannel |
| >>ul-TransportChannelType | Dch | Dch | Dch | Dch |
| >>>transportChannelIdentity | RB1- RB3: 2 RB5: 1 | RB1- RB3: 2 RB5: 1 | RB1- RB3: 2 RB5: 1 | RB1- RB3: 2 RB5: 1 |

| | | | | |
|--|---|---|---|--|
| >>logicalChannelIdentity | RB1: 1, RB2: 2, RB3: 3 RB5: N/A | RB1: 1, RB2: 2, RB3: 3 RB5: N/A | RB1: 1, RB2: 2, RB3: 3 RB5: N/A | RB1: 1, RB2: 2, RB3: 3 RB5: N/A |
| >>rlc-SizeList | RB1- RB3: all RB5: N/A | RB1- RB3: all RB5: N/A | RB1- RB3: all RB5: N/A | RB1- RB3: all RB5: N/A |
| >>mac-LogicalChannelPriority | RB1: 1, RB2: 2, RB3: 3 RB5: 5 | RB1: 1, RB2: 2, RB3: 3 RB5: 5 | RB1: 1, RB2: 2, RB3: 3 RB5: 5 | RB1: 1, RB2: 2, RB3: 3 RB5: 5 |
| >DL-logicalChannelMappingList | | | | |
| >>Mapping option 1 | One mapping option | One mapping option | One mapping option | One mapping option |
| >>>dl-TransportChannelType | Dch | Dch | Dch | Dch |
| >>>>transportChannelIdentity | RB1- RB3: 2 RB5: 1 | RB1- RB3: 2 RB5: 1 | RB1- RB3: 2 RB5: 1 | RB1- RB3: 2 RB5: 1 |
| >>>>logicalChannelIdentity | RB1: 1, RB2: 2, RB3: 3 RB5: N/A | RB1: 1, RB2: 2, RB3: 3 RB5: N/A | RB1: 1, RB2: 2, RB3: 3 RB5: N/A | RB1: 1, RB2: 2, RB3: 3 RB5: N/A |
| TrCH INFORMATION PER TrCH | | | | |
| UL-AddReconfTransChInfoList | | | | |
| >transportChannelIdentity | TrCH1: 1, TrCH2: 2 | TrCH1: 1, TrCH2: 2 | TrCH1: 1, TrCH2: 2 | TrCH1: 1, TrCH2: 2 |
| >transportFormatSet | DedicatedTransChTFS | DedicatedTransChTFS | DedicatedTransChTFS | DedicatedTransChTFS |
| >>dynamicTF-information | | | | |
| >>>>tf0/ tf0,1 | TrCH1: (0x576, 1x576, 2x576) TrCH2: (0x144, 1x144) | TrCH1: (0x640, 1x640) TrCH2: (0x144, 1x144) | TrCH1: (0x640, 2x640) TrCH2: (0x144, 1x144) | TrCH1: (0x576, 1x576) TrCH2: (0x144, 1x144) |
| >>>>>rlcSize | TrCH1: OctetMode TrCH2:BitMode | TrCH1: OctetMode TrCH2:BitMode | TrCH1: OctetMode TrCH2:BitMode | TrCH1: OctetMode TrCH2:BitMode |
| >>>>>>sizeType | TrCH1: type 2, part1= 11, part2= 2 (576) TrCH2: type 2, part1= 2, part2= 0 (144) | TrCH1: type 2, part1= 11, part2= 2 (640) TrCH2: type 2, part1= 2, part2= 0 (144) | TrCH1: type 2, part1= 11, part2= 2 (640) TrCH2: type 2, part1= 2, part2= 0 (144) | TrCH1: type 2, part1= 9, part2= 2 (576) TrCH2: type 2, part1= 2, part2= 0 (144) |
| >>>>>>numberOfTbSizeList | TrCH1: Zero,1, 2 (4) TrCH2: Zero, one | TrCH1: Zero, one TrCH2: Zero, one | TrCH1: Zero, 2 (4) TrCH2: Zero, one | TrCH1: Zero, one, TrCH2: Zero, one |
| >>>>>>logicalChannelList | All | All | All | All |
| >>semiStaticTF-Information | | | | |
| >>>>tti | TrCH1: 40 TrCH2: 40 | TrCH1: 20 TrCH2: 40 | TrCH1: 20 TrCH2: 40 | TrCH1: 40 TrCH2: 40 |
| >>>>channelCodingType | TrCH1: Turbo TrCH2: Convolutional | TrCH1: Turbo TrCH2: Convolutional | TrCH1: Turbo TrCH2: Convolutional | TrCH1: Turbo TrCH2: Convolutional |
| >>>>>codingRate | TrCH1: N/A TrCH2: Third | TrCH1: N/A TrCH2: Third | TrCH1: N/A TrCH2: Third | TrCH1: N/A TrCH2: Third |
| >>>>>>rateMatchingAttribute | TrCH1: 180 TrCH2: 160 | TrCH1: 185 TrCH2: 160 | TrCH1: 170 TrCH2: 160 | TrCH1: 165 TrCH2: 160 |
| >>>>>>>crc-Size | TrCH1: 16 TrCH2: 16 | TrCH1: 16 TrCH2: 16 | TrCH1: 16 TrCH2: 16 | TrCH1: 16 TrCH2: 16 |
| DL-AddReconfTransChInfoList | | | | |
| >dl-TransportChannelIdentity (should be as for UL) | TrCH1: 1, TrCH2: 2 | TrCH1: 1, TrCH2: 2 | TrCH1: 1, TrCH2: 2 | TrCH1: 1, TrCH2: 2 |
| >tfs-SignallingMode | SameAsUL | SameAsUL | SameAsUL | SameAsUL |
| >>transportFormatSet | | | | |
| >>>>dynamicTF-information | | | | |
| >>>>>>>tf0/ tf0,1 | | | | |
| >>>>>>>>rlcSize | | | | |

| | | | | |
|---|--|--|--|--|
| >>>>sizeType | | | | |
| >>>>numberOfTbSizeList | | | | |
| >>>>logicalChannelList | | | | |
| >>ULTrCH-Id | TrCH1: 1, TrCH2: 2 | TrCH1: 1, TrCH2: 2 | TrCH1: 1, TrCH2: 2 | TrCH1: 1, TrCH2: 2 |
| >dch-QualityTarget | | | | |
| >>bler-QualityValue | TrCH1: 2×10^{-3} TrCH2: Absent | TrCH1: 2×10^{-3} TrCH2: Absent | TrCH1: 2×10^{-3} TrCH2: Absent | TrCH1: 1×10^{-2} TrCH2: Absent |
| TrCH INFORMATION, COMMON | | | | |
| ul-CommonTransChInfo | | | | |
| >tfc-ID (TDD only) | 1 | 1 | 1 | 1 |
| >sharedChannelIndicator (TDD only) | FALSE | FALSE | FALSE | FALSE |
| >tfc-Subset | Absent, not required | Absent, not required | Absent, not required | Absent, not required |
| >ul-TFCS | Normal TFCI signalling | Normal TFCI signalling | Normal TFCI signalling | Normal TFCI signalling |
| >>explicitTFCS- ConfigurationMode | Complete | Complete | Complete | Complete |
| >>>ctfcSize | Ctfc2Bit | Ctfc2Bit | Ctfc2Bit | Ctfc4Bit |
| >>>>TFCS representation | Addition | Addition | Addition | Addition |
| >>>>>TFCS list | | | | |
| >>>>>>TFCS 1 | (TF0, TF0) | (TF0, TF0) | (TF0, TF0) | (TF0, TF0) |
| >>>>>>>ctfc | 0 | 0 | 0 | 0 |
| >>>>>>>>gainFactorInform ation | Computed | Computed | Computed | Computed |
| >>>>>>>>>referenceTFCl d | 0 | 0 | 0 | 0 |
| >>>>>>>>>TFCS 2 | (TF1, TF0) | (TF1, TF0) | (TF1, TF0) | (TF1, TF0) |
| >>>>>>>>>ctfc | 1 | 1 | 1 | 1 |
| >>>>>>>>>>gainFactorInform ation | Computed | Computed | Computed | Computed |
| >>>>>>>>>>>>βc (FDD only) | N/A | N/A | N/A | N/A |
| >>>>>>>>>>>>βd | N/A | N/A | N/A | N/A |
| >>>>>>>>>>>>>referenceTFCl d | 0 | 0 | 0 | 0 |
| >>>>>>>>>>>>>TFCS 3 | (TF2, TF0) | (TF0, TF1) | (TF0, TF1) | (TF0, TF1) |
| >>>>>>>>>>>>>>ctfc | 2 | 2 | 2 | 2 |
| >>>>>>>>>>>>>>>gainFactorInform ation | Computed | Computed | Computed | Computed |
| >>>>>>>>>>>>>>>>referenceTFCl d | 0 | 0 | 0 | 0 |
| >>>>>>>>>>>>>>>>TFCS 4 | (TF0, TF1) | (TF1, TF1) | (TF1, TF1) | (TF1, TF1) |
| >>>>>>>>>>>>>>>>>ctfc | 3 | 3 | 3 | 3 |
| >>>>>>>>>>>>>>>>>>gainFactorInform ation | Computed | Signalled | Signalled | Signalled |
| >>>>>>>>>>>>>>>>>>>>βc (FDD only) | N/A | 8 | 8 | 11 |
| >>>>>>>>>>>>>>>>>>>>βd | N/A | 15 | 15 | 15 |
| >>>>>>>>>>>>>>>>>>>>>>referenceTFCl d | N/A | N/A | N/A | N/A |
| >>>>>>>>>>>>>>>>>>>>>>TFCS 5 | (TF1, TF1) | N/A | N/A | |
| >>>>>>>>>>>>>>>>>>>>>>>>ctfc | 4 | | | |
| >>>>>>>>>>>>>>>>>>>>>>>>>gainFactorInform ation | Computed | | | |
| >>>>>>>>>>>>>>>>>>>>>>>>>>>>referenceTFCl d | 8 | | | |
| >>>>>>>>>>>>>>>>>>>>>>>>>>>>TFCS 6 | (TF2, TF1) | N/A | N/A | |
| >>>>>>>>>>>>>>>>>>>>>>>>>>>>>>ctfc | 5 | | | |
| >>>>>>>>>>>>>>>>>>>>>>>>>>>>>>>gainFactorInform ation | Signalled | | | |
| >>>>>>>>>>>>>>>>>>>>>>>>>>>>>>>>>βc (FDD only) | 8 | | | |
| >>>>>>>>>>>>>>>>>>>>>>>>>>>>>>>>>βd | 15 | | | |
| >>>>>>>>>>>>>>>>>>>>>>>>>>>>>>>>>>referenceTFCl d | N/A | | | |
| >>>>>>>>>>>>>>>>>>>>>>>>>>>>>>>>>>TFCS 7 | | | | |
| >>>>>>>>>>>>>>>>>>>>>>>>>>>>>>>>>>>ctfc | | | | |
| >>>>>>>>>>>>>>>>>>>>>>>>>>>>>>>>>>>>gainFactorInform ation | | | | |
| >>>>>>>>>>>>>>>>>>>>>>>>>>>>>>>>>>>>>>referenceTFCl d | | | | |
| >>>>>>>>>>>>>>>>>>>>>>>>>>>>>>>>>>>>>>>TFCS 8 | | | | |

| | | | | |
|------------------------------|-------------------|-------------------|-------------------|-------------------|
| >>>>>>ctfc | | | | |
| >>>>>>gainFactorInformation | | | | |
| >>>>>>referenceTFCId | | | | |
| >>>>>>TFCS 9 | | | | |
| >>>>>>ctfc | | | | |
| >>>>>>gainFactorInformation | | | | |
| >>>>>>referenceTFCId | | | | |
| >>>>>>TFCS 10 | | | | |
| >>>>>>ctfc | | | | |
| >>>>>>gainFactorInformation | | | | |
| >>>>>> β_c (FDD only) | | | | |
| >>>>>> β_d | | | | |
| >>>>>>referenceTFCId | | | | |
| dl-CommonTransChInfo | | | | |
| >tfc-SignallingMode | Same as UL | Same as UL | Same as UL | Same as UL |
| PhyCH INFORMATION FDD | | | | |
| UL-DPCH-InfoPredef | | | | |
| >ul-DPCH-PowerControlInfo | | | | |
| >>powerControlAlgorithm | Algorithm 1 | Algorithm 1 | Algorithm 1 | Algorithm 1 |
| >>>tpcStepSize | 1 | 1 | 1 | 1 |
| >tfc-Existence | TRUE | TRUE | TRUE | TRUE |
| >puncturingLimit | 0.92 | 0.8 | 0.92 | 1 |
| DL-CommonInformationPredef | | | | |
| >dl-DPCH-InfoCommon | | | | |
| >>spreadingFactor | 64 | 64 | 32 | 128 |
| >>pilotBits | 8 | 8 | 8 | 8 |
| >>positionFixed | Flexible | Flexible | Flexible | Flexible |
| PhyCH INFORMATION TDD | | | | |
| UL-DPCH-InfoPredef | | | | |
| >ul-DPCH-PowerControlInfo | | | | |
| >>dpch-ConstantValue | -20 | -20 | -20 | -20 |
| >commonTimeslotInfo | | | | |
| >>secondInterleavingMode | frameRelated | frameRelated | frameRelated | frameRelated |
| >>tfc-Coding | 8 | 8 | 8 | 16 |
| >>puncturingLimit | 0.56 | 0.8 | 0.56 | 1 |
| >>repetitionPeriodAndLength | repetitionPeriod1 | repetitionPeriod1 | repetitionPeriod1 | repetitionPeriod1 |
| DL-CommonInformationPredef | | | | |
| >dl-DPCH-InfoCommon | | | | |
| >>commonTimeslotInfo | | | | |
| >>>secondInterleavingMode | frameRelated | frameRelated | frameRelated | frameRelated |
| >>>tfc-Coding | 8 | 8 | 8 | 16 |
| >>>puncturingLimit | 0.52 | 0.52 | 0.52 | 0.46 |
| >>>repetitionPeriodAndLength | repetitionPeriod1 | repetitionPeriod1 | repetitionPeriod1 | repetitionPeriod1 |

| Configuration | 28.8 kbps streaming CS- data + 3.4 kbps signalling | 57.6 kbps streaming CS- data + 3.4 kbps signalling |
|-----------------------------------|---|---|
| Ref 34.108 | 16 | 17 |
| Default configuration identity | 8 | 9 |
| RB INFORMATION | | |
| rb-Identity | RB1: 1, RB2: 2, RB3: 3, RB5: 5 | RB1: 1, RB2: 2, RB3: 3, RB5: 5 |
| rlc-InfoChoice | Rlc-info | Rlc-info |
| >ul-RLC-Mode | RB1: UM RB2- RB3: AM RB5: TM | RB1: UM RB2- RB3: AM RB5: TM |
| >>transmissionRLC- DiscardMode | RB1: N/A RB2- RB3: NoDiscard RB5: N/A | RB1: N/A RB2- RB3: NoDiscard RB5: N/A |
| >>>maxDat | RB1: N/A RB2- RB3: 15 RB5: N/A | RB1: N/A RB2- RB3: 15 RB5: N/A |
| >>transmissionWindowSiz e | RB1: N/A RB2- RB3: 128 RB5: N/A | RB1: N/A RB2- RB3: 128 RB5: N/A |
| >>timerRST | RB1: N/A RB2- RB3: 300 RB5: N/A | RB1: N/A RB2- RB3: 300 RB5: N/A |
| >>max-RST | RB1: N/A RB2- RB3: 1 RB5: N/A | RB1: N/A RB2- RB3: 1 RB5: N/A |
| >>pollingInfo | RB1: N/A RB2- RB3: as below RB5: N/A | RB1: N/A RB2- RB3: as below RB5: N/A |
| >>>lastTransmissionPU- Poll | RB2- RB3: FALSE | RB2- RB3: FALSE |
| >>>lastRetransmissionPU- Poll | RB2- RB3: FALSE | RB2- RB3: FALSE |
| >>>timerPollPeriodic | RB2- RB3: 100 | RB2- RB3: 100 |
| >>segmentationIndication | RB1- RB3: N/A RB5: FALSE | RB1- RB3: N/A RB5: FALSE |
| >dl-RLC-Mode | RB1: UM RB2- RB3: AM RB5: TM | RB1: UM RB2- RB3: AM RB5: TM |
| >>inSequenceDelivery | RB1: N/A RB2- RB3: TRUE RB5: N/A | RB1: N/A RB2- RB3: TRUE RB5: N/A |
| >>receivingWindowSize | RB1: N/A RB2- RB3: 128 RB5: N/A | RB1: N/A RB2- RB3: 128 RB5: N/A |
| >>dl-RLC-StatusInfo | RB1: N/A RB2- RB3: as below RB5: N/A | RB1: N/A RB2- RB3: as below RB5: N/A |
| >>>timerStatusProhibit | RB2- RB3: 100 | RB2- RB3: 100 |
| >>>missingPU-Indicator | RB2- RB3: FALSE | RB2- RB3: FALSE |
| >>>timerStatusPeriodic | RB2- RB3: 100 | RB2- RB3: 100 |
| >>segmentationIndication | RB1- RB3: N/A RB5: FALSE | RB1- RB3: N/A RB5: FALSE |
| rb-MappingInfo | | |
| >UL- LogicalChannelMappings | OneLogicalChannel | OneLogicalChannel |
| >>ul- TransportChannelType | Dch | Dch |
| >>>transportChannelIdenti ty | RB1- RB3: 2 RB5: 1 | RB1- RB3: 2 RB5: 1 |

| | | |
|--|--|--|
| >>logicalChannelIdentity | RB1: 1, RB2: 2, RB3: 3 RB5: N/A | RB1: 1, RB2: 2, RB3: 3 RB5: N/A |
| >>rlc-SizeList | RB1- RB3: all RB5: N/A | RB1- RB3: all RB5: N/A |
| >>mac-LogicalChannelPriority | RB1: 1, RB2: 2, RB3: 3 RB5: 5 | RB1: 1, RB2: 2, RB3: 3 RB5: 5 |
| >DL-logicalChannelMappingList | | |
| >>Mapping option 1 | One mapping option | One mapping option |
| >>>dl-TransportChannelType | Dch | Dch |
| >>>>transportChannelIdentity | RB1- RB3: 2 RB5: 1 | RB1- RB3: 2 RB5: 1 |
| >>>>logicalChannelIdentity | RB1: 1, RB2: 2, RB3: 3 RB5: N/A | RB1: 1, RB2: 2, RB3: 3 RB5: N/A |
| TrCH INFORMATION PER TrCH | | |
| UL-AddReconfTransChInfoList | | |
| >transportChannelIdentity | TrCH1: 1, TrCH2: 2 | TrCH1: 1, TrCH2: 2 |
| >transportFormatSet | DedicatedTransChTFS | DedicatedTransChTFS |
| >>dynamicTF-information | | |
| >>>tf0/ tf0,1 | TrCH1: (0x576, 1x576, 2x576) TrCH2: (0x144, 1x144) | TrCH1: (0x576, 1x576, 2x576, 3x576, 4x576) TrCH2: (0x144, 1x144) |
| >>>>rlcSize | TrCH1: OctetMode TrCH2:BitMode | TrCH1: OctetMode TrCH2:BitMode |
| >>>>>sizeType | TrCH1: type 2, part1= 9, part2= 2 (576) TrCH2: type 2, part1= 2, part2= 0 (144) | TrCH1: type 2, part1= 9, part2= 2 (576) TrCH2: type 2, part1= 2, part2= 0 (144) |
| >>>>>numberOfTbSizeList | TrCH1: Zero, one, 2 TrCH2: Zero, one | TrCH1: Zero, one, 2, 3, 4 TrCH2: Zero, one |
| >>>>>logicalChannelList | All | All |
| >>semiStaticTF-Information | | |
| >>>tti | TrCH1: 40 TrCH2: 40 | TrCH1: 40 TrCH2: 40 |
| >>>>channelCodingType | TrCH1: Turbo TrCH2: Convolutional | TrCH1: Turbo TrCH2: Convolutional |
| >>>>>codingRate | TrCH1: N/A TrCH2: Third | TrCH1: N/A TrCH2: Third |
| >>>>rateMatchingAttribute | TrCH1: 155 TrCH2: 160 | TrCH1: 145 TrCH2: 160 |
| >>>>crc-Size | TrCH1: 16 TrCH2: 16 | TrCH1: 16 TrCH2: 16 |
| DL-AddReconfTransChInfoList | | |
| >dl-TransportChannelIdentity (should be as for UL) | TrCH1: 1, TrCH2: 2 | TrCH1: 1, TrCH2: 2 |
| >tfs-SignallingMode | SameAsUL | SameAsUL |
| >>transportFormatSet | | |
| >>>dynamicTF-information | | |

| | | |
|---------------------------------------|--|--|
| >>>>tf0/ tf0,1 | | |
| >>>>rlcSize | | |
| >>>>>sizeType | | |
| >>>>>numberOfTbSizeList | | |
| >>>>>logicalChannelList | | |
| >>ULTrCH-Id | TrCH1: 1, TrCH2: 2 | TrCH1: 1, TrCH2: 2 |
| >dch-QualityTarget | | |
| >>bler-QualityValue | TrCH1: 1×10^{-2} TrCH2: Absent | TrCH1: 1×10^{-2} TrCH2: Absent |
| TrCH INFORMATION, COMMON | | |
| ul-CommonTransChInfo | | |
| >tfcs-ID (TDD only) | 1 | 1 |
| >sharedChannelIndicator (TDD only) | FALSE | FALSE |
| >tfcs-Subset | Absent, not required | Absent, not required |
| >ul-TFCS | Normal TFCS signalling | Normal TFCS signalling |
| >>explicitTFCS- ConfigurationMode | Complete | Complete |
| >>>ctfcSize | Ctfc4Bit | Ctfc4Bit |
| >>>>TFCS representation | Addition | Addition |
| >>>>>TFCS list | | |
| >>>>>>TFCS 1 | (TF0, TF0) | (TF0, TF0) |
| >>>>>>>ctfc | 0 | 0 |
| >>>>>>>>gainFactorInform ation | Computed | Computed |
| >>>>>>>>>referenceTFCSId | 0 | 0 |
| >>>>>>>TFCS 2 | (TF1, TF0) | (TF1, TF0) |
| >>>>>>>>ctfc | 1 | 1 |
| >>>>>>>>>gainFactorInform ation | Computed | Computed |
| >>>>>>>>>> β_c (FDD only) | N/A | N/A |
| >>>>>>>>>> β_d | N/A | N/A |
| >>>>>>>>>>>referenceTFCSId | 0 | 0 |
| >>>>>>>>TFCS 3 | (TF2, TF0) | (TF2, TF0) |
| >>>>>>>>>ctfc | 2 | 2 |
| >>>>>>>>>>>gainFactorInform ation | Computed | Computed |
| >>>>>>>>>>>>referenceTFCSId | 0 | 0 |
| >>>>>>>>TFCS 4 | (TF0, TF1) | (TF3, TF0) |
| >>>>>>>>>ctfc | 3 | 3 |
| >>>>>>>>>>>gainFactorInform ation | Computed | Computed |
| >>>>>>>>>>>> β_c (FDD only) | N/A | N/A |
| >>>>>>>>>>>> β_d | N/A | N/A |
| >>>>>>>>>>>>>referenceTFCSId | 0 | 0 |
| >>>>>>>>TFCS 5 | (TF1, TF1) | (TF4, TF0) |
| >>>>>>>>>>ctfc | 4 | 4 |
| >>>>>>>>>>>>gainFactorInform ation | Computed | Computed |
| >>>>>>>>>>>>>referenceTFCSId | 0 | 0 |
| >>>>>>>>TFCS 6 | (TF2, TF1) | (TF0, TF1) |
| >>>>>>>>>>ctfc | 5 | 5 |
| >>>>>>>>>>>>gainFactorInform ation | Signalled | Computed |
| >>>>>>>>>>>>> β_c (FDD only) | 8 | N/A |
| >>>>>>>>>>>>> β_d | 15 | N/A |
| >>>>>>>>>>>>>>referenceTFCSId | N/A | 0 |
| >>>>>>>>TFCS 7 | | (TF1, TF1) |
| >>>>>>>>>>ctfc | | 6 |
| >>>>>>>>>>>>gainFactorInform ation | | Computed |

| | | |
|----------------------------------|-------------------|-------------------|
| >>>>>>>referenceTFClId | | 0 |
| >>>>>>TFCS 8 | | (TF2, TF1) |
| >>>>>>ctfc | | 7 |
| >>>>>>>gainFactorInformation | | Computed |
| >>>>>>>referenceTFClId | | 0 |
| >>>>>>>TFCS 9 | | (TF3, TF1) |
| >>>>>>>ctfc | | 8 |
| >>>>>>>>gainFactorInformation | | Computed |
| >>>>>>>>referenceTFClId | | 0 |
| >>>>>>>>TFCS 10 | | (TF4, TF1) |
| >>>>>>>>ctfc | | 9 |
| >>>>>>>>>gainFactorInformation | | Signalled |
| >>>>>>>>>>> β c (FDD only) | | 8 |
| >>>>>>>>>>> β d | | 15 |
| >>>>>>>>>>>referenceTFClId | | 0 |
| dl-CommonTransChInfo | | |
| >tfcs-SignallingMode | Same as UL | Same as UL |
| PhyCH INFORMATION FDD | | |
| UL-DPCH-InfoPredef | | |
| >ul-DPCH-PowerControlInfo | | |
| >>powerControlAlgorithm | Algorithm 1 | Algorithm 1 |
| >>>tpcStepSize | 1 | 1 |
| >tfci-Existence | TRUE | TRUE |
| >puncturingLimit | 1 | 1 |
| DL-CommonInformationPredef | | |
| >dl-DPCH-InfoCommon | | |
| >>spreadingFactor | 64 | 32 |
| >>pilotBits | 8 | 8 |
| >>positionFixed | Flexible | Flexible |
| PhyCH INFORMATION TDD | | |
| UL-DPCH-InfoPredef | | |
| >ul-DPCH-PowerControlInfo | | |
| >>dpch-ConstantValue | -20 | -20 |
| >commonTimeslotInfo | | |
| >>secondInterleavingMode | frameRelated | frameRelated |
| >>>tfci-Coding | 16 | 16 |
| >>>puncturingLimit | 0.50 | 0.50 |
| >>>repetitionPeriodAndLength | repetitionPeriod1 | repetitionPeriod1 |
| DL-CommonInformationPredef | | |
| >dl-DPCH-InfoCommon | | |
| >>commonTimeslotInfo | | |
| >>>secondInterleavingMode | frameRelated | frameRelated |
| >>>>tfci-Coding | 16 | 16 |
| >>>>puncturingLimit | 0.46 | 0.46 |
| >>>>repetitionPeriodAndLength | repetitionPeriod1 | repetitionPeriod1 |

14 Specific functions

14.1 Intra-frequency measurements

14.1.1 Intra-frequency measurement quantities

- 1 Downlink E_c/I_0 (chip energy per total received channel power density).
- 2 Downlink path loss.

For FDD:

Pathloss in dB = Primary CPICH Tx power - CPICH RSCP.

For Primary CPICH Tx power the IE "Primary CPICH Tx power" shall be used. The unit is dBm.

CPICH RSCP is the result of the CPICH RSCP measurement. The unit is dBm.

For TDD:

Pathloss in dB = Primary CCPCH TX power - Primary CCPCH RSCP.

For Primary CCPCH TX power the IE "Primary CCPCH TX Power" shall be used. The unit is dBm.

Primary CCPCH RSCP is the result of the Primary CCPCH RSCP measurement. The unit is dBm.

If necessary Pathloss shall be rounded up to the next higher integer.

Results higher than 158 shall be reported as 158.

Results lower than 46 shall be reported as 46.

- 3 Downlink received signal code power (RSCP) after despreading.
- 4 ISCP measured on Timeslot basis.

14.1.2 Intra-frequency reporting events for FDD

Within the measurement reporting criteria field in the Measurement Control message the UTRAN notifies the UE which events should trigger a measurement report. The listed events are the toolbox from which the UTRAN can choose the reporting events that are needed for the implemented handover evaluation function, or other radio network functions.

All the illustrated events are measured with respect to any of the measurement quantities given in subclause 14.1.1. The measurement objects are the monitored primary common pilot channels (CPICH).

NOTE: The events below are numbered 1A, 1B, 1C,... since all intra-frequency reporting events would be labelled 1X, inter-frequency reporting events would be labelled 2X, and so on for the other measurement types.

14.1.2.1 Reporting event 1A: A Primary CPICH enters the reporting range

When event 1A is configured in the UE, the UE shall:

- if "Measurement quantity" is "pathloss" and Equation 1 below is fulfilled for a primary CPICH, or if "Measurement quantity" is "CPICH E_c/N_0 " or "CPICH RSCP", and Equation 2 below is fulfilled for a primary CPICH:
- if the equations have been fulfilled during the time "Time to trigger", and if that primary CPICH is part of cells allowed to trigger the event according to "Triggering condition 2", and if that primary CPICH is not included in the "cells triggered" in the variable TRIGGERED_1A_EVENTS:
- include that primary CPICH in the "cells triggered" in the variable TRIGGERED_1A_EVENTS;

- if the value of "Reporting deactivations threshold" for this event is greater than the current number of cells in the active set or equal to 0:
 - if "Reporting interval" for this event is not equal to 0:
 - start a timer for that primary CPICH with the value of "Reporting interval" for this event;
 - set "sent reports" for that primary CPICH in the variable TRIGGERED_1A_EVENTS;
 - send a measurement report with IEs set as below:
 - in "intra-frequency event results": "Intrafrequency event identity" to "1a" and "cell measurement event results" to the CPICH info of the primary CPICH that triggered the report; and
 - include this for each 1a event that is triggered without a report being sent;
 - "measured results" and possible "additional measured results" according to 8.4.2;
- if that primary CPICH is included in the "cells triggered" in the variable TRIGGERED_1A_EVENTS, and not included in the current active set:
 - if "Reporting interval" for this event is not equal to 0, and if "Reporting interval is larger than "sent reports" stored for that primary CPICH, in "cells triggered" in the variable TRIGGERED_1A_EVENTS; and
 - and if the timer for that primary CPICH in the variable TRIGGERED_1A_EVENTS has expired:
 - increment the stored counter "sent reports" for that CPICH in "cell triggered" in variable TRIGGERED_1A_EVENTS;
 - start a timer for that primary CPICH with the value of "Reporting interval" for this event;
 - send a measurement report with IEs set as below:
 - in "intra-frequency event results": "Intrafrequency event identity" to "1a" and "cell measurement event results" to the CPICH info of the primary CPICH that triggered the report; and
 - include this for each 1a event that is triggered without a report being sent;
 - "measured results" and possible "additional measured results" according to 8.4.2;
 - if "Measurement quantity" is "pathloss" and Equation 3 below is fulfilled for a primary CPICH, or if "Measurement quantity" is "CPICH Ec/N0" or "CPICH RSCP", and Equation 4 below is fulfilled for a primary CPICH:
 - if that primary CPICH is included in the "cells triggered" in the variable TRIGGERED_1A_EVENTS:
 - remove that primary CPICH and sent reports from "cells triggered" in the variable TRIGGERED_1A_EVENTS;
 - stop reporting interval timers related to that primary CPICH.

Upon transition to CELL_DCH the UE shall:

- Include the primary CPICH of all cells in the current active set into the "cells triggered" in the variable TRIGGERED_1A_EVENTS.

Equation 1 (Triggering condition for pathloss)

$$10 \cdot \text{Log}M_{\text{New}} \leq W \cdot 10 \cdot \text{Log} \left(1 / \sum_{i=1}^{N_A} (1/M_i) \right) + (1-W) \cdot 10 \cdot \text{Log}M_{\text{Best}} + (R_{1a} - H_{1a} / 2),$$

Equation 2 (Triggering condition for all the other measurement quantities)

$$10 \cdot \text{Log}M_{\text{New}} \geq W \cdot 10 \cdot \text{Log} \left(\sum_{i=1}^{N_A} M_i \right) + (1-W) \cdot 10 \cdot \text{Log}M_{\text{Best}} - (R_{1a} - H_{1a} / 2),$$

Equation 3 (Leaving triggering condition for pathloss)

$$10 \cdot \text{Log}M_{New} \geq W \cdot 10 \cdot \text{Log} \left(1 / \sum_{i=1}^{N_A} (1/M_i) \right) + (1-W) \cdot 10 \cdot \text{Log}M_{Best} + (R_{1a} + H_{1a}/2),$$

Equation 4 (Leaving triggering condition for all the other measurement quantities)

$$10 \cdot \text{Log}M_{New} \leq W \cdot 10 \cdot \text{Log} \left(\sum_{i=1}^{N_A} M_i \right) + (1-W) \cdot 10 \cdot \text{Log}M_{Best} - (R_{1a} + H_{1a}/2),$$

The variables in the formula are defined as follows:

M_{New} is the measurement result of the cell entering the reporting range.

M_i is a measurement result of a cell in the active set.

N_A is the number of cells in the current active set.

For pathloss

M_{Best} is the measurement result of the cell in the active set with the lowest measurement result.

for other measurements quantities.

M_{Best} is the measurement result of the cell in the active set with the highest measurement result.

W is a parameter sent from UTRAN to UE.

R_{1a} is the reporting range constant.

H_{1a} is the hysteresis parameter for the event 1a.

If the measurement results are pathloss or CPICH-Ec/No then M_{New} , M_i and M_{Best} are expressed as ratios.

If the measurement result is CPICH-RSCP then M_{New} , M_i and M_{Best} are expressed in [mW].

The addition window of cells in event 1A is configured with the **reporting range constant** parameter (R_{1a}) with an additional **hysteresis** parameter (H_{1a}).

The occurrence of event 1A is conditional on a **report deactivation threshold** parameter.

Event 1A may be enhanced with an addition timer, which is configured with the **time-to-trigger** parameter (see subclause 14.1.5.2). If a time-to-trigger value is used, a cell must continuously stay within the reporting range for the given time period, before the UE shall send a measurement report.

Event 1A may be used for triggering a measurement report, which includes cells, which the UE has detected without having received a neighbour cell list.

If more than one cell triggers event 1A within the UE internal event evaluation period (defined in [19]) and fulfils the reporting criteria after the addition timer has elapsed, the UE shall report all of the triggering cells in the event results. The triggering cells shall be sorted in descending order according to the measured quantity.

14.1.2.2 Reporting event 1B: A primary CPICH leaves the reporting range

When event 1B is configured in the UE, the UE shall:

- if "Measurement quantity" is "pathloss" and Equation 1 below is fulfilled for a primary CPICH, or if "Measurement quantity" is "CPICH Ec/No" or "CPICH RSCP", and Equation 2 below is fulfilled for a primary CPICH:
 - if the equations have been fulfilled during the time "Time to trigger", and if that primary CPICH is part of cells allowed to trigger the event according to "Triggering condition 1", and if that primary CPICH is not included in the "cells triggered" in the variable TRIGGERED_1B_EVENTS:
 - include that primary CPICH in the "cells triggered" in the variable TRIGGERED_1B_EVENTS;

- send a measurement report with IEs set as below:
 - in "intra-frequency event results": "Intrafrequency event identity" to "1b" and "cell measurement event results" to the CPICH info of the primary CPICH that triggered the report; and
 - include this for each 1b event that is triggered without a report being sent;
 - "measured results" and possible "additional measured results" according to 8.4.2.
- if "Measurement quantity" is "pathloss" and Equation 3 below is fulfilled for a primary CPICH, or if "Measurement quantity" is "CPICH Ec/N0" or "CPICH RSCP", and Equation 4 below is fulfilled for a primary CPICH:
 - if that primary CPICH is included in the "cells triggered" in the variable TRIGGERED_1B_EVENTS:
 - remove that primary CPICH and sent reports from "cells triggered" in the variable TRIGGERD_1B_EVENTS;

Equation 1 (Triggering condition for pathloss)

$$10 \cdot \text{Log}M_{Old} \geq W \cdot 10 \cdot \text{Log} \left(1 / \sum_{i=1}^{N_A} (1 / M_i) \right) + (1 - W) \cdot 10 \cdot \text{Log}M_{Best} + (R + H_{1b} / 2),$$

Equation 2 (Triggering condition for all the other measurement quantities)

$$10 \cdot \text{Log}M_{Old} \leq W \cdot 10 \cdot \text{Log} \left(\sum_{i=1}^{N_A} M_i \right) + (1 - W) \cdot 10 \cdot \text{Log}M_{Best} - (R + H_{1b} / 2),$$

Equation 3 (Leaving triggering condition for pathloss)

$$10 \cdot \text{Log}M_{Old} \leq W \cdot 10 \cdot \text{Log} \left(1 / \sum_{i=1}^{N_A} (1 / M_i) \right) + (1 - W) \cdot 10 \cdot \text{Log}M_{Best} + (R - H_{1b} / 2),$$

Equation 4 (Leaving triggering condition for all the other measurement quantities)

$$10 \cdot \text{Log}M_{Old} \geq W \cdot 10 \cdot \text{Log} \left(\sum_{i=1}^{N_A} M_i \right) + (1 - W) \cdot 10 \cdot \text{Log}M_{Best} - (R - H_{1b} / 2),$$

The variables in the formula are defined as follows:

M_{Old} is the measurement result of the cell leaving the reporting range.

M_i is a measurement result of a cell in the active set.

N_A is the number of cells in the current active set.

For pathloss

M_{Best} is the measurement result of the cell in the active set with the lowest measurement result.

for other measurements quantities.

M_{Best} is the measurement result of the cell in the active set with the highest measurement result.

W is a parameter sent from UTRAN to UE.

R_{1a} is the reporting range constant.

H_{1b} is the hysteresis parameter for the event 1b.

If the measurement results are pathloss or CPICH-Ec/No then M_{New} , M_i and M_{Best} are expressed as ratios.

If the measurement result is CPICH-RSCP then M_{New} , M_i and M_{Best} are expressed in [mW].

The drop window of cells in event 1B is configured with the **reporting range constant** parameter (R_{1b}) with an additional **hysteresis** parameter (H_{1b}).

Event 1B may be enhanced with a drop timer, which is configured with the **time-to-trigger** parameter. If the timer is used, the weakening cell must continuously stay below the reporting range for the given time period before the UE may send a measurement report.

If more than one cell triggers event 1B within the UE internal event evaluation period (defined in [19]) and fulfils the reporting criteria after the drop timer has elapsed, the UE shall report all of the triggering cells in the event results. The triggering cells shall be sorted in descending order according to the measured quantity.

14.1.2.3 Reporting event 1C: A non-active primary CPICH becomes better than an active primary CPICH

When event 1C is configured in the UE, the UE shall:

- if "Measurement quantity" is "pathloss" and Equation 1 below is fulfilled for a primary CPICH, or if "Measurement quantity" is "CPICH Ec/N0" or "CPICH RSCP", and Equation 2 below is fulfilled for a primary CPICH:
 - if the equations have been fulfilled during the time "Time to trigger", and if the primary CPICH that is better is not included in the active set but the other primary CPICH is any of the primary CPICHs included in the active set, and if that primary CPICH is not included in the "cells triggered" in the variable TRIGGERED_1C_EVENTS:
 - include that primary CPICH in the "cells triggered" in the variable TRIGGERED_1C_EVENTS;
 - if the value of "Replacement activation threshold" for this event is lower than the current number of cells in the active set or equal to 0:
 - if "Reporting interval" for this event is not equal to 0:
 - start a timer for that primary CPICH with the value of "Reporting interval" for this event;
 - set "sent reports" for that primary CPICH in the variable TRIGGERED_1C_EVENTS;
 - send a measurement report with IEs set as below:
 - in "intra-frequency event results": "Intrafrequency event identity" to "1c" and the first entry in "cell measurement event results" to the CPICH info of the primary CPICH not in the active set that triggered the report; and
 - the second entry in "cell measurement event results" to the CPICH info of the primary CPICH in the active set that now is worse than the new primary CPICH and has the best measured value (lowest measured result for pathloss and highest measured result for other measurements); and
 - the rest of the entries to other primary CPICHs that are now worse than this new primary CPICH in the order of their measured value;
 - "measured results" and possible "additional measured results" according to 8.4.2;
- if that primary CPICH is included in the "cells triggered" in the variable TRIGGERED_1C_EVENTS, and not included in the current active set:
 - if "Reporting interval" for this event is not equal to 0, and if "Reporting interval is larger than "sent reports" stored for that primary CPICH, in "cells triggered" in the variable TRIGGERED_1C_EVENTS; and
 - if the timer for that primary CPICH in the variable TRIGGERED_1C_EVENTS has expired:
 - increment the stored counter "sent reports" for that CPICH in "cell triggered" in variable TRIGGERED_1C_EVENTS;
 - start a timer for that primary CPICH with the value of "Reporting interval" for this event;

- send a measurement report with IEs set as below:
 - in "intra-frequency event results": "Intrafrequency event identity" to "1c" and the first entry in "cell measurement event results" to the CPICH info of the primary CPICH not in the active set that triggered the report; and
 - the second entry in "cell measurement event results" to the CPICH info of the primary CPICH in the active set that now is worse than the new primary CPICH and has the best measured value (lowest measured result for pathloss and highest measured result for other measurements); and
 - the rest of the entries to other primary CPICHs that is now worse than this new primary CPICH in the order of their measured value;
 - "measured results" and possible "additional measured results" according to 8.4.2;
- if "Measurement quantity" is "pathloss" and Equation 3 below is fulfilled for a primary CPICH, or if "Measurement quantity" is "CPICH Ec/N0" or "CPICH RSCP", and Equation 4 below is fulfilled for a primary CPICH:
 - if that primary CPICH is included in the "cells triggered" in the variable TRIGGERED_1C_EVENTS:
 - remove that primary CPICH and sent reports from "cells triggered" in the variable TRIGGERD_1C_EVENTS;
 - stop reporting interval timers related to that primary CPICH.

Equation 1 (Triggering condition for pathloss)

$$M_{New} \leq M_{InAS} - H_{1c} / 2,$$

Equation 2 (Triggering condition for all the other measurement quantities)

$$M_{New} \geq M_{InAS} + H_{1c} / 2,$$

Equation 3 (Leaving triggering condition for pathloss)

$$M_{New} \geq M_{InAS} + H_{1c} / 2,$$

Equation 4 (Leaving triggering condition for all the other measurement quantities)

$$M_{New} \leq M_{InAS} - H_{1c} / 2,$$

The variables in the formula are defined as follows:

M_{New} is the measurement result of the cell not included in the active set.

M_{InAS} is the measurement result of a cell in the active set.

H_{1c} is the hysteresis parameter for the event 1c.

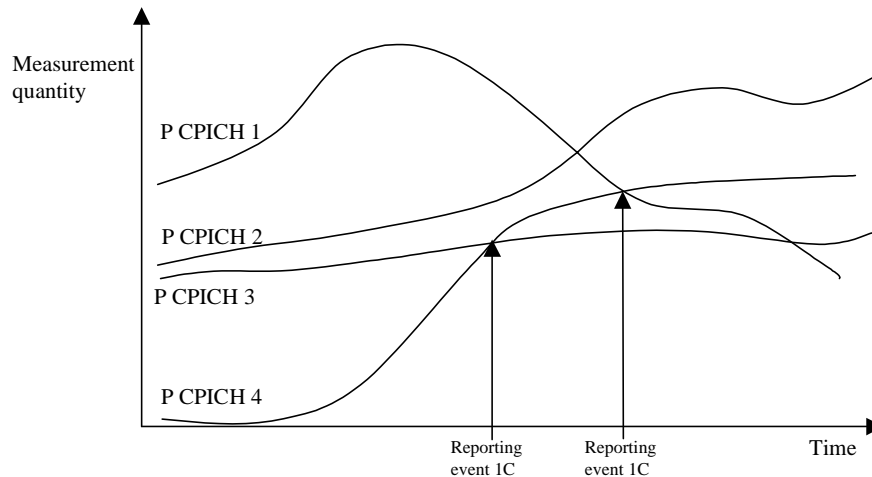

Figure 63: A primary CPICH that is not included in the active set becomes better than a primary CPICH that is in the active set

In this example the cells belonging to primary CPICH 1, 2 and 3 are supposed to be in the active set, but the cell transmitting primary CPICH 4 is not (yet) in the active set.

If a primary CPICH that is not included in the active set becomes better than a primary CPICH that is in the active set, and event 1C has been ordered by UTRAN, this event shall trigger a report to be sent from the UE.

This event may be used for replacing cells in the active set. It is activated if the number of active cells is equal to or greater than a **replacement activation threshold** parameter that UTRAN signals to the UE in the MEASUREMENT CONTROL message. This parameter indicates the minimum number of cells required in the active set for measurement reports triggered by event 1C to be transmitted.

14.1.2.4 Reporting event 1D: Change of best cell

When event 1D is configured in the UE, the UE shall:

- if "Measurement quantity" is "pathloss" and Equation 1 below is fulfilled for a primary CPICH that is not stored in "Best cell" in variable BEST_CELL_1D_EVENT, or if "Measurement quantity" is "CPICH Ec/N0" or "CPICH RSCP", and Equation 2 below is fulfilled for a primary CPICH that is not stored in "Best cell" in variable BEST_CELL_1D_EVENT:
 - if the equations have been fulfilled during the time "Time to trigger":
 - set "best cell" in the variable BEST_CELL_1D_EVENT to that primary CPICH that triggered the event;
 - send a measurement report with IEs set as below:
 - in "intra-frequency event results"; "Intrafrequency event identity" to "1d" and "cell measurement event results" to the CPICH info of the primary CPICH that triggered the report.
 - "measured results" and possible "additional measured results" according to 8.4.2;

Upon transition to CELL_DCH the UE shall:

- set "best cell" in the variable BEST_CELL_1D_EVENT to the best cell of the primary CPICHs included in the active set.

Equation 1 (Triggering condition for pathloss)

$$M_{NotBest} \leq M_{Best} - H_{1d} / 2$$

Equation 2 (Triggering condition for all the other measurement quantities)

$$M_{NotBest} \geq M_{Best} + H_{1d} / 2$$

The variables in the formula are defined as follows:

$M_{NotBest}$ is the measurement result of a cell not stored in "best cell" in the variable BEST_CELL_1D_EVENT.

M_{Best} is the measurement result of the cell stored in "best cell" in variable BEST_CELL_1D_EVENT.

H_{1d} is the hysteresis parameter for the event 1d.

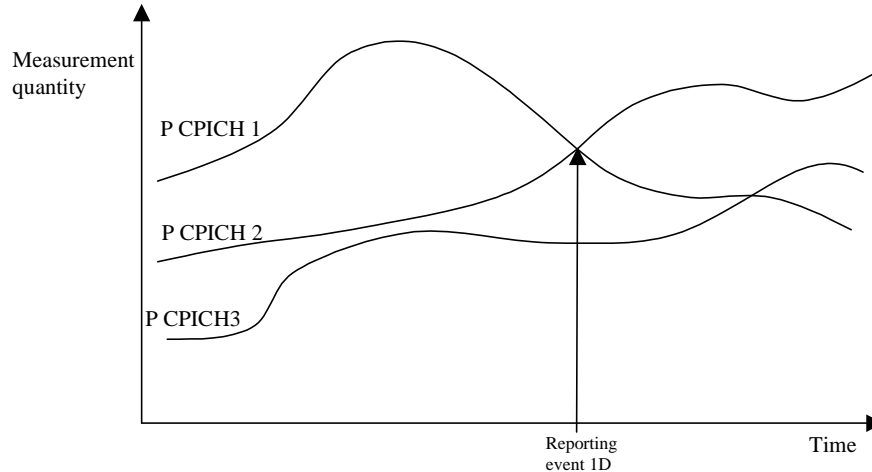

Figure 64: A primary CPICH becomes better than the previously best primary CPICH

14.1.2.5 Reporting event 1E: A Primary CPICH becomes better than an absolute threshold

When event 1E is configured in the UE, the UE shall:

- if "Measurement quantity" is "pathloss" and Equation 1 below is fulfilled for a primary CPICH, or if "Measurement quantity" is "CPICH Ec/N0" or "CPICH RSCP", and Equation 2 below is fulfilled for a primary CPICH:
 - if the equations have been fulfilled during the time "Time to trigger", and if that primary CPICH is part of cells allowed to trigger the event according to "Triggering condition 2", and that primary CPICH is not included in the "cells triggered" in the variable TRIGGERED_1E_EVENTS:
 - include that primary CPICH in the "cells triggered" in the variable TRIGGERED_1E_EVENTS;
 - send a measurement report with IEs set as below:
 - in "intra-frequency event results": "Intrafrequency event identity" to "1e" and "cell measurement event results" to the CPICH info of the primary CPICH that triggered the report; and
 - include this for each 1e event that is triggered without a report being sent;
 - "measured results" and possible "additional measured results" according to 8.4.2;
 - if "Measurement quantity" is "pathloss" and Equation 3 below is fulfilled for a primary CPICH, or if "Measurement quantity" is "CPICH Ec/N0" or "CPICH RSCP", and Equation 4 below is fulfilled for a primary CPICH:
 - if that primary CPICH is included in the "cells triggered" in the variable TRIGGERED_1E_EVENTS:
 - remove that primary CPICH and sent reports from "cells triggered" in the variable TRIGGERED_1E_EVENTS.

Upon transition to CELL_DCH the UE shall:

- include the primary CPICH of all cells in the current active set that fulfil the equations 1 or 2 according to the "Measurement quantity" of event 1e into the "cells triggered" in the variable TRIGGERED_1E_EVENTS.

Equation 1 (Triggering condition for pathloss)

$$M_{New} \leq T_{le} - H_{le} / 2$$

Equation 2 (Triggering condition for all the other measurement quantities)

$$M_{New} \geq T_{le} + H_{le} / 2$$

Equation 3 (Leaving triggering condition for pathloss)

$$M_{New} \geq T_{le} + H_{le} / 2$$

Equation 4 (Leaving triggering condition for all the other measurement quantities)

$$M_{New} \leq T_{le} - H_{le} / 2$$

The variables in the formula are defined as follows:

M_{New} is the measurement result of a cell that becomes better than an absolute threshold.

T_{le} is an absolute threshold.

H_{le} is the hysteresis parameter for the event 1e.

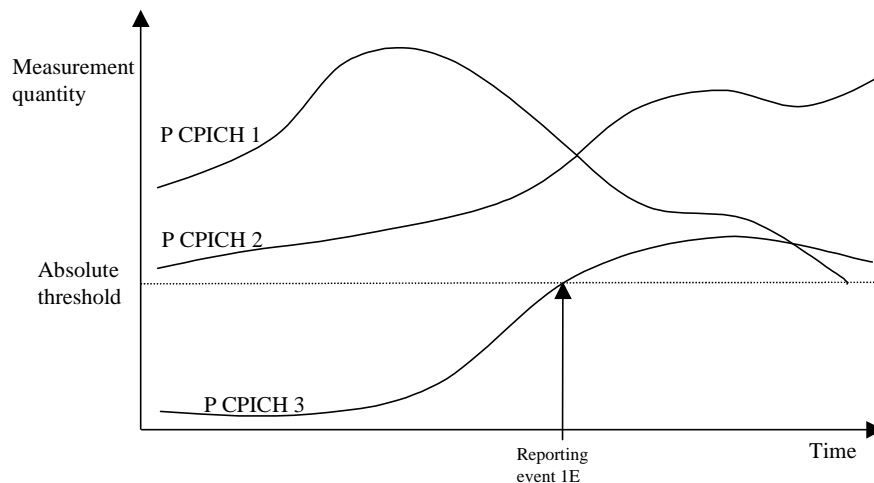

Figure 65: Event-triggered report when a Primary CPICH becomes better than an absolute threshold

Event 1E may be used for triggering a measurement report, which includes cells, which the UE has detected without having received a neighbour cell list.

14.1.2.6 Reporting event 1F: A Primary CPICH becomes worse than an absolute threshold

When event 1F is configured in the UE, the UE shall:

- if "Measurement quantity" is "pathloss" and Equation 1 below is fulfilled for a primary CPICH, or if "Measurement quantity" is "CPICH Ec/N0" or "CPICH RSCP", and Equation 2 below is fulfilled for a primary CPICH:
- if the equations have been fulfilled during the time "Time to trigger", and if that primary CPICH is part of cells allowed to trigger the event according to "Triggering condition 1", and that primary CPICH is not included in the "cells triggered" in the variable TRIGGERED_1F_EVENTS:
 - include that primary CPICH in the "cells triggered" in the variable TRIGGERED_1F_EVENTS;
 - send a measurement report with IEs set as below:

- in "intra-frequency event results": "Intrafrequency event identity" to "1f" and "cell measurement event results" to the CPICH info of the primary CPICH that triggered the report; and
- include this for each 1f event that is triggered without a report being sent;
- "measured results" and possible "additional measured results" according to 8.4.2;
- if "Measurement quantity" is "pathloss" and Equation 3 below is fulfilled for a primary CPICH, or if "Measurement quantity" is "CPICH Ec/N0" or "CPICH RSCP", and Equation 4 below is fulfilled for a primary CPICH:
 - if that primary CPICH is included in the "cells triggered" in the variable TRIGGERED_1F_EVENTS:
 - remove that primary CPICH and sent reports from "cells triggered" in the variable TRIGGERD_1F_EVENTS.

Upon transition to CELL_DCH the UE shall:

- include the primary CPICH of all cells that fulfil the equations 1 or 2 according to the "Measurement quantity" of event 1f into the "cells triggered" in the variable TRIGGERED_1F_EVENTS.

Equation 1 (Triggering condition for pathloss)

$$M_{New} \geq T_{1f} + H_{1f} / 2,$$

Equation 2 (Triggering condition for all the other measurement quantities)

$$M_{New} \leq T_{1f} - H_{1f} / 2,$$

Equation 3 (Leaving triggering condition for pathloss)

$$M_{New} \leq T_{1f} - H_{1f} / 2,$$

Equation 4 (Leaving triggering condition for all the other measurement quantities)

$$M_{New} \geq T_{1f} + H_{1f} / 2,$$

The variables in the formula are defined as follows:

M_{New} is the measurement result of a cell that becomes worse than an absolute threshold

T_{1f} is an absolute threshold

H_{1f} is the hysteresis parameter for the event 1f.

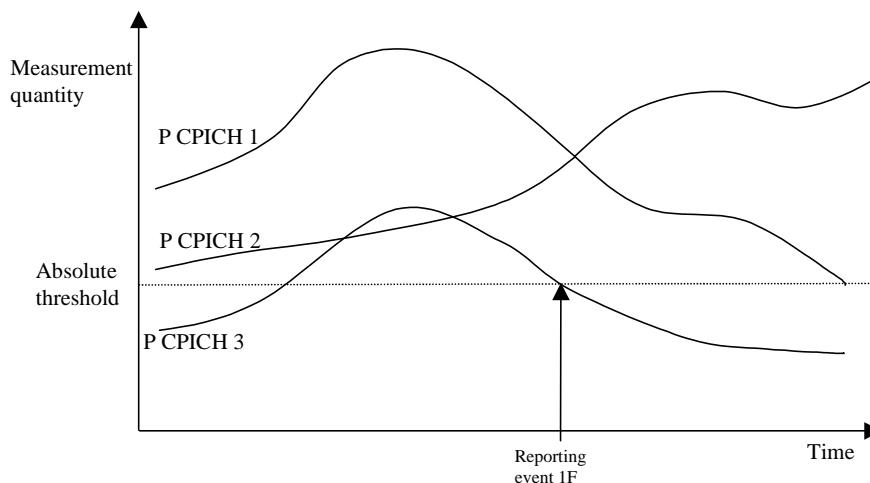

Figure 66: Event-triggered report when a Primary CPICH becomes worse than an absolute threshold

14.1.3 Intra-frequency reporting events for TDD

14.1.3.1 Reporting event 1G: Change of best cell (TDD)

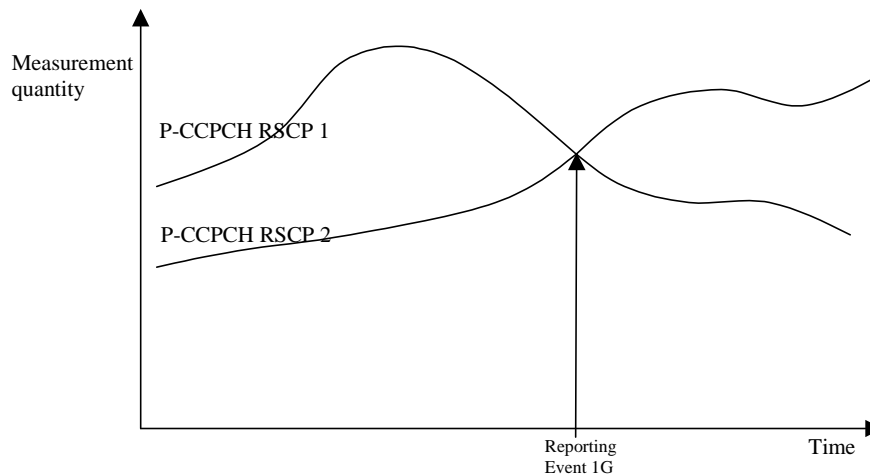

Figure 67: A P-CCPCH RSCP becomes better than the previous best P-CCPCH RSCP

If any of the monitored P-CCPCH RSCPs becomes better than the previously best P-CCPCH RSCP, and event 1G has been ordered by UTRAN then this event shall trigger a report to be sent from the UE.

Before any evaluation is done, the values are filtered according to sub-clause 8.6.7.2.

Event 1G may be used with a hysteresis parameter (see sub-clause 14.1.5.1) and a time-to-trigger parameter (see sub-clause 14.1.5.2). If a time-to-trigger parameter is used, the UE shall send a measurement report if the P-CCPCH RSCP of a cell stays continuously better within the given time period.

The hysteresis always corresponds to the best P-CCPCH.

Event 1G may be used with cell-individual-offset for each cell, which is added to the P-CCPCH RSCP measurement before event evaluation.

If more than one cell triggers event 1G within the UE event evaluation period and fulfils the reporting criteria after the time-to-trigger has elapsed, the UE shall send at least the best cell but may report all these cells, sorted in descending order according to the measurement quantity.

14.1.3.2 Reporting event 1H: Timeslot ISCP below a certain threshold (TDD)

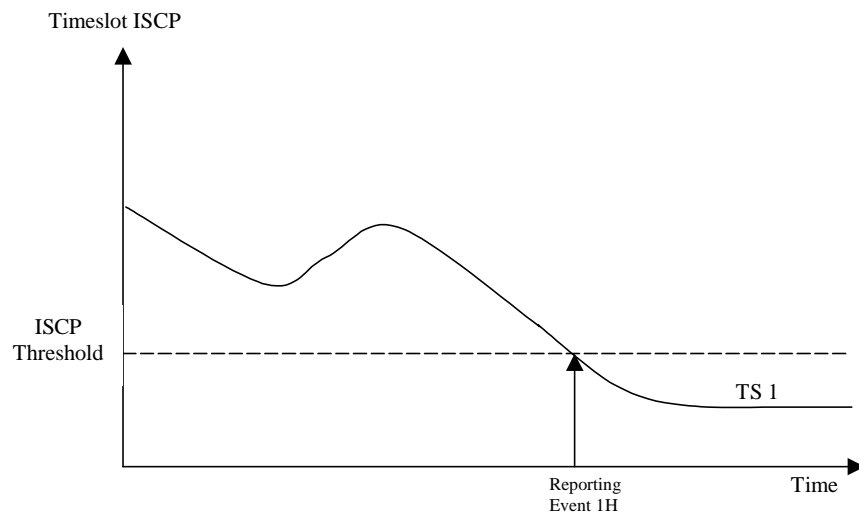

Figure 68: An ISCP value of a timeslot drops below an absolute threshold

When this event is ordered by UTRAN in a measurement control message the UE shall send a report when the Timeslot ISCP drops below an absolute threshold.

Event 1H may be used with a time-to-trigger parameter (see sub-clause 14.1.5.2). If a time-to-trigger parameter is used a cell must stay continuously below the threshold for the given time period, before the UE shall send a measurement report.

Event 1H may be used with a cell-individual-offset parameter for each cell, which is added to the Timeslot ISCP measurement before event evaluation.

The hysteresis parameter has no impact on event 1H.

14.1.3.3 Reporting event 1I: Timeslot ISCP above a certain threshold (TDD)

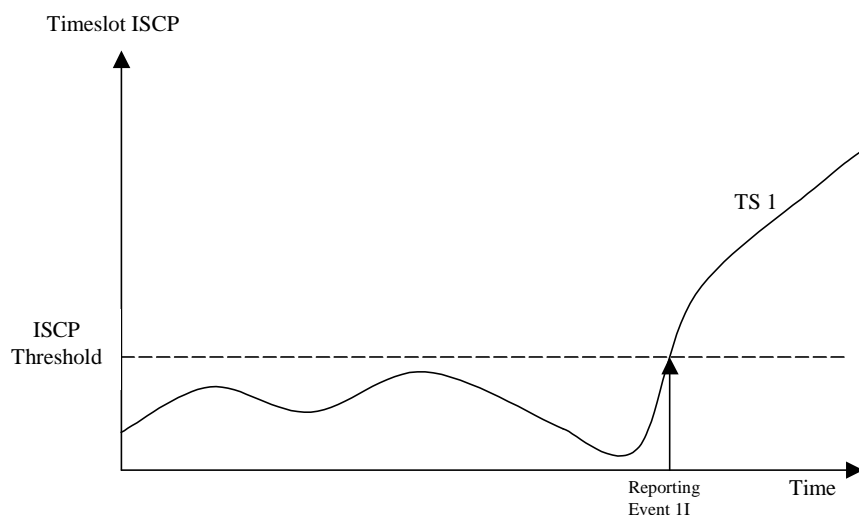

Figure 69: An ISCP value of a timeslot exceeds a certain threshold

When this event is ordered by UTRAN in a measurement control message the UE shall send a report when the Timeslot ISCP exceeds an absolute threshold.

Event 1I may be used with a time-to-trigger parameter (see sub-clause 14.1.5.2). If a time-to-trigger parameter is used a cell must stay continuously above the threshold for the given time period, before the UE shall send a measurement report.

Event 1I may be used with a cell-individual-offset parameter for each cell, which is added to the Timeslot ISCP measurement before event evaluation.

The hysteresis parameter has no impact on event 1I.

14.1.4 Event-triggered periodic intra-frequency measurement reports

14.1.4.1 Cell addition failure (FDD only)

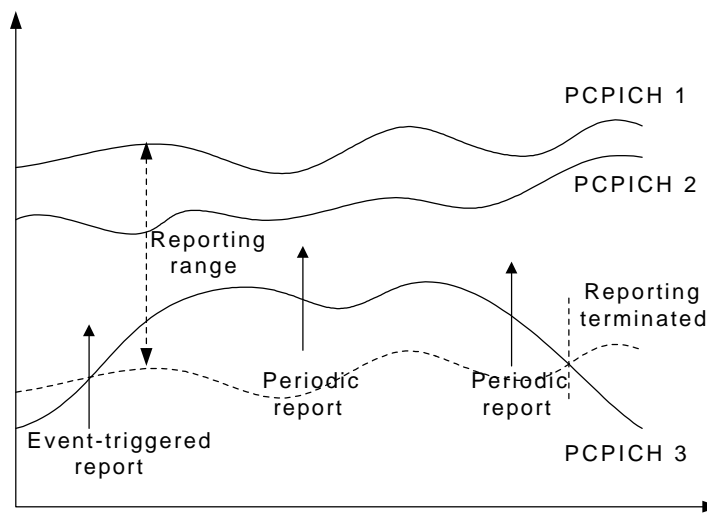

Figure 70: Periodic reporting triggered by event 1A

When a cell enters the reporting range and triggers event 1A, the UE shall transmit a MEASUREMENT REPORT to the UTRAN and typically this may result in an update of the active set. However, in some situations the UTRAN may be unable to add a strong cell to the active set typically due to capacity shortage for example.

The UE shall continue reporting after the initial report by reverting to periodical measurement reporting if the reported cell is not added to the active set. This is illustrated in Figure 70. During periodic reporting the UE shall transmit MEASUREMENT REPORT messages to the UTRAN at predefined intervals. The reports shall include reporting information of the cells in the current active set and of the monitored cell(s) in the reporting range.

Event-triggered periodic measurement reporting shall be terminated if:

- there are no longer any monitored cell(s) within the reporting range; or
- the UTRAN has added cells to the active set so that it includes the maximum number of cells (defined by the **reporting deactivation threshold** parameter), which are allowed for event 1A to be triggered; or
- the UE has sent the maximum number of MEASUREMENT REPORT messages (defined by the **amount of reporting** parameter).

The reporting period is assigned by the UTRAN (with the **Reporting interval** parameter). If the reporting interval is set to zero event-triggered measurement reporting shall not be applied.

14.1.4.2 Cell replacement failure (FDD only)

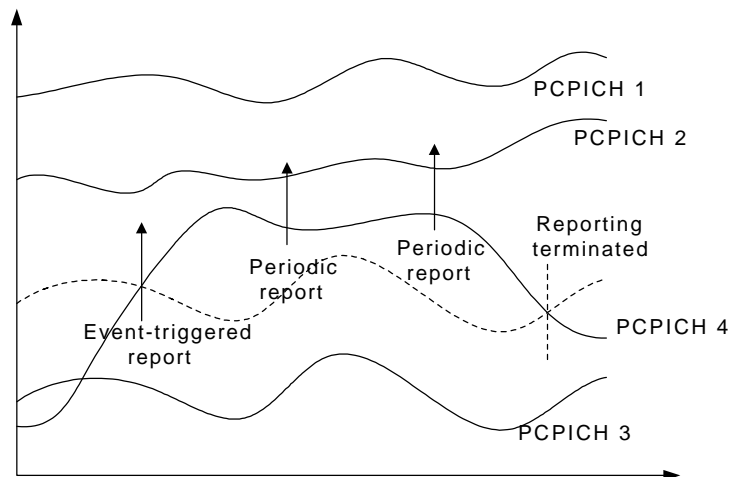

Figure 71: Periodic reporting triggered by event 1C

When a cell enters the replacement range and triggers event 1C, the UE shall transmit a MEASUREMENT REPORT to the UTRAN and typically this may result in the replacement of the weakest active cell. If the UTRAN is unable to replace the cell due to for example capacity shortage, it is beneficial to receive continuous reports in this case as well.

The UE shall revert to periodical measurement reporting if the UTRAN does not update the active set after the transmission of the measurement report. This is illustrated in Figure 71. During periodic reporting the UE shall transmit MEASUREMENT REPORT messages to the UTRAN at predefined intervals. The reports shall include reporting information of the cells in the current active set and of the monitored cell(s) in the replacement range.

Event-triggered periodic measurement reporting shall be terminated if:

- there are no longer any monitored cell(s) within the replacement range; or
- the UTRAN has removed cells from the active set so that there are no longer the minimum amount of active cells for event 1C to be triggered (as defined by the **replacement activation threshold** parameter); or
- the UE has sent the maximum number of MEASUREMENT REPORT messages (defined by the **amount of reporting** parameter).

The reporting period is assigned by the UTRAN (with the **Reporting interval** parameter). If the reporting interval is set to zero, event-triggered measurement reporting shall not be applied.

14.1.5 Mechanisms available for modifying intra-frequency measurement reporting behaviour

14.1.5.1 Hysteresis

To limit the amount of event-triggered reports, a hysteresis parameter may be connected with each reporting event given above. The value of the hysteresis is given to the UE in the Reporting criteria field of the Measurement Control message.

In the example in Figure 72, the hysteresis ensures that the event 1D (FDD) or IG(TDD) (primary CPICH(FDD)/CCPCH(TDD) 2 becomes the best cell) is not reported until the difference is equal to the hysteresis value. The fact that primary CPICH(FDD)/CCPCH(TDD) 1 becomes best afterwards is not reported at all in the example since the primary CPICH(FDD)/CCPCH(TDD) 1 does not become sufficiently better than the primary CPICH(FDD)/CCPCH(TDD) 2.

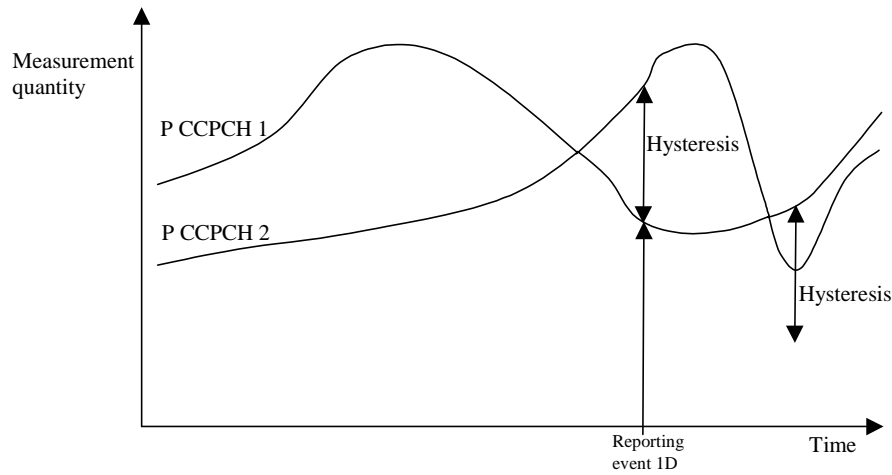

Figure 72: Hysteresis limits the amount of measurement reports

14.1.5.2 Time-to-trigger

To limit the measurement signalling load, a time-to-trigger parameter could be connected with each reporting event given above. The value of the time-to-trigger is given to the UE in the Reporting criteria field of the Measurement Control message.

The effect of the time-to-trigger is that the report is triggered only after the conditions for the event have existed for the specified time-to-trigger. In the following FDD example in Figure 73, the use of time-to-trigger means that the event (primary CPICH 3 enters the reporting range) is not reported until it has been within the range for the time given by the time-to-trigger parameter.

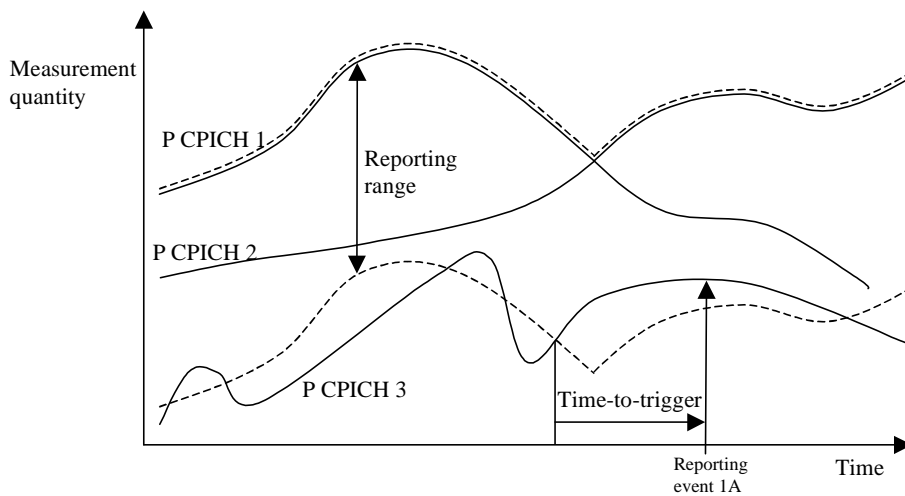

Figure 73: Time-to-trigger limits the amount of measurement reports

In the following TDD example in Figure 74, the use of time-to-trigger means that the event (Timeslot ISCP upon certain threshold) is not reported until it has been upon the threshold for the time given by the time-to trigger parameter.

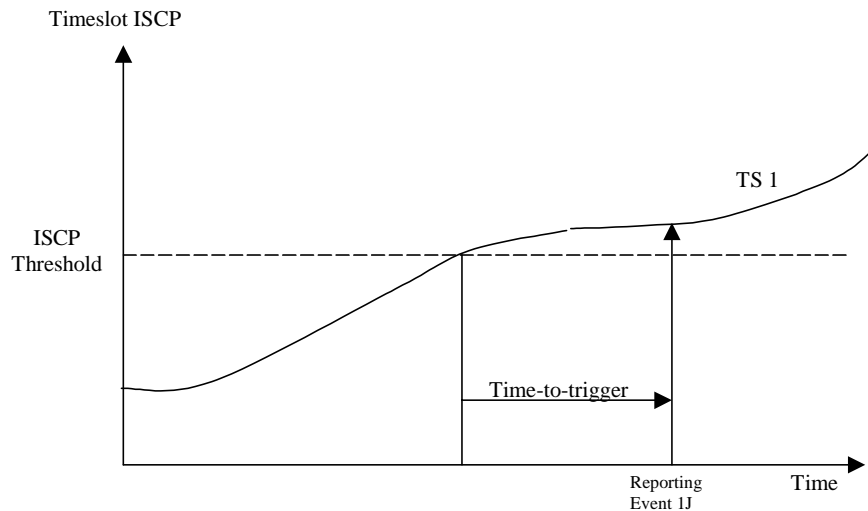

Figure 74: Time-to-trigger limits the amount of measurement reports

NOTE: The time-to-trigger could be combined with hysteresis, i.e. a hysteresis value is added to the measurement quantity before evaluating if the time-to-trigger timer should be started.

14.1.5.3 Cell individual offsets

For each cell that is monitored, an offset can be assigned with inband signalling. The offset can be either positive or negative. The offset is added to the measurement quantity before the UE evaluates if an event has occurred. The UE receives the cell individual offsets for each primary CPICH(FDD)/CCPCH(TDD) in the measurement object field of the MEASUREMENT CONTROL message.

For the FDD example, in Figure 75, since an offset is added to primary CPICH 3, it is the dotted curve that is used to evaluate if an event occurs. Hence, this means that measurement reports from UE to UTRAN are triggered when primary CPICH plus the corresponding offset, i.e. the dotted curve, leaves and enters the reporting range and when it gets better than primary CPICH 1 (if these events have been ordered by UTRAN). This offset mechanism provides the network with an efficient tool to change the reporting of an individual primary CPICH.

By applying a positive offset, as in Figure 75, the UE will send measurement reports as if the primary CPICH is offset x dB better than what it really is. This could be useful if the operator knows that a specific cell is interesting to monitor more carefully, even though it is not so good for the moment. In the example in Figure 75, the operator might know by experience that in this area primary CPICH 3 can become good very quickly (e.g. due to street corners) and therefore that it is worth reporting more intensively. Depending on the implemented handover evaluation algorithm, this may result in the cell with primary CPICH 3 being included in the active set earlier than would have been the case without the positive offset.

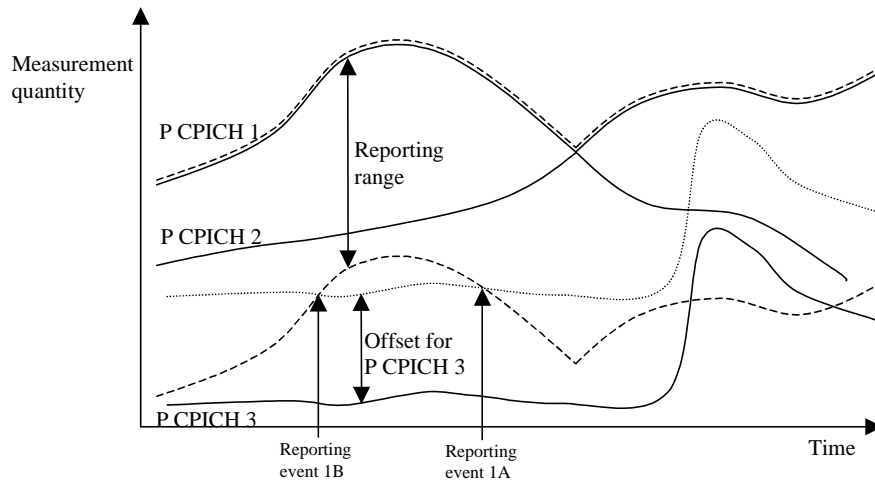

Figure 75: A positive offset is applied to primary CPICH 3 before event evaluation in the UE

For the TDD example, in Figure 76, an offset is added to primary CCPCH2, it is the dotted curve that is used to evaluate if the primary CCPCH2 becomes better than primary CCPCH1 (ordered by the UTRAN).

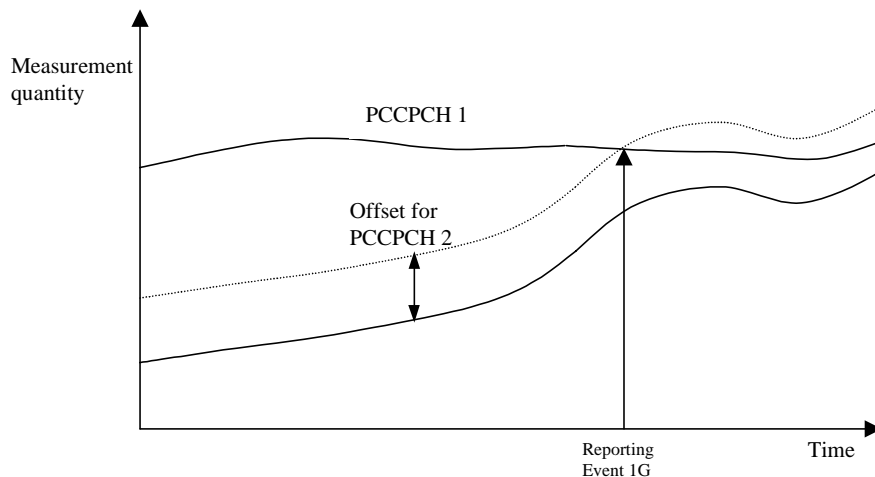

Figure 76: A positive offset is applied to primary CCPCH 2

Correspondingly, the operator can choose to apply a negative offset to a primary CCPCH. Then the reporting on that primary CCPCH is limited and the corresponding cell may be, at least temporarily excluded from the active set or as a target cell for handover.

The cell individual offset can be seen as a tool to move the cell border. It is important to note that the offset is added before triggering events, i.e. the offset is added by the UE before evaluating if a measurement report should be sent as opposed to offsets that are applied in the network and used for the actual handover evaluation.

14.1.5.4 Forbid a Primary CPICH to affect the reporting range (FDD only)

The reporting range affects the reporting events 1A and 1B presented above. The reporting range is defined as a function of all the Primary CPICHs in the active set (see 14.1.2.1 and 14.1.2.2). If the parameter W is set to 0, the reporting range is defined relative to the best Primary CPICH. However, there could be cases where it is good to forbid a specific Primary CPICH to affect the reporting range. For example in Figure 77 the network has requested the UE to not let Primary CPICH 3 affect the reporting range. This mechanism could be effective if the operator knows by experience that the quality of Primary CPICH 3 is very unstable in a specific area and therefore should not affect the reporting of the other Primary CPICHs.

The UE shall ignore that a Primary CPICH is forbidden to affect the reporting range if all of the following conditions are fulfilled:

- the Primary CPICH is included in active set; and
- all cells in active set are defined as Primary CPICHs forbidden to affect the reporting range.

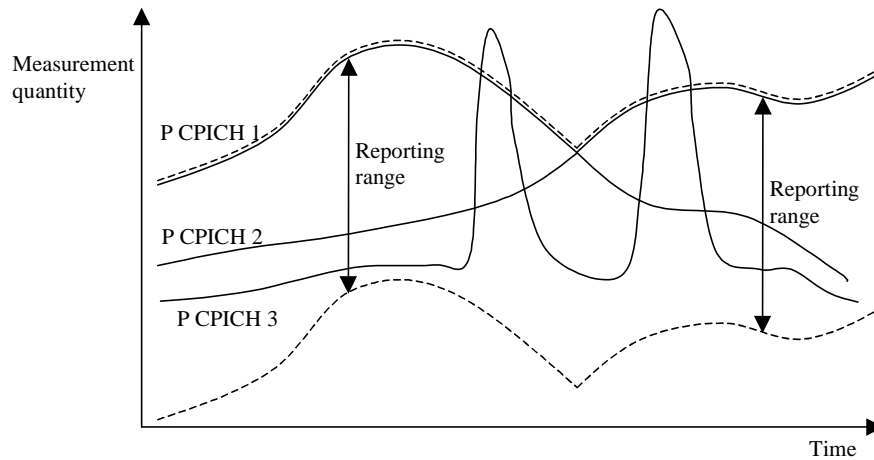

Figure 77: Primary CPICH 3 is forbidden to affect the reporting range

14.1.6 Report quantities

In the event-triggered measurement reports, mandatory information connected to the events is always reported. For instance, at the event "a primary CPICH(FDD)/CCPCH(TDD) enters the reporting range" the corresponding report identifies the primary CPICH(FDD)/CCPCH(TDD) that entered the range.

However, besides this mandatory information, UTRAN should be able to optionally require additional measurement information in the report to support the radio network functions in UTRAN. Furthermore, it will allow the UTRAN to use the UE as a general tool for radio network optimisation if necessary.

Examples of report quantities that may be appended to the measurement reports are:

- Downlink transport channel block error rate.
- Downlink E_c/I_0 on primary CPICH(FDD)/CCPCH(TDD) (e.g. used for initial DL power setting on new radio links).
- Time difference between the received primary CPICH(FDD)/CCPCH(TDD) frame-timing from the target cell and the earliest received existing DPCH path. [Note: This measurement is identified in [26] (denoted T_m in clause 7)].
- UE transmit power.
- UE position.

14.2 Inter-frequency measurements

The frequency quality estimate used in events 2a, 2b 2c, 2d and 2e is defined as:

$$Q_{carrier\ j} = 10 \cdot \text{Log}M_{carrier\ j} = W_j \cdot 10 \cdot \text{Log} \left(\sum_{i=1}^{N_{A\ j}} M_{i\ j} \right) + (1 - W_j) \cdot 10 \cdot \text{Log}M_{Best\ j} - H,$$

The variables in the formula are defined as follows:

$Q_{frequency\ j}$ is the estimated quality of the active set on frequency j.

$M_{frequency\ j}$ is the estimated quality of the active set on frequency j.

$M_{i\ j}$ is a measurement result of cell i in the active set on frequency j.

$N_{A,j}$ is the number of cells in the active set on frequency j .

$M_{Best,j}$ is the measurement result of the cell in the active set on frequency j with the highest measurement result.

W_j is a parameter sent from UTRAN to UE and used for frequency j .

H is the hysteresis parameter.

If the measurement result is CPICH-Ec/No then M_{New} , $M_{i,j}$ and M_{Best} are expressed as ratios.

If the measurement result is CPICH-RSCP or PCCPCH-RSCP then M_{New} , $M_{i,j}$ and M_{Best} are expressed in [mW].

14.2.1 Inter-frequency reporting events

Within the measurement reporting criteria field in the MEASUREMENT CONTROL message UTRAN notifies the UE which events should trigger the UE to send a MEASUREMENT REPORT message. Examples of inter-frequency reporting events that would be useful for inter-frequency handover evaluation are given below. Note that normally the UEs do not need to report all these events. The listed events are the toolbox from which the UTRAN can choose the reporting events that are needed for the implemented handover evaluation function, or other radio network functions.

All events are evaluated with respect to one of the measurement quantities given in subclause 14.1.1. The measurement objects are the monitored primary common pilot channels (CPICH) in FDD mode and the monitored primary common control channels (PCCPCH) in TDD mode. A "non-used frequency" is a frequency that the UE have been ordered to measure upon but are not used of the active set. A "used frequency" is a frequency that the UE have been ordered to measure upon and is also currently used for the connection.

14.2.1.1 Event 2a: Change of best frequency.

If any of the non- used frequencies quality estimate becomes better than the currently used frequency quality estimate, and event 2a has been ordered by UTRAN then this event shall trigger a report to be sent from the UE when the hysteresis and time to trigger conditions is fulfilled. The corresponding report contains (at least) the best primary CPICH (FDD) or primary CCPCH (TDD) on the non-used frequency that triggered the event.

14.2.1.2 Event 2b: The estimated quality of the currently used frequency is below a certain threshold **and** the estimated quality of a non-used frequency is above a certain threshold.

When this event is ordered by UTRAN in a MEASUREMENT CONTROL message the UE shall send a report when the estimated quality of the currently used frequency is below the value of the IE "Threshold used frequency" and the estimated quality of a non-used frequency is above the value of the IE "Threshold non-used frequency" and the hysteresis and time to trigger conditions are fulfilled. The corresponding report contains at least the best primary CPICH (FDD) or primary CCPCH (TDD) on the non-used frequency that triggered the event.

14.2.1.3 Event 2c: The estimated quality of a non-used frequency is above a certain threshold

When this event is ordered by UTRAN in a MEASUREMENT CONTROL message the UE shall send a report when the estimated quality of a non-used frequency is above the value of the IE "Threshold non-used frequency" and the hysteresis and time to trigger conditions are fulfilled. The corresponding report contains at least the best primary CPICH (FDD) or primary CCPCH (TDD) on the non-used frequency.

14.2.1.4 Event 2d: The estimated quality of the currently used frequency is below a certain threshold

When this event is ordered by UTRAN in a MEASUREMENT CONTROL message the UE shall send a report when the estimated quality of the currently used frequency is below the value of the IE "Threshold used frequency" and the hysteresis and time to trigger conditions are fulfilled. The corresponding report contains at least the best primary CPICH (FDD) or primary CCPCH (TDD) on the used frequency.

14.2.1.5 Event 2e: The estimated quality of a non-used frequency is below a certain threshold

When this event is ordered by UTRAN in a MEASUREMENT CONTROL message the UE shall send a report when the estimated quality of a non-used frequency is below the value of the IE "Threshold non-used frequency" and the hysteresis and time to trigger conditions are fulfilled. The corresponding report contains at least the best primary CPICH (FDD) or primary CCPCH (TDD) on the non-used frequency.

14.2.1.6 Event 2 f: The estimated quality of the currently used frequency is above a certain threshold

When this event is ordered by UTRAN in a MEASUREMENT CONTROL message the UE shall send a report when the estimated quality of the currently used frequency is above the value of the IE "Threshold used frequency" and the hysteresis and time to trigger conditions are fulfilled. The corresponding report contains at least the best primary CPICH (FDD) or primary CCPCH (TDD) on the used frequency.

14.3 Inter-RAT measurements

The estimated quality of the active set in UTRAN in events 3a is defined as:

$$Q_{UTRAN} = 10 \cdot \text{Log}M_{UTRAN} = W \cdot 10 \cdot \text{Log} \left(\sum_{i=1}^{N_A} M_i \right) + (1 - W) \cdot 10 \cdot \text{Log}M_{Best},$$

The variables in the formula are defined as follows:

Q_{UTRAN} is the estimated quality of the active set on the currently used UTRAN frequency.

M_{UTRAN} is the estimated quality of the active set on currently used UTRAN frequency expressed in another unit.

M_i is a measurement result of cell i in the active set.

N_A is the number of cells in the active set.

M_{Best} is the measurement result of the cell in the active set with the highest measurement result.

W is a parameter sent from UTRAN to UE.

M_{UTRAN} , M_i and M_{Best} are expressed in [mW].

14.3.1 Inter-RAT reporting events

Within the measurement reporting criteria field in the MEASUREMENT CONTROL message the UTRAN notifies the UE which events should trigger the UE to send a MEASUREMENT REPORT message. Examples of inter-RAT reporting events that would be useful for inter-RAT handover evaluation are given below. Note that normally the UEs do not need to report all these events. The listed events are the toolbox from which the UTRAN can choose the reporting events that are needed for the implemented handover evaluation function, or other radio network functions.

All events are measured with respect to one of the measurement quantities given in subclause 14.3 The measurement objects are the monitored primary common pilot channels (CPICH) in FDD mode and the monitored primary common control channels (PCCPCH) in TDD mode for UTRAN and objects specific for other systems. A "used UTRAN frequency" is a frequency that the UE have been ordered to measure upon and is also currently used for the connection to UTRAN. "Other system" is e.g. GSM.

14.3.1.1 Event 3a: The estimated quality of the currently used UTRAN frequency is below a certain threshold **and** the estimated quality of the other system is above a certain threshold.

When this event is ordered by UTRAN in a MEASUREMENT CONTROL message the UE shall send a report when the estimated quality of the currently used frequency is below the value of the IE "Threshold own system" and the hysteresis and time to trigger conditions are fulfilled and the estimated quality of the other system is above the value of

the IE "Threshold other system" and the hysteresis and time to trigger conditions are fulfilled. The corresponding report contains information specific for the other system and the best primary CPICH (FDD) or primary CCPCH (TDD) on the used frequency.

14.3.1.2 Event 3b: The estimated quality of other system is below a certain threshold

When this event is ordered by UTRAN in a measurement control message the UE shall send a report when the estimated quality of the other system is below the value of the IE "Threshold other system" and the hysteresis and time to trigger conditions are fulfilled. The corresponding report contains information specific for the other system.

14.3.1.3 Event 3c: The estimated quality of other system is above a certain threshold

When this event is ordered by UTRAN in a measurement control message the UE shall send a report when the estimated quality of the other system is above the value of the IE "Threshold other system" and the hysteresis and time to trigger conditions are fulfilled. The corresponding report contains information specific for the other system.

14.3.1.4 Event 3d: Change of best cell in other system

If any of the quality estimates for the cells in the other system becomes better than the quality estimate for the currently best cell in the other system, and event 3d has been ordered by UTRAN then this event shall trigger a report to be sent from the UE when the hysteresis and time to trigger conditions is fulfilled. The corresponding report contains (at least) information the best cell in the other system.

14.3.2 GSM measurements in compressed mode

14.3.2.1 GSM RSSI measurements

The UE shall perform GSM RSSI measurements in the gaps of compressed mode pattern sequence specified for GSM RSSI measurement purpose. The UE cannot be required to measure "Observed time difference to GSM" in gaps specified for this purpose.

14.3.2.2 Initial BSIC identification

The UE shall perform Initial BSIC identification in compressed mode pattern sequence specified for Initial BSIC identification measurement purpose.

The parameter "N identify abort" in the IE "DPCH compressed mode info" indicates the maximum number of patterns that the UE shall use to attempt to decode the unknown BSIC of the GSM cell in the initial BSIC identification procedure.

The UE shall be able to measure the "Observed time difference to GSM cell" during a compressed mode pattern sequence configured for this purpose.

The BSIC identification procedure is defined in detail in [19].

14.3.2.3 BSIC re-confirmation

The UE shall perform BSIC re-confirmation in compressed mode pattern sequence specified for BSIC re-confirmation measurement purpose.

The parameter "T reconfirm abort" in the IE "DPCH compressed mode info" indicates the maximum time allowed for the re-confirmation of the BSIC of one GSM cell in the BSIC re-confirmation procedure.

The UE shall be able to measure the "Observed time difference to GSM cell" during a compressed mode pattern sequence configured for this purpose.

The BSIC re-confirmation procedure is defined in detail in [19].

14.4 Traffic Volume Measurements

14.4.1 Traffic Volume Measurement Quantity

In order to support a large variation of bit rates and RLC buffer size capabilities, a non-linear scale is used. Since, for each RB, the expected traffic includes both new and retransmitted RLC PDUs and potentially existing Control PDUs, all these should be included in the Buffer Occupancy measure. It should also be noted that traffic volume measurements are only applicable for acknowledged and unacknowledged mode.

According to what is stated in the Measurement Control message, the UE should support reporting of RLC Buffer Payload, Average of RLC Buffer Payload, and Variance of RLC Buffer Payload for RBs multiplexed onto the same Transport channel. The Reporting Quantities (i.e. RLC Buffer Payload, Average of RLC Buffer Payload, and Variance of RLC Buffer Payload of each RB) are indicated in the measurement control message. If Average of RLC Buffer Payload or Variance of RLC Buffer Payload is included as Reporting Quantity, the time interval to take an average or a variance shall be used. When the RLC buffer payload, Average of RLC buffer payload or Variance of RLC buffer payload is reported, the measured quantity shall be rounded upwards to the closest higher value possible to report.

14.4.2 Traffic Volume reporting triggers

Traffic volume can be reported in two different ways, periodical and event triggered. The reporting criteria are specified in the measurement control message.

For periodical reporting the UE simply determines the Reporting Quantities in number of bytes for each RB mapped onto the indicated transport channels and reports the results at the time interval and for the number of times specified.

For traffic volume measurements in the UE only one quantity is compared with the thresholds. This quantity is Transport Channel Traffic Volume [15] (which equals the sum of Buffer Occupancies of RBs multiplexed onto a transport channel) in number of bytes. Event triggered reporting is performed when the Transport Channel Traffic Volume exceeds an upper threshold or becomes smaller than a lower threshold. Every TTI, UE measures the Transport Channel Traffic Volume for each transport channel and compares it with the configured thresholds. If the value is out of range, the UE determines the Reporting Quantities for the RBs mapped onto that transport channel and reports the results.

14.4.2.1 Reporting event 4 A: Transport Channel Traffic Volume exceeds an absolute threshold

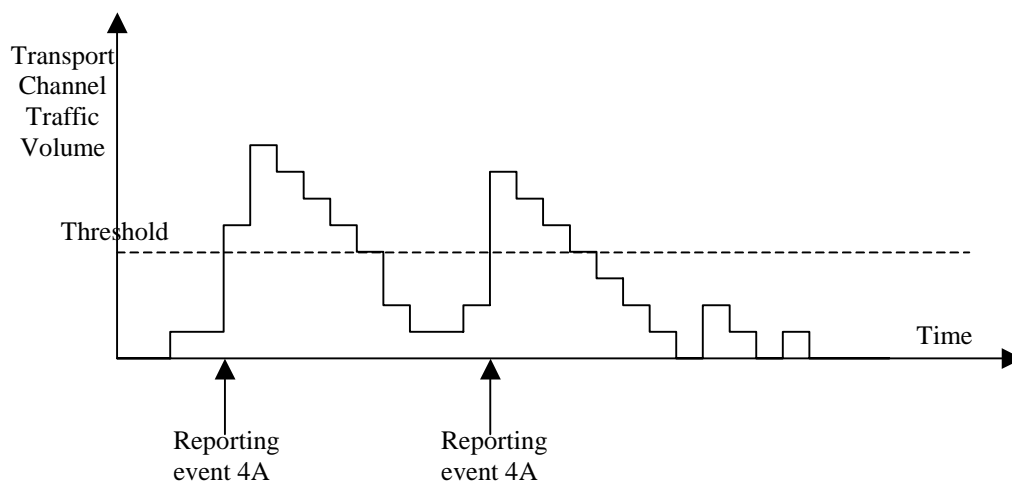

Figure 78: Event triggered report when Transport Channel Traffic Volume exceeds a certain threshold

If the monitored Transport Channel Traffic Volume [15] exceeds an absolute threshold, i.e. if $TCTF > \text{Reporting threshold}$, this is an event that could trigger a report. The corresponding report specifies at least which measurement ID the event that triggered the report belongs to.

14.4.2.2 Reporting event 4 B: Transport Channel Traffic Volume becomes smaller than an absolute threshold

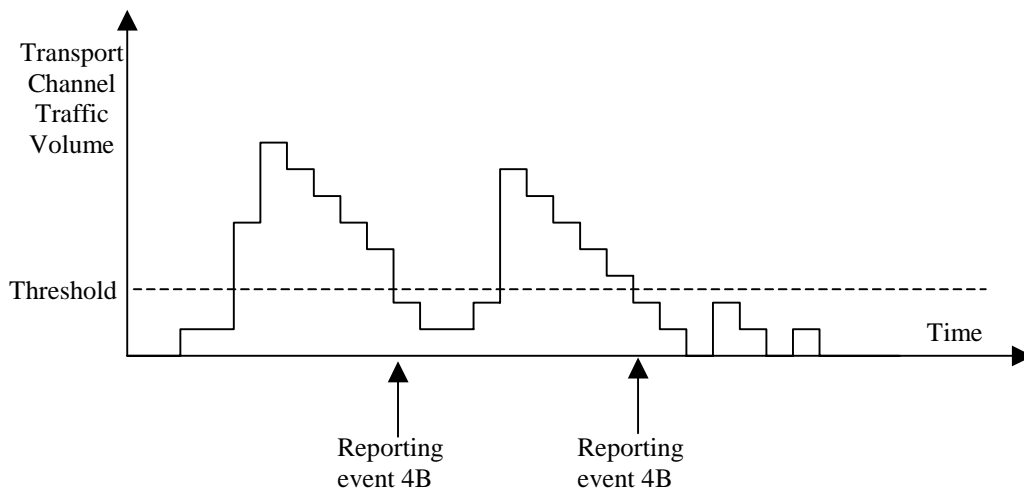

Figure 79: Event triggered report when Transport Channel Traffic Volume becomes smaller than certain threshold

If the monitored Transport Channel Traffic Volume [15] becomes smaller than an absolute threshold, i.e. if $TCTF < \text{Reporting threshold}$, this is an event that could trigger a report. The corresponding report specifies at least which measurement ID the event that triggered the report belongs to.

14.4.3 Traffic volume reporting mechanisms

Traffic volume measurement triggering could be associated with both a *time-to-trigger* and a *pending time after trigger*. The time-to-trigger is used to get time domain hysteresis, i.e. the condition must be fulfilled during the time-to-trigger time before a report is sent. Pending time after trigger is used to limit consecutive reports when one traffic volume measurement report already has been sent. This is described in detail below.

14.4.3.1 Pending time after trigger

This timer is started in the UE when a measurement report has been triggered. The UE is then forbidden to send any new measurement reports with the same measurement ID during this time period even when the triggering condition is fulfilled again. Instead the UE waits until the timer has suspended. If the Transport Channel Traffic Volume [15] is still above the threshold when the timer has expired the UE sends a new measurement report, and the timer is restarted. Otherwise it waits for a new triggering.

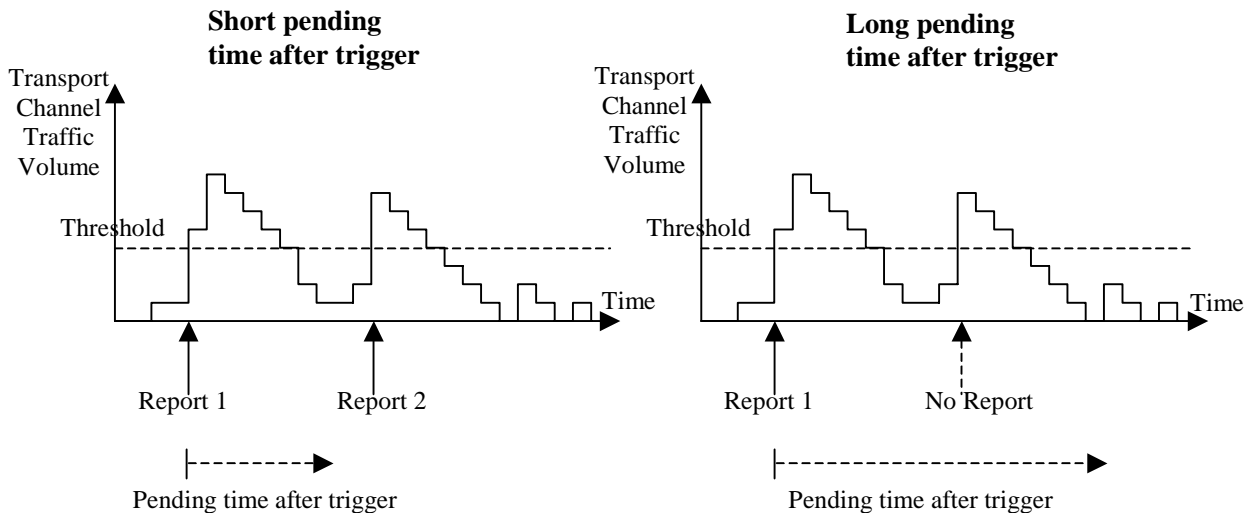

Figure 80: Pending time after trigger limits the amount of consecutive measurement reports

Figure 80 shows that by increasing the pending time after trigger a triggered second event does not result in a measurement report.

14.4.4 Interruption of user data transmission

A UE in CELL_FACH substate may be instructed by the UTRAN to cease transmission of user data on the RACH after a measurement report has been triggered. Before resuming transmission of user data,

- the UE shall receive from the UTRAN either a message allocating a dedicated physical channel, and make a transition to CELL_DCH state; or
- the UE shall receive an individually assigned measurement control message indicating that interruption of user data transmission is not be applied.

The transmission of signalling messages on the signalling bearer shall not be interrupted.

14.5 Quality Measurements

14.5.1 Quality reporting measurement quantities

For quality measurements, the following measurement quantities are used:

1. Downlink transport channel BLER
2. Timeslot SIR (TDD only)

14.5.2 Quality reporting events

14.5.2.1 Reporting event 5A: A predefined number of bad CRCs is exceeded

When this event is ordered by UTRAN in a measurement control message, the UE shall send a measurement report when the amount of bad CRCs during a predefined sliding window exceeds a predefined number.

The following three parameters are used in the scheme:

- **Total CRC** = the length of the sliding window over which the number of bad CRCs are counted.
- **Bad CRC** = the number of bad CRC that is required within the latest "Total CRC" received CRCs for the event to be triggered.

- **Pending after trigger** = a new event can not be triggered until "Pending after trigger" CRCs have been received,

When a DCH is established, the UE shall begin to count the number of bad CRCs within the last "Total CRC" received CRCs. No event can be triggered until at least "Total CRC" CRCs have been received. For each new received CRC, the UE shall compare the number of bad CRCs within the latest "Total CRC" received CRCs with the parameter "Bad CRC". An event shall be triggered if the number of bad CRCs is equal or larger than "Bad CRC".

At the time when the event is triggered a pending time after trigger timer is started with the length of "Pending after trigger" CRCs. A new event can not be triggered until "Pending after trigger" CRCs have been received. When "Pending after trigger" CRCs have been received the event evaluation start again and a new event can be triggered.

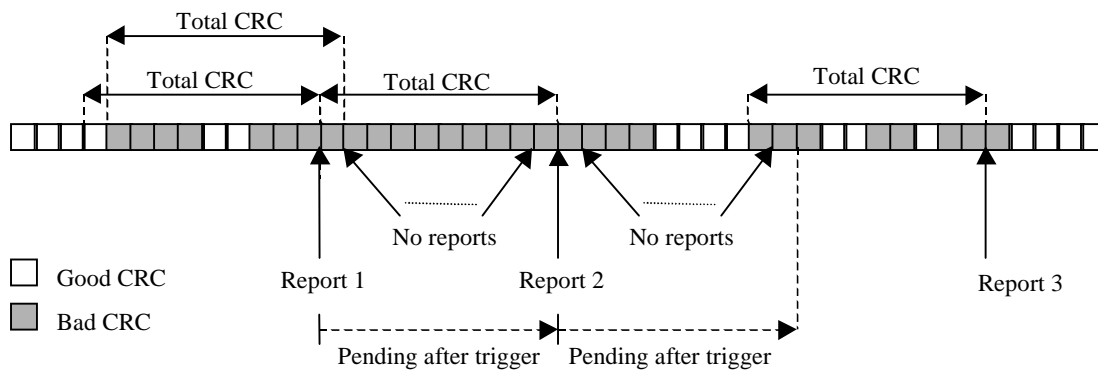

Figure 81: Event triggered CRC error reporting

14.6 UE internal measurements

14.6.1 UE internal measurement quantities

For UE internal measurements the following measurement quantities exist:

1. UE transmission (Tx) power, for TDD measured on a timeslot basis.
2. UE received signal strength power (RSSI).
3. UE Rx-Tx time difference.

14.6.2 UE internal measurement reporting events

In the Measurement reporting criteria field in the Measurement Control messages, the UTRAN notifies the UE of which events should trigger a measurement report. UE internal measurement reporting events that can trigger a report are given below. The reporting events are marked with vertical arrows in the figures below. All events can be combined with time-to-trigger. In that case, the measurement report is only sent if the condition for the event has been fulfilled for the time given by the time-to-trigger parameter.

NOTE: The reporting events are numbered 6A, 6B, 6C,.. where 6 denotes that the event belongs to the type UE internal measurements.

14.6.2.1 Reporting event 6A: The UE Tx power becomes larger than an absolute threshold

When this event is ordered by UTRAN in a measurement control message, the UE shall send a measurement report when the UE transmission power (for TDD within a single TS) becomes larger than a predefined threshold. The corresponding report identifies the threshold that was exceeded.

14.6.2.2 Reporting event 6B: The UE Tx power becomes less than an absolute threshold

When this event is ordered by UTRAN in a measurement control message, the UE shall send a measurement report when the UE transmission power (for TDD within a single TS) becomes less than a predefined threshold. The corresponding report identifies the threshold that the UE Tx power went below.

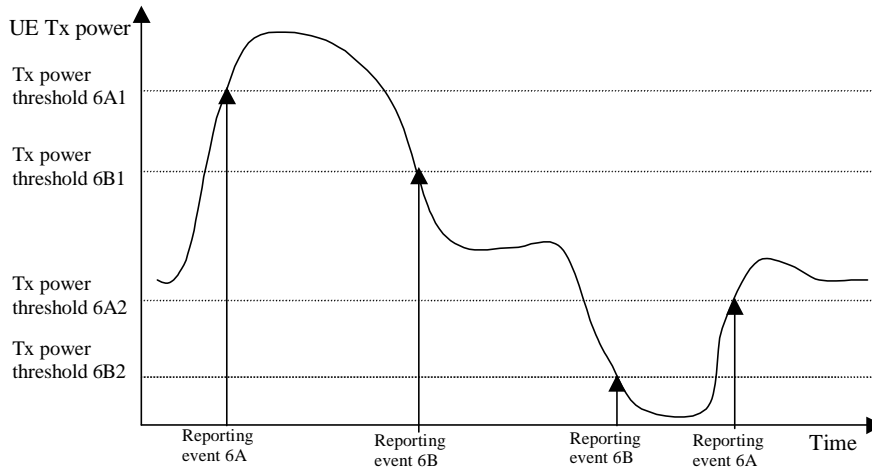

Figure 82: Event-triggered measurement reports when the UE Tx power becomes larger or less than absolute thresholds

14.6.2.3 Reporting event 6C: The UE Tx power reaches its minimum value

When this event is ordered by UTRAN in a measurement control message, the UE shall send a measurement report when the UE Tx power reaches its minimum value, for TDD its minimum value on a single timeslot.

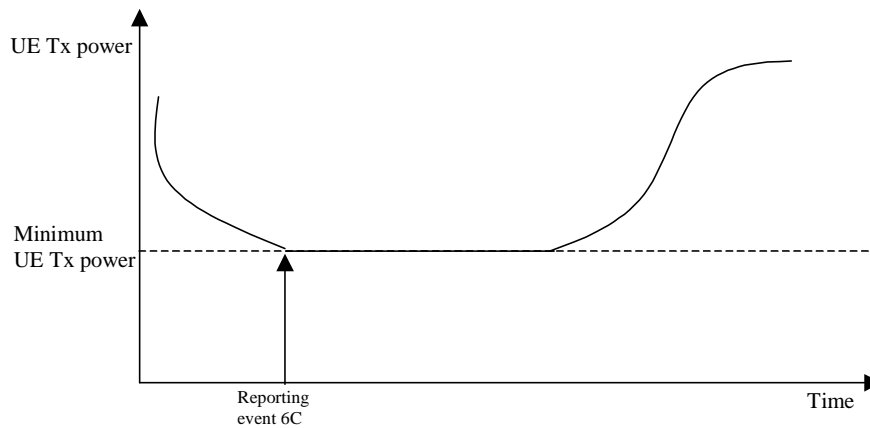

Figure 83: Event-triggered measurement report when the UE Tx power reaches its minimum value

14.6.2.4 Reporting event 6D: The UE Tx power reaches its maximum value

When this event is ordered by UTRAN in a measurement control message, the UE shall send a measurement report when the UE Tx power reaches its maximum value, for TDD its maximum value on a single timeslot.

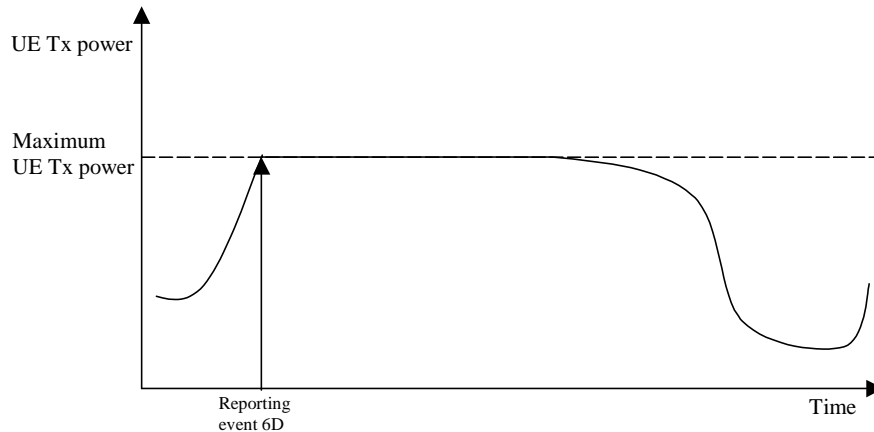

Figure 84: Event-triggered report when the UE Tx power reaches its maximum value

14.6.2.5 Reporting event 6E: The UE RSSI reaches the UE's dynamic receiver range

When this event is ordered by UTRAN in a measurement control message, the UE shall send a measurement report when the UE RSSI reaches the UE's dynamic receiver range.

14.6.2.6 Reporting event 6F: The UE Rx-Tx time difference for a RL included in the active set becomes larger than an absolute threshold

When this event is ordered by UTRAN in a MEASUREMENT CONTROL message, the UE shall send a MEASUREMENT REPORT message when the UE Rx-Tx time difference becomes larger than the threshold defined by the IE "UE Rx-Tx time difference threshold".

14.6.2.7 Reporting event 6G: The UE Rx-Tx time difference for a RL included in the active set becomes less than an absolute threshold

When this event is ordered by UTRAN in a MEASUREMENT CONTROL message, the UE shall send a MEASUREMENT REPORT when the UE Rx-Tx time difference becomes less than the threshold defined by the IE "UE Rx-Tx time difference threshold".

14.7 UE positioning measurements

14.7.1 UE positioning measurement quantity

The quantity to measure for UE positioning is dependent on the location method and the method type requested in the IE "UE positioning reporting quantity". In case the OTDOA method is requested, the UE shall measure the following quantities disregarding of the method type used:

- SFN-SFN observed time difference

If the Assisted GPS method is requested, the UE has to request its internal GPS receiver to make measurements. The measurements to be made by the GPS receiver are not within the scope of this subclause.

If it is indicated in the IE "UE positioning reporting quantity" to report the GPS timing of the cell, the UE shall measure the following quantity:

- UE GPS timing of cell frames for UE positioning

14.7.2 UE positioning reporting quantity

The quantity to report is also dependent on the location method and method type requested in the IE "UE positioning reporting quantity". If the method type is set to "UE based", the IE "UE positioning Position" has to be included in the report.

In case the method type is set to "UE assisted", the following IEs have to be included in the report:

- IE "UE positioning OTDOA measurement" in case the OTDOA location method is requested.
- IE "UE positioning GPS measurement" in case the GPS location method is requested.

14.7.3 UE positioning reporting events

In the UE positioning reporting criteria field in the Measurement Control messages, the UTRAN notifies the UE of which events should trigger a measurement report. UE positioning reporting events that can trigger a report are given below. The content of the measurement report is dependant on the location method and method type requested in the IE "UE positioning reporting quantity" of the Measurement Control message and is described in detail in [18].

14.7.3.1 Reporting Event 7a: The UE position changes more than an absolute threshold

When this event is ordered by UTRAN in a measurement control message, the UE shall send a measurement report when the UE changes its position compared to the last reported position more than a predefined threshold. This event is used for UE-based methods only.

14.7.3.2 Reporting Event 7b: SFN-SFN measurement changes more than an absolute threshold

When this event is ordered by UTRAN in a measurement control message, the UE shall send a measurement report when the SFN-SFN time difference measurement of any measured cell changes more than a predefined threshold. This event is primarily used for UE-assisted methods, but can be used also for UE-based methods.

14.7.3.3 Reporting Event 7c: GPS time and SFN time have drifted apart more than an absolute threshold

When this event is ordered by UTRAN in a measurement control message, the UE shall send a measurement report when the GPS Time Of Week and the SFN timer have drifted apart more than a predefined threshold. This event is primarily used for UE-assisted methods, but can be used also for UE-based methods.

14.8 Dynamic Resource Allocation Control of Uplink DCH (FDD only)

The network uses this procedure to dynamically control the allocation of resources on an uplink DCH.

This procedure shall be activated in the UE when it has been allocated an uplink DCH with DRAC static information elements. Such uplink DCHs can be established through RB establishment procedure, RB reconfiguration procedure, RB release procedure or Transport Channel Reconfiguration procedure by setting the DRAC static information elements to indicate that the DCH is controlled by the DRAC procedure.

The UE shall periodically listen to the SIB 10 of each cell in its Active Set. The scheduling information of SIB10 and the SCCPCH info on which the SIB10 is transmitted are provided to the UE when the DCH is set up and when a cell is added in its active set. In case several SIB10 messages from different cells are scheduled at the same time, the UE shall only listen to the SIB10 broadcast in the cell of its Active Set having the best CPICH measurements.

Upon reception of a SYSTEM INFORMATION message comprising a SIB10, the UE shall:

1. Determine and store the most stringent DRAC parameters from the last received values from each cell of its active set (i.e. select the lowest product $p_{tr} \cdot \text{maximum bit rate}$ corresponding to its DRAC class identity)

2. Determine the allowed subset of TFCS according to the selected maximum bit rate value, and store it for later usage.
The allowed subset of TFCS are the ones of the TFCS for which the sum of bit rates of the DCH controlled by DRAC is lower than Maximum Bit Rate IE, i.e.

$$\sum_{\text{DCHi controlled by DRAC}} TBSsize_i / TTI_i < MaximumBitRate$$

DCHi controlled by DRAC

After the first SIB10 has been received, the UE shall start the following process:

1. At the start of the next TTI, the UE shall randomly select $p \in [0,1]$.
2. If $p < ptr$, the UE shall transmit on the DCH controlled by DRAC during T_{validity} frames using the last stored allowed subset of TFCS and comes back to step 1, otherwise the UE shall stop transmission on these DCH during T_{retry} frames and then comes back to step 1.

Transmission time validity (T_{validity}) and Time duration before retry (T_{retry}) are indicated to the UE at the establishment of a DCH controlled by this procedure and may be changed through RB or transport channel reconfiguration. The UE shall always use the latest received DRAC static parameters.

A UE that supports the simultaneous reception of one SCCPCH and one DPCH shall support the DRAC procedure.

14.9 Downlink power control

14.9.1 Generalities

This function is implemented in the UE in order to set the SIR target value on each CCTrCH used for the downlink power control. This SIR value shall be adjusted according to an autonomous function in the UE in order to achieve the same measured quality as the quality target set by UTRAN. The quality target is set as the transport channel BLER value for each transport channel as signalled by UTRAN. For CPCH the quality target is set as the BER of the DL DPCCCH as signalled by UTRAN.

When transport channel BLER is used the UE shall run a quality target control loop such that the quality requirement is met for each transport channel, which has been assigned a BLER target.

When DL DPCCCH BER is used the UE shall run a quality target control loop such that the quality requirement is met for each CPCH transport channel, which has been assigned a DL DPCCCH BER target.

The UE shall set the SIR target when the physical channel has been set up or reconfigured. It shall not increase the SIR target value before the power control has converged on the current value. The UE may estimate whether the power control has converged on the current value, by comparing the averaged measured SIR to the SIR target value.

14.9.2 Downlink power control in compressed mode

In compressed mode, the target SIR needs to be changed in several frames compared to normal mode. For this purpose, four values DeltaSIR1, DeltaSIRafter1, DeltaSIR2 and DeltaSIRafter2 are signalled by the UTRAN to the UE (see subclause 10.2.9).

For each frame, the target SIR offset during compressed mode, compared to normal mode is:

$$\Delta\text{SIR} = \max(\Delta\text{SIR1}_{\text{compression}}, \dots, \Delta\text{SIRn}_{\text{compression}}) + \Delta\text{SIR1}_{\text{coding}} + \Delta\text{SIR2}_{\text{coding}}$$

where n is the number of TTI lengths for all TrChs of the CCTrCh, F_i is the length in number of frames of the i-th TTI and where $\Delta\text{SIR}_{\text{coding}}$ fulfils:

- $\Delta\text{SIR1}_{\text{coding}} = \text{DeltaSIR1}$ if the start of the first transmission gap in the transmission gap pattern is within the current frame.
- $\Delta\text{SIR1}_{\text{coding}} = \text{DeltaSIRafter1}$ if the current frame just follows a frame containing the start of the first transmission gap in the transmission gap pattern.

- $\Delta\text{SIR2_coding} = \text{DeltaSIR2}$ if the start of the second transmission gap in the transmission gap pattern is within the current frame.
- $\Delta\text{SIR2_coding} = \text{DeltaSIRafter2}$ if the current frame just follows a frame containing the start of the second transmission gap in the transmission gap pattern.
- $\Delta\text{SIR1_coding} = 0$ and $\Delta\text{SIR2_coding} = 0$ otherwise.

and ΔSIR_i _compression is defined by :

- ΔSIR_i _compression = 3 dB for downlink frames compressed by reducing the spreading factor by 2.
- ΔSIR_i _compression = $10 \log (15 \cdot F_i / (15 \cdot F_i - \text{TGL}_i))$ if there is a transmission gap created by puncturing method within the current TTI of length F_i frames, where TGL_i is the gap length in number of slots (either from one gap or a sum of gaps) in the current TTI of length F_i frames.
- ΔSIR_i _compression = 0 dB in all other cases.

Several compressed mode patterns applying to the same frames should be avoided as much as possible.

In particular; several simultaneous patterns by puncturing applying to the same frames shall be considered as a protocol error by the UE. The handling of this error is described in the procedure descriptions in clause 8

In case several compressed mode patterns are used simultaneously, a ΔSIR offset is computed for each compressed mode pattern and the sum of all ΔSIR offsets is applied to the frame.

14.10 Calculated Transport Format Combination

The Calculated Transport Format Combination (CTFC) is a tool for efficient signalling of transport format combinations.

Let I be the number of transport channels that are included in the transport format combination. Each transport channel TrCH_i , $i = 1, 2, \dots, I$, has L_i transport formats, i.e. the transport format indicator TFI_i can take L_i values, $\text{TFI}_i \in \{0, 1, 2, \dots, L_i - 1\}$.

Define $P_i = \prod_{j=0}^{i-1} L_j$, where $i = 1, 2, \dots, I$, and $L_0 = 1$.

Let $\text{TFC}(\text{TFI}_1, \text{TFI}_2, \dots, \text{TFI}_I)$ be the transport format combination for which TrCH_1 has transport format TFI_1 , TrCH_2 has transport format TFI_2 , etc. The corresponding $\text{CTFC}(\text{TFI}_1, \text{TFI}_2, \dots, \text{TFI}_I)$ is then computed as:

$$\text{CTFC}(\text{TFI}_1, \text{TFI}_2, \dots, \text{TFI}_I) = \sum_{i=1}^I \text{TFI}_i \cdot P_i.$$

For FACH and PCH transport channels, " TrCH_1 " corresponds to the transport channel listed at the first position in IE "FACH/PCH information" in IE "Secondary CCPCH System Information", " TrCH_2 " corresponds to the transport channel listed at the second position in IE "FACH/PCH information" and so on.

For all other transport channels, " TrCH_1 " corresponds to the transport channel having the lowest transport channel identity in the transport format combination mapped to the TFCI field in FDD, and for all configured transport channels of the transport channel type (i.e. DCH, DSCH, USCH) in TDD. " TrCH_2 " corresponds to the transport channel having the next lowest transport channel identity, and so on.

14.11 UE autonomous update of active set on non-used frequency (FDD only)

Within the measurement reporting criteria field in the MEASUREMENT CONTROL message the UTRAN notifies the UE which events should trigger a measurement report. For inter frequency measurements it is possible to specify intra-frequency measurements reporting events for support of maintenance of a active set associated with a non-used

frequency, a "virtual active set". A "non-used frequency" is a frequency that the UE has been ordered to measure upon but are not used by the active set. A "used frequency" is a frequency that the UE has been ordered to measure upon and is also currently used for the connection.

The autonomous update is controlled by the IE "UE autonomous update mode" that can be set to the following values.

- On: Do the autonomous updates of the "virtual active set" according to the described rules below and also report the events that trigger the update of the "virtual active set".
- On with no reporting: Do the autonomous updates of the "virtual active set" according to the described rules below.
- Off: Only report the events and do no updates of the "virtual active set" unless ordered to do so by the IE "Inter-frequency set update".

If the IE "UE autonomous update mode" is set to "on" or "on with no reporting" the UE shall evaluate the following intra-frequency events and update the "virtual active set" associated with the frequency measured upon, according to the following rules:

- Event 1a shall make the UE add the primary CPICH that enters the reporting range to the "virtual active set".
- Event 1b shall make the UE remove a primary CPICH that leaves the reporting range from the "virtual active set".
- Event 1c shall make the UE replace an active primary CPICH in the "virtual active set" with a non-active primary CPICH that have become better than the active primary CPICH.

14.12 Provision and reception of RRC information between network nodes

14.12.0 General

In certain cases, e.g., when performing handover to UTRAN or when performing SRNC relocation, RRC information may need to be transferred between other RATs and UTRAN or between UTRAN nodes within UTRAN. In the following, the details of the RRC information to be transferred are specified per direction.

In the following the RRC information exchanged between network nodes is sometimes referred to as RRC information containers. This term is used for information which handling resembles that of RRC messages rather than of RRC information elements.

In future versions of this specification, it is possible to extend the RRC information transferred between network nodes. For RRC information containers the same extension mechanism applies as defined for RRC messages, which is specified in subclause 10.1. For RRC information containers specified in the following, both critical and non-critical extensions may be added.

Like for the Uu interface, the transfer syntax for RRC transferred between UTRAN network nodes and/or between UTRAN and other RATs is derived from their ASN.1 definitions by use of Packed Encoding Rules, unaligned (X.691). It should be noted that the encoder adds final padding to achieve octet alignment. The resulting octet string is, carried in a container, transferred between the network nodes.

14.12.0a General error handling for RRC information containers

The handling of RRC messages that are terminated in the UE and transferred using RRC information containers is covered by clauses 8 and 9 of this specification.

The error handling for RRC information containers that are terminated in network nodes applies the same principles as defined for RRC messages, as specified in the following.

Although the same principles apply for network nodes receiving unknown, unforeseen and erroneous RRC information containers, although the notification of the error should be done in a different manner, as specified in the following:

The network node receiving an invalid RRC information container from another network node should:

- if the received RRC information container was unknown, unforeseen or erroneous:
 - prepare an RRC INFORMATION CONTAINER FAILURE INFO container, including the IE "Failure cause" set to "Protocol error" and the IE "Protocol error information" including an IE "Protocol error cause" which should be set as follows:
 - to "ASN.1 violation or encoding error" upon receiving an RRC information container for which the encoded message does not result in any valid abstract syntax value;
 - to "Message type non-existent or not implemented" upon receiving an unknown RRC information container type;
 - to "Message extension not comprehended" upon receiving an RRC information container including an undefined critical message extension;
 - to "Information element value not comprehended" upon receiving an RRC information container including an mandatory IE for which no default value is defined and for which either the value is set to spare or for which the encoded IE does not result in a valid transfer syntax. The same applies for conditional IEs, for which the conditions for presence are met, the IE is present but has a value set to spare or for which the encoded IE does not result in a valid transfer syntax;
 - to "Conditional information element error" upon receiving an RRC information container with an absent conditional IE for which the conditions for presence are met;
- if there was another failure to perform the operation requested by the received RRC information container:
 - prepare an RRC INFORMATION CONTAINER FAILURE INFO container, including the IE "Failure cause" set to a value that reflects the failure cause;
- send the RRC INFORMATION CONTAINER FAILURE INFO container to the network node from which the invalid RRC protocol information was received.

NOTE: The RRC information container may be transferred across the network interfaces by means of a transparent container, if available.

14.12.1 RRC Information to target RNC

RRC Information to target RNC may either be sent from source RNC or from another RAT. In case of handover to UTRAN, this information originates from another RAT, while in case of SRNC relocation the RRC information originates from the source RNC. In case of SRNC information, the RRC information transferred specifies the configuration of RRC and the lower layers it controls, e.g., including the radio bearer and transport channel configuration. It is used by the target RNC to initialise RRC and the lower layer protocols to facilitate SRNC relocation in a manner transparent to the UE.

| Information Element/Group Name | Need | Multi | Type and reference | Semantics description |
|--------------------------------|------|-------|----------------------------------|---|
| CHOICE case | MP | | | At least one spare choice, Criticality: Reject, is needed |
| >Handover to UTRAN | | | HANDOVER TO UTRAN INFO 14.12.4.1 | |
| >SRNC relocation | | | SRNS RELOCATION INFO14.12.4.2 | |

14.12.2 RRC information, target RNC to source RNC

There are 2 possible cases for RNC relocation:

1. The UE is already under control of target RNC; and
2. The SRNC Relocation with Hard Handover (UE still under control of SRNC), but UE is moving to a location controlled by the target RNC (based on measurement information).

In case 1 the relocation is transparent to the UE and there is no "reverse" direction container. The SRNC just assigns the 'serving' function to the target RNC, which then becomes the Serving RNC.

In case 2 the relocation is initiated by SRNC, which also provides the RRC Initialisation Information to the target RNC. Base on this information, the target RNC prepares the Hard Handover Message ("Physical channel reconfiguration" (subclause 8.2.6), "radio bearer establishment" (subclause 8.2.1), "Radio bearer reconfiguration" (subclause 8.2.2), "Radio bearer release" (subclause 8.2.3) or "Transport channel reconfiguration" (subclause 8.2.4).

The source RNC then transmits the Handover Message to the UE, which then performs the handover.

In the successful case, the UE transmits an XXX COMPLETE message, using the new configuration, to the target RNC.

In case of failure, the UE transmits an XXX FAILURE, using the old configuration, to the source RNC and the RRC context remains unchanged (has to be confirmed and checked with the SRNS relocation procedure).

| Information Element/Group name | Need | Multi | Type and reference | Semantics description |
|---|------|-------|---|---|
| CHOICE <i>RRC message</i> | MP | | | At least one spare choice, Criticality: Reject, is needed |
| >RADIO BEARER SETUP | | | RADIO BEARER SETUP 10.2.31 | |
| >RADIO BEARER RECONFIGURATION | | | RADIO BEARER RECONFIGURATION 10.2.25 | |
| >RADIO BEARER RELEASE | | | RADIO BEARER RELEASE 10.2.28 | |
| >TRANSPORT CHANNEL RECONFIGURATION | | | TRANSPORT CHANNEL RECONFIGURATION 10.2.51 | |
| >PHYSICAL CHANNEL RECONFIGURATION | | | PHYSICAL CHANNEL RECONFIGURATION 10.2.20 | |
| >RRC INFORMATION CONTAINER FAILURE INFO | | | RRC INFORMATION CONTAINER FAILURE INFO 14.12.4.3 | |

14.12.3 RRC information, target RNC to source system

The RRC information, target RNC to source system is used to transfer information to another RAT, e.g., in case of handover to UTRAN. In this case, the RRC information concerns the "Handover To UTRAN Command" that is compiled by the target RNC but transferred via another RAT towards the UE, as specified in 8.3.6.

| Information Element/Group name | Need | Multi | Type and reference | Semantics description |
|---|------|-------|---|---|
| CHOICE <i>case</i> | MP | | | At least one spare choice, Criticality: Reject, is needed |
| >handover to UTRAN | | | HANDOVER TO UTRAN COMMAND 10.2.12 | |
| >RRC INFORMATION CONTAINER FAILURE INFO | | | RRC INFORMATION CONTAINER FAILURE INFO 14.12.4.3 | |

14.12.4 RRC information containers exchanged between network nodes

14.12.4.1 HANDOVER TO UTRAN INFO

This RRC information container is sent between network nodes when preparing for an inter RAT handover to UTRAN.

Direction: source RAT→target RNC

| Information Element/Group Name | Need | Multi | Type and reference | Semantics description |
|--|------|-------|--|-----------------------|
| UE Information elements | | | | |
| UE radio access capability | OP | | UE radio access capability 10.3.3.42 | |
| UE radio access capability extension | OP | | UE radio access capability extension 10.3.3.42a | |
| Non RRC IEs | | | | |
| UE system specific capability | OP | | UE system specific capability 14.13.2.4 | |
| UE security information | OP | | UE security information 14.13.2.2 | |
| Pre-defined configuration status information | OP | | Pre-defined configuration status information 14.13.2.3 | |

14.12.4.1 SRNS RELOCATION INFO

This RRC information container is sent between network nodes when preparing for an SRNS relocation.

Direction: source RAT→target RNC

| Information Element/Group Name | Need | Multi | Type and reference | Semantics description |
|--|----------------------|-----------------------|---|--|
| Non RRC IEs | | | | |
| >State of RRC | MP | | RRC state indicator, 10.3.3.10 | |
| >State of RRC procedure | MP | | Enumerated (await no RRC message, Complete, await RB Setup Complete, await RB Reconfiguration Complete, await RB Release Complete, await Transport CH Reconfiguration Complete, await Physical CH Reconfiguration Complete, await Active Set Update Complete, await Handover Complete, send Cell Update Confirm, send URA Update Confirm, , others) | |
| Ciphering related information | | | | |
| >Ciphering status | MP | | Enumerated(Not started, Started) | |
| >Calculation time for ciphering related information | CV- <i>Ciphering</i> | | | Time when the ciphering information of the message were calculated, relative to a cell of the target RNC |
| >>Cell Identity | MP | | Cell Identity 10.3.2.2 | Identity of one of the cells under the target RNC and included in the active set of the current call |
| >>SFN | MP | | Integer(0..4095) | |
| >COUNT-C list | CV- <i>Ciphering</i> | 1 to <maxCN domains > | | COUNT-C values for radio bearers using transparent mode RLC |
| >>CN domain identity | MP | | CN domain identity 10.3.1.1 | |
| >>COUNT-C | MP | | Bitstring(32) | |
| >Ciphering info per radio bearer | OP | 1 to <maxRB > | | For signalling radio bearers this IE is mandatory. |
| >>RB identity | MP | | RB identity 10.3.4.16 | |
| >>Downlink HFN | MP | | Bitstring(20..25) | This IE is either RLC AM HFN (20 bits) or RLC UM HFN (25 bits) |
| >>Uplink HFN | MP | | Bitstring(20..25) | This IE is either RLC AM HFN (20 bits) or RLC UM HFN (25 bits) |
| Integrity protection related information | | | | |
| >Integrity protection status | MP | | Enumerated(Not started, Started) | |
| >Signalling radio bearer specific integrity protection information | CV- <i>IP</i> | 4 to <maxSR | | |

| Information Element/Group Name | Need | Multi | Type and reference | Semantics description |
|--|------|----------------------------|--|--|
| | | Bsetup> | | |
| >>Uplink RRC HFN | MP | | Bitstring (28) | |
| >>Downlink RRC HFN | MP | | Bitstring (28) | |
| >>Uplink RRC Message sequence number | MP | | Integer (0..15) | |
| >>Downlink RRC Message sequence number | MP | | Integer (0..15) | |
| >Implementation specific parameters | OP | | Bitstring (1..512) | |
| RRC IEs | | | | |
| UE Information elements | | | | |
| >U-RNTI | MP | | U-RNTI 10.3.3.47 | |
| >C-RNTI | OP | | C-RNTI 10.3.3.8 | |
| >UE radio access Capability | MP | | UE radio access capability 10.3.3.42 | |
| >UE radio access capability extension | OP | | UE radio access capability extension 10.3.3.42a | |
| >Last known UE position | OP | | | |
| >>SFN | MP | | Integer (0..4095) | Time when position was estimated |
| >>Cell ID | MP | | Cell identity; 10.3.2.2 | Indicates the cell, the SFN is valid for. |
| >>CHOICE <i>Position estimate</i> | MP | | | |
| >>>Ellipsoid Point | | | Ellipsoid Point; 10.3.8.4a | |
| >>>Ellipsoid point with uncertainty circle | | | Ellipsoid point with uncertainty circle 10.3.8.4d | |
| >>>Ellipsoid point with uncertainty ellipse | | | Ellipsoid point with uncertainty ellipse 10.3.8.4e | |
| >>>Ellipsoid point with altitude | | | Ellipsoid point with altitude 10.3.8.4b | |
| >>>Ellipsoid point with altitude and uncertainty ellipsoid | | | Ellipsoid point with altitude and uncertainty ellipsoid 10.3.8.4c | |
| Other Information elements | | | | |
| >UE system specific capability | OP | 1 to <maxSystemCapability> | | |
| >>Inter-RAT UE radio access capability | MP | | Inter-RAT UE radio access capability 10.3.8.7 | |
| UTRAN Mobility Information elements | | | | |
| >URA Identifier | OP | | URA identity 10.3.2.6 | |
| CN Information Elements | | | | |
| >CN common GSM-MAP NAS system information | MP | | NAS system information (GSM-MAP) 10.3.1.9 | |
| >CN domain related information | OP | 1 to <MaxCN domains > | | CN related information to be provided for each CN domain |
| >>CN domain identity | MP | | | |
| >>CN domain specific GSM-MAP NAS system info | MP | | NAS system information (GSM-MAP) | |

| Information Element/Group Name | Need | Multi | Type and reference | Semantics description |
|---|-----------------|---------------------|---|-----------------------|
| | | | 10.3.1.9 | |
| >>CN domain specific DRX cycle length coefficient | MP | | CN domain specific DRX cycle length coefficient, 10.3.3.6 | |
| Measurement Related Information elements | | | | |
| >For each ongoing measurement reporting | OP | 1 to <MaxNo OfMeas> | | |
| >>Measurement Identity | MP | | Measurement identity 10.3.7.48 | |
| >>Measurement Command | MP | | Measurement command 10.3.7.46 | |
| >>Measurement Type | <i>CV-Setup</i> | | Measurement type 10.3.7.50 | |
| >>Measurement Reporting Mode | OP | | Measurement reporting mode 10.3.7.49 | |
| >>Additional Measurements list | OP | | Additional measurements list 10.3.7.1 | |
| >>CHOICE <i>Measurement</i> | OP | | | |
| >>>Intra-frequency | | | | |
| >>>>Intra-frequency cell info | OP | | Intra-frequency cell info list 10.3.7.33 | |
| >>>>Intra-frequency measurement quantity | OP | | Intra-frequency measurement quantity 10.3.7.38 | |
| >>>>Intra-frequency reporting quantity | OP | | Intra-frequency reporting quantity 10.3.7.41 | |
| >>>>Reporting cell status | OP | | Reporting cell status 10.3.7.61 | |
| >>>>Measurement validity | OP | | Measurement validity 10.3.7.51 | |
| >>>>CHOICE <i>report criteria</i> | OP | | | |
| >>>>>Intra-frequency measurement reporting criteria | | | Intra-frequency measurement reporting criteria 10.3.7.39 | |
| >>>>>Periodical reporting | | | Periodical reporting criteria 10.3.7.53 | |
| >>>>>No reporting | | | NULL | |
| >>>Inter-frequency | | | | |
| >>>>Inter-frequency cell info | OP | | Inter-frequency cell info list 10.3.7.13 | |
| >>>>Inter-frequency measurement quantity | OP | | Inter-frequency measurement quantity 10.3.7.18 | |
| >>>>Inter-frequency reporting quantity | OP | | Inter-frequency reporting quantity 10.3.7.21 | |
| >>>>Reporting cell status | OP | | Reporting cell status 10.3.7.61 | |
| >>>>Measurement validity | OP | | Measurement validity 10.3.7.51 | |
| >>>>CHOICE <i>report criteria</i> | OP | | | |
| >>>>>Inter-frequency measurement reporting criteria | | | Inter-frequency measurement reporting criteria 10.3.7.19 | |

| Information Element/Group Name | Need | Multi | Type and reference | Semantics description |
|--|------|-------|--|-----------------------|
| >>>>Periodical reporting | | | Periodical reporting criteria 10.3.7.53 | |
| >>>>No reporting | | | NULL | |
| >>>Inter-RAT | | | | |
| >>>>Inter-RAT cell info | OP | | Inter-RAT cell info list 10.3.7.23 | |
| >>>>Inter-RAT measurement quantity | OP | | Inter-RAT measurement quantity 10.3.7.29 | |
| >>>>Inter-RAT reporting quantity | OP | | Inter-RAT reporting quantity 10.3.7.32 | |
| >>>>Reporting cell status | OP | | Reporting cell status 10.3.7.61 | |
| >>>>Measurement validity | OP | | Measurement validity 10.3.7.51 | |
| >>>>CHOICE <i>report criteria</i> | OP | | | |
| >>>>>Inter-RAT measurement reporting criteria | | | Inter-RAT measurement reporting criteria 10.3.7.30 | |
| >>>>>Periodical reporting | | | Periodical reporting criteria 10.3.7.53 | |
| >>>>>No reporting | | | NULL | |
| >>>Traffic Volume | | | | |
| >>>>Traffic volume measurement Object | OP | | Traffic volume measurement object 10.3.7.70 | |
| >>>>Traffic volume measurement quantity | OP | | Traffic volume measurement quantity 10.3.7.71 | |
| >>>>Traffic volume reporting quantity | OP | | Traffic volume reporting quantity 10.3.7.74 | |
| >>>>CHOICE <i>report criteria</i> | OP | | | |
| >>>>>Traffic volume measurement reporting criteria | | | Traffic volume measurement reporting criteria 10.3.7.72 | |
| >>>>>Periodical reporting | | | Periodical reporting criteria 10.3.7.53 | |
| >>>>>No reporting | | | NULL | |
| >>>Quality | | | | |
| >>>>Quality measurement Object | OP | | Quality measurement object | |
| >>>>CHOICE <i>report criteria</i> | OP | | | |
| >>>>>Quality measurement reporting criteria | | | Quality measurement reporting criteria 10.3.7.58 | |
| >>>>>Periodical reporting | | | Periodical reporting criteria 10.3.7.53 | |
| >>>>>No reporting | | | NULL | |
| >>>UE internal | | | | |
| >>>>UE internal measurement quantity | OP | | UE internal measurement quantity 10.3.7.79 | |
| >>>>UE internal reporting quantity | OP | | UE internal reporting quantity 10.3.7.82 | |
| >>>>CHOICE <i>report criteria</i> | OP | | | |
| >>>>>UE internal measurement | | | UE internal | |

| Information Element/Group Name | Need | Multi | Type and reference | Semantics description |
|---|------|---------------------|---|----------------------------------|
| reporting criteria | | | measurement reporting criteria 10.3.7.80 | |
| >>>>Periodical reporting | | | Periodical reporting criteria 10.3.7.53 | |
| >>>>No reporting | | | NULL | |
| >>>UE positioning | | | | |
| >>>>LCS reporting quantity | OP | | LCS reporting quantity 10.3.7.111 | |
| >>>>CHOICE <i>report criteria</i> | OP | | | |
| >>>>>LCS reporting criteria | | | LCS reporting criteria 10.3.7.110 | |
| >>>>>Periodical reporting | | | Periodical reporting criteria 10.3.7.53 | |
| >>>>>No reporting | | | | |
| Radio Bearer Information Elements | | | | |
| >Pre-defined configuration status information | OP | | Pre-defined configuration status information 14.13.2.3 | |
| >Signalling RB information list | MP | 1 to <maxSR Bsetup> | | For each signalling radio bearer |
| >>Signalling RB information | MP | | Signalling RB information to setup 10.3.4.24 | |
| >RAB information list | OP | 1 to <maxRA Bsetup> | | Information for each RAB |
| >>RAB information | MP | | RAB information to setup 10.3.4.10 | |
| Transport Channel Information Elements | | | | |
| Uplink transport channels | | | | |
| >UL Transport channel information common for all transport channels | OP | | UL Transport channel information common for all transport channels 10.3.5.24 | |
| >UL transport channel information list | OP | 1 to <MaxTrC H> | | |
| >>UL transport channel information | MP | | Added or reconfigured UL TrCH information 10.3.5.2 | |
| >CHOICE <i>mode</i> | OP | | | |
| >>FDD | | | | |
| >>>CPCH set ID | OP | | CPCH set ID 10.3.5.5 | |
| >>>>Transport channel information for DRAC list | OP | 1 to <MaxTrC H> | | |
| >>>>>DRAC static information | MP | | DRAC static information 10.3.5.7 | |
| >>TDD | | | | (no data) |
| Downlink transport channels | | | | |
| >DL Transport channel information common for all transport channels | OP | | DL Transport channel information common for all transport channels 10.3.5.6 | |
| >DL transport channel information list | OP | 1 to <MaxTrC H> | | |

| Information Element/Group Name | Need | Multi | Type and reference | Semantics description |
|------------------------------------|------|-------|--|-----------------------|
| >>DL transport channel information | MP | | Added or reconfigured DL TrCH information 10.3.5.1 | |
| >Measurement report | OP | | MEASUREMENT REPORT 10.2.17 | |

| Multi Bound | Explanation |
|-------------|---|
| MaxNoOfMeas | Maximum number of active measurements, upper limit 16 |

| Condition | Explanation |
|------------------|--|
| <i>Setup</i> | The IE is mandatory when the IE Measurement command has the value "Setup", otherwise the IE is not needed. |
| <i>Ciphering</i> | The IE is mandatory when the IE Ciphering Status has the value "started" and the ciphering counters need not be reinitialised, otherwise the IE is not needed. |
| <i>IP</i> | The IE is mandatory when the IE Integrity protection status has the value "started" and the integrity protection counters need not be reinitialised, otherwise the IE is not needed. |
| <i>PDCP</i> | The IE is mandatory when the PDCP Info IE is present, otherwise the IE is not needed. |

14.12.4.3 RRC INFORMATION CONTAINER FAILURE INFO

This RRC information container is sent between network nodes to provide information about the cause for failure to perform the requested operation.

Direction: target RNC→source RNC, source RAT

| Information Element/Group Name | Need | Multi | Type and reference | Semantics description |
|-----------------------------------|------------|-------|--------------------------------------|-----------------------|
| Other Information elements | | | | |
| Failure cause | MP | | Failure cause 10.3.3.13 | |
| Protocol error information | CV-ProtErr | | Protocol error information 10.3.8.12 | |

| Condition | Explanation |
|----------------|---|
| <i>ProtErr</i> | Presence is mandatory if the IE "Failure cause" has the value "Protocol error"; otherwise the element is not needed in the message. |

14.13 RRC information transferred between UE and other systems

14.13.0 General

This subclause specifies RRC information that is exchanged between other systems and the UE. This information is transferred via another RAT in accordance with the specifications applicable for those systems. This subclause specifies the UTRAN RRC information applicable for the different information flows.

NOTE: Currently RRC information containers, using the RRC protocol extension mechanism, are not used for information transferred between UE and another RAT

Like for the Uu interface, the transfer syntax for RRC transferred between UE and other RATs is derived from their ASN.1 definitions by use of Packed Encoding Rules, unaligned (X.691). It should be noted that the encoder adds final padding to achieve octet alignment. The resulting octet string is transferred across the other RAT as defined in the specifications applicable for that RAT.

14.13.1 RRC information, another RAT to UE

14.13.1.1 Void

14.13.2 RRC information, UE to another RAT

14.13.2.1 UE capability information

Upon receiving a UE information request from another system, the UE shall indicate the requested capabilities. The UE capability information includes the following RRC information.

| Information Element/Group name | Need | Multi | Type and reference | Semantics description |
|--------------------------------------|------|-------|--|-----------------------|
| UE information elements | | | | |
| UE radio access capability | OP | | UE radio access capability 10.3.3.42 | |
| UE radio access capability extension | OP | | UE radio access capability extension 10.3.3.42a | |

14.13.2.2 UE security information

Upon receiving a UE information request from another system, the UE shall indicate the requested security information. The UE security information includes the following RRC information.

| Information Element/Group name | Need | Multi | Type and reference | Semantics description |
|--------------------------------|------|-------|--------------------|--|
| UE information elements | | | | |
| START-CS | MP | | START 10.3.3.38 | START values to be used in this CN domain. |

14.13.2.3 Pre-defined configuration status information

Another system may provide the UE with one or more pre-defined UTRAN configurations, comprising of radio bearer, transport channel and physical channel parameters. If requested, the UE shall indicate the configurations it has stored. The pre-defined configuration status information should include the following RRC information.

| Information Element/Group name | Need | Multi | Type and reference | Semantics description |
|-------------------------------------|------|------------------------------|--|---|
| RB information elements | | | | |
| Predefined configurations | | maxPredef ConfigCou nt | | The list is in order of preconfiguration identity |
| >Predefined configuration value tag | OP | | Predefined configuration value tag 10.3.4.6 | The UE shall include the value tag if it has stored the concerned configuration |

| Multi Bound | Explanation |
|----------------------|---|
| MaxPredefConfigCount | Maximum number of predefined configurations |

14.13.2.4 Void

14.14 Versatile Channel Assignment Mode (VCAM) mapping rule (FDD only)

When Versatile Channel Assignment Method (VCAM) is used in the CPCH procedure, the following mapping rules shall be used to specify one PCPCH.

If the number of PCPCHs is less than or equal to 16, there is a one to one mapping between the CA index and the PCPCH index. Thus a suitable AP signature (and/or AP sub-channel) number is transmitted for the required spreading factor based on the broadcast system information, and the assigned PCPCH index (having the requested spreading factor) corresponds to the received CA index.

When the number of PCPCHs is greater than 16, a combination of an AP signature (and/or AP sub-channel) number and a CA signature number specifies one PCPCH as follows:

In VCAM mapping rule, a combination of an AP signature (and/or AP sub-channel) number and a CA signature number specifies one PCPCH. In a CPCH set, there are K available PCPCHs which are numbered $k=0,1,\dots,K-1$, and there are R available Minimum Spreading Factor A_r , $r=0,1,\dots,R-1$, that a UE can request and use. The maximum available number of PCPCHs and the number of available AP signatures (and/or AP sub-channels) for A_r are denoted as P_{0r} and S_r , respectively, for $r=0,1,\dots,R-1$. Let P_r be equal to 16 if P_{0r} is less than 16 and to P_{0r} otherwise. T_r represents the number of CA signatures for A_r , which are needed for specifying PCPCH. The default value of T_r is 16.

S_r always satisfies $S_r \geq \min\{s : s \in N, s \times T_r \geq P_r\}$, where N is the set of positive integers.

The list of available AP signatures (and/or AP sub-channels) for each A_r is renumbered from signature index 0 to signature index $S_r - 1$, starting with the lowest AP signature (and/or AP sub-channel) number, and continuing in sequence, in the order of increasing signature numbers.

Then for given AP signature (and/or AP sub-channel) number and CA signature number, the number k that signifies the assigned PCPCH is obtained as:

$$k = \{[(i + n) \bmod S_r] + j \times S_r\} \bmod P_r,$$

where i ($i=0,1,\dots,S_r-1$) is the AP signature (and/or AP sub-channel) index for A_r , j ($j=0,1,\dots,\min(P_r,T_r)-1$) is the CA signature number for A_r , and n is a nonnegative integer which satisfies

$$n \times M_r \times S_r \leq i + j \times S_r < (n + 1) \times M_r \times S_r \text{ where } M_r = \min\{m : m \in N, (m \times S_r) \bmod P_r = 0\}.$$

An example of the above mapping rule is shown in [38].

Annex A (informative): USIM parameters

A.1 Introduction

This annex contains recommendations about the RRC parameters to be stored in the USIM.

A.2 Cipherring information

| Information Element/Group name | Need | Multi | Type and reference | Semantics description |
|--|------|---------------------|--------------------|--|
| Cipher key for each CN domain | MP | <1 to maxCNDomains> | | Cipher key is described in [40]. |
| >Old CK | MP | | Bitstring (128) | |
| >New CK | MP | | Bitstring (128) | |
| Integrity key for each CN domain | MP | <1 to maxCNDomains> | | Integrity key is described in [40]. |
| >Old IK | MP | | Bitstring (128) | |
| >New IK | MP | | Bitstring (128) | |
| THRESHOLD | MP | | Bitstring (20) | |
| START value for each CN domain | MP | <1 to maxCNDomains> | | START value is described in [40]. |
| >Old START | MP | | Bitstring (20) | |
| >New START | MP | | Bitstring (20) | |
| KSI, Key set identifier for each CN domain | MP | <1 to maxCNDomains> | | Key set identifier is described in [40]. |
| >Old KSI | MP | | Bitstring (3) | |
| >New KSI | MP | | Bitstring (3) | |

A.3 Frequency information

Neighbour cell list.

| Information Element/Group name | Need | Multi | Type and reference | Semantics description | Version |
|--------------------------------|------|----------------------------|------------------------------|---|---------|
| FDD cell list | OP | <1 to maxFDDFr eqList> | | | |
| >UARFCN uplink (Nu) | OP | | Integer(0..16383) | [21] If IE not present, default duplex distance of 190 MHz shall be used. | |
| >UARFCN downlink (Nd) | MP | | Integer(0 .. 16383) | [21] | |
| >Primary scrambling code | OP | <1 to maxFDDFr eqCellList> | Primary CPICH info 10.3.6.60 | | |
| 3.84 Mcps TDD cell list | OP | <1 to maxTDDFr eqList> | | | |
| >UARFCN (Nt) | MP | | Integer(0 .. 16383) | [22] | |
| >Cell parameters ID | OP | <1 to maxTDDFr eqCellList> | Integer (0..127) | The Cell parameters ID is described in [32]. | |
| 1.28 Mcps TDD cell list | OP | <1 to maxTDDFr eqList> | | | REL-4 |
| >UARFCN (Nt) | MP | | Integer(0 .. 16383) | [22] | REL-4 |
| >Cell parameters ID | OP | <1 to maxTDDFr eqCellList> | Integer (0..127) | The Cell parameters ID is described in [32]. | REL-4 |
| GSM Neighbour cell list | OP | | | | |
| >GSM neighbour cell info | MP | <1 to maxGSMCellList> | | | |
| >>BSIC | MP | | | | |
| >>BCCH ARFCN | MP | | | | |

A.4 Multiplicity values and type constraint values

| Constant | Explanation | Value |
|------------------------------|--|-------|
| Ciphering information | | |
| maxCNDomains | Maximum number of CN domains | 4 |
| Frequency information | | |
| maxFDDFr eqList | Maximum number of FDD carrier frequencies to be stored in USIM | 4 |
| maxTDDFr eqList | Maximum number of TDD carrier frequencies to be stored in USIM | 4 |
| maxFDDFr eqCellList | Maximum number of neighbouring FDD cells on one carrier to be stored in USIM | 32 |
| maxTDDFr eqCellList | Maximum number of neighbouring TDD cells on one carrier to be stored in USIM | 32 |
| maxGSMCellList | Maximum number of GSM cells to be stored in USIM | 32 |

Annex B (informative): Description of RRC state transitions

This annex contains Stage 2 description of RRC states and state transitions.

B.1 RRC states and state transitions including GSM

After power on, the UE stays in Idle Mode until it transmits a request to establish an RRC Connection. In Idle Mode the connection of the UE is closed on all layers of the access stratum. In Idle Mode the UE is identified by non-access stratum identities such as IMSI, TMSI and P-TMSI. In addition, the UTRAN has no own information about the individual Idle Mode UEs, and it can only address e.g. all UEs in a cell or all UEs monitoring a paging occasion. The UE behaviour within this mode is described in [4].

The UTRA RRC Connected Mode is entered when the RRC Connection is established. The UE is assigned a radio network temporary identity (RNTI) to be used as UE identity on common transport channels.

The RRC states within UTRA RRC Connected Mode reflect the level of UE connection and which transport channels that can be used by the UE.

For inactive stationary data users the UE may fall back to PCH on both the Cell and URA levels. That is, upon the need for paging, the UTRAN checks the current level of connection of the given UE, and decides whether the paging message is sent within the URA, or should it be sent via a specific cell.

B.2 Transition from Idle Mode to UTRA RRC Connected Mode

The transition to the UTRA RRC Connected Mode from the Idle Mode can only be initiated by the UE by transmitting a request for an RRC Connection. The event is triggered either by a paging request from the network or by a request from upper layers in the UE.

When the UE receives a message from the network that confirms the RRC connection establishment, the UE enters the CELL_FACH or CELL_DCH state of UTRA RRC Connected Mode.

In the case of a failure to establish the RRC Connection the UE goes back to Idle Mode. Possible causes are radio link failure, a received reject response from the network or lack of response from the network (timeout).

B.2.1 Transitions for Emergency Calls

Refer to [4] for all states and procedures referred to in this subclause. When UE leaves idle mode from state *Camped on any cell* in order to make an emergency call, moving to state *Connected mode (emergency calls only)*, the UE shall attempt to access the current serving cell. If the access attempt to the serving cell fails the UE shall use the *Cell Reselection* procedure. If no acceptable cell is found, the UE shall use the *Any cell selection*. When returning to idle mode, the UE shall use the procedure *Cell selection when leaving connected mode* in order to find an acceptable cell to camp on, state *Camped on any cell*.

B.3 UTRA RRC Connected Mode States and Transitions

B.3.1 CELL_DCH state

The CELL_DCH state is characterised by

- A dedicated physical channel is allocated to the UE in uplink and downlink.
- The UE is known on cell level according to its current active set.
- Dedicated transport channels, downlink and uplink (TDD) shared transport channels, and a combination of these transport channels can be used by the UE.

The CELL_DCH-state is entered from the Idle Mode through the setup of an RRC connection, or by establishing a dedicated physical channel from the CELL_FACH state.

A PDSCH may be assigned to the UE in this state, to be used for a DSCH. In TDD a PUSCH may also be assigned to the UE in this state, to be used for a USCH. If PDSCH or PUSCH are used for TDD, a FACH transport channel may be assigned to the UE for reception of physical shared channel allocation messages.

B.3.1.1 Transition from CELL_DCH to Idle Mode

Transition to Idle Mode is realised through the release of the RRC connection.

B.3.1.2 Transition from CELL_DCH to CELL_FACH state

Transition to CELL_FACH state occurs when all dedicated channels have been released, which may be

- a) via explicit signalling (e.g. PHYSICAL CHANNEL RECONFIGURATION, RADIO BEARER RECONFIGURATION, RADIO BEARER RELEASE, RADIO BEARER SETUP, TRANSPORT CHANNEL RECONFIGURATION, etc.).

at the end of the time period for which the dedicated channel was allocated (TDD)

B.3.1.3 Transition from CELL_DCH to CELL_PCH state

Transition to CELL_PCH state occurs via explicit signalling (e.g. PHYSICAL CHANNEL RECONFIGURATION, RADIO BEARER RECONFIGURATION, RADIO BEARER RELEASE, RADIO BEARER SETUP, TRANSPORT CHANNEL RECONFIGURATION, etc.).

B.3.1.4 Transition from CELL_DCH to URA_PCH state

Transition to URA_PCH state occurs via explicit signalling (e.g. PHYSICAL CHANNEL RECONFIGURATION, RADIO BEARER RECONFIGURATION, RADIO BEARER RELEASE, RADIO BEARER SETUP, TRANSPORT CHANNEL RECONFIGURATION, etc.).

B.3.1.5 Radio Resource Allocation tasks (CELL_DCH)

For the DCH, several physical channel allocation strategies may be applied. The allocations can be either permanent (needing a DCH release message) or based on time or amount-of-data.

Resource allocation can be done separately for each packet burst with fast signalling on the DCH

For each radio frame the UE and the network indicate the current data rate (in uplink and downlink respectively) using the transport format combination indicator (TFCI). However, in TDD, DCH and DSCH or USCH may be mapped on different CCTrCHs, their TFCI are totally independent. DCH transmission is not modified by the simultaneous existence of DSCH/USCH. If the configured set of combinations (i.e. transport format set for one transport channel) are found to be insufficient to retain the QoS requirements for a transport channel, the network initiates a reconfiguration of the transport format set (TFS) for that transport channel. This reconfiguration can be done during or in between data transmission. Further, the network can reconfigure the physical channel allowing an increase or decrease of the peak data rate.

For the uplink data transmission, the UE reports the observed traffic volume to the network in order for the network to re-evaluate the current allocation of resources. This report contains e.g. the amount of data to be transmitted or the buffer status in the UE.

B.3.1.6 RRC Connection mobility tasks (CELL_DCH)

Depending on the amount and frequency of data macrodiversity (soft handover) may or may not be applied.

The RRC Connection mobility is handled by measurement reporting, soft handover and Timing re-initialised or Timing-maintained hard handover procedures.

B.3.1.7 UE Measurements (CELL_DCH)

The UE performs measurements and transmit measurement reports according to the measurement control information.

The UE uses the connected mode measurement control information received in other states until new measurement control information has been assigned to the UE.

B.3.1.8 Acquisition of system information (CELL_DCH)

FDD UEs with certain capabilities reads system information broadcast on FACH.

TDD UEs reads the BCH to acquire valid system information. For each acquisition, the UE may need different combinations of system information broadcast on BCH. The scheduling on the broadcast channel is done in such way that the UE knows when the requested information can be found.

B.3.2 CELL_FACH state

The CELL_FACH state is characterised by:

- No dedicated physical channel is allocated to the UE.
- The UE continuously monitors a FACH in the downlink.
- The UE is assigned a default common or shared transport channel in the uplink (e.g. RACH) that it can use anytime according to the access procedure for that transport channel.
- The position of the UE is known by UTRAN on cell level according to the cell where the UE last made a cell update.
- In TDD mode, one or several USCH or DSCH transport channels may have been established.

B.3.2.1 Transition from CELL_FACH to CELL_DCH state

A transition occurs, when a dedicated physical channel is established via explicit signalling (e.g. PHYSICAL CHANNEL RECONFIGURATION, RADIO BEARER RECONFIGURATION, RADIO BEARER RELEASE, RADIO BEARER SETUP, TRANSPORT CHANNEL RECONFIGURATION, etc.).

B.3.2.2 Transition from CELL_FACH to CELL_PCH state

The transition occurs when UTRAN orders the UE to move to CELL_PCH state, which is done via explicit signalling (e.g. CELL UPDATE CONFIRM, RADIO BEARER RECONFIGURATION, etc.).

B.3.2.3 Transition from CELL_FACH to Idle Mode

Upon release of the RRC connection, the UE moves to the idle mode.

B.3.2.4 Transition from CELL_FACH to URA_PCH State

The transition occurs when UTRAN orders the UE to move to URA_PCH state, which is done via explicit signalling (e.g. URA UPDATE CONFIRM, RADIO BEARER RECONFIGURATION, etc.).

B.3.2.5 Radio Resource Allocation Tasks (CELL_FACH)

In the CELL_FACH state the UE will monitor an FACH. It is enabled to transmit uplink control signals and it may be able to transmit small data packets on the RACH.

The network can assign the UE transport channel parameters (e.g. transport format sets) in advance, to be used when a DCH is used. Upon assignment of the physical channel for DCH, the UE moves to CELL_DCH state and uses the pre-assigned TFS for the DCH.

If no UE dedicated physical channel or transport channel configuration has been assigned, the UE uses the common physical channel and transport channel configuration according to the system information.

For the uplink data transmission, the UE reports the observed traffic volume to the network in order for the network to re-evaluate the current allocation of resources. This report contains e.g. the amount of data to be transmitted or the buffer status in the UE.

When there is either user or control data to transmit, a selection procedure determines whether the data should be transmitted on a common transport channel, or if a transition to CELL_DCH should be executed. The selection is dynamic and depends on e.g. traffic parameters (amount of data, packet burst frequency).

In FDD mode, the UTRAN can assign CPCH resources to the UE in CELL_FACH state. When CPCH resources are assigned, the UE will continue to monitor FACHs. When CPCH resources are assigned, the UE will use CPCH for all uplink traffic in accordance with RB mapping.

In FDD mode, UTRAN may configure the UE to provide CPCH measurement reports of traffic volume on each CPCH channel used. With these measures, the UTRAN can reallocate network resources on a periodic basis. The UTRAN allocates CPCH Sets to each cell and assigns UEs to one of the cell's CPCH Sets. The UEs can dynamically access the CPCH resources without further UTRAN control.

In the TDD mode, the UTRAN can assign USCH / DSCH resources to the UE in CELL_FACH state. When USCH / DSCH resources are assigned, the UE will continue to monitor FACHs, depending on the UE capability. The UE may use the USCH / DSCH to transmit signalling messages or user data in the uplink and / or the downlink using USCH and / or DSCH when resources are allocated to cell and UE is assigned use of those USCH / DSCH.

For the uplink data transmission on USCH the UE reports to the network the traffic volume (current size of RLC data buffers), The UTRAN can use these measurement reports to re-evaluate the current allocation of the USCH / DSCH resources.

B.3.2.6 RRC Connection mobility tasks (CELL_FACH)

In this state the location of the UE is known on cell level. A cell update procedure is used to report to the UTRAN, when the UE selects a new cell to observe the common downlink channels of a new cell. Downlink data transmission on the FACH can be started without prior paging.

The UE monitors the broadcast channel and system information on BCCH of its own and neighbour cells and from this the need for the updating of cell location is identified.

The UE performs cell reselection and upon selecting a new UTRA cell, it initiates a cell update procedure. Upon selecting a new cell belonging to another radio access system than UTRA, the UE enters idle mode and makes an access to that system according to its specifications.

B.3.2.7 UE Measurements (CELL_FACH)

The UE performs measurements and transmit measurement reports according to the measurement control information.

By default, the UE uses the measurement control information broadcast within the system information. However, for measurements for which the network also provides measurement control information within a MEASUREMENT CONTROL message, the latter information takes precedence.

B.3.2.8 Transfer and update of system information (CELL_FACH)

The UE reads the BCH to acquire valid system information. For each acquisition, the UE may need different combinations of system information broadcast on BCH. The scheduling on the broadcast channel is done in such way that the UE knows when the requested information can be found.

When the system information is modified, the scheduling information is updated to reflect the changes in system information transmitted on BCH. The new scheduling information is broadcast on FACH in order to inform UEs about the changes. If the changes are applicable for the UE, the modified system information is read on BCH.

B.3.3 CELL_PCH state

The CELL_PCH state is characterised by:

- No dedicated physical channel is allocated to the UE.
- The UE selects a PCH with the algorithm specified in subclause 8.5.19, and uses DRX for monitoring the selected PCH via an associated PICH.
- No uplink activity is possible.
- The position of the UE is known by UTRAN on cell level according to the cell where the UE last made a cell update in CELL_FACH state.

The DCCH logical channel cannot be used in this state. If the network wants to initiate any activity, it needs to make a paging request on the PCCH logical channel in the known cell to initiate any downlink activity.

B.3.3.1 Transition from CELL_PCH to CELL_FACH state

The UE is transferred to CELL_FACH state:

- a) by paging from UTRAN (PAGING TYPE1 message)
- b) through any uplink access

B.3.3.2 Radio Resource Allocation Tasks (CELL_PCH)

In CELL_PCH state no resources have been granted for data transmission. For this purpose, a transition to another state has to be executed.

The UE may use Discontinuous Reception (DRX) in order to reduce power consumption. When DRX is used the UE needs only to receive at one paging occasion per DRX cycle. The UE may be instructed to use a specific DRX cycle length by the network. The UE determines its paging occasions in the same way as for Idle Mode, see [4].

B.3.3.3 RRC Connection mobility tasks (CELL_PCH)

In the CELL_PCH state, the UE mobility is performed through cell reselection procedures, which may differ from the one defined in [4].

The UE performs cell reselection and upon selecting a new UTRA cell, it moves to CELL_FACH state and initiates a cell update procedure in the new cell. After the cell update procedure has been performed, the UE changes its state back to CELL_PCH state if neither the UE nor the network has any more data to transmit.

Upon selecting a new cell belonging to another radio access system than UTRA, the UE enters idle mode and make an access to that system according to its specifications.

In case of low UE activity, UTRAN may want to reduce the cell-updating overhead by ordering the UE to move to the URA_PCH State. This transition is made via the CELL_FACH state. UTRAN may apply an inactivity timer, and optionally, a counter, which counts the number of cell updates e.g. UTRAN orders the UE to move to URA_PCH when the number of cell updates has exceeded certain limits (network parameter).

B.3.3.4 UE Measurements (CELL_PCH)

The UE performs measurements and transmit measurement reports according to the measurement control information.

The UE uses the measurement control information according to the system information when no UE dedicated measurement control information has been assigned.

B.3.3.5 Transfer and update of system information (CELL_PCH)

The UE reads the BCH to acquire valid system information. For each acquisition, the UE may need different combinations of system information broadcast on BCH. The scheduling on the broadcast channel is done in such way that the UE knows when the requested information can be found.

B.3.4 URA_PCH State

The URA_PCH state is characterised by:

- No dedicated channel is allocated to the UE.
- The UE selects a PCH with the algorithm specified in subclause 8.5.19, and uses DRX for monitoring the selected PCH via an associated PICH.
- No uplink activity is possible.
- The location of the UE is known on UTRAN Registration area level according to the URA assigned to the UE during the last URA update in CELL_FACH state.

The DCCH logical channel cannot be used in this state. If the network wants to initiate any activity, it needs to make a paging request on the PCCH logical channel within the URA where the location of the UE is known. If the UE needs to transmit anything to the network, it goes to the CELL_FACH state. The transition to URA_PCH State can be controlled with an inactivity timer, and optionally, with a counter that counts the number of cell updates. When the number of cell updates has exceeded certain limits (a network parameter), then the UE changes to the URA_PCH State.

URA updating is initiated by the UE, which, upon the detection of the Registration area, sends the network the Registration area update information on the RACH of the new cell.

B.3.4.1 Transition from URA_PCH State to CELL_FACH State (URA_PCH)

Any activity causes the UE to be transferred to CELL_FACH State.

- a) Uplink access is performed by RACH.
- b) by paging from UTRAN (PAGING TYPE1 message).

NOTE: The release of an RRC connection is not possible in the URA_PCH State. The UE will first move to CELL_FACH State to perform the release signalling.

B.3.4.2 Radio Resource Allocation Tasks (URA_PCH)

In URA_PCH State no resources have been granted for data transmission. For this purpose, a transition to CELL_FACH State has to be executed.

The UE may use Discontinuous Reception (DRX) in order to reduce power consumption. When DRX is used the UE needs only to receive at one paging occasion per DRX cycle. The UE may be instructed to use a specific DRX cycle length by the network. The UE determines its paging occasions in the same way as for Idle Mode, see [4].

B.3.4.3 RRC Connection mobility tasks (URA_PCH)

In URA_PCH State the location of a UE is known on UTRAN Registration area level.

In this state, the UE mobility is performed through URA reselection procedures, which may differ from the definitions in [4]. The UE performs cell reselection and upon selecting a new UTRA cell belonging to a URA that does not match the URA used by the UE, the UE moves to CELL_FACH state and initiates a URA update towards the network. After the URA update procedure has been performed, the UE changes its state back to URA_PCH state if neither the UE nor the network has any more data to transmit.

Upon selecting a new cell belonging to another radio access system than UTRA, the UE enters idle mode and makes an access to that system according to its specifications (FFS).

B.3.4.4 UE Measurements (URA_PCH)

The UE performs measurements and transmit measurement reports according to the measurement control information.

The UE uses the measurement control information according to the system information when no UE dedicated measurement control information has been assigned.

B.3.4.5 Transfer and update of system information (URA_PCH)

The same mechanisms to transfer and update system information as for state CELL_PCH are applicable for UEs in URA_PCH state.

B.3.5 States and Transitions for Cell Reselection in URA_PCH, CELL_PCH, and CELL_FACH

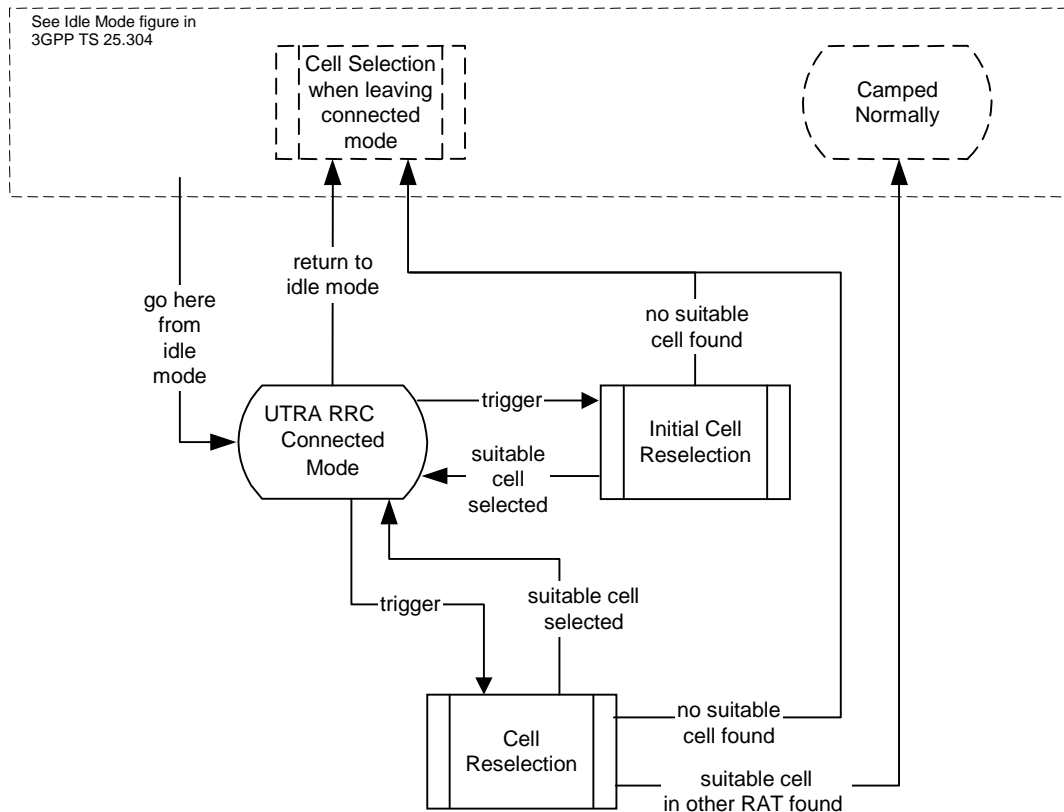

Figure 61: UTRA RRC Connected mode cell reselection for URA_PCH, CELL_PCH, and CELL_FACH

In some states the UE performs cell reselection procedures. The UE selects a suitable cell (defined in [4]) and radio access technology based on connected mode radio measurements and cell reselection criteria.

Figure 61 shows the states and procedures in the cell reselection process in connected mode.

When a cell reselection is triggered, the UE evaluates the cell reselection criteria based on radio measurements, and if a better cell is found that cell is selected, procedure Cell reselection (see [4]). If the change of cell implies a change of radio access technology, the RRC connection is released, and the UE enters idle mode of the other RAT. If no suitable cell is found in the cell reselection procedure, the UE eventually enters idle mode.

When an Initial cell reselection is triggered, the UE shall use the Initial cell reselection procedure (see [4]) to find a suitable cell. One example where this procedure is triggered is at radio link failure, where the UE may trigger an initial cell reselection in order to request re-establishment of the RRC connection. If the UE is unable to find a suitable cell, the UE eventually enters idle mode.

B.4 Inter-RAT handover with CS domain services

When using CS domain services, UTRAN is using an Inter-Radio access system Handover Procedure and GSM is using a Handover procedure for the transition from UTRA RRC Connected Mode to GSM Connected Mode.

B.5 Inter-RAT handover with PS domain services

When using PS domain services, the UE initiates cell reselection from a GSM/GPRS cell to a UTRAN cell and then uses the RRC Connection Establishment procedure for the transition to UTRA RRC Connected mode.

When the RRC Connection is established from Idle Mode (GPRS Packet Idle Mode) the RRC CONNECTION REQUEST message contains an indication, that UTRAN needs to continue an already established GPRS UE context from the CN. This indication allows UTRAN to e.g. prioritise the RRC CONNECTION REQUEST from the UE.

In UTRA RRC connected mode UTRAN is using UE or network initiated cell reselection to change from a UTRAN cell to a GSM/GPRS cell. If the cell reselection was successful the UE enters Idle Mode (GPRS Packet Idle Mode). The UE sends a packet channel request from Idle Mode (GPRS Packet Idle mode) to establish a Temporary Block flow and enter GPRS Packet Transfer Mode. In the GPRS Packet Transfer Mode the UE sends a RA Update request message. The RA Update Request message sent from the UE contains an indication that GSM/GPRS need to continue an already established UTRAN UE context from the CN. This means that the RA Update request is always sent for the transition from UTRA RRC Connected Mode to GSM/GPRS regardless if the RA is changed or not.

NOTE: The reason for using RA update instead of a new message is to reduce the impact on the existing GSM/GPRS specification.

B.6 Inter-RAT handover with simultaneous PS and CS domain services

NOTE: This is an initial assumption that needs to be seen by TSG-GERAN and requires checking by TSG-GERAN, when the work on this item has progressed.

B.6.1 Inter-RAT handover UTRAN to GSM / BSS

For a UE in CELL_DCH state using both CS and PS Domain services the Inter-RAT handover procedure is based on measurement reports from the UE but initiated from UTRAN.

The UE performs the Inter-RAT handover from UTRA RRC Connected Mode to GSM Connected Mode first. When the UE has sent handover complete message to GSM / BSS the UE initiates a temporary block flow towards GPRS and sends a RA update request.

If the Inter-RAT handover from UTRA RRC Connected Mode to GSM Connected Mode was successful the handover is considered as successful regardless if the UE was able to establish a temporary block flow or not towards GPRS.

In case of Inter-RAT handover failure the UE has the possibility to go back to UTRA RRC Connected Mode and re-establish the connection in the state it originated from without attempting to establish a temporary block flow. If the UE has the option to try to establish a temporary block flow towards GSM / GPRS after Inter-RAT handover failure is FFS.

B.6.2 Inter-RAT handover GSM / BSS to UTRAN

For a UE in GSM Connected Mode using both CS and PS domain services the Inter-RAT handover procedure is based on measurement reports from the UE but initiated from GSM / BSS.

The UE performs the Inter-RAT handover from GSM Connected Mode to UTRA RRC Connected Mode.

In UTRA RRC Connected Mode both services are established in parallel.

If the Inter-RAT handover from GSM Connected mode to UTRA RRC Connected Mode was successful the handover is considered as successful.

In case of Inter-RAT handover failure the UE has the possibility to go back to GSM Connected Mode and re-establish the connection in the state it originated from.

Annex C (informative): Change history

| Change history | | | | | | | |
|----------------|-------|----------|-----|-----|--|-------|-------|
| Date | TSG # | TSG Doc. | CR | Rev | Subject/Comment | Old | New |
| 10/1999 | RP-05 | RP-99524 | - | | Approved at TSG-RAN #5 and placed under Change Control | - | 3.0.0 |
| 12/1999 | RP-06 | RP-99650 | 001 | | Modification of RRC procedure specifications | 3.0.0 | 3.1.0 |
| | RP-06 | RP-99654 | 005 | 1 | Introduction of Information Element for Power Control Algorithm | 3.0.0 | 3.1.0 |
| | RP-06 | RP-99654 | 007 | 1 | RRC parameters for SS DT | 3.0.0 | 3.1.0 |
| | RP-06 | RP-99656 | 009 | 1 | Inclusion of information elements for integrity protection | 3.0.0 | 3.1.0 |
| | RP-06 | RP-99656 | 010 | 2 | Security mode control procedure | 3.0.0 | 3.1.0 |
| | RP-06 | RP-99656 | 011 | 3 | Updates of the system information procedure | 3.0.0 | 3.1.0 |
| | RP-06 | RP-99656 | 012 | 2 | Inter-frequency measurements and reporting | 3.0.0 | 3.1.0 |
| | RP-06 | RP-99656 | 013 | 1 | Inter-system measurements and reporting | 3.0.0 | 3.1.0 |
| | RP-06 | RP-99656 | 014 | 1 | Additional measurements in RRC measurement messages | 3.0.0 | 3.1.0 |
| | RP-06 | RP-99656 | 015 | 3 | Value range for Measurement Information Elements | 3.0.0 | 3.1.0 |
| | RP-06 | RP-99656 | 016 | 2 | Message contents for inter system handover to UTRAN | 3.0.0 | 3.1.0 |
| | RP-06 | RP-99652 | 017 | | Inclusion of ciphering information elements | 3.0.0 | 3.1.0 |
| | RP-06 | RP-99651 | 018 | | Corrections and editorial changes | 3.0.0 | 3.1.0 |
| | RP-06 | RP-99654 | 019 | 1 | Algorithm for CTCF Calculation | 3.0.0 | 3.1.0 |
| | RP-06 | RP-99651 | 025 | | Logical CH for RRC Connection Re-establishment (RRC Connection Re-establishment deleted in RAN_10, RP-000715) | 3.0.0 | 3.1.0 |
| | RP-06 | RP-99719 | 026 | 1 | Gain Factors | 3.0.0 | 3.1.0 |
| | RP-06 | RP-99654 | 027 | 1 | Parameters for CELL UPDATE CONFIRM message | 3.0.0 | 3.1.0 |
| | RP-06 | RP-99651 | 028 | | Cell Update Cause | 3.0.0 | 3.1.0 |
| | RP-06 | RP-99654 | 029 | 1 | RRC Initialisation Information | 3.0.0 | 3.1.0 |
| | RP-06 | RP-99656 | 034 | 1 | Open loop power control for PRACH | 3.0.0 | 3.1.0 |
| | RP-06 | RP-99652 | 038 | | Addition of the UE controlled AMR mode adaptation | 3.0.0 | 3.1.0 |
| | RP-06 | RP-99651 | 039 | | Information elements for RLC reset | 3.0.0 | 3.1.0 |
| | RP-06 | RP-99656 | 040 | | Support for DS-41 Initial UE Identity | 3.0.0 | 3.1.0 |
| | RP-06 | RP-99656 | 042 | 2 | Integration of Cell Broadcast Service (CBS) | 3.0.0 | 3.1.0 |
| | RP-06 | RP-99654 | 044 | 1 | Gated transmission of DPCH | 3.0.0 | 3.1.0 |
| | RP-06 | RP-99656 | 045 | | Modification to the Transport Format Combination Control message | 3.0.0 | 3.1.0 |
| | RP-06 | RP-99656 | 046 | | New Information elements and modifications to messages required in order to support configuration and re-configuration of the DSCH in FDD mode | 3.0.0 | 3.1.0 |
| | RP-06 | RP-99654 | 047 | 1 | Editorial Corrections and Alignments with Layer 1 specifications | 3.0.0 | 3.1.0 |
| | RP-06 | RP-99654 | 048 | 1 | Information elements for TDD shared channel operation | 3.0.0 | 3.1.0 |
| | RP-06 | RP-99656 | 049 | | Description of CN dependent IEs in Master Information Block | 3.0.0 | 3.1.0 |
| | RP-06 | RP-99650 | 050 | | UE capability information elements | 3.0.0 | 3.1.0 |
| | RP-06 | RP-99656 | 051 | 1 | UTRAN response time to uplink feedback commands of TX diversity control | 3.0.0 | 3.1.0 |
| | RP-06 | RP-99654 | 052 | | New and corrected CPCH parameters | 3.0.0 | 3.1.0 |
| | RP-06 | RP-99654 | 053 | 2 | Compressed mode parameters without gating | 3.0.0 | 3.1.0 |
| | RP-06 | RP-99654 | 054 | | Transport format combination set and transport format combination subset | 3.0.0 | 3.1.0 |
| | RP-06 | RP-99656 | 055 | 1 | Information elements for cell selection and reselection | 3.0.0 | 3.1.0 |
| | RP-06 | RP-99654 | 056 | | Corrections and Alignments of the RRC to the L1 for TDD | 3.0.0 | 3.1.0 |
| | RP-06 | RP-99656 | 057 | 1 | Introduction of a SCCH procedure | 3.0.0 | 3.1.0 |
| | RP-06 | RP-99656 | 061 | | Support for DS-41 Paging UE Identity | 3.0.0 | 3.1.0 |
| | RP-06 | RP-99656 | 062 | 2 | Support for cdma2000 Hard Handover | 3.0.0 | 3.1.0 |
| | RP-06 | RP-99656 | 063 | 1 | Provide necessary signalling to support FDD DSCH | 3.0.0 | 3.1.0 |
| | RP-06 | RP-99654 | 064 | | RRC procedure interactions | 3.0.0 | 3.1.0 |
| | RP-06 | RP-99654 | 066 | 1 | Transfer of UE capabilities | 3.0.0 | 3.1.0 |
| | RP-06 | RP-99654 | 067 | | Selection of initial UE identity | 3.0.0 | 3.1.0 |
| | RP-06 | RP-99657 | 069 | | UE capability verification in the security mode control procedure | 3.0.0 | 3.1.0 |
| | RP-06 | RP-99657 | 070 | 1 | DPCH initial power | 3.0.0 | 3.1.0 |
| | RP-06 | RP-99657 | 071 | | Actions when entering idle mode | 3.0.0 | 3.1.0 |

| Change history | | | | | | | |
|----------------|-------|-----------|-----|-----|--|-------|-------|
| Date | TSG # | TSG Doc. | CR | Rev | Subject/Comment | Old | New |
| | RP-06 | RP-99657 | 072 | | Specification of inter-frequency and inter-system reporting events for FDD | 3.0.0 | 3.1.0 |
| | RP-06 | RP-99657 | 073 | 1 | Signalling radio bearers | 3.0.0 | 3.1.0 |
| | RP-06 | RP-99654 | 074 | | CN information elements | 3.0.0 | 3.1.0 |
| | RP-06 | RP-99654 | 076 | | UE information elements | 3.0.0 | 3.1.0 |
| | RP-06 | RP-99657 | 077 | 1 | Radio bearer, transport channel and physical channel information elements | 3.0.0 | 3.1.0 |
| | RP-06 | RP-99654 | 078 | | Other information elements | 3.0.0 | 3.1.0 |
| | RP-06 | RP-99657 | 079 | 2 | RRC signalling for PDCP | 3.0.0 | 3.1.0 |
| | RP-06 | RP-99654 | 080 | | Content of Measurement Control Messages | 3.0.0 | 3.1.0 |
| | RP-06 | RP-99654 | 081 | | RRC Information Elements to support Block STTD transmission diversity in TDD | 3.0.0 | 3.1.0 |
| | RP-06 | RP-99657 | 082 | 1 | Signalling connection release | 3.0.0 | 3.1.0 |
| | RP-06 | RP-99657 | 083 | 1 | Addition of cell access restriction information elements to System Information | 3.0.0 | 3.1.0 |
| | RP-06 | RP-99655 | 085 | 1 | RRC Connection Establishment parameters | 3.0.0 | 3.1.0 |
| | RP-06 | RP-99657 | 092 | 1 | Support of UE autonomous update of a active set on a non-used frequency | 3.0.0 | 3.1.0 |
| | RP-06 | RP-99657 | 095 | 1 | TPC combining for power control | 3.0.0 | 3.1.0 |
| | RP-06 | RP-99653 | 096 | 1 | Editorial Modification of IEs in RRC messages | 3.0.0 | 3.1.0 |
| | RP-06 | RP-99655 | 097 | | Selection of SCCPCH | 3.0.0 | 3.1.0 |
| | RP-06 | RP-99655 | 098 | 1 | RRC Initialisation Information | 3.0.0 | 3.1.0 |
| | RP-06 | RP-99657 | 100 | 1 | Support of physical channel establishment and failure criteria in the UE | 3.0.0 | 3.1.0 |
| | RP-06 | RP-99655 | 102 | 1 | RRC Connection Re-establishment (Message deleted in RAN_10, RP-000715) | 3.0.0 | 3.1.0 |
| | RP-06 | RP-99657 | 106 | 1 | System information on FACH | 3.0.0 | 3.1.0 |
| | RP-06 | RP-99657 | 108 | 1 | SAPs and Primitives for DS-41 mode | 3.0.0 | 3.1.0 |
| | RP-06 | RP-99655 | 109 | 1 | TX Diversity Mode for Dedicated Channel | 3.0.0 | 3.1.0 |
| | RP-06 | RP-99657 | 110 | 1 | RACH message length signalling on System Information | 3.0.0 | 3.1.0 |
| | RP-06 | RP-99657 | 113 | 1 | Routing of NAS messages in UTRAN | 3.0.0 | 3.1.0 |
| | RP-06 | RP-99655 | 116 | 3 | TBS Identification in TFS | 3.0.0 | 3.1.0 |
| | RP-06 | RP-99657 | 117 | 1 | Merging the hard handover and some radio bearer control procedures | 3.0.0 | 3.1.0 |
| | RP-06 | RP-99653 | 120 | 1 | Selected RRC message transfer syntax | 3.0.0 | 3.1.0 |
| | RP-06 | RP-99657 | 121 | | Efficient rate command signalling | 3.0.0 | 3.1.0 |
| 03/2000 | RP-07 | RP-000043 | 122 | | TDD Mode BCH Reception in Cell DCH State | 3.1.0 | 3.2.0 |
| | RP-07 | RP-000043 | 123 | | Uplink Outer Loop Power Control in TDD Mode | 3.1.0 | 3.2.0 |
| | RP-07 | RP-000043 | 124 | 1 | TFS TB Size Calculation with Bit Aligned TDD MAC Headers | 3.1.0 | 3.2.0 |
| | RP-07 | RP-000043 | 125 | | Grouping of DRAC IEs, and detailed definitions of these IEs | 3.1.0 | 3.2.0 |
| | RP-07 | RP-000043 | 126 | | Correction of specifications for the 'Dynamic Resource Allocation Control of Uplink DCH' Procedure | 3.1.0 | 3.2.0 |
| | RP-07 | RP-000043 | 131 | 2 | Clarification of PDCP info and PDCP capability IEs | 3.1.0 | 3.2.0 |
| | RP-07 | RP-000043 | 132 | | Editorial change to "Specification of system information block characteristics" | 3.1.0 | 3.2.0 |
| | RP-07 | RP-000043 | 133 | | Additions of CBS related Information Elements | 3.1.0 | 3.2.0 |
| | RP-07 | RP-000043 | 134 | | Signalling for computed gain factors | 3.1.0 | 3.2.0 |
| | RP-07 | RP-000043 | 137 | 1 | General error handling procedures | 3.1.0 | 3.2.0 |
| | RP-07 | RP-000043 | 138 | 1 | RRC message extensions | 3.1.0 | 3.2.0 |
| | RP-07 | RP-000043 | 139 | | Padding of RRC messages using RLC transparent mode | 3.1.0 | 3.2.0 |
| | RP-07 | RP-000043 | 140 | 2 | UE information elements | 3.1.0 | 3.2.0 |
| | RP-07 | RP-000043 | 141 | | Other information elements | 3.1.0 | 3.2.0 |
| | RP-07 | RP-000043 | 142 | 3 | Integrity protection function | 3.1.0 | 3.2.0 |
| | RP-07 | RP-000043 | 143 | 4 | RAB-RB relations | 3.1.0 | 3.2.0 |
| | RP-07 | RP-000043 | 144 | 1 | Inter-system handover from UTRAN | 3.1.0 | 3.2.0 |
| | RP-07 | RP-000043 | 145 | 3 | Handover to UTRAN including procedure for pre- configuration | 3.1.0 | 3.2.0 |
| | RP-07 | RP-000043 | 146 | 2 | RRC measurement filtering parameters | 3.1.0 | 3.2.0 |
| | RP-07 | RP-000043 | 147 | | New event "RL out of UE Rx window" | 3.1.0 | 3.2.0 |
| | RP-07 | RP-000044 | 148 | 1 | Access control on RACH | 3.1.0 | 3.2.0 |
| | RP-07 | RP-000044 | 149 | 2 | cdma2000 Hard Handover | 3.1.0 | 3.2.0 |
| | RP-07 | RP-000044 | 150 | 1 | CPCH parameters with corrections | 3.1.0 | 3.2.0 |

| Change history | | | | | | | |
|----------------|-------|-----------|-----|-----|---|-------|-------|
| Date | TSG # | TSG Doc. | CR | Rev | Subject/Comment | Old | New |
| | RP-07 | RP-000044 | 152 | | U-plane AM RLC reconfiguration by cell update procedure | 3.1.0 | 3.2.0 |
| | RP-07 | RP-000044 | 154 | 3 | CPCCH | 3.1.0 | 3.2.0 |
| | RP-07 | RP-000044 | 155 | 1 | Information elements for ASC in TDD | 3.1.0 | 3.2.0 |
| | RP-07 | RP-000044 | 156 | | Addition of timing advance value in handover related messages | 3.1.0 | 3.2.0 |
| | RP-07 | RP-000044 | 157 | 2 | Physical channel description for TDD | 3.1.0 | 3.2.0 |
| | RP-07 | RP-000044 | 159 | | Message contents for the intersystem command message to UTRAN operating in TDD mode | 3.1.0 | 3.2.0 |
| | RP-07 | RP-000044 | 160 | | Corrections on use of PUSCH power control info and minor corrections | 3.1.0 | 3.2.0 |
| | RP-07 | RP-000044 | 162 | 2 | UE individual DRX cycles in CELL_PCH and URA_PCH states | 3.1.0 | 3.2.0 |
| | RP-07 | RP-000044 | 163 | | Correction to Transport Format Combination Control procedure | 3.1.0 | 3.2.0 |
| | RP-07 | RP-000044 | 164 | 3 | Downlink outer loop power control | 3.1.0 | 3.2.0 |
| | RP-07 | RP-000044 | 165 | 2 | Redirection of RRC connection setup | 3.1.0 | 3.2.0 |
| | RP-07 | RP-000044 | 166 | 2 | Inter-frequency measurements in CELL_FACH state | 3.1.0 | 3.2.0 |
| | RP-07 | RP-000044 | 167 | | List of found editorial mistakes in the Dec99 version of 25.331 (V3.1.0) | 3.1.0 | 3.2.0 |
| | RP-07 | RP-000044 | 168 | 1 | Transport block size | 3.1.0 | 3.2.0 |
| | RP-07 | RP-000044 | 169 | 1 | Cell Access Restriction | 3.1.0 | 3.2.0 |
| | RP-07 | RP-000044 | 170 | | Editorial modification | 3.1.0 | 3.2.0 |
| | RP-07 | RP-000044 | 171 | | Modification of DPCH info | 3.1.0 | 3.2.0 |
| | RP-07 | RP-000045 | 172 | 1 | Measurement control message | 3.1.0 | 3.2.0 |
| | RP-07 | RP-000045 | 173 | 2 | Reporting cell status | 3.1.0 | 3.2.0 |
| | RP-07 | RP-000045 | 174 | | Additional IE for RB release | 3.1.0 | 3.2.0 |
| | RP-07 | RP-000045 | 175 | | Available SF in PRACH info | 3.1.0 | 3.2.0 |
| | RP-07 | RP-000045 | 176 | | Traffic volume measurement event | 3.1.0 | 3.2.0 |
| | RP-07 | RP-000045 | 177 | | Report of multiple cells on an event result | 3.1.0 | 3.2.0 |
| | RP-07 | RP-000045 | 178 | | Editorial modification on Direct Transfer | 3.1.0 | 3.2.0 |
| | RP-07 | RP-000045 | 179 | | Correction of the Security Mode Control procedure | 3.1.0 | 3.2.0 |
| | RP-07 | RP-000045 | 180 | 1 | Maximum calculated Transport Format Combination | 3.1.0 | 3.2.0 |
| | RP-07 | RP-000045 | 183 | | Additional DPCH IEs to align 25.331 with 25.214 | 3.1.0 | 3.2.0 |
| | RP-07 | RP-000045 | 184 | 1 | RB – DCH mapping | 3.1.0 | 3.2.0 |
| | RP-07 | RP-000045 | 188 | 1 | Modifications related to FDD mode DSCH | 3.1.0 | 3.2.0 |
| | RP-07 | RP-000045 | 189 | 1 | Identification of Shared Channel Physical Configuration in TDD Mode | 3.1.0 | 3.2.0 |
| | RP-07 | RP-000045 | 192 | 1 | Uplink Outer Loop Power Control During Hard Handover | 3.1.0 | 3.2.0 |
| | RP-07 | RP-000045 | 193 | | Support of Multiple CCTrCH's in TDD Mode | 3.1.0 | 3.2.0 |
| | RP-07 | RP-000045 | 194 | 1 | Uplink Physical Channel Control in TDD Mode | 3.1.0 | 3.2.0 |
| | RP-07 | RP-000045 | 201 | 1 | Transfer of initial information from UE to target RNC prior to handover to UTRAN | 3.1.0 | 3.2.0 |
| | RP-07 | RP-000045 | 202 | 1 | CN information elements | 3.1.0 | 3.2.0 |
| | RP-07 | RP-000045 | 203 | | UTRAN mobility information elements | 3.1.0 | 3.2.0 |
| | RP-07 | RP-000045 | 204 | 1 | RB information elements | 3.1.0 | 3.2.0 |
| | RP-07 | RP-000046 | 205 | 1 | Physical channel information elements | 3.1.0 | 3.2.0 |
| | RP-07 | RP-000046 | 206 | 1 | UE capability information elements | 3.1.0 | 3.2.0 |
| | RP-07 | RP-000046 | 207 | | UE variables | 3.1.0 | 3.2.0 |
| | RP-07 | RP-000046 | 208 | 1 | Actions when entering idle mode | 3.1.0 | 3.2.0 |
| | RP-07 | RP-000046 | 209 | | Usage of pilot bits | 3.1.0 | 3.2.0 |
| | RP-07 | RP-000046 | 210 | | System information procedure corrections | 3.1.0 | 3.2.0 |
| | RP-07 | RP-000046 | 212 | | Reconfiguration of ciphering | 3.1.0 | 3.2.0 |
| | RP-07 | RP-000046 | 213 | 1 | Enhancements to RRC connection re-establishment procedure (Message subsequently deleted in RAN !), RP-000715) | 3.1.0 | 3.2.0 |
| | RP-07 | RP-000046 | 215 | | Updates to RRC Initialisation Information transparent container and addition of reverse direction container description | 3.1.0 | 3.2.0 |
| | RP-07 | RP-000046 | 220 | 1 | Changes in RRC messages to support lossless SRNC relocation | 3.1.0 | 3.2.0 |
| | RP-07 | RP-000046 | 229 | 1 | Measurements of unlisted neighbouring cells | 3.1.0 | 3.2.0 |
| | RP-07 | RP-000046 | 234 | 2 | Inclusion of Location Services | 3.1.0 | 3.2.0 |
| | RP-07 | RP-000046 | 236 | 1 | Application of Access Service Classes and relation to Access Classes | 3.1.0 | 3.2.0 |
| | RP-07 | RP-000046 | 252 | 1 | DRX indicator presence and state entering mechanism at the end of a procedure | 3.1.0 | 3.2.0 |

| Change history | | | | | | | |
|----------------|-------|-----------|-----|-----|---|-------|-------|
| Date | TSG # | TSG Doc. | CR | Rev | Subject/Comment | Old | New |
| | RP-07 | RP-000046 | 254 | 1 | Physical shared channel allocation procedure | 3.1.0 | 3.2.0 |
| | RP-07 | RP-000046 | 255 | | Corrections to TDD specific parameters in PICH info | 3.1.0 | 3.2.0 |
| | RP-07 | RP-000046 | 256 | | Editorial modifications | 3.1.0 | 3.2.0 |
| | RP-07 | RP-000046 | 259 | 2 | Introduction of mapping function information in Cell selection and | 3.1.0 | 3.2.0 |
| | RP-07 | RP-000046 | 263 | | Ciphering and integrity HFN | 3.1.0 | 3.2.0 |
| | RP-07 | RP-000046 | 267 | | New SIB for UP | 3.1.0 | 3.2.0 |
| | RP-07 | RP-000047 | 268 | | Removal of synchronization Case 3 | 3.1.0 | 3.2.0 |
| | RP-07 | RP-000047 | 271 | | TX Diversity | 3.1.0 | 3.2.0 |
| | RP-07 | RP-000047 | 272 | | Update of tabular format clause 10 | 3.1.0 | 3.2.0 |
| | RP-07 | RP-000047 | 273 | | ASN.1 description | 3.1.0 | 3.2.0 |
| 06/2000 | RP-08 | RP-000222 | 228 | 5 | Downlink power control in compressed mode | 3.2.0 | 3.3.0 |
| | RP-08 | RP-000222 | 260 | 1 | Clarification on physical channel allocations in TDD | 3.2.0 | 3.3.0 |
| | RP-08 | RP-000222 | 261 | 4 | TDD Measurements and Reporting | 3.2.0 | 3.3.0 |
| | RP-08 | RP-000222 | 262 | 4 | Signalling of IEs related to System Information on FACH | 3.2.0 | 3.3.0 |
| | RP-08 | RP-000222 | 265 | 3 | Transport Format Combination Control | 3.2.0 | 3.3.0 |
| | RP-08 | RP-000222 | 269 | 1 | Signalling of partial failure in radio bearer related procedures | 3.2.0 | 3.3.0 |
| | RP-08 | RP-000222 | 275 | | Clarification on PDCP info | 3.2.0 | 3.3.0 |
| | RP-08 | RP-000222 | 279 | | Editorial modification on Transport Ch capability | 3.2.0 | 3.3.0 |
| | RP-08 | RP-000222 | 280 | | Editorial modification on CN IE | 3.2.0 | 3.3.0 |
| | RP-08 | RP-000222 | 281 | 3 | Editorial modification on Physical CH IE | 3.2.0 | 3.3.0 |
| | RP-08 | RP-000222 | 282 | 1 | Editorial modification on ASN.1 description | 3.2.0 | 3.3.0 |
| | RP-08 | RP-000222 | 283 | 1 | IEs on SIB5/6 | 3.2.0 | 3.3.0 |
| | RP-08 | RP-000222 | 285 | 2 | Re-establishment timer | 3.2.0 | 3.3.0 |
| | RP-08 | RP-000222 | 286 | 1 | CN DRX cycle coefficient | 3.2.0 | 3.3.0 |
| | RP-08 | RP-000222 | 287 | 1 | Cell Access Restriction | 3.2.0 | 3.3.0 |
| | RP-08 | RP-000222 | 288 | 1 | Cell selection and re-selection parameters | 3.2.0 | 3.3.0 |
| | RP-08 | RP-000222 | 289 | 2 | Modification on Measurement IE | 3.2.0 | 3.3.0 |
| | RP-08 | RP-000222 | 291 | 1 | RACH Transmission parameters | 3.2.0 | 3.3.0 |
| | RP-08 | RP-000222 | 292 | 1 | SCCPCH System Info | 3.2.0 | 3.3.0 |
| | RP-08 | RP-000222 | 293 | 1 | Addition of HFN for RRC CONNECTION RE-ESTABLISHMENT COMPLETE | 3.2.0 | 3.3.0 |
| | RP-08 | RP-000223 | 294 | 1 | RLC reconfiguration indicator | 3.2.0 | 3.3.0 |
| | RP-08 | RP-000223 | 296 | 3 | RLC Info | 3.2.0 | 3.3.0 |
| | RP-08 | RP-000223 | 297 | 1 | Usage of Transport CH ID | 3.2.0 | 3.3.0 |
| | RP-08 | RP-000223 | 298 | 2 | Transport format combination set | 3.2.0 | 3.3.0 |
| | RP-08 | RP-000223 | 300 | 1 | Usage of U-RNTI and C-RNTI in DL DCCH message | 3.2.0 | 3.3.0 |
| | RP-08 | RP-000223 | 301 | | Description of Cell Update Procedure | 3.2.0 | 3.3.0 |
| | RP-08 | RP-000223 | 304 | 1 | System information modification procedure | 3.2.0 | 3.3.0 |
| | RP-08 | RP-000223 | 305 | | Functional descriptions of the RRC messages | 3.2.0 | 3.3.0 |
| | RP-08 | RP-000223 | 306 | | Clarification of CTFC calculation | 3.2.0 | 3.3.0 |
| | RP-08 | RP-000223 | 307 | 3 | Compressed mode parameters | 3.2.0 | 3.3.0 |
| | RP-08 | RP-000223 | 309 | 2 | Signalling procedure for periodic local authentication | 3.2.0 | 3.3.0 |
| | RP-08 | RP-000223 | 310 | 5 | Editorial corrections on security | 3.2.0 | 3.3.0 |
| | RP-08 | RP-000223 | 311 | 2 | Security capability | 3.2.0 | 3.3.0 |
| | RP-08 | RP-000223 | 312 | 1 | Corrections on ASN.1 definitions | 3.2.0 | 3.3.0 |
| | RP-08 | RP-000223 | 313 | 2 | DRX cycle lower limit | 3.2.0 | 3.3.0 |
| | RP-08 | RP-000223 | 314 | 1 | Removal of CPICH SIR measurement quantity | 3.2.0 | 3.3.0 |
| | RP-08 | RP-000223 | 315 | 1 | Signalling connection release request | 3.2.0 | 3.3.0 |
| | RP-08 | RP-000223 | 318 | 1 | Change to IMEI coding from BCD to hexadecimal | 3.2.0 | 3.3.0 |
| | RP-08 | RP-000223 | 319 | 1 | Removal of RLC sequence numbers from RRC initialisation information | 3.2.0 | 3.3.0 |
| | RP-08 | RP-000223 | 320 | 3 | Addition of the length of PDCP sequence numbers into PDCP info | 3.2.0 | 3.3.0 |
| | RP-08 | RP-000224 | 323 | 1 | BSIC verification of GSM cells | 3.2.0 | 3.3.0 |
| | RP-08 | RP-000224 | 324 | | Reporting cell status | 3.2.0 | 3.3.0 |
| | RP-08 | RP-000224 | 325 | | RRC measurement filtering parameters | 3.2.0 | 3.3.0 |
| | RP-08 | RP-000224 | 326 | | Cell-reselection parameter signalling | 3.2.0 | 3.3.0 |
| | RP-08 | RP-000224 | 328 | 3 | Multiplicity values | 3.2.0 | 3.3.0 |

| Change history | | | | | | | |
|----------------|-------|-----------|-----|-----|---|-------|-------|
| Date | TSG # | TSG Doc. | CR | Rev | Subject/Comment | Old | New |
| | RP-08 | RP-000224 | 329 | | Quality measurements | 3.2.0 | 3.3.0 |
| | RP-08 | RP-000224 | 330 | 4 | CPCH Status Indication mode correction | 3.2.0 | 3.3.0 |
| | RP-08 | RP-000224 | 331 | 4 | End of CPCH transmission | 3.2.0 | 3.3.0 |
| | RP-08 | RP-000224 | 332 | | Handover to UTRAN procedure | 3.2.0 | 3.3.0 |
| | RP-08 | RP-000224 | 333 | | Harmonization of access service classes in FDD and TDD | 3.2.0 | 3.3.0 |
| | RP-08 | RP-000224 | 334 | 1 | Correction to usage of primary CCPCH info and primary CPICH info | 3.2.0 | 3.3.0 |
| | RP-08 | RP-000224 | 335 | | Corrections and clarifications on system information handling | 3.2.0 | 3.3.0 |
| | RP-08 | RP-000224 | 336 | | Editorial corrections | 3.2.0 | 3.3.0 |
| | RP-08 | RP-000224 | 337 | 1 | Editorial corrections on uplink timing advance | 3.2.0 | 3.3.0 |
| | RP-08 | RP-000224 | 339 | | Correction of Transport Format Combination tabular format and ASN.1 | 3.2.0 | 3.3.0 |
| | RP-08 | RP-000224 | 340 | 1 | UE variables | 3.2.0 | 3.3.0 |
| | RP-08 | RP-000224 | 342 | 1 | General error handling | 3.2.0 | 3.3.0 |
| | RP-08 | RP-000224 | 344 | 1 | System Information extensibility in ASN.1 definitions | 3.2.0 | 3.3.0 |
| | RP-08 | RP-000224 | 345 | | Usage of pilot bits | 3.2.0 | 3.3.0 |
| | RP-08 | RP-000224 | 346 | 3 | RRC connection release procedure | 3.2.0 | 3.3.0 |
| | RP-08 | RP-000225 | 347 | 1 | Alignment of Section 10.3 on methodology defined in 25.921 | 3.2.0 | 3.3.0 |
| | RP-08 | RP-000225 | 348 | | Modifications of cell (re)selection parameters | 3.2.0 | 3.3.0 |
| | RP-08 | RP-000225 | 350 | 1 | GPS time-of-week represented as seconds and fractions of seconds | 3.2.0 | 3.3.0 |
| | RP-08 | RP-000225 | 351 | 2 | CPCH corrections | 3.2.0 | 3.3.0 |
| | RP-08 | RP-000225 | 352 | | PLMN type selection | 3.2.0 | 3.3.0 |
| | RP-08 | RP-000225 | 353 | 3 | Paging and establishment cause values | 3.2.0 | 3.3.0 |
| | RP-08 | RP-000225 | 354 | | Common channel configurations | 3.2.0 | 3.3.0 |
| | RP-08 | RP-000225 | 355 | 2 | Clarification of prioritization of logical channels in UE | 3.2.0 | 3.3.0 |
| | RP-08 | RP-000225 | 357 | 2 | UE capability corrections | 3.2.0 | 3.3.0 |
| | RP-08 | RP-000225 | 358 | 2 | Clarification of HFN | 3.2.0 | 3.3.0 |
| | RP-08 | RP-000225 | 359 | 3 | Clarification of Integrity Protection | 3.2.0 | 3.3.0 |
| | RP-08 | RP-000225 | 360 | 1 | RRC message size optimization regarding TrCH parameters | 3.2.0 | 3.3.0 |
| | RP-08 | RP-000225 | 361 | | Protocol extensions in ASN | 3.2.0 | 3.3.0 |
| | RP-08 | RP-000225 | 362 | 1 | Downloading of pre- defined configurations via SIB 16 | 3.2.0 | 3.3.0 |
| | RP-08 | RP-000225 | 363 | 1 | Optimization of System Information | 3.2.0 | 3.3.0 |
| | RP-08 | RP-000225 | 364 | 1 | CPCH gain factor | 3.2.0 | 3.3.0 |
| | RP-08 | RP-000225 | 368 | 2 | SFN Transmission Rate in TDD Mode | 3.2.0 | 3.3.0 |
| | RP-08 | RP-000225 | 371 | 1 | Integrity Control | 3.2.0 | 3.3.0 |
| | RP-08 | RP-000225 | 372 | | Modification to measurement event evaluation | 3.2.0 | 3.3.0 |
| | RP-08 | RP-000225 | 373 | | System Information related parameters | 3.2.0 | 3.3.0 |
| | RP-08 | RP-000226 | 375 | 1 | Changes in RB mapping info | 3.2.0 | 3.3.0 |
| | RP-08 | RP-000226 | 377 | | Editorial corrections to PRACH system information and Cell info | 3.2.0 | 3.3.0 |
| | RP-08 | RP-000226 | 378 | | Editorial Corrections to 25.331 Procedures and Tabular Format | 3.2.0 | 3.3.0 |
| | RP-08 | RP-000226 | 379 | 1 | Corrections to figures and procedures for the failure cases | 3.2.0 | 3.3.0 |
| | RP-08 | RP-000226 | 380 | | Corrections on use of ORDERED_CONFIG | 3.2.0 | 3.3.0 |
| | RP-08 | RP-000226 | 382 | 1 | Corrections to Transport Channel and RB Reconfiguration procedures | 3.2.0 | 3.3.0 |
| | RP-08 | RP-000226 | 383 | 1 | Corrections to INITIAL DIRECT TRANSFER and UE CAPABILITY INFORMATION CONFIRM procedures | 3.2.0 | 3.3.0 |
| | RP-08 | RP-000226 | 384 | | Corrections to Transparent mode signalling info Tabular format and ASN.1 | 3.2.0 | 3.3.0 |
| | RP-08 | RP-000226 | 385 | | Corrections to Soft Handover messages and procedures | 3.2.0 | 3.3.0 |
| | RP-08 | RP-000226 | 387 | | Corrections to RRC CONNECTION REJECT procedures | 3.2.0 | 3.3.0 |
| | RP-08 | RP-000226 | 388 | 1 | Transport format combination in TDD and Transport channel ID | 3.2.0 | 3.3.0 |
| | RP-08 | RP-000226 | 389 | 1 | Signalling for dynamic TTI in TDD | 3.2.0 | 3.3.0 |
| | RP-08 | RP-000226 | 390 | 1 | Usage of DCCH for Shared Channel Allocation message | 3.2.0 | 3.3.0 |
| | RP-08 | RP-000226 | 391 | 1 | Correction to physical channel IEs in TDD | 3.2.0 | 3.3.0 |
| | RP-08 | RP-000226 | 392 | 1 | TDD preconfiguration for Handover to UTRAN | 3.2.0 | 3.3.0 |
| | RP-08 | RP-000226 | 393 | | Corrections to measurement control descriptions and messages | 3.2.0 | 3.3.0 |
| | RP-08 | RP-000226 | 394 | 1 | Corrections on ASN.1 definitions | 3.2.0 | 3.3.0 |
| | RP-08 | RP-000226 | 395 | | Addition of the Segmentation indication field for transparent mode | 3.2.0 | 3.3.0 |

| Change history | | | | | | | |
|----------------|-------|-----------|-----|-----|---|-------|-------|
| Date | TSG # | TSG Doc. | CR | Rev | Subject/Comment | Old | New |
| | | | | | RLC in the RLC Info | | |
| | RP-08 | RP-000226 | 396 | 1 | Radio Bearer identity for CCCH | 3.2.0 | 3.3.0 |
| | RP-08 | RP-000226 | 397 | 1 | ASN.1 definitions for RRC information between network nodes | 3.2.0 | 3.3.0 |
| | RP-08 | RP-000227 | 398 | 1 | NAS Routing | 3.2.0 | 3.3.0 |
| | RP-08 | RP-000227 | 399 | | DPCCH power control preamble | 3.2.0 | 3.3.0 |
| | RP-08 | RP-000227 | 400 | 2 | Modifications of Assisted GPS Messages | 3.2.0 | 3.3.0 |
| | RP-08 | RP-000227 | 401 | | Choice of Initial UE Identity | 3.2.0 | 3.3.0 |
| | RP-08 | RP-000227 | 402 | | ANSI-41 information elements | 3.2.0 | 3.3.0 |
| | RP-08 | RP-000227 | 404 | 1 | RLC value ranges | 3.2.0 | 3.3.0 |
| | RP-08 | RP-000227 | 408 | 1 | HFN Reset | 3.2.0 | 3.3.0 |
| | RP-08 | RP-000227 | 409 | 1 | Clarification on ciphering parameters and integrity protection procedure in case of SRNS relocation | 3.2.0 | 3.3.0 |
| | RP-08 | RP-000227 | 410 | 1 | Clarification of compressed mode activation and configuration failure | 3.2.0 | 3.3.0 |
| | RP-08 | RP-000227 | 412 | 1 | Modification of the RLC Size IE | 3.2.0 | 3.3.0 |
| | RP-08 | RP-000227 | 414 | | CPCH DL Power control | 3.2.0 | 3.3.0 |
| | RP-08 | RP-000227 | 415 | 1 | SFN measurements in TDD | 3.2.0 | 3.3.0 |
| 09/2000 | RP-09 | RP-000361 | 356 | 3 | Clarification on multiplicity of PCH and PICH and S-CCPCH selection | 3.3.0 | 3.4.0 |
| | RP-09 | RP-000361 | 403 | 3 | Parameters to be stored in the USIM | 3.3.0 | 3.4.0 |
| | RP-09 | RP-000361 | 413 | 3 | Optimization of Inter-system handover message | 3.3.0 | 3.4.0 |
| | RP-09 | RP-000361 | 416 | 2 | Timing Advance in Handover Procedures | 3.3.0 | 3.4.0 |
| | RP-09 | RP-000361 | 417 | 2 | Synchronization of Timing Advance and Timing Deviation Measurement | 3.3.0 | 3.4.0 |
| | RP-09 | RP-000361 | 418 | | Downlink Physical Channels Per Timeslot | 3.3.0 | 3.4.0 |
| | RP-09 | RP-000361 | 419 | | TDD Mode DCH Reception in Cell DCH State | 3.3.0 | 3.4.0 |
| | RP-09 | RP-000361 | 420 | 2 | Downlink Power Control During DTX in TDD Mode | 3.3.0 | 3.4.0 |
| | RP-09 | RP-000361 | 421 | 1 | Paging Indicator Length Definition | 3.3.0 | 3.4.0 |
| | RP-09 | RP-000361 | 422 | | Updating & alignment of RRC containers & handover to UTRAN information transfer | 3.3.0 | 3.4.0 |
| | RP-09 | RP-000361 | 424 | | Default values for UE timers and counters | 3.3.0 | 3.4.0 |
| | RP-09 | RP-000361 | 425 | 1 | Security mode control | 3.3.0 | 3.4.0 |
| | RP-09 | RP-000361 | 426 | 1 | Corrections and Editorial updates to chapter 8 | 3.3.0 | 3.4.0 |
| | RP-09 | RP-000361 | 427 | | Corrections and editorial updates to chapter 10 | 3.3.0 | 3.4.0 |
| | RP-09 | RP-000361 | 428 | | Transition from CELL_DCH to CELL_PCH and URA_PCH state | 3.3.0 | 3.4.0 |
| | RP-09 | RP-000361 | 430 | | Assisted GPS Messaging and Procedures | 3.3.0 | 3.4.0 |
| | RP-09 | RP-000361 | 431 | 2 | Corrections to Activation Time use | 3.3.0 | 3.4.0 |
| | RP-09 | RP-000361 | 432 | | Editorial Corrections to measurement reporting range | 3.3.0 | 3.4.0 |
| | RP-09 | RP-000361 | 434 | 4 | Default DPCH offset value and DPCH offset | 3.3.0 | 3.4.0 |
| | RP-09 | RP-000361 | 435 | 3 | RLC info | 3.3.0 | 3.4.0 |
| | RP-09 | RP-000362 | 437 | | Clarification of the description of IE semantics in "RB with PDCP information" | 3.3.0 | 3.4.0 |
| | RP-09 | RP-000362 | 438 | 1 | Editorial corrections on security | 3.3.0 | 3.4.0 |
| | RP-09 | RP-000362 | 439 | | Editorial correction to RB mapping info | 3.3.0 | 3.4.0 |
| | RP-09 | RP-000362 | 440 | 1 | Compressed mode configuration failure | 3.3.0 | 3.4.0 |
| | RP-09 | RP-000362 | 441 | | Gain factors for TDD | 3.3.0 | 3.4.0 |
| | RP-09 | RP-000362 | 442 | | Introduction of Default DPCH Offset Value in TDD | 3.3.0 | 3.4.0 |
| | RP-09 | RP-000362 | 444 | 1 | Optimization of handover to UTRAN command | 3.3.0 | 3.4.0 |
| | RP-09 | RP-000362 | 445 | | Editorial corrections | 3.3.0 | 3.4.0 |
| | RP-09 | RP-000362 | 448 | 1 | Mapping of channelisation code | 3.3.0 | 3.4.0 |
| | RP-09 | RP-000362 | 449 | 2 | DL TFCS Limitation | 3.3.0 | 3.4.0 |
| | RP-09 | RP-000362 | 450 | | SIB offset | 3.3.0 | 3.4.0 |
| | RP-09 | RP-000362 | 451 | | RRC CONNECTION RELEASE cause | 3.3.0 | 3.4.0 |
| | RP-09 | RP-000362 | 452 | | Addition of RACH TFCS | 3.3.0 | 3.4.0 |
| | RP-09 | RP-000362 | 453 | 2 | Cell Identity | 3.3.0 | 3.4.0 |
| | RP-09 | RP-000362 | 454 | | Editorial Modifications | 3.3.0 | 3.4.0 |
| | RP-09 | RP-000362 | 455 | 1 | TDD PRACH Power Control for Spreading Factor 8/16 | 3.3.0 | 3.4.0 |
| | RP-09 | RP-000362 | 456 | | TDD CCTrCH Repetition Length Definition | 3.3.0 | 3.4.0 |
| | RP-09 | RP-000362 | 457 | 1 | Reporting threshold of traffic volume measurements | 3.3.0 | 3.4.0 |

| Change history | | | | | | | |
|----------------|-------|-----------|-----|-----|---|-------|-------|
| Date | TSG # | TSG Doc. | CR | Rev | Subject/Comment | Old | New |
| | RP-09 | RP-000362 | 459 | 2 | UP GPS assistance data for SIB | 3.3.0 | 3.4.0 |
| | RP-09 | RP-000362 | 461 | 1 | Support of cell update confirm on CCCH | 3.3.0 | 3.4.0 |
| | RP-09 | RP-000363 | 462 | 1 | Max Window Size in RLC capabilities | 3.3.0 | 3.4.0 |
| | RP-09 | RP-000363 | 463 | 3 | UE handling of CFN | 3.3.0 | 3.4.0 |
| | RP-09 | RP-000363 | 464 | 1 | Correction of padding description in clause 12 | 3.3.0 | 3.4.0 |
| | RP-09 | RP-000363 | 465 | 1 | Window size in RLC info | 3.3.0 | 3.4.0 |
| | RP-09 | RP-000363 | 466 | 1 | TFC Control Duration | 3.3.0 | 3.4.0 |
| | RP-09 | RP-000363 | 467 | | System Information Block Tabular Information | 3.3.0 | 3.4.0 |
| | RP-09 | RP-000363 | 469 | 1 | Frequency encoding in inter-system handover messages | 3.3.0 | 3.4.0 |
| | RP-09 | RP-000363 | 470 | | RRC message size optimization regarding TFS parameters | 3.3.0 | 3.4.0 |
| | RP-09 | RP-000363 | 471 | 2 | RACH selection | 3.3.0 | 3.4.0 |
| | RP-09 | RP-000363 | 472 | | DRX cycle lower limit | 3.3.0 | 3.4.0 |
| | RP-09 | RP-000363 | 474 | | Rx window size in RLC info | 3.3.0 | 3.4.0 |
| | RP-09 | RP-000363 | 476 | 1 | Corrections & optimizations regarding system information blocks of length 215..221 | 3.3.0 | 3.4.0 |
| | RP-09 | RP-000363 | 477 | 1 | Corrections on 8.1.1 resulting from RRC review at R2#14 | 3.3.0 | 3.4.0 |
| | RP-09 | RP-000363 | 478 | 1 | Corrections to the RRC connection release procedure | 3.3.0 | 3.4.0 |
| | RP-09 | RP-000363 | 479 | 1 | New release cause for signalling connection re-establishment | 3.3.0 | 3.4.0 |
| | RP-09 | RP-000363 | 480 | 1 | Correction to IE midamble shift and burst type | 3.3.0 | 3.4.0 |
| | RP-09 | RP-000363 | 481 | 1 | Correction in RLC info | 3.3.0 | 3.4.0 |
| | RP-09 | RP-000363 | 483 | | Description of CTCH occasions | 3.3.0 | 3.4.0 |
| | RP-09 | RP-000363 | 485 | 1 | TDD CCTrCH UL/DL Pairing for Inner Loop Power Control | 3.3.0 | 3.4.0 |
| | RP-09 | RP-000363 | 486 | 1 | DCCH and BCCH Signalling of TDD UL OL PC Information | 3.3.0 | 3.4.0 |
| | RP-09 | RP-000364 | 487 | 1 | Broadcast SIBs for TDD UL OL PC Information | 3.3.0 | 3.4.0 |
| | RP-09 | RP-000364 | 490 | 1 | CPCH corrections | 3.3.0 | 3.4.0 |
| | RP-09 | RP-000364 | 492 | 3 | Corrections to Security IEs | 3.3.0 | 3.4.0 |
| | RP-09 | RP-000364 | 494 | 1 | Corrections to parameters to be stored in the USIM | 3.3.0 | 3.4.0 |
| | RP-09 | RP-000364 | 496 | | Editorial corrections | 3.3.0 | 3.4.0 |
| | RP-09 | RP-000364 | 497 | 2 | Physical Shared Channel Allocation procedure | 3.3.0 | 3.4.0 |
| | RP-09 | RP-000364 | 498 | | Correction to Transport Format Combination Control Message | 3.3.0 | 3.4.0 |
| | RP-09 | RP-000364 | 499 | 1 | Usage of Cell Parameter ID | 3.3.0 | 3.4.0 |
| | RP-09 | RP-000364 | 500 | | RB description for SHCCH | 3.3.0 | 3.4.0 |
| | RP-09 | RP-000364 | 501 | 1 | Use of LI in UM | 3.3.0 | 3.4.0 |
| | RP-09 | RP-000364 | 502 | 1 | Minor Corrections to RRC Protocol Specification | 3.3.0 | 3.4.0 |
| | RP-09 | RP-000364 | 503 | 1 | Correction to Cell Update Cause | 3.3.0 | 3.4.0 |
| | RP-09 | RP-000364 | 504 | | Correction on T307 definition | 3.3.0 | 3.4.0 |
| | RP-09 | RP-000364 | 505 | | Corrections to relative priorities in RRC Protocol | 3.3.0 | 3.4.0 |
| | RP-09 | RP-000364 | 506 | | Unification of Reconfiguration Procedures | 3.3.0 | 3.4.0 |
| | RP-09 | RP-000364 | 507 | 1 | Changes to section 8.2 proposed at Paris RRC Ad Hoc | 3.3.0 | 3.4.0 |
| | RP-09 | RP-000364 | 508 | | Establishment Cause | 3.3.0 | 3.4.0 |
| | RP-09 | RP-000364 | 509 | 1 | PRACH partitioning | 3.3.0 | 3.4.0 |
| | RP-09 | RP-000364 | 510 | | Editorial Correction on Active Set Update | 3.3.0 | 3.4.0 |
| | RP-09 | RP-000364 | 511 | | Editorial Correction regarding system information | 3.3.0 | 3.4.0 |
| | RP-09 | RP-000365 | 512 | 1 | Clarification on Reporting Cell Status | 3.3.0 | 3.4.0 |
| | RP-09 | RP-000365 | 513 | 1 | Editorial corrections on RRC Connection Establishment and Release procedures NOTE: In subclause 8.1.4.6, the change from "decrease" to "increase" for V308 was decided to be incorrect after discussion on the TSG-RAN WG2 reflector and was not implemented | 3.3.0 | 3.4.0 |
| | RP-09 | RP-000365 | 514 | | Gated Transmission Control Info | 3.3.0 | 3.4.0 |
| | RP-09 | RP-000365 | 515 | 1 | Cell selection/reselection parameters for SIB 3/4 | 3.3.0 | 3.4.0 |
| | RP-09 | RP-000365 | 516 | | Implementation of Ec/N0 parameters and optimization of SIB 11/12 | 3.3.0 | 3.4.0 |
| | RP-09 | RP-000365 | 517 | | PRACH Info | 3.3.0 | 3.4.0 |
| | RP-09 | RP-000365 | 518 | 1 | Uplink DPCH power control info | 3.3.0 | 3.4.0 |
| | RP-09 | RP-000365 | 519 | | AICH power offset value range | 3.3.0 | 3.4.0 |
| | RP-09 | RP-000365 | 520 | | Direct paging of RRC connected UE in CELL_PCH/URA_PCH NOTE: This CR was postponed in TSG-RAN #9 and was wrongly included in v3.4.0. This was corrected in v3.4.1 | 3.3.0 | 3.4.0 |
| | RP-09 | RP-000365 | 521 | | Corrections to Sections 1-7 | 3.3.0 | 3.4.0 |

| Change history | | | | | | | |
|----------------|-------|-----------|-----|-----|--|-------|-------|
| Date | TSG # | TSG Doc. | CR | Rev | Subject/Comment | Old | New |
| | RP-09 | RP-000365 | 522 | | Error handling for Uplink Physical Channel Control procedure | 3.3.0 | 3.4.0 |
| | RP-09 | RP-000365 | 523 | | Corrections to downlink outer loop power control in compressed mode | 3.3.0 | 3.4.0 |
| | RP-09 | RP-000365 | 524 | 1 | Clarification on measurement procedure using compressed mode | 3.3.0 | 3.4.0 |
| | RP-09 | RP-000365 | 525 | 1 | Updates to cell and URA update procedures based on RRC Ad Hoc | 3.3.0 | 3.4.0 |
| | RP-09 | RP-000365 | 526 | 1 | Updates to RNTI allocation procedure based on RRC Ad Hoc | 3.3.0 | 3.4.0 |
| | RP-09 | RP-000365 | 528 | | PRACH constant value | 3.3.0 | 3.4.0 |
| | RP-09 | RP-000365 | 530 | 1 | Corrections to the paging procedure | 3.3.0 | 3.4.0 |
| | RP-09 | RP-000365 | 532 | 1 | Moving of text from 25.304 | 3.3.0 | 3.4.0 |
| | RP-09 | RP-000365 | 533 | 1 | Message extensibility | 3.3.0 | 3.4.0 |
| | RP-09 | RP-000365 | 534 | 1 | Additions to "State of RRC Procedure" in RRC Initialisation information, source RNC to target RNC | 3.3.0 | 3.4.0 |
| | RP-09 | RP-000365 | 535 | 1 | Support of codec negotiation | 3.3.0 | 3.4.0 |
| | - | - | - | | Removal of contents of CR 520 from v3.4.0, because it was postponed at TSG-RAN #9 and by accident included anyway. | 3.4.0 | 3.4.1 |
| 12/2000 | RP-10 | RP-000570 | 536 | | Downlink outer-loop power control in compressed mode | 3.4.1 | 3.5.0 |
| | RP-10 | RP-000570 | 537 | 1 | Correction in the use of "U-RNTI Short" | 3.4.1 | 3.5.0 |
| | RP-10 | RP-000570 | 538 | | Corrections related to UE Timing | 3.4.1 | 3.5.0 |
| | RP-10 | RP-000570 | 539 | | Corrections to SFN-SFN definition | 3.4.1 | 3.5.0 |
| | RP-10 | RP-000570 | 541 | 1 | Corrections to definition and use of Activation Time | 3.4.1 | 3.5.0 |
| | RP-10 | RP-000570 | 542 | | Corrections to logical channel priorities | 3.4.1 | 3.5.0 |
| | RP-10 | RP-000570 | 543 | 1 | Correction to codec negotiation | 3.4.1 | 3.5.0 |
| | RP-10 | RP-000570 | 544 | 1 | CFN-SFN observed time difference measurement | 3.4.1 | 3.5.0 |
| | RP-10 | RP-000570 | 545 | 1 | Correction to timing indication for hard handover | 3.4.1 | 3.5.0 |
| | RP-10 | RP-000570 | 546 | 1 | UE Radio Access Capability Corrections | 3.4.1 | 3.5.0 |
| | RP-10 | RP-000570 | 548 | 1 | RRC establishment and paging causes for NAS signalling | 3.4.1 | 3.5.0 |
| | RP-10 | RP-000570 | 549 | | Corrections to Intra-frequency measurements and Traffic volume measurements | 3.4.1 | 3.5.0 |
| | RP-10 | RP-000570 | 551 | 1 | PRACH/RACH System information | 3.4.1 | 3.5.0 |
| | RP-10 | RP-000570 | 553 | 1 | GSM Measurement reporting | 3.4.1 | 3.5.0 |
| | RP-10 | RP-000570 | 554 | 1 | BLER measurement and quality target | 3.4.1 | 3.5.0 |
| | RP-10 | RP-000570 | 556 | 1 | Clarification of PDCP sequence number window terminology | 3.4.1 | 3.5.0 |
| | RP-10 | RP-000570 | 559 | 1 | Clarification on Error Handling | 3.4.1 | 3.5.0 |
| | RP-10 | RP-000570 | 560 | | Removal of compressed mode measurement purpose "other" | 3.4.1 | 3.5.0 |
| | RP-10 | RP-000570 | 561 | | Clarification of compressed mode measurement purpose "GSM" | 3.4.1 | 3.5.0 |
| | RP-10 | RP-000570 | 564 | 2 | Reporting multiple GSM cells | 3.4.1 | 3.5.0 |
| | RP-10 | RP-000571 | 566 | 1 | Number of RLS that can be removed in Active Set update | 3.4.1 | 3.5.0 |
| | RP-10 | RP-000571 | 568 | 1 | Clarification on Segment Index | 3.4.1 | 3.5.0 |
| | RP-10 | RP-000571 | 571 | 3 | RRC procedure performance requirements | 3.4.1 | 3.5.0 |
| | RP-10 | RP-000571 | 572 | 1 | Correction of newInterSystemCellList and MeasurementControlSysInfo in ASN.1 | 3.4.1 | 3.5.0 |
| | RP-10 | RP-000571 | 573 | 4 | Removal of Flow Id concept while maintaining lu interface flexibility | 3.4.1 | 3.5.0 |
| | RP-10 | RP-000571 | 574 | 2 | Ciphering and reset | 3.4.1 | 3.5.0 |
| | RP-10 | RP-000571 | 575 | 1 | Corrections and clarifications concerning inter-RAT change procedures | 3.4.1 | 3.5.0 |
| | RP-10 | RP-000571 | 576 | 1 | General Security Clarifications | 3.4.1 | 3.5.0 |
| | RP-10 | RP-000571 | 577 | | Clarification on RB 0 | 3.4.1 | 3.5.0 |
| | RP-10 | RP-000571 | 578 | | Clarification on the transition of RRC state | 3.4.1 | 3.5.0 |
| | RP-10 | RP-000571 | 580 | 1 | UP measurements for RRC information to target RNC | 3.4.1 | 3.5.0 |
| | RP-10 | RP-000571 | 581 | | Correction on LCS reporting criteria | 3.4.1 | 3.5.0 |
| | RP-10 | RP-000574 | 583 | 1 | CSICH Corrections | 3.4.1 | 3.5.0 |
| | RP-10 | RP-000571 | 584 | 1 | Clarification to handling of satellite health issues | 3.4.1 | 3.5.0 |
| | RP-10 | RP-000571 | 585 | | Clarification on activation time | 3.4.1 | 3.5.0 |
| | RP-10 | RP-000571 | 586 | | Clarification on activation time for ciphering in TM | 3.4.1 | 3.5.0 |
| | RP-10 | RP-000571 | 587 | 2 | Measurement procedures and messages | 3.4.1 | 3.5.0 |
| | RP-10 | RP-000571 | 590 | 1 | Inter-RAT UE radio access capability | 3.4.1 | 3.5.0 |
| | RP-10 | RP-000571 | 592 | 1 | Clarification on cell update/URA update procedures | 3.4.1 | 3.5.0 |
| | RP-10 | RP-000571 | 595 | 4 | Protocol States and Process | 3.4.1 | 3.5.0 |

| Change history | | | | | | | |
|----------------|-------|-----------|-----|-----|--|-------|-------|
| Date | TSG # | TSG Doc. | CR | Rev | Subject/Comment | Old | New |
| | RP-10 | RP-000571 | 596 | 1 | System Information | 3.4.1 | 3.5.0 |
| | RP-10 | RP-000715 | 597 | 5 | RRC Connection Management Procedures, Generic procedures and actions | 3.4.1 | 3.5.0 |
| | RP-10 | RP-000572 | 598 | 1 | Paging Procedures | 3.4.1 | 3.5.0 |
| | RP-10 | RP-000572 | 599 | | NAS signalling Procedures | 3.4.1 | 3.5.0 |
| | RP-10 | RP-000572 | 600 | 3 | Radio Bearer Control Procedures | 3.4.1 | 3.5.0 |
| | RP-10 | RP-000572 | 601 | 1 | Corrections to the Counter Check Procedure | 3.4.1 | 3.5.0 |
| | RP-10 | RP-000572 | 602 | | Tabular Information and ASN.1 | 3.4.1 | 3.5.0 |
| | RP-10 | RP-000572 | 604 | 2 | Corrections to Measurement Occasion concept | 3.4.1 | 3.5.0 |
| | RP-10 | RP-000572 | 606 | | Corrections concerning optimisation of RB information | 3.4.1 | 3.5.0 |
| | RP-10 | RP-000572 | 608 | 1 | Corrections to security | 3.4.1 | 3.5.0 |
| | RP-10 | RP-000572 | 609 | 1 | Ciphering activation time for DPCH | 3.4.1 | 3.5.0 |
| | RP-10 | RP-000572 | 610 | | Confirmation of signalling connection establishment | 3.4.1 | 3.5.0 |
| | RP-10 | RP-000572 | 611 | 2 | RACH Sub-channel signalling | 3.4.1 | 3.5.0 |
| | RP-10 | RP-000572 | 613 | 2 | Assistance data delivery for UP | 3.4.1 | 3.5.0 |
| | RP-10 | RP-000572 | 614 | 1 | Clarification of LCS measurements | 3.4.1 | 3.5.0 |
| | RP-10 | RP-000572 | 615 | 2 | Configuration of RLC PDU sizes for logical channels | 3.4.1 | 3.5.0 |
| | RP-10 | RP-000574 | 616 | | PICH power offset for TDD | 3.4.1 | 3.5.0 |
| | RP-10 | RP-000572 | 617 | | Correction for PDSCH power control for TDD | 3.4.1 | 3.5.0 |
| | RP-10 | RP-000574 | 618 | | Usage of dynamic spreading factor in uplink | 3.4.1 | 3.5.0 |
| | RP-10 | RP-000572 | 619 | | Correction of Midamble Shift for Burst Type 3 | 3.4.1 | 3.5.0 |
| | RP-10 | RP-000572 | 621 | | Correction of text concerning Scheduling of System Information | 3.4.1 | 3.5.0 |
| | RP-10 | RP-000572 | 622 | 1 | Alignment of GSM'99 BA Range concept and its inclusion in UTRA | 3.4.1 | 3.5.0 |
| | RP-10 | RP-000572 | 623 | 1 | Clarification of RB mapping info | 3.4.1 | 3.5.0 |
| | RP-10 | RP-000572 | 624 | 1 | Correction to UE multi-RAT capability | 3.4.1 | 3.5.0 |
| | RP-10 | RP-000573 | 625 | | Correction to PDCP sequence number exchange during hard handover | 3.4.1 | 3.5.0 |
| | RP-10 | RP-000573 | 628 | 2 | DCH Quality Target | 3.4.1 | 3.5.0 |
| | RP-10 | RP-000573 | 629 | 1 | Simultaneous release of RBs and signalling connection | 3.4.1 | 3.5.0 |
| | RP-10 | RP-000573 | 630 | | Correction on Transport Channel Reconfiguration | 3.4.1 | 3.5.0 |
| | RP-10 | RP-000573 | 631 | | Limitation of DRX cycle length | 3.4.1 | 3.5.0 |
| | RP-10 | RP-000574 | 632 | | Signalling of the alpha value in TDD for open loop power control | 3.4.1 | 3.5.0 |
| | RP-10 | RP-000573 | 633 | | Support for improved compressed mode handling for TDD measurements | 3.4.1 | 3.5.0 |
| | RP-10 | RP-000573 | 636 | | Usage of secondary CPICH and secondary scrambling code | 3.4.1 | 3.5.0 |
| | RP-10 | RP-000573 | 639 | | Expiration time of SIB type 7, 14 | 3.4.1 | 3.5.0 |
| | RP-10 | RP-000573 | 640 | | Correction to integrity protection | 3.4.1 | 3.5.0 |
| | RP-10 | RP-000684 | 641 | | Downlink Outer Loop Control | 3.4.1 | 3.5.0 |
| 03/2001 | RP-11 | RP-010029 | 642 | 2 | RL Failure in cell update procedure | 3.5.0 | 3.6.0 |
| | RP-11 | RP-010029 | 645 | 1 | Clarification on COUNTER CHECK | 3.5.0 | 3.6.0 |
| | RP-11 | RP-010029 | 646 | 2 | Traffic Volume Measurement corrections | 3.5.0 | 3.6.0 |
| | RP-11 | RP-010029 | 650 | 2 | Reserved TFCI for the TDD Special Burst | 3.5.0 | 3.6.0 |
| | RP-11 | RP-010029 | 653 | | Correction to description of RRC state transitions | 3.5.0 | 3.6.0 |
| | RP-11 | RP-010029 | 657 | | RLC re-establish correction | 3.5.0 | 3.6.0 |
| | RP-11 | RP-010029 | 658 | 1 | Removal of RLC logical channel mapping indicator | 3.5.0 | 3.6.0 |
| | RP-11 | RP-010029 | 659 | | New paging and establishment cause "Unknown" | 3.5.0 | 3.6.0 |
| | RP-11 | RP-010029 | 660 | 1 | Miscellaneous procedure corrections | 3.5.0 | 3.6.0 |
| | RP-11 | RP-010029 | 661 | | Corrections to compressed mode pattern sequence handling | 3.5.0 | 3.6.0 |
| | RP-11 | RP-010029 | 662 | | Inter-system change clarifications | 3.5.0 | 3.6.0 |
| | RP-11 | RP-010029 | 663 | 1 | RLC status transmission in CELL_PCH and URA_PCH | 3.5.0 | 3.6.0 |
| | RP-11 | RP-010029 | 665 | 1 | Clarification of RB information parameter values for SRB0 | 3.5.0 | 3.6.0 |
| | RP-11 | RP-010029 | 666 | | Encoding for RRC- container | 3.5.0 | 3.6.0 |
| | RP-11 | RP-010029 | 667 | 2 | Update of message extension and encoding descriptions | 3.5.0 | 3.6.0 |
| | RP-11 | RP-010032 | 668 | 4 | Introduction of default pre-defined configurations | 3.5.0 | 3.6.0 |
| | RP-11 | RP-010029 | 669 | 2 | Security corrections | 3.5.0 | 3.6.0 |
| | RP-11 | RP-010029 | 670 | | Clarifications on Blind Handover Support | 3.5.0 | 3.6.0 |
| | RP-11 | RP-010029 | 671 | 1 | Missing descriptions of UE actions | 3.5.0 | 3.6.0 |
| | RP-11 | RP-010029 | 672 | 2 | Corrections on UE Positioning information | 3.5.0 | 3.6.0 |

| Change history | | | | | | | |
|----------------|-------|-----------|-----|-----|--|-------|-------|
| Date | TSG # | TSG Doc. | CR | Rev | Subject/Comment | Old | New |
| | RP-11 | RP-010029 | 674 | 1 | Security related corrections to SRNS | 3.5.0 | 3.6.0 |
| | RP-11 | RP-010032 | 675 | 2 | Downlink power offsets | 3.5.0 | 3.6.0 |
| | RP-11 | RP-010274 | 676 | 2 | Checking the integrity of UE security capabilities | 3.5.0 | 3.6.0 |
| | RP-11 | RP-010030 | 678 | 1 | Clarification to Secondary CCPCH info | 3.5.0 | 3.6.0 |
| | RP-11 | RP-010030 | 679 | 1 | Miscellaneous corrections | 3.5.0 | 3.6.0 |
| | RP-11 | RP-010030 | 680 | | Removal of Layer 3 filtering for RACH | 3.5.0 | 3.6.0 |
| | RP-11 | RP-010030 | 681 | 2 | Correction of compressed mode parameters | 3.5.0 | 3.6.0 |
| | RP-11 | RP-010030 | 682 | | Removal of immediate cell evaluation | 3.5.0 | 3.6.0 |
| | RP-11 | RP-010030 | 684 | 2 | Scheduling of SIB 15.2 and SIB 15.3 | 3.5.0 | 3.6.0 |
| | RP-11 | RP-010030 | 685 | 1 | Correction to ECN modules | 3.5.0 | 3.6.0 |
| | RP-11 | RP-010030 | 686 | 1 | Improvement of the description of timing advance for TDD | 3.5.0 | 3.6.0 |
| | RP-11 | RP-010030 | 687 | | Correction on timing advance and allocation for shared channels | 3.5.0 | 3.6.0 |
| | RP-11 | RP-010030 | 688 | 1 | Clarification on SF 1 signalling | 3.5.0 | 3.6.0 |
| | RP-11 | RP-010030 | 689 | 1 | Correction to power control in TDD | 3.5.0 | 3.6.0 |
| | RP-11 | RP-010030 | 690 | | Midamble - Channelisation code association for TDD | 3.5.0 | 3.6.0 |
| | RP-11 | RP-010030 | 691 | | Network requested reporting for physical shared channel allocation | 3.5.0 | 3.6.0 |
| | RP-11 | RP-010030 | 693 | | System Information | 3.5.0 | 3.6.0 |
| | RP-11 | RP-010030 | 694 | 1 | Clarification on Transport Channel Identity | 3.5.0 | 3.6.0 |
| | RP-11 | RP-010030 | 696 | 1 | Editorial Correction | 3.5.0 | 3.6.0 |
| | RP-11 | RP-010030 | 698 | 2 | Correction to add coding of intra domain NAS node selector | 3.5.0 | 3.6.0 |
| | RP-11 | RP-010030 | 700 | 1 | Corrections to system information block characteristics in TDD | 3.5.0 | 3.6.0 |
| | RP-11 | RP-010030 | 701 | 2 | ASN.1 corrections | 3.5.0 | 3.6.0 |
| | RP-11 | RP-010030 | 702 | 2 | Measurement related corrections | 3.5.0 | 3.6.0 |
| | RP-11 | RP-010031 | 703 | 1 | Clarifications on TFC Control procedure | 3.5.0 | 3.6.0 |
| | RP-11 | RP-010031 | 704 | 2 | Association of PLMN ID to neighbour cells | 3.5.0 | 3.6.0 |
| | RP-11 | RP-010031 | 705 | 1 | TFCS Selection Guidelines | 3.5.0 | 3.6.0 |
| | RP-11 | RP-010031 | 710 | | Special Burst Scheduling During DTX in TDD | 3.5.0 | 3.6.0 |
| | RP-11 | RP-010031 | 711 | 1 | Radio Link Failure Criteria in TDD | 3.5.0 | 3.6.0 |
| | RP-11 | RP-010031 | 712 | 1 | Correction & Clarification to TDD RACH Subchannels | 3.5.0 | 3.6.0 |
| | RP-11 | RP-010031 | 713 | 1 | Number of retransmission of RRC CONNECTION REQUEST | 3.5.0 | 3.6.0 |
| | RP-11 | RP-010031 | 714 | | Uplink Frequency Notification | 3.5.0 | 3.6.0 |
| | RP-11 | RP-010031 | 715 | | Clarification of Radio Bearer Mapping for DCH/DSCH Transport Channels | 3.5.0 | 3.6.0 |
| | RP-11 | RP-010031 | 716 | | Correction of mismatches between tabular and ASN.1 | 3.5.0 | 3.6.0 |
| | RP-11 | RP-010031 | 717 | | Correction to discontinuous reception in TDD | 3.5.0 | 3.6.0 |
| | RP-11 | RP-010031 | 718 | | Power control preamble | 3.5.0 | 3.6.0 |
| | RP-11 | RP-010031 | 719 | | Maximum number of AM entity | 3.5.0 | 3.6.0 |
| | RP-11 | RP-010031 | 720 | 1 | Real-time Integrity Broadcast | 3.5.0 | 3.6.0 |
| | RP-11 | RP-010031 | 721 | 3 | Moving Real-time Integrity description to different chapter | 3.5.0 | 3.6.0 |
| | RP-11 | RP-010031 | 723 | 1 | Removal of the payload unit concept | 3.5.0 | 3.6.0 |
| | RP-11 | RP-010031 | 724 | | Security related corrections to SRNS | 3.5.0 | 3.6.0 |
| | RP-11 | RP-010031 | 725 | | Periodic PLMN selection correction | 3.5.0 | 3.6.0 |
| | RP-11 | RP-010042 | 683 | 1 | Modification of "SSDT Information" IE parameters to indicate if SSDT is used in the UL only | 3.6.0 | 4.0.0 |
| | RP-11 | RP-010041 | 692 | 1 | Idle allocation for Node B synchronisation | 3.6.0 | 4.0.0 |
| | RP-11 | RP-010037 | 706 | 1 | Physical channel configuration information elements for 1.28 Mcps TDD | 3.6.0 | 4.0.0 |
| | RP-11 | RP-010037 | 707 | 2 | Changes to Measurement Related Signalling and Introduction of Cell (Re)selection Parameters for 1.28Mcps TDD | 3.6.0 | 4.0.0 |
| | RP-11 | RP-010037 | 708 | 1 | Introduction of RACH Parameters for 1.28 Mcps TDD | 3.6.0 | 4.0.0 |
| | RP-11 | RP-010037 | 709 | | Introduction of UE radio access capability Parameters for 1.28 Mcps TDD | 3.6.0 | 4.0.0 |
| | RP-11 | RP-010040 | 722 | 1 | Introduction of IPDLs for TDD | 3.6.0 | 4.0.0 |
| | RP-11 | RP-010039 | 726 | 1 | ROHC updates to RRC | 3.6.0 | 4.0.0 |
| 06/2001 | RP-12 | RP-010311 | 731 | | Clarification of the IE 'spreading factor' in Uplink DPCH info for FDD mode | 4.0.0 | 4.1.0 |
| | RP-12 | RP-010311 | 733 | | Correction of UE Radio Access Capability depending on UTRAN FDD bands | 4.0.0 | 4.1.0 |
| | RP-12 | RP-010311 | 735 | | Clarification on Security mode control | 4.0.0 | 4.1.0 |

| Change history | | | | | | | |
|----------------|-------|-----------|-----|-----|---|-------|-------|
| Date | TSG # | TSG Doc. | CR | Rev | Subject/Comment | Old | New |
| | RP-12 | RP-010311 | 738 | | Correction of TrCH parameter handling | 4.0.0 | 4.1.0 |
| | RP-12 | RP-010311 | 740 | | TFC Subsets in TDD | 4.0.0 | 4.1.0 |
| | RP-12 | RP-010311 | 746 | | RRC containers | 4.0.0 | 4.1.0 |
| | RP-12 | RP-010311 | 748 | | Various corrections | 4.0.0 | 4.1.0 |
| | RP-12 | RP-010311 | 750 | | General error handling for system information | 4.0.0 | 4.1.0 |
| | RP-12 | RP-010311 | 752 | | Order of elements in strings | 4.0.0 | 4.1.0 |
| | RP-12 | RP-010311 | 754 | | Configuration consistency checks | 4.0.0 | 4.1.0 |
| | RP-12 | RP-010312 | 756 | | Compressed mode corrections | 4.0.0 | 4.1.0 |
| | RP-12 | RP-010312 | 758 | | Correction concerning inter-RAT procedures | 4.0.0 | 4.1.0 |
| | RP-12 | RP-010312 | 762 | | Measurement corrections | 4.0.0 | 4.1.0 |
| | RP-12 | RP-010312 | 764 | | RLC Tr Discard | 4.0.0 | 4.1.0 |
| | RP-12 | RP-010312 | 766 | | Annex B CPCH Correction | 4.0.0 | 4.1.0 |
| | RP-12 | RP-010312 | 768 | | SIB Correction for CSICH Power Offset | 4.0.0 | 4.1.0 |
| | RP-12 | RP-010312 | 770 | | Transfer of Last known position in case of SRNS relocation | 4.0.0 | 4.1.0 |
| | RP-12 | RP-010312 | 772 | | Corrections to UE Positioning measurements | 4.0.0 | 4.1.0 |
| | RP-12 | RP-010312 | 779 | | GSM measurements in compressed mode | 4.0.0 | 4.1.0 |
| | RP-12 | RP-010312 | 781 | | Correction of Activation Time in Inter-Rat HO Commands | 4.0.0 | 4.1.0 |
| | RP-12 | RP-010313 | 785 | | Clarification of FRESH in SRNS relocation | 4.0.0 | 4.1.0 |
| | RP-12 | RP-010313 | 789 | | Correction to UE timers and constants in idle mode | 4.0.0 | 4.1.0 |
| | RP-12 | RP-010313 | 793 | | Clarification on multiframe allocation in TDD | 4.0.0 | 4.1.0 |
| | RP-12 | RP-010313 | 795 | | Predefined parameters for logical channels | 4.0.0 | 4.1.0 |
| | RP-12 | RP-010313 | 797 | | Pathloss calculation | 4.0.0 | 4.1.0 |
| | RP-12 | RP-010313 | 799 | | Clarification on periodic measurement reporting | 4.0.0 | 4.1.0 |
| | RP-12 | RP-010313 | 803 | 1 | Handling of IE PRACH TFCS and Primary CPICH/Primary CCPCH info | 4.0.0 | 4.1.0 |
| | RP-12 | RP-010313 | 805 | | Correction to FACH measurement occasion in TDD | 4.0.0 | 4.1.0 |
| | RP-12 | RP-010313 | 807 | | Clarification of L1 synchronization procedures | 4.0.0 | 4.1.0 |
| | RP-12 | RP-010313 | 809 | | Correction of Activation Time definition | 4.0.0 | 4.1.0 |
| | RP-12 | RP-010314 | 813 | | Corrections to RRC procedure performance | 4.0.0 | 4.1.0 |
| | RP-12 | RP-010314 | 815 | | Removal of mapping function | 4.0.0 | 4.1.0 |
| | RP-12 | RP-010314 | 817 | | Security clarifications | 4.0.0 | 4.1.0 |
| | RP-12 | RP-010314 | 819 | | Corrections to UE Positioning | 4.0.0 | 4.1.0 |
| | RP-12 | RP-010314 | 825 | | Definition of DPCH numbering | 4.0.0 | 4.1.0 |
| | RP-12 | RP-010314 | 827 | | Corrections to System Information Procedure | 4.0.0 | 4.1.0 |
| | RP-12 | RP-010314 | 829 | | Relation between DOFF and DPCH Frame Offset | 4.0.0 | 4.1.0 |
| | RP-12 | RP-010314 | 831 | | Procedures for "same as UL" | 4.0.0 | 4.1.0 |
| | RP-12 | RP-010314 | 837 | | Editorial and minor corrections | 4.0.0 | 4.1.0 |
| | RP-12 | RP-010314 | 839 | | Editorial Correction | 4.0.0 | 4.1.0 |
| | RP-12 | RP-010315 | 841 | | UE Positioning Measurement Accuracy Indication | 4.0.0 | 4.1.0 |
| | RP-12 | RP-010315 | 843 | | Corrections on OTDOA-IPDL specific burst parameter semantic description | 4.0.0 | 4.1.0 |
| | RP-12 | RP-010315 | 845 | | Error handling for messages sent from another RAT | 4.0.0 | 4.1.0 |
| | RP-12 | RP-010315 | 849 | | Needed TFC in the TFCS for TDD | 4.0.0 | 4.1.0 |
| | RP-12 | RP-010315 | 855 | | Clarification of TFCS selection guidelines | 4.0.0 | 4.1.0 |
| | RP-12 | RP-010315 | 861 | | Clarification of Traffic Volume measurements | 4.0.0 | 4.1.0 |
| | RP-12 | RP-010315 | 863 | | CFN synchronisation problems at timing re-initialised hard handover | 4.0.0 | 4.1.0 |
| | RP-12 | RP-010315 | 866 | | Corrections on UP Assistance Message Descriptions | 4.0.0 | 4.1.0 |
| | RP-12 | RP-010315 | 868 | | Correction on Area Scope of SIB 15.3 | 4.0.0 | 4.1.0 |
| | RP-12 | RP-010315 | 872 | | Correction to AICH power offset | 4.0.0 | 4.1.0 |
| | RP-12 | RP-010316 | 875 | | Clarification on IE 'Downlink rate matching restriction information' | 4.0.0 | 4.1.0 |
| | RP-12 | RP-010316 | 877 | | Corrections on Tabular/ASN.1 | 4.0.0 | 4.1.0 |
| | RP-12 | RP-010316 | 879 | | Corrections on Tabular and ASN.1 inconsistencies | 4.0.0 | 4.1.0 |
| | RP-12 | RP-010316 | 881 | | Editorial corrections on Tabular and ASN.1 inconsistencies | 4.0.0 | 4.1.0 |
| | RP-12 | RP-010316 | 883 | | UE Positioning corrections to ASN.1 and tabular | 4.0.0 | 4.1.0 |
| | RP-12 | RP-010316 | 885 | | Corrections to resolve inconsistencies between Tabular and ASN.1 | 4.0.0 | 4.1.0 |
| | RP-12 | RP-010316 | 887 | | UE positioning OTDOA Neighbour Cell Info | 4.0.0 | 4.1.0 |
| | RP-12 | RP-010316 | 889 | | DRAC corrections | 4.0.0 | 4.1.0 |

| Change history | | | | | | | |
|----------------|-------|-----------|-----|-----|---|-------|-------|
| Date | TSG # | TSG Doc. | CR | Rev | Subject/Comment | Old | New |
| | RP-12 | RP-010316 | 893 | | ASN.1 Correction of IE TFCS ID | 4.0.0 | 4.1.0 |
| | RP-12 | RP-010316 | 895 | | Correction of IE IODE range in AGPS Positioning | 4.0.0 | 4.1.0 |
| | RP-12 | RP-010317 | 897 | | Correction to BurstModeParameters in IPDL | 4.0.0 | 4.1.0 |
| | RP-12 | RP-010317 | 899 | | Corrections on inconsistencies between Tabular and ASN.1 | 4.0.0 | 4.1.0 |
| | RP-12 | RP-010317 | 901 | | Naming of message abstract types in ASN.1 | 4.0.0 | 4.1.0 |
| | RP-12 | RP-010317 | 904 | | Information elements outside the extension container | 4.0.0 | 4.1.0 |
| | RP-12 | RP-010317 | 906 | | Correction concerning DRX cycle upon inter-RAT change towards UTRAN | 4.0.0 | 4.1.0 |
| | RP-12 | RP-010323 | 773 | | Corrections to IPDLs for TDD | 4.0.0 | 4.1.0 |
| | RP-12 | RP-010323 | 850 | 2 | Correction to 1.28Mcps TDD RACH parameters and operation | 4.0.0 | 4.1.0 |
| | RP-12 | RP-010323 | 851 | | TFCI coding in case of 8PSK | 4.0.0 | 4.1.0 |
| | RP-12 | RP-010323 | 902 | 1 | Structure and naming of information elements | 4.0.0 | 4.1.0 |

History

| Document history | | |
|-------------------------|------------|-------------|
| V4.0.0 | April 2001 | Publication |
| V4.1.0 | July 2001 | Publication |
| | | |
| | | |
| | | |